



GAS COMPONENTS



ELECTRIC COMPONENTS



WATER TECHNOLOGY



MECHANICAL COMPONENTS



TOOLS

Spare parts suitable for

ZANOLLI

Find the complete and up-to-date range of products in our GEV Webshop



Manufacturer catalogue

The most important spare parts and accessories arranged clearly for every manufacturer

- ✓ Complete product range and all appliance data always up to date in the GEV Webshop
- ✓ Alphabetical Index at the end of the catalogue

GEV Webshop

www.gev-online.co.uk

www.gev-online.com



- 🔍 Add to Favourites
- 🔍 Sign In with email address and usual password
- 🔍 Easy-order – place several items in your basket at the same time
- 🔍 Quick Item search – no login needed





heating elements

heating elements for pizza ovens





GEV No.	420176	Ref. No.	RESI0078
description	heating element 800W 230V L 1040mm W 98mm flange length 140mm flange width 25mm hole distance 120mm connection length 120mm connection male faston 6.3mm tube ø 8.5mm heating circuits 1 2 hole fixing mounting pos. rear hole ø 6mm		







GEV No.	418116	Ref. No.	RESI0051
description	heating element 1000W 220V L 810mm W 214mm thread M14x1.5 mounting distance 205mm connection length 50mm tube ø 8.6mm cable length 520mm heating circuits 1 dry heating element mounting pos. rear 2 hole fixing		
For models:	T2 POLIS MC16, T2 POLIS MC26, T4 POLIS MC16, T4 POLIS MC26		
accessories for	418116		
	GEV No.	510417	Ref. No. —
	flat gasket fibre ED ø 20mm ID ø 14mm thickness 2mm Qty 1 pcs		
	GEV No.	520228	Ref. No. —
	tooth lock washer ID ø 15.3mm ED ø 24mm steel Qty 1 pcs for thread M14		
	GEV No.	520230	Ref. No. —
	nut thread M14x1.5 H 5mm WS 19 zinc-coated steel Qty 1 pcs		
	GEV No.	521101	Ref. No. —
	nut thread M14x1.5 H 5mm WS 19 SS Qty 1 pcs		
	GEV No.	550262	Ref. No. —
	flat gasket copper ED ø 20mm ID ø 14mm thickness 2mm		



GEV No.	418113	Ref. No.	RESI0068
description	heating element 1000W 230V L 810mm W 100mm thread M14x1.5 mounting distance 86mm connection length 36mm tube ø 8.5mm cable length 1200mm heating circuits 1 dry heating element mounting pos. front 2 hole fixing		
For models:	T2 POLIS MC16, T2 POLIS MC26, T4 POLIS MC16, T4 POLIS MC26		
spare parts for	418113		
	GEV No.	510417	Ref. No. —
	flat gasket fibre ED ø 20mm ID ø 14mm thickness 2mm Qty 1 pcs		
accessories for	418113		
	GEV No.	520228	Ref. No. —
	tooth lock washer ID ø 15.3mm ED ø 24mm steel Qty 1 pcs for thread M14		
	GEV No.	520230	Ref. No. —
	nut thread M14x1.5 H 5mm WS 19 zinc-coated steel Qty 1 pcs		
	GEV No.	521101	Ref. No. —
	nut thread M14x1.5 H 5mm WS 19 SS Qty 1 pcs		
	GEV No.	550262	Ref. No. —
	flat gasket copper ED ø 20mm ID ø 14mm thickness 2mm		



GEV No.	415524	Ref. No.	RESI00211
description	heating element 1100W 230V L 720mm W 200mm thread M14x1.5 mounting distance 210mm connection length 40mm tube ø 8.5mm cable length 1000mm heating circuits 1 dry heating element 2 hole fixing		
accessories for	415524		
	GEV No.	361182	Ref. No. —
	nut thread 1/4" H 5mm nickel-plated brass WS 17 Qty 1 pcs		
	GEV No.	510417	Ref. No. —
	flat gasket fibre ED ø 20mm ID ø 14mm thickness 2mm Qty 1 pcs		
	GEV No.	520228	Ref. No. —
	tooth lock washer ID ø 15.3mm ED ø 24mm steel Qty 1 pcs for thread M14		
	GEV No.	550262	Ref. No. —
	flat gasket copper ED ø 20mm ID ø 14mm thickness 2mm		



GEV No.	415525	Ref. No.	RESI0065
description	heating element 1100W 380V L 716mm W 205mm thread M15x1 mounting distance 197mm connection length 40mm tube ø 8mm cable length 980mm heating circuits 1 dry heating element 2 hole fixing		



GEV No.	418117	Ref. No.	RESI0057
description	heating element 1200W 230V heating circuits 1 mounting pos. upper L 147mm W 157mm L1 100mm ø 47mm thread M14x1.5 mounting distance 148mm cable length 970mm tube ø 8.5mm connection cable dry heating element 2 hole fixing		









GEV No.	418115	Ref. No.	RESI0052
description	heating element 1300W 220V L 1220mm W 250mm thread M14x1.5 mounting distance 252mm connection length 47mm tube ø 8.5mm cable length 1550mm dry heating element mounting pos. rear 2 hole fixing		
For models:	T3 POLIS MC16, T3 POLIS MC26, T6 POLIS MC16, T6 POLIS MC26		
accessories for	418115		
	GEV No.	510417	Ref. No. —
	flat gasket fibre ED ø 20mm ID ø 14mm thickness 2mm Qty 1 pcs		
	GEV No.	520228	Ref. No. —
	tooth lock washer ID ø 15.3mm ED ø 24mm steel Qty 1 pcs for thread M14		
	GEV No.	520230	Ref. No. —
	nut thread M14x1.5 H 5mm WS 19 zinc-coated steel Qty 1 pcs		

Table continues overleaf

electric components

accessories for	418115		
	GEV No.	521101	Ref. No. —
	nut thread M14x1.5 H 5mm WS 19 SS Qty 1 pcs		
	GEV No.	550262	Ref. No. —
	flat gasket copper ED ø 20mm ID ø 14mm thickness 2mm		





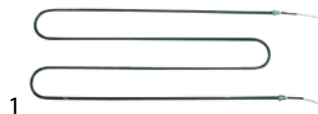

	1		
GEV No.	418114	Ref. No.	RESI0069
description	heating element 1300W 230V L 1220mm W 100mm thread M14x1.5 mounting distance 92mm connection length 34mm tube ø 8.5mm cable length 1200mm heating circuits 1 dry heating element mounting pos. front 2 hole fixing		
For models:	T3 POLIS MC16, T3 POLIS MC26, T6 POLIS MC16, T6 POLIS MC26		

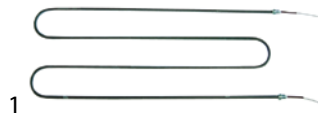



accessories for	418114		
	GEV No.	510417	Ref. No. —
	flat gasket fibre ED ø 20mm ID ø 14mm thickness 2mm Qty 1 pcs		
	GEV No.	520228	Ref. No. —
	tooth lock washer ID ø 15.3mm ED ø 24mm steel Qty 1 pcs for thread M14		
	GEV No.	520230	Ref. No. —
	nut thread M14x1.5 H 5mm WS 19 zinc-coated steel Qty 1 pcs		
	GEV No.	521101	Ref. No. —
	nut thread M14x1.5 H 5mm WS 19 SS Qty 1 pcs		
	GEV No.	550262	Ref. No. —
	flat gasket copper ED ø 20mm ID ø 14mm thickness 2mm		

	1		
GEV No.	415527	Ref. No.	RESI0022
description	heating element 1500W 220V L 720mm W 260mm thread M14x1.5 mounting distance 252mm tube ø 8.5mm cable length 1000mm heating circuits 1 dry heating element 2 hole fixing		

	1		
GEV No.	418119	Ref. No.	RESI0079
description	heating element 1500W 230V heating circuits 1 mounting pos. upper L 142mm W 158mm L1 95mm ø 49mm thread M14x1.5 mounting distance 150mm cable length 970mm tube ø 8.5mm dry heating element 2 hole fixing		

	1		
GEV No.	415526	Ref. No.	RESI0066
description	heating element 1500W 380V L 720mm W 260mm thread M14x1.5 mounting distance 290mm connection cable tube ø 8.5mm cable length 1000mm heating circuits 1 dry heating element 2 hole fixing		

	1		
GEV No.	418118	Ref. No.	RESI0058
description	heating element 1800W 230V heating circuits 1 mounting pos. lower L 150mm W 155mm ø 55mm thread M14x1.5 mounting distance 150mm cable length 945mm tube ø 8.5mm connection cable dry heating element 2 hole fixing pizza oven		
accessories for	418118		
	GEV No.	510417	Ref. No. —
	flat gasket fibre ED ø 20mm ID ø 14mm thickness 2mm Qty 1 pcs		
	GEV No.	520228	Ref. No. —
	tooth lock washer ID ø 15.3mm ED ø 24mm steel Qty 1 pcs for thread M14		
	GEV No.	520230	Ref. No. —
	nut thread M14x1.5 H 5mm WS 19 zinc-coated steel Qty 1 pcs		
	GEV No.	521101	Ref. No. —
	nut thread M14x1.5 H 5mm WS 19 SS Qty 1 pcs		
	GEV No.	550262	Ref. No. —
	flat gasket copper ED ø 20mm ID ø 14mm thickness 2mm		

	1		
GEV No.	415528	Ref. No.	N/A
description	heating element 2000W 230V L 465mm W 450mm thread M14x1.5 mounting distance 441mm connection length 36mm tube ø 8.5mm cable length 430mm heating circuits 1 dry heating element 2 hole fixing		
spare parts for	415528		
	GEV No.	510417	Ref. No. —
	flat gasket fibre ED ø 20mm ID ø 14mm thickness 2mm Qty 1 pcs		
accessories for	415528		
	GEV No.	361182	Ref. No. —
	nut thread 1/4" H 5mm nickel-plated brass WS 17 Qty 1 pcs		
	GEV No.	520228	Ref. No. —
	tooth lock washer ID ø 15.3mm ED ø 24mm steel Qty 1 pcs for thread M14		
	GEV No.	550262	Ref. No. —
	flat gasket copper ED ø 20mm ID ø 14mm thickness 2mm		





 <p>1</p>			
GEV No.	418120	Ref. No.	RESI0080
description	heating element 2200W 230V heating circuits 1 mounting pos. lower L 150mm W 155mm L1 95mm ø 49mm thread M14x1.5 mounting distance 146mm cable length 950mm tube ø 8.5mm connection cable dry heating element 2 hole fixing		

 <p>1</p>			
GEV No.	418121	Ref. No.	RESI0060
description	heating element 2200W 230V heating circuits 1 mounting pos. upper L 230mm W 262mm L1 170mm ø 60mm thread M14x1.5 mounting distance 254mm cable length 1120mm tube ø 8.5mm connection cable dry heating element 2 hole fixing		
For models:	SYNTHESIS 08/50		







accessories for	418121		
	GEV No.	510417	Ref. No. —
	flat gasket fibre ED ø 20mm ID ø 14mm thickness 2mm Qty 1 pcs		
	GEV No.	520228	Ref. No. —
	tooth lock washer ID ø 15.3mm ED ø 24mm steel Qty 1 pcs for thread M14		
	GEV No.	520230	Ref. No. —
	nut thread M14x1.5 H 5mm WS 19 zinc-coated steel Qty 1 pcs		
	GEV No.	521101	Ref. No. —
	nut thread M14x1.5 H 5mm WS 19 SS Qty 1 pcs		
	GEV No.	550262	Ref. No. —
	flat gasket copper ED ø 20mm ID ø 14mm thickness 2mm		

 <p>1</p>			
GEV No.	416432	Ref. No.	N/A
description	heating element 2500W 230V L 575mm W 570mm thread M14x1.5 mounting distance 561mm connection length 37mm tube ø 8.7mm cable length 570mm heating circuits 1 dry heating element 2 hole fixing		
accessories for	416432		
	GEV No.	510417	Ref. No. —
	flat gasket fibre ED ø 20mm ID ø 14mm thickness 2mm Qty 1 pcs		
	GEV No.	520228	Ref. No. —
	tooth lock washer ID ø 15.3mm ED ø 24mm steel Qty 1 pcs for thread M14		
	GEV No.	520230	Ref. No. —
	nut thread M14x1.5 H 5mm WS 19 zinc-coated steel Qty 1 pcs		

accessories for	416432		
	GEV No.	521101	Ref. No. —
	nut thread M14x1.5 H 5mm WS 19 SS Qty 1 pcs		
	GEV No.	550262	Ref. No. —
	flat gasket copper ED ø 20mm ID ø 14mm thickness 2mm		

 <p>1</p>			
GEV No.	418123	Ref. No.	RESI0081
description	heating element 2800W 230V heating circuits 1 mounting pos. upper L 228mm W 260mm L1 168mm ø 60mm thread M14x1.5 mounting distance 251.5mm cable length 1170mm tube ø 8.5mm connection cable dry heating element 2 hole fixing		
For models:	SYNTHESIS08-50V		

 <p>1</p>			
GEV No.	418125	Ref. No.	RESI0041 RESI0125
description	heating element 3000W 220V L 925mm W 70mm thread M15x1 mounting distance 61mm connection length 10mm tube ø 10mm cable length 480mm heating circuits 1 dry heating element 2 hole fixing		
For models:	SYNTHESIS 10/75		

 <p>1</p>			
GEV No.	418122	Ref. No.	RESI0061
description	heating element 3300W 230V heating circuits 1 mounting pos. lower L 230mm W 263mm L1 168mm ø 60mm thread M14x1.5 mounting distance 254.5mm cable length 1140mm tube ø 8.5mm connection cable dry heating element 2 hole fixing		
For models:	SYNTHESIS 08/50		
spare parts for	418122		
	GEV No.	510417	Ref. No. —
	flat gasket fibre ED ø 20mm ID ø 14mm thickness 2mm Qty 1 pcs		
accessories for	418122		
	GEV No.	520228	Ref. No. —
	tooth lock washer ID ø 15.3mm ED ø 24mm steel Qty 1 pcs for thread M14		
	GEV No.	520230	Ref. No. —
	nut thread M14x1.5 H 5mm WS 19 zinc-coated steel Qty 1 pcs		
	GEV No.	521101	Ref. No. —
	nut thread M14x1.5 H 5mm WS 19 SS Qty 1 pcs		
	GEV No.	550262	Ref. No. —
	flat gasket copper ED ø 20mm ID ø 14mm thickness 2mm		



1

GEV No.	418124	Ref. No.	RESI0082
description	heating element 4100W 230V heating circuits 1 mounting pos. lower L 230mm W 248.5mm L1 175mm ϕ 65mm thread M14x1.5 mounting distance 240mm cable length 1200mm tube ϕ 8.5mm connection cable dry heating element 2 hole fixing		
For models:	SYNTHESIS08-50V		

energy regulators

EGO

1-circuit



1

GEV No.	380015	Ref. No.	TERM0014 TERM0050
description	energy regulator 230V 13A single-circuit turn direction right shaft ϕ 6x4.6mm shaft L 23mm mounting thread M4 power release 6-100% no. 50.57021.010		
For models:	SYNTHESIS 08/50, SYNTHESIS 10/75, SYNTHESIS08-50V		

thermostats

control and safety thermostats

EGO

control thermostats

55.10/19_ series



1

GEV No.	375002	Ref. No.	ELET0013
description	thermostat t.max. 320°C temperature range 55-320°C 1-pole 1NO 16A probe ϕ 3.1mm probe L 226mm capillary pipe 870mm capillary pipe isolated 850mm gland nut shaft L 23mm shaft position upper rotation 270°		
For models:	SYNTHESIS 05/40 A		



1

GEV No.	375499	Ref. No.	TERM0013 TERM0059
description	thermostat t.max. 320°C temperature range 60-320°C 1-pole 1NO 16A probe ϕ 3.1mm probe L 226mm capillary pipe 870mm capillary pipe isolated 600mm gland nut shaft ϕ 6x4.6mm shaft L 23mm shaft position upper rotation 270°		



1

GEV No.	375884	Ref. No.	TERMO0072
description	thermostat t.max. 400°C temperature range 65-400°C 1-pole 1NO probe ϕ 3.9mm probe L 163mm capillary pipe 870mm capillary pipe isolated 600mm gland nut shaft ϕ 6x4.6mm shaft L 23mm shaft position upper rotation 270°		

accessories for 375884



GEV No.	112172	Ref. No.	—
description	knob universal ϕ 70mm black without adaptor/dial plate		



GEV No.	112311	Ref. No.	—
description	knob adapter shaft ϕ 6x4.6mm L 0mm with spring		



GEV No.	112405	Ref. No.	—
description	knob dial plate silver thermostat t.max. 350°C 100-350°C rotation 270° ED ϕ 63mm ID ϕ 45.5mm		





safety thermostats			
55.32_ series			
			
GEV No.	375065	Ref. No.	TERM0005
description	safety thermostat switch-off temp. 500°C 3-pole 3NC 20A probe ø 4mm probe L 308mm capillary pipe 890mm capillary pipe isolated-mm gland nut probe SS		
For models:	CITIZEN 6, CITIZEN 9, SYNTHESIS 05/40 A, SYNTHESIS 08/50, SYNTHESIS 08/50 A, SYNTHESIS 10/75, SYNTHESIS 10/75 A, SYNTHESIS 10/75 B22, SYNTHESIS08-50V, T2 POLIS MC16, T2 POLIS MC26, T3 POLIS MC16, T3 POLIS MC26, T4 POLIS MC16, T4 POLIS MC26, T6 POLIS MC16, T6 POLIS MC26		

switches and momentary switches

rocker/momentary rocker switches

30x22mm			
			
GEV No.	301020	Ref. No.	INTE0012
description	momentary rocker switch mounting measurements 30x22mm red 2NO 250V 16A illuminated 0-I connection male faston 6.3mm ambient temperature max. 100/55°C protection IP65		
For models:	CITIZEN 6, CITIZEN 9, SYNTHESIS 05/40 A		

				
GEV No.	301003	Ref. No.	INTE0010	
description	rocker switch mounting measurements 30x22mm green 2NO 250V 16A illuminated 0-I connection male faston 6.3mm ambient temperature max. 125/55°C protection IP65			
For models:	CITIZEN 6, CITIZEN 9, SYNTHESIS 05/40 A, SYNTHESIS 10/75, SYNTHESIS08-50V			
accessories for	301003			
	GEV No.	301036	Ref. No.	—
	protective cover internal size 30x22mm for rocker switch mounting measurementsmm			

				
GEV No.	301002	Ref. No.	INTE0009	
description	rocker switch mounting measurements 30x22mm orange 2NO 250V 16A illuminated 0-I connection male faston 6.3mm ambient temperature max. 85/125°C protection IP65			
For models:	CITIZEN 6, CITIZEN 9, SYNTHESIS 05/40 A, SYNTHESIS 08/50, SYNTHESIS 10/75, SYNTHESIS08-50V			
accessories for	301002			
	GEV No.	301036	Ref. No.	—
	protective cover internal size 30x22mm for rocker switch mounting measurementsmm			

				
GEV No.	301001	Ref. No.	INTE0004	
description	rocker switch mounting measurements 30x22mm red 2NO 250V 16A illuminated 0-I connection male faston 6.3mm ambient temperature max. 125/55°C protection IP65			
For models:	SYNTHESIS 05/40 A, SYNTHESIS 08/50, SYNTHESIS 10/75, SYNTHESIS08-50V			
accessories for	301001			
	GEV No.	301036	Ref. No.	—
	protective cover internal size 30x22mm for rocker switch mounting measurementsmm			

				
GEV No.	346361	Ref. No.	INTE0011	
description	rocker switch mounting measurements 30x22mm white 2CO 250V 16A I-II connection male faston 6.3mm ambient temperature max. 85°C protection IP40			
For models:	CITIZEN 6, CITIZEN 9, SYNTHESIS 05/40 A			
accessories for	346361			
	GEV No.	301036	Ref. No.	—
	protective cover internal size 30x22mm for rocker switch mounting measurementsmm			

rotary switches

BREMAS

CR025 series

			
GEV No.	347832	Ref. No.	INTE0001
description	rotary switch 3 0-1-2 sets of contacts 8 type CR0250010 690V 32A shaft ø 5x5mm shaft L 17mm shaft square connection screw		



BRETER

rotary switches



GEV No.	346546	Ref. No.	INTE001
description	rotary switch Y-0-D 25A 3 operating positions 3-pole		



GEV No.	359178	Ref. No.	LAMP006	
description	indicator light mounting measurements 30x22mm 230V green connection male faston 6.3mm temp.-resist. 85°C type Marquardt 1667.. IP44			
For models:	CITIZEN 6, CITIZEN 9, SYNTHESIS 05/40 A, SYNTHESIS 08/50, SYNTHESIS 10/75, SYNTHESIS08-50V			
accessories for	359178			
	GEV No.	301036	Ref. No.	—
	protective cover internal size 30x22mm for rocker switch mounting measurementsmm			

encoders and potentiometers



GEV No.	300189	Ref. No.	ELET020
description	potentiometer		
For models:	SYNTHESIS 05/40 A, SYNTHESIS 08/50, SYNTHESIS 10/75, SYNTHESIS08-50V		



GEV No.	359156	Ref. No.	LAMP002
description	indicator light mounting measurements 30x22mm 230V yellow connection male faston 6.3mm temp.-resist. 125/55°C type RL2		

lamps

indicator lights

indicator lights (complete)

ø10mm

with screw socket



GEV No.	359791	Ref. No.	LAMP007
description	indicator light ø 10mm 230V green cable length 250mm		
For models:	SYNTHESIS 05/40 A		



GEV No.	359180	Ref. No.	LAMP002	
description	indicator light mounting measurements 30x22mm 230V yellow connection male faston 6.3mm type Marquardt 1667..			
For models:	CITIZEN 6, CITIZEN 9, SYNTHESIS 08/50, SYNTHESIS 10/75, SYNTHESIS08-50V			
accessories for	359180			
	GEV No.	301036	Ref. No.	—
	protective cover internal size 30x22mm for rocker switch mounting measurementsmm			

30x22mm



GEV No.	359157	Ref. No.	LAMP006	
description	indicator light mounting measurements 30x22mm 230V green connection male faston 6.3mm temp.-resist. 125/55°C type RL2			
accessories for	359157			
	GEV No.	301036	Ref. No.	—
	protective cover internal size 30x22mm for rocker switch mounting measurementsmm			

screw-on/push-on fit

light bulbs

for ovens





GEV No.	359614	Ref. No.	LAMP003
description	light bulb t.max. 300°C socket E27 230V 40W ø 45mm L 71mm lens L 44mm Qty 1 pcs		
For models:	CITIZEN 6, CITIZEN 9		

halogen lamp			
for socket G4 / G6.35 / G9			
			
GEV No.	359074	Ref. No.	LAMP0045
description	halogen lamp socket G6.35 12V 35W temp.-resist. 500°C		

for socket GU5.3 / GU10 / GZ5.3			
			
GEV No.	359665	Ref. No.	ELET0226 LAMP0037
description	halogen lamp socket GU10 230V 50W temp.-resist.°C		
For models:	T2 POLIS MC16, T2 POLIS MC26, T3 POLIS MC16, T3 POLIS MC26, T4 POLIS MC16, T4 POLIS MC26, T6 POLIS MC16, T6 POLIS MC26		

oven lamps

producer-specific oven lamps			
ZANOLLI			
			
GEV No.	693380	Ref. No.	CRIS0023
description	glass panel L 100mm W 100mm square thickness 6mm		
For models:	CITIZEN 6, CITIZEN 9		

			
GEV No.	359666	Ref. No.	ELET0227 LAMP0008
description	lamp socket 250V socket E27 connection screw ø 40mm H 46mm with fastening angle mounting distancemm holder length 46mm Qty 1 pcs		
For models:	CITIZEN 6, CITIZEN 9		

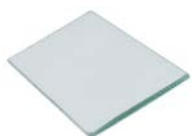
			
GEV No.	693379	Ref. No.	CRIS0006
description	glass panel L 180mm W 90mm rectangular thickness 6mm		
For models:	T2 POLIS MC16, T2 POLIS MC26, T3 POLIS MC16, T3 POLIS MC26, T4 POLIS MC16, T4 POLIS MC26, T6 POLIS MC16, T6 POLIS MC26		

			
GEV No.	359664	Ref. No.	LAMP0021
description	lamp socket W 21mm 24V socket GU10 connection grip connection ø 17mm H 12mm with 2 hole fixing mounting distance 11.5mm Qty 1 pcs		
For models:	T2 POLIS MC16, T2 POLIS MC26, T3 POLIS MC16, T3 POLIS MC26, T4 POLIS MC16, T4 POLIS MC26, T6 POLIS MC16, T6 POLIS MC26		

			
GEV No.	359665	Ref. No.	ELET0226 LAMP0037
description	halogen lamp socket GU10 230V 50W temp.-resist.°C		
For models:	T2 POLIS MC16, T2 POLIS MC26, T3 POLIS MC16, T3 POLIS MC26, T4 POLIS MC16, T4 POLIS MC26, T6 POLIS MC16, T6 POLIS MC26		

lamps

light bulbs			
			
GEV No.	359614	Ref. No.	LAMP0003
description	light bulb t.max. 300°C socket E27 230V 40W ø 45mm L 71mm lens L 44mm Qty 1 pcs		
For models:	CITIZEN 6, CITIZEN 9		

halogen lamps			
for socket G4 / G6.35 / G9			
			
GEV No.	359074	Ref. No.	LAMP0045
description	halogen lamp socket G6.35 12V 35W temp.-resist. 500°C		

for socket GU5,3 / GU10			
			
GEV No.	359665	Ref. No.	ELET0226 LAMP0037
description	halogen lamp socket GU10 230V 50W temp.-resist.°C		
For models:	T2 POLIS MC16, T2 POLIS MC26, T3 POLIS MC16, T3 POLIS MC26, T4 POLIS MC16, T4 POLIS MC26, T6 POLIS MC16, T6 POLIS MC26		



contactors

GENERAL ELECTRIC (AEG)

power contactors



1			
GEV No.	380261	Ref. No.	ELET0002
description	power contactor resistive load 32A 230VAC (AC3/400V) 17A/7.5kW main contacts 3NO auxiliary contacts 1NO connection screw connection type AEG LS7K 10A type GE CL02A 310		
For models:	SYNTHESIS 05/40 A, SYNTHESIS 08/50, SYNTHESIS 08/50 A, SYNTHESIS 10/75, SYNTHESIS 10/75 A, SYNTHESIS 10/75 B22, SYNTHESIS08-50V, T2 POLIS MC16, T2 POLIS MC26, T3 POLIS MC16, T3 POLIS MC26, T4 POLIS MC16, T4 POLIS MC26, T6 POLIS MC16, T6 POLIS MC26		

LOVATO

power contactors



1			
GEV No.	380788	Ref. No.	ELET0432
description	power contactor resistive load 32A 230VAC (AC3/400V) 18A/7.5kW main contacts 4NO connection screw connection type BF18T4A230		

ALLEN BRADLEY

power contactors



1			
GEV No.	380469	Ref. No.	ELET0160
description	power contactor resistive load 32A 230VAC (AC3/400V) 9A/4kW main contacts 4NO connection screw connection type 100-C09KF400		

transformers

open transformers

with clamp terminal



1			
GEV No.	401199	Ref. No.	ELET0003 (old version)
description	transformer 63VA		



1			
GEV No.	401198	Ref. No.	ELET0094
description	transformer primary 0/230/400V secondary 12/0/12V 160VA		
For models:	CITIZEN 6, CITIZEN 9, SYNTHESIS 05/40 A, SYNTHESIS 08/50, SYNTHESIS08-50V		



1			
GEV No.	403573	Ref. No.	ELET0003
description	transformer primary 230/400VAC secondary 115VAC 63VA secondary 0.5A H 78mm L 85mm W 77mm connection screw 50/60Hz type SFM00063CC15 open		
For models:	SYNTHESIS 05/40 A, SYNTHESIS 08/50 A, SYNTHESIS 10/75 A, SYNTHESIS 10/75 B22		



electronic controllers

ELIWELL

universal controllers

built-in version



1

GEV No.	378202	Ref. No.	TERM0011
description	electronic controller ELIWELL type EW7210 model E7211A0XHD700 mounting measurements 66.5x66.5mm 95-240V voltage AC TC (J,K) relay outputs 1 CO-8A(3) TC (J,K) built-in depth 80mm protection IP55 built-in version defr. funct. no -40 up to 1600°C display 2x 4 digits		
accessories for	378202		
	GEV No.	378074	Ref. No. —
	temperature probe thermocouple J (Fe-CuNi) cable Vetrotex probe -50 up to +750°C cable -50 up to +350°C probe ø3x100mm cable length 3m without screw connection 2-wire		
	GEV No.	378075	Ref. No. —
	temperature probe thermocouple K (NiCr-Ni) cable Vetrotex probe -50 up to 1150°C cable -50 up to +350°C probe ø4.5x150mm cable length 3m without screw connection 2-wire		
	GEV No.	379051	Ref. No. TERM0017
	temperature probe thermocouple J (Fe-CuNi) cable Vetrotex probe -50 up to +750°C cable -50 up to +350°C probe ø6x100mm cable length 3m without screw connection cable colours red/blue 2-wire		
	GEV No.	379062	Ref. No. —
	temperature probe thermocouple J (Fe-CuNi) cable Vetrotex probe -50 up to +750°C cable -50 up to +350°C probe ø6x50mm cable length 3m without screw connection 2-wire		



1

GEV No.	379568	Ref. No.	TERM0012
description	electronic controller ELIWELL type ICPPlus915 model ICP22JI750000 mounting measurements 71x29mm 230V voltage AC Pt100/TC (J,K) relay outputs 2 CO-8A(4) CO-8A(4) Pt100/TC (J,K,S) DI front measurements 78x37mm built-in depth 60mm mode of operation cooking protection IPx0 accuracy 1% built-in version defr. funct. no -150 to 1350°C display 3½ digits		
For models:	CITIZEN 6, CITIZEN 9, SYNTHESIS 08/50, SYNTHESIS 10/75, SYNTHESIS08-50V		
accessories for	379568		
	GEV No.	378065	Ref. No. —
	alarm device AKO type AKO-520641 mounting measurements 214x214mm 230V voltage AC relay outputs 1 CO-8A(4) up to 4 front measurements 222x222mm yes yes		
	GEV No.	378074	Ref. No. —
	temperature probe thermocouple J (Fe-CuNi) cable Vetrotex probe -50 up to +750°C cable -50 up to +350°C probe ø3x100mm cable length 3m without screw connection 2-wire		

accessories for	379568		
	GEV No.	378075	Ref. No. —
	temperature probe thermocouple K (NiCr-Ni) cable Vetrotex probe -50 up to 1150°C cable -50 up to +350°C probe ø4.5x150mm cable length 3m without screw connection 2-wire		
	GEV No.	379050	Ref. No. —
	temperature probe Pt100 cable Vetrotex probe -200 up to +600°C cable -50 up to +350°C probe ø6x100mm cable length 2.7m without screw connection 3-wire		
	GEV No.	379062	Ref. No. —
	temperature probe thermocouple J (Fe-CuNi) cable Vetrotex probe -50 up to +750°C cable -50 up to +350°C probe ø6x50mm cable length 3m without screw connection 2-wire		

electronic thermometers



1

GEV No.	378198	Ref. No.	TERM0009
description	thermometer ELIWELL type EM300LX mounting measurements 71x29mm 12V voltage AC/DC -200 up to +800°C Pt100/TC (J,K) display 3½ digits front measurements 35x76mm accuracy 1%		
accessories for	378198		
	GEV No.	378075	Ref. No. —
	temperature probe thermocouple K (NiCr-Ni) cable Vetrotex probe -50 up to 1150°C cable -50 up to +350°C probe ø4.5x150mm cable length 3m without screw connection 2-wire		
	GEV No.	379050	Ref. No. —
	temperature probe Pt100 cable Vetrotex probe -200 up to +600°C cable -50 up to +350°C probe ø6x100mm cable length 2.7m without screw connection 3-wire		
	GEV No.	379051	Ref. No. TERM0017
	temperature probe thermocouple J (Fe-CuNi) cable Vetrotex probe -50 up to +750°C cable -50 up to +350°C probe ø6x100mm cable length 3m without screw connection cable colours red/blue 2-wire		
	GEV No.	379054	Ref. No. —
	transformer primary 230VAC secondary 12VAC 3VA secondary 0.25A H 40mm L 45mm W 50mm connection screw 50/60Hz type 153/M		
	GEV No.	379063	Ref. No. —
	temperature probe thermocouple J (Fe-CuNi) cable Vetrotex probe -50 up to +750°C cable -50 up to +350°C probe ø6x50mm cable length 1.9m without screw connection 2-wire		

→ electric components



electric components

EVCO - EVERY CONTROL

universal controllers

built-in version



GEV No.	378134	Ref. No.	TERM0060
description	electronic controller EVERY CONTROL EVK411 mounting measurements 71x29mm built-in depth 59mm 230V voltage AC NTC/PTC/Pt100/Pt1000/TC(J,K)/mV/mA relay outputs 1 CO-16A(8) NTC/PTC/Pt100/Pt1000/TC(J,K)/mV/mA yes protection IP55 dependend on probe°C display 3½ digits		
accessories for	378134		
	GEV No.	Ref. No.	—
	temperature probe thermocouple K (NiCr-Ni) cable Vetrotex probe -50 up to 1150°C cable -50 up to +350°C probe ø4.5x150mm cable length 3m without screw connection 2-wire		
	GEV No.	Ref. No.	TERM0017
	temperature probe thermocouple J (Fe-CuNi) cable Vetrotex probe -50 up to +750°C cable -50 up to +350°C probe ø6x100mm cable length 3m without screw connection cable colours red/blue 2-wire		
	GEV No.	Ref. No.	—
	temperature probe thermocouple J (Fe-CuNi) cable Vetrotex probe -50 up to +750°C cable -50 up to +350°C probe ø6x50mm cable length 3m without screw connection 2-wire		

GEV No.	379941	Ref. No.	TERM0020 TERM0084
description	temperature probe thermocouple J (Fe-CuNi) cable Vetrotex probe -50 up to +750°C cable -50 up to +350°C connection 2-wire thread probe ø6x200mm cable length 1m		
For models:	CITIZEN 6, CITIZEN 9, SYNTHESIS 08/50, SYNTHESIS 10/75, SYNTHESIS08-50V, T2 POLIS MC16, T2 POLIS MC26, T3 POLIS MC16, T3 POLIS MC26, T4 POLIS MC16, T4 POLIS MC26, T6 POLIS MC16, T6 POLIS MC26		

GEV No.	379942	Ref. No.	TERM0018
description	temperature probe thermocouple J cable Vetrotex probe -50 up to +750°C cable -50 up to +350°C connection 2-wire thread probe ø6x200mm cable length 1.5m		
For models:	SYNTHESIS 10/75		

electronics

PCBs

GEV No.	401204	Ref. No.	ELET0155
description	display PCB		
For models:	SYNTHESIS 05/40 A, SYNTHESIS 08/50, SYNTHESIS 08/50 A, SYNTHESIS 10/75, SYNTHESIS 10/75 A, SYNTHESIS 10/75 B22, SYNTHESIS08-50V		

GEV No.	401200	Ref. No.	ELET0149
description	keypad PCB		
For models:	T2 POLIS MC16, T2 POLIS MC26, T3 POLIS MC16, T3 POLIS MC26, T4 POLIS MC16, T4 POLIS MC26, T6 POLIS MC16, T6 POLIS MC26		

probes

universal probes

temperature probes

GEV No.	379051	Ref. No.	TERM0017
description	temperature probe thermocouple J (Fe-CuNi) cable Vetrotex probe -50 up to +750°C cable -50 up to +350°C probe ø6x100mm cable length 3m without screw connection cable colours red/blue 2-wire		
accessories for	379051		
	GEV No.	Ref. No.	—
	electronic controller HONEYWELL type DC10N-400 mounting measurements 92x92mm 24/230V voltage AC TC (J) relay outputs 1 CO-10A(6) TC (J) universal built-in depth 55mm protection IP54 accuracy 1% built-in version defr. funct. no 0 up to +400°C display 3 digits		

producer-specific probes

probes

GEV No.	379944	Ref. No.	TERM0019 TERM0022 TERM0049
description	temperature probe Pt1000 cable Vetrotex probe -70 up to +500°C cable -50 up to +350°C connection 2-wire thread probe ø6x180mm cable length 1.7m		
For models:	SYNTHESIS 05/40 A, SYNTHESIS 08/50, SYNTHESIS 08/50 A, SYNTHESIS 10/75, SYNTHESIS 10/75 A, SYNTHESIS 10/75 B22, SYNTHESIS08-50V		

1

GEV No.	401201	Ref. No.	ELET0148
description	main PCB		
For models:	T2 POLIS MC16, T2 POLIS MC26, T3 POLIS MC16, T3 POLIS MC26, T4 POLIS MC16, T4 POLIS MC26, T6 POLIS MC16, T6 POLIS MC26		



1

GEV No.	401205	Ref. No.	ELET0212
description	main PCB		
For models:	SYNTHESIS 05/40 A, SYNTHESIS 08/50 A, SYNTHESIS 10/75 A, SYNTHESIS 10/75 B22, SYNTHESIS08-50V		



1

GEV No.	401206	Ref. No.	ELET0203
description	PCB motor control		
For models:	SYNTHESIS 05/40 A, SYNTHESIS 08/50, SYNTHESIS 10/75, SYNTHESIS08-50V		



1

GEV No.	401207	Ref. No.	ELET0213
description	PCB motor control		
For models:	SYNTHESIS 05/40 A, SYNTHESIS 08/50, SYNTHESIS 08/50 A, SYNTHESIS 10/75, SYNTHESIS 10/75 A, SYNTHESIS 10/75 B22, SYNTHESIS08-50V		

keypads

front foils



1

GEV No.	504381	Ref. No.	PANN0275
description	keypad foil for pizza oven black suitable for ZANOLLI L 325mm W 130mm buttons 11		

membrane keypads



1

GEV No.	401202	Ref. No.	ELET0165
description	membrane keypad 6 buttons		
For models:	SYNTHESIS 08/50, SYNTHESIS 10/75, SYNTHESIS08-50V		



1

GEV No.	401203	Ref. No.	ELET0153
description	membrane keypad 6 buttons		
For models:	SYNTHESIS 05/40 A, SYNTHESIS 08/50 A, SYNTHESIS 10/75 A, SYNTHESIS 10/75 B22		



pressure switches

for coffee machines

miscellaneous

			
1			
GEV No.	541477	Ref. No.	ELET0548
description	pressure control pressure range 0.6bar connection 1/4" 16A 1-pole type coffee machine parts		



for gas equipment

			
1			
GEV No.	541348	Ref. No.	ELET0130
description	pressure control gas technology connection male faston 6.3mm suitable for ZANOLLI		
For models:	SYNTHESIS 05/40 A, SYNTHESIS 08/50 A, SYNTHESIS 10/75 A, SYNTHESIS 10/75 B22		

			
1			
GEV No.	542115	Ref. No.	ELET0641
description	pressure control ø 65mm pressure range 0.17-0.75mbar connection 6.8mm pressure connection ø 6.8mm		
accessories for	542115		
	GEV No.	542366	Ref. No. SUPP0413
	bracket for pressure switches		
	GEV No.	542367	Ref. No. SUPP0414
	bracket for pressure switches		
	GEV No.	560521	Ref. No. —
	sheet-metal screw ø 4mm L 10mm SS Qty 1 pcs 14585 intake Phillips head ø 8mm		

accessories



			
1			
GEV No.	542366	Ref. No.	SUPP0413
description	bracket for pressure switches		

			
1			
GEV No.	542367	Ref. No.	SUPP0414
description	bracket for pressure switches		
accessories for	542367		
	GEV No.	542115	Ref. No. ELET0641
	pressure control ø 65mm pressure range 0.17-0.75mbar connection 6.8mm pressure connection ø 6.8mm		



fans

axial fans

import

			
1			
GEV No.	601080 ¹	Ref. No.	VENT0012
description	axial fan L 119mm W 119mm H 38mm 230VAC 50/60Hz 23/20W bearing ball bearing connection male faston 2.8mm metal ADDA fan wheel ø 110mm temp.-resist. 70°C		
For models:	SYNTHESIS 08/50, SYNTHESIS 10/75, SYNTHESIS08-50V		
accessories for	601080		
	GEV No.	550898	Ref. No. —
	connecting cable cable length 2000mm connection F 2.8 connection distance 7.9mm for axial flow fan		
	GEV No.	692519	Ref. No. —
	guard L 120mm W 120mm plastic		

¹with ball bearings

			
1			
GEV No.	601130 ¹	Ref. No.	VENT0024
description	axial fan L 80mm W 80mm H 25mm 230VAC 50/60Hz 13/14W bearing ball bearing connection male faston 2.8mm metal ADDA fan wheel ø 75mm temp.-resist. 70°C airflow 30.6m³/h		
accessories for	601130		
	GEV No.	550898	Ref. No. —
	connecting cable cable length 2000mm connection F 2.8 connection distance 7.9mm for axial flow fan		



¹with ball bearings

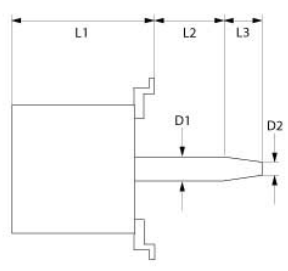

hot air motors

1

GEV No.	500681	Ref. No.	MOTO0030
description	fan motor 220-240V 1 phase 50Hz 0.37kW 1400rpm speeds 1 L1 265mm L2 45mm L3 47mm D1 ø 24mm D2 ø 20mm M8L IT 2A suitable capacitor 12.5µF/400V at 50Hz 1400rpm type 1021S2252		
For models:	SYNTHESIS 08/50, SYNTHESIS 10/75, SYNTHESIS08-50V		
spare parts for	500681		
	GEV No.	521078	Ref. No. VENT0022
	fan wheel		
	GEV No.	601217	Ref. No. VENT0015
	fan wheel D1 ø 335mm H1 100mm blades 24 D2 ø 19.5mm D3 ø 23mm H2 45mm		
accessories for	500681		
	GEV No.	365014	Ref. No. —
	operating capacitor capacity 12.5µF 450V tolerance 5%Hz ambient temperature max. -25 to +85°C ø 35mm L 70mm M8 plastic connection male faston 6.3mm 45S.C3DS.12.5 protection		

1

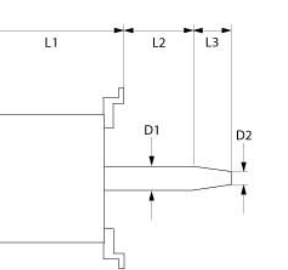
GEV No.	500664	Ref. No.	MOTO0034
description	fan motor 230V 1 phase 50Hz 0.37kW 1400rpm speeds 1 L1 170mm L2 50mm L3 28mm D1 ø 17mm D2 ø 12mm M8L IT 2.2A suitable capacitor 10µF/450V Cos(φ) 0.95 at 50Hz 1400rpm type 1020A2353		

1

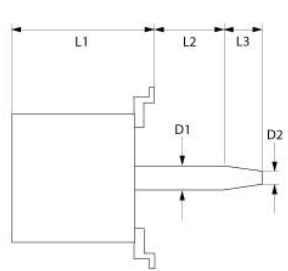
GEV No.	500651	Ref. No.	MOTO0030
description	fan motor 230V 1 phase 50Hz 0.75HP 1400rpm speeds 1 3.6A suitable capacitor 16µF/450V		



1

GEV No.	601215	Ref. No.	VENT0001
description	fan wheel D1 ø 250mm H1 78mm blades 20 D2 ø 11.5mm D3 ø 16mm H2 30mm		
For models:	SYNTHESIS 05/40 A		



1

GEV No.	601216	Ref. No.	VENT0018
description	fan wheel D1 ø 300mm H1 100mm blades 20 D2 ø 19.5mm D3 ø 23mm H2 45mm		



1

GEV No.	601241	Ref. No.	VENT0018
description	fan wheel D1 ø 300mm H1 100mm blades 20 D2 ø 19.5mm D3 ø 23mm H2 46mm		
For models:	SYNTHESIS 08/50, SYNTHESIS 08/50 A, SYNTHESIS08-50V		



1

GEV No.	601217	Ref. No.	VENT0015
description	fan wheel D1 ø 335mm H1 100mm blades 24 D2 ø 19.5mm D3 ø 23mm H2 45mm		
For models:	SYNTHESIS 10/75, SYNTHESIS 10/75 B22, SYNTHESIS 10/75A		

motors

gear motors

for ovens

for conveyor belt



1

GEV No.	500809	Ref. No.	MOTO0052
description	gear motor TRANSTECNO type MCB34480190G8 70W 48V 7.46rpm shaft ø 12mm L 220mm W 95mm H 175mm for conveyor belt		
For models:	SYNTHESIS 05/40 A, SYNTHESIS 08/50, SYNTHESIS 10/75, SYNTHESIS08-50V		

fuses

fine fuses

fine fuse holders



1

GEV No.	550691	Ref. No.	ELET0058
description	fuse holder		
For models:	CITIZEN 6, CITIZEN 9, SYNTHESIS 08/50, SYNTHESIS 10/75, SYNTHESIS08-50V		



1

GEV No.	550848	Ref. No.	ELET0440
description	fuse holder suitable fuse ø5x20mm		

electric accessories

terminals

rail-mounted terminals

WIELAND

rail-mounted terminals type 9700A



1

GEV No.	550378	Ref. No.	ELET0053
description	rail-mounted terminal WIELAND type 9700A/16 SL2 S35 2.5-35mm ² top-hat rail 35mm yellow/green W 16mm L 53mm		

gas valves and ignition boxes

gas control valves

SIT

TANDEM



1



GEV No.	101984	Ref. No.	GASI0007	
description	gas valve 230V 50Hz gas inlet 1/2" gas outlet 1/2" pilot connection level slow ignition ignition times pressure range 2-50mbar power supply for modulator 230VAC rectified Tandem equiv. no. 0.836.010			
For models:	CITIZEN 6, CITIZEN 9, SYNTHESIS 05/40 A, SYNTHESIS 08/50 A, SYNTHESIS 10/75 A, SYNTHESIS 10/75 B22			
spare parts for	101984			
	GEV No.	101379	Ref. No.	—
		solenoid coil 230V 50Hz suitable for Tandem		
accessories for	101984			
	GEV No.	101274	Ref. No.	—
		olive for pipe ø 16mm Qty 1 pcs		
	GEV No.	101275	Ref. No.	—
		union screw thread 1/2" for pipe ø 16mm Qty 1 pcs		
	GEV No.	101925	Ref. No.	—
		plug with O-ring thread M10x1 for pilot burner suitable for NOVASIT		
	GEV No.	102845	Ref. No.	—
		gas connection angled 1/2" flange 32x32mm hole distance 24x24mm Tandem		
	GEV No.	102846	Ref. No.	—
		gas connection straight 1/2" flange 32x32mm hole distance 24x24mm suitable for Tandem		

Table continues overleaf



accessories for	101984			
	GEV No.	102847	Ref. No.	—
	O-ring			

ignition boxes

BRAHMA



1

GEV No.	102338	Ref. No.	ELET0134
description	ignition box BRAHMA type SM11PMIX electrodes 2 waiting time 1.5s safety time 5s 230V 7VA 50-60Hz		
For models:	CITIZEN 6, CITIZEN 9, SYNTHESIS 05/40 A, SYNTHESIS 08/50 A, SYNTHESIS 10/75 A, SYNTHESIS 10/75 B22		

ignition parts

electrodes



1

GEV No.	102339	Ref. No.	AGAS0014
description	ignition electrode D1 ø 7mm D2 ø 8.5mm connection M4 L1 125mm BL1 18mm BL2 3mm BL3 22mm to clip		
For models:	CITIZEN 6, CITIZEN 9, SYNTHESIS 05/40 A, SYNTHESIS 08/50 A, SYNTHESIS 10/75 A, SYNTHESIS 10/75 B22		

ignition units



1

GEV No.	101017	Ref. No.	ELET0135
description	ignition unit outputs 2 230VAC dimensions 85x70x35mm mounting distance 60mm inlet cable outlet ø4mm type TC2STCAF 55VA 50/60Hz		
For models:	CITIZEN 6, CITIZEN 9, SYNTHESIS 05/40 A, SYNTHESIS 08/50 A, SYNTHESIS 10/75 A, SYNTHESIS 10/75 B22		

gas nozzles

main nozzles

gas nozzles M10x1



1

GEV No.	106503	Ref. No.	UGAS0039
description	gas injector thread M10x1 WS 11 bore ø 1.1mm		



1

GEV No.	107146	Ref. No.	UGAS0007
description	gas injector thread M10x1 WS 11 bore ø 3.85mm		

auxiliary gas parts



pressure switches



1

GEV No.	541348	Ref. No.	ELET0130
description	pressure control gas technology connection male faston 6.3mm suitable for ZANOLLI		
For models:	SYNTHESIS 05/40 A, SYNTHESIS 08/50 A, SYNTHESIS 10/75 A, SYNTHESIS 10/75 B22		



			
1			
GEV No.	542115	Ref. No.	ELET0641
description	pressure control ø 65mm pressure range 0.17-0.75mbar connection 6.8mm pressure connection ø 6.8mm		
accessories for	542115		
	GEV No.	542366	Ref. No. SUPP0413
	bracket for pressure switches		
	GEV No.	542367	Ref. No. SUPP0414
	bracket for pressure switches		
	GEV No.	560521	Ref. No. —
	sheet-metal screw ø 4mm L 10mm SS Qty 1 pcs 14585 intake Phillips head ø 8mm		

for pizza ovens

drive shafts

			
1			
GEV No.	693381	Ref. No.	MECC0417
description	drive shaft for pizza oven L 490mm		
For models:	SYNTHESIS 05/40 A		

			
1			
GEV No.	693382	Ref. No.	MECC0125
description	spindle for pizza oven L 595mm		
For models:	SYNTHESIS 08/50, SYNTHESIS 08/50 A, SYNTHESIS08-50V		

			
1			
GEV No.	693383	Ref. No.	MECC0155
description	spindle for pizza oven L 856mm		
For models:	SYNTHESIS 10/75, SYNTHESIS 10/75 A, SYNTHESIS 10/75 B22		

spare parts and accessories

			
1			
GEV No.	693393	Ref. No.	MECC0114
description	coupling for pizza oven for drive shaft		
For models:	SYNTHESIS 05/40 A, SYNTHESIS 08/50, SYNTHESIS 08/50 A, SYNTHESIS 10/75, SYNTHESIS 10/75 A, SYNTHESIS 10/75 B22, SYNTHESIS08-50V		

			
1			
GEV No.	693394	Ref. No.	MECC0419
description	spacer piece for drive shaft for pizza oven		
For models:	SYNTHESIS 05/40 A		

			
1			
GEV No.	693395	Ref. No.	MECC0036
description	spacer piece for drive shaft ID ø 20mm for pizza oven ø 38mm H 20mm		
For models:	SYNTHESIS 08/50, SYNTHESIS 08/50 A, SYNTHESIS 10/75, SYNTHESIS 10/75 A, SYNTHESIS 10/75 B22, SYNTHESIS08-50V		

equipment-specific units

for conveyor oven

cover caps

			
1			
GEV No.	693390	Ref. No.	CUSC0012
description	cover cap for drive shaft with hole mounting pos. right		

			
1			
GEV No.	693389	Ref. No.	CUSC0013
description	cover cap for drive shaft without hole mounting pos. left		
For models:	SYNTHESIS 05/40 A, SYNTHESIS 08/50 A, SYNTHESIS 10/75 A, SYNTHESIS 10/75 B22		

conveyor belts

			
1			
GEV No.	694278	Ref. No.	RETE0013
description	conveyor belt W 500mm for pizza oven Qty supplied by meter		
For models:	SYNTHESIS08-50V		



glass panels



1

GEV No.	693377	Ref. No.	CRIS0026
description	glass panel L 325mm W 93mm thickness 6mm rectangular		
For models:	CITIZEN 6, CITIZEN 9		



1

GEV No.	693378	Ref. No.	CRIS0034
description	glass panel L 415mm W 105mm thickness 6mm rectangular		
For models:	SYNTHESIS 08/50, SYNTHESIS 10/75, SYNTHESIS08-50V		



1

GEV No.	693375	Ref. No.	CRIS0025
description	glass panel L 525mm W 93mm thickness 6mm rectangular		
For models:	T2 POLIS MC16, T2 POLIS MC26, T4 POLIS MC16, T4 POLIS MC26		



1

GEV No.	693376	Ref. No.	CRIS0028
description	glass panel L 725mm W 93mm thickness 6mm rectangular		
For models:	T3 POLIS MC16, T3 POLIS MC26, T6 POLIS MC16, T6 POLIS MC26		

firebricks



1

GEV No.	850022	Ref. No.	N/A REFR0001
description	bottom plate L 495mm W 495mm H 16mm pizza oven for ELP500		

gear wheels



GEV No.	693392	Ref. No.	MECC0035
description	gear wheel teeth 10 shaft intake ø 20mm ø 44mm hub ømm stainless steel		
For models:	SYNTHESIS 08/50, SYNTHESIS 08/50 A, SYNTHESIS 10/75, SYNTHESIS 10/75 A, SYNTHESIS 10/75 B22, SYNTHESIS08-50V		

handles and hand wheels

star handles



GEV No.	111128	Ref. No.	MANI0020
description	star handle shaft 5x5mm ø 60mm		

hinges

door bearing



GEV No.	693385	Ref. No.	SUPP0140 SUPP0206 SUPP0392
description	hinge bearing mounting pos. left with bolt		
For models:	CITIZEN 6, CITIZEN 9, T2 POLIS MC16, T3 POLIS MC16, T4 POLIS MC16, T6 POLIS MC16		

GEV No.	693384	Ref. No.	SUPP0139 SUPP0207 SUPP0391
description	hinge bearing mounting pos. right with bolt		
For models:	CITIZEN 6, CITIZEN 9, T2 POLIS MC16, T3 POLIS MC16, T4 POLIS MC16, T6 POLIS MC16		

gaskets

gaskets for heated units

door seals

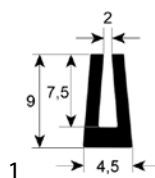

GEV No.	900456	Ref. No.	GUAR0010
description	door seal profile 2934 Qty supplied by meter		
For models:	CITIZEN 6, CITIZEN 9, T2 POLIS MC16, T2 POLIS MC26, T3 POLIS MC16, T3 POLIS MC26, T4 POLIS MC16, T4 POLIS MC26, T6 POLIS MC16, T6 POLIS MC26		

knobs

universal knobs



GEV No.	110253	Ref. No.	MANI0021 MANI0025
description	knob switch zero mark t.max.°C°C ø 50mm shaft ø 6x4.6mm shaft flat upper black		
For models:	SYNTHESIS 08/50, SYNTHESIS 10/75, SYNTHESIS08-50V		

producer-specific knobs

ZANOLLI



GEV No.	111748	Ref. No.	MANI0022
description	knob potentiometer ø 46mm shaft ø 6.5mm silver		
For models:	SYNTHESIS 05/40 A, SYNTHESIS 08/50, SYNTHESIS 10/75, SYNTHESIS08-50V		



transmission technology and ball bearings

ball bearings

flange bearings



1

GEV No.	693388	Ref. No.	CUSC0022
description	flange bearing shaft \varnothing 12mm W 38mm 2 hole flange hole distance 48mm H 15mm		
For models:	SYNTHESIS 05/40 A, SYNTHESIS 08/50, SYNTHESIS 08/50 A, SYNTHESIS 10/75, SYNTHESIS 10/75 A, SYNTHESIS 10/75 B22, SYNTHESIS08-50V		

springs

torsion springs



1

GEV No.	693386	Ref. No.	SPRI0010
description	torsion spring \varnothing 27.4mm L2 148mm wire gauge \varnothing 3.4mm mounting pos. right L1 9mm		
For models:	T2 POLIS MC16, T2 POLIS MC26, T3 POLIS MC16, T3 POLIS MC26, T4 POLIS MC16, T4 POLIS MC26, T6 POLIS MC16, T6 POLIS MC26		



1

GEV No.	693387	Ref. No.	SPRI0009
description	torsion spring \varnothing 27.4mm L2 150mm wire gauge \varnothing 3.6mm mounting pos. left L1 10mm		
For models:	CITIZEN 6, CITIZEN 9, T2 POLIS MC16, T2 POLIS MC26, T3 POLIS MC16, T3 POLIS MC26, T4 POLIS MC16, T4 POLIS MC26, T6 POLIS MC16, T6 POLIS MC26		

consumables

fuses

fine fuses

fine fuse holders



1

GEV No.	550691	Ref. No.	ELET0058
description	fuse holder		
For models:	CITIZEN 6, CITIZEN 9, SYNTHESIS 08/50, SYNTHESIS 10/75, SYNTHESIS08-50V		



1

GEV No.	550848	Ref. No.	ELET0440
description	fuse holder suitable fuse \varnothing 5x20mm		

A			
axial fans		14	
C			
consumables		21	
contactors		10	
control thermostats		6	
D			
door seals		20	
E			
electric accessories		16	
electronic controllers		11	
energy regulators		6	
F			
fans		14	
fine fuses		21	
fuses		16, 21	
G			
gas control valves		16	
gas nozzles		17	
gaskets for heated units		20	
H			
halogen lamp		9	
heating elements		3	
heating elements for pizza ovens		3	
hot air motors		15	
I			
ignition boxes		17	
ignition units		17	
indicator lights		8	
indicator lights (complete)		8	
L			
lamps		8	
light bulbs		8	
M			
motors		16	
O			
oven lamps		9	
P			
pressure switches		14, 17	
probes		12	
R			
rocker/momentary rocker switches		7	
rotary switches		7	
S			
safety thermostats		7	
switches and momentary switches		7	
T			
temperature probes		12	
terminals		16	
thermostats		6	
transformers		10	
U			
universal probes		12	