



GAS COMPONENTS



ELECTRIC COMPONENTS



WATER TECHNOLOGY



MECHANICAL COMPONENTS



TOOLS

Spare parts suitable for

WHIRLPOOL

Find the complete and up-to-date range of products in our GEV Webshop



Manufacturer catalogue

The most important spare parts and accessories arranged clearly for every manufacturer

- ✓ Complete product range and all appliance data always up to date in the GEV Webshop
- ✓ Alphabetical Index at the end of the catalogue

GEV Webshop

www.gev-online.co.uk

www.gev-online.com









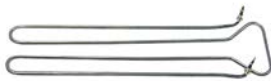

- 🔍 Add to Favourites
- 🔍 Sign In with email address and usual password
- 🔍 Easy-order – place several items in your basket at the same time
- 🔍 Quick Item search – no login needed



heating elements

heating elements for ovens

			
1			
GEV No.	415078	Ref. No.	771985002864
description	heating element 1500W 240V L 540mm W 150mm H 28mm 2 hole fixing mounting distance 145mm connection M4 tube ø 6.25mm dry heating element thread M10x1 heating circuits 1		
accessories for	415078		
	GEV No.	510416	Ref. No. —
	flat gasket fibre ED ø 19mm ID ø 10.5mm thickness 1.5mm for thread M10 Qty 1 pcs		
	GEV No.	510893	Ref. No. —
	O-ring EPDM thickness 2.62mm ID ø 9.92mm Qty 1 pcs		
	GEV No.	520231	Ref. No. —
	nut thread M10x1 H 6mm WS 14 zinc-coated steel Qty 1 pcs		
	GEV No.	521103	Ref. No. —
	nut thread M4 H 3mm WS 7 brass Qty 20 pcs		
	GEV No.	521104	Ref. No. —
	washer ID ø 4.3mm ED ø 8mm thickness 0.5mm brass Qty 20 pcs for thread M4		
	GEV No.	560111	Ref. No. —
	plain washer ID ø 4.3mm ED ø 9mm thickness 0.8mm SS Qty 20 pcs DIN 125A for thread M4		
	GEV No.	560131	Ref. No. —
	hexagonal nut thread M4 H 3.2mm WS 7 SS DIN/ISO DIN 934 / ISO 4032/8673 Qty 20 pcs		

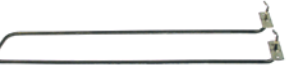
			
1			
GEV No.	416043	Ref. No.	483286009614
description	heating element 990W 230V L 475mm W 106mm H 24mm lug length 55mm lug width 18mm hole distance 138mm hole ø 5mm tube ø 6.3mm connection M4 heating circuits 1 bracket mounting oven		





heating elements for frying pans



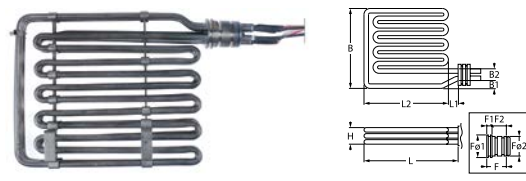

			
1			
GEV No.	415184	Ref. No.	771985003774
description	heating element 2000W 230V heating circuits 1 L 570mm W 86mm connection length 24mm connection M5 tube ø 8.5mm dry heating element griddle H 87mm		

heating elements for fryers

off-center connection

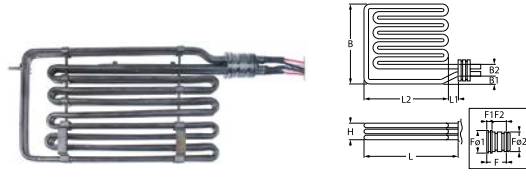
with retaining rings

			
1			
GEV No.	416408	Ref. No.	483286009367
description	heating element 12000W 230/400V heating circuits 3 mounting pos. left L 280mm W 225mm H 32mm flange length 45mm flange length 1 9.6mm flange length 2 35.4mm flange ø1 44.5mm flange ø2 39.5mm thermostat sleeves ø 7mm length thermostat sleeves 280mm number of thermostat sleeves 1 thermostat sleeve eccentric, non clinging windings 5 L1 10mm L2 270mm W1 13mm W2 31mm tube ø 8.5mm cable length 600mm rotation flange fryer connection length 50mm		
accessories for	416408		
	GEV No.	510899	Ref. No. 483286009314
	O-ring EPDM thickness 3.53mm ID ø 37.69mm Qty 1 pcs		
	GEV No.	528155	Ref. No. —
	O-ring Viton thickness 3.53mm ID ø 32.93mm Qty 1 pcs		
	GEV No.	532545	Ref. No. —
	O-ring Viton thickness 3.53mm ID ø 49.21mm Qty 1 pcs		
	GEV No.	691621	Ref. No. —
	retaining ring shaft ø 40mm thickness 1.8mm steel DIN 471		

			
1			
GEV No.	416407	Ref. No.	483286009359
description	heating element 15000W 230/400V heating circuits 3 mounting pos. left L 355mm W 190mm H 32mm flange length 45mm flange length 1 9.6mm flange length 2 35.4mm flange ø1 44.5mm flange ø2 39.5mm thermostat sleeves ø 7mm length thermostat sleeves 280mm number of thermostat sleeves 1 thermostat sleeve eccentric, clinging windings 4 L1 15mm L2 340mm W1 13mm W2 32mm tube ø 8.5mm cable length 570mm rotation flange connection length 60mm		
accessories for	416407		
	GEV No.	510899	Ref. No. 483286009314
	O-ring EPDM thickness 3.53mm ID ø 37.69mm Qty 1 pcs		
	GEV No.	528155	Ref. No. —
	O-ring Viton thickness 3.53mm ID ø 32.93mm Qty 1 pcs		
	GEV No.	532545	Ref. No. —
	O-ring Viton thickness 3.53mm ID ø 49.21mm Qty 1 pcs		
	GEV No.	691621	Ref. No. —
	retaining ring shaft ø 40mm thickness 1.8mm steel DIN 471		



GEV No.	415354	Ref. No.	771985003588
description	heating element 1500W 230V heating circuits 1 L 375mm W 26mm H 275mm rectangular flange connection M4 fryer heaters L1 20mm L2 75mm L3 280mm H1 118mm H2 115mm H3 42mm hole distance 22mm hole ø 6mm flange length 33mm flange width 41mm tube ø 8.5mm		

2 hole fixing			
GEV No.	416648	Ref. No.	771985009698
description	heating element 3000W 230V heating circuits 1 L 315mm W 185mm H 180mm L1 28mm L2 277mm thread 1/4" mounting distance 174mm tube ø 8.5mm windings 6 2 hole fixing connection male faston 6.3mm fryer heaters		
accessories for	416648		
	GEV No.	361182	Ref. No. —
	nut thread 1/4" H 5mm nickel-plated brass WS 17 Qty 1 pcs		
	GEV No.	510417	Ref. No. —
	flat gasket fibre ED ø 20mm ID ø 14mm thickness 2mm Qty 1 pcs		
	GEV No.	520228	Ref. No. —
	tooth lock washer ID ø 15.3mm ED ø 24mm steel Qty 1 pcs for thread M14		
	GEV No.	550262	Ref. No. —
	flat gasket copper ED ø 20mm ID ø 14mm thickness 2mm		

heating elements for griddles			
GEV No.	415079	Ref. No.	771985002659 771985002682
description	heating element 1250W 230V heating circuits 1 L 473mm W 52mm H 43mm tube ø 8.5mm griddle connection distance 44mm dry heating element		

GEV No.	416985	Ref. No.	771985000474
description	heating element 1250W 230V heating circuits 1 L 482mm W 54mm H 55mm tube ø 8.5mm connection male faston 6.3mm connection distance 46mm dry heating element		

GEV No.	416046	Ref. No.	483286009373
description	heating element 2350/2560W 220/240V heating circuits 1 L 590mm W 77mm H 80mm tube ø 8.5mm dry heating element		

heating elements for refrigeration

heating elements for defrosting			
GEV No.	420449	Ref. No.	182733
description	heating element 160W 220V L 370mm W 60mm H 8.5mm cable length 1190mm tube ø 8.5mm refrigeration connection F6.3		

GEV No.	420450	Ref. No.	771985005004
description	heating element 335W 220V L 255mm W 315mm H 35mm cable length 980mm tube ø 8.5mm refrigeration		

GEV No.	419025	Ref. No.	183530
description	heating element 400W 230V L 440mm W 70mm H 100mm cable length 500mm tube ø 8.5mm		

GEV No.	419101	Ref. No.	208017
description	heating element 450W 230V L 380mm W 37mm H 100mm cable length 1100mm tube ø 8.5mm immersion heater		

GEV No.	420452	Ref. No.	182279 771985004825
description	heating element 540W 220V L 305mm W 695mm H 10mm cable length 985mm tube ø 8.5mm refrigeration		

GEV No.	420447	Ref. No.	182731
description	heating element 95W 230V L 425mm W 48mm H 120mm cable length 1200mm tube ø 8.5mm refrigerated counter		

heating elements for condensate evaporation



GEV No.	418996	Ref. No.	208134
description	heating element 95W 220V L 435mm W 56mm H 28mm cable length 3000mm tube ø 6.25mm		



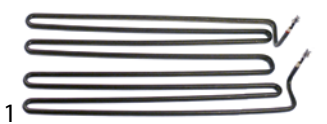

heating elements for tilting bratt pan







GEV No.	417344	Ref. No.	483286009389
description	heating element tilting bratt pan 4700W 230V L 540mm W 210mm H 60mm heating circuits 1 tube ø 8.5mm W1 70mm W2 70mm		

heating elements for pasta cookers









GEV No.	416408	Ref. No.	483286009367	
description	heating element 12000W 230/400V heating circuits 3 mounting pos. left L 280mm W 225mm H 32mm flange length 45mm flange length 1 9.6mm flange length 2 35.4mm flange ø1 44.5mm flange ø2 39.5mm thermostat sleeves ø 7mm length thermostat sleeves 280mm number of thermostat sleeves 1 thermostat sleeve eccentric, non clinging windings 5 L1 10mm L2 270mm W1 13mm W2 31mm tube ø 8.5mm cable length 600mm rotation flange fryer connection length 50mm			
accessories for	416408			
	GEV No.	510899	Ref. No.	483286009314
	O-ring EPDM thickness 3.53mm ID ø 37.69mm Qty 1 pcs			
	GEV No.	528155	Ref. No.	—
	O-ring Viton thickness 3.53mm ID ø 32.93mm Qty 1 pcs			
	GEV No.	532545	Ref. No.	—
	O-ring Viton thickness 3.53mm ID ø 49.21mm Qty 1 pcs			
	GEV No.	691621	Ref. No.	—
	retaining ring shaft ø 40mm thickness 1.8mm steel DIN 471			



GEV No.	416407	Ref. No.	483286009359	
description	heating element 15000W 230/400V heating circuits 3 mounting pos. left L 355mm W 190mm H 32mm flange length 45mm flange length 1 9.6mm flange length 2 35.4mm flange ø1 44.5mm flange ø2 39.5mm thermostat sleeves ø 7mm length thermostat sleeves 280mm number of thermostat sleeves 1 thermostat sleeve eccentric, clinging windings 4 L1 15mm L2 340mm W1 13mm W2 32mm tube ø 8.5mm cable length 570mm rotation flange connection length 60mm			
accessories for	416407			
	GEV No.	510899	Ref. No.	483286009314
	O-ring EPDM thickness 3.53mm ID ø 37.69mm Qty 1 pcs			
	GEV No.	528155	Ref. No.	—
	O-ring Viton thickness 3.53mm ID ø 32.93mm Qty 1 pcs			
	GEV No.	532545	Ref. No.	—
	O-ring Viton thickness 3.53mm ID ø 49.21mm Qty 1 pcs			
	GEV No.	691621	Ref. No.	—
	retaining ring shaft ø 40mm thickness 1.8mm steel DIN 471			



GEV No.	418651	Ref. No.	483286000159	
description	heating element 1500W 230V heating circuits 1 L 300mm W 51mm 2 hole fixing connection male faston 6.3mm thread M14x1 tube ø 8.5mm mounting distance 43mm pasta cooker immersion heater			
spare parts for	418651			
	GEV No.	507313	Ref. No.	—
	O-ring EPDM thickness 2.62mm ID ø 13.95mm Qty 1 pcs			
accessories for	418651			
	GEV No.	510417	Ref. No.	—
	flat gasket fibre ED ø 20mm ID ø 14mm thickness 2mm Qty 1 pcs			
	GEV No.	520228	Ref. No.	—
	tooth lock washer ID ø 15.3mm ED ø 24mm steel Qty 1 pcs for thread M14			
	GEV No.	521133	Ref. No.	—
	nut thread M14x1.5 H 6mm WS 19 zinc-coated steel Qty 1 pcs			
	GEV No.	550261	Ref. No.	—
	nut thread M14x1 H 4mm WS 19 SS Qty 1 pcs			
	GEV No.	550262	Ref. No.	—
	flat gasket copper ED ø 20mm ID ø 14mm thickness 2mm			



heating elements for pizza ovens

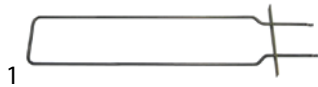

GEV No.	415917	Ref. No.	104152
description	heating element 1400W 230V L 572mm W 159mm flange length 220mm flange width 32mm hole distance 199mm connection length 134mm connection M5 L1 30mm L2 27mm L3 515mm W1 25mm W2 110mm tube ø 10.2mm heating circuits 1 rectangular flange hole ø 4mm dry heating element		

heating elements for salamanders/toast-



GEV No.	416050	Ref. No.	483286002058
description	heating element 1600W 220V heating circuits 1 L 304mm W 208mm H 50mm W1 94mm W2 30mm flange length 70mm flange width 22mm hole distance 56mm cable length 1480mm connection cable tube ø 6.3mm connection length 29mm hole ø 6mm rectangular flange dry heating element		

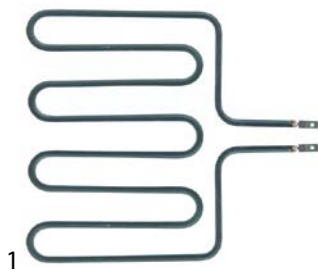

GEV No.	416579	Ref. No.	771985003375
description	heating element 1900W 220V heating circuits 1 L 245mm W 240mm L1 63mm L2 182mm W1 98mm W2 45mm connection distance 16mm connection M4 dry heating element tube ø 6.3mm H 6.3mm		

heating elements for heated trolleys

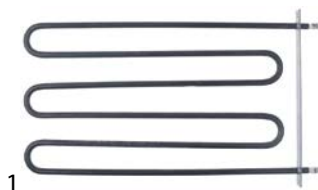

GEV No.	419130	Ref. No.	153577
description	heating element 1500W 230V L 388mm W 208mm connection M4 tube ø 8.5mm heating circuits 1 hole distance 230mm flange length 245mm flange width 20mm hole ø 6mm		

heating cables

connection on both sides

with wire end ferrules



GEV No.	420385	Ref. No.	483286000023
description	heating cable 23W 220V L 4500mm for blast chiller		



GEV No.	420386	Ref. No.	483286002824
description	heating cable 32W 220V L 4450mm for blast chiller		

heating cartridges



GEV No.	417227	Ref. No.	183814
description	heating cartridge 90W 230V ø 12mm L 124mm thread 3/8" cable length 4000mm Hmm Wmm condensate evaporation		

immersion heating elements

3 hole flange ø38.5mm



GEV No.	416263	Ref. No.	483286008132
description	heating element 2600W 230V mounting ø 38.5mm heating circuits 1 L 293mm W 26mm H 26mm number of thermostat sleeves 1 thermostat sleeves ø 7mm length thermostat sleeves 260mm thermostat sleeve not clinging tube ø 6.3mm hole distance 57mm hole ø 10mm 3 hole flange connection male faston 6.3mm immersion heater		

spare parts for	416263		
GEV No.	521120	Ref. No.	483286008139



O-ring EPDM thickness 5.34mm ID ø 37.47mm Qty 1 pcs

accessories for	416263		
GEV No.	532577	Ref. No.	—



O-ring EPDM thickness 5.34mm ID ø 40.65mm Qty 1 pcs



3 hole flange ø47.5mm





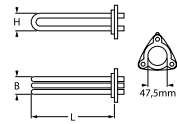

1

GEV No.	416130	Ref. No.	149371
description	heating element 2800W 230V mounting ø 47.5mm heating circuits 1 L 310mm W 8.5mm H 39mm tube ø 8.5mm hole distance 63mm hole ø 6mm connection male faston 6.3mm 3 hole flange immersion heater		
accessories for	416130		
	GEV No.	510408	Ref. No. —
	O-ring EPDM thickness 5.34mm ID ø 47mm Qty 1 pcs		
	GEV No.	510562	Ref. No. —
	O-ring silicone thickness 5.34mm ID ø 47mm Qty 1 pcs		



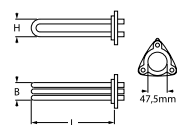

1

GEV No.	418126	Ref. No.	771985002940
description	heating element 7500W 220V mounting ø 47.5mm heating circuits 3 L 550mm W 37mm H 37mm number of thermostat sleeves 1 thermostat sleeves ø 7mm length thermostat sleeves 185mm thermostat sleeve upper tube ø 6.5mm hole distance 6.5mm hole ø 10mm connection male faston 6.3mm 3 hole flange immersion heater		
spare parts for	418126		
	GEV No.	510408	Ref. No. —
	O-ring EPDM thickness 5.34mm ID ø 47mm Qty 1 pcs		
accessories for	418126		
	GEV No.	510562	Ref. No. —
	O-ring silicone thickness 5.34mm ID ø 47mm Qty 1 pcs		

1

GEV No.	416410	Ref. No.	483286009435
description	heating element 9000W 230V mounting ø 47.5mm heating circuits 3 L 395mm W 33mm H 35mm number of thermostat sleeves 1 thermostat sleeves ø 7mm length thermostat sleeves 210mm thermostat sleeve eccentric, clinging tube ø 8.5mm hole distance 63mm hole ø 8mm connection M4		
accessories for	416410		
	GEV No.	510408	Ref. No. —
	O-ring EPDM thickness 5.34mm ID ø 47mm Qty 1 pcs		
	GEV No.	510562	Ref. No. —
	O-ring silicone thickness 5.34mm ID ø 47mm Qty 1 pcs		

3 hole flange ø57.5mm



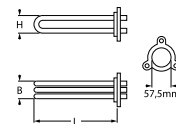

1

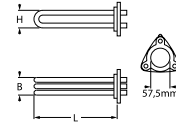
GEV No.	418249	Ref. No.	483286001218
description	heating element 10000W 230V mounting ø 57.5mm heating circuits 3 L 512mm W 50mm H 33mm number of thermostat sleeves 1 thermostat sleeves ø 8.5mm length thermostat sleeves 458mm thermostat sleeve eccentric, clinging tube ø 6.3mm hole distance 70mm hole ø 9mm connection length 30mm connection M4 3 hole flange immersion heater		

1

GEV No.	418779	Ref. No.	149992 771985010906
description	heating element 9000W 230V mounting ø 57.5mm heating circuits 3 L 340mm W 52mm H 54mm tube ø 8.5mm hole distance 72mm hole ø 8mm with integrated fuse INCOLOY		
spare parts for	418779		
	GEV No.	510409	Ref. No. —
	O-ring EPDM thickness 5.34mm ID ø 56.52mm Qty 1 pcs		

with round flange ø47.5mm



1









GEV No.	415652	Ref. No.	102751 771985000215
description	heating element 24000W 400V heating circuits 6 mounting ø 47.5mm L 585mm W 32mm H 35mm round flange connection male faston 6.3mm immersion heater tube ø 6.3mm connection length 86mm thermostat sleeves ø 5mm number of thermostat sleeves 1 length thermostat sleeves 155mm thermostat sleeve clinging		
spare parts for	415652		
	GEV No.	510408	Ref. No. —
	O-ring EPDM thickness 5.34mm ID ø 47mm Qty 1 pcs		
accessories for	415652		
	GEV No.	510408	Ref. No. —
	O-ring EPDM thickness 5.34mm ID ø 47mm Qty 1 pcs		
	GEV No.	510562	Ref. No. —
	O-ring silicone thickness 5.34mm ID ø 47mm Qty 1 pcs		
	GEV No.	520235	Ref. No. —
	3 hole flange hole distance 70.5mm perforation ø 6.5mm ID ø 53.5mm		
	GEV No.	520236	Ref. No. —
	flange for heating element ID ø 50mm ED ø 90mm hole ø 6.5mm 3 holes		
	GEV No.	550002	Ref. No. —
	tension strap H 10mm L 21mm W 10mm hole ø 6.5mm for heating element		

Table continues overleaf



accessories for	415652			
	GEV No.	550362	Ref. No.	—
	blind flange ø 64mm mounting ø 47.5mm			
	GEV No.	550460	Ref. No.	—
	kable set			

with round flange ø57.5mm





GEV No.	420316	Ref. No.	248249	
description	heating element 6000W 230V heating circuits 3 mounting ø 57.5mm L 463mm W 40mm H 40mm round flange connection male faston 6.3mm immersion heater tube ø 6.25mm thermostat sleeves ø 6.5mm number of thermostat sleeves 1 length thermostat sleeves 308mm thermostat sleeve eccentric, clinging			

accessories for	420316			
	GEV No.	510409	Ref. No.	—
	O-ring EPDM thickness 5.34mm ID ø 56.52mm Qty 1 pcs			



GEV No.	416259	Ref. No.	4832 860 08142	
description	heating element 1600W 230V heating circuits 1 L 275mm W 38mm H 28mm thread M10x1 mounting distance 27mm tube ø 7.1mm connection male faston 6.3mm 2 hole fixing connection length 26mm immersion heater			

accessories for	416259			
	GEV No.	510416	Ref. No.	—
	flat gasket fibre ED ø 19mm ID ø 10.5mm thickness 1.5mm for thread M10 Qty 1 pcs			

	GEV No.	510893	Ref. No.	—
	O-ring EPDM thickness 2.62mm ID ø 9.92mm Qty 1 pcs			

	GEV No.	520231	Ref. No.	—
	nut thread M10x1 H 6mm WS 14 zinc-coated steel Qty 1 pcs			

	GEV No.	521129	Ref. No.	—
	nut thread M10 H 6mm SS WS 17 Qty 1 pcs DIN/ISO DIN 439			



GEV No.	416260	Ref. No.	483286001391	
description	heating element 2500W 230V heating circuits 1 L 357mm W 34mm H 39mm H1 4mm H2 35mm thread M10x1 mounting distance 28mm tube ø 6.3mm connection male faston 6.3mm 2 hole fixing immersion heater connection length 25mm			

accessories for	416260			
	GEV No.	510416	Ref. No.	—
	flat gasket fibre ED ø 19mm ID ø 10.5mm thickness 1.5mm for thread M10 Qty 1 pcs			

	GEV No.	510893	Ref. No.	—
	O-ring EPDM thickness 2.62mm ID ø 9.92mm Qty 1 pcs			

	GEV No.	520231	Ref. No.	—
	nut thread M10x1 H 6mm WS 14 zinc-coated steel Qty 1 pcs			

accessories for	416260			
	GEV No.	521129	Ref. No.	—
	nut thread M10 H 6mm SS WS 17 Qty 1 pcs DIN/ISO DIN 439			

heating elements for convection



GEV No.	415966	Ref. No.	483286000411	
description	heating element 2500W 230V heating circuits 1 ID ø 176mm ED ø 188mm L 210mm H 28mm L1 22mm W1 30mm H1 3mm H2 25mm flange length 70mm flange width 22mm hole distance 56mm connection male faston 6.3mm tube ø 6.3mm convection heating element hole ø 5mm rectangular flange			

spare parts for	415966			
	GEV No.	510368	Ref. No.	—
	gasket L 70mm W 23.5mm hole ø 5mm hole distance 56mm FIBER thickness 2mm for heating element			

accessories for	415966			
	GEV No.	510368	Ref. No.	—
	gasket L 70mm W 23.5mm hole ø 5mm hole distance 56mm FIBER thickness 2mm for heating element			







GEV No.	418018	Ref. No.	483286008226	
description	heating element 2800W 230V heating circuits 1 ID ø 192mm L 290mm H 37mm L1 85mm W1 59mm flange length 100mm flange width 22mm hole distance 86mm ED ø 210mm connection M4 connection length 22mm tube ø 6.3mm convection heating element hole ø 5mm rectangular flange			



GEV No.	418019	Ref. No.	483286008226	
description	heating element 3900W 230V heating circuits 3 ID ø 206mm ED ø 218mm L 275mm H 40mm L1 48mm W1 104mm H1 10mm H2 24mm flange length 142mm flange width 25mm hole distance 62.5mm connection M4 connection length 62mm tube ø 6mm convection heating element hole ø 6.5mm rectangular flange			



			
1			
GEV No.	415654	Ref. No.	771985000168
description	heating element 5666W 230V heating circuits 2 ID ø 465mm ED ø 480mm L 580mm H 65mm L1 90mm W1 32mm H1 34mm H2 31mm flange length 80mm flange width 45mm hole distance 56mm connection M5 connection length 108mm tube ø 8.5mm convection heating element hole ø 6mm rectangular flange		
accessories for	415654		
	GEV No.	550256	Ref. No. —
	gasket L 75mm W 50mm hole ø 5mm hole distance 59.5mm rubber thickness 3mm for heating element suitable for JUNO equiv. no. 55327		
	GEV No.	550257	Ref. No. 771985000169
	gasket L 137mm W 79mm thickness 3.5mm for heating element suitable for JUNO equiv. no. 02689		

			
1			
GEV No.	418020	Ref. No.	483286008722
description	heating element 7800W 230V heating circuits 3 ID ø 264mm ED ø 277mm L 315mm H 100mm L1 35mm W1 101mm H1 29mm H2 67mm flange length 142mm flange width 23mm hole distance 63mm connection M4 connection length 75mm tube ø 6.3mm convection heating element mounting thread M4 rectangular flange		

radiation heaters

2-circuit

			
1			
GEV No.	490139	Ref. No.	483286009165
description	radiation heater ø 250mm 2500W 230V heating circuits 2 energy regulation with temperature signalization partial power 1000W with ribbon heater connections 3+2 connection type male faston 6.3mm EGO		

foil heating elements

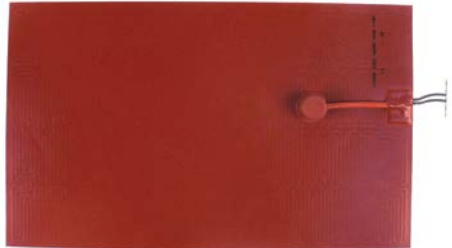
			
1			
GEV No.	416406	Ref. No.	483286009194
description	foil heating element L 400mm W 240mm 1000W 230V t.max. 150°C with temperature limiter silicone cable length 2000mm thickness 1mm		

hot plates

square & rectangular

with radiused edge

			
1			
GEV No.	490071 ¹	Ref. No.	483286009631
description	hot plate dimensions 300x300mm 4000W 230V with spill ring connection 4 screw clamps protector yes square		

¹incl. protector

round

with radiused edge

for domestic and commercial kitchens

			
1			
GEV No.	490020	Ref. No.	483286002844
description	hot plate ø 220mm 2600W 230V connection 4 screw clamps with 8mm spill ring		
accessories for	490020		
	GEV No.	550796	Ref. No. —
	fixing plate for hot plate ø220mm		



energy regulators

EGO

1-circuit



GEV No.	380015	Ref. No.	483286008224
description	energy regulator 230V 13A single-circuit turn direction right shaft ø 6x4.6mm shaft L 23mm mounting thread M4 power release 6-100% no. 50.57021.010		



GEV No.	375608	Ref. No.	483286008211
description	thermostat t.max. 265°C temperature range 50-265°C 1-pole 1NO 16A probe ø 3mm probe L 219mm capillary pipe 900mm capillary pipe isolated 800mm gland nut M9x1 shaft ø 6x4.6mm shaft L 23mm shaft position upper rotation 270°		

thermostats

control and safety thermostats

EGO

control thermostats

55.10/19_series



GEV No.	375607	Ref. No.	483286008707
description	thermostat t.max. 110°C temperature range fixed 110°C 1-pole 1CO 16A probe ø 3mm probe L 219mm capillary pipe 900mm capillary pipe isolated 800mm gland nut M9x1		



GEV No.	390068	Ref. No.	483286009388
description	thermostat t.max. 269°C temperature range 55-269°C 1-pole 1CO 16A probe ø 3.1mm probe L 219mm capillary pipe 1280mm capillary pipe isolated 1270mm gland nut shaft ø 6x4.6mm shaft L 23mm shaft position upper* rotation 318°		

55.13_series



GEV No.	375237	Ref. No.	483286009345
description	thermostat t.max. 190°C temperature range 100-190°C 1-pole 1NO 16A probe ø 6mm probe L 130mm capillary pipe 1800mm capillary pipe isolated 1200mm gland nut M9x1 shaft L 23mm shaft position upper rotation 270°		



GEV No.	375954	Ref. No.	483286008707
description	thermostat t.max. 109°C 1-pole 1CO 16A probe ø 3.03mm probe L 198mm capillary pipe 900mm capillary pipe isolated 610mm gland nut M9x1 shaft ø 6mm shaft Lmm shaft position* shaft position rotation°		



E·G·O



1

GEV No.	375010	Ref. No.	481227118033
description	thermostat t.max. 250°C temperature range 50-250°C 1-pole 1NO 16A probe ø 3.1mm probe L 208mm capillary pipe 1130mm capillary pipe isolatedmm gland nut shaft L 23mm shaft position upper rotation 270°		

55.34_ series

E·G·O



1

GEV No.	375097	Ref. No.	483286000171
description	thermostat t.max. 195°C temperature range 95-195°C 3-pole 3NO 16A probe ø 6mm probe L 117mm capillary pipe 1780mm capillary pipe isolated 1400mm gland nut M9x1 shaft ø 6x4.6mm shaft L 23mm shaft position upper rotation 270°		

E·G·O



1

GEV No.	375038	Ref. No.	483286009368
description	thermostat t.max. 300°C temperature range 50-300°C 3-pole 3NO 16A probe ø 6mm probe L 79mm capillary pipe 1740mm capillary pipe isolated 800mm gland nut shaft ø 6x4.6mm shaft L 23mm shaft position upper rotation 270°		
accessories for	375038		
	GEV No.	110123	Ref. No. —
	knob thermostat t.max. 300°C ø 50mm shaft ø 6x4.6mm shaft flat upper black temperature range 50-300°C rotation 270°		

safety thermostats

55.10/19_ series

E·G·O



1

GEV No.	375178	Ref. No.	483286009341
description	safety thermostat switch-off temp. 230°C 1-pole 0.5A probe ø 4mm probe L 116mm capillary pipe 1500mm capillary pipe isolatedmm gland nut probe SS		

E·G·O



1

GEV No.	375282	Ref. No.	483286000478
description	safety thermostat switch-off temp. 230°C 1-pole 16A probe ø 11mm probe L 28mm capillary pipe 850mm capillary pipe isolated 830mm gland nut probe screw-in probe probe thread M14x1		
accessories for	375282		
	GEV No.	507313	Ref. No. —
	O-ring EPDM thickness 2.62mm ID ø 13.95mm Qty 1 pcs		
	GEV No.	510420	Ref. No. —
	gasket copper ED ø 19.9mm ID ø 14.3mm thickness 2mm Qty 1 pcs		
	GEV No.	521133	Ref. No. —
	nut thread M14x1.5 H 6mm WS 19 zinc-coated steel Qty 1 pcs		

E·G·O



1

GEV No.	390062	Ref. No.	483286009348
description	safety thermostat switch-off temp. 235°C 1-pole 0.5A probe ø 6mm probe L 130mm capillary pipe 1800mm capillary pipe isolated 1500mm gland nut M9x1 probe SS		
accessories for	390062		
	GEV No.	551083	Ref. No. —
	cap for safety thermostat thread M8x1		



GEV No.	375352	Ref. No.	48328600173
description	safety thermostat switch-off temp. 245°C 1-pole 1NC 16A probe ø 6mm probe L 130mm capillary pipe 1200mm capillary pipe isolated 1200mm gland nut probe		

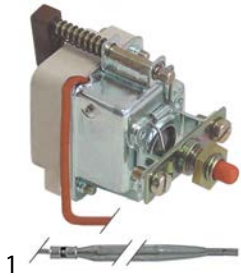

GEV No.	375353	Ref. No.	483286009238
description	safety thermostat switch-off temp. 355°C 1-pole 0.5A probe ø 4mm probe L 120mm capillary pipe 870mm capillary pipe isolated 870mm gland nut probe SS		

55.14_series

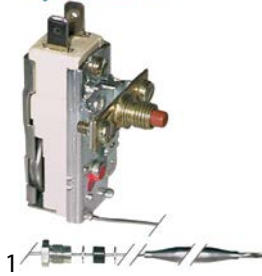

GEV No.	375610	Ref. No.	483286008208
description	safety thermostat switch-off temp. 340°C 1-pole 16A probe ø 3.03mm probe L 144mm capillary pipe 880mm capillary pipe isolated 750mm gland nut M9x1 probe		

55.32_series



GEV No.	375649	Ref. No.	483286002546
description	safety thermostat switch-off temp. 160°C 3-pole 20A probe ø 6mm probe L 87mm capillary pipe 890mm capillary pipe isolated 880mm gland nut probe SS		





GEV No.	375252	Ref. No.	483286009372
description	safety thermostat switch-off temp. 350°C 3-pole 20A probe ø 6mm probe L 89mm capillary pipe 3000mm capillary pipe isolated 960mm gland nut probe		

IMIT / TEMPOMATIC / ARATHERMO

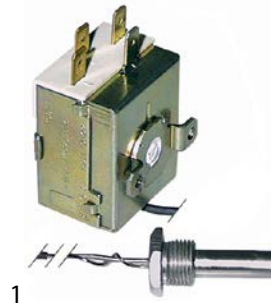
control thermostats



GEV No.	390310	Ref. No.	483286008151
description	thermostat t.max. 85°C temperature range fixed 55°C 1-pole 1CO 16A probe ø 9.5mm probe L 37mm capillary pipe 600mm capillary pipe isolated 540mm gland nut shaft ømm shaft Lmm shaft position rotation° screw-in probe probe thread 3/8" probe material SS		

accessories for	390310			
	GEV No.	506024	Ref. No.	—
	nut thread 3/8" H 6mm SS WS 22 Qty 1 pcs			
	GEV No.	529349	Ref. No.	—
	flat gasket FIBER ED ø 22mm ID ø 16.5mm thickness 2mm for thread 3/8" Qty 1 pcs			



CAEM

control thermostats



GEV No.	375609	Ref. No.	483286008704
description	thermostat t.max. 90°C temperature range 30-90°C 1-pole 1CO 16A probe ø 6mm probe L 95mm capillary pipe 1600mm capillary pipe isolated 1550mm shaft ø 6x4.6mm rotation 270°		



GEV No.	390211	Ref. No.	481927128578
description	thermostat ATEA type A03 0045 probe ø 2mm probe L 20mm capillary pipe 700mm starting temperature +5°C temperature range -13° up to -25°C for evaporator 68		

various

safety thermostats



GEV No.	390798	Ref. No.	756308 771985009339
description	safety thermostat switch-off temp. 235°C 1-pole 1CO probe ø 6mm probe L 63mm capillary pipe 1600mm capillary pipe isolated 80mm		

accessories

capillary tube clips



GEV No.	551105	Ref. No.	483286009649
description	capillary tube clip for pipe ø 6mm Qty 1 pcs		



GEV No.	550980	Ref. No.	483286000554
description	capillary tube clip for pipe ø 8.5mm Qty 1 pcs		

refrigeration thermostats

RANCO

K50 series





GEV No.	390271	Ref. No.	208089
description	thermostat RANCO type K50L3078 probe ømm probe Lmm capillary pipe 2000mm temperature range -7 up to -3°C		

switches and momentary switches

rocker/momentary rocker switches

30x22mm



GEV No.	301003	Ref. No.	483286011125	
description	rocker switch mounting measurements 30x22mm green 2NO 250V 16A illuminated 0-I connection male faston 6.3mm ambient temperature max. 125/55°C protection IP65			
accessories for	301003			
	GEV No.	301036	Ref. No.	—
	protective cover internal size 30x22mm for rocker switch mounting measurementsmm			

ATEA



GEV No.	390506	Ref. No.	481927128579
description	thermostat ATEA type A01 0046 probe ø 8mm probe L 120mm capillary pipemm temperature range°C		

labelled



GEV No.	300125	Ref. No.	483286000334	
description	rocker switch mounting measurements 30x22mm green 2NO 230V 16A 0-I connection male faston 6.3mm ambient temperature max. 125/55°C protection IP65 with cover cap			
accessories for	300125			
	GEV No.	301036	Ref. No.	—
	protective cover internal size 30x22mm for rocker switch mounting measurementsmm			



push/momentary push switches

ø16mm



1

GEV No.	346287 ¹	Ref. No.	771985000077
description	momentary push switch mounting ø 16mm red 1NO 250V 3A illuminated connection male faston 2.8mm ambient temperature max. 125/55°C protection IP65 with cover cap		

¹illuminated

1

GEV No.	346320	Ref. No.	483286008692
description	momentary push switch mounting ø 16mm red 1NO/indicator light 250V 3A ignition connection male faston 6.3mm ambient temperature max. 85°C protection IP40		

ø25mm



1

GEV No.	346094	Ref. No.	483286002425
description	push switch mounting ø 25mm orange 2NO/indicator light 250V 16A with rubber collar connection male faston 6.3mm ambient temperature max. 85°C protection IP65		

microswitches

lever actuated



1

GEV No.	346927	Ref. No.	771985009990 820035
description	microswitch with lever 250V 10A 2CO connection male faston 6.3mm Lmm ambient temperature max. 125°C mounting distance 22mm double type VRSR01DA1 actuating force: 220g		

pin-plunger actuated

M10



1

GEV No.	345032	Ref. No.	483286008198
description	microswitch with plunger thread M10x1 thread L 12mm 250V 16A 1CO connection male faston 6.3mm stroke 7mm mounting distance 22mm L 28mm ambient temperature max. 125°C type SP9603 actuating force: 180g		

M12



1

GEV No.	345360	Ref. No.	483286002641
description	microswitch with plunger mounting distance 25.4mm thread M12x1 thread L 15mm 250V 10A 1CO connection screw stroke 5mm ambient temperature max. 125°C type Highly D5000 actuating force: 200g		

system switches (ROLD)



1

GEV No.	345724	Ref. No.	192919 771985004988
description	cap size 23x23mm black MIN/MED/MAX		



1

GEV No.	345537	Ref. No.	483286008922
description	element holder mounting measurements 20.6x16.4mm grey arched for push buttons 13x17mm		



1

GEV No.	345539	Ref. No.	483286008921
description	push button size 17x13mm grey		



1

GEV No.	345605	Ref. No.	483286008918
description	switch 2CO 250V 16A connection male faston 6.3mm		



cam switches

on/off

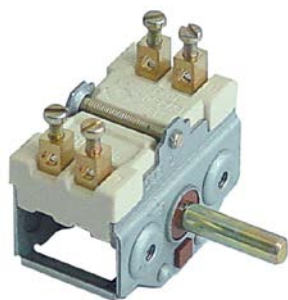

1

GEV No.	300151	Ref. No.	483286009387
description	cam switch 2 operating positions 2NO sequence 0-1 16A shaft \varnothing 6x4.6mm shaft L 23mm connection screw ceramic		

4-position

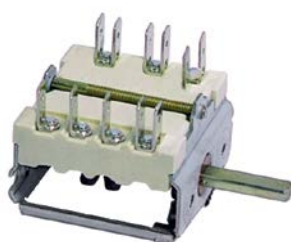

1

GEV No.	300007	Ref. No.	483286009309
description	cam switch 4 operating positions 1NO/2CO sequence 0-1-2-3 16A shaft \varnothing 6x4.6mm shaft L 23mm connection male faston 6.3mm 4-position ceramic		

7-position



1

GEV No.	300004	Ref. No.	483286009633
description	cam switch 7 operating positions 1NO/2CO sequence 0-1-2-3-4-5-6 16A shaft \varnothing 6x4.6mm shaft L 23mm connection male faston 6.3mm 7-position ceramic		

3 operating positions



1

GEV No.	300167	Ref. No.	483286009427
description	cam switch 3 operating positions 2NO/1CO sequence 0-1-2 16A shaft \varnothing 6x4.6mm shaft L 23mm connection screw		

4 operating positions

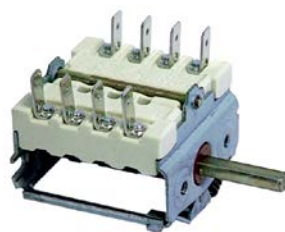

1

GEV No.	300184	Ref. No.	483286009617
description	cam switch 4 operating positions sequence 0-3-2-1 shaft \varnothing 6x4.6mm connection male faston 4-pole		

8 operating positions

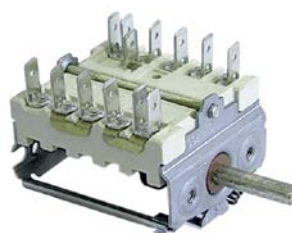

1

GEV No.	301094	Ref. No.	155017 771985007011
description	cam switch 8 operating positions 7NO sequence 0-1-2-3-4-5-6-7 16A shaft \varnothing 6x4.6mm shaft L 23mm connection male faston 6.3mm ceramic		

operation switches



1

GEV No.	300080	Ref. No.	483286009371
description	cam switch 2 operating positions 4NO 16A sequence 0-1 shaft \varnothing 6x4.6mm shaft L 23mm connection screw operation switch ceramic ambient temperature max. 150°C		

accessories for	300080		
	GEV No.	Ref. No.	—
	gasket for switch ED \varnothing 14mm ID \varnothing 2.5mm thickness 3.5mm white		



1	GEV No.	300091	Ref. No.	483286009351
description	operation switch EGO 2 operating positions 2NO 16A sequence 0-1 shaft \varnothing 6x4.6mm shaft L 23mm connection screw ceramic			

rotary switches

TECNOMATIC



1	GEV No.	346102	Ref. No.	483286002479
description	rotary switch 6 2-1-0-3-4-5 sets of contacts 10 type HD12X303R000 600V 12A shaft \varnothing 6mm shaft L 22mm shaft round connection male faston 6.3mm			

magnetic switches

36x13mm



1	GEV No.	347557	Ref. No.	188578 771985012950
description	magnetic switch L 36mm W 13mm 1NO cable length 800mm H 8mm mounting distance 22mm			

50x19mm

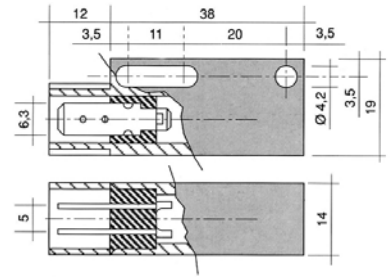

1	GEV No.	345821	Ref. No.	149921 771985002220
description	magnetic switch L 50mm W 19mm 1NO 250V 1A P max. 50W connection male faston 6.3mm			
accessories for	345821			
	GEV No.	519049	Ref. No.	149627 4832 860 08117 483286008762 483286008861
magnet \varnothing mm L 63mm H 10.7mm W 18.8mm hole distance 52mm M2 hole \varnothing 2mm				

M10x0.75

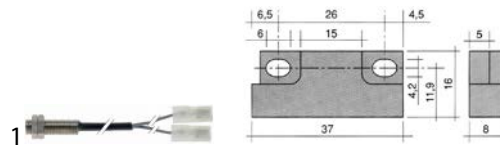

1	GEV No.	347936 ¹	Ref. No.	483286001215
description	magnetic switch thread M10x0.75 1NO 230V 0.04A P max. 10W connection Faston 6.3mm cable length 1100mm			

¹with coded connector

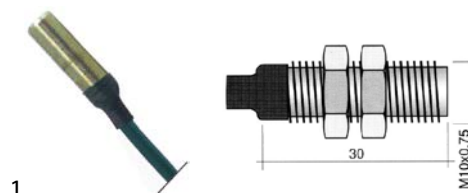

1	GEV No.	345632	Ref. No.	483286008341
description	magnetic switch thread M10x0.75 1NO 250V 0.5A P max. 50W connection cable cable length 2000mm type 102			
accessories for	345632			
	GEV No.	100779	Ref. No.	—
nut thread M10x0.75 H 3mm WS 14 SS Qty 2 pcs				



accessories

magnets

1

GEV No.	345398	Ref. No.	483286008354
description	magnet ømm L 36mm H 8mm W 13mm hole distance 20mm M3 hole ø 3mm		

1

GEV No.	519049	Ref. No.	149627 4832 860 08117 483286008762 483286008861
description	magnet ømm L 63mm H 10.7mm W 18.8mm hole distance 52mm M2 hole ø 2mm		
accessories for	519049		
	GEV No.	560095	Ref. No.
	sheet metal screws ø 2.9mm L 9.5mm SS Qty 20 pcs DIN 7981/ISO 7049 head ø 5.6mm oval head		

encoders and potentiometers

1

GEV No.	403908	Ref. No.	483286010114
description	encoder shaft ø 6x4.6mm shaft L 10mm connection coded cable length 980mm		

lamps

indicator lights

indicator lights (complete)

ø 9mm

1

GEV No.	359136	Ref. No.	483286008203 771985010290
description	indicator light ø 9mm 230V green connection male faston 6.3mm temp.-resist. 120°C		

ø10mm

with screw socket

1

GEV No.	359378	Ref. No.	771985003566 771985010932
description	indicator light ø 10mm 230V green connection male faston 6.3mm socket screw base		

ø12mm

with plug-in socket

1

GEV No.	359041	Ref. No.	483286009168
description	indicator light ø 12mm green 230V connection male faston 6.3mm temp.-resist. 120°C Qty 1 pcs		

1

GEV No.	359042	Ref. No.	483286009189
description	indicator light ø 12mm yellow 230V connection male faston 6.3mm temp.-resist. 120°C Qty 1 pcs		

ø13mm

with plug-in socket

1

GEV No.	359364	Ref. No.	771985000510
description	indicator light ø 13mm green 230V		

screw-on/push-on fit

halogen lamp

for socket G4 / G6.35 / G9

1

GEV No.	359074	Ref. No.	483286008688
description	halogen lamp socket G6.35 12V 35W temp.-resist. 500°C		



oven lamps

universal oven lamps

mounting diameter 47.8mm



GEV No.	357187	Ref. No.	771985010401
description	oven lamp mounting ø 47.8mm 230V 15W socket E14 temp.-resist. 300°C connection male faston 6.3mm hard glas		
spare parts for	357187		
	GEV No.	359610	Ref. No. —
	light bulb t.max. 300°C socket E14 15W 230V ø 22mm L 47mm lens L 20mm for oven lamp type Philips		
	GEV No.	359725	Ref. No. —
	oven lamp glass thread ø 44mm H 43mm ø 54mm hard glas temp.-resist. 350°C		

55x70mm



GEV No.	360731	Ref. No.	483286002063
description	oven lamp complete 230V 25W socket G9 L 70mm W 55mm		

lamps

halogen lamps

for socket G4 / G6.35 / G9



GEV No.	359074	Ref. No.	483286008688
description	halogen lamp socket G6.35 12V 35W temp.-resist. 500°C		

sockets

G4 / G5,3 / G6,35





GEV No.	359369	Ref. No.	483286002473
description	lamp socket socket G4/G5.3/G6.35 24V ø 17mm H 10mm connection cable 120mm mounting distance 11.5mm for halogen lamp cable length 730mm		

timers

programme timers



GEV No.	360234	Ref. No.	483286008916
description	timer FIBER P25 engines 2 chambers 4 operation time 6s / 3min 230V shaft ømm shaft Lmm manuf. no. P255J04JBC7 motor type M51B-JOR6400 / M51BJ0L6400		
spare parts for	360234		
	GEV No.	360673	Ref. No. —
	motor kit pinion ø 6.8mm teeth 15 230V voltage AC 50/60Hz turn direction clockwise motor ø 48mm H 18.5mm motor type UDS-40NE1RNZ165 cable length 150mm with holder		
	GEV No.	360674	Ref. No. —
	motor kit pinion ø 6.8mm teeth 15 230V voltage AC 50/60Hz turn direction counterclockwise motor ø 48mm H 18.5mm motor type UDS40NE1RNZ165 cable length 150mm with holder		

electric timers

with time spread



GEV No.	350074	Ref. No.	483286008723
description	timer MS65 operation time 120min time spread 30min 1CO/2NO/1NC at 250V 16A permanent position yes impulse electric shaft ø 6x4.6mm shaft L 22mm mounting distance 28mm connection lateral Invensys 4-pole shaft position lower°		

defrost timers

miscellaneous



GEV No.	360187	Ref. No.	184986 771985005240
description	defrost timer type RZ-2001-21 defrosting interval 4H defrosting time 15min fan delay 5min 230V 50Hz defr. funct. 4x per 24h		



alarm devices

buzzer boards

			
1			
GEV No.	401062	Ref. No.	483286008724
description	buzzer board 230VAC L 48mm W 45mm connection Faston 6.3mm		

contactors

GENERAL ELECTRIC (AEG)



power contactors



			
1			
GEV No.	380244	Ref. No.	483286009363
description	power contactor resistive load 25A 230VAC (AC3/400V) 9A/4kW main contacts 3NO auxiliary contacts 1NO connection screw connection type AEG LS4K 10A type GE CL00A 310		

			
1			
GEV No.	380262	Ref. No.	483286009362
description	power contactor resistive load 32A 230VAC (AC3/400V) 17A/7.5kW main contacts 3NO auxiliary contacts 1NC connection screw connection type AEG LS7K01A type GE CL02A 301 H 85mm		

LOVATO

power contactors

				
1				
GEV No.	380705	Ref. No.	483286002413	
description	power contactor resistive load 20A 230VAC (AC3/400V) 9A/4kW main contacts 3NO auxiliary contacts 1NO connection screw connection type 11BG0910A230			
accessories for	380705			
	GEV No.	380057	Ref. No.	483286003058
	auxiliary contact contacts 1NO/1NC AC1 10A for contactors BG series connection screw type BGX1011			

				
1				
GEV No.	380855	Ref. No.	483286002467	
description	power contactor resistive load 25A 230VAC (AC3/400V) 4.2kW main contacts 3NO auxiliary contacts 1NO			
accessories for	380855			
	GEV No.	380055	Ref. No.	483286002486
	RC circuit voltage AC/DC suitable for BF09-32 rated 240V			
	GEV No.	380118	Ref. No.	483286002617
	auxiliary contact contacts 1NO/1NC AC1 10A for contactors BF series connection screw type G480/11			

auxiliary contacts

			
1			
GEV No.	380118	Ref. No.	483286002617
description	auxiliary contact contacts 1NO/1NC AC1 10A for contactors BF series connection screw type G480/11		



			
1			
GEV No.	380057	Ref. No.	483286003058
description	auxiliary contact contacts 1NO/1NC AC1 10A for contactors BG series connection screw type BGX1011		

miscellaneous

RC circuits

			
1			
GEV No.	380056	Ref. No.	483286002398
description	RC circuit 250V		

relays

power relays

with bracket mounting

			
1			
GEV No.	380139	Ref. No.	483286008915
description	power relays FINDER 230VAC 16A 2CO connection F6.3 bracket mounting dimensions 68x38.2x35.8mm manuf. no. 62.82.8.230.0000		

transformers

open transformers

with clamp terminal

			
1			
GEV No.	401128	Ref. No.	483286002488
description	transformer primary 230V secondary 12V 100VA		

			
1			
GEV No.	401065	Ref. No.	483286003066
description	transformer primary 230V secondary 12V 120VA secondary 7.5A+2.5A connection screw 50/60Hz		

encapsulated transformers

multiple connections

			
1			
GEV No.	401136	Ref. No.	483286002397
description	transformer primary 230V secondary 12V 60VA		

			
1			
GEV No.	401087	Ref. No.	483286002556
description	transformer primary 230V secondary 24V 60VA secondary 2.5A connection male faston 6.3mm 50/60Hz		

probes

producer-specific probes

probes

			
1			
GEV No.	378047	Ref. No.	483286002455
description	temperature probe NTC 100kOhm cable TPE probe -40 up to +110°C cable -40 up to +110°C connection male faston thread probe ø5x-20mm cable length 0.9m		

			
1			
GEV No.	378671	Ref. No.	483286002451
description	temperature probe Pt1000 cable PTFE connection 2-wire probe ø4x60mm cable length 1.3m		



core probes



1

GEV No.	401944	Ref. No.	771985011103
description	core temperature probe NTC 10kOhm cable silicone probe -40 up to +120°C cable -50 up to +180°C connection plug probe ø5x80mm thread cable length 3m handle ø 10mm handle length 100mm L1 150mm L2 70mm		

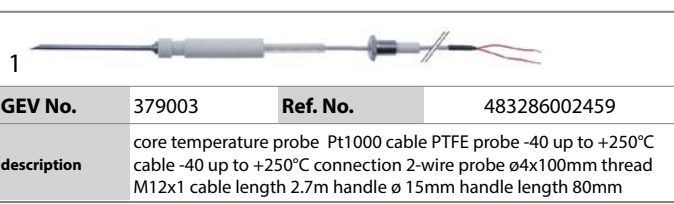

1

GEV No.	379003	Ref. No.	483286002459
description	core temperature probe Pt1000 cable PTFE probe -40 up to +250°C cable -40 up to +250°C connection 2-wire probe ø4x100mm thread M12x1 cable length 2.7m handle ø 15mm handle length 80mm		

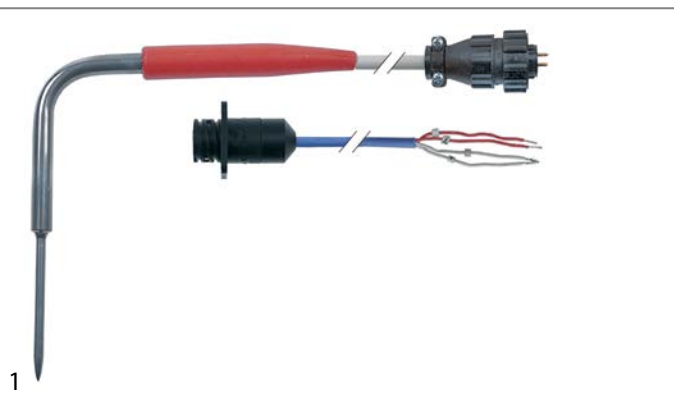

1

GEV No.	379548	Ref. No.	483286000033
description	core temperature probe PTC 1kOhm cable silicone probe -50 up to +150°C cable -50 up to +180°C connection 4-wire probe ø5x70mm thread cable length 1.2m handle ø 10mm handle length 120mm L1 150mm L2 80mm		

electronics

PCBs

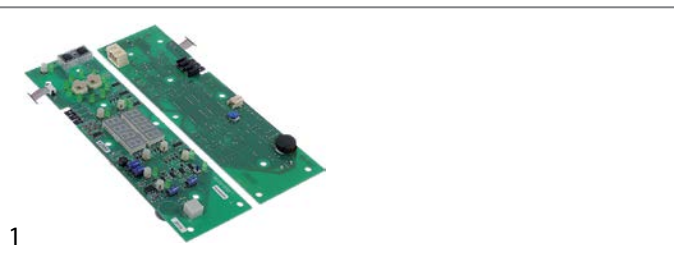

1

GEV No.	403444	Ref. No.	188591 771985011102
description	control PCB L 290mm W 80mm cable length 800mm green display 2x4 digits		

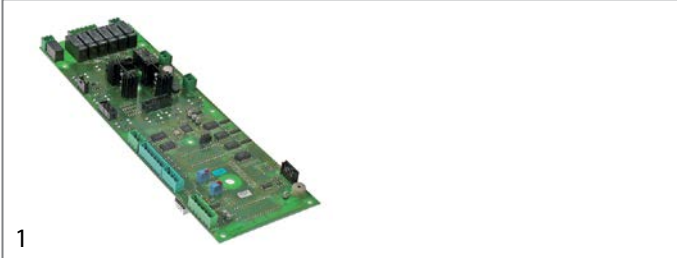

1

GEV No.	401063	Ref. No.	483286002099
description	keypad PCB		



1

GEV No.	401742	Ref. No.	187338
description	keypad PCB		

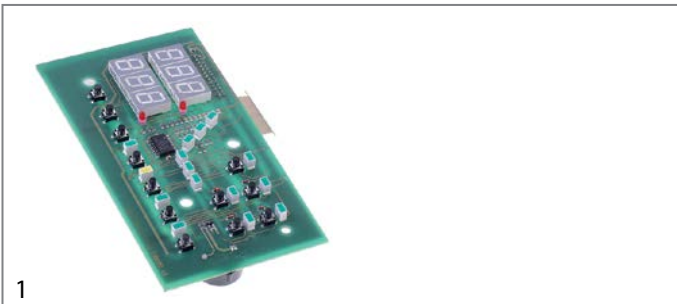

1

GEV No.	401780	Ref. No.	483286002799
description	keypad PCB blast chiller L 160mm W 85mm suitable for ILSA vertical		
accessories for	401780		
	GEV No.	Ref. No.	—
	401781		
	keypad foil vertical L 138mm W 68mm		



1

GEV No.	401753	Ref. No.	185925 771985005280
description	keypad PCB for HACCP with main PCB		

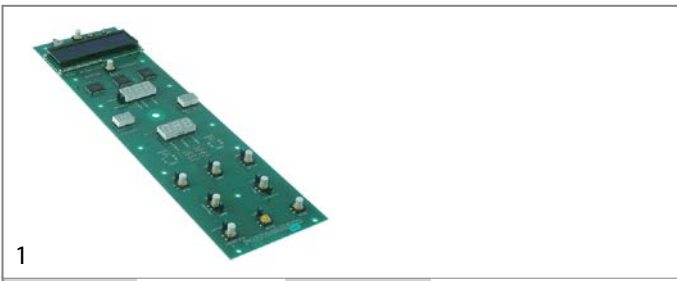

1

GEV No.	401064	Ref. No.	483286003065
description	keypad PCB programmable key pad F-Series encoder		



1	GEV No.	403608	Ref. No.	771985000639
	description	main PCB convection oven L 340mm W 115mm display		



1	GEV No.	403442	Ref. No.	190018
	description	PCB blast freezer BC100 L 165mm W 120mm suitable for ZANUSSI 50/60Hz 230V H 40mm 2.8A Qty 1 pcs		



1	GEV No.	403443	Ref. No.	185926 771985005281
	description	PCB blast freezer BCF 72/144 suitable for ZANUSSI		

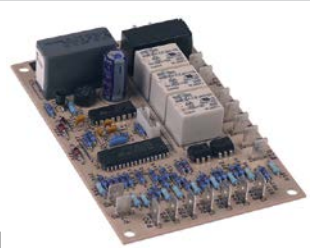

1	GEV No.	401029	Ref. No.	483286003286 4832860032B2
	description	PCB dishwasher LF 50 L 122mm W 80mm Qty 1 pcs		



1	GEV No.	403326	Ref. No.	483286008844
	description	PCB dishwasher Tronic L 145mm W 116mm		



1	GEV No.	401061	Ref. No.	483286002558
	description	PCB for fan		



1	GEV No.	401058	Ref. No.	483286003183
	description	PCB suitable for programmable key pad F-Series controller		

solenoid valves

solenoid valves (water)

ROBERTSHAW/INVENSYS

medium temperature: 90°C 90°C 60°C
 ambient temperature: 60°C 25°C 60°C
 duty cycle: 40% 100% 100%



1	GEV No.	372025	Ref. No.	483286008703
	description	solenoid valve triple straight 230VAC inlet 3/4" outlet 11.5mm DN10 EATON (INVENSYS)		

RPE



1	GEV No.	374021	Ref. No.	483286002456
	description	solenoid valve double straight 230VAC inlet 3/4" outlet 10mm DN10 RPE		



solenoid valves with reducers			
2-fold			
			
1			
GEV No.	374035	Ref. No.	483286002457
description	solenoid valve double straight 230VAC inlet 3/4" outlet 11.5mm input 10-12l/min t.max. 60°C duty cycle 100% plastic		

TP			
			
			
1			
GEV No.	370017	Ref. No.	483286008141
description	solenoid valve single straight 230VAC inlet 3/4" outlet 11.5mm DN10 TP p max 10bar		
spare parts for	370017		
	GEV No.	371013	Ref. No. —
solenoid coil TP 230VAC 50/60Hz			
accessories for	370017		
	GEV No.	371220	Ref. No. —
reducer TP flow rate 3l/min red tolerance ±15%			
	GEV No.	371221	Ref. No. —
reducer TP flow rate 5.5l/min yellow tolerance ±15%			
	GEV No.	371222	Ref. No. —
reducer TP flow rate 6l/min grey tolerance ±15%			
	GEV No.	371223	Ref. No. —
reducer TP flow rate 10l/min white tolerance ±15%			
	GEV No.	371224	Ref. No. —
reducer TP flow rate 12l/min bronze tolerance ±15%			
	GEV No.	371225	Ref. No. —
reducer TP flow rate 16l/min light brown tolerance ±15%			
	GEV No.	371226	Ref. No. —
reducer TP flow rate 20l/min red tolerance ±15%			
	GEV No.	371230	Ref. No. —
reducer TP flow rate 0.25l/min red tolerance ±25%			
	GEV No.	371231	Ref. No. —
reducer TP flow rate 0.35l/min violet tolerance ±25%			
	GEV No.	371232	Ref. No. —
reducer TP flow rate 0.5l/min orange tolerance ±25%			
	GEV No.	371233	Ref. No. —
reducer TP flow rate 0.8l/min white tolerance ±25%			

accessories for	370017		
	GEV No.	371234	Ref. No. —
reducer TP flow rate 1l/min light blue tolerance ±25%			
	GEV No.	371235	Ref. No. —
reducer TP flow rate 1.2l/min brown tolerance ±25%			
	GEV No.	371236	Ref. No. —
reducer TP flow rate 1.5l/min light brown tolerance ±25%			
	GEV No.	371237	Ref. No. —
reducer TP flow rate 2.5l/min yellow tolerance ±25%			
	GEV No.	371238	Ref. No. —
reducer TP flow rate 3.4l/min dark green tolerance ±25%			
	GEV No.	371239	Ref. No. —
reducer TP flow rate 5l/min black tolerance ±25%			
	GEV No.	371240	Ref. No. —
reducer TP flow rate 8l/min blue tolerance ±20%			

various			
			
1			
GEV No.	370673	Ref. No.	771985006245
description	solenoid valve 3-way 230VAC BÜRKERT		

metal			
SIRAI			
2-way			
L180-B series			
			
1			
GEV No.	370391	Ref. No.	483286001624
description	solenoid valve 2-ways 24VAC connection 3/4" L 79mm DN 18mm -10 up to +90°C coil type Z610A membranes NBR (water) p max 12bar p min 0.35bar		
accessories for	370391		
	GEV No.	371091	Ref. No. —
power socket plug type DIN 43650B cable lengthmm small			



solenoid valves (various)



1

GEV No.	370338	Ref. No.	483286002414
description	solenoid valve 2-ways 230VAC connection 1/8" DN 6mm		



1

GEV No.	370319	Ref. No.	483286002553
description	solenoid valve 2-ways 230VAC inlet 1/4" outlet 1/4" p max 13bar p min 0.1bar 50Hz 230V brass		
spare parts for	370319		
	GEV No.	371188	Ref. No. —
	solenoid coil 50Hz 230V H 35mm seat ø 13mm type H 17VA series 688		

drain valves



1

GEV No.	370789	Ref. No.	483286008384
description	drain valve 220-240V 50/60Hz NO inlet 50mm outlet 50/35mm MDB-O-2-SO		

ball valves electric



1

GEV No.	401085	Ref. No.	483286002415
description	ball valve inlet 1/2" IT outlet 1/2" IT 230V L 60mm 50/60Hz closed off-current mode of operation electric connection cable 400mm cable 3-pole		

pressure switches

for warewashing

ø 58mm with male faston 6.3mm

with connection horizontal



1

GEV No.	541787	Ref. No.	483286000512
description	pressure control double pressure range 40/20 90/35mbar connection 6mm ø 58mm pressure connection horizontal warewashing pressure connection ø 5.5mm		



1

GEV No.	541781	Ref. No.	483286008801
description	pressure control pressure range 118/50mbar connection male faston 6.3mm ø 58mm pressure connection horizontal pressure connection ø 6mm		

for coffee machines

ø 38mm



1

GEV No.	541340	Ref. No.	483286002416
description	pressure control ø 38mm pressure range 0.5-1.2bar pressure connection vertical preset at 0.9bar coffee machine parts connection male faston 6.3mm pressure connection 1/8"		



1

GEV No.	541341	Ref. No.	483286002417
description	pressure control ø 38mm pressure range 1.5-4bar pressure connection vertical preset at 3bar 16A 250V coffee machine parts connection 1/8" pressure connection 1/8"		



for steam control



1

GEV No.	541581	Ref. No.	483286002547
description	pressure control ø 38mm pressure range fixed 1.6bar connection 1/8" 1CO 16A preset at 1.6barbar pressure connection 1/8" ET		



1

GEV No.	541350	Ref. No.	202480
description	pressure control pressure range adjustable 0.3-0.8bar connection 1/4" CO 250V 10A ambient temperature max. 60°C pressure connection 1/4"		

electrodes



1

GEV No.	401086	Ref. No.	483286002548
description	level electrode 1/4" total length 70mm probe L 44mm insulated probe length 39mm PTFE insulated connection male faston 6.3mm stainless steel ø 2.5mm		

compressors

ACC/ZEL

R134A

HMBP monophase

High/Medium evaporation temperature above -20/-15 °C



1

GEV No.	605012	Ref. No.	185501 771985005257
description	compressor coolant R134a type GL45TB 220-240V 50Hz HMBP fully hermetic 8.4kg 1/6HP power input 342W cylinder capacity 4.5cm ³ CSIR H 175.5mmW 76W 101W 134W 175W 223W 278W 342W 413W test method ASHRAE ambient temperature max. 43°C		

CUBIGEL

R404a/R507

LBP monophase

Lower evaporation temperature below -20°C



1

GEV No.	605180	Ref. No.	483286000077
description	compressor coolant R404a/R507 type MX23FB 220-240V 50Hz LBP 17.5kg 1HP power input 7/8W cylinder capacity 23.2cm ³ CSR H 221mm 749W 982W 1246W 1541W 1868WWWWWW		

EMBRACO / ASPERA

R134A

LBP monophase

Lower evaporation temperature below -20°C



1

GEV No.	605231	Ref. No.	481936058775
description	compressor coolant R134a type EMT43HLP 220-240V 50Hz LBP 7.5kg 1/8HP cylinder capacity 4.85cm ³ RSIR/RSCR H 166mm 89W 118W 153W 195W 246W 308WWWWWW test method EN 12900 ambient temperature max. 43°C		



1

GEV No.	605265	Ref. No.	485409918009
description	compressor coolant R134a type NE2134Z 220-240V 50Hz LBP 11.65kg 1/2HP cylinder capacity 14.28cm ³ CSIR 261W 350W 458W 588W 741WWWWWW test method ASHRAE		



HBP monophase

High evaporation temperature above -15°C



GEV No.	605254	Ref. No.	485409918012
description	compressor coolant R134a type NJ6220Z-A 220-240V 50Hz HBP 20.3kg 1HP cylinder capacity 26.2cm ³ CSIRWWW 962W 1263W 1638W 2087W 2610W 3206W test method EN 12900		



GEV No.	605175	Ref. No.	485409918015
description	compressor coolant R134a type NJ6226Z 220-240V 50Hz HBP 19.8kg 1 1/4HP cylinder capacity 34.37cm ³ CSR H 253mmWWW 1144W 1497W 1892W 2340W 2852W 3438W		

R404a/R507

HMBP monophase

High/Medium evaporation temperature above -20/-15 °C



GEV No.	605190	Ref. No.	485409918034
description	compressor coolant R404a/R507 type NJ9232GK 220-240V 50Hz HMBP 22.1kg 1 1/4HP cylinder capacity 26.2cm ³ CSR H 277mmWW 1093W 1470W 1911W 2413W 2973W 3588W 4255W ambient temperature max. 45°C		



GEV No.	605177	Ref. No.	485409918084
description	compressor coolant R404a/R507 type NJ9238GK 220-240V 50Hz HMBP 22.1kg 1 1/2HP cylinder capacity 32.7cm ³ CSR H 277mmW 2016W 2640W 3315W 4045W 4830W 5668W 6560W		

R600A

LBP monophase

Lower evaporation temperature below -20°C



GEV No.	605246	Ref. No.	481236038764
description	compressor coolant R600a type EMT26CLP 220-240V 50Hz LBP 1/10HP cylinder capacity 5.19cm ³ RSIR H 166mm 54W 73W 95W 120W 151W 190WWWW test method EN 12900		



SECOP DANFOSS

R134A

HMBP monophase

High/Medium evaporation temperature above -20/-15 °C



GEV No.	605088	Ref. No.	483286008054
description	compressor coolant R134a type FR7.5G 220-240V 50Hz HMBP fully hermetic 10.6kg 1/5HP power input 175W cylinder capacity 6.93cm ³ RSIR/CSIR H 196mm 62W 99W 142W 193W 254W 325W 408W 505W 618W test method ASHRAEW		
spare parts for	605088		
	GEV No.	381529	Ref. No. —
	start relay DANFOSS 117U6001		

R404a/R507

LBP monophase

Lower evaporation temperature below -20°C



GEV No.	605056	Ref. No.	485409918013
description	compressor coolant R404a/R507 type SC18CLX.2 220-240V 50Hz LBP fully hermetic 13.7kg 5/8HP cylinder capacity 17.69cm ³ CSR H 219mm 562W 691W 881W 1095W 1332W 1593W test method ASHRAE		
spare parts for	605056		
	GEV No.	381548	Ref. No. —
	start relay DANFOSS		

evaporation and condensing trays

condensing trays heated

universal

heating cartridges

GEV No.	417227	Ref. No.	183814
description	heating cartridge 90W 230V ø 12mm L 124mm thread 3/8" cable length 4000mm Hmm Wmm condensate evaporation		

fans

axial fans

import

GEV No.	601080 ¹	Ref. No.	483286008695
description	axial fan L 119mm W 119mm H 38mm 230VAC 50/60Hz 23/20W bearing ball bearing connection male faston 2.8mm metal ADDA fan wheel ø 110mm temp.-resist. 70°C		
accessories for	601080		
	GEV No.	550898	Ref. No. —
	connecting cable cable length 2000mm connection F 2.8 connection distance 7.9mm for axial flow fan		
	GEV No.	692519	Ref. No. —
	guard L 120mm W 120mm plastic		

¹with ball bearings

refrigeration fans

refrigeration motors universal

ebm-papst

standard motors



GEV No.	601952	Ref. No.	483286002784
description	fan motor 25W 230V 50/60Hz cable length 450mm 1300/1550rpm ebm-papst 5 mounting options bearing slide bearing		

accessories

fan wheels

aluminium

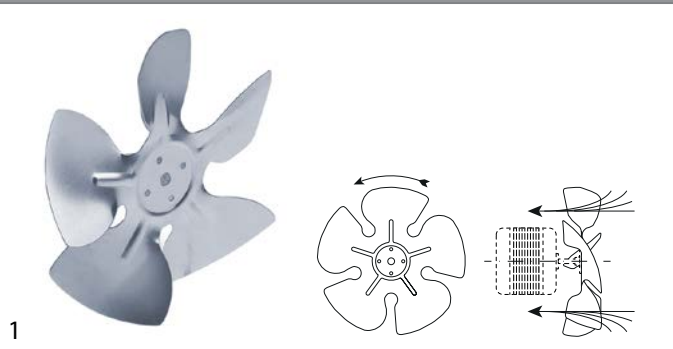

GEV No.	601566	Ref. No.	483286008076
description	fan wheel sucking ø 154mm fan wheel mounting 25.4mm blade angle 28° W 34mm aluminium		

cold air circulating fans (complete)

ebm-papst

A2E series

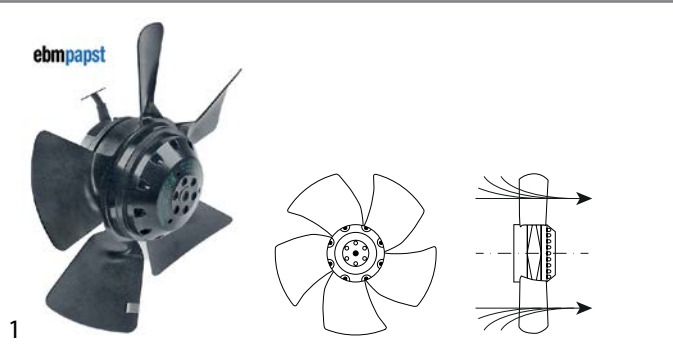

GEV No.	601959	Ref. No.	184722 771985005224
description	fan A2E250-AE65-02 fan wheel ø 250mm blades 5 230V 50/60Hz 115/165W 2550/2750rpm cable length 1800mm ebm-papst blowing		

R2E series

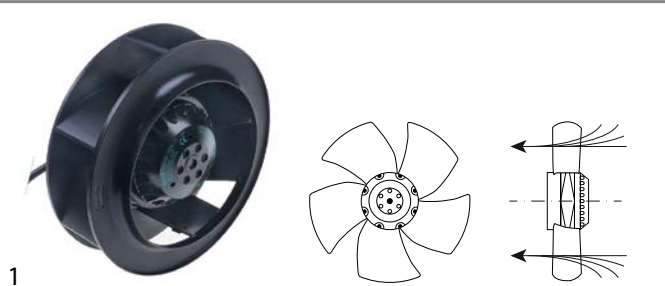

GEV No.	601536	Ref. No.	771985010360	
description	fan R2E190-A026-73 fan wheel ø 190mm blades 6 230V 50/60Hz 58/75W ø 190mm H 70mm 2700rpm cable length 450mm rotation direction right ebm-papst sucking suitable capacitor 2µF			
spare parts for	601536			
	GEV No.	365170	Ref. No.	—
	capacitor capacity 2µF 425V tolerance 5% 50/60Hz ambient temperature max. -25 to +85°C ø 25mm L 49mm M8 plastic connection cable 250mm 416.17.74 protection			

cross flow fans

EMMEVI - FERGAS

with moulded coils



GEV No.	601110	Ref. No.	483286008073
description	cross flow fan TGO 60/1-180/20 roller ø 60mm roller length 180mm laminated core thickness 20mm motor position left 230V/50Hz 28W refrigeration bearing rubber connection male faston 6.3mm -30 up to +100°C 230V cable length 1800mm		

COPREL

with standard coil



GEV No.	602044	Ref. No.	483286008055
description	cross flow fan COPREL TFR 180/20-14CSN roller ø 60mm roller length 180mm laminated core thickness 20mm motor position right 230V/50Hz 27W refrigeration bearing rubber connection male faston 6.3mm t.max. 60°C airflow 144m³/h -30 bis +60°C		



hot air motors

1



GEV No.	550049	Ref. No.	483286008699
description	counterflange for fan motor ED \varnothing 60mm int. \varnothing 1 27.3mm int. \varnothing 2 18.5mm thickness 5.8mm brass		

1

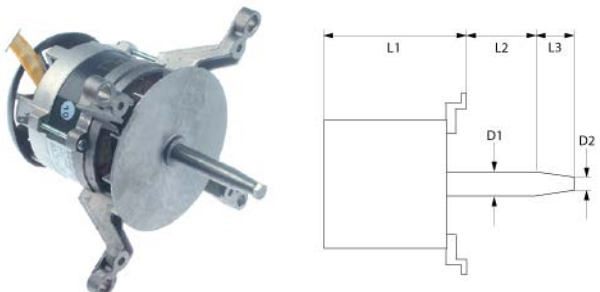

GEV No.	500630	Ref. No.	483286008681
description	fan motor 230/400V 3 phase 50Hz 0.37kW 2600rpm speeds 1 L1 175mm L2 50mm L3 28mm D1 \varnothing 17mm D2 \varnothing 12mm M8R IT 1.1/1.9A Cos(fi) 0.75 at 50Hz 2600rpm type 1020.5450		

1



GEV No.	602082	Ref. No.	771985000205
description	fan wheel blades 6 D1 \varnothing 440mm D2 \varnothing 10mm D3 \varnothing 10mm H1 154mm H2 15mm		

1

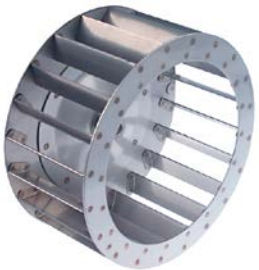

GEV No.	514261	Ref. No.	483286008701
description	fan wheel D1 \varnothing 210mm H1 100mm blades 20 D2 \varnothing 11mm D3 \varnothing 16mm H2 30mm		

1



GEV No.	541580	Ref. No.	483286002963
description	fan wheel D1 \varnothing 250mm H1 120mm blades 26 D2 \varnothing 11.5mm D3 \varnothing 16.5mm H2 29mm		

1



GEV No.	514262	Ref. No.	483286002963
description	fan wheel D1 \varnothing 250mm H1 120mm blades 26 D2 \varnothing 11mm D3 \varnothing 16mm H2 30mm		

pumps

wash and rinse pumps

LGB



1



GEV No.	500567	Ref. No.	483286008976	
description	pump inlet \varnothing 28mm outlet \varnothing 28mm type ZF121DX 230V 50Hz 1 phase 0.25kW L 195mm rotation direction left capacitor 6.3 μ F LGB			
spare parts for	500567			
	GEV No.	365012	Ref. No.	—
	operating capacitor capacity 6.3 μ F 450V tolerance 5% 50Hz ambient temperature max. -25 to +85°C \varnothing 30mm L 61mm M8 plastic connection male faston 6.3mm protection			
	GEV No.	510703	Ref. No.	—
	mechanical shaft seal for shaft \varnothing 13mm slide ring H 13mm height counter ring 5.5mm ED \varnothing 26mm			

Table continues overleaf



spare parts for 500567			
	GEV No.	521098	Ref. No. —
pump cover LGB inlet ø 28mm outlet ø 26mm auxiliary pressure connection 12mm ID ø 77mm			
	GEV No.	521099	Ref. No. —
impellor ø 72mm H 17mm thread M7R shaft ø 13mm shaft length 12mm			
	GEV No.	528800	Ref. No. —
O-ring EPDM thickness 2.62mm ID ø 75.87mm Qty 1 pcs			



1			
GEV No.	500508	Ref. No.	483286008775
description	pump inlet ø 45mm outlet ø 38mm type ZF320VSX 230V 50Hz 1 phase 0.75kW 1HP L 230mm rotation direction right capacitor 12.5µF LGB		
spare parts for 500508			
	GEV No.	365014	Ref. No. —
operating capacitor capacity 12.5µF 450V tolerance 5%Hz ambient temperature max. -25 to +85°C ø 35mm L 70mm M8 plastic connection male faston 6.3mm 455.C3D5.12.5 protection			
	GEV No.	510702	Ref. No. —
mechanical shaft seal height counter ring 5.5mm ID ø 12mm			
	GEV No.	521247	Ref. No. —
impellor ø 90mm H 27mm rotation direction right thread M8L blades 6			
	GEV No.	521542	Ref. No. —
pump cover LGB inlet ø 45mm outlet ø 40mm auxiliary pressure connection 13mm supporting pressure open ø 150mm ID ø 120mm inner height 25mm			
	GEV No.	521714	Ref. No. —
pump cover gasket thickness 4x4mm Qty 1 pcs			

drain pumps

GRE



1			
GEV No.	500385	Ref. No.	483286000127
description	drain pump inlet ø 30mm outlet ø 21mm 100W 230V 50Hz GRE		
accessories for 500385			
	GEV No.	500307	Ref. No. —
filter			



1			
GEV No.	500959	Ref. No.	483286003283
description	drain pump inlet ø 30mm outlet ø 23mm 100W 230V 50Hz GRE		

vibration pumps



1			
GEV No.	500564	Ref. No.	483286002395
description	vibration pump type EP 5 230V 48W 50Hz inlet ø 6 outlet ø 1/8" IT ULKA L 123mm		



1			
GEV No.	500173	Ref. No.	483286002395
description	vibration pump type EP 5 230V 48W 50Hz inlet ø 6 outlet ø 1/8" IT ULKA outlet flat plastic L 123mm		



pumps for ice machines





1

GEV No.	500597	Ref. No.	186545
description	pump GRE type MH50F 60W 230V 50Hz outlet ø 21mm L 110mm rotation direction right for ice maker		



1

GEV No.	500166	Ref. No.	185340	
description	pump REBO type 63/45 150W 230V 50/60Hz inlet ø 28mm outlet ø 26mm L 200mm rotation direction right capacitor 5µF			
spare parts for	500166			
	GEV No.	365017	Ref. No.	—
	operating capacitor capacity 5µF 450V tolerance 5% 50/60Hz ambient temperature max. -25 to +85°C ø 28mm L 54mm M8 plastic connection male faston 6.3mm 16.10.08 protection			
	GEV No.	601412	Ref. No.	—
	fan wheel sucking ø 154mm fan wheel mounting 25.4mm blade angle 28° W 34mm plastic			
	GEV No.	601413	Ref. No.	—
	fixing plate suitable for fanwheel ED ø 32mm shaft ø 7 mounting distance 26mm			



1

GEV No.	500047	Ref. No.	186389
description	pump REBO type MH30F1 30W 230V 50Hz outlet ø 12.7mm L 135mm rotation direction left		



1

GEV No.	500048	Ref. No.	186124
description	pump REBO type MH50F 60W 230V 50Hz outlet ø 18mm L 137mm rotation direction right for ice maker		



1

GEV No.	500203	Ref. No.	186166
description	pump REBO type MH50F 60W 230V 50Hz outlet ø 21mm L 110mm rotation direction right for ice maker		



1

GEV No.	501476	Ref. No.	481936178251 48400000908
description	pump type T3400 50W 220V 50Hz outlet ø 14mm L 105mm rotation direction right for ice-cube maker		

condensators & interference suppression filters

interference suppression filters



1

GEV No.	365090	Ref. No.	483286008712
description	interference suppression filter 250V 50/60Hz capacity 0.47µF(X2)+2X0.027µF(Y2)+2x1mH+0.68MµF		



1

GEV No.	365168	Ref. No.	483286008914
description	interference suppression filter type FCP045000 250V 50/60Hz conductor 4 with E connection male faston 6.3mm L 56mm ø 38mm Hmm Wmm M8 plastic Qty 1 pcs		

RC circuits



1

GEV No.	380056	Ref. No.	483286002398
description	RC circuit 250V		



1

GEV No.	380738	Ref. No.	483286002493
description	RC circuit type 11BGX79240 suitable for BG series rated 125-240VACV		



1

GEV No.	380055	Ref. No.	483286002486
description	RC circuit voltage AC/DC suitable for BF09-32 rated 240V		

electric accessories

terminals

terminal blocks



1

GEV No.	550838	Ref. No.	483286000846
description	lustre terminal 12-pole cross section 6mm ² max. 41A max 750V temp.-resist. 150°C		

electronic magnets



1

GEV No.	691625	Ref. No.	483286002434
description	electronic magnet 230V 50Hz duty cycle 100% L 57mm W 46mm H 32mm		













gas taps

PEL













21S series



1

GEV No.	101397	Ref. No.	483286009272	
description	gas tap PEL type 21S gas inlet M16x1.5 (tube ø 10mm) bypass nozzle ø 0.35mm gas outlet M16x1.5 (tube ø 10/8mm) thermocouple connection M9x1 pilot connection M10x1 shaft ø 8x6.5mm shaft L 22/15mm shaft flat lower			
For models:	AGB352WP, AGB353WP, AGB354WP			
spare parts for	101397			
	GEV No.	100408	Ref. No.	—
	bypass nozzle type PEL20/21 bore ø 0.35mm thread M5x0.5			
	GEV No.	101060	Ref. No.	—
	magnet unit standard L 39mm D1 ø 15.4mm D2 ø 11mm suitable for PEL20-21/JUNKERS/EGA			
	GEV No.	101206	Ref. No.	—
	gas tap front part shaft ø 8x6.5mm shaft L 22/15mm shaft flat upper/lower suitable for PEL21			
	GEV No.	101231	Ref. No.	—
	thermocouple nut T1: M9x1 T2: M18x1			
accessories for	101397			
	GEV No.	100908	Ref. No.	—
	union screw thread M10x1 for pipe ø 4mm Qty 1 pcs			
	GEV No.	100909	Ref. No.	—
	union screw thread M10x1 for pipe ø 6mm Qty 1 pcs			
	GEV No.	101246	Ref. No.	—
	olive for pipe ø 4mm Qty 1 pcs			
	GEV No.	101278	Ref. No.	—
	olive for pipe ø 10mm Qty 1 pcs			
	GEV No.	101286	Ref. No.	—
	olive ID ø 6mm Qty 1 pcs			
	GEV No.	101300	Ref. No.	—
	union nut thread M16x1.5 tube ø 10mm			
	GEV No.	101450	Ref. No.	—
	olive for pipe ø 8mm L 12.7mm Qty 1 pcs ED ø 10mm			
	GEV No.	101451	Ref. No.	—
	union nut thread M16x1.5 tube ø 8mm			
	GEV No.	110081	Ref. No.	—
	knob ø 70mm shaft ø 8x6.5mm shaft flat universal			
	GEV No.	112206	Ref. No.	—
	knob dial plate silver gas tap PEL21/22/23 t.max.°C ED ø 63mm ID ø 45.5mm			



			
1			
GEV No.	101897	Ref. No.	270205
description	gas tap PEL type 215 gas inlet pipe flange ø21mm bypass nozzle ø 0.35mm gas outlet M16x1.5 (tube ø 10/8mm) thermocouple connection M8x1 pilot connection M10x1 shaft ø 8x6.5mm shaft L 32/25mm shaft flat upper		
spare parts for	101897		
	GEV No.	101060	Ref. No. —
	magnet unit standard L 39mm D1 ø 15.4mm D2 ø 11mm suitable for PEL20-21/JUNKERS/EGA		
	GEV No.	101230	Ref. No. —
	thermocouple nut T1: M8x1 T2: M18x1 aluminium		
	GEV No.	101875	Ref. No. —
	gas tap front part shaft ø 8x6.5mm shaft L 32/25mm shaft flat upper/lower type PEL21		
	GEV No.	528347	Ref. No. —
	O-ring Viton thickness 1.78mm ID ø 2.9mm Qty 1 pcs		
accessories for	101897		
	GEV No.	100908	Ref. No. —
	union screw thread M10x1 for pipe ø 4mm Qty 1 pcs		
	GEV No.	100909	Ref. No. —
	union screw thread M10x1 for pipe ø 6mm Qty 1 pcs		
	GEV No.	101246	Ref. No. —
	olive for pipe ø 4mm Qty 1 pcs		
	GEV No.	101278	Ref. No. —
	olive for pipe ø 10mm Qty 1 pcs		
	GEV No.	101286	Ref. No. —
	olive ID ø 6mm Qty 1 pcs		
	GEV No.	101300	Ref. No. —
	union nut thread M16x1.5 tube ø 10mm		
	GEV No.	110081	Ref. No. —
	knob ø 70mm shaft ø 8x6.5mm shaft flat universal		
	GEV No.	112206	Ref. No. —
	knob dial plate silver gas tap PEL21/22/23 t.max.°C ED ø 63mm ID ø 45.5mm		







23S/V series			
			
1			
GEV No.	101093	Ref. No.	483286009212
description	gas tap PEL type 23S/V gas inlet M28x1.5 (tube ø 20mm) bypass nozzle ø 0.35mm thermocouple connection M10x1 pilot connection M10x1 shaft ø 10x8mm shaft L 25/17mm shaft flat lower		
spare parts for	101093		
	GEV No.	100455	Ref. No. —
	bypass nozzle type PEL23/24 bore ø 0.35mm thread M8x0.5		
	GEV No.	101059	Ref. No. —
	magnet unit T1: M10x1 T2: M22x1 L 46mm ø 18mm suitable for PEL23S M10x1		
	GEV No.	101204	Ref. No. —
	gas tap front part shaft ø 10x8mm shaft L 25/17mm shaft flat upper/lower suitable for PEL23S		
	GEV No.	101245	Ref. No. —
	gas connection thread M24x1.5 tube ø 12/16mm vertical for PEL gas taps		
	GEV No.	101463	Ref. No. —
	screw suitable for PEL23S Qty 4 pcs		
	GEV No.	528455	Ref. No. —
	O-ring Viton thickness 2.62mm ID ø 18.72mm Qty 1 pcs		
accessories for	101093		
	GEV No.	100908	Ref. No. —
	union screw thread M10x1 for pipe ø 4mm Qty 1 pcs		
	GEV No.	100909	Ref. No. —
	union screw thread M10x1 for pipe ø 6mm Qty 1 pcs		
	GEV No.	101246	Ref. No. —
	olive for pipe ø 4mm Qty 1 pcs		
	GEV No.	101252	Ref. No. —
	union nut thread M24x1.5 for pipe ø 12mm		
	GEV No.	101253	Ref. No. —
	union nut thread M24x1.5 PEL for pipe ø 16mm		
	GEV No.	101254	Ref. No. —
	union nut thread M28x1.5 tube ø 20mm		
	GEV No.	101255	Ref. No. —
	olive for pipe ø 12mm Qty 1 pcs		
	GEV No.	101256	Ref. No. —
	olive for pipe ø 16mm Qty 1 pcs		
	GEV No.	101257	Ref. No. —
	olive for pipe ø 20mm Qty 1 pcs		

Table continues overleaf

accessories for	101093			
	GEV No.	101286	Ref. No.	—
	olive ID ø 6mm Qty 1 pcs			
	GEV No.	110080	Ref. No.	—
	knob ø 70mm shaft ø 10x8mm shaft flat universal			
	GEV No.	112206	Ref. No.	—
	knob dial plate silver gas tap PEL21/22/23 t.max.°C ED ø 63mm ID ø 45.5mm			

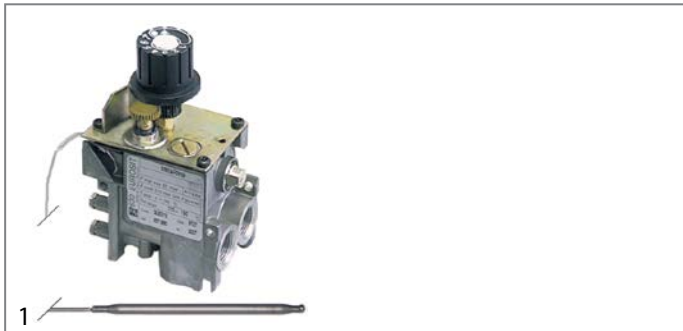

GEV No.	101409	Ref. No.	158772
description	gas thermostat type 630 Eurosit series t.max. 280°C 40-280°C gas inlet 3/8" gas outlet 3/8" thermocouple connection M9x1 pilot connection M10x1 probe ø 4mm probe L 72mm capillary pipe 1050mm SIT		

accessories for	101409			
	GEV No.	101333	Ref. No.	—
	plug thread 3/8" with O-ring			

accessories for	101409			
	GEV No.	100904	Ref. No.	—
	locking screw M10x1 for pipe ø 4mm Qty 1 pcs			

	GEV No.	100905	Ref. No.	—
	locking screw M10x1 for pipe ø 6mm Qty 1 pcs			

	GEV No.	101273	Ref. No.	—
	olive for pipe ø 12mm L 9.5mm brass Qty 1 pcs suitable for universal			

	GEV No.	101276	Ref. No.	—
	union screw thread 3/8" tube ø 12mm Qty 1 pcs			



GEV No.	101915	Ref. No.	483286009225
description	gas thermostat type 630 Eurosit series t.max. 320°C 80-320°C gas inlet 3/8" gas outlet 3/8" thermocouple connection M9x1 pilot connection M10x1 probe ø 4mm probe L 72mm capillary pipe 1050mm SIT		

For models:	AGB352WP, AGB353WP, AGB354WP		
--------------------	------------------------------	--	--

accessories for	101915			
	GEV No.	100825	Ref. No.	—
	gas tap spindle shaft ø 8x6.5mm shaft L 22/14mm suitable for EUROSIT			

	GEV No.	100904	Ref. No.	—
	locking screw M10x1 for pipe ø 4mm Qty 1 pcs			

	GEV No.	100905	Ref. No.	—
	locking screw M10x1 for pipe ø 6mm Qty 1 pcs			

	GEV No.	100949	Ref. No.	—
	gasket suitable for 630 Eurosit series			

Table continues overleaf

gas thermostats

SIT

630 Eurosit series

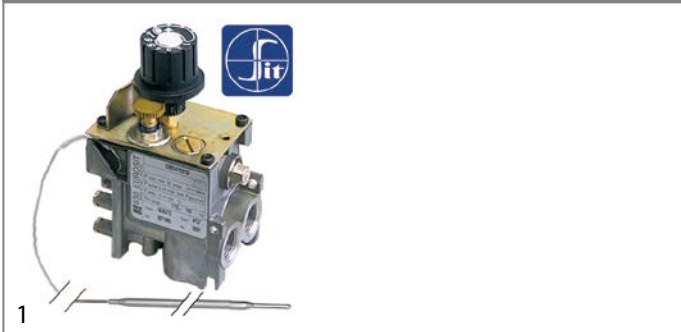



GEV No.	101188	Ref. No.	483286000479
description	gas thermostat type 630 Eurosit series t.max. 190°C 110-190°C gas inlet 3/8" gas outlet 3/8" thermocouple connection M9x1 pilot connection M10x1 probe ø 4mm probe L 202mm capillary pipe 1050mm SIT		

accessories for	101188			
	GEV No.	100904	Ref. No.	—
	locking screw M10x1 for pipe ø 4mm Qty 1 pcs			

	GEV No.	100905	Ref. No.	—
	locking screw M10x1 for pipe ø 6mm Qty 1 pcs			

	GEV No.	101273	Ref. No.	—
	olive for pipe ø 12mm L 9.5mm brass Qty 1 pcs suitable for universal			



	GEV No.	101276	Ref. No.	—
	union screw thread 3/8" tube ø 12mm Qty 1 pcs			

	GEV No.	101333	Ref. No.	—
	plug thread 3/8" with O-ring			



accessories for		101915	
	GEV No.	101273	Ref. No. —
olive for pipe ø 12mm L 9.5mm brass Qty 1 pcs suitable for universal			
	GEV No.	101276	Ref. No. —
union screw thread 3/8" tube ø 12mm Qty 1 pcs			
	GEV No.	101333	Ref. No. —
plug thread 3/8" with O-ring			
	GEV No.	101390	Ref. No. —
gas tap spindle shaft ø 6x4.6mm shaft L 32/15mm gas tap with ignition flame suitable for ZANUSSI, MARENO for gas thermostat EUROSIT			
	GEV No.	101392	Ref. No. —
adapter suitable for 630 Eurosit series			
	GEV No.	110357	Ref. No. —
gas tap spindle shaft ø 8x6.5mm shaft L 36/12mm suitable for 630 Eurosit series			
	GEV No.	110358	Ref. No. —
adapter shaft ø 10x8mm shaft L 29/18mm suitable for 630 Eurosit series			

710 Minisit series

			
1			
GEV No.	107237	Ref. No.	153360 771985026824
description	gas thermostat without cap, button and angle SIT type MINISIT 710 t.max. 210°C 70-210°C gas inlet 1/2" gas outlet 3/8" thermocouple connection M9x1 pilot connection M10x1 probe ø 4mm probe L 122mm capillary pipe 1300mm probe type pressure controller no pressure regulator mbar gland nut		
accessories for		107237	
	GEV No.	101137	Ref. No. —
cover cap without piezoelectric igniter			
	GEV No.	101267	Ref. No. —
reducer IT 3/8" ET 1/2" L 21mm			
	GEV No.	101268	Ref. No. —
gas connection thread 3/8" angled with O-ring MINISIT 710			
	GEV No.	110068	Ref. No. —
knob suitable for Minisit ø 37mm			

PEL

25ST series

			
1			
GEV No.	101955	Ref. No.	771985000630
description	gas thermostat PEL type 25ST 140 up to approx. 300°C gas inlet M16x1.5 (tube ø 10mm) bypass nozzle ø 0.5mm gas outlet M16x1.5 (tube ø 10/8mm) thermocouple connection M8x1 pilot connection M10x1 capillary pipe 1200mm probe ø 6mm probe L 120mm shaft ø 8x6.5mm shaft L 38/15mm shaft flat upper		
spare parts for		101955	
	GEV No.	100390	Ref. No. —
bypass nozzle type PEL22 bore ø 0.5mm thread M6x0.5			
	GEV No.	101060	Ref. No. —
magnet unit standard L 39mm D1 ø 15.4mm D2 ø 11mm suitable for PEL20-21/JUNKERS/EGA			
	GEV No.	106199	Ref. No. —
nut thread M8x1			
accessories for		101955	
	GEV No.	100908	Ref. No. —
union screw thread M10x1 for pipe ø 4mm Qty 1 pcs			
	GEV No.	100909	Ref. No. —
union screw thread M10x1 for pipe ø 6mm Qty 1 pcs			
	GEV No.	101246	Ref. No. —
olive for pipe ø 4mm Qty 1 pcs			
	GEV No.	101278	Ref. No. —
olive for pipe ø 10mm Qty 1 pcs			
	GEV No.	101286	Ref. No. —
olive ID ø 6mm Qty 1 pcs			
	GEV No.	101300	Ref. No. —
union nut thread M16x1.5 tube ø 10mm			
	GEV No.	101450	Ref. No. —
olive for pipe ø 8mm L 12.7mm Qty 1 pcs ED ø 10mm			
	GEV No.	101451	Ref. No. —
union nut thread M16x1.5 tube ø 8mm			
	GEV No.	110079	Ref. No. —
knob dial plate gas thermostat 1-8 silver			
	GEV No.	110081	Ref. No. —
knob ø 70mm shaft ø 8x6.5mm shaft flat universal			



conversion kits



GEV No.	106751	Ref. No.	270006
description	gas thermostat PEL type 25ST 150-290°C gas inlet M16x1.5 pipe input ø 10mm gas outlet M16x1.5 pipe output ø 10/8mm thermo-couple connection M8x1 probe ø 6mm probe L 120mm capillary pipe 1200mm shaft ø 8x6.5mm shaft L 25mm bypass nozzle ø 0.45/0.5/0.55/0.8/0.9mm conversion kit L1 25mm L2 15mm incl. gas/ignition gas line, nozzles, knob shaft flat upper		

accessories for	106280		
	GEV No.	101307	Ref. No. —
	gas connection straight flange 45x45mm hole distance 36x36mm 3/4" ELETTROSIT/V4400/4600/4605 screw with O-ring suitable for SIT/HONEYWELL		
	GEV No.	101308	Ref. No. —
	gas connection angled flange 45x45mm hole distance 36x36mm 3/4" ELETTROSIT/V4400/4600/4605 screw with O-ring suitable for SIT/HONEYWELL		

gas valves and ignition boxes

gas control valves

HONEYWELL



GEV No.	106012	Ref. No.	483286002568
description	gas valve type VK4115V 220-240V 50/60Hz gas inlet flange 32x32mm gas outlet flange 32x32mm thermocouple connection pilot connection pressure range 15-60mbar max 60mbar operator type HONEYWELL flange 32x32mm		
accessories for	106012		
	GEV No.	102845	Ref. No. —
	gas connection angled 1/2" flange 32x32mm hole distance 24x24mm Tandem		
	GEV No.	102846	Ref. No. —
	gas connection straight 1/2" flange 32x32mm hole distance 24x24mm suitable for Tandem		



GEV No.	106280	Ref. No.	483286003056
description	gas valve type VK4115V 230V 50Hz gas inlet 3/8" gas outlet ø 14mm, edgewise max 60mbar HONEYWELL		
accessories for	106280		
	GEV No.	101305	Ref. No. —
	gas connection straight 1/2" flange 45x45mm ELETTROSIT/V4400/4600/4605 suitable for SIT/HONEYWELL hole distance 36x36mm		
	GEV No.	101306	Ref. No. —
	gas connection angled flange 45x45mm hole distance 36x36mm 1/2" ELETTROSIT/V4400/4600/4605 screw with O-ring suitable for SIT/HONEYWELL		

SIT
NOVASIT

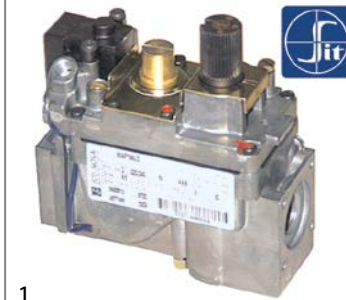

GEV No.	101162	Ref. No.	483286009413
description	gas valve SIT series Novasit 820 230V 50Hz gas inlet 1/2" gas outlet 1/2" thermocouple connection M9x1 pilot connection M10x1 ignition pressure 3-5mbar pressure range 3-30mbar pressure regulator connection blind equiv. no. 0.820.010		
spare parts for	101162		
	GEV No.	101065	Ref. No. —
	magnet unit with cable L 44mm D1 ø 30mm D2 ø 20mm suitable for NOVASIT		
	GEV No.	101313	Ref. No. —
	solenoid coil 230V 50Hz		
accessories for	101162		
	GEV No.	100006	Ref. No. —
	piezoelectric igniter suitable for ELETTROSIT body plastic blowing connection ø2.4mm ø 14mm		
	GEV No.	101305	Ref. No. —
	gas connection straight 1/2" flange 45x45mm ELETTROSIT/V4400/4600/4605 suitable for SIT/HONEYWELL hole distance 36x36mm		
	GEV No.	101306	Ref. No. —
	gas connection angled flange 45x45mm hole distance 36x36mm 1/2" ELETTROSIT/V4400/4600/4605 screw with O-ring suitable for SIT/HONEYWELL		
	GEV No.	101307	Ref. No. —
	gas connection straight flange 45x45mm hole distance 36x36mm 3/4" ELETTROSIT/V4400/4600/4605 screw with O-ring suitable for SIT/HONEYWELL		
	GEV No.	101308	Ref. No. —
	gas connection angled flange 45x45mm hole distance 36x36mm 3/4" ELETTROSIT/V4400/4600/4605 screw with O-ring suitable for SIT/HONEYWELL		
	GEV No.	101312	Ref. No. 483286009412
	microswitch		
	GEV No.	101314	Ref. No. —
	solenoid coil 24V 50Hz		
	GEV No.	101317	Ref. No. —
	plug with cable L 1000mm suitable for NOVASIT		

Table continues overleaf





accessories for	101162			
	GEV No.	101318	Ref. No.	—
	cover cap for solenoid coil suitable for NOVASIT			





GEV No.	101967	Ref. No.	483286008689
description	gas valve SIT series Novasit 822 230V 50Hz gas inlet 1/2" gas outlet 1/2" thermocouple connection pilot connection M10x1 ignition pressure 3-5mbar pressure range 3-30mbar pressure regulator connection perforated equiv. no. 0.822.110		

spare parts for	101967			
	GEV No.	101313	Ref. No.	—
	solenoid coil 230V 50Hz			

	GEV No.	101542	Ref. No.	—
	solenoid coil 50Hz NOVA 822/826/827 suitable for NOVASIT 230V			

accessories for	101967			
	GEV No.	100904	Ref. No.	—
	locking screw M10x1 for pipe ø 4mm Qty 1 pcs			

	GEV No.	100905	Ref. No.	—
	locking screw M10x1 for pipe ø 6mm Qty 1 pcs			

	GEV No.	101305	Ref. No.	—
	gas connection straight 1/2" flange 45x45mm ELETTROSIT/V4400/4600/4605 suitable for SIT/HONEYWELL hole distance 36x36mm			

	GEV No.	101306	Ref. No.	—
	gas connection angled flange 45x45mm hole distance 36x36mm 1/2" ELETTROSIT/V4400/4600/4605 screw with O-ring suitable for SIT/HONEYWELL			

	GEV No.	101307	Ref. No.	—
	gas connection straight flange 45x45mm hole distance 36x36mm 3/4" ELETTROSIT/V4400/4600/4605 screw with O-ring suitable for SIT/HONEYWELL			

	GEV No.	101308	Ref. No.	—
	gas connection angled flange 45x45mm hole distance 36x36mm 3/4" ELETTROSIT/V4400/4600/4605 screw with O-ring suitable for SIT/HONEYWELL			

	GEV No.	101503	Ref. No.	—
	O-ring EPDM thickness 2mm ID ø 32mm Qty 1 pcs			

	GEV No.	101924	Ref. No.	—
	plug with cable L 1090mm suitable for NOVA 822/826/827			

accessories				
	1			
GEV No.	101312	Ref. No.	483286009412	
description	microswitch			

	1			
GEV No.	101859	Ref. No.	483286003052	
description	panel-mounted inlet with cable L 1000mm for rectifier suitable for NOVASIT			

ignition boxes

HONEYWELL

	1			
GEV No.	102367	Ref. No.	483286002569	
description	ignition box HONEYWELL type S4565A 2092 1 electrodes 3 waiting times safety time 10s 220-240V 4VA 50/60Hz			

safety valves

SIT

400 series





	1			
GEV No.	101470	Ref. No.	483286009416	
description	safety valve front fixing M12x1 pressure range 50mbar gas inlet 1/8" IT gas outlet 1/8" - M6x0.75 thermocouple connection M8x1 equiv. no. 0.400.088 suitable for SIT			
spare parts for	101470			
	GEV No.	101052	Ref. No.	—
	magnet unit L 43.5mm D1 ø 15.3mm D2 ø 10.5mm suitable for SIT M1			
accessories for	101470			
	GEV No.	101299	Ref. No.	—
	nut thread M12x1			

Table continues overleaf

accessories for	101470			
	GEV No.	101499	Ref. No.	—
	protection cap for safety valve thread M12x0.75 ID ø 18mm L 24mm aluminium			









ignition parts





pilot burners

SIT

100 series



GEV No.	106904	Ref. No.	483286009246	
description	pilot burner SIT type 100 series 1 flame nozzle ø 0.2mm gas connection 6mm			
spare parts for	106904			
	GEV No.	100245	Ref. No.	—
	pilot burner nozzle LPG code 20 bore ø 0.2mm Qty 1 pcs thread M8x0.75			
	GEV No.	100855	Ref. No.	—
	pilot burner bracket triple			
	GEV No.	100885	Ref. No.	—
	air mixing sleeve for pilot burner Qty 1 pcs			
	GEV No.	100916	Ref. No.	—
	compression spring for pilot burner Qty 1 pcs			
	GEV No.	100917	Ref. No.	—
	gasket for pilot burner Qty 1 pcs aluminium			
	GEV No.	100918	Ref. No.	—
	screw for pilot burner			
	GEV No.	107160	Ref. No.	—
	pilot burner cap SIT 1 flame Hmm Lmm Qty 1 pcs			
	GEV No.	107166	Ref. No.	—
	pilot burner head SIT 1 flame Hmm Lmm Qty 1 pcs			
	GEV No.	107701	Ref. No.	—
	pilot burner bottom part SIT 100 series nozzle ø 0.2mm			
accessories for	106904			
	GEV No.	100246	Ref. No.	483286009258
	pilot burner nozzle natural gas bore ø 0.35mm Qty 1 pcs thread M8x0.75			
	GEV No.	100904	Ref. No.	—
	locking screw M10x1 for pipe ø 4mm Qty 1 pcs			
	GEV No.	100905	Ref. No.	—
	locking screw M10x1 for pipe ø 6mm Qty 1 pcs			
	GEV No.	102110	Ref. No.	—
	pilot tube copper pipe ø 4mm thickness 1mm L 3000mm			

accessories for	106904			
	GEV No.	102111	Ref. No.	—
	pilot tube copper pipe ø 6mm thickness 1mm L 3000mm			
	GEV No.	107171	Ref. No.	—
	pilot burner nozzle SIT natural/liquid gas bore ø 0.25mm Qty 1 pcs			
	GEV No.	107700	Ref. No.	—
	pilot burner bottom part SIT 100 series nozzle ø 0.25mm			
	GEV No.	107702	Ref. No.	—
	pilot burner bottom part SIT 100 series nozzle ø 0.35mm			















	GEV No.	106906	Ref. No.	483286009215	
	description	pilot burner SIT type 100 series 3 flames nozzle ø 0.2mm gas connection 6mm			
	spare parts for	106906			
	GEV No.	100245	Ref. No.	—	
	pilot burner nozzle LPG code 20 bore ø 0.2mm Qty 1 pcs thread M8x0.75				
	GEV No.	100855	Ref. No.	—	
	pilot burner bracket triple				
	GEV No.	100885	Ref. No.	—	
	air mixing sleeve for pilot burner Qty 1 pcs				
	GEV No.	100916	Ref. No.	—	
	compression spring for pilot burner Qty 1 pcs				
	GEV No.	100917	Ref. No.	—	
	gasket for pilot burner Qty 1 pcs aluminium				
	GEV No.	100918	Ref. No.	—	
	screw for pilot burner				
	GEV No.	107162	Ref. No.	—	
	pilot burner cap SIT 3 flames Hmm Lmm Qty 1 pcs				
	GEV No.	107701	Ref. No.	—	
	pilot burner bottom part SIT 100 series nozzle ø 0.2mm				
accessories for	106906				
	GEV No.	100245	Ref. No.	—	
	pilot burner nozzle LPG code 20 bore ø 0.2mm Qty 1 pcs thread M8x0.75				
	GEV No.	100246	Ref. No.	483286009258	
	pilot burner nozzle natural gas bore ø 0.35mm Qty 1 pcs thread M8x0.75				
	GEV No.	100904	Ref. No.	—	
	locking screw M10x1 for pipe ø 4mm Qty 1 pcs				

Table continues overleaf











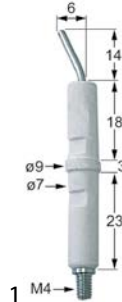





accessories for		106906	
	GEV No.	100905	Ref. No. —
locking screw M10x1 for pipe ø 6mm Qty 1 pcs			
	GEV No.	102110	Ref. No. —
pilot tube copper pipe ø 4mm thickness 1mm L 3000mm			
	GEV No.	102111	Ref. No. —
pilot tube copper pipe ø 6mm thickness 1mm L 3000mm			
	GEV No.	107171	Ref. No. —
pilot burner nozzle SIT natural/liquid gas bore ø 0.25mm Qty 1 pcs			
	GEV No.	107700	Ref. No. —
pilot burner bottom part SIT 100 series nozzle ø 0.25mm			
	GEV No.	107702	Ref. No. —
pilot burner bottom part SIT 100 series nozzle ø 0.35mm			

accessories			
pilot burner nozzles			
	1		
GEV No.	100247	Ref. No.	156578
description	pilot burner nozzle LPG bore ø 0.2mm Qty 1 pcs suitable for SIT 100 series thread M8x0.75		

	1		
GEV No.	100246	Ref. No.	483286009258
description	pilot burner nozzle natural gas bore ø 0.35mm Qty 1 pcs thread M8x0.75		
For models:	AGB352WP, AGB353WP, AGB354WP		

	1		
GEV No.	100248	Ref. No.	156750
description	pilot burner nozzle natural gas bore ø 0.3mm Qty 1 pcs suitable for SIT 100 series		

ignition electrodes			
	1		
GEV No.	100706	Ref. No.	483286009205
description	ignition electrode connection M4 Qty 1 pcs		

140 - 145 -150 series			
	1		
GEV No.	100170	Ref. No.	483286009227
description	pilot burner SIT type 150 series 1 flame nozzle ømm gas connecti-onmm		
spare parts for	100170		
	GEV No.	100907	Ref. No. —
screw connection thread M10x1 Qty 1 pcs type SEF 1 ømm for thermocouple			
accessories for	100170		
	GEV No.	100204	Ref. No. —
pilot burner nozzle SIT LPG code 14 bore ø 0.18/0.20mm Qty 1 pcs suitable for 140 series			
	GEV No.	100205	Ref. No. 483286009231
pilot burner nozzle SIT LPG code 19 bore ø 0.23/0.26mm Qty 1 pcs suitable for SIT 150 series			
	GEV No.	100206	Ref. No. 483286009232
pilot burner nozzle SIT natural gas code 36 bore ø 0.60/0.55mm Qty 1 pcs suitable for SIT 150 series			
	GEV No.	100207	Ref. No. —
pilot burner nozzle SIT natural gas code 27 bore ø 0.40/0.38mm suitable for SIT 140 series			
	GEV No.	100216	Ref. No. —
pilot burner nozzle SIT natural gas code 38 bore ø 0.45mm Qty 1 pcs suitable for SIT 150 series			
	GEV No.	100701	Ref. No. 483286009228
ignition electrode connection M4 Qty 1 pcs			
	GEV No.	100801	Ref. No. —
gasket for pilot burner Qty 1 pcs			
	GEV No.	100897	Ref. No. —
olive for pipe ø 4mm Qty 1 pcs for pilot burner			
	GEV No.	100898	Ref. No. —
olive for pipe ø 6mm Qty 1 pcs for pilot burner			
	GEV No.	100906	Ref. No. —
screw connection thread M10x1 for ignition electrode brass Qty 1 pcs WS 10			
	GEV No.	100908	Ref. No. —
union screw thread M10x1 for pipe ø 4mm Qty 1 pcs			
	GEV No.	100909	Ref. No. —
union screw thread M10x1 for pipe ø 6mm Qty 1 pcs			



accessories universal

covers



GEV No.	106572	Ref. No.	483286009639
description	cover for pilot burner		

electrodes

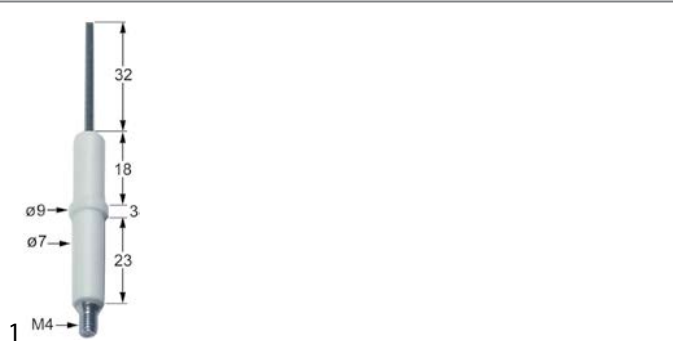

GEV No.	100701	Ref. No.	483286009228
description	ignition electrode connection M4 Qty 1 pcs		

accessories for	100701			
	GEV No.	100906	Ref. No.	—
	screw connection thread M10x1 for ignition electrode brass Qty 1 pcs WS 10			



GEV No.	100706	Ref. No.	483286009205
description	ignition electrode connection M4 Qty 1 pcs		



GEV No.	102315	Ref. No.	483286008715
description	ignition electrode flange length 23mm flange width 15mm D1 ø 7mm L1 5mm BL1 30mm BL2 23mm connection F 2.8x0.8mm fixing dimensions ø5x4mm with flange		

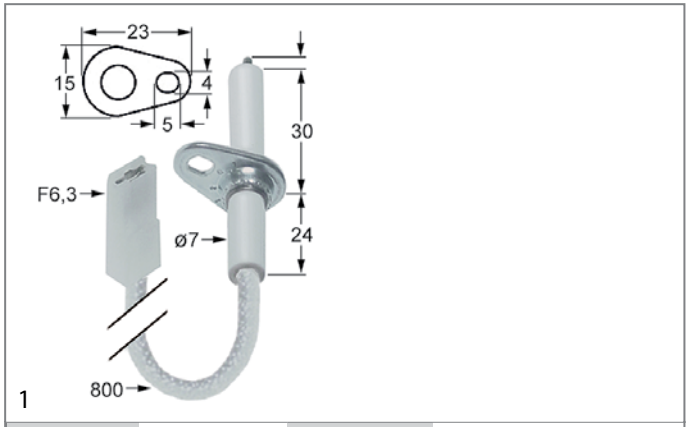

GEV No.	102316	Ref. No.	483286008714
description	ignition electrode flange length 23mm flange width 15mm D1 ø 7mm L1 5mm BL1 30mm BL2 24mm connection F 6.3 cable length 800mm fixing dimensions ø5x4mm with flange		



1

GEV No.	102293	Ref. No.	483286002563
description	ignition electrode flange length 51mm flange width 23mm cable length 440mm		



1

GEV No.	100004	Ref. No.	483286009198
description	piezoelectric igniter body plastic blowing mounting ø 18mm connection ø2.4mm		

ignition units



1

GEV No.	101002	Ref. No.	483286009414
description	ignition unit outputs 2 230VAC dimensions 88x23x34mm mounting distance 73mm inlet F6.3x0.8 outlet F2.8x0.8 0.6VA 50/60Hz		

ignition cables

pre-assembled cables



1

GEV No.	100176	Ref. No.	483286009303
description	ignition cable cable length 1000mm connection ø2.4mm / ø4mm permanent temperature 200°C		



1

GEV No.	100175	Ref. No.	483286009245
description	ignition cable cable length 1750mm connection ø2.4mm / ø4mm		



1

GEV No.	100178	Ref. No.	483286009409
description	ignition cable cable length 900mm connection F2.8mm / ø2.4mm		

piezoelectric igniters

mounting diameter 18mm



1

GEV No.	100003	Ref. No.	483286009226
description	piezoelectric igniter body metal blowing mounting ø 18mm connection F2.8x0.8		

thermocouples

plug-in thermocouples

plug-in thermocouples standard

with barrel socket ø5mm - type Junkers with aluminised tip



1

GEV No.	102205	Ref. No.	154102 154103 154104 158332
description	thermocouple M8x1 L 750mm plug connection ø5.0mm		
accessories for	102205		
	GEV No.	Ref. No.	—
	thermocouple fitting thread M8x1 Qty 1 pcs		

with barrel socket ø6mm

SIT

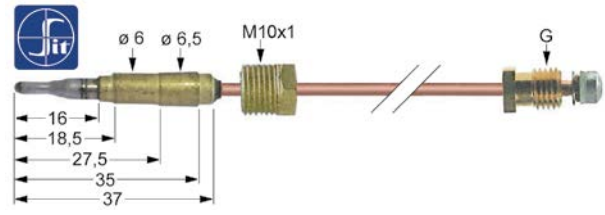

1

GEV No.	102438	Ref. No.	483286009281
description	thermocouple M10x1 L 600mm plug connection ø6.0mm		



with barrel socket $\varnothing 6(6.5)$ mm

thermocouples SIT

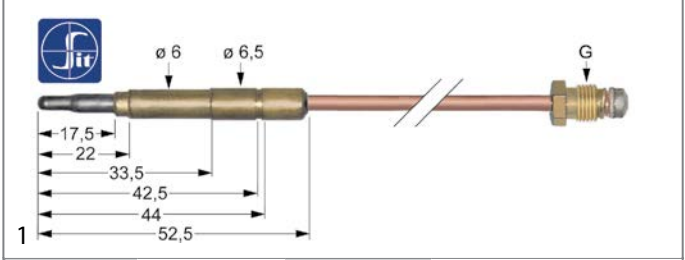

GEV No.	107608	Ref. No.	483286009247
description	thermocouple SIT M9x1 L 500mm plug connection $\varnothing 6.0(6.5)$ mm		

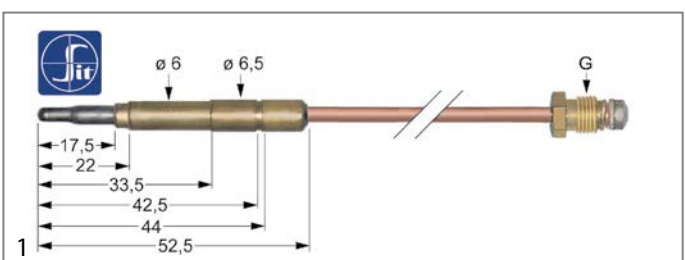

GEV No.	107609	Ref. No.	483286009282
description	thermocouple SIT M9x1 L 600mm plug connection $\varnothing 6.0(6.5)$ mm		
For models:	AGB352WP, AGB353WP, AGB354WP		

thermocouples with aluminised tip

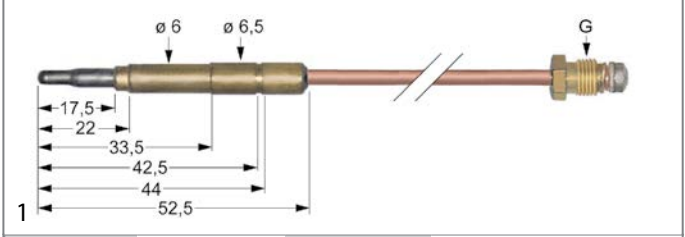

GEV No.	102144	Ref. No.	483286009294
description	thermocouple M9x1 L 450mm plug connection $\varnothing 6.0(6.5)$ mm		

plug-in thermocouples with interruption

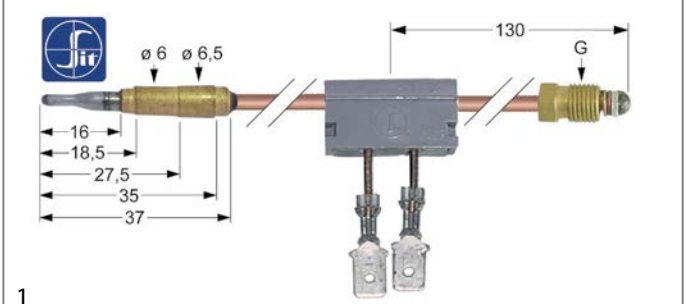

GEV No.	100172	Ref. No.	483286009229
description	thermocouple SIT with interrupter ASA 11/32 L 400mm plug connection $\varnothing 6.0$ mm F 6.3mm		

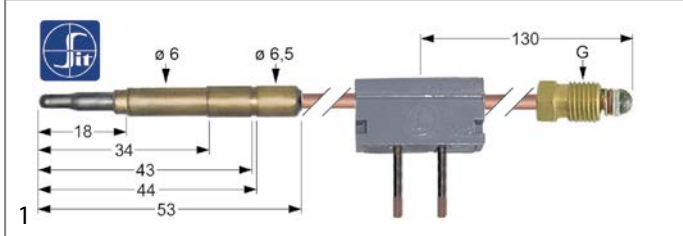

GEV No.	107164	Ref. No.	483286009219
description	thermocouple SIT with interrupter M9x1 L 1000mm plug connection $\varnothing 6.0(6.5)$ mm soldering connection		

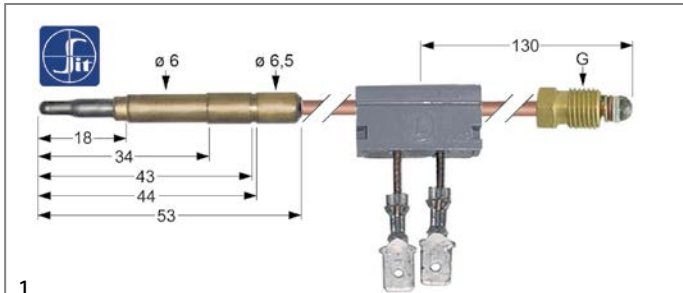

GEV No.	107177	Ref. No.	483286009324
description	thermocouple SIT with interrupter M9x1 L 600mm plug connection $\varnothing 6.0$ mm F 6.3mm		

extensions



GEV No.	102852	Ref. No.	483286009265	
description	thermocouple extension thread M9x1 L 1500mm			
accessories for	102852			
	GEV No.	101261	Ref. No.	—
	thermocouple fitting thread M9x1 Qty 1 pcs			

gas burners

hob burners

universal hob burners

SABAF

2 series - standard



GEV No.	107374	Ref. No.	C00319454
description	burner cap 3kW $\varnothing 100$ mm H 3.5mm matt finish		

accessories for	107374			
	GEV No.	105058	Ref. No.	—
	burner head 3kW for igniter $\varnothing 6$ mm for burner cap $\varnothing 100$ mm			

	GEV No.	105059	Ref. No.	—
	burner lower part 3kW for igniter $\varnothing 6$ mm for thermocouple $\varnothing 6$ mm without nozzle for burner cap $\varnothing 100$ mm			





accessories

pan supports

			
1			
GEV No.	210138	Ref. No.	102436 771985000078
description	pan support W 285mm L 345mm		

air mixers

			
1			
GEV No.	106521	Ref. No.	483286009277
description	air mixing sleeve L 30mm thread 3/8" IT		

			
1			
GEV No.	104741	Ref. No.	483286009249
description	air mixing tube L 42mm ø 20mm		

bar burners

bar burners

			
1			
GEV No.	105718	Ref. No.	483286009213
description	bar burner ø 40mm Wmm Hmm L 395mm flange ø 61mm tilting bratt pan		

gas nozzles

main nozzles

gas nozzles M10x1

			
1			
GEV No.	102867	Ref. No.	483286009237
description	gas injector thread M10x1 WS 11 bore ø 1.65mm		

			
1			
GEV No.	106291	Ref. No.	483286002438
description	gas injector thread M10x1 WS 11 bore ø 1.95mm inner peaked		

			
1			
GEV No.	106284	Ref. No.	483286009252
description	gas injector thread M10x1 WS 11 bore ø 2.15mm		
For models:	AGB352WP, AGB353WP, AGB354WP		

			
1			
GEV No.	106495	Ref. No.	483286009287
description	gas injector thread M10x1 WS 11 bore ø 2.25mm		
For models:	AGB352WP, AGB353WP, AGB354WP		

			
1			
GEV No.	107343	Ref. No.	483286009637
description	gas injector thread M10x1 WS 12 bore ø 1.2mm LPG gas pressure 30mbar		

pilot burner nozzles

pilot burner nozzles SIT

100 series

			
1			
GEV No.	100247	Ref. No.	156578
description	pilot burner nozzle LPG bore ø 0.2mm Qty 1 pcs suitable for SIT 100 series thread M8x0.75		

			
1			
GEV No.	100246	Ref. No.	483286009258
description	pilot burner nozzle natural gas bore ø 0.35mm Qty 1 pcs thread M8x0.75		
For models:	AGB352WP, AGB353WP, AGB354WP		

			
1			
GEV No.	100248	Ref. No.	156750
description	pilot burner nozzle natural gas bore ø 0.3mm Qty 1 pcs suitable for SIT 100 series		



140/150 series



1

GEV No.	100205	Ref. No.	483286009231
description	pilot burner nozzle SIT LPG code 19 bore \varnothing 0.23/0.26mm Qty 1 pcs suitable for SIT 150 series		



1

GEV No.	100206	Ref. No.	483286009232
description	pilot burner nozzle SIT natural gas code 36 bore \varnothing 0.60/0.55mm Qty 1 pcs suitable for SIT 150 series		

equipment-specific units

for fridges

miscellaneous



1

GEV No.	694849	Ref. No.	483286008084
description	cover with sump for evaporator L 390mm W 355mm H 140mm plastic		

for ice-cube maker

drain systems

drain pans



1

GEV No.	696616	Ref. No.	310084 771985006376
description	drain pan L 160mm W 55mm H 200mm plastic		

pan mechanics

sumps



1

GEV No.	696619	Ref. No.	310058 771985006362
description	sump for ice maker L 450mm W 185mm H 70mm white		

cutting grid



1

GEV No.	480100	Ref. No.	4819 259 98186
description	cutting grid for ice-cube maker L 350mm W 285mm H 40mm		

for convection ovens/combi-steamers

injection nozzles



1

GEV No.	691627	Ref. No.	483286002465
description	injection nozzle bore \varnothing 0.4mm D1 \varnothing 6mm D2 \varnothing 11.5mm L 35mm WS 14 brass		



1

GEV No.	691628	Ref. No.	483286002466
description	injection nozzle bore \varnothing 0.5mm D1 \varnothing 6mm D2 \varnothing 10.5mm L 35mm WS 14 brass		



1

GEV No.	691629	Ref. No.	483286002399
description	injection nozzle bore \varnothing 0.7mm D1 \varnothing 6mm D2 \varnothing 11.5mm L 38mm WS 14 brass thread 1/8"		



cleaning system

nozzles



1

GEV No.	510000	Ref. No.	483286003062
description	nozzle ø 1.5/2.8mm H 13mm thread 1/8" ET WS 13		

miscellaneous

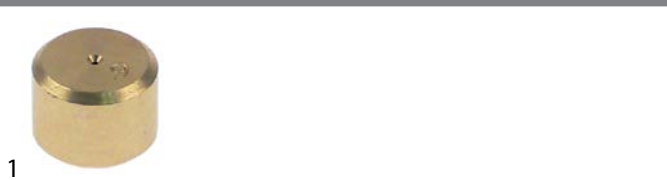

1

GEV No.	692446	Ref. No.	102091 771985000017
description	reducer bore ø 0.6mm brass ø 12mm thickness 9mm code 6		

for tilting bratt pans

spindles



1

GEV No.	690546	Ref. No.	483286009394
description	thread block thread Tr24x5 right-hand thread W 38mm bolt ø 20mm D 40mm H 40mm		

for dishwashers

boilers

boilers for dishwashers



1

GEV No.	504791	Ref. No.	771985000127
description	boiler L 700mm W 290mm H 170mm		



1

GEV No.	519022	Ref. No.	483286008869
description	boiler ø 150mm L 400mm		

hood mechanics for dishwashers

rollers



1

GEV No.	524963	Ref. No.	148260 771985001839
description	roller ø 49mm H 21.5mm for hood mechanics plastic white hole ø 10mm		

air traps

air traps



1

GEV No.	511450	Ref. No.	483286008796	
description	air trap			
accessories for	511450			
	GEV No.	511197	Ref. No.	—
	gasket L 46mm W 33mm for air trap			

door mechanics

hinges



1

GEV No. 502263 **Ref. No.** 483286008926

description hinge mounting pos. left L 94mm N45/N50



1

GEV No. 502262 **Ref. No.** 483286008927

description hinge mounting pos. right L 94mm N45/N50

miscellaneous



1

GEV No. 504435 **Ref. No.** 483286008935

description flat gasket plastic ED ø 18mm ID ø 9.5mm thickness 2.5mm for door hinge Qty 1 pcs



1

GEV No. 541996 **Ref. No.** 771985004707

description plug for door handle H 14.1mm D1 ø 18.8mm D2 ø 27mm green

curtains

curtains

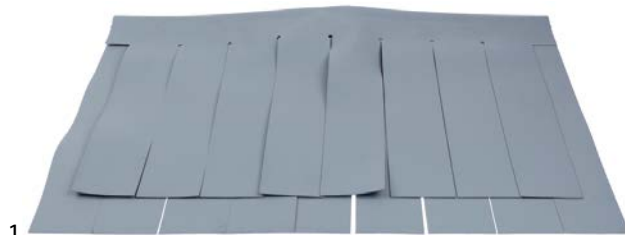

1

GEV No. 533016 **Ref. No.** 483286001676

description curtain W 640mm H 410mm plastic thickness 1.5mm warewashing

washing and rinsing systems



1

GEV No. 519167 **Ref. No.** 483286002296

description bush for wash arm

accessories for 519167



GEV No. 519087 **Ref. No.** —

locknut for wash arm



1

GEV No. 519122 **Ref. No.** 4832 860 08158

description flat gasket for rinse arm



1

GEV No. 510000 **Ref. No.** 483286003062

description nozzle ø 1.5/2.8mm H 13mm thread 1/8" ET WS 13



1

GEV No. 519007 **Ref. No.** 4832 860 01182

description opposite support mounting pos. lower for wash arm support



knobs

producer-specific knobs

WHIRLPOOL



1

GEV No.	112012	Ref. No.	483286009275 483286009382
description	knob gas tap with ignition flame t.max.°C°C ø 71mm shaft ø 8x6.5mm shaft flat upper		



1

GEV No.	112136	Ref. No.	483286009308
description	knob switch 4-position t.max.°C°C ø 71mm shaft ø 6x4.6mm shaft flat upper black		



1

GEV No.	112137	Ref. No.	483286009353
description	knob thermostat t.max. 195°C ø 71mm shaft ø 6x4.6mm shaft flat upper black temperature range 100-195°C		



1

GEV No.	112135	Ref. No.	483286009369
description	knob thermostat t.max. 300°C ø 71mm shaft ø 6x4.6mm shaft flat upper black temperature range 50-300°C rotation 270°		



1

GEV No.	110465	Ref. No.	483286009618
description	knob dial plate oven BH/TH/BH+TH ED ø 66mm ID ø 50mm silver		

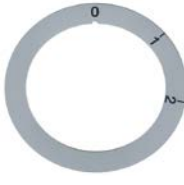

1

GEV No.	110690	Ref. No.	483286009428
description	knob dial plate switch 0-1-2 ED ø 66mm ID ø 50mm silver		

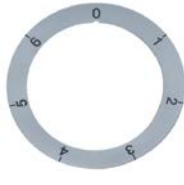

1

GEV No.	110464	Ref. No.	483286009632
description	knob dial plate switch 7-position ED ø 66mm ID ø 50mm silver		



1

GEV No.	111000	Ref. No.	483286002387
description	knob ø 60mm shaft ø 18.5x18.5mm for safety valve		



1

GEV No.	111072	Ref. No.	483286002386
description	knob switch zero mark ø 55mm shaft ø 6x4.6mm shaft flat upper silver		



1

GEV No.	111003 ¹	Ref. No.	483286002444
description	knob switch zero mark ø 55mm shaft ø 6x4.6mm shaft flat upper silver deepend shaft intake		

¹deepend shaft intake

handles and hand wheels

hand wheels

hand wheels



1

GEV No.	692431	Ref. No.	483286009392
description	hand wheel \varnothing 200mm D1 \varnothing 50mm bore \varnothing 20mm thread groove width 8mm groove depth 12mm mounting distance 32mm L1 40mm L2 43mm handle length 65mm with folding handle		

bracket handles



1

GEV No.	691626	Ref. No.	483286002643
description	pull handle L 140mm H 73mm handle M5		



1

GEV No.	690448	Ref. No.	181906 182448 771985008758
description	pull handle L 402mm H 42mm mounting distance 375mm		

door handles

door handles



1

GEV No.	694918	Ref. No.	132933
description	door handle L 198mm W 70mm H 15mm grey		

locks

edgemount latches

handle latches

producer-specific

INOXTREND





1

GEV No.	690536	Ref. No.	483286002378
description	catch L 172mm mounting distance 133mm non lockable chrome-plated 6200 total length 248mm		
accessories for	690536		
	GEV No.	690123	Ref. No. —
		door catch with roller	



1

GEV No.	690146	Ref. No.	483286008725
description	handle latch L 172mm mounting distance 134mm non lockable heated units 6200 H 65mm type DUPLO total length 248mm		
accessories for	690146		
	GEV No.	690123	Ref. No. —
		door catch with roller	
	GEV No.	693777	Ref. No. —
		gasket H 6.6mm L 105mm W 45mm L1 78mm W1 25mm for handle	
	GEV No.	693778	Ref. No. —
		door catch	







MODULAR

			
1			
GEV No.	690146	Ref. No.	483286008725
description	handle latch L 172mm mounting distance 134mm non lockable heated units 6200 H 65mm type DUPLO total length 248mm		
accessories for	690146		
	GEV No.	690123	Ref. No. —
	door catch with roller		
	GEV No.	693777	Ref. No. —
	gasket H 6.6mm L 105mm W 45mm L1 78mm W1 25mm for handle		
	GEV No.	693778	Ref. No. —
	door catch		

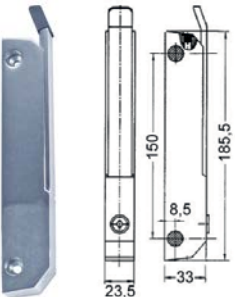
RAHRBACH

6188 ERGO series

			
1			
GEV No.	690808	Ref. No.	483286000205
description	handle latch L 185mm mounting distance 150mm chrome-plated non lockable for headed units 6188 type ERGO		
accessories for	690808		
	GEV No.	690110	Ref. No. —
	base plate H 1mm L 38mm W 11mm mounting distance 26mm plastic		
	GEV No.	690111	Ref. No. —
	base plate H 2mm L 38mm W 11mm mounting distance 26mm plastic		
	GEV No.	690114	Ref. No. —
	base plate H 3.5mm L 185mm W 30mm mounting distance 150mm with inclination thread M5		
	GEV No.	700082	Ref. No. —
	door catch L 38mm W 18mm mounting distance 26mm		

hinges

spring assisted hinges

universal

INTERKLIMAT

hinges

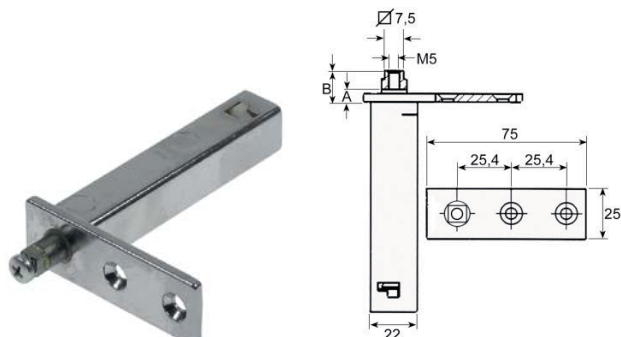
			
1			
GEV No.	690622	Ref. No.	181653 182219 771985004801
description	spring assisted hinge series 28L mounting pos. left/right L 75mm W 25mm H 103mm A 13mm B 18mm mounting measurements 22x22mm intake 7.5x7.5 refrigeration units		

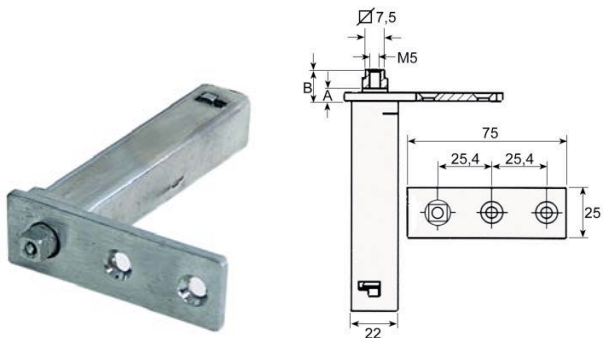
			
1			
GEV No.	690714	Ref. No.	183876 771985005195 771985010339
description	spring assisted hinge series 28XC mounting pos. left/right L 75mm W 25mm H 103mm A 8mm B 11mm intake 7.5x7.5 refrigeration units mounting distance 25mm		

accessories

			
1			
GEV No.	690747	Ref. No.	771985004680 771985010369
description	bush for hinge ID \varnothing 7.5mm L 25.5mm W 25.5mm white mounting measurements 22x22mm H 4.5mm		

producer-specific

ELECTROLUX/ZANUSSI



1

GEV No.	690747	Ref. No.	771985004680 771985010369
description	bush for hinge ID ϕ 7.5mm L 25.5mm W 25.5mm white mounting measurements 22x22mm H 4.5mm		



1

GEV No.	690633	Ref. No.	182587 771985004894
description	spring assisted hinge refrigerator		

accessories for 690633



GEV No.	690634	Ref. No.	187135 771985004875
----------------	--------	-----------------	------------------------

hinge bearing mounting pos. lower with bolt refrigerator



GEV No.	690635	Ref. No.	187136 771985004874
----------------	--------	-----------------	------------------------

hinge bearing mounting pos. upper with bolt refrigerator

SAGI



1

GEV No.	690747	Ref. No.	771985004680 771985010369
description	bush for hinge ID ϕ 7.5mm L 25.5mm W 25.5mm white mounting measurements 22x22mm H 4.5mm		

oven hinges



1

GEV No.	700006	Ref. No.	483286009243
description	oven hinge mounting distance 173mm mounting distance 2 105mm lug mounting 14mm lever length 120mm groove distance 11mm spring thickness 3.5mm mounting ear position left spring length 112mm W 25mm		

accessories for 700006



GEV No.	700001	Ref. No.	—
opposite support L 118mm W 17mm mounting distance 94mm			

accessories for	700006		
GEV No.	700007	Ref. No.	483286009255
description	oven hinge mounting distance 173mm mounting distance 2 105mm lug mounting 14mm lever length 120mm groove distance 11mm spring thickness 3.5mm mounting ear position right spring length 112mm W 25mm		

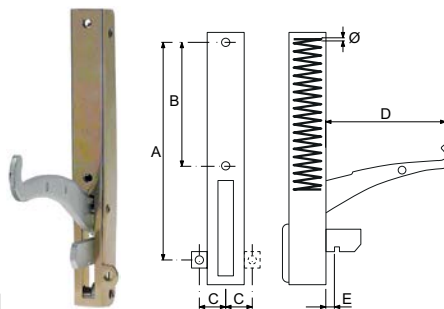

1

GEV No.	700007	Ref. No.	483286009255
description	oven hinge mounting distance 173mm mounting distance 2 105mm lug mounting 14mm lever length 120mm groove distance 11mm spring thickness 3.5mm mounting ear position right spring length 112mm W 25mm		

accessories for 700007



GEV No.	700001	Ref. No.	—
opposite support L 118mm W 17mm mounting distance 94mm			

door bearing



1

GEV No.	691310	Ref. No.	183875 771985005194
description	bush L 23mm W 23mm ID ϕ 7mm for hinge		



1

GEV No.	697999	Ref. No.	187822 771985010780
description	hinge L 55mm W 20mm H 71mm mounting pos. upper bolt 45mm bolt ϕ 7mm suitable for refrigerator		





1

GEV No.	690625	Ref. No.	182374 771985004842
description	hinge bearing mounting pos. centre with bolt refrigerator		



			
1			
GEV No.	690634	Ref. No.	187135 771985004875
description	hinge bearing mounting pos. lower with bolt refrigerator		

			
1			
GEV No.	690627	Ref. No.	182256 771985004819
description	hinge bearing mounting pos. right/left with bolt refrigerator		

			
1			
GEV No.	690635	Ref. No.	187136 771985004874
description	hinge bearing mounting pos. upper with bolt refrigerator		

			
1			
GEV No.	691965	Ref. No.	483286008992
description	hinge camp mounting pos. lower		

			
1			
GEV No.	692501	Ref. No.	209124 771985006125
description	hinge pine L 29mm thread M5 ø 7mm for blast chiller Qty 1 pcs		

accessories

miscellaneous

			
1			
GEV No.	690647	Ref. No.	182964 771985004997
description	bush refrigerator		

			
1			
GEV No.	690646	Ref. No.	209092 771985006103
description	bush refrigerator ID ø 7mm		

			
1			
GEV No.	690648	Ref. No.	182962 771985004996
description	pressure pin refrigerator		

pullouts

rollers

			
1			
GEV No.	690692	Ref. No.	483286002644
description	roller rollerø 55mm B1 10mm overall width 14mm A 55mm B 10mm C 14mm SS bore ø 12mm		

			
1			
GEV No.	692465	Ref. No.	483286008748
description	roller rollerø 33mm B1 8mm A 33mm B 8mm C 14.5mm D M8mm E 11.5mm plastic tread plastic bearing ball bearing thread M8x1.25 thread L 20mm Qty 1 pcs		

fittings for catering equipment

lid hinges







type RUBINETTERIE DEL FRIULI

for circular lids

lid hinges



1

GEV No.	540839	Ref. No.	483286009195
description	lid hinge L 270mm mounting distance 139mm flange radius 470mm opening angle 80° spring thickness 5mm bore ø M16mm for circular lids		
spare parts for	540839		
	GEV No.	514137	Ref. No. —
	spring guide for lid hinge ID ø 28mm ED ø 32mm L 225mm zinc-coated steel		
	GEV No.	514140	Ref. No. —
	lid hinge body lid radius 470mm		
	GEV No.	514144	Ref. No. —
	bracket for lid hinge		
	GEV No.	514145	Ref. No. —
	adjusting bush L 108mm ø 80/60mm		
	GEV No.	540854	Ref. No. —
	torsion spring ø 50.8mm wire gauge ø 5.1mm L1 34mm L2 104mm L3 29mm mounting pos. right		
	GEV No.	540855	Ref. No. —
	torsion spring ø 50.8mm wire gauge ø 5.1mm L1 34mm L2 104mm L3 29mm mounting pos. left		

equipment feet and end caps

screw-in feet



1

GEV No.	513284	Ref. No.	771985006416
description	equipment foot thread M8 thread L 20mm ø 30mm H 12mm Qty 1 pcs		

baskets

crumb screens

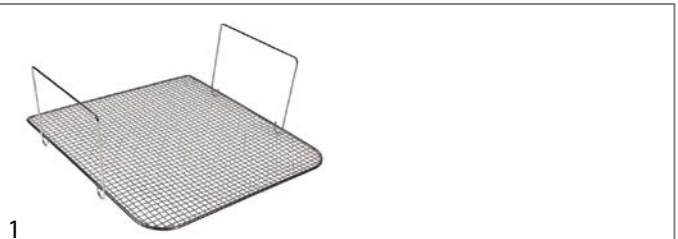

1

GEV No.	970605	Ref. No.	483286009366
description	crumb screen L 310mm W 295mm suitable for fryer		

shelves and shelf rails



grates

universal

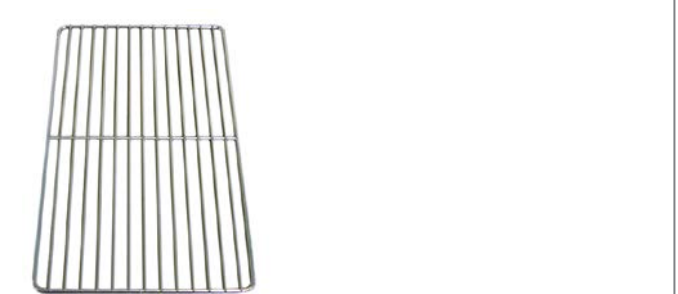
without upstand



1

GEV No.	970120	Ref. No.	771985003454
description	grate W 325mm D 530mm GN 1/1 chrome-plated steel wire gauge frame 7mm lengthwise wires gauge 4mm crossing wires 1		
accessories for	970120		
	GEV No.	690330	Ref. No. —
	rack L 1000mm W 22mm H 4mm aperture 3x8mm hole distance 12.5mm stainless steel		
	GEV No.	694700	Ref. No. —
	shelf support L 31/28mm W 22mm H 18mm SS Qty 12 pcs		
	GEV No.	694701	Ref. No. —
	shelf support L 31/28mm W 22mm H 17mm SS with hook Qty 12 pcs		

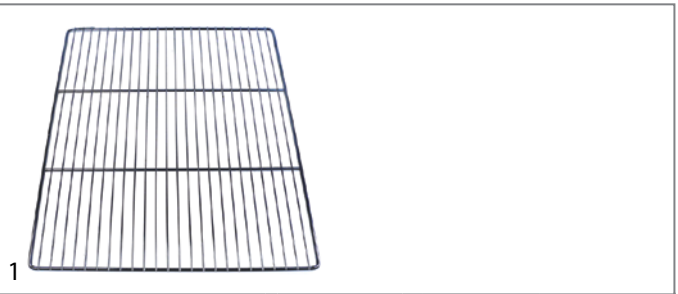

1













GEV No.	970121	Ref. No.	125020
description	grate W 650mm D 530mm GN 2/1 chrome-plated steel crossing wires 2		
accessories for	970121		
	GEV No.	690330	Ref. No. —
	rack L 1000mm W 22mm H 4mm aperture 3x8mm hole distance 12.5mm stainless steel		

Table continues overleaf



accessories for	970121		
	GEV No.	694700	Ref. No. —
	shelf support L 31/28mm W 22mm H 18mm SS Qty 12 pcs		
	GEV No.	694701	Ref. No. —
	shelf support L 31/28mm W 22mm H 17mm SS with hook Qty 12 pcs		

with upstand			
			
1			
GEV No.	970527	Ref. No.	771985000673 771985004752
description	grate W 530mm D 650mm GN 2/1 chrome-plated steel with hinge camp crossing wires 2 suitable for refrigerator		
accessories for	970527		
	GEV No.	690330	Ref. No. —
	rack L 1000mm W 22mm H 4mm aperture 3x8mm hole distance 12.5mm stainless steel		
	GEV No.	694700	Ref. No. —
	shelf support L 31/28mm W 22mm H 18mm SS Qty 12 pcs		
	GEV No.	694701	Ref. No. —
	shelf support L 31/28mm W 22mm H 17mm SS with hook Qty 12 pcs		

			
1			
GEV No.	970556	Ref. No.	182885 483286009003 771985004972
description	grate W 530mm D 650mm GN 2/1 plastic-coated steel with hinge camp wire gauge frame 9mm lengthwise wires gauge 5mm crossing wires 2 white suitable for refrigerator		
accessories for	970556		
	GEV No.	690330	Ref. No. —
	rack L 1000mm W 22mm H 4mm aperture 3x8mm hole distance 12.5mm stainless steel		
	GEV No.	690332	Ref. No. —
	shelf support L 31/28mm W 22mm H 17mm SS with hook Qty 1 pcs		
	GEV No.	694700	Ref. No. —
	shelf support L 31/28mm W 22mm H 18mm SS Qty 12 pcs		
	GEV No.	694701	Ref. No. —
	shelf support L 31/28mm W 22mm H 17mm SS with hook Qty 12 pcs		

gaskets

refrigeration gaskets

plug-in gaskets

profile 9048

We offer custom-made gaskets for this profile

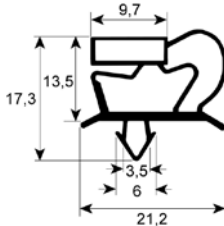
			
1			
GEV No.	900021	Ref. No.	131694 771985000885
description	refrigeration gasket profile 9048 W 142mm L 372mm plug size drawer refrigeration size 2/5 suitable for ELECTROLUX, ZANUSSI		

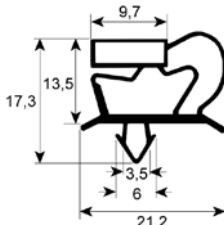
			
1			
GEV No.	900303	Ref. No.	181772 771985004725
description	refrigeration gasket profile 9048 W 195mm L 372mm plug size drawer refrigeration size 1/3 suitable for ELECTROLUX, ZANUSSI		

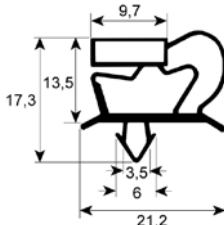
			
1			
GEV No.	900019	Ref. No.	182759
description	refrigeration gasket profile 9048 W 262mm L 372mm plug size drawer size 1/2		

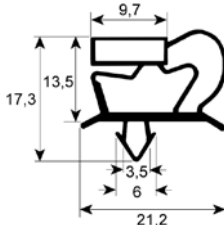
			
1			
GEV No.	901047	Ref. No.	483286009965
description	refrigeration gasket profile 9048 W 282mm L 390mm plug size		

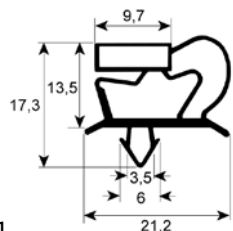

GEV No.	900020	Ref. No.	131693 771985000884
description	refrigeration gasket profile 9048 W 372mm L 385mm plug size drawer refrigeration size 3/5 suitable for ELECTROLUX, ZANUSSI		

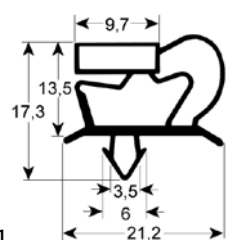

GEV No.	900018	Ref. No.	182725
description	refrigeration gasket profile 9048 W 372mm L 572mm plug size door size 1/1		

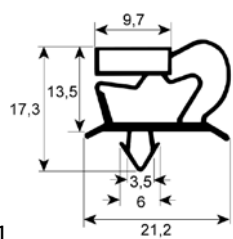

GEV No.	900304	Ref. No.	181805
description	refrigeration gasket profile 9048 W 372mm L 587mm plug size door refrigeration size 1/1		

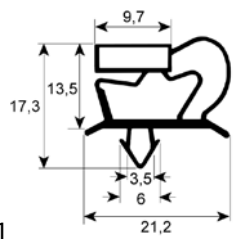

GEV No.	900926	Ref. No.	483286009955
description	refrigeration gasket profile 9048 W 388mm L 610mm plug size		

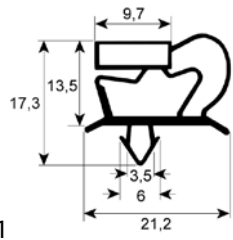

GEV No.	901222	Ref. No.	483286002794
description	refrigeration gasket profile 9048 W 415mm L 709mm plug size for blast chiller		

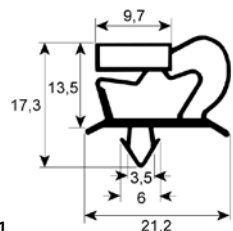

GEV No.	900986	Ref. No.	208992
description	refrigeration gasket profile 9048 W 450mm L 578mm plug size		

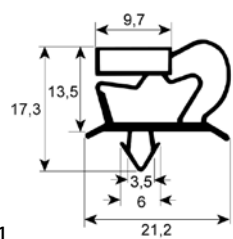

GEV No.	901045	Ref. No.	483286000052
description	refrigeration gasket profile 9048 W 465mm L 615mm plug size		

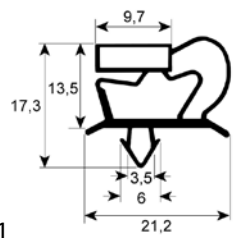

GEV No.	900023	Ref. No.	182375
description	refrigeration gasket profile 9048 W 647mm L 1517mm plug size door refrigeration suitable for ELECTROLUX, ZANUSSI		

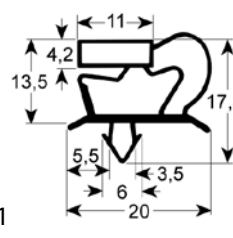

GEV No.	901677	Ref. No.	771985010351
description	refrigeration gasket profile 9048 W 650mm L 1550mm plug size		

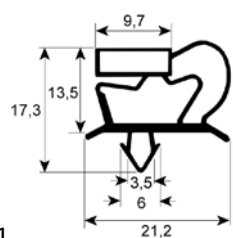

GEV No.	901308	Ref. No.	188724
description	refrigeration gasket profile 9048 W 650mm L 1700mm plug size		



GEV No.	900301	Ref. No.	180959
description	refrigeration gasket profile 9048 W 660mm L 1565mm plug size door refrigeration		

GEV No.	902258	Ref. No.	N/A
description	refrigeration gasket profile 9048 Wmm L 2500mm		

GEV No.	901235	Ref. No.	183461 771985005126
description	refrigeration gasket profile 9048 W 706mm L 1506mm plug size for blast chiller suitable for ELECTROLUX, ZANUSSI		

profile 9051

GEV No.	901797	Ref. No.	483286008098
description	refrigeration gasket profile 9051 W 560mm L 1685mm		

GEV No.	901220	Ref. No.	483286002826
description	refrigeration gasket profile 9048 W 721mm L 929mm plug size for blast chiller		

profile 9773

We offer custom-made gaskets for this profile

GEV No.	901088	Ref. No.	483286008003
description	refrigeration gasket profile 9773 W 566mm L 1705mm external size W1 553mm L1 1692mm plug size		

GEV No.	900375	Ref. No.	209180 771985006143
description	refrigeration gasket profile 9048 W 740mm L 1810mm plug size		

GEV No.	900985	Ref. No.	771985005298
description	refrigeration gasket profile 9773 W 598mm L 1690mm external size W1 585mm L1 1677mm plug size suitable for ELECTROLUX, ZANUSSI		

GEV No.	900379	Ref. No.	209099
description	refrigeration gasket profile 9773 W 620mm L 1700mm external size W1 607mm L1 1687mm plug size suitable for ELECTROLUX, ZANUSSI		

GEV No.	900983	Ref. No.	208225
description	refrigeration gasket profile 9773 W 665mm L 1570mm external size W1 652mm L1 1557mm plug size suitable for ELECTROLUX, ZANUSSI		

GEV No.	901039	Ref. No.	483286009058
description	refrigeration gasket profile 9773 W 658mm L 723mm external size W1 645mm L1 710mm plug size		

GEV No.	900254	Ref. No.	185719 771985005268
description	refrigeration gasket profile 9773 W 682mm L 1531mm external size W1 669mm L1 1518mm plug size suitable for ELECTROLUX, ZANUSSI		

GEV No.	901038	Ref. No.	483286008994
description	refrigeration gasket profile 9773 W 659mm L 1539mm external size W1 646mm L1 1526mm plug size		

GEV No.	900381	Ref. No.	208647
description	refrigeration gasket profile 9773 W 685mm L 1518mm external size W1 672mm L1 1505mm plug size suitable for ELECTROLUX, ZANUSSI		

GEV No.	900984	Ref. No.	208230
description	refrigeration gasket profile 9773 W 664mm L 762mm external size W1 651mm L1 749mm plug size suitable for ELECTROLUX, ZANUSSI		

GEV No.	901087	Ref. No.	483286008031
description	refrigeration gasket profile 9773 W 740mm L 1700mm external size W1 727mm L1 1687mm plug size		

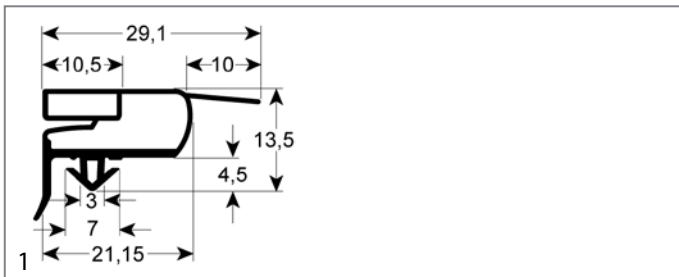

GEV No.	902305	Ref. No.	N/A
description	refrigeration gasket profile 9773 Wmm L 2500mm		

profile 9704

We offer custom-made gaskets for this profile

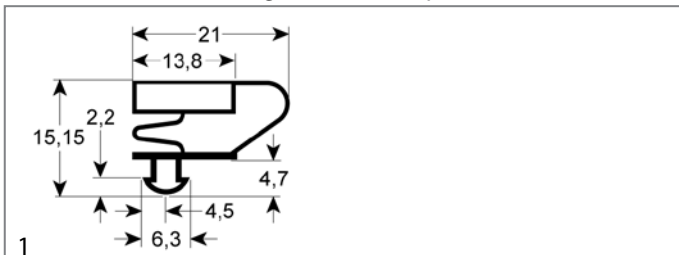

GEV No.	900374	Ref. No.	182586
description	refrigeration gasket profile 9704 W 665mm L 1535mm plug size glass door refrigeration suitable for ELECTROLUX, ZANUSSI		

profile 9151

We offer custom-made gaskets for this profile

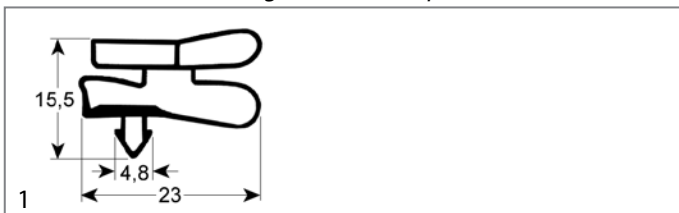

GEV No.	901098	Ref. No.	483286008065
description	refrigeration gasket profile 9151 W 565mm L 1690mm plug size		

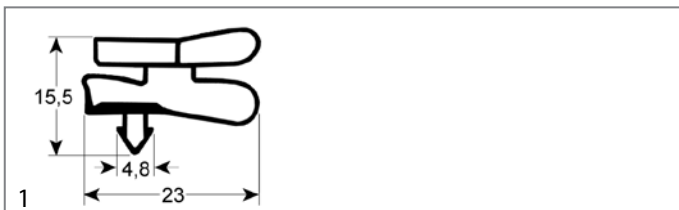

GEV No.	902265	Ref. No.	N/A
description	refrigeration gasket profile 9151 Wmm L 2500mm		

profile 9237

We offer custom-made gaskets for this profile

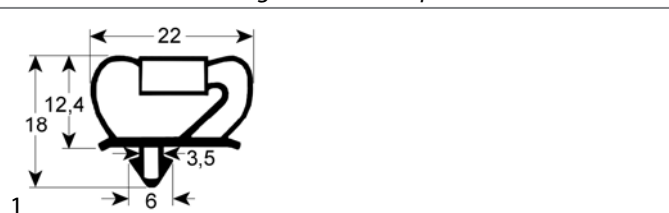

GEV No.	900012	Ref. No.	181943
description	refrigeration gasket profile 9237 W 645mm L 1535mm plug size door refrigeration		



GEV No.	900015	Ref. No.	181724
description	refrigeration gasket profile 9237 W 710mm L 1500mm plug size door refrigeration		

profile 9794

We offer custom-made gaskets for this profile

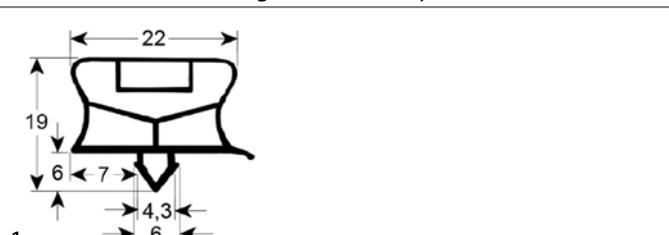

GEV No.	901390	Ref. No.	188484 771985013107
description	refrigeration gasket profile 9794 W 150mm L 380mm plug size plug-in gasket		

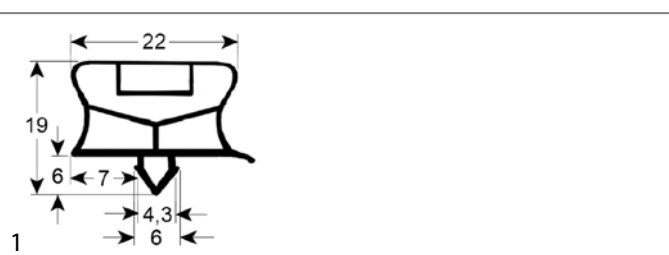

GEV No.	900987	Ref. No.	187691 771985013774
description	refrigeration gasket profile 9794 W 254mm L 387mm plug size		

GEV No.	900890	Ref. No.	187664 771985011377
description	refrigeration gasket profile 9794 W 390mm L 555mm plug size		

GEV No.	900981	Ref. No.	187129 771985001173
description	refrigeration gasket profile 9794 W 626mm L 1467mm plug size		

GEV No.	902308	Ref. No.	N/A
description	refrigeration gasket profile 9794 Wmm L 2500mm		

profile 9794Z (blast freezer)

GEV No.	901237 ¹	Ref. No.	183377 771985005094
description	blast freezer gasket profile 9794Z W 406mm L 666mm plug size for blast chiller suitable for ELECTROLUX, ZANUSSI		

¹for blast freezer

GEV No.	901236 ¹	Ref. No.	183397 771985005106
description	blast freezer gasket profile 9794Z W 666mm L 736mm plug size suitable for ELECTROLUX, ZANUSSI		

¹for blast freezer

screw-in gaskets

profile 9663

We offer custom-made gaskets for this profile

GEV No.	902295	Ref. No.	N/A
description	refrigeration gasket profile 9663 Wmm L 2500mm		

profile 9030

We offer custom-made gaskets for this profile

GEV No.	900003	Ref. No.	208081
description	refrigeration gasket profile 9030 W 390mm L 435mm external size drawer for refrigerated counter refrigeration size 3/5		

GEV No.	900004	Ref. No.	208075
description	refrigeration gasket profile 9030 W 391mm L 640mm external size door for refrigerated counter refrigeration size 1/1		

GEV No.	900006	Ref. No.	181293 208048
description	refrigeration gasket profile 9030 W 670mm L 1570mm external size door refrigeration suitable for ELECTROLUX, ZANUSSI		



GEV No.	900005	Ref. No.	181294 208049
description	refrigeration gasket profile 9030 W 675mm L 770mm external size 1/2 door refrigeration suitable for ELECTROLUX, ZANUSSI		

GEV No.	900828	Ref. No.	483286008694
description	window gasket profile 1885 L 2430mm Qty 1		

gaskets for heated units

window seals

GEV No.	900416	Ref. No.	483586008727
description	window gasket profile 1580 L 1800mm Qty 1 mounting pos. inner		

GEV No.	900826	Ref. No.	483286002635
description	window gasket profile 1886 L 600mm Qty 1 external size mounting pos. horizontal		

GEV No.	900825	Ref. No.	483286002636
description	window gasket profile 1886 L 800mm Qty 1 external size mounting pos. vertical		

GEV No.	900427	Ref. No.	483286002633
description	window gasket profile 1580 L 2900mm Qty 1 mounting pos. inner		

GEV No.	900425	Ref. No.	483286002637
description	window gasket profile 1890 L 2370mm Qty 1 mounting pos. outer		

GEV No.	900827	Ref. No.	483286002472
description	window gasket profile 1580 L 990mm Qty 1		

GEV No.	900415	Ref. No.	483286002383
description	window gasket profile 1895 L 3000mm Qty 1 mounting pos. outer		

GEV No.	900426	Ref. No.	483286002638
description	window gasket profile 1885 L 2300mm Qty 1		

GEV No.	900824	Ref. No.	483286008682
description	window gasket profile 1895 L 3570mm Qty 1 mounting pos. inner		

door seals

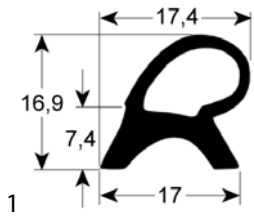

GEV No.	900188	Ref. No.	771985003102
description	door seal profile 2450 W 640mm H 720mm external size Qty 1 suitable for ELECTROLUX 640x720		

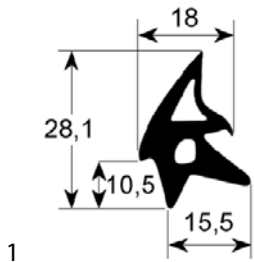

GEV No.	900417	Ref. No.	483286008726
description	door seal profile 2470 L 2300mm Qty 1		

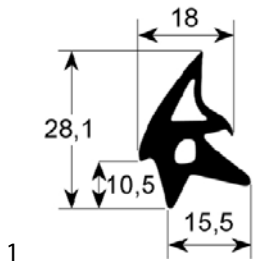

GEV No.	900420	Ref. No.	483286008684
description	door seal profile 2470 L 2850mm Qty 1		

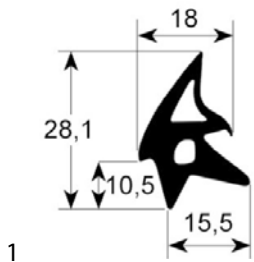

GEV No.	900428	Ref. No.	483286002634
description	door seal profile 2470 L 3600mm Qty 1		

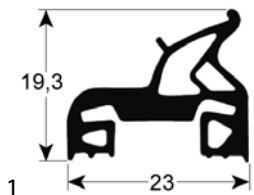

GEV No.	900160	Ref. No.	771985000576
description	door seal profile 2520 W 655mm L 725mm external size Qty 1 suitable for ELECTROLUX		

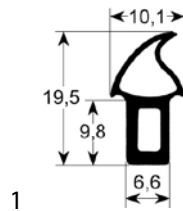

GEV No.	900544	Ref. No.	483286009256
description	door seal profile 2740 L 1350mm Qty 1		

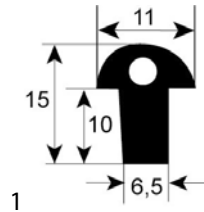

GEV No.	900229	Ref. No.	483286009256
description	door seal profile 2930 L 1350mm Qty 1		

O-rings

EPDM

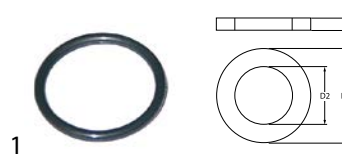

GEV No.	510072	Ref. No.	483286009313
description	O-ring EPDM thickness 3.53mm ID ø 32.93mm Qty 1 pcs		

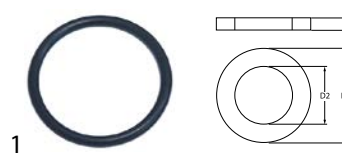

GEV No.	510899	Ref. No.	483286009314
description	O-ring EPDM thickness 3.53mm ID ø 37.69mm Qty 1 pcs		

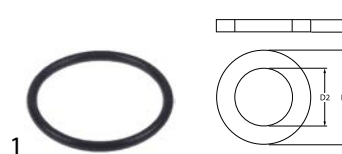

GEV No.	519179	Ref. No.	4832 860 08173
description	O-ring EPDM thickness 3.53mm ID ø 41.28mm Qty 1 pcs		

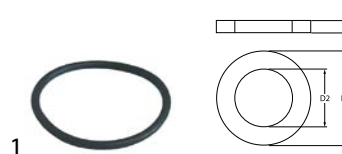

GEV No.	532113	Ref. No.	483286009312
description	O-ring EPDM thickness 3.53mm ID ø 49.21mm Qty 10 pcs		

GEV No.	521120	Ref. No.	483286008139
description	O-ring EPDM thickness 5.34mm ID ø 37.47mm Qty 1 pcs		

sealing washers

rubber gaskets



GEV No.	519114	Ref. No.	483286008162
description	flat gasket rubber ED ø 25mm ID ø 16.5mm thickness 2mm Qty 1 pcs		



GEV No.	519347	Ref. No.	4832 860 01183
description	flat gasket rubber ED ø 80mm ID ø 60mm thickness 3mm Qty 1 pcs equiv. no. TR2448 suitable for Silanos		

plastic gaskets



GEV No.	504435	Ref. No.	483286008935
description	flat gasket plastic ED ø 18mm ID ø 9.5mm thickness 2.5mm for door hinge Qty 1 pcs		

refrigeration cycle components

valves

Schrader valves

Schrader valves (complete)



GEV No.	750340	Ref. No.	208171 771985005990	
description	Schrader valve complete connection soldering connection ø 6mm pipe length 100mm			
accessories for	750340			
	GEV No.	750479	Ref. No.	—
	screw cap CASTEL 8392/A size 1/4" SAE for Schrader valve connection 1/4" Qty 1			

indicators

CASTEL



GEV No.	750418	Ref. No.	485609933017
description	moisture indicator CASTEL type 3940/M10 with indicator connection ODF 10mm L 117mm -30 jusqu'à +110°C		

evaporators

for fridges

producer-specific



GEV No.	750354	Ref. No.	483286008071
description	evaporator L 1000mm W 470mm Hmm suitable for BEV/KIC		



GEV No.	750449	Ref. No.	483286009936
description	evaporator L 490mm W 295mm H 70mm refrigerated counter suitable for ILSA		

springs

torsion springs



GEV No.	690683	Ref. No.	182178
description	torsion spring ø 14.5mm wire gauge ø 2.5mm L1 86mm L2 30mm L3 16mm refrigerator		

			
1			
GEV No.	700087	Ref. No.	182179
description	torsion spring ϕ 14.5mm wire gauge ϕ 2.7mm L1 86mm L2 30mm L3 16mm refrigerator		

manometers

			
1			
GEV No.	541579	Ref. No.	483286009207
description	manometer ϕ 52mm pressure range 0 up to 1bar connection marking 0.5 thread 1/4"		

			
1			
GEV No.	541798	Ref. No.	771985003651
description	manometer ϕ 52mm pressure range 0-6bar connection lower thread 1/4"		





dosing pumps











membrane dosing pumps

self-priming with supporting pressure

GERMAC

type 2001

			
1			
GEV No.	361545	Ref. No.	483286008816
description	dosing pump type 2001 rinse aid inlet 4x6mm outlet M10x1 suction connection ϕ 4x6mm supporting pressure 11mm rebound ball PTFE 1mm GERMAC CODE VNR/U3		
spare parts for	361545		
	GEV No.	361551	Ref. No.
	compression spring wire gauge ϕ 1mm		
	GEV No.	361700	Ref. No.
	hose connector rotary hose ϕ 4x6mm plastic connection M10x1		
	GEV No.	361702	Ref. No.
	hose connector brass hose ϕ 4x6mm		
	GEV No.	361705	Ref. No.
	gasket for hose connector M12x1		

spare parts for	361545		
	GEV No.	510298	Ref. No.
	lip valve dosing pump suitable for DB2/DS5		
accessories for	361545		
	GEV No.	361142	Ref. No.
	mounting set detergent hose type 4x6mm hose length 2m PVC 2x hose/container filter/tank intake transparent		
	GEV No.	361550	Ref. No.
	hose connector hose ϕ 4x6mm		
	GEV No.	361553	Ref. No.
	membrane EPDM		
	GEV No.	361701	Ref. No.
	hose connector thread M10x1 grommet ϕ 7.5mm		
	GEV No.	361703	Ref. No.
	hose connector thread M10x1 brass pipe connection ϕ 4x6mm		
	GEV No.	361704	Ref. No.
	hose connector brass straight thread M12x1 hose ϕ 11mm Qty 1 pcs		
	GEV No.	510296	Ref. No.
	membrane silicone		
	GEV No.	520090	Ref. No.
	PVC hose ID ϕ 4mm ED ϕ 6mm L 2m thickness 1mm t.max. 60°C transparent		
	GEV No.	520091	Ref. No.
	nylon hose ID ϕ 4mm ED ϕ 6mm L 2m thickness 1mm operating p. 10bar burst p. 50bar t.max. 100°C transparent		

hoses

drain hoses

			
1			
GEV No.	530571	Ref. No.	483286008165
description	drain hose DN24 L 1500mm straight ϕ inside 24mm straight ext. ϕ 29mm elbow ϕ inside 29mm elbow ext. ϕ 35mm outer hose ϕ 28mm		



fittings, hose and pipe connectors

hose connectors

nickel-plated brass



1

GEV No.	519239	Ref. No.	4832 860 08802
description	hose connector nickel-plated brass thread 1/4" hose ø 11mm Qty 1 pcs		

producer-specific



1

GEV No.	520336	Ref. No.	483286002402
description	hose connector thread 1/4" grommet ø 12mm ID ø 8mm grommet length 19mm WS 14 total length 35mm thread L 10mm		



1

GEV No.	520337	Ref. No.	483286002401
description	hose connector thread 1/4" grommet ø 7mm ID ø 4.5mm grommet length 19mm WS 14 total length 35mm thread L 10mm		

valves and tank inlets

ball valves

ball valves electric



1





GEV No.	401085	Ref. No.	483286002415
description	ball valve inlet 1/2" IT outlet 1/2" IT 230V L 60mm 50/60Hz closed off-current mode of operation electric connection cable 400mm cable 3-pole		

shut-off valves

universal



1

GEV No.	514370	Ref. No.	483286009187	
description	shut-off valve connection 1/2" 1/2" hot total length 54mm shaft ø M5x0.8mm			
spare parts for	514370			
	GEV No.	514085	Ref. No.	—
	rosette connection 26x19G chrome-plated total lengthmm mounting pos.			
	GEV No.	514086	Ref. No.	—
	hexagonal nut connection 26x19G brass total lengthmm mounting pos. H 6mm WS 34 Qty 1 pcs			
	GEV No.	540414	Ref. No.	—
	star handle connection hot total lengthmm mounting pos. shaft diameter 7x7mm ø 55mm 35 built-in depth 22mm			
	GEV No.	540415	Ref. No.	—
	star handle connection cold total lengthmm mounting pos. shaft diameter 7x7mm ø 55mm 35 built-in depth 22mm			
	GEV No.	540672	Ref. No.	—
	gasket suitable for tap head			

water cycle components

pressure reduction valves

pressure reduction valves

producer-specific



1

GEV No.	520329	Ref. No.	483286002062
description	pressure reduction valve connection 1/2" brass		

measuring equipment

thermometers

built-in thermometers

ø60mm



1

GEV No.	379593	Ref. No.	158081 771985010704
description	thermometer mounting ø 60mm t.max. 300°C 50-300°C probe ø 4mm probe L 135mm capillary pipe 1050mm		

fastening material

screws

hexagonal screws



1

GEV No.	560539	Ref. No.	483286002139
description	hexagonal screw thread M10 thread L 42mm SS WS 17 Qty 1 pcs head thickness 6.5mm DIN 933 / ISO 4017		

A		H	
alarm devices	19	halogen lamp	17
axial fans	27	handle latches	48
B		heating cables	6
ball valves	63	heating cartridges	6
ball valves electric	24, 63	heating elements	3, 6
bar burners	43	heating elements for condensate evaporation	5
C		heating elements for convection	8
cam switches	15	heating elements for defrosting	4
capillary tube clips	13	heating elements for fryers	3
cold air circulating fans (complete)	28	heating elements for frying pans	3
compressors	25	heating elements for griddles	4
condensators & interference suppression filters	31	heating elements for heated trolleys	6
condensing trays heated	27	heating elements for ovens	3
contactors	19	heating elements for pasta cookers	5
control thermostats	10, 12	heating elements for pizza ovens	6
cross flow fans	28	heating elements for refrigeration	4
D		heating elements for salamanders/toasters	6
defrost timers	18	heating elements for tilting bratt pan	5
door seals	60	hexagonal screws	64
dosing pumps	62	hob burners	42
drain hoses	62	hose connectors	63
drain pumps	30	hoses	62
E		hot air motors	29
edgemount latches	48	hot plates	9
electric accessories	32	I	
electric timers	18	ignition boxes	37
electrodes	25	ignition cables	41
electronic magnets	32	ignition units	41
energy regulators	10	immersion heating elements	6
evaporators	61	indicator lights	17
F		indicator lights (complete)	17
fans	27	indicators	61
fastening material	64	L	
filters	31	lamps	17
foil heating elements	9	M	
G		magnetic switches	16
gas burners	42	measuring equipment	64
gas control valves	36	microswitches	14
gas nozzles	43	O	
gas taps	32	O-rings	60
gas thermostats	34	oven hinges	50
gaskets for heated units	59	oven lamps	18
grates	52	P	
		piezoelectric igniters	41
		pilot burners	38
		plug-in gaskets	53

pressure reduction valves	63, 63
pressure switches	24
probes	20
programme timers	18
pumps	29
pumps for ice machines	31
push/momentary push switches	14

R

radiation heaters	9
refrigeration cycle components	61
refrigeration fans	28
refrigeration gaskets	53
refrigeration motors universal	28
refrigeration thermostats	13
relays	20
rocker/momentary rocker switches	13
rotary switches	16

S

safety thermostats	11
safety valves	37
Schrader valves	61
screw-in gaskets	58
screws	64
sealing washers	61
shelves and shelf rails	52
shut-off valves	63
solenoid valves	22
spring assisted hinges	49
switches and momentary switches	13
system switches (ROLD)	14

T

terminals	32
thermocouples	41
thermostats	10
timers	18
transformers	20

V

valves and tank inlets	63
vibration pumps	30

W

wash and rinse pumps	29
water cycle components	63
window seals	59