



GAS COMPONENTS



ELECTRIC COMPONENTS



WATER TECHNOLOGY



MECHANICAL COMPONENTS



TOOLS

Spare parts suitable for

WAMSLER

Find the complete and up-to-date range of products in our GEV Webshop



Manufacturer catalogue

The most important spare parts and accessories arranged clearly for every manufacturer

- ✓ Complete product range and all appliance data always up to date in the GEV Webshop
- ✓ Alphabetical Index at the end of the catalogue

GEV Webshop

www.gev-online.co.uk

www.gev-online.com



- 🔍 Add to Favourites
- 🔍 Sign In with email address and usual password
- 🔍 Easy-order – place several items in your basket at the same time
- 🔍 Quick Item search – no login needed



heating elements

heating elements for fryers



GEV No.	418630	Ref. No.	00011110092 0783408030
description	heating element 6900W 400V heating circuits 3 L 375mm W 170mm H 255mm L1 105mm L2 270mm W1 35mm W2 100mm H1 230mm H2 25mm windings 12 rotation flange connection cable		

heating elements for large hobs

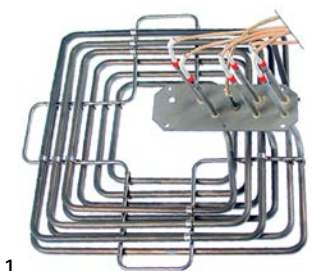

GEV No.	418692	Ref. No.	0073335100
description	heating element 3860W 400V heating circuits 3 L 275mm W 260mm H 47mm tube ø 6.5mm connection length 53mm cable length 1300mm		

hot plates

square & rectangular

with cast edge

with screw connection



GEV No.	490162	Ref. No.	0011110046
description	hot plate dimensions 300x300mm 4000W 230V with cast edge H 42mm connection 4 screw clamps		

thermostats

control and safety thermostats

EGO

control thermostats

55.34_series



GEV No.	375872	Ref. No.	011170067
description	thermostat t.max. 490°C temperature range 70-490°C 3-pole 3NO 16A probe ø 3.9mm probe L 380mm capillary pipe 1180mm capillary pipe isolated 960mm gland nut shaft ø 6x4.6mm shaft L 25mm shaft position upper rotation 270° probe material copper 44mm curved		





gas taps

alternatives to EGA



GP21 series

with pipe outlet



GEV No.	101646 ¹	Ref. No.	011320055	
description	gas tap alternatives to EGA type GP21RD with pipe outlet with throttle screw gas inlet M15x1 (tube ø 10mm) bypass nozzle ø 0.35mm gas outlet M17x1 (tube ø 10mm) thermocouple connection M8x1 pilot connection M10x1 shaft ø 6x4.6mm shaft L 31/23mm shaft flat upper			
spare parts for	101646			
	GEV No.	100408	Ref. No.	—
	bypass nozzle type PEL20/21 bore ø 0.35mm thread M5x0.5			
	GEV No.	101060	Ref. No.	—
	magnet unit standard L 39mm D1 ø 15.4mm D2 ø 11mm suitable for PEL20-21/JUNKERS/EGA			
	GEV No.	101230	Ref. No.	—
	thermocouple nut T1: M8x1 T2: M18x1 aluminium			
	GEV No.	101526	Ref. No.	—
	O-ring Viton thickness 1.78mm ID ø 4.48mm Qty 1 pcs			
	GEV No.	101552	Ref. No.	—
	throttle screw thread M8x0.75			

¹with reducer for main gas line
Table continues overleaf

accessories for		101646	
	GEV No.	100908	Ref. No. —
union screw thread M10x1 for pipe ø 4mm Qty 1 pcs			
	GEV No.	100909	Ref. No. —
union screw thread M10x1 for pipe ø 6mm Qty 1 pcs			
	GEV No.	100926	Ref. No. —
centring piece thread M17x1			
	GEV No.	100942	Ref. No. —
union nut thread M15x1 for pipe ø 10mm			
	GEV No.	101246	Ref. No. —
olive for pipe ø 4mm Qty 1 pcs			
	GEV No.	101278	Ref. No. —
olive for pipe ø 10mm Qty 1 pcs			
	GEV No.	101286	Ref. No. —
olive ID ø 6mm Qty 1 pcs			
	GEV No.	110078	Ref. No. —
knob without symbol ø 70mm shaft ø 6x4.6mm shaft flat universal			
	GEV No.	112206	Ref. No. —
knob dial plate silver gas tap PEL21/22/23 t.max.°C ED ø 63mm ID ø 45.5mm			

ignition parts

thermocouples

plug-in thermocouples

plug-in thermocouples standard

with barrel socket ø6mm

type Junkers with aluminised tip

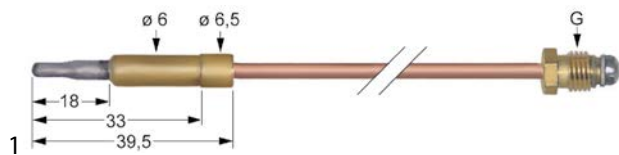



GEV No.	102219	Ref. No.	0011170027
description	thermocouple M8x1 L 450mm plug connection ø6.0mm		

threaded thermocouples

threaded thermocouples standard

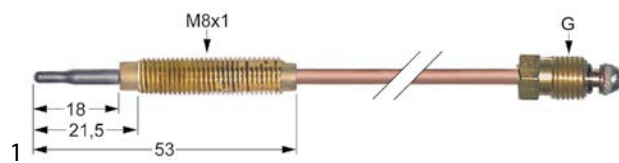
threaded thermocouples (miscellaneous)



GEV No.	102055	Ref. No.	011170007
description	thermocouple M8x1 L 450mm M8x1		
accessories for	102055		
	GEV No.	102067	Ref. No. —
nut thread M8x1 H 3mm brass Qty 1 pcs type SEF 1			

gas burners

accessories

nozzle holders



GEV No.	101369	Ref. No.	011600905
description	nozzle holder ET 3/8" IT M10x1 WS 19		

gas nozzles

pilot burner nozzles

pilot burner nozzles EGA



GEV No.	102793	Ref. No.	00820337700
description	pilot burner nozzle LPG bore ø 0.23mm Qty 1 pcs		



GEV No.	102792	Ref. No.	800337600
description	pilot burner nozzle natural gas bore ø 0.35mm Qty 1 pcs		



pilot burner nozzles JUNKERS

CB 50203_/503_ series

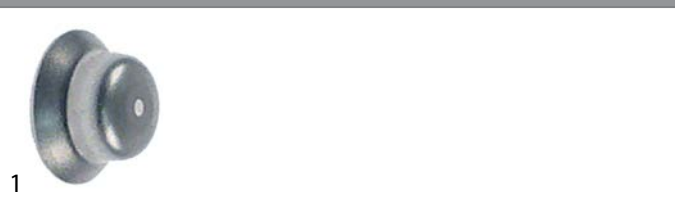

GEV No.	100222	Ref. No.	0011320009
description	pilot burner nozzle LPG gas pressure 50mbar code 5 Qty 1 pcs suitable for JUNKERS CB50203_		



GEV No.	100227	Ref. No.	0011320008
description	pilot burner nozzle natural gas gas pressure 25mbar code 6 Qty 1 pcs suitable for JUNKERS CB50203_		

internal nozzles

internal nozzles for EGA gas taps/nozzle holders

EGA 24197/24362



GEV No.	100340	Ref. No.	880331110
description	internal nozzle bore ø 0.85mm type EGA/PEL22		

baskets

fryer baskets

WAMSLER



GEV No.	970168	Ref. No.	N/A
description	fryer basket L1 305mm W1 170mm H1 120mm SS		

C

control thermostats 3

G

gas burners 4

gas nozzles 4

gas taps 3

H

heating elements 3

heating elements for fryers 3

heating elements for large hobs 3

hot plates 3

T

thermocouples 4

thermostats 3