



GAS COMPONENTS



ELECTRIC COMPONENTS



WATER TECHNOLOGY



MECHANICAL COMPONENTS



TOOLS

Spare parts suitable for

VEGA

Find the complete and up-to-date range of products in our GEV Webshop



Manufacturer catalogue

The most important spare parts and accessories arranged clearly for every manufacturer

- ✓ Complete product range and all appliance data always up to date in the GEV Webshop
- ✓ Alphabetical Index at the end of the catalogue

GEV Webshop

www.gev-online.co.uk

www.gev-online.com





- 🔍 Add to Favourites
- 🔍 Sign In with email address and usual password
- 🔍 Easy-order – place several items in your basket at the same time
- 🔍 Quick Item search – no login needed



heating elements

heating elements for bain maries

| | | | |
|---|---|-----------------|-------|
|  | | | |
| GEV No. | 416161 | Ref. No. | 92023 |
| description | heating element 1000W 230V heating circuits 1 L 430mm W 95mm connection male faston 6.3mm connection distance 40mm connection length 10mm tube ø 6.3mm dry heating element W2 39mm H 36mm | | |
| For models: | BM1 | | |





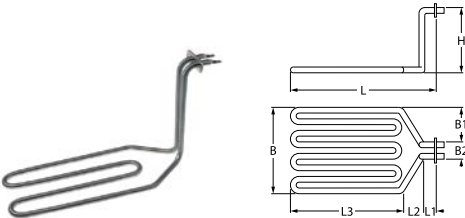

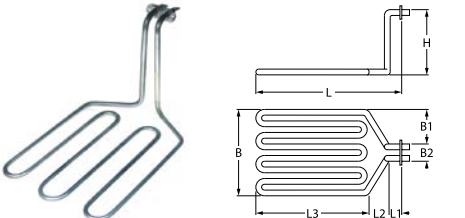

| | | | |
|---|---|-----------------|-----------------|
|  | | | |
| GEV No. | 418502 | Ref. No. | 92028 92028G |
| description | heating element 1200W 230V heating circuits 1 L 410mm W 195mm connection male faston 6.3mm tube ø 6.5mm dry heating element | | |

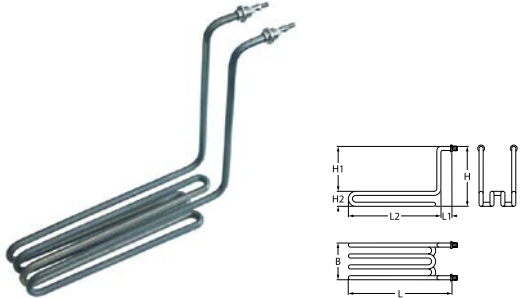
heating elements for fryers

| | | | |
|--|---|-----------------|-----|
|  | | | |
| GEV No. | 418531 | Ref. No. | N/A |
| description | heating element 2000W 230V heating circuits 1 L 296mm W 120mm H 170mm rectangular flange connection male faston 6.3mm immersion heater L1 14mm L2 70mm L3 212mm W1 50mm W2 27mm hole distance 40mm windings 2 hole ø 4mm flange length 51mm flange width 22mm tube ø 8.5mm connection length 37mm | | |

| | | | |
|---|--|-----------------|-------|
|  | | | |
| GEV No. | 418501 | Ref. No. | 93178 |
| description | heating element 3000W 230V heating circuits 1 L 280mm W 191mm H 164mm rectangular flange connection male faston 6.3mm L1 15mm L2 35mm L3 230mm W1 80mm W2 31mm hole distance 40mm windings 3 hole ø 4mm flange length 50mm flange width 22mm | | |

2 hole fixing

| | | | |
|---|---|-----------------|-------------------|
|  | | | |
| GEV No. | 416172 | Ref. No. | 93097 |
| description | heating element 3000W 230V heating circuits 1 L 300mm W 80mm H 255mm L1 43mm L2 257mm H1 215mm H2 40mm thread 1/4" mounting distance 67mm tube ø 8.5mm 2 hole fixing connection M5 connection length 12mm immersion heater windings 4 | | |
| spare parts for | 416172 | | |
|  | GEV No. | 510417 | Ref. No. — |
| | flat gasket fibre ED ø 20mm ID ø 14mm thickness 2mm Qty 1 pcs | | |
|  | GEV No. | 528723 | Ref. No. — |
| | flat gasket FIBER ED ø 20mm ID ø 13mm thickness 1mm Qty 1 pcs | | |
| accessories for | 416172 | | |
|  | GEV No. | 361182 | Ref. No. — |
| | nut thread 1/4" H 5mm nickel-plated brass WS 17 Qty 1 pcs | | |
|  | GEV No. | 520228 | Ref. No. — |
| | tooth lock washer ID ø 15.3mm ED ø 24mm steel Qty 1 pcs for thread M14 | | |
|  | GEV No. | 550262 | Ref. No. — |
| | flat gasket copper ED ø 20mm ID ø 14mm thickness 2mm | | |
|  | GEV No. | 560112 | Ref. No. — |
| | plain washer ID ø 5.3mm ED ø 10mm thickness 1mm SS Qty 20 pcs DIN 125A for thread M5 | | |
|  | GEV No. | 560132 | Ref. No. — |
| | hexagonal nut thread M5 H 4mm WS 8 SS DIN/ISO DIN 934 / ISO 4032/8673 Qty 20 pcs | | |

heating elements for griddles





| | | | |
|--|---|-----------------|-------|
|  | | | |
| GEV No. | 416161 | Ref. No. | 92023 |
| description | heating element 1000W 230V heating circuits 1 L 430mm W 95mm connection male faston 6.3mm connection distance 40mm connection length 10mm tube ø 6.3mm dry heating element W2 39mm H 36mm | | |
| For models: | BM1 | | |



heating elements for contact grills

| | | | |
|---|---|-----------------|------------------|
|  | | | |
| 1 | | | |
| GEV No. | 417662 | Ref. No. | Heizung zu 80879 |
| description | heating element 2400W 230V heating circuits 1 L 315mm W 285mm H 50mm connection distance 280mm tube ø 8.5mm | | |

heating elements for pizza ovens

| | | | |
|---|--|-----------------|-------------------|
|  | | | |
| 1 | | | |
| GEV No. | 416848 | Ref. No. | 93107 |
| description | heating element 800W 230V L 445mm W 195mm thread 1/4" mounting distance 186mm connection length 15mm connection M4 tube ø 8.5mm heating circuits 1 dry heating element 2 hole fixing | | |
| accessories for | 416848 | | |
|  | GEV No. | 361182 | Ref. No. — |
| | nut thread 1/4" H 5mm nickel-plated brass WS 17 Qty 1 pcs | | |
|  | GEV No. | 510417 | Ref. No. — |
| | flat gasket fibre ED ø 20mm ID ø 14mm thickness 2mm Qty 1 pcs | | |
|  | GEV No. | 520228 | Ref. No. — |
| | tooth lock washer ID ø 15.3mm ED ø 24mm steel Qty 1 pcs for thread M14 | | |
|  | GEV No. | 550262 | Ref. No. — |
| | flat gasket copper ED ø 20mm ID ø 14mm thickness 2mm | | |

heating elements for rechauds

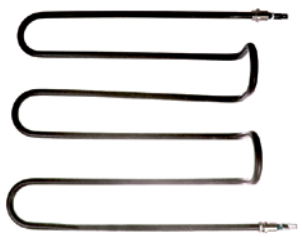
| | | | |
|---|----------------------------|-----------------|-------------|
|  | | | |
| 1 | | | |
| GEV No. | 418518 | Ref. No. | für 81133V1 |
| description | heating element 1300W 230V | | |

| | | | |
|--|---------------------------|-----------------|-----------|
|  | | | |
| 1 | | | |
| GEV No. | 418516 | Ref. No. | für 81132 |
| description | heating element 650W 230V | | |

heating elements for heated cabinets

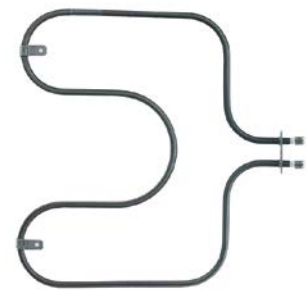
| | | | |
|--|---|-----------------|-------|
|  | | | |
| 1 | | | |
| GEV No. | 416719 | Ref. No. | 93272 |
| description | heating element 600W 230V heating circuits 1 L 259mm W 275mm flange length 44mm flange width 22mm connection male faston 6.3mm tube ø 6.5mm rectangular flange hole ø 4mm dry heating element L1 45mm L2 214mm W1 125mm W2 29mm | | |

quartz heating elements

| | | | |
|--|---|-----------------|-------|
|  | | | |
| 1 | | | |
| GEV No. | 415303 | Ref. No. | 92027 |
| description | heating element 400W 115V L 340mm ø 12mm connection male faston 6.3mm | | |
| For models: | T2 | | |

| | | | |
|--|---|-----------------|-----------------|
|  | | | |
| 1 | | | |
| GEV No. | 419179 | Ref. No. | 93119 93119G |
| description | quartz heating element 700W 110V L 560mm ø 11.5mm connection F6.3 17.5Ohm | | |

| | | | |
|--|---|-----------------|-------|
|  | | | |
| 1 | | | |
| GEV No. | 416020 | Ref. No. | 92000 |
| description | quartz tube WV L 390mm ID ø 9mm ED ø 11mm | | |



energy regulators

EGO

1-circuit



1

| | | | |
|--------------------|---|-----------------|--------|
| GEV No. | 380015 | Ref. No. | 93087G |
| description | energy regulator 230V 13A single-circuit turn direction right shaft ø 6x4.6mm shaft L 23mm mounting thread M4 power release 6-100% no. 50.57021.010 | | |

thermostats

control and safety thermostats

EGO

control thermostats

55.10/19_ series



1

| | | | |
|--------------------|---|-----------------|-------|
| GEV No. | 375856 | Ref. No. | 93238 |
| description | thermostat t.max. 187°C temperature range 101-187°C 1-pole 1NO 16A probe ø 6mm probe L 130mm capillary pipe 900mm capillary pipe isolated 700mm gland nut M10x1 shaft ø 6x4.6mm shaft L 23mm shaft position upper rotation 270° | | |

55.13_ series



1

| | | | |
|--------------------|---|-----------------|---------|
| GEV No. | 375530 | Ref. No. | 93044 G |
| description | thermostat t.max. 400°C temperature range 100-400°C 1-pole 1NO 16A probe ø 3.9mm probe L 163mm capillary pipe 830mm capillary pipe isolatedmm gland nut shaft ø 6x4.6mm shaft L 23mm shaft position upper rotation 270° | | |

safety thermostats

55.10/19_ series



1

| | | | |
|--------------------|---|-----------------|--------|
| GEV No. | 375339 | Ref. No. | 93239G |
| description | safety thermostat switch-off temp. 225°C 1-pole 0.5A probe ø 6mm probe L 133mm capillary pipe 870mm capillary pipe isolatedmm gland nut M10x1 probe | | |

accessories for



| | | | |
|--------------------|---------------------------------------|-----------------|---|
| GEV No. | 551083 | Ref. No. | — |
| description | cap for safety thermostat thread M8x1 | | |

IMIT / TEMPOMATIC / ARTERMO

control thermostats



1

| | | | |
|--------------------|--|-----------------|-------|
| GEV No. | 375805 | Ref. No. | 93001 |
| description | thermostat t.max. 90°C temperature range 0-90°C 1-pole 1CO 15A probe ø 6.5mm probe L 85mm capillary pipe 1000mm capillary pipe isolated 900mm gland nut shaft ø 6x4.6mm shaft L 19mm rotation 270° | | |

TECASA

control thermostats



1

| | | | |
|--------------------|---|-----------------|-------|
| GEV No. | 375801 | Ref. No. | 93179 |
| description | thermostat t.max. 180°C temperature range 50-180°C 1-pole 1NO 16A probe ø 6mm probe L 75mm capillary pipe 420mm capillary pipe isolatedmm gland nut shaft ø 6x4.6mm rotation 270° | | |
| For models: | 81064, 81065, CHEF | | |

safety thermostats



1

| | | | |
|--------------------|---|-----------------|-------|
| GEV No. | 390028 | Ref. No. | 93037 |
| description | safety thermostat switch-off temp. 230°C 1-pole 16A probe ø 3mm probe L 155mm capillary pipe 890mm capillary pipe isolated 600mm gland nut probe SS | | |





| | | | |
|--|--|-----------------|-------|
|  | | | |
| GEV No. | 375195 | Ref. No. | 93180 |
| description | safety thermostat switch-off temp. 240°C 1-pole 16A probe ø 4mm probe L 84mm capillary pipe 400mm capillary pipe isolated 130mm gland nut probe SS | | |
| For models: | 81064, 81065, CHEF | | |

switches and momentary switches

rocker/momentary rocker switches

30x11mm

| | | | |
|---|---|-----------------|-------------------|
|  | | | |
| GEV No. | 301010 | Ref. No. | 93258 |
| description | rocker switch mounting measurements 30x11mm red 1NO/indicator light 250V 16A 0-I connection male faston 6.3mm ambient temperature max. 85/125°C protection IP40 | | |
| accessories for | 301010 | | |
|  | GEV No. | 301035 | Ref. No. — |
| | protective cover mounting measurements 30x11mm | | |

30x22mm

| | | | |
|--|--|-----------------|-------|
|  | | | |
| GEV No. | 345641 | Ref. No. | 93002 |
| description | rocker switch mounting measurements 30x22mm red 2NO 230V 16A illuminated 0-I connection male faston 6.3mm ambient temperature max. 125/55°C protection IP65 with rubber collar | | |

microswitches

lever actuated

| | | | |
|--|--|-----------------|------------------------|
|  | | | |
| GEV No. | 346969 | Ref. No. | Microschalter zu 81207 |
| description | microswitch with lever 250V 16A 1NO connection male faston 6.3mm L 59mm L1 29mm ambient temperature max. 120°C mounting distance 22mm actuating force: 50g lever length 50mm | | |

lamps

indicator lights

indicator lights (complete)

ø12mm

with plug-in socket

| | | | |
|--|--|-----------------|-------------|
|  | | | |
| GEV No. | 359898 | Ref. No. | für 81141V1 |
| description | indicator light ø 12mm 230V green connection male faston 6.3mm | | |



ø13mm

with plug-in socket

| | | | |
|--|---|-----------------|-------|
|  | | | |
| GEV No. | 359143 | Ref. No. | 93004 |
| description | indicator light ø 13mm yellow 230V connection male faston 6.3mm temp.-resist. 120°C Qty 1 pcs | | |
| For models: | 81064, 81065, T2 | | |

timers

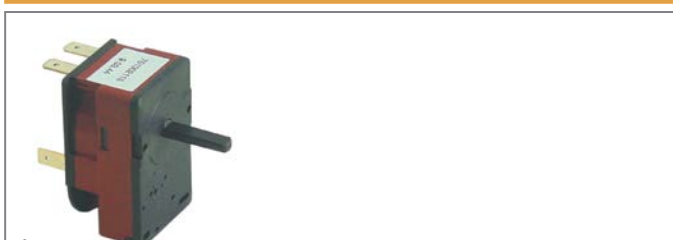
mechanical timers

| | | | |
|--|---|-----------------|-------------------|
|  | | | |
| GEV No. | 350044 | Ref. No. | 93003 |
| description | timer C20 2-pole operation time 15min impulse mechanical 2NO at 250V 16A permanent position no shaft ø 6x4.6mm shaft 6x4.6mm shaft L 20mm mounting distance 28mm connection lateral for toaster | | |
| For models: | T2 | | |
| accessories for | 350044 | | |
|  | GEV No. | 110285 | Ref. No. — |
| | knob switch zero mark t.max.°C°C ø 40mm shaft ø 6x4.6mm shaft flat upper black | | |



equipment-specific units

for rechauds

warming plates

components



1

| | | | |
|--------------------|--|-----------------|-------|
| GEV No. | 693839 | Ref. No. | 93234 |
| description | warming plate dimensions 270x150x10(6)mm | | |

knobs

universal knobs



1

| | | | |
|--------------------|---|-----------------|-------|
| GEV No. | 112121 | Ref. No. | 93314 |
| description | knob thermostat t.max. 180°C ø 48mm shaft ø 6x4.6mm shaft flat upper temperature range 70-180°C rotation 270° | | |

producer-specific knobs

VEGA



1

| | | | |
|--------------------|------------------------------|-----------------|-------|
| GEV No. | 112120 | Ref. No. | 93052 |
| description | knob switch zero mark ø 40mm | | |



1

| | | | |
|--------------------|---|-----------------|-------|
| GEV No. | 110650 | Ref. No. | 93052 |
| description | knob switch zero mark ø 40mm shaft ø 6x4.6mm shaft flat lower black | | |



1

| | | | |
|--------------------|--|-----------------|-------|
| GEV No. | 110657 | Ref. No. | 93052 |
| description | knob switch zero mark t.max.°C temperature range°C ø 40mm shaft ø 6x4.6mm shaft flat lower black | | |



1

| | | | |
|--------------------|---|-----------------|-------|
| GEV No. | 112121 | Ref. No. | 93314 |
| description | knob thermostat t.max. 180°C ø 48mm shaft ø 6x4.6mm shaft flat upper temperature range 70-180°C rotation 270° | | |

fittings for catering equipment

outlet taps

universal



1

| | | | |
|--------------------|---|-----------------|-------|
| GEV No. | 540699 | Ref. No. | 93038 |
| description | outlet tap W 35mm H 35mm thread 3/4" IT | | |

C

control thermostats 5,5

E

energy regulators 5

H

heating elements 3

heating elements for bain maries 3

heating elements for contact grills 4

heating elements for fryers 3

heating elements for griddles 3

heating elements for heated cabinets 4

heating elements for pizza ovens 4

heating elements for rechauds 4

I

indicator lights 6

indicator lights (complete) 6

L

lamps 6

M

mechanical timers 6

microswitches 6

Q

quartz heating elements 4

R

rocker/momentary rocker switches 6

S

safety thermostats 5

switches and momentary switches 6

T

thermostats 5

timers 6