



GAS COMPONENTS



ELECTRIC COMPONENTS



WATER TECHNOLOGY



MECHANICAL COMPONENTS



TOOLS

Spare parts suitable for

TORNATI

Find the complete and up-to-date range of products in our GEV Webshop



Manufacturer catalogue

The most important spare parts and accessories arranged clearly for every manufacturer

- ✓ Complete product range and all appliance data always up to date in the GEV Webshop
- ✓ Alphabetical Index at the end of the catalogue

GEV Webshop

www.gev-online.co.uk

www.gev-online.com







- 🔍 Add to Favourites
- 🔍 Sign In with email address and usual password
- 🔍 Easy-order – place several items in your basket at the same time
- 🔍 Quick Item search – no login needed









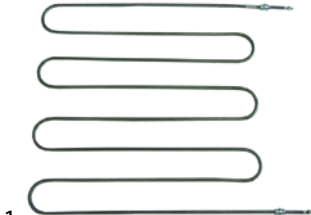



heating elements

heating elements for pizza ovens

 <p>1</p>			
GEV No.	415890	Ref. No.	336023
description	heating element 1500W 230V L 455mm W 410mm thread 1/4" mounting distance 402mm connection length 60mm connection M6x1 tube ø 8.5mm heating circuits 1 dry heating element 2 hole fixing pizza oven		
accessories for	415890		
	GEV No.	361182	Ref. No. —
	nut thread 1/4" H 5mm nickel-plated brass WS 17 Qty 1 pcs		
	GEV No.	510417	Ref. No. —
	flat gasket fibre ED ø 20mm ID ø 14mm thickness 2mm Qty 1 pcs		
	GEV No.	520228	Ref. No. —
	tooth lock washer ID ø 15.3mm ED ø 24mm steel Qty 1 pcs for thread M14		
	GEV No.	550262	Ref. No. —
	flat gasket copper ED ø 20mm ID ø 14mm thickness 2mm		

 <p>1</p>			
GEV No.	415891	Ref. No.	336014 336024
description	heating element 2000W 230V L 560mm W 545mm thread 1/4" mounting distance 540mm connection M6 tube ø 8.5mm heating circuits 1 dry heating element 2 hole fixing pizza oven		

 <p>1</p>			
GEV No.	415896	Ref. No.	336005
description	heating element 550W 230V L 1180mm W 63mm thread 1/4" mounting distance 54.5mm connection length 49mm connection M4 tube ø 8.5mm heating circuits 1 dry heating element 2 hole fixing		
accessories for	415896		
	GEV No.	361182	Ref. No. —
	nut thread 1/4" H 5mm nickel-plated brass WS 17 Qty 1 pcs		
	GEV No.	510417	Ref. No. —
	flat gasket fibre ED ø 20mm ID ø 14mm thickness 2mm Qty 1 pcs		
	GEV No.	520228	Ref. No. —
	tooth lock washer ID ø 15.3mm ED ø 24mm steel Qty 1 pcs for thread M14		
	GEV No.	550262	Ref. No. —
	flat gasket copper ED ø 20mm ID ø 14mm thickness 2mm		

 <p>1</p>			
GEV No.	415521	Ref. No.	336007 f.Export60x60
description	heating element 650W 230V L 570mm W 160mm thread 1/4" mounting distance 164mm connection length 39mm connection M6 tube ø 8.5mm heating circuits 1 dry heating element 2 hole fixing		
accessories for	415521		
	GEV No.	361182	Ref. No. —
	nut thread 1/4" H 5mm nickel-plated brass WS 17 Qty 1 pcs		
	GEV No.	510417	Ref. No. —
	flat gasket fibre ED ø 20mm ID ø 14mm thickness 2mm Qty 1 pcs		
	GEV No.	520228	Ref. No. —
	tooth lock washer ID ø 15.3mm ED ø 24mm steel Qty 1 pcs for thread M14		
	GEV No.	550262	Ref. No. —
	flat gasket copper ED ø 20mm ID ø 14mm thickness 2mm		



thermostats

control and safety thermostats

EGO

safety thermostats

55.10/19_series

 <p>1</p>			
GEV No.	375662	Ref. No.	333014
description	safety thermostat switch-off temp. 512°C 1-pole 16A probe ø 3.9mm probe L 228mm capillary pipe 1470mm capillary pipe isolated 960mm gland nut probe SS screw connection M8x1		
accessories for	375662		
	GEV No.	102067	Ref. No. —
	nut thread M8x1 H 3mm brass Qty 1 pcs type SEF 1		



JUMO

control thermostats

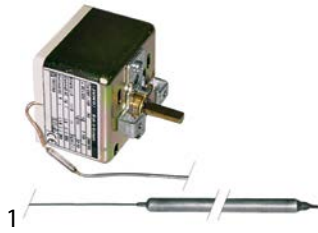

GEV No.	375103	Ref. No.	333003
description	thermostat t.max. 500°C temperature range 20-500°C 3-pole 3CO 16A probe ø 8mm probe L 155mm capillary pipe 1000mm capillary pipe isolatedmm gland nut shaft ø 6x4.6mm shaft L 17mm rotation 270°		

safety thermostats



GEV No.	390169	Ref. No.	333007
description	safety thermostat switch-off temp. 20-500°C temperature range°C 1-pole 1NC 16A probe ø 6mm probe L 275mm capillary pipe 1000mm capillary pipe isolatedmm gland nut shaft ømm probe material copper 230V		
For models:	TF60, TF99		

control thermostats with actual value



GEV No.	379039	Ref. No.	333002
description	thermostat t.max. 500°C temperature range 0-500°C 1CO 5A probe ø 8mm probe L 150mm capillary pipe 1100mm mounting ø 60mm front measurements 72x72mm		

switches and momentary switches
rocker/momentary rocker switches

30x22mm

labelled



GEV No.	300125	Ref. No.	304026	
description	rocker switch mounting measurements 30x22mm green 2NO 230V 16A 0-I connection male faston 6.3mm ambient temperature max. 125/55°C protection IP65 with cover cap			
For models:	TF60, TF99			
accessories for	300125			
	GEV No.	301036	Ref. No.	—
	protective cover internal size 30x22mm for rocker switch mounting measurementsmm			

rotary switches

BREMAS

A1600 series



GEV No.	345315 ¹	Ref. No.	304023
description	rotary switch 3 1-0-2 sets of contacts 6 type CA160007 400V 16A shaft ø 5x5mm shaft L 23mm shaft square with knob connection screw		

¹incl. knob

CQ016R series



GEV No.	301065	Ref. No.	304023
description	rotary switch 400V 16A shaft ø 5x5mm connection screw clamp shaft squaremm		



lamps

screw-on/push-on fit

light bulbs

for ovens



1

GEV No.	359610	Ref. No.	321006
description	light bulb t.max. 300°C socket E14 15W 230V ø 22mm L 47mm lens L 20mm for oven lamp type Philips		
For models:	TF60, TF99		

halogen lamp

for socket G4 / G6.35 / G9



1

GEV No.	359599	Ref. No.	321012
description	halogen lamp socket G4 12V 20W temp.-resist. 500°C		

oven lamps

universal oven lamps

mounting diameter 35.5mm



1

GEV No.	359701	Ref. No.	323004
description	lamp socket socket E14 220-230V mounting ø 35.5mm connection male faston 6.3mm 15W		
For models:	TF60, TF99		
accessories for	359701		

	GEV No.	359705	Ref. No.	—
	oven lamp glass thr.ø 33.5mm ø 52mm hard glas temp.-resist. 350°C			

	GEV No.	359709	Ref. No.	323013
	oven lamp glass thr.ø 33.5mm ø 42mm hard glas temp.-resist. 350°C			

	GEV No.	359721	Ref. No.	—
	gasket silicone ED ø 48mm ID ø 39.5mm thickness 5mm Qty 1 pcs			

	GEV No.	359942	Ref. No.	323005 TO323005
	oven lamp glass thr.ø 33.5mm ø 41mm hard glas temp.-resist. 350°C			



1

GEV No.	359942	Ref. No.	323005 TO323005
description	oven lamp glass thr.ø 33.5mm ø 41mm hard glas temp.-resist. 350°C		



1

GEV No.	359709	Ref. No.	323013
description	oven lamp glass thr.ø 33.5mm ø 42mm hard glas temp.-resist. 350°C		

mounting diameter 65.5mm



1

GEV No.	359724	Ref. No.	323006
description	oven lamp glass thread ø 62mm H 46mm ø 74mm hard glas temp.-resist. 350°C		
For models:	TF60, TF99		

lamps

light bulbs



1

GEV No.	359610	Ref. No.	321006
description	light bulb t.max. 300°C socket E14 15W 230V ø 22mm L 47mm lens L 20mm for oven lamp type Philips		
For models:	TF60, TF99		

halogen lamps

for socket G4 / G6.35 / G9



1

GEV No.	359599	Ref. No.	321012
description	halogen lamp socket G4 12V 20W temp.-resist. 500°C		



electronic controllers

EVCO - EVERY CONTROL

universal controllers

built-in version



1

GEV No.	379027	Ref. No.	331008
description	electronic controller EVERY CONTROL mounting measurements 66.5x138mm 230V voltage AC TC J/K protection IP54 0-700°C for pizza oven type EC8		

probes

producer-specific probes

probes



1

GEV No.	379423	Ref. No.	TO338014
description	temperature probe thermocouple J (Fe-CuNi) cable Vetrotex probe -50 up to +750°C cable -50 up to +350°C connection wire end ferrules thread probe ø6x150mm cable length 1.5m		

fans

axial fans

import



1

GEV No.	601080 ¹	Ref. No.	328022
description	axial fan L 119mm W 119mm H 38mm 230VAC 50/60Hz 23/20W bearing ball bearing connection male faston 2.8mm metal ADDA fan wheel ø 110mm temp.-resist. 70°C		
For models:	TF60, TF99		
accessories for	601080		
	GEV No.	550898	Ref. No. —
	connecting cable cable length 2000mm connection F 2.8 connection distance 7.9mm for axial flow fan		

¹with ball bearings

accessories for	601080		
	GEV No.	692519	Ref. No. —
	guard L 120mm W 120mm plastic		





gas valves and ignition boxes

gas control valves

HONEYWELL



1

GEV No.	101164	Ref. No.	512001
description	gas valve type VR4605A 230V 50Hz gas inlet 1/2" gas outlet 1/2" thermocouple connection pilot connection pressure range 3-37mbar operator type 230V (V404A 1329)		
For models:	TF60, TF99		
accessories for	101164		
	GEV No.	101305	Ref. No. —
	gas connection straight 1/2" flange 45x45mm ELETTROSIT/V4400/4600/4605 suitable for SIT/HONEYWELL hole distance 36x36mm		
	GEV No.	101306	Ref. No. —
	gas connection angled flange 45x45mm hole distance 36x36mm 1/2" ELETTROSIT/V4400/4600/4605 screw with O-ring suitable for SIT/HONEYWELL		
	GEV No.	101307	Ref. No. —
	gas connection straight flange 45x45mm hole distance 36x36mm 3/4" ELETTROSIT/V4400/4600/4605 screw with O-ring suitable for SIT/HONEYWELL		
	GEV No.	101308	Ref. No. —
	gas connection angled flange 45x45mm hole distance 36x36mm 3/4" ELETTROSIT/V4400/4600/4605 screw with O-ring suitable for SIT/HONEYWELL		



ignition boxes

HONEYWELL



1

GEV No.	101165	Ref. No.	512002
description	ignition box HONEYWELL type S4560A 1008 equiv. no. S4560A 1008 electrodes 1 waiting time 0s safety time 10s 220-240V 10VA 50Hz		
For models:	TF60, TF99		
spare parts for	101165		
	GEV No.	358696	Ref. No. —
fine fuse size ø5x20mm 4A medium lag rated 250V Qty 10 pcs			



1

GEV No.	106949	Ref. No.	512030
description	ignition box HONEYWELL type S4960A 1008 electrodes 1 waiting time 2s safety time 10s 220-240V 10VA 50Hz		

ignition parts

electrodes

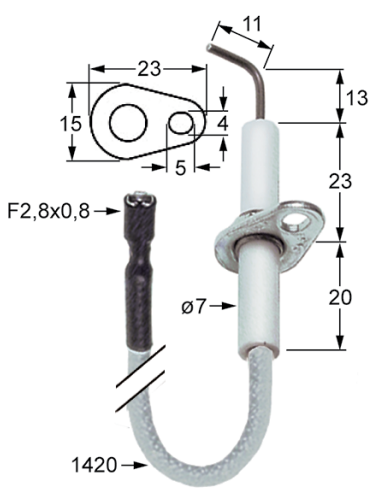

1

GEV No.	100726	Ref. No.	337001
description	ignition electrode flange length 23mm flange width 15mm D1 ø 7mm L1 13mm L2 11mm BL1 23mm BL2 20mm connection F 2.8x0.8mm cable length 1420mm fixing dimensions ø5x4mm with flange		
For models:	TF60, TF99		

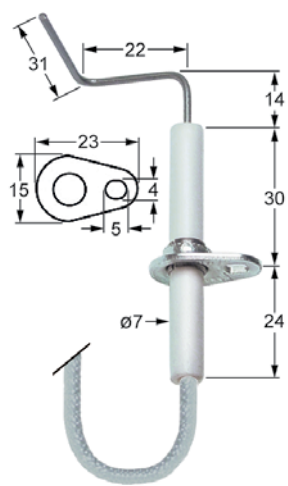

1

GEV No.	100727	Ref. No.	338002
description	ignition electrode flange length 23mm flange width 15mm D1 ø 7mm L1 14mm L2 22mm L3 31mm BL1 30mm BL2 24mm cable length 1400mm fixing dimensions ø5x4mm with flange		
For models:	TF60, TF99		

gas nozzles

main nozzles

gas nozzles M13x1



1

GEV No.	102783	Ref. No.	502018 FR23-30/37
description	gas injector thread M13x1 bore ø 1.8mm WS 13		



1

GEV No.	102785	Ref. No.	FR20/25
description	gas injector thread M13x1 bore ø 2.65mm WS 13		

equipment-specific units

for pizza ovens

firebricks



1

GEV No.	850005	Ref. No.	201078
description	firebrick L 615mm W 606mm H 25mm delivery freight forwarding company only		
For models:	TF60		



mechanical components, equipment accessories

1 

GEV No.	850116	Ref. No.	201112
description	firebrick L 615mm W 610mm H 18mm delivery freight forwarding company only		

1 

GEV No.	850006	Ref. No.	201080
description	firebrick L 913mm W 606mm H 25mm delivery freight forwarding company only		

1 

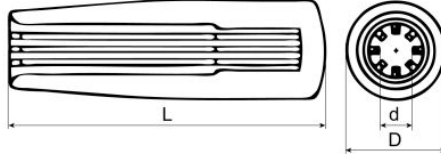
1 

GEV No.	110331	Ref. No.	I580/80 N12,513010
description	cylindrical handle bore \varnothing 12mm \varnothing 26mm L 80mm		

gaskets

sealing cords

square

1 

GEV No.	693738	Ref. No.	211003
description	sealing cord square size 10x10mm t.max. 550°C braided L 5m		
For models:	TF60, TF99		

springs

gas tension springs

gas tension springs

1 

GEV No.	692685	Ref. No.	514002
description	gas tension spring 150N hub 100mm D1 \varnothing 6mm D2 \varnothing 15mm hole distance 260mm hole \varnothing 6mm L 275mm		

measuring equipment

thermometers

built-in thermometers

\varnothing 60mm

1 

GEV No.	541054	Ref. No.	332001 JUMO DIAM.60
description	thermometer mounting \varnothing 60mm t.max. 500°C 0 up to +500°C probe \varnothing 10mm probe L 80mm capillary pipe 700mm		

knobs

producer-specific knobs

TORNATI

1 

GEV No.	112538	Ref. No.	513002
description	knob switch zero mark \varnothing 27mm shaft \varnothing 6mm shaft flat lower black		

handles and hand wheels

cylindrical handles

fixed

1 

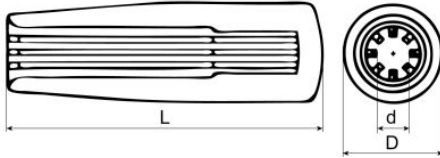
1 

GEV No.	110332	Ref. No.	I580/65 N10,513007
description	cylindrical handle bore \varnothing 10mm \varnothing 23mm L 65mm		

A	
axial fans	6
C	
control thermostats	4
E	
electronic controllers	6
F	
fans	6
G	
gas control valves	6
gas nozzles	7
H	
halogen lamp	5
heating elements	3
heating elements for pizza ovens	3
I	
ignition boxes	7
L	
lamps	5
light bulbs	5
M	
measuring equipment	8
O	
oven lamps	5
P	
probes	6
R	
rocker/momentary rocker switches	4
rotary switches	4
S	
safety thermostats	3,4
sealing cords	8
switches and momentary switches	4
T	
thermostats	3