



GAS COMPONENTS



ELECTRIC COMPONENTS



WATER TECHNOLOGY



MECHANICAL COMPONENTS



TOOLS

Spare parts suitable for

THIRODE

Find the complete and up-to-date range of products in our GEV Webshop



Manufacturer catalogue

The most important spare parts and accessories arranged clearly for every manufacturer

- ✓ Complete product range and all appliance data always up to date in the GEV Webshop
- ✓ Alphabetical Index at the end of the catalogue

GEV Webshop

www.gev-online.co.uk

www.gev-online.com



- 🔍 Add to Favourites
- 🔍 Sign In with email address and usual password
- 🔍 Easy-order – place several items in your basket at the same time
- 🔍 Quick Item search – no login needed



heating elements

heating elements for ovens

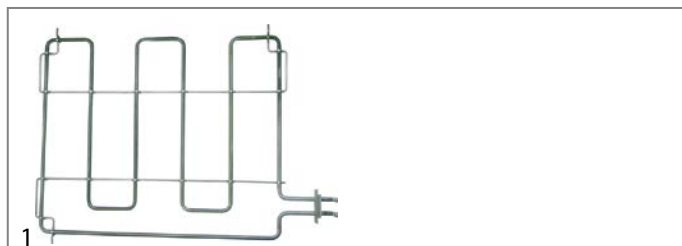

GEV No.	418525	Ref. No.	302191
description	heating element 3300W 400V L 610mm W 450mm L1 75mm L2 535mm W1 40mm W2 55mm flange length 72mm flange width 53mm hole distance 62mm hole ø 5mm tube ø 8.5mm connection M5 heating circuits 1 rectangular flange dry heating element oven		

heating elements for frying pans



GEV No.	420432	Ref. No.	302197 302256
description	heating element 1800W 230V heating circuits 1 L 90mm W 556mm hole distance 55mm tube ø 8mm H 134mm		

immersion heating elements

with expansion flange 70 x 18mm



GEV No.	420171	Ref. No.	903121
description	heating element 1500W 220V heating circuits 1 flange 70x18mm L 255mm W 65mm H 32mm connection male faston 6.3mm immersion heater tube ø 8.5mm		



GEV No.	415016	Ref. No.	903101
description	heating element 3000W 230V heating circuits 3 flange 70x18mm L 398mm W 60mm H 24mm connection male faston 6.3mm immersion heater expansion flange tube ø 6.3mm		



GEV No.	416243	Ref. No.	2001624H
description	heating element 7600W 230V heating circuits 3 flange 70x18mm L 390mm W 60mm H 13mm connection male faston 6.3mm tube ø 6.3mm immersion heater expansion flange INCOLOY-800		

accessories

sealing washers

O-rings

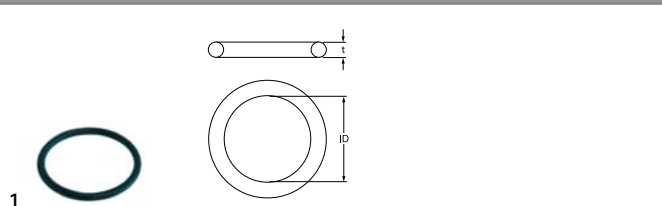

GEV No.	510409	Ref. No.	905588
description	O-ring EPDM thickness 5.34mm ID ø 56.52mm Qty 1 pcs		

hot plates

square & rectangular

with radiused edge



GEV No.	490066 ¹	Ref. No.	303001
description	hot plate dimensions 220x220mm 2600W 230V with spill ring connection 4 screw clamps protector yes square		

¹incl. protector



GEV No.	490068 ¹	Ref. No.	303002
description	hot plate dimensions 220x220mm 2600W 400V with spill ring connection 4 screw clamps protector yes square		

¹incl. protector



round

with radiused edge

for domestic and commercial kitchens



GEV No.	490020	Ref. No.	303003
description	hot plate ø 220mm 2600W 230V connection 4 screw clamps with 8mm spill ring		
accessories for	490020		
	GEV No.	550796	Ref. No.
			—
	fixing plate for hot plate ø220mm		



GEV No.	490021	Ref. No.	303004
description	hot plate ø 220mm 2600W 400V connection 4 screw clamps with 8mm spill ring		



GEV No.	490061	Ref. No.	303009
description	hot plate ø 300mm 2500W 230V connection 4 screw clamps with 8mm spill ring		



GEV No.	490063	Ref. No.	303008
description	hot plate ø 300mm 2500W 400V connection 4 screw clamps with 8mm spill ring		

energy regulators

EGO

1-circuit



GEV No.	380015	Ref. No.	301200
description	energy regulator 230V 13A single-circuit turn direction right shaft ø 6x4.6mm shaft L 23mm mounting thread M4 power release 6-100% no. 50.57021.010		

accessories

knobs



GEV No.	110075	Ref. No.	308091
description	knob energy regulator 1-3 t.max.°C ø 50mm shaft ø 6x4.6mm shaft flat upper black		
accessories for	110075		
	GEV No.	110135	Ref. No.
			—
	rosette knob up to ø 52mm		

thermostats

control and safety thermostats

EGO

control thermostats

55.10/19_ series





GEV No.	376054	Ref. No.	2020062
description	thermostat t.max. 200°C temperature range 65-200°C 1CO 6.3A probe ø 6mm probe L 78mm capillary pipe 900mm capillary pipe isolatedmm gland nut M12 shaft ø 6x4.6mm shaft L 23mm rotation 270° probe material SS screw connection M9x1 disc ø 7.7mm		
accessories for	376054		
	GEV No.	110121	Ref. No.
			—
	knob thermostat t.max. 200°C ø 50mm shaft ø 6x4.6mm shaft flat upper black temperature range 60-200°C rotation 270°		



Table continues overleaf



accessories for	376054			
	GEV No.	110135	Ref. No.	—
	rosette knob up to ø 52mm			





GEV No.	375664	Ref. No.	301031
description	thermostat t.max. 287°C temperature range 60-287°C 1-pole 1NO 16A probe ø 3.1mm probe L 226mm capillary pipe 1470mm capillary pipe isolated 350mm gland nut shaft ø 6x4.6mm shaft L 23mm shaft position upper rotation 270°		

GEV No.	390416	Ref. No.	901001
description	thermostat t.max. 85°C temperature range fixed 85°C 1-pole 1CO 16A probe ø 6mm probe L 129mm capillary pipe 1470mm capillary pipe isolated 1430mm gland nut shaft Lmm shaft position		

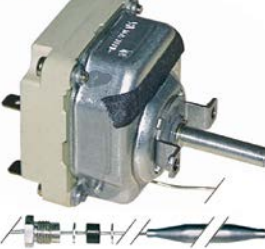

GEV No.	375143	Ref. No.	901007
description	thermostat t.max. 110°C temperature range 32-110°C 3-pole 3NO 16A probe ø 6mm probe L 138mm capillary pipe 1480mm capillary pipe isolated 1100mm gland nut M9x1 shaft ø 6x4.6mm shaft L 23mm shaft position upper rotation 270°		

GEV No.	375022	Ref. No.	301062
description	thermostat t.max. 180°C temperature range 95-180°C 3-pole 3NO 16A probe ø 6mm probe L 133mm capillary pipe 1780mm capillary pipe isolated 1400mm gland nut M9x1 shaft ø 6x4.6mm shaft L 23mm rotation 270°		



GEV No.	375026	Ref. No.	301006
description	thermostat t.max. 350°C temperature range 100-350°C 3-pole 3NO 16A probe ø 6mm probe L 77mm capillary pipe 2430mm capillary pipe isolated 1100mm gland nut shaft ø 6x4.6mm shaft L 23mm shaft position upper rotation 270°		



GEV No.	375022	Ref. No.	301062
description	thermostat t.max. 180°C temperature range 95-180°C 3-pole 3NO 16A probe ø 6mm probe L 133mm capillary pipe 1780mm capillary pipe isolated 1400mm gland nut M9x1 shaft ø 6x4.6mm shaft L 23mm rotation 270°		



GEV No.	375026	Ref. No.	301006
description	thermostat t.max. 350°C temperature range 100-350°C 3-pole 3NO 16A probe ø 6mm probe L 77mm capillary pipe 2430mm capillary pipe isolated 1100mm gland nut shaft ø 6x4.6mm shaft L 23mm shaft position upper rotation 270°		

safety thermostats

55.13_series



GEV No.	375830	Ref. No.	905886
description	safety thermostat switch-off temp. 365°C 1-pole 1NC 16A probe ø 3mm probe L 160mm capillary pipe 1730mm capillary pipe isolated 1710mm gland nut probe		

55.32_ series

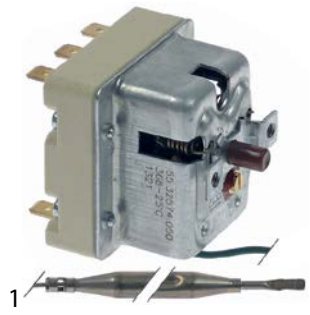

GEV No.	376062	Ref. No.	1040069
description	safety rod thermostat switch-off temp. 370°C 3-pole probe ø 6mm probe L 77mm capillary pipe 1500mm		



GEV No.	375984	Ref. No.	301061
description	safety thermostat switch-off temp. 225°C 3-pole 3NC 20A probe ø 6mm probe L 94mm capillary pipe 900mm capillary pipe isolated 670mm gland nut M10x1 probe SS		



GEV No.	375706	Ref. No.	301049
description	safety thermostat switch-off temp. 400°C 3-pole 3NC 20A probe ø 3.9mm probe L 228mm capillary pipe 1190mm capillary pipe isolatedmm gland nut probe SS		

56_ series



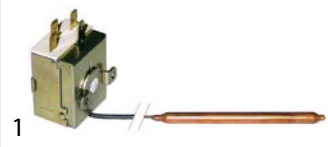

GEV No.	375442	Ref. No.	301039 301066
description	safety thermostat capillary pipe 1760mm probe ø 4mm 1-pole probe L 100mm 16A capillary pipe isolated 1600mm gland nut switch-off temp. 320°C probe		

IMIT / TEMPOMATIC / ARATHERMO control thermostats

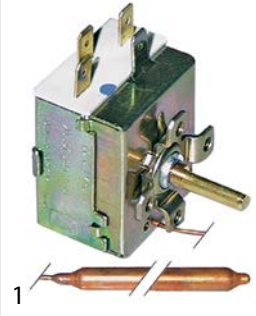

GEV No.	390314	Ref. No.	2001895H
description	thermostat t.max. 60°C temperature range fixed 60°C-pole 1CO 15A probe ø 6.5mm probe L 95mm capillary pipe 2000mm capillary pipe isolated 1950mm gland nut shaft ømm shaft Lmm shaft position rotation° probe material copper		



GEV No.	390006	Ref. No.	901017	
description	thermostat t.max. 86°C temperature range 0-86°C 1-pole 1CO 16A probe ø 6.5mm probe L 95mm capillary pipe 1500mm capillary pipe isolatedmm gland nut shaft ø 6x4.6mm shaft L 19mm rotation 270°			
accessories for	390006			
	GEV No.	110100	Ref. No.	—
	knob thermostat t.max. 90°C 0-90°C ø 42mm shaft ø 6x4.6mm shaft flat -135° black			
	GEV No.	110105	Ref. No.	—
	rosette knob ø 42mm ø 56mm zero mark			



safety thermostats



GEV No.	390770	Ref. No.	2002136H
description	safety thermostat switch-off temp. 90-110°C 1-pole 1CO 16/0.5A probe ø 6.5mm probe L 90mm capillary pipe 2000mm capillary pipe isolated 1950mm gland nut probe		

PRODIGY / FIRT

safety thermostats

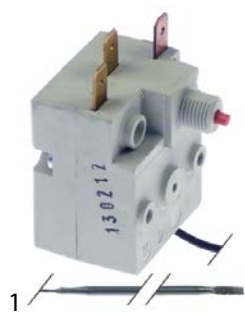

GEV No.	375478	Ref. No.	2001687H
description	safety thermostat switch-off temp. 200°C temperature range°C 1-pole 1CO 20A probe ø 3.3mm probe L 190mm capillary pipe 2150mm capillary pipe isolatedmm gland nut probe SS		

switches and momentary switches

rocker/momentary rocker switches

30x22mm



GEV No.	346068	Ref. No.	905022	
description	momentary rocker switch mounting measurements 30x22mm black 2NO 250V 16A 0-1 connection male faston 6.3mm ambient temperature max. 85/125°C protection IP40			
accessories for	346068			
	GEV No.	301036	Ref. No.	—
	protective cover internal size 30x22mm for rocker switch mounting measurementsmm			

microswitches

lever actuated



GEV No.	345257	Ref. No.	300688
description	microswitch with lever 250V 16A 1CO connection male faston 6.3mm L 29mm L1 33mm ambient temperature max. 120°C mounting distance 22mm actuating force: 130g lever length 31.5mm		

system switches (ROLD)





GEV No.	345650	Ref. No.	900054
description	momentary switch unit 2CO 250V 16A connection male faston 6.3mm		

cam switches

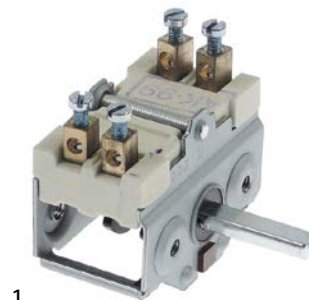
on/off





GEV No.	300020	Ref. No.	300002	
description	cam switch 4 operating positions 2NO sequence 0-1-0-1 16A shaft ø 6x4.6mm shaft L 23mm connection screw ceramic			
accessories for	300020			
	GEV No.	110135	Ref. No.	—
	rosette knob up to ø 52mm			
	GEV No.	110231	Ref. No.	—
	knob switch 0-1-0-1 t.max.°C°C ø 50mm shaft ø 6x4.6mm shaft flat upper black			



7-position



GEV No.	300025	Ref. No.	300011
description	cam switch 7 operating positions 1NO/2CO sequence 0-1-2-3-4-5-6 16A shaft \varnothing 6x4.6mm shaft L 23mm connection screw 7-position ceramic		
accessories for	300025		
	GEV No.	112172	Ref. No. —
	knob universal \varnothing 70mm black without adaptor/dial plate		
	GEV No.	112213	Ref. No. —
	knob dial plate silver switch 7-position t.max. $^{\circ}$ C ED \varnothing 63mm ID \varnothing 45.5mm		
	GEV No.	112311	Ref. No. —
	knob adapter shaft \varnothing 6x4.6mm L 0mm with spring		



GEV No.	300106	Ref. No.	300010
description	cam switch 7 operating positions 1NO/2CO sequence 0-1-2-3-4-5-6 32A shaft \varnothing 6x4.6mm shaft L 23mm connection screw 7-position shaft flat upper		

4 operating positions

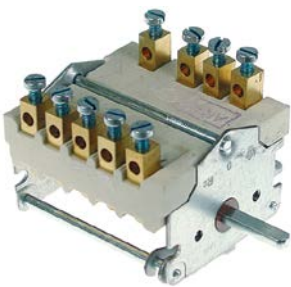

GEV No.	300360	Ref. No.	300051
description	cam switch 4 operating positions 3NO/1CO sequence 0-1-2-3 32A shaft \varnothing 6x4.6mm shaft L 23mm connection screw ceramic		

operation switches



GEV No.	300091	Ref. No.	300175 300176
description	operation switch EGO 2 operating positions 2NO 16A sequence 0-1 shaft \varnothing 6x4.6mm shaft L 23mm connection screw ceramic		

magnetic switches

accessories

magnets

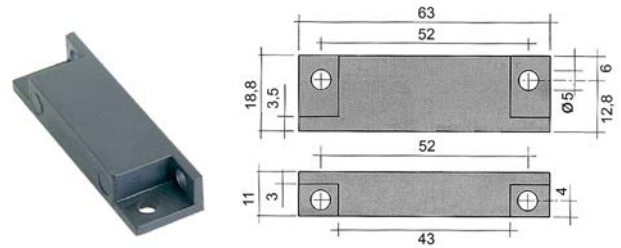

GEV No.	345336	Ref. No.	2001868H
description	magnet \varnothing 4.8mm L 63mm H 11mm W 18.8mm hole distance 51mm M4		

encoders and potentiometers



GEV No.	300265	Ref. No.	309411
description	potentiometer		

lamps

LED

indicator lamps

mounting diameter 6mm



GEV No.	358098	Ref. No.	2001677H
description	indicator light LED mounting \varnothing 6mm 5VDC yellow connection cable 200mm 2mA		



timers

programme timers

			
1			
GEV No.	360025	Ref. No.	905026
description	timer CDC 7003F engines 1 chambers 3 operation time 360s 230V 50Hz shaft ø 6x7mm shaft L 26mm manif. no. 7003F3 / 360025 motor type M37LN		
spare parts for	360025		
		GEV No.	360131 Ref. No. —
	motor CDC pinion ø 5.4mm teeth 12 230V turn direction left motor ø 37mm motor type M37LN for timer		
accessories for	360025		
		GEV No.	110085 Ref. No. —
	push button t.max.°C ø 36mm shaft ømm shaft flat grey for knob		
		GEV No.	110086 Ref. No. —
	knob switch zero mark t.max.°C ø 45mm shaft ømm shaft flat special black		
		GEV No.	110087 Ref. No. —
	retaining ring shaft ø 8mm DIN 471		

relays

power relays

with bracket mounting





			
1			
GEV No.	380185	Ref. No.	2001929h
description	power relays Italiana Relè 230VAC 30A 1NO connection F6.3 bracket mounting dimensions 36.5x32.2x51.8mm manif. no. A10-230AC-FA		

electronic controllers

EVCO - EVERY CONTROL

refrigeration controllers

built-in version

			
1			
GEV No.	378153	Ref. No.	651094
description	electronic controller EVERY CONTROL type EVK213N3VXBS mounting measurements 71x29mm 12/24V voltage AC/DC NTC/PTC relay outputs 3 NO-16A(5) CO-8A(4) NO-8A(4) NTC/PTC NTC/PTC DI front measurementsmm built-in depth 59mm protection IP65 yes -50 up to +150°C display 3½ digits		
accessories for	378153		
		GEV No.	379053 Ref. No. —
	temperature probe PTC 1kOhm cable PVC probe -50 up to +150°C cable -10 up to 100°C probe ø6x30mm cable length 3m without screw connection 2-wire		
		GEV No.	379064 Ref. No. —
	temperature probe PTC 1kOhm cable silicone probe -50 up to +150°C cable -50 up to +180°C probe ø6x40mm cable length 3m without screw connection 2-wire		
		GEV No.	379161 Ref. No. —
	temperature probe NTC 10kOhm cable thermoplastic probe -40 up to +110°C cable -40 up to +110°C probe ø6x14mm cable length 3m without screw connection 2-wire		
		GEV No.	379782 Ref. No. —
	temperature probe PTC 1kOhm cable thermoplastic probe -50 up to +150°C cable -40 up to +110°C probe ø6x14mm cable length 3m 2-wire resistor 1kOhm		

electronics

PCBs

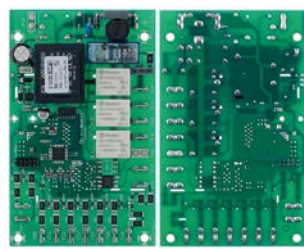
			
1			
GEV No.	403093	Ref. No.	2002140H
description	PCB dishwasher L 135mm W 82mm		



solenoid valves

solenoid valves (water)

ELBI



GEV No.	370357	Ref. No.	634086
description	solenoid valve double straight 230VAC inlet 3/4" outlet 11.5mm plastic flow regulating valve outlet A 0.25		

TP



GEV No.	370021	Ref. No.	634086
----------------	--------	-----------------	--------

description solenoid valve double straight 230VAC inlet 3/4" outlet 11.5mm DN10 TP flow regulating valve inlet white

spare parts for 370021

	GEV No.	371013	Ref. No.	—
solenoid coil TP 230VAC 50/60Hz				

accessories for 370021





	GEV No.	371220	Ref. No.	—
reducer TP flow rate 3l/min red tolerance ±15%				
	GEV No.	371221	Ref. No.	—
reducer TP flow rate 5.5l/min yellow tolerance ±15%				
	GEV No.	371222	Ref. No.	—
reducer TP flow rate 6l/min grey tolerance ±15%				
	GEV No.	371223	Ref. No.	—
reducer TP flow rate 10l/min white tolerance ±15%				
	GEV No.	371224	Ref. No.	—
reducer TP flow rate 12l/min bronze tolerance ±15%				
	GEV No.	371225	Ref. No.	—
reducer TP flow rate 16l/min light brown tolerance ±15%				
	GEV No.	371226	Ref. No.	—
reducer TP flow rate 20l/min red tolerance ±15%				
	GEV No.	371230	Ref. No.	—
reducer TP flow rate 0.25l/min red tolerance ±25%				
	GEV No.	371231	Ref. No.	—
reducer TP flow rate 0.35l/min violet tolerance ±25%				
	GEV No.	371232	Ref. No.	—
reducer TP flow rate 0.5l/min orange tolerance ±25%				

accessories for	370021			
	GEV No.	371233	Ref. No.	—
reducer TP flow rate 0.8l/min white tolerance ±25%				
	GEV No.	371234	Ref. No.	—
reducer TP flow rate 1l/min light blue tolerance ±25%				
	GEV No.	371235	Ref. No.	—
reducer TP flow rate 1.2l/min brown tolerance ±25%				
	GEV No.	371236	Ref. No.	—
reducer TP flow rate 1.5l/min light brown tolerance ±25%				
	GEV No.	371237	Ref. No.	—
reducer TP flow rate 2.5l/min yellow tolerance ±25%				
	GEV No.	371238	Ref. No.	—
reducer TP flow rate 3.4l/min dark green tolerance ±25%				
	GEV No.	371239	Ref. No.	—
reducer TP flow rate 5l/min black tolerance ±25%				
	GEV No.	371240	Ref. No.	—
reducer TP flow rate 8l/min blue tolerance ±20%				

GEV No.	370024	Ref. No.	634089	
description	solenoid valve triple angled 230VAC inlet 3/4" outlet 14mm DN10 TP			
spare parts for	370024			
	GEV No.	371013	Ref. No.	—
solenoid coil TP 230VAC 50/60Hz				
accessories for	370024			
	GEV No.	371220	Ref. No.	—
reducer TP flow rate 3l/min red tolerance ±15%				
	GEV No.	371221	Ref. No.	—
reducer TP flow rate 5.5l/min yellow tolerance ±15%				
	GEV No.	371222	Ref. No.	—
reducer TP flow rate 6l/min grey tolerance ±15%				
	GEV No.	371223	Ref. No.	—
reducer TP flow rate 10l/min white tolerance ±15%				
	GEV No.	371224	Ref. No.	—
reducer TP flow rate 12l/min bronze tolerance ±15%				
	GEV No.	371225	Ref. No.	—
reducer TP flow rate 16l/min light brown tolerance ±15%				

Table continues overleaf



accessories for		370024		
	GEV No.	371226	Ref. No.	—
reducer TP flow rate 20l/min red tolerance ±15%				
	GEV No.	371230	Ref. No.	—
reducer TP flow rate 0.25l/min red tolerance ±25%				
	GEV No.	371231	Ref. No.	—
reducer TP flow rate 0.35l/min violet tolerance ±25%				
	GEV No.	371232	Ref. No.	—
reducer TP flow rate 0.5l/min orange tolerance ±25%				
	GEV No.	371233	Ref. No.	—
reducer TP flow rate 0.8l/min white tolerance ±25%				
	GEV No.	371234	Ref. No.	—
reducer TP flow rate 1l/min light blue tolerance ±25%				
	GEV No.	371235	Ref. No.	—
reducer TP flow rate 1.2l/min brown tolerance ±25%				
	GEV No.	371236	Ref. No.	—
reducer TP flow rate 1.5l/min light brown tolerance ±25%				
	GEV No.	371237	Ref. No.	—
reducer TP flow rate 2.5l/min yellow tolerance ±25%				
	GEV No.	371238	Ref. No.	—
reducer TP flow rate 3.4l/min dark green tolerance ±25%				
	GEV No.	371239	Ref. No.	—
reducer TP flow rate 5l/min black tolerance ±25%				
	GEV No.	371240	Ref. No.	—
reducer TP flow rate 8l/min blue tolerance ±20%				

various			
	1		
GEV No.	370726	Ref. No.	2002183H
description	solenoid valve double straight 220-240VAC inlet 11mm outlet 11mm MILANO plastic output B red		

pressure switches

for warewashing

ø 58mm with male faston 6.3mm

with connection horizontal



1

GEV No.	541002	Ref. No.	2001959H
description	pressure control pressure range 110/60mbar connection 6mm ø 58mm pressure connection horizontal warewashing pressure connection ø 6mm		

compressors

L'UNITE HERMETIQUE / TECUMSEH

R404A

LBP monophase

Lower evaporation temperature below -20°C



1

GEV No.	605134	Ref. No.	653243
description	compressor coolant R404A type CAJ2446Z 220-240V 50Hz LBP 23kg 1.2HP cylinder capacity 26.1cm ³ CSR H 280mm 797W 1110W 1423W 1821W 2290WWWWW 549W		



fans

axial fans

import



1			
GEV No.	601080 ¹	Ref. No.	304194
description	axial fan L 119mm W 119mm H 38mm 230VAC 50/60Hz 23/20W bearing ball bearing connection male faston 2.8mm metal ADDA fan wheel ø 110mm temp.-resist. 70°C		
accessories for	601080		
	GEV No.	550898	Ref. No. —
	connecting cable cable length 2000mm connection F 2.8 connection distance 7.9mm for axial flow fan		
	GEV No.	692519	Ref. No. —
	guard L 120mm W 120mm plastic		

¹with ball bearings

cross flow fans

COPREL

double fans



1			
GEV No.	601026	Ref. No.	504365
description	cross flow fan COPREL TFD(FD) roller ø 60mm roller length 2x180mm laminated core thickness 35mm motor position centre 230V/50-60Hz 42W refrigeration bearing rubber connection male faston 6.3mm coil type airflow 255m ³ /h -10 up to +60°C		

hot air fans

ebm-papst

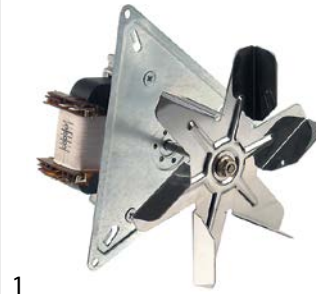

1

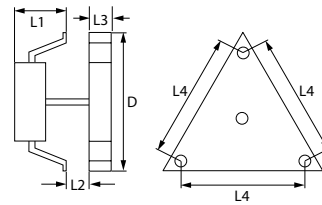

GEV No.	601267	Ref. No.	645457
description	hot air fan 230V 32W 0.27A L1 60mm L2 50mm L3 20mm L4 157mm fan wheel ø 150mm ebm-papst type R2K150-0020A9		

motors

gear motors

for dishwashers



1

GEV No.	601861	Ref. No.	2001419H
description	gear motor FIR type 71-B5 180W 400V voltage AC 50/60Hz 3 phase 900/1100rpm shaft ø 14mm L 227mm for transport system without gearbox		

pumps





wash and rinse pumps

FIR

pumps





1

GEV No.	499079	Ref. No.	5519E
description	pump inlet ø 28mm outlet ø 26mm type 2211.1610 220-240V 50Hz 1 phase 0.07kW 0.1HP rotation direction left capacitor 5µF FIR		
spare parts for	499079		
	GEV No.	365017	Ref. No. —
	operating capacitor capacity 5µF 450V tolerance 5% 50/60Hz ambient temperature max. -25 to +85°C ø 28mm L 54mm M8 plastic connection male faston 6.3mm 16.10.08 protection		
	GEV No.	510384	Ref. No. —
	pump cover inlet ø 28mm outlet ø 26mm ø 100mm ID ø 76mm		
	GEV No.	510695	Ref. No. —
	mechanical shaft seal height counter ring 5.5mm ID ø 11mm		
	GEV No.	521203	Ref. No. —
	impellor ø 72mm H 18mm thread M7 shaft ø 11mm shaft length 32mm blades 3		
	GEV No.	521703	Ref. No. —
	pump cover gasket EPDM thickness 2.5mm ID ø 75mm Qty 1 pcs		





1

GEV No.	500038	Ref. No.	904001 904013
description	pump inlet ø 45mm outlet ø 40mm type 3911.1425 230V 50Hz 1 phase 0.55kW 0.75HP L 205mm rotation direction right capacitor 10µF FIR		
spare parts for	500038		
	GEV No.	365015	Ref. No. —
	operating capacitor capacity 10µF 400V tolerance 5%Hz ambient temperature max. -25 to +85°C ø 35.5mm L 59mm M8 plastic connection male faston 6.3mm protection		
	GEV No.	510508	Ref. No. —
	pump cover FIR inlet ø 45mm outlet ø 40mm pump type PU 0.5/3911 turn direction right ø 160mm ID ø 125mm inner height 25mm		
	GEV No.	510610	Ref. No. —
	impellor ø 95.5mm H 23mm shaft intake ø 9/8mm rotation direction right seat ø 16mm blades 6		
	GEV No.	510692	Ref. No. —
	mechanical shaft seal for shaft ø 11mm slide ring ext. ø 24mm slide ring H 13mm counter ring mounting ø 26mm height counter ring 8mm counter ring int. ø 14mm		
	GEV No.	521702	Ref. No. —
	pump cover gasket thickness 3.5x4.5mm Qty 1 pcs		
accessories for	500038		
	GEV No.	551286	Ref. No. —
	adapter L 120mm 4-pole for Meiko pump suitable for 500038 plug type dependent on equipment		





1



GEV No.	499334	Ref. No.	2001896H
description	pump inlet ø 62mm outlet ø 62mm type 2250.2731 230/400V 50Hz 1 phase 3kW FIR		
spare parts for	499334		
	GEV No.	510687	Ref. No. 904115
	mechanical shaft seal for shaft ø 18mm height counter ring 8mm ID ø 17mm ED ø 39mm H 15mm mounting ø 42mm int. ø 1 21mm		
	GEV No.	512455	Ref. No. —
	fan wheel ø 155mm H 18mm shaft intake ø 18mm plastic blades 12		
	GEV No.	521026	Ref. No. —
	pump cover gasket ID ø 182.5mm thickness 5x4.5mm		
	GEV No.	521028	Ref. No. 904112
	pump cover FIR inlet ø 62mm outlet ø 62mm turn direction right ø 215mm ID ø 175mm inner height 40mm		
	GEV No.	521277	Ref. No. —
	impellor ø 135mm H 39mm pump type Fir 2275 - 3.6HP thread M14L		



1

GEV No.	500056	Ref. No.	904003
description	pump inlet ø 63mm outlet ø 47mm type 1211.2706 230/400V 50Hz 3 phase 0.55kW 0.75HP L 305mm rotation direction right FIR		
spare parts for	500056		
	GEV No.	510601	Ref. No. —
	impellor ø 103mm H 25mm rotation direction right thread M8L seat ø 12.2mm blades 6		
	GEV No.	510693	Ref. No. —
	mechanical shaft seal for shaft ø 12mm slide ring ext. ø 24mm slide ring H 15.5mm slide ring int. ø 11mm counter ring mounting ø 24mm height counter ring 8mm counter ring int. ø 13.5mm		

spare parts for 500056

	GEV No.	521513	Ref. No.	—
	pump cover FIR inlet ø 63mm outlet ø 47mm turn direction right ID ø 150mm inner height 32mm			
	GEV No.	524416	Ref. No.	1476E 2001956H 904121
	pump cover gasket thickness 4x4mm Qty 1 pcs			

LGB



1

GEV No.	499099	Ref. No.	2002220H
description	pump inlet ø 28mm outlet ø 26mm type CRC-R DX 230V 50Hz 1 phase 0.2kW L 175mm rotation direction left capacitor 4µF LGB		
spare parts for	499099		
	GEV No.	365031	Ref. No. —
	operating capacitor capacity 4µF 450V tolerance 5% 50/60Hz ambient temperature max. -25 to +85°C ø 31mm L 58mm M8 plastic connection male faston 6.3mm protection		
	GEV No.	509002	Ref. No. —
	O-ring EPDM thickness 2.62mm ID ø 82.22mm Qty 1 pcs		
	GEV No.	510703	Ref. No. —
	mechanical shaft seal for shaft ø 13mm slide ring H 13mm height counter ring 5.5mm ED ø 26mm		
	GEV No.	521091	Ref. No. —
	pump cover LGB inlet ø 28mm outlet ø 26mm pump type CRC-R DX		
	GEV No.	521092	Ref. No. —
	impellor ø 80mm H 25mm pump type CRC-R DX thread M6R shaft ø 13mm shaft length 20mm		

drain pumps

ASKOLL



1

GEV No.	500210	Ref. No.	2001519H
description	drain pump 230V 40W		



HANNING



GEV No.	500573	Ref. No.	2001523H
description	drain pump 30W 4-piece 230V inlet \varnothing 24/30mm outlet \varnothing 24mm 50Hz HANNING type DPS25-032 1x pump, 3x pump cover		

service kits



GEV No.	500573	Ref. No.	2001523H
description	drain pump 30W 4-piece 230V inlet \varnothing 24/30mm outlet \varnothing 24mm 50Hz HANNING type DPS25-032 1x pump, 3x pump cover		

electric accessories

cables

ribbon cables

group 1



GEV No.	400902	Ref. No.	2001087H
description	ribbon cable 10-pole L 750mm plug type FC-10P raster size 2.54mm		

terminals

connection terminals with screw/faston connections

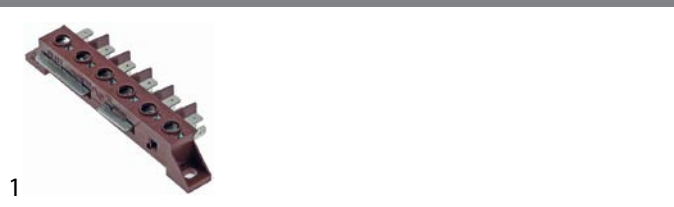

GEV No.	550411	Ref. No.	2001039H
description	power terminal block 6-pole max. 40A max 450V connection \varnothing 6mm ² / F6.3 temp.-resist. 150°C cross section 6mm ²		







gas taps







PEL

21S series

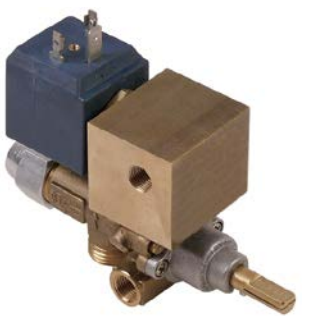

GEV No.	101397	Ref. No.	310139	
description	gas tap PEL type 21S gas inlet M16x1.5 (tube \varnothing 10mm) bypass nozzle \varnothing 0.35mm gas outlet M16x1.5 (tube \varnothing 10/8mm) thermocouple connection M9x1 pilot connection M10x1 shaft \varnothing 8x6.5mm shaft L 22/15mm shaft flat lower			
spare parts for	101397			
	GEV No.	100408	Ref. No.	—
	bypass nozzle type PEL20/21 bore \varnothing 0.35mm thread M5x0.5			
	GEV No.	101060	Ref. No.	—
	magnet unit standard L 39mm D1 \varnothing 15.4mm D2 \varnothing 11mm suitable for PEL20-21/JUNKERS/EGA			
	GEV No.	101206	Ref. No.	—
	gas tap front part shaft \varnothing 8x6.5mm shaft L 22/15mm shaft flat upper/lower suitable for PEL21			
	GEV No.	101231	Ref. No.	—
	thermocouple nut T1: M9x1 T2: M18x1			
accessories for	101397			
	GEV No.	100908	Ref. No.	—
	union screw thread M10x1 for pipe \varnothing 4mm Qty 1 pcs			
	GEV No.	100909	Ref. No.	—
	union screw thread M10x1 for pipe \varnothing 6mm Qty 1 pcs			
	GEV No.	101246	Ref. No.	—
	olive for pipe \varnothing 4mm Qty 1 pcs			
	GEV No.	101278	Ref. No.	—
	olive for pipe \varnothing 10mm Qty 1 pcs			
	GEV No.	101286	Ref. No.	—
	olive ID \varnothing 6mm Qty 1 pcs			
	GEV No.	101300	Ref. No.	—
	union nut thread M16x1.5 tube \varnothing 10mm			
	GEV No.	101450	Ref. No.	—
	olive for pipe \varnothing 8mm L 12.7mm Qty 1 pcs ED \varnothing 10mm			
	GEV No.	101451	Ref. No.	—
	union nut thread M16x1.5 tube \varnothing 8mm			
	GEV No.	110081	Ref. No.	—
	knob \varnothing 70mm shaft \varnothing 8x6.5mm shaft flat universal			
	GEV No.	112206	Ref. No.	—
	knob dial plate silver gas tap PEL21/22/23 t.max.°C ED \varnothing 63mm ID \varnothing 45.5mm			

			
GEV No.	106815	Ref. No.	N/A
description	gas tap PEL type 21S gas inlet M16x1.5 (tube ø 10mm) bypass nozzle ø 0mm gas outlet 2x M10x1 thermocouple connection M9x1 pilot connection M10x1 shaft ø 8x6.5mm shaft L 22/15mm shaft flat upper		
spare parts for	106815		
	GEV No.	101060	Ref. No. —
magnet unit standard L 39mm D1 ø 15.4mm D2 ø 11mm suitable for PEL20-21/JUNKERS/EGA			
	GEV No.	101206	Ref. No. —
gas tap front part shaft ø 8x6.5mm shaft L 22/15mm shaft flat upper/lower suitable for PEL21			
	GEV No.	101231	Ref. No. —
thermocouple nut T1: M9x1 T2: M18x1			
	GEV No.	106202	Ref. No. —
bypass nozzle type PEL20/21 bore ø 0mm thread M5x0.5			
	GEV No.	106823	Ref. No. —
gas connection gas inlet M16x1.5 gas outlet 2x M10x1			

			
GEV No.	106817	Ref. No.	165961
description	gas tap PEL type 21S gas inlet M16x1.5 (tube ø 10mm) bypass nozzle ø 0mm gas outlet 2x M10x1 thermocouple connection M9x1 pilot connection M10x1 shaft ø 8x6.5mm shaft L 22/15mm shaft flat upper		
spare parts for	106817		
	GEV No.	101060	Ref. No. —
magnet unit standard L 39mm D1 ø 15.4mm D2 ø 11mm suitable for PEL20-21/JUNKERS/EGA			
	GEV No.	101206	Ref. No. —
gas tap front part shaft ø 8x6.5mm shaft L 22/15mm shaft flat upper/lower suitable for PEL21			
	GEV No.	101231	Ref. No. —
thermocouple nut T1: M9x1 T2: M18x1			
	GEV No.	106202	Ref. No. —
bypass nozzle type PEL20/21 bore ø 0mm thread M5x0.5			
	GEV No.	106819	Ref. No. —
solenoid valve body			
	GEV No.	106820	Ref. No. —
solenoid valve connection gas inlet M16x1.5 gas outlet 2x M10x1 thread size valve body M20x1			

spare parts for	106817		
	GEV No.	371157	Ref. No. —
solenoid coil t.max. 125°C 230V seat ø 13mm 17VA			
accessories for	106817		
	GEV No.	100908	Ref. No. —
union screw thread M10x1 for pipe ø 4mm Qty 1 pcs			
	GEV No.	100909	Ref. No. —
union screw thread M10x1 for pipe ø 6mm Qty 1 pcs			
	GEV No.	101246	Ref. No. —
olive for pipe ø 4mm Qty 1 pcs			
	GEV No.	101278	Ref. No. —
olive for pipe ø 10mm Qty 1 pcs			
	GEV No.	101286	Ref. No. —
olive ID ø 6mm Qty 1 pcs			
	GEV No.	101300	Ref. No. —
union nut thread M16x1.5 tube ø 10mm			
	GEV No.	101450	Ref. No. —
olive for pipe ø 8mm L 12.7mm Qty 1 pcs ED ø 10mm			
	GEV No.	101451	Ref. No. —
union nut thread M16x1.5 tube ø 8mm			
	GEV No.	110081	Ref. No. —
knob ø 70mm shaft ø 8x6.5mm shaft flat universal			
	GEV No.	112206	Ref. No. —
knob dial plate silver gas tap PEL21/22/23 t.max.°C ED ø 63mm ID ø 45.5mm			

			
GEV No.	106816	Ref. No.	165962
description	gas tap PEL type 21S gas inlet M16x1.5 (tube ø 10mm) bypass nozzle ø 0mm gas outlet M10x1 thermocouple connection M9x1 pilot connection M10x1 shaft ø 8x6.5mm shaft L 22/15mm shaft flat upper with solenoid valve with ignition safety device		
spare parts for	106816		
	GEV No.	101060	Ref. No. —
magnet unit standard L 39mm D1 ø 15.4mm D2 ø 11mm suitable for PEL20-21/JUNKERS/EGA			
	GEV No.	101206	Ref. No. —
gas tap front part shaft ø 8x6.5mm shaft L 22/15mm shaft flat upper/lower suitable for PEL21			
	GEV No.	101231	Ref. No. —
thermocouple nut T1: M9x1 T2: M18x1			

Table continues overleaf



spare parts for		106816	
	GEV No.	106202	Ref. No. —
bypass nozzle type PEL20/21 bore \varnothing 0mm thread M5x0.5			
	GEV No.	106819	Ref. No. —
solenoid valve body			
	GEV No.	106821	Ref. No. —
solenoid valve connection gas inlet M16x1.5 gas outlet 3/8" thread size valve body M20x1			
	GEV No.	371157	Ref. No. —
solenoid coil t.max. 125°C 230V seat \varnothing 13mm 17VA			
accessories for		106816	
	GEV No.	100908	Ref. No. —
union screw thread M10x1 for pipe \varnothing 4mm Qty 1 pcs			
	GEV No.	100909	Ref. No. —
union screw thread M10x1 for pipe \varnothing 6mm Qty 1 pcs			
	GEV No.	101246	Ref. No. —
olive for pipe \varnothing 4mm Qty 1 pcs			
	GEV No.	101278	Ref. No. —
olive for pipe \varnothing 10mm Qty 1 pcs			
	GEV No.	101286	Ref. No. —
olive ID \varnothing 6mm Qty 1 pcs			
	GEV No.	101300	Ref. No. —
union nut thread M16x1.5 tube \varnothing 10mm			
	GEV No.	101450	Ref. No. —
olive for pipe \varnothing 8mm L 12.7mm Qty 1 pcs ED \varnothing 10mm			
	GEV No.	101451	Ref. No. —
union nut thread M16x1.5 tube \varnothing 8mm			
	GEV No.	110081	Ref. No. —
knob \varnothing 70mm shaft \varnothing 8x6.5mm shaft flat universal			
	GEV No.	112206	Ref. No. —
knob dial plate silver gas tap PEL21/22/23 t.max.°C ED \varnothing 63mm ID \varnothing 45.5mm			

22S/O series









1

GEV No.	101086	Ref. No.	310140
description	gas tap PEL type 22S/O gas inlet M20x1.5 (tube \varnothing 12mm) bypass nozzle \varnothing 0.35mm gas outlet M20x1.5 (tube \varnothing 12/10mm) thermocouple connection M9x1 pilot connection M10x1 shaft \varnothing 10x8mm shaft L 25/17mm shaft flat lower		
spare parts for		101086	
	GEV No.	100259	Ref. No. —
bypass nozzle type PEL22 bore \varnothing 0.35mm thread M6x0.5			

spare parts for		101086	
	GEV No.	101058	Ref. No. —
magnet unit L 39mm D1 \varnothing 15.4mm D2 \varnothing 13.5mm suitable for PEL22/ EGA24197 standard			
	GEV No.	101201	Ref. No. —
gas tap front part shaft \varnothing 10x8mm shaft L 25/17mm shaft flat upper/lower suitable for PEL22			
	GEV No.	101231	Ref. No. —
thermocouple nut T1: M9x1 T2: M18x1			
	GEV No.	101240	Ref. No. —
gas connection thread M20x1.5 tube \varnothing 12/10mm for PEL gas taps with gasket and screws horizontal			
	GEV No.	101460	Ref. No. —
O-ring \varnothing 12.37mm D1 \varnothing 2.62mm suitable for PEL22			
	GEV No.	101461	Ref. No. —
screw kit suitable for PEL22 Qty 4 pcs			
accessories for		101086	
	GEV No.	100908	Ref. No. —
union screw thread M10x1 for pipe \varnothing 4mm Qty 1 pcs			
	GEV No.	100909	Ref. No. —
union screw thread M10x1 for pipe \varnothing 6mm Qty 1 pcs			
	GEV No.	101241	Ref. No. —
gas connection thread M20x1.5 tube \varnothing 12/10mm for PEL gas taps vertical			
	GEV No.	101246	Ref. No. —
olive for pipe \varnothing 4mm Qty 1 pcs			
	GEV No.	101248	Ref. No. —
olive for pipe \varnothing 12mm Qty 1 pcs suitable for PEL			
	GEV No.	101249	Ref. No. —
olive for pipe \varnothing 10mm Qty 1 pcs			
	GEV No.	101250	Ref. No. —
union nut thread M20x1.5 for pipe \varnothing 10mm			
	GEV No.	101251	Ref. No. —
union nut thread M20x1.5 for pipe \varnothing 12mm			
	GEV No.	101286	Ref. No. —
olive ID \varnothing 6mm Qty 1 pcs			
	GEV No.	110080	Ref. No. —
knob \varnothing 70mm shaft \varnothing 10x8mm shaft flat universal			
	GEV No.	112206	Ref. No. —
knob dial plate silver gas tap PEL21/22/23 t.max.°C ED \varnothing 63mm ID \varnothing 45.5mm			

			
1			
GEV No.	106818	Ref. No.	156033
description	gas tap PEL type 225/O gas inlet M20x1.5 (tube ø 12mm) bypass nozzle ø 0mm gas outlet 3/8" thermocouple connection M9x1 pilot connection M10x1 shaft ø 10x8mm shaft L 25/17mm shaft flat lower with solenoid valve		
spare parts for	106818		
	GEV No.	101058	Ref. No. —
	magnet unit L 39mm D1 ø 15.4mm D2 ø 13.5mm suitable for PEL22/ EGA24197 standard		
	GEV No.	101231	Ref. No. —
	thermocouple nut T1: M9x1 T2: M18x1		
	GEV No.	101365	Ref. No. —
	gas connection thread M20x1.5 tube ø 12mm for PEL gas taps horizontal		
	GEV No.	106191	Ref. No. —
	bypass nozzle type PEL22 bore ø 0mm thread M6x0.5		
	GEV No.	106819	Ref. No. —
	solenoid valve body		
	GEV No.	106822	Ref. No. —
	solenoid valve connection gas inlet M20x1.5 gas outlet 3/8" thread size valve body M20x1		
	GEV No.	371157	Ref. No. —
	solenoid coil t.max. 125°C 230V seat ø 13mm 17VA		
accessories for	106818		
	GEV No.	101248	Ref. No. —
	olive for pipe ø 12mm Qty 1 pcs suitable for PEL		
	GEV No.	101249	Ref. No. —
	olive for pipe ø 10mm Qty 1 pcs		
	GEV No.	101250	Ref. No. —
	union nut thread M20x1.5 for pipe ø 10mm		
	GEV No.	101251	Ref. No. —
	union nut thread M20x1.5 for pipe ø 12mm		



			
1			
GEV No.	109510	Ref. No.	310140
description	gas tap PEL type 225/O gas inlet M20x1.5 (tube ø 12mm) bypass nozzle ø 1.3mm gas outlet M20x1.5 (tube ø 12/10mm) thermocouple connection M8x1 pilot connection M10x1 shaft ø 10x8mm shaft L 25/17mm shaft flat right		
spare parts for	109510		
	GEV No.	100438	Ref. No. —
	bypass nozzle type PEL22 bore ø 1.2mm thread M6x0.5		
	GEV No.	101058	Ref. No. —
	magnet unit L 39mm D1 ø 15.4mm D2 ø 13.5mm suitable for PEL22/ EGA24197 standard		
	GEV No.	101202	Ref. No. —
	gas tap front part shaft ø 8x10mm shaft L 25/17mm shaft flat right/ left suitable for PEL22		
	GEV No.	101230	Ref. No. —
	thermocouple nut T1: M8x1 T2: M18x1 aluminium		
	GEV No.	101240	Ref. No. —
	gas connection thread M20x1.5 tube ø 12/10mm for PEL gas taps with gasket and screws horizontal		
	GEV No.	101460	Ref. No. —
	O-ring ø 12.37mm D1 ø 2.62mm suitable for PEL22		
	GEV No.	101461	Ref. No. —
	screw kit suitable for PEL22 Qty 4 pcs		
accessories for	109510		
	GEV No.	100908	Ref. No. —
	union screw thread M10x1 for pipe ø 4mm Qty 1 pcs		
	GEV No.	100909	Ref. No. —
	union screw thread M10x1 for pipe ø 6mm Qty 1 pcs		
	GEV No.	101241	Ref. No. —
	gas connection thread M20x1.5 tube ø 12/10mm for PEL gas taps vertical		
	GEV No.	101246	Ref. No. —
	olive for pipe ø 4mm Qty 1 pcs		
	GEV No.	101248	Ref. No. —
	olive for pipe ø 12mm Qty 1 pcs suitable for PEL		
	GEV No.	101249	Ref. No. —
	olive for pipe ø 10mm Qty 1 pcs		
	GEV No.	101250	Ref. No. —
	union nut thread M20x1.5 for pipe ø 10mm		
	GEV No.	101251	Ref. No. —
	union nut thread M20x1.5 for pipe ø 12mm		
	GEV No.	101286	Ref. No. —
	olive ID ø 6mm Qty 1 pcs		





22S/V series



1

GEV No.	101087	Ref. No.	160094
description	gas tap PEL type 22S/V gas inlet M20x1.5 (tube ø 12mm) bypass nozzle ø 0.35mm gas outlet M20x1.5 (tube ø 12/10mm) thermocouple connection M9x1 pilot connection M10x1 shaft ø 10x8mm shaft L 25/17mm shaft flat upper		
spare parts for	101087		
	GEV No.	100259	Ref. No. —
	bypass nozzle type PEL22 bore ø 0.35mm thread M6x0.5		
	GEV No.	101058	Ref. No. —
	magnet unit L 39mm D1 ø 15.4mm D2 ø 13.5mm suitable for PEL22/EGA24197 standard		
	GEV No.	101201	Ref. No. —
	gas tap front part shaft ø 10x8mm shaft L 25/17mm shaft flat upper/lower suitable for PEL22		
	GEV No.	101231	Ref. No. —
	thermocouple nut T1: M9x1 T2: M18x1		
	GEV No.	101241	Ref. No. —
	gas connection thread M20x1.5 tube ø 12/10mm for PEL gas taps vertical		
	GEV No.	101460	Ref. No. —
	O-ring ø 12.37mm D1 ø 2.62mm suitable for PEL22		
	GEV No.	101461	Ref. No. —
	screw kit suitable for PEL22 Qty 4 pcs		
accessories for	101087		
	GEV No.	100908	Ref. No. —
	union screw thread M10x1 for pipe ø 4mm Qty 1 pcs		
	GEV No.	100909	Ref. No. —
	union screw thread M10x1 for pipe ø 6mm Qty 1 pcs		
	GEV No.	101240	Ref. No. —
	gas connection thread M20x1.5 tube ø 12/10mm for PEL gas taps with gasket and screws horizontal		
	GEV No.	101246	Ref. No. —
	olive for pipe ø 4mm Qty 1 pcs		
	GEV No.	101248	Ref. No. —
	olive for pipe ø 12mm Qty 1 pcs suitable for PEL		
	GEV No.	101249	Ref. No. —
	olive for pipe ø 10mm Qty 1 pcs		
	GEV No.	101250	Ref. No. —
	union nut thread M20x1.5 for pipe ø 10mm		
	GEV No.	101251	Ref. No. —
	union nut thread M20x1.5 for pipe ø 12mm		

accessories for	101087		
	GEV No.	101286	Ref. No. —
	olive ID ø 6mm Qty 1 pcs		
	GEV No.	110080	Ref. No. —
	knob ø 70mm shaft ø 10x8mm shaft flat universal		
	GEV No.	112206	Ref. No. —
	knob dial plate silver gas tap PEL21/22/23 t.max.°C ED ø 63mm ID ø 45.5mm		

23S/O series



1





GEV No.	101091	Ref. No.	310141
description	gas tap PEL type 23S/O gas inlet M28x1.5 (tube ø 20mm) bypass nozzle ø 0.35mm gas outlet M24x1.5 (tube ø 16mm) thermocouple connection M9x1 pilot connection M10x1 shaft ø 10x8mm shaft L 35/19mm shaft flat upper		
spare parts for	101091		
	GEV No.	100455	Ref. No. —
	bypass nozzle type PEL23/24 bore ø 0.35mm thread M8x0.5		
	GEV No.	101045	Ref. No. —
	magnet unit T1: M9x1 T2: M22x1 L 46mm ø 18mm suitable for PEL23S M9x1		
	GEV No.	101244	Ref. No. —
	gas connection thread M24x1.5 tube ø 12/16mm horizontal for PEL gas taps		
	GEV No.	101336	Ref. No. —
	gas tap front part shaft ø 10x8mm shaft L 35/17mm shaft flat upper/lower suitable for PEL23S		
	GEV No.	101463	Ref. No. —
	screw suitable for PEL23S Qty 4 pcs		
	GEV No.	528455	Ref. No. —
	O-ring Viton thickness 2.62mm ID ø 18.72mm Qty 1 pcs		
accessories for	101091		
	GEV No.	100908	Ref. No. —
	union screw thread M10x1 for pipe ø 4mm Qty 1 pcs		
	GEV No.	100909	Ref. No. —
	union screw thread M10x1 for pipe ø 6mm Qty 1 pcs		
	GEV No.	101246	Ref. No. —
	olive for pipe ø 4mm Qty 1 pcs		
	GEV No.	101252	Ref. No. —
	union nut thread M24x1.5 for pipe ø 12mm		
	GEV No.	101253	Ref. No. —
	union nut thread M24x1.5 PEL for pipe ø 16mm		

Table continues overleaf







accessories for		101091		
	GEV No.	101254	Ref. No.	—
union nut thread M28x1.5 tube ø 20mm				
	GEV No.	101255	Ref. No.	—
olive for pipe ø 12mm Qty 1 pcs				
	GEV No.	101256	Ref. No.	—
olive for pipe ø 16mm Qty 1 pcs				
	GEV No.	101257	Ref. No.	—
olive for pipe ø 20mm Qty 1 pcs				
	GEV No.	101286	Ref. No.	—
olive ID ø 6mm Qty 1 pcs				
	GEV No.	110080	Ref. No.	—
knob ø 70mm shaft ø 10x8mm shaft flat universal				
	GEV No.	112206	Ref. No.	—
knob dial plate silver gas tap PEL21/22/23 t.max.°C ED ø 63mm ID ø 45.5mm				

gas thermostats

SIT

710 Minisit series



accessories for		107237		
	GEV No.	101137	Ref. No.	—
cover cap without piezoelectric igniter				
	GEV No.	101267	Ref. No.	—
reducer IT 3/8" ET 1/2" L 21mm				
	GEV No.	101268	Ref. No.	—
gas connection thread 3/8" angled with O-ring MINISIT 710				
	GEV No.	110068	Ref. No.	—
knob suitable for Minisit ø 37mm				

PEL

25ST series



accessories for		101172		
	GEV No.	100259	Ref. No.	—
bypass nozzle type PEL22 bore ø 0.35mm thread M6x0.5				
	GEV No.	101060	Ref. No.	—
magnet unit standard L 39mm D1 ø 15.4mm D2 ø 11mm suitable for PEL20-21/JUNKERS/EGA				
	GEV No.	106200	Ref. No.	—
nut thread M9x1 suitable for PEL 24/25S				

description		310137		
gas thermostat PEL type 25ST 100-300°C gas inlet M16x1.5 (tube ø 10mm) bypass nozzle ø 0.35mm gas outlet M16x1.5 (tube ø 10/8mm) thermocouple connection M9x1 pilot connection M10x1 capillary pipe 1200mm probe ø 6mm probe L 100mm shaft ø 8x6.5mm shaft L 21/15mm shaft flat upper				

accessories for		101172		
	GEV No.	100908	Ref. No.	—
union screw thread M10x1 for pipe ø 4mm Qty 1 pcs				
	GEV No.	100909	Ref. No.	—
union screw thread M10x1 for pipe ø 6mm Qty 1 pcs				
	GEV No.	101246	Ref. No.	—
olive for pipe ø 4mm Qty 1 pcs				
	GEV No.	101278	Ref. No.	—
olive for pipe ø 10mm Qty 1 pcs				
	GEV No.	101286	Ref. No.	—
olive ID ø 6mm Qty 1 pcs				
	GEV No.	101300	Ref. No.	—
union nut thread M16x1.5 tube ø 10mm				
	GEV No.	101450	Ref. No.	—
olive for pipe ø 8mm L 12.7mm Qty 1 pcs ED ø 10mm				
	GEV No.	101451	Ref. No.	—
union nut thread M16x1.5 tube ø 8mm				
	GEV No.	110079	Ref. No.	—
knob dial plate gas thermostat 1-8 silver				
	GEV No.	110081	Ref. No.	—
knob ø 70mm shaft ø 8x6.5mm shaft flat universal				



ignition parts















pilot burners



SIT

100 series



1

GEV No.	106906	Ref. No.	311022
description	pilot burner SIT type 100 series 3 flames nozzle \varnothing 0.2mm gas connection 6mm		
spare parts for	106906		
	GEV No.	100245	Ref. No. —
	pilot burner nozzle LPG code 20 bore \varnothing 0.2mm Qty 1 pcs thread M8x0.75		
	GEV No.	100855	Ref. No. —
	pilot burner bracket triple		
	GEV No.	100885	Ref. No. —
	air mixing sleeve for pilot burner Qty 1 pcs		
	GEV No.	100916	Ref. No. —
	compression spring for pilot burner Qty 1 pcs		
	GEV No.	100917	Ref. No. —
	gasket for pilot burner Qty 1 pcs aluminium		
	GEV No.	100918	Ref. No. —
	screw for pilot burner		
	GEV No.	107162	Ref. No. —
	pilot burner cap SIT 3 flames Hmm Lmm Qty 1 pcs		
	GEV No.	107701	Ref. No. —
	pilot burner bottom part SIT 100 series nozzle \varnothing 0.2mm		
accessories for	106906		
	GEV No.	100245	Ref. No. —
	pilot burner nozzle LPG code 20 bore \varnothing 0.2mm Qty 1 pcs thread M8x0.75		
	GEV No.	100246	Ref. No. —
	pilot burner nozzle natural gas bore \varnothing 0.35mm Qty 1 pcs thread M8x0.75		
	GEV No.	100904	Ref. No. —
	locking screw M10x1 for pipe \varnothing 4mm Qty 1 pcs		
	GEV No.	100905	Ref. No. —
	locking screw M10x1 for pipe \varnothing 6mm Qty 1 pcs		
	GEV No.	102110	Ref. No. —
	pilot tube copper pipe \varnothing 4mm thickness 1mm L 3000mm		
	GEV No.	102111	Ref. No. —
	pilot tube copper pipe \varnothing 6mm thickness 1mm L 3000mm		



accessories for	106906		
	GEV No.	107171	Ref. No. —
	pilot burner nozzle SIT natural/liquid gas bore \varnothing 0.25mm Qty 1 pcs		
	GEV No.	107700	Ref. No. —
	pilot burner bottom part SIT 100 series nozzle \varnothing 0.25mm		
	GEV No.	107702	Ref. No. —
	pilot burner bottom part SIT 100 series nozzle \varnothing 0.35mm		

HONEYWELL

pilot burners



1

GEV No.	102887	Ref. No.	310092
description	pilot burner HONEYWELL type Q327 3 flames		
accessories for	102887		
	GEV No.	102891	Ref. No. —
	pilot burner nozzle HONEYWELL LPG code KR14 model Q3480, Q3481, Q348, Q179, Q327		
	GEV No.	107496	Ref. No. —
	pilot burner nozzle HONEYWELL natural gas code NE22 model Q3480, Q3481, Q348, Q179, Q327		

electrodes



1

GEV No.	102981	Ref. No.	308469
description	ignition electrode D1 \varnothing 7mm L1 30mm BL1 24mm BL2 21.5mm connection F2.8x0.8 cable length 1300mm 1/8"		



1

GEV No.	100906	Ref. No.	317980
description	screw connection thread M10x1 for ignition electrode brass Qty 1 pcs WS 10		



piezoelectric igniters

miscellaneous



1	GEV No.	nla ¹	Ref. No.	310034
	description	piezoelectric igniter suitable for Minisit connection F6.3x0.8 ømm		

¹no longer available

ignition units



1	GEV No.	102485	Ref. No.	308465
	description	ignition unit outputs 2 220-240VAC 0.6VA 50-60Hz		

thermocouples

thermocouple sets universal



1	GEV No.	102284	Ref. No.	310144
	description	thermocouple set 8-piece L 900mm		



1	GEV No.	102286	Ref. No.	634321
	description	thermocouple set 8-piece L 900mm flexible		

threaded thermocouples

threaded thermocouples standard

with socket with thread M8x1

type Junkers with aluminised tip

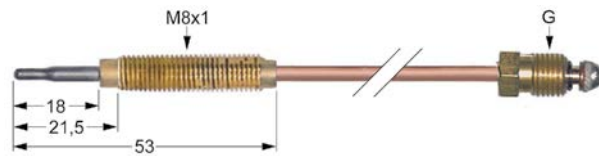

1	GEV No.	102060	Ref. No.	310193
	description	thermocouple M8x1 L 1500mm M8x1		
	accessories for	102060		
	GEV No.	102067	Ref. No.	—
		nut thread M8x1 H 3mm brass Qty 1 pcs type SEF 1		

gas burners

hob burners

producer-specific hob burners

THIRODE

833 series



1	GEV No.	107039	Ref. No.	301004
	description	burner type 833 ø 80mm L 250mm		
	spare parts for	107039		
	GEV No.	108011	Ref. No.	303001
		burner cap type 833 ø 78mm		



1	GEV No.	108011	Ref. No.	303001
	description	burner cap type 833 ø 78mm		





1	GEV No.	108040	Ref. No.	311138
	description	burner head type 833 ø 80mm		
	accessories for	108040		
	GEV No.	108011	Ref. No.	303001
		burner cap type 833 ø 78mm		

861 series



1	GEV No.	107009	Ref. No.	313001 99013752
	description	burner type 861 ø 80mm L 185mm complete		



			
1			
GEV No.	108003	Ref. No.	311138 75496
description	burner head for burner cap ø 78mm seat ø 35mm ID ø 30mm ED ø 83mm		
accessories for	108003		
	GEV No.	108004	Ref. No. 303001
description	burner cap ø 78mm 5kW mounting ø 72mm		

bar burners

bar burners

			
1			
GEV No.	104732	Ref. No.	141610
description	bar burner ø 50mm Wmm Hmm L 350mm		

gas nozzles

pilot burner nozzles

pilot burner nozzles HONEYWELL

for series Q349

			
1			
GEV No.	102889	Ref. No.	310150
description	pilot burner nozzle HONEYWELL LPG bore ø 0.25mm model Q349		

			
1			
GEV No.	106938	Ref. No.	310152
description	pilot burner nozzle HONEYWELL natural gas code 0.51 model Q349		

bypass nozzles

bypass nozzles PEL22

			
1			
GEV No.	100428	Ref. No.	310165
description	bypass nozzle type PEL22 bore ø 0.65mm thread M6x0.5		

			
1			
GEV No.	100407	Ref. No.	310166
description	bypass nozzle type PEL22 bore ø 1mm thread M6x0.5		

burner nozzles

			
1			
GEV No.	102897	Ref. No.	312126
description	burner nozzle LPG		

			
1			
GEV No.	102896	Ref. No.	312127
description	burner nozzle natural gas		

auxiliary gas parts

screw connections

union screws

			
1			
GEV No.	100906	Ref. No.	317980
description	screw connection thread M10x1 for ignition electrode brass Qty 1 pcs WS 10		

			
1			
GEV No.	100907	Ref. No.	317979
description	screw connection thread M10x1 Qty 1 pcs type SEF 1 ømm for thermocouple		

equipment-specific units

for espresso machines

brewing units

filter holder gaskets

O-rings

			
1			
GEV No.	510409	Ref. No.	905588
description	O-ring EPDM thickness 5.34mm ID ø 56.52mm Qty 1 pcs		



for dishwashers

boilers

boilers for dishwashers



1

GEV No.	518235	Ref. No.	2002149H
description	boiler ø 145mm L 405mm flange 3 hole flange		

air traps



air traps



1

GEV No.	518200	Ref. No.	2001861H
description	air trap ø 34mm H 78mm hose ø 6mm plastic		

spare parts for

	GEV No.	504618	Ref. No.	—
	O-ring EPDM thickness 2.62mm ID ø 15.54mm Qty 1 pcs			
	GEV No.	510075	Ref. No.	—
	flat gasket rubber ED ø 22mm ID ø 13mm thickness 1.5mm Qty 1 pcs			
	GEV No.	510106	Ref. No.	—
	hose connector for air trap			



washing and rinsing systems



1

GEV No.	517568	Ref. No.	2001143H
description	counterflange for wash arm support ø 69mm ID ø 63mm H 35mm mounting distance 64mm hole ø 7mm		

accessories for

	GEV No.	531605	Ref. No.	2001907H
	extension for rinsing shaft ø 16mm H 122mm thread L 12mm WS 19			
	GEV No.	532603	Ref. No.	—
	O-ring EPDM thickness 3.53mm ID ø 69.85mm Qty 1 pcs			
	GEV No.	698750	Ref. No.	—
	throttle disc ø 71.5mm hole ø 17/22mm			

EQUIPMENT-SPECIFIC UNITS/KNOBS THIRODE



1

GEV No.	513270	Ref. No.	2001604H
description	throttle disc		

knobs

universal knobs



1

GEV No.	110247	Ref. No.	308078
description	knob thermostat t.max. 350°C ø 50mm shaft ø 6x4.6mm shaft flat upper black temperature range 100-350°C		



1

GEV No.	110240	Ref. No.	308064
description	knob thermostat t.max. 85°C ø 50mm shaft ø 6x4.6mm shaft flat upper black temperature range 30-85°C		



1

GEV No.	110075	Ref. No.	308091
description	knob energy regulator 1-3 t.max.°C ø 50mm shaft ø 6x4.6mm shaft flat upper black		

accessories for

	GEV No.	110135	Ref. No.	—
	rosette knob up to ø 52mm			



hinges

edgemount hinges

CAFF/FERMOD

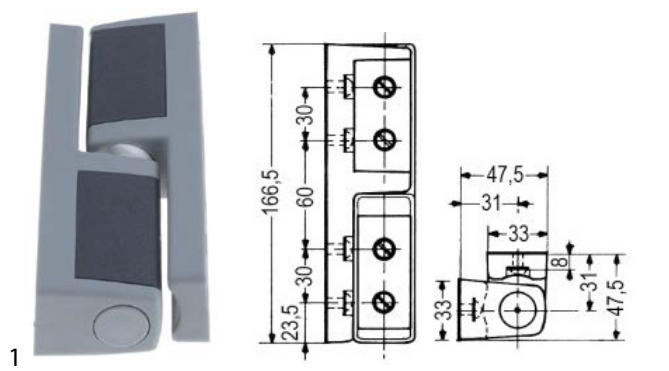

GEV No.	700566	Ref. No.	621090
description	edgemount hinge L 166.5mm W 33mm mounting distance 30/60mm hinging left/right with gradient series G 481		

fittings for catering equipment

drain taps

brass

drain taps



GEV No.	548001	Ref. No.	313001
description	drain tap 1 1/2" IT O-ring seal kettle connection with union nut A 80mm B1 68mm B2 132mm		
spare parts for	548001		
	GEV No.	505092	Ref. No. —
	O-ring EPDM thickness 5.34mm ID ø 43.82mm Qty 1 pcs		
	GEV No.	540213	Ref. No. —
	handle ID ø 5mm L 117mm		



GEV No.	541673	Ref. No.	3130
description	drain tap 1 1/2" IT with union nut conical seal		
spare parts for	541673		
	GEV No.	540213	Ref. No. —
	handle ID ø 5mm L 117mm		
	GEV No.	540956	Ref. No. —
	gasket for drain tap hose ext. ø 46mm ID ø 38mm H 2mm		
accessories for	541673		
	GEV No.	510404	Ref. No. —
	flat gasket fibre ED ø 44mm ID ø 34mm thickness 2mm Qty 1 pcs		
	GEV No.	890116	Ref. No. —
	fitting grease FERMIT GLISSA tube 60g -20 up to +140°C approval complies with KTW recommendation		
	GEV No.	890118	Ref. No. —
	fitting grease FERMIT GLISSA can 1000g -20 up to +140°C approval complies with KTW recommendation		
	GEV No.	890119	Ref. No. —
	fitting grease FERMIT GLISSA tube 30g -20 up to +140°C approval complies with KTW recommendation		

equipment feet and end caps

equipment feet

with screw mounting

GEV No.	513287	Ref. No.	2001489H
description	equipment foot tube ø 60mm thread M12 thread L 33mm H 155-235mm SS size 2" Qty 1 pcs		

gaskets

refrigeration gaskets

plug-in gaskets

profile 9704

We offer custom-made gaskets for this profile

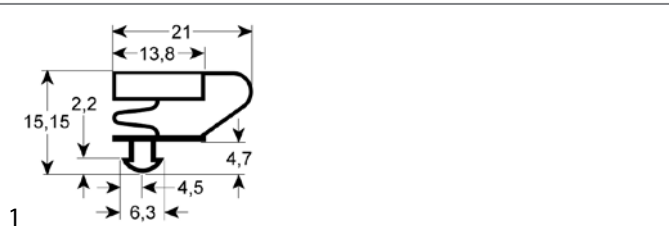

GEV No.	902299	Ref. No.	N/A
description	refrigeration gasket profile 9704 Wmm L 2500mm		

profile 9195

We offer custom-made gaskets for this profile

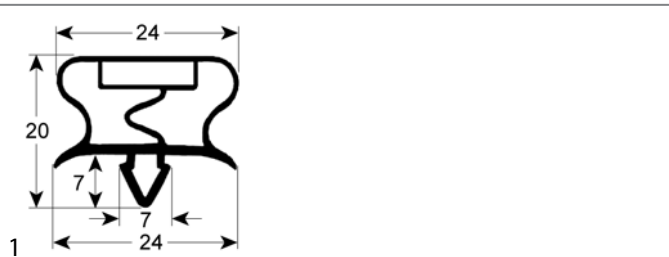

GEV No.	901915	Ref. No.	638255
description	refrigeration gasket profile 9195 W 387mm L 572mm plug size		

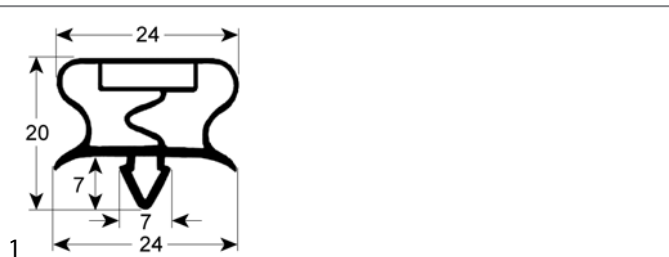

GEV No.	901905	Ref. No.	638138
description	refrigeration gasket profile 9195 W 627mm L 1500mm plug size		

gaskets for heated units

door seals

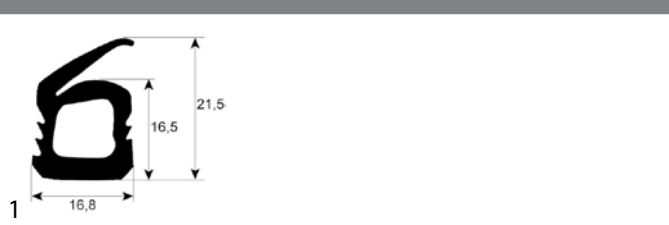

GEV No.	900610	Ref. No.	366371
description	door seal profile 2275 W 290mm L 690mm external size Qty 1 3-sided		

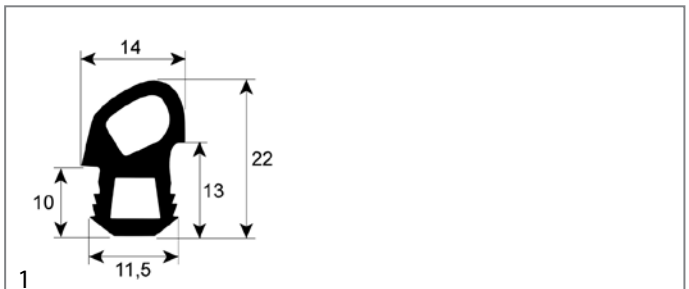

GEV No.	901362	Ref. No.	366386
description	door seal profile 2707 Qty supplied by meter		

O-rings

EPDM

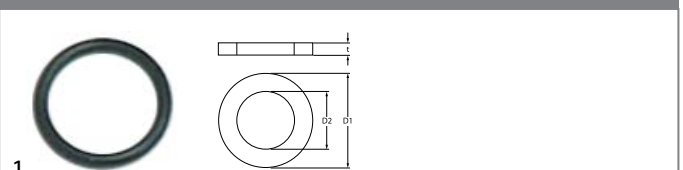

GEV No.	510302	Ref. No.	966011
description	O-ring EPDM ID ø 12.42mm thickness 1.78mm Qty 1 pcs		

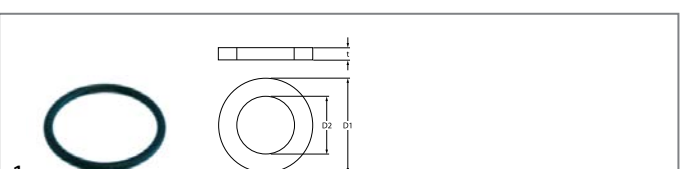

GEV No.	510409	Ref. No.	905588
description	O-ring EPDM thickness 5.34mm ID ø 56.52mm Qty 1 pcs		

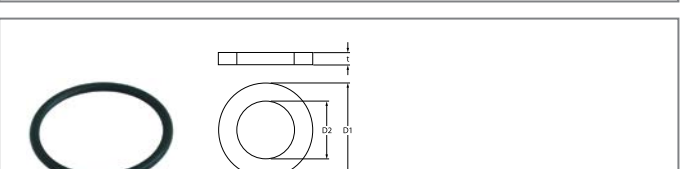

GEV No.	691033	Ref. No.	966005
description	O-ring EPDM thickness 5.34mm ID ø 62.87mm Qty 1 pcs		

Viton

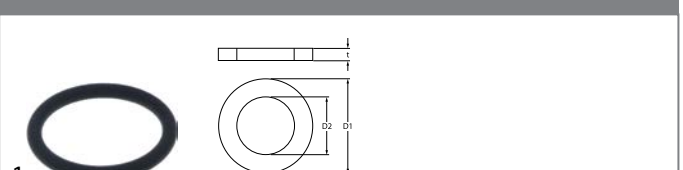

GEV No.	524478	Ref. No.	15118K 966003 966017
description	O-ring Viton thickness 5.7mm ID ø 44.2mm Qty 1 pcs		



sealing washers

rubber gaskets



GEV No.	518205	Ref. No.	2001368H
description	flat gasket rubber ED ø 61mm ID ø 47mm thickness 2mm Qty 1 pcs		

springs

tension springs



GEV No.	693881	Ref. No.	385053
description	tension spring ø 23mm total length 90mm wire gauge ø 3mm thread M8		

hoses

drain hoses



GEV No.	518068	Ref. No.	2001854H
description	drain hose DN34 L 2000mm elbow ø inside 50mm elbow ext. ø 59mm inner hose ø 35mm outer hose ø 42mm PVC		

formed hoses

form U



GEV No.	518517	Ref. No.	2001408H
description	formed hose for drain pump D1 ø 28mm D2 ø 21mm warewashing U-shape		

fittings, hose and pipe connectors

hose connectors

without screw connection



GEV No.	504302	Ref. No.	904364
description	T-piece plastic hose ø 10-6-10mm ID ø 5/7.5mm L 62mm W 34mm		

measuring equipment

thermometers

built-in thermometers



GEV No.	541086	Ref. No.	901018
description	thermometer mounting measurements 58x25.5mm 0 up to +120°C capillary pipe 2000mm probe ø 6mm probe L 23mm		

fastening material

screws

hexagonal screws



GEV No.	560083	Ref. No.	388105
description	hexagonal screw thread M5 thread L 10mm SS WS 8 Qty 20 pcs DIN 933 / ISO 4017		

cylinder head bolts

DIN 912/ISO 4762



GEV No.	560335	Ref. No.	388107
description	cylinder head bolt thread M5 thread L 20mm WS 4 SS Qty 1 pcs DIN 912/ISO 4762		

nuts

hexagonal nuts

DIN 934 / ISO 4032/8673



1

GEV No.	560197	Ref. No.	388146
description	nut thread M10 H 8mm WS 17 SS DIN/ISO DIN 934 / ISO 4032/8673 Qty 1 pcs		

DIN 985



1

GEV No.	560141	Ref. No.	389540
description	hexagonal nut thread M5 H 5.4mm SS WS 8 Qty 20 pcs DIN/ISO DIN 985 self-locking		

A			
axial fans		12	
B			
bar burners		23	
C			
cables		15	
cam switches		7	
compressors		11	
control thermostats		4, 6	
cross flow fans		12	
cylinder head bolts		27	
D			
door seals		26	
drain hoses		27	
drain pumps		14	
E			
edgemount hinges		25	
electric accessories		15	
electronic controllers		9	
energy regulators		4	
F			
fans		12	
fastening material		27	
formed hoses		27	
G			
gas burners		22	
gas nozzles		23	
gas taps		15	
gas thermostats		20	
gaskets for heated units		26	
H			
heating elements		3	
heating elements for frying pans		3	
heating elements for ovens		3	
hexagonal nuts		28	
hexagonal screws		27	
hob burners		22	
hose connectors		27	
hoses		27	
hot air fans		12	
hot plates		3	
I			
ignition units		22	
immersion heating elements		3	
L			
lamps		8	
LED		8	
M			
magnetic switches		8	
measuring equipment		27	
microswitches		7	
motors		12	
N			
nuts		28	
O			
O-rings		26	
P			
piezoelectric igniters		22	
pilot burners		21	
plug-in gaskets		26	
pressure switches		11	
programme timers		9	
pumps		13	
R			
refrigeration gaskets		26	
relays		9	
ribbon cables		15	
rocker/momentary rocker switches		7	
S			
safety thermostats		5, 7	
screws		27	
sealing washers		27	
solenoid valves		10	
switches and momentary switches		7	
system switches (ROLD)		7	
T			
terminals		15	
thermocouples		22	
thermostats		4	
timers		9	
W			
wash and rinse pumps		13	