



**GAS COMPONENTS**



**ELECTRIC COMPONENTS**



**WATER TECHNOLOGY**



**MECHANICAL COMPONENTS**



**TOOLS**

Spare parts suitable for

**THIELMANN**

Find the complete and up-to-date range of products in our GEV Webshop



# Manufacturer catalogue

The most important spare parts and accessories arranged clearly for every manufacturer

- ✓ Complete product range and all appliance data always up to date in the GEV Webshop
- ✓ Alphabetical Index at the end of the catalogue

## GEV Webshop

[www.gev-online.co.uk](http://www.gev-online.co.uk)

[www.gev-online.com](http://www.gev-online.com)



- 🔍 Add to Favourites
- 🔍 Sign In with email address and usual password
- 🔍 Easy-order – place several items in your basket at the same time
- 🔍 Quick Item search – no login needed



# heating elements

## heating elements for ovens

<b>GEV No.</b>	418223	<b>Ref. No.</b>	144168 540471
<b>description</b>	heating element 2000W 400V L 490mm W 560mm L1 25mm L2 465mm W1 530mm W2 30mm flange length 70mm flange width 22mm hole distance 56mm hole ø M4mm tube ø 6.3mm connection length 41mm connection male faston 6.3mm heating circuits 1 rectangular flange dry heating element oven		

<b>GEV No.</b>	418222	<b>Ref. No.</b>	144169 540831
<b>description</b>	heating element 2800W 400V L 500mm W 560mm L1 50mm L2 450mm W1 530mm W2 30mm flange length 70mm flange width 22mm hole distance 56mm tube ø 6.3mm dry heating element oven		

## heating elements for fryers

<b>GEV No.</b>	415753	<b>Ref. No.</b>	N/A
<b>description</b>	heating element 6000W 400V L 324mm W 195mm H 265mm rectangular flange connection cable heating circuits 3 immersion heater L1 64mm L2 260mm hole distance 27mm hole ø 7mm flange length 90mm flange width 40mm cable length 1000mm tube ø 18mm W1 64mm W2 65mm		

<b>GEV No.</b>	418263	<b>Ref. No.</b>	144187 540441
<b>description</b>	heating element 7200W 230/400V heating circuits 3 L 360mm W 150mm H 220mm L1 25mm L2 335mm W1 58mm W2 42mm flange length 75mm flange width 30mm hole distance 63mm hole ø 5.5mm rectangular flange immersion heater		

<b>GEV No.</b>	415484	<b>Ref. No.</b>	N/A
<b>description</b>	heating element 6000W 230/400V heating circuits 3 L 367mm W 175mm H 246mm L1 90mm L2 277mm H1 229mm H2 17mm W1 50mm W2 75mm windings 6 flange ø 40.4mm cable length 130mm mounting ø 27mm rotation flange immersion heater		

<b>GEV No.</b>	415613	<b>Ref. No.</b>	140768
<b>description</b>	heating element 8000W 380V heating circuits 3 L 423mm W 145mm H 308mm L1 65mm L2 358mm W1 65mm W2 17mm H1 33mm H2 258mm H3 17mm thread M26x1.5 cable length 1200mm immersion heater		





## heating elements for griddles

<b>GEV No.</b>	415759	<b>Ref. No.</b>	N/A	
<b>description</b>	heating element 2000W 230V heating circuits 1 L 455mm W 153mm H 20mm tube ø 8.5mm 2 hole fixing connection male faston 6.3mm thread M14x1.5 mounting distance 140mm for grill dry heating element			
<b>accessories for</b>	415759			
	<b>GEV No.</b>	510417	<b>Ref. No.</b>	—
	flat gasket fibre ED ø 20mm ID ø 14mm thickness 2mm Qty 1 pcs			
	<b>GEV No.</b>	520228	<b>Ref. No.</b>	—
	tooth lock washer ID ø 15.3mm ED ø 24mm steel Qty 1 pcs for thread M14			





Table continues overleaf







bottom heaters

			
1			
<b>GEV No.</b>	415760	<b>Ref. No.</b>	144167 540463
<b>description</b>	bottom heater 1800W 230V heating circuits 1 ø 196mm safety thermostat°C thermostat 128°C M5 mounting distance 180mm		
<b>spare parts for</b>	415760		
	<b>GEV No.</b>	375300	<b>Ref. No.</b> —
<b>description</b>	thermostat t.max. 128°C temperature range 35-128°C 1-pole 1NO 16A probe ø 3.1mm probe L 174mm capillary pipe 880mm capillary pipe isolated 800mm gland nut shaft L 23mm shaft position lower rotation 270°		
<b>accessories for</b>	415760		
	<b>GEV No.</b>	520323	<b>Ref. No.</b> 144334
<b>description</b>	gasket ID ø 160mm ED ø 200mm hole distance 90/180mm hole ø 7mm silicone for bottom heaters		
	<b>GEV No.</b>	520324	<b>Ref. No.</b> 144343
<b>description</b>	counterflange ID ø 160mm ED ø 200mm hole distance 90/180mm hole ø 7mm SS for bottom heaters		

pilot heating elements

			
1			
<b>GEV No.</b>	415653	<b>Ref. No.</b>	143895
<b>description</b>	heating element 600W 230V heating circuits 1 mounting ø 47.5mm L 280mm W 36mm H 16mm round flange connection male faston 6.3mm immersion heater tube ø 6.3mm thermostat sleeves ø 7mm length thermostat sleeves 220mm number of thermostat sleeves 1 pilot heating element		
<b>spare parts for</b>	415653		
	<b>GEV No.</b>	510408	<b>Ref. No.</b> —
<b>description</b>	O-ring EPDM thickness 5.34mm ID ø 47mm Qty 1 pcs		
<b>accessories for</b>	415653		
	<b>GEV No.</b>	510562	<b>Ref. No.</b> —
<b>description</b>	O-ring silicone thickness 5.34mm ID ø 47mm Qty 1 pcs		
	<b>GEV No.</b>	550675	<b>Ref. No.</b> —
<b>description</b>	O-ring Viton thickness 6mm ID ø 47mm Qty 1 pcs		

<b>accessories for</b>	415759		
	<b>GEV No.</b>	520230	<b>Ref. No.</b> —
<b>description</b>	nut thread M14x1.5 H 5mm WS 19 zinc-coated steel Qty 1 pcs		
	<b>GEV No.</b>	521101	<b>Ref. No.</b> —
<b>description</b>	nut thread M14x1.5 H 5mm WS 19 SS Qty 1 pcs		
	<b>GEV No.</b>	550262	<b>Ref. No.</b> —
<b>description</b>	flat gasket copper ED ø 20mm ID ø 14mm thickness 2mm		

			
1			
<b>GEV No.</b>	418238	<b>Ref. No.</b>	143831 540458
<b>description</b>	heating element 2000W 400V heating circuits 1 L 494mm W 96mm H 29mm tube ø 6.3mm rectangular flange connection male faston 6.3mm hole distance 36mm flange length 45mm flange width 16mm connection length 28mm mounting thread M4 dry heating element		

			
1			
<b>GEV No.</b>	415733	<b>Ref. No.</b>	N/A
<b>description</b>	heating element 2500W 220V heating circuits 1 L 484mm W 150mm H 85mm tube ø 6.3mm L1 50mm L2 434mm W1 36mm W2 78mm 2 hole fixing connection male faston 6.3mm thread M10x1 windings 3 mounting distance 72mm for grill dry heating element		

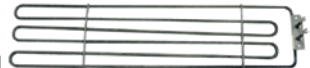
			
1			
<b>GEV No.</b>	415594	<b>Ref. No.</b>	143648 182329
<b>description</b>	heating element 2565W 400V L 556mm W 126mm H 33mm connection male faston 6.3mm dry heating element heating circuits 1 tube ø 6.3mm W1 48mm W2 30mm rectangular flange hole distance 56mm flange length 70mm flange width 22mm mounting thread M4		

			
1			
<b>GEV No.</b>	415732	<b>Ref. No.</b>	N/A
<b>description</b>	heating element 3000W 230V heating circuits 1 L 440mm W 180mm H 176mm tube ø 8.5mm L1 40mm L2 400mm W1 10mm W2 160mm 2 hole fixing connection male faston 6.3mm thread M14x1.5 mounting distance 152mm grill dry heating element		

heating elements for tilting bratt pan

			
1			
<b>GEV No.</b>	415594	<b>Ref. No.</b>	143648 182329
<b>description</b>	heating element 2565W 400V L 556mm W 126mm H 33mm connection male faston 6.3mm dry heating element heating circuits 1 tube ø 6.3mm W1 48mm W2 30mm rectangular flange hole distance 56mm flange length 70mm flange width 22mm mounting thread M4		

immersion heating elements

with round flange ø47.5mm



<b>GEV No.</b>	415604	<b>Ref. No.</b>	143833 541218
<b>description</b>	heating element 3000W 230/400V heating circuits 3 L 160mm W 36mm H 25mm connection male faston 6.3mm immersion heater round flange mounting ø 47.5mm		
<b>accessories for</b>	415604		
	GEV No.	510408	Ref. No. —
	O-ring EPDM thickness 5.34mm ID ø 47mm Qty 1 pcs		
	GEV No.	510562	Ref. No. —
	O-ring silicone thickness 5.34mm ID ø 47mm Qty 1 pcs		
	GEV No.	520235	Ref. No. —
	3 hole flange hole distance 70.5mm perforation ø 6.5mm ID ø 53.5mm		
	GEV No.	520236	Ref. No. —
	flange for heating element ID ø 50mm ED ø 90mm hole ø 6.5mm 3 holes		
	GEV No.	550002	Ref. No. —
	tension strap H 10mm L 21mm W 10mm hole ø 6.5mm for heating element		
	GEV No.	550362	Ref. No. —
	blind flange ø 64mm mounting ø 47.5mm		



<b>GEV No.</b>	418286	<b>Ref. No.</b>	143834 540821
<b>description</b>	heating element 6000W 230V heating circuits 2 L 392mm W 35mm H 40mm tube ø 6.2mm connection male faston 6.3mm immersion heater round flange L1 32mm L2 360mm H1 27mm H2 13mm mounting ø 47.5mm		
<b>accessories for</b>	418286		
	GEV No.	510408	Ref. No. —
	O-ring EPDM thickness 5.34mm ID ø 47mm Qty 1 pcs		
	GEV No.	510562	Ref. No. —
	O-ring silicone thickness 5.34mm ID ø 47mm Qty 1 pcs		
	GEV No.	520235	Ref. No. —
	3 hole flange hole distance 70.5mm perforation ø 6.5mm ID ø 53.5mm		
	GEV No.	520236	Ref. No. —
	flange for heating element ID ø 50mm ED ø 90mm hole ø 6.5mm 3 holes		
	GEV No.	550002	Ref. No. —
	tension strap H 10mm L 21mm W 10mm hole ø 6.5mm for heating element		
	GEV No.	550362	Ref. No. —
	blind flange ø 64mm mounting ø 47.5mm		







<b>GEV No.</b>	415405	<b>Ref. No.</b>	144346
<b>description</b>	heating element 6000W 230V heating circuits 3 L 465mm W 38mm H 24mm tube ø 6.3mm connection male faston 6.3mm immersion heater round flange mounting ø 47.5mm		
<b>spare parts for</b>	415405		
	GEV No.	504148	Ref. No. —
	boiler		
<b>accessories for</b>	415405		
	GEV No.	520235	Ref. No. —
	3 hole flange hole distance 70.5mm perforation ø 6.5mm ID ø 53.5mm		
	GEV No.	520236	Ref. No. —
	flange for heating element ID ø 50mm ED ø 90mm hole ø 6.5mm 3 holes		
	GEV No.	521012	Ref. No. —
	gasket graphite ED ø 15mm ID ø 5mm thickness 1.2mm Qty 1 pcs		
	GEV No.	550002	Ref. No. —
	tension strap H 10mm L 21mm W 10mm hole ø 6.5mm for heating element		
	GEV No.	550362	Ref. No. —
	blind flange ø 64mm mounting ø 47.5mm		





<b>GEV No.</b>	418270	<b>Ref. No.</b>	143836 540717
<b>description</b>	heating element 9000W 230V heating circuits 3 L 535mm W 36mm H 45mm tube ø 6.2mm connection male faston 6.3mm immersion heater round flange L1 35mm L2 500mm H1 35mm H2 10mm mounting ø 47.5mm		
<b>accessories for</b>	418270		
	GEV No.	510408	Ref. No. —
	O-ring EPDM thickness 5.34mm ID ø 47mm Qty 1 pcs		
	GEV No.	510562	Ref. No. —
	O-ring silicone thickness 5.34mm ID ø 47mm Qty 1 pcs		
	GEV No.	520235	Ref. No. —
	3 hole flange hole distance 70.5mm perforation ø 6.5mm ID ø 53.5mm		
	GEV No.	520236	Ref. No. —
	flange for heating element ID ø 50mm ED ø 90mm hole ø 6.5mm 3 holes		
	GEV No.	550002	Ref. No. —
	tension strap H 10mm L 21mm W 10mm hole ø 6.5mm for heating element		
	GEV No.	550362	Ref. No. —
	blind flange ø 64mm mounting ø 47.5mm		





1 			
<b>GEV No.</b>	418287	<b>Ref. No.</b>	144347
<b>description</b>	heating element 9000W 230V heating circuits 3 L 540mm W 37mm H 28mm tube ø 6.2mm immersion heater round flange mounting ø 47.5mm		
<b>accessories for</b>	418287		
	<b>GEV No.</b>	510408	<b>Ref. No.</b> —
	O-ring EPDM thickness 5.34mm ID ø 47mm Qty 1 pcs		
	<b>GEV No.</b>	510562	<b>Ref. No.</b> —
	O-ring silicone thickness 5.34mm ID ø 47mm Qty 1 pcs		
	<b>GEV No.</b>	520235	<b>Ref. No.</b> —
	3 hole flange hole distance 70.5mm perforation ø 6.5mm ID ø 53.5mm		
	<b>GEV No.</b>	520236	<b>Ref. No.</b> —
	flange for heating element ID ø 50mm ED ø 90mm hole ø 6.5mm 3 holes		
	<b>GEV No.</b>	550002	<b>Ref. No.</b> —
	tension strap H 10mm L 21mm W 10mm hole ø 6.5mm for heating element		
	<b>GEV No.</b>	550362	<b>Ref. No.</b> —
	blind flange ø 64mm mounting ø 47.5mm		

## accessories

## flange gaskets

1 			
<b>GEV No.</b>	520324	<b>Ref. No.</b>	144343
<b>description</b>	counterflange ID ø 160mm ED ø 200mm hole distance 90/180mm hole ø 7mm SS for bottom heaters		
<b>accessories for</b>	520324		
	<b>GEV No.</b>	520323	<b>Ref. No.</b> 144334
	gasket ID ø 160mm ED ø 200mm hole distance 90/180mm hole ø 7mm silicone for bottom heaters		

1 			
<b>GEV No.</b>	520323	<b>Ref. No.</b>	144334
<b>description</b>	gasket ID ø 160mm ED ø 200mm hole distance 90/180mm hole ø 7mm silicone for bottom heaters		

counterflanges			
1 			
<b>GEV No.</b>	520324	<b>Ref. No.</b>	144343
<b>description</b>	counterflange ID ø 160mm ED ø 200mm hole distance 90/180mm hole ø 7mm SS for bottom heaters		
<b>accessories for</b>	520324		
	<b>GEV No.</b>	520323	<b>Ref. No.</b> 144334
	gasket ID ø 160mm ED ø 200mm hole distance 90/180mm hole ø 7mm silicone for bottom heaters		

## hot plates

## square &amp; rectangular



## tiltable

1 			
<b>GEV No.</b>	490090	<b>Ref. No.</b>	144171
<b>description</b>	hot plate dimensions 300x300mm 4000W 400V with cast edge tilt boiling plate connection 4 screw clamps H 43mm square		

## energy regulators

## EGO

## 1-circuit

1 			
<b>GEV No.</b>	380036	<b>Ref. No.</b>	221406 538255
<b>description</b>	energy regulator 230V 13A turn direction right shaft ø 6x4.6mm mounting thread M12x1 no. 50.57024.010		
<b>accessories for</b>	380036		
	<b>GEV No.</b>	510792	<b>Ref. No.</b> —
	hexagonal nut thread M12x1 H 4mm WS 17 stainless steel Qty 1 pcs		



thermostats

control and safety thermostats

EGO

control thermostats

55.34\_series



<b>GEV No.</b>	375708	<b>Ref. No.</b>	143766 540444
<b>description</b>	thermostat t.max. 188°C temperature range 95-188°C 3-pole 3NO 16A probe ø 6mm probe L 117mm capillary pipe 1780mm capillary pipe isolated 1400mm gland nut shaft ø 6x4.6mm shaft L 23mm shaft position upper rotation 270°		



<b>GEV No.</b>	375038	<b>Ref. No.</b>	139783
<b>description</b>	thermostat t.max. 300°C temperature range 50-300°C 3-pole 3NO 16A probe ø 6mm probe L 79mm capillary pipe 1740mm capillary pipe isolated 800mm gland nut shaft ø 6x4.6mm shaft L 23mm shaft position upper rotation 270°		
<b>accessories for</b>	375038		
	<b>GEV No.</b>	110123	<b>Ref. No.</b> —
	knob thermostat t.max. 300°C ø 50mm shaft ø 6x4.6mm shaft flat upper black temperature range 50-300°C rotation 270°		



<b>GEV No.</b>	375019	<b>Ref. No.</b>	144180
<b>description</b>	thermostat t.max. 85°C temperature range 30-85°C 3-pole 3NO 16A probe ø 6mm probe L 131mm capillary pipe 1440mm capillary pipe isolatedmm gland nut M9x1 shaft ø 6x4.6mm shaft L 23mm shaft position upper rotation 270°		

safety thermostats

55.13\_series



<b>GEV No.</b>	375519	<b>Ref. No.</b>	143830 540414
<b>description</b>	safety thermostat switch-off temp. 130°C 1-pole 1NO 16A probe ø 6mm probe L 129mm capillary pipe 830mm capillary pipe isolatedmm gland nut mounting thread M8x1 probe SS		
<b>accessories for</b>	375519		
	<b>GEV No.</b>	102067	<b>Ref. No.</b> —
	nut thread M8x1 H 3mm brass Qty 1 pcs type SEF 1		

55.32\_series

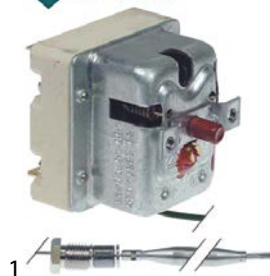

<b>GEV No.</b>	375707	<b>Ref. No.</b>	144182 540443
<b>description</b>	safety thermostat switch-off temp. 230°C 3-pole 20A probe ø 6mm probe L 87mm capillary pipe 1490mm capillary pipe isolated 1100mm gland nut M9x1 probe SS		

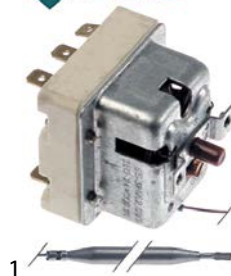

<b>GEV No.</b>	375695	<b>Ref. No.</b>	251116 540470
<b>description</b>	safety thermostat switch-off temp. 350°C 3-pole 20A probe ø 6mm probe L 77mm capillary pipe 890mm capillary pipe isolatedmm gland nut probe SS		



E-G-O

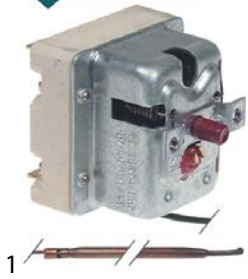

<b>GEV No.</b>	375706	<b>Ref. No.</b>	144095 540406
<b>description</b>	safety thermostat switch-off temp. 400°C 3-pole 3NC 20A probe ø 3.9mm probe L 228mm capillary pipe 1190mm capillary pipe isolatedmm gland nut probe SS		

## switches and momentary switches

## microswitches

## pin-plunger actuated



<b>GEV No.</b>	345061	<b>Ref. No.</b>	144412
<b>description</b>	microswitch with plunger 250V 16A 1NC connection male faston 6.3mm ambient temperature max. 85°C mounting distance 22mm type BS1011 actuating force: 350g red stroke 15mm		



<b>GEV No.</b>	345060	<b>Ref. No.</b>	141907
<b>description</b>	microswitch with plunger 250V 16A 1NO connection male faston 6.3mm ambient temperature max. 85°C mounting distance 22mm type BS1010 actuating force: 350g red stroke 9mm		

## cam switches

## on/off

E-G-O

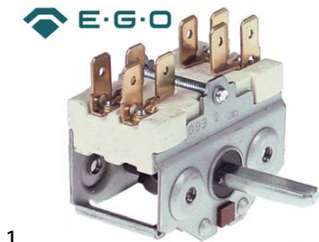

<b>GEV No.</b>	300074	<b>Ref. No.</b>	144696
<b>description</b>	cam switch 4 operating positions 2NO sequence 0-1-0-1 16A shaft ø 6x4.6mm shaft L 23mm connection male faston 6.3mm ceramic		

## 4-position

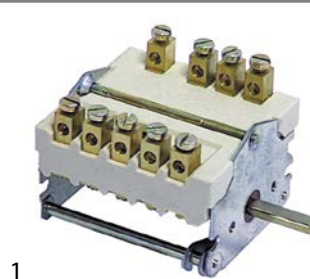

<b>GEV No.</b>	300104	<b>Ref. No.</b>	141188
<b>description</b>	cam switch 4 operating positions 3NO/1CO sequence 0-1-2-3 32A shaft ø 6x4.6mm shaft L 23mm connection screw ceramic		

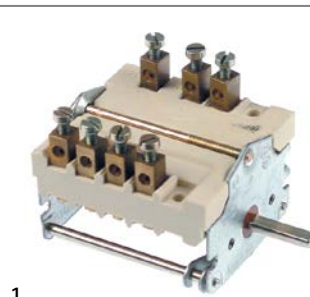

<b>GEV No.</b>	300190	<b>Ref. No.</b>	141924 540472
<b>description</b>	cam switch 4-position sequence 0-3-2-1 shaft ø 6x4.6mm connection screw clamp 3-pole		

## 7-position



<b>GEV No.</b>	300106	<b>Ref. No.</b>	141187
<b>description</b>	cam switch 7 operating positions 1NO/2CO sequence 0-1-2-3-4-5-6 32A shaft ø 6x4.6mm shaft L 23mm connection screw 7-position shaft flat upper		

## 4 operating positions

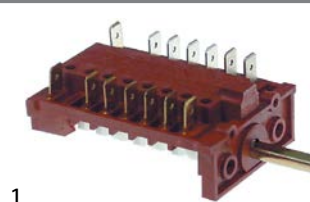

<b>GEV No.</b>	300193	<b>Ref. No.</b>	143765 540445
<b>description</b>	cam switch sequence 0-1-0-2		



operation switches



1

<b>GEV No.</b>	300200	<b>Ref. No.</b>	142752 540461
<b>description</b>	operation switch 2 operating positions 2NO 16A sequence 0-1 shaft ø 6x4.6mm shaft L 23mm connection male faston 6.3mm operation switch ceramic		

control equipment

MOELLER/EATON

push buttons - signal lamps



1

<b>GEV No.</b>	346271	<b>Ref. No.</b>	144412
<b>description</b>	push button mounting measurements ø22mm silver without button plate momentary		

switch blocks



1

<b>GEV No.</b>	345707	<b>Ref. No.</b>	143052
<b>description</b>	contact block 1NC/1NO		

button plates with symbol



1

<b>GEV No.</b>	346435	<b>Ref. No.</b>	141188 144411 144415
<b>description</b>	button plate black arrow		

lamps

indicator lights

indicator lights (complete)

ø12mm

with screw socket



1

<b>GEV No.</b>	359026	<b>Ref. No.</b>	540181
<b>description</b>	indicator light ø 12mm 230V red connection male faston 6.3mm model CM/5		



1

<b>GEV No.</b>	359048	<b>Ref. No.</b>	540180
<b>description</b>	indicator light ø 12mm 230V yellow connection male faston 6.3mm		



1

<b>GEV No.</b>	359027	<b>Ref. No.</b>	143841
<b>description</b>	indicator light ø 12mm 250V green connection male faston 6.3mm		

contactors

GENERAL ELECTRIC (AEG)

power contactors



1

<b>GEV No.</b>	380261	<b>Ref. No.</b>	130274
<b>description</b>	power contactor resistive load 32A 230VAC (AC3/400V) 17A/7.5kW main contacts 3NO auxiliary contacts 1NO connection screw connection type AEG LS7K 10A type GE CL02A 310		



1

<b>GEV No.</b>	380265	<b>Ref. No.</b>	144345
<b>description</b>	power contactor resistive load 60A 230VAC (AC3/400V) 32A/16kW main contacts 3NO auxiliary contacts 1NO connection screw connection type AEG LS15K 00A type GE CL04A 310 H 98mm L 87mm W 55mm		

## pressure switches

for steam control



1

<b>GEV No.</b>	541408	<b>Ref. No.</b>	143896 540416
<b>description</b>	pressure control ø 45mm pressure range 450/300mbar pressure connection vertical steam control pressure range 0.45/0.3bar connection 1/4" pressure connection 1/4"		

## electric accessories

terminals and connectors

not insulated

female bullets



1

<b>GEV No.</b>	100112	<b>Ref. No.</b>	144992
<b>description</b>	female bullet size 2mm 0.25-1.0mm <sup>2</sup> CuZn gal Sn t.max. 125°C Qty 20 pcs		

## gas taps

PEL

21S series



1

<b>GEV No.</b>	101095	<b>Ref. No.</b>	144424	
<b>description</b>	gas tap PEL type 21S gas inlet M16x1.5 (tube ø 10mm) bypass nozzle ø 0.35mm gas outlet M16x1.5 (tube ø 10/8mm) thermocouple connection M8x1 pilot connection M10x1 shaft ø 8x6.5mm shaft L 22/15mm shaft flat lower			
<b>spare parts for</b>	101095			
	<b>GEV No.</b>	100408	<b>Ref. No.</b>	—
	bypass nozzle type PEL20/21 bore ø 0.35mm thread M5x0.5			
	<b>GEV No.</b>	101060	<b>Ref. No.</b>	—
	magnet unit standard L 39mm D1 ø 15.4mm D2 ø 11mm suitable for PEL20-21/JUNKERS/EGA			
	<b>GEV No.</b>	101206	<b>Ref. No.</b>	—
	gas tap front part shaft ø 8x6.5mm shaft L 22/15mm shaft flat upper/lower suitable for PEL21			
	<b>GEV No.</b>	101230	<b>Ref. No.</b>	—
	thermocouple nut T1: M8x1 T2: M18x1 aluminium			
<b>accessories for</b>	101095			
	<b>GEV No.</b>	100908	<b>Ref. No.</b>	—
	union screw thread M10x1 for pipe ø 4mm Qty 1 pcs			
	<b>GEV No.</b>	100909	<b>Ref. No.</b>	—
	union screw thread M10x1 for pipe ø 6mm Qty 1 pcs			
	<b>GEV No.</b>	101246	<b>Ref. No.</b>	—
	olive for pipe ø 4mm Qty 1 pcs			
	<b>GEV No.</b>	101278	<b>Ref. No.</b>	—
	olive for pipe ø 10mm Qty 1 pcs			
	<b>GEV No.</b>	101286	<b>Ref. No.</b>	—
	olive ID ø 6mm Qty 1 pcs			
	<b>GEV No.</b>	101300	<b>Ref. No.</b>	—
	union nut thread M16x1.5 tube ø 10mm			
	<b>GEV No.</b>	101450	<b>Ref. No.</b>	—
	olive for pipe ø 8mm L 12.7mm Qty 1 pcs ED ø 10mm			
	<b>GEV No.</b>	101451	<b>Ref. No.</b>	—
	union nut thread M16x1.5 tube ø 8mm			
	<b>GEV No.</b>	110081	<b>Ref. No.</b>	—
	knob ø 70mm shaft ø 8x6.5mm shaft flat universal			
	<b>GEV No.</b>	112206	<b>Ref. No.</b>	—
	knob dial plate silver gas tap PEL21/22/23 t.max.°C ED ø 63mm ID ø 45.5mm			



23S/V series



<b>GEV No.</b>	101630	<b>Ref. No.</b>	130124
<b>description</b>	gas tap PEL type 23S/V gas inlet 1/2" IT bypass nozzle ø 0.35mm gas outlet 1/2" MT (tube ø 14mm) thermocouple connection M10x1 pilot connection M10x1 shaft ø 10mm shaft L 25mm shaft flat		
<b>spare parts for</b>	101630		
	<b>GEV No.</b>	100455	<b>Ref. No.</b> —
	bypass nozzle type PEL23/24 bore ø 0.35mm thread M8x0.5		
	<b>GEV No.</b>	101059	<b>Ref. No.</b> —
	magnet unit T1: M10x1 T2: M22x1 L 46mm ø 18mm suitable for PEL23S M10x1		
	<b>GEV No.</b>	102767	<b>Ref. No.</b> —
	gas tap front part shaft ø 10mm shaft L 26.5mm shaft flat suitable for PEL23S		
<b>accessories for</b>	101630		
	<b>GEV No.</b>	100908	<b>Ref. No.</b> —
	union screw thread M10x1 for pipe ø 4mm Qty 1 pcs		
	<b>GEV No.</b>	100909	<b>Ref. No.</b> —
	union screw thread M10x1 for pipe ø 6mm Qty 1 pcs		
	<b>GEV No.</b>	100945	<b>Ref. No.</b> —
	roll pin ø 3.2mm L 10mm		
	<b>GEV No.</b>	101218	<b>Ref. No.</b> —
	shaft extension JUNKERS		
	<b>GEV No.</b>	101219	<b>Ref. No.</b> —
	shaft extension L 25mm JUNKERS		
	<b>GEV No.</b>	101246	<b>Ref. No.</b> —
	olive for pipe ø 4mm Qty 1 pcs		
	<b>GEV No.</b>	101286	<b>Ref. No.</b> —
	olive ID ø 6mm Qty 1 pcs		
	<b>GEV No.</b>	110064	<b>Ref. No.</b> —
	knob		
	<b>GEV No.</b>	110066	<b>Ref. No.</b> —
	knob screw		
	<b>GEV No.</b>	550396	<b>Ref. No.</b> —
	shaft extension L 25mm JUNKERS		

alternatives to JUNKERS

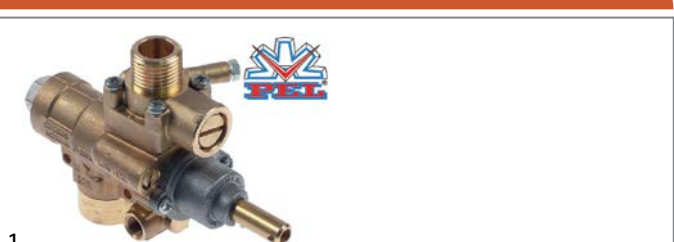

<b>GEV No.</b>	101630	<b>Ref. No.</b>	130124
<b>description</b>	gas tap PEL type 23S/V gas inlet 1/2" IT bypass nozzle ø 0.35mm gas outlet 1/2" MT (tube ø 14mm) thermocouple connection M10x1 pilot connection M10x1 shaft ø 10mm shaft L 25mm shaft flat		
<b>spare parts for</b>	101630		
	<b>GEV No.</b>	100455	<b>Ref. No.</b> —
	bypass nozzle type PEL23/24 bore ø 0.35mm thread M8x0.5		
	<b>GEV No.</b>	101059	<b>Ref. No.</b> —
	magnet unit T1: M10x1 T2: M22x1 L 46mm ø 18mm suitable for PEL23S M10x1		
	<b>GEV No.</b>	102767	<b>Ref. No.</b> —
	gas tap front part shaft ø 10mm shaft L 26.5mm shaft flat suitable for PEL23S		
<b>accessories for</b>	101630		
	<b>GEV No.</b>	100908	<b>Ref. No.</b> —
	union screw thread M10x1 for pipe ø 4mm Qty 1 pcs		
	<b>GEV No.</b>	100909	<b>Ref. No.</b> —
	union screw thread M10x1 for pipe ø 6mm Qty 1 pcs		
	<b>GEV No.</b>	100945	<b>Ref. No.</b> —
	roll pin ø 3.2mm L 10mm		
	<b>GEV No.</b>	101218	<b>Ref. No.</b> —
	shaft extension JUNKERS		
	<b>GEV No.</b>	101219	<b>Ref. No.</b> —
	shaft extension L 25mm JUNKERS		
	<b>GEV No.</b>	101246	<b>Ref. No.</b> —
	olive for pipe ø 4mm Qty 1 pcs		
	<b>GEV No.</b>	101286	<b>Ref. No.</b> —
	olive ID ø 6mm Qty 1 pcs		
	<b>GEV No.</b>	110064	<b>Ref. No.</b> —
	knob		
	<b>GEV No.</b>	110066	<b>Ref. No.</b> —
	knob screw		
	<b>GEV No.</b>	550396	<b>Ref. No.</b> —
	shaft extension L 25mm JUNKERS		















## gas thermostats

PEL

### 24ST series



<b>GEV No.</b>	101900	<b>Ref. No.</b>	144428
<b>description</b>	gas thermostat PEL type 24ST up to 280°C gas inlet M20x1.5 (tube ø 12mm) bypass nozzle ø 0.8mm gas outlet M20x1.5 (tube ø 12/10mm) thermocouple connection M8x1 pilot connection M10x1 capillary pipe 1200mm probe ø 6mm probe L 120mm shaft ø 10x9mm shaft L 31/15mm shaft flat upper		
<b>spare parts for</b>	101900		
	<b>GEV No.</b>	100497	<b>Ref. No.</b> —
	bypass nozzle type PEL23/24 bore ø 0.8mm thread M8x0.5		
	<b>GEV No.</b>	101058	<b>Ref. No.</b> —
	magnet unit L 39mm D1 ø 15.4mm D2 ø 13.5mm suitable for PEL22/ EGA24197 standard		
	<b>GEV No.</b>	106199	<b>Ref. No.</b> —
	nut thread M8x1		
<b>accessories for</b>	101900		
	<b>GEV No.</b>	100908	<b>Ref. No.</b> —
	union screw thread M10x1 for pipe ø 4mm Qty 1 pcs		
	<b>GEV No.</b>	100909	<b>Ref. No.</b> —
	union screw thread M10x1 for pipe ø 6mm Qty 1 pcs		
	<b>GEV No.</b>	101246	<b>Ref. No.</b> —
	olive for pipe ø 4mm Qty 1 pcs		
	<b>GEV No.</b>	101248	<b>Ref. No.</b> —
	olive for pipe ø 12mm Qty 1 pcs suitable for PEL		
	<b>GEV No.</b>	101249	<b>Ref. No.</b> —
	olive for pipe ø 10mm Qty 1 pcs		
	<b>GEV No.</b>	101250	<b>Ref. No.</b> —
	union nut thread M20x1.5 for pipe ø 10mm		
	<b>GEV No.</b>	101251	<b>Ref. No.</b> —
	union nut thread M20x1.5 for pipe ø 12mm		
	<b>GEV No.</b>	101286	<b>Ref. No.</b> —
	olive ID ø 6mm Qty 1 pcs		
	<b>GEV No.</b>	110079	<b>Ref. No.</b> —
	knob dial plate gas thermostat 1-8 silver		
	<b>GEV No.</b>	110080	<b>Ref. No.</b> —
	knob ø 70mm shaft ø 10x8mm shaft flat universal		

### 24STS series













<b>GEV No.</b>	106027	<b>Ref. No.</b>	144561 540403
<b>description</b>	gas thermostat PEL type 24STS 100-300°C gas inlet M20x1.5 (tube ø 12/10mm) bypass nozzle ø 0mm gas outlet M20x1.5 (tube ø 12/10mm) thermocouple connection M9x1 pilot connection M10x1 capillary pipe 1200mm probe ø 6mm probe L 100mm shaft ø 10x8mm shaft L 27/17mm shaft flat upper t.max. 300°C		
<b>spare parts for</b>	106027		
	<b>GEV No.</b>	100455	<b>Ref. No.</b> —
	bypass nozzle type PEL23/24 bore ø 0.35mm thread M8x0.5		
	<b>GEV No.</b>	101058	<b>Ref. No.</b> —
	magnet unit L 39mm D1 ø 15.4mm D2 ø 13.5mm suitable for PEL22/ EGA24197 standard		
<b>accessories for</b>	106027		
	<b>GEV No.</b>	101235	<b>Ref. No.</b> —
	gas connection thread M20x1.5 tube ø 12/10mm for PEL gas taps horizontal		
	<b>GEV No.</b>	101236	<b>Ref. No.</b> —
	gas connection thread M20x1.5 tube ø 12/10mm for PEL gas taps vertical		
	<b>GEV No.</b>	101240	<b>Ref. No.</b> —
	gas connection thread M20x1.5 tube ø 12/10mm for PEL gas taps with gasket and screws horizontal		
	<b>GEV No.</b>	101241	<b>Ref. No.</b> —
	gas connection thread M20x1.5 tube ø 12/10mm for PEL gas taps vertical		
	<b>GEV No.</b>	101248	<b>Ref. No.</b> —
	olive for pipe ø 12mm Qty 1 pcs suitable for PEL		
	<b>GEV No.</b>	101249	<b>Ref. No.</b> —
	olive for pipe ø 10mm Qty 1 pcs		
	<b>GEV No.</b>	101250	<b>Ref. No.</b> —
	union nut thread M20x1.5 for pipe ø 10mm		
	<b>GEV No.</b>	101251	<b>Ref. No.</b> —
	union nut thread M20x1.5 for pipe ø 12mm		
	<b>GEV No.</b>	101356	<b>Ref. No.</b> —
	gas tap PEL type 21S gas inlet M16x1.5 (tube ø 10mm) bypass nozzle ø 0.35mm gas outlet M16x1.5 (tube ø 10/8mm) thermocouple connection M10x1 pilot connection M10x1 shaft ø 8x6.5mm shaft L 22/15mm shaft flat lower		
	<b>GEV No.</b>	101460	<b>Ref. No.</b> —
	O-ring ø 12.37mm D1 ø 2.62mm suitable for PEL22		
	<b>GEV No.</b>	101461	<b>Ref. No.</b> —
	screw kit suitable for PEL22 Qty 4 pcs		
	<b>GEV No.</b>	106165	<b>Ref. No.</b> —
	gasket ø 27mm		

Table continues overleaf



<b>accessories for</b> 106027			
	GEV No.	110079	Ref. No. —
knob dial plate gas thermostat 1-8 silver			
	GEV No.	110080	Ref. No. —
knob ø 70mm shaft ø 10x8mm shaft flat universal			

<b>accessories for</b> 102831			
	GEV No.	100206	Ref. No. —
pilot burner nozzle SIT natural gas code 36 bore ø 0.60/0.55mm Qty 1 pcs suitable for SIT 150 series			
	GEV No.	100207	Ref. No. —
pilot burner nozzle SIT natural gas code 27 bore ø 0.40/0.38mm suitable for SIT 140 series			
	GEV No.	100216	Ref. No. —
pilot burner nozzle SIT natural gas code 38 bore ø 0.45mm Qty 1 pcs suitable for SIT 150 series			
	GEV No.	100897	Ref. No. —
olive for pipe ø 4mm Qty 1 pcs for pilot burner			
	GEV No.	100898	Ref. No. —
olive for pipe ø 6mm Qty 1 pcs for pilot burner			
	GEV No.	100908	Ref. No. —
union screw thread M10x1 for pipe ø 4mm Qty 1 pcs			
	GEV No.	100909	Ref. No. —
union screw thread M10x1 for pipe ø 6mm Qty 1 pcs			

## gas valves and ignition boxes

### ignition boxes

#### HONEYWELL







			
1			
<b>GEV No.</b>	101166	<b>Ref. No.</b>	144750 540409
<b>description</b>	ignition box HONEYWELL type S4560B 1006 electrodes 1 waiting time 0s safety time 10s 220-240V 10VA 50Hz		

## ignition parts

### pilot burners

#### SIT

##### 140 - 145 -150 series

			
1			
<b>GEV No.</b>	102831	<b>Ref. No.</b>	144400 540450
<b>description</b>	pilot burner SIT type 140 series 2 flames nozzle ømm gas connectionmm		
<b>spare parts for</b>	102831		
	GEV No.	100701	Ref. No. —
ignition electrode connection M4 Qty 1 pcs			
	GEV No.	100906	Ref. No. —
screw connection thread M10x1 for ignition electrode brass Qty 1 pcs WS 10			
	GEV No.	100907	Ref. No. —
screw connection thread M10x1 Qty 1 pcs type SEF 1 ømm for thermocouple			
<b>accessories for</b>	102831		
	GEV No.	100204	Ref. No. —
pilot burner nozzle SIT LPG code 14 bore ø 0.18/0.20mm Qty 1 pcs suitable for 140 series			
	GEV No.	100205	Ref. No. —
pilot burner nozzle SIT LPG code 19 bore ø 0.23/0.26mm Qty 1 pcs suitable for SIT 150 series			

#### JUNKERS

##### CB 502 series

##### pilot burners

















			
1			
<b>GEV No.</b>	100062	<b>Ref. No.</b>	130132
<b>description</b>	pilot burner JUNKERS type CB502021 natural gas nozzle no.6 gas connection 6mm with primary air		
<b>spare parts for</b>	100062		
	GEV No.	100227	Ref. No. —
pilot burner nozzle natural gas gas pressure 25mbar code 6 Qty 1 pcs suitable for JUNKERS CB50203_			
	GEV No.	100719	Ref. No. —
ignition electrode D1 ø 7mm D2 ø 9mm connection M4 L1 12mm L2 17mm BL1 18mm BL2 3mm BL3 23mm			
	GEV No.	100907	Ref. No. —
screw connection thread M10x1 Qty 1 pcs type SEF 1 ømm for thermocouple			
	GEV No.	100909	Ref. No. —
union screw thread M10x1 for pipe ø 6mm Qty 1 pcs			
	GEV No.	101287	Ref. No. —
olive for pipe ø 6mm Qty 1 pcs			
	GEV No.	101291	Ref. No. —
screw connection for igniter			

Table continues overleaf

accessories for		100062		
GEV No.		100220	Ref. No.	143544
	pilot burner nozzle LPG gas pressure 50mbar code 2 Qty 1 pcs suitable for JUNKERS CB503_			
	pilot burner nozzle LPG gas pressure 30mbar code 29 Qty 1 pcs suitable for JUNKERS CB50203_			
	pilot burner nozzle LPG gas pressure 50mbar code 5 Qty 1 pcs suitable for JUNKERS CB50203_			
	pilot burner nozzle natural gas gas pressure 20mbar code 3 Qty 1 pcs suitable for JUNKERS CB503_			
	pilot burner nozzle natural gas gas pressure 25mbar code 26 Qty 1 pcs suitable for JUNKERS CB503_			
	pilot burner nozzle LPG gas pressure 30mbar code 39 Qty 1 pcs suitable for JUNKERS CB503_			
	pilot burner nozzle LPG gas pressure 50mbar code 15 suitable for JUNKERS			
	pilot burner nozzle town gas gas pressure 8mbar code 4 Qty 1 pcs suitable for JUNKERS CB50203_			
	olive for pipe ø 4mm L 8.7mm Qty 1 pcs suitable for CB 502/503			
	union screw thread M10x1 for pipe ø 4mm Qty 1 pcs			

accessories for		100085		
GEV No.		100220	Ref. No.	143544
	pilot burner nozzle LPG gas pressure 50mbar code 2 Qty 1 pcs suitable for JUNKERS CB503_			
	pilot burner nozzle LPG gas pressure 30mbar code 29 Qty 1 pcs suitable for JUNKERS CB50203_			
	pilot burner nozzle LPG gas pressure 50mbar code 5 Qty 1 pcs suitable for JUNKERS CB50203_			
	pilot burner nozzle natural gas gas pressure 20mbar code 3 Qty 1 pcs suitable for JUNKERS CB503_			
	pilot burner nozzle natural gas gas pressure 25mbar code 26 Qty 1 pcs suitable for JUNKERS CB503_			
	pilot burner nozzle LPG gas pressure 30mbar code 39 Qty 1 pcs suitable for JUNKERS CB503_			
	pilot burner nozzle LPG gas pressure 50mbar code 15 suitable for JUNKERS			
	pilot burner nozzle town gas gas pressure 8mbar code 4 Qty 1 pcs suitable for JUNKERS CB50203_			
	olive for pipe ø 4mm L 8.7mm Qty 1 pcs suitable for CB 502/503			
	union screw thread M10x1 for pipe ø 4mm Qty 1 pcs			

				
<b>GEV No.</b>	100085	<b>Ref. No.</b>	140928	
<b>description</b>	pilot burner JUNKERS type CB502031 natural gas nozzle no.6 gas connection 6mm with primary air			
<b>spare parts for</b>	100085			
	GEV No.	100227	Ref. No.	—
	pilot burner nozzle natural gas gas pressure 25mbar code 6 Qty 1 pcs suitable for JUNKERS CB50203_			
	GEV No.	100704	Ref. No.	—
	ignition electrode D1 ø 9mm connection M4 D2 ø 11mm L1 17mm L2 17mm BL1 13mm BL2 4mm BL3 22mm			
	GEV No.	100909	Ref. No.	—
	union screw thread M10x1 for pipe ø 6mm Qty 1 pcs			
	GEV No.	101287	Ref. No.	—
	olive for pipe ø 6mm Qty 1 pcs			
	GEV No.	101292	Ref. No.	—
	union screw for igniter suitable for CB 502/505 Qty 1 pcs			
	GEV No.	101295	Ref. No.	—
	clamping collet for thermocouple suitable for CB 502/505 Qty 1 pcs			







				
<b>GEV No.</b>	100061	<b>Ref. No.</b>	140928	
<b>description</b>	pilot burner JUNKERS type CB502031 natural gas nozzle no.6 gas pressure 25mbar gas connection 6mm with primary air code 6			
<b>spare parts for</b>	100061			
	GEV No.	100227	Ref. No.	—
	pilot burner nozzle natural gas gas pressure 25mbar code 6 Qty 1 pcs suitable for JUNKERS CB50203_			
	GEV No.	100909	Ref. No.	—
	union screw thread M10x1 for pipe ø 6mm Qty 1 pcs			
	GEV No.	101287	Ref. No.	—
	olive for pipe ø 6mm Qty 1 pcs			
	GEV No.	101295	Ref. No.	—
	clamping collet for thermocouple suitable for CB 502/505 Qty 1 pcs			
<b>accessories for</b>	100061			
	GEV No.	100220	Ref. No.	143544
	pilot burner nozzle LPG gas pressure 50mbar code 2 Qty 1 pcs suitable for JUNKERS CB503_			



Table continues overleaf



accessories for		100061	
	GEV No.	100221	Ref. No. —
pilot burner nozzle LPG gas pressure 30mbar code 29 Qty 1 pcs suitable for JUNKERS CB50203_			
	GEV No.	100222	Ref. No. —
pilot burner nozzle LPG gas pressure 50mbar code 5 Qty 1 pcs suitable for JUNKERS CB50203_			
	GEV No.	100223	Ref. No. —
pilot burner nozzle natural gas gas pressure 20mbar code 3 Qty 1 pcs suitable for JUNKERS CB503_			
	GEV No.	100224	Ref. No. —
pilot burner nozzle natural gas gas pressure 25mbar code 26 Qty 1 pcs suitable for JUNKERS CB503_			
	GEV No.	100225	Ref. No. —
pilot burner nozzle LPG gas pressure 30mbar code 39 Qty 1 pcs suitable for JUNKERS CB503_			
	GEV No.	100226	Ref. No. —
pilot burner nozzle LPG gas pressure 50mbar code 15 suitable for JUNKERS			
	GEV No.	100228	Ref. No. —
pilot burner nozzle town gas gas pressure 8mbar code 4 Qty 1 pcs suitable for JUNKERS CB50203_			
	GEV No.	100704	Ref. No. —
ignition electrode D1 ø 9mm connection M4 D2 ø 11mm L1 17mm L2 17mm BL1 13mm BL2 4mm BL3 22mm			
	GEV No.	100851	Ref. No. —
cover for pilot burner suitable for JUNKERS CB502_ SS			
	GEV No.	100907	Ref. No. —
screw connection thread M10x1 Qty 1 pcs type SEF 1 ømm for thermocouple			
	GEV No.	101281	Ref. No. —
olive for pipe ø 4mm L 8.7mm Qty 1 pcs suitable for CB 502/503			
	GEV No.	101283	Ref. No. —
union screw thread M10x1 for pipe ø 4mm Qty 1 pcs			
	GEV No.	101292	Ref. No. —
union screw for igniter suitable for CB 502/505 Qty 1 pcs			

CB 503 series

pilot burners

			
1			
GEV No.	100118	Ref. No.	141118
description	pilot burner JUNKERS type CB503002 natural gas nozzle no.3 gas connection 4mm with primary air		
spare parts for	100118		
	GEV No.	100223	Ref. No. —
pilot burner nozzle natural gas gas pressure 20mbar code 3 Qty 1 pcs suitable for JUNKERS CB503_			
	GEV No.	101281	Ref. No. —
olive for pipe ø 4mm L 8.7mm Qty 1 pcs suitable for CB 502/503			

spare parts for		100118	
	GEV No.	101283	Ref. No. —
union screw thread M10x1 for pipe ø 4mm Qty 1 pcs			
accessories for		100118	
	GEV No.	100220	Ref. No. 143544
pilot burner nozzle LPG gas pressure 50mbar code 2 Qty 1 pcs suitable for JUNKERS CB503_			
	GEV No.	100221	Ref. No. —
pilot burner nozzle LPG gas pressure 30mbar code 29 Qty 1 pcs suitable for JUNKERS CB50203_			
	GEV No.	100222	Ref. No. —
pilot burner nozzle LPG gas pressure 50mbar code 5 Qty 1 pcs suitable for JUNKERS CB50203_			
	GEV No.	100224	Ref. No. —
pilot burner nozzle natural gas gas pressure 25mbar code 26 Qty 1 pcs suitable for JUNKERS CB503_			
	GEV No.	100909	Ref. No. —
union screw thread M10x1 for pipe ø 6mm Qty 1 pcs			
	GEV No.	101287	Ref. No. —
olive for pipe ø 6mm Qty 1 pcs			















			
1			
GEV No.	100101	Ref. No.	141119
description	pilot burner JUNKERS type CB503003 LPG nozzle no.2 gas connection 4mm with primary air		
spare parts for	100101		
	GEV No.	100224	Ref. No. —
pilot burner nozzle natural gas gas pressure 25mbar code 26 Qty 1 pcs suitable for JUNKERS CB503_			
	GEV No.	101281	Ref. No. —
olive for pipe ø 4mm L 8.7mm Qty 1 pcs suitable for CB 502/503			
	GEV No.	101283	Ref. No. —
union screw thread M10x1 for pipe ø 4mm Qty 1 pcs			
accessories for		100101	
	GEV No.	100220	Ref. No. 143544
pilot burner nozzle LPG gas pressure 50mbar code 2 Qty 1 pcs suitable for JUNKERS CB503_			
	GEV No.	100221	Ref. No. —
pilot burner nozzle LPG gas pressure 30mbar code 29 Qty 1 pcs suitable for JUNKERS CB50203_			
	GEV No.	100222	Ref. No. —
pilot burner nozzle LPG gas pressure 50mbar code 5 Qty 1 pcs suitable for JUNKERS CB50203_			
	GEV No.	100223	Ref. No. —
pilot burner nozzle natural gas gas pressure 20mbar code 3 Qty 1 pcs suitable for JUNKERS CB503_			
	GEV No.	100226	Ref. No. —
pilot burner nozzle LPG gas pressure 50mbar code 15 suitable for JUNKERS			





Table continues overleaf



<b>accessories for</b> 100101				
	GEV No.	100227	Ref. No.	—
pilot burner nozzle natural gas gas pressure 25mbar code 6 Qty 1 pcs suitable for JUNKERS CB50203_				
	GEV No.	100228	Ref. No.	—
pilot burner nozzle town gas gas pressure 8mbar code 4 Qty 1 pcs suitable for JUNKERS CB50203_				
	GEV No.	100909	Ref. No.	—
union screw thread M10x1 for pipe ø 6mm Qty 1 pcs				
	GEV No.	101287	Ref. No.	—
olive for pipe ø 6mm Qty 1 pcs				
	GEV No.	102110	Ref. No.	—
pilot tube copper pipe ø 4mm thickness 1mm L 3000mm				
	GEV No.	102111	Ref. No.	—
pilot tube copper pipe ø 6mm thickness 1mm L 3000mm				



<b>1</b>	<b>GEV No.</b>	100058	<b>Ref. No.</b>	141118
<b>description</b> pilot burner JUNKERS type CB503006 natural gas nozzle no.26 gas connection 4mm				
<b>spare parts for</b> 100058				
	GEV No.	100224	Ref. No.	—
pilot burner nozzle natural gas gas pressure 25mbar code 26 Qty 1 pcs suitable for JUNKERS CB503_				
	GEV No.	101281	Ref. No.	—
olive for pipe ø 4mm L 8.7mm Qty 1 pcs suitable for CB 502/503				
	GEV No.	101283	Ref. No.	—
union screw thread M10x1 for pipe ø 4mm Qty 1 pcs				
<b>accessories for</b> 100058				
	GEV No.	100220	Ref. No.	143544
pilot burner nozzle LPG gas pressure 50mbar code 2 Qty 1 pcs suitable for JUNKERS CB503_				
	GEV No.	100221	Ref. No.	—
pilot burner nozzle LPG gas pressure 30mbar code 29 Qty 1 pcs suitable for JUNKERS CB50203_				
	GEV No.	100222	Ref. No.	—
pilot burner nozzle LPG gas pressure 50mbar code 5 Qty 1 pcs suitable for JUNKERS CB50203_				
	GEV No.	100223	Ref. No.	—
pilot burner nozzle natural gas gas pressure 20mbar code 3 Qty 1 pcs suitable for JUNKERS CB503_				
	GEV No.	100226	Ref. No.	—
pilot burner nozzle LPG gas pressure 50mbar code 15 suitable for JUNKERS				
	GEV No.	100227	Ref. No.	—
pilot burner nozzle natural gas gas pressure 25mbar code 6 Qty 1 pcs suitable for JUNKERS CB50203_				
	GEV No.	100228	Ref. No.	—
pilot burner nozzle town gas gas pressure 8mbar code 4 Qty 1 pcs suitable for JUNKERS CB50203_				

<b>accessories for</b> 100058				
	GEV No.	100909	Ref. No.	—
union screw thread M10x1 for pipe ø 6mm Qty 1 pcs				
	GEV No.	101287	Ref. No.	—
olive for pipe ø 6mm Qty 1 pcs				
	GEV No.	102110	Ref. No.	—
pilot tube copper pipe ø 4mm thickness 1mm L 3000mm				
	GEV No.	102111	Ref. No.	—
pilot tube copper pipe ø 6mm thickness 1mm L 3000mm				

producer-specific pilot burners

THIELMANN



<b>1</b>	<b>GEV No.</b>	102829	<b>Ref. No.</b>	193301 540920
<b>description</b> pilot burner type C				



<b>1</b>	<b>GEV No.</b>	102830	<b>Ref. No.</b>	193303 540921
<b>description</b> pilot burner type D/E				

ignition cables

terminals and connectors



<b>1</b>	<b>GEV No.</b>	100112	<b>Ref. No.</b>	144992
<b>description</b> female bullet size 2mm 0.25-1.0mm <sup>2</sup> CuZn gal Sn t.max. 125°C Qty 20 pcs				





piezoelectric igniters

mounting diameter 18mm



1			
<b>GEV No.</b>	100004	<b>Ref. No.</b>	540955
<b>description</b>	piezoelectric igniter body plastic blowing mounting ø 18mm connection ø2.4mm		

mounting diameter 22mm



1			
<b>GEV No.</b>	100008	<b>Ref. No.</b>	144333
<b>description</b>	piezoelectric igniter body plastic blowing mounting ø 22mm connection ø2mm cable lengthmm		

miscellaneous



1			
<b>GEV No.</b>	nla <sup>1</sup>	<b>Ref. No.</b>	137552
<b>description</b>	piezoelectric igniter body metal connection F6.3x0.8 2 hole fixing ø 22mm		

<sup>1</sup>no longer available

thermocouples

plug-in thermocouples

plug-in thermocouples standard

with barrel socket ø5mm - type Junkers with aluminised tip



1			
<b>GEV No.</b>	102204	<b>Ref. No.</b>	144902
<b>description</b>	thermocouple M8x1 L 600mm plug connection ø5.0mm		

with barrel socket ø6mm

type Junkers with aluminised tip

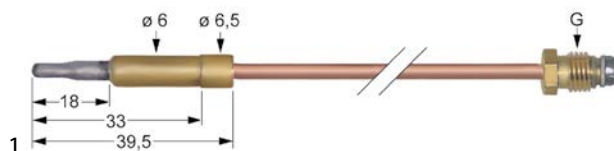

1			
<b>GEV No.</b>	102017	<b>Ref. No.</b>	136031
<b>description</b>	thermocouple M8x1 L 1000mm plug connection ø6.0mm		

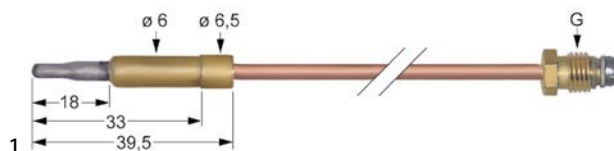

1			
<b>GEV No.</b>	102219	<b>Ref. No.</b>	136030
<b>description</b>	thermocouple M8x1 L 450mm plug connection ø6.0mm		

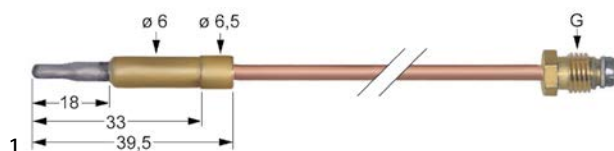

1			
<b>GEV No.</b>	102220	<b>Ref. No.</b>	139384
<b>description</b>	thermocouple M8x1 L 600mm plug connection ø6.0mm		

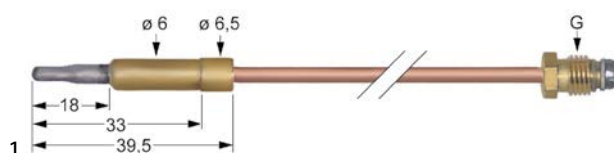

1			
<b>GEV No.</b>	102221	<b>Ref. No.</b>	136031
<b>description</b>	thermocouple M8x1 L 750mm plug connection ø6.0mm		

with barrel socket ø6(6.5)mm

thermocouples SIT

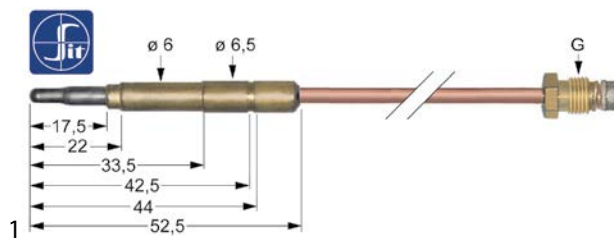

1			
<b>GEV No.</b>	107619	<b>Ref. No.</b>	144404
<b>description</b>	thermocouple SIT M10x1 L 1000mm plug connection ø6.0(6.5)mm		





threaded thermocouples

threaded thermocouples standard

with socket with thread M8x1

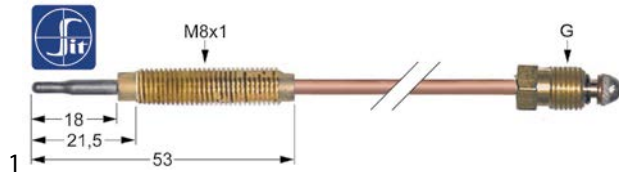
SIT



<b>GEV No.</b>	107628	<b>Ref. No.</b>	144305
<b>description</b>	thermocouple SIT M8x1 L 320mm M8x1		
<b>accessories for</b>	107628		
	<b>GEV No.</b>	102067	<b>Ref. No.</b>
			—
nut thread M8x1 H 3mm brass Qty 1 pcs type SEF 1			

accessories

display adapters



<b>GEV No.</b>	100947	<b>Ref. No.</b>	141109
<b>description</b>	display adapter thread M8x1		

interrupters



<b>GEV No.</b>	101258	<b>Ref. No.</b>	140286
<b>description</b>	interrupter thread M10x1		

gas burners

hob burners

producer-specific hob burners

THIELMANN

HG series



<b>GEV No.</b>	105873	<b>Ref. No.</b>	144340 540486
<b>description</b>	burner cap C ø 94mm with central hole		



<b>GEV No.</b>	105874	<b>Ref. No.</b>	114341 540487
<b>description</b>	burner cap D/E ø 94mm with central hole		



<b>GEV No.</b>	105871	<b>Ref. No.</b>	193466
<b>description</b>	burner head C		



<b>GEV No.</b>	105870	<b>Ref. No.</b>	193467
<b>description</b>	burner head D		



<b>GEV No.</b>	105869	<b>Ref. No.</b>	193468
<b>description</b>	burner head E		

solid tops



<b>GEV No.</b>	105875	<b>Ref. No.</b>	144818
<b>description</b>	burner suitable for solid top		





bar burners

bar burners

 <p>1</p>			
<b>GEV No.</b>	105905	<b>Ref. No.</b>	141960 541545
<b>description</b>	bar burner ømm W 28mm H 42mm L 295mm flange width 35mm flange length 70mm kettle		

 <p>Image not available</p> <p>1</p>			
<b>GEV No.</b>	105877	<b>Ref. No.</b>	193635
<b>description</b>	burner griddle		

 <p>Image not available</p> <p>1</p>			
<b>GEV No.</b>	105917	<b>Ref. No.</b>	144615
<b>description</b>	burner ømm tilting bratt pan		

 <p>1</p>			
<b>GEV No.</b>	105919	<b>Ref. No.</b>	144558
<b>description</b>	burner ømm tilting bratt pan		

 <p>Image not available</p> <p>1</p>			
<b>GEV No.</b>	105876	<b>Ref. No.</b>	193660
<b>description</b>	burner oven		

gas nozzles

pilot burner nozzles

pilot burner nozzles JUNKERS

CB 50203\_/503\_ series

 <p>1</p>			
<b>GEV No.</b>	100220	<b>Ref. No.</b>	143544
<b>description</b>	pilot burner nozzle LPG gas pressure 50mbar code 2 Qty 1 pcs suitable for JUNKERS CB503_		

knobs

producer-specific knobs

THIELMANN

 <p>1</p>			
<b>GEV No.</b>	111831	<b>Ref. No.</b>	144104 540422
<b>description</b>	knob without symbol ø 68mm shaft ø 6x4.6mm shaft flat upper		

 <p>1</p>			
<b>GEV No.</b>	111835	<b>Ref. No.</b>	540449
<b>description</b>	knob dial plate gas tap with ignition flame ED ø 65mm ID ø 50mm		

 <p>1</p>			
<b>GEV No.</b>	111839	<b>Ref. No.</b>	540456
<b>description</b>	knob dial plate gas thermostat 1-8 t.max.°C		



1

<b>GEV No.</b>	111833	<b>Ref. No.</b>	144108 540469
<b>description</b>	knob dial plate oven TH/BH/TH+BH t.max. °C ED ø 65mm ID ø 50mm		



1

<b>GEV No.</b>	111838	<b>Ref. No.</b>	144107 540477
<b>description</b>	knob dial plate switch 7-position		



1

<b>GEV No.</b>	111869	<b>Ref. No.</b>	541138
<b>description</b>	knob dial plate thermostat t.max. 180°C 100-180°C		

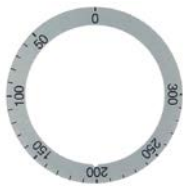

1

<b>GEV No.</b>	111834	<b>Ref. No.</b>	144109 540457
<b>description</b>	knob dial plate thermostat t.max. 300°C 50-300°C ED ø 65mm ID ø 50mm		

## handles and hand wheels

### hand wheels

#### hand wheels



1

<b>GEV No.</b>	690800	<b>Ref. No.</b>	144139 540403
<b>description</b>	hand wheel ø 160mm D1 ø 45mm bore ø 16mm depth of bore 32mm thread groove width 5mm L1 25mm L2 60mm handle length 82mm with folding handle		
<b>spare parts for</b>	690800		
	<b>GEV No.</b>	514428	<b>Ref. No.</b> —
	folding handle ø 25mm total length 115mm seat ø 26mm thread M8 with automatic return		



1

<b>GEV No.</b>	690901	<b>Ref. No.</b>	144139 540403
<b>description</b>	hand wheel ø 160mm D1 ø 45mm bore ø 16mm thread groove width 5mm L1 27mm L2 60mm handle length 85mm with folding handle		
<b>spare parts for</b>	690901		
	<b>GEV No.</b>	514428	<b>Ref. No.</b> —
	folding handle ø 25mm total length 115mm seat ø 26mm thread M8 with automatic return		



accessories

marking caps



1

<b>GEV No.</b>	514358	<b>Ref. No.</b>	151904
<b>description</b>	marking cap blue hood handle		



1

<b>GEV No.</b>	514359	<b>Ref. No.</b>	151903
<b>description</b>	marking cap red hood handle		

fittings for catering equipment

lid hinges

type ECHTERMANN

10 series

10.80

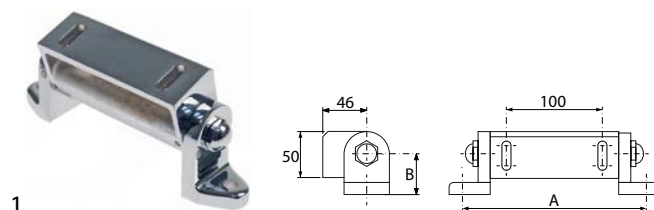

1

<b>GEV No.</b>	693448	<b>Ref. No.</b>	144466
<b>description</b>	lid hinge type 1080 level of centre of rotation 45mm load capacity 50-60NM opening angle 80° closing angle 10° mounting distance 198mm bore ø 11mm MD lid 100mm chrome-plated brass		
<b>spare parts for</b>	693448		
	<b>GEV No.</b>	691614	<b>Ref. No.</b>
			—
	repair kit for lid hinge load capacity 50-60NM		

12 series

12.84

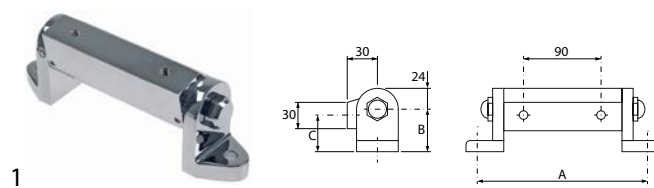

1

<b>GEV No.</b>	693447	<b>Ref. No.</b>	144138
<b>description</b>	lid hinge type 1284 level of centre of rotation 50mm load capacity 30-50NM opening angle 80° closing angle 10° mounting distance 198mm bore ø 11mm MD lid 90mm 26.5 MT lid M8mm chrome-plated brass		
<b>spare parts for</b>	693447		
	<b>GEV No.</b>	691613	<b>Ref. No.</b>
			—
	repair kit for lid hinge load capacity 30-50NM		

steam traps

steam traps

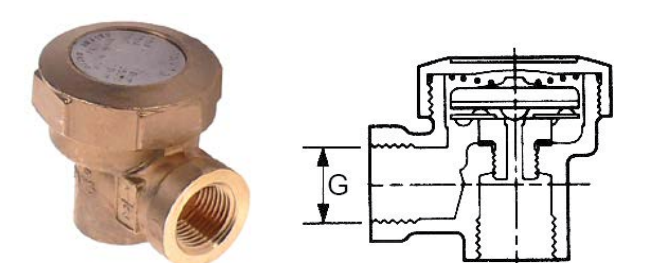

1

<b>GEV No.</b>	514272	<b>Ref. No.</b>	144742 540408
<b>description</b>	thermostatic steam trap thread 1/2" type AV13 brass		

safety valves

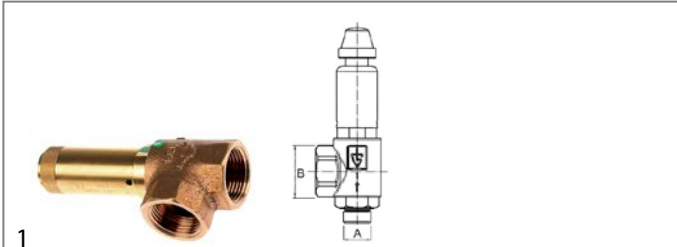

1

<b>GEV No.</b>	514354	<b>Ref. No.</b>	144749
<b>description</b>	safety valve T1: 1" T2: 1" triggering pressure 0.5bar		



1

<b>GEV No.</b>	700515	<b>Ref. No.</b>	144661 541124
<b>description</b>	gas tension spring 900N		

valves and tank inlets

inlet taps

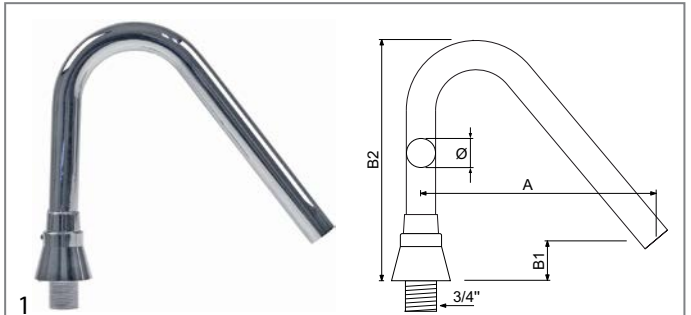

1

<b>GEV No.</b>	514332	<b>Ref. No.</b>	144407
<b>description</b>	inlet tap connection 3/4" ET tube ø 25mm projection 200mm overall height 200mm spout height 25mm rotation 360°		

baskets

fryer baskets

THIELMANN



1

<b>GEV No.</b>	970448	<b>Ref. No.</b>	143772 540446
<b>description</b>	fryer basket L1 320mm W1 180mm H1 120mm		

springs

gas tension springs

gas tension springs



1

<b>GEV No.</b>	700513	<b>Ref. No.</b>	144662 540478
<b>description</b>	gas tension spring 700N		

<b>B</b>			
bar burners	19		
bottom heaters	4		
<b>C</b>			
cam switches	8		
contactors	9		
control equipment	9		
control thermostats	7		
<b>E</b>			
electric accessories	10		
energy regulators	6		
<b>F</b>			
female bullets	10		
<b>G</b>			
gas burners	18		
gas nozzles	19		
gas taps	10		
gas thermostats	12		
<b>H</b>			
heating elements	3		
heating elements for fryers	3		
heating elements for griddles	3		
heating elements for ovens	3		
heating elements for tilting bratt pan	4		
hob burners	18		
hot plates	6		
<b>I</b>			
ignition boxes	13		
ignition cables	16		
immersion heating elements	5		
indicator lights	9		
indicator lights (complete)	9		
inlet spouts	22		
inlet taps	22		
<b>L</b>			
lamps	9		
<b>M</b>			
microswitches	8		
<b>P</b>			
piezoelectric igniters	17		
pilot burners	13		
pilot heating elements	4		
pressure switches	10		
<b>S</b>			
safety thermostats	7		
switches and momentary switches	8		
<b>T</b>			
terminals and connectors	10		
thermocouples	17		
thermostats	7		
<b>V</b>			
valves and tank inlets	22		