



GAS COMPONENTS



ELECTRIC COMPONENTS



WATER TECHNOLOGY



MECHANICAL COMPONENTS



TOOLS

Spare parts suitable for

THERMOPLAN

Find the complete and up-to-date range of products in our GEV Webshop



Manufacturer catalogue

The most important spare parts and accessories arranged clearly for every manufacturer

- ✓ Complete product range and all appliance data always up to date in the GEV Webshop
- ✓ Alphabetical Index at the end of the catalogue

GEV Webshop

www.gev-online.co.uk

www.gev-online.com



- 🔍 Add to Favourites
- 🔍 Sign In with email address and usual password
- 🔍 Easy-order – place several items in your basket at the same time
- 🔍 Quick Item search – no login needed



thermostats

bi-metal thermostats

safety bi-metal thermostats



GEV No.	390222	Ref. No.	106,495 106,497 90.16.26 95.16.25
description	bi-metal safety thermostat hole distance 23.8mm switch-off temp. 112°C 1NCA connection F6.3 2 hole fixing		

switches and momentary switches

push/momentary push switches

27.2x22.2mm



GEV No.	345033 ¹	Ref. No.	10.16.00 102,743
description	push switch mounting measurements 27.2x22.2mm red 2NO 250V 16A illuminated connection male faston 6.3mm ambient temperature max. 85°C protection IP40		

¹illuminated

ø 9mm



GEV No.	346053	Ref. No.	104,503 90.40.00
description	momentary push switch mounting ø 9mm red 1NC connection cable 280mm with plug protection IP40		

magnetic switches

ø 6mm



GEV No.	347044 ¹	Ref. No.	105,323 95.16.26
description	magnetic switch 200V 0.1A P max. 10W probe L 26mm 1NO connection coded plug cable length 490mm		

¹with coded connector

probes

producer-specific probes

probes



GEV No.	401344	Ref. No.	107,263 95.16.23
description	temperature probe 2x NTC 10K cable silicone probe -40 up to +110°C cable -50 up to +180°C connection plug thread probe ø3mm cable length 0.6/0.8m		



GEV No.	401478	Ref. No.	107,262 99.16.23
description	temperature probe 3x NTC 10kOhm cable silicone probe -40 up to +110°C cable -50 up to +180°C connection plug thread probe ø3mm cable length 0.86m		



GEV No.	379002	Ref. No.	107,260 92.16.23
description	temperature probe NTC 10kOhm cable silicone probe -40 up to +110°C cable -50 up to +180°C connection 2-wire thread probe ø3x20mm cable length 0.3m		



GEV No.	401626	Ref. No.	102,199 95.60.00
description	temperature probe NTC 10kOhm cable silicone probe -40 up to +110°C cable -50 up to +180°C connection plug thread probe ø22x50mm cable length 0.1m		



GEV No.	401627	Ref. No.	102,198 99.60.00
description	temperature probe NTC 10kOhm cable silicone probe -40 up to +110°C cable -50 up to +180°C connection plug thread probe ø22x50mm cable length 0.24m		



electronics

PCBs



1

GEV No.	401687	Ref. No.	106,840 95.23.00
description	keypad PCB milk foamer F5/F10		



1

GEV No.	401686	Ref. No.	106,838 94.24.00
description	keypad PCB milk foamer Foamino		



1

GEV No.	401685	Ref. No.	103,987 95.26.10
description	PCB milk foamer		



1

GEV No.	401688	Ref. No.	103,993 99.26.10
description	PCB milk foamer F5/F10		



1

GEV No.	401689	Ref. No.	104,669 90.38.00
description	PCB milk foamer F5/F10		

keypads

front foils



1

GEV No.	401690	Ref. No.	107,134 92.11.00
description	keypad foil milk foamer Foamino for milk foamer L 93mm W 26mm buttons 2		



1

GEV No.	401691	Ref. No.	107,139 95.12.00
description	keypad foil milk foamer MilkFoamer for milk foamer buttons 6		

solenoid valves

solenoid valves (water)

metal

BÜRKERT

solenoid valves (various)



1

GEV No.	370143	Ref. No.	104,171 90.19.10
description	solenoid valve 2-way 196V voltage DC BÜRKERT		



fans

axial fans

ebm-papst



1

GEV No.	602061	Ref. No.	100690 714239
description	axial fan L 80mm W 80mm H 25mm 24VDC 1.2W ebm-papst		

pumps

booster pumps II

pump motors

flange connection



1

GEV No.	500689	Ref. No.	104,156 91.39.10
description	motor RPM type C021002 60W 230V 50/60Hz connection flange L 170mm W 105mm H 130mm capacitor 4µF		

vibration pumps



1

GEV No.	500694	Ref. No.	105,119 94.21.00
description	vibration pump 230V 40W 50Hz inlet ø 6 outlet ø 7 THERMOPLAN type ETXM17-P/DLC L 100mm		

pumps for milk foamers

pumps



1

GEV No.	500691	Ref. No.	101,718 95.39.00
description	pump 230V 180W 50/60 L 230mm LEROY SOMER type D18P/T for milk foamer		

spare parts for

GEV No.	500692	Ref. No.	101,716 90.39.10
description	pump motor 180W 230V 50/60Hz LEROY SOMER L 140mm for milk foamer 1340/1560rpm		

GEV No.	500693	Ref. No.	105,130 92.21.20
description	pump head L 85mm for milk foamer		

pump motors



1

GEV No.	500692	Ref. No.	101,716 90.39.10
description	pump motor 180W 230V 50/60Hz LEROY SOMER L 140mm for milk foamer 1340/1560rpm		

accessories for

GEV No.	500693	Ref. No.	105,130 92.21.20
description	pump head L 85mm for milk foamer		

pump heads



1

GEV No.	500693	Ref. No.	105,130 92.21.20
description	pump head L 85mm for milk foamer		

accessories for

GEV No.	500692	Ref. No.	101,716 90.39.10
description	pump motor 180W 230V 50/60Hz LEROY SOMER L 140mm for milk foamer 1340/1560rpm		

magnetic-drive pumps



1

GEV No.	500690	Ref. No.	104,157 91.39.20
description	magnetic-drive pump		



1

GEV No.	550758	Ref. No.	102,484 94.20.00
description	low temperature appliance plug C14 max 15A/250V T70 plastic male faston 6.3mm		

condensators & interference suppression filters

operating capacitors

plastic



1

GEV No.	365021	Ref. No.	10.27.00 103,839
description	operating capacitor capacity 16µF 425V tolerance 5% 50/60Hz ambient temperature max. -25 to +85°C ø 35mm L 73mm single M8 plastic connection male faston 6.3mm 416.10.99 protection		

equipment-specific units for milk foamers



1

GEV No.	527378	Ref. No.	104,565 90.35.00
description	bracket for milk foamer for pump		

fuses

fine fuses

fine fuse holders



1

GEV No.	358512	Ref. No.	388220003
description	fuse holder		



1

GEV No.	527296	Ref. No.	105,857 94.13.10
description	connecting block for milk foamer		

electric accessories

plugs - couplings - power sockets

appliance sockets/plugs

low temperature appliances 70°C



1

GEV No.	550704	Ref. No.	102,488 50.32.00
description	low temperature appliance plug C14 male faston 6.3mm max 10A/250V T70 mounting distance 40mm hole ø 3.5mm thermoplastic		



			
1			
GEV No.	527324	Ref. No.	105,833 94.36.00
description	connecting fitting for milk foamer		

			
1			
GEV No.	527356	Ref. No.	100,552 90.36.21
description	connecting fitting for milk foamer		

			
1			
GEV No.	527376	Ref. No.	100,555 90.36.50
description	connecting fitting for milk foamer		

			
1			
GEV No.	527361	Ref. No.	100,565 90.15.20
description	connection angle for milk foamer ED ø 6mm		

			
1			
GEV No.	527297	Ref. No.	105,872 94.13.30
description	drain pipe for milk foamer		

			
1			
GEV No.	527298	Ref. No.	108,148 90.14.10
description	foamer for milk foamer ED ø 16mm H 34mm		

			
1			
GEV No.	527321	Ref. No.	108,151 90.14.00
description	foamer for milk foamer ED ø 16mm H 66mm		

			
1			
GEV No.	527377	Ref. No.	105,879 94.43.00
description	formed hose for milk foamer L-shape		

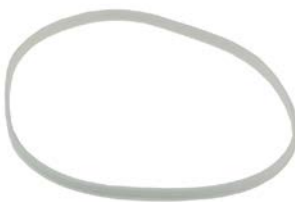
			
1			
GEV No.	527363	Ref. No.	105,277 92.16.11
description	gasket for milk foamer L 540mm		

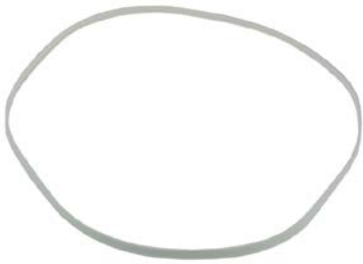
			
1			
GEV No.	527362	Ref. No.	105,278 90.18.11
description	gasket for milk foamer L 930mm		

			
1			
GEV No.	527272	Ref. No.	107,677 20.19.15
description	gasket for milk foamer V-shape ID ø 9mm ED ø 15mm H 7mm		

			
1			
GEV No.	527364	Ref. No.	108,229 90.39.23
description	gear wheel pair for milk foamer		

			
1			
GEV No.	527358	Ref. No.	101,737 90.13.20
description	lid for milk foamer for outlet		

			
1			
GEV No.	527368	Ref. No.	104,144 94.08.13
description	lid for mixer for milk foamer		

			
1			
GEV No.	527369	Ref. No.	104,090 95.08.13
description	lid for mixer for milk foamer		

			
1			
GEV No.	527294	Ref. No.	104,376 90.08.11
description	mixer for milk foamer air/milk		

			
1			
GEV No.	527367	Ref. No.	104,377 94.08.10
description	mixer for milk foamer air/milk		

			
1			
GEV No.	527365	Ref. No.	104,426 94.08.00
description	mixer for milk foamer complete with hose		

			
1			
GEV No.	527291	Ref. No.	108,119 20.19.22
description	shaft seal ID ø 11mm ED ø 22mm thickness 8mm for milk foamer		

			
1			
GEV No.	530524	Ref. No.	105,762 105.957
description	silicone hose for milk foamer glass fibre braided ID ø 4mm ED ø 8mm		



			
1			
GEV No.	527374	Ref. No.	101,583 94.21.30
description	silicone hose for milk foamer glass fibre braided ID ø 4mm ED ø 8mm L 120mm		

			
1			
GEV No.	527375	Ref. No.	94.21.20
description	silicone hose for milk foamer glass fibre braided ID ø 4mm ED ø 8mm L 230mm		

			
1			
GEV No.	527371	Ref. No.	105,978 95.08.20
description	silicone hose for milk foamer ID ø 5mm ED ø 8mm L 180mm		

			
1			
GEV No.	527372	Ref. No.	106,020 99.08.20
description	silicone hose for milk foamer ID ø 5mm ED ø 8mm L 310mm		

			
1			
GEV No.	527370	Ref. No.	106,572 90.36.60
description	silicone hose for milk foamer ID ø 6.4mm ED ø 13.2mm L 50mm		

			
1			
GEV No.	527373	Ref. No.	105,873 90.20.00
description	silicone hose ID ø 5mm ED ø 8mm L 115mm		

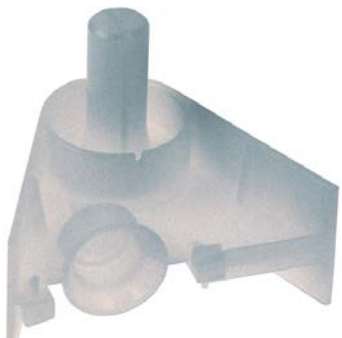
			
1			
GEV No.	527357	Ref. No.	105,859 90.13.10
description	spout for milk foamer		

			
1			
GEV No.	527359	Ref. No.	100,632 90.15.10
description	spout for milk foamer		



1

GEV No.	527295	Ref. No.	100,447 90.08.30
description	suction valve for milk foamer ED ø 20mm H 41mm hose ø 7mm		



1

GEV No.	527292	Ref. No.	107,695 50.23.40
description	valve for milk foamer with spring		



1

GEV No.	527293	Ref. No.	107,758 50.23.50
description	valve support for milk foamer		

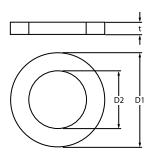
1

GEV No.	510902	Ref. No.	104.817
description	O-ring EPDM thickness 2mm ID ø 9.5mm Qty 1 pcs		

silicone

1

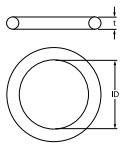
GEV No.	532532	Ref. No.	104,827 20.20.31
description	O-ring silicone thickness 1.5mm ID ø 11mm Qty 1 pcs		



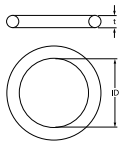

1

GEV No.	532531	Ref. No.	104,878 20.19.23
description	O-ring silicone thickness 2mm ID ø 54mm Qty 1 pcs		

equipment feet and end caps

screw-in feet



1

GEV No.	527271	Ref. No.	102,290 50.31.00
description	equipment feet kit thread M6 thread L 10mm ø 20mm H 23mm Qty 4 pcs		

gaskets

O-rings

EPDM

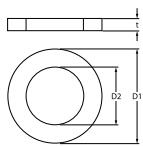



1

GEV No.	532533	Ref. No.	104,852 90.36.20
description	O-ring EPDM thickness 1.5mm ID ø 17mm Qty 1 pcs		

shaft gaskets

shaft gaskets



1

GEV No.	527291	Ref. No.	108,119 20.19.22
description	shaft seal ID ø 11mm ED ø 22mm thickness 8mm for milk foamer		



1

GEV No.	694829	Ref. No.	127.221
description	shaft sealing ID ø 14mm ED ø 22mm H 8.4mm for milk foamer		



special gaskets

miscellaneous



1

GEV No.	527363	Ref. No.	105,277 92.16.11
description	gasket for milk foamer L 540mm		



1

GEV No.	527362	Ref. No.	105,278 90.18.11
description	gasket for milk foamer L 930mm		



1

GEV No.	527272	Ref. No.	107,677 20.19.15
description	gasket for milk foamer V-shape ID ø 9mm ED ø 15mm H 7mm		

hoses

industrial hoses

silicone hoses

without fabric



1

GEV No.	527371	Ref. No.	105,978 95.08.20
description	silicone hose for milk foamer ID ø 5mm ED ø 8mm L 180mm		



1

GEV No.	527373	Ref. No.	105,873 90.20.00
description	silicone hose ID ø 5mm ED ø 8mm L 115mm		

tools

cleaning tools

brushes

pipe brushes

nylon



1

GEV No.	801463	Ref. No.	10.51.00 105,352
description	pipe brush nylon ø 8mm total length 300mm brush length 100mm		

consumables

fuses

fine fuses

fine fuse holders



1

GEV No.	358512	Ref. No.	388220003
description	fuse holder		

A			
appliance sockets/plugs	6		
axial fans	5		
B			
bi-metal thermostats	3		
booster pumps II	5		
brushes	12		
C			
cleaning tools	12		
condensators & interference suppression filters	6		
consumables	12		
E			
electric accessories	6		
F			
fans	5		
fine fuses	12		
fuses	6, 12		
H			
hoses	11		
I			
industrial hoses	11		
M			
magnetic switches	3		
O			
operating capacitors	6		
O-rings	10		
P			
pipe brushes	12		
plugs - couplings - power sockets	6		
probes	3		
pumps	5		
pumps for milk foamers	5		
push/momentary push switches	3		
S			
safety bi-metal thermostats	3		
shaft gaskets	10		
silicone hoses	11		
solenoid valves	4		
switches and momentary switches	3		
T			
thermostats	3		
		tools	12
		V	
		vibration pumps	5