



**GAS COMPONENTS**



**ELECTRIC COMPONENTS**



**WATER TECHNOLOGY**



**MECHANICAL COMPONENTS**



**TOOLS**

Spare parts suitable for

**THERMA**

Find the complete and up-to-date range of products in our GEV Webshop



# Manufacturer catalogue

The most important spare parts and accessories arranged clearly for every manufacturer

- ✓ Complete product range and all appliance data always up to date in the GEV Webshop
- ✓ Alphabetical Index at the end of the catalogue

## GEV Webshop

[www.gev-online.co.uk](http://www.gev-online.co.uk)

[www.gev-online.com](http://www.gev-online.com)



- 🔍 Add to Favourites
- 🔍 Sign In with email address and usual password
- 🔍 Easy-order – place several items in your basket at the same time
- 🔍 Quick Item search – no login needed



## heating elements

### heating elements for ovens

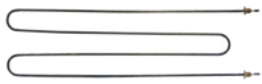

1

<b>GEV No.</b>	415350	<b>Ref. No.</b>	OK4982
<b>description</b>	heating element 1600W 400V heating circuits 1 L 610mm W 180mm tube ø 6.5mm 2 hole fixing thread 1/4" dry heating element bain marie mounting distance 173mm		

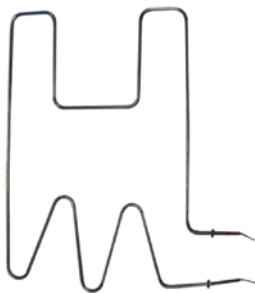

1

<b>GEV No.</b>	415356	<b>Ref. No.</b>	OK4863
<b>description</b>	heating element 2750W 400V heating circuits 1 L 538mm W 618mm L1 58mm L2 480mm W1 523mm W2 95mm mounting distance 86.5mm tube ø 8.5mm connection M4 dry heating element		

### heating elements for bain maries

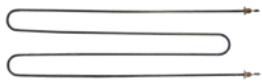

1

<b>GEV No.</b>	415350	<b>Ref. No.</b>	OK4982
<b>description</b>	heating element 1600W 400V heating circuits 1 L 610mm W 180mm tube ø 6.5mm 2 hole fixing thread 1/4" dry heating element bain marie mounting distance 173mm		



1

<b>GEV No.</b>	415624	<b>Ref. No.</b>	OK4984
<b>description</b>	heating element 2400W 400V heating circuits 1 L 605mm W 380mm connection male faston 6.3mm tube ø 6.5mm 2 hole fixing thread M14x1.5 dry heating element bain marie mounting distance 374mm		

### heating elements for griddles



1

<b>GEV No.</b>	415624	<b>Ref. No.</b>	OK4984
<b>description</b>	heating element 2400W 400V heating circuits 1 L 605mm W 380mm connection male faston 6.3mm tube ø 6.5mm 2 hole fixing thread M14x1.5 dry heating element bain marie mounting distance 374mm		

### heating elements for large hobs

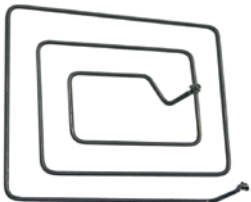

1

<b>GEV No.</b>	415576	<b>Ref. No.</b>	OK4814
<b>description</b>	heating element 1335W 400V L 320mm W 275mm H 76mm heating circuits 1 tube ø 6.3mm mounting pos. centre connection length 18mm connection male faston dry heating element 400V		

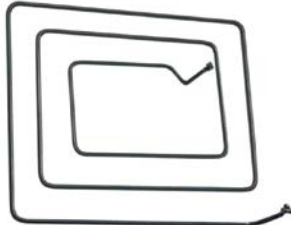

1

<b>GEV No.</b>	420291	<b>Ref. No.</b>	OK4855
<b>description</b>	heating element 1505W 440V L 350mm W 300mm H 95mm heating circuits 1 tube ø 6.5mm mounting pos. outer connection length 22mm connection M5		

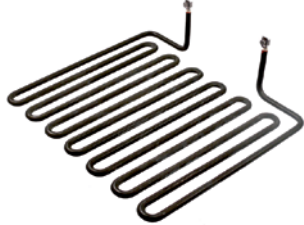



1

<b>GEV No.</b>	418701	<b>Ref. No.</b>	OG2883
<b>description</b>	heating element 4000W 400V heating circuits 1 L 300mm W 330mm H 80mm tube ø 8.5mm W1 92.5mm W2 145mm connection screw clamp windings 7		









### heating elements for tilting bratt pan

			
1			
<b>GEV No.</b>	415747	<b>Ref. No.</b>	N/A
<b>description</b>	heating element tilting bratt pan 2500W 230V L 518mm W 95mm dry heating element heating circuits 1 tube ø 8.5mm cable length 215mm connection distance 87mm		

			
1			
<b>GEV No.</b>	415355	<b>Ref. No.</b>	OK4810
<b>description</b>	heating element tilting bratt pan 2500W 230V L 612mm W 130mm H 8.5mm dry heating element heating circuits 1 tube ø 8.5mm cable length 750mm connection length 17mm connection distance 122mm		



### heating elements for salamanders/toast-

			
1			
<b>GEV No.</b>	415559	<b>Ref. No.</b>	OK4777
<b>description</b>	heating element 2100W 400V heating circuits 1 L 260mm W 217mm H 20mm thread M14x1.25 mounting distance 210mm connection length 14mm tube ø 6.5mm 2 hole fixing dry heating element		

			
1			
<b>GEV No.</b>	415558	<b>Ref. No.</b>	OK4784
<b>description</b>	heating element 2600W 400V L 361mm W 310mm H 30mm thread M14x1.5 mounting distance 280mm connection length 34mm tube ø 8.5mm connection M4 2 hole fixing dry heating element		
<b>accessories for</b>	415558		
	<b>GEV No.</b>	510417	<b>Ref. No.</b> —
	flat gasket fibre ED ø 20mm ID ø 14mm thickness 2mm Qty 1 pcs		
	<b>GEV No.</b>	520228	<b>Ref. No.</b> —
	tooth lock washer ID ø 15.3mm ED ø 24mm steel Qty 1 pcs for thread M14		
	<b>GEV No.</b>	520230	<b>Ref. No.</b> —
	nut thread M14x1.5 H 5mm WS 19 zinc-coated steel Qty 1 pcs		
	<b>GEV No.</b>	521101	<b>Ref. No.</b> —
	nut thread M14x1.5 H 5mm WS 19 SS Qty 1 pcs		
	<b>GEV No.</b>	550262	<b>Ref. No.</b> —
	flat gasket copper ED ø 20mm ID ø 14mm thickness 2mm		



### ceramic heaters

#### 245x60mm

			
1			
<b>GEV No.</b>	415104	<b>Ref. No.</b>	0A2843
<b>description</b>	ceramic emitter 1000W 230V cable beaded cord L 245mm W 60mm H 35mm		
<b>spare parts for</b>	415104		
	<b>GEV No.</b>	415109	<b>Ref. No.</b> —
	spring clip		
<b>accessories for</b>	415104		
	<b>GEV No.</b>	415110	<b>Ref. No.</b> —
	reflector L 245mm W 95mm H 31mm thickness 0.75mm hole ø 15x40mm		



### immersion heating elements

#### 3 hole flange ø47.5mm

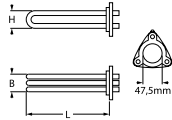
			
1			
<b>GEV No.</b>	415063	<b>Ref. No.</b>	OC5336
<b>description</b>	heating element 17000W 230V mounting ø 47.5mm heating circuits 3 L 590mm W 29mm H 38mm number of thermostat sleeves 1 thermostat sleeves ø 4mm length thermostat sleeves 225mm thermostat sleeve centre tube ø 8.5mm hole distance 63mm hole ø 10mm connection M5 3 hole flange immersion heater		
<b>accessories for</b>	415063		
	<b>GEV No.</b>	510408	<b>Ref. No.</b> 067620
	O-ring EPDM thickness 5.34mm ID ø 47mm Qty 1 pcs		
	<b>GEV No.</b>	510562	<b>Ref. No.</b> —
	O-ring silicone thickness 5.34mm ID ø 47mm Qty 1 pcs		

1

<b>GEV No.</b>	415066	<b>Ref. No.</b>	OL1849
<b>description</b>	heating element 4500W 230V mounting $\varnothing$ 47.5mm heating circuits 3 L 310mm W 30mm H 36mm number of thermostat sleeves 1 thermostat sleeves $\varnothing$ 7mm length thermostat sleeves 185mm thermostat sleeve eccentric, clinging tube $\varnothing$ 6.3mm hole distance 64mm hole $\varnothing$ 10mm connection male faston 6.3mm 3 hole flange immersion heater		
<b>spare parts for</b>	415066		
	<b>GEV No.</b>	510408	<b>Ref. No.</b> 067620
	O-ring EPDM thickness 5.34mm ID $\varnothing$ 47mm Qty 1 pcs		
<b>accessories for</b>	415066		
	<b>GEV No.</b>	510408	<b>Ref. No.</b> 067620
	O-ring EPDM thickness 5.34mm ID $\varnothing$ 47mm Qty 1 pcs		
	<b>GEV No.</b>	510562	<b>Ref. No.</b> —
	O-ring silicone thickness 5.34mm ID $\varnothing$ 47mm Qty 1 pcs		

with round flange  $\varnothing$ 47.5mm



1

<b>GEV No.</b>	418782	<b>Ref. No.</b>	OK4734
<b>description</b>	heating element 4500W 230V heating circuits 3 L 330mm W 43mm H 33mm tube $\varnothing$ 6.3mm thermostat sleeves $\varnothing$ 6.25mm length thermostat sleeves 203mm number of thermostat sleeves 1 connection male faston 6.3mm immersion heater round flange mounting $\varnothing$ 47.5mm with temperature protection		
<b>accessories for</b>	418782		
	<b>GEV No.</b>	510408	<b>Ref. No.</b> 067620
	O-ring EPDM thickness 5.34mm ID $\varnothing$ 47mm Qty 1 pcs		

with round flange  $\varnothing$ 57.5mm



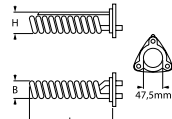

1

<b>GEV No.</b>	418983	<b>Ref. No.</b>	OK7530
<b>description</b>	heating element 12000W 220V heating circuits 3 mounting $\varnothing$ 57.5mm L 455mm W 40mm H 30mm connection M5 immersion heater tube $\varnothing$ 6.3mm connection length 20mm thermostat sleeves $\varnothing$ 6mm number of thermostat sleeves 1 length thermostat sleeves 290mm thermostat sleeve upper dishwasher		

1

<b>GEV No.</b>	415668	<b>Ref. No.</b>	OK3789
<b>description</b>	heating element 2625W 230V mounting $\varnothing$ 47.5mm heating circuits 1 L 190mm W 41mm H 54mm number of thermostat sleeves 1 thermostat sleeves $\varnothing$ 7mm length thermostat sleeves 170mm thermostat sleeve eccentric, non clinging tube $\varnothing$ 6.3mm hole distance 62mm hole $\varnothing$ 8mm connection M4 3 hole flange immersion heater		
<b>spare parts for</b>	415668		
	<b>GEV No.</b>	510408	<b>Ref. No.</b> 067620
	O-ring EPDM thickness 5.34mm ID $\varnothing$ 47mm Qty 1 pcs		
<b>accessories for</b>	415668		
	<b>GEV No.</b>	510562	<b>Ref. No.</b> —
	O-ring silicone thickness 5.34mm ID $\varnothing$ 47mm Qty 1 pcs		





1

<b>GEV No.</b>	418982	<b>Ref. No.</b>	OL1833
<b>description</b>	heating element 4000W 230V heating circuits 3 mounting $\varnothing$ 57.5mm L 455mm W 40mm H 32mm connection male faston 6.3mm immersion heater tube $\varnothing$ 6.3mm thermostat sleeves $\varnothing$ 6mm number of thermostat sleeves 1 length thermostat sleeves 290mm thermostat sleeve upper dishwasher		



1

<b>GEV No.</b>	418615	<b>Ref. No.</b>	OL1859
<b>description</b>	heating element 7500W 230V heating circuits 3 mounting $\varnothing$ round flange $\varnothing$ 57.5mm L 440mm W 35mm H 55mm round flange immersion heater tube $\varnothing$ 6.2mm H1 20mm H2 35mm L1 40mm L2 400mm		
<b>spare parts for</b>	418615		
	<b>GEV No.</b>	510409	<b>Ref. No.</b> —
	O-ring EPDM thickness 5.34mm ID $\varnothing$ 56.52mm Qty 1 pcs		
<b>accessories for</b>	418615		
	<b>GEV No.</b>	550002	<b>Ref. No.</b> —
	tension strap H 10mm L 21mm W 10mm hole $\varnothing$ 6.5mm for heating element		

3 hole flange  $\varnothing$ 57.5mm

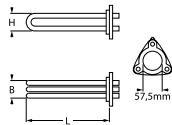
1



<b>GEV No.</b>	418779	<b>Ref. No.</b>	OL1630
<b>description</b>	heating element 9000W 230V mounting $\varnothing$ 57.5mm heating circuits 3 L 340mm W 52mm H 54mm tube $\varnothing$ 8.5mm hole distance 72mm hole $\varnothing$ 8mm with integrated fuse INCOLOY		
<b>spare parts for</b>	418779		
	<b>GEV No.</b>	510409	<b>Ref. No.</b> —
	O-ring EPDM thickness 5.34mm ID $\varnothing$ 56.52mm Qty 1 pcs		









3/4"



<b>GEV No.</b>	415580	<b>Ref. No.</b>	OG0334
<b>description</b>	heating element 5000W 400V heating circuits 1 L 404mm W 23mm H 80mm cable length 400mm connection length 85mm immersion heater flange with thread H1 52mm H2 28mm thread 3/4"		
<b>accessories for</b>	415580		
	GEV No.	510403	Ref. No. —
	flat gasket fibre ED ø 36.5mm ID ø 27mm thickness 2mm Qty 1 pcs		
	GEV No.	510421	Ref. No. —
	gasket copper ED ø 31.8mm ID ø 26.4mm thickness 2.2mm for thread 3/4"		
	GEV No.	520234	Ref. No. —
	nut thread 3/4" H 5mm brass WS 30 Qty 1 pcs		



<b>GEV No.</b>	415072	<b>Ref. No.</b>	048086
<b>description</b>	heating element 2200W 230V heating circuits 1 L 325mm W 83mm H 25mm thread M14x1 mounting distance 75mm tube ø 8.5mm connection male faston 6.3mm 2 hole fixing immersion heater		
<b>accessories for</b>	415072		
	GEV No.	510417	Ref. No. —
	flat gasket fibre ED ø 20mm ID ø 14mm thickness 2mm Qty 1 pcs		
	GEV No.	520228	Ref. No. —
	tooth lock washer ID ø 15.3mm ED ø 24mm steel Qty 1 pcs for thread M14		
	GEV No.	521133	Ref. No. —
	nut thread M14x1.5 H 6mm WS 19 zinc-coated steel Qty 1 pcs		
	GEV No.	550261	Ref. No. —
	nut thread M14x1 H 4mm WS 19 SS Qty 1 pcs		
	GEV No.	550262	Ref. No. —
	flat gasket copper ED ø 20mm ID ø 14mm thickness 2mm		

radiation heaters

square



<b>GEV No.</b>	490008	<b>Ref. No.</b>	OK0589
<b>description</b>	radiation heater L 300mm W 300mm 4000W 400V heating circuits 2 connections 3 square connection type male faston 6.3mm without pan detection EGO		
<b>accessories for</b>	490008		
	GEV No.	499157	Ref. No. —
	protection pipe for temperature probe ceramic L 297mm ED ø 7mm ID ø 5mm		



<b>GEV No.</b>	416999	<b>Ref. No.</b>	005942
<b>description</b>	radiation heater rectangular 5000W 230V L 410mm W 280mm heating circuits 3 connections 3x 2 IRCA for fryer		

hot plates

square & rectangular

with radiused edge



<b>GEV No.</b>	490056 <sup>1</sup>	<b>Ref. No.</b>	052198
<b>description</b>	hot plate dimensions 300x300mm 3000W 230V with spill ring connection 4 screw clamps protector yes square		

<sup>1</sup>incl. protector



1

<b>GEV No.</b>	490057 <sup>1</sup>	<b>Ref. No.</b>	OK4756
<b>description</b>	hot plate dimensions 300x300mm 3000W 400V with spill ring connection 4 screw clamps protector yes square		

<sup>1</sup>incl. protector



1

<b>GEV No.</b>	490187	<b>Ref. No.</b>	OG0233
<b>description</b>	hot plate dimensions 350x400mm 4500W 380V with spill ring		

tiltable

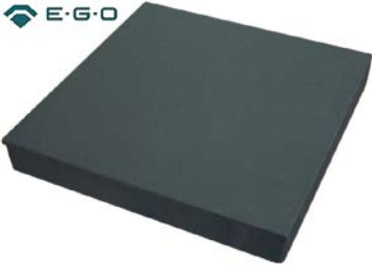

1

<b>GEV No.</b>	490090	<b>Ref. No.</b>	OK0381
<b>description</b>	hot plate dimensions 300x300mm 4000W 400V with cast edge tilt boiling plate connection 4 screw clamps H 43mm square		

miscellaneous



1

<b>GEV No.</b>	490165	<b>Ref. No.</b>	OK4760
<b>description</b>	hot plate dimensions 350x400mm 4000W 400V connection 2x3		

round

with radiused edge

for domestic and commercial kitchens



1

<b>GEV No.</b>	490021	<b>Ref. No.</b>	003931
<b>description</b>	hot plate ø 220mm 2600W 400V connection 4 screw clamps with 8mm spill ring		

accessories

fasteners



1

<b>GEV No.</b>	550129	<b>Ref. No.</b>	OG4300
<b>description</b>	bearing screw for tilt boiling plate straight thread M12x80		

energy regulators

EGO

1-circuit



1

<b>GEV No.</b>	380015	<b>Ref. No.</b>	OC1605
<b>description</b>	energy regulator 230V 13A single-circuit turn direction right shaft ø 6x4.6mm shaft L 23mm mounting thread M4 power release 6-100% no. 50.57021.010		

thermostats

bi-metal thermostats

safety bi-metal thermostats



1



<b>GEV No.</b>	390138	<b>Ref. No.</b>	048887	
<b>description</b>	bi-metal safety thermostat hole distancemm switch-off temp. 112°C 1NC 1-pole 16A connection F6.3			
<b>accessories for</b>	390138			
	<b>GEV No.</b>	504736	<b>Ref. No.</b>	—
	bracket for contact thermostat			

Table continues overleaf



accessories for	390138		
	GEV No.	550388	Ref. No.
			—
	bracket for contact thermostat mounting distance 24.5mm mounting ø 3.8		

## bi-metal thermostats

	1		
GEV No.	390101	Ref. No.	048487
description	bi-metal thermostat hole distance 38mm switch-off temp. 53°C 1CO 1-pole 16A connection F6.3 2 hole fixing		

## control and safety thermostats

EGO

control thermostats

55.13\_ series

	1		
GEV No.	375871	Ref. No.	0E5032
description	thermostat t.max. 110°C temperature range 30-110°C 1-pole 1CO 16A probe ø 6mm probe L 113mm capillary pipe 2930mm capillary pipe isolated gland nut M9x1 shaft ø 6x4.6mm shaft L 23mm shaft position upper rotation 270° H 40mm W 35mm D 30mm		

	1		
GEV No.	375505	Ref. No.	0H2049
description	thermostat t.max. 320°C temperature range 50-320°C 1-pole 1NO 16A probe ø 3mm probe L 160mm capillary pipe 870mm capillary pipe isolated gland nut shaft ø 6x4.6mm shaft L 23mm shaft position upper rotation 270°		

E-G-O



1

GEV No.	375810	Ref. No.	0H9843
description	thermostat t.max. 80°C temperature range fixed 80°C 1-pole 1NC 16A probe ø 7.5mm probe L 30.5mm capillary pipe 810mm capillary pipe isolated gland nut shaft L 23mm		

55.34\_ series

E-G-O



1

GEV No.	375022	Ref. No.	0H6127
description	thermostat t.max. 180°C temperature range 95-180°C 3-pole 3NO 16A probe ø 6mm probe L 133mm capillary pipe 1780mm capillary pipe isolated 1400mm gland nut M9x1 shaft ø 6x4.6mm shaft L 23mm rotation 270°		

E-G-O



1

GEV No.	375766	Ref. No.	002587
description	thermostat t.max. 190°C temperature range 120-190°C 3-pole 1CO/2NO 16A probe ø 6mm probe L 133mm capillary pipe 880mm capillary pipe isolated 350mm gland nut shaft ø 6x4.6mm shaft L 23mm shaft position upper rotation 270°		





<b>GEV No.</b>	375763	<b>Ref. No.</b>	OKW841
<b>description</b>	thermostat t.max. 206°C temperature range 120-206°C 3-pole 1CO/2NO 16A probe ø 4mm probe L 157mm capillary pipe 1780mm capillary pipe isolated 1500mm gland nut shaft ø 6x4.6mm shaft L 23mm shaft position upper rotation 270°		



<b>GEV No.</b>	390038	<b>Ref. No.</b>	OKI260
<b>description</b>	thermostat t.max. 90°C temperature range 30-90°C 3-pole 3CO 16A probe ø 6mm probe L 215mm capillary pipe 900mm capillary pipe isolatedmm gland nut shaft Lmm		



<b>GEV No.</b>	375038	<b>Ref. No.</b>	0H6217
<b>description</b>	thermostat t.max. 300°C temperature range 50-300°C 3-pole 3NO 16A probe ø 6mm probe L 79mm capillary pipe 1740mm capillary pipe isolated 800mm gland nut shaft ø 6x4.6mm shaft L 23mm shaft position upper rotation 270°		
<b>accessories for</b>	375038		
	<b>GEV No.</b>	110123	<b>Ref. No.</b> —
	knob thermostat t.max. 300°C ø 50mm shaft ø 6x4.6mm shaft flat upper black temperature range 50-300°C rotation 270°		

safety thermostats

55.13\_ series



<b>GEV No.</b>	375854	<b>Ref. No.</b>	0E5086
<b>description</b>	safety thermostat switch-off temp. 126°C 1-pole 16A probe ø 6mm probe L 129mm capillary pipe 1730mm capillary pipe isolated 800mm gland nut M9x1 shaft ø 6x4.6mm starting temperature 120°C probe		



<b>GEV No.</b>	375621	<b>Ref. No.</b>	OK8421
<b>description</b>	thermostat t.max. 320°C temperature range 50-320°C 3-pole 3NO 16A probe ø 3mm probe L 219mm capillary pipe 1200mm capillary pipe isolated 1200mm gland nut shaft ø 6x4.6mm shaft L 23mm shaft position upper rotation 318°		



<b>GEV No.</b>	375106	<b>Ref. No.</b>	0H6142
<b>description</b>	safety thermostat switch-off temp. 190°C 1-pole 16A probe ø 3.1mm probe L 178mm capillary pipe 350mm capillary pipe isolatedmm gland nut M9x1 probe SS		

55.31\_series



<b>GEV No.</b>	375108	<b>Ref. No.</b>	052331
<b>description</b>	safety thermostat switch-off temp. 250°C 3-pole 1x20/2x0.5A probe ø 6mm probe L 157mm capillary pipe 1230mm capillary pipe isolated 800mm gland nut probe SS		

55.32\_series



<b>GEV No.</b>	375394	<b>Ref. No.</b>	0K3967
<b>description</b>	safety thermostat switch-off temp. 135°C 3-pole 1CO/2NC 20A probe ø 6mm probe L 73mm capillary pipe 1490mm capillary pipe isolated 1350mm gland nut M9x1 probe SS		



<b>GEV No.</b>	375150	<b>Ref. No.</b>	0H6219
<b>description</b>	safety thermostat switch-off temp. 145°C 3-pole 20A probe ø 3mm probe L 178mm capillary pipe 1790mm capillary pipe isolatedmm gland nut M9x1 probe		



<b>GEV No.</b>	375455	<b>Ref. No.</b>	002730
<b>description</b>	safety thermostat switch-off temp. 350°C 1-pole 16A probe ø 11mm probe L 16mm capillary pipe 900mm capillary pipe isolated 900mm gland nut probe screw-in probe probe thread M14x1		



<b>GEV No.</b>	390141	<b>Ref. No.</b>	006826
<b>description</b>	safety thermostat switch-off temp. 350°C 3-pole 3NC 20A probe ø 6mm probe L 77mm capillary pipe 1490mm capillary pipe isolated 800mm gland nut probe SS		

control thermostats with operation switch

55.10/19\_series



<b>GEV No.</b>	390052	<b>Ref. No.</b>	052330
<b>description</b>	thermostat t.max. 185°C temperature range 90-185°C 1-pole 1NO 15A probe ø 4mm probe L 229mm capillary pipe 2500mm capillary pipe isolated 1200/200mm gland nut shaft ø 6x4.6mm shaft L 23mm shaft position upper° rotation 270° outer switch 2NO		



55.13\_series



1

<b>GEV No.</b>	375053	<b>Ref. No.</b>	OK5023
<b>description</b>	thermostat t.max. 110°C temperature range 30-110°C 1-pole 1NO 16A probe ø 6mm probe L 113mm capillary pipe 830mm capillary pipe isolated 800mm gland nut shaft ø 6x4.6mm shaft L 23mm shaft position upper rotation 270° outer switch 2NO/2NO		

55.34\_series



1

<b>GEV No.</b>	375877	<b>Ref. No.</b>	0G2529
<b>description</b>	thermostat t.max. 530°C temperature range 100-530°C 3-pole 3NO 16A probe ø 3.9mm probe L 228mm capillary pipe 1110mm capillary pipe isolated 1000mm gland nut shaft ø 6x4.6mm shaft L 23mm shaft position shaft position 90° rotation 270° outer switch 0-1 with operation switch		



1

<b>GEV No.</b>	390919	<b>Ref. No.</b>	077018015428
<b>description</b>	thermostat temperature range 50-300°C 3-pole 3NO 16A probe ø 4mm probe L 292mm capillary pipe 2300mm capillary pipe isolated 2260mm gland nut shaft ø 6x4.6mm shaft L 25.5mm shaft position upper rotation 270° outer switch 49.41015.500		
<b>spare parts for</b>	390919		
	<b>GEV No.</b>	300002	<b>Ref. No.</b> 0A2134
	cam switch 2 operating positions 4NO 16A sequence 0-1 shaft ø 6x4.6mm shaft L 23mm connection male faston 6.3mm ceramic		
	<b>GEV No.</b>	550059	<b>Ref. No.</b> 0A2205
	connecting bow short for switch Qty 1 pcs		

accessories

gland nut accessories

locking screws



1

<b>GEV No.</b>	504738	<b>Ref. No.</b>	067899
<b>description</b>	screw connection for probe thread M12x1 ID ø 6.3mm L 18mm		
<b>accessories for</b>	504738		
	<b>GEV No.</b>	528485	<b>Ref. No.</b> —
	O-ring EPDM thickness 1.78mm ID ø 6.07mm Qty 1 pcs		

connecting bows



1

<b>GEV No.</b>	550059	<b>Ref. No.</b>	0A2205
<b>description</b>	connecting bow short for switch Qty 1 pcs		

switches and momentary switches

rocker/momentary rocker switches

30x11mm



1

<b>GEV No.</b>	301014	<b>Ref. No.</b>	OK6805
<b>description</b>	momentary rocker switch mounting measurements 30x11mm black 1NO 250V 16A connection male faston 6.3mm ambient temperature max. 85/125°C protection IP40 mounting ømm male faston 6.3mm		

30x22mm



1

<b>GEV No.</b>	301091	<b>Ref. No.</b>	OK7092
<b>description</b>	rocker switch mounting measurements 30x22mm red 2NO 400V 10A illuminated 0-1 connection male faston 6.3mm ambient temperature max. 125/55°C protection IP40		



## microswitches

## lever actuated



1

<b>GEV No.</b>	347006	<b>Ref. No.</b>	OK5144
<b>description</b>	microswitch with lever 250V 1NO connection with cable ambient temperature max. 85°C		



1

<b>GEV No.</b>	345254	<b>Ref. No.</b>	046286
<b>description</b>	microswitch with lever 250V 16A 1CO connection male faston 6.3mm ambient temperature max. 120°C mounting distance 22mm actuating force: 60g lever length 58mm		



1

<b>GEV No.</b>	346072	<b>Ref. No.</b>	0E0209
<b>description</b>	microswitch with lever 250V 6A 1CO connection male faston 6.3mm ambient temperature max. 85°C lever length 71mm		



1

<b>GEV No.</b>	345049	<b>Ref. No.</b>	OK3764
<b>description</b>	microswitch with lever CO connection male faston		

## roller-lever actuated

## non-standard



1

<b>GEV No.</b>	347008	<b>Ref. No.</b>	0E5629
<b>description</b>	microswitch with handle with a switch 250V 5A 1CO connection cable ambient temperature max. 85°C lever length 20mm		

## pin-plunger actuated

## M10



1

<b>GEV No.</b>	345032	<b>Ref. No.</b>	OKI395
<b>description</b>	microswitch with plunger thread M10x1 thread L 12mm 250V 16A 1CO connection male faston 6.3mm stroke 7mm mounting distance 22mm L 28mm ambient temperature max. 125°C type SP9603 actuating force: 180g		

## M12



1

<b>GEV No.</b>	347009	<b>Ref. No.</b>	OK7633
<b>description</b>	microswitch with plunger thread M12x1 380V 20A 1CO connection screw ambient temperature max. 85°C		

## non-standard



1

<b>GEV No.</b>	345777	<b>Ref. No.</b>	004288
<b>description</b>	microswitch		

## position switches

## TELEMECANIQUE (EFA)



1

<b>GEV No.</b>	346807	<b>Ref. No.</b>	OK4382
<b>description</b>	position switch plastic 1NO/1NC 400V 3A L 116.7mm W 40mm H 36mm protection IP67 actuating force: 1800g screw connection M19 mounting distance 30x60mm		



float switches

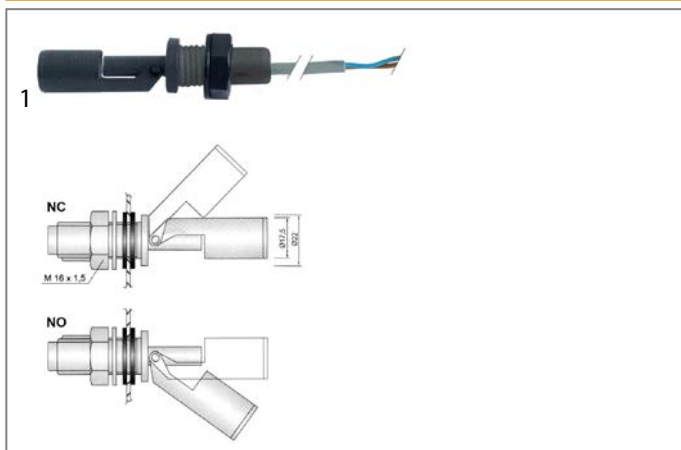

<b>GEV No.</b>	345484	<b>Ref. No.</b>	OE5808
<b>description</b>	float switch thread M16x1.5 1NO or 1NC ø 17.5mm L 92mm mounting ø 16mm 250V 1A cable cable length 2000mm		

cam switches

on/off

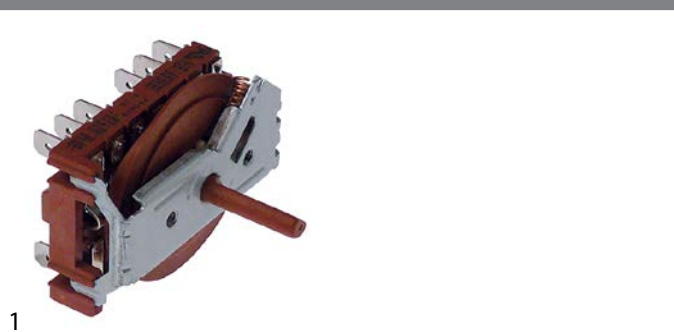

<b>GEV No.</b>	300218	<b>Ref. No.</b>	OE5222
<b>description</b>	cam switch 2 operating positions 6NO sequence 0-1 16A shaft ø 6x4.6mm shaft L 23mm connection male faston 6.3mm plastic		

4-position

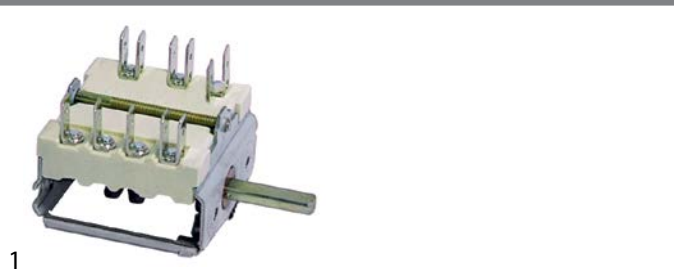

<b>GEV No.</b>	300007	<b>Ref. No.</b>	OH6602
<b>description</b>	cam switch 4 operating positions 1NO/2CO sequence 0-1-2-3 16A shaft ø 6x4.6mm shaft L 23mm connection male faston 6.3mm 4-position ceramic		

7-position



<b>GEV No.</b>	300004	<b>Ref. No.</b>	OK6627
<b>description</b>	cam switch 7 operating positions 1NO/2CO sequence 0-1-2-3-4-5-6 16A shaft ø 6x4.6mm shaft L 23mm connection male faston 6.3mm 7-position ceramic		

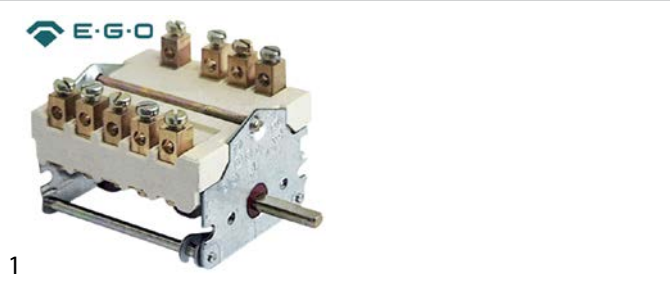

<b>GEV No.</b>	300106	<b>Ref. No.</b>	0A2022
<b>description</b>	cam switch 7 operating positions 1NO/2CO sequence 0-1-2-3-4-5-6 32A shaft ø 6x4.6mm shaft L 23mm connection screw 7-position shaft flat upper		



<b>GEV No.</b>	300237	<b>Ref. No.</b>	18005022
<b>description</b>	cam switch 7-position shaft ø 6x4.6mm shaft L 23mm ambient temperature max. 150°C		

with potentiometer

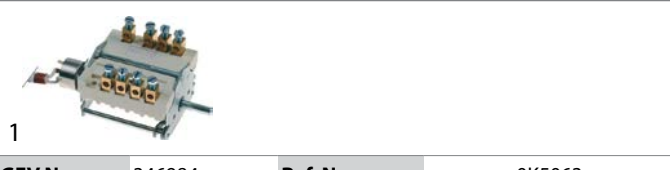

<b>GEV No.</b>	346984	<b>Ref. No.</b>	OK5063
<b>description</b>	cam switch 2 operating positions 4NO sequence 0-1 32A shaft ø 6x4.6mm shaft L 23mm connection cable 2400mm cable length 2400mm 50kOhm ceramic		





## operation switches

E-G-O



1

<b>GEV No.</b>	300002	<b>Ref. No.</b>	0A2134
<b>description</b>	cam switch 2 operating positions 4NO 16A sequence 0-1 shaft $\varnothing$ 6x4.6mm shaft L 23mm connection male faston 6.3mm ceramic		

E-G-O



1

<b>GEV No.</b>	300080	<b>Ref. No.</b>	026945
<b>description</b>	cam switch 2 operating positions 4NO 16A sequence 0-1 shaft $\varnothing$ 6x4.6mm shaft L 23mm connection screw operation switch ceramic ambient temperature max. 150°C		

**accessories for** 300080

	<b>GEV No.</b>	551456	<b>Ref. No.</b>	—
gasket for switch ED $\varnothing$ 14mm ID $\varnothing$ 2.5mm thickness 3.5mm white				

E-G-O



1

<b>GEV No.</b>	300200	<b>Ref. No.</b>	054375
<b>description</b>	operation switch 2 operating positions 2NO 16A sequence 0-1 shaft $\varnothing$ 6x4.6mm shaft L 23mm connection male faston 6.3mm operation switch ceramic		

## miscellaneous



1

<b>GEV No.</b>	300221	<b>Ref. No.</b>	0E5131
<b>description</b>	cam switch 2 operating positions 4NO sequence 1-2 16A shaft $\varnothing$ 6x4.6mm shaft L 23mm connection male faston 6.3mm plastic		

## rotary switches

## GOTTAK



1

<b>GEV No.</b>	300219	<b>Ref. No.</b>	0E5132
<b>description</b>	switch 3 operating positions 3NO sequence 0-1 momentary switch 16A shaft $\varnothing$ 6x4.6mm shaft L 23mm connection male faston 6.3mm plastic		

## KRAUS &amp; NAIMER

## rotary switches



1

<b>GEV No.</b>	301206	<b>Ref. No.</b>	0K4923
<b>description</b>	rotary switch 4 0-1-2-3 sets of contacts 8 type CA11-AT08A188 690V 7.5A shaft $\varnothing$ 4.8x6mm shaft L 18mm shaft round connection screw code 37/000100 marking 7BC540		

## miscellaneous



1

<b>GEV No.</b>	346390	<b>Ref. No.</b>	0K4925
<b>description</b>	rotary switch sets of contacts 1 2 0-1 250V 16A illuminated connection male faston 6.3mm mounting measurements 25x25mm		

## magnetic switches

## 35x22mm

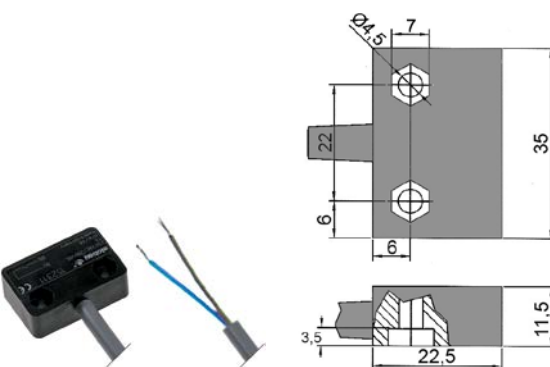



1

<b>GEV No.</b>	347003	<b>Ref. No.</b>	0K7171
<b>description</b>	magnetic switch L 35mm W 22mm 1NO 230V 1A 60W		

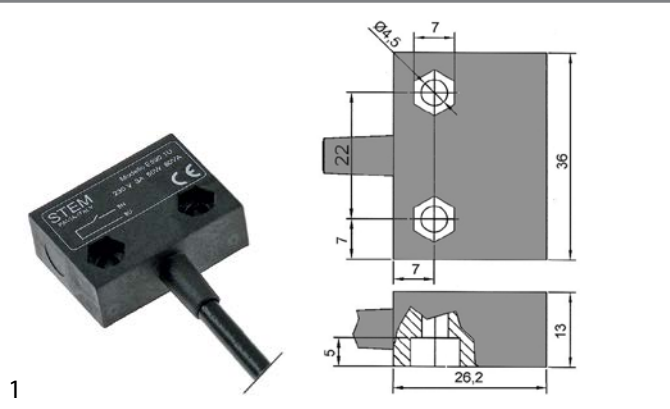

36x26mm



<b>GEV No.</b>	346998	<b>Ref. No.</b>	049966
<b>description</b>	magnetic switch L 36mm W 26mm 1NO 230V 3A P max. 60W connection cable cable length 2000mm		
<b>accessories for</b>	346998		
	<b>GEV No.</b>	347001	<b>Ref. No.</b> 088361
	magnet ømm L 23mm H 18mm W 16mm ID ømm ED ømm M5		

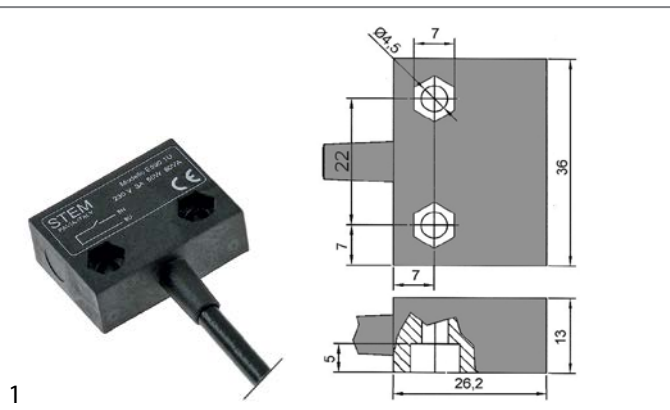

<b>GEV No.</b>	347000	<b>Ref. No.</b>	049967
<b>description</b>	magnetic switch L 36mm W 26mm 1NO 230V 3A P max. 60W connection cable cable length 5500mm		

accessories

magnets

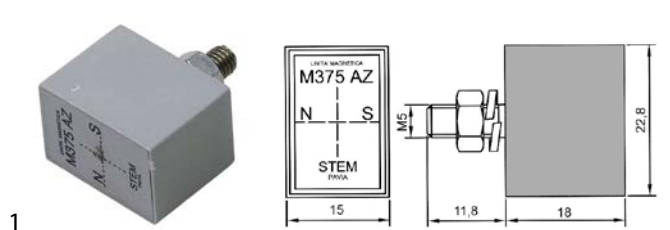

<b>GEV No.</b>	347001	<b>Ref. No.</b>	088361
<b>description</b>	magnet ømm L 23mm H 18mm W 16mm ID ømm ED ømm M5		

miscellaneous

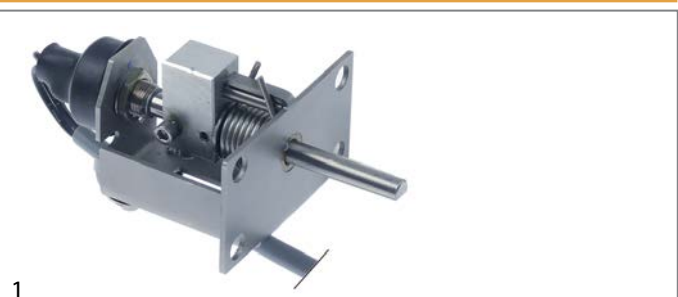



<b>GEV No.</b>	347830	<b>Ref. No.</b>	769045-01
<b>description</b>	switch for tilting kettle with potentiometer		
<b>accessories for</b>	347830		
	<b>GEV No.</b>	347831	<b>Ref. No.</b> —
	stop for switch shaft ø 6x4.6mm		

control equipment

lamps



<b>GEV No.</b>	359606	<b>Ref. No.</b>	OK2043
<b>description</b>	neon light bulb socket Ba9s 220V 2W clear ø 10mm L 28mm		
<b>accessories for</b>	359606		
	<b>GEV No.</b>	359832	<b>Ref. No.</b> —
	lamp socket mounting measurements ø16.2mm socket Ba9s connection male faston 6.3mm		
	<b>GEV No.</b>	359853	<b>Ref. No.</b> —
	lamp socket mounting measurements ø18.2mm socket Ba9s connection male faston 6.3mm		





<b>GEV No.</b>	359807	<b>Ref. No.</b>	OK9110
<b>description</b>	light bulb socket Ba9s 24V 2W ø 10mm L 28mm clear		

encoders and potentiometers



<b>GEV No.</b>	346984	<b>Ref. No.</b>	OK5063
<b>description</b>	cam switch 2 operating positions 4NO sequence 0-1 32A shaft ø 6x4.6mm shaft L 23mm connection cable 2400mm cable length 2400mm 50kOhm ceramic		

			
1			
<b>GEV No.</b>	402070	<b>Ref. No.</b>	OG0317
<b>description</b>	potentiometer 10KOhm rotation 360° shaft ø6x4.6mm shaft L 18mm connection male faston 2.8mm thread M10x0.75 thread L 9mm		

			
1			
<b>GEV No.</b>	402071	<b>Ref. No.</b>	OG2907
<b>description</b>	potentiometer cable length 1200mm		



## lamps

### indicator lights

#### indicator lights 2-piece (lens and indicator lamp)

#### indicator light lenses

ø10mm (type SRZ-3)

			
1			
<b>GEV No.</b>	359123	<b>Ref. No.</b>	004896
<b>description</b>	indicator light housings mounting measurements ø10mm green round Qty 1 pcs		
<b>accessories for</b>	359123		
	<b>GEV No.</b>	359132	<b>Ref. No.</b>
			—
	indicator lamp green 250V connection male faston 6.3mm protection IP54 ambient temperature max. 85°C		

#### indicator lamps for socket type SRZ / SDK / SDY / SFK

			
1			
<b>GEV No.</b>	359133	<b>Ref. No.</b>	OKI362
<b>description</b>	indicator lamp 400V green connection male faston 6.3mm		



#### indicator lights 3-piece (housing, lens and bulb)

#### lamps

#### light bulbs

			
1			
<b>GEV No.</b>	359807	<b>Ref. No.</b>	OK9110
<b>description</b>	light bulb socket Ba9s 24V 2W ø 10mm L 28mm clear		

### neon light bulbs

			
1			
<b>GEV No.</b>	359606	<b>Ref. No.</b>	OK2043
<b>description</b>	neon light bulb socket Ba9s 220V 2W clear ø 10mm L 28mm		
<b>accessories for</b>	359606		
	<b>GEV No.</b>	359832	<b>Ref. No.</b>
			—
	lamp socket mounting measurements ø16.2mm socket Ba9s connection male faston 6.3mm		
	<b>GEV No.</b>	359853	<b>Ref. No.</b>
			—
	lamp socket mounting measurements ø18.2mm socket Ba9s connection male faston 6.3mm		

			
1			
<b>GEV No.</b>	359602	<b>Ref. No.</b>	OH7036
<b>description</b>	neon light bulb socket E14 230V clear ø 14mm L 30mm		

			
1			
<b>GEV No.</b>	359603	<b>Ref. No.</b>	OH7037
<b>description</b>	neon light bulb socket E14 380V clear ø 14mm L 30mm		

#### indicator lights (complete)

ø10mm

#### with screw socket

			
1			
<b>GEV No.</b>	359378	<b>Ref. No.</b>	0A2224
<b>description</b>	indicator light ø 10mm 230V green connection male faston 6.3mm socket screw base		

ø12.5mm

			
1			
<b>GEV No.</b>	359999	<b>Ref. No.</b>	OK9096
<b>description</b>	indicator light ø 12.5mm 230V clear connection male faston 6.3mm		





ø14mm			
with plug-in socket			
			
1			
<b>GEV No.</b>	359150	<b>Ref. No.</b>	053153
<b>description</b>	indicator light ø 14mm red 400V connection male faston 6.3mm temp.-resist. 105°C square		

ø19mm			
			
1			
<b>GEV No.</b>	359519	<b>Ref. No.</b>	0K4898
<b>description</b>	indicator light housings mounting measurements ø19mm socket E14 clear		

ø20mm			
			
1			
<b>GEV No.</b>	359516	<b>Ref. No.</b>	0K4903
<b>description</b>	indicator light ø 20mm 230V clear		



			
1			
<b>GEV No.</b>	359514	<b>Ref. No.</b>	18003964
<b>description</b>	indicator light ø 20mm 230V green connection male faston 6.3mm ambient temperature max. 125°C		

ø22mm			
			
1			
<b>GEV No.</b>	359506	<b>Ref. No.</b>	0K5094
<b>description</b>	indicator light ø 22mm 230V green connection screw temp.-resist. 60°C		

			
1			
<b>GEV No.</b>	359512	<b>Ref. No.</b>	0K6368
<b>description</b>	indicator light ø 22mm 400V clear connection screw temp.-resist. 60°C		

			
1			
<b>GEV No.</b>	359510	<b>Ref. No.</b>	0K6366
<b>description</b>	indicator light ø 22mm 400V green connection screw temp.-resist. 60°C		

miscellaneous			
			
1			
<b>GEV No.</b>	359006	<b>Ref. No.</b>	0K3776
<b>description</b>	indicator light white 230V		

screw-on/push-on fit				
neon light bulbs				
				
1				
<b>GEV No.</b>	359606	<b>Ref. No.</b>	0K2043	
<b>description</b>	neon light bulb socket Ba9s 220V 2W clear ø 10mm L 28mm			
<b>accessories for</b>	359606			
	<b>GEV No.</b>	359832	<b>Ref. No.</b>	—
	lamp socket mounting measurements ø16.2mm socket Ba9s connection male faston 6.3mm			
	<b>GEV No.</b>	359853	<b>Ref. No.</b>	—
	lamp socket mounting measurements ø18.2mm socket Ba9s connection male faston 6.3mm			

			
1			
<b>GEV No.</b>	359602	<b>Ref. No.</b>	0H7036
<b>description</b>	neon light bulb socket E14 230V clear ø 14mm L 30mm		

			
1			
<b>GEV No.</b>	359603	<b>Ref. No.</b>	0H7037
<b>description</b>	neon light bulb socket E14 380V clear ø 14mm L 30mm		

light bulbs			
for ovens			
			
1			
<b>GEV No.</b>	359612	<b>Ref. No.</b>	054840
<b>description</b>	light bulb t.max. 300°C socket E14 25W 230V ø 25mm L 56mm lens L 30mm for oven lamp type Philips		

for indicator lights



1

<b>GEV No.</b>	359807	<b>Ref. No.</b>	OK9110
<b>description</b>	light bulb socket Ba9s 24V 2W ø 10mm L 28mm clear		

oven lamps

universal oven lamps

55x100mm



1

<b>GEV No.</b>	359714	<b>Ref. No.</b>	055022
<b>description</b>	gasket for bulb socket		



1

<b>GEV No.</b>	101372	<b>Ref. No.</b>	OK7521	
<b>description</b>	oven lamp complete L 100mm W 55mm 230V 25W socket E14 rectangular temp.-resist. 300°C connection male faston 6.3mm			
<b>spare parts for</b>	101372			
	<b>GEV No.</b>	359612	<b>Ref. No.</b>	054840
	<b>description</b>	light bulb t.max. 300°C socket E14 25W 230V ø 25mm L 56mm lens L 30mm for oven lamp type Philips		
	<b>GEV No.</b>	359698	<b>Ref. No.</b>	—
	<b>description</b>	lamp socket L 100mm W 55mm socket E14 connection male faston 6.3mm		
	<b>GEV No.</b>	359714	<b>Ref. No.</b>	055022
	<b>description</b>	gasket for bulb socket		
	<b>GEV No.</b>	359715	<b>Ref. No.</b>	—
	<b>description</b>	lamp glass L 110mm W 65mm thickness 5mm		
	<b>GEV No.</b>	359716	<b>Ref. No.</b>	—
	<b>description</b>	frame for bulb socket		

lamps

light bulbs



1

<b>GEV No.</b>	359612	<b>Ref. No.</b>	054840
<b>description</b>	light bulb t.max. 300°C socket E14 25W 230V ø 25mm L 56mm lens L 30mm for oven lamp type Philips		

timers

programme timers



1

<b>GEV No.</b>	360349	<b>Ref. No.</b>	069926	
<b>description</b>	timer CDC 11803 engines 1 chambers 3 operation time 150s 230V shaft ømm shaft Lmm manuf. no. 11803F1BEE000.0010 motor type M48R ATS type 11803F1 / 238046			
<b>spare parts for</b>	360349			
	<b>GEV No.</b>	360673	<b>Ref. No.</b>	—
	<b>description</b>	motor kit pinion ø 6.8mm teeth 15 230V voltage AC 50/60Hz turn direction clockwise motor ø 48mm H 18.5mm motor type UDS-40NE1RNZ165 cable length 150mm with holder		

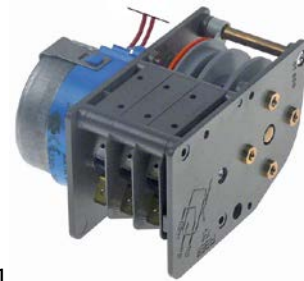

1

<b>GEV No.</b>	360024	<b>Ref. No.</b>	069926 (old version)	
<b>description</b>	timer FIBER P25 engines 1 chambers 3 operation time 2min 230V shaft ømm shaft Lmm manuf. no. P255J03H3N6 motor type M51B-JOL6400			
<b>spare parts for</b>	360024			
	<b>GEV No.</b>	360674	<b>Ref. No.</b>	—
	<b>description</b>	motor kit pinion ø 6.8mm teeth 15 230V voltage AC 50/60Hz turn direction counterclockwise motor ø 48mm H 18.5mm motor type UDS40NE1RNZ165 cable length 150mm with holder		





mechanical timers

			
1			
<b>GEV No.</b>	350170	<b>Ref. No.</b>	0H6114
<b>description</b>	timer 600 2-pole operation time 60min impulse mechanical 2NO at 250V 16A permanent position no shaft 6x4.6mm shaft L 21mm mounting distance 28mm		

contactors

BENEDIKT & JÄGER

power contactors

			
1			
<b>GEV No.</b>	380777	<b>Ref. No.</b>	0K9134
<b>description</b>	auxiliary contactor resistive load 20A 230VAC main contacts 4NO type K2-07A40230		

			
1			
<b>GEV No.</b>	380773	<b>Ref. No.</b>	0L0285
<b>description</b>	power contactor resistive load 25A 230VAC (AC3/400V) 10A/4kW main contacts 3NO auxiliary contacts 1NC connection screw connection type K3-10A01230		

			
1			
<b>GEV No.</b>	380679	<b>Ref. No.</b>	003598
<b>description</b>	power contactor resistive load 25A 230VAC (AC3/400V) 12A/5.5kW main contacts 3NO auxiliary contacts 1NO connection screw connection type K2-12A01230		

			
1			
<b>GEV No.</b>	380674	<b>Ref. No.</b>	0H7051
<b>description</b>	power contactor resistive load 25A 230VAC (AC3/400V) 12A/5.5kW main contacts 4NO connection screw connection type K2-12A0040230		

			
1			
<b>GEV No.</b>	381079	<b>Ref. No.</b>	004012
<b>description</b>	power contactor resistive load 25A 230VAC (AC3/400V) 16A/7.5kW main contacts 3NO auxiliary contacts 1NO connection screw connection type K2-16A10230		

			
1			
<b>GEV No.</b>	380779	<b>Ref. No.</b>	0K3968
<b>description</b>	power contactor resistive load 25A 24VAC (AC3/400V) 14A/5.5kW main contacts 3NO auxiliary contacts 1NO connection screw connection type K3-14ND10		

			
1			
<b>GEV No.</b>	380789	<b>Ref. No.</b>	0K9132
<b>description</b>	power contactor resistive load 32A 230VAC main contacts 3 auxiliary contacts 1 with 2 auxiliary contacts NC		

1

<b>GEV No.</b>	381171	<b>Ref. No.</b>	0K9124
<b>description</b>	power contactor resistive load 32A 24VAC (AC3/400V) 22A/11kW main contacts 3NO auxiliary contacts 1NO connection screw connection type K3-22ND10		



1

<b>GEV No.</b>	380637	<b>Ref. No.</b>	054928
<b>description</b>	power contactor resistive load 45A 230VAC main contacts 3NO auxiliary contacts 1NO connection screw type K2-23A10 230		



1

<b>GEV No.</b>	380776	<b>Ref. No.</b>	007104
<b>description</b>	power contactor resistive load 80A 230VAC (AC3/400V) 40A/18.5kW main contacts 3NO auxiliary contacts connection screw connection type K3-40A00230 contacts		



1

<b>GEV No.</b>	380676	<b>Ref. No.</b>	0TRA70
<b>description</b>	power contactor resistive load 80A 230VAC (AC3/400V) 45A/20kW main contacts 3NO connection screw connection type K2-45A00230		

auxiliary contacts



1

<b>GEV No.</b>	380677	<b>Ref. No.</b>	047046
<b>description</b>	auxiliary contact contacts 1NC AC15 10A for contactors K2/K3 connection screw type HN01 AC1 25A		



1

<b>GEV No.</b>	380678	<b>Ref. No.</b>	046995
<b>description</b>	auxiliary contact contacts 1NO AC15 10A for contactors K2/K3 connection screw type HN10 AC1 25A		



1

<b>GEV No.</b>	380781	<b>Ref. No.</b>	048497
<b>description</b>	auxiliary contact contacts 1NO AC15 6A for contactors K2/K5 connection screw type HA10 AC1 25A		

solid state relays

CRYDOM



1

<b>GEV No.</b>	403038	<b>Ref. No.</b>	0K5070
<b>description</b>	solid state relay CRYDOM 1 phase 50A 480V 4-32VDC L 57mm W 45mm screw type CWD4850P		



## relays

### power relays

#### with bracket mounting



1

<b>GEV No.</b>	380702	<b>Ref. No.</b>	005033
<b>description</b>	power relays FINDER 230VAC 16A 3NO connection male faston 6.3mm flange dimensions 36x38x68mm manuf. no. 62.83.8.230.0300 230V		

#### with male contacts

#### bullet connectors, 11 contacts



1

<b>GEV No.</b>	380132	<b>Ref. No.</b>	0K3700	
<b>description</b>	power relays Italiana Relè 230VAC 10A 3CO connection plug-in connection round 11-pole manuf. no. C43-230AC ZVE11 250V 11-pole			
<b>accessories for</b>	380132			
	<b>GEV No.</b>	380136	<b>Ref. No.</b>	—
	relay socket 11-pole connection plug-in connection round 11-pole dimensions 65x28x40mm 250V voltage AC 10A Italiana Relè manuf. no. ZVE11			

#### female contact 4.8mm





1

<b>GEV No.</b>	380475	<b>Ref. No.</b>	0K4944	
<b>description</b>	power relays FINDER 220-240VAC 12A 2CO connection F4.8 raster size 10mm plug-in connection manuf. no. 56.32.8.230.0040 250V 2-pole connection 4.8mm			
<b>accessories for</b>	380475			
	<b>GEV No.</b>	380476	<b>Ref. No.</b>	—
	relay socket dimensions 78x27x33.5mm 250V voltage AC 10A FINDER manuf. no. 96.72			

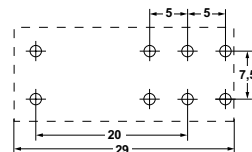
### plug-in/print relays



1

<b>GEV No.</b>	380333	<b>Ref. No.</b>	0E5849	
<b>description</b>	print relay 230VAC 2CO at 250V 8A connection pins raster size 5mm FINDER manuf. no. 40.52.8.230.0000 95.65/95.75			
<b>accessories for</b>	380333			
	<b>GEV No.</b>	380340	<b>Ref. No.</b>	—
	relay socket dimensions 62x36x15mm 250V voltage AC 10A Italiana Relè manuf. no. ZMEM/5			
	<b>GEV No.</b>	380505	<b>Ref. No.</b>	—
	relay socket 2CO 40.52 dimensions 81.9x15.5x75mm 250V voltage AC 10A FINDER manuf. no. 95.95.3			
	<b>GEV No.</b>	381181	<b>Ref. No.</b>	—
	relay socket 2-pole 40.51/40.52/40.61 connection screw clamp dimensions 15.8x78.6mm 250V voltage AC 10A FINDER manuf. no. 95.75			

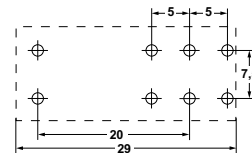

1

<b>GEV No.</b>	380853	<b>Ref. No.</b>	0E5172
<b>description</b>	print relay 24VAC 1CO at 250V 16A connection pins raster size 5mm FINDER manuf. no. 40.61.8.024.0000 95.65/95.75		

### time relays

#### time relays



1

<b>GEV No.</b>	360407	<b>Ref. No.</b>	075659
<b>description</b>	timer FINDER T23522203F0 time range 0.5s-120h 24VAC 2x6A mounting measurements 45x70mm 2CO		



## transformers

### toroidal core transformers

			
1			
<b>GEV No.</b>	401663	<b>Ref. No.</b>	OL0174
<b>description</b>	transformer primary 230V secondary 12V 25VA		

### encapsulated transformers

#### with screw connection

			
1			
<b>GEV No.</b>	401665	<b>Ref. No.</b>	OL1158
<b>description</b>	transformer primary 230/400V secondary 24-48V 400VA connection screw 50-60Hz		

### for lighting

			
1			
<b>GEV No.</b>	401547	<b>Ref. No.</b>	002856
<b>description</b>	transformer primary 230V secondary 11.5V 50W		

## electronic controllers

### ELIWELL

#### universal controllers

##### built-in version

			
1			
<b>GEV No.</b>	379559	<b>Ref. No.</b>	0S0989
<b>description</b>	electronic controller ELIWELL type IC901 mounting measurements 71x29mm 12V voltage AC/DC NTC/PTC relay outputs 1 relay refrigeration front measurements 74x32mm built-in depth 60mm protection IP65 accuracy superior to 0.5% from final value% defr. funct. no -55 up to +150°C display 2½ digit Templ1 yes 15A		
<b>accessories for</b>	379559		
	<b>GEV No.</b>	379053	<b>Ref. No.</b> —
	temperature probe PTC 1kOhm cable PVC probe -50 up to +150°C cable -10 up to 100°C probe ø6x30mm cable length 3m without screw connection 2-wire		
	<b>GEV No.</b>	379064	<b>Ref. No.</b> —
	temperature probe PTC 1kOhm cable silicone probe -50 up to +150°C cable -50 up to +180°C probe ø6x40mm cable length 3m without screw connection 2-wire		
	<b>GEV No.</b>	379161	<b>Ref. No.</b> —
	temperature probe NTC 10kOhm cable thermoplastic probe -40 up to +110°C cable -40 up to +110°C probe ø6x14mm cable length 3m without screw connection 2-wire		
	<b>GEV No.</b>	379782	<b>Ref. No.</b> —
	temperature probe PTC 1kOhm cable thermoplastic probe -50 up to +150°C cable -40 up to +110°C probe ø6x14mm cable length 3m 2-wire resistor 1kOhm		

			
1			
<b>GEV No.</b>	379690	<b>Ref. No.</b>	0S0789
<b>description</b>	electronic controller ELIWELL type ICP16D0750000 mounting measurements 71x29mm 230V voltage AC NTC/PTC relay outputs 1 CO-15A(8) NTC/PTC built-in depth 60mm defr. funct. -50 up to +150°C display 3½ digits		
<b>accessories for</b>	379690		
	<b>GEV No.</b>	378194	<b>Ref. No.</b> —
	temperature probe NTC 10kOhm cable PVC probe -20 up to +80°C cable -10 up to 100°C probe ø7x24.5mm cable length 1.5m without screw connection 2-wire		
	<b>GEV No.</b>	379052	<b>Ref. No.</b> —
	temperature probe PTC 1kOhm cable silicone probe -50 up to +150°C cable -50 up to +180°C probe ø6x40mm cable length 1.5m without screw connection 2-wire		
	<b>GEV No.</b>	379053	<b>Ref. No.</b> —
	temperature probe PTC 1kOhm cable PVC probe -50 up to +150°C cable -10 up to 100°C probe ø6x30mm cable length 3m without screw connection 2-wire		

Table continues overleaf



<b>accessories for</b>	379690		
<b>GEV No.</b>	379057	<b>Ref. No.</b>	—
<b>description</b>	temperature probe NTC 10kOhm cable PVC probe -20 up to +80°C cable -10 up to 100°C probe ø6x25mm cable length 3m 2-wire		
<b>GEV No.</b>	379064	<b>Ref. No.</b>	—
<b>description</b>	temperature probe PTC 1kOhm cable silicone probe -50 up to +150°C cable -50 up to +180°C probe ø6x40mm cable length 3m without screw connection 2-wire		
<b>GEV No.</b>	379142	<b>Ref. No.</b>	—
<b>description</b>	temperature probe PTC 1kOhm cable PVC probe -50 up to +150°C cable -10 up to 100°C probe ø6x30mm cable length 1.5m without screw connection 2-wire		
<b>GEV No.</b>	379160	<b>Ref. No.</b>	—
<b>description</b>	temperature probe NTC 10kOhm cable thermoplastic probe -40 up to +110°C cable -40 up to +110°C probe ø6x14mm cable length 1.5m without screw connection 2-wire		
<b>GEV No.</b>	379161	<b>Ref. No.</b>	—
<b>description</b>	temperature probe NTC 10kOhm cable thermoplastic probe -40 up to +110°C cable -40 up to +110°C probe ø6x14mm cable length 3m without screw connection 2-wire		
<b>GEV No.</b>	379343	<b>Ref. No.</b>	—
<b>description</b>	temperature probe NTC 10kOhm cable silicone probe -40 up to +110°C cable -50 up to +180°C probe ø6x40mm cable length 3m 2-wire		
<b>GEV No.</b>	379458	<b>Ref. No.</b>	—
<b>description</b>	temperature probe NTC 10kOhm cable silicone probe -40 up to +110°C cable -50 up to +180°C probe ø6x40mm cable length 1.5m without screw connection 2-wire		
<b>GEV No.</b>	379781	<b>Ref. No.</b>	—
<b>description</b>	temperature probe PTC 1kOhm cable thermoplastic probe -50 up to +150°C cable -40 up to +110°C probe ø6x14mm cable length 1.5m without screw connection 2-wire		
<b>GEV No.</b>	379782	<b>Ref. No.</b>	—
<b>description</b>	temperature probe PTC 1kOhm cable thermoplastic probe -50 up to +150°C cable -40 up to +110°C probe ø6x14mm cable length 3m 2-wire resistor 1kOhm		



<b>GEV No.</b>	400910	<b>Ref. No.</b>	0C0202
<b>description</b>	temperature probe NTC 10kOhm cable silicone probe -40 up to +110°C cable -50 up to +180°C connection coded plug thread probe ø4.5x30mm cable length 0.35m		



<b>GEV No.</b>	379404	<b>Ref. No.</b>	0K8490
<b>description</b>	temperature probe Pt1000 cable glass fibre probe -70 up to +500°C cable -50 up to +350°C connection male faston thread probe ø4x60mm cable length 1.6m		



<b>GEV No.</b>	379100	<b>Ref. No.</b>	0C5342
<b>description</b>	temperature probe Pt1000 cable silicone probe -70 up to +500°C cable -50 up to +180°C connection male faston 4.8mm thread probe ø4x235mm cable length 1.8m		

<b>accessories for</b>	379100		
<b>GEV No.</b>	693745	<b>Ref. No.</b>	—
<b>description</b>	gasket PTFE ED ø 20mm ID ø 15mm thickness 1mm Qty 1 pcs		
<b>GEV No.</b>	697993	<b>Ref. No.</b>	—
<b>description</b>	sleeve for temperature probe ø 11mm ID ø 4.3mm H 22.4mm		



<b>GEV No.</b>	378012	<b>Ref. No.</b>	0K5047
<b>description</b>	temperature probe PTC 2kOhm cable probe -50 up to +150°C cable°C connection F6.3 thread M10x1 cable lengthm		

miscellaneous

<b>miscellaneous</b>			
<b>GEV No.</b>	381419	<b>Ref. No.</b>	712.340.179
<b>description</b>	electronic controller kit type ERT4V 230V Pt1000 +50 up to +130°C relay outputs 1CO		



<b>GEV No.</b>	402005	<b>Ref. No.</b>	086344
<b>description</b>	temperature probe PTC 2kOhm cable TPE probe -50 up to +150°C cable -40 up to +110°C connection plug thread probe ø6x50mm cable length 1.6m		

probes

producer-specific probes

<b>probes</b>			
<b>GEV No.</b>	379476	<b>Ref. No.</b>	0K5154
<b>description</b>	probe Pt1000 cable PTFE probe -100 up to 450°C cable -40 up to +250°C connection male faston 4.8mm thread probe ø6/10x22mm cable length 2m		



<b>GEV No.</b>	379427	<b>Ref. No.</b>	0K5058
<b>description</b>	temperature probe thermocouple K (NiCr-Ni) cable glass fibre probe -50 up to 1150°C cable -50 up to +350°C connection 2-wire thread probe ø4x20mm cable length 2.6m		



<b>GEV No.</b>	379098	<b>Ref. No.</b>	0K5623
<b>description</b>	temperature probe thermocouple K (NiCr-Ni) cable Vetrotex probe -50 up to 1150°C cable -50 up to +350°C connection 2-wire thread M6/M10 probe ø6x20mm cable length 2.1m		





core probes



1

<b>GEV No.</b>	379407	<b>Ref. No.</b>	OK8488
<b>description</b>	core temperature probe Pt1000 cable SS corrugated hose probe -40 up to +250°C cable -40 up to +250°C connection 2-wire probe ø4x100mm thread M8 cable length 2.7m handle ø 10mm handle length 45mm		



1

<b>GEV No.</b>	379060	<b>Ref. No.</b>	002673
<b>description</b>	core temperature probe Pt1000 cable SS corrugated hose probe -40 up to +250°C cable -40 up to +250°C connection 2-wire probe ø4x100mm thread M8 cable length 2m handle ø 10mm handle length 45mm		

accessories

adapters



1

<b>GEV No.</b>	379093	<b>Ref. No.</b>	OK5057
<b>description</b>	bayonet adapter L 18mm thread M6x1 ID ø 7/4mm ED ø 12mm		





1

<b>GEV No.</b>	378127	<b>Ref. No.</b>	OKI657
<b>description</b>	bayonet adapter L 32mm thread M6x1 ID ø 7/4mm ED ø 12mm		



1

<b>GEV No.</b>	379094	<b>Ref. No.</b>	OG2155
<b>description</b>	bayonet adapter L 39mm thread M6x1 ID ø 7/4mm ED ø 12mm		
<b>accessories for</b>	379094		
	<b>GEV No.</b>	<b>Ref. No.</b>	—
	temperature probe thermocouple K (NiCr-Ni) cable silicone probe -50 up to 1150°C cable -50 up to +180°C connection 2-wire thread probe ø4x20mm cable length 2.6m		



1

<b>GEV No.</b>	378128	<b>Ref. No.</b>	0KE127
<b>description</b>	bayonet adapter L 59mm thread M6x1 ID ø 7/4mm ED ø 12mm		

miscellaneous



1

<b>GEV No.</b>	550924	<b>Ref. No.</b>	002075
<b>description</b>	gasket for probe ID ø 6mm EPDM		

electronics

PCBs



1

<b>GEV No.</b>	401575	<b>Ref. No.</b>	OK4880
<b>description</b>	control PCB		



1

<b>GEV No.</b>	400929	<b>Ref. No.</b>	048926
<b>description</b>	PCB		



1

<b>GEV No.</b>	401964	<b>Ref. No.</b>	OK5071
<b>description</b>	PCB		

1

<b>GEV No.</b>	401573	<b>Ref. No.</b>	OK4882
<b>description</b>	power PCB		

Triacs



1

<b>GEV No.</b>	402072	<b>Ref. No.</b>	OK5065
<b>description</b>	Triac		

keypads

front foils



1

<b>GEV No.</b>	401574	<b>Ref. No.</b>	OK4333
<b>description</b>	keypad foil		

membrane keypads



1

<b>GEV No.</b>	400915	<b>Ref. No.</b>	049956
<b>description</b>	membrane keypad		

accessories



1

<b>GEV No.</b>	400997	<b>Ref. No.</b>	002670
<b>description</b>	push button		

solenoid valves

solenoid valves (water)

ROBERTSHAW/INVENSYS

medium temperature: 90°C 90°C 60°C  
 ambient temperature: 60°C 25°C 60°C  
 duty cycle: 40% 100% 100%



1

<b>GEV No.</b>	372021	<b>Ref. No.</b>	OK5389
<b>description</b>	solenoid valve double straight 230VAC inlet 3/4" outlet 11.5mm DN10 EATON (INVENSYS)		

spare parts and accessories

reducers

outlet side



1

<b>GEV No.</b>	371252	<b>Ref. No.</b>	OK5369
<b>description</b>	reducer type EATON (INVENSYS) flow rate 1.2l/min pressure range 0 up to 10bar tolerance ±15/25% blue		



1

<b>GEV No.</b>	371253	<b>Ref. No.</b>	OK5368
<b>description</b>	reducer type EATON (INVENSYS) flow rate 2.5l/min pressure range 0 up to 10bar tolerance ±15/25% brown		

TP

solenoid valves with reducers



1

<b>GEV No.</b>	370375	<b>Ref. No.</b>	0F0001
<b>description</b>	solenoid valve triple straight 230VAC inlet 3/4" outlet 11.5mm t.max. 90°C TP plastic output A 2.5l/min output C 0.25l/min flow regulating valve outlet A yellow flow regulating valve outlet C red		



## solenoid valves (gas)

## BRAHMA

## spare parts and accessories

## solenoid coils



1

<b>GEV No.</b>	101968	<b>Ref. No.</b>	005548
<b>description</b>	solenoid valve 230VAC 20VA seat ø 17mm coil type 13902001 BRAHMA		

## ball valves electric



1

<b>GEV No.</b>	401139	<b>Ref. No.</b>	0C0882
<b>description</b>	ball valve inlet 3/4" IT outlet 3/4" IT with plug 230V L 65mm 50/60Hz closed off-current mode of operation electric connection cable 200mm		

## pressure switches

## for boiling pans



1

<b>GEV No.</b>	541459	<b>Ref. No.</b>	0G2935
<b>description</b>	pressure control with cable		

## electrodes



1

<b>GEV No.</b>	400121	<b>Ref. No.</b>	055346
<b>description</b>	level electrode 1/4" total length 121mm probe L 94mm insulated probe length 90mm PTFE insulated connection angled, male faston 6.3mm stainless steel		



1

<b>GEV No.</b>	400124	<b>Ref. No.</b>	002694
<b>description</b>	level electrode push-in total length 128mm probe L 103mm insulated probe length 93mm PTFE insulated connection F6.3 ø 2.5mm		



1

<b>GEV No.</b>	378013	<b>Ref. No.</b>	0K4871
<b>description</b>	level electrode to clip		

## fans

## axial fans

## import



1

<b>GEV No.</b>	601080 <sup>1</sup>	<b>Ref. No.</b>	0C4423
<b>description</b>	axial fan L 119mm W 119mm H 38mm 230VAC 50/60Hz 23/20W bearing ball bearing connection male faston 2.8mm metal ADDA fan wheel ø 110mm temp.-resist. 70°C		

<b>accessories for</b>	601080		
------------------------	--------	--	--

	<b>GEV No.</b>	550898	<b>Ref. No.</b>	—
	<b>description</b>	connecting cable cable length 2000mm connection F 2.8 connection distance 7.9mm for axial flow fan		

	<b>GEV No.</b>	692519	<b>Ref. No.</b>	—
	<b>description</b>	guard L 120mm W 120mm plastic		

<sup>1</sup>with ball bearings

refrigeration fans

cold air circulating fans (complete)

ebm-papst

R2E series

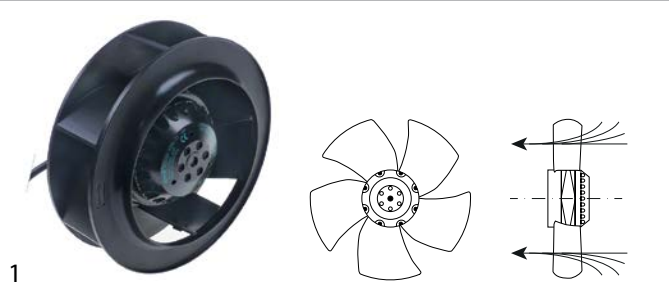

<b>GEV No.</b>	601536	<b>Ref. No.</b>	0E5666
<b>description</b>	fan R2E190-A026-73 fan wheel ø 190mm blades 6 230V 50/60Hz 58/75W ø 190mm H 70mm 2700rpm cable length 450mm rotation direction right ebm-papst sucking suitable capacitor 2µF		
<b>spare parts for</b>	601536		
	<b>GEV No.</b>	365170	<b>Ref. No.</b>
	capacitor capacity 2µF 425V tolerance 5% 50/60Hz ambient temperature max. -25 to +85°C ø 25mm L 49mm M8 plastic connection cable 250mm 416.17.74 protection		

cross flow fans

ebm-papst



<b>GEV No.</b>	601505	<b>Ref. No.</b>	0K5059
<b>description</b>	cross flow fan QLN65/2400A17-3030L roller ø 65mm roller length 240mm laminated core thickness 29mm motor position right 230V/50Hz 22W refrigeration bearing silicone connection F 6.3 0 up to +60°C 230V throughput 200m³/h 50Hz		

COPREL

double fans



<b>GEV No.</b>	601026	<b>Ref. No.</b>	0K3707
<b>description</b>	cross flow fan COPREL TFD(FD) roller ø 60mm roller length 2x180mm laminated core thickness 35mm motor position centre 230V/50-60Hz 42W refrigeration bearing rubber connection male faston 6.3mm coil type airflow 255m³/h -10 up to +60°C		

hot air motors

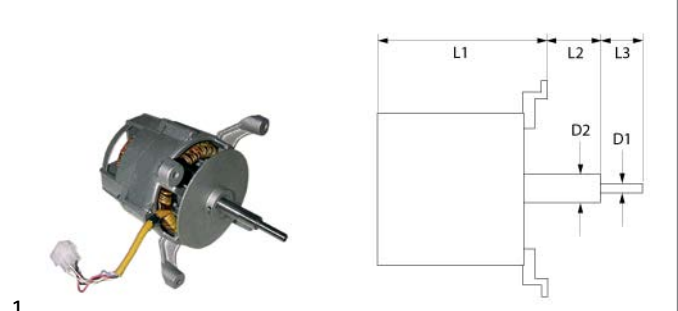

<b>GEV No.</b>	500141	<b>Ref. No.</b>	0F0007
<b>description</b>	fan motor 230V 1 phase 50/60Hz 0.19kW 1450/1750rpm speeds 1 L1 150mm L2 52mm L3 35mm D1 ø 9/10mm D2 ø 14mm M6R IT 1.3A Cos(φ) 0.91 at 50Hz 1450rpm at 60Hz 1750rpm type LM80/4 no. 596477 shaft flat length 12mm		



<b>GEV No.</b>	601220	<b>Ref. No.</b>	0C6462
<b>description</b>	fan wheel D1 ø 280mm H1 100mm blades 6 D2 ø 10mm D3 ø 10mm H2 37mm H3 22mm		



<b>GEV No.</b>	511300	<b>Ref. No.</b>	002873
<b>description</b>	O-ring Viton thickness 3.53mm ID ø 28.17mm for 57 series for motor shaft		



<b>GEV No.</b>	511301	<b>Ref. No.</b>	002699
<b>description</b>	shaft seal ID ø 16mm ED ø 38mm thickness 18mm		



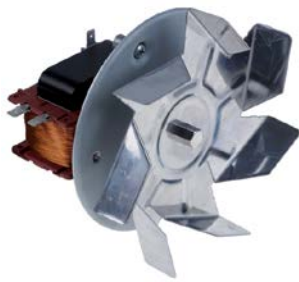

hot air fans

miscellaneous

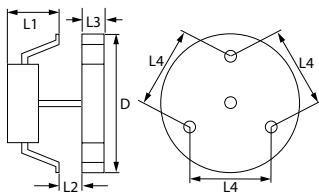

1



<b>GEV No.</b>	601011	<b>Ref. No.</b>	031484
<b>description</b>	hot air fan 220-240V 40W 50/60Hz L1 65mm L2 15mm L3 25mm L4 87mm fan wheel ø 150mm FIME type C25R8023CLH		
<b>accessories for</b>	601011		
	<b>GEV No.</b>	550879	<b>Ref. No.</b> —
	insulation ø 130mm thickness 3mm hole ø 20mm for hot air fan		
	<b>GEV No.</b>	601260	<b>Ref. No.</b> —
	nut thread M6L IT for hot air fan		

motors

gear motors

for tilting bratt pans



1

<b>GEV No.</b>	501580	<b>Ref. No.</b>	763001 763090
<b>description</b>	gear motor SKF/ATB type MAX30-C220450A101N0-005 24V L 490mm W 185mm H 120mm		

miscellaneous



1

<b>GEV No.</b>	500620	<b>Ref. No.</b>	0K4843
<b>description</b>	gear motor for kettle		

spindle motors

SKF/ATB



1

<b>GEV No.</b>	501580	<b>Ref. No.</b>	763001 763090
<b>description</b>	gear motor SKF/ATB type MAX30-C220450A101N0-005 24V L 490mm W 185mm H 120mm		

pumps







wash and rinse pumps

ALBA (C&A)

pumps



1

<b>GEV No.</b>	500090	<b>Ref. No.</b>	046370
<b>description</b>	pump inlet ø 45mm outlet ø 40mm type C5803 230V 50Hz 1 phase 0.55kW 0.75HP L 210mm rotation direction right capacitor 12.5µF ALBA PUMPS (C&A)		
<b>spare parts for</b>	500090		
	<b>GEV No.</b>	365014	<b>Ref. No.</b> —
	operating capacitor capacity 12.5µF 450V tolerance 5%Hz ambient temperature max. -25 to +85°C ø 35mm L 70mm M8 plastic connection male faston 6.3mm 45S.C3DS.12.5 protection		
	<b>GEV No.</b>	504320	<b>Ref. No.</b> —
	pump cover gasket ID ø 160.75mm thickness 3.53mm EPDM Qty 1 pcs		
	<b>GEV No.</b>	509021	<b>Ref. No.</b> —
	impeller ø 102mm H 32mm shaft intake ø 9/8mm rotation direction right		
	<b>GEV No.</b>	510692	<b>Ref. No.</b> —
	mechanical shaft seal for shaft ø 11mm slide ring ext. ø 24mm slide ring H 13mm counter ring mounting ø 26mm height counter ring 8mm counter ring int. ø 14mm		
	<b>GEV No.</b>	521531	<b>Ref. No.</b> —
	pump cover ALBA PUMPS (C&A) inlet ø 45mm outlet ø 40mm turn direction right ø 153mm ID ø 127mm inner height 24mm		
	<b>GEV No.</b>	521709	<b>Ref. No.</b> —
	O-ring EPDM thickness 3mm ID ø 126mm Qty 1 pcs		





**FIR**  
pumps



1

<b>GEV No.</b>	500985	<b>Ref. No.</b>	0L0437
<b>description</b>	pump inlet ø 62mm outlet ø 64mm type 4290.2700 220-240/380-415V 50Hz 3 phase 1.5kW 2HP L 350mm rotation direction right FIR installation kit inclusive		

**spare parts for** 500003

<b>GEV No.</b>	510693	<b>Ref. No.</b>	—
----------------	--------	-----------------	---



mechanical shaft seal for shaft ø 12mm slide ring ext. ø 24mm slide ring H 15.5mm slide ring int. ø 11mm counter ring mounting ø 24mm height counter ring 8mm counter ring int. ø 13.5mm

**drain pumps**

**PLASET**







1

<b>GEV No.</b>	500206	<b>Ref. No.</b>	047562
<b>description</b>	drain pump with auxiliary pressure connection inlet ø 25mm outlet ø 22mm 230V 90W 50Hz PLASET type 8411		

**OLYMPIA**  
pumps



1

<b>GEV No.</b>	500003	<b>Ref. No.</b>	069540	
<b>description</b>	pump inlet ø 45mm outlet ø 32mm type T30 230V 50Hz 1 phase 0.29kW 0.39HP L 190mm rotation direction right capacitor 8µF OLYMPIA			
<b>spare parts for</b>	500003			
	<b>GEV No.</b>	365013	<b>Ref. No.</b>	—
	operating capacitor capacity 8µF 400V tolerance 5%Hz ambient temperature max. -25 to +85°C ø 31.5mm L 55mm M8 plastic connection male faston 6.3mm protection			
	<b>GEV No.</b>	510512	<b>Ref. No.</b>	—
	pump cover OLYMPIA inlet ø 45mm outlet ø 31mm outlet 2 ø 24 turn direction right ø 130mm ID ø 124mm inner height 20mm			
	<b>GEV No.</b>	510554	<b>Ref. No.</b>	—
	O-ring EPDM thickness 2mm ID ø 120mm Qty 1 pcs			
	<b>GEV No.</b>	510615	<b>Ref. No.</b>	—
	impellor ø 90mm H 22mm rotation direction right thread M10L blades 4			

**condensators & interference suppression filters**

**operating capacitors**

**metal**



1

<b>GEV No.</b>	365139	<b>Ref. No.</b>	056148
<b>description</b>	operating capacitor capacity 10µF 450V tolerance 5% 60Hz ambient temperature max. -25 up to +70°C ø 40mm L 83mm M8 aluminium connection male faston 6.3mm C.87.8BF2 MKP protection		

**filters**

**interference suppression filters**



1

<b>GEV No.</b>	365045	<b>Ref. No.</b>	0K4865
<b>description</b>	interference suppression filter type FC701Y2F 250V 50-60Hz conductor 2 with E connection cable 200mm L 40mm ø 30mm Hmm Wmm plastic Qty 1 pcs		



## fuses

### fine fuses

			
1			
<b>GEV No.</b>	358677	<b>Ref. No.</b>	057783
<b>description</b>	fine fuse size ø5x20mm 4A fast-acting rated 250V Qty 10 pcs		

			
1			
<b>GEV No.</b>	358695	<b>Ref. No.</b>	005032
<b>description</b>	fine fuse size ø5x20mm 3.15A medium lag rated 250V Qty 10 pcs		

			
1			
<b>GEV No.</b>	358703	<b>Ref. No.</b>	002750
<b>description</b>	fine fuse size ø5x20mm 0.4A slow-acting rated 250V Qty 10 pcs		

### various

			
1			
<b>GEV No.</b>	358397	<b>Ref. No.</b>	0K5074
<b>description</b>	fuse size 76mm 25A rated 690V Qty 1 pcs		

### overload switches

			
1			
<b>GEV No.</b>	358523	<b>Ref. No.</b>	0H6104
<b>description</b>	overload switch drop-away current 0.6A		

### line circuit breakers

#### miscellaneous

			
1			
<b>GEV No.</b>	380689	<b>Ref. No.</b>	0K3682
<b>description</b>	line circuit breaker		

## electric accessories

### cables

#### copper wire

up to 200°C

			
1			
<b>GEV No.</b>	550081	<b>Ref. No.</b>	0K3285
<b>description</b>	copper wire 1.5mm <sup>2</sup> permanent temperature -60 up to +200°C conductor nickel-plated copper wire insulation glass fibre braiding/silicone rubber Qty 10m green/yellow t.max. 250°C rated 300/500V test voltage 2000V		

### terminals

#### connection terminals with screw/faston connections

			
1			
<b>GEV No.</b>	550411	<b>Ref. No.</b>	046347
<b>description</b>	power terminal block 6-pole max. 40A max 450V connection ø6mm <sup>2</sup> / F6.3 temp.-resist. 150°C cross section 6mm <sup>2</sup>		

## gas taps

### PEL

#### 21S series

				
1				
<b>GEV No.</b>	101897	<b>Ref. No.</b>	0C0205	
<b>description</b>	gas tap PEL type 21S gas inlet pipe flange ø21mm bypass nozzle ø 0.35mm gas outlet M16x1.5 (tube ø 10/8mm) thermocouple connection M8x1 pilot connection M10x1 shaft ø 8x6.5mm shaft L 32/25mm shaft flat upper			
<b>spare parts for</b>	101897			
	<b>GEV No.</b>	101060	<b>Ref. No.</b>	—
	magnet unit standard L 39mm D1 ø 15.4mm D2 ø 11mm suitable for PEL20-21/JUNKERS/EGA			
	<b>GEV No.</b>	101230	<b>Ref. No.</b>	—
	thermocouple nut T1: M8x1 T2: M18x1 aluminium			
	<b>GEV No.</b>	101875	<b>Ref. No.</b>	—
	gas tap front part shaft ø 8x6.5mm shaft L 32/25mm shaft flat upper/lower type PEL21			
	<b>GEV No.</b>	528347	<b>Ref. No.</b>	—
	O-ring Viton thickness 1.78mm ID ø 2.9mm Qty 1 pcs			









Table continues overleaf



<b>accessories for</b>	101897		
	GEV No.	100908	Ref. No. 052125
	union screw thread M10x1 for pipe ø 4mm Qty 1 pcs		
	GEV No.	100909	Ref. No. —
	union screw thread M10x1 for pipe ø 6mm Qty 1 pcs		
	GEV No.	101246	Ref. No. —
	olive for pipe ø 4mm Qty 1 pcs		
	GEV No.	101278	Ref. No. 060325
	olive for pipe ø 10mm Qty 1 pcs		
	GEV No.	101286	Ref. No. —
	olive ID ø 6mm Qty 1 pcs		
	GEV No.	101300	Ref. No. —
	union nut thread M16x1.5 tube ø 10mm		
	GEV No.	110081	Ref. No. —
	knob ø 70mm shaft ø 8x6.5mm shaft flat universal		
	GEV No.	112206	Ref. No. —
	knob dial plate silver gas tap PEL21/22/23 t.max.°C ED ø 63mm ID ø 45.5mm		



<b>GEV No.</b>	106060	<b>Ref. No.</b>	OKI367
<b>description</b>	gas tap PEL type 21S/O gas inlet pipe flange ø21mm bypass nozzle ø 0mm gas outlet M16x1.5 (tube ø 10/8mm) thermocouple connection M8x1 pilot connection M10x1 shaft ø 6x4.6mm shaft L 45/19mm shaft flat upper		
<b>spare parts for</b>	106060		
	GEV No.	101060	Ref. No. —
	magnet unit standard L 39mm D1 ø 15.4mm D2 ø 11mm suitable for PEL20-21/JUNKERS/EGA		
	GEV No.	101230	Ref. No. —
	thermocouple nut T1: M8x1 T2: M18x1 aluminium		
	GEV No.	101880	Ref. No. —
	gasket Viton ED ø 14mm ID ø 9mm thickness 7.7mm Qty 1 pcs		
<b>accessories for</b>	106060		
	GEV No.	101278	Ref. No. 060325
	olive for pipe ø 10mm Qty 1 pcs		
	GEV No.	101300	Ref. No. —
	union nut thread M16x1.5 tube ø 10mm		















<b>22N/V series</b>			
	1		
<b>GEV No.</b>	106169	<b>Ref. No.</b>	OG0113
<b>description</b>	gas tap PEL type 22N/V gas inlet M20x1.5 (tube ø 12mm) bypass nozzle ø 0.35mm gas outlet M20x1.5 (tube ø 12/10mm) thermocouple connection pilot connection M10x1 shaft ø 6x4.6mm shaft L 45/20mm shaft flat left		
<b>spare parts for</b>	106169		
	GEV No.	100259	Ref. No. —
	bypass nozzle type PEL22 bore ø 0.35mm thread M6x0.5		
	GEV No.	101213	Ref. No. —
	gas tap front part shaft ø 6x4.6mm shaft L 45/20mm shaft flat right/left suitable for PEL22		
	GEV No.	101241	Ref. No. —
	gas connection thread M20x1.5 tube ø 12/10mm for PEL gas taps vertical		
	GEV No.	101460	Ref. No. —
	O-ring ø 12.37mm D1 ø 2.62mm suitable for PEL22		
	GEV No.	101461	Ref. No. —
	screw kit suitable for PEL22 Qty 4 pcs		
<b>accessories for</b>	106169		
	GEV No.	100908	Ref. No. 052125
	union screw thread M10x1 for pipe ø 4mm Qty 1 pcs		
	GEV No.	100909	Ref. No. —
	union screw thread M10x1 for pipe ø 6mm Qty 1 pcs		
	GEV No.	101246	Ref. No. —
	olive for pipe ø 4mm Qty 1 pcs		
	GEV No.	101248	Ref. No. 050682
	olive for pipe ø 12mm Qty 1 pcs suitable for PEL		
	GEV No.	101249	Ref. No. —
	olive for pipe ø 10mm Qty 1 pcs		
	GEV No.	101250	Ref. No. —
	union nut thread M20x1.5 for pipe ø 10mm		
	GEV No.	101251	Ref. No. —
	union nut thread M20x1.5 for pipe ø 12mm		
	GEV No.	101286	Ref. No. —
	olive ID ø 6mm Qty 1 pcs		



## 22S/O series



1

GEV No.	106022	Ref. No.	OK5756	
<b>description</b>	gas tap PEL type 22S/O gas inlet M20x1.5 (tube ø 12mm) bypass nozzle ø 0.35mm gas outlet M20x1.5 (tube ø 12/10mm) thermocouple connection M8x1 pilot connection M10x1 shaft ø 6x4.6mm shaft L 45/20mm shaft flat left			
<b>spare parts for</b>	106022			
	GEV No.	101058	Ref. No.	056594
	magnet unit L 39mm D1 ø 15.4mm D2 ø 13.5mm suitable for PEL22/EGA24197 standard			
	GEV No.	101213	Ref. No.	—
	gas tap front part shaft ø 6x4.6mm shaft L 45/20mm shaft flat right/left suitable for PEL22			
	GEV No.	101230	Ref. No.	—
	thermocouple nut T1: M8x1 T2: M18x1 aluminium			
	GEV No.	101240	Ref. No.	—
	gas connection thread M20x1.5 tube ø 12/10mm for PEL gas taps with gasket and screws horizontal			
	GEV No.	101460	Ref. No.	—
	O-ring ø 12.37mm D1 ø 2.62mm suitable for PEL22			
	GEV No.	101461	Ref. No.	—
	screw kit suitable for PEL22 Qty 4 pcs			
<b>accessories for</b>	106022			
	GEV No.	100908	Ref. No.	052125
	union screw thread M10x1 for pipe ø 4mm Qty 1 pcs			
	GEV No.	100909	Ref. No.	—
	union screw thread M10x1 for pipe ø 6mm Qty 1 pcs			
	GEV No.	101241	Ref. No.	—
	gas connection thread M20x1.5 tube ø 12/10mm for PEL gas taps vertical			
	GEV No.	101246	Ref. No.	—
	olive for pipe ø 4mm Qty 1 pcs			
	GEV No.	101248	Ref. No.	050682
	olive for pipe ø 12mm Qty 1 pcs suitable for PEL			
	GEV No.	101249	Ref. No.	—
	olive for pipe ø 10mm Qty 1 pcs			
	GEV No.	101250	Ref. No.	—
	union nut thread M20x1.5 for pipe ø 10mm			
	GEV No.	101251	Ref. No.	—
	union nut thread M20x1.5 for pipe ø 12mm			
	GEV No.	101286	Ref. No.	—
	olive ID ø 6mm Qty 1 pcs			



1

GEV No.	106023	Ref. No.	OK5619	
<b>description</b>	gas tap PEL type 22S/O gas inlet M20x1.5 (tube ø 12mm) bypass nozzle ø 0mm gas outlet M20x1.5 (tube ø 12/10mm) thermocouple connection M8x1 pilot connection M10x1 shaft ø 6x4.6mm shaft L 29/19.5mm shaft flat lower			
<b>spare parts for</b>	106023			
	GEV No.	101058	Ref. No.	056594
	magnet unit L 39mm D1 ø 15.4mm D2 ø 13.5mm suitable for PEL22/EGA24197 standard			
	GEV No.	101230	Ref. No.	—
	thermocouple nut T1: M8x1 T2: M18x1 aluminium			
	GEV No.	101240	Ref. No.	—
	gas connection thread M20x1.5 tube ø 12/10mm for PEL gas taps with gasket and screws horizontal			
	GEV No.	101460	Ref. No.	—
	O-ring ø 12.37mm D1 ø 2.62mm suitable for PEL22			
	GEV No.	101461	Ref. No.	—
	screw kit suitable for PEL22 Qty 4 pcs			
	GEV No.	106154	Ref. No.	—
	gas tap front part shaft ø 6x4.6mm shaft L 29/19.5mm shaft flat upper/lower suitable for PEL22			
<b>accessories for</b>	106023			
	GEV No.	100908	Ref. No.	052125
	union screw thread M10x1 for pipe ø 4mm Qty 1 pcs			
	GEV No.	100909	Ref. No.	—
	union screw thread M10x1 for pipe ø 6mm Qty 1 pcs			
	GEV No.	101246	Ref. No.	—
	olive for pipe ø 4mm Qty 1 pcs			
	GEV No.	101248	Ref. No.	050682
	olive for pipe ø 12mm Qty 1 pcs suitable for PEL			
	GEV No.	101249	Ref. No.	—
	olive for pipe ø 10mm Qty 1 pcs			
	GEV No.	101250	Ref. No.	—
	union nut thread M20x1.5 for pipe ø 10mm			
	GEV No.	101251	Ref. No.	—
	union nut thread M20x1.5 for pipe ø 12mm			
	GEV No.	101286	Ref. No.	—
	olive ID ø 6mm Qty 1 pcs			
	GEV No.	110080	Ref. No.	—
	knob ø 70mm shaft ø 10x8mm shaft flat universal			

Table continues overleaf





<b>accessories for</b> 106023	
	GEV No. 112206 Ref. No. — knob dial plate silver gas tap PEL21/22/23 t.max.°C ED ø 63mm ID ø 45.5mm

## gas thermostats



### SIT

#### 710 Minisit series



1

<b>GEV No.</b>	106061	<b>Ref. No.</b>	OK5692
<b>description</b>	gas thermostat SIT type MINISIT 710 t.max. 340°C 100-340°C		
<b>spare parts for</b>	106061		
	GEV No. 100809	Ref. No.	—
	O-ring EPDM thickness 2mm ID ø 21mm Qty 1 pcs		
	GEV No. 101053	Ref. No.	—
	magnet unit T1: M9x1 T2: M24x1 L 45mm ø 17mm suitable for Minisit		
	GEV No. 101136	Ref. No.	054269
	piezoelectric igniter suitable for Minisit with cover cap ømm connection F6.3x0.8		
	GEV No. 101269	Ref. No.	—
	gas connection thread 1/2" angled with O-ring MINISIT 710		
	GEV No. 101516	Ref. No.	—
	flat-headed bolt thread M4 thread L 16mm SS DIN 7985/ISO 7045 Qty 1 pcs		
	GEV No. 101517	Ref. No.	—
	flat-headed bolt thread M4 thread L 23mm		
	GEV No. 102107	Ref. No.	—
	probe 100-340°C probe ø 4mm probe L 72mm capillary pipe 1050mm t.max. 340°C oven/grill probe type type C1 suitable for MINISIT 710		
	GEV No. 107564	Ref. No.	—
	piezoelectric igniter body plastic blowing connection F6.3x0.8 ø 22mm		
	GEV No. 110068	Ref. No.	054268
	knob suitable for Minisit ø 37mm		
<b>accessories for</b>	106061		
	GEV No. 101273	Ref. No.	—
	olive for pipe ø 12mm L 9.5mm brass Qty 1 pcs suitable for universal		
	GEV No. 101274	Ref. No.	—
	olive for pipe ø 16mm Qty 1 pcs		
	GEV No. 101275	Ref. No.	—
	union screw thread 1/2" for pipe ø 16mm Qty 1 pcs		

<b>accessories for</b> 106061	
	GEV No. 101276 Ref. No. — union screw thread 3/8" tube ø 12mm Qty 1 pcs
	GEV No. 101278 Ref. No. 060325 olive for pipe ø 10mm Qty 1 pcs
	GEV No. 101279 Ref. No. — union screw thread 3/8" for pipe ø 10mm Qty 1 pcs

## gas valves and ignition boxes

### gas control valves

#### SIT

#### ELETTROSIT



1

<b>GEV No.</b>	101127	<b>Ref. No.</b>	057543
<b>description</b>	gas valve SIT type ELETTROSIT 230V gas inlet 3/4" gas outlet 3/4" thermocouple connection M9x1 pilot connection M10x1 lateral equiv. no. 0.810.175		
<b>spare parts for</b>	101127		
	GEV No. 101312	Ref. No.	—
	microswitch		
	GEV No. 101352	Ref. No.	—
	solenoid coil 230V 50Hz suitable for ELETTROSIT		
<b>accessories for</b>	101127		
	GEV No. 100006	Ref. No.	—
	piezoelectric igniter suitable for ELETTROSIT body plastic blowing connection ø2.4mm ø 14mm		
	GEV No. 100904	Ref. No.	—
	locking screw M10x1 for pipe ø 4mm Qty 1 pcs		
	GEV No. 100905	Ref. No.	—
	locking screw M10x1 for pipe ø 6mm Qty 1 pcs		
	GEV No. 101301	Ref. No.	—
	gas connection thread 1/2" straight ELETTROSIT screw with O-ring		
	GEV No. 101303	Ref. No.	—
	gas connection straight thread 3/4" ELETTROSIT		
	GEV No. 101309	Ref. No.	—
	extension		





NOVASIT



<b>GEV No.</b>	101187	<b>Ref. No.</b>	002606
<b>description</b>	gas valve SIT series Novasit 820 0.17VHz gas inlet 1/2" gas outlet 1/2" thermocouple connection M9x1 pilot connection M10x1 ignition pressurebar pressure range 5-50mbar pressure regulator connection blind equiv. no. 0.820.301 supply Operator millivolt		
<b>spare parts for</b>	101187		
	<b>GEV No.</b>	101065	<b>Ref. No.</b> —
	magnet unit with cable L 44mm D1 ø 30mm D2 ø 20mm suitable for NOVASIT		
<b>accessories for</b>	101187		
	<b>GEV No.</b>	100110	<b>Ref. No.</b> —
	pilot burner SIT type 190 series 3 flames nozzle ømm gas connectionmm		
	<b>GEV No.</b>	101305	<b>Ref. No.</b> —
	gas connection straight 1/2" flange 45x45mm ELETTRISIT/V4400/4600/4605 suitable for SIT/HONEYWELL hole distance 36x36mm		
	<b>GEV No.</b>	101306	<b>Ref. No.</b> —
	gas connection angled flange 45x45mm hole distance 36x36mm 1/2" ELETTRISIT/V4400/4600/4605 screw with O-ring suitable for SIT/HONEYWELL		
	<b>GEV No.</b>	101307	<b>Ref. No.</b> —
	gas connection straight flange 45x45mm hole distance 36x36mm 3/4" ELETTRISIT/V4400/4600/4605 screw with O-ring suitable for SIT/HONEYWELL		
	<b>GEV No.</b>	101308	<b>Ref. No.</b> —
	gas connection angled flange 45x45mm hole distance 36x36mm 3/4" ELETTRISIT/V4400/4600/4605 screw with O-ring suitable for SIT/HONEYWELL		
	<b>GEV No.</b>	102116	<b>Ref. No.</b> 002607
	thermopile ROBERTSHAW L 900mm probe ø 9mm probe L 57mm 250-750mV screw connection 7/16"		

accessories



<b>GEV No.</b>	101928	<b>Ref. No.</b>	059305
<b>description</b>	knob adapter shaft ø 10x8mm shaft L 18mm catch upper suitable for ZANUSSI shaft flat upper		

TANDEM



<b>GEV No.</b>	106219	<b>Ref. No.</b>	0K5838
<b>description</b>	gas valve 230V 50Hz gas inlet 1/2" gas outlet 1/2" pilot connection M10x1 level slow ignition standard ignition time 3-7s Tandem equiv. no. 0.830.020		
<b>spare parts for</b>	106219		
	<b>GEV No.</b>	101379	<b>Ref. No.</b> —
	solenoid coil 230V 50Hz suitable for Tandem		
<b>accessories for</b>	106219		
	<b>GEV No.</b>	101274	<b>Ref. No.</b> —
	olive for pipe ø 16mm Qty 1 pcs		
	<b>GEV No.</b>	101275	<b>Ref. No.</b> —
	union screw thread 1/2" for pipe ø 16mm Qty 1 pcs		
	<b>GEV No.</b>	101925	<b>Ref. No.</b> —
	plug with O-ring thread M10x1 for pilot burner suitable for NOVASIT		
	<b>GEV No.</b>	101936	<b>Ref. No.</b> —
	gasket with screw Tandem		
	<b>GEV No.</b>	102845	<b>Ref. No.</b> —
	gas connection angled 1/2" flange 32x32mm hole distance 24x24mm Tandem		
	<b>GEV No.</b>	102846	<b>Ref. No.</b> —
	gas connection straight 1/2" flange 32x32mm hole distance 24x24mm suitable for Tandem		

ignition parts

pilot burners

SIT

100 series



















<b>GEV No.</b>	106902	<b>Ref. No.</b>	029776
<b>description</b>	pilot burner SIT type 100 series 2 flames nozzle ø 0.2mm gas connection 6mm		
<b>spare parts for</b>	106902		
	<b>GEV No.</b>	100245	<b>Ref. No.</b> 056799
	pilot burner nozzle LPG code 20 bore ø 0.2mm Qty 1 pcs thread M8x0.75		

Table continues overleaf





spare parts for		106902		
	GEV No.	100842	Ref. No.	—
pilot burner cap 2 flames Qty 1 pcs				
	GEV No.	100885	Ref. No.	—
air mixing sleeve for pilot burner Qty 1 pcs				
	GEV No.	100916	Ref. No.	—
compression spring for pilot burner Qty 1 pcs				
	GEV No.	100917	Ref. No.	—
gasket for pilot burner Qty 1 pcs aluminium				
	GEV No.	100918	Ref. No.	—
screw for pilot burner				
	GEV No.	107161	Ref. No.	—
pilot burner cap SIT 2 flames Hmm Lmm Qty 1 pcs				
	GEV No.	107701	Ref. No.	—
pilot burner bottom part SIT 100 series nozzle $\varnothing$ 0.2mm				
accessories for		106902		
	GEV No.	100246	Ref. No.	056656
pilot burner nozzle natural gas bore $\varnothing$ 0.35mm Qty 1 pcs thread M8x0.75				
	GEV No.	100904	Ref. No.	—
locking screw M10x1 for pipe $\varnothing$ 4mm Qty 1 pcs				
	GEV No.	100905	Ref. No.	—
locking screw M10x1 for pipe $\varnothing$ 6mm Qty 1 pcs				
	GEV No.	102110	Ref. No.	—
pilot tube copper pipe $\varnothing$ 4mm thickness 1mm L 3000mm				
	GEV No.	102111	Ref. No.	—
pilot tube copper pipe $\varnothing$ 6mm thickness 1mm L 3000mm				
	GEV No.	107171	Ref. No.	—
pilot burner nozzle SIT natural/liquid gas bore $\varnothing$ 0.25mm Qty 1 pcs				
	GEV No.	107700	Ref. No.	—
pilot burner bottom part SIT 100 series nozzle $\varnothing$ 0.25mm				
	GEV No.	107702	Ref. No.	—
pilot burner bottom part SIT 100 series nozzle $\varnothing$ 0.35mm				

spare parts for		106907		
	GEV No.	100855	Ref. No.	—
pilot burner bracket triple				
	GEV No.	100885	Ref. No.	—
air mixing sleeve for pilot burner Qty 1 pcs				
	GEV No.	100916	Ref. No.	—
compression spring for pilot burner Qty 1 pcs				
	GEV No.	100917	Ref. No.	—
gasket for pilot burner Qty 1 pcs aluminium				
	GEV No.	100918	Ref. No.	—
screw for pilot burner				
	GEV No.	107162	Ref. No.	—
pilot burner cap SIT 3 flames Hmm Lmm Qty 1 pcs				
	GEV No.	107702	Ref. No.	—
pilot burner bottom part SIT 100 series nozzle $\varnothing$ 0.35mm				
accessories for		106907		
	GEV No.	100245	Ref. No.	056799
pilot burner nozzle LPG code 20 bore $\varnothing$ 0.2mm Qty 1 pcs thread M8x0.75				
	GEV No.	100904	Ref. No.	—
locking screw M10x1 for pipe $\varnothing$ 4mm Qty 1 pcs				
	GEV No.	100905	Ref. No.	—
locking screw M10x1 for pipe $\varnothing$ 6mm Qty 1 pcs				
	GEV No.	102110	Ref. No.	—
pilot tube copper pipe $\varnothing$ 4mm thickness 1mm L 3000mm				
	GEV No.	102111	Ref. No.	—
pilot tube copper pipe $\varnothing$ 6mm thickness 1mm L 3000mm				
	GEV No.	107171	Ref. No.	—
pilot burner nozzle SIT natural/liquid gas bore $\varnothing$ 0.25mm Qty 1 pcs				
	GEV No.	107700	Ref. No.	—
pilot burner bottom part SIT 100 series nozzle $\varnothing$ 0.25mm				
	GEV No.	107701	Ref. No.	—
pilot burner bottom part SIT 100 series nozzle $\varnothing$ 0.2mm				

				
1				
<b>GEV No.</b>	106907	<b>Ref. No.</b>	058329	
<b>description</b>	pilot burner SIT type 100 series 3 flames nozzle $\varnothing$ 0.35mm gas connection 6mm			
spare parts for		106907		
	GEV No.	100246	Ref. No.	056656
pilot burner nozzle natural gas bore $\varnothing$ 0.35mm Qty 1 pcs thread M8x0.75				



accessories			
pilot burner brackets			
universal			
			
1			
<b>GEV No.</b>	100854	<b>Ref. No.</b>	052256
<b>description</b>	pilot burner bracket double		

pilot burner nozzles			
			
1			
<b>GEV No.</b>	100245	<b>Ref. No.</b>	056799
<b>description</b>	pilot burner nozzle LPG code 20 bore $\varnothing$ 0.2mm Qty 1 pcs thread M8x0.75		

			
1			
<b>GEV No.</b>	100246	<b>Ref. No.</b>	056656
<b>description</b>	pilot burner nozzle natural gas bore $\varnothing$ 0.35mm Qty 1 pcs thread M8x0.75		

ignition electrodes			
			
1			
<b>GEV No.</b>	100706	<b>Ref. No.</b>	056754
<b>description</b>	ignition electrode connection M4 Qty 1 pcs		

140 - 145 -150 series			
			
1			
<b>GEV No.</b>	100094	<b>Ref. No.</b>	059214
<b>description</b>	pilot burner SIT type 140 series 1 flame nozzle $\varnothing$ mm gas connectionmm for thermocouple $\varnothing$ 5mm		
<b>accessories for</b>	100094		
	<b>GEV No.</b>	100182	<b>Ref. No.</b> 003547
cover for pilot burner Qty 1 pcs			
	<b>GEV No.</b>	100204	<b>Ref. No.</b> —
pilot burner nozzle SIT LPG code 14 bore $\varnothing$ 0.18/0.20mm Qty 1 pcs suitable for 140 series			
	<b>GEV No.</b>	100205	<b>Ref. No.</b> —
pilot burner nozzle SIT LPG code 19 bore $\varnothing$ 0.23/0.26mm Qty 1 pcs suitable for SIT 150 series			

<b>accessories for</b>	100094		
	<b>GEV No.</b>	100206	<b>Ref. No.</b> —
pilot burner nozzle SIT natural gas code 36 bore $\varnothing$ 0.60/0.55mm Qty 1 pcs suitable for SIT 150 series			
	<b>GEV No.</b>	100207	<b>Ref. No.</b> —
pilot burner nozzle SIT natural gas code 27 bore $\varnothing$ 0.40/0.38mm suitable for SIT 140 series			
	<b>GEV No.</b>	100216	<b>Ref. No.</b> —
pilot burner nozzle SIT natural gas code 38 bore $\varnothing$ 0.45mm Qty 1 pcs suitable for SIT 150 series			
	<b>GEV No.</b>	100897	<b>Ref. No.</b> 059161
olive for pipe $\varnothing$ 4mm Qty 1 pcs for pilot burner			
	<b>GEV No.</b>	100898	<b>Ref. No.</b> —
olive for pipe $\varnothing$ 6mm Qty 1 pcs for pilot burner			
	<b>GEV No.</b>	100908	<b>Ref. No.</b> 052125
union screw thread M10x1 for pipe $\varnothing$ 4mm Qty 1 pcs			
	<b>GEV No.</b>	100909	<b>Ref. No.</b> —
union screw thread M10x1 for pipe $\varnothing$ 6mm Qty 1 pcs			
	<b>GEV No.</b>	102110	<b>Ref. No.</b> —
pilot tube copper pipe $\varnothing$ 4mm thickness 1mm L 3000mm			
	<b>GEV No.</b>	102111	<b>Ref. No.</b> —
pilot tube copper pipe $\varnothing$ 6mm thickness 1mm L 3000mm			

## JUNKERS







### CB 503 series

#### pilot burners

			
1			
<b>GEV No.</b>	100058	<b>Ref. No.</b>	0K0205
<b>description</b>	pilot burner JUNKERS type CB503006 natural gas nozzle no.26 gas connection 4mm		
<b>spare parts for</b>	100058		
	<b>GEV No.</b>	100224	<b>Ref. No.</b> —
pilot burner nozzle natural gas gas pressure 25mbar code 26 Qty 1 pcs suitable for JUNKERS CB503_			
	<b>GEV No.</b>	101281	<b>Ref. No.</b> —
olive for pipe $\varnothing$ 4mm L 8.7mm Qty 1 pcs suitable for CB 502/503			
	<b>GEV No.</b>	101283	<b>Ref. No.</b> —
union screw thread M10x1 for pipe $\varnothing$ 4mm Qty 1 pcs			
<b>accessories for</b>	100058		
	<b>GEV No.</b>	100220	<b>Ref. No.</b> 0K1176
pilot burner nozzle LPG gas pressure 50mbar code 2 Qty 1 pcs suitable for JUNKERS CB503_			
	<b>GEV No.</b>	100221	<b>Ref. No.</b> —
pilot burner nozzle LPG gas pressure 30mbar code 29 Qty 1 pcs suitable for JUNKERS CB50203_			

Table continues overleaf



accessories for		100058	
	GEV No.	100222	Ref. No. 0K1126
pilot burner nozzle LPG gas pressure 50mbar code 5 Qty 1 pcs suitable for JUNKERS CB50203_			
	GEV No.	100223	Ref. No. —
pilot burner nozzle natural gas gas pressure 20mbar code 3 Qty 1 pcs suitable for JUNKERS CB503_			
	GEV No.	100226	Ref. No. —
pilot burner nozzle LPG gas pressure 50mbar code 15 suitable for JUNKERS			
	GEV No.	100227	Ref. No. —
pilot burner nozzle natural gas gas pressure 25mbar code 6 Qty 1 pcs suitable for JUNKERS CB50203_			
	GEV No.	100228	Ref. No. —
pilot burner nozzle town gas gas pressure 8mbar code 4 Qty 1 pcs suitable for JUNKERS CB50203_			
	GEV No.	100909	Ref. No. —
union screw thread M10x1 for pipe ø 6mm Qty 1 pcs			
	GEV No.	101287	Ref. No. —
olive for pipe ø 6mm Qty 1 pcs			
	GEV No.	102110	Ref. No. —
pilot tube copper pipe ø 4mm thickness 1mm L 3000mm			
	GEV No.	102111	Ref. No. —
pilot tube copper pipe ø 6mm thickness 1mm L 3000mm			





spare parts for		100093	
	GEV No.	100908	Ref. No. 052125
union screw thread M10x1 for pipe ø 4mm Qty 1 pcs			
accessories for		100093	
	GEV No.	100204	Ref. No. —
pilot burner nozzle SIT LPG code 14 bore ø 0.18/0.20mm Qty 1 pcs suitable for 140 series			
	GEV No.	100205	Ref. No. —
pilot burner nozzle SIT LPG code 19 bore ø 0.23/0.26mm Qty 1 pcs suitable for SIT 150 series			
	GEV No.	100206	Ref. No. —
pilot burner nozzle SIT natural gas code 36 bore ø 0.60/0.55mm Qty 1 pcs suitable for SIT 150 series			
	GEV No.	100207	Ref. No. —
pilot burner nozzle SIT natural gas code 27 bore ø 0.40/0.38mm suitable for SIT 140 series			
	GEV No.	100803	Ref. No. —
gasket for pilot burner Qty 1 pcs			
	GEV No.	100898	Ref. No. —
olive for pipe ø 6mm Qty 1 pcs for pilot burner			
	GEV No.	100909	Ref. No. —
union screw thread M10x1 for pipe ø 6mm Qty 1 pcs			
	GEV No.	102110	Ref. No. —
pilot tube copper pipe ø 4mm thickness 1mm L 3000mm			
	GEV No.	102111	Ref. No. —
pilot tube copper pipe ø 6mm thickness 1mm L 3000mm			

**PRO-GAS**

140 - 145 -150 series

pilot burners



GEV No.	100093	Ref. No.	0H6311
<b>description</b> pilot burner type 150 series 1 flame with accessories			
spare parts for		100093	
	GEV No.	100216	Ref. No. —
pilot burner nozzle SIT natural gas code 38 bore ø 0.45mm Qty 1 pcs suitable for SIT 150 series			
	GEV No.	100701	Ref. No. 059380
ignition electrode connection M4 Qty 1 pcs			
	GEV No.	100897	Ref. No. 059161
olive for pipe ø 4mm Qty 1 pcs for pilot burner			
	GEV No.	100906	Ref. No. 057960
screw connection thread M10x1 for ignition electrode brass Qty 1 pcs WS 10			
	GEV No.	100907	Ref. No. —
screw connection thread M10x1 Qty 1 pcs type SEF 1 ømm for thermocouple			

**producer-specific pilot burners**

THERMA

Thermaline S90 series (version 1)

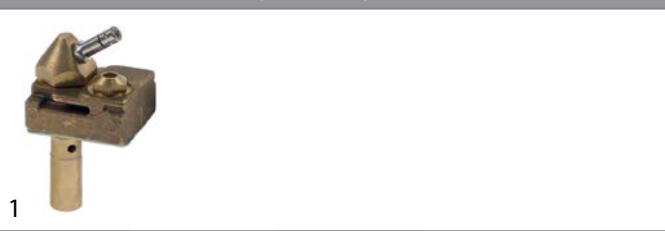

GEV No.	102956	Ref. No.	-
<b>description</b> pilot burner type C without nozzle			









GEV No.	102957	Ref. No.	-
<b>description</b> pilot burner type D without nozzle			





			
1			
<b>GEV No.</b>	102958	<b>Ref. No.</b>	-
<b>description</b>	pilot burner type E without nozzle		

**Thermaline S90 series (version 2)**

			
1			
<b>GEV No.</b>	101856	<b>Ref. No.</b>	0G3101
<b>description</b>	pilot burner with nozzles		
<b>spare parts for</b>	101856		
	<b>GEV No.</b>	100900	<b>Ref. No.</b> —
	air mixing sleeve for pilot burner Qty 1 pcs		
	<b>GEV No.</b>	100979	<b>Ref. No.</b> —
	pilot burner nozzle LPG bore ø 0.25mm code 25 gas pressure 30mbar thread M5x0.8		
	<b>GEV No.</b>	101534	<b>Ref. No.</b> 0G2372
	pilot burner nozzle LPG bore ø 0.19mm code 19 gas pressure 50mbar thread M5x0.8 suitable for THERMA/ELECTROLUX		
	<b>GEV No.</b>	101543	<b>Ref. No.</b> 0K1185
	pilot burner nozzle natural gas bore ø 0.3mm code 30 gas pressure 20mbar thread M5x0.8		
	<b>GEV No.</b>	101583	<b>Ref. No.</b> —
	pilot burner head slit width 0.8mm bore ø 3mm ø 6mm M7x0.75mm total length 22mm WS 8 nickel-plated brass		
	<b>GEV No.</b>	101587	<b>Ref. No.</b> —
	gasket for pilot burner without ignition electrode		

**Thermaline 800 / 900 series**

			
1			
<b>GEV No.</b>	102916	<b>Ref. No.</b>	0K5767
<b>description</b>	cap for pilot burner		

			
1			
<b>GEV No.</b>	102917	<b>Ref. No.</b>	0K5768
<b>description</b>	cap for pilot burner		

			
1			
<b>GEV No.</b>	106247	<b>Ref. No.</b>	0K5715
<b>description</b>	double nipple T1: M10x1 T2: M10x1		

**miscellaneous**

			
1			
<b>GEV No.</b>	101937	<b>Ref. No.</b>	0G2965
<b>description</b>	pilot burner		

**electrodes**

			
1			
<b>GEV No.</b>	102965	<b>Ref. No.</b>	0K1351
<b>description</b>	ignition electrode connection F 2.8x0.8mm		





<b>GEV No.</b>	100701	<b>Ref. No.</b>	059380
<b>description</b>	ignition electrode connection M4 Qty 1 pcs		
<b>accessories for</b>	100701		
	<b>GEV No.</b>	100906	<b>Ref. No.</b> 057960
	screw connection thread M10x1 for ignition electrode brass Qty 1 pcs WS 10		

<b>GEV No.</b>	100706	<b>Ref. No.</b>	056754
<b>description</b>	ignition electrode connection M4 Qty 1 pcs		

<b>GEV No.</b>	101779	<b>Ref. No.</b>	N/A
<b>description</b>	ignition electrode D1 ø 7mm D2 ø 9mm connection M4 L1 10mm L2 5mm BL1 18mm BL2 3mm BL3 23mm to clip		

<b>GEV No.</b>	102170	<b>Ref. No.</b>	0A5169
<b>description</b>	ignition electrode flange length 24mm flange width 17mm D1 ø 10mm fixing dimensions ø4.5mm with flange		

<b>GEV No.</b>	102169	<b>Ref. No.</b>	003556
<b>description</b>	ignition electrode flange length 24mm flange width 17mm D1 ø 9.5mm L1 45mm L2 30mm L4 18mm L3 17mm BL1 30mm BL2 28mm fixing dimensions ø4.5mm with flange connection ø 6mm		

<b>GEV No.</b>	100906	<b>Ref. No.</b>	057960
<b>description</b>	screw connection thread M10x1 for ignition electrode brass Qty 1 pcs WS 10		

**ignition cables**

pre-assembled cables

<b>GEV No.</b>	100026	<b>Ref. No.</b>	054273
<b>description</b>	ignition cable cable length 1000mm connection ø4mm / F6.3mm		

**piezoelectric igniters**

miscellaneous

<b>GEV No.</b>	nla <sup>1</sup>	<b>Ref. No.</b>	0K5693
<b>description</b>	piezoelectric igniter body metal connection F6.3x0.8 3 hole fixing ø 22mm		

<sup>1</sup>no longer available

1

<b>GEV No.</b>	nla <sup>1</sup>	<b>Ref. No.</b>	002057
<b>description</b>	piezoelectric igniter suitable for Minisit connection F6.3x0.8 ømm		

<sup>1</sup>no longer available



1

<b>GEV No.</b>	nla <sup>1</sup>	<b>Ref. No.</b>	054269
<b>description</b>	piezoelectric igniter suitable for Minisit with cover cap ømm connection F6.3x0.8		
<b>spare parts for</b>	101136		
	<b>GEV No.</b>	100001	<b>Ref. No.</b> 002057
	piezoelectric igniter suitable for Minisit connection F6.3x0.8 ømm		

<sup>1</sup>no longer available

## ignition switches



1

<b>GEV No.</b>	301014	<b>Ref. No.</b>	0K6805
<b>description</b>	momentary rocker switch mounting measurements 30x11mm black 1NO 250V 16A connection male faston 6.3mm ambient temperature max. 85/125°C protection IP40 mounting ømm male faston 6.3mm		

## thermocouples

### plug-in thermocouples

### plug-in thermocouples standard

### with barrel socket ø5mm - type Junkers with aluminised tip





1

<b>GEV No.</b>	102202	<b>Ref. No.</b>	0K1368
<b>description</b>	thermocouple M8x1 L 320mm plug connection ø5.0mm		
<b>accessories for</b>	102202		
	<b>GEV No.</b>	101260	<b>Ref. No.</b> —
	thermocouple fitting thread M8x1 Qty 1 pcs		



1

<b>GEV No.</b>	102205	<b>Ref. No.</b>	058332
<b>description</b>	thermocouple M8x1 L 750mm plug connection ø5.0mm		
<b>accessories for</b>	102205		
	<b>GEV No.</b>	101260	<b>Ref. No.</b> —
	thermocouple fitting thread M8x1 Qty 1 pcs		



1

<b>GEV No.</b>	102294	<b>Ref. No.</b>	0K1369
<b>description</b>	thermocouple M8x1 L 750mm plug connection ø5.0mm		

### with barrel socket ø6(6.5)mm thermocouples SIT

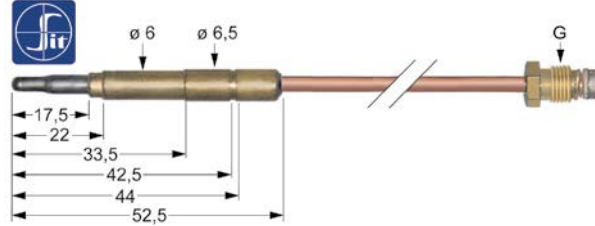

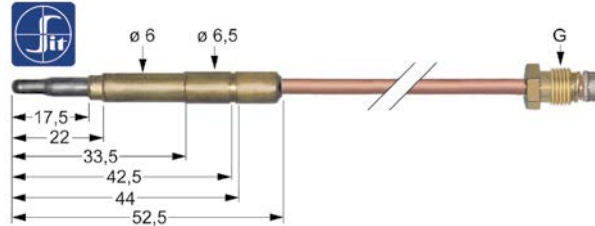

1

<b>GEV No.</b>	107601	<b>Ref. No.</b>	0G1120
<b>description</b>	thermocouple SIT M8x1 L 600mm plug connection ø6.0(6.5)mm		



1

<b>GEV No.</b>	107602	<b>Ref. No.</b>	0C0202
<b>description</b>	thermocouple SIT M8x1 L 850mm plug connection ø6.0(6.5)mm		
<b>accessories for</b>	107602		
	<b>GEV No.</b>	100920	<b>Ref. No.</b> —
	thermocouple fitting thread M8x1 / M9x1 Qty 1 pcs		
	<b>GEV No.</b>	100922	<b>Ref. No.</b> —
	thermocouple fitting thread M10x1 / ASA 11/32 Qty 1 pcs		



<b>GEV No.</b>	107613	<b>Ref. No.</b>	0K3464
<b>description</b>	thermocouple SIT M9x1 L 1200mm plug connection ø6.0(6.5)mm		

plug-in thermocouples with interruption

<b>GEV No.</b>	107863	<b>Ref. No.</b>	0C3162
<b>description</b>	thermocouple SIT with interrupter M9x1 L 1000mm plug connection ø6.0(6.5)mm cable 820mm		

threaded thermocouples  
threaded thermocouples standard  
with socket with thread M8x1  
SIT

<b>GEV No.</b>	107630	<b>Ref. No.</b>	19012635	
<b>description</b>	thermocouple SIT M8x1 L 600mm M8x1			
<b>accessories for</b>	107630			
	<b>GEV No.</b>	102067	<b>Ref. No.</b>	—
	nut thread M8x1 H 3mm brass Qty 1 pcs type SEF 1			

thermopiles

<b>GEV No.</b>	102116	<b>Ref. No.</b>	002607
<b>description</b>	thermopile ROBERTSHAW L 900mm probe ø 9mm probe L 57mm 250-750mV screw connection 7/16"		

accessories

screws

<b>GEV No.</b>	106246	<b>Ref. No.</b>	0K5713
<b>description</b>	screw thread M8x1 IT / M12x1 ET for thermocouple		

miscellaneous

<b>GEV No.</b>	106245	<b>Ref. No.</b>	0K5775
<b>description</b>	sleeve for thermocouple thread M12x1		

gas burners  
hob burners

producer-specific hob burners

THERMA

Thermaline S90 series

<b>GEV No.</b>	104540	<b>Ref. No.</b>	17012726
<b>description</b>	burner cap C ø 83mm 3.5kW		

<b>GEV No.</b>	104460	<b>Ref. No.</b>	17012727
<b>description</b>	burner cap D ø 94mm 5kW with central hole		

<b>GEV No.</b>	104542	<b>Ref. No.</b>	17012728	
<b>description</b>	burner cap E ø 114mm mounting ø 105mm ID ø 45mm 7kW with central hole bore ø 3mm			
<b>accessories for</b>	104542			
	<b>GEV No.</b>	104507	<b>Ref. No.</b>	17012725
	burner head E for burner cap ø 115mm			





		
1		
<b>GEV No.</b>	104500	<b>Ref. No.</b>
		17012723
<b>description</b>	burner head C for burner cap ø 85mm	

		
1		
<b>GEV No.</b>	104505	<b>Ref. No.</b>
		17012724
<b>description</b>	burner head D for burner cap ø 95mm	

		
1		
<b>GEV No.</b>	104507	<b>Ref. No.</b>
		17012725
<b>description</b>	burner head E for burner cap ø 115mm	

		
1		
<b>GEV No.</b>	104707	<b>Ref. No.</b>
		17012729
<b>description</b>	burner lower part C complete	

		
1		
<b>GEV No.</b>	104708	<b>Ref. No.</b>
		17012730
<b>description</b>	burner lower part D complete	

		
1		
<b>GEV No.</b>	104709	<b>Ref. No.</b>
		17012731
<b>description</b>	burner lower part E complete	

		
1		
<b>GEV No.</b>	104511	<b>Ref. No.</b>
		17012722
<b>description</b>	gasket ø 72mm ID ø 45mm for burner head H 1.2mm perforation ø 5mm	

		
1		
<b>GEV No.</b>	104522	<b>Ref. No.</b>
		17012721
<b>description</b>	nozzle holder ID ø 10mm ET M17x1	

## Thermaline 800/900, Starline series

		
1		
<b>GEV No.</b>	106248	<b>Ref. No.</b>
		19012588
<b>description</b>	air mixing tube ID ø 15mm	

		
1		
<b>GEV No.</b>	106249	<b>Ref. No.</b>
		19012587
<b>description</b>	air mixing tube ID ø 17mm	

		
1		
<b>GEV No.</b>	104744	<b>Ref. No.</b>
		19012600
<b>description</b>	burner cap 3.5kW ø 53mm	

		
1		
<b>GEV No.</b>	104746	<b>Ref. No.</b>
		19012601
<b>description</b>	burner cap 5.6kW ø 78mm	

		
1		
<b>GEV No.</b>	104748	<b>Ref. No.</b>
		19012602
<b>description</b>	burner cap 8.4kW ø 103mm	

		
1		
<b>GEV No.</b>	105990	<b>Ref. No.</b>
		19012941
<b>description</b>	burner cap ø 103mm 7kW with central hole mounting pos. outer	



			
1			
<b>GEV No.</b>	105988	<b>Ref. No.</b>	19012942
<b>description</b>	burner cap ø 40mm 7kW mounting pos. inner		

			
1			
<b>GEV No.</b>	104750	<b>Ref. No.</b>	19012925
<b>description</b>	burner head 3.5kW for burner cap ø 53mm KBF suitable for simmering plate		

			
1			
<b>GEV No.</b>	104759	<b>Ref. No.</b>	0G1905
<b>description</b>	burner head 3.5kW for burner cap ø 53mm simmering plate		

			
1			
<b>GEV No.</b>	104747	<b>Ref. No.</b>	0K5682
<b>description</b>	burner head 5.6kW for burner cap ø 78mm		

			
1			
<b>GEV No.</b>	104751	<b>Ref. No.</b>	19012619
<b>description</b>	burner head 5.6kW for burner cap ø 78mm		

			
1			
<b>GEV No.</b>	104769	<b>Ref. No.</b>	19013008
<b>description</b>	burner head 5.6kW for burner cap ø 78mm grill/griddle plate		

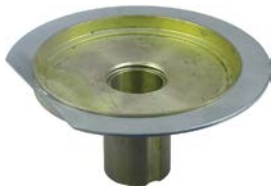
			
1			
<b>GEV No.</b>	104749	<b>Ref. No.</b>	19012612
<b>description</b>	burner head 8.4kW for burner cap ø 103mm		

			
1			
<b>GEV No.</b>	105989	<b>Ref. No.</b>	19012946
<b>description</b>	burner head for burner cap ø 40/103mm 7kW		

			
1			
<b>GEV No.</b>	104745	<b>Ref. No.</b>	0K5681
<b>description</b>	burner head suitable for burner 3.7kW		

			
1			
<b>GEV No.</b>	104753	<b>Ref. No.</b>	19012711
<b>description</b>	nozzle holder		

**bar burners**

bar burners

			
1			
<b>GEV No.</b>	104581	<b>Ref. No.</b>	006650
<b>description</b>	bar burner 2 row L 550mm W 190mm ømm H 50mm griddle		

			
1			
<b>GEV No.</b>	104580	<b>Ref. No.</b>	0A5124
<b>description</b>	bar burner 3 row L 645mm W 190mm ømm H 45mm griddle		





			
1			
<b>GEV No.</b>	104186	<b>Ref. No.</b>	0H6337
<b>description</b>	bar burner ømm W 28mm H 49mm L 510mm with ignition bridge 170mm flange width 35mm flange length 70mm tilting bratt pan		

			
1			
<b>GEV No.</b>	105999	<b>Ref. No.</b>	0G3823
<b>description</b>	bar burner slotted ømm W 30mm H 55mm L 500mm gas range		

			
1			
<b>GEV No.</b>	104590	<b>Ref. No.</b>	0TR593
<b>description</b>	bar burner T-shape L 224mm ø 32mm bain marie		

### tube burners

			
1			
<b>GEV No.</b>	105071	<b>Ref. No.</b>	059297
<b>description</b>	tubular burner L 265mm W 50mm H 71mm for fryer oval suitable for 700/900 series		

### accessories

#### nozzle holders

			
1			
<b>GEV No.</b>	104753	<b>Ref. No.</b>	19012711
<b>description</b>	nozzle holder		

			
1			
<b>GEV No.</b>	104522	<b>Ref. No.</b>	17012721
<b>description</b>	nozzle holder ID ø 10mm ET M17x1		

### gas nozzles

#### main nozzles

##### gas nozzles M10x1

			
1			
<b>GEV No.</b>	100155	<b>Ref. No.</b>	056470
<b>description</b>	gas injector thread M10x1 bore ø 1.45mm L 30mm WS 12		

			
1			
<b>GEV No.</b>	106403	<b>Ref. No.</b>	054033
<b>description</b>	gas injector thread M10x1 bore ø 1.9mm L 30mm WS 12		

			
1			
<b>GEV No.</b>	102499	<b>Ref. No.</b>	056471
<b>description</b>	gas injector thread M10x1 bore ø 2.25mm L 30mm WS 12		

##### gas nozzles M12x1

			
1			
<b>GEV No.</b>	100279	<b>Ref. No.</b>	0KW937
<b>description</b>	gas injector thread M12x1 WS 14 bore ø 0.82mm		

			
1			
<b>GEV No.</b>	100280	<b>Ref. No.</b>	0G2773
<b>description</b>	gas injector thread M12x1 WS 14 bore ø 0.93mm		

			
1			
<b>GEV No.</b>	100282	<b>Ref. No.</b>	0KW934
<b>description</b>	gas injector thread M12x1 WS 14 bore ø 0.95mm		





			
1			
<b>GEV No.</b>	100285	<b>Ref. No.</b>	0G2774
<b>description</b>	gas injector thread M12x1 WS 14 bore ø 1.10mm		

			
1			
<b>GEV No.</b>	100239	<b>Ref. No.</b>	0G2396
<b>description</b>	gas injector thread M12x1 WS 14 bore ø 1.65mm		

			
1			
<b>GEV No.</b>	100243	<b>Ref. No.</b>	0KW933
<b>description</b>	gas injector thread M12x1 WS 14 bore ø 1.12mm		

			
1			
<b>GEV No.</b>	100288	<b>Ref. No.</b>	0K1229
<b>description</b>	gas injector thread M12x1 WS 14 bore ø 1.70mm		

			
1			
<b>GEV No.</b>	100286	<b>Ref. No.</b>	0K1246
<b>description</b>	gas injector thread M12x1 WS 14 bore ø 1.30mm		

			
1			
<b>GEV No.</b>	100289	<b>Ref. No.</b>	0G3001
<b>description</b>	gas injector thread M12x1 WS 14 bore ø 1.80mm		

			
1			
<b>GEV No.</b>	100669	<b>Ref. No.</b>	0G2395
<b>description</b>	gas injector thread M12x1 WS 14 bore ø 1.37mm		

			
1			
<b>GEV No.</b>	100740	<b>Ref. No.</b>	0G2397
<b>description</b>	gas injector thread M12x1 WS 14 bore ø 1.95mm		

			
1			
<b>GEV No.</b>	100307	<b>Ref. No.</b>	0K1224
<b>description</b>	gas injector thread M12x1 WS 14 bore ø 1.40mm		

			
1			
<b>GEV No.</b>	100291	<b>Ref. No.</b>	0G2914
<b>description</b>	gas injector thread M12x1 WS 14 bore ø 2.00mm		

			
1			
<b>GEV No.</b>	100700	<b>Ref. No.</b>	0G3463
<b>description</b>	gas injector thread M12x1 WS 14 bore ø 1.50mm		

			
1			
<b>GEV No.</b>	100744	<b>Ref. No.</b>	0G2915
<b>description</b>	gas injector thread M12x1 WS 14 bore ø 2.12mm		

			
1			
<b>GEV No.</b>	100301	<b>Ref. No.</b>	0G3804
<b>description</b>	gas injector thread M12x1 WS 14 bore ø 1.55mm		

			
1			
<b>GEV No.</b>	100309	<b>Ref. No.</b>	0K1230
<b>description</b>	gas injector thread M12x1 WS 14 bore ø 2.30mm		

			
1			
<b>GEV No.</b>	100294	<b>Ref. No.</b>	0G3803
<b>description</b>	gas injector thread M12x1 WS 14 bore ø 2.40mm		

			
1			
<b>GEV No.</b>	100416	<b>Ref. No.</b>	0G3511
<b>description</b>	gas injector thread M12x1 WS 14 bore ø 2.55mm		

			
1			
<b>GEV No.</b>	100304	<b>Ref. No.</b>	0G3891
<b>description</b>	gas injector thread M12x1 WS 14 bore ø 2.60mm		

			
1			
<b>GEV No.</b>	100752	<b>Ref. No.</b>	0G2964
<b>description</b>	gas injector thread M12x1 WS 14 bore ø 3.20mm		

			
1			
<b>GEV No.</b>	100762	<b>Ref. No.</b>	0G3892
<b>description</b>	gas injector thread M12x1 WS 14 bore ø 4.10mm		

**pilot burner nozzles**

**pilot burner nozzles EGA**

			
1			
<b>GEV No.</b>	101534	<b>Ref. No.</b>	0G2372
<b>description</b>	pilot burner nozzle LPG bore ø 0.19mm code 19 gas pressure 50mbar thread M5x0.8 suitable for THERMA/ELECTROLUX		

			
1			
<b>GEV No.</b>	101543	<b>Ref. No.</b>	0K1185
<b>description</b>	pilot burner nozzle natural gas bore ø 0.3mm code 30 gas pressure 20mbar thread M5x0.8		

**pilot burner nozzles JUNKERS**

**CB 50203\_/503\_ series**

			
1			
<b>GEV No.</b>	100220	<b>Ref. No.</b>	0K1176
<b>description</b>	pilot burner nozzle LPG gas pressure 50mbar code 2 Qty 1 pcs suitable for JUNKERS CB503_		

			
1			
<b>GEV No.</b>	100222	<b>Ref. No.</b>	0K1126
<b>description</b>	pilot burner nozzle LPG gas pressure 50mbar code 5 Qty 1 pcs suitable for JUNKERS CB50203_		

**pilot burner nozzles SIT**

**100 series**

			
1			
<b>GEV No.</b>	100245	<b>Ref. No.</b>	056799
<b>description</b>	pilot burner nozzle LPG code 20 bore ø 0.2mm Qty 1 pcs thread M8x0.75		

			
1			
<b>GEV No.</b>	100246	<b>Ref. No.</b>	056656
<b>description</b>	pilot burner nozzle natural gas bore ø 0.35mm Qty 1 pcs thread M8x0.75		

			
1			
<b>GEV No.</b>	107170	<b>Ref. No.</b>	058525
<b>description</b>	pilot burner nozzle SIT natural gas bore ø 0.35mm Qty 1 pcs		

**160 series**

			
1			
<b>GEV No.</b>	107172	<b>Ref. No.</b>	054593
<b>description</b>	pilot burner nozzle SIT LPG code 25 Qty 1 pcs		



bypass nozzles

bypass nozzles PEL20/21



1			
<b>GEV No.</b>	100554	<b>Ref. No.</b>	002900
<b>description</b>	bypass nozzle type PEL20/21 bore $\varnothing$ 0.45mm thread M5x0.5		



1			
<b>GEV No.</b>	100548	<b>Ref. No.</b>	002991
<b>description</b>	bypass nozzle type PEL20/21 bore $\varnothing$ 0.65mm thread M5x0.5		



1			
<b>GEV No.</b>	100528	<b>Ref. No.</b>	002926
<b>description</b>	bypass nozzle type PEL20/21 bore $\varnothing$ 0.9mm thread M5x0.5		

bypass nozzles PEL22



1			
<b>GEV No.</b>	100414	<b>Ref. No.</b>	004261
<b>description</b>	bypass nozzle type PEL22 bore $\varnothing$ 0.45mm thread M6x0.5		

auxiliary gas parts

screw connections

olives



1			
<b>GEV No.</b>	101278	<b>Ref. No.</b>	060325
<b>description</b>	olive for pipe $\varnothing$ 10mm Qty 1 pcs		

<b>accessories for</b>	101278		
	<b>GEV No.</b>	100943	<b>Ref. No.</b>
			OKL494

union nut thread M17x1 tube  $\varnothing$  10mm

	<b>GEV No.</b>	101300	<b>Ref. No.</b>
			—

union nut thread M16x1.5 tube  $\varnothing$  10mm

	<b>GEV No.</b>	101478	<b>Ref. No.</b>
			—

union nut thread 3/8" for pipe  $\varnothing$  10mm



1			
<b>GEV No.</b>	101248	<b>Ref. No.</b>	050682
<b>description</b>	olive for pipe $\varnothing$ 12mm Qty 1 pcs suitable for PEL		

<b>accessories for</b>	101248		
	<b>GEV No.</b>	101251	<b>Ref. No.</b>
			—

union nut thread M20x1.5 for pipe  $\varnothing$  12mm



1			
<b>GEV No.</b>	100897	<b>Ref. No.</b>	059161
<b>description</b>	olive for pipe $\varnothing$ 4mm Qty 1 pcs for pilot burner		

union nuts



1			
<b>GEV No.</b>	100943	<b>Ref. No.</b>	OKL494
<b>description</b>	union nut thread M17x1 tube $\varnothing$ 10mm		

<b>accessories for</b>	100943		
	<b>GEV No.</b>	101278	<b>Ref. No.</b>
			060325

olive for pipe  $\varnothing$  10mm Qty 1 pcs

union screws



1			
<b>GEV No.</b>	100906	<b>Ref. No.</b>	057960
<b>description</b>	screw connection thread M10x1 for ignition electrode brass Qty 1 pcs WS 10		



1			
<b>GEV No.</b>	100908	<b>Ref. No.</b>	052125
<b>description</b>	union screw thread M10x1 for pipe $\varnothing$ 4mm Qty 1 pcs		

<b>accessories for</b>	100908		
	<b>GEV No.</b>	100897	<b>Ref. No.</b>
			059161

olive for pipe  $\varnothing$  4mm Qty 1 pcs for pilot burner

	<b>GEV No.</b>	101246	<b>Ref. No.</b>
			—

olive for pipe  $\varnothing$  4mm Qty 1 pcs

	<b>GEV No.</b>	101280	<b>Ref. No.</b>
			—

olive for pipe  $\varnothing$  4mm Qty 1 pcs

	<b>GEV No.</b>	101282	<b>Ref. No.</b>
			—

olive for pipe  $\varnothing$  4mm L 7.4mm Qty 1 pcs

## equipment-specific units

## for convection ovens/combi-steamers

## filters



1

<b>GEV No.</b>	514425	<b>Ref. No.</b>	0C1740
<b>description</b>	drain filter ø 102mm		

## for boiling pans

## miscellaneous



1

<b>GEV No.</b>	691254	<b>Ref. No.</b>	0KJ532
<b>description</b>	lever for tilting kettle		



1

<b>GEV No.</b>	540993	<b>Ref. No.</b>	0TR591
<b>description</b>	support for manometer size 1/2"		

## for dishwashers

## containers

## accessories



1

<b>GEV No.</b>	504703	<b>Ref. No.</b>	048434
<b>description</b>	lid suitable for ZANUSSI equiv. no. 048434 external height 20mm		

## boilers

## accessories



1

<b>GEV No.</b>	517339	<b>Ref. No.</b>	005381
<b>description</b>	flange ø 74mm ID ø 33mm thickness 1mm hole ø 9mm		

## air traps

## air traps



1

<b>GEV No.</b>	504620	<b>Ref. No.</b>	048308
----------------	--------	-----------------	--------

**description** air trap**accessories for** 504620

<b>GEV No.</b>	504618	<b>Ref. No.</b>	—
<b>description</b>	O-ring EPDM thickness 2.62mm ID ø 15.54mm Qty 1 pcs		



<b>GEV No.</b>	504621	<b>Ref. No.</b>	—
<b>description</b>	nut		



1

<b>GEV No.</b>	504622	<b>Ref. No.</b>	046631
----------------	--------	-----------------	--------

**description** air trap**accessories for** 504622

<b>GEV No.</b>	511452	<b>Ref. No.</b>	—
<b>description</b>	gasket for air trap		



<b>GEV No.</b>	528487	<b>Ref. No.</b>	—
<b>description</b>	O-ring EPDM thickness 2.62mm ID ø 9.19mm Qty 1 pcs		



1

<b>GEV No.</b>	510103	<b>Ref. No.</b>	069515
----------------	--------	-----------------	--------

**description** air trap L 85mm W 20mm H 80mm hose ø 6mm plastic**spare parts for** 510103

<b>GEV No.</b>	505045	<b>Ref. No.</b>	—
<b>description</b>	O-ring EPDM thickness 1.78mm ID ø 5.28mm Qty 1 pcs		



<b>GEV No.</b>	505094	<b>Ref. No.</b>	—
<b>description</b>	air trap		



<b>GEV No.</b>	510016	<b>Ref. No.</b>	—
<b>description</b>	eye bolt for rinse aid container connection		

Table continues overleaf







spare parts for 510103			
	GEV No.	510105	Ref. No. —
hose connector for air trap			

## mechanics for flight type dishwashers

			
1	GEV No.	510598	Ref. No. 0E5006
description guide for spindle L 60mm W 40mm hole ø 21mm thickness 15mm			

			
1	GEV No.	511483	Ref. No. 0K8142
description hook			

			
1	GEV No.	504603	Ref. No. 0K8166
description hook for dishwasher			

## door mechanics

### springs

#### roller springs

			
1	GEV No.	519449	Ref. No. 0E5158
description roller spring W 25mm ID ø 32mm lug lengthmm			

### locks

			
1	GEV No.	504659	Ref. No. 047491
description door catch L 84mm W 19mm H 31mm mounting distance 64mm catch housing			

## curtains

### curtains

			
1	GEV No.	533004	Ref. No. 0E5038
description curtain W 550mm H 355mm			

## washing and rinsing systems

			
1	GEV No.	504547	Ref. No. 047283
description knurled nut thread M8x1 ø 25mm H 6mm SS			

			
1	GEV No.	504258	Ref. No. 0E2969
description wash pipe ø 63mm L 185mm L-shape			

## knobs

### universal knobs

			
1	GEV No.	110242	Ref. No. 0K9909
description knob thermostat t.max. 180°C ø 50mm shaft ø 6x4.6mm shaft flat upper black temperature range 100-180°C			

### producer-specific knobs

#### ELECTROLUX/THERMA

			
1	GEV No.	112054	Ref. No. 0KI391
description knob gas tap with ignition flame t.max.°C temperature range°C ø 60mm shaft ø 6x4.6mm shaft flat lower blue			



1

<b>GEV No.</b>	111824	<b>Ref. No.</b>	OG3711
<b>description</b>	knob gas tap with ignition flame t.max.°C temperature range°C ø 60mm shaft ø 6x4.6mm shaft flat upper blue		



1

<b>GEV No.</b>	111827	<b>Ref. No.</b>	OG3648
<b>description</b>	knob switch zero mark t.max.°C temperature range°C ø 60mm shaft ø 6x4.6mm shaft flat lower dark blue		

### accessories

#### covers



1

<b>GEV No.</b>	112107	<b>Ref. No.</b>	OG3399
<b>description</b>	lid knob		

#### fascias



1

<b>GEV No.</b>	112106	<b>Ref. No.</b>	OK5794
<b>description</b>	bezel zero mark		

## handles and hand wheels

### hand wheels

#### hand wheels



1

<b>GEV No.</b>	690085	<b>Ref. No.</b>	OK5532
<b>description</b>	hand wheel ø 200mm D1 ø 48mm bore ø 20mm thread groove widthmm L1 30mm L2 60mm handle length 82mm with folding handle		
<b>spare parts for</b>	690085		
	<b>GEV No.</b>	514255	<b>Ref. No.</b> —
	folding handle ø 26mm total length 85mm seat ø 20mm shaft ømm thread M6 with pin L 85mm		



1

<b>GEV No.</b>	690551	<b>Ref. No.</b>	0H6472
<b>description</b>	hand wheel ø 200mm D1 ø 48mm bore ø 20mm thread M8 groove widthmm L1 30mm L2 60mm handle length 80mm no fold-away handle		

### lever handles



1

<b>GEV No.</b>	540929	<b>Ref. No.</b>	056887
<b>description</b>	lever handle suitable for outlet tap shaft 8x8mm L 90mm		

### recessed handles



1

<b>GEV No.</b>	504780	<b>Ref. No.</b>	047481
<b>description</b>	handle		



## locks

### edgemount latches

#### handle latches

#### producer-specific

#### ZANUSSI

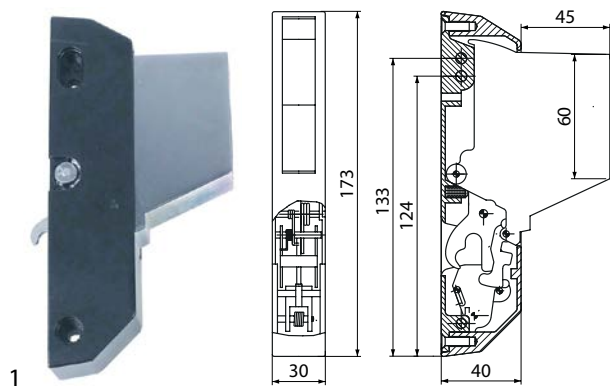

1

<b>GEV No.</b>	700467	<b>Ref. No.</b>	002647
----------------	--------	-----------------	--------

**description** catch L 173mm H 40mm mounting distance 133/124mm W 30mm non lockable 6200 total length 170mm overall height 85mm

**accessories for** 700467

	<b>GEV No.</b>	693937	<b>Ref. No.</b>	0F0029
--	----------------	--------	-----------------	--------

door handle H 44mm L 220mm W 50mm plastic black

	<b>GEV No.</b>	700468	<b>Ref. No.</b>	002650
--	----------------	--------	-----------------	--------

door catch with roller

	<b>GEV No.</b>	701412	<b>Ref. No.</b>	—
--	----------------	--------	-----------------	---

cover cap plastic round  $\varnothing$  11mm black for catch thickness 8mm

### door catches



1

<b>GEV No.</b>	700468	<b>Ref. No.</b>	002650
----------------	--------	-----------------	--------

**description** door catch with roller

## hinges

### door bearing



1

<b>GEV No.</b>	700480	<b>Ref. No.</b>	002875
----------------	--------	-----------------	--------

**description** hinge bearing mounting pos. lower with bolt

### accessories

#### base plate



1

<b>GEV No.</b>	700479	<b>Ref. No.</b>	002877
----------------	--------	-----------------	--------

**description** base plate for door hinge mounting pos. upper left

### miscellaneous



1

<b>GEV No.</b>	700474	<b>Ref. No.</b>	002653
----------------	--------	-----------------	--------

**description** disc for hinge corrugated



1

<b>GEV No.</b>	700478	<b>Ref. No.</b>	002645
----------------	--------	-----------------	--------

**description** protector for glass door for hinge

## fittings for catering equipment

### aerators and air bleeders



1

<b>GEV No.</b>	540014	<b>Ref. No.</b>	OK5787
----------------	--------	-----------------	--------

**description** aerator and air bleeder thread 1/2" ET chrome-plated L 78mm

**spare parts for** 540014



	<b>GEV No.</b>	112777	<b>Ref. No.</b>	—
--	----------------	--------	-----------------	---

star handle shaft 6x6mm  $\varnothing$  50mm L 18mm black plastic

	<b>GEV No.</b>	540365	<b>Ref. No.</b>	—
--	----------------	--------	-----------------	---

star handle shaft 6x6mm  $\varnothing$  50mm L 18mm black thermoplastic



<b>GEV No.</b>	540013	<b>Ref. No.</b>	OG3246	
<b>description</b>	aerator and air bleeder thread 3/8" ET WS 27 chrome-plated L 86mm			
<b>spare parts for</b>	540013			
	<b>GEV No.</b>	112777	<b>Ref. No.</b>	—
	star handle shaft 6x6mm ø 50mm L 18mm black plastic			
	<b>GEV No.</b>	540365	<b>Ref. No.</b>	—
	star handle shaft 6x6mm ø 50mm L 18mm black thermoplastic			



<b>GEV No.</b>	540949	<b>Ref. No.</b>	0H9729
<b>description</b>	aerator and air bleeder thread 1/2" ET chrome-plated with O-ring L 15mm ø 25mm		

## lid hinges

### type ECHTERMANN

#### 10 series

#### 10.81



<b>GEV No.</b>	692648	<b>Ref. No.</b>	OK5245
<b>description</b>	lid hinge type 1081 level of centre of rotation 35mm load capacity 10-20NM opening angle 75° closing angle 10° mounting distance 198mm bore ø 11mm MD lid 100mm chrome-plated brass		



<b>GEV No.</b>	691203	<b>Ref. No.</b>	OK5247	
<b>description</b>	lid hinge type 1081 level of centre of rotation 45mm load capacity 50-60NM opening angle 75° closing angle 10° mounting distance 198mm bore ø 11mm MD lid 100mm chrome-plated brass			
<b>spare parts for</b>	691203			
	<b>GEV No.</b>	691614	<b>Ref. No.</b>	—
	repair kit for lid hinge load capacity 50-60NM			

## FITTINGS FOR CATERING EQUIPMENT THERMA

### 10.82

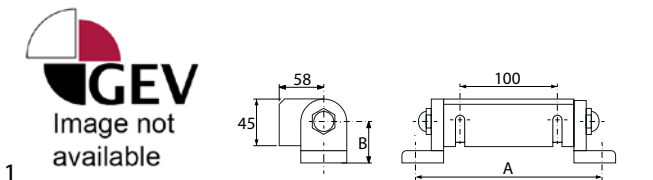

**GEV**  
Image not available

<b>GEV No.</b>	692652	<b>Ref. No.</b>	OG3736
<b>description</b>	lid hinge type 1082 level of centre of rotation 35mm load capacity 70-100NM opening angle 72° closing angle 10° mounting distance 220mm bore ø 11mm MD lid 100mm chrome-plated brass		

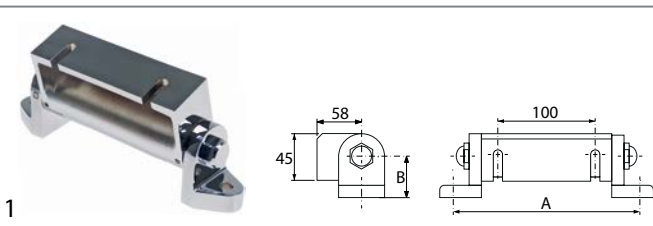

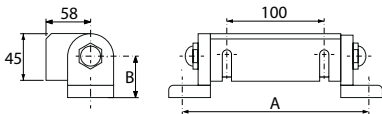
<b>GEV No.</b>	691204	<b>Ref. No.</b>	0H9913	
<b>description</b>	lid hinge type 1082 level of centre of rotation 35mm load capacity 70-100NM opening angle 75° closing angle 10° mounting distance 220mm bore ø 11mm MD lid 100mm chrome-plated brass			
<b>spare parts for</b>	691204			
	<b>GEV No.</b>	691615	<b>Ref. No.</b>	—
	repair kit for lid hinge load capacity 70-100NM			

## drain taps

### brass

#### drain taps



<b>GEV No.</b>	548001	<b>Ref. No.</b>	OS1037	
<b>description</b>	drain tap 1 1/2" IT O-ring seal kettle connection with union nut A 80mm B1 68mm B2 132mm			
<b>spare parts for</b>	548001			
	<b>GEV No.</b>	505092	<b>Ref. No.</b>	—
	O-ring EPDM thickness 5,34mm ID ø 43,82mm Qty 1 pcs			
	<b>GEV No.</b>	540213	<b>Ref. No.</b>	—
	handle ID ø 5mm L 117mm			



 <p>1</p>			
<b>GEV No.</b>	540275	<b>Ref. No.</b>	0C4850
<b>description</b>	drain tap 2" IT with union nut A 90mm B 151mm B1 80mm chrome-plated brass		
<b>spare parts for</b>	540275		
	<b>GEV No.</b>	540214	<b>Ref. No.</b> —
	handle ID ø 6mm L 145mm		
<b>accessories for</b>	540275		
	<b>GEV No.</b>	529484	<b>Ref. No.</b> —
	flat gasket fibre ED ø 58mm ID ø 50mm thickness 2mm Qty 1 pcs		
	<b>GEV No.</b>	542448	<b>Ref. No.</b> —
	gasket silicone 60x49x2 for drain tap 2"		

<b>accessories</b>			
 <p>1</p>			
<b>GEV No.</b>	540222	<b>Ref. No.</b>	053809
<b>description</b>	O-ring EPDM thickness 2.62mm ID ø 47.3mm Qty 1 pcs		

 <p>1</p>			
<b>GEV No.</b>	540083	<b>Ref. No.</b>	0K1469
<b>description</b>	pressure bolt for drain tap		

steam traps

steam traps

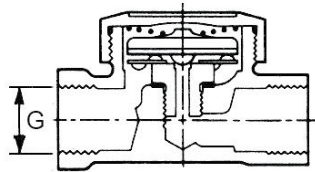
  <p>1</p>			
<b>GEV No.</b>	541461	<b>Ref. No.</b>	0K5388
<b>description</b>	thermostatic steam trap thread 1/2" type BPT13S brass		

safety valves

 <p>1</p>			
<b>GEV No.</b>	541458	<b>Ref. No.</b>	0K5784
<b>description</b>	safety valve T1: 1/2" T2: 1/2" triggering pressure 1.3bar		

gaskets

gaskets for heated units

door seals

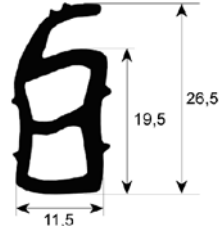
 <p>1</p>			
<b>GEV No.</b>	900763	<b>Ref. No.</b>	0K9170
<b>description</b>	door seal profile 2276 Qty supplied by meter		

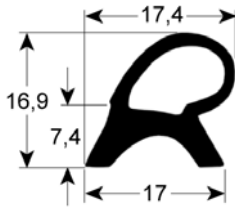
 <p>1</p>			
<b>GEV No.</b>	900758	<b>Ref. No.</b>	0K8016
<b>description</b>	door seal profile 2450 W 445mm H 1360mm external size Qty 1 suitable for ELECTROLUX 450x1360		



<b>GEV No.</b>	900759	<b>Ref. No.</b>	OK8015
<b>description</b>	door seal profile 2450 W 450mm H 720mm external size Qty 1 suitable for ELECTROLUX 447x719		

<b>GEV No.</b>	900764	<b>Ref. No.</b>	OK8159
<b>description</b>	door seal profile 2921 L 1600mm Qty 1		

<b>GEV No.</b>	900579	<b>Ref. No.</b>	005708
<b>description</b>	door seal profile 2520 W 450mm L 1490mm external size Qty 1 suitable for ELECTROLUX 450x1490		

### boiling pan gaskets

<b>GEV No.</b>	900755	<b>Ref. No.</b>	OK5571
<b>description</b>	boiling pan gasket profile 3030 L 1130mm W 655mm		

<b>GEV No.</b>	900577	<b>Ref. No.</b>	005710
<b>description</b>	door seal profile 2520 W 450mm L 550mm external size Qty 1 suitable for ELECTROLUX 450x550		

<b>GEV No.</b>	900609	<b>Ref. No.</b>	OK5574
<b>description</b>	door seal profile 3030 ø 430mm		

<b>GEV No.</b>	900578	<b>Ref. No.</b>	005709
<b>description</b>	door seal profile 2520 W 450mm L 770mm external size Qty 1 suitable for ELECTROLUX 450x770		

### O-rings

#### EPDM

<b>GEV No.</b>	532003	<b>Ref. No.</b>	059293
<b>description</b>	O-ring EPDM thickness 1.78mm ID ø 3.69mm Qty 10 pcs		

<b>GEV No.</b>	900753	<b>Ref. No.</b>	OK9171
<b>description</b>	door seal profile 2905 Qty supplied by meter		

<b>GEV No.</b>	532581	<b>Ref. No.</b>	0E5118
<b>description</b>	O-ring EPDM thickness 2.3mm ID ø 17.2mm Qty 1 pcs		

<b>GEV No.</b>	540222	<b>Ref. No.</b>	053809
<b>description</b>	O-ring EPDM thickness 2.62mm ID ø 47.3mm Qty 1 pcs		



1

<b>GEV No.</b>	510009	<b>Ref. No.</b>	069531
<b>description</b>	O-ring EPDM thickness 3.53mm ID ø 101.2mm Qty 1 pcs		

1

<b>GEV No.</b>	510408	<b>Ref. No.</b>	067620
<b>description</b>	O-ring EPDM thickness 5.34mm ID ø 47mm Qty 1 pcs		

Viton

1

<b>GEV No.</b>	511300	<b>Ref. No.</b>	002873
<b>description</b>	O-ring Viton thickness 3.53mm ID ø 28.17mm for 57 series for motor shaft		

1

<b>GEV No.</b>	528412	<b>Ref. No.</b>	002874
<b>description</b>	O-ring Viton thickness 3.53mm ID ø 31.34mm Qty 1 pcs		

sealing washers

rubber gaskets

1

<b>GEV No.</b>	504776	<b>Ref. No.</b>	049828
<b>description</b>	gasket rubber ED ø 60mm ID ø 50mm thickness 1.5mm for intake body		

shaft gaskets

miscellaneous

1

<b>GEV No.</b>	511301	<b>Ref. No.</b>	002699
<b>description</b>	shaft seal ID ø 16mm ED ø 38mm thickness 18mm		

special gaskets

miscellaneous

1

<b>GEV No.</b>	550924	<b>Ref. No.</b>	002075
<b>description</b>	gasket for probe ID ø 6mm EPDM		

1

<b>GEV No.</b>	900775	<b>Ref. No.</b>	0K5103
<b>description</b>	gasket L 1000mm size 10x2mm self-adhesive silicone		

1

<b>GEV No.</b>	691252	<b>Ref. No.</b>	0K5262
<b>description</b>	gasket profile V ED ø 46mm ID ø 36mm		

## transmission technology and ball bearings

### drive belts

#### toothed belts



1

<b>GEV No.</b>	504778	<b>Ref. No.</b>	0E5050
<b>description</b>	toothed belt profile T10 L 610mm H 4mm teeth 61 rubber with textile insertion CODE 354TI W 16mm		

## springs

### compression springs



1

<b>GEV No.</b>	504660	<b>Ref. No.</b>	047492
<b>description</b>	compression spring $\phi$ 8.9mm L 37.5mm wire gauge $\phi$ 1.15mm		

### roller springs

#### roller springs



1

<b>GEV No.</b>	519449	<b>Ref. No.</b>	0E5158
<b>description</b>	roller spring W 25mm ID $\phi$ 32mm lug lengthmm		



1

<b>GEV No.</b>	504518	<b>Ref. No.</b>	0E5167
<b>description</b>	roller spring W 39mm ID $\phi$ 32mm lug lengthmm		

## manometers



1

<b>GEV No.</b>	541460	<b>Ref. No.</b>	0K5402
<b>description</b>	manometer pressure range 0 up to 2.5bar marking 1.3		

## hoses

### supply hoses

#### PVC supply hoses



1

<b>GEV No.</b>	520011	<b>Ref. No.</b>	0L1887
<b>description</b>	supply hose PVC straight-curved DN13 connections 3/4" L 2000mm operating p. 10bar burst p. 32bar t.max. 90°C approval VDE flat seal		

### industrial hoses

#### Niplaflex hoses



1

<b>GEV No.</b>	530561	<b>Ref. No.</b>	0C4158
<b>description</b>	pressure hose ID $\phi$ 10mm ED $\phi$ 17mm L 5m thickness 3.5mm operating p. 10bar burst p. 30bar t.max. 110°C		

## valves and tank inlets

### ball valves

#### universal

#### ball valves with butterfly handle



1

<b>GEV No.</b>	540982	<b>Ref. No.</b>	005927
<b>description</b>	ball valve connection 3/4" IT - 3/4" ET DN20 total length 69mm shaft $\phi$ 8x5mm		



ball valves electric

 <p>1</p>			
<b>GEV No.</b>	401139	<b>Ref. No.</b>	0C0882
<b>description</b>	ball valve inlet 3/4" IT outlet 3/4" IT with plug 230V L 65mm 50/60Hz closed off-current mode of operation electric connection cable 200mm		

ancillary products

clamps

hose clamps

DIN 3017 - W2

 <p>1</p>			
<b>GEV No.</b>	520112	<b>Ref. No.</b>	048126
<b>description</b>	hose clamp ø 12-20mm width 9mm Qty 10 pcs DIN 3017		

 <p>1</p>			
<b>GEV No.</b>	520116	<b>Ref. No.</b>	046878
<b>description</b>	hose clamp ø 32-50mm width 9mm Qty 5 pcs DIN 3017		

 <p>1</p>			
<b>GEV No.</b>	520118	<b>Ref. No.</b>	046855
<b>description</b>	hose clamp ø 50-70mm width 9mm Qty 5 pcs DIN 3017		

measuring equipment

thermometers

built-in thermometers

 <p>1</p>			
<b>GEV No.</b>	541522	<b>Ref. No.</b>	048525
<b>description</b>	thermometer mounting measurements 45x45mm +40 up to +120°C capillary pipe 5000mm probe ø 6mm probe L 36mm front measurements 48x48mm		

fastening material

nuts

knurled nuts

 <p>1</p>			
<b>GEV No.</b>	504547	<b>Ref. No.</b>	047283
<b>description</b>	knurled nut thread M8x1 ø 25mm H 6mm SS		

hexagonal nuts

DIN 6923 / ISO 4161

 <p>1</p>			
<b>GEV No.</b>	504315	<b>Ref. No.</b>	0E5372
<b>description</b>	nut thread M5 H 5mm WS 8 Qty 10 pcs		

washers

washers

DIN 125A

 <p>1</p>			
<b>GEV No.</b>	560114	<b>Ref. No.</b>	0K5101
<b>description</b>	plain washer ID ø 8.4mm ED ø 16mm thickness 1.6mm SS Qty 20 pcs DIN 125A for thread M8		

fasteners

slot nuts



1			
<b>GEV No.</b>	560268	<b>Ref. No.</b>	0E5048
<b>description</b>	slot nut W 8mm H 7mm L 35mm		

clamps

hose clamps

DIN 3017 - W2



1			
<b>GEV No.</b>	520112	<b>Ref. No.</b>	048126
<b>description</b>	hose clamp ø 12-20mm width 9mm Qty 10 pcs DIN 3017		



1			
<b>GEV No.</b>	520116	<b>Ref. No.</b>	046878
<b>description</b>	hose clamp ø 32-50mm width 9mm Qty 5 pcs DIN 3017		



1			
<b>GEV No.</b>	520118	<b>Ref. No.</b>	046855
<b>description</b>	hose clamp ø 50-70mm width 9mm Qty 5 pcs DIN 3017		

roll pins



1			
<b>GEV No.</b>	692013	<b>Ref. No.</b>	0H6043
<b>description</b>	roll pin ø 3mm L 16mm		

consumables

sealants and adhesives

high temperature silicone



1			
<b>GEV No.</b>	890050	<b>Ref. No.</b>	OK3948
<b>description</b>	high temperature silicone NOVASIL 576 acetoxy-curing -40 up to +265°C t.max. 280°C anthracite cartridge 310ml		
<b>description</b>	<p>Novasil 556 - cartridge 310ml - anthracite</p> <ul style="list-style-type: none"> <li>- Developed for applications in the home appliance industry: <ul style="list-style-type: none"> <li>- Gluing of oven door seals</li> </ul> </li> <li>- Gluing of mounting brackets for cooker fascias, oven door seals and handles</li> <li>- Attachment of elastic seals, e.g. to oven doors</li> </ul> <p>Temperature resistance: -40°C to +265°C</p>		

lubricants

silicone fats



1			
<b>GEV No.</b>	890101	<b>Ref. No.</b>	0H7004
<b>description</b>	silicone grease FERMIT GLISSA tube 60g -40 to +200°C approval		
<b>description</b>	<p>Fermit GLISSA - tube 60g</p> <p>Non-drip lubricating grease for drinking water valves and fittings. Glissa silicone grease is suitable as a lubricant and sealant for drinking water valves and fittings (e.g. cartridges of single-lever mixers, switching valves and swivel spouts). Water-repellent, physiologically safe, sealing and has a high temperature resistance up to 200°C. Complies with the guidelines of the UBA for sanitary lubricants, tested by TZW for suitability for drinking water and approved in accordance with DIN ISO 21469.</p> <p>Temperature range: -40°C to +200°C</p>		

fuses

fine fuses





1			
<b>GEV No.</b>	358677	<b>Ref. No.</b>	057783
<b>description</b>	fine fuse size ø5x20mm 4A fast-acting rated 250V Qty 10 pcs		





			
1			
<b>GEV No.</b>	358695	<b>Ref. No.</b>	005032
<b>description</b>	fine fuse size ø5x20mm 3.15A medium lag rated 250V Qty 10 pcs		

			
1			
<b>GEV No.</b>	358703	<b>Ref. No.</b>	002750
<b>description</b>	fine fuse size ø5x20mm 0.4A slow-acting rated 250V Qty 10 pcs		

			
1			
<b>GEV No.</b>	358397	<b>Ref. No.</b>	OK5074
<b>description</b>	fuse size 76mm 25A rated 690V Qty 1 pcs		



<b>A</b>			
axial fans		26	
<b>B</b>			
ball valves		56	
ball valves electric		26, 57	
bar burners		43	
bi-metal thermostats		7, 8	
boiling pan gaskets		54	
<b>C</b>			
cables		30	
cam switches		13	
ceramic heaters		4	
clamps		57, 58	
cold air circulating fans (complete)		27	
condensators & interference suppression filters		29	
consumables		58	
contactors		19	
control equipment		15	
control thermostats		8	
copper wire		30	
cross flow fans		27	
<b>D</b>			
door catches		51	
door seals		53	
drain pumps		29	
<b>E</b>			
edgemount latches		51	
electric accessories		30	
electrodes		26	
electronic controllers		22	
energy regulators		7	
<b>F</b>			
fans		26	
fasteners		58	
fastening material		57	
filters		29	
fine fuses		58	
float switches		13	
fuses		30, 58	
<b>G</b>			
gas burners		41	
gas control valves		33	
gas nozzles		44	
gas taps		30	
gas thermostats		33	
gaskets for heated units		53	
<b>H</b>			
handle latches		51	
heating elements		3	
heating elements for bain maries		3	
heating elements for griddles		3	
heating elements for large hobs		3	
heating elements for ovens		3	
heating elements for salamanders/toasters		4	
heating elements for tilting bratt pan		4	
hexagonal nuts		57	
high temperature silicone		58	
hob burners		41	
hose clamps		57, 58	
hoses		56	
hot air fans		28	
hot air motors		27	
hot plates		6	
<b>I</b>			
ignition cables		39	
ignition switches		40	
immersion heating elements		4	
indicator lights		16	
indicator lights (complete)		16	
industrial hoses		56	
<b>K</b>			
knurled nuts		57	
<b>L</b>			
lamps		16	
light bulbs		17	
lubricants		58	
<b>M</b>			
magnetic switches		14	
measuring equipment		57	
mechanical timers		19	
microswitches		12	
motors		28	
<b>N</b>			
neon light bulbs		16, 17	
Niplaflex hoses		56	
nuts		57	
<b>O</b>			
operating capacitors		29	
O-rings		54	
oven lamps		18	

**P**

piezoelectric igniters	39
pilot burners	34
position switches	12
pressure switches	26
probes	23
programme timers	18
pumps	28
PVC supply hoses	56

**R**

radiation heaters	6
refrigeration fans	27
relays	21
rocker/momentary rocker switches	11
roll pins	58
rotary switches	14

**S**

safety bi-metal thermostats	7
safety thermostats	9
sealants and adhesives	58
sealing washers	55
shaft gaskets	55
silicone	58
silicone fats	58
slot nuts	58
solenoid valves	25
solid state relays	20
supply hoses	56
switches and momentary switches	11

**T**

terminals	30
thermocouples	40
thermostats	7
time relays	21
timers	18
transformers	22
tube burners	44

**V**

valves and tank inlets	56
------------------------	----

**W**

wash and rinse pumps	28
washers	57