



GAS COMPONENTS



ELECTRIC COMPONENTS



WATER TECHNOLOGY



MECHANICAL COMPONENTS



TOOLS

Spare parts suitable for

TECNOINOX

Find the complete and up-to-date range of products in our GEV Webshop



Manufacturer catalogue

The most important spare parts and accessories arranged clearly for every manufacturer

- ✓ Complete product range and all appliance data always up to date in the GEV Webshop
- ✓ Alphabetical Index at the end of the catalogue

GEV Webshop

www.gev-online.co.uk

www.gev-online.com



- 🔍 Add to Favourites
- 🔍 Sign In with email address and usual password
- 🔍 Easy-order – place several items in your basket at the same time
- 🔍 Quick Item search – no login needed



heating elements



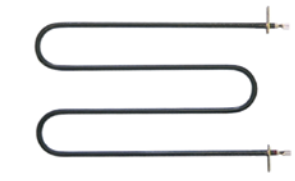

heating elements for ovens

 <p>1</p>			
GEV No.	416601	Ref. No.	00775 RC00775000
description	heating element 1000W 230V L 396mm W 65mm H 35mm 2 hole fixing mounting distance 87mm connection M4 tube ø 6.5mm immersion heater thread 1/4" heating circuits 1 connection length 26mm		

heating elements for bain maries





 <p>1</p>			
GEV No.	415293	Ref. No.	00269 RC00269000
description	heating element 1300W 230V heating circuits 1 L 330mm W 184mm tube ø 8.5mm lug length 40mm lug width 18mm connection male faston 6.3mm hole ø 5mm dry heating element bracket mounting		

heating elements for frying pans

 <p>1</p>			
GEV No.	415292	Ref. No.	00528 RC00528000
description	heating element 1100W 230V L 205mm W 110mm connection M4 tube ø 6.3mm 2 hole fixing thread 1/4" dry heating element H 54mm mounting distance 220mm		
accessories for	415292		
	GEV No.	361182	Ref. No. —
	nut thread 1/4" H 5mm nickel-plated brass WS 17 Qty 1 pcs		
	GEV No.	510417	Ref. No. —
	flat gasket fibre ED ø 20mm ID ø 14mm thickness 2mm Qty 1 pcs		
	GEV No.	520228	Ref. No. —
	tooth lock washer ID ø 15.3mm ED ø 24mm steel Qty 1 pcs for thread M14		
	GEV No.	550262	Ref. No. —
	flat gasket copper ED ø 20mm ID ø 14mm thickness 2mm		

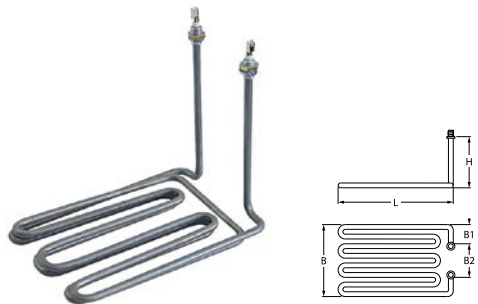
heating elements for fryers

2 hole fixing

 <p>1</p>			
GEV No.	416659	Ref. No.	00772 RC00772000
description	heating element 3000W 230V heating circuits 1 L 250mm W 175mm H 197mm 2 hole fixing connection male faston 6.3mm W1 35mm W2 95mm H1 175mm H2 20mm immersion heater thread 1/4" tube ø 8.9mm mounting distance 86mm connection length 21mm windings 3		
accessories for	416659		
	GEV No.	361182	Ref. No. —
	nut thread 1/4" H 5mm nickel-plated brass WS 17 Qty 1 pcs		
	GEV No.	510417	Ref. No. —
	flat gasket fibre ED ø 20mm ID ø 14mm thickness 2mm Qty 1 pcs		
	GEV No.	520228	Ref. No. —
	tooth lock washer ID ø 15.3mm ED ø 24mm steel Qty 1 pcs for thread M14		
	GEV No.	550262	Ref. No. —
	flat gasket copper ED ø 20mm ID ø 14mm thickness 2mm		







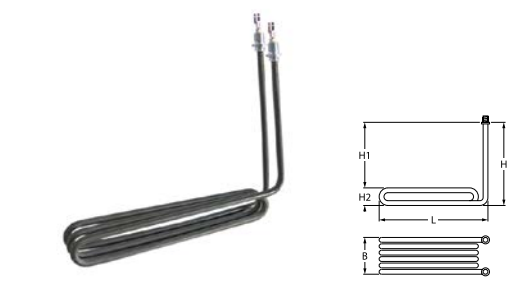

 <p>1</p>			
GEV No.	415291	Ref. No.	00282 RC00282000
description	heating element 2000W 230V heating circuits 1 L 250mm W 45mm H 190mm H1 154mm H2 36mm thread 1/4" tube ø 8.5mm mounting distance 30mm windings 3 2 hole fixing connection male faston 6.3mm immersion heater		
spare parts for	415291		
	GEV No.	510417	Ref. No. —
	flat gasket fibre ED ø 20mm ID ø 14mm thickness 2mm Qty 1 pcs		
accessories for	415291		
	GEV No.	361182	Ref. No. —
	nut thread 1/4" H 5mm nickel-plated brass WS 17 Qty 1 pcs		
	GEV No.	520228	Ref. No. —
	tooth lock washer ID ø 15.3mm ED ø 24mm steel Qty 1 pcs for thread M14		

Table continues overleaf



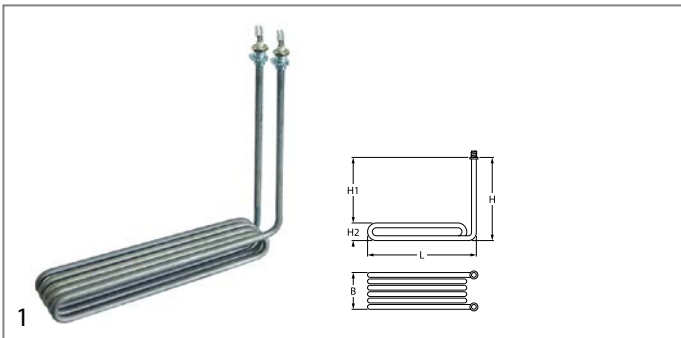



accessories for	415291		
	GEV No.	550262	Ref. No. —
	flat gasket copper ED ø 20mm ID ø 14mm thickness 2mm		

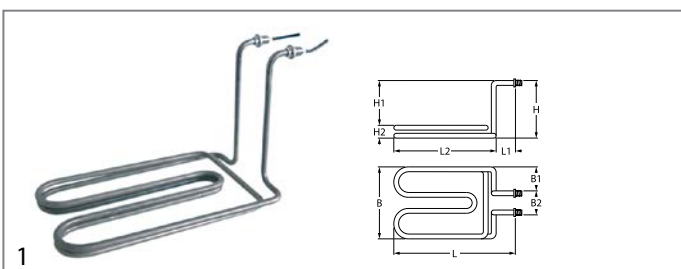





GEV No.	416660	Ref. No.	01276 RC01276000
description	heating element 3600W 230V heating circuits 1 L 280mm W 68mm H 246mm H1 210mm H2 36mm thread 1/4" tube ø 8.5mm windings 5 2 hole fixing connection male faston 6.3mm		
accessories for	416660		
	GEV No.	361182	Ref. No. —
	nut thread 1/4" H 5mm nickel-plated brass WS 17 Qty 1 pcs		
	GEV No.	510417	Ref. No. —
	flat gasket fibre ED ø 20mm ID ø 14mm thickness 2mm Qty 1 pcs		
	GEV No.	520228	Ref. No. —
	tooth lock washer ID ø 15.3mm ED ø 24mm steel Qty 1 pcs for thread M14		
	GEV No.	550262	Ref. No. —
	flat gasket copper ED ø 20mm ID ø 14mm thickness 2mm		

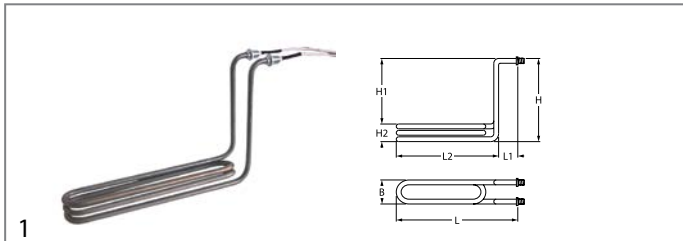

GEV No.	415284	Ref. No.	00067 RC00067000
description	heating element 3400W 230V heating circuits 1 L 301mm W 185mm H 185mm 2 hole fixing immersion heater L1 22mm L2 282mm W1 50mm W2 85mm H1 165mm H2 20mm cable length 225mm tube ø 8.5mm thread 1/4" mounting distance 76mm connection length 55mm		
accessories for	415284		
	GEV No.	361182	Ref. No. —
	nut thread 1/4" H 5mm nickel-plated brass WS 17 Qty 1 pcs		
	GEV No.	510417	Ref. No. —
	flat gasket fibre ED ø 20mm ID ø 14mm thickness 2mm Qty 1 pcs		
	GEV No.	520228	Ref. No. —
	tooth lock washer ID ø 15.3mm ED ø 24mm steel Qty 1 pcs for thread M14		
	GEV No.	550262	Ref. No. —
	flat gasket copper ED ø 20mm ID ø 14mm thickness 2mm		





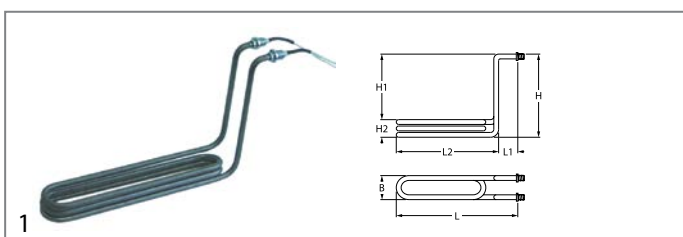



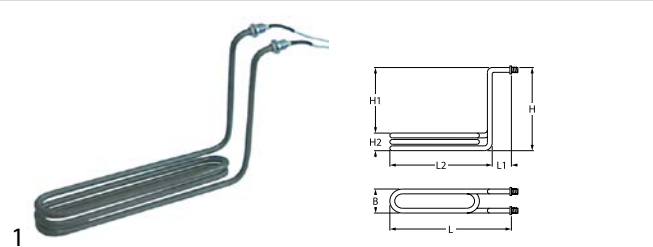

GEV No.	415285	Ref. No.	00073 RC00073000
description	heating element 1200W 230V heating circuits 1 L 295mm W 55mm H 185mm L1 20mm L2 275mm H1 154mm H2 31mm thread 1/4" tube ø 8.5mm cable length 290mm 2 hole fixing windings 3		
accessories for	415285		
	GEV No.	361182	Ref. No. —
	nut thread 1/4" H 5mm nickel-plated brass WS 17 Qty 1 pcs		
	GEV No.	510417	Ref. No. —
	flat gasket fibre ED ø 20mm ID ø 14mm thickness 2mm Qty 1 pcs		
	GEV No.	520228	Ref. No. —
	tooth lock washer ID ø 15.3mm ED ø 24mm steel Qty 1 pcs for thread M14		
	GEV No.	550262	Ref. No. —
	flat gasket copper ED ø 20mm ID ø 14mm thickness 2mm		





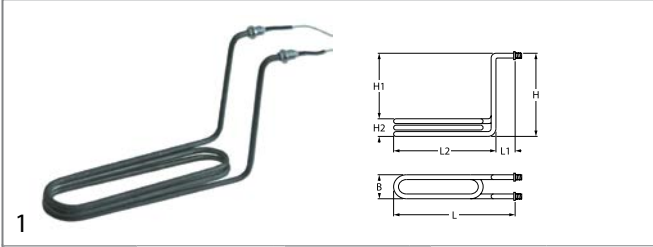

GEV No.	415286	Ref. No.	00075 RC00075000
description	heating element 1500W 230V heating circuits 1 L 299mm W 50mm H 180mm L1 22mm L2 275mm H1 148mm H2 32mm thread 1/4" tube ø 8.5mm cable length 295mm 2 hole fixing windings 3		
accessories for	415286		
	GEV No.	361182	Ref. No. —
	nut thread 1/4" H 5mm nickel-plated brass WS 17 Qty 1 pcs		
	GEV No.	510417	Ref. No. —
	flat gasket fibre ED ø 20mm ID ø 14mm thickness 2mm Qty 1 pcs		
	GEV No.	520228	Ref. No. —
	tooth lock washer ID ø 15.3mm ED ø 24mm steel Qty 1 pcs for thread M14		
	GEV No.	550262	Ref. No. —
	flat gasket copper ED ø 20mm ID ø 14mm thickness 2mm		



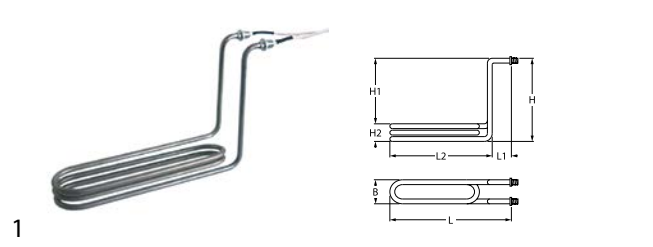

			
GEV No.	415287	Ref. No.	00142 RC00142000
description	heating element 2000W 230V heating circuits 1 L 298mm W 50mm H 183mm L1 22mm L2 275mm H1 144mm H2 37mm thread 1/4" tube ø 8.5mm cable length 275mm 2 hole fixing windings 3		
accessories for	415287		
	GEV No.	361182	Ref. No. —
	nut thread 1/4" H 5mm nickel-plated brass WS 17 Qty 1 pcs		
	GEV No.	510417	Ref. No. —
	flat gasket fibre ED ø 20mm ID ø 14mm thickness 2mm Qty 1 pcs		
	GEV No.	520228	Ref. No. —
	tooth lock washer ID ø 15.3mm ED ø 24mm steel Qty 1 pcs for thread M14		
	GEV No.	550262	Ref. No. —
	flat gasket copper ED ø 20mm ID ø 14mm thickness 2mm		

			
GEV No.	415283	Ref. No.	00054 RC00054000
description	heating element 3000W 230V heating circuits 1 L 290mm W 78mm H 185mm L1 18mm L2 267mm H1 155mm H2 27mm thread 1/4" mounting distance 67mm tube ø 8.5mm cable length 250mm 2 hole fixing connection male faston 6.3mm immersion heater windings 3		
accessories for	415283		
	GEV No.	361182	Ref. No. —
	nut thread 1/4" H 5mm nickel-plated brass WS 17 Qty 1 pcs		
	GEV No.	510417	Ref. No. —
	flat gasket fibre ED ø 20mm ID ø 14mm thickness 2mm Qty 1 pcs		
	GEV No.	520228	Ref. No. —
	tooth lock washer ID ø 15.3mm ED ø 24mm steel Qty 1 pcs for thread M14		
	GEV No.	550262	Ref. No. —
	flat gasket copper ED ø 20mm ID ø 14mm thickness 2mm		

			
GEV No.	415282	Ref. No.	00049 RC00049000
description	heating element 2200W 230V heating circuits 1 L 295mm W 70mm H 183mm L1 20mm L2 275mm H1 148mm H2 35mm thread 1/4" tube ø 8.5mm cable length 250mm 2 hole fixing fryer heaters windings 3		
accessories for	415282		
	GEV No.	361182	Ref. No. —
	nut thread 1/4" H 5mm nickel-plated brass WS 17 Qty 1 pcs		
	GEV No.	510417	Ref. No. —
	flat gasket fibre ED ø 20mm ID ø 14mm thickness 2mm Qty 1 pcs		
	GEV No.	520228	Ref. No. —
	tooth lock washer ID ø 15.3mm ED ø 24mm steel Qty 1 pcs for thread M14		
	GEV No.	550262	Ref. No. —
	flat gasket copper ED ø 20mm ID ø 14mm thickness 2mm		

heating elements for griddles

			
GEV No.	415290	Ref. No.	00286 RC00286000
description	heating element 1300W 230V heating circuits 1 L 473mm W 80mm H 55mm tube ø 6.5mm connection M4 griddle connection distance 75mm dry heating element		

			
GEV No.	416613	Ref. No.	00767 RC00767000
description	heating element 3000W 230V heating circuits 1 L 474mm W 285mm H 54mm tube ø 8.5mm connection M4 griddle connection distance 277mm dry heating element		

heating elements for chicken rotisseries

			
GEV No.	416657	Ref. No.	00243 RC00243000
description	heating element 1500W 230V 2 hole fixing thread M14x1.25 L 535mm W 49mm heating circuits 1 connection M5 dry heating element tube ø 10mm mounting distance 39mm connection length 55mm chicken rotisserie		



heating elements for pasta cookers



1

GEV No.	416629	Ref. No.	00595 01250 RC00595000 RC01250000
description	heating element 1600W 230V heating circuits 1 L 368mm W 70mm H 178mm connection M4 tube ø 9mm connection length 24mm dry heating element		

heating elements for chargrills







1

GEV No.	416601	Ref. No.	00775 RC00775000
description	heating element 1000W 230V L 396mm W 65mm H 35mm 2 hole fixing mounting distance 87mm connection M4 tube ø 6.5mm immersion heater thread 1/4" heating circuits 1 connection length 26mm		



1

GEV No.	415288	Ref. No.	00513 RC00513000
description	heating element 1350W 230V L 396mm W 80mm H 37mm thread 1/4" mounting distance 72mm tube ø 6.3mm connection M4 heating circuits 1 2 hole fixing dry heating element		
accessories for	415288		
	GEV No.	361182	Ref. No. —
	nut thread 1/4" H 5mm nickel-plated brass WS 17 Qty 1 pcs		
	GEV No.	510417	Ref. No. —
	flat gasket fibre ED ø 20mm ID ø 14mm thickness 2mm Qty 1 pcs		
	GEV No.	520228	Ref. No. —
	tooth lock washer ID ø 15.3mm ED ø 24mm steel Qty 1 pcs for thread M14		
	GEV No.	550262	Ref. No. —
	flat gasket copper ED ø 20mm ID ø 14mm thickness 2mm		



1

GEV No.	416618	Ref. No.	01111 RC01111000
description	heating element 1350W 230V L 450mm W 76mm H 36mm thread 1/4" mounting distance 71mm tube ø 6.3mm connection M4 heating circuits 1 connection length 36mm 2 hole fixing dry heating element		

heating elements for salamanders/toast-



1

GEV No.	420271	Ref. No.	03708 RC00003708
description	heating element 1000W 230V L 215mm W 95mm L1 25mm L2 25mm L3 165mm W1 16mm W2 63mm hole distance 96mm connection M4 tube ø 8.5mm flange length 106mm flange width 32mm heating circuits 1 hole ø 5mm tilt flange dry heating element H 8.5mm		

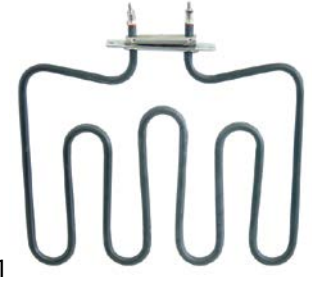

1

GEV No.	416653	Ref. No.	03804 RC00003804
description	heating element 2000W 230V L 225mm W 283mm L1 15mm L2 210mm W1 110mm W2 63mm hole distance 96mm connection M4 tube ø 8.5mm flange length 106mm flange width 32mm heating circuits 1 hole ø 5mm tilt flange dry heating element H 8.5mm		



1

GEV No.	416654	Ref. No.	03706 RC00003706
description	heating element 2000W 230V L 230mm W 230mm L1 22mm L2 208mm W1 83mm W2 63mm hole distance 96mm tube ø 8.5mm flange length 106mm flange width 32mm heating circuits 1 hole ø 5mm tilt flange dry heating element H 8.5mm		

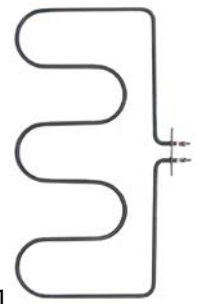

1

GEV No.	415280	Ref. No.	00171 RC00171000
description	heating element 1000W 230V heating circuits 1 L 217mm W 424mm L1 19mm L2 203mm W1 195mm W2 30mm flange length 70mm flange width 22mm hole distance 56mm tube ø 6.3mm windings 3 dry heating element connection M4 rectangular flange hole ø 6mm H 6.3mm		

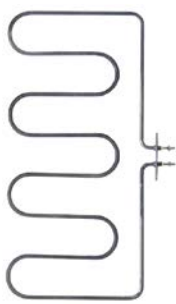
1

GEV No.	415279	Ref. No.	RC00000613
description	heating element 1500W 230V heating circuits 1 L 223mm W 430mm L1 12mm L2 211mm W1 200mm W2 30mm flange length 70mm flange width 23mm hole distance 56mm tube ø 6.3mm windings 4 dry heating element connection M4 rectangular flange hole ø 6mm H 6.3mm		

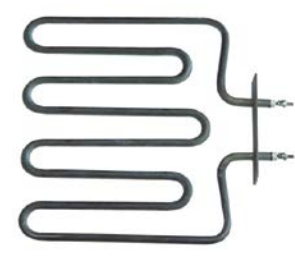

1

GEV No.	415621	Ref. No.	03706 RC00003706
description	heating element 2000W 230V heating circuits 1 L 228mm W 230mm L1 29mm L2 228mm W1 84mm W2 62mm flange length 116mm flange width 32mm hole distance 96mm tube ø 8.5mm connection length 17mm dry heating element connection M4 rectangular flange hole ø 5mm H 8.5mm		

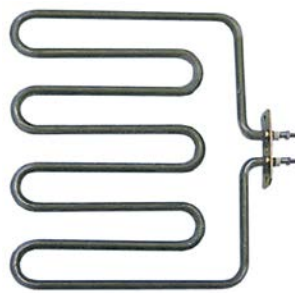

1

GEV No.	415622	Ref. No.	00109 RC00000109
description	heating element 2000W 230V heating circuits 1 L 229mm W 255mm L1 17mm L2 212mm W1 112mm W2 32mm flange length 70mm flange width 23mm hole distance 25mm tube ø 8.5mm connection length 20mm dry heating element connection M4 rectangular flange hole ø 5mm H 8.5mm		



1

GEV No.	415281	Ref. No.	6000 RC00006000
description	heating element 1000W 230V L 290mm W 130mm 2 hole fixing thread M12x1.25 mounting distance 123mm connection male faston 6.3mm dry heating element tube ø 6.3mm heating circuits 1 H 6.3mm		



1



GEV No.	416655	Ref. No.	01029 RC01029000
description	radiation heater rectangular 2000W 230V L 290mm W 240mm heating circuits 1 connections 2 IRCA for salamander grill		

ceramic heaters

245x60mm



1

GEV No.	415104	Ref. No.	01098 RC01098000	
description	ceramic emitter 1000W 230V cable beaded cord L 245mm W 60mm H 35mm			
spare parts for	415104			
	GEV No.	415109	Ref. No.	—
	spring clip			
accessories for	415104			
	GEV No.	415110	Ref. No.	—
	reflector L 245mm W 95mm H 31mm thickness 0.75mm hole ø 15x40mm			



1

GEV No.	415103	Ref. No.	00288 RC00288000	
description	ceramic emitter 650W 230V cable beaded cord L 245mm W 60mm H 35mm			
spare parts for	415103			
	GEV No.	415109	Ref. No.	—
	spring clip			
accessories for	415103			
	GEV No.	415110	Ref. No.	—
	reflector L 245mm W 95mm H 31mm thickness 0.75mm hole ø 15x40mm			



immersion heating elements

3 hole flange ø47.5mm

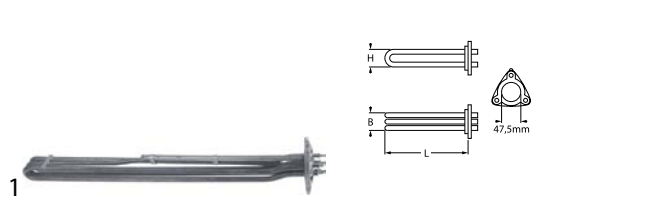

GEV No.	419113	Ref. No.	40400038 RC40400038
----------------	--------	-----------------	------------------------

description heating element 9000W 230V mounting ø 47.5mm heating circuits 3 L 550mm W 38mm H 45mm number of thermostat sleeves 1 thermostat sleeves ø 7.3mm length thermostat sleeves 260mm tube ø 8.5mm connection M4 3 hole flange immersion heater L1 55mm H1 33mm H2 34mm

accessories for	419113
	GEV No. 510408 Ref. No. —

O-ring EPDM thickness 5.34mm ID ø 47mm Qty 1 pcs

heating elements for convection



GEV No.	418087	Ref. No.	RCK6002125
----------------	--------	-----------------	------------

description heating element 15000W 230/400V heating circuits 3 ID ø 398mm ED ø 415mm L 452mm H 121mm L1 32mm W1 105mm H1 80mm H2 25mm flange length 142mm flange width 25mm hole distance 126mm connection M4 tube ø 8.5mm convection heating element hole ø 6mm rectangular flange

accessories for	418087
	GEV No. 550548 Ref. No. RCK2005173

gasket L 144mm W 25.5mm thickness 2.2mm for heating element suitable for GIORIK equiv. no. 2005173

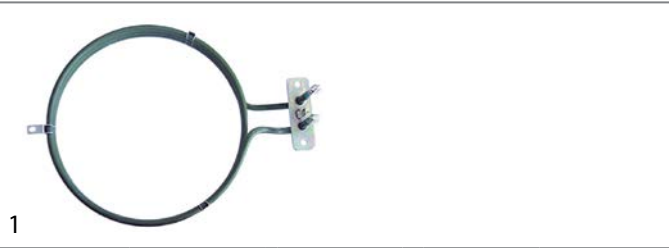

GEV No.	415251	Ref. No.	00568 RC00568000
----------------	--------	-----------------	---------------------

description heating element 2500W 230V heating circuits 1 ID ø 178mm ED ø 190mm L 242mm H 35mm L1 46mm W1 31mm H1 10mm H2 25mm flange length 70mm flange width 22mm hole distance 56mm connection male faston 6.3mm horizontal tube ø 6.3mm convection heating element hole ø 5mm rectangular flange

spare parts for	415251
	GEV No. 510368 Ref. No. —

gasket L 70mm W 23.5mm hole ø 5mm hole distance 56mm FIBER thickness 2mm for heating element



GEV No.	418086	Ref. No.	RCK6002001
----------------	--------	-----------------	------------

description heating element 8400W 230V heating circuits 3 ID ø 218mm ED ø 235mm L 275mm H 112mm L1 40mm W1 105mm H1 32mm H2 80mm flange length 142mm flange width 25mm hole distance 64mm connection M4 tube ø 8.5mm convection heating element hole ø 6mm rectangular flange

accessories for	418086
	GEV No. 550548 Ref. No. RCK2005173

gasket L 144mm W 25.5mm thickness 2.2mm for heating element suitable for GIORIK equiv. no. 2005173

radiation heaters

square



GEV No.	490159	Ref. No.	RC01434000
----------------	--------	-----------------	------------

description radiation heater L 300mm W 300mm 3500W 230V connections 3 square without pan detection EGO

spare parts for	490159
	GEV No. 499157 Ref. No. —



protection pipe for temperature probe ceramic L 297mm ED ø 7mm ID ø 5mm



GEV No.	416655	Ref. No.	01029 RC01029000
----------------	--------	-----------------	---------------------

description radiation heater rectangular 2000W 230V L 290mm W 240mm heating circuits 1 connections 2 IRCA for salamander grill



			
1			
GEV No.	416656	Ref. No.	01030 RC01030000 RC01229000
description	radiation heater rectangular 4000W 230V L 490mm W 245mm heating circuits 2 connections 2+2 IRCA		
spare parts for	416656		
	GEV No.	417727	Ref. No.
	 terminal L 20m W 8.2mm		

1-circuit

			
1			
GEV No.	490113	Ref. No.	00931 RC00931000
description	radiation heater ø 200mm 1800W 230V heating circuits 1 energy regulation with temperature signalization with ribbon heater connections 2+2 connection type male faston 6.3mm CERAMASPEED		

2-circuit

			
1			
GEV No.	490118	Ref. No.	00932 RC00932000
description	radiation heater ø 250mm 2500W heating circuits 2 partial power 1000W		

accessories

flange gaskets

			
1			
GEV No.	550548	Ref. No.	RCK2005173
description	gasket L 144mm W 25.5mm thickness 2.2mm for heating element suitable for GIORIK equiv. no. 2005173		

spring clips

			
1			
GEV No.	550539	Ref. No.	RC00091000
description	probe clip for pipe ø 8.5mm for probe ø 4mm Qty 1 pcs		

			
1			
GEV No.	550398	Ref. No.	00333 RC00333000
description	probe spring for pipe ø 2x8.5mm for probe ø 4mm L 42mm W 11mm Qty 1 pcs		

hot plates

square & rectangular

with radiused edge

			
1			
GEV No.	490066 ¹	Ref. No.	01110 RC01110000
description	hot plate dimensions 220x220mm 2600W 230V with spill ring connection 4 screw clamps protector yes square		

¹incl. protector



round

with radiused edge

for domestic and commercial kitchens



1

GEV No.	490012	Ref. No.	00764 RC00764000
description	hot plate ø 145mm 1500W 230V connection 4 screw clamps with 8mm spill ring		



1

GEV No.	490016	Ref. No.	00290 RC00290000
description	hot plate ø 180mm 2000W 230V connection 4 screw clamps with 8mm spill ring		



1

GEV No.	490020	Ref. No.	01107 RC01107000	
description	hot plate ø 220mm 2600W 230V connection 4 screw clamps with 8mm spill ring			
accessories for	490020			
	GEV No.	550796	Ref. No.	—
	fixing plate for hot plate ø220mm			

energy regulators

EGO

1-circuit



1

GEV No.	380015	Ref. No.	00012 00937 06501 RC00006501 RC00012000 RC00937000
description	energy regulator 230V 13A single-circuit turn direction right shaft ø 6x4.6mm shaft L 23mm mounting thread M4 power release 6-100% no. 50.57021.010		

2-circuit



1

GEV No.	380027	Ref. No.	00938 RC00938000
description	energy regulator EGO 230V 13A dual circuit turn direction right shaft ø 6x4.6mm shaft L 23mm mounting thread M4 power release 6-70% no. 50.55021.100		

thermostats

control and safety thermostats

EGO

control thermostats

55.10/19_ series



1

GEV No.	375309	Ref. No.	00038 00779 RC00038000 RC00779000
description	thermostat t.max. 180°C temperature range 95-180°C 1-pole 1NO 16A probe ø 6mm probe L 130mm capillary pipe 1500mm capillary pipe isolated 1100mm gland nut shaft L 23mm shaft position upper rotation 270°		



1

GEV No.	375327	Ref. No.	00769 RC00769000
description	thermostat t.max. 297°C temperature range 58-297°C 1-pole 1NO 16A probe ø 3.03mm probe L 219mm capillary pipe 870mm capillary pipe isolatedmm gland nut shaft L 23mm shaft position upper rotation 270°		



GEV No.	375002	Ref. No.	00569 RC00569000
description	thermostat t.max. 320°C temperature range 55-320°C 1-pole 1NO 16A probe ø 3.1mm probe L 226mm capillary pipe 870mm capillary pipe isolated 850mm gland nut shaft L 23mm shaft position upper rotation 270°		



GEV No.	375143	Ref. No.	00274 RC00274000
description	thermostat t.max. 110°C temperature range 32-110°C 3-pole 3NO 16A probe ø 6mm probe L 138mm capillary pipe 1480mm capillary pipe isolated 1100mm gland nut M9x1 shaft ø 6x4.6mm shaft L 23mm shaft position upper rotation 270°		



GEV No.	375437	Ref. No.	RC40100042
description	thermostat t.max. 324°C temperature range 66-324°C 1-pole 1NO 16A probe ø 4mm probe L 124mm capillary pipe 1470mm capillary pipe isolatedmm gland nut shaft ø 6x4.6mm shaft L 23mm shaft position upper rotation 270°		



GEV No.	375256	Ref. No.	00064 RC00064000
description	thermostat t.max. 175°C temperature range 100-175°C 3-pole 3NO 16A probe ø 4mm probe L 157mm capillary pipe 850mm capillary pipe isolated 350mm gland nut shaft ø 6x4.6mm shaft L 23mm shaft position upper rotation 270°		

55.34_series



GEV No.	375630	Ref. No.	1207 RC00001207
description	thermostat t.max. 110°C temperature range 30-110°C 3-pole 3NO 16A probe ø 6mm probe L 131mm capillary pipe 900mm capillary pipe isolatedmm gland nut M9x1 shaft ø 6x4.6mm shaft L 23mm shaft position upper rotation 318°		



GEV No.	390056	Ref. No.	00281 RC00281000
description	thermostat t.max. 185°C temperature range 100-185°C 3-pole 3NO 16A probe ø 4mm probe L 231mm capillary pipe 2600mm capillary pipe isolated 1000mm gland nut shaft ø 6x4.6mm shaft L 23mm shaft position upper rotation 270°		

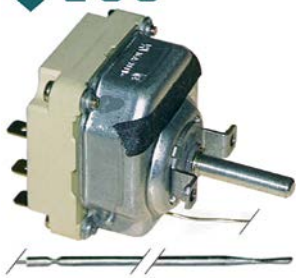

GEV No.	375183	Ref. No.	00285 RC00285000
description	thermostat t.max. 298°C temperature range 50-298°C 3-pole 3NO 16A probe ø 3mm probe L 219mm capillary pipe 900mm capillary pipe isolatedmm gland nut shaft ø 6x4.6mm shaft L 23mm shaft position upper rotation 318°		

safety thermostats

55.10/19_series

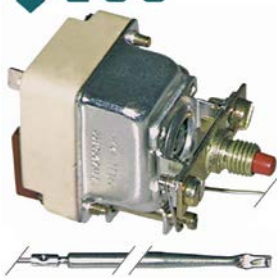

GEV No.	375254	Ref. No.	00031 RC00031000
description	safety thermostat 1-pole capillary pipe isolatedmm gland nut switch-off temp. 295°C probe		

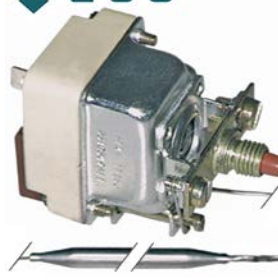

GEV No.	390060	Ref. No.	00450 RC00450000
description	safety thermostat switch-off temp. 230°C 1-pole 0.5A probe SS probe ø 6mm probe L 77mm capillary pipe 870mm capillary pipe isolatedmm gland nut		

accessories for	390060			
	GEV No.	551083	Ref. No.	—
	cap for safety thermostat thread M8x1			

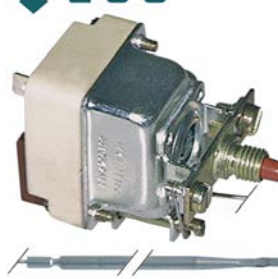

GEV No.	390786	Ref. No.	RC00770000
description	safety thermostat switch-off temp. 360°C 1-pole 16A probe ø 4mm probe L 128mm capillary pipe 1170mm capillary pipe isolated 990mm gland nut probe		

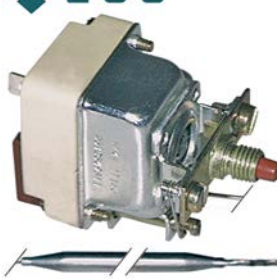

GEV No.	375250	Ref. No.	00427 RC00427000
description	safety thermostat capillary pipe 870mm probe ø 6mm 1-pole probe L 129mm 16A capillary pipe isolatedmm gland nut switch-off temp. 130°C probe SS		

spare parts for	375250			
	GEV No.	551083	Ref. No.	—
	cap for safety thermostat thread M8x1			

55.32_series



GEV No.	375328	Ref. No.	1007 RC00001007
description	safety thermostat switch-off temp. 162°C 3-pole 20A probe ø 6mm probe L 77mm capillary pipe 900mm capillary pipe isolatedmm gland nut probe		



GEV No.	375340	Ref. No.	00031 00063 RC00031000 RC00063000
description	safety thermostat switch-off temp. 295°C 3-pole 20A probe ø 4mm probe L 120mm capillary pipe 1800mm capillary pipe isolated gland nut probe probe material SS		



GEV No.	390142	Ref. No.	00305 RC00305000
description	safety thermostat switch-off temp. 360°C 3-pole 20A probe ø 3.1mm probe L 188mm capillary pipe 1490mm capillary pipe isolated 800mm gland nut probe SS		



GEV No.	375220	Ref. No.	00238 RC00238000
description	safety thermostat switch-off temp. 330°C 3-pole 20A probe ø 11mm probe L 18.5mm capillary pipe 900mm capillary pipe isolated 900mm gland nut probe screw-in probe probe thread M14x1		

accessories

probe clips

spring clips

for thermostat

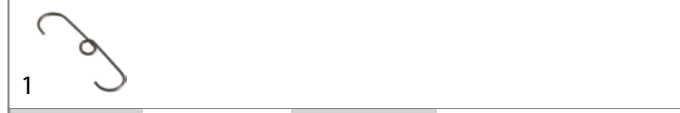

GEV No.	550398	Ref. No.	00333 RC00333000
description	probe spring for pipe ø 2x8.5mm for probe ø 4mm L 42mm W 11mm Qty 1 pcs		

for safety thermostat



GEV No.	550539	Ref. No.	RC00091000
description	probe clip for pipe ø 8.5mm for probe ø 4mm Qty 1 pcs		



GEV No.	375628	Ref. No.	RCK6010008
description	safety thermostat switch-off temp. 350°C 3-pole 20A probe ø 4mm probe L 120mm capillary pipe 900mm capillary pipe isolated 670mm gland nut M10x1 probe SS		

switches and momentary switches

rocker/momentary rocker switches

30x22mm



GEV No.	301003	Ref. No.	00021 04702 RC00004702 RC00021000
description	rocker switch mounting measurements 30x22mm green 2NO 250V 16A illuminated 0-1 connection male faston 6.3mm ambient temperature max. 125/55°C protection IP65		
accessories for	301003		

	GEV No.	301036	Ref. No.	—
	protective cover internal size 30x22mm for rocker switch mounting measurementsmm			



push/momentary push switches

ø16mm



1

GEV No.	346346	Ref. No.	RCK6032038
description	momentary push switch mounting ø 16mm red 1NO/indicator light 250V 3A connection male faston 2.8mm ambient temperature max. 125/55°C protection IP40		

microswitches

lever actuated



1

GEV No.	345107	Ref. No.	00204 RC00204000
description	microswitch with lever 250V 16A 1CO connection male faston 6.3mm L 98mm ambient temperature max. 125°C mounting distance 22mm actuating force: 30g lever length 90mm		

pin-plunger actuated



1

GEV No.	300092	Ref. No.	00092 RC00092000
description	microswitch with plunger 400V 16A 2NO connection male faston 6.3mm ambient temperature max. 85°C mounting distance 22mm type XTD22A21 actuating force: 150g fryer black		



1

GEV No.	345285	Ref. No.	00283 RC7804 n.änd. RC00283000
description	microswitch with plunger 400V 16A 2NO connection male faston 6.3mm ambient temperature max. 85°C mounting distance 22mm type XTD22J actuating force: 400g black		

M10



1

GEV No.	347216	Ref. No.	RC01853000
description	microswitch with plunger thread M10x0.75 thread L 14mm 250V 10A 1CO connection male faston 6.3mm stroke 7.5mm mounting distance 22mm L 28mm ambient temperature max. 125°C type NR6K5 actuating force: 260g		



1

GEV No.	346347	Ref. No.	RCK6043088
description	microswitch with plunger thread M10x0.75 thread L 14mm 250V 6A 2NO connection male faston 6.3mm stroke 4mm mounting distance 22mm ambient temperature max. 85°C actuating force: 100g		

cam switches

on/off



1

GEV No.	300129	Ref. No.	RCK6030007
description	cam switch 2 operating positions 2NO sequence 0-1 16A shaft ø 6x4.6mm shaft L 23mm connection male faston 6.3mm ceramic		

7-position



1

GEV No.	300004	Ref. No.	00291 RC00291000
description	cam switch 7 operating positions 1NO/2CO sequence 0-1-2-3-4-5-6 16A shaft ø 6x4.6mm shaft L 23mm connection male faston 6.3mm 7-position ceramic		



1

GEV No.	300106	Ref. No.	RC01482000
description	cam switch 7 operating positions 1NO/2CO sequence 0-1-2-3-4-5-6 32A shaft ø 6x4.6mm shaft L 23mm connection screw 7-position shaft flat upper		



4 operating positions



1

GEV No.	345765	Ref. No.	01071 RC01071000
description	cam switch 4 operating positions 8NO sequence 0-1-2-3 16A shaft ø 6x4.6mm shaft L 23mm connection male faston 6.3mm plastic		

with potentiometer



1

GEV No.	345636	Ref. No.	01028 RC01028000
description	cam switch 2 operating positions 4NO sequence 0-1 16A shaft ø 6x4.6mm shaft L 23mm connection cable 560mm 0.1-10KOhm with potentiometer		

operation switches



1

GEV No.	300002	Ref. No.	00070 RC00070000
description	cam switch 2 operating positions 4NO 16A sequence 0-1 shaft ø 6x4.6mm shaft L 23mm connection male faston 6.3mm ceramic		



1

GEV No.	300080	Ref. No.	RC40100006
description	cam switch 2 operating positions 4NO 16A sequence 0-1 shaft ø 6x4.6mm shaft L 23mm connection screw operation switch ceramic ambient temperature max. 150°C		
accessories for	300080		
	GEV No.	551456	Ref. No. —
gasket for switch ED ø 14mm ID ø 2.5mm thickness 3.5mm white			



1

GEV No.	300200	Ref. No.	00037 RC00037000
description	operation switch 2 operating positions 2NO 16A sequence 0-1 shaft ø 6x4.6mm shaft L 23mm connection male faston 6.3mm operation switch ceramic		

rotary switches

BREMAS

A1600 series



1

GEV No.	346341	Ref. No.	RCK6030030
description	rotary switch 8 1-2-3-4-5-6-7-8 sets of contacts 10 type CS0169134 400V 16A shaft ø 4x5mm shaft L 20mm shaft square connection screw		

control equipment

GENERAL ELECTRIC (AEG)

push buttons



1

GEV No.	346854	Ref. No.	RC00004811
description	push button mounting measurements ø22mm green		

encoders and potentiometers

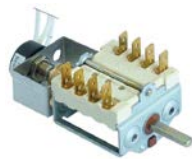

1

GEV No.	345636	Ref. No.	01028 RC01028000
description	cam switch 2 operating positions 4NO sequence 0-1 16A shaft ø 6x4.6mm shaft L 23mm connection cable 560mm 0.1-10KOhm with potentiometer		



			
1			
GEV No.	300187	Ref. No.	RCK6010097
description	potentiometer 4.7KOhm rotation 310° shaft ø 0.6x4.5mm shaft L 20mm cable length 650mm		

lamps



indicator lights



indicator lights 2-piece (lens and indicator lamp)

indicator light lenses

ø10mm (type SRZ-3)

			
1			
GEV No.	359228	Ref. No.	RC01783000
description	indicator light housings mounting measurements ø10mm clear round Qty 1 pcs		

				
1				
GEV No.	359123	Ref. No.	00053 RC00053000	
description	indicator light housings mounting measurements ø10mm green round Qty 1 pcs			
accessories for	359123			
	GEV No.	359132	Ref. No.	00052 RC01782000
	indicator lamp green 250V connection male faston 6.3mm protection IP54 ambient temperature max. 85°C			

				
1				
GEV No.	359124	Ref. No.	00319 RC00319000	
description	indicator light housings mounting measurements ø10mm yellow round Qty 1 pcs			
accessories for	359124			
	GEV No.	359132	Ref. No.	00052 RC01782000
	indicator lamp green 250V connection male faston 6.3mm protection IP54 ambient temperature max. 85°C			

indicator lamps for socket type SRZ / SDK / SDY / SFK

			
1			
GEV No.	359130	Ref. No.	RC00052000
description	indicator lamp 230V clear connection male faston 6.3mm ø 8mm		

			
1			
GEV No.	359132	Ref. No.	00052 RC01782000
description	indicator lamp green 250V connection male faston 6.3mm protection IP54 ambient temperature max. 85°C		

indicator lights (complete)

ø 6mm

			
1			
GEV No.	357084	Ref. No.	RC00006601
description	indicator lamp ø 6mm 240V green		

			
1			
GEV No.	359031	Ref. No.	00011 RC00011000
description	indicator light ø 6mm 230V green		

ø12mm

with screw socket

			
1			
GEV No.	359048	Ref. No.	RC40200150
description	indicator light ø 12mm 230V yellow connection male faston 6.3mm		

screw-on/push-on fit

light bulbs

for ovens

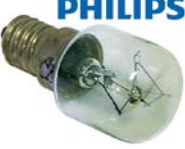
			
1			
GEV No.	359610	Ref. No.	00566 RC00566000
description	light bulb t.max. 300°C socket E14 15W 230V ø 22mm L 47mm lens L 20mm for oven lamp type Philips		



halogen lamp

for socket G4 / G6.35 / G9

1			
GEV No.	357191	Ref. No.	RCE00C4396
description	halogen lamp socket G4 12V 10W temp.-resist. 300°C OSRAM HALOSTAR OVEN		

1			
GEV No.	359599	Ref. No.	RCK6061054
description	halogen lamp socket G4 12V 20W temp.-resist. 500°C		

1			
GEV No.	359946	Ref. No.	RC01856000
description	halogen lamp socket G9 230V 40W temp.-resist. 300°C		

linear lamps

infrared lamps

with base type X lug

1			
GEV No.	359617	Ref. No.	00217 RC00217000
description	infrared lamp 1000W 220V L 365mm lens L 340mm total length 480mm with mounting strap		

sockets for linear lamps

X lug

1			
GEV No.	359710	Ref. No.	00218 RC00218000
description	lamp socket L 70mm W 70mm H 49mm mounting distance 50mm bracket mounting		

oven lamps

universal oven lamps

mounting diameter 35.5mm

1				
GEV No.	359718	Ref. No.	00805 RC00805000	
description	oven lamp mounting ø 35.5mm 230V 15W socket E14 temp.-resist. 300°C connection male faston 6.3mm hard glas			
spare parts for	359718			
	GEV No.	359701	Ref. No.	—
	lamp socket socket E14 220-230V mounting ø 35.5mm connection male faston 6.3mm 15W			
	GEV No.	359740	Ref. No.	—
	light bulb t.max. 300°C socket E14 15W 230V ø 22mm L 48mm lens L 20mm for oven lamp IMPORT			

30x70mm

1			
GEV No.	359338	Ref. No.	RCK6063077
description	lamp glass		

1			
GEV No.	359337	Ref. No.	RCK6063075
description	oven lamp socket G4 cable length 800mm connection Faston 6.3mm L 70mm W 29mm		

accessories for	359337			
	GEV No.	359599	Ref. No.	RCK6061054
	halogen lamp socket G4 12V 20W temp.-resist. 500°C			

55x70mm

1			
GEV No.	359659	Ref. No.	00275 RC00275000
description	oven lamp complete 230V 25W socket E14 L 70mm W 55mm mounting measurements 55x70mm temp.-resist. 300°C connection male faston 6.3mm		

			
1			
GEV No.	359299	Ref. No.	RC02027000
description	gasket L 91mm W 77mm hole ø 3mm for oven lamp		

lamps			
light bulbs			
			
1			
GEV No.	359610	Ref. No.	00566 RC00566000
description	light bulb t.max. 300°C socket E14 15W 230V ø 22mm L 47mm lens L 20mm for oven lamp type Philips		

halogen lamps			
for socket G4 / G6.35 / G9			
			
1			
GEV No.	357191	Ref. No.	RCE00C4396
description	halogen lamp socket G4 12V 10W temp.-resist. 300°C OSRAM HALOSTAR OVEN		

			
1			
GEV No.	359599	Ref. No.	RCK6061054
description	halogen lamp socket G4 12V 20W temp.-resist. 500°C		

			
1			
GEV No.	359946	Ref. No.	RC01856000
description	halogen lamp socket G9 230V 40W temp.-resist. 300°C		



timers

electric timers

with time spread



			
1			
GEV No.	350074	Ref. No.	RCK6032047
description	timer MS65 operation time 120min time spread 30min 1CO/2NO/1NC at 250V 16A permanent position yes impulse electric shaft ø 6x4.6mm shaft L 22mm mounting distance 28mm connection lateral Invensys 4-pole shaft position lower°		

mechanical timers

			
1			
GEV No.	350032	Ref. No.	00022 00713 RC00000713 RC00022000
description	timer M2 2-pole operation time 15min impulse mechanical 2NO at 250V 16A permanent position no shaft ø 6x4.6mm shaft 6x4.6mm shaft L 18mm mounting distance 28mm connection rear		
accessories for	350032		
	GEV No.	110366	Ref. No. —
	knob switch zero mark t.max.°C ø 44mm shaft ø 6x4.6mm shaft flat upper black		
	GEV No.	110371	Ref. No. —
	dial plate graduation 15min permanent position no rotation 30-330° ø 60mm timers knob ø 45mm		

			
1			
GEV No.	350049	Ref. No.	RC01261000
description	timer M2 with bell 2-pole operation time 30min impulse mechanical 2NO at 250V 16A permanent position yes shaft ø 6x4.6mm shaft 6x4.6mm shaft L 23mm mounting distance 28mm connection lateral		
accessories for	350049		
	GEV No.	110366	Ref. No. —
	knob switch zero mark t.max.°C ø 44mm shaft ø 6x4.6mm shaft flat upper black		
	GEV No.	111205	Ref. No. —
	dial plate graduation 30min permanent position yes rotation 30-300° ø 60mm		



			
1			
GEV No.	350040	Ref. No.	RC00576000
description	timer M2 with bell 2-pole operation time 60min impulse mechanical 2NO at 250V 16A permanent position yes shaft ø 6x4.6mm shaft 6x4.6mm shaft L 23mm mounting distance 28mm connection lateral		
accessories for	350040		
	GEV No.	110366	Ref. No. —
	 knob switch zero mark t.max.°C ø 44mm shaft ø 6x4.6mm shaft flat upper black		
	GEV No.	111202	Ref. No. —
	 dial plate graduation 60min permanent position yes rotation 0-300° ø 60mm timers knob ø 45mm with permanent position		

audible timers

			
1			
GEV No.	350036	Ref. No.	00570 RC00570000
description	audible timer operation time 60min ø 55mm shaft ø 6x4.6mm shaft L 22mm mounting distance 28mm		

alarm devices

buzzers



			
1			
GEV No.	350080	Ref. No.	RCK6010103
description	buzzer buzzer		

contactors

ISKRA (FANAL)

power contactors

			
1			
GEV No.	380204	Ref. No.	00938 06208 RC00006208 RC00938000
description	power contactor resistive load 25A 230VAC (AC3/400V) 9A/4kW main contacts 3NO auxiliary contacts 1NO connection screw connection type Fanal DSL9 10 type ISKRA KNL9 10		

			
1			
GEV No.	380424	Ref. No.	RCK6046041
description	power contactor resistive load 35A 230VAC (AC3/400V) 32A/15kW main contacts 3NO auxiliary contacts 1NO connection screw connection type Fanal DSL9 10 type ISKRA KNL30		
accessories for	380424		
	GEV No.	381378	Ref. No. —
	 overload switch connection screw setting range 24,5-30A for contactors KNL30 type BR30 24.5-30A		

miscellaneous

overload switches

			
1			
GEV No.	380373	Ref. No.	00239 RC00239000
description	overload switch		



relays

power relays

with bracket mounting



1

GEV No.	380403	Ref. No.	00774 01213 RC00001213 RC00774000
description	power relays FINDER 230VAC 16A 3CO connection F6.3 bracket mounting manuf. no. 62.83.8.230.0500		

time relays

time relays



1

GEV No.	381119	Ref. No.	RCK6042049
description	time relay LOVATO TM D time range 0.06-180s		



1

GEV No.	380607	Ref. No.	RCK6042054
description	time relay LOVATO TM M1 time range 0s-10 days 12-24V AC/DC 8A 1CO connection grip connection		



1

GEV No.	380606	Ref. No.	RCK6042056
description	time relay LOVATO TM PL time range 2x 0.1s-100 days 12-240V AC/DC 8A 1CO connection grip connection		

transformers

for lighting



1

GEV No.	401175	Ref. No.	RCK6041065
description	transformer primary 230V secondary 11.5V 90VA		

probes

universal probes

temperature probes



1

GEV No.	379860	Ref. No.	RCK6000100
description	temperature probe NTC 10kOhm cable PVC probe -20 up to +80°C cable -10 up to 100°C probe ø6x40mm cable length 1.5m without screw connection 2-wire		



1

GEV No.	379222 ¹	Ref. No.	RCK6000083
description	temperature probe Pt100 cable Vetrotex probe -200 up to +600°C cable -50 up to +350°C probe ø4x110mm cable length 1.4m 3-wire		

¹3-wire

electronics

PCBs

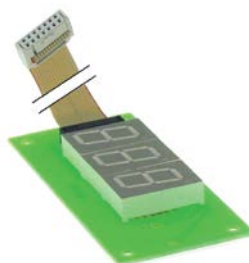

1

GEV No.	401166	Ref. No.	RCK6010095
description	display		



1

GEV No.	400952	Ref. No.	01014 RC01014000
description	PCB		

1

GEV No.	400953	Ref. No.	01015 RC01015000
description	PCB		



1

GEV No.	401171	Ref. No.	RCK6010084
description	PCB combi-steamer		



1

GEV No.	401172	Ref. No.	RCK6010093
description	PCB combi-steamer VE 06/10		



1

GEV No.	401167	Ref. No.	RCK6010096
description	PCB combi-steamer VE 06/10 230V 50/60Hz		
accessories for	401167		
	GEV No.	401062	Ref. No. —
	buzzer board 230VAC L 48mm W 45mm connection Faston 6.3mm		

keypads

front foils



1

GEV No.	693150	Ref. No.	01016 RC01016000
description	keypad foil salamander grill QSE40		



1

GEV No.	693151	Ref. No.	01017 RC01017000
description	keypad foil salamander grill QSE60		

solenoid valves

solenoid valves (water)

RPE



1

GEV No.	374017	Ref. No.	RCK6042070
description	solenoid valve single straight 230VAC inlet 3/4" outlet 10mm input 6l/min DN10 RPE polyamide flow regulating valve inlet white membranes NBR pressure range 0.2-10bar		

JOHN GUEST



1

GEV No.	370768 ¹	Ref. No.	RC01964000
description	solenoid valve single straight 230VAC inlet 3/4" outlet 10mm input/ min output/ min DN10 t.max. 90°C duty cycle 100% RPE		

¹cylindrical outlet



pressure switches

for steam control

			
1			
GEV No.	541074	Ref. No.	RC01842000
description	pressure control ø 45mm triggering pressure 0.5bar reset pressure 0.35bar pressure connection vertical steam control pressure range 0.35/0.51bar connection 1/8" pressure connection 1/8"		

fans



axial fans

import

			
1			
GEV No.	601604 ¹	Ref. No.	RC01863000
description	axial fan L 119mm W 119mm H 38mm 230VAC 50/60Hz 17/15W bearing slide bearing manuf. no. AA1282HS-AT connection cable 300mm fan wheel ø 110mm temp.-resist. 70°C input current 0.1A airflow 130m ³ /h 2600rpm		

¹with slide bearings

hot air motors

			
1			
GEV No.	500640	Ref. No.	RCK6032122
description	fan motor 220-240V 1 phase 50Hz 0.05/0.25HP 1400/2700rpm speeds 2 L1 145mm L2 65mm L3 35mm D1 ø 15mm D2 ø 12mm M10L ET 1.1/0.55A suitable capacitor 12.5µF/450V at 50Hz 1400/2700rpm type 2758D2253 no. 6032122		
spare parts for	500640		
	GEV No.	560280	Ref. No. —
	nut thread M10L H 8mm WS 17 SS DIN/ISO DIN 934 / ISO 4032/8673 Qty 1 pcs		

			
1			
GEV No.	500642	Ref. No.	RCK6033145
description	fan motor 380-415V 3 phase 50Hz 0.22/0.75kW 700/1400rpm speeds 2 L1 166mm L2 45mm L3 67mm D1 ø 24mm D2 ø 20mm M6R ITA at 50Hz 380-415V at 50Hz 700/1400rpm type FB80 4/8 no. 629764		

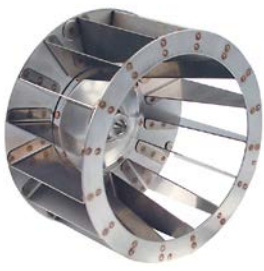
			
1			
GEV No.	601202	Ref. No.	RCK5901006
description	fan wheel D1 ø 180mm H1 100mm blades 16 D2 ø 11.5mm D3 ø 16mm H2 30mm		

			
1			
GEV No.	601203	Ref. No.	RCK5901010
description	fan wheel D1 ø 310mm H1 100mm blades 30 D2 ø 19.5mm D3 ø 23mm H2 46mm		

hot air fans

ebm-papst

			
1			
GEV No.	601103	Ref. No.	00229 RC00229000
description	radial fan 230V 47W L1 60mm L2 26mm L3 20mm L4 157mm fan wheel ø 150mm type G25150-AB08-44		



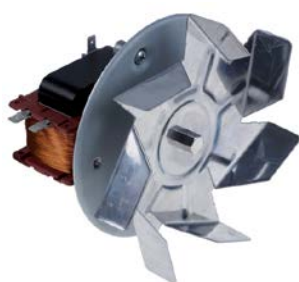

miscellaneous

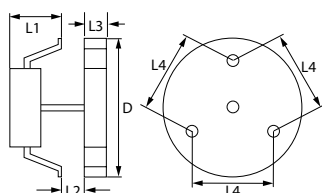

1





GEV No.	601011	Ref. No.	00565 RC00565000
description	hot air fan 220-240V 40W 50/60Hz L1 65mm L2 15mm L3 25mm L4 87mm fan wheel ø 150mm FIME type C25R8023CLH		
accessories for	601011		
	GEV No.	550879	Ref. No. —
	insulation ø 130mm thickness 3mm hole ø 20mm for hot air fan		
	GEV No.	601260	Ref. No. —
	nut thread M6L IT for hot air fan		

pumps

vibration pumps



1

GEV No.	500568	Ref. No.	RC01969000
description	vibration pump 230V 32W 50Hz inlet ø 7 outlet ø 1/8" IT CEME type E512/A32		
spare parts for	500568		
	GEV No.	390698	Ref. No. —
	thermal fuse switch-off temp. 110°C suitable for ULKA pump		
	GEV No.	520153	Ref. No. —
	bracket rubber dimensions 53x34x28mm		

condensators & interference sup-
pression filters

operating capacitors

plastic



1

GEV No.	365014	Ref. No.	LF3068081 RCK2013001
description	operating capacitor capacity 12.5µF 450V tolerance 5%Hz ambient temperature max. -25 to +85°C ø 35mm L 70mm M8 plastic connection male faston 6.3mm 45S.C3DS.12.5 protection		

filters

interference suppression filters



1

GEV No.	365044	Ref. No.	RCK6090050
description	interference suppression filter type FC701Y2F 250V 50-60Hz conductor 2 with E connection cable 200mm L 42mm ø 23mm Hmm Wmm plastic Qty 1 pcs		

fuses

fine fuses



1

GEV No.	358677	Ref. No.	RC01861000
description	fine fuse size ø5x20mm 4A fast-acting rated 250V Qty 10 pcs		

electric accessories

cables

accessories

cable glands

threaded cable glands

screw connections



1

GEV No.	550571	Ref. No.	RC00241000
description	cable gland thread PG16 cable ø 12.0-14.0mm mounting ø 21.5mm nickel-plated brass Qty 1 pcs		







terminals

connection terminals with screw/faston connections



GEV No.	550977 ¹	Ref. No.	RC00194000
description	power terminal block 6-pole max. 40A max 450V connection ø6mm ² / F6.3 temp.-resist. 150°C cross section 6mm ² with ground lug		

¹with ground lug

accessories for	101095		
	GEV No.	101300	Ref. No. —
	union nut thread M16x1.5 tube ø 10mm		
	GEV No.	101450	Ref. No. —
	olive for pipe ø 8mm L 12.7mm Qty 1 pcs ED ø 10mm		
	GEV No.	101451	Ref. No. —
	union nut thread M16x1.5 tube ø 8mm		
	GEV No.	110081	Ref. No. RC05001300
	knob ø 70mm shaft ø 8x6.5mm shaft flat universal		
	GEV No.	112206	Ref. No. —
	knob dial plate silver gas tap PEL21/22/23 t.max.°C ED ø 63mm ID ø 45.5mm		

gas taps

PEL

21S series



GEV No.	101095	Ref. No.	50014 RC05001400
----------------	--------	-----------------	---------------------

description gas tap PEL type 21S gas inlet M16x1.5 (tube ø 10mm) bypass nozzle ø 0.35mm gas outlet M16x1.5 (tube ø 10/8mm) thermocouple connection M8x1 pilot connection M10x1 shaft ø 8x6.5mm shaft L 22/15mm shaft flat lower

spare parts for 101095

	GEV No.	100408	Ref. No. —
	bypass nozzle type PEL20/21 bore ø 0.35mm thread M5x0.5		

	GEV No.	101060	Ref. No. —
	magnet unit standard L 39mm D1 ø 15.4mm D2 ø 11mm suitable for PEL20-21/JUNKERS/EGA		

	GEV No.	101206	Ref. No. —
	gas tap front part shaft ø 8x6.5mm shaft L 22/15mm shaft flat upper/lower suitable for PEL21		

	GEV No.	101230	Ref. No. —
	thermocouple nut T1: M8x1 T2: M18x1 aluminium		

accessories for 101095

	GEV No.	100908	Ref. No. —
	union screw thread M10x1 for pipe ø 4mm Qty 1 pcs		

	GEV No.	100909	Ref. No. —
	union screw thread M10x1 for pipe ø 6mm Qty 1 pcs		

	GEV No.	101246	Ref. No. —
	olive for pipe ø 4mm Qty 1 pcs		

	GEV No.	101278	Ref. No. —
	olive for pipe ø 10mm Qty 1 pcs		

	GEV No.	101286	Ref. No. —
	olive ID ø 6mm Qty 1 pcs		

22S/V series



GEV No.	101087	Ref. No.	00126 RC00126000
----------------	--------	-----------------	---------------------

description gas tap PEL type 22S/V gas inlet M20x1.5 (tube ø 12mm) bypass nozzle ø 0.35mm gas outlet M20x1.5 (tube ø 12/10mm) thermocouple connection M9x1 pilot connection M10x1 shaft ø 10x8mm shaft L 25/17mm shaft flat upper

spare parts for 101087

	GEV No.	100259	Ref. No. —
	bypass nozzle type PEL22 bore ø 0.35mm thread M6x0.5		

	GEV No.	101058	Ref. No. —
	magnet unit L 39mm D1 ø 15.4mm D2 ø 13.5mm suitable for PEL22/EGA24197 standard		

	GEV No.	101201	Ref. No. —
	gas tap front part shaft ø 10x8mm shaft L 25/17mm shaft flat upper/lower suitable for PEL22		

	GEV No.	101231	Ref. No. —
	thermocouple nut T1: M9x1 T2: M18x1		

	GEV No.	101241	Ref. No. —
	gas connection thread M20x1.5 tube ø 12/10mm for PEL gas taps vertical		

	GEV No.	101460	Ref. No. —
	O-ring ø 12.37mm D1 ø 2.62mm suitable for PEL22		

	GEV No.	101461	Ref. No. —
	screw kit suitable for PEL22 Qty 4 pcs		

accessories for 101087

	GEV No.	100908	Ref. No. —
	union screw thread M10x1 for pipe ø 4mm Qty 1 pcs		

	GEV No.	100909	Ref. No. —
	union screw thread M10x1 for pipe ø 6mm Qty 1 pcs		

Table continues overleaf



accessories for		101087	
	GEV No.	101240	Ref. No. —
gas connection thread M20x1.5 tube ø 12/10mm for PEL gas taps with gasket and screws horizontal			
	GEV No.	101246	Ref. No. —
olive for pipe ø 4mm Qty 1 pcs			
	GEV No.	101248	Ref. No. —
olive for pipe ø 12mm Qty 1 pcs suitable for PEL			
	GEV No.	101249	Ref. No. —
olive for pipe ø 10mm Qty 1 pcs			
	GEV No.	101250	Ref. No. —
union nut thread M20x1.5 for pipe ø 10mm			
	GEV No.	101251	Ref. No. —
union nut thread M20x1.5 for pipe ø 12mm			
	GEV No.	101286	Ref. No. —
olive ID ø 6mm Qty 1 pcs			
	GEV No.	110080	Ref. No. 00127 RC00127000
knob ø 70mm shaft ø 10x8mm shaft flat universal			
	GEV No.	112206	Ref. No. —
knob dial plate silver gas tap PEL21/22/23 t.max.°C ED ø 63mm ID ø 45.5mm			

accessories for		101396	
	GEV No.	520656	Ref. No. —
union nut thread 1/4" tube ø 6/8mm			
	GEV No.	560082	Ref. No. —
hexagonal screw thread M4 thread L 16mm SS WS 7 Qty 20 pcs DIN 933 / ISO 4017			

gas thermostats

SIT

630 Eurosit series

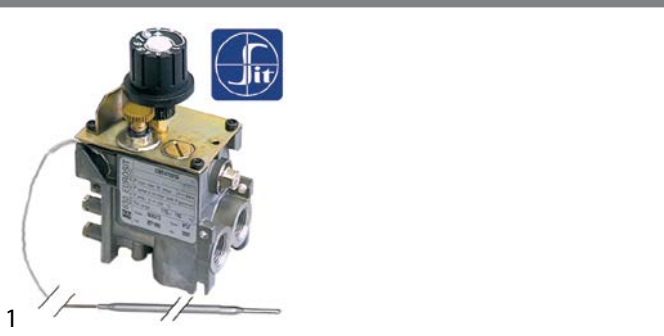

GEV No.	101188	Ref. No.	00446 RC00446000
description	gas thermostat type 630 Eurosit series t.max. 190°C 110-190°C gas inlet 3/8" gas outlet 3/8" thermocouple connection M9x1 pilot connection M10x1 probe ø 4mm probe L 202mm capillary pipe 1050mm SIT		

accessories for		101188	
	GEV No.	100904	Ref. No. —
locking screw M10x1 for pipe ø 4mm Qty 1 pcs			
	GEV No.	100905	Ref. No. —
locking screw M10x1 for pipe ø 6mm Qty 1 pcs			
	GEV No.	101273	Ref. No. —
olive for pipe ø 12mm L 9.5mm brass Qty 1 pcs suitable for universal			
	GEV No.	101276	Ref. No. —
union screw thread 3/8" tube ø 12mm Qty 1 pcs			
	GEV No.	101333	Ref. No. —
plug thread 3/8" with O-ring			

SABAF



GEV No.	101396	Ref. No.	00369 RC00369000
description	gas tap SABAF type 10 gas inlet pipe flange ø 16mm bypass nozzle ø 0mm gas outlet 1/4" (tube ø 8mm) front fixing thermocouple connection M8x1 shaft ø 8x6.5mm shaft L 26/12mm shaft flat lower		

spare parts for		101396	
	GEV No.	101376	Ref. No. —
gasket ID ø 8mm ED ø 12mm H 3/5mm			
	GEV No.	101751	Ref. No. —
bracket			
	GEV No.	106724	Ref. No. —
magnet unit L 30mm D1 ø 12.5mm D2 ø 8.5mm suitable for SABAF			

accessories for		101396	
	GEV No.	101277	Ref. No. —
olive ID ø 8mm Qty 1 pcs			
	GEV No.	101751	Ref. No. —
bracket			







GEV No.	101696	Ref. No.	01171 RC01171000
description	gas thermostat type 630 Eurosit series t.max. 300°C 60-300°C gas inlet 3/8" gas outlet 3/8" thermocouple connection M9x1 pilot connection M10x1 probe ø 4mm probe L 72mm capillary pipe 1050mm SIT		

spare parts for		101696	
	GEV No.	101333	Ref. No. —
plug thread 3/8" with O-ring			

Table continues overleaf





accessories for	101696		
	GEV No.	100904	Ref. No. —
	locking screw M10x1 for pipe ø 4mm Qty 1 pcs		
	GEV No.	100905	Ref. No. —
	locking screw M10x1 for pipe ø 6mm Qty 1 pcs		
	GEV No.	101273	Ref. No. —
	olive for pipe ø 12mm L 9.5mm brass Qty 1 pcs suitable for universal		
	GEV No.	101276	Ref. No. —
	union screw thread 3/8" tube ø 12mm Qty 1 pcs		

PEL





25ST series



GEV No.	101172	Ref. No.	01133 RC01133000
description	gas thermostat PEL type 25ST 100-300°C gas inlet M16x1.5 (tube ø 10mm) bypass nozzle ø 0.35mm gas outlet M16x1.5 (tube ø 10/8mm) thermocouple connection M9x1 pilot connection M10x1 capillary pipe 1200mm probe ø 6mm probe L 100mm shaft ø 8x6.5mm shaft L 21/15mm shaft flat upper		
spare parts for	101172		
	GEV No.	100259	Ref. No. —
	bypass nozzle type PEL22 bore ø 0.35mm thread M6x0.5		
	GEV No.	101060	Ref. No. —
	magnet unit standard L 39mm D1 ø 15.4mm D2 ø 11mm suitable for PEL20-21/JUNKERS/EGA		
	GEV No.	106200	Ref. No. —
	nut thread M9x1 suitable for PEL 24/25S		
accessories for	101172		
	GEV No.	100908	Ref. No. —
	union screw thread M10x1 for pipe ø 4mm Qty 1 pcs		
	GEV No.	100909	Ref. No. —
	union screw thread M10x1 for pipe ø 6mm Qty 1 pcs		
	GEV No.	101246	Ref. No. —
	olive for pipe ø 4mm Qty 1 pcs		
	GEV No.	101278	Ref. No. —
	olive for pipe ø 10mm Qty 1 pcs		
	GEV No.	101286	Ref. No. —
	olive ID ø 6mm Qty 1 pcs		
	GEV No.	101300	Ref. No. —
	union nut thread M16x1.5 tube ø 10mm		
	GEV No.	101450	Ref. No. —
	olive for pipe ø 8mm L 12.7mm Qty 1 pcs ED ø 10mm		
	GEV No.	101451	Ref. No. —
	union nut thread M16x1.5 tube ø 8mm		

accessories for	101172		
	GEV No.	110079	Ref. No. —
	knob dial plate gas thermostat 1-8 silver		
	GEV No.	110081	Ref. No. RC05001300
	knob ø 70mm shaft ø 8x6.5mm shaft flat universal		

SABAF

GEV No.	101694	Ref. No.	00889 RC00889000 RC02228000
description	gas thermostat SABAF t.max. 300°C gas inlet pipe flange bypass nozzle ø 0.38mm gas outlet M13x1 IT (tube ø 8mm) gas outlet 2 thermocouple connection M8x1 capillary pipe 850mm probe ø 4mm probe L 150mm shaft ø 8x6.5mm shaft flat lower L1 29mm L2 29mm		
spare parts for	101694		
	GEV No.	101060	Ref. No. —
	magnet unit standard L 39mm D1 ø 15.4mm D2 ø 11mm suitable for PEL20-21/JUNKERS/EGA		
accessories for	101694		
	GEV No.	101277	Ref. No. —
	olive ID ø 8mm Qty 1 pcs		
	GEV No.	101376	Ref. No. —
	gasket ID ø 8mm ED ø 12mm H 3/5mm		
	GEV No.	101477	Ref. No. —
	union screw thread M13x1 tube ø 8mm Qty 1 pcs		
	GEV No.	101751	Ref. No. —
	bracket		





GEV No.	101695	Ref. No.	00890 RC00890000
description	gas thermostat SABAF t.max. 300°C gas inlet pipe flange bypass nozzle ø 0.52mm gas outlet M13x1 IT (tube ø 8mm) gas outlet 2 thermocouple connection M8x1 capillary pipe 850mm probe ø 4mm probe L 150mm shaft ø 8x6.5mm shaft L 29/29mm shaft flat lower		
spare parts for	101695		
	GEV No.	101060	Ref. No. —
	magnet unit standard L 39mm D1 ø 15.4mm D2 ø 11mm suitable for PEL20-21/JUNKERS/EGA		
accessories for	101695		
	GEV No.	101277	Ref. No. —
	olive ID ø 8mm Qty 1 pcs		
	GEV No.	101376	Ref. No. —
	gasket ID ø 8mm ED ø 12mm H 3/5mm		

Table continues overleaf



accessories for	101695		
	GEV No.	101477	Ref. No. —
	union screw thread M13x1 tube ø 8mm Qty 1 pcs		
	GEV No.	101479	Ref. No. —
	bracket		

gas valves and ignition boxes







gas control valves

SIT

NOVASIT



1

GEV No.	101187	Ref. No.	RC30300014
description	gas valve SIT series Novasit 820 0.17VHz gas inlet 1/2" gas outlet 1/2" thermocouple connection M9x1 pilot connection M10x1 ignition pressurembar pressure range 5-50mbar pressure regulator connection blind equiv. no. 0.820.301 supply Operator millivolt		
spare parts for	101187		
	GEV No.	101065	Ref. No. —
	magnet unit with cable L 44mm D1 ø 30mm D2 ø 20mm suitable for NOVASIT		
accessories for	101187		
	GEV No.	100110	Ref. No. —
	pilot burner SIT type 190 series 3 flames nozzle ømm gas connectionmm		
	GEV No.	101305	Ref. No. —
	gas connection straight 1/2" flange 45x45mm ELETTROSIT/V4400/4600/4605 suitable for SIT/HONEYWELL hole distance 36x36mm		
	GEV No.	101306	Ref. No. —
	gas connection angled flange 45x45mm hole distance 36x36mm 1/2" ELETTROSIT/V4400/4600/4605 screw with O-ring suitable for SIT/HONEYWELL		
	GEV No.	101307	Ref. No. —
	gas connection straight flange 45x45mm hole distance 36x36mm 3/4" ELETTROSIT/V4400/4600/4605 screw with O-ring suitable for SIT/HONEYWELL		
	GEV No.	101308	Ref. No. —
	gas connection angled flange 45x45mm hole distance 36x36mm 3/4" ELETTROSIT/V4400/4600/4605 screw with O-ring suitable for SIT/HONEYWELL		
	GEV No.	102116	Ref. No. —
	thermopile ROBERTSHAW L 900mm probe ø 9mm probe L 57mm 250-750mV screw connection 7/16"		

TANDEM



1

GEV No.	101881	Ref. No.	RCK7020080
description	gas valve 230V 50Hz gas inlet 1/2" gas outlet 1/2" pilot connection level slow ignition ignition times pressure range 3-50mbar power supply for modulator equiv. no. 0.830.041 suitable for Tandem		
spare parts for	101881		
	GEV No.	101379	Ref. No. —
	solenoid coil 230V 50Hz suitable for Tandem		
accessories for	101881		
	GEV No.	101274	Ref. No. RCK7070036
	olive for pipe ø 16mm Qty 1 pcs		
	GEV No.	101275	Ref. No. —
	union screw thread 1/2" for pipe ø 16mm Qty 1 pcs		
	GEV No.	101925	Ref. No. —
	plug with O-ring thread M10x1 for pilot burner suitable for NOVASIT		
	GEV No.	102845	Ref. No. —
	gas connection angled 1/2" flange 32x32mm hole distance 24x24mm Tandem		
	GEV No.	102846	Ref. No. —
	gas connection straight 1/2" flange 32x32mm hole distance 24x24mm suitable for Tandem		
	GEV No.	102847	Ref. No. —
	O-ring		

ignition boxes

SIT



1

GEV No.	101685	Ref. No.	RCK7020085
description	ignition box SIT type 503EFD electrodes 2 waiting time 1.5s safety time 10s 220/240V 10VA 50-60Hz protection IP40		



ignition parts

pilot burners

SIT

100 series



GEV No.	106901	Ref. No.	01140 RC01140000
----------------	--------	-----------------	---------------------

description pilot burner SIT type 100 series 1 flame nozzle ø 0.2mm gas connection 6mm

spare parts for 106901

	GEV No.	100854	Ref. No.	—
pilot burner bracket double				

	GEV No.	100916	Ref. No.	—
compression spring for pilot burner Qty 1 pcs				

	GEV No.	100917	Ref. No.	—
gasket for pilot burner Qty 1 pcs aluminium				

	GEV No.	100918	Ref. No.	—
screw for pilot burner				

accessories for 106901

	GEV No.	100904	Ref. No.	—
locking screw M10x1 for pipe ø 4mm Qty 1 pcs				

	GEV No.	100905	Ref. No.	—
locking screw M10x1 for pipe ø 6mm Qty 1 pcs				

	GEV No.	102110	Ref. No.	—
pilot tube copper pipe ø 4mm thickness 1mm L 3000mm				

	GEV No.	102111	Ref. No.	—
pilot tube copper pipe ø 6mm thickness 1mm L 3000mm				

	GEV No.	102742	Ref. No.	—
pilot burner nozzle LPG code 25 bore ø 0.25mm Qty 1 pcs				



GEV No.	106903	Ref. No.	00119 RC00119000
----------------	--------	-----------------	---------------------

description pilot burner SIT type 100 series 3 flames nozzle ø 0.2mm gas connection 6mm

spare parts for 106903

	GEV No.	100245	Ref. No.	00435 RC00435000
pilot burner nozzle LPG code 20 bore ø 0.2mm Qty 1 pcs thread M8x0.75				

spare parts for	106903			
	GEV No.	100854	Ref. No.	—
pilot burner bracket double				
	GEV No.	100885	Ref. No.	—
air mixing sleeve for pilot burner Qty 1 pcs				
	GEV No.	100916	Ref. No.	—
compression spring for pilot burner Qty 1 pcs				
	GEV No.	100917	Ref. No.	—
gasket for pilot burner Qty 1 pcs aluminium				
	GEV No.	100918	Ref. No.	—
screw for pilot burner				
	GEV No.	107162	Ref. No.	—
pilot burner cap SIT 3 flames Hmm Lmm Qty 1 pcs				
	GEV No.	107701	Ref. No.	—
pilot burner bottom part SIT 100 series nozzle ø 0.2mm				
accessories for	106903			
	GEV No.	100245	Ref. No.	00435 RC00435000
pilot burner nozzle LPG code 20 bore ø 0.2mm Qty 1 pcs thread M8x0.75				
	GEV No.	100246	Ref. No.	00436 RC00436000
pilot burner nozzle natural gas bore ø 0.35mm Qty 1 pcs thread M8x0.75				
	GEV No.	100904	Ref. No.	—
locking screw M10x1 for pipe ø 4mm Qty 1 pcs				
	GEV No.	100905	Ref. No.	—
locking screw M10x1 for pipe ø 6mm Qty 1 pcs				
	GEV No.	102110	Ref. No.	—
pilot tube copper pipe ø 4mm thickness 1mm L 3000mm				
	GEV No.	102111	Ref. No.	—
pilot tube copper pipe ø 6mm thickness 1mm L 3000mm				
	GEV No.	107171	Ref. No.	—
pilot burner nozzle SIT natural/liquid gas bore ø 0.25mm Qty 1 pcs				
	GEV No.	107700	Ref. No.	—
pilot burner bottom part SIT 100 series nozzle ø 0.25mm				
	GEV No.	107702	Ref. No.	—
pilot burner bottom part SIT 100 series nozzle ø 0.35mm				



			
1			
GEV No.	106906	Ref. No.	00445 RC00445000
description	pilot burner SIT type 100 series 3 flames nozzle \varnothing 0.2mm gas connection 6mm		
spare parts for	106906		
	GEV No.	100245	Ref. No. 00435 RC00435000
	pilot burner nozzle LPG code 20 bore \varnothing 0.2mm Qty 1 pcs thread M8x0.75		
	GEV No.	100855	Ref. No. 00411 RC00411000
	pilot burner bracket triple		
	GEV No.	100885	Ref. No. —
	air mixing sleeve for pilot burner Qty 1 pcs		
	GEV No.	100916	Ref. No. —
	compression spring for pilot burner Qty 1 pcs		
	GEV No.	100917	Ref. No. —
	gasket for pilot burner Qty 1 pcs aluminium		
	GEV No.	100918	Ref. No. —
	screw for pilot burner		
	GEV No.	107162	Ref. No. —
	pilot burner cap SIT 3 flames Hmm Lmm Qty 1 pcs		
	GEV No.	107701	Ref. No. —
	pilot burner bottom part SIT 100 series nozzle \varnothing 0.2mm		
accessories for	106906		
	GEV No.	100245	Ref. No. 00435 RC00435000
	pilot burner nozzle LPG code 20 bore \varnothing 0.2mm Qty 1 pcs thread M8x0.75		
	GEV No.	100246	Ref. No. 00436 RC00436000
	pilot burner nozzle natural gas bore \varnothing 0.35mm Qty 1 pcs thread M8x0.75		
	GEV No.	100904	Ref. No. —
	locking screw M10x1 for pipe \varnothing 4mm Qty 1 pcs		
	GEV No.	100905	Ref. No. —
	locking screw M10x1 for pipe \varnothing 6mm Qty 1 pcs		
	GEV No.	102110	Ref. No. —
	pilot tube copper pipe \varnothing 4mm thickness 1mm L 3000mm		
	GEV No.	102111	Ref. No. —
	pilot tube copper pipe \varnothing 6mm thickness 1mm L 3000mm		
	GEV No.	107171	Ref. No. —
	pilot burner nozzle SIT natural/liquid gas bore \varnothing 0.25mm Qty 1 pcs		
	GEV No.	107700	Ref. No. —
	pilot burner bottom part SIT 100 series nozzle \varnothing 0.25mm		























accessories for	106906		
	GEV No.	107702	Ref. No. —
	pilot burner bottom part SIT 100 series nozzle \varnothing 0.35mm		
			
1			
GEV No.	106907	Ref. No.	RC30100005
description	pilot burner SIT type 100 series 3 flames nozzle \varnothing 0.35mm gas connection 6mm		
spare parts for	106907		
	GEV No.	100246	Ref. No. 00436 RC00436000
	pilot burner nozzle natural gas bore \varnothing 0.35mm Qty 1 pcs thread M8x0.75		
	GEV No.	100855	Ref. No. 00411 RC00411000
	pilot burner bracket triple		
	GEV No.	100885	Ref. No. —
	air mixing sleeve for pilot burner Qty 1 pcs		
	GEV No.	100916	Ref. No. —
	compression spring for pilot burner Qty 1 pcs		
	GEV No.	100917	Ref. No. —
	gasket for pilot burner Qty 1 pcs aluminium		
	GEV No.	100918	Ref. No. —
	screw for pilot burner		
	GEV No.	107162	Ref. No. —
	pilot burner cap SIT 3 flames Hmm Lmm Qty 1 pcs		
	GEV No.	107702	Ref. No. —
	pilot burner bottom part SIT 100 series nozzle \varnothing 0.35mm		
accessories for	106907		
	GEV No.	100245	Ref. No. 00435 RC00435000
	pilot burner nozzle LPG code 20 bore \varnothing 0.2mm Qty 1 pcs thread M8x0.75		
	GEV No.	100904	Ref. No. —
	locking screw M10x1 for pipe \varnothing 4mm Qty 1 pcs		
	GEV No.	100905	Ref. No. —
	locking screw M10x1 for pipe \varnothing 6mm Qty 1 pcs		
	GEV No.	102110	Ref. No. —
	pilot tube copper pipe \varnothing 4mm thickness 1mm L 3000mm		
	GEV No.	102111	Ref. No. —
	pilot tube copper pipe \varnothing 6mm thickness 1mm L 3000mm		
	GEV No.	107171	Ref. No. —
	pilot burner nozzle SIT natural/liquid gas bore \varnothing 0.25mm Qty 1 pcs		

Table continues overleaf





accessories for 106907				
	GEV No.	107700	Ref. No.	—
pilot burner bottom part SIT 100 series nozzle ø 0.25mm				
	GEV No.	107701	Ref. No.	—
pilot burner bottom part SIT 100 series nozzle ø 0.2mm				

accessories
pilot burner brackets
universal

				
GEV No.	100855	Ref. No.	00411 RC00411000	
description	pilot burner bracket triple			
accessories for 100855				
	GEV No.	100855	Ref. No.	00411 RC00411000
pilot burner bracket triple				
	GEV No.	100886	Ref. No.	—
pilot burner bracket suitable for 100 series 3-piece				
	GEV No.	100888	Ref. No.	—
screw bolt for pilot burner				

pilot burner nozzles				
				
GEV No.	100245	Ref. No.	00435 RC00435000	
description	pilot burner nozzle LPG code 20 bore ø 0.2mm Qty 1 pcs thread M8x0.75			

				
GEV No.	100246	Ref. No.	00436 RC00436000	
description	pilot burner nozzle natural gas bore ø 0.35mm Qty 1 pcs thread M8x0.75			

ignition electrodes			
			
GEV No.	100706	Ref. No.	00120 RC00120000
description	ignition electrode connection M4 Qty 1 pcs		





























140 - 145 -150 series			
			
GEV No.	107134	Ref. No.	01169 RC01169000
description	pilot burner SIT type 140 series 1 flame nozzle ømm gas connectionmm		
accessories for 107134			
	GEV No.	100204	Ref. No. RC01219000
pilot burner nozzle SIT LPG code 14 bore ø 0.18/0.20mm Qty 1 pcs suitable for 140 series			
	GEV No.	100205	Ref. No. —
pilot burner nozzle SIT LPG code 19 bore ø 0.23/0.26mm Qty 1 pcs suitable for SIT 150 series			
	GEV No.	100206	Ref. No. —
pilot burner nozzle SIT natural gas code 36 bore ø 0.60/0.55mm Qty 1 pcs suitable for SIT 150 series			
	GEV No.	100207	Ref. No. RCK7042013
pilot burner nozzle SIT natural gas code 27 bore ø 0.40/0.38mm suitable for SIT 140 series			
	GEV No.	100216	Ref. No. —
pilot burner nozzle SIT natural gas code 38 bore ø 0.45mm Qty 1 pcs suitable for SIT 150 series			
	GEV No.	100701	Ref. No. 01168 RC01168000
ignition electrode connection M4 Qty 1 pcs			
	GEV No.	100897	Ref. No. —
olive for pipe ø 4mm Qty 1 pcs for pilot burner			
	GEV No.	100898	Ref. No. —
olive for pipe ø 6mm Qty 1 pcs for pilot burner			
	GEV No.	100906	Ref. No. RCK7050028
screw connection thread M10x1 for ignition electrode brass Qty 1 pcs WS 10			
	GEV No.	100907	Ref. No. —
screw connection thread M10x1 Qty 1 pcs type SEF 1 ømm for thermocouple			
	GEV No.	100908	Ref. No. —
union screw thread M10x1 for pipe ø 4mm Qty 1 pcs			

Table continues overleaf



accessories for	107134		
	GEV No.	100909	Ref. No. —
	union screw thread M10x1 for pipe ø 6mm Qty 1 pcs		

1			
GEV No.	107114 ¹	Ref. No.	RCK7090028
description	pilot burner SIT type 140 series 2 flames nozzle ømm gas connectionmm		
spare parts for	107114		
	GEV No.	100907	Ref. No. —
	screw connection thread M10x1 Qty 1 pcs type SEF 1 ømm for thermocouple		
accessories for	107114		
	GEV No.	100204	Ref. No. RC01219000
	pilot burner nozzle SIT LPG code 14 bore ø 0.18/0.20mm Qty 1 pcs suitable for 140 series		
	GEV No.	100205	Ref. No. —
	pilot burner nozzle SIT LPG code 19 bore ø 0.23/0.26mm Qty 1 pcs suitable for SIT 150 series		
	GEV No.	100206	Ref. No. —
	pilot burner nozzle SIT natural gas code 36 bore ø 0.60/0.55mm Qty 1 pcs suitable for SIT 150 series		
	GEV No.	100207	Ref. No. RCK7042013
	pilot burner nozzle SIT natural gas code 27 bore ø 0.40/0.38mm suitable for SIT 140 series		
	GEV No.	100216	Ref. No. —
	pilot burner nozzle SIT natural gas code 38 bore ø 0.45mm Qty 1 pcs suitable for SIT 150 series		
	GEV No.	100701	Ref. No. 01168 RC01168000
	ignition electrode connection M4 Qty 1 pcs		
	GEV No.	100801	Ref. No. —
	gasket for pilot burner Qty 1 pcs		
	GEV No.	100897	Ref. No. —
	olive for pipe ø 4mm Qty 1 pcs for pilot burner		
	GEV No.	100898	Ref. No. —
	olive for pipe ø 6mm Qty 1 pcs for pilot burner		
	GEV No.	100906	Ref. No. RCK7050028
	screw connection thread M10x1 for ignition electrode brass Qty 1 pcs WS 10		
	GEV No.	100908	Ref. No. —
	union screw thread M10x1 for pipe ø 4mm Qty 1 pcs		
	GEV No.	100909	Ref. No. —
	union screw thread M10x1 for pipe ø 6mm Qty 1 pcs		
	GEV No.	102110	Ref. No. —
	pilot tube copper pipe ø 4mm thickness 1mm L 3000mm		
	GEV No.	102111	Ref. No. —
	pilot tube copper pipe ø 6mm thickness 1mm L 3000mm		

¹incl. thermocouple fitting























POLIDORO			
pilot burners			
1			
GEV No.	100051	Ref. No.	RCK7090026
description	pilot burner POLIDORO 3 flames code gas connectionmm		
spare parts for	100051		
	GEV No.	100907	Ref. No. —
	screw connection thread M10x1 Qty 1 pcs type SEF 1 ømm for thermocouple		
accessories for	100051		
	GEV No.	100000	Ref. No. —
	pilot burner nozzle POLIDORO LPG code 22 bore ø 0.22mm Qty 1 pcs		
	GEV No.	100208	Ref. No. —
	pilot burner nozzle POLIDORO LPG code 20 bore ø 0.2mm Qty 1 pcs		
	GEV No.	100209	Ref. No. —
	pilot burner nozzle POLIDORO natural gas code 40 bore ø 0.4mm Qty 1 pcs		
	GEV No.	100701	Ref. No. 01168 RC01168000
	ignition electrode connection M4 Qty 1 pcs		
	GEV No.	100906	Ref. No. RCK7050028
	screw connection thread M10x1 for ignition electrode brass Qty 1 pcs WS 10		
	GEV No.	100907	Ref. No. —
	screw connection thread M10x1 Qty 1 pcs type SEF 1 ømm for thermocouple		
	GEV No.	100908	Ref. No. —
	union screw thread M10x1 for pipe ø 4mm Qty 1 pcs		
	GEV No.	100909	Ref. No. —
	union screw thread M10x1 for pipe ø 6mm Qty 1 pcs		
	GEV No.	102110	Ref. No. —
	pilot tube copper pipe ø 4mm thickness 1mm L 3000mm		
	GEV No.	102111	Ref. No. —
	pilot tube copper pipe ø 6mm thickness 1mm L 3000mm		
	GEV No.	102508	Ref. No. —
	union screw thread M10x1 for pipe ø 4mm Qty 5 pcs		
	GEV No.	102509	Ref. No. —
	union screw thread M10x1 for pipe ø 6mm Qty 5 pcs		
	GEV No.	102699	Ref. No. —
	pilot burner nozzle POLIDORO natural gas code 25.2 bore ø 2x0.25mm Qty 1 pcs 2 bores		
	GEV No.	102795	Ref. No. —
	olive for pipe ø 4mm Qty 1 pcs		
	GEV No.	102797	Ref. No. —
	olive for pipe ø 6mm Qty 1 pcs		

Table continues overleaf



accessories for		100051	
	GEV No.	106703	Ref. No. RCK7042008
pilot burner nozzle POLIDORO natural gas code 27.2 bore ϕ 2x0.27mm Qty 1 pcs			
	GEV No.	106704	Ref. No. —
pilot burner nozzle POLIDORO LPG code 16.2 bore ϕ 2x0.16mm Qty 1 pcs			
	GEV No.	106763	Ref. No. —
pilot burner nozzle POLIDORO natural gas code 27.2A bore ϕ 2x 0.27mm Qty 1 pcs			
	GEV No.	106859	Ref. No. —
pilot burner nozzle POLIDORO LPG code 24 bore ϕ 0.24mm Qty 1 pcs			



GEV No.	100738	Ref. No.	00368 RC00368000
description	ignition electrode D1 ϕ 6mm cable length 750mm D2 ϕ 10mm BL1 14mm BL2 2mm BL3 15mm to clip with spring and insulation connection ϕ 2.4mm		

electrodes

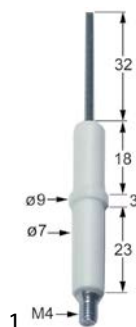

GEV No.	100701	Ref. No.	01168 RC01168000
description	ignition electrode connection M4 Qty 1 pcs		

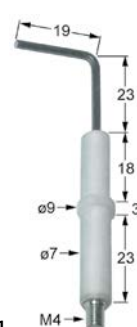

GEV No.	102333	Ref. No.	RCK2012111
description	ignition electrode D1 ϕ 7mm D2 ϕ 9mm connection M4 L1 23mm L2 19mm BL1 18mm BL2 3mm BL3 23mm to clip		

accessories for		100701	
	GEV No.	100906	Ref. No. RCK7050028
screw connection thread M10x1 for ignition electrode brass Qty 1 pcs WS 10			

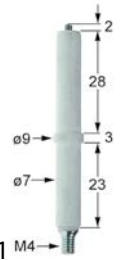

GEV No.	102314	Ref. No.	RCK6010061
description	ignition electrode D1 ϕ 7mm D2 ϕ 9mm connection M4 L1 2mm BL1 28mm BL2 3mm BL3 23mm to clip		



GEV No.	100706	Ref. No.	00120 RC00120000
description	ignition electrode connection M4 Qty 1 pcs		

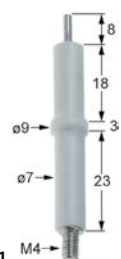

GEV No.	102871	Ref. No.	RC01168000
description	ignition electrode D1 ϕ 7mm D2 ϕ 9mm connection M4 L1 8mm BL1 18mm BL2 3mm BL3 23mm to clip		

GEV No.	102314	Ref. No.	RCK6010061
description	ignition electrode D1 ϕ 7mm D2 ϕ 9mm connection M4 L1 2mm BL1 28mm BL2 3mm BL3 23mm to clip		

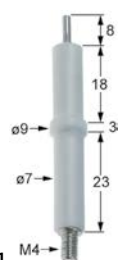

GEV No.	102871	Ref. No.	RC01168000
description	ignition electrode D1 ϕ 7mm D2 ϕ 9mm connection M4 L1 8mm BL1 18mm BL2 3mm BL3 23mm to clip		

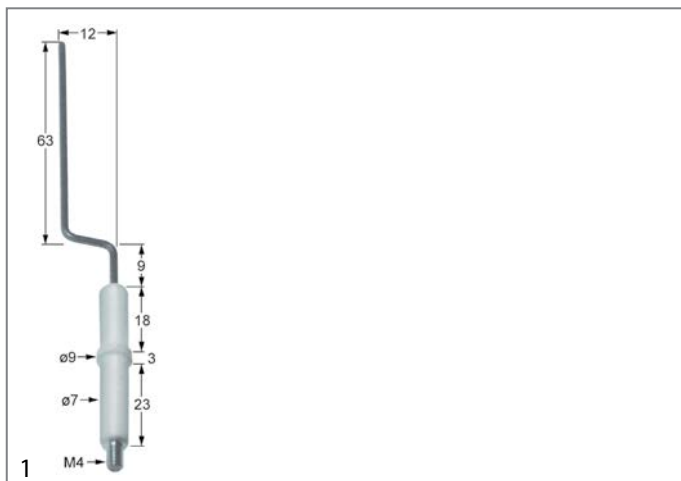

GEV No.	102334	Ref. No.	RCK2012110
description	ignition electrode D1 ø 7mm D2 ø 9mm connection M4 L1 9mm L2 12mm L3 62mm BL1 18mm BL2 3mm BL3 23mm to clip		

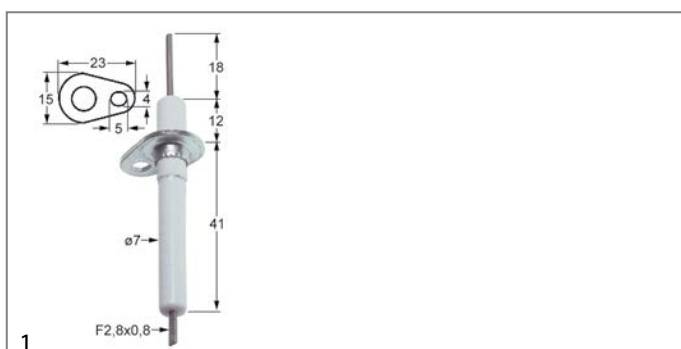

GEV No.	100818	Ref. No.	00861 RC00861000
description	ignition electrode flange length 23mm flange width 15mm D1 ø 7mm L1 18mm BL1 12mm BL2 41mm connection F 2.8x0.8mm fixing dimensions ø5x4mm with flange		



GEV No.	100906	Ref. No.	RCK7050028
description	screw connection thread M10x1 for ignition electrode brass Qty 1 pcs WS 10		

ignition cables

pre-assembled cables

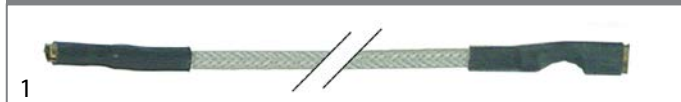

GEV No.	100176	Ref. No.	RCK6050610
description	ignition cable cable length 1000mm connection ø2.4mm / ø4mm permanent temperature 200°C		



GEV No.	100174	Ref. No.	00867 RC00867000
description	ignition cable cable length 1500mm connection F2.8mm / F2.8mm		



GEV No.	100140	Ref. No.	RCK6050051
description	ignition cable cable length 400mm connection ø2.4mm / ø4mm		



GEV No.	100018	Ref. No.	00123 RC00123000
description	ignition cable cable length 600mm connection ø2.4mm / ø4mm permanent temperature 200°C		

piezoelectric igniters

mounting diameter 18mm

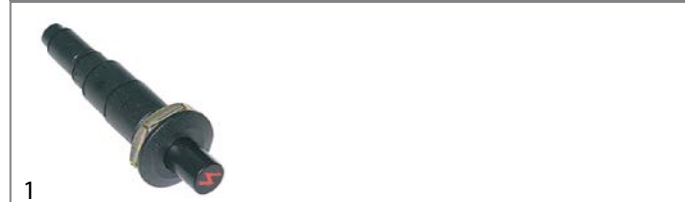

GEV No.	100009	Ref. No.	00128 RC00128000
description	piezoelectric igniter body plastic blowing mounting ø 18mm connection ø2.4mm front measurements 26mm M18x1.5		

accessories for	100009			
	GEV No.	101339	Ref. No.	—
	cover cap for piezoelectric igniter			
	GEV No.	106869	Ref. No.	—
	cover cap for piezoelectric igniter ID ø 22mm ED ø 35mm H 25mm			
	GEV No.	107931	Ref. No.	—
	cover cap for piezoelectric igniter ID ø 21mm ED ø 36mm			

ignition units



GEV No.	102485	Ref. No.	RC00862000 RCK6041059
description	ignition unit outputs 2 220-240VAC 0.6VA 50-60Hz		



gas components
1

			
GEV No.	101002	Ref. No.	00862
description	ignition unit outputs 2 230VAC dimensions 88x23x34mm mounting distance 73mm inlet F6.3x0.8 outlet F2.8x0.8 0.6VA 50/60Hz		

thermocouples

plug-in thermocouples

plug-in thermocouples standard

with barrel socket $\varnothing 6(6.5)$ mm

thermocouples SIT

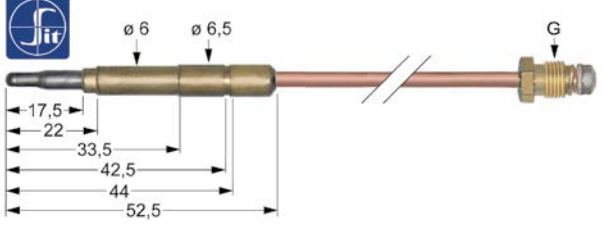
			
GEV No.	107605	Ref. No.	RC01483000
description	thermocouple SIT M8x1 L 1500mm plug connection $\varnothing 6.0(6.5)$ mm		

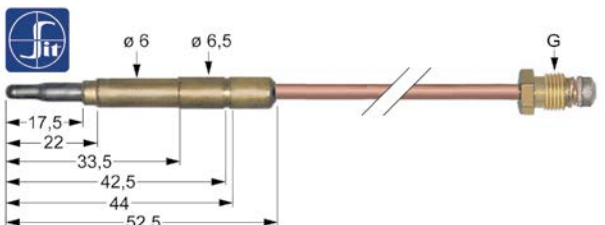
			
GEV No.	107613	Ref. No.	RC40400100
description	thermocouple SIT M9x1 L 1200mm plug connection $\varnothing 6.0(6.5)$ mm		

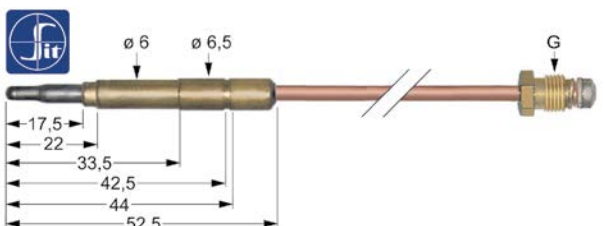
			
GEV No.	107609	Ref. No.	00118 RC00118000
description	thermocouple SIT M9x1 L 600mm plug connection $\varnothing 6.0(6.5)$ mm		

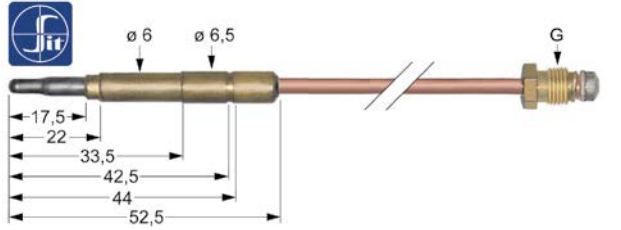

			
GEV No.	107611	Ref. No.	RC40400110 RCK6010057
description	thermocouple SIT M9x1 L 850mm plug connection $\varnothing 6.0(6.5)$ mm		



threaded thermocouples

threaded thermocouples standard

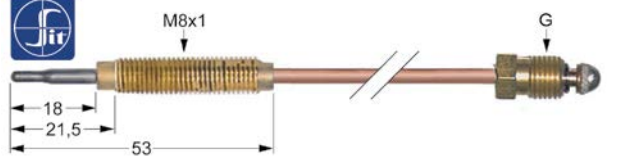
with socket with thread M8x1

SIT

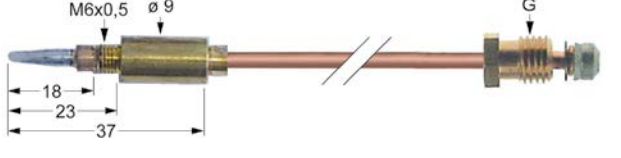
				
GEV No.	107634	Ref. No.	00864 RC00864000	
description	thermocouple SIT M8x1 L 1500mm M8x1			
accessories for	107634			
	GEV No.	102067	Ref. No.	00865 RC00865000
	nut thread M8x1 H 3mm brass Qty 1 pcs type SEF 1			

threaded thermocouples (miscellaneous)				
				
GEV No.	102121	Ref. No.	00367 RC00367000	
description	thermocouple M8x1 L 600mm M6x0.5			
accessories for	102121			
	GEV No.	100892	Ref. No.	—
	thermocouple nut thread M6x0.5 H 6.5mm WS 8 brass Qty 1 pcs			

accessories

nuts			
			
GEV No.	102067	Ref. No.	00865 RC00865000
description	nut thread M8x1 H 3mm brass Qty 1 pcs type SEF 1		



interrupters

 <p>1</p>			
GEV No.	101265	Ref. No.	RC00460000
description	interrupter thread M9x1		





gas burners





hob burners

universal hob burners

SABAF

1 series

 <p>1</p>			
GEV No.	104288	Ref. No.	00375 RC00375000
description	burner cap 3.6kW ø 120mm		
accessories for	104288		
	GEV No.	104289	Ref. No. 00377 RC00377000
burner lower part 3/3.6kW for burner cap ø 90/120mm			
	GEV No.	105086	Ref. No. —
burner ring 3.6kW for burner cap ø 120mm			
	GEV No.	105087	Ref. No. —
burner head 3.6kW for burner cap ø 120mm			

 <p>1</p>			
GEV No.	104286	Ref. No.	00373 RC00373000
description	burner cap 3kW ø 90mm		
accessories for	104286		
	GEV No.	104289	Ref. No. 00377 RC00377000
burner lower part 3/3.6kW for burner cap ø 90/120mm			
	GEV No.	105089	Ref. No. —
burner ring 3kW for burner cap ø 90mm			
	GEV No.	105090	Ref. No. —
burner head 3kW for burner cap ø 90mm			





 <p>1</p>			
GEV No.	104289	Ref. No.	00377 RC00377000
description	burner lower part 3/3.6kW for burner cap ø 90/120mm		
accessories for	104289		
	GEV No.	104286	Ref. No. 00373 RC00373000
burner cap 3kW ø 90mm			
	GEV No.	104288	Ref. No. 00375 RC00375000
burner cap 3.6kW ø 120mm			
	GEV No.	105086	Ref. No. —
burner ring 3.6kW for burner cap ø 120mm			
	GEV No.	105087	Ref. No. —
burner head 3.6kW for burner cap ø 120mm			
	GEV No.	105089	Ref. No. —
burner ring 3kW for burner cap ø 90mm			
	GEV No.	105090	Ref. No. —
burner head 3kW for burner cap ø 90mm			
	GEV No.	106482	Ref. No. —
gas injector thread M6x0.75 WS 7 bore ø 1.1mm			
	GEV No.	106485	Ref. No. —
gas injector thread M6x0.75 WS 7 bore ø 1.6mm			

producer-specific hob burners



TECNOINOX

650 (1) series



 <p>1</p>			
GEV No.	104288	Ref. No.	00375 RC00375000
description	burner cap 3.6kW ø 120mm		
accessories for	104288		
	GEV No.	104289	Ref. No. 00377 RC00377000
burner lower part 3/3.6kW for burner cap ø 90/120mm			
	GEV No.	105086	Ref. No. —
burner ring 3.6kW for burner cap ø 120mm			
	GEV No.	105087	Ref. No. —
burner head 3.6kW for burner cap ø 120mm			





			
1			
GEV No.	104286	Ref. No.	00373 RC00373000
description	burner cap 3kW ø 90mm		
accessories for	104286		
	GEV No.	104289	Ref. No. 00377 RC00377000
burner lower part 3/3.6kW for burner cap ø 90/120mm			
	GEV No.	105089	Ref. No. —
burner ring 3kW for burner cap ø 90mm			
	GEV No.	105090	Ref. No. —
burner head 3kW for burner cap ø 90mm			





			
1			
GEV No.	104289	Ref. No.	00377 RC00377000
description	burner lower part 3/3.6kW for burner cap ø 90/120mm		
accessories for	104289		
	GEV No.	104286	Ref. No. 00373 RC00373000
burner cap 3kW ø 90mm			
	GEV No.	104288	Ref. No. 00375 RC00375000
burner cap 3.6kW ø 120mm			
	GEV No.	105086	Ref. No. —
burner ring 3.6kW for burner cap ø 120mm			
	GEV No.	105087	Ref. No. —
burner head 3.6kW for burner cap ø 120mm			
	GEV No.	105089	Ref. No. —
burner ring 3kW for burner cap ø 90mm			
	GEV No.	105090	Ref. No. —
burner head 3kW for burner cap ø 90mm			
	GEV No.	106482	Ref. No. —
gas injector thread M6x0.75 WS 7 bore ø 1.1mm			
	GEV No.	106485	Ref. No. —
gas injector thread M6x0.75 WS 7 bore ø 1.6mm			

			
1			
GEV No.	104287	Ref. No.	00374 RC00374000
description	burner ring for burner cap ø 120mm		
accessories for	104287		
	GEV No.	105086	Ref. No. —
burner ring 3.6kW for burner cap ø 120mm			





accessories for	104287		
	GEV No.	105087	Ref. No. —
burner head 3.6kW for burner cap ø 120mm			





			
1			
GEV No.	104285	Ref. No.	00372 RC00372000
description	burner ring ø 90mm for burner cap ø 90mm		
accessories for	104285		
	GEV No.	105089	Ref. No. —
burner ring 3kW for burner cap ø 90mm			
	GEV No.	105090	Ref. No. —
burner head 3kW for burner cap ø 90mm			





650 (2) series			
			
1			
GEV No.	105379	Ref. No.	00969 RC00969000
description	air mixing tube		
accessories for	105379		
	GEV No.	105376	Ref. No. 00967 RC00967000
burner cap ø 110mm			
	GEV No.	105377	Ref. No. 00968 RC00968000
burner head for burner cap ø 110mm			
	GEV No.	105378	Ref. No. 00976 RC00976000
burner holder			





			
1			
GEV No.	105376	Ref. No.	00967 RC00967000
description	burner cap ø 110mm		
accessories for	105376		
	GEV No.	105377	Ref. No. 00968 RC00968000
burner head for burner cap ø 110mm			
	GEV No.	105378	Ref. No. 00976 RC00976000
burner holder			
	GEV No.	105379	Ref. No. 00969 RC00969000
air mixing tube			











			
1			
GEV No.	105377	Ref. No.	00968 RC00968000
description	burner head for burner cap ø 110mm		
accessories for	105377		
	GEV No.	105376	Ref. No. 00967 RC00967000
burner cap ø 110mm			
	GEV No.	105378	Ref. No. 00976 RC00976000
burner holder			
	GEV No.	105379	Ref. No. 00969 RC00969000
air mixing tube			

			
1			
GEV No.	105378	Ref. No.	00976 RC00976000
description	burner holder		
accessories for	105378		
	GEV No.	105376	Ref. No. 00967 RC00967000
burner cap ø 110mm			
	GEV No.	105377	Ref. No. 00968 RC00968000
burner head for burner cap ø 110mm			
	GEV No.	105379	Ref. No. 00969 RC00969000
air mixing tube			

700 series			
			
1			
GEV No.	105393	Ref. No.	01142 RC01142000
description	air mixing tube H 44mm ø 20mm suitable for burner 4.5kW		
accessories for	105393		
	GEV No.	105390	Ref. No. 01150 RC01150000
burner cap ø 110mm 4.5kW			
	GEV No.	105391	Ref. No. 01147 RC01147000
burner head for burner cap ø 110mm 4.5kW			
	GEV No.	105392	Ref. No. 01139 RC01139000
venturi suitable for burner 4.5kW			

			
1			
GEV No.	105397	Ref. No.	01143 RC01143000
description	air mixing tube H 48mm ø 22mm suitable for burner 7.2kW		
accessories for	105397		
	GEV No.	105394	Ref. No. 01149 RC01149000
burner cap ø 130mm 7.2kW with central hole			
	GEV No.	105395	Ref. No. 01146 RC01146000
burner head for burner cap ø 130mm 7.2kW			
	GEV No.	105396	Ref. No. 01137 RC01137000
venturi suitable for burner 7.2kW			

			
1			
GEV No.	105389	Ref. No.	01141 RC01141000
description	air mixing tube L 44mm ø 16mm suitable for burner 3.3kW		
accessories for	105389		
	GEV No.	105386	Ref. No. 01151 RC01151000
burner cap ø 75mm 3.3kW			
	GEV No.	105387	Ref. No. 01148 RC01148000
burner head for burner cap ø 75mm 3.3kW			
	GEV No.	105388	Ref. No. 01138 RC01138000
venturi suitable for burner 3.3kW			

			
1			
GEV No.	105390	Ref. No.	01150 RC01150000
description	burner cap ø 110mm 4.5kW		
accessories for	105390		
	GEV No.	105391	Ref. No. 01147 RC01147000
burner head for burner cap ø 110mm 4.5kW			
	GEV No.	105392	Ref. No. 01139 RC01139000
venturi suitable for burner 4.5kW			
	GEV No.	105393	Ref. No. 01142 RC01142000
air mixing tube H 44mm ø 20mm suitable for burner 4.5kW			









			
1			
GEV No.	105394	Ref. No.	01149 RC01149000
description	burner cap ø 130mm 7.2kW with central hole		
accessories for	105394		
	GEV No.	105395	Ref. No. 01146 RC01146000
burner head for burner cap ø 130mm 7.2kW			





Table continues overleaf





accessories for 105394				
	GEV No.	105396	Ref. No.	01137 RC01137000
venturi suitable for burner 7.2kW				
	GEV No.	105397	Ref. No.	01143 RC01143000
air mixing tube H 48mm ø 22mm suitable for burner 7.2kW				





				
1	GEV No.	105386	Ref. No.	01151 RC01151000
description burner cap ø 75mm 3.3kW				
accessories for 105386				
	GEV No.	105387	Ref. No.	01148 RC01148000
burner head for burner cap ø 75mm 3.3kW				
	GEV No.	105388	Ref. No.	01138 RC01138000
venturi suitable for burner 3.3kW				
	GEV No.	105389	Ref. No.	01141 RC01141000
air mixing tube L 44mm ø 16mm suitable for burner 3.3kW				

				
1	GEV No.	105391	Ref. No.	01147 RC01147000
description burner head for burner cap ø 110mm 4.5kW				
accessories for 105391				
	GEV No.	105390	Ref. No.	01150 RC01150000
burner cap ø 110mm 4.5kW				
	GEV No.	105392	Ref. No.	01139 RC01139000
venturi suitable for burner 4.5kW				
	GEV No.	105393	Ref. No.	01142 RC01142000
air mixing tube H 44mm ø 20mm suitable for burner 4.5kW				





				
1	GEV No.	105395	Ref. No.	01146 RC01146000
description burner head for burner cap ø 130mm 7.2kW				
accessories for 105395				
	GEV No.	105394	Ref. No.	01149 RC01149000
burner cap ø 130mm 7.2kW with central hole				
	GEV No.	105396	Ref. No.	01137 RC01137000
venturi suitable for burner 7.2kW				
	GEV No.	105397	Ref. No.	01143 RC01143000
air mixing tube H 48mm ø 22mm suitable for burner 7.2kW				

				
1	GEV No.	105387	Ref. No.	01148 RC01148000
description burner head for burner cap ø 75mm 3.3kW				
accessories for 105387				
	GEV No.	105386	Ref. No.	01151 RC01151000
burner cap ø 75mm 3.3kW				
	GEV No.	105388	Ref. No.	01138 RC01138000
venturi suitable for burner 3.3kW				
	GEV No.	105389	Ref. No.	01141 RC01141000
air mixing tube L 44mm ø 16mm suitable for burner 3.3kW				

				
1	GEV No.	105388	Ref. No.	01138 RC01138000
description venturi suitable for burner 3.3kW				
accessories for 105388				
	GEV No.	105386	Ref. No.	01151 RC01151000
burner cap ø 75mm 3.3kW				
	GEV No.	105387	Ref. No.	01148 RC01148000
burner head for burner cap ø 75mm 3.3kW				
	GEV No.	105389	Ref. No.	01141 RC01141000
air mixing tube L 44mm ø 16mm suitable for burner 3.3kW				

				
1	GEV No.	105392	Ref. No.	01139 RC01139000
description venturi suitable for burner 4.5kW				
accessories for 105392				
	GEV No.	105390	Ref. No.	01150 RC01150000
burner cap ø 110mm 4.5kW				
	GEV No.	105391	Ref. No.	01147 RC01147000
burner head for burner cap ø 110mm 4.5kW				
	GEV No.	105393	Ref. No.	01142 RC01142000
air mixing tube H 44mm ø 20mm suitable for burner 4.5kW				





			
1			
GEV No.	105396	Ref. No.	01137 RC01137000
description	venturi suitable for burner 7.2kW		
accessories for	105396		
			
GEV No.	105394	Ref. No.	01149 RC01149000
burner cap ø 130mm 7.2kW with central hole			
			
GEV No.	105395	Ref. No.	01146 RC01146000
burner head for burner cap ø 130mm 7.2kW			
			
GEV No.	105397	Ref. No.	01143 RC01143000
air mixing tube H 48mm ø 22mm suitable for burner 7.2kW			

pan supports			
			
1			
GEV No.	210182	Ref. No.	01144 RC01144000
description	pan support W 285mm L 315mm		

			
1			
GEV No.	210155	Ref. No.	00376 RC00376000
description	pan support W 320mm L 530mm		

			
1			
GEV No.	210181	Ref. No.	00970 RC00970000
description	pan support W 330mm L 540mm		

reducers for pan supports			
			
1			
GEV No.	210050	Ref. No.	N/A
description	reducer for pan support L 260mm W 260mm chrome-plated steel suitable for universal		

			
1			
GEV No.	210001	Ref. No.	N/A
description	reducer for pan support L 265mm W 265mm SS suitable for universal		

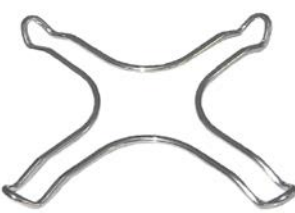
accessories			
reducers for pan supports			
			
1			
GEV No.	210050	Ref. No.	N/A
description	reducer for pan support L 260mm W 260mm chrome-plated steel suitable for universal		

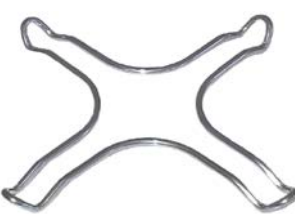
			
1			
GEV No.	210001	Ref. No.	N/A
description	reducer for pan support L 265mm W 265mm SS suitable for universal		



pan supports			
			
1			
GEV No.	210182	Ref. No.	01144 RC01144000
description	pan support W 285mm L 315mm		









			
1			
GEV No.	210155	Ref. No.	00376 RC00376000
description	pan support W 320mm L 530mm		



			
1			
GEV No.	210181	Ref. No.	00970 RC00970000
description	pan support W 330mm L 540mm		





air mixers

			
1			
GEV No.	105379	Ref. No.	00969 RC00969000
description	air mixing tube		
accessories for	105379		
	GEV No.	105378	Ref. No.
burner holder			00976 RC00976000

			
1			
GEV No.	105393	Ref. No.	01142 RC01142000
description	air mixing tube H 44mm ø 20mm suitable for burner 4.5kW		
accessories for	105393		
	GEV No.	105390	Ref. No.
burner cap ø 110mm 4.5kW			01150 RC01150000
	GEV No.	105391	Ref. No.
burner head for burner cap ø 110mm 4.5kW			01147 RC01147000
	GEV No.	105392	Ref. No.
venturi suitable for burner 4.5kW			01139 RC01139000

			
1			
GEV No.	105397	Ref. No.	01143 RC01143000
description	air mixing tube H 48mm ø 22mm suitable for burner 7.2kW		
accessories for	105397		
	GEV No.	105394	Ref. No.
burner cap ø 130mm 7.2kW with central hole			01149 RC01149000

accessories for	105397		
	GEV No.	105395	Ref. No.
burner head for burner cap ø 130mm 7.2kW			01146 RC01146000
	GEV No.	105396	Ref. No.
venturi suitable for burner 7.2kW			01137 RC01137000

			
1			
GEV No.	105389	Ref. No.	01141 RC01141000
description	air mixing tube L 44mm ø 16mm suitable for burner 3.3kW		
accessories for	105389		
	GEV No.	105386	Ref. No.
burner cap ø 75mm 3.3kW			01151 RC01151000
	GEV No.	105387	Ref. No.
burner head for burner cap ø 75mm 3.3kW			01148 RC01148000
	GEV No.	105388	Ref. No.
venturi suitable for burner 3.3kW			01138 RC01138000

bar burners

			
1			
GEV No.	105483	Ref. No.	00539 RC00539000
description	bar burner 2 row L 468mm W 200mm ømm H 45mm chargrill		

			
1			
GEV No.	104292	Ref. No.	50000 RC05000000
description	bar burner 2 row L 493mm W 200mm ømm H 45mm chargrill		

			
1			
GEV No.	105408	Ref. No.	01164 RC01164000
description	bar burner 2 row L 510mm W 190mm ømm H 40mm griddle		





 <p>1</p>			
GEV No.	105475	Ref. No.	RCK2010924
description	bar burner 2 row L 575mm W 225mm ømm H 45mm 11kW chargrill		

 <p>1</p>			
GEV No.	105427	Ref. No.	00117 RC00117000
description	bar burner 2 row L 680mm W 240mm ømm H 260mm salamander grill		

 <p>1</p>			
GEV No.	104291	Ref. No.	00420 RC00420000
description	bar burner ø 26mm Wmm Hmm L 260mm bain marie		

 <p>1</p>			
GEV No.	105405	Ref. No.	00882 RC00882000
description	bar burner ø 27mm Wmm Hmm L 640mm oven		



 <p>1</p>			
GEV No.	105406	Ref. No.	01134 RC01134000
description	bar burner ø 40mm Wmm Hmm L 520mm flange width 46mm oven flange ø 61mm		

 <p>1</p>			
GEV No.	105776	Ref. No.	RCK7090100
description	bar burner ø 50mm Wmm Hmm L 305mm with bolt M5x12 flange width 52mm convection oven flange ø 75mm		

 <p>1</p>			
GEV No.	105407	Ref. No.	00587 RC00587000
description	bar burner ø 50mm Wmm Hmm L 320mm flange width 72mm pasta cooker flange ø 75mm		

 <p>1</p>			
GEV No.	104290	Ref. No.	00366 RC00366000
description	bar burner ø 50mm Wmm Hmm L 390mm tilting bratt pan		

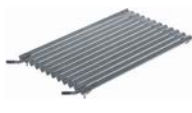
 <p>1</p>			
GEV No.	105775	Ref. No.	RCK7090101
description	bar burner ø 50mm Wmm Hmm L 425mm with bolt M5x12 flange width 52mm convection oven flange ø 75mm		

 <p>1</p>				
GEV No.	211025	Ref. No.	00541 RC00541000	
description	chargrill grid L 480mm W 305mm H 14mm			
accessories for	211025			
	GEV No.	211098	Ref. No.	RC05001900
	handle ø 28mm L 89mm thread M10x1 black			



1

GEV No.	211024	Ref. No.	00543 RC00543000
description	lava rock grid L 420mm W 268mm		

chargrill grids



1

GEV No.	211025	Ref. No.	00541 RC00541000
description	chargrill grid L 480mm W 305mm H 14mm		
accessories for	211025		
	GEV No.	211098	Ref. No. RC05001900
	handle ø 28mm L 89mm thread M10x1 black		

lava rock grids



1

GEV No.	211024	Ref. No.	00543 RC00543000
description	lava rock grid L 420mm W 268mm		

tube burners



1

GEV No.	105409	Ref. No.	01184 RC01184000
description	tubular burner L 300mm W 75mm H 42mm for fryer oval		



1

GEV No.	104293	Ref. No.	00440 RC00440000
description	tubular burner ø 74mm L 200mm H 60mm round for fryer		

solid top burners



1

GEV No.	105398	Ref. No.	01161 RC01161000
description	solid top burner ø 65mm H 102mm L 284mm		

accessories

nozzle holders



1

GEV No.	105399	Ref. No.	00414 RC00414000
description	nozzle holder		

gas nozzles

main nozzles

gas nozzles M10x1



1

GEV No.	100477	Ref. No.	01195
description	gas injector thread M10x1 WS 12 bore ø 1.65mm		

pilot burner nozzles

pilot burner nozzles POLIDORO



1

GEV No.	106703	Ref. No.	RCK7042008
description	pilot burner nozzle POLIDORO natural gas code 27.2 bore ø 2x0.27mm Qty 1 pcs		



pilot burner nozzles SIT

100 series

1 			
GEV No.	100245	Ref. No.	00435 RC00435000
description	pilot burner nozzle LPG code 20 bore ø 0.2mm Qty 1 pcs thread M8x0.75		

1 			
GEV No.	100246	Ref. No.	00436 RC00436000
description	pilot burner nozzle natural gas bore ø 0.35mm Qty 1 pcs thread M8x0.75		

140/150 series



1 			
GEV No.	100204	Ref. No.	RC01219000
description	pilot burner nozzle SIT LPG code 14 bore ø 0.18/0.20mm Qty 1 pcs suitable for 140 series		



1 			
GEV No.	100207	Ref. No.	RCK7042013
description	pilot burner nozzle SIT natural gas code 27 bore ø 0.40/0.38mm suitable for SIT 140 series		

auxiliary gas parts

screw connections

olives

1   Image not available			
GEV No.	106426	Ref. No.	RCK7070025
description	olive		

1 			
GEV No.	101274	Ref. No.	RCK7070036
description	olive for pipe ø 16mm Qty 1 pcs		
accessories for	101274		
	GEV No.	101275	Ref. No. —
	union screw thread 1/2" for pipe ø 16mm Qty 1 pcs		

union screws

1 			
GEV No.	100906	Ref. No.	RCK7050028
description	screw connection thread M10x1 for ignition electrode brass Qty 1 pcs WS 10		

gas lines

pilot tubes

producer-specific

1 			
GEV No.	106883	Ref. No.	RC00125000 RC0082551
description	pilot tube tube ø 6mm L 245mm copper T1: M10x1 T2: M10x1 with screw connection		

consumables

lava rocks / ceramic briquetts

1 			
GEV No.	211002	Ref. No.	50017 RC05001700
description	lava rocks size ca.40mm Qty 3.3Kg		



equipment-specific units

for vegetable slicers

miscellaneous



1			
GEV No.	110703	Ref. No.	4205 RC00004205
description	cylindrical handle thread M10 ø 28mm L 87mm		

for cheese graters

miscellaneous



1			
GEV No.	110703	Ref. No.	4205 RC00004205
description	cylindrical handle thread M10 ø 28mm L 87mm		

for cream whipping machines

spare parts



1			
GEV No.	655001	Ref. No.	RC00492000
description	angle piece for cream maker		



1			
GEV No.	750219	Ref. No.	RC00003211
description	container lid for cream maker		



1			
GEV No.	750220	Ref. No.	RC00003511
description	lid handle for cream maker mounting pos. front		



1			
GEV No.	750221	Ref. No.	RC00003011
description	lid handle for cream maker rear		

decorator tips



1			
GEV No.	696411	Ref. No.	RC00087000
description	decorator tip for cream maker L 36mm ID ø 25mm ED ø 29.5mm		
For models:	POLOBAR		

for grills

glass panels

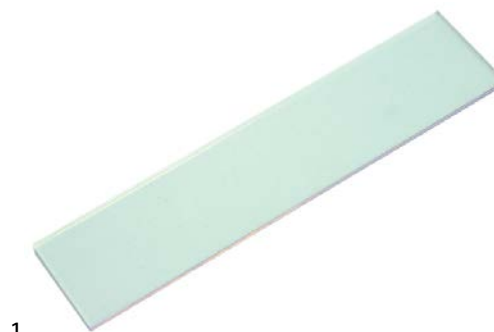

1			
GEV No.	693152	Ref. No.	00213 RC00213000
description	glass panel L 280mm W 65mm thickness 4mm rectangular		

for convection ovens/combi-steamers

doors



1			
GEV No.	690585	Ref. No.	RCK2011212
description	bush for door mechanism L 35mm ED ø 36mm int. ø 1 31mm int. ø 2 13mm mounting distance 28mm brass		

door mechanics



miscellaneous



1			
GEV No.	690585	Ref. No.	RCK2011212
description	bush for door mechanism L 35mm ED ø 36mm int. ø 1 31mm int. ø 2 13mm mounting distance 28mm brass		



vibration pumps

 <p>1</p>			
GEV No.	500568	Ref. No.	RC01969000
description	vibration pump 230V 32W 50Hz inlet ϕ 7 outlet ϕ 1/8" IT CEME type E512/A32		
spare parts for	500568		
	GEV No.	390698	Ref. No. —
	thermal fuse switch-off temp. 110°C suitable for ULKA pump		
	GEV No.	520153	Ref. No. —
	bracket rubber dimensions 53x34x28mm		

for toasters

pliers

pliers

 <p>1</p>			
GEV No.	690010	Ref. No.	9014
description	plier for toaster H 180mm total length 100mm		

knobs

universal knobs

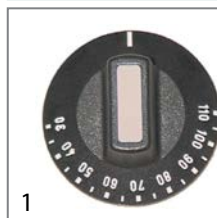
 <p>1</p>			
GEV No.	110241	Ref. No.	00598 RC00598000
description	knob thermostat t.max. 110°C ϕ 50mm shaft ϕ 6x4.6mm shaft flat upper black temperature range 30-110°C		

producer-specific knobs

TECNOINOX

 <p>1</p>			
GEV No.	110701	Ref. No.	06301 RC00006301
description	knob energyregulator 1-10 + MAX t.max.°C temperature range°C ϕ 38mm shaft ϕ 6x4.6mm shaft flat upper black		

 <p>1</p>			
GEV No.	110081	Ref. No.	RC05001300
description	knob ϕ 70mm shaft ϕ 8x6.5mm shaft flat universal		

 <p>1</p>			
GEV No.	110702	Ref. No.	00035 RC00035000
description	knob switch zero mark ϕ 40mm shaft ϕ 6x4.6mm shaft flat upper black		

 <p>1</p>			
GEV No.	110709	Ref. No.	00086 01113 RC00001113 RC00086000
description	knob switch zero mark t.max.°C temperature range°C ϕ 38mm shaft ϕ 6x4.6mm shaft flat upper black		

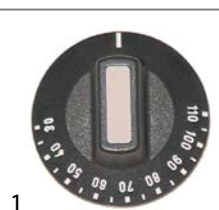
 <p>1</p>			
GEV No.	110241	Ref. No.	00598 RC00598000
description	knob thermostat t.max. 110°C ϕ 50mm shaft ϕ 6x4.6mm shaft flat upper black temperature range 30-110°C		



1

GEV No.	110708	Ref. No.	00287 RC00287000
description	knob energy regulator 1-6 + MAX t.max.°C temperature range°C ø 60mm shaft ø 6x4.6mm shaft flat left black		



1

GEV No.	110711	Ref. No.	00289 RC00289000
description	knob switch 7-position t.max.°C temperature range°C ø 60mm shaft ø 6x4.6mm shaft flat right black		



1

GEV No.	110716	Ref. No.	00538 RC00538000
description	knob gas tap with ignition flame t.max.°C temperature range°C ø 60mm shaft ø 8x6.5mm shaft flat lower black		



1

GEV No.	110715	Ref. No.	00280 RC00280000
description	knob thermostat t.max. 190°C temperature range 10x9°C ø 60mm shaft ø 6x4.6mm shaft flat right black		



1

GEV No.	110710	Ref. No.	00401 RC00401000
description	knob gas tap without ignition flame t.max.°C temperature range°C ø 60mm shaft ø 8x6.5mm shaft flat lower black		



1

GEV No.	110707	Ref. No.	00495 RC00495000
description	knob thermostat t.max. 275°C temperature range 50-275°C ø 59mm shaft ø 6x4.6mm shaft flat right rotation 270° black		



1

GEV No.	110714	Ref. No.	00448 RC00448000
description	knob gas thermostat 1-7 t.max.°C temperature range°C ø 60mm shaft ø 8x6.5mm shaft flat lower black		



1

GEV No.	110713	Ref. No.	00284 RC00284000
description	knob thermostat t.max. 310°C temperature range 100-310°C ø 60mm shaft ø 6x4.6mm shaft flat right black		



1

GEV No.	110938	Ref. No.	00917 RC00917000
description	knob gas thermostat t.max. 260°C ø 60mm shaft ø 8x6.5mm shaft flat lower black		





1

GEV No.	110712	Ref. No.	00268 RC00268000
description	knob thermostat t.max. 90°C temperature range 30-90°C ø 60mm shaft ø 6x4.6mm shaft flat right rotation 270° black		





			
1			
GEV No.	110706	Ref. No.	00494 RC00494000
description	knob time 50min ø 60mm shaft ø 6x4.6mm shaft flat right black		

			
1			
GEV No.	110940	Ref. No.	01059 RC01059000
description	knob oven BH/TH/BH+TH ø 70mm shaft ø 6x4.6mm shaft flat right blue		

			
1			
GEV No.	110937	Ref. No.	01070 RC01070000
description	knob energy regulator 1-6 + MAX ø 70mm shaft ø 6x4.6mm shaft flat left blue		

			
1			
GEV No.	110944	Ref. No.	01249 RC01249000
description	knob switch 4-position ø 70mm shaft ø 6x4.6mm shaft flat left blue		

			
1			
GEV No.	110943	Ref. No.	01172 RC01172000
description	knob gas thermostat 1-7 ø 70mm shaft ø 8x6.5mm shaft flat lower blue		

			
1			
GEV No.	110936	Ref. No.	01109 RC01109000
description	knob switch 7-position ø 70mm shaft ø 6x4.6mm shaft flat right blue		

			
1			
GEV No.	110939	Ref. No.	01152 RC01152000
description	knob gas thermostat t.max. 290°C temperature range 150-290°C ø 70mm shaft ø 8x6.5mm shaft flat upper blue		

			
1			
GEV No.	110946	Ref. No.	01121 RC01121000
description	knob thermostat t.max. 190°C temperature range 100-190°C ø 70mm shaft ø 6x4.6mm shaft flat right blue		

			
1			
GEV No.	110732	Ref. No.	01011 RC01011000
description	knob graduated ø 70mm shaft ø 6x4.6mm shaft flat left blue		

			
1			
GEV No.	110942	Ref. No.	01079 RC01079000
description	knob thermostat t.max. 300°C temperature range 100-300°C ø 70mm shaft ø 6x4.6mm shaft flat right rotation 270° blue		



1

GEV No.	110941	Ref. No.	01060 RC01060000
description	knob thermostat t.max. 300°C temperature range 60-300°C ø 70mm shaft ø 6x4.6mm shaft flat right rotation 270° blue		



1

GEV No.	110945	Ref. No.	01085 RC01085000
description	knob thermostat t.max. 90°C temperature range 30-90°C ø 70mm shaft ø 6x4.6mm shaft flat right blue		

mushroom cap handles



1

GEV No.	110705	Ref. No.	00323 RC00323000
description	mushroom cap handle thread M5 handle ø 25mm L 19mm plastic black		

bracket handles



1

GEV No.	700551	Ref. No.	3101 70501611 RC00003101
description	pull handle L 200mm H 62mm mounting distance 179mm handle M8		

handles and hand wheels

cylindrical handles

fixed



1

GEV No.	110703	Ref. No.	4205 RC00004205
description	cylindrical handle thread M10 ø 28mm L 87mm		

lever handles



1

GEV No.	211098	Ref. No.	RC05001900
description	handle ø 28mm L 89mm thread M10x1 black		

cone handles



1

GEV No.	110704	Ref. No.	00329 RC00329000
description	cone handle thread M6 ø 16mm L 25mm plastic black		

locks

handle latches

producer-specific

TECNOINOX



1

GEV No.	694067	Ref. No.	RC01940000
description	door catch with spigot 1-stage L 26mm total length 51mm thread M8		



espagnolette locks

universal



1

GEV No.	690041	Ref. No.	RCK5900121
description	cam L 148mm mounting distance 32mm		



1

GEV No.	690040	Ref. No.	RCK5900122
description	door catch with roller H 42mm L 40mm W 40mm zinc die cast mounting distance 26mm type 0751 series		



1

GEV No.	700771	Ref. No.	RCK5900123
description	latch gear opening to the left shaft intake ø 8x8mm L 170mm W 40mm H 40mm		

hinges

oven hinges

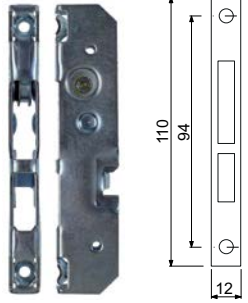

1

GEV No.	700003	Ref. No.	00804 RC00804000
description	opposite support L 110mm W 12mm mounting distance 94mm		



1

GEV No.	690496	Ref. No.	00940 RC00940000
description	oven hinge mounting distance 118mm lug mounting 13mm lever length 119mm groove distance 12mm spring thickness 3.5mm mounting ear position left spring length 59mm mounting pos. W 21mm		



1

GEV No.	690498	Ref. No.	00802 RC00802000
description	oven hinge mounting distance 118mm lug mounting 13mm lever length 119mm groove distance 12mm spring thickness 4mm mounting ear position right spring length 59mm L 155mm W 21mm		
accessories for	690498		
	GEV No.	700003	Ref. No.
			00804 RC00804000
	opposite support L 110mm W 12mm mounting distance 94mm		





1



GEV No.	694505	Ref. No.	00803 RC00803000
description	oven hinge mounting distance 118mm mounting distance 2mm lug mounting 13mm lever length 125mm groove distance 12mm spring thickness 4mm mounting ear position left spring length 59mm L 155mm W 21mm with hook		



1

GEV No.	690495	Ref. No.	00939 RC00939000
description	oven hinge mounting distance 118mm spring thickness 3.5mm spring length 59mm L 155mm mounting pos. right W 22mm C 13mm D 119mm		

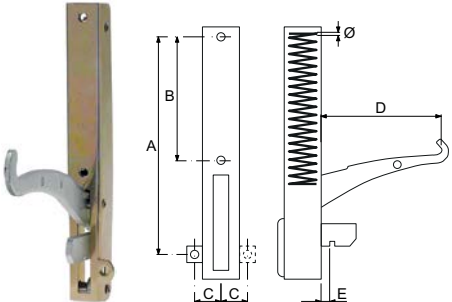
			
GEV No.	700006	Ref. No.	01067 RC01067000
description	oven hinge mounting distance 173mm mounting distance 2 105mm lug mounting 14mm lever length 120mm groove distance 11mm spring thickness 3.5mm mounting ear position left spring length 112mm W 25mm		
accessories for	700006		
	GEV No.	700001	Ref. No. —
	opposite support L 118mm W 17mm mounting distance 94mm		
	GEV No.	700007	Ref. No. 01068 RC01068000
description	oven hinge mounting distance 173mm mounting distance 2 105mm lug mounting 14mm lever length 120mm groove distance 11mm spring thickness 3.5mm mounting ear position right spring length 112mm W 25mm		

			
GEV No.	700007	Ref. No.	01068 RC01068000
description	oven hinge mounting distance 173mm mounting distance 2 105mm lug mounting 14mm lever length 120mm groove distance 11mm spring thickness 3.5mm mounting ear position right spring length 112mm W 25mm		
accessories for	700007		
	GEV No.	700001	Ref. No. —
	opposite support L 118mm W 17mm mounting distance 94mm		

fittings for catering equipment

inlet taps

			
GEV No.	514048	Ref. No.	00583 RC00583000
description	ball valve connection 1/2" complete total length 55mm mounting pos. any brass H 30mm L 55mm rosette ø 70mm rosette thread G2 M22x1		
spare parts for	514048		
	GEV No.	540871	Ref. No. —
	lever handle cold water suitable for intake tap		

baskets

fryer baskets

TECNOINOX

			
GEV No.	970188	Ref. No.	00024 RC00024000
description	fryer basket L1 245mm W1 130mm H1 100mm		
			
GEV No.	970194	Ref. No.	00055 RC00055000
description	fryer basket L1 245mm W1 220mm H1 100mm		

1

GEV No.	970139	Ref. No.	00678 RC00678000
description	fryer basket L1 265mm W1 210mm H1 105mm L2 480mm H2 147mm H3 205mm chrome-plated steel		



1

GEV No.	970420	Ref. No.	RC01295000
description	fryer basket L1 290mm W1 105mm H1 120mm L2 490mm H2 170mm H3 200mm chrome-plated steel		



1

GEV No.	970147	Ref. No.	00076 RC00076000
description	fryer basket L1 290mm W1 220mm H1 100mm L2 540mm H2 230mm H3 175mm chrome-plated steel		

pasta baskets

TECNOINOX



1

GEV No.	970387	Ref. No.	00606 RC00606000
description	pasta basket H1 200mm W1 290mm L1 145mm H3 343mm stainless steel		
accessories for	970387		
	GEV No.	691314	Ref. No. —
	cylindrical handle thread M8 ø 28mm L 86mm		



1

GEV No.	970388	Ref. No.	00603 RC00603000
description	pasta basket H1 200mm W1 290mm L1 290mm H3 340mm stainless steel		



1

GEV No.	970385	Ref. No.	00605 RC00605000
description	pasta basket left H1 200mm W1 145mm L1 145mm H3 340mm stainless steel		



1

GEV No.	970386	Ref. No.	00604 RC00604000
description	pasta basket right H1 200mm W1 145mm L1 145mm H3 340mm stainless steel		

gaskets

gaskets for heated units

door seals



1

GEV No.	902409	Ref. No.	RCK7070100
description	door seal profile 2714 Qty supplied by meter suitable for GIORIK		

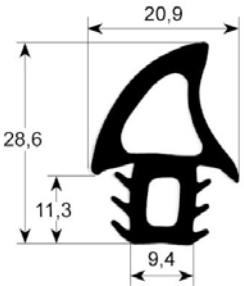

1

GEV No.	900439	Ref. No.	RCK7070166
description	door seal profile 2750 Qty supplied by meter		

door seals with fixing hook

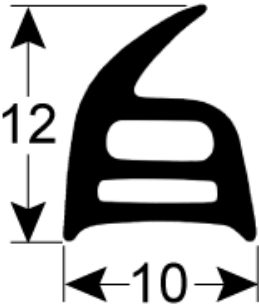

1

GEV No.	901434	Ref. No.	RC70044040
description	door seal W 600mm with 6 mounting clips H 400mm		



1

GEV No.	901371	Ref. No.	RC70044030
description	oven gasket L 540mm W 390mm with 6 mounting clips		

O-rings

EPDM

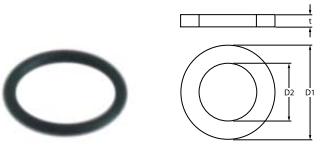

1

GEV No.	529545	Ref. No.	RC00002611
description	O-ring EPDM thickness 1.78mm ID ø 10.82mm Qty 1 pcs		
For models:	POLOBAR		

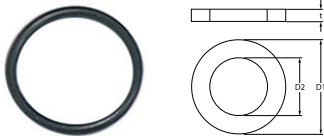

1

GEV No.	532011	Ref. No.	RC00009011
description	O-ring EPDM thickness 1.78mm ID ø 17.17mm Qty 10 pcs		
For models:	POLOBAR		

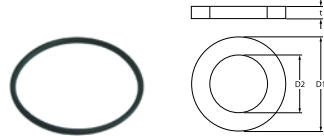

1

GEV No.	510824	Ref. No.	RC00007811
description	O-ring EPDM thickness 1.78mm ID ø 20.35mm Qty 1 pcs		



1

GEV No.	532014	Ref. No.	RC00003315
description	O-ring EPDM thickness 1.78mm ID ø 21.95mm Qty 10 pcs		
For models:	POLOBAR		

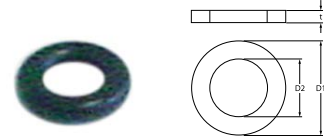

1

GEV No.	532003	Ref. No.	RC00009511
description	O-ring EPDM thickness 1.78mm ID ø 3.69mm Qty 10 pcs		



1

GEV No.	510177	Ref. No.	RC00008711
description	O-ring EPDM thickness 1.78mm ID ø 7.66mm Qty 1 pcs		
For models:	POLOBAR		

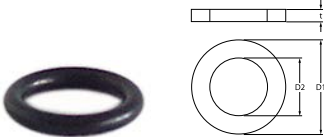

1

GEV No.	532050	Ref. No.	RC00008911
description	O-ring EPDM thickness 2.62mm ID ø 11.91mm Qty 10 pcs		
For models:	POLOBAR		

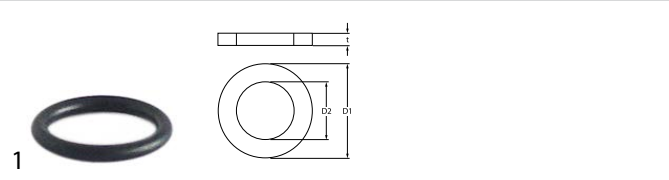
GEV No.	532053	Ref. No.	RC00008012
description	O-ring EPDM thickness 2.62mm ID ø 15.88mm Qty 10 pcs		

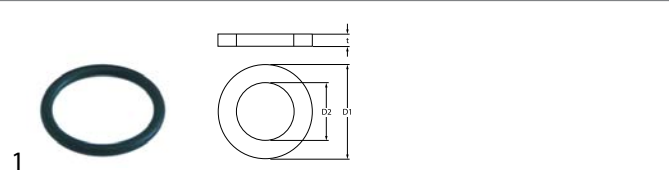

GEV No.	511513	Ref. No.	RC00009711
description	O-ring EPDM thickness 2.62mm ID ø 20.24mm Qty 10 pcs		

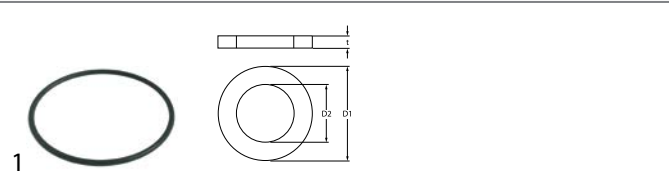

GEV No.	532081	Ref. No.	RC00007211
description	O-ring EPDM thickness 2.62mm ID ø 60mm Qty 10 pcs		

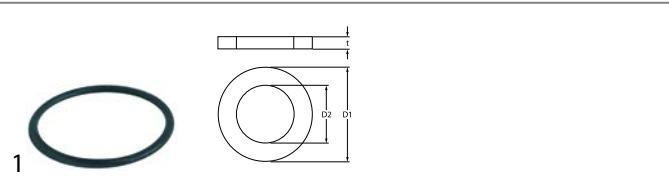

GEV No.	532118	Ref. No.	RCK6090145
description	O-ring EPDM thickness 3.53mm ID ø 55.56mm Qty 10 pcs		

shaft gaskets

shaft gaskets



GEV No.	550549	Ref. No.	RCK7070150
description	shaft sealing for fan motor		

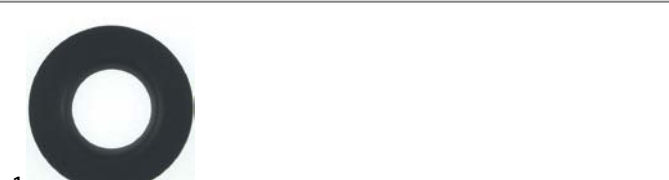

GEV No.	550550	Ref. No.	RCK7070151
description	shaft sealing for fan motor		

fittings, hose and pipe connectors

fittings

angle pieces



GEV No.	520824	Ref. No.	RCK7050374
description	angle piece thread 1/8" ET - 1/8" IT nickel-plated brass		

push-in fittings

JOHN GUEST



GEV No.	520494	Ref. No.	RC01922000	
description	push-in fitting John Guest angled pipe connection ø10mm - ø10mm			
accessories for	520494			
	GEV No.	520973	Ref. No.	—
	hose John Guest thickness 1.5mm LLDPE blue ID ø 7mm ED ø 10mm			



GEV No.	520495	Ref. No.	RC01927000	
description	push-in fitting John Guest straight thread 1/8" BSP stub ø 8mm			
accessories for	520495			
	GEV No.	520971	Ref. No.	—
	hose thickness 1mm LLDPE blue ID ø 4mm ED ø 6mm operating pressure at 20°C 16bar			



valves and tank inlets

ball valves

universal

ball valves with lever handle



1

GEV No.	540758	Ref. No.	00579 RC00579000
description	ball valve connection 1" IT - 1" ET DN25 total length 90mm with lever handle handle length 95mm		

fastening material

nuts

hexagonal nuts

hexagonal nuts metric (without norm)



1

GEV No.	102067	Ref. No.	00865 RC00865000
description	nut thread M8x1 H 3mm brass Qty 1 pcs type SEF 1		

consumables

lava rocks / ceramic briquettes



1

GEV No.	211002	Ref. No.	50017 RC05001700
description	lava rocks size ca.40mm Qty 3.3Kg		

fuses

fine fuses



1

GEV No.	358677	Ref. No.	RC01861000
description	fine fuse size ø5x20mm 4A fast-acting rated 250V Qty 10 pcs		

A			
alarm devices	19	heating elements for convection	8
audible timers	19	heating elements for fryers	3
axial fans	22	heating elements for frying pans	3
		heating elements for griddles	5
B		heating elements for ovens	3
ball valves	54	heating elements for pasta cookers	6
bar burners	40	heating elements for salamanders/toasters	6
		hexagonal nuts	54
C		hob burners	35
cable glands	23	hot air fans	22
cables	23	hot air motors	22
cam switches	14	hot plates	9
ceramic heaters	7		
condensators & interference suppression filters	23	I	
consumables	54	ignition boxes	27
contactors	19	ignition cables	33
control equipment	15	ignition units	33
control thermostats	10	immersion heating elements	8
		indicator lights	16
D		indicator lights (complete)	16
door seals	51	infrared lamps	17
door seals with fixing hook	52		
		L	
E		lamps	16
electric accessories	23	lava rocks / ceramic briquetts	43, 54
electric timers	18	light bulbs	16
energy regulators	10	linear lamps	17
espagnolette locks	49		
		M	
F		mechanical timers	18
fans	22	microswitches	14
fastening material	54		
filters	23	N	
fine fuses	54	nuts	54
fittings	53		
fuses	23, 54	O	
		operating capacitors	23
G		O-rings	52
gas burners	35	oven hinges	49
gas control valves	27	oven lamps	17
gas lines	43		
gas nozzles	42	P	
gas taps	24	piezoelectric igniters	33
gas thermostats	25	pilot burners	28
gaskets for heated units	51	pressure switches	22
		probe clips	13
H		probes	20
halogen lamp	17	pumps	23
heating elements	3	push/momentary push switches	14
heating elements for bain maries	3	push-in fittings	53
heating elements for charrills	6		
		R	
		radiation heaters	8

relays	20
rocker/momentary rocker switches	13
rotary switches	15

S

safety thermostats	12
shaft gaskets	53
solenoid valves	21
solid top burners	42
spring clips	13
switches and momentary switches	13

T

temperature probes	20
terminals	24
thermocouples	34
thermostats	10
threaded cable glands	23
time relays	20
timers	18
transformers	20
tube burners	42

U

universal probes	20
------------------	----

V

valves and tank inlets	54
vibration pumps	23