



**GAS COMPONENTS**



**ELECTRIC COMPONENTS**



**WATER TECHNOLOGY**



**MECHANICAL COMPONENTS**



**TOOLS**

Spare parts suitable for

**TECNOEKA**

Find the complete and up-to-date range of products in our GEV Webshop



# Manufacturer catalogue

The most important spare parts and accessories arranged clearly for every manufacturer

- ✓ Complete product range and all appliance data always up to date in the GEV Webshop
- ✓ Alphabetical Index at the end of the catalogue

## GEV Webshop

[www.gev-online.co.uk](http://www.gev-online.co.uk)

[www.gev-online.com](http://www.gev-online.com)





- 🔍 Add to Favourites
- 🔍 Sign In with email address and usual password
- 🔍 Easy-order – place several items in your basket at the same time
- 🔍 Quick Item search – no login needed



# heating elements

## heating elements for ovens



<b>GEV No.</b>	416969	<b>Ref. No.</b>	01200870 01203250 09950327000 SP007950067
<b>description</b>	heating element 1400W 230V heating circuits 1 L 370mm W 400mm L1 45mm L2 325mm W1 184mm W2 30mm flange length 70mm flange width 22mm hole distance 46mm bridge length 420mm hole ø 5mm tube ø 6.3mm connection male faston 6.3mm windings 3 rectangular flange dry heating element		
<b>For models:</b>	648 CI, EKF423ALM, EKF423M, KF723M		
<b>accessories for</b>	416969		
	<b>GEV No.</b>	510368	<b>Ref. No.</b> —
	gasket L 70mm W 23.5mm hole ø 5mm hole distance 56mm FIBER thickness 2mm for heating element		

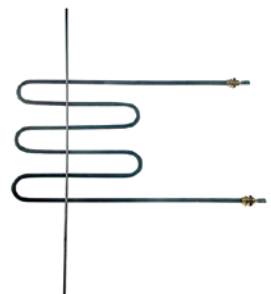

<b>GEV No.</b>	416968	<b>Ref. No.</b>	09950027000
<b>description</b>	heating element 2000W 230V heating circuits 1 L 347mm thread 1/4" W 215mm tube ø 6.3mm mounting distance 209mm bridge length 490mm connection male faston 6.3mm 2 hole fixing dry heating element		
<b>For models:</b>	640 CI+GRILL		

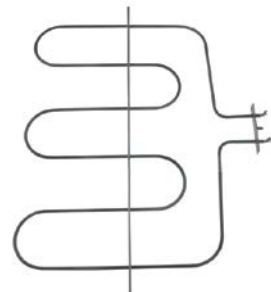

<b>GEV No.</b>	416971	<b>Ref. No.</b>	09950447000
<b>description</b>	heating element 2000W 230V heating circuits 1 L 428mm W 505mm L1 67mm L2 357mm W1 222mm W2 60mm flange length 100mm flange width 22mm hole distance 86mm bridge length 600mm hole ø 5mm tube ø 6.3mm connection male faston 6.3mm windings 3 rectangular flange dry heating element		
<b>For models:</b>	938.3, KF965M		

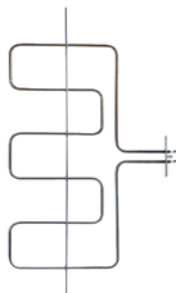

<b>GEV No.</b>	419251	<b>Ref. No.</b>	01200261 01200262 01951017000
<b>description</b>	heating element 2500W 230V heating circuits 1 L 360mm W 530mm L1 110mm L2 250mm W1 250mm W2 30mm flange length 100mm flange width 22mm hole distance 86mm bridge length 700mm hole ø 5mm tube ø 6.5mm connection male faston 6.3mm windings 3		
<b>For models:</b>	EKF411.3GRILL, EKF464.3GRILL, KC96V, KCV96, KCV96P		

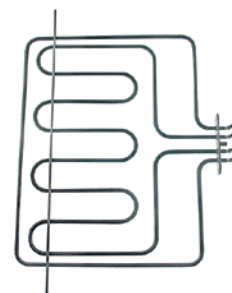

<b>GEV No.</b>	416970	<b>Ref. No.</b>	01200860 01203240 09950317000 SP007950066
<b>description</b>	heating element 2800W 230V heating circuits 2 L 323mm W 393mm L1 30mm L2 293mm W1 166mm W2 61mm flange length 100mm flange width 22mm hole distance 76mm bridge length 485mm hole ø 5mm tube ø 6.3mm connection male faston 6.3mm rectangular flange dry heating element		
<b>For models:</b>	648 CI, EKF423ALM, EKF423M, KF723M		
<b>accessories for</b>	416970		
	<b>GEV No.</b>	528090	<b>Ref. No.</b> 01000160 01980518000
	gasket L 100mm W 22mm thickness 1mm		

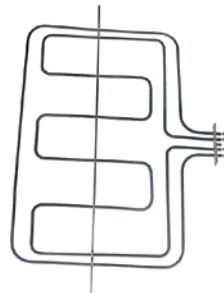

<b>GEV No.</b>	416972	<b>Ref. No.</b>	01200910 09950457000
<b>description</b>	heating element 3700W 230V heating circuits 2 L 442mm W 575mm L1 73mm L2 369mm W1 258mm W2 60mm flange length 100mm flange width 22mm hole distance 86mm bridge length 700mm hole ø 5mm tube ø 6.3mm connection length 28mm rectangular flange dry heating element		
<b>For models:</b>	938.3, KF965M		

electric components

heating elements for heated cabinets



1

<b>GEV No.</b>	419155	<b>Ref. No.</b>	01201441 01201441+30303201
<b>description</b>	heating element 1200W 230V heating circuits 1 L 350mm W 150mm connection male faston 6.3mm tube ø 6.3mm thread M12x1.25 mounting distance 145mm		



1

<b>GEV No.</b>	418860	<b>Ref. No.</b>	10950017000 10950017000-1
<b>description</b>	heating element 800W 230V heating circuits 1 L 345mm W 90mm thread M12x1.5 mounting distance 83mm tube ø 6.5mm connection male faston 6.3mm dry heating element 2 hole fixing		
<b>For models:</b>	KL823, KL864, KL898		

heating elements for convection





1

<b>GEV No.</b>	418042	<b>Ref. No.</b>	01200390 01951147000
<b>description</b>	heating element 1200W 230V heating circuits 1 ID ø 180mm ED ø 194mm L 245mm H 34mm L1 44mm W1 31mm H1 15mm H2 18mm flange length 70mm flange width 22mm hole distance 56mm connection male faston 6.3mm tube ø 6.3mm convection heating element hole ø 5mm rectangular flange		
<b>For models:</b>	KCV96, KCV96P		
<b>spare parts for</b>	418042		
	<b>GEV No.</b>	510368	<b>Ref. No.</b> —
gasket L 70mm W 23.5mm hole ø 5mm hole distance 56mm FIBER thickness 2mm for heating element			





1

<b>GEV No.</b>	415119	<b>Ref. No.</b>	01201010
<b>description</b>	heating element 1600W 230V heating circuits 1 ID ø 179mm ED ø 197mm L 254mm H 30mm L1 51mm W1 31mm H1 9mm H2 21mm flange length 70mm flange width 22mm hole distance 56mm connection male faston 6.3mm connection length 41mm tube ø 6.3mm convection heating element hole ø 4mm rectangular flange		
<b>accessories for</b>	415119		
	<b>GEV No.</b>	510368	<b>Ref. No.</b> —
gasket L 70mm W 23.5mm hole ø 5mm hole distance 56mm FIBER thickness 2mm for heating element			





1

<b>GEV No.</b>	418043	<b>Ref. No.</b>	09950987000
<b>description</b>	heating element 1600W 230V heating circuits 1 ID ø 180mm ED ø 192mm L 245mm H 25mm L1 45mm W1 30mm H1 12mm H2 18mm flange length 70mm flange width 22mm hole distance 56mm connection male faston 6.3mm tube ø 6.3mm convection heating element hole ø 5mm rectangular flange		
<b>For models:</b>	900, KF912, KF912IX		
<b>spare parts for</b>	418043		
	<b>GEV No.</b>	510368	<b>Ref. No.</b> —
gasket L 70mm W 23.5mm hole ø 5mm hole distance 56mm FIBER thickness 2mm for heating element			



1

<b>GEV No.</b>	418045	<b>Ref. No.</b>	01950137000
<b>description</b>	heating element 2200W 230V heating circuits 1 ID ø 175mm ED ø 187mm L 246mm H 25mm L1 58mm W1 31mm H1 7mm H2 18mm flange length 70mm flange width 22mm hole distance 56mm connection male faston 6.3mm tube ø 6.3mm convection heating element hole ø 5mm flange 70 x 22mm		
<b>For models:</b>	938.3		
<b>accessories for</b>	418045		
	<b>GEV No.</b>	510368	<b>Ref. No.</b> —
gasket L 70mm W 23.5mm hole ø 5mm hole distance 56mm FIBER thickness 2mm for heating element			





1

<b>GEV No.</b>	418044	<b>Ref. No.</b>	01200080 01201000 01203260 09950977000
<b>description</b>	heating element 2500W 230V heating circuits 1 ID ø 180mm ED ø 192mm L 245mm H 28mm L1 45mm W1 30mm H1 3mm H2 25mm flange length 70mm flange width 22mm hole distance 56mm connection male faston 6.3mm tube ø 6.3mm convection heating element hole ø 5mm rectangular flange		
<b>For models:</b>	440, 640 CI, 640 CI+GRILL, 640 CI+U, 648 CI, 930, 938.3, CV5-90/X, EKF411.3D, EKF411.3GRILL, EKF412US, EKF423ALM, EKF423M, EKF464.3D, EKF464.3GRILL, KC96V, KCV96, KCV96P, KF412, KF412U, KF723, KF723M		
<b>accessories for</b>	418044		
	<b>GEV No.</b>	550937	<b>Ref. No.</b> 01000140 01960368000
gasket L 71mm W 21mm hole ø 5mm hole distance 57mm fibre thickness 1mm for heating element			





			
1			
<b>GEV No.</b>	420507	<b>Ref. No.</b>	01201210 01203220 09952477000
<b>description</b>	heating element 2700W 230V heating circuits 1 ID ø 180mm ED ø 192mm L 240mm H 250mm L1 54mm W1 30mm H1 30mm H2 24mm flange length 70mm flange width 22mm hole distance 56mm connection F6.3 tube ø 6.5mm hole ø 4.5mm mounting pos. rear		
<b>For models:</b>	EKF423, EKF423AL, EKF423ALP, EKF423ALU, EKF423ALUD, EKF423ALUP, EKF423DALUD, EKF423DUD, EKF423P, EKF423U, EKF423UD, EKF423UP, EKF620S, EKF620US		

			
1			
<b>GEV No.</b>	419016	<b>Ref. No.</b>	01200800 11950537000
<b>description</b>	heating element 3000W 230V heating circuits 1 ID ø 227mm ED ø 240mm L 265mm H 50mm L1 21mm W1 30mm H1 18mm H2 32mm flange length 70mm flange width 22mm hole distance 56mm connection male faston 6.3mm connection length 34mm tube ø 6.5mm convection heating element hole ø 5mm		
<b>For models:</b>	KF733, KF933, KF933AL, KF933AL-U, KF933U, KF965, KF965AL-UD, KF965M, KF981-DOUBLE-EV, KF981-DOUBLE-EV-UD, KF981-DOUBLE-EV-UI, KF981EV		

			
1			
<b>GEV No.</b>	418894	<b>Ref. No.</b>	11950537000
<b>description</b>	heating element 3000W 230V heating circuits 1 ID ø 210mm ED ø 225mm L 260mm H 45mm L1 30mm W1 31mm H1 12.5mm H2 32.5mm flange length 70mm flange width 22mm hole distance 56mm connection male faston 6.3mm connection length 47mm tube ø 6.3mm hole ø 5mm		

			
1			
<b>GEV No.</b>	420506	<b>Ref. No.</b>	01201300
<b>description</b>	heating element 3500W 230V heating circuits 1 ID ø 218mm ED ø 232mm H 46mm L1 264mm W1 32mm H1 8mm H2 38mm hole distance 57mm connection F6.3 tube ø 8.5mm hole ø 5mm mounting pos. rear		
<b>For models:</b>	EKF311DUD, EKF311UD, EKF364DUD, EKF364UD		

			
1			
<b>GEV No.</b>	420508	<b>Ref. No.</b>	01201610 01202671
<b>description</b>	heating element 3000W 230V heating circuits 1 ID ø 215mm ED ø 226mm L 261mm H 40mm L1 15mm H1 10mm H2 27mm flange length 70mm flange width 22mm hole distance 57mm connection F6.3 tube ø 6.5mm		
<b>For models:</b>	EKF411ALUD, EKF411DALUD, EKF411DUD, EKF411UD, EKF416ALUD, EKF416DALUD, EKF416DUD, EKF416UD, EKF443DUD, EKF464ALP, EKF464ALUD, EKF464DALUD, EKF464DUD, EKF464UD, EKF523EUD, EKF523UD		

			
1			
<b>GEV No.</b>	419024	<b>Ref. No.</b>	01200810 09950247000
<b>description</b>	heating element 4000W 230V heating circuits 1 ID ø 217mm ED ø 233mm L 265mm H 50mm L1 25mm W1 33mm H1 5mm H2 45mm flange length 70mm flange width 22mm hole distance 56mm connection male faston 6.3mm connection length 29mm tube ø 8.5mm convection heating element hole ø 5mm rectangular flange oven		
<b>For models:</b>	KF981, KF981-DOUBLE, KF981-DOUBLE-EV-UD, KF981-DOUBLE-EV-UI, KF981-DOUBLE-UD, KF981-DOUBLE-V, KF981-DOUBLE-V-UD, KF981-DOUBLE-V-UI, KF981UD, KF981V		
<b>accessories for</b>	419024		
	<b>GEV No.</b>	510368	<b>Ref. No.</b> —
	gasket L 70mm W 23.5mm hole ø 5mm hole distance 56mm FIBER thickness 2mm for heating element		

			
1			
<b>GEV No.</b>	419215	<b>Ref. No.</b>	01203130
<b>description</b>	heating element 4000W 230V heating circuits 2 ID ø 220mm ED ø 230mm L 262mm H 60mm L1 20mm W1 92mm H1 10mm H2 50mm flange length 100mm flange width 22mm hole distance 86mm connection F6.3 tube ø 6.5mm hole ø 5mm threaded		
<b>For models:</b>	EKF616EUD, EKF616UD, EKF664.3EUD, EKF664EUD, EKF664P, EKF664UD, EKF711.3EUD, EKF711EUD, EKF711EV, EKF711UD		

			
1			
<b>GEV No.</b>	420509	<b>Ref. No.</b>	01202660
<b>description</b>	heating element 5000W 230V heating circuits 2 ID ø 225mm ED ø 235mm L 248mm H 60mm L1 18mm W1 90mm H1 18mm H2 50mm flange length 100mm flange width 22mm hole distance 85mm connection F6.3 tube ø 6.5mm hole ø 4mm		
<b>For models:</b>	EKF1016EUD, EKF1016UD, EKF1064EUD, EKF1064TC, EKF1064UD, EKF1111EUD, EKF1111EVUD, EKF1111TC, EKF1111UD, EKF664.3EUD, EKF664TC, EKF711.3EUD, EKF711TC		

accessories

flange gaskets

			
1			
<b>GEV No.</b>	528090	<b>Ref. No.</b>	01000160 01980518000
<b>description</b>	gasket L 100mm W 22mm thickness 1mm		
<b>For models:</b>	EKF411.3GRILL, EKF423ALM, EKF423M, EKF464.3GRILL, KCV96, KCV96, KCV96P, KF723M, KF965M, TCFG		

			
1			
<b>GEV No.</b>	528963	<b>Ref. No.</b>	0196036800
<b>description</b>	gasket L 70mm W 22.5mm fibre thickness 1mm		

			
1			
<b>GEV No.</b>	550937	<b>Ref. No.</b>	01000140 01960368000
<b>description</b>	gasket L 71mm W 21mm hole ø 5mm hole distance 57mm fibre thickness 1mm for heating element		
<b>For models:</b>	EKF411, EKF411.3D, EKF411.3GRILL, EKF411D, EKF412US, EKF423, EKF423AL, EKF423ALM, EKF423ALP, EKF423ALU, EKF423ALUP, EKF423M, EKF423P, EKF423U, EKF423UP, EKF464, EKF464.3D, EKF464.3GRILL, EKF464D, EKF620S, EKF620US, KCV96, KCV96P, KF412, KF412U, KF620, KF622, KF630, KF723, KF723M, KF733, KF912, KF912IX, KF933, KF933AL, KF933AL-U, KF933U, KF937, KF965, KF965AL-UD, KF965M, KF981, KF981-DOUBLE, KF981-DOUBLE-EV, KF981-DOUBLE-EV-UD, KF981-DOUBLE-EV-UI, KF981-DOUBLE-UD, KF981-DOUBLE-V, KF981-DOUBLE-V-UD, KF981-DOUBLE-V-UI...(Other models you can see in the webshop)		

energy regulators

EGO

1-circuit

			
1			
<b>GEV No.</b>	380015	<b>Ref. No.</b>	01201450 11950017000
<b>description</b>	energy regulator 230V 13A single-circuit turn direction right shaft ø 6x4.6mm shaft L 23mm mounting thread M4 power release 6-100% no. 50.57021.010		
<b>For models:</b>	EKF1016UD, EKF1064UD, EKF1111UD, EKF311UD, EKF364UD, EKF411ALUD, EKF411UD, EKF416ALUD, EKF416UD, EKF464ALUD, EKF464UD, EKF523UD, EKF616UD, EKF664UD, EKF711UD, KF981, KF981-DOUBLE, KF981-DOUBLE-EV-UD, KF981-DOUBLE-EV-UI, KF981-DOUBLE-UD, KF981-DOUBLE-V-UD, KF981-DOUBLE-V-UI, KF981UD		



# thermostats

## control and safety thermostats

EGO

control thermostats

55.10/19\_series



<b>GEV No.</b>	375463	<b>Ref. No.</b>	01201310 09953137000
<b>description</b>	thermostat t.max. 277°C 1-pole 1NO 16A probe ø 3.03mm probe L 139mm capillary pipe 870mm capillary pipe isolatedmm gland nut shaft ø 6x4.6mm shaft L 23mm		
<b>For models:</b>	EKF1016UD, EKF1064UD, EKF1111UD, EKF523UD, EKF616UD, EKF664P, EKF664UD, EKF711UD, KF733		



<b>GEV No.</b>	375595	<b>Ref. No.</b>	01201550 11950417000
<b>description</b>	thermostat t.max. 303°C temperature range 71-303°C 1-pole 1NO 16A probe ø 3mm probe L 114mm capillary pipe 1230mm capillary pipe isolatedmm gland nut shaft ø 6x4.6mm shaft L 23mm shaft position upper rotation 270° with 2 probes		
<b>For models:</b>	EKF411ALUD, EKF411UD, EKF416ALUD, EKF416UD, EKF464ALP, EKF464ALUD, EKF464P, EKF464UD, KCP97-VG-A, KCV96, KCV96P, KF1001G, KF1001G-IX-AL, KF1001G-LPG, KF1001G-LPG-IX-AL		



<b>GEV No.</b>	375800	<b>Ref. No.</b>	09952637000
<b>description</b>	thermostat t.max. 308°C temperature range 65-308°C 1-pole 1NO 16A probe ø 3.03mm probe L 120mm capillary pipe 600mm capillary pipe isolatedmm gland nut shaft ø 6x4.6mm shaft L 23mm shaft position upper rotation 270° with 2 probes		
<b>For models:</b>	KF723M, KF933, KF933AL, KF933AL-U, KF933U, KF965, KF965AL-UD, KF965M, KF981, KF981-DOUBLE, KF981-DOUBLE-EV-UD, KF981-DOUBLE-EV-UI, KF981-DOUBLE-UD, KF981-DOUBLE-V, KF981-DOUBLE-V-UD, KF981-DOUBLE-V-UI, KF981UD, KF981V		

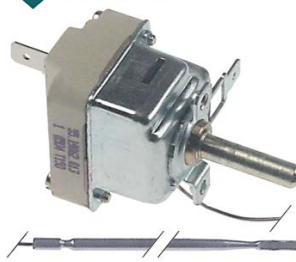

<b>GEV No.</b>	375594	<b>Ref. No.</b>	01200370 01950267000 01951317000
<b>description</b>	thermostat t.max. 318°C temperature range 60-318°C 1-pole 1NO 16A probe ø 3.03mm probe L 139mm capillary pipe 870mm capillary pipe isolatedmm gland nut shaft ø 6x4.6mm shaft L 23mm shaft position upper rotation 270°		
<b>For models:</b>	440, 640 CI, 640 CI+U, EKF311UD, EKF364UD, EKF412US, EKF423, EKF423AL, EKF423ALP, EKF423ALU, EKF423ALUD, EKF423ALUP, EKF423P, EKF423U, EKF423UD, EKF423UP, EKF620S, EKF620US, KF412, KF412U, KF620, KF622, KF630, KF723, KF937		

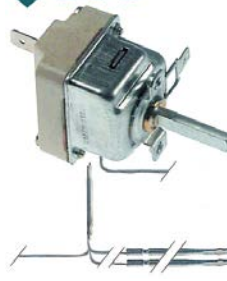

<b>GEV No.</b>	375799	<b>Ref. No.</b>	01201230 09952647000
<b>description</b>	thermostat t.max. 325°C temperature range 55-325°C 1-pole 1NO 16A probe ø 3.03mm probe L 120mm capillary pipe 600mm capillary pipe isolatedmm gland nut shaft ø 6x4.6mm shaft L 23mm shaft position upper rotation 270° with 2 probes		
<b>For models:</b>	EKF411, EKF411.3GRILL, EKF464, EKF464.3GRILL, KF912, KF912IX		

## safety thermostats

55.32\_series



<b>GEV No.</b>	390999	<b>Ref. No.</b>	01202690
<b>description</b>	safety thermostat switch-off temp. 350°C temperature range°C 2-pole NC 20A probe ø 3mm probe L 187mm capillary pipe 690mm capillary pipe isolated 680mm gland nut shaft ømm probe SS		
<b>For models:</b>	EKF412US, EKF423, EKF423AL, EKF423ALM, EKF423ALU, EKF423ALUD, EKF423DALUD, EKF423DUD, EKF423M, EKF423U, EKF423UD, EKF443DUD, EKF523EUD, EKF523UD		



## IMIT / TEMPOMATIC / ARATHERMO

## control thermostats



<b>GEV No.</b>	375847	<b>Ref. No.</b>	01201430
<b>description</b>	thermostat t.max. 90°C temperature range 0-90°C 1-pole 1CO 15A probe ø 6.5mm probe L 100mm capillary pipe 1500mm capillary pipe isolatedmm gland nut shaft ø 6x4.6mm shaft L 18mm shaft position +135° rotation 270° 250V		

## CAEM

## safety thermostats



<b>GEV No.</b>	375597	<b>Ref. No.</b>	01201190 09952387000
<b>description</b>	safety thermostat switch-off temp. 335°C 1-pole 16A probe ø 5mm probe L 80mm capillary pipe 900mm capillary pipe isolatedmm gland nut probe SS		
<b>For models:</b>	900, 938.3, KF912, KF912IX, KF933, KF933AL, KF933AL-U, KF933U, KF937, KF965, KF965AL-UD, KF965M, KF981, KF981-DOUBLE, KF981-DOUBLE-EV, KF981-DOUBLE-EV-UD, KF981-DOUBLE-EV-UI, KF981-DOUBLE-UD, KF981-DOUBLE-V, KF981-DOUBLE-V-UD, KF981-DOUBLE-V-UI, KF981EV, KF981UD, KF981V		



<b>GEV No.</b>	375456	<b>Ref. No.</b>	01200400 01951367000
<b>description</b>	safety thermostat switch-off temp. 335°C 2-pole 20A probe ø 3mm probe L 200mm capillary pipe 1050mm capillary pipe isolated 650mm gland nut probe SS at 250V 20A at 400V 10A		
<b>For models:</b>	EKF423ALP, EKF423P, EKF620S, EKF620US, KF1010GE-UD, KF412U, KF622, KF630, KF733		

## TECASA

## control thermostats

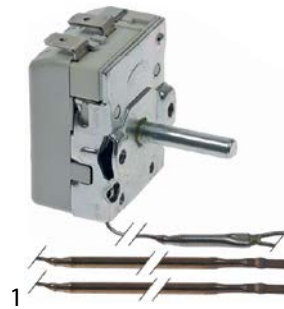

<b>GEV No.</b>	376091	<b>Ref. No.</b>	01201220 01204190
<b>description</b>	thermostat t.max. 328°C temperature range 57-328°C 1-pole 1NO 16A probe ø 3mm probe L 98mm capillary pipe 1540mm capillary pipe isolatedmm gland nut shaft ø 6x4.6mm shaft L 21mm rotation 270° outer switch probe thread disc ømm		

## CAMPINI

## safety thermostats

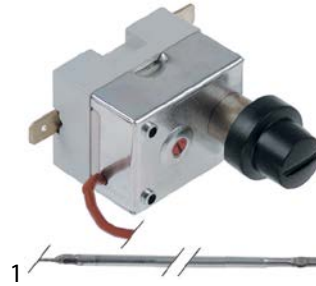

<b>GEV No.</b>	375892	<b>Ref. No.</b>	01202780 SP00916
<b>description</b>	safety thermostat switch-off temp. 318°C 1-pole 16A probe ø 3mm probe L 137mm capillary pipe 1260mm capillary pipe isolated 710mm gland nut probe SS type Ty 95-H		
<b>For models:</b>	EKF1016EUD, EKF1016UD, EKF1064EUD, EKF1064TC, EKF1064UD, EKF1111EUD, EKF1111EVUD, EKF1111TC, EKF1111UD, EKF1664TC, EKF2011TC, EKF311DUD, EKF311UD, EKF364DUD, EKF364UD, EKF411, EKF411.3D, EKF411.3GRILL, EKF411ALUD, EKF411D, EKF411DALUD, EKF411DUD, EKF411UD, EKF416ALUD, EKF416DALUD, EKF416DUD, EKF416UD, EKF464, EKF464.3D, EKF464.3GRILL, EKF464ALP, EKF464ALUD, EKF464D, EKF464DALUD, EKF464DUD, EKF464P, EKF464TC, EKF464UD, EKF511TC, EKF616EUD, EKF616UD, EKF664.3EUD, EKF664EUD, EKF664P, EKF664TC, EKF664UD, EKF711.3EUD, EKF711EUD, EKF711EV, EKF711TC...(Other models you can see in the webshop)		

## accessories

## fitting parts



<b>GEV No.</b>	699163	<b>Ref. No.</b>	30307040
<b>description</b>	mounting flange L 50mm W 30mm bore ø 5/12mm		
<b>For models:</b>	EKF1016UD, EKF1064UD, EKF1111UD, EKF311UD, EKF364UD, EKF411.3GRILL, EKF411UD, EKF412US, EKF416UD, EKF423, EKF423AL, EKF423ALM, EKF423ALU, EKF423ALUD, EKF423M, EKF423U, EKF423UD, EKF464.3GRILL, EKF464ALP, EKF464P, EKF464UD, EKF523UD, EKF616UD, EKF664P, EKF664UD, EKF711UD		





## switches and momentary switches

### push/momentary push switches

#### 19x13mm



<b>GEV No.</b>	347627	<b>Ref. No.</b>	00010300
<b>description</b>	momentary push switch mounting measurements 19x13mm black 2NO 250V 16A connection male faston 6.3mm ambient temperature max. 85°C protection IP65 with cover cap		
<b>For models:</b>	EKF411, EKF411.3GRILL, EKF412US, EKF423ALU, EKF423ALUD, EKF423ALUP, EKF423U, EKF423UD, EKF423UP, EKF464, EKF464.3GRILL		

#### 28.5x28.5mm



<b>GEV No.</b>	346313	<b>Ref. No.</b>	00002610 09951687000
<b>description</b>	push switch mounting measurements 28.5x28.5mm red/green 1CO/1NO 250V 16A connection male faston 6.3mm ambient temperature max. 150°C protection IP40 with indicator		
<b>For models:</b>	1308, 1311-A, 1408, 1411-A, 640 CI+GRILL, 900, 930, 938.3, KL823, KL864, KL898		



<b>GEV No.</b>	346317	<b>Ref. No.</b>	09950067023
<b>description</b>	momentary push switch mounting measurements 28.5x28.5mm black 1NO 250V 16A connection male faston 6.3mm ambient temperature max. 150°C protection IP40		
<b>For models:</b>	900, 930, 938.3, CV5-90/X, KC96V		

#### ø16mm



<b>GEV No.</b>	346315	<b>Ref. No.</b>	00005750 11950427000
<b>description</b>	momentary push switch mounting ø 16mm red 1NO/indicator light 250V 3A connection male faston 2.8mm ambient temperature max. 85°C protection IP40		
<b>For models:</b>	KCP97-VG-A, KCV96, KCV96P, KF1001G, KF1001G-IX-AL, KF1001G-LPG, KF1001G-LPG-IX-AL		
<b>accessories for</b>	346315		
	<b>GEV No.</b>	346343	<b>Ref. No.</b> —
protective cover			
	<b>GEV No.</b>	346344	<b>Ref. No.</b> —
ring for protecting cover			

#### ø25mm



<b>GEV No.</b>	346312	<b>Ref. No.</b>	00002600 09951677000
<b>description</b>	momentary push switch mounting ø 25mm black 1NO 250V 16A water connection male faston 6.3mm ambient temperature max. 85°C protection IP40		
<b>For models:</b>	640 CI+U, EKF620US, KF1001G, KF1001G-IX-AL, KF1001G-LPG, KF1001G-LPG-IX-AL, KF412U, KF630, KF912, KF912IX, KF933AL-U, KF933U, KF965, KF965AL-UD, KF965M, KF981-DOUBLE-V, KF981-DOUBLE-V-UD, KF981-DOUBLE-V-UI, KF981V		



<b>GEV No.</b>	346316	<b>Ref. No.</b>	00002630 09951707000
<b>description</b>	push switch mounting ø 25mm black 2NO 250V 16A connection male faston 6.3mm ambient temperature max. 85°C protection IP40		
<b>For models:</b>	KF1001G, KF1001G-IX-AL, KF1001G-LPG, KF1001G-LPG-IX-AL, KF912, KF912IX, KF965, KF965AL-UD, KF981, KF981-DOUBLE, KF981-DOUBLE-EV-UD, KF981-DOUBLE-EV-UI, KF981-DOUBLE-UD, KF981-DOUBLE-V, KF981-DOUBLE-V-UD, KF981-DOUBLE-V-UI, KF981UD, KF981V		

## microswitches

### lever actuated



<b>GEV No.</b>	346314	<b>Ref. No.</b>	01201160 09951147000 09951727000
<b>description</b>	microswitch with lever 250V 16A 1CO connection male faston 6.3mm L 56mm ambient temperature max. 125°C mounting distance 22mm type VRSR01DA1 actuating force: 50g		
<b>For models:</b>	900, 900 G, 938.3, KC96V, KCP97-VG-A, KCV96, KCV96P, TCFG		

### pin-plunger actuated



#### M10



<b>GEV No.</b>	347603	<b>Ref. No.</b>	01200890
<b>description</b>	microswitch with plunger thread M10x0.75 thread L 10mm 250V 16A 1CO connection male faston 6.3mm stroke 5mm mounting distance 22mm L 29mm ambient temperature max. 125°C type VRSR01DZ2 actuating force: 170g		
<b>For models:</b>	EKF311DUD, EKF311UD, EKF364DUD, EKF364UD, EKF411, EKF411.3D, EKF411D, EKF411DUD, EKF411UD, EKF416DUD, EKF416UD, EKF423ALUD, EKF423DALUD, EKF423DUD, EKF423UD, EKF443DUD, EKF464, EKF464.3D, EKF464ALP, EKF464D, EKF464DUD, EKF464P, EKF464UD		



			
1			
<b>GEV No.</b>	347216	<b>Ref. No.</b>	09950437000
<b>description</b>	microswitch with plunger thread M10x0.75 thread L 14mm 250V 10A 1CO connection male faston 6.3mm stroke 7.5mm mounting distance 22mm L 28mm ambient temperature max. 125°C type NR6K5 actuating force: 260g		
<b>For models:</b>	KF1001G, KF1001G-IX-AL, KF1001G-LPG, KF1001G-LPG-IX-AL, KF630, KF733, KF912, KF912IX, KF933, KF933AL, KF933AL-U, KF933U, KF937, KF965, KF965AL-UD, KF965M, KF981, KF981-DOUBLE, KF981-DOUBLE-EV-UD, KF981-DOUBLE-EV-UI, KF981-DOUBLE-UD, KF981-DOUBLE-V-UD, KF981-DOUBLE-V-UI, KF981UD		

			
1			
<b>GEV No.</b>	347762	<b>Ref. No.</b>	01201700
<b>description</b>	microswitch with plunger thread M10x0.75 thread L 14mm 250V 16A 2NO connection male faston 6.3mm stroke 4mm mounting distance 22mm ambient temperature max. 85°C actuating force: 650g		
<b>For models:</b>	EKF411.3GRILL, EKF464.3GRILL		
<b>accessories for</b>	347762		
	<b>GEV No.</b>	100779	<b>Ref. No.</b> —
nut thread M10x0.75 H 3mm WS 14 SS Qty 2 pcs			

## cam switches

### 10 operating positions

			
1			
<b>GEV No.</b>	301205	<b>Ref. No.</b>	01200040 01950037000
<b>description</b>	cam switch 10 operating positions 5NO/1CO sequence 0-1-2-3-4-5-6-7-8-9 16A shaft $\phi$ 6x4.6mm shaft L 23mm connection male faston 6.3mm ceramic		
<b>For models:</b>	648 CI, EKF423ALM, EKF423M, KF723M, KF965M		

## operation switches

			
1			
<b>GEV No.</b>	300183	<b>Ref. No.</b>	01200180 01950337400
<b>description</b>	operation switch 5 operating positions 5NO 16A sequence 0-1-2-3-4 shaft $\phi$ 6x4.6mm shaft L 23mm connection male faston 6.3mm plastic ambient temperature max. 270°C		
<b>For models:</b>	CV5-90/X, KC96V		

## magnetic switches

### M10x0.75

			
1			
<b>GEV No.</b>	348182	<b>Ref. No.</b>	00005771 00010510
<b>description</b>	magnetic switch thread M10x0.75 1NO 250V 0.04A cable length 570mm L 40mm		
<b>For models:</b>	EKF1016EUD, EKF1016UD, EKF1064EUD, EKF1064TC, EKF1064UD, EKF1111EUD, EKF1111EVUD, EKF1111TC, EKF1111UD, EKF1664TC, EKF2011TC, EKF411ALUD, EKF411DALUD, EKF416ALUD, EKF416DALUD, EKF464ALUD, EKF464DALUD, EKF464TC, EKF511TC, EKF523EUD, EKF523UD, EKF616EUD, EKF616UD, EKF664.3EUD, EKF664EUD, EKF664P, EKF664TC, EKF664UD, EKF711.3EUD, EKF711EUD, EKF711EV, EKF711TC, EKF711UD		

## lamps

### indicator lights

#### indicator lights 2-piece (lens and indicator lamp)





#### indicator light lenses



#### $\phi$ 8mm (type RL-2)

			
1			
<b>GEV No.</b>	359819	<b>Ref. No.</b>	00002360 09950388535
<b>description</b>	indicator light lens green Qty 1 pcs $\phi$ 8mm		
<b>For models:</b>	440, 640 CI, 640 CI+GRILL, 640 CI+U, 648 CI, 900, 930, 938.3, CV5-90/X, EKF1016UD, EKF1064UD, EKF1111UD, EKF311UD, EKF364UD, EKF411, EKF411.3GRILL, EKF411ALUD, EKF411UD, EKF412US, EKF416ALUD, EKF416UD, EKF423, EKF423AL, EKF423ALM, EKF423ALP, EKF423ALU, EKF423ALUD, EKF423ALUP, EKF423M, EKF423P, EKF423U, EKF423UD, EKF423UP, EKF464, EKF464.3GRILL, EKF464ALP, EKF464ALUD, EKF464P, EKF464UD, EKF523UD, EKF616UD, EKF620US, EKF664P, EKF664UD, EKF711UD, KC96V, KF412, KF412U, KF620, KF622...(Other models you can see in the webshop)		

			
1			
<b>GEV No.</b>	359820	<b>Ref. No.</b>	00002350 09950368534
<b>description</b>	indicator light lens yellow Qty 1 pcs $\phi$ 8mm		
<b>For models:</b>	440, 640 CI, 640 CI+GRILL, 640 CI+U, 648 CI, 900, 930, 938.3, CV5-90/X, EKF1016UD, EKF1064UD, EKF1111UD, EKF311UD, EKF364UD, EKF411, EKF411.3GRILL, EKF411ALUD, EKF411UD, EKF412US, EKF416ALUD, EKF416UD, EKF423, EKF423AL, EKF423ALM, EKF423ALP, EKF423ALU, EKF423ALUD, EKF423ALUP, EKF423M, EKF423P, EKF423U, EKF423UD, EKF423UP, EKF464, EKF464.3GRILL, EKF464ALP, EKF464ALUD, EKF464P, EKF464UD, EKF523UD, EKF616UD, EKF620S, EKF620US, EKF664P, EKF664UD, EKF711UD, KC96V, KCP97-VG-A, KCV96, KCV96P...(Other models you can see in the webshop)		



indicator lamps for socket type RL				
 <p>1</p>				
GEV No.	359818	Ref. No.	01200330 01950377000 01951177000	
description	indicator light 230V clear connection male faston 6.3mm			
For models:	440, 640 CI, 640 CI+GRILL, 640 CI+U, 648 CI, 900, 938.3, CV5-90/X, EKF1016UD, EKF1064UD, EKF1111UD, EKF311UD, EKF364UD, EKF411, EKF411.3GRILL, EKF411ALUD, EKF411UD, EKF412US, EKF416ALUD, EKF416UD, EKF423, EKF423AL, EKF423ALM, EKF423ALP, EKF423ALU, EKF423ALUD, EKF423ALUP, EKF423M, EKF423P, EKF423U, EKF423UD, EKF423UP, EKF464, EKF464.3GRILL, EKF464ALP, EKF464ALUD, EKF464P, EKF464UD, EKF523UD, EKF616UD, EKF620S, EKF620US, EKF664P, EKF664UD, EKF711UD, KC96V, KCP97-VG-A, KCV96, KCV96P, KF1001G...(Other models you can see in the webshop)			
accessories for	359818			
	GEV No.	359820	Ref. No.	00002350 09950368534
indicator light lens yellow Qty 1 pcs ø 8mm				
	GEV No.	359833	Ref. No.	—
indicator light lens red Qty 1 pcs ø 8mm				
	GEV No.	359948	Ref. No.	—
indicator light lens clear Qty 1 pcs ø 8mm				

 <p>1</p>				
GEV No.	359817	Ref. No.	01200340 01951187000 09950377000	
description	indicator light 230V green connection male faston 6.3mm			
For models:	440, 640 CI, 640 CI+GRILL, 640 CI+U, 648 CI, 900, 930, 938.3, CV5-90/X, EKF1016UD, EKF1064UD, EKF1111UD, EKF311UD, EKF364UD, EKF411, EKF411.3GRILL, EKF411ALUD, EKF411UD, EKF412US, EKF416ALUD, EKF416UD, EKF423, EKF423AL, EKF423ALM, EKF423ALP, EKF423ALU, EKF423ALUD, EKF423ALUP, EKF423M, EKF423P, EKF423U, EKF423UD, EKF423UP, EKF464, EKF464.3GRILL, EKF464ALP, EKF464ALUD, EKF464P, EKF464UD, EKF523UD, EKF616UD, EKF620S, EKF620US, EKF664P, EKF664UD, EKF711UD, KC96V, KF412, KF412U, KF620...(Other models you can see in the webshop)			
accessories for	359817			
	GEV No.	359819	Ref. No.	00002360 09950388535
indicator light lens green Qty 1 pcs ø 8mm				

screw-on/push-on fit

light bulbs			
for ovens			
 <p>1</p>			
GEV No.	359610	Ref. No.	01950108400
description	light bulb t.max. 300°C socket E14 15W 230V ø 22mm L 47mm lens L 20mm for oven lamp type Philips		
For models:	440, 640 CI, 640 CI+GRILL, 640 CI+U, 648 CI, 900, 900 G, 930, 938.3, CV5-90/X, KC96V, KCP97-VG-A, KCV96, KCV96P, KF1001G, KF1001G-IX-AL, KF1001G-LPG, KF1001G-LPG-IX-AL, KF412, KF412U, KF630, KF723, KF723M, KF733, KF912, KF912IX, KF933, KF933AL, KF933AL-U, KF933U, KF937, KF965, KF965M, TCFG		

halogen lamp			
for socket G4 / G6.35 / G9			
 <p>1</p>			
GEV No.	359074	Ref. No.	01201470 11950097000
description	halogen lamp socket G6.35 12V 35W temp.-resist. 500°C		
For models:	EKF1016EUD, EKF1016UD, EKF1064EUD, EKF1064UD, EKF1111EUD, EKF1111EVUD, EKF1111UD, EKF616EUD, EKF616UD, EKF664.3EUD, EKF664EUD, EKF664P, EKF664UD, EKF711.3EUD, EKF711EUD, EKF711EV, EKF711UD, KF1010GE-UD, KF981, KF981-DOUBLE, KF981-DOUBLE-EV, KF981-DOUBLE-EV-UD, KF981-DOUBLE-EV-UI, KF981-DOUBLE-UD, KF981-DOUBLE-V, KF981-DOUBLE-V-UD, KF981-DOUBLE-V-UI, KF981EV, KF981UD, KF981V		

oven lamps

universal oven lamps				
mounting diameter 35.5mm				
 <p>1</p>				
GEV No.	359718	Ref. No.	00002330 09950187400	
description	oven lamp mounting ø 35.5mm 230V 15W socket E14 temp.-resist. 300°C connection male faston 6.3mm hard glas			
For models:	EKF411, EKF411.3D, EKF411.3GRILL, EKF411D, EKF423, EKF423AL, EKF423ALM, EKF423ALP, EKF423ALU, EKF423ALUP, EKF423M, EKF423P, EKF423U, EKF423UD, EKF423UP, EKF464, EKF464.3D, EKF464.3GRILL, EKF464ALP, EKF464UD, EKF464P			
spare parts for	359718			
	GEV No.	359701	Ref. No.	09950197400
lamp socket socket E14 220-230V mounting ø 35.5mm connection male faston 6.3mm 15W				
	GEV No.	359740	Ref. No.	—
light bulb t.max. 300°C socket E14 15W 230V ø 22mm L 48mm lens L 20mm for oven lamp IMPORT				





 <p>1</p>				
GEV No.	359259	Ref. No.	00002720 00002730	
description	oven lamp mounting ø 35.5mm 230V 40W socket G9 temp.-resist. 300°C connection cable 380mm hard glas			
For models:	EKF311DUD, EKF311UD, EKF364DUD, EKF364UD, EKF411ALUD, EKF411DALUD, EKF411DUD, EKF411UD, EKF416ALUD, EKF416DALUD, EKF416DUD, EKF416UD, EKF423ALUD, EKF423DALUD, EKF423DUD, EKF423UD, EKF443DUD, EKF464ALUD, EKF464DALUD, EKF464DUD, EKF464UD, EKF523EUD, EKF523UD			
spare parts for	359259			
	GEV No.	357161	Ref. No.	—
lamp socket socket G9 220-230V mounting ø 35.5mm connection cable 380mm				
	GEV No.	358128	Ref. No.	—
gasket for oven lamp silicone ID ø 30mm ED ø 38mm thickness 2mm				

Table continues overleaf

<b>spare parts for</b> 359259			
	<b>GEV No.</b>	359942	<b>Ref. No.</b> —
oven lamp glass thr.ø 33.5mm ø 41mm hard glas temp.-resist. 350°C			
	<b>GEV No.</b>	359946	<b>Ref. No.</b> —
halogen lamp socket G9 230V 40W temp.-resist. 300°C			

			
<b>1</b>	<b>GEV No.</b>	359701	<b>Ref. No.</b> 09950197400
<b>description</b> lamp socket socket E14 220-230V mounting ø 35.5mm connection male faston 6.3mm 15W			
<b>For models:</b> 900, 900 G, 930, 938.3, CV5-90/X, KC96V, KCP97-VG-A, KCV96, KCV96P, KF1001G, KF1001G-IX-AL, KF1001G-LPG, KF1001G-LPG-IX-AL, KF630, KF733, KF912, KF912IX, KF933, KF933AL, KF933AL-U, KF933U, KF937, KF965, KF965M			
<b>accessories for</b> 359701			
	<b>GEV No.</b>	359705	<b>Ref. No.</b> —
oven lamp glass thr.ø 33.5mm ø 52mm hard glas temp.-resist. 350°C			
	<b>GEV No.</b>	359709	<b>Ref. No.</b> 09950208400
oven lamp glass thr.ø 33.5mm ø 42mm hard glas temp.-resist. 350°C			
	<b>GEV No.</b>	359721	<b>Ref. No.</b> —
gasket silicone ED ø 48mm ID ø 39.5mm thickness 5mm Qty 1 pcs			
	<b>GEV No.</b>	359942	<b>Ref. No.</b> —
oven lamp glass thr.ø 33.5mm ø 41mm hard glas temp.-resist. 350°C			

			
<b>1</b>	<b>GEV No.</b>	359709	<b>Ref. No.</b> 09950208400
<b>description</b> oven lamp glass thr.ø 33.5mm ø 42mm hard glas temp.-resist. 350°C			
<b>For models:</b> 900, 900 G, 930, 938.3, CV5-90/X, KC96V, KCP97-VG-A, KCV96, KCV96P, KF1001G, KF1001G-IX-AL, KF1001G-LPG, KF1001G-LPG-IX-AL, KF733, KF912, KF912IX, KF933, KF933AL, KF933AL-U, KF933U, KF937, KF965, KF965M, TCFG			

<b>mounting diameter 47.8mm</b>			
			
<b>1</b>	<b>GEV No.</b>	359703	<b>Ref. No.</b> 01200050 01950077400
<b>description</b> oven lamp mounting ø 47.8mm 230V 15W socket E14 temp.-resist. 300°C connection male faston 6.3mm hard glas			
<b>For models:</b> EKF412US			
<b>spare parts for</b> 359703			
	<b>GEV No.</b>	359610	<b>Ref. No.</b> 01950108400
light bulb t.max. 300°C socket E14 15W 230V ø 22mm L 47mm lens L 20mm for oven lamp type Philips			
	<b>GEV No.</b>	359725	<b>Ref. No.</b> —
oven lamp glass thread ø 44mm H 43mm ø 54mm hard glas temp.-resist. 350°C			

<b>lamps</b>			
<b>light bulbs</b>			
			
<b>1</b>	<b>GEV No.</b>	359610	<b>Ref. No.</b> 01950108400
<b>description</b> light bulb t.max. 300°C socket E14 15W 230V ø 22mm L 47mm lens L 20mm for oven lamp type Philips			
<b>For models:</b> 440, 640 CI, 640 CI+GRILL, 640 CI+U, 648 CI, 900, 900 G, 930, 938.3, CV5-90/X, KC96V, KCP97-VG-A, KCV96, KCV96P, KF1001G, KF1001G-IX-AL, KF1001G-LPG, KF1001G-LPG-IX-AL, KF412, KF412U, KF630, KF723, KF723M, KF733, KF912, KF912IX, KF933, KF933AL, KF933AL-U, KF933U, KF937, KF965, KF965M, TCFG			

<b>halogen lamps</b>			
<b>for socket G4 / G6.35 / G9</b>			
			
<b>1</b>	<b>GEV No.</b>	359074	<b>Ref. No.</b> 01201470 11950097000
<b>description</b> halogen lamp socket G6.35 12V 35W temp.-resist. 500°C			
<b>For models:</b> EKF1016EUD, EKF1016UD, EKF1064EUD, EKF1064UD, EKF1111EUD, EKF1111EVUD, EKF1111UD, EKF616EUD, EKF616UD, EKF664.3EUD, EKF664EUD, EKF664P, EKF664UD, EKF711.3EUD, EKF711EUD, EKF711EV, EKF711UD, KF1010GE-UD, KF981, KF981-DOUBLE, KF981-DOUBLE-EV, KF981-DOUBLE-EV-UD, KF981-DOUBLE-EV-UI, KF981-DOUBLE-UD, KF981-DOUBLE-V, KF981-DOUBLE-V-UD, KF981-DOUBLE-V-UI, KF981EV, KF981UD, KF981V			



sockets

G4 / G5,3 / G6,35



<b>GEV No.</b>	359646	<b>Ref. No.</b>	00005690
<b>description</b>	lamp socket socket G4/G5.3/G6.35 24V ø 17mm H 15mm connection cable 130mm mounting distance 26mm for halogen lamp holder length 31mm cable length 130mm		

timers

programme timers



<b>GEV No.</b>	360329	<b>Ref. No.</b>	01201040 01201350 09951027000 09954657000
<b>description</b>	timer CDC 11902F3 engines 1 chambers 2 operation time 240s 230V manuf. no. PWE5J02H620 motor type M51B10R0000		
<b>For models:</b>	900 G, 930, 938.3, EKF1016UD, EKF1064UD, EKF1111UD, EKF311UD, EKF364UD, EKF411ALUD, EKF411UD, EKF416ALUD, EKF416UD, EKF423ALUD, EKF423UD, EKF464ALP, EKF464ALUD, EKF464P, EKF464UD, EKF523UD, EKF616UD, EKF664P, EKF664UD, EKF711UD, KCP97-VG-A, KF1001G, KF1001G-IX-AL, KF1001G-LPG, KF1001G-LPG-IX-AL, KF630, KF733, KF933, KF933AL, KF933AL-U, KF933U, KF937, KF965, KF965AL-UD, KF965M, KF981, KF981-DOUBLE, KF981-DOUBLE-EV-UD, KF981-DOUBLE-EV-UI, KF981-DOUBLE-UD, KF981-DOUBLE-V, KF981-DOUBLE-V-UD, KF981-DOUBLE-V-UI, KF981EV, KF981UD, KF981V		
<b>spare parts for</b>	360329		
	<b>GEV No.</b>	360118	<b>Ref. No.</b> —
	motor CDC pinion ø 4.9mm teeth 10 230V voltage AC 50/60Hz turn direction right motor ø 47mm H 19.3mm motor type M48R ATS for timer cable length 260mm 1.9/2.5W		

electric timers

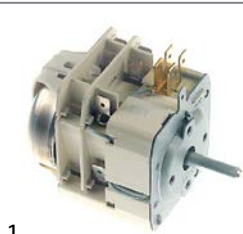

<b>GEV No.</b>	350072	<b>Ref. No.</b>	01200950 09950677000
<b>description</b>	timer MS65 with bell operation time 120min 2CO/1NO at 250V 16A impulse electric shaft ø 6x4.6mm shaft L 23mm with permanent position mounting distance 28mm connection lateral Invensys 3-pole 230V		
<b>For models:</b>	440, 640 CI, 640 CI+GRILL, 640 CI+U, 648 CI, 930, KCP97-VG-A, KCV96, KCV96P, KF412U		

with time spread



<b>GEV No.</b>	350142	<b>Ref. No.</b>	01201200 01201200+2x00002520 09952437000
<b>description</b>	timer MS65 with bell operation time 120min time spread 30min 1CO/1NC/2NO at 250V 16A permanent position yes time range 0-120min impulse electric 16A shaft ø 6x4.6mm shaft L 22mm connection male faston 6.3mm Invensys screw/F6.3 230V voltage AC 50Hz		
<b>For models:</b>	KF1001G, KF1001G-IX-AL, KF1001G-LPG, KF1001G-LPG-IX-AL, KF412, KF723M, KF733, KF912, KF912IX, KF933, KF933AL, KF933AL-U, KF933U, KF937, KF965, KF965AL-UD, KF965M, KF981, KF981-DOUBLE, KF981-DOUBLE-EV-UD, KF981-DOUBLE-EV-UI, KF981-DOUBLE-UD, KF981-DOUBLE-V, KF981-DOUBLE-V-UD, KF981-DOUBLE-V-UI, KF981UD, KF981V		



<b>GEV No.</b>	350073	<b>Ref. No.</b>	01200930 01201200+2x00002520 09950507000
<b>description</b>	timer MS65 with buzzer board operation time 120min time spread 30min 1CO/1NC/2NO at 250V 16A permanent position yes impulse electric shaft ø 6x4.6mm shaft L 20mm with bell mounting distance 28mm connection lateral 3-pole		
<b>For models:</b>	900, 938.3, CV5-90/X, KC96V, KF723		

mechanical timers

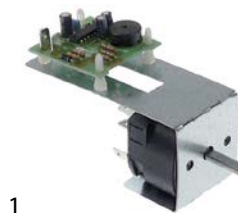



<b>GEV No.</b>	350159	<b>Ref. No.</b>	01200950 01201270 21003700+2x00002520 21004130 21004131
<b>description</b>	timer M2 2-pole operation time 120min impulse mechanical 2CO at 250V 16A permanent position yes shaft ø 6x4.6mm shaft 6x4.6mm shaft L 22mm mounting distance 28mm mounting thread M4 connection male faston 6.3mm ambient temperature max. 125°C with buzzer		
<b>For models:</b>	EKF620S, EKF620US		
<b>spare parts for</b>	350159		
	<b>GEV No.</b>	350186	<b>Ref. No.</b> 01202980
	timer M2 2-pole operation time 120min impulse mechanical 2CO at 250V 16A permanent position yes shaft ø 6x4.6mm shaft 6x4.6mm shaft L 23mm mounting distance 28mm		

Table continues overleaf



<b>spare parts for</b> 350159			
	<b>GEV No.</b>	401062	<b>Ref. No.</b> 01201250 09952707000
buzzer board 230VAC L 48mm W 45mm connection Faston 6.3mm			



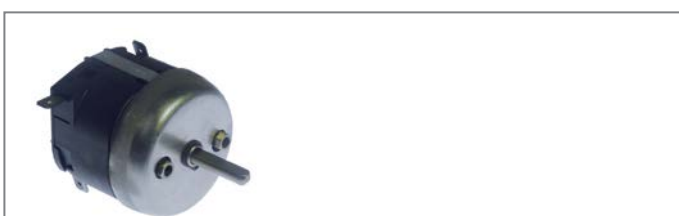

<b>GEV No.</b>	350186	<b>Ref. No.</b>	01202980
<b>description</b>	timer M2 2-pole operation time 120min impulse mechanical 2CO at 250V 16A permanent position yes shaft ø 6x4.6mm shaft 6x4.6mm shaft L 23mm mounting distance 28mm		

<b>accessories for</b> 350186			
	<b>GEV No.</b>	112627	<b>Ref. No.</b> —
knob time 120min ø 58mm shaft ø 6x4.6mm shaft flat lower			



<b>GEV No.</b>	350003	<b>Ref. No.</b>	09950617000
<b>description</b>	timer M2 with bell 2-pole operation time 120min impulse mechanical 2NO at 250V 16A permanent position no shaft ø 6x4.6mm shaft 6x4.6mm shaft L 23mm mounting distance 28mm connection lateral		

<b>accessories for</b> 350003			
	<b>GEV No.</b>	110366	<b>Ref. No.</b> —
knob switch zero mark t.max.°C ø 44mm shaft ø 6x4.6mm shaft flat upper black			

	<b>GEV No.</b>	111199	<b>Ref. No.</b> —
dial plate graduation 120min permanent position no rotation 0-330° ø 60mm timers knob ø 45mm			

## alarm devices

### buzzer boards

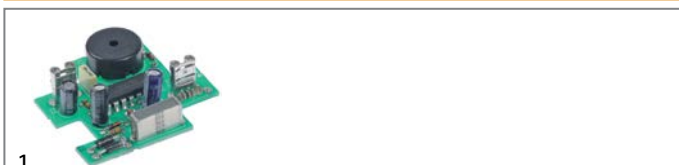

<b>GEV No.</b>	401062	<b>Ref. No.</b>	01201250 09952707000
<b>description</b>	buzzer board 230VAC L 48mm W 45mm connection Faston 6.3mm		

## contactors

### SIEMENS

#### power contactors



<b>GEV No.</b>	380526	<b>Ref. No.</b>	01201680
<b>description</b>	power contactor resistive load 20A 230VAC (AC3/400V) 8.4A/4kW main contacts 4NO auxiliary contacts connection screw connection type 3TG10-10-0A2L2		
<b>For models:</b>	EKF1016EUD, EKF1016UD, EKF1064EUD, EKF1064TC, EKF1064UD, EKF1111EUD, EKF1111EVUD, EKF1111TC, EKF1111UD, EKF1664TC, EKF2011TC, EKF311DUD, EKF311UD, EKF364DUD, EKF364UD, EKF411, EKF411.3D, EKF411.3GRILL, EKF411ALUD, EKF411D, EKF411DALUD, EKF411DUD, EKF411UD, EKF416ALUD, EKF416DALUD, EKF416DUD, EKF416UD, EKF423ALUD, EKF423DALUD, EKF423DUD, EKF423UD, EKF443DUD, EKF464, EKF464.3D, EKF464.3GRILL, EKF464ALP, EKF464ALUD, EKF464D, EKF464DALUD, EKF464DUD, EKF464P, EKF464TC, EKF464UD, EKF511TC, EKF523EUD, EKF523UD, EKF616EUD, EKF616UD, EKF664.3EUD, EKF664EUD...(Other models you can see in the webshop)		

### TELEMECANIQUE (Schneider Electric)

#### power contactors



<b>GEV No.</b>	380090	<b>Ref. No.</b>	11950197000
<b>description</b>	power contactor resistive load 25A 230VAC (AC3/400V) 12A/5.5kW main contacts 4NO auxiliary contacts 1NO/1NC connection screw connection type LC1DT25P7		
<b>For models:</b>	900, 930, 938.3, CV5-90/X, KC96V		



## relays

### power relays

#### with bracket mounting



<b>GEV No.</b>	380197	<b>Ref. No.</b>	09950287000
<b>description</b>	power relays 230VAC 16A 2CO connection male faston bracket mounting		
<b>For models:</b>	900, 930, 938.3, CV5-90/X, KC96V, KF965M		



<b>GEV No.</b>	380139	<b>Ref. No.</b>	01200820
<b>description</b>	power relays FINDER 230VAC 16A 2CO connection F6.3 bracket mounting dimensions 68x38.2x35.8mm manuf. no. 62.82.8.230.0000		

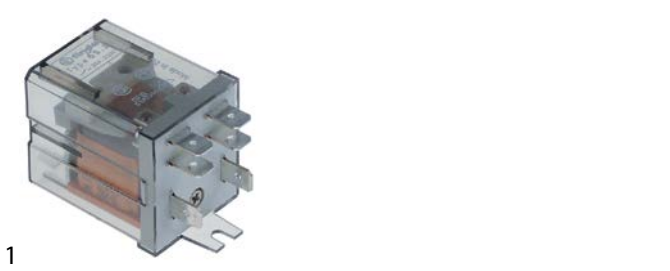

<b>GEV No.</b>	380900	<b>Ref. No.</b>	01200020
<b>description</b>	power relays FINDER 230VAC 20A 1NO/1NC connection F6.3 bracket mounting dimensions 36.5x32.2x51.8mm manuf. no. 65.31.8.230.0000 2-pole		
<b>For models:</b>	EKF1016UD, EKF1064UD, EKF1111UD, EKF411.3GRILL, EKF411ALUD, EKF416ALUD, EKF464.3GRILL, EKF464ALUD, EKF523UD, EKF616UD, EKF664P, EKF664UD, EKF711UD		

## transformers

### for lighting



<b>GEV No.</b>	401177	<b>Ref. No.</b>	00005680
<b>description</b>	transformer primary 230V secondary 11.5V 50W		



<b>GEV No.</b>	403698	<b>Ref. No.</b>	00012590
<b>description</b>	transformer primary 230VAC secondary 12VAC 105VA secondary A L 128mm W 38mm H 28mm 50/60Hz		
<b>For models:</b>	EKF1016EUD, EKF1016UD, EKF1064EUD, EKF1064UD, EKF1111EUD, EKF1111EVUD, EKF1111UD, EKF616EUD, EKF616UD, EKF664.3EUD, EKF664EUD, EKF664P, EKF664UD, EKF711.3EUD, EKF711EUD, EKF711EV, EKF711UD		

## probes

### producer-specific probes

#### probes



<b>GEV No.</b>	379638	<b>Ref. No.</b>	00005790 11950677000
<b>description</b>	temperature probe Pt100 cable silicone probe -50 up to +250°C cable -50 up to +180°C connection plug thread probe ø3x100mm cable length 1m		



<b>GEV No.</b>	378552	<b>Ref. No.</b>	00002660
<b>description</b>	temperature probe Pt100 cable Vetrotex probe -100 up to 450°C cable°C connection coded plug thread M10 probe ø4x100mm cable length 1m		
<b>For models:</b>	EKF1016EUD, EKF1064EUD, EKF1064TC, EKF1111EUD, EKF1111EVUD, EKF1111TC, EKF311DUD, EKF364DUD, EKF411.3D, EKF411D, EKF411DALUD, EKF411DUD, EKF416DALUD, EKF416DUD, EKF423DALUD, EKF423DUD, EKF443DUD, EKF464.3D, EKF464D, EKF464DALUD, EKF464DUD, EKF464TC, EKF511TC, EKF523EUD, EKF616EUD, EKF664.3EUD, EKF664EUD, EKF664TC, EKF711.3EUD, EKF711EUD, EKF711EV, EKF711TC		



# electronics

## PCBs



<b>GEV No.</b>	403701	<b>Ref. No.</b>	01900081
<b>description</b>	control PCB combi-steamer EKF series L 432mm W 80mm		
<b>For models:</b>	EKF1016EUD, EKF1064EUD, EKF1111EUD, EKF1111EVUD, EKF523EUD, EKF616EUD, EKF664.3EUD, EKF664EUD, EKF711.3EUD, EKF711EUD, EKF711EV		

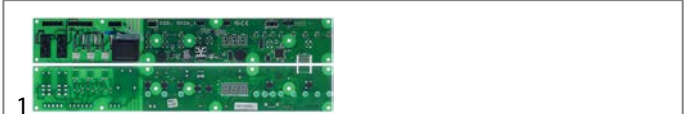

<b>GEV No.</b>	403726	<b>Ref. No.</b>	01202500 01202501 01202502 01900170 11951767000
<b>description</b>	display PCB pizza oven EKF L 364mm W 54mm		
<b>For models:</b>	EKF311DUD, EKF364DUD, EKF411.3D, EKF411D, EKF411DALUD, EKF411DUD, EKF416DALUD, EKF416DUD, EKF423DALUD, EKF423DUD, EKF443DUD, EKF464.3D, EKF464D, EKF464DALUD, EKF464DUD		



<b>GEV No.</b>	403725	<b>Ref. No.</b>	01900090 01900130 11950577000
<b>description</b>	main PCB combi-steamer L 262mm W 108mm		
<b>For models:</b>	EKF1016EUD, EKF1064EUD, EKF1111EUD, EKF523EUD, EKF616EUD, EKF664.3EUD, EKF664EUD, EKF711.3EUD, EKF711EUD, EKF711EV, KF981-DOUBLE-EV, KF981-DOUBLE-EV-UD, KF981-DOUBLE-EV-UI, KF981EV		

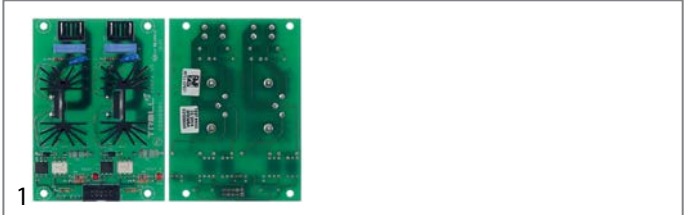

<b>GEV No.</b>	403699	<b>Ref. No.</b>	01900100
<b>description</b>	PCB combi-steamer EKF 523 L 102mm W 54mm		
<b>For models:</b>	EKF523EUD		



<b>GEV No.</b>	403700	<b>Ref. No.</b>	01900480
<b>description</b>	PCB combi-steamer EKF series L 105mm W 98mm suitable for TECNOEKA		
<b>For models:</b>	EKF1016EUD, EKF1064EUD, EKF1111EUD, EKF1111EVUD, EKF616EUD, EKF664.3EUD, EKF664EUD, EKF711.3EUD, EKF711EUD, EKF711EV		

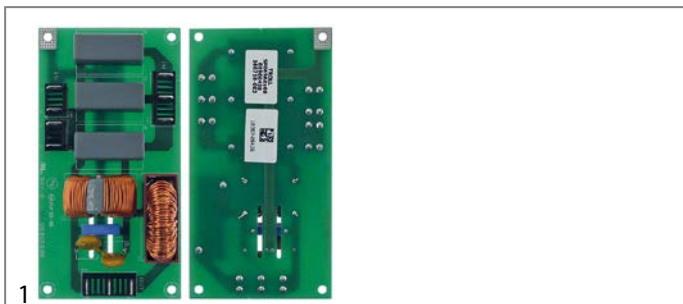

<b>GEV No.</b>	403697	<b>Ref. No.</b>	01900430
<b>description</b>	PCB combi-steamer EKF664/EKF1064 L 128mm W 67mm		
<b>For models:</b>	EKF1016EUD, EKF1064EUD, EKF1111EUD, EKF1111EVUD, EKF616EUD, EKF664.3EUD, EKF664EUD, EKF711.3EUD, EKF711EUD, EKF711EV		

# solenoid valves

## solenoid valves (water)

### RPE JOHN GUEST



<b>GEV No.</b>	370772	<b>Ref. No.</b>	01201790
<b>description</b>	solenoid valve double straight 230VAC inlet 3/4" outlet JG 8 DN10 t.max. 60°C duty cycle 100% RPE		

accessories for 370772

	<b>GEV No.</b>	371265	<b>Ref. No.</b>	—
				reducer flow rate 3l/min black

	<b>GEV No.</b>	371269	<b>Ref. No.</b>	—
				reducer flow rate 0.07-0.14l/min brown



<b>GEV No.</b>	374090	<b>Ref. No.</b>	01201800
----------------	--------	-----------------	----------

**description** solenoid valve triple straight 220-240VAC inlet 3/4" outlet JG 8 DN8 t.max. 25/60/90°C duty cycle 100% RPE output A 0.2l/min output B 0.2l/min output C 0.2l/min flow regulating valve outlet A red flow regulating valve outlet B red flow regulating valve outlet C red

**For models:** EKF1016EUD, EKF1016UD, EKF1064EUD, EKF1064TC, EKF1064UD, EKF1111EUD, EKF1111TC, EKF1111UD







solenoid valves with reducers			
single			
			
<b>GEV No.</b>	374012	<b>Ref. No.</b>	01201860
<b>description</b>	solenoid valve single straight 220-240VAC inlet 3/4" outlet JG 8 input 10-12l/min t.max. 60°C duty cycle 100% RPE plastic flow regulating valve outlet brown flow regulating valve inlet white output A 0.07-0.14l/min 2-ways medium temp max. 25°C male faston 6.3mm		
<b>For models:</b>	EKF311DUD, EKF311UD, EKF364DUD, EKF364UD, EKF411, EKF411.3D, EKF411.3GRILL, EKF411ALUD, EKF411D, EKF411DALUD, EKF411DUD, EKF411UD, EKF412US, EKF416ALUD, EKF416DALUD, EKF416DUD, EKF416UD, EKF423ALU, EKF423ALUD, EKF423ALUP, EKF423DALUD, EKF423DUD, EKF423U, EKF423UD, EKF423UP, EKF443DUD, EKF464, EKF464.3D, EKF464.3GRILL, EKF464ALUD, EKF464D, EKF464DALUD, EKF464DUD, EKF464TC, EKF464UD, EKF511TC, EKF523EUD, EKF523UD, EKF620US		

2-fold			
			
<b>GEV No.</b>	374037	<b>Ref. No.</b>	01203180
<b>description</b>	solenoid valve double straight 220-240VAC inlet 3/4" outlet JG 8 input 10-12l/min t.max. 60°C duty cycle 100% RPE plastic flow regulating valve inlet white output A 0.2-0.33l/min output B 0.2-0.33l/min flow regulating valve outlet A red flow regulating valve outlet B red output A John Guest 8mm output B John Guest 8mm		
<b>For models:</b>	EKF616EUD, EKF616UD, EKF664.3EUD, EKF664EUD, EKF664TC, EKF664UD, EKF711.3EUD, EKF711EUD, EKF711TC, EKF711UD		

			
<b>GEV No.</b>	374109	<b>Ref. No.</b>	01201640 259179
<b>description</b>	solenoid valve double straight 230VAC inlet 3/4" outlet JG 8 t.max. 60°C duty cycle 100% RPE plastic flow regulating valve inlet output A 0.7-1l/min output B l/min flow regulating valve outlet A light blue		
<b>For models:</b>	EKF711EV		

TP			
			
<b>GEV No.</b>	370017	<b>Ref. No.</b>	11950277000
<b>description</b>	solenoid valve single straight 230VAC inlet 3/4" outlet 11.5mm DN10 TP p max 10bar		
<b>For models:</b>	640 Cl+U, 900, 900 G, 930, 938.3, KF412U		
<b>spare parts for</b>	370017		
	<b>GEV No.</b>	371013	<b>Ref. No.</b> —
solenoid coil TP 230VAC 50/60Hz			

accessories for 370017			
	<b>GEV No.</b>	371220	<b>Ref. No.</b> —
reducer TP flow rate 3l/min red tolerance ±15%			
	<b>GEV No.</b>	371221	<b>Ref. No.</b> —
reducer TP flow rate 5.5l/min yellow tolerance ±15%			
	<b>GEV No.</b>	371222	<b>Ref. No.</b> —
reducer TP flow rate 6l/min grey tolerance ±15%			
	<b>GEV No.</b>	371223	<b>Ref. No.</b> —
reducer TP flow rate 10l/min white tolerance ±15%			
	<b>GEV No.</b>	371224	<b>Ref. No.</b> —
reducer TP flow rate 12l/min bronze tolerance ±15%			
	<b>GEV No.</b>	371225	<b>Ref. No.</b> —
reducer TP flow rate 16l/min light brown tolerance ±15%			
	<b>GEV No.</b>	371226	<b>Ref. No.</b> —
reducer TP flow rate 20l/min red tolerance ±15%			
	<b>GEV No.</b>	371230	<b>Ref. No.</b> —
reducer TP flow rate 0.25l/min red tolerance ±25%			
	<b>GEV No.</b>	371231	<b>Ref. No.</b> —
reducer TP flow rate 0.35l/min violet tolerance ±25%			
	<b>GEV No.</b>	371232	<b>Ref. No.</b> —
reducer TP flow rate 0.5l/min orange tolerance ±25%			
	<b>GEV No.</b>	371233	<b>Ref. No.</b> —
reducer TP flow rate 0.8l/min white tolerance ±25%			
	<b>GEV No.</b>	371234	<b>Ref. No.</b> —
reducer TP flow rate 1l/min light blue tolerance ±25%			
	<b>GEV No.</b>	371235	<b>Ref. No.</b> —
reducer TP flow rate 1.2l/min brown tolerance ±25%			
	<b>GEV No.</b>	371236	<b>Ref. No.</b> —
reducer TP flow rate 1.5l/min light brown tolerance ±25%			
	<b>GEV No.</b>	371237	<b>Ref. No.</b> —
reducer TP flow rate 2.5l/min yellow tolerance ±25%			
	<b>GEV No.</b>	371238	<b>Ref. No.</b> —
reducer TP flow rate 3.4l/min dark green tolerance ±25%			
	<b>GEV No.</b>	371239	<b>Ref. No.</b> —
reducer TP flow rate 5l/min black tolerance ±25%			
	<b>GEV No.</b>	371240	<b>Ref. No.</b> —
reducer TP flow rate 8l/min blue tolerance ±20%			



## fans

## cross flow fans

## EMMEVI - FER GAS

with standard coil



1

<b>GEV No.</b>	601018	<b>Ref. No.</b>	01202330 09950337000 15950077000 15950427000
<b>description</b>	cross flow fan TG 180 roller ø 60mm roller length 180mm motor position right 230V/50Hz 25W universal bearing silicone connection male faston 6.3mm -10 up to +60°C 230V connections 1-2 1950U/min connections 1-4 1500U/min		
<b>For models:</b>	EKF1016EUD, EKF1016UD, EKF1064EUD, EKF1064TC, EKF1064UD, EKF1111EUD, EKF1111EVUD, EKF1111TC, EKF1111UD, EKF1664TC, EKF2011TC, EKF3111DUD, EKF3111UD, EKF364DUD, EKF364UD, EKF411, EKF411.3D, EKF411.3GRILL, EKF411ALUD, EKF411D, EKF411DALUD, EKF411DUD, EKF411UD, EKF416ALUD, EKF416DALUD, EKF416DUD, EKF416UD, EKF423, EKF423AL, EKF423ALM, EKF423ALU, EKF423ALUD, EKF423DALUD, EKF423DUD, EKF423M, EKF423U, EKF423UD, EKF443DUD, EKF464, EKF464.3D, EKF464.3GRILL, EKF464ALP, EKF464ALUD, EKF464D, EKF464DALUD, EKF464DUD, EKF464P, EKF464TC, EKF464UD, EKF511TC...(Other models you can see in the webshop)		

## COPREL

with moulded coils



1

<b>GEV No.</b>	601194	<b>Ref. No.</b>	09951057000
<b>description</b>	cross flow fan roller ø 60mm roller length 300mm laminated core thickness 20mm motor position right 230V/50Hz 43W universal bearing silicone connection male faston 6.3mm -30 up to +100°C 230V 50Hz		
<b>For models:</b>	930		

## accessories for cross flow fans

## air ducts



1

<b>GEV No.</b>	701630	<b>Ref. No.</b>	00012330
<b>description</b>	air duct for cross flow fan for combi-steamer plastic grey		
<b>For models:</b>	EKF1016EUD, EKF1016UD, EKF1064EUD, EKF1064UD, EKF1111EUD, EKF1111EVUD, EKF1111UD, EKF3111DUD, EKF3111UD, EKF364DUD, EKF364UD, EKF411, EKF411.3D, EKF411.3GRILL, EKF411ALUD, EKF411D, EKF411DALUD, EKF411DUD, EKF411UD, EKF416ALUD, EKF416DALUD, EKF416DUD, EKF416UD, EKF423, EKF423AL, EKF423ALM, EKF423ALU, EKF423ALUD, EKF423DALUD, EKF423DUD, EKF423M, EKF423U, EKF423UD, EKF443DUD, EKF464, EKF464.3D, EKF464.3GRILL, EKF464ALP, EKF464ALUD, EKF464D, EKF464DALUD, EKF464DUD, EKF464P, EKF464UD, EKF523EUD, EKF523UD, EKF616EUD, EKF616UD, EKF664.3EUD, EKF664EUD...(Other models you can see in the webshop)		

## hot air motors



1

<b>GEV No.</b>	602099	<b>Ref. No.</b>	01202600 01202600+01203600
<b>description</b>	fan motor 220/240V 1 phase 50/60Hz 0.12kW 2800/3400rpm suitable capacitor 6.3 type 1004.2459		

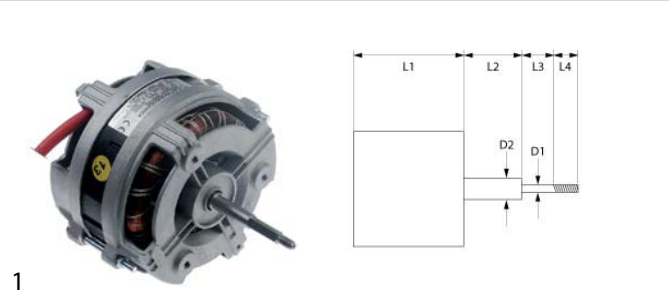

1

<b>GEV No.</b>	601648	<b>Ref. No.</b>	01201330 01201330+01201030 01201330+01203600 01202600+00010380+01201330 09954527000
<b>description</b>	fan motor 220-240V 1 phase 50/60Hz 0.12kW 2800/3400rpm speeds 1 L1 95mm L2 32mm L3 23mm L4 12mm D1 $\varnothing$ 6x8mm D2 $\varnothing$ 10mm M6R ET 0.9A power input 0.12W at 50Hz 2800rpm at 60Hz 3400rpm suitable capacitor 6.3 $\mu$ F/450V		
<b>For models:</b>	KF733, KF933AL, KF933AL-U, KF933U, KF981, KF981-DOUBLE, KF981-DOUBLE-EV, KF981-DOUBLE-EV-UD, KF981-DOUBLE-EV-UI, KF981-DOUBLE-UD, KF981-DOUBLE-V, KF981-DOUBLE-V-UD, KF981-DOUBLE-V-UI, KF981EV, KF981UD, KF981V		
<b>accessories for</b>	601648		
		<b>GEV No.</b>	365012 <b>Ref. No.</b> 01201030
	operating capacitor capacity 6.3 $\mu$ F 450V tolerance 5% 50Hz ambient temperature max. -25 to +85°C $\varnothing$ 30mm L 61mm M8 plastic connection male faston 6.3mm protection		

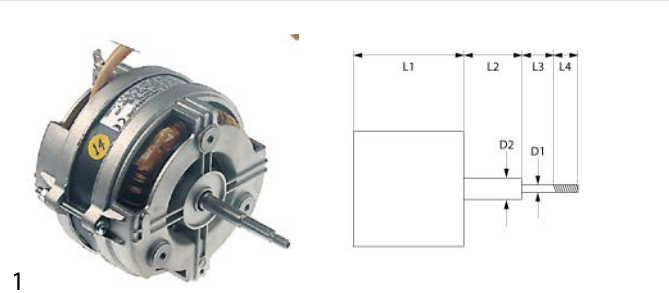

1

<b>GEV No.</b>	601195	<b>Ref. No.</b>	01201130 01201130+01203600 09951627000
<b>description</b>	fan motor 220-240V 1 phase 50/60Hz 0.12kW 2800/3400rpm speeds 1 L1 95mm L2 32mm L3 23mm L4 12mm D1 $\varnothing$ 7x8mm D2 $\varnothing$ 10mm M6R ET 0.9A at 50Hz 2800rpm at 60Hz 3400rpm suitable capacitor 6.3 $\mu$ F/450V type FIR1004		
<b>For models:</b>	900 G, 930, 938.3, KCP97-VG-A, KF1001G, KF1001G-IX-AL, KF1001G-LPG, KF1001G-LPG-IX-AL, KF630, KF933, KF937, KF965, KF965AL-UD, KF965M		



1

<b>GEV No.</b>	602096	<b>Ref. No.</b>	00002570
<b>description</b>	fan wheel blades 30 D1 $\varnothing$ 160mm D2 $\varnothing$ 6.8mm D3 $\varnothing$ 6.9mm H1 38mm H2 24mm H3 4mm		
<b>For models:</b>	EKF423ALUD, EKF423DALUD, EKF423DUD, EKF423UD		



1

<b>GEV No.</b>	602097	<b>Ref. No.</b>	00005870 11951439400
<b>description</b>	fan wheel blades 38 D1 $\varnothing$ 200mm D2 $\varnothing$ 6.5x8mm D3 $\varnothing$ 7mm H1 38mm H2 22mm H3 3mm		
<b>For models:</b>	EKF311DUD, EKF311UD, EKF364DUD, EKF364UD, EKF411ALUD, EKF411DALUD, EKF411DUD, EKF411UD, EKF416ALUD, EKF416DALUD, EKF416DUD, EKF416UD, EKF443DUD, EKF464ALP, EKF464ALUD, EKF464DALUD, EKF464DUD, EKF464UD, EKF523EUD, EKF523UD, KF933, KF933AL, KF933U, KF981, KF981-DOUBLE, KF981-DOUBLE-EV, KF981-DOUBLE-EV-UD, KF981-DOUBLE-EV-UI, KF981-DOUBLE-UD, KF981-DOUBLE-V, KF981-DOUBLE-V-UD, KF981-DOUBLE-V-UI, KF981EV, KF981UD, KF981V		



1

<b>GEV No.</b>	602098	<b>Ref. No.</b>	00007180 00007181
<b>description</b>	fan wheel blades 45 D1 $\varnothing$ 196mm D2 $\varnothing$ 6.5x8mm D3 $\varnothing$ 8mm H1 60mm H2 23mm H3 3mm		
<b>For models:</b>	EKF1016EUD, EKF1016UD, EKF1064EUD, EKF1064TC, EKF1064UD, EKF1111EUD, EKF1111EVUD, EKF1111TC, EKF1111UD, EKF464ALP, EKF464P, EKF464TC, EKF511TC, EKF616EUD, EKF616UD, EKF664.3EUD, EKF664EUD, EKF664P, EKF664TC, EKF664UD, EKF711.3EUD, EKF711EUD, EKF711EV, EKF711TC, EKF711UD		



1

<b>GEV No.</b>	601187	<b>Ref. No.</b>	00005740 11950389400
<b>description</b>	fan wheel D1 $\varnothing$ 200mm H1 40mm blades 38 D2 $\varnothing$ 8mm D3 $\varnothing$ 8mm H2 28mm		
<b>For models:</b>	930, 938.3, KF937, KF965, KF965AL-UD, KF965M		



1

<b>GEV No.</b>	601186	<b>Ref. No.</b>	11950509400
<b>description</b>	fan wheel D1 ø 215mm H1 40mm blades 38 D2 ø 8mm D3 ø 8mm H2 26.5mm		
<b>For models:</b>	900 G, KCP97-VG-A, KF1001G, KF1001G-IX-AL, KF1001G-LPG, KF1001G-LPG-IX-AL		

hot air fans

miscellaneous



1

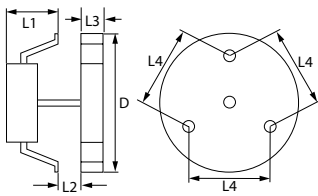

<b>GEV No.</b>	601125	<b>Ref. No.</b>	01201460 11950057000 11950257000
<b>description</b>	hot air fan 220-240V 45W 50/60Hz L1 70mm L2 11mm L3 25mm L4 87mm fan wheel ø 150mm FIME type C30R0479CLF		
<b>For models:</b>	440, 640 CI, 640 CI+GRILL, 640 CI+U, 648 CI, 900, CV5-90/X, EKF411, EKF411.3D, EKF411.3GRILL, EKF411D, EKF412US, EKF464, EKF464.3D, EKF464.3GRILL, EKF464D, EKF620S, EKF620US, KCV96, KCV96P, KF412, KF412U, KF620, KF622, KF723, KF723M, KF912, KF912IX		
<b>accessories for</b>	601125		
	<b>GEV No.</b>	550879	<b>Ref. No.</b> —
	insulation ø 130mm thickness 3mm hole ø 20mm for hot air fan		



1

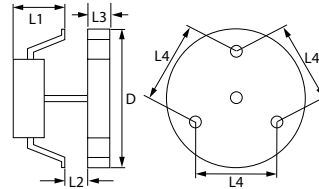

<b>GEV No.</b>	602100	<b>Ref. No.</b>	01203230 01203231
<b>description</b>	hot air fan 240V 59W 50/60Hz L1 80mm L2 16mm fan wheel ø 150mm IMS type 138251		
<b>For models:</b>	EKF423, EKF423AL, EKF423ALM, EKF423ALP, EKF423ALU, EKF423ALUP, EKF423M, EKF423P, EKF423U, EKF423UP		

accessories

miscellaneous



1

<b>GEV No.</b>	211088	<b>Ref. No.</b>	00002830 09960218715
<b>description</b>	guard L 155mm W 155mm for fan		
<b>For models:</b>	EKF412US, EKF620S, EKF620US, KC96V, KCV96, KCV96P, KF412, KF412U, KF620, KF622, KF723, KF723M, KF912, KF912IX		



## pumps

### booster pumps II

#### accessories



1			
<b>GEV No.</b>	365012	<b>Ref. No.</b>	01201030
<b>description</b>	operating capacitor capacity 6.3µF 450V tolerance 5% 50Hz ambient temperature max. -25 to +85°C ø 30mm L 61mm M8 plastic connection male faston 6.3mm protection		
<b>For models:</b>	EKF1016EUD, EKF1016UD, EKF1064EUD, EKF1064TC, EKF1064UD, EKF1111EUD, EKF1111EVUD, EKF1111TC, EKF1111UD, EKF1664TC, EKF2011TC, EKF311DUD, EKF311UD, EKF364DUD, EKF364UD, EKF411ALUD, EKF411DALUD, EKF411DUD, EKF411UD, EKF416ALUD, EKF416DALUD, EKF416DUD, EKF416UD, EKF423ALUD, EKF423DALUD, EKF423DUD, EKF423UD, EKF443DUD, EKF464ALUD, EKF464DALUD, EKF464DUD, EKF464UD, EKF523EUD, EKF523UD, EKF616EUD, EKF616UD, EKF664.3EUD, EKF664EUD, EKF664P, EKF664TC, EKF664UD, EKF711.3EUD, EKF711EUD, EKF711EV, EKF711TC, EKF711UD		

## condensators & interference suppression filters

### operating capacitors

#### plastic



1			
<b>GEV No.</b>	365012	<b>Ref. No.</b>	01201030
<b>description</b>	operating capacitor capacity 6.3µF 450V tolerance 5% 50Hz ambient temperature max. -25 to +85°C ø 30mm L 61mm M8 plastic connection male faston 6.3mm protection		
<b>For models:</b>	EKF1016EUD, EKF1016UD, EKF1064EUD, EKF1064TC, EKF1064UD, EKF1111EUD, EKF1111EVUD, EKF1111TC, EKF1111UD, EKF1664TC, EKF2011TC, EKF311DUD, EKF311UD, EKF364DUD, EKF364UD, EKF411ALUD, EKF411DALUD, EKF411DUD, EKF411UD, EKF416ALUD, EKF416DALUD, EKF416DUD, EKF416UD, EKF423ALUD, EKF423DALUD, EKF423DUD, EKF423UD, EKF443DUD, EKF464ALUD, EKF464DALUD, EKF464DUD, EKF464UD, EKF523EUD, EKF523UD, EKF616EUD, EKF616UD, EKF664.3EUD, EKF664EUD, EKF664P, EKF664TC, EKF664UD, EKF711.3EUD, EKF711EUD, EKF711EV, EKF711TC, EKF711UD		

## fuses

### fine fuses



1			
<b>GEV No.</b>	358675	<b>Ref. No.</b>	11950227000
<b>description</b>	fine fuse size ø5x20mm 2.5A fast-acting rated 250V Qty 10 pcs		

### fine fuse holders



1			
<b>GEV No.</b>	550105	<b>Ref. No.</b>	11950147000
<b>description</b>	rail-mounted terminal WIELAND type WK10/SIU 5X20 /V0 suitable fuse ø5x20mm 1.0-16mm <sup>2</sup> 10A rated 250V		

## electric accessories

### terminals

#### connection terminals with screw/faston connections



1			
<b>GEV No.</b>	551444	<b>Ref. No.</b>	01200720 481560 FV71
<b>description</b>	power terminal block 3-pole max. 25A max 450V connection male faston 6.3mm temp.-resist. 150°C		
<b>For models:</b>	EKF412US, EKF423, EKF423AL, EKF423ALM, EKF423ALU, EKF423M, EKF423U		

#### connection terminals with screw connection



1			
<b>GEV No.</b>	550507	<b>Ref. No.</b>	01200980 09950957300
<b>description</b>	power terminal block 4-pole max. 40A max 400V connection M6/M6 temp.-resist. 150°C		
<b>For models:</b>	900, CV5-90/X, EKF311DUD, EKF311UD, EKF364DUD, EKF364UD, EKF411, EKF411.3D, EKF411.3GRILL, EKF411ALUD, EKF411D, EKF411DALUD, EKF411DUD, EKF411UD, EKF416ALUD, EKF416DALUD, EKF416DUD, EKF416UD, EKF423ALUD, EKF423DALUD, EKF423DUD, EKF423UD, EKF443DUD, EKF464, EKF464.3D, EKF464.3GRILL, EKF464ALP, EKF464ALUD, EKF464D, EKF464DALUD, EKF464DUD, EKF464P, EKF464UD, EKF523EUD, EKF523UD, KC96V, KF912, KF912IX, KF933, KF933AL, KF933AL-U, KF933U, KF937, KF965, KF965AL-UD, KF965M, KF981, KF981-DOUBLE, KF981-DOUBLE-EV-UD, KF981-DOUBLE-EV-UI...(Other models you can see in the webshop)		



1

<b>GEV No.</b>	550355	<b>Ref. No.</b>	01201760
<b>description</b>	power terminal block 6-pole max. 40A max 400V connection M6/M6 temp.-resist. 150°C cross section 6mm <sup>2</sup> hole distance 122mm		
<b>For models:</b>	EKF1016EUD, EKF1016UD, EKF1064EUD, EKF1064TC, EKF1064UD, EKF1111EUD, EKF1111EVUD, EKF1111TC, EKF1111UD, EKF464TC, EKF511TC, EKF616EUD, EKF616UD, EKF664.3EUD, EKF664EUD, EKF664P, EKF664TC, EKF664UD, EKF711.3EUD, EKF711EUD, EKF711EV, EKF711TC, EKF711UD		

connection boxes



1

<b>GEV No.</b>	550755 <sup>1</sup>	<b>Ref. No.</b>	00002260 09950047000
<b>description</b>	connecting cable 3-pole contacts P+N+E with strain relief black L 1600mm 2.5mm <sup>2</sup>		
<b>For models:</b>	EKF423ALP, EKF423ALUP, EKF423P, EKF423UP, EKF620S, EKF620US, KCP97-VG-A, KCV96, KCV96P, KF1001G, KF1001G-IX-AL, KF1001G-LPG, KF1001G-LPG-IX-AL, KF412, KF412U, KF620, KF622, KF630, KF723, KF723M, KF733, KL823, KL864, KL898, TCFG		

<sup>1</sup>with cable 1600mm

rail-mounted terminals

WIELAND

fuse terminal blocks



1

<b>GEV No.</b>	550105	<b>Ref. No.</b>	11950147000
<b>description</b>	rail-mounted terminal WIELAND type WK10/SIU 5X20 /V0 suitable fuse ø5x20mm 1.0-16mm <sup>2</sup> 10A rated 250V		

accessories



1

<b>GEV No.</b>	550370	<b>Ref. No.</b>	11950137000
<b>description</b>	terminal block end bracket clampsmm <sup>2</sup>		

gas taps

SABAF



1

<b>GEV No.</b>	101747	<b>Ref. No.</b>	00000820 01991628700 21003740	
<b>description</b>	gas tap SABAF type 10 gas inlet pipe flange ø14mm bypass nozzle ø 0.4mm gas outlet 1/4" (tube ø 8mm) front fixing M13x1 thermocouple connection M8x1 shaft ø 6x4.6mm shaft L 23.5/18.5mm shaft flat upper			
<b>For models:</b>	CV5-90/X, KC96V, KCP97-VG-A, KCV96, KCV96P, KPP96, KTTP96			
<b>spare parts for</b>	101747			
	<b>GEV No.</b>	101376	<b>Ref. No.</b>	01990308000
	gasket ID ø 8mm ED ø 12mm H 3/5mm			
	<b>GEV No.</b>	106724	<b>Ref. No.</b>	—
	magnet unit L 30mm D1 ø 12.5mm D2 ø 8.5mm suitable for SABAF			
<b>accessories for</b>	101747			
	<b>GEV No.</b>	101277	<b>Ref. No.</b>	01991738700
	olive ID ø 8mm Qty 1 pcs			
	<b>GEV No.</b>	101751	<b>Ref. No.</b>	01990279512
	bracket			
	<b>GEV No.</b>	520656	<b>Ref. No.</b>	—
	union nut thread 1/4" tube ø 6/8mm			
	<b>GEV No.</b>	560082	<b>Ref. No.</b>	—
	hexagonal screw thread M4 thread L 16mm SS WS 7 Qty 20 pcs DIN 933 / ISO 4017			



1





<b>GEV No.</b>	101748	<b>Ref. No.</b>	01991578700 21003870	
<b>description</b>	gas tap SABAF type 10 gas inlet pipe flange ø14mm bypass nozzle ø 0.5mm gas outlet 1/4" (tube ø 8mm) front fixing M13x1 thermocouple connection M8x1 shaft ø 6x4.6mm shaft L 24/18mm shaft flat upper			
<b>For models:</b>	CV5-90/X, KC96V, KCP97-VG-A, KCV96, KCV96P, KPP96, KTTP96, TCFG			
<b>spare parts for</b>	101748			
	<b>GEV No.</b>	101376	<b>Ref. No.</b>	01990308000
	gasket ID ø 8mm ED ø 12mm H 3/5mm			
	<b>GEV No.</b>	106724	<b>Ref. No.</b>	—
	magnet unit L 30mm D1 ø 12.5mm D2 ø 8.5mm suitable for SABAF			



Table continues overleaf





<b>accessories for</b>	101748		
	GEV No.	101277	Ref. No. 01991738700
	olive ID ø 8mm Qty 1 pcs		
	GEV No.	101751	Ref. No. 01990279512
	bracket		
	GEV No.	520656	Ref. No. —
	union nut thread 1/4" tube ø 6/8mm		



<b>GEV No.</b>	101749	<b>Ref. No.</b>	00000810 01991608700
<b>description</b>	gas tap SABAF type 10 gas inlet pipe flange ø14mm bypass nozzle ø 0.74mm gas outlet 1/4" (tube ø 8mm) front fixing thermocouple connection M8x1 shaft ø 6x4.6mm shaft L 23/17mm shaft flat upper		
<b>For models:</b>	CV5-90/X, KC96V, KCP97-VG-A, KCV96, KCV96P, KPP96, KTPP96		

<b>spare parts for</b>	101749		
	GEV No.	101376	Ref. No. 01990308000
	gasket ID ø 8mm ED ø 12mm H 3/5mm		
	GEV No.	106724	Ref. No. —
	magnet unit L 30mm D1 ø 12.5mm D2 ø 8.5mm suitable for SABAF		

<b>accessories for</b>	101749		
	GEV No.	101277	Ref. No. 01991738700
	olive ID ø 8mm Qty 1 pcs		
	GEV No.	101751	Ref. No. 01990279512
	bracket		
	GEV No.	520656	Ref. No. —
	union nut thread 1/4" tube ø 6/8mm		

## gas valves and ignition boxes

### gas control valves

#### HONEYWELL



<b>GEV No.</b>	107579	<b>Ref. No.</b>	01201810
<b>description</b>	gas valve type VK4105A 1100 4 220/240V 50/60Hz gas inlet 3/4" gas outlet 3/4" pressure range 15-60mbar max 60mbar HONEYWELL		

## SIT

### SIGMA



<b>GEV No.</b>	101989	<b>Ref. No.</b>	11950407000
<b>description</b>	gas valve 230V 50Hz gas inlet 3/4" gas outlet 3/4" SIT pressure range 2-50mbar equiv. no. 0.840.016		
<b>For models:</b>	900 G, KCP97-VG-A, KF1001G, KF1001G-IX-AL, KF1001G-LPG, KF1001G-LPG-IX-AL, KF1010GE-UD		

<b>spare parts for</b>	101989		
	GEV No.	106214	Ref. No. —
	solenoid coil 230V 50Hz Sigma		

<b>accessories for</b>	101989		
	GEV No.	107222	Ref. No. —
	plug for solenoid valve 3-pole cable length 1070mm		

## ignition boxes

### SIT



<b>GEV No.</b>	101990	<b>Ref. No.</b>	11950397000
<b>description</b>	ignition box SIT type 537ABC electrodes 3 waiting time 1.5s safety time 5s 230V 10VA 50-60Hz protection IP40		
<b>For models:</b>	900 G, KCP97-VG-A, KF1001G, KF1001G-IX-AL, KF1001G-LPG, KF1001G-LPG-IX-AL		



<b>GEV No.</b>	107850	<b>Ref. No.</b>	01900020
<b>description</b>	ignition box SIT type 579DBC electrodes 2 waiting time 1.5s safety time 6s 220/240V 12VA 50/60Hz		

# ignition parts

## electrodes



1

<b>GEV No.</b>	102496	<b>Ref. No.</b>	07991148000
<b>description</b>	gasket for ignition electrode		
<b>For models:</b>	KCP97-VG-A, KCV96, KCV96P, KPP96, KTPP96		



1

<b>GEV No.</b>	102495	<b>Ref. No.</b>	01993247000
<b>description</b>	ignition electrode D1 ø 6mm cable length 580mm connection male faston 2.8mm D2 ø 8mm L1 1mm BL1 22mm BL2 3.5mm BL3 13mm		
<b>For models:</b>	KCP97-VG-A		

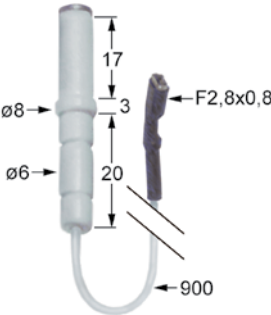

1

<b>GEV No.</b>	102312	<b>Ref. No.</b>	01951047000
<b>description</b>	ignition electrode D1 ø 6mm cable length 900mm connection F 2.8x0.8mm D2 ø 8mm BL1 17mm BL2 3mm BL3 20mm to clip		
<b>For models:</b>	CV5-90/X, KC96V		





1

<b>GEV No.</b>	102494	<b>Ref. No.</b>	01200600 01200610 01992307000
<b>description</b>	ignition electrode D1 ø 6mm total length 710mm cable length 660mm connection male faston 2.8mm D2 ø 8mm L1 1mm BL1 17mm BL2 3.5mm BL3 13mm		
<b>For models:</b>	KCP97-VG-A, KCV96, KCV96P, KPP96, KTPP96		



1

<b>GEV No.</b>	102313	<b>Ref. No.</b>	01951077000	
<b>description</b>	ignition electrode D1 ø 7mm D2 ø 12mm connection F 2.8x0.8mm			
<b>For models:</b>	CV5-90/X, KC96V			
<b>accessories for</b>	102313			
	<b>GEV No.</b>	105704	<b>Ref. No.</b>	01951057720
	compression spring L 14.5mm ø 9mm wire gauge ø 0.9mm			
	<b>GEV No.</b>	550542	<b>Ref. No.</b>	01951067720
	retaining ring E D1 ø 5mm D2 ø 11mm DIN 6799 thickness 0.7mm			



1

<b>GEV No.</b>	101795	<b>Ref. No.</b>	01201570 11950447000
<b>description</b>	ignition electrode flange length 23mm flange width 15mm D1 ø 6.5mm L1 12mm L2 27mm BL1 17mm BL2 17mm connection F 4.8x0.8mm cable length 970mm fixing dimensions ø5x4mm with flange		
<b>For models:</b>	900 G, KF1001G, KF1001G-IX-AL, KF1001G-LPG, KF1001G-LPG-IX-AL		

<b>GEV No.</b>	101795	<b>Ref. No.</b>	01201570 11950447000
<b>description</b>	ignition electrode flange length 23mm flange width 15mm D1 ø 6.5mm L1 12mm L2 27mm BL1 17mm BL2 17mm connection F 4.8x0.8mm cable length 970mm fixing dimensions ø5x4mm with flange		
<b>For models:</b>	900 G, KF1001G, KF1001G-IX-AL, KF1001G-LPG, KF1001G-LPG-IX-AL		



1

<b>GEV No.</b>	101794	<b>Ref. No.</b>	01201560 11950437000
<b>description</b>	ignition electrode flange length 23mm flange width 15mm D1 ø 6.5mm L1 9mm L2 16mm BL1 17mm BL2 17mm connection F 2.8x0.8mm cable length 960mm fixing dimensions ø5x4mm with flange		
<b>For models:</b>	900 G, KF1001G, KF1001G-IX-AL, KF1001G-LPG, KF1001G-LPG-IX-AL		

<b>GEV No.</b>	101794	<b>Ref. No.</b>	01201560 11950437000
<b>description</b>	ignition electrode flange length 23mm flange width 15mm D1 ø 6.5mm L1 9mm L2 16mm BL1 17mm BL2 17mm connection F 2.8x0.8mm cable length 960mm fixing dimensions ø5x4mm with flange		
<b>For models:</b>	900 G, KF1001G, KF1001G-IX-AL, KF1001G-LPG, KF1001G-LPG-IX-AL		







			
1			
<b>GEV No.</b>	102498	<b>Ref. No.</b>	07991159001
<b>description</b>	spring clip for ignition electrode		
<b>For models:</b>	KCP97-VG-A, KCV96, KCV96P, KPP96, KTPP96		

			
1			
<b>GEV No.</b>	102257	<b>Ref. No.</b>	01990368700
<b>description</b>	thermocouple M8x1 L 600mm M8x1		
<b>For models:</b>	CV5-90/X, KC96V, TCFG		

ignition units

			
1			
<b>GEV No.</b>	101037	<b>Ref. No.</b>	01951327000 07950017000
<b>description</b>	ignition unit outputs 6		
<b>For models:</b>	CV5-90/X, KC96V, KCP97-VG-A, KCV96, KCV96P		

			
1			
<b>GEV No.</b>	102493	<b>Ref. No.</b>	01200590 01992288700
<b>description</b>	thermocouple M8x1 L 650mm M6x0.75		
<b>For models:</b>	KCP97-VG-A, KCV96, KCV96P, KPP96, KTPP96		

			
1			
<b>GEV No.</b>	102389	<b>Ref. No.</b>	01202611
<b>description</b>	ignition unit outputs 6 230VAC dimensions 135x23x34mm mounting distance 123mm inlet F6.3x0.8 outlet F2.8x0.8 0.6VA 50/60Hz		

<b>accessories</b>			
<b>nuts</b>			
			
1			
<b>GEV No.</b>	102497	<b>Ref. No.</b>	01500810 07991978700
<b>description</b>	nut thread M6x0.75 H 3mm WS 8 steel Qty 1 pcs		
<b>For models:</b>	KCP97-VG-A, KCV96, KCV96P, KPP96, KTPP96, TCFG		

thermocouples

- plug-in thermocouples
- plug-in thermocouples standard
- threaded thermocouples (miscellaneous)

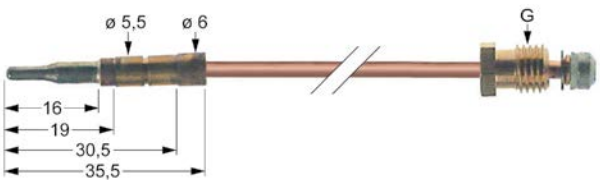
			
1			
<b>GEV No.</b>	102258	<b>Ref. No.</b>	01991828700
<b>description</b>	thermocouple M8x1 L 600mm plug connection ø5.5mm		
<b>For models:</b>	CV5-90/X, KC96V		

gas burners



hob burners



- universal hob burners
- SABAF
- 2 series - standard





			
1			
<b>GEV No.</b>	105993	<b>Ref. No.</b>	00001230 01992246610
<b>description</b>	burner cap 1.8kW ø 75mm bright finish		
<b>For models:</b>	KCP97-VG-A, KCV96, KCV96P, KPP96, KTPP96		

- threaded thermocouples
- threaded thermocouples standard
- threaded thermocouples (miscellaneous)



			
1			
<b>GEV No.</b>	102492	<b>Ref. No.</b>	01992278700
<b>description</b>	thermocouple M8x1 L 600mm M6x0.75		
<b>For models:</b>	KCP97-VG-A, KCV96, KCV96P, KPP96, KTPP96		

			
1			
<b>GEV No.</b>	105054	<b>Ref. No.</b>	07991196610
<b>description</b>	burner cap 3kW ø 100mm H 3.5mm bright finish		
<b>For models:</b>	KCP97-VG-A, KCV96, KCV96P, KPP96, KTPP96		
<b>accessories for</b>	105054		
	<b>GEV No.</b>	105058	<b>Ref. No.</b>
			00001940 07991188901
	<b>GEV No.</b>	105059	<b>Ref. No.</b>
			—

			
1			
<b>GEV No.</b>	104271	<b>Ref. No.</b>	00001220 01992238901
<b>description</b>	burner head 1.8kW for burner cap ø 75mm		
<b>For models:</b>	KCP97-VG-A, KCV96, KCV96P, KPP96, KTPP96		
<b>accessories for</b>	104271		
	<b>GEV No.</b>	107372	<b>Ref. No.</b> —
burner lower part 1.8kW for igniter ø 6mm for thermocouple ø 6mm without nozzle for burner cap ø 75mm			
	<b>GEV No.</b>	107373	<b>Ref. No.</b> —
burner cap 1.8kW ø 75mm matt finish			



			
1			
<b>GEV No.</b>	105058	<b>Ref. No.</b>	00001940 07991188901
<b>description</b>	burner head 3kW for igniter ø 6mm for burner cap ø 100mm		
<b>For models:</b>	KCP97-VG-A, KCV96, KCV96P, KPP96, KTPP96		
<b>accessories for</b>	105058		
	<b>GEV No.</b>	105054	<b>Ref. No.</b> 07991196610
burner cap 3kW ø 100mm H 3.5mm bright finish			
	<b>GEV No.</b>	105059	<b>Ref. No.</b> —
burner lower part 3kW for igniter ø 6mm for thermocouple ø 6mm without nozzle for burner cap ø 100mm			
	<b>GEV No.</b>	107374	<b>Ref. No.</b> —
burner cap 3kW ø 100mm H 3.5mm matt finish			

			
1			
<b>GEV No.</b>	104272	<b>Ref. No.</b>	01992228900
<b>description</b>	burner lower part 1.8kW for igniter ø 6mm for thermocouple ø 6mm with nozzle ø0.97mm for burner cap ø 75mm		
<b>For models:</b>	KCP97-VG-A, KCV96, KCV96P, KPP96, KTPP96		

			
1			
<b>GEV No.</b>	105120	<b>Ref. No.</b>	00002080 07991698900
<b>description</b>	burner lower part 3kW for igniter ø 7mm for thermocouple ø 6mm with nozzle ø1.15mm for burner cap ø 100mm		
<b>For models:</b>	KCP97-VG-A, KCV96, KCV96P, KPP96, KTPP96		
<b>accessories for</b>	105120		
	<b>GEV No.</b>	105121	<b>Ref. No.</b> —
burner head 3kW for igniter ø 7.5mm for burner cap ø 100mm			

<b>accessories for</b>	105120		
	<b>GEV No.</b>	105122	<b>Ref. No.</b> —
burner cap 3kW ø 100mm H 6mm matt finish			

<b>2 series - flat skirt version</b>			
			
1			
<b>GEV No.</b>	105993	<b>Ref. No.</b>	00001230 01992246610
<b>description</b>	burner cap 1.8kW ø 75mm bright finish		
<b>For models:</b>	KCP97-VG-A, KCV96, KCV96P, KPP96, KTPP96		

			
1			
<b>GEV No.</b>	105054	<b>Ref. No.</b>	07991196610
<b>description</b>	burner cap 3kW ø 100mm H 3.5mm bright finish		
<b>For models:</b>	KCP97-VG-A, KCV96, KCV96P, KPP96, KTPP96		
<b>accessories for</b>	105054		
	<b>GEV No.</b>	105058	<b>Ref. No.</b> 00001940 07991188901
burner head 3kW for igniter ø 6mm for burner cap ø 100mm			
	<b>GEV No.</b>	105059	<b>Ref. No.</b> —
burner lower part 3kW for igniter ø 6mm for thermocouple ø 6mm without nozzle for burner cap ø 100mm			





			
1			
<b>GEV No.</b>	104272	<b>Ref. No.</b>	01992228900
<b>description</b>	burner lower part 1.8kW for igniter ø 6mm for thermocouple ø 6mm with nozzle ø0.97mm for burner cap ø 75mm		
<b>For models:</b>	KCP97-VG-A, KCV96, KCV96P, KPP96, KTPP96		



			
1			
<b>GEV No.</b>	105120	<b>Ref. No.</b>	00002080 07991698900
<b>description</b>	burner lower part 3kW for igniter ø 7mm for thermocouple ø 6mm with nozzle ø1.15mm for burner cap ø 100mm		
<b>For models:</b>	KCP97-VG-A, KCV96, KCV96P, KPP96, KTPP96		
<b>accessories for</b>	105120		
	<b>GEV No.</b>	105121	<b>Ref. No.</b> —
burner head 3kW for igniter ø 7.5mm for burner cap ø 100mm			
	<b>GEV No.</b>	105122	<b>Ref. No.</b> —
burner cap 3kW ø 100mm H 6mm matt finish			



triple ring burner series - standard version			
			
1			
<b>GEV No.</b>	105063	<b>Ref. No.</b>	07991116610
<b>description</b>	burner cap 3.6kW ø 131mm H 4mm mounting pos. outer		
<b>For models:</b>	KCP97-VG-A, KCV96, KCV96P, KPP96, KTPP96		
<b>accessories for</b>	105063		
	<b>GEV No.</b>	105064	<b>Ref. No.</b> 07991126610
	burner cap 3.6kW ø 61mm H 6.5mm mounting pos. inner bright finish		
	<b>GEV No.</b>	105065	<b>Ref. No.</b> 01993448901
	burner head 3.6kW for burner cap ø 61/131mm		
	<b>GEV No.</b>	105717	<b>Ref. No.</b> 01992398900
	burner lower part 3.6kW for igniter ø 6mm for thermocouple ø 6mm with nozzle ø1.35mm ID ø 64mm for burner cap ø 61/131mm		
	<b>GEV No.</b>	105922	<b>Ref. No.</b> —
	burner lower part 3.6kW for igniter ø 6mm for thermocouple ø 6mm with nozzle ø1.35mm ID ø 75mm for burner cap ø 61/131mm		

			
1			
<b>GEV No.</b>	105064	<b>Ref. No.</b>	07991126610
<b>description</b>	burner cap 3.6kW ø 61mm H 6.5mm mounting pos. inner bright finish		
<b>For models:</b>	KCP97-VG-A, KCV96, KCV96P, KPP96, KTPP96		
<b>accessories for</b>	105064		
	<b>GEV No.</b>	105063	<b>Ref. No.</b> 07991116610
	burner cap 3.6kW ø 131mm H 4mm mounting pos. outer		
	<b>GEV No.</b>	105065	<b>Ref. No.</b> 01993448901
	burner head 3.6kW for burner cap ø 61/131mm		
	<b>GEV No.</b>	105717	<b>Ref. No.</b> 01992398900
	burner lower part 3.6kW for igniter ø 6mm for thermocouple ø 6mm with nozzle ø1.35mm ID ø 64mm for burner cap ø 61/131mm		
	<b>GEV No.</b>	105922	<b>Ref. No.</b> —
	burner lower part 3.6kW for igniter ø 6mm for thermocouple ø 6mm with nozzle ø1.35mm ID ø 75mm for burner cap ø 61/131mm		

			
1			
<b>GEV No.</b>	105065	<b>Ref. No.</b>	01993448901
<b>description</b>	burner head 3.6kW for burner cap ø 61/131mm		
<b>accessories for</b>	105065		
	<b>GEV No.</b>	105063	<b>Ref. No.</b> 07991116610
	burner cap 3.6kW ø 131mm H 4mm mounting pos. outer		
	<b>GEV No.</b>	105064	<b>Ref. No.</b> 07991126610
	burner cap 3.6kW ø 61mm H 6.5mm mounting pos. inner bright finish		
	<b>GEV No.</b>	105717	<b>Ref. No.</b> 01992398900
	burner lower part 3.6kW for igniter ø 6mm for thermocouple ø 6mm with nozzle ø1.35mm ID ø 64mm for burner cap ø 61/131mm		

			
1			
<b>GEV No.</b>	105717	<b>Ref. No.</b>	01992398900
<b>description</b>	burner lower part 3.6kW for igniter ø 6mm for thermocouple ø 6mm with nozzle ø1.35mm ID ø 64mm for burner cap ø 61/131mm		
<b>For models:</b>	KCP97-VG-A, KCV96, KCV96P, KPP96, KTPP96		
<b>accessories for</b>	105717		
	<b>GEV No.</b>	101277	<b>Ref. No.</b> 01991738700
	olive ID ø 8mm Qty 1 pcs		
	<b>GEV No.</b>	101477	<b>Ref. No.</b> —
	union screw thread M13x1 tube ø 8mm Qty 1 pcs		

			
1			
<b>GEV No.</b>	104273	<b>Ref. No.</b>	01000170 01981558000
<b>description</b>	gasket for burner cap ø 61/131mm		
<b>For models:</b>	KCP97-VG-A, KCV96, KCV96P, KPP96, KTPP96		

triple ring burner series - flat skirt version			
			
1			
<b>GEV No.</b>	105063	<b>Ref. No.</b>	07991116610
<b>description</b>	burner cap 3.6kW ø 131mm H 4mm mounting pos. outer		
<b>For models:</b>	KCP97-VG-A, KCV96, KCV96P, KPP96, KTPP96		
<b>accessories for</b>	105063		
	<b>GEV No.</b>	105064	<b>Ref. No.</b> 07991126610
	burner cap 3.6kW ø 61mm H 6.5mm mounting pos. inner bright finish		
	<b>GEV No.</b>	105065	<b>Ref. No.</b> 01993448901
	burner head 3.6kW for burner cap ø 61/131mm		
	<b>GEV No.</b>	105717	<b>Ref. No.</b> 01992398900
	burner lower part 3.6kW for igniter ø 6mm for thermocouple ø 6mm with nozzle ø1.35mm ID ø 64mm for burner cap ø 61/131mm		
	<b>GEV No.</b>	105922	<b>Ref. No.</b> —
	burner lower part 3.6kW for igniter ø 6mm for thermocouple ø 6mm with nozzle ø1.35mm ID ø 75mm for burner cap ø 61/131mm		







			
1			
<b>GEV No.</b>	105064	<b>Ref. No.</b>	07991126610
<b>description</b>	burner cap 3.6kW ø 61mm H 6.5mm mounting pos. inner bright finish		
<b>For models:</b>	KCP97-VG-A, KCV96, KCV96P, KPP96, KTPP96		
<b>accessories for</b>	105064		
	<b>GEV No.</b>	105063	<b>Ref. No.</b> 07991116610
	burner cap 3.6kW ø 131mm H 4mm mounting pos. outer		

Table continues overleaf

<b>accessories for</b>	105064		
	<b>GEV No.</b>	105065	<b>Ref. No.</b> 01993448901
	burner head 3.6kW for burner cap ø 61/131mm		
	<b>GEV No.</b>	105717	<b>Ref. No.</b> 01992398900
	burner lower part 3.6kW for igniter ø 6mm for thermocouple ø 6mm with nozzle ø 1.35mm ID ø 64mm for burner cap ø 61/131mm		
	<b>GEV No.</b>	105922	<b>Ref. No.</b> —
	burner lower part 3.6kW for igniter ø 6mm for thermocouple ø 6mm with nozzle ø 1.35mm ID ø 75mm for burner cap ø 61/131mm		

	1		
<b>GEV No.</b>	105717	<b>Ref. No.</b>	01992398900
<b>description</b>	burner lower part 3.6kW for igniter ø 6mm for thermocouple ø 6mm with nozzle ø 1.35mm ID ø 64mm for burner cap ø 61/131mm		
<b>For models:</b>	KCP97-VG-A, KCV96, KCV96P, KPP96, KTPP96		
<b>accessories for</b>	105717		
	<b>GEV No.</b>	101277	<b>Ref. No.</b> 01991738700
	olive ID ø 8mm Qty 1 pcs		
	<b>GEV No.</b>	101477	<b>Ref. No.</b> —
	union screw thread M13x1 tube ø 8mm Qty 1 pcs		

	1		
<b>GEV No.</b>	104273	<b>Ref. No.</b>	01000170 01981558000
<b>description</b>	gasket for burner cap ø 61/131mm		
<b>For models:</b>	KCP97-VG-A, KCV96, KCV96P, KPP96, KTPP96		

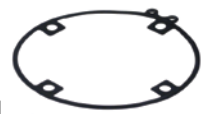
producer-specific hob burners  
TECNOEKA

900 series

	1		
<b>GEV No.</b>	105703	<b>Ref. No.</b>	01991778700
<b>description</b>	air mixing tube for burner UR		
<b>For models:</b>	CV5-90/X, KC96V		

	1		
<b>GEV No.</b>	105887	<b>Ref. No.</b>	01980838700
<b>description</b>	burner 3.1kW complete		

	1		
<b>GEV No.</b>	105886	<b>Ref. No.</b>	01980818700
<b>description</b>	burner 3.6kW complete		

	1		
<b>GEV No.</b>	105888	<b>Ref. No.</b>	01980828700 01982228700
<b>description</b>	burner R 2.7kW complete ball port ø 1.19mm		

	1		
<b>GEV No.</b>	105489	<b>Ref. No.</b>	01982218700
<b>description</b>	burner SR 3.1kW complete		

	1		
<b>GEV No.</b>	105702	<b>Ref. No.</b>	01991818700
<b>description</b>	burner cap mounting pos. inner type UR		
<b>For models:</b>	CV5-90/X, KC96V		

	1		
<b>GEV No.</b>	105631	<b>Ref. No.</b>	01991808700
<b>description</b>	burner cap mounting pos. outer type UR		
<b>For models:</b>	CV5-90/X, KC96V		

	1		
<b>GEV No.</b>	105623	<b>Ref. No.</b>	01991958700
<b>description</b>	burner cap R 2.7kW		
<b>For models:</b>	CV5-90/X, KC96V		

	1		
<b>GEV No.</b>	105621	<b>Ref. No.</b>	01991968700
<b>description</b>	burner cap SR ø 67mm 3.1kW		
<b>For models:</b>	CV5-90/X, KC96V		





 <p>1</p>			
<b>GEV No.</b>	105633	<b>Ref. No.</b>	01991788900
<b>description</b>	burner head 3.6kW type UR		
<b>For models:</b>	CV5-90/X, KC96V		

 <p>1</p>			
<b>GEV No.</b>	105624	<b>Ref. No.</b>	01991938900
<b>description</b>	burner head R 2.7kW		
<b>For models:</b>	CV5-90/X, KC96V		

 <p>1</p>			
<b>GEV No.</b>	105622	<b>Ref. No.</b>	01991978900
<b>description</b>	burner head SR 3.1kW		
<b>For models:</b>	CV5-90/X, KC96V		

 <p>1</p>			
<b>GEV No.</b>	105626	<b>Ref. No.</b>	01991878700
<b>description</b>	burner lower part for burner R, SR		

 <p>1</p>			
<b>GEV No.</b>	105632	<b>Ref. No.</b>	01991798700
<b>description</b>	burner ring 3.6kW type UR		
<b>For models:</b>	CV5-90/X, KC96V		

 <p>1</p>			
<b>GEV No.</b>	105630	<b>Ref. No.</b>	01991928900
<b>description</b>	mounting flange mounting pos. outer for burner UR		
<b>For models:</b>	CV5-90/X, KC96V		

 <p>1</p>			
<b>GEV No.</b>	105628	<b>Ref. No.</b>	01991858700
<b>description</b>	nozzle holder for burner R, SR		
<b>For models:</b>	CV5-90/X, KC96V		

 <p>1</p>			
<b>GEV No.</b>	105634	<b>Ref. No.</b>	01991768900
<b>description</b>	nozzle holder for burner UR		
<b>For models:</b>	CV5-90/X, KC96V		

 <p>1</p>			
<b>GEV No.</b>	105625	<b>Ref. No.</b>	01991918700
<b>description</b>	nut for burner R, SR		
<b>For models:</b>	CV5-90/X, KC96V		

 <p>1</p>			
<b>GEV No.</b>	105629	<b>Ref. No.</b>	01992028700
<b>description</b>	nut for nozzle holder R, SR		
<b>For models:</b>	CV5-90/X, KC96V		



 <p>1</p>			
<b>GEV No.</b>	532454	<b>Ref. No.</b>	01991948000
<b>description</b>	O-ring silicone thickness 3.53mm ID ø 101.2mm Qty 1 pcs		
<b>For models:</b>	CV5-90/X, KC96V		

 <p>1</p>			
<b>GEV No.</b>	532455	<b>Ref. No.</b>	01991988000
<b>description</b>	O-ring silicone thickness 3.53mm ID ø 78.97mm Qty 1 pcs		
<b>For models:</b>	CV5-90/X, KC96V		

 <p>1</p>			
<b>GEV No.</b>	532456	<b>Ref. No.</b>	01991898000
<b>description</b>	O-ring Viton thickness 2mm ID ø 16mm Qty 1 pcs		
<b>For models:</b>	CV5-90/X, KC96V		

 <p>1</p>			
<b>GEV No.</b>	105627	<b>Ref. No.</b>	01991888900
<b>description</b>	venturi for burner R, SR		
<b>For models:</b>	CV5-90/X, KC96V		

miscellaneous

 <p>1</p>			
<b>GEV No.</b>	104271	<b>Ref. No.</b>	00001220 01992238901
<b>description</b>	burner head 1.8kW for burner cap ø 75mm		
<b>For models:</b>	KCP97-VG-A, KCV96, KCV96P, KPP96, KTPP96		
<b>accessories for</b>	104271		
 <p>GEV No. 107372 Ref. No. —</p> <p>burner lower part 1.8kW for igniter ø 6mm for thermocouple ø 6mm without nozzle for burner cap ø 75mm</p>			
 <p>GEV No. 107373 Ref. No. —</p> <p>burner cap 1.8kW ø 75mm matt finish</p>			

 <p>1</p>			
<b>GEV No.</b>	104272	<b>Ref. No.</b>	01992228900
<b>description</b>	burner lower part 1.8kW for igniter ø 6mm for thermocouple ø 6mm with nozzle ø0.97mm for burner cap ø 75mm		
<b>For models:</b>	KCP97-VG-A, KCV96, KCV96P, KPP96, KTPP96		

pan supports

 <p>1</p>			
<b>GEV No.</b>	210203	<b>Ref. No.</b>	01960796610 30500010
<b>description</b>	pan support W 220mm L 530mm		
<b>For models:</b>	CV5-90/X, KC96V, KCP97-VG-A, KCV96, KCV96P, KPP96, KTPP96		

 <p>1</p>			
<b>GEV No.</b>	210204	<b>Ref. No.</b>	01960806610 30500020
<b>description</b>	pan support W 290mm L 520mm		
<b>For models:</b>	CV5-90/X, KC96V, KCP97-VG-A, KCV96, KCV96P, KPP96, KTPP96		

accessories

pan supports

 <p>1</p>			
<b>GEV No.</b>	210203	<b>Ref. No.</b>	01960796610 30500010
<b>description</b>	pan support W 220mm L 530mm		
<b>For models:</b>	CV5-90/X, KC96V, KCP97-VG-A, KCV96, KCV96P, KPP96, KTPP96		

 <p>1</p>			
<b>GEV No.</b>	210204	<b>Ref. No.</b>	01960806610 30500020
<b>description</b>	pan support W 290mm L 520mm		
<b>For models:</b>	CV5-90/X, KC96V, KCP97-VG-A, KCV96, KCV96P, KPP96, KTPP96		

bar burners

 <p>1</p>			
<b>GEV No.</b>	105635	<b>Ref. No.</b>	11980137915
<b>description</b>	bar burner angled L 740mm W 355mm ømm Hmm convection oven		
<b>For models:</b>	900 G, KCP97-VG-A, KF1001G, KF1001G-IX-AL, KF1001G-LPG, KF1001G-LPG-IX-AL		

accessories

nozzle holders

 <p>1</p>			
<b>GEV No.</b>	105628	<b>Ref. No.</b>	01991858700
<b>description</b>	nozzle holder for burner R, SR		
<b>For models:</b>	CV5-90/X, KC96V		



miscellaneous			
			
1			
<b>GEV No.</b>	105703	<b>Ref. No.</b>	01991778700
<b>description</b>	air mixing tube for burner UR		
<b>For models:</b>	CV5-90/X, KC96V		

			
1			
<b>GEV No.</b>	105704	<b>Ref. No.</b>	01951057720
<b>description</b>	compression spring L 14.5mm ø 9mm wire gauge ø 0.9mm		
<b>For models:</b>	CV5-90/X, KC96V		

			
1			
<b>GEV No.</b>	105625	<b>Ref. No.</b>	01991918700
<b>description</b>	nut for burner R, SR		
<b>For models:</b>	CV5-90/X, KC96V		

			
1			
<b>GEV No.</b>	105629	<b>Ref. No.</b>	01992028700
<b>description</b>	nut for nozzle holder R, SR		
<b>For models:</b>	CV5-90/X, KC96V		

## gas nozzles

### main nozzles



gas nozzles M6x0.75			
			
1			
<b>GEV No.</b>	106481	<b>Ref. No.</b>	00001960
<b>description</b>	gas injector thread M6x0.75 WS 7 bore ø 0.95mm		

gas nozzles M8x1			
			
1			
<b>GEV No.</b>	102694	<b>Ref. No.</b>	00000920 01991848700
<b>description</b>	gas injector thread M8x1 WS 10 bore ø 0.9mm		
<b>For models:</b>	CV5-90/X, KC96V		

			
1			
<b>GEV No.</b>	102693	<b>Ref. No.</b>	01991758700
<b>description</b>	gas injector thread M8x1 WS 10 bore ø 1.4mm gas pressure 20mbar		
<b>For models:</b>	CV5-90/X, KC96V		

## auxiliary gas parts

### screw connections

union nuts			
			
1			
<b>GEV No.</b>	101296	<b>Ref. No.</b>	01991748612
<b>description</b>	union nut thread M12x1 for pipe ø 8mm		
<b>For models:</b>	CV5-90/X, KC96V		
<b>accessories for</b>	101296		
		<b>GEV No.</b>	101277
		<b>Ref. No.</b>	01991738700
	olive ID ø 8mm Qty 1 pcs		

## equipment-specific units

### for convection ovens/combi-steamers

			
1			
<b>GEV No.</b>	692843	<b>Ref. No.</b>	00004380 09980728000
<b>description</b>	spacer bush ID ø 7mm H 7.5mm ED ø 17.5mm for glass plate white Spacer		
<b>For models:</b>	EKF311DUD, EKF311UD, EKF364DUD, EKF364UD, EKF411, EKF411.3D, EKF411.3GRILL, EKF411D, EKF411DUD, EKF411UD, EKF416DUD, EKF416UD, EKF423, EKF423AL, EKF423ALM, EKF423ALP, EKF423ALU, EKF423ALUD, EKF423ALUP, EKF423DALUD, EKF423DUD, EKF423M, EKF423P, EKF423U, EKF423UD, EKF423UP, EKF443DUD, EKF464, EKF464.3D, EKF464.3GRILL, EKF464ALP, EKF464D, EKF464DUD, EKF464P, EKF464UD, KC96V, KCV96, KCV96P, KF1001G, KF1001G-IX-AL, KF1001G-LPG, KF1001G-LPG-IX-AL, KF1010GE-UD, KF630, KF733, KF912, KF912IX, KF933, KF933AL-U, KF933U...(Other models you can see in the webshop)		

flow controllers



<b>GEV No.</b>	101752	<b>Ref. No.</b>	00004390 09980758900
<b>description</b>	flow controller for hot air oven		
<b>For models:</b>	900, 900 G, 930, 938.3		

glass panels



<b>GEV No.</b>	693226	<b>Ref. No.</b>	01400400 09980438300
<b>description</b>	glass panel L 340mm W 280mm rectangular		
<b>For models:</b>	440, KF412, KF412U		

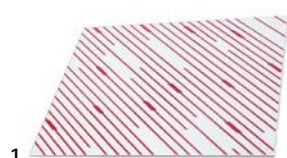

<b>GEV No.</b>	693227	<b>Ref. No.</b>	09980448316
<b>description</b>	glass panel L 340mm W 280mm thickness 4mm rectangular		
<b>For models:</b>	440		



<b>GEV No.</b>	693230	<b>Ref. No.</b>	01400020 01981248300
<b>description</b>	glass panel L 430mm W 345mm thickness 4mm rectangular		
<b>For models:</b>	440, 640 CI, 640 CI+GRILL, 640 CI+U, 648 CI, 723KFM, EKF620S, EKF620US, KF723, KF723M, TCFG		



<b>GEV No.</b>	692841	<b>Ref. No.</b>	21100870 SP007952204
<b>description</b>	glass panel L 447mm mounting pos. inner W 585mm		
<b>accessories for</b>	692841		



<b>GEV No.</b>	692842	<b>Ref. No.</b>	21100880 SP007952206
<b>description</b>	glass panel L 450mm mounting pos. outer W 590mm		



<b>GEV No.</b>	692843	<b>Ref. No.</b>	00004380 09980728000
<b>description</b>	spacer bush ID ø 7mm H 7.5mm ED ø 17.5mm for glass plate white Spacer		



<b>GEV No.</b>	692842	<b>Ref. No.</b>	21100880 SP007952206
<b>description</b>	glass panel L 450mm mounting pos. outer W 590mm		
<b>accessories for</b>	692842		



<b>GEV No.</b>	692841	<b>Ref. No.</b>	21100870 SP007952204
<b>description</b>	glass panel L 447mm mounting pos. inner W 585mm		



<b>GEV No.</b>	692843	<b>Ref. No.</b>	00004380 09980728000
<b>description</b>	spacer bush ID ø 7mm H 7.5mm ED ø 17.5mm for glass plate white Spacer		



<b>GEV No.</b>	694993	<b>Ref. No.</b>	00011680 11680
<b>description</b>	door handle ø 18mm L 350mm stainless steel M5 black matt		



<b>GEV No.</b>	693231	<b>Ref. No.</b>	09980578418
<b>description</b>	glass panel L 520mm W 280mm thickness 4mm rectangular		
<b>For models:</b>	440, 640 CI, 640 CI+GRILL, 640 CI+U, 648 CI		



<b>GEV No.</b>	691811	<b>Ref. No.</b>	09982338418 21000250
<b>description</b>	glass panel L 583mm W 450mm mounting pos. outer		
<b>For models:</b>	KF723, KF723M		

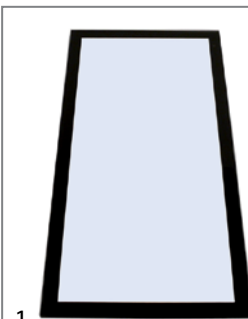

<b>GEV No.</b>	693224	<b>Ref. No.</b>	01400430 09980648418
<b>description</b>	glass panel L 645mm W 315mm thickness 5mm rectangular		
<b>For models:</b>	900, 900 G, 930, 938, 938.3, CV5-90/X, KC96V, KCV96, KCV96P		





			
1			
<b>GEV No.</b>	694454	<b>Ref. No.</b>	09981219002 09981498418 21000170
<b>description</b>	glass panel L 770mm W 455mm thickness 4mm with frame		
<b>For models:</b>	KCV96, KCV96P		

Fans - accessories

			
1			
<b>GEV No.</b>	701630	<b>Ref. No.</b>	00012330
<b>description</b>	air duct for cross flow fan for combi-steamer plastic grey		
<b>For models:</b>	EKF1016EUD, EKF1016UD, EKF1064EUD, EKF1064UD, EKF1111EUD, EKF1111EVUD, EKF1111UD, EKF311DUD, EKF311UD, EKF364DUD, EKF364UD, EKF411, EKF411.3D, EKF411.3GRILL, EKF411ALUD, EKF411D, EKF411DALUD, EKF411DUD, EKF411UD, EKF416ALUD, EKF416DALUD, EKF416DUD, EKF416UD, EKF423, EKF423AL, EKF423ALM, EKF423ALU, EKF423ALUD, EKF423DALUD, EKF423DUD, EKF423M, EKF423U, EKF423UD, EKF443DUD, EKF464, EKF464.3D, EKF464.3GRILL, EKF464ALP, EKF464ALUD, EKF464D, EKF464DALUD, EKF464DUD, EKF464P, EKF464UD, EKF523EUD, EKF523UD, EKF616EUD, EKF616UD, EKF664.3EUD, EKF664EUD...(Other models you can see in the webshop)		

doors

			
1			
<b>GEV No.</b>	699174	<b>Ref. No.</b>	21004930 21100350 S0902897
<b>description</b>	door glass L 720mm W 480mm H 70mm		
<b>For models:</b>	EKF411, EKF411.3D, EKF411.3GRILL, EKF411D, EKF411DUD, EKF411UD, EKF416DUD, EKF416UD, EKF464, EKF464.3D, EKF464.3GRILL, EKF464D, EKF464DUD, EKF464P, EKF464UD		

knobs

producer-specific knobs

			
1			
<b>GEV No.</b>	111586	<b>Ref. No.</b>	00002780 09960028500
<b>description</b>	knob switch zero mark ø 43mm shaft ø 6x4.6mm shaft flat lower black		
<b>For models:</b>	440, 640 CI, 640 CI+GRILL, 640 CI+U, 648 CI, 900, 938.3, EKF1016UD, EKF1064UD, EKF1111UD, EKF523UD, EKF616UD, EKF664P, EKF664UD, EKF711UD, KF412, KF412U, KF630, KF723, KF723M, KF912, KF912IX, KF965, KF965AL-UD, KF965M, KF981, KF981-DOUBLE, KF981-DOUBLE-EV-UD, KF981-DOUBLE-EV-UI, KF981-DOUBLE-UD, KF981-DOUBLE-V-UD, KF981-DOUBLE-V-UI, KF981UD		

			
1			
<b>GEV No.</b>	111587	<b>Ref. No.</b>	09960018500
<b>description</b>	knob switch zero mark ø 43mm shaft ø 6x4.6mm shaft flat right black		
<b>For models:</b>	440, 640 CI, 640 CI+GRILL, 640 CI+U, 648 CI, 930, KF412, KF412U, KF620, KF622, KF723, KF733, KF933, KF933AL, KF933AL-U, KF933U, KF937, KF981-DOUBLE-V, KF981-DOUBLE-V-UD, KF981-DOUBLE-V-UI, KF981V		

			
1			
<b>GEV No.</b>	111585	<b>Ref. No.</b>	00000190 01960778504
<b>description</b>	knob switch zero mark ø 48mm shaft ø 6x4.6mm shaft flat upper blue/black		
<b>For models:</b>	CV5-90/X, KC96V, KF1001G, KF1001G-IX-AL, KF1001G-LPG, KF1001G-LPG-IX-AL		

			
1			
<b>GEV No.</b>	699164	<b>Ref. No.</b>	00006170
<b>description</b>	knob zero mark ø 40mm shaft ø 6x4.6mm shaft flat upper		
<b>For models:</b>	EKF1016EUD, EKF1064EUD, EKF1111EUD, EKF1111EVUD, EKF523EUD, EKF616EUD, EKF664.3EUD, EKF664EUD, EKF711.3EUD, EKF711EUD, EKF711EV		



<b>GEV No.</b>	699162	<b>Ref. No.</b>	00002770
<b>description</b>	knob zero mark ø 42.5mm shaft flat left black		
<b>For models:</b>	EKF311UD, EKF364UD, EKF411, EKF411.3GRILL, EKF411ALUD, EKF411UD, EKF412US, EKF416ALUD, EKF416UD, EKF423, EKF423AL, EKF423ALM, EKF423ALP, EKF423ALU, EKF423ALUD, EKF423ALUP, EKF423M, EKF423P, EKF423U, EKF423UD, EKF423UP, EKF464, EKF464.3GRILL, EKF464ALP, EKF464ALUD, EKF464P, EKF464UD, EKF620S, EKF620US		



<b>GEV No.</b>	111809	<b>Ref. No.</b>	00003030 09961258504
<b>description</b>	knob zero mark ø 48mm shaft ø 6x4.6mm silver/black		

## handles and hand wheels

### handle bars

#### producer-specific handle rails

#### TECNOEKA



<b>GEV No.</b>	694993	<b>Ref. No.</b>	00011680
<b>description</b>	door handle ø 18mm L 350mm stainless steel M5 black matt		
<b>For models:</b>	EKF311DUD, EKF311UD, EKF364DUD, EKF364UD, EKF411, EKF411.3D, EKF411.3GRILL, EKF411D, EKF423, EKF423AL, EKF423ALM, EKF423ALP, EKF423ALU, EKF423ALUD, EKF423ALUP, EKF423DALUD, EKF423DUD, EKF423M, EKF423P, EKF423U, EKF423UD, EKF423UP, EKF464, EKF464.3D, EKF464.3GRILL, EKF464ALP, EKF464D, EKF464P		

### bracket handles



<b>GEV No.</b>	693229	<b>Ref. No.</b>	00002800 09960099002
<b>description</b>	pull handle L 296mm H 45mm mounting distance 280mm		
<b>For models:</b>	440, KF412, KF412U		



<b>GEV No.</b>	693225	<b>Ref. No.</b>	00002820 09960209002
<b>description</b>	pull handle L 515mm H 43mm mounting distance 497mm		
<b>For models:</b>	440, 640 CI, 640 CI+GRILL, 640 CI+U, 648 CI, 900, 900 G, 930, 938, 938.3, CV5-90/X, KC96V, KCV96, KCV96P, KF630, KF723M, KF733, KF912, KF912IX, KF933, KF933U, KF937, KF965, KF965M, KL823, TCFG		

## locks

### handle latches

#### universal

#### inside fixing

#### locks



<b>GEV No.</b>	694054	<b>Ref. No.</b>	00006390 11961668500	
<b>description</b>	door handle for headed units L 145mm W 40mm H 62mm spring length 33mm inner black			
<b>For models:</b>	EKF411ALUD, EKF411DALUD, EKF416ALUD, EKF416DALUD, EKF464ALUD, EKF464DALUD, EKF523EUD, EKF523UD, KF1001G-IX-AL, KF1001G-LPG-IX-AL, KF933AL, KF933AL-U, KF965AL-UD			
<b>spare parts for</b>	694054			
	<b>GEV No.</b>	514390	<b>Ref. No.</b>	—
	spring for door handle ø 6mm L 54mm W 27.5mm			
	<b>GEV No.</b>	694675	<b>Ref. No.</b>	—
	door catch L 88mm W 40mm H 37mm spring length 33mm mounting distance 60mm			
	<b>GEV No.</b>	694734	<b>Ref. No.</b>	—
	door handle L 165mm W 40mm H 25mm black			
	<b>GEV No.</b>	694735	<b>Ref. No.</b>	—
	cap ø 32mm black			
<b>accessories for</b>	694054			
	<b>GEV No.</b>	691123	<b>Ref. No.</b>	—
	duct for door opener			
	<b>GEV No.</b>	694055	<b>Ref. No.</b>	—
	door catch L 25mm W 14mm total length 54mm thread M8 thread L 29mm			
	<b>GEV No.</b>	694066	<b>Ref. No.</b>	—
	door catch with spigot 2-stage L 28mm W 14mm H 15mm H1 16mm total length 51mm thread M8 thread L 23mm stainless steel			
	<b>GEV No.</b>	694067	<b>Ref. No.</b>	—
	door catch with spigot 1-stage L 26mm total length 51mm thread M8			



 <p>1</p>			
<b>GEV No.</b>	694234	<b>Ref. No.</b>	00006090 11960928500
<b>description</b>	door handle for headed units L 145mm W 40mm H 62mm spring length 40mm inner black		
<b>For models:</b>	EKF464TC, EKF511TC, EKF616EUD, EKF616UD, EKF664EUD, EKF664P, EKF664UD, EKF711EUD, EKF711EV, EKF711UD, KF981, KF981-DOUBLE, KF981-DOUBLE-EV, KF981-DOUBLE-EV-UD, KF981-DOUBLE-EV-UI, KF981-DOUBLE-UD, KF981-DOUBLE-V, KF981-DOUBLE-V-UD, KF981-DOUBLE-V-UI, KF981EV, KF981UD, KF981V		
<b>spare parts for</b>	694234		
		<b>GEV No.</b>	514450 <b>Ref. No.</b> —
	spring for door handle ø 6mm L 61mm W 27.5mm		
		<b>GEV No.</b>	694734 <b>Ref. No.</b> —
	door handle L 165mm W 40mm H 25mm black		
		<b>GEV No.</b>	694735 <b>Ref. No.</b> —
	cap ø 32mm black		

 <p>1</p>			
<b>GEV No.</b>	694882	<b>Ref. No.</b>	00005060 09988098500
<b>description</b>	door handle L 165mm W 40mm H 62mm inner black		
<b>For models:</b>	EKF1016EUD, EKF1016UD, EKF1064EUD, EKF1064TC, EKF1064UD, EKF1111EUD, EKF1111EVUD, EKF1111TC, EKF1111UD, EKF1664TC, EKF2011TC, EKF664.3EUD, EKF664TC, EKF711.3EUD, EKF711TC, KF1010GE-UD		
<b>accessories for</b>	694882		
		<b>GEV No.</b>	694881 <b>Ref. No.</b> 00005050 09988088500
	door catch total length 40mm M8 thread L 23mm W 26mm		

## snap locks

### universal

 <p>1</p>			
<b>GEV No.</b>	700410	<b>Ref. No.</b>	00004310 09980358700
<b>description</b>	snap lock L 57mm W 12mm H 15mm mounting distance 47/12.5mm complete with door catch brass		
<b>For models:</b>	440, EKF412US, KF412, KF412U		

## miscellaneous

 <p>1</p>			
<b>GEV No.</b>	694883	<b>Ref. No.</b>	00010950
<b>description</b>	fixing plate L 100mm W 45mm H 2mm		
<b>For models:</b>	EKF1016EUD, EKF1016UD, EKF1064EUD, EKF1064TC, EKF1064UD, EKF1111EUD, EKF1111EVUD, EKF1111TC, EKF1111UD, EKF1664TC, EKF2011TC, EKF464TC, EKF511TC, EKF616EUD, EKF616UD, EKF664.3EUD, EKF664EUD, EKF664P, EKF664TC, EKF664UD, EKF711.3EUD, EKF711EUD, EKF711EV, EKF711TC, EKF711UD		

 <p>1</p>			
<b>GEV No.</b>	694884	<b>Ref. No.</b>	00011060
<b>description</b>	fixing plate L 100mm W 45mm H 5mm		
<b>For models:</b>	EKF1016EUD, EKF1016UD, EKF1064EUD, EKF1064TC, EKF1064UD, EKF1111EUD, EKF1111EVUD, EKF1111TC, EKF1111UD, EKF1664TC, EKF2011TC, EKF464TC, EKF511TC, EKF616EUD, EKF616UD, EKF664.3EUD, EKF664EUD, EKF664TC, EKF664UD, EKF711.3EUD, EKF711EUD, EKF711EV, EKF711TC, EKF711UD		

 <p>1</p>			
<b>GEV No.</b>	694885	<b>Ref. No.</b>	01502400
<b>description</b>	threaded bush L 17mm W 11mm M8		

## hinges

### oven hinges

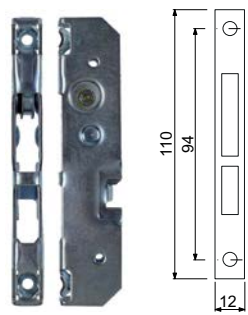
 <p>1</p>			
<b>GEV No.</b>	700003	<b>Ref. No.</b>	00000310 01980059512
<b>description</b>	opposite support L 110mm W 12mm mounting distance 94mm		



<b>GEV No.</b>	701631	<b>Ref. No.</b>	00014600 SP007950923
<b>description</b>	opposite support mounting distance 119mm L 135mm W 12mm		
<b>accessories for</b>	701631		

<b>GEV No.</b>	701573	<b>Ref. No.</b>	00014610 SP007950922
<b>description</b>	oven hinge mounting distance 142mm mounting distance 2mm lug mountingmm lever lengthmm groove distance 12mm spring thickness 3.3mm mounting ear position spring length 116mm L 170mm mounting pos. left/right W 22mm		



<b>GEV No.</b>	700841	<b>Ref. No.</b>	00003170 09964139512
<b>description</b>	opposite support mounting distance 85mm L 107mm W 12.5mm for hinge		
<b>For models:</b>	EKF311DUD, EKF311UD, EKF364DUD, EKF364UD, EKF411, EKF411.3GRILL, EKF411DUD, EKF411UD, EKF416DUD, EKF416UD, EKF423, EKF423DUD, EKF423M, EKF423P, EKF423U, EKF423UD, EKF423UP, EKF443DUD, EKF464, EKF464.3GRILL, EKF464DUD, EKF464P, EKF464UD, KF630		



<b>GEV No.</b>	700707	<b>Ref. No.</b>	01981589512 30304870
<b>description</b>	opposite support mounting distance 94mm L 140mm mounting pos. left W 13mm with welded metal sheet H 110mm for hinge		
<b>For models:</b>	KCP97-VG-A, KCV96, KCV96P		
<b>accessories for</b>	700707		

<b>GEV No.</b>	693045	<b>Ref. No.</b>	—
<b>description</b>	opposite support L 110mm W 12mm mounting distance 94mm		



<b>GEV No.</b>	700434	<b>Ref. No.</b>	01980869512
<b>description</b>	opposite support oven hinge		
<b>For models:</b>	440, 640 CI, 640 CI+GRILL, 640 CI+U, 648 CI, 900, 900 G, 930, 938, 938.3, CV5-90/X, KC96V, KF723, TCFG		



<b>GEV No.</b>	701511	<b>Ref. No.</b>	30304880 + 30304900
<b>description</b>	opposite support set mounting distance 94mm L 140mm mounting pos. left/right H 110mm W 13mm for oven width 60cm for hinge		
<b>accessories for</b>	701511		

<b>GEV No.</b>	693045	<b>Ref. No.</b>	—
<b>description</b>	opposite support L 110mm W 12mm mounting distance 94mm		



<b>GEV No.</b>	701512	<b>Ref. No.</b>	30304870 + 30304880
<b>description</b>	opposite support set mounting distance 94mm L 140mm mounting pos. left/right H 110mm W 13mm for oven width 90cm for hinge		





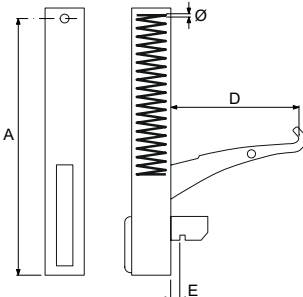

1

<b>GEV No.</b>	690700	<b>Ref. No.</b>	00004360 09980699512
<b>description</b>	oven hinge mounting distance 118mm lug mounting 13mm lever length 119mm groove distance 12mm spring thickness 4mm mounting ear position left/right spring length 60mm L 155mm W 20mm FEP040		
<b>accessories for</b>	690700		
	<b>GEV No.</b>	700003	<b>Ref. No.</b> 00000310 01980059512
opposite support L 110mm W 12mm mounting distance 94mm			



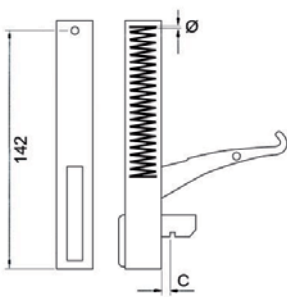

1

<b>GEV No.</b>	700000	<b>Ref. No.</b>	00000350 01980859512
<b>description</b>	oven hinge mounting distance 142mm mounting distance 2mm lug mountingmm lever length 127mm groove distance 10mm spring thickness 3.7mm mounting ear position L 155mm mounting pos. left/right		
<b>For models:</b>	EKF620S, EKF620US, KF723, KF723M, KF733, KF937, TCFG		
<b>accessories for</b>	700000		
	<b>GEV No.</b>	693045	<b>Ref. No.</b> —
opposite support L 110mm W 12mm mounting distance 94mm			
	<b>GEV No.</b>	700707	<b>Ref. No.</b> 01981589512 30304870
opposite support mounting distance 94mm L 140mm mounting pos. left W 13mm with welded metal sheet H 110mm for hinge			





1

<b>GEV No.</b>	700433	<b>Ref. No.</b>	00004440 09981619512
<b>description</b>	oven hinge mounting distance 142mm mounting distance 2mm lug mountingmm lever length 100mm groove distance 14mm spring thickness 4mm mounting ear position spring length 55mm L 155mm mounting pos. left/right		
<b>For models:</b>	900, 900 G, 930, 938, 938.3, CV5-90/X, KC96V, KCP97-VG-A, KCV96, KCV96P, KF1001G, KF1001G-LPG, KF912, KF912IX, KF965, KF965M		
<b>accessories for</b>	700433		
	<b>GEV No.</b>	700434	<b>Ref. No.</b> 01980869512
opposite support oven hinge			



1

<b>GEV No.</b>	701573	<b>Ref. No.</b>	00014610 SP007950922
<b>description</b>	oven hinge mounting distance 142mm mounting distance 2mm lug mountingmm lever lengthmm groove distance 12mm spring thickness 3.3mm mounting ear position spring length 116mm L 170mm mounting pos. left/right W 22mm		
<b>accessories for</b>	701573		
	<b>GEV No.</b>	701631	<b>Ref. No.</b> 00014600 SP007950923
opposite support mounting distance 119mm L 135mm W 12mm			

 <p>1</p>			
<b>GEV No.</b>	701538	<b>Ref. No.</b>	00003180 09964199512
<b>description</b>	oven hinge set mounting distance 155mm mounting distance 2mm lug mountingmm lever length 77mm groove distance 14mm spring thickness 3.5mm mounting ear position spring length 53mm L 165mm mounting pos. left/right W 22mm pair		
<b>For models:</b>	EKF423, EKF423DUD, EKF423M, EKF423P, EKF423U, EKF423UD, EKF423UP, EKF443DUD, KF630		

 <p>2</p>			
<b>GEV No.</b>	701539	<b>Ref. No.</b>	00012580 00013340
<b>description</b>	oven hinge set mounting distance 155mm mounting distance 2mm lug mountingmm lever length 78mm groove distance 12mm spring thickness 3.2mm mounting ear position spring length 53mm L 165mm mounting pos. left/right W 22mm pair		
<b>For models:</b>	EKF311DUD, EKF311UD, EKF364DUD, EKF364UD		

 <p>1</p>			
<b>GEV No.</b>	701537	<b>Ref. No.</b>	00007150 00007510 11982239512
<b>description</b>	oven hinge set pair mounting distance 155mm mounting distance 2mm lug mountingmm lever length 77mm groove distance 14mm spring thickness 4mm mounting ear position spring length 53mm L 165mm mounting pos. left/right W 22mm		
<b>For models:</b>	EKF411, EKF411.3D, EKF411.3GRILL, EKF411D, EKF411DUD, EKF411UD, EKF416DUD, EKF416UD, EKF464, EKF464.3D, EKF464.3GRILL, EKF464D, EKF464DUD, EKF464UD		

door bearing

 <p>1</p>			
<b>GEV No.</b>	700412	<b>Ref. No.</b>	09980309202 30203740
<b>description</b>	hinge bottom left		
<b>For models:</b>	440, KF412, KF412U		

 <p>1</p>			
<b>GEV No.</b>	700411	<b>Ref. No.</b>	09980299202 30203730
<b>description</b>	hinge upper left		
<b>For models:</b>	440, KF412, KF412U		

accessories

<p>bushes</p>  <p>1</p>			
<b>GEV No.</b>	694886	<b>Ref. No.</b>	00006080 11960918700
<b>description</b>	bush ID ø 7mm ED ø 12mm L 10mm		
<b>For models:</b>	EKF411ALUD, EKF411DALUD, EKF416ALUD, EKF416DALUD, EKF423AL, EKF423ALM, EKF423ALP, EKF423ALU, EKF423ALUD, EKF423ALUP, EKF423DALUD, EKF464ALP, EKF464ALUD, EKF464DALUD, EKF523EUD, EKF523UD, KF1001G-IX-AL, KF1001G-LPG-IX-AL, KF933AL, KF933AL-U, KF965AL-UD, KF981, KF981-DOUBLE, KF981-DOUBLE-EV, KF981-DOUBLE-EV-UD, KF981-DOUBLE-EV-UI, KF981-DOUBLE-UD, KF981-DOUBLE-V, KF981-DOUBLE-V-UD, KF981-DOUBLE-V-UI, KF981EV, KF981UD, KF981V		



## equipment feet and end caps

### screw-in feet

 <p>1</p>			
<b>GEV No.</b>	802156	<b>Ref. No.</b>	00002790 09960058500
<b>description</b>	equipment foot thread M10 thread L 20mm ø 60mm H 50mm Qty 1 pcs		
<b>For models:</b>	EKF1016EUD, EKF1016UD, EKF1064EUD, EKF1064TC, EKF1064UD, EKF1111EUD, EKF1111EVUD, EKF1111TC, EKF1111UD, EKF311DUD, EKF311UD, EKF364DUD, EKF364UD, EKF411, EKF411.3D, EKF411.3GRILL, EKF411ALUD, EKF411D, EKF411DALUD, EKF411DUD, EKF411UD, EKF412US, EKF416ALUD, EKF416DALUD, EKF416DUD, EKF416UD, EKF423, EKF423AL, EKF423ALM, EKF423ALP, EKF423ALU, EKF423ALUD, EKF423ALUP, EKF423DALUD, EKF423DUD, EKF423M, EKF423P, EKF423U, EKF423UD, EKF423UP, EKF443DUD, EKF464, EKF464.3D, EKF464.3GRILL, EKF464ALP, EKF464ALUD, EKF464D, EKF464DALUD, EKF464DUD, EKF464P...(Other models you can see in the webshop)		

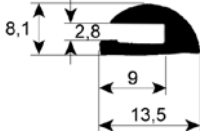
 <p>1</p>			
<b>GEV No.</b>	901272	<b>Ref. No.</b>	01000060
<b>description</b>	window gasket profile 1882 L 1000mm suitable for TECNOEKA Qty 2		

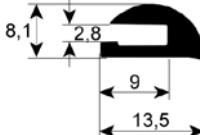
 <p>1</p>			
<b>GEV No.</b>	693228	<b>Ref. No.</b>	09980458000
<b>description</b>	window gasket profile 1882 L 2200mm Qty 1		
<b>For models:</b>	440, KF412, KF412U		

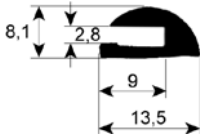
 <p>1</p>			
<b>GEV No.</b>	691202	<b>Ref. No.</b>	09980458000 09989738000
<b>description</b>	window gasket profile 1882 Qty supplied by meter		

## shelves and shelf rails

### grates

 <p>1</p>			
producer-specific			
<b>GEV No.</b>	693930	<b>Ref. No.</b>	01960597915 KG7
<b>description</b>	grate W 435mm D 340mm chrome-plated steel suitable for refrigerator TECNOEKA		
<b>For models:</b>	KF620, KF622, KF723, KF723M, TCFG		

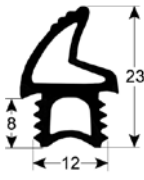
 <p>1</p>			
door seals			
<b>GEV No.</b>	902497	<b>Ref. No.</b>	01000770 SP007260456
<b>description</b>	door seal profile 2764 L 1020mm suitable for TECNOEKA		

## gaskets

### gaskets for heated units

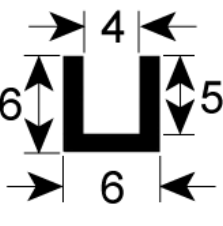
 <p>1</p>			
window seals			
<b>GEV No.</b>	902418	<b>Ref. No.</b>	01000270 09963468000
<b>description</b>	window gasket profile 1595 suitable for TECNOEKA Qty supplied by meter		
<b>For models:</b>	KF1001G, KF1001G-LPG, KF630, KF733, KF912, KF912IX, KF933, KF933U, KF937, KF965, KF965M		

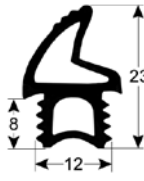
 <p>1</p>			
<b>GEV No.</b>	902496	<b>Ref. No.</b>	01000030 09989708000
<b>description</b>	door seal profile 2764 L 2105mm suitable for TECNOEKA		
<b>For models:</b>	EKF411, EKF411.3D, EKF411.3GRILL, EKF411D, EKF464, EKF464.3D, EKF464.3GRILL, EKF464D		

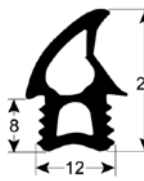
 <p>1</p>			
<b>GEV No.</b>	902495	<b>Ref. No.</b>	01000050 09989728000
<b>description</b>	door seal profile 2765 L 2510mm suitable for TECNOEKA		

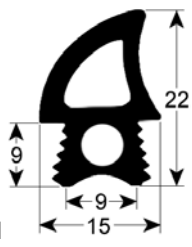

<b>GEV No.</b>	902419	<b>Ref. No.</b>	01000810 09981998000
<b>description</b>	door seal profile 2767 L 1780mm suitable for TECNOEKA		
<b>For models:</b>	EKF423AL, EKF423ALP, EKF423ALUP, EKF423P, EKF423UP		

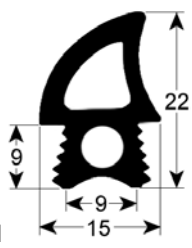

<b>GEV No.</b>	902420	<b>Ref. No.</b>	01000320 09982008000 09985548000
<b>description</b>	door seal profile 2767 L 2100mm suitable for TECNOEKA		
<b>For models:</b>	KF1010GE-UD, KF630, KF965AL-UD, KF981, KF981-DOUBLE, KF981-DOUBLE-EV, KF981-DOUBLE-EV-UD, KF981-DOUBLE-EV-UI, KF981-DOUBLE-UD, KF981-DOUBLE-V, KF981-DOUBLE-V-UD, KF981-DOUBLE-V-UI, KF981EV, KF981UD, KF981V		

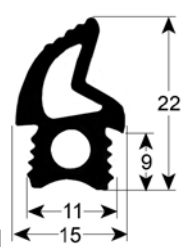

<b>GEV No.</b>	902196	<b>Ref. No.</b>	01000310
<b>description</b>	door seal profile 2769 L 1850mm		
<b>For models:</b>	EKF423, EKF423DUD, EKF423M, EKF423U, EKF423UD, EKF443DUD		

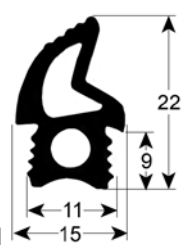

<b>GEV No.</b>	902195	<b>Ref. No.</b>	01000710 01000780
<b>description</b>	door seal profile 2769 L 2140mm		
<b>For models:</b>	EKF411DUD, EKF411UD, EKF416DUD, EKF416UD, EKF464DUD, EKF464UD		

### door seals with fixing hook



<b>GEV No.</b>	900394	<b>Ref. No.</b>	01000370 01000371 09981148000 09988078000
<b>description</b>	oven gasket L 370mm W 640mm 6 hooks external size		
<b>For models:</b>	900, 900 G, 930, 938.3, CV5-90/X, KC96V, KCP97-VG-A, KCV96, KCV96P, KF1001G, KF1001G-IX-AL, KF1001G-LPG, KF1001G-LPG-IX-AL, KF912, KF912IX, KF933, KF933AL, KF933AL-U, KF933U, KF965, KF965M		



<b>GEV No.</b>	900396	<b>Ref. No.</b>	01000390 09980748000 09988928000
<b>description</b>	oven gasket L 440mm W 370mm external size		
<b>For models:</b>	640 CI, 640 CI+GRILL, 640 CI+U, 648 CI, EKF620S, EKF620US, KF620, KF622, KF723, KF723M, TCFG		

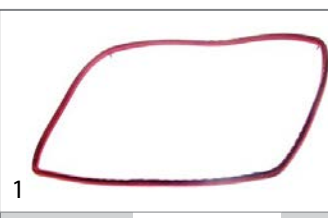

<b>GEV No.</b>	900395	<b>Ref. No.</b>	01000290 01000380 09980288000 09988848000
<b>description</b>	oven gasket W 320mm with 4 mounting clips H 260mm		
<b>For models:</b>	440, EKF412US, KF412, KF412U		

### door gaskets (wire reinforced)



<b>GEV No.</b>	693232	<b>Ref. No.</b>	01000300 09980928000
<b>description</b>	oven gasket wire reinforced L 425mm W 350mm		
<b>For models:</b>	440, 640 CI, 640 CI+GRILL, 640 CI+U, 648 CI, EKF620S, EKF620US, KF723, KF723M, TCFG		





## O-rings

### EPDM



<b>GEV No.</b>	510955	<b>Ref. No.</b>	00002001
<b>description</b>	O-ring EPDM thickness 3mm ID ø 6mm Qty 1 pcs		
<b>For models:</b>	EKF1016EUD, EKF1016UD, EKF1064EUD, EKF1064UD, EKF1111EUD, EKF1111EVUD, EKF1111UD, EKF311UD, EKF364UD, EKF411, EKF411.3GRILL, EKF411ALUD, EKF411UD, EKF412US, EKF416ALUD, EKF416UD, EKF423, EKF423AL, EKF423ALM, EKF423ALU, EKF423ALUD, EKF423M, EKF423U, EKF423UD, EKF464, EKF464.3GRILL, EKF464ALP, EKF464ALUD, EKF464P, EKF464UD, EKF523EUD, EKF523UD, EKF523UD, EKF616EUD, EKF616UD, EKF664.3EUD, EKF664EUD, EKF664P, EKF664UD, EKF711.3EUD, EKF711EUD, EKF711EV, EKF711UD		

### silicone

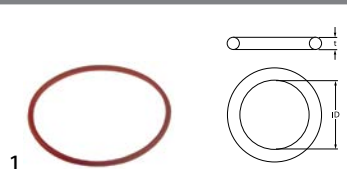

<b>GEV No.</b>	532454	<b>Ref. No.</b>	01991948000
<b>description</b>	O-ring silicone thickness 3.53mm ID ø 101.2mm Qty 1 pcs		
<b>For models:</b>	CV5-90/X, KC96V		

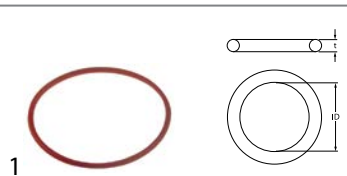

<b>GEV No.</b>	532455	<b>Ref. No.</b>	01991988000
<b>description</b>	O-ring silicone thickness 3.53mm ID ø 78.97mm Qty 1 pcs		
<b>For models:</b>	CV5-90/X, KC96V		

### Viton



<b>GEV No.</b>	532456	<b>Ref. No.</b>	01991898000
<b>description</b>	O-ring Viton thickness 2mm ID ø 16mm Qty 1 pcs		
<b>For models:</b>	CV5-90/X, KC96V		

## springs

### compression springs



<b>GEV No.</b>	105704	<b>Ref. No.</b>	01951057720
<b>description</b>	compression spring L 14.5mm ø 9mm wire gauge ø 0.9mm		
<b>For models:</b>	CV5-90/X, KC96V		

## kitchen accessories

### baking sheets



<b>GEV No.</b>	694531	<b>Ref. No.</b>	09960148801 KV4
<b>description</b>	baking sheet W 258mm L 324mm H 10mm aluminium		
<b>For models:</b>	EKF412US, KF412, KF412U		

## fittings, hose and pipe connectors

### push-in fittings

#### JOHN GUEST



<b>GEV No.</b>	440671	<b>Ref. No.</b>	00011090
<b>description</b>	push-in fitting John Guest angled pipe connection ø8mm grommet ø 8mm		
<b>For models:</b>	EKF1016EUD, EKF1064EUD, EKF1064TC, EKF1111EUD, EKF1111EVUD, EKF1111TC, EKF1664TC, EKF2011TC, EKF311DUD, EKF311UD, EKF364DUD, EKF364UD, EKF411UD, EKF416UD, EKF423ALUD, EKF423DALUD, EKF423DUD, EKF423UD, EKF464TC, EKF464UD, EKF511TC, EKF523EUD, EKF523UD, EKF616EUD, EKF664.3EUD, EKF664EUD, EKF664TC, EKF711.3EUD, EKF711EUD, EKF711EV, EKF711TC		
<b>accessories for</b>	440671		
<b>GEV No.</b>	520972	<b>Ref. No.</b>	—
<b>description</b>	hose John Guest thickness 1mm LLDPE blue ID ø 6mm ED ø 8mm		



1

<b>GEV No.</b>	520493	<b>Ref. No.</b>	00006430
<b>description</b>	hose connector John Guest straight pipe connection ø8mm - ø10mm L 41mm PM201008E NSF, SK		
<b>For models:</b>	EKF1016EUD, EKF1016UD, EKF1064EUD, EKF1064TC, EKF1064UD, EKF1111EUD, EKF1111EVUD, EKF1111TC, EKF1111UD, EKF1664TC, EKF2011TC, EKF311DUD, EKF311UD, EKF364DUD, EKF364UD, EKF411ALUD, EKF411DALUD, EKF411DUD, EKF411UD, EKF416ALUD, EKF416DALUD, EKF416DUD, EKF416UD, EKF423ALUD, EKF423DALUD, EKF423DUD, EKF423UD, EKF443DUD, EKF464ALUD, EKF464DALUD, EKF464DUD, EKF464TC, EKF464UD, EKF511TC, EKF523EUD, EKF523UD, EKF616EUD, EKF616UD, EKF664.3EUD, EKF664EUD, EKF664TC, EKF664UD, EKF711.3EUD, EKF711EUD, EKF711TC, EKF711UD		

## fastening material

### nuts

#### hexagonal nuts

#### hexagonal nuts metric (without norm)



1

<b>GEV No.</b>	102497	<b>Ref. No.</b>	01500810 07991978700
<b>description</b>	nut thread M6x0.75 H 3mm WS 8 steel Qty 1 pcs		
<b>For models:</b>	KCP97-VG-A, KCV96, KCV96P, KPP96, KTPP96, TCFG		

### fasteners

#### mounting clips



1

<b>GEV No.</b>	692865	<b>Ref. No.</b>	00007750 15980609202
<b>description</b>	mounting clip for bulb socket L 16mm H 19mm		
<b>For models:</b>	EKF423AL, EKF423ALP, EKF423ALUP		

### retaining rings

#### DIN 6799



1



<b>GEV No.</b>	550542	<b>Ref. No.</b>	01951067720
<b>description</b>	retaining ring E D1 ø 5mm D2 ø 11mm DIN 6799 thickness 0.7mm		
<b>For models:</b>	CV5-90/X, KC96V		

#### type C



1

<b>GEV No.</b>	550544	<b>Ref. No.</b>	01992007700
<b>description</b>	retaining ring igniter		
<b>For models:</b>	CV5-90/X, KC96V		

## consumables

### fuses

#### fine fuses



1

<b>GEV No.</b>	358675	<b>Ref. No.</b>	11950227000
<b>description</b>	fine fuse size ø5x20mm 2.5A fast-acting rated 250V Qty 10 pcs		

<b>A</b>		<b>I</b>	
alarm devices	14	ignition boxes	23
<b>B</b>		ignition units	25
bar burners	30	indicator lights	10
booster pumps II	21	<b>L</b>	
<b>C</b>		lamps	10
cam switches	10	light bulbs	11
condensators & interference suppression filters	21	<b>M</b>	
consumables	42	magnetic switches	10
contactors	14	mechanical timers	13
control thermostats	7, 8	microswitches	9
cross flow fans	18	mounting clips	42
<b>D</b>		<b>N</b>	
door gaskets (wire reinforced)	40	nuts	42
door seals	39	<b>O</b>	
door seals with fixing hook	40	operating capacitors	21
<b>E</b>		O-rings	41
electric accessories	21	oven hinges	35
electric timers	13	oven lamps	11
energy regulators	6	<b>P</b>	
<b>F</b>		probes	15
fans	18	programme timers	13
fasteners	42	pumps	21
fastening material	42	push/momentary push switches	9
fine fuses	42	push-in fittings	41
fuses	21, 42	<b>R</b>	
<b>G</b>		relays	15
gas burners	25	retaining rings	42
gas control valves	23	<b>S</b>	
gas nozzles	31	safety thermostats	7
gas taps	22	shelves and shelf rails	39
gaskets for heated units	39	snap locks	35
grates	39	solenoid valves	16
<b>H</b>		switches and momentary switches	9
halogen lamp	11	<b>T</b>	
heating elements	3	terminals	21
heating elements for convection	4	thermocouples	25
heating elements for heated cabinets	4	thermostats	7
heating elements for ovens	3	timers	13
hexagonal nuts	42	transformers	15
hob burners	25	<b>W</b>	
hot air fans	20	window seals	39
hot air motors	18		