



**GAS COMPONENTS**



**ELECTRIC COMPONENTS**



**WATER TECHNOLOGY**



**MECHANICAL COMPONENTS**



**TOOLS**

Spare parts suitable for

**STAR10**

Find the complete and up-to-date range of products in our GEV Webshop



# Manufacturer catalogue

The most important spare parts and accessories arranged clearly for every manufacturer

- ✓ Complete product range and all appliance data always up to date in the GEV Webshop
- ✓ Alphabetical Index at the end of the catalogue

## GEV Webshop

[www.gev-online.co.uk](http://www.gev-online.co.uk)

[www.gev-online.com](http://www.gev-online.com)



- 🔍 Add to Favourites
- 🔍 Sign In with email address and usual password
- 🔍 Easy-order – place several items in your basket at the same time
- 🔍 Quick Item search – no login needed



# heating elements

## heating elements for ovens

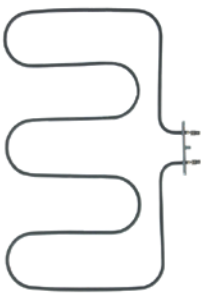

1

<b>GEV No.</b>	416042	<b>Ref. No.</b>	X68203
<b>description</b>	heating element 1500W 230V heating circuits 1 L 365mm W 500mm L1 45mm L2 315mm W1 240mm W2 30mm flange length 100mm flange width 22mm hole distance 86mm hole ø 5mm tube ø 6.3mm connection male faston 6.3mm mounting pos. lower rectangular flange dry heating element oven		
<b>For models:</b>	ACA2006, ACA2010, ACA2011		

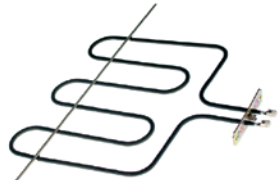

1

<b>GEV No.</b>	418266	<b>Ref. No.</b>	071065
<b>description</b>	heating element 1800W 230V heating circuits 1 L 320mm W 290mm L1 78mm L2 242mm W1 130mm W2 30mm flange length 100mm flange width 22mm hole distance 86mm bridge length 480mm hole ø 5mm tube ø 6.3mm connection male faston 6.3mm windings 3 rectangular flange oven heating element		
<b>For models:</b>	BSC4FC, BSC4FE, BS-C4FE-4563, BSC4FG, BSC6FG		

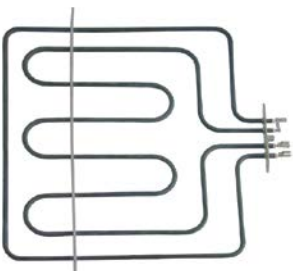

1

<b>GEV No.</b>	416041	<b>Ref. No.</b>	X68202
<b>description</b>	heating element 2600W 230V heating circuits 2 L 350mm W 355mm L1 36mm L2 314mm W1 147mm W2 60mm flange length 100mm flange width 22mm hole distance 80mm bridge length 480mm hole ø 5mm tube ø 6.3mm connection male faston 6.3mm mounting pos. upper rectangular flange dry heating element oven		
<b>For models:</b>	ACA2006, ACA2010, ACA2011		

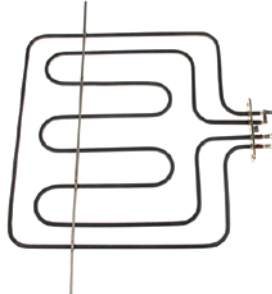

1

<b>GEV No.</b>	418227	<b>Ref. No.</b>	071084
<b>description</b>	heating element 2600W 230V heating circuits 2 L 355mm W 358mm L1 37mm L2 318mm W1 149mm W2 60mm flange length 100mm flange width 22mm hole distance 86mm bridge length 485mm hole ø 5mm tube ø 6.3mm connection male faston 6.3mm mounting pos. upper rectangular flange dry heating element oven		

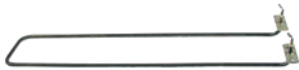

1

<b>GEV No.</b>	416043	<b>Ref. No.</b>	X47000
<b>description</b>	heating element 990W 230V L 475mm W 106mm H 24mm lug length 55mm lug width 18mm hole distance 138mm hole ø 5mm tube ø 6.3mm connection M4 heating circuits 1 bracket mounting oven		
<b>For models:</b>	ACA1004, ACA1005, ACA1006, ACA2007, ADA1004, ADA1005, ADA1006, ADA2005, ADA2008, ADA2010, C89E, K4FFE		

## heating elements for bain maries



1



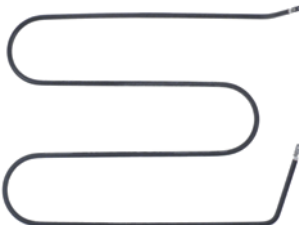



<b>GEV No.</b>	416161	<b>Ref. No.</b>	071007 071027
<b>description</b>	heating element 1000W 230V heating circuits 1 L 430mm W 95mm connection male faston 6.3mm connection distance 40mm connection length 10mm tube ø 6.3mm dry heating element W2 39mm H 36mm		
<b>For models:</b>	BM1, BM1375, BM140, BM1-40-4304, BM1BSI, BM260, BM260BSI, BM3GNI, BM47, BM4GNI, BM67, BME150ZAV, BMZ, BMZ200, BMZ2R, BMZ2R200, BMZ-4030, BMZR, BMZR200, BMZR-4035, CP1BSI, CR32000C, FT140, FT1BSI, FT1C40, FT1CBSI, FT1R40, FT1RBSI, FT2CBSI, FT2LBSI, FT2LRBSI, FT67C, TOPFTC, TOPFTR		





1

<b>GEV No.</b>	419022	<b>Ref. No.</b>	071110
<b>description</b>	heating element 1200W 230V heating circuits 1 L 346mm W 260mm connection distance 170mm tube ø 6.3mm for bain marie H 30mm suitable for immersion heater		

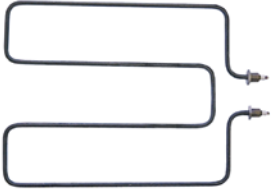

			
<b>GEV No.</b>	415130	<b>Ref. No.</b>	X45800
<b>description</b>	heating element 1500W 230V heating circuits 1 L 412mm W 50mm connection M3 tube $\varnothing$ 8.5mm 2 hole fixing thread 3/8" immersion heater mounting distance 42mm		
<b>For models:</b>	ACB0002, ACB0004, ACB0005		
<b>accessories for</b>	415130		
	<b>GEV No.</b>	361183	<b>Ref. No.</b> —
	nut thread 3/8" H 6mm nickel-plated brass WS 20 Qty 1 pcs		
	<b>GEV No.</b>	521137	<b>Ref. No.</b> —
	flat gasket fibre ED $\varnothing$ 20mm ID $\varnothing$ 18mm thickness 1.5mm for thread 3/8" Qty 1 pcs		
	<b>GEV No.</b>	527169	<b>Ref. No.</b> —
	hexagonal nut thread M3 H 2.8mm WS 5.5 brass Qty 1 pcs		
	<b>GEV No.</b>	560110	<b>Ref. No.</b> —
	plain washer ID $\varnothing$ 3.2mm ED $\varnothing$ 7mm thickness 0.5mm SS Qty 20 pcs DIN 125A for thread M3		
	<b>GEV No.</b>	560130	<b>Ref. No.</b> —
	hexagonal nut thread M3 H 2.4mm WS 5.5 SS DIN/ISO DIN 934 / ISO 4032/8673 Qty 20 pcs		

			
<b>GEV No.</b>	415844	<b>Ref. No.</b>	X45900
<b>description</b>	heating element 2600W 230V heating circuits 1 L 410mm W 300mm connection length 10mm connection M4 tube $\varnothing$ 8.5mm 2 hole fixing thread 3/8" immersion heater L1 27mm L2 383mm W1 120mm W2 60mm mounting distance 50mm		
<b>For models:</b>	ACB0003		
<b>spare parts for</b>	415844		
	<b>GEV No.</b>	521137	<b>Ref. No.</b> —
	flat gasket fibre ED $\varnothing$ 20mm ID $\varnothing$ 18mm thickness 1.5mm for thread 3/8" Qty 1 pcs		
<b>accessories for</b>	415844		
	<b>GEV No.</b>	361183	<b>Ref. No.</b> —
	nut thread 3/8" H 6mm nickel-plated brass WS 20 Qty 1 pcs		

## heating elements for crepes makers

			
<b>GEV No.</b>	416157	<b>Ref. No.</b>	071066
<b>description</b>	heating element 2400W 230V L 305mm W 250mm H 60mm tube $\varnothing$ 8.5mm connection M4 connection length 16mm connection distance 225mm dry heating element heating circuits 1 crepes maker		
<b>For models:</b>	CREP1E, CREP1E400, CREP2E		

## heating elements for chip scuttles

			
<b>GEV No.</b>	416082	<b>Ref. No.</b>	X48400
<b>description</b>	heating element 350W 230V heating circuits 8.5 L 172mm W 74mm flange length 110mm flange width 22mm hole distance 94mm connection length 20mm connection male faston 6.3mm tube $\varnothing$ 8.5mm rectangular flange hole $\varnothing$ 6mm dry heating element		
<b>For models:</b>	ABD0001, ADC0001, ADC0002, SKP40E		

## heating elements for fryers

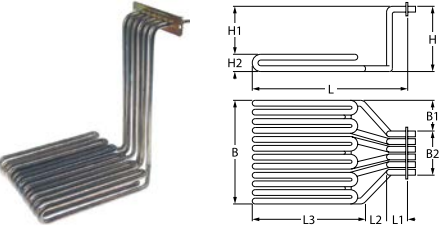
			
<b>GEV No.</b>	417338	<b>Ref. No.</b>	071069
<b>description</b>	heating element 6000W 230/400V heating circuits 3 L 270mm W 188mm H 265mm L1 28mm L2 245mm W1 53mm W2 82mm H1 230mm H2 35mm windings 12 flange length 130mm flange width 28mm hole distance 120mm hole $\varnothing$ 5.5mm connection M5 connection length 31mm tube $\varnothing$ 8.5mm rectangular flange immersion heater		
<b>For models:</b>	F101R, F102R, F18RBSI, F28RBSI, F4710, F6710		

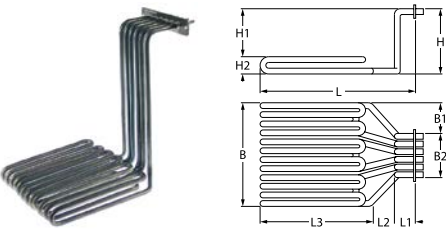
			
<b>GEV No.</b>	418269	<b>Ref. No.</b>	071028
<b>description</b>	heating element 7500W 230/400V heating circuits 3 L 310mm W 180mm H 260mm L1 70mm L2 240mm W2 75mm H1 225mm H2 35mm windings 12 flange length 130mm flange width 30mm hole distance 120mm hole $\varnothing$ 5.5mm connection M5 connection length 35mm rectangular flange immersion heater		



**2 hole fixing**

**1**

<b>GEV No.</b>	416169	<b>Ref. No.</b>	071052
<b>description</b>	heating element 3000W 230V heating circuits 1 L 290mm W 160mm H 185mm L1 18mm L2 272mm thread 1/4" mounting distance 144mm tube ø 8.5mm windings 4 2 hole fixing connection M5 fryer heaters		
<b>For models:</b>	F10, F1010, F10-1170, F88M, F88T, F8M, F8T, FE8, FE88, FM8, FM8+8-1241, FM8-1240, FM88		

**1**

<b>GEV No.</b>	419100	<b>Ref. No.</b>	071109
<b>description</b>	heating element 3000W 230V heating circuits 1 L 355mm W 110mm H 225mm thread 1/4" mounting distance 100mm tube ø 8.5mm windings 3 2 hole fixing connection M5 fryer		
<b>For models:</b>	F25, F40M		

**1**

<b>GEV No.</b>	416168	<b>Ref. No.</b>	071077	
<b>description</b>	heating element 2500W 230V heating circuits 1 L 222mm W 154mm H 175mm 2 hole fixing connection male faston 6.3mm immersion heater L1 25mm L2 197mm W1 31mm W2 76mm tube ø 8.5mm thread 1/4" mounting distance 60mm connection length 22mm windings 4			
<b>For models:</b>	F6, F6-1120, F66, FC6, FE6, FE66, FE8			
<b>accessories for</b>	416168			
	<b>GEV No.</b>	361182	<b>Ref. No.</b>	—
	nut thread 1/4" H 5mm nickel-plated brass WS 17 Qty 1 pcs			
	<b>GEV No.</b>	510417	<b>Ref. No.</b>	—
	flat gasket fibre ED ø 20mm ID ø 14mm thickness 2mm Qty 1 pcs			
	<b>GEV No.</b>	520228	<b>Ref. No.</b>	—
	tooth lock washer ID ø 15.3mm ED ø 24mm steel Qty 1 pcs for thread M14			
	<b>GEV No.</b>	550262	<b>Ref. No.</b>	—
	flat gasket copper ED ø 20mm ID ø 14mm thickness 2mm			

**1**

<b>GEV No.</b>	416167	<b>Ref. No.</b>	071055.1	
<b>description</b>	heating element 2500W 230V heating circuits 1 L 275mm W 157mm H 185mm 2 hole fixing connection male faston 6.3mm immersion heater L1 17mm L2 260mm W1 34mm W2 90mm tube ø 9mm thread 1/4" mounting distance 53mm connection length 24mm windings 3			
<b>accessories for</b>	416167			
	<b>GEV No.</b>	361182	<b>Ref. No.</b>	—
	nut thread 1/4" H 5mm nickel-plated brass WS 17 Qty 1 pcs			
	<b>GEV No.</b>	510417	<b>Ref. No.</b>	—
	flat gasket fibre ED ø 20mm ID ø 14mm thickness 2mm Qty 1 pcs			
	<b>GEV No.</b>	520228	<b>Ref. No.</b>	—
	tooth lock washer ID ø 15.3mm ED ø 24mm steel Qty 1 pcs for thread M14			
	<b>GEV No.</b>	550262	<b>Ref. No.</b>	—
	flat gasket copper ED ø 20mm ID ø 14mm thickness 2mm			

**1**

<b>GEV No.</b>	417567	<b>Ref. No.</b>	071001
<b>description</b>	heating element 3000W 230V heating circuits 1 L 290mm W 205mm H 195mm VNR/D1 connection screw immersion heater L1 35mm L2 270mm W1 60mm W2 75mm tube ø 8mm thread M12 windings 3		
<b>For models:</b>	F10, F1010, F10-1170, F88T, F8T		

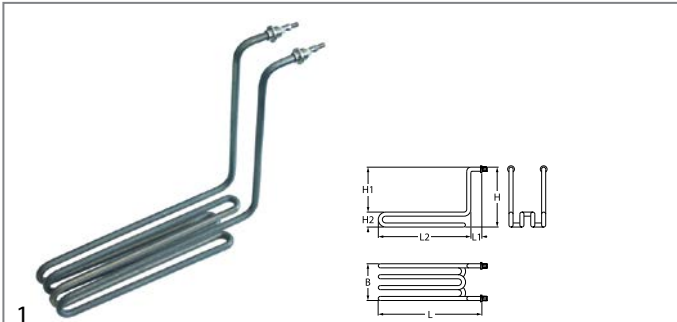



<b>GEV No.</b>	416172	<b>Ref. No.</b>	071005
<b>description</b>	heating element 3000W 230V heating circuits 1 L 300mm W 80mm H 255mm L1 43mm L2 257mm H1 215mm H2 40mm thread 1/4" mounting distance 67mm tube ø 8.5mm 2 hole fixing connection M5 connection length 12mm immersion heater windings 4		
<b>For models:</b>	F101, F102, F121, F12140, F121-4328, F121-4332, F121-4528, F121M, F121M-4345, F122, F122M, FRY101, FRY102, FRY121M-1171, FRY122, FRY122M-1172		
<b>spare parts for</b>	416172		

	<b>GEV No.</b>	510417	<b>Ref. No.</b>	—
		flat gasket fibre ED ø 20mm ID ø 14mm thickness 2mm Qty 1 pcs		
<b>accessories for</b>	416172			
	<b>GEV No.</b>	361182	<b>Ref. No.</b>	—
		nut thread 1/4" H 5mm nickel-plated brass WS 17 Qty 1 pcs		
	<b>GEV No.</b>	520228	<b>Ref. No.</b>	—
		tooth lock washer ID ø 15.3mm ED ø 24mm steel Qty 1 pcs for thread M14		
	<b>GEV No.</b>	550262	<b>Ref. No.</b>	—
		flat gasket copper ED ø 20mm ID ø 14mm thickness 2mm		
	<b>GEV No.</b>	560112	<b>Ref. No.</b>	—
		plain washer ID ø 5.3mm ED ø 10mm thickness 1mm SS Qty 20 pcs DIN 125A for thread M5		
	<b>GEV No.</b>	560132	<b>Ref. No.</b>	—
		hexagonal nut thread M5 H 4mm WS 8 SS DIN/ISO DIN 934 / ISO 4032/8673 Qty 20 pcs		

### heating elements for griddles

	<b>GEV No.</b>	415703	<b>Ref. No.</b>	071044
<b>description</b>	heating element 1000W 230V heating circuits 1 L 333mm W 80mm H 64mm tube ø 6.3mm W1 20mm W2 51mm connection male faston 6.3mm connection length 19mm dry heating element			
<b>For models:</b>	CP67EM-7560			

	<b>GEV No.</b>	416161	<b>Ref. No.</b>	071007 071027
<b>description</b>	heating element 1000W 230V heating circuits 1 L 430mm W 95mm connection male faston 6.3mm connection distance 40mm connection length 10mm tube ø 6.3mm dry heating element W2 39mm H 36mm			
<b>For models:</b>	BM1, BM1375, BM140, BM1-40-4304, BM1BSI, BM260, BM260BSI, BM3GNI, BM47, BM4GNI, BM67, BME150ZAV, BMZ, BMZ200, BMZ2R, BMZ2R200, BMZ-4030, BMZR, BMZR200, BMZR-4035, CP1BSI, CR32000C, FT140, FT1BSI, FT1C40, FT1CBSI, FT1R40, FT1RBSI, FT2CBSI, FT2LBSI, FT2LRBSI, FT67C, TOPFTC, TOPFTR			

	<b>GEV No.</b>	415651	<b>Ref. No.</b>	X45700
<b>description</b>	heating element 1500W 230V heating circuits 1 L 425mm W 72mm H 53mm tube ø 8.5mm L1 22mm connection male faston 6.3mm connection distance 52mm dry heating element			
<b>For models:</b>	ABH3001, ABH3002, ABH3003, ABH3004, ABH3005, ABH3006, ABH3007, ABH3008, ABH3009, ACH3001, ACH3002, ACH3003, ACH3004, ACH3005, ACH3006, ACH3007, ACH3018, ACH3019, ACH3020, SKT40E, SKT40EC, SKT40ER			

	<b>GEV No.</b>	416046	<b>Ref. No.</b>	Y10400
<b>description</b>	heating element 2350/2560W 220/240V heating circuits 1 L 590mm W 77mm H 80mm tube ø 8.5mm dry heating element			
<b>For models:</b>	ADH3001, ADH3002, ADH3003, ADH3004, ADH3005, ADH3006, AEH3001, AEH3002, AEH3003, AEH3004, AEH3005, AEH3006			

### heating elements for gyros grills

	<b>GEV No.</b>	416164	<b>Ref. No.</b>	071085
<b>description</b>	heating element 1500W 230V L 343mm W 74mm H 53mm connection male faston 6.3mm L1 125mm L2 110mm L3 108mm tube ø 6.3mm bracket mounting thread dry heating element			
<b>For models:</b>	GY100E, GY40E, GY60E, GY60E-9830, GY80E, GY80E-9831			

	<b>GEV No.</b>	416163	<b>Ref. No.</b>	071067.1 071067/A
<b>description</b>	heating element 2800W 230V L 327mm W 230mm H 68mm connection M6 thread 1/4" tube ø 8.5mm connection length 28mm 2 hole fixing dry heating element mounting distance 295mm			
<b>For models:</b>	GYINO10E, GY-INO10E-9841			

<b>accessories for</b>	416163			
	<b>GEV No.</b>	361182	<b>Ref. No.</b>	—
		nut thread 1/4" H 5mm nickel-plated brass WS 17 Qty 1 pcs		
	<b>GEV No.</b>	510417	<b>Ref. No.</b>	—
		flat gasket fibre ED ø 20mm ID ø 14mm thickness 2mm Qty 1 pcs		
	<b>GEV No.</b>	520228	<b>Ref. No.</b>	—
		tooth lock washer ID ø 15.3mm ED ø 24mm steel Qty 1 pcs for thread M14		
	<b>GEV No.</b>	550262	<b>Ref. No.</b>	—
		flat gasket copper ED ø 20mm ID ø 14mm thickness 2mm		



heating elements for hot dog machines



1

<b>GEV No.</b>	416159	<b>Ref. No.</b>	071015
<b>description</b>	heating element 750W 230V L 180mm W 327mm H 6.5mm tube ø 6.3mm W1 137mm W2 50mm connection male faston 6.3mm connection length 19mm dry heating element heating circuits 1		

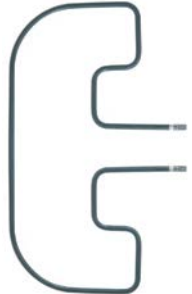

1

<b>GEV No.</b>	416487	<b>Ref. No.</b>	71015
<b>description</b>	heating element 750W 230V L 183mm W 324mm H mm tube ø 6.3mm L1 31mm L2 152mm W1 134mm W2 56mm connection male faston 6.3mm connection distance 51mm dry heating element heating circuits 1		

heating elements for refrigeration

condensing trays heated



1

<b>GEV No.</b>	695271	<b>Ref. No.</b>	Q32-0196
<b>description</b>	condensing tray heated L 410mm W 300mm H 80mm 230V 230W		
<b>For models:</b>	HE140A, HE70A		

heating elements for tilting bratt pan



1

<b>GEV No.</b>	415077	<b>Ref. No.</b>	Y00100
<b>description</b>	heating element stock pot 1300W 230V L 280mm W 150mm H 40mm connection male faston 6.3mm tilting bratt pan heating circuits 1 tube ø 8.5mm bracket mounting hole distance 142mm hole ø 5mm lug length 25mm lug width 15mm		
<b>For models:</b>	ABK1001		



1

<b>GEV No.</b>	416045	<b>Ref. No.</b>	X48100
<b>description</b>	heating element tilting bratt pan 3400W 230V L 313mm W 195mm H 82mm connection M5 dry heating element heating circuits 1 tube ø 10mm W1 67mm W2 61mm		
<b>For models:</b>	ACK2003, BRE70		

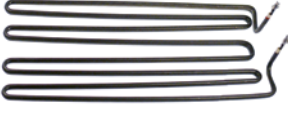

1

<b>GEV No.</b>	417344	<b>Ref. No.</b>	Y10500
<b>description</b>	heating element tilting bratt pan 4700W 230V L 540mm W 210mm H 60mm heating circuits 1 tube ø 8.5mm W1 70mm W2 70mm		
<b>For models:</b>	ADK2001, ADK2002, ADK2003, ADK2004, AEK2001, AEK2002, AEK2003, AEK2004		

heating elements for contact grills



1

<b>GEV No.</b>	416722	<b>Ref. No.</b>	RG.D02140
<b>description</b>	heating element 750W 230V L 175mm W 212mm H 22mm tube ø 6.5mm W1 90mm W2 33mm connection cable cable length 75mm mounting pos. upper dry heating element heating circuits 1		
<b>For models:</b>	WAFFLE1, WAFFLE2		

heating elements for pasta cookers



1









<b>GEV No.</b>	415902	<b>Ref. No.</b>	X47100	
<b>description</b>	heating element 2510W 230V L 295mm W 115mm H mm 2 hole fixing connection male faston 6.3mm thread M14x1 tube ø 8.5mm			
<b>For models:</b>	ACE0003, ACE0004			
<b>accessories for</b>	415902			
	<b>GEV No.</b>	510417	<b>Ref. No.</b>	—
	flat gasket fibre ED ø 20mm ID ø 14mm thickness 2mm Qty 1 pcs			
	<b>GEV No.</b>	520228	<b>Ref. No.</b>	—
	tooth lock washer ID ø 15.3mm ED ø 24mm steel Qty 1 pcs for thread M14			
	<b>GEV No.</b>	521133	<b>Ref. No.</b>	—
	nut thread M14x1.5 H 6mm WS 19 zinc-coated steel Qty 1 pcs			

Table continues overleaf



<b>accessories for</b>	415902		
	GEV No.	550261	Ref. No. —
	nut thread M14x1 H 4mm WS 19 SS Qty 1 pcs		
	GEV No.	550262	Ref. No. —
	flat gasket copper ED ø 20mm ID ø 14mm thickness 2mm		



<b>GEV No.</b>	416989	<b>Ref. No.</b>	Y00900
<b>description</b>	heating element 4500W 230/400V heating circuits 3 L 357mm W 200mm H 25mm rotation flange tube ø 6.3mm L1 45mm L2 312mm W1 30mm W2 170mm cable length 570mm connection length 40mm flange length 1 9.6mm flange length 2 35.5mm flange length 45mm flange ø1 44.5mm flange ø2 39.5mm mounting pos. left fryer		
<b>For models:</b>	ACE0008		
<b>accessories for</b>	416989		
	GEV No.	510899	Ref. No. X05400
	O-ring EPDM thickness 3.53mm ID ø 37.69mm Qty 1 pcs		
	GEV No.	528155	Ref. No. X05300
	O-ring Viton thickness 3.53mm ID ø 32.93mm Qty 1 pcs		
	GEV No.	532545	Ref. No. X05000
	O-ring Viton thickness 3.53mm ID ø 49.21mm Qty 1 pcs		
	GEV No.	691621	Ref. No. M29600
	retaining ring shaft ø 40mm thickness 1.8mm steel DIN 471		

## heating elements for pizza ovens

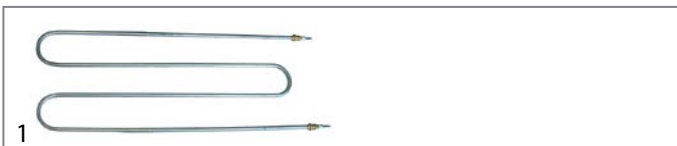

<b>GEV No.</b>	416162	<b>Ref. No.</b>	071083 071083, 076018
<b>description</b>	heating element 1000W 230V L 582mm W 242mm thread 1/4" mounting distance 233.5mm connection length 42mm connection M4 tube ø 8.5mm heating circuits 1 dry heating element 2 hole fixing pizza oven		

## heating elements for chargrills







<b>GEV No.</b>	418231	<b>Ref. No.</b>	071025
<b>description</b>	heating element 2300W 230V heating circuits 1 L 457mm W 183mm H 111mm rectangular flange hole distance 76mm hole ø 5mm L1 27mm L2 430mm W1 62mm W2 60mm connection cable cable length 900mm flange length 90mm flange width 40mm tube ø 17x6mm windings 6 dry heating element		
<b>For models:</b>	RG100, RG105, RG80		



<b>GEV No.</b>	418232	<b>Ref. No.</b>	071034
<b>description</b>	heating element 3100W 230V heating circuits 1 L 440mm W 280mm H 105mm rectangular flange hole distance 76mm hole ø 5.5mm L1 30mm L2 410mm W1 93mm W2 62mm connection cable cable length 900mm flange length 90mm flange width 40mm tube ø 17x6mm windings 8 dry heating element		
<b>For models:</b>	RG100, RG70, TOPRG1, TOPRG2		



<b>GEV No.</b>	416000	<b>Ref. No.</b>	Y00200
<b>description</b>	heating element 1500W 230V L 438mm W 80mm H 62mm thread 1/4" mounting distance 19mm tube ø 8.5mm connection male faston 6.3mm windings 2 heating circuits 1 connection length 23mm 2 hole fixing dry heating element		
<b>For models:</b>	ABK3001, ABK3002, ACK3001, ACK3002, ACK3003, ACK3004		
<b>spare parts for</b>	416000		
	GEV No.	510417	Ref. No. —
	flat gasket fibre ED ø 20mm ID ø 14mm thickness 2mm Qty 1 pcs		
<b>accessories for</b>	416000		
	GEV No.	361182	Ref. No. —
	nut thread 1/4" H 5mm nickel-plated brass WS 17 Qty 1 pcs		
	GEV No.	520228	Ref. No. —
	tooth lock washer ID ø 15.3mm ED ø 24mm steel Qty 1 pcs for thread M14		
	GEV No.	550262	Ref. No. —
	flat gasket copper ED ø 20mm ID ø 14mm thickness 2mm		

## heating elements for salamanders/toast-

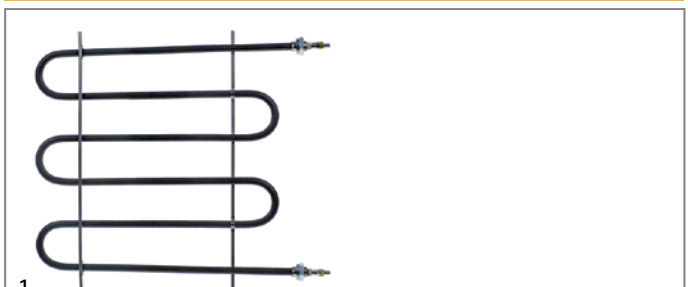





<b>GEV No.</b>	416155	<b>Ref. No.</b>	071019
<b>description</b>	heating element 2000W 230V L 197mm W 263mm 2 hole fixing thread 1/4" mounting distance 255mm connection screw dry heating element tube ø 8.5mm heating circuits 1 connection length 34mm H 8.5mm		
<b>For models:</b>	ST650		
<b>accessories for</b>	416155		
	GEV No.	361182	Ref. No. —
	nut thread 1/4" H 5mm nickel-plated brass WS 17 Qty 1 pcs		
	GEV No.	510417	Ref. No. —
	flat gasket fibre ED ø 20mm ID ø 14mm thickness 2mm Qty 1 pcs		

Table continues overleaf



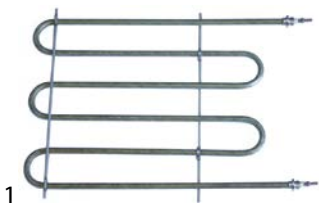

<b>accessories for</b> 416155	
	GEV No. 520228 Ref. No. — tooth lock washer ID ø 15.3mm ED ø 24mm steel Qty 1 pcs for thread M14
	GEV No. 550262 Ref. No. — flat gasket copper ED ø 20mm ID ø 14mm thickness 2mm

	
<b>GEV No.</b>	416154 Ref. No. 071018
<b>description</b>	heating element 2500W 230V L 368mm W 255mm thread 1/4" mounting distance 246mm connection M5 dry heating element tube ø 8.5mm heating circuits 1 connection length 36mm H 8.5mm connection distance 247mm
<b>For models:</b>	S110E-GIGA, ST400

	
<b>GEV No.</b>	416156 Ref. No. 071036
<b>description</b>	heating element 3000W 230V L 600mm W 265mm flange with thread thread 1/4" mounting distance 260mm connection M5 dry heating element tube ø 8.5mm connection length 34mm
<b>For models:</b>	C127E, C2EF, C3EF, C5FE, C87E, S300E-GIGA, ST650B



heating cables

miscellaneous

	
<b>GEV No.</b>	418499 Ref. No. R35-0002
<b>description</b>	heating cable L 7000mm door frame heating 2050hm/m
<b>For models:</b>	HE140A

ceramic heaters

245x60mm

	
<b>GEV No.</b>	415103 Ref. No. 071053 X48000
<b>description</b>	ceramic emitter 650W 230V cable beaded cord L 245mm W 60mm H 35mm
<b>For models:</b>	ABD0001, FWI, SF140, SF1BSI, SF47, SFE, SFE23, SFE23-4088, SKP40E
<b>spare parts for</b> 415103	
	GEV No. 415109 Ref. No. — spring clip

<b>accessories for</b> 415103	
	GEV No. 415110 Ref. No. — reflector L 245mm W 95mm H 31mm thickness 0.75mm hole ø 15x40mm

quartz heating elements

	
<b>GEV No.</b>	416414 Ref. No. 071014
<b>description</b>	quartz heating element 500W 115V L 385mm ø 10mm connection male faston 6.3mm



	
<b>GEV No.</b>	416152 Ref. No. 071014.1
<b>description</b>	quartz heating element 500W 230V L 390mm ø 12mm connection male faston 6.3mm
<b>For models:</b>	CP140, CP1-4330, CP1BSI, CP67EM-7560, SR 11, T23GN, T3, T3-2046, T3-2050, T6, T6-2048, T6-2052, T6CB, TE3, TE3-2072, TE3G-2072G, TE6, TE6G-2073G, TGRILL

	
<b>GEV No.</b>	418834 Ref. No. 071051
<b>description</b>	quartz heating element 600W 230V L 525mm ø 10mm connection male faston 6.3mm
<b>For models:</b>	SAM650, SAM650-2158, T92, T9-2051, WBC

	
<b>GEV No.</b>	416153 Ref. No. 071051.1
<b>description</b>	quartz heating element 600W 230V L 530mm ø 12mm connection male faston 6.3mm
<b>For models:</b>	S9KER, SA650, SA650-2155, SAM650, SAM650-2158, STA650KER, T11GN, T9, T92, T9-2051, T92GN, WBC, WBS

immersion heating elements

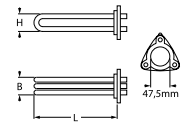
3 hole flange ø47.5mm

	
	
<b>GEV No.</b>	418439 Ref. No. E11500
<b>description</b>	heating element 8000W 230V mounting ø 47.5mm heating circuits 3 L 315mm W 37mm H 35mm number of thermostat sleeves 1 thermostat sleeves ø 8.5mm length thermostat sleeves 215mm thermostat sleeve clinging tube ø 8.5mm hole distance 62mm hole ø 8mm connection M4 3 hole flange immersion heater
<b>For models:</b>	ADL0001, ADL0003, ADL0016, AEL0001
<b>accessories for</b> 418439	
	GEV No. 510408 Ref. No. — O-ring EPDM thickness 5.34mm ID ø 47mm Qty 1 pcs
	GEV No. 510562 Ref. No. — O-ring silicone thickness 5.34mm ID ø 47mm Qty 1 pcs



3 hole flange ø57.5mm

1

<b>GEV No.</b>	416232	<b>Ref. No.</b>	X60500
<b>description</b>	heating element 6000W 230V mounting ø 57.5mm heating circuits 3 L 293mm W 40mm H 36mm number of thermostat sleeves 1 thermostat sleeves ø 7mm length thermostat sleeves 280mm thermostat sleeve eccentric, non clinging tube ø 8.5mm hole distance 74mm hole ø 8x10mm connection M5 3 hole flange immersion heater		
<b>For models:</b>	ABC0004, ACC0004, SKF2E4		
<b>spare parts for</b>	416232		
	<b>GEV No.</b>	510409	<b>Ref. No.</b> —
	O-ring EPDM thickness 5.34mm ID ø 56.52mm Qty 1 pcs		

heating elements for convection

1

<b>GEV No.</b>	418267	<b>Ref. No.</b>	071041
<b>description</b>	heating element 2500W 230V heating circuits 1 ID ø 181mm ED ø 193mm L 208mm H 30mm L1 10mm W1 30mm H1 6mm H2 24mm flange length 70mm flange width 22mm hole distance 56mm connection male faston 6.3mm tube ø 6.3mm convection heating element hole ø 5mm rectangular flange		
<b>For models:</b>	BSC4FC, BSC4FE, BS-C4FE-4563, BSC4FG, BSC4FV, BSC6FG, C127FE, C127FV, C87FE		
<b>spare parts for</b>	418267		
	<b>GEV No.</b>	510368	<b>Ref. No.</b> —
	gasket L 70mm W 23.5mm hole ø 5mm hole distance 56mm FIBER thickness 2mm for heating element		

radiation heaters

1

<b>GEV No.</b>	416165	<b>Ref. No.</b>	071097
<b>description</b>	radiation heater rectangular 1500W 230V L 180mm W 170mm heating circuits 1 connections 2 for gyro grill		

1

<b>GEV No.</b>	416166	<b>Ref. No.</b>	071098
<b>description</b>	radiation heater rectangular 3300W 230V L 380mm W 175mm heating circuits 3 connections 3x 2		
<b>For models:</b>	F4715, F471R, F8715, F871R, FR871R, FRY471R-1164, FT80CBSI, FT87LC, FT87LR, GY30EIR, GY80EIR		

1

<b>GEV No.</b>	418230	<b>Ref. No.</b>	071096
<b>description</b>	radiation heater rectangular 4000W 230V L 425mm W 265mm heating circuits 3 connections 3x 2 IRCA griddle		
<b>For models:</b>	CP1, CP1-4330, CP11, CP47M, CP67EM-7260, CP67EM-7560, CP67M, FT1, FT1-4356, FT1BSI, FT1C, FT1CBSI, FT1CI, FT1R, FT1R-4357, FT1RBSI, FT2CBSI, FT2CI, FT2L, FT2LBSI, FT2LC, FT2LR, FT2LRBSI, FT47C, FT47L, FT47R, FT67C, FT67L, FT67LC, FT67LR, FT80CBSI, FT87LC, FT87LR, FTAL, FTAR, PC127FTE, TOP60FT, TOP60FTC, TOP60FTC-4262, TOP60FTLR, TOP80FTC, TOPFT, TOPFTC, TOPFTR		

1-circuit

1

<b>GEV No.</b>	490045	<b>Ref. No.</b>	071011
<b>description</b>	radiation heater ø 165mm 1200W 230V heating circuits 1 7-position control with temperature signalization connections 4+2 connection type male faston 6.3mm EGO		
<b>For models:</b>	PC1V40, PC1VBISI, PC2V, PC2VBISI, TOP2V		

1

<b>GEV No.</b>	490024	<b>Ref. No.</b>	071011.1
<b>description</b>	radiation heater ø 165mm 1200W 230V heating circuits 1 energy regulation with temperature signalization with heating coil connections 2+2 connection type male faston 6.3mm EGO		
<b>For models:</b>	BM1-40-4304, BM11, BM3I, BM4I, BSC4FV, C127FV, C87FV, PC127V, PC1V40, PC1VBISI, PC2V, PC2VBISI, PC2VI, PC47V, PC4V, PC4VI, PC87V, TOP2V, TOPV		



1

<b>GEV No.</b>	490116	<b>Ref. No.</b>	Y12208
<b>description</b>	radiation heater ø 165mm 1200W 230V heating circuits 1 H 33mm 7-position control with temperature signalization with ribbon heater connections 2+2 connection type male faston 6.3mm CERAMASPEED		
<b>For models:</b>	ABJ0005, ABJ0006		



1

<b>GEV No.</b>	490113	<b>Ref. No.</b>	Y12207
<b>description</b>	radiation heater ø 200mm 1800W 230V heating circuits 1 energy regulation with temperature signalization with ribbon heater connections 2+2 connection type male faston 6.3mm CERAMASPEED		
<b>For models:</b>	ABJ0005, ABJ0006		



1

<b>GEV No.</b>	490047	<b>Ref. No.</b>	071010
<b>description</b>	radiation heater ø 230mm 2100W 230V heating circuits 1 7-position control with temperature signalization connections 4+2 connection type male faston 6.3mm EGO		
<b>For models:</b>	PC1V40, PC1VBSI, PC2V, PC2VBSI, TOP2V		



1

<b>GEV No.</b>	490026	<b>Ref. No.</b>	071010.1
<b>description</b>	radiation heater ø 230mm 2100W 230V heating circuits 1 H 31mm energy regulation with temperature signalization with heating coil connections 2+2 connection type male faston 6.3mm EGO		
<b>For models:</b>	BM2I, BM3I, BM4I, BM60I, BSC4FV, C127FV, C87FV, HP1V, PC127V, PC1V40, PC1VBSI, PC2V, PC2VBSI, PC2VI, PC47V, PC4V, PC4VI, PC87V, TOP2V, TOPV		



1

<b>GEV No.</b>	490050	<b>Ref. No.</b>	Y12408
<b>description</b>	radiation heater ø 250mm 2500W 230V heating circuits 1 with ribbon heater		
<b>For models:</b>	ACA1003, ACA1010, ACJ0006		

2-circuit



1

<b>GEV No.</b>	490114	<b>Ref. No.</b>	Y12409
<b>description</b>	radiation heater ø 230mm 2200W 230V heating circuits 2 energy regulation with temperature signalization partial power 750W with ribbon heater connections 2+2 connection type male faston 6.3mm CERAMASPEED		
<b>For models:</b>	ACA1003, ACA1006, ACA1010, ACJ0006		

## hot plates

### square & rectangular

#### with radiused edge



1

<b>GEV No.</b>	490066 <sup>1</sup>	<b>Ref. No.</b>	X45500
<b>description</b>	hot plate dimensions 220x220mm 2600W 230V with spill ring connection 4 screw clamps protector yes square		
<b>For models:</b>	ACA1001, ACA1002, ACA1004, ACA1005		

<sup>1</sup>incl. protector



1

<b>GEV No.</b>	490071 <sup>1</sup>	<b>Ref. No.</b>	Y12100
<b>description</b>	hot plate dimensions 300x300mm 4000W 230V with spill ring connection 4 screw clamps protector yes square		
<b>For models:</b>	ADA1001, ADA1003, ADA1004, ADA1006, AEA1001, AEA1003, AEA1005, C89E, K2P, K4FFE, K4P, PC49E, PC89E		

<sup>1</sup>incl. protector



round

with radiused edge

for domestic and commercial kitchens

E-G-O



1

<b>GEV No.</b>	490012	<b>Ref. No.</b>	071008 071075
<b>description</b>	hot plate ø 145mm 1500W 230V connection 4 screw clamps with 8mm spill ring		
<b>For models:</b>	BSC4FC, BSC4FE, BS-C4FE-4563, C5FE, PC1E, PC1E-4520, PC1EBSI, PC2E, PC2EBSI, PC4E, TOP2E, TOP4E, TOPE		



1

<b>GEV No.</b>	490018	<b>Ref. No.</b>	071009 071076
<b>description</b>	hot plate ø 220mm 2000W 230V connection 4 screw clamps with 8mm spill ring		
<b>For models:</b>	BSC4FC, BSC4FE, BS-C4FE-4563, C127E, C5FE, HP1, HP1E, HP2E, PC127E, PC1E, PC1E-4520, PC1EBSI, PC2E, PC2EBSI, PC4E, PC87E, TOP2E, TOP4E, TOPE		



1

<b>GEV No.</b>	490020	<b>Ref. No.</b>	X45300
<b>description</b>	hot plate ø 220mm 2600W 230V connection 4 screw clamps with 8mm spill ring		
<b>For models:</b>	ABJ0003, ABJ0004, ACJ0005, ACJ0007, ACJ0008		
<b>accessories for</b>	490020		
	<b>GEV No.</b>	550796	<b>Ref. No.</b> —
	fixing plate for hot plate ø220mm		

## energy regulators

EGO

1-circuit

E-G-O



1

<b>GEV No.</b>	380015	<b>Ref. No.</b>	073010 Y12206
<b>description</b>	energy regulator 230V 13A single-circuit turn direction right shaft ø 6x4.6mm shaft L 23mm mounting thread M4 power release 6-100% no. 50.57021.010		

2-circuit

E-G-O



1

<b>GEV No.</b>	380027	<b>Ref. No.</b>	Y12406 Y12407
<b>description</b>	energy regulator EGO 230V 13A dual circuit turn direction right shaft ø 6x4.6mm shaft L 23mm mounting thread M4 power release 6-70% no. 50.55021.100		
<b>For models:</b>	ACA1003, ACA1006, ACA1010, ACJ0006		

## thermostats

bi-metal thermostats

bi-metal thermostats



1

<b>GEV No.</b>	390158	<b>Ref. No.</b>	072011
<b>description</b>	bi-metal thermostat switch-off temp. 140°C connection M4		

control and safety thermostats

EGO

control thermostats

55.10/19\_ series

E-G-O



1

<b>GEV No.</b>	375055	<b>Ref. No.</b>	X43100
<b>description</b>	thermostat t.max. 110°C temperature range 30-110°C 1-pole 1CO 16A probe ø 6mm probe L 130mm capillary pipe 1500mm capillary pipe isolatedmm gland nut shaft L 23mm shaft position upper rotation 318° 250V		
<b>For models:</b>	ACB0002, ACB0003, ACB0004, ACB0005		



<b>GEV No.</b>	375718	<b>Ref. No.</b>	072001 072001.1
<b>description</b>	thermostat t.max. 180°C temperature range 70-180°C 1-pole 1NO 16A probe ø 6mm probe L 87mm capillary pipe 1500mm capillary pipe isolatedmm gland nut shaft ø 6x4.6mm shaft L 23mm shaft position upper rotation 270°		
<b>For models:</b>	BM2I, F101R, F102R, F18RBSI, F25, F28RBSI, F4710, F4715, F47GM, F47IR, F6710, F8715, F87IR, FR87IR, FRY121G, FRY121G-1190, FRY47IR-1164		



<b>GEV No.</b>	375719	<b>Ref. No.</b>	072032 072032, 072024
<b>description</b>	thermostat t.max. 250°C temperature range 48-250°C 1-pole 1NO 16A probe ø 3.03mm probe L 160mm capillary pipe 1270mm capillary pipe isolatedmm gland nut shaft ø 6x4.6mm shaft L 23mm shaft position upper rotation 270°		
<b>For models:</b>	BSC4FE, BSC4FE80, BSC6FG, C127FE, C127FV, C87FE, C87FV, C87VFE, CO1, CO323, CO511, FT1C40, STARROLLY5, STARROLLY8, TOP60FTC, TOP60FTC-4262, TOPFTC		



<b>GEV No.</b>	375720	<b>Ref. No.</b>	072020.1 072051
<b>description</b>	thermostat t.max. 184°C temperature range 80-184°C 1-pole 1NO 16A probe ø 6mm probe L 87mm capillary pipe 570mm capillary pipe isolatedmm gland nut shaft ø 6x4.6mm shaft L 23mm shaft position upper rotation 270°		
<b>For models:</b>	F10, F101, F1010, F10-1170, F102, F121, F12140, F121-4328, F121-4332, F121-4528, F121GM, F121M, F121M-4345, F122, F122GTM, F122M, F25, F4, F40M, F44, F4715, F47GM, F6, F6-1120, F66, F8715, F87GM, F88M, F88T, F8M, F8T, FC4, FC6, FE4, FE44, FE6, FE66, FE8, FE88, FM4, FM4+4-1206, FM4-1205, FM8, FM8+8-1241, FM8-1240, FM88, FRIT0001, FRY101, FRY102, FRY121GM...(Other models you can see in the webshop)		



<b>GEV No.</b>	390068	<b>Ref. No.</b>	X43600
<b>description</b>	thermostat t.max. 269°C temperature range 55-269°C 1-pole 1CO 16A probe ø 3.1mm probe L 219mm capillary pipe 1280mm capillary pipe isolated 1270mm gland nut shaft ø 6x4.6mm shaft L 23mm shaft position upper* rotation 318°		
<b>For models:</b>	ADK2001, ADK2002, ADK2003, ADK2004, ADK2007, ADK2008, ADK2009, ADK2010, AEK2001, AEK2002, AEK2003, AEK2004, AEK2005, AEK2006, AEK2007, AEK2008		



<b>GEV No.</b>	375237	<b>Ref. No.</b>	Y16000
<b>description</b>	thermostat t.max. 190°C temperature range 100-190°C 1-pole 1NO 16A probe ø 6mm probe L 130mm capillary pipe 1800mm capillary pipe isolated 1200mm gland nut M9x1 shaft L 23mm shaft position upper rotation 270°		
<b>For models:</b>	ABC0004, ACC0004, ACC0005, AEC0003, AEC0004, AEC0005, AEC0006, SKF2E4		



<b>GEV No.</b>	375270	<b>Ref. No.</b>	X49800
<b>description</b>	thermostat t.max. 295°C temperature range 45-295°C 1-pole 1NO 16A probe ø 4mm probe L 100mm capillary pipe 900mm capillary pipe isolated 350mm gland nut shaft L 23mm shaft position upper rotation 270°		
<b>For models:</b>	ACK2003, BRE70		



<b>GEV No.</b>	375327	<b>Ref. No.</b>	072005 072005.1
<b>description</b>	thermostat t.max. 297°C temperature range 58-297°C 1-pole 1NO 16A probe ø 3.03mm probe L 219mm capillary pipe 870mm capillary pipe isolatedmm gland nut shaft L 23mm shaft position upper rotation 270°		
<b>For models:</b>	CREP1E, CREP1E400, CREP2E, DOPPIAVTC, FT1, FT140, FT1-4356, FT1B5I, FT1R, FT1R40, FT1R-4357, FT1RBSI, FT2L, FT2LBSI, FT2LR, FT2LRBSI, FT47L, FT47R, FT67L, FT67LR, FT87LR, MEDIAVTC, PANINI1C, PANINI2C, PANINIMC, PANINIMC-2004, PC127FTE, TOP60FTLR, TOPFT, TOPFT60GL, TOPFTGL, TOPFTGLC, TOPFTR		



<b>GEV No.</b>	375330	<b>Ref. No.</b>	072039
<b>description</b>	thermostat t.max. 415°C temperature range 65-415°C 1-pole 1NO 16A probe ø 3.9mm probe L 228mm capillary pipe 870mm capillary pipe isolated 660mm gland nut shaft L 23mm shaft position upper rotation 270°		
<b>For models:</b>	PIZZA41, PIZZA41S, PIZZA42, PIZZA42S, PIZZA61S, PIZZA62, PIZZA62S		

55.13\_ series



<b>GEV No.</b>	375723	<b>Ref. No.</b>	10013023740 16001142401
<b>description</b>	thermostat t.max. 320°C temperature range 50-320°C 1-pole 1NO 16A probe ø 3mm probe L 219mm capillary pipe 900mm capillary pipe isolated 700mm gland nut shaft ø 6x4.6mm shaft L 23mm shaft position upper rotation 270°		



<b>GEV No.</b>	375505	<b>Ref. No.</b>	RG.A06042
<b>description</b>	thermostat t.max. 320°C temperature range 50-320°C 1-pole 1NO 16A probe ø 3mm probe L 160mm capillary pipe 870mm capillary pipe isolatedmm gland nut shaft ø 6x4.6mm shaft L 23mm shaft position upper rotation 270°		
<b>For models:</b>	WAFFLE1, WAFFLE2		

55.34\_ series



<b>GEV No.</b>	375002	<b>Ref. No.</b>	X68205
<b>description</b>	thermostat t.max. 320°C temperature range 55-320°C 1-pole 1NO 16A probe ø 3.1mm probe L 226mm capillary pipe 870mm capillary pipe isolated 850mm gland nut shaft L 23mm shaft position upper rotation 270°		
<b>For models:</b>	ACA2006, ACA2010, ACA2011		



<b>GEV No.</b>	375097	<b>Ref. No.</b>	X43800
<b>description</b>	thermostat t.max. 195°C temperature range 95-195°C 3-pole 3NO 16A probe ø 6mm probe L 117mm capillary pipe 1780mm capillary pipe isolated 1400mm gland nut M9x1 shaft ø 6x4.6mm shaft L 23mm shaft position upper rotation 270°		
<b>For models:</b>	ABC0003, ABC0005, ACC0003, ACC0008, ACC0009, ACC0010, AEC0001, AEC0002, SKF4E, SKF6E		



<b>GEV No.</b>	375453	<b>Ref. No.</b>	X43200 X43900
<b>description</b>	thermostat t.max. 308°C temperature range 100-300°C 3-pole 3NO 16A probe ø 6mm probe L 75mm capillary pipe 1150mm capillary pipe isolated gland nut shaft ø 6x4.6mm shaft L 23mm rotation 270° probe material SS		
<b>For models:</b>	ABH3001, ABH3002, ABH3003, ABH3004, ABH3005, ABH3006, ABH3007, ABH3008, ABH3009, ABK1001, ACA1004, ACA1005, ACA1006, ACA2007, ACH3001, ACH3002, ACH3003, ACH3004, ACH3005, ACH3006, ACH3007, ACH3018, ACH3019, ACH3020, ADA1004, ADA1005, ADA1006, ADA2005, ADA2008, ADA2010, ADH3001, ADH3002, ADH3003, ADH3004, ADH3005, ADH3006, AEH3001, AEH3002, AEH3003, AEH3004, AEH3005, AEH3006, C89E, K4FFE, SKT40E, SKT40EC, SKT40ER		



<b>GEV No.</b>	390062	<b>Ref. No.</b>	Y16300
<b>description</b>	safety thermostat switch-off temp. 235°C 1-pole 0.5A probe ø 6mm probe L 130mm capillary pipe 1800mm capillary pipe isolated 1500mm gland nut M9x1 probe SS		
<b>For models:</b>	ACC0005, AEC0001, AEC0002, AEC0003, AEC0004, AEC0005, AEC0006		
<b>accessories for</b>	390062		
	<b>GEV No.</b>	551083	<b>Ref. No.</b> —
	cap for safety thermostat thread M8x1		

safety thermostats

55.10/19\_ series



<b>GEV No.</b>	375282	<b>Ref. No.</b>	0000X43400
<b>description</b>	safety thermostat switch-off temp. 230°C 1-pole 16A probe ø 11mm probe L 28mm capillary pipe 850mm capillary pipe isolated 830mm gland nut probe screw-in probe probe thread M14x1		
<b>For models:</b>	ACC0001, ACC0002, ACC0006, ACC0007, ADC0001, ADC0002, AEC0007, AEC0008		
<b>accessories for</b>	375282		
	<b>GEV No.</b>	507313	<b>Ref. No.</b> —
	O-ring EPDM thickness 2.62mm ID ø 13.95mm Qty 1 pcs		
	<b>GEV No.</b>	510420	<b>Ref. No.</b> —
	gasket copper ED ø 19.9mm ID ø 14.3mm thickness 2mm Qty 1 pcs		
	<b>GEV No.</b>	521133	<b>Ref. No.</b> —
	nut thread M14x1.5 H 6mm WS 19 zinc-coated steel Qty 1 pcs		



<b>GEV No.</b>	375352	<b>Ref. No.</b>	X49500
<b>description</b>	safety thermostat switch-off temp. 245°C 1-pole 1NC 16A probe ø 6mm probe L 130mm capillary pipe 1200mm capillary pipe isolated 1200mm gland nut probe		
<b>For models:</b>	ABC0003, ABC0004, ABC0005, ACC0003, ACC0004, ACC0008, ACC0009, ACC0010, SKF2E4, SKF4E, SKF6E		

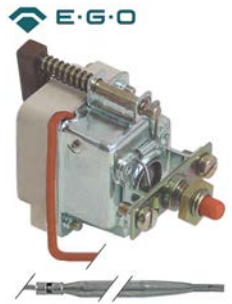

<b>GEV No.</b>	375353	<b>Ref. No.</b>	Y16500
<b>description</b>	safety thermostat switch-off temp. 355°C 1-pole 0.5A probe ø 4mm probe L 120mm capillary pipe 870mm capillary pipe isolated 870mm gland nut probe SS		
<b>For models:</b>	ADH3007, ADH3008, ADH3010, ADH3011, ADK2001, ADK2002, ADK2003, ADK2004, ADK2007, ADK2008, ADK2009, ADK2010, ADL0011, ADL0012, AEH3007, AEH3008, AEH3009, AEH3010, AEH3011, AEH3012, AEK2001, AEK2002, AEK2003, AEK2004, AEK2005, AEK2006, AEK2007, AEK2008, GFT49L, GFT49LC, GFT49R, GFT89L, GFT89LC, GFT89LR, KFT8GLR		

55.32\_ series



<b>GEV No.</b>	375290	<b>Ref. No.</b>	072027
<b>description</b>	safety thermostat switch-off temp. 240°C 3-pole 20A probe ø 6mm probe L 87mm capillary pipe 2000mm capillary pipe isolated 1800mm gland nut probe SS		
<b>For models:</b>	F10, F101, F1010, F10-1170, F101R, F102, F102R, F121, F12140, F121-4328, F121-4332, F121-4528, F121M, F121M-4345, F122, F122M, F18RBSI, F25, F25M, F28RBSI, F40M, F4710, F4715, F47GM, F47IR, F6710, F8715, F87IR, F88T, F8T, FR87IR, FRY101, FRY102, FRY121M-1171, FRY122, FRY122M-1172, FRY47IR-1164, FRY47IRG		



<b>GEV No.</b>	375252	<b>Ref. No.</b>	X44800
<b>description</b>	safety thermostat switch-off temp. 350°C 3-pole 20A probe ø 6mm probe L 89mm capillary pipe 3000mm capillary pipe isolated 960mm gland nut probe		
<b>For models:</b>	ABH3001, ABH3002, ABH3003, ABH3004, ABH3005, ABH3006, ABH3007, ABH3008, ABH3009, ACH3001, ACH3002, ACH3003, ACH3004, ACH3005, ACH3006, ACH3007, ACH3018, ACH3019, ACH3020, ADA1004, ADA1005, ADA1006, ADA2005, ADA2008, ADA2010, ADH3001, ADH3002, ADH3003, ADH3004, ADH3005, ADH3006, AEH3001, AEH3002, AEH3003, AEH3004, AEH3005, AEH3006, C89E, K4FFE, SKT40E, SKT40EC, SKT40ER		

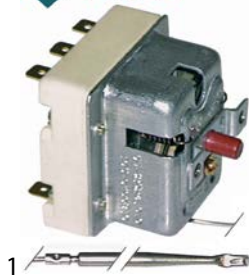

<b>GEV No.</b>	375350	<b>Ref. No.</b>	X49900
<b>description</b>	safety thermostat switch-off temp. 360°C 3-pole 20A probe ø 4mm probe L 120mm capillary pipe 1800mm capillary pipe isolated 1800mm gland nut probe SS		
<b>For models:</b>	ACK2003, BRE70		

56\_ series



<b>GEV No.</b>	375263	<b>Ref. No.</b>	072028
<b>description</b>	safety thermostat switch-off temp. 232°C 1-pole 16A probe ø 4mm probe L 91mm capillary pipe 510mm capillary pipe isolated 350mm gland nut		
<b>For models:</b>	F4, F44, F88M, F88T, F8M, FE4, FE44, FE6, FE66, FE8, FE88, FM4, FM8, FM8+8-1241, FM8-1240, FM88		



<b>GEV No.</b>	390610	<b>Ref. No.</b>	072028.1
<b>description</b>	safety thermostat switch-off temp. 235°C 1-pole 16A probe ø 3mm probe L 190mm capillary pipe 1000mm capillary pipe isolated 640mm gland nut probe SS		
<b>For models:</b>	F10, F101, F1010, F10-1170, F121, F121-4528, F121GM, F6, F6-1120, F66, F88T, F8T, FC4, FC6, FE6, FE8, FM4+4-1206, FM4-1205, FRY121G-1190, FRY121GTM-1191, FRY47IRGT-1162		

IMIT / TEMPOMATIC / ARTHERMO

control thermostats



<b>GEV No.</b>	390006	<b>Ref. No.</b>	072029
<b>description</b>	thermostat t.max. 86°C temperature range 0-86°C 1-pole 1CO 16A probe ø 6.5mm probe L 95mm capillary pipe 1500mm capillary pipe isolatedmm gland nut shaft ø 6x4.6mm shaft L 19mm rotation 270°		
<b>For models:</b>	BM1, BM1375, BM140, BM1-40-4304, BM1BSI, BM260, BM260BSI, BM-3GNI, BM3I, BM47, BM4GNI, BMZ200, BMZ2R, BMZ2R200, BMZ-4030, BMZR, BMZR200, BMZR-4035, CR32000C, CR3BMAB, LB350A, LB400, LB400EX, LBP500EX, LP1000, LP1300, LP500E, LP500EX, SVELTINA, TARC12, TARC16, TARC20		



<b>accessories for</b>	390006		
	<b>GEV No.</b>	110100	<b>Ref. No.</b> —
	knob thermostat t.max. 90°C 0-90°C ø 42mm shaft ø 6x4.6mm shaft flat -135° black		

Table continues overleaf





accessories for	390006			
	GEV No.	110105	Ref. No.	—
	rosette knob ø 42mm ø 56mm zero mark			

accessories

probe clips

spring clips

for thermostat

	1		
<b>GEV No.</b>	550041	<b>Ref. No.</b>	063001
<b>description</b>	probe clip for pipe ø 7mm for probe ø 6mm		
<b>For models:</b>	F10, F101, F1010, F10-1170, F101R, F102, F102R, F121, F12140, F121-4328, F121-4332, F121-4528, F121M, F121M-4345, F122, F122M, F18RBSI, F25, F25M, F28RBSI, F4, F40M, F44, F4710, F6, F6-1120, F66, F6710, F88M, F88T, F8M, F8T, FC4, FC6, FE4, FE44, FE6, FE66, FE8, FE88, FM4, FM4+4-1206, FM4-1205, FM8, FM8+8-1241, FM8-1240, FM88, FRY101, FRY102, FRY121M-1171...(Other models you can see in the webshop)		

	1		
<b>GEV No.</b>	550258	<b>Ref. No.</b>	M86500
<b>description</b>	probe clip for pipe ø 8mm for probe ø 6mm		
<b>For models:</b>	ABC0003, ABC0004, ABC0005, ACC0003, ACC0004, ACC0008, ACC0009, ACC0010, AEC0001, AEC0002, SKF2E4, SKF4E, SKF6E		

capillary tube clips

	1		
<b>GEV No.</b>	550138	<b>Ref. No.</b>	063002
<b>description</b>	capillary tube clip for pipe ø 8.5mm for circular tube heating elements		
<b>For models:</b>	F10, F101, F1010, F10-1170, F101R, F102, F102R, F121, F12140, F121-4328, F121-4332, F121-4528, F121M, F121M-4345, F122, F122M, F18RBSI, F25, F25M, F28RBSI, F4, F40M, F44, F4710, F6, F6-1120, F66, F6710, F88M, F88T, F8M, F8T, FC4, FC6, FE4, FE44, FE6, FE66, FE8, FE88, FM4, FM4+4-1206, FM4-1205, FM8, FM8+8-1241, FM8-1240, FM88, FRY101, FRY102, FRY121M-1171...(Other models you can see in the webshop)		



connecting bows

	1		
<b>GEV No.</b>	550060	<b>Ref. No.</b>	063016
<b>description</b>	connecting bow long for thermostat Qty 1 pcs		
<b>For models:</b>	BSC4FC, BS-C4FE-4563, BSC4FG, BSC4FV, C5FE, FE6, FE8, FR87IR, FT1, FT140, FT1-4356, FT1C, FT1C40, FT1R, FT1R40, FT1R-4357, FT2CI, FT2L, FT2LC, FT2LR, FT47C, FT47L, FT47R, GY30EIR, GY80EIR, PIZZA41, PIZZA41S, PIZZA42, PIZZA42S, PIZZA61S, PIZZA62, PIZZA62S, SP40Y-5008, TOP60FTC, TOP60FTLR		



switches and momentary switches

rocker/momentary rocker switches

30x11mm

	1			
<b>GEV No.</b>	301010	<b>Ref. No.</b>	009973.05	
<b>description</b>	rocker switch mounting measurements 30x11mm red 1NO/indicator light 250V 16A 0-I connection male faston 6.3mm ambient temperature max. 85/125°C protection IP40			
<b>accessories for</b>	301010			
	GEV No.	301035	Ref. No.	—
	protective cover mounting measurements 30x11mm			



30x22mm



	1			
<b>GEV No.</b>	301002	<b>Ref. No.</b>	073013	
<b>description</b>	rocker switch mounting measurements 30x22mm orange 2NO 250V 16A illuminated 0-I connection male faston 6.3mm ambient temperature max. 85/125°C protection IP65			
<b>For models:</b>	BM4I, RG100, RG105, RG70, RG80			
<b>accessories for</b>	301002			
	GEV No.	301036	Ref. No.	—
	protective cover internal size 30x22mm for rocker switch mounting measurementsmm			

	1		
<b>GEV No.</b>	301016	<b>Ref. No.</b>	073025
<b>description</b>	rocker switch mounting measurements 30x22mm orange 2CO 250V 16A illuminated connection male faston 6.3mm ambient temperature max. 125/55°C protection IP40		
<b>For models:</b>	BSC4FC, BSC4FE, BS-C4FE-4563, BSC4FG, BSC4FV, BSC6FG, C5FE		



	1		
<b>GEV No.</b>	301060	<b>Ref. No.</b>	073004
<b>description</b>	rocker switch mounting measurements 30x22mm red 2NO 250V 16A illuminated connection male faston 6.3mm ambient temperature max. 125/55°C protection IP40		
<b>For models:</b>	BMC, BMCR, BMCR-4042, BME100, BME100C, BME23100, BME23150, BMZ, BMZ200, BMZ2R, BMZ2R200, BMZ-4030, BMZR, BMZR200, BMZR-4035, COMP2GN, COMP2GN-9805, COMP3E, COMP3E-9746, COMP3GN, COMP3GN-9806, CP67EM-7260, CP67EM-7560, CP67M, CSP80-A-5001, DIAM1, DIAM150, DIAM150-9770, DIAM2, DIAM-2GCSS, DIAM2PG, DIAM2PG-9795, DIAM3, DIAM3PG, DIAM3PG-9796, DIAM4, DIAM40-9755, DIAM40BT-9748, DIAM60, DIAM75, DIAM75-2P-9798, DIAM75-9765, DIAM75BT-9815, DIAMV120, DIAM-V120-9853, DIAMV165, DIAM-V165-9785, DIAMV220, DIAM-V220-9786, F4...(Other models you can see in the webshop)		



labelled			
			
1			
<b>GEV No.</b>	300125	<b>Ref. No.</b>	R25-0010 X50800
<b>description</b>	rocker switch mounting measurements 30x22mm green 2NO 230V 16A 0-I connection male faston 6.3mm ambient temperature max. 125/55°C protection IP65 with cover cap		
<b>For models:</b>	ABD0001, ACB0002, ACB0003, ACB0004, ACB0005, ADC0001, ADC0002, HD140A, HD70A, HE140A, HE70A, SKP40E		
<b>accessories for</b>	300125		
	<b>GEV No.</b>	301036	<b>Ref. No.</b> —
	protective cover internal size 30x22mm for rocker switch mounting measurementsmm		



			
1			
<b>GEV No.</b>	345747	<b>Ref. No.</b>	073009 073018
<b>description</b>	rocker switch mounting measurements 30x22mm red/red 1NO/NO 250V 16A with LED 0-I/0-II connection male faston 6.3mm ambient temperature max. 125/55°C protection IP40		
<b>For models:</b>	T3, T3-2046, T3-2050, T6, T6-2048, T6-2052, TE3-2072, TE3G-2072G, TE6, TE6G-2073G		
<b>accessories for</b>	345747		
	<b>GEV No.</b>	301036	<b>Ref. No.</b> —
	protective cover internal size 30x22mm for rocker switch mounting measurementsmm		

### push/momentary push switches

ø22mm			
			
1			
<b>GEV No.</b>	401357	<b>Ref. No.</b>	AM.F2138
<b>description</b>	momentary push switch mounting measurements ø22mm 1NO/1NC/indicator light 400V 4A indicator lamp 24V 0-I connection screw ambient temperature max. 125/55°C protection IP40		
<b>For models:</b>	FGS106, TG12, TG12R, TS12, TS22		
<b>spare parts for</b>	401357		
	<b>GEV No.</b>	346181	<b>Ref. No.</b> —
	push button mounting ø 21mm external size 30x55mm oval		
<b>accessories for</b>	401357		
	<b>GEV No.</b>	401709	<b>Ref. No.</b> —
	protective cover external size 57x32mm internal size 47x22mm matt finish rubber H 27.5mm		



### microswitches

#### pin-plunger actuated

M10			
			
1			
<b>GEV No.</b>	345678	<b>Ref. No.</b>	073003 073017
<b>description</b>	microswitch with plunger thread M10x0.75 thread L 16mm 250V 16A 1NO connection male faston 6.3mm stroke 2.5mm mounting distance 22mm ambient temperature max. 125°C actuating force: 290g		
<b>For models:</b>	BSC6FG, CO511, CO511Y, F10, F101, F1010, F10-1170, F101R, F102, F102R, F121, F12140, F121-4328, F121-4332, F121-4528, F121M, F121M-4345, F122, F122M, F18RBSI, F25, F25M, F28RBSI, F4, F40M, F44, F4710, F6, F6-1120, F66, F6710, F8715, F88M, F88T, F8M, F8T, FC4, FC6, FE4, FE44, FE6, FE66, FE8, FE88, FM4, FM4+4-1206, FM4-1205, FM8, FM8+8-1241, FM8-1240...(Other models you can see in the webshop)		
<b>accessories for</b>	345678		
	<b>GEV No.</b>	100779	<b>Ref. No.</b> —
	nut thread M10x0.75 H 3mm WS 14 SS Qty 2 pcs		

			
1			
<b>GEV No.</b>	345032	<b>Ref. No.</b>	FX.1519
<b>description</b>	microswitch with plunger thread M10x1 thread L 12mm 250V 16A 1CO connection male faston 6.3mm stroke 7mm mounting distance 22mm L 28mm ambient temperature max. 125°C type SP9603 actuating force: 180g		
<b>For models:</b>	ABR511		

#### M12

			
1			
<b>GEV No.</b>	345350	<b>Ref. No.</b>	R31600
<b>description</b>	microswitch with plunger mounting distance 22mm thread M12x0.75 thread L 16mm 250V 16A 1CO connection male faston 6.3mm stroke 4mm ambient temperature max. 125°C type EF83161.3 actuating force: 66g		
<b>For models:</b>	ABK3001, ABK3002, ACK3001, ACK3002, ACK3003, ACK3004		
<b>accessories for</b>	345350		
	<b>GEV No.</b>	345351	<b>Ref. No.</b> —
	nut thread M12x0.75 H 1.6mm WS 14 chrome-plated brass Qty 1 pcs		



with push button

switches with snap-fit



1			
<b>GEV No.</b>	346772	<b>Ref. No.</b>	R25-0086
<b>description</b>	microswitch with push button 250V 5A 1CO connection male faston 4.8mm L 24x27mm ambient temperature max. 85°C actuating force: 160g		
<b>For models:</b>	HD140A, HD70A, HE140A, HE70A		

cam switches

on/off

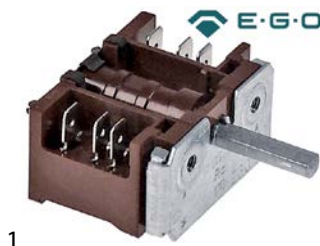

1			
<b>GEV No.</b>	301115	<b>Ref. No.</b>	073015.46
<b>description</b>	cam switch 2 operating positions 2NO sequence 0-1 16A shaft ø 6x4.6mm shaft L 23mm connection male faston 6.3mm		
<b>For models:</b>	F6, F6-1120, F66, FC4, FC6, FE4, FE44, FE6, FE66, FE8, FE88, FM4, FM4+4-1206, FM4-1205, FM8, FM8+8-1241, FM8-1240, FM88, PANINI1C, PANINIMC, PANINIMC-2004		



1			
<b>GEV No.</b>	300129	<b>Ref. No.</b>	073016
<b>description</b>	cam switch 2 operating positions 2NO sequence 0-1 16A shaft ø 6x4.6mm shaft L 23mm connection male faston 6.3mm ceramic		
<b>For models:</b>	BM1, BM1375, BM140, BM1-40-4304, BM11, BM260, BM3GNI, BM3I, BM47, BM4GNI, BM4I, BM60I, BM67, BME23100, CO323, CO511, CO60C, CP1, CP1-4330, CP1I, CP67GM, CREP1E, CREP1E400, DOPPI-AVTC, F10, F101, F1010, F10-1170, F101R, F102, F102R, F121, F12140, F121-4328, F121-4332, F121-4528, F121M, F121M-4345, F122, F122GTM, F122M, F18RBSI, F28RBSI, F47GM, F47IR, F88M, F88T, F8M, F8T, FRY101...(Other models you can see in the webshop)		

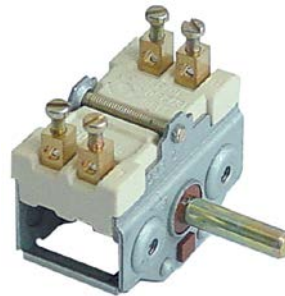

1			
<b>GEV No.</b>	300151	<b>Ref. No.</b>	X51300
<b>description</b>	cam switch 2 operating positions 2NO sequence 0-1 16A shaft ø 6x4.6mm shaft L 23mm connection screw ceramic		
<b>For models:</b>	ADK2001, ADK2002, ADK2003, ADK2004, ADK2007, ADK2008, ADK2009, ADK2010, AEK2001, AEK2002, AEK2003, AEK2004, AEK2005, AEK2006, AEK2007, AEK2008		



1			
<b>GEV No.</b>	300176	<b>Ref. No.</b>	073005
<b>description</b>	cam switch 2 operating positions 4NO sequence 0-1 16A shaft ø 6x4.6mm shaft L 23mm connection screw		
<b>For models:</b>	CP1-4330, CP47M, CP67EM-7260, CP67EM-7560, CP67M, CREP2E, F101R, F102R, F18RBSI, F25, F25M, F28RBSI, F40M, F4710, F4715, F471R, F6710, F8715, F871R, FT67L, FT67LC, FT67LR, FT87LC, FT87LR, RG100, RG105, RG70, RG80		

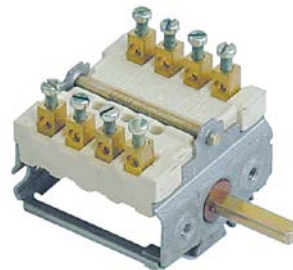

1			
<b>GEV No.</b>	345665	<b>Ref. No.</b>	X40700
<b>description</b>	cam switch 2 operating positions 4NO sequence 0-1 16A shaft ø 6x4.6mm shaft L 23mm connection screw		
<b>For models:</b>	ABK3001, ACK3001, ACK3004		



1			
<b>GEV No.</b>	300095	<b>Ref. No.</b>	X40600
<b>description</b>	cam switch ON-OFF connection screw clamp		
<b>For models:</b>	ABK3002, ACK3002, ACK3003		

4-position



<b>GEV No.</b>	300007	<b>Ref. No.</b>	X44000
<b>description</b>	cam switch 4 operating positions 1NO/2CO sequence 0-1-2-3 16A shaft $\varnothing$ 6x4.6mm shaft L 23mm connection male faston 6.3mm 4-position ceramic		
<b>For models:</b>	ACE0003, ACE0004, ACE0008, ADE0003, ADE0004, AEE0001, AEE0002		



<b>GEV No.</b>	300023	<b>Ref. No.</b>	073055
<b>description</b>	cam switch 4 operating positions 1NO/2CO sequence 0-1-2-3 16A shaft $\varnothing$ 6x4.6mm shaft L 23mm connection screw 4-position ceramic		

7-position





<b>GEV No.</b>	300004	<b>Ref. No.</b>	X54100
<b>description</b>	cam switch 7 operating positions 1NO/2CO sequence 0-1-2-3-4-5-6 16A shaft $\varnothing$ 6x4.6mm shaft L 23mm connection male faston 6.3mm 7-position ceramic		
<b>For models:</b>	ABJ0003, ABJ0004, ACA1001, ACA1002, ACA1004, ACA1005, ACJ0005, ACJ0007, ACJ0008, ADA1001, ADA1003, ADA1004, ADA1006, AEA1001, AEA1003, AEA1005, C89E, K2P, K4FFE, K4P, PC49E, PC89E		



<b>GEV No.</b>	300025	<b>Ref. No.</b>	073007
<b>description</b>	cam switch 7 operating positions 1NO/2CO sequence 0-1-2-3-4-5-6 16A shaft $\varnothing$ 6x4.6mm shaft L 23mm connection screw 7-position ceramic		
<b>For models:</b>	BSC4FC, BSC4FE, BS-C4FE-4563, C127E, C1E, C2E, C2EF, C3E, C3EF, C5FE, C87E, HP1, HP1E, HP2E, PC127E, PC1E, PC1E-4520, PC1EBSI, PC1V40, PC1VBSI, PC2E, PC2EBSI, PC2V, PC2VBSI, PC47E, PC4E, PC87E, TOP2E, TOP2V, TOP4E, TOPE, TOPV, WBC		

<b>accessories for</b>	300025		
	<b>GEV No.</b>	112172	<b>Ref. No.</b> —
	knob universal $\varnothing$ 70mm black without adaptor/dial plate		

<b>accessories for</b>	300025		
	<b>GEV No.</b>	112213	<b>Ref. No.</b> —
	knob dial plate silver switch 7-position t.max.°C ED $\varnothing$ 63mm ID $\varnothing$ 45.5mm		
	<b>GEV No.</b>	112311	<b>Ref. No.</b> —
	knob adapter shaft $\varnothing$ 6x4.6mm L 0mm with spring		

4 operating positions



<b>GEV No.</b>	300081	<b>Ref. No.</b>	X44100
<b>description</b>	cam switch 4 operating positions 3NO/2CO sequence 0-1-2-3 16A shaft $\varnothing$ 6x4.6mm shaft L 23mm connection screw		
<b>For models:</b>	ACA1004, ACA1005, ACA1006, ACA2007, ADA1004, ADA1005, ADA1006, ADA2005, ADA2008, ADA2010, C89E, K4FFE		

10 operating positions



<b>GEV No.</b>	345666	<b>Ref. No.</b>	073034 X68204
<b>description</b>	cam switch 10 operating positions 6NO/1CO sequence 0-1-2-3-4-5-6-7-8-9 8A shaft $\varnothing$ 6x4.6mm shaft L 23mm connection male faston 6.3mm plastic		
<b>For models:</b>	ACA2006, ACA2010, ACA2011, BSC4FE80, C127FE, C127FV, C87FE, C87FV, C87VFE		

operation switches



<b>GEV No.</b>	300002	<b>Ref. No.</b>	X40900
<b>description</b>	cam switch 2 operating positions 4NO 16A sequence 0-1 shaft $\varnothing$ 6x4.6mm shaft L 23mm connection male faston 6.3mm ceramic		
<b>For models:</b>	ABH3001, ABH3002, ABH3003, ABH3004, ABH3005, ABH3006, ABH3007, ABH3008, ABH3009, ABK1001, ACH3001, ACH3002, ACH3003, ACH3004, ACH3005, ACH3006, ACH3007, ACH3018, ACH3019, ACH3020, ACK2003, BRE70, SKT40E, SKT40EC, SKT40ER		

1

<b>GEV No.</b>	300080	<b>Ref. No.</b>	X49700
<b>description</b>	cam switch 2 operating positions 4NO 16A sequence 0-1 shaft $\varnothing$ 6x4.6mm shaft L 23mm connection screw operation switch ceramic ambient temperature max. 150°C		
<b>For models:</b>	ACA1004, ACA1005, ACA1006, ACA2007, ADA1004, ADA1005, ADA1006, ADA2005, ADA2008, ADA2010, ADH3001, ADH3002, ADH3003, ADH3004, ADH3005, ADH3006, AEH3001, AEH3002, AEH3003, AEH3004, AEH3005, AEH3006, C89E, K4FFE		
<b>accessories for</b>	300080		
		<b>GEV No.</b>	551456 <b>Ref. No.</b> —
	gasket for switch ED $\varnothing$ 14mm ID $\varnothing$ 2.5mm thickness 3.5mm white		



1

<b>GEV No.</b>	300200	<b>Ref. No.</b>	073015
<b>description</b>	operation switch 2 operating positions 2NO 16A sequence 0-1 shaft $\varnothing$ 6x4.6mm shaft L 23mm connection male faston 6.3mm operation switch ceramic		
<b>For models:</b>	BSC4FC, BSC4FE, BS-C4FE-4563, BSC4FG, BSC4FV, BSC6FG, C5FE, CG312E, CO1, CP67EM-7560, F49E, F89E, FE6, FE8, FR87IR, FT1, FT140, FT1-4356, FT1BSI, FT1C, FT1C40, FT1CBSI, FT1R, FT1R40, FT1R-4357, FT1RBSI, FT2CBSI, FT2CI, FT2L, FT2LBSI, FT2LC, FT2LR, FT2LRB-SI, FT47C, FT47L, FT47R, GY80EIR, PIZZA41, PIZZA41S, PIZZA42, PIZZA42S, PIZZA61S, PIZZA62, PIZZA62S, SP40Y, SP40Y-5008, SP80Y, TOP60FT, TOP60FTC, TOP60FTC-4262...(Other models you can see in the webshop)		



1

<b>GEV No.</b>	300091	<b>Ref. No.</b>	Y16200
<b>description</b>	operation switch EGO 2 operating positions 2NO 16A sequence 0-1 shaft $\varnothing$ 6x4.6mm shaft L 23mm connection screw ceramic		

## control equipment

### GENERAL ELECTRIC (AEG)



1



<b>GEV No.</b>	345779	<b>Ref. No.</b>	079003
<b>description</b>	contact block GENERAL ELECTRIC P9B10VN 1NO max 400V 10A brown		
<b>For models:</b>	SAM650, SAM650-2158, SAM650G, SAM650G-2623		

### GIOVENZANA

#### switches (complete)



1

<b>GEV No.</b>	401357	<b>Ref. No.</b>	AM.F2138
<b>description</b>	momentary push switch mounting measurements $\varnothing$ 22mm 1NO/1NC/indicator light 400V 4A indicator lamp 24V 0-1 connection screw ambient temperature max. 125/55°C protection IP40		
<b>For models:</b>	FGS106, TG12, TG12R, TS12, TS22		
<b>spare parts for</b>	401357		
		<b>GEV No.</b>	346181 <b>Ref. No.</b> —
	push button mounting $\varnothing$ 21mm external size 30x55mm oval		
<b>accessories for</b>	401357		
		<b>GEV No.</b>	401709 <b>Ref. No.</b> —
	protective cover external size 57x32mm internal size 47x22mm matt finish rubber H 27.5mm		

## lamps

### indicator lights

#### indicator lights (complete)

$\varnothing$  9mm





1

<b>GEV No.</b>	359136	<b>Ref. No.</b>	076025
<b>description</b>	indicator light $\varnothing$ 9mm 230V green connection male faston 6.3mm temp.-resist. 120°C		
<b>For models:</b>	BM1, CO323, CO60FU, CO80FU, DOPPIAVTC, F101R, F102R, F121-4328, F121-4332, F121GM, F121M-4345, F25, F88T, FE6, FRIT0001, FRY121M-1171, FRY122M-1172, FT140, FT1C40, FT1R40, GEM646X, GY-INO10E-9841, LB350A, LB400, LB400EX, LBP500EX, LP1000, LP1000X, LP1300, LP500E, LP500EX, MEDIAVTC, RAP1500, RAP400, RAP450, RAP600, RG100, RG80, SA650-2155, SVELTINA, TOPFTC, TOPFTR		

			
<b>GEV No.</b>	359137	<b>Ref. No.</b>	076026
<b>description</b>	indicator light ø 9mm 230V yellow connection male faston 6.3mm temp.-resist. 120°C with lens		
<b>For models:</b>	BM1, BMZ2R200, BMZR200, CO60FU, CO80FU, CP140, DOPPIAVTC, F101R, F102R, F121-4328, F121-4332, F121GM, F121M-4345, F25, F88T, FRIT0001, FRY121M-1171, FRY122M-1172, FT140, FT1C40, FT1R40, GY-INO10E-9841, LB350A, LB400, LP1000, LP1000X, LP1300, LP500E, LP500EX, MEDIAVTC, PC1E, PC1V40, PC2E, PC2V, RAP1500, RAP400, RAP450, RAP600, RG100, RG80, SA650-2155, STARROLLY5, STARROLLY8, SVELTINA, TOP2E, TOP2V, TOPFTC, TOPFTR		

ø12mm  
with screw socket

			
<b>GEV No.</b>	359026	<b>Ref. No.</b>	076004
<b>description</b>	indicator light ø 12mm 230V red connection male faston 6.3mm model CM/5		
<b>For models:</b>	CP47GM, CP67GM, F121GM, F122GTM, F47GM, F87GM, FRY121G, FRY121G-1190, FRY121GM, FRY47IRG, TOPFTGL, TOPFTGLC		

			
<b>GEV No.</b>	359048	<b>Ref. No.</b>	076006
<b>description</b>	indicator light ø 12mm 230V yellow connection male faston 6.3mm		
<b>For models:</b>	BM1, BM1375, BM140, BM1-40-4304, BM1BSI, BM11, BM260, BM260BSI, BM21, BM3GNI, BM31, BM47, BM4GNI, BM41, BM60I, BM67, BMCR-4042, BME150ZAV, BME23100, BMZ, BMZ200, BMZ2R, BMZ-4030, BMZR, BMZR200, BMZR-4035, BSC4FC, BSC4FE, BS-C4FE-4563, BSC4FE80, BSC4FG, BSC4FV, C127E, C127FE, C127FV, C1E, C2E, C2EF, C3EF, C5FE, C87E, C87FE, C87FV, C87VFE, CG312E, CO60C, CP1, CP140, CP1-4330, CP1BSI...(Other models you can see in the webshop)		

			
<b>GEV No.</b>	359027	<b>Ref. No.</b>	076005
<b>description</b>	indicator light ø 12mm 250V green connection male faston 6.3mm		
<b>For models:</b>	BM1, BM1375, BM140, BM1-40-4304, BM1BSI, BM11, BM260, BM260BSI, BM21, BM3GNI, BM31, BM47, BM4GNI, BM41, BM60I, BM67, BSC4FC, BSC4FE, BS-C4FE-4563, BSC4FE80, BSC4FG, BSC4FV, C127E, C127FE, C1E, C2EF, C3EF, C5FE, C87E, C87FE, C87FV, C87VFE, CG312E, CO60C, CP1, CP140, CP1-4330, CP1BSI, CP11, CP47GM, CP47M, CP67EM-7260, CP67EM-7560, CP67GM, CP67M, CR32000C, CREP1E, CREP1E400, CREP2E, F10...(Other models you can see in the webshop)		

with plug-in socket			
			
<b>GEV No.</b>	359041	<b>Ref. No.</b>	RG.A08009 X50900
<b>description</b>	indicator light ø 12mm green 230V connection male faston 6.3mm temp.-resist. 120°C Qty 1 pcs		
<b>For models:</b>	ABC0003, ABC0004, ABC0005, ABH3001, ABH3002, ABH3003, ABH3004, ABH3005, ABH3006, ABH3007, ABH3008, ABH3009, ABJ0003, ABJ0004, ABJ0005, ABJ0006, ABK1001, ABK3001, ABK3002, ACA1001, ACA1002, ACA1003, ACA1004, ACA1005, ACA1006, ACA1010, ACA2006, ACA2007, ACA2010, ACA2011, ACC0003, ACC0004, ACC0005, ACC0008, ACC0009, ACC0010, ACE0003, ACE0004, ACE0008, ACH3001, ACH3002, ACH3003, ACH3004, ACH3005, ACH3006, ACH3007, ACH3018, ACH3019, ACH3020, ACJ0005...(Other models you can see in the webshop)		

			
<b>GEV No.</b>	359043	<b>Ref. No.</b>	RG.A08008
<b>description</b>	indicator light ø 12mm red 230V connection male faston 6.3mm temp.-resist. 120°C Qty 1 pcs		
<b>For models:</b>	WAFFLE1, WAFFLE2		

			
<b>GEV No.</b>	359042	<b>Ref. No.</b>	X41200
<b>description</b>	indicator light ø 12mm yellow 230V connection male faston 6.3mm temp.-resist. 120°C Qty 1 pcs		
<b>For models:</b>	ABC0003, ABC0004, ABC0005, ABH3001, ABH3002, ABH3003, ABH3004, ABH3005, ABH3006, ABH3007, ABH3008, ABH3009, ABK1001, ABK3001, ABK3002, ACA1004, ACA1005, ACA1006, ACA2006, ACA2007, ACA2010, ACA2011, ACB0002, ACB0003, ACB0004, ACB0005, ACC0003, ACC0004, ACC0005, ACC0008, ACC0009, ACC0010, ACH3001, ACH3002, ACH3003, ACH3004, ACH3005, ACH3006, ACH3007, ACH3018, ACH3019, ACH3020, ACK2003, ACK3001, ACK3002, ACK3003, ACK3004, ADA1004, ADA1005, ADA1006...(Other models you can see in the webshop)		

screw-on/push-on fit

light bulbs  
for ovens

			
<b>GEV No.</b>	359610	<b>Ref. No.</b>	076007
<b>description</b>	light bulb t.max. 300°C socket E14 15W 230V ø 22mm L 47mm lens L 20mm for oven lamp type Philips		
<b>For models:</b>	BSC4FE, BSC6FG, CO60C, CO60FU, CO80FU		



linear lamps

halogen lamps



1			
<b>GEV No.</b>	359305	<b>Ref. No.</b>	076018
<b>description</b>	halogen lamp socket R7s L 78.3mm 230V 60W IMPORT		
<b>For models:</b>	PIZZA41, PIZZA41S, PIZZA42, PIZZA42S, PIZZA61S, PIZZA62, PIZ- ZA62S		

fluorescent lamps

fluorescent lamps

G23





1			
<b>GEV No.</b>	359933	<b>Ref. No.</b>	009973.03
<b>description</b>	fluorescent lamp socket G23 L 237mm 11W 230V		

oven lamps

universal oven lamps

mounting diameter 35.5mm



1			
<b>GEV No.</b>	359718	<b>Ref. No.</b>	076008
<b>description</b>	oven lamp mounting ø 35.5mm 230V 15W socket E14 temp.-resist. 300°C connection male faston 6.3mm hard glas		
<b>For models:</b>	BSC4FE, BSC6FG		
<b>spare parts for</b>	359718		
	<b>GEV No.</b>	359701	<b>Ref. No.</b> —
	lamp socket socket E14 220-230V mounting ø 35.5mm connection male faston 6.3mm 15W		
	<b>GEV No.</b>	359740	<b>Ref. No.</b> —
	light bulb t.max. 300°C socket E14 15W 230V ø 22mm L 48mm lens L 20mm for oven lamp IMPORT		

lamps

light bulbs



1			
<b>GEV No.</b>	359610	<b>Ref. No.</b>	076007
<b>description</b>	light bulb t.max. 300°C socket E14 15W 230V ø 22mm L 47mm lens L 20mm for oven lamp type Philips		
<b>For models:</b>	BSC4FE, BSC6FG, CO60C, CO60FU, CO80FU		

residual heat indicators



1			
<b>GEV No.</b>	359326	<b>Ref. No.</b>	Y12506
<b>description</b>	residual heat indicator 4-fold		
<b>For models:</b>	ACA1006, ACA1010		





1			
<b>GEV No.</b>	359096	<b>Ref. No.</b>	Y12209 Y12410
<b>description</b>	residual heat indicator single		
<b>For models:</b>	ABJ0005, ABJ0006, ACA1003, ACJ0006		

timers

mechanical timers



1			
<b>GEV No.</b>	350032	<b>Ref. No.</b>	073008
<b>description</b>	timer M2 2-pole operation time 15min impulse mechanical 2NO at 250V 16A permanent position no shaft ø 6x4.6mm shaft 6x4.6mm shaft L 18mm mounting distance 28mm connection rear		
<b>For models:</b>	S9KER, ST450A, T11GN, T23GN, T3, T3-2046, T3-2050, T6, T6-2048, T6-2052, T6CB, T9, T92, T9-2051, T92GN, TE3, TE3-2072, TE3G-2072G, TE6, TE6G-2073G		
<b>accessories for</b>	350032		
	<b>GEV No.</b>	110366	<b>Ref. No.</b> —
	knob switch zero mark t.max. °C ø 44mm shaft ø 6x4.6mm shaft flat upper black		
	<b>GEV No.</b>	110371	<b>Ref. No.</b> —
	dial plate graduation 15min permanent position no rotation 30-330° ø 60mm timers knob ø 45mm		



## contactors

## GENERAL ELECTRIC (AEG)

## power contactors



1

<b>GEV No.</b>	380244	<b>Ref. No.</b>	Y10000
<b>description</b>	power contactor resistive load 25A 230VAC (AC3/400V) 9A/4kW main contacts 3NO auxiliary contacts 1NO connection screw connection type AEG LS4K 10A type GE CL00A 310		
<b>For models:</b>	ACC0005, ADK2001, ADK2002, ADK2003, ADK2004, AEC0003, AEC0004, AEC0005, AEC0006, AEK2001, AEK2002, AEK2003, AEK2004		



1

<b>GEV No.</b>	380262	<b>Ref. No.</b>	Y11100
<b>description</b>	power contactor resistive load 32A 230VAC (AC3/400V) 17A/7.5kW main contacts 3NO auxiliary contacts 1NC connection screw connection type AEG LS7K01A type GE CL02A 301 H 85mm		
<b>For models:</b>	ACC0005, ADK2001, ADK2002, ADK2003, ADK2004, AEC0003, AEC0004, AEC0005, AEC0006, AEK2001, AEK2002, AEK2003, AEK2004		



1

<b>GEV No.</b>	380261	<b>Ref. No.</b>	X55300
<b>description</b>	power contactor resistive load 32A 230VAC (AC3/400V) 17A/7.5kW main contacts 3NO auxiliary contacts 1NO connection screw connection type AEG LS7K 10A type GE CL02A 310		
<b>For models:</b>	ACK2003, BRE70		

## ISKRA (FANAL)

## power contactors



1

<b>GEV No.</b>	380213	<b>Ref. No.</b>	073050
<b>description</b>	power contactor resistive load 20A 230VAC (AC3/400V) 8.5A/5.5kW main contacts 3NO auxiliary contacts 1NO connection screw connection type Fanal DSL7 10 type ISKRA K07M 10		
<b>For models:</b>	BM3I, BM4I, BME150ZAV, CO511Y, CP1, CP140, CP1-4330, CP1I, CP47M, CP67EM-7260, CP67EM-7560, CP67M, F10, F101, F1010, F10-1170, F101R, F102, F102R, F121, F12140, F121-4328, F121-4332, F121-4528, F121M, F121M-4345, F122, F122M, F18RBSI, F25, F25M, F28RBSI, F40M, F4710, F4715, F47GM, F47IR, F6710, F8715, F87IR, F88T, F8T, FR87IR, FRY101, FRY102, FRY121M-1171, FRY122, FRY122M-1172, FRY47IR-1164, FRY47IRG...(Other models you can see in the webshop)		

## relays

## power relays

## with bracket mounting



1

<b>GEV No.</b>	380687	<b>Ref. No.</b>	R35-0253
<b>description</b>	power relays FINDER 230VAC 30A 2NO connection F6.3 bracket mounting manuf. no. 66.82.8.230.0300		
<b>For models:</b>	HD140A, HD70A, HE140A		





## electronic controllers

### ELIWELL

#### refrigeration controllers

##### built-in version



1

<b>GEV No.</b>	378022	<b>Ref. No.</b>	R35-0156
<b>description</b>	electronic controller ELIWELL type ID974 mounting measurements 71x29mm 230V voltage AC NTC/PTC front measurements 33x75mm protection IP65 -50 up to +150°C display 3½ digits		
<b>For models:</b>	HD140A, HD70A, HE140A, HE70A		

### EVCO - EVERY CONTROL

#### refrigeration controllers

##### built-in version



1

<b>GEV No.</b>	378126	<b>Ref. No.</b>	072061
<b>description</b>	electronic controller EVERY CONTROL type EVK201N7 mounting measurements 71x29mm 230V voltage AC NTC/PTC relay outputs 1 CO-16A(5) NTC/PTC front measurements 33x75mm built-in depth 59mm protection IP65 -40 up to +105°C display 3½ digits		
<b>For models:</b>	COMP2GN, COMP2GN-9805, COMP3E, COMP3E-9746, COMP3GN, COMP3GN-9806, DIAM1, DIAM150, DIAM150-9770, DIAM2, DIAM-2GCS, DIAM2PG, DIAM2PG-9795, DIAM3, DIAM3PG, DIAM3PG-9796, DIAM4, DIAM40-9755, DIAM60, DIAM75, DIAM75-2P-9798, DIAM75-9765, DIAMV120, DIAM-V120-9853, DIAMV165, DIAM-V165-9785, DIAMV220, DIAM-V220-9786, SALAD108, SALAD95		
<b>accessories for</b>	378126		
	<b>GEV No.</b>	<b>Ref. No.</b>	—
	379053		
	temperature probe PTC 1kOhm cable PVC probe -50 up to +150°C cable -10 up to 100°C probe ø6x30mm cable length 3m without screw connection 2-wire		
	<b>GEV No.</b>	<b>Ref. No.</b>	—
	379064		
	temperature probe PTC 1kOhm cable silicone probe -50 up to +150°C cable -50 up to +180°C probe ø6x40mm cable length 3m without screw connection 2-wire		
	<b>GEV No.</b>	<b>Ref. No.</b>	R35-0227
	379161		
	temperature probe NTC 10kOhm cable thermoplastic probe -40 up to +110°C cable -40 up to +110°C probe ø6x14mm cable length 3m without screw connection 2-wire		
	<b>GEV No.</b>	<b>Ref. No.</b>	—
	379782		
	temperature probe PTC 1kOhm cable thermoplastic probe -50 up to +150°C cable -40 up to +110°C probe ø6x14mm cable length 3m 2-wire resistor 1kOhm		

## probes

### universal probes

#### temperature probes



<b>GEV No.</b>	379161	<b>Ref. No.</b>	R35-0227
<b>description</b>	temperature probe NTC 10kOhm cable thermoplastic probe -40 up to +110°C cable -40 up to +110°C probe ø6x14mm cable length 3m without screw connection 2-wire		
<b>For models:</b>	HD140A, HD70A, HE140A		

### producer-specific probes

#### probes



<b>GEV No.</b>	402191	<b>Ref. No.</b>	FR.62040411
<b>description</b>	temperature probe PTC 2kOhm cable TPE probe -50 up to +150°C cable -40 up to +110°C connection plug thread probe ø5x20mm cable length 1.8m		
<b>For models:</b>	FL8025		



<b>GEV No.</b>	402005	<b>Ref. No.</b>	FR.62040410
<b>description</b>	temperature probe PTC 2kOhm cable TPE probe -50 up to +150°C cable -40 up to +110°C connection plug thread probe ø6x50mm cable length 1.6m		
<b>For models:</b>	FL8025		

### Hall sensors



1

<b>GEV No.</b>	402044	<b>Ref. No.</b>	FR.62040403
<b>description</b>	Hall sensor L 29mm W 26mm H 26mm mounting distance 10mm cable length 1250mm		
<b>For models:</b>	FL8025		



## electronics

## housing for PCBs



1

<b>GEV No.</b>	694356	<b>Ref. No.</b>	009973.09
<b>description</b>	housing for PCB L 144mm W 130mm H 75mm plastic		

## PCBs



1

<b>GEV No.</b>	692027	<b>Ref. No.</b>	009451.42
<b>description</b>	PCB dough rolling machine STP30/40 new edition 230V		
<b>For models:</b>	STP30, STP40		



1

<b>GEV No.</b>	401359	<b>Ref. No.</b>	AM.F2140
<b>description</b>	PCB meat mincer/cheese grater T12 230V		
<b>For models:</b>	FGS106, TG12, TG12R, TS12, TS22		



1

<b>GEV No.</b>	401360	<b>Ref. No.</b>	AM.F2141
<b>description</b>	PCB Mod.12 400V		
<b>For models:</b>	TS12		





1

<b>GEV No.</b>	401358	<b>Ref. No.</b>	AM.F2027
<b>description</b>	PCB Mod.8 230V		
<b>For models:</b>	TS8		

## central units



1

<b>GEV No.</b>	402004	<b>Ref. No.</b>	FR.62046202	
<b>description</b>	control box			
<b>For models:</b>	FL8025			
<b>accessories for</b>	402004			
	<b>GEV No.</b>	402005	<b>Ref. No.</b>	FR.62040410
	temperature probe PTC 2kOhm cable TPE probe -50 up to +150°C cable -40 up to +110°C connection plug thread probe ø6x50mm cable length 1.6m			
	<b>GEV No.</b>	402044	<b>Ref. No.</b>	FR.62040403
	Hall sensor L 29mm W 26mm H 26mm mounting distance 10mm cable length 1250mm			
	<b>GEV No.</b>	402191	<b>Ref. No.</b>	FR.62040411
	temperature probe PTC 2kOhm cable TPE probe -50 up to +150°C cable -40 up to +110°C connection plug thread probe ø5x20mm cable length 1.8m			



1

<b>GEV No.</b>	402942	<b>Ref. No.</b>	074154
<b>description</b>	control box for vegetable slicer 230V for Star 10		



## keypads

### front foils



1

<b>GEV No.</b>	401587	<b>Ref. No.</b>	009451.41
<b>description</b>	keypad foil dough rolling machine STP 30/40 P30/40/45/35 Start/Stop L 100mm W 80mm		
<b>For models:</b>	STP30, STP40		

### membrane keypads



1

<b>GEV No.</b>	401356	<b>Ref. No.</b>	AM.F2033
<b>description</b>	membrane keypad		
<b>For models:</b>	TS8		

### keypad units



1

<b>GEV No.</b>	401356	<b>Ref. No.</b>	AM.F2033
<b>description</b>	membrane keypad		
<b>For models:</b>	TS8		

## solenoïd valves

### solenoïd valves (refrigeration)

CEME

valves

with pipe clamp



1

<b>GEV No.</b>	370380	<b>Ref. No.</b>	R30-0031
<b>description</b>	solenoid valve straight CEME type 6806 230V p max 25bar connection 6mm soldering connection -45 up to +125°C refrigeration 50Hz		
<b>For models:</b>	HD140A, HD70A		

## compressors

### ACC/ZEL

R404a/R507

HMBP monophase

High/Medium evaporation temperature above -20/-15 °C



1

<b>GEV No.</b>	605014	<b>Ref. No.</b>	Q32-0434
<b>description</b>	compressor coolant R404a/R507 type ML80TB 220-240V 50Hz HMBP fully hermetic 11.4kg 3/8HP cylinder capacity 7.57cm <sup>3</sup> CSIR H 175.5mmW 261W 346W 446W 561W 691W 835W 993W 1167W test method ASHRAE ambient temperature max. 43°C		
<b>For models:</b>	HD140A		

### CUBIGEL

R404a/R507

HMBP monophase

High/Medium evaporation temperature above -20/-15 °C



1

<b>GEV No.</b>	605013	<b>Ref. No.</b>	Q32-0438
<b>description</b>	compressor coolant R404a/R507 type ML60TB 220-240V 50Hz HMBP fully hermetic 10.1kg 1/4HP power input 647W cylinder capacity 5.68cm <sup>3</sup> CSIR H 175.5mmW 244W 319W 407W 511W 628W 760W 906W 1067W test method ASHRAE		
<b>For models:</b>	HD70A		



## evaporation and condensing trays

### condensing trays heated

#### producer-specific



1

<b>GEV No.</b>	695271	<b>Ref. No.</b>	Q32-0196
<b>description</b>	condensing tray heated L 410mm W 300mm H 80mm 230V 230W		
<b>For models:</b>	HE140A, HE70A		

## fans



### hot air fans

#### miscellaneous

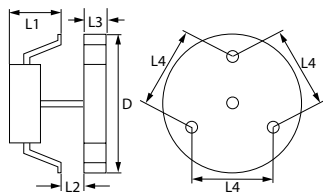

1



<b>GEV No.</b>	601054	<b>Ref. No.</b>	X68003
<b>description</b>	hot air fan 220-240V 32W 50/60Hz L1 60mm L2 10mm L3 25mm L4 87mm fan wheel ø 150mm FIME type C20X0E01/46		
<b>For models:</b>	ACA2006, ACA2010, ACA2011		
<b>spare parts for</b>	601054		
	<b>GEV No.</b>	601441	<b>Ref. No.</b> —
	fan wheel ø 150mm W 25mm shaft intake ø 6x5mm stainless steel blades 7		
<b>accessories for</b>	601054		
	<b>GEV No.</b>	550879	<b>Ref. No.</b> —
	insulation ø 130mm thickness 3mm hole ø 20mm for hot air fan		

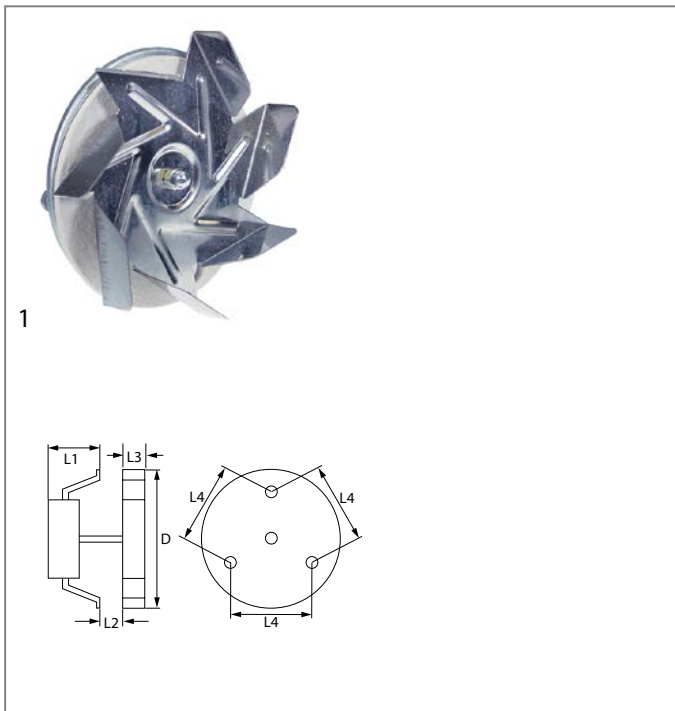

1

<b>GEV No.</b>	601123	<b>Ref. No.</b>	079510 079529
<b>description</b>	hot air fan 220-240V 47W 50/60Hz L1 80mm L2 12mm L3 20mm L4 87mm fan wheel ø 150mm FIME type C30R6086		
<b>For models:</b>	BSC4FC, BSC4FE, BS-C4FE-4563, BSC4FG, BSC4FV, BSC6FG, C127FE, CO60C		
<b>spare parts for</b>	601123		
	<b>GEV No.</b>	550879	<b>Ref. No.</b> —
	insulation ø 130mm thickness 3mm hole ø 20mm for hot air fan		

## motors

### gear motors

#### for grills



1

<b>GEV No.</b>	500498	<b>Ref. No.</b>	079501
<b>description</b>	gear motor shaft ø 24mm L 180mm W 105mm H 95mm		



for gyros grills



1			
<b>GEV No.</b>	500868	<b>Ref. No.</b>	079515
<b>description</b>	gear motor BITRON type 323 4W 230V 50/60Hz 2.4rpm shaft ø 9mm shaft diameter 6x6mm L 81mm W 57mm H 31mm		
<b>For models:</b>	GY20EIR, GY30EIR, GYINO10E, GY-INO10E-9841, GYINO10G, GYINO30G, GYROS-10G-9842, GYROS-20G-9843, TTC		



1			
<b>GEV No.</b>	500869	<b>Ref. No.</b>	079513
<b>description</b>	gear motor KENTA type K9113077 21W 230V 50Hz 0.5rpm shaft ø 8.5mm L 152mm W 60mm H 110mm for gyro grill		
<b>For models:</b>	GY100E, GY100G, GY40E, GY40G, GY60E, GY60E-9830, GY60G, GY70G, GY80E, GY80E-9831, GY80EIR, GY80G, GY90EIR, GY90G, GYROS-100G-9828, GYROS-40G-9825, GYROS-60G-9826, GYROS-80G-9827		

motors

for kebab knife



1			
<b>GEV No.</b>	401864	<b>Ref. No.</b>	079523
<b>description</b>	motor for kebab knife shaft ø 20mm flange ø 50mm type 314101 L 103mm MAXON		

pumps

pumps for ice machines



1			
<b>GEV No.</b>	500047	<b>Ref. No.</b>	FR.62043300
<b>description</b>	pump REBO type MH30F1 30W 230V 50Hz outlet ø 12.7mm L 135mm rotation direction left		
<b>For models:</b>	FI186, FI238, FI3013, FI4016, FI5018, FI9030		

electric accessories

terminals

connection terminals with screw/faston connections



1			
<b>GEV No.</b>	550278	<b>Ref. No.</b>	X52400
<b>description</b>	power terminal block 3-pole max. 40A max 400V connection ø6mm² / F6.3 temp.-resist. 150°C cross section 6mm²		
<b>For models:</b>	ABD0001, ACA2006, ACA2010, ACA2011, ACB0002, ACB0003, ACB0004, ACB0005, ADC0001, ADC0002, SKP40E		



1			
<b>GEV No.</b>	550411	<b>Ref. No.</b>	X52300 X59000
<b>description</b>	power terminal block 6-pole max. 40A max 450V connection ø6mm² / F6.3 temp.-resist. 150°C cross section 6mm²		
<b>For models:</b>	ABC0004, ABH3001, ABH3002, ABH3003, ABH3004, ABH3005, ABH3006, ABH3007, ABH3008, ABH3009, ABJ0003, ABJ0004, ABJ0005, ABJ0006, ABK1001, ABK3001, ABK3002, ACA1001, ACA1002, ACA1003, ACA1010, ACC0004, ACE0003, ACE0004, ACE0008, ACH3001, ACH3002, ACH3003, ACH3004, ACH3005, ACH3006, ACH3007, ACH3018, ACH3019, ACH3020, ACJ0005, ACJ0006, ACJ0007, ACJ0008, ACK3001, ACK3002, ACK3003, ACK3004, ADA1001, ADA1002, ADA1003, ADA1004, ADA1005, ADA1006, ADA2005...(Other models you can see in the webshop)		

connection terminals with screw connection



1			
<b>GEV No.</b>	550495	<b>Ref. No.</b>	077014
<b>description</b>	connection terminal 4-pole max. 15A max 500V connection screw temp.-resist. 150°C		
<b>For models:</b>	HP1		



1			
<b>GEV No.</b>	550507	<b>Ref. No.</b>	X59100
<b>description</b>	power terminal block 4-pole max. 40A max 400V connection M6/M6 temp.-resist. 150°C		
<b>For models:</b>	AEC0001, AEC0002, AEC0003, AEC0004, AEC0005, AEC0006		



## rail-mounted terminals

## rail-mounted terminal blocks



1			
<b>GEV No.</b>	550407	<b>Ref. No.</b>	0000X53900
<b>description</b>	rail-mounted terminal block 5-pole cross section 16mm <sup>2</sup> max 600V		
<b>For models:</b>	ABC0003, ABC0005, ACA1006, ACC0003, ACC0005, ACC0008, ACC0009, ACC0010, ADK2001, ADK2002, ADK2003, ADK2004, AEC0001, AEC0002, AEC0003, AEC0004, AEC0005, AEC0006, AEK2001, AEK2002, AEK2003, AEK2004, SKF4E, SKF6E		

## various



1			
<b>GEV No.</b>	550408	<b>Ref. No.</b>	X52500
<b>description</b>	power terminal block		
<b>For models:</b>	ABC0003, ABC0005, ACC0003, ACC0005, ACC0008, ACC0009, ACC0010, SKF4E, SKF6E		

## gas taps

## PEL

## 20S series



1			
<b>GEV No.</b>	101491	<b>Ref. No.</b>	0000X10100 0000X10400 1000X10100 2000X10100
<b>description</b>	gas tap PEL type 20S gas inlet M16x1.5 (tube ø 10mm) bypass nozzle ø 0.35mm gas outlet M16x1.5 (tube ø 10/8mm) thermocouple connection M9x1 pilot connection shaft ø 8x6.5mm shaft L 22/15mm shaft flat lower		
<b>For models:</b>	ABJ0001, ABJ0002, ACA2004, ACA2006, ACA2008, ACA2010, ACA2011		
<b>spare parts for</b>	101491		
	<b>GEV No.</b>	100408	<b>Ref. No.</b> —
	bypass nozzle type PEL20/21 bore ø 0.35mm thread M5x0.5		
	<b>GEV No.</b>	101060	<b>Ref. No.</b> —
	magnet unit standard L 39mm D1 ø 15.4mm D2 ø 11mm suitable for PEL20-21/JUNKERS/EGA		
	<b>GEV No.</b>	101205	<b>Ref. No.</b> —
	gas tap front part shaft ø 8x6.5mm shaft L 22/15mm shaft flat upper/lower suitable for PEL20		
	<b>GEV No.</b>	101231	<b>Ref. No.</b> —
	thermocouple nut T1: M9x1 T2: M18x1		

<b>accessories for</b>	101491		
	<b>GEV No.</b>	101287	<b>Ref. No.</b> —
	olive for pipe ø 6mm Qty 1 pcs		
	<b>GEV No.</b>	101300	<b>Ref. No.</b> —
	union nut thread M16x1.5 tube ø 10mm		
	<b>GEV No.</b>	101450	<b>Ref. No.</b> —
	olive for pipe ø 8mm L 12.7mm Qty 1 pcs ED ø 10mm		
	<b>GEV No.</b>	101451	<b>Ref. No.</b> —
	union nut thread M16x1.5 tube ø 8mm		
	<b>GEV No.</b>	110081	<b>Ref. No.</b> —
	knob ø 70mm shaft ø 8x6.5mm shaft flat universal		
	<b>GEV No.</b>	110083	<b>Ref. No.</b> —
	knob dial plate gas tap without ignition flame silver		



## 21S series



1			
<b>GEV No.</b>	101397	<b>Ref. No.</b>	0000X10500 0000X10800 062116 2000X10500 3000X10500 X08100
<b>description</b>	gas tap PEL type 21S gas inlet M16x1.5 (tube ø 10mm) bypass nozzle ø 0.35mm gas outlet M16x1.5 (tube ø 10/8mm) thermocouple connection M9x1 pilot connection M10x1 shaft ø 8x6.5mm shaft L 22/15mm shaft flat lower		
<b>For models:</b>	ABH1001, ABH1002, ABH3010, ABH3011, ABH3012, ABH3014, ABH3015, ABH3016, ABH3017, ABH3018, ACA2001, ACA2002, ACA2003, ACA2012, ACH1001, ACH1002, ACH1003, ACH1004, ACH3008, ACH3010, ACH3011, ACH3013, ACH3014, ACH3015, ACH3017, ACJ0001, ACJ0003, ADA2001, ADA2002, ADA2003, ADA2004, ADA2005, ADA2006, ADA2007, ADA2008, ADA2009, ADA2010, ADA2017, ADH1001, ADH1002, AEA2001, AEA2002, AEA2003, AEA2004, AEA2005, AEH1001, AEH1002, C129FG, C89FG, GFTL11070...(Other models you can see in the webshop)		
<b>spare parts for</b>	101397		
	<b>GEV No.</b>	100408	<b>Ref. No.</b> —
	bypass nozzle type PEL20/21 bore ø 0.35mm thread M5x0.5		
	<b>GEV No.</b>	101060	<b>Ref. No.</b> —
	magnet unit standard L 39mm D1 ø 15.4mm D2 ø 11mm suitable for PEL20-21/JUNKERS/EGA		
	<b>GEV No.</b>	101206	<b>Ref. No.</b> —
	gas tap front part shaft ø 8x6.5mm shaft L 22/15mm shaft flat upper/lower suitable for PEL21		
	<b>GEV No.</b>	101231	<b>Ref. No.</b> —
	thermocouple nut T1: M9x1 T2: M18x1		
<b>accessories for</b>	101397		
	<b>GEV No.</b>	100908	<b>Ref. No.</b> —
	union screw thread M10x1 for pipe ø 4mm Qty 1 pcs		

Table continues overleaf





















accessories for		101397	
	GEV No.	100909	Ref. No. —
union screw thread M10x1 for pipe ø 6mm Qty 1 pcs			
	GEV No.	101246	Ref. No. —
olive for pipe ø 4mm Qty 1 pcs			
	GEV No.	101278	Ref. No. —
olive for pipe ø 10mm Qty 1 pcs			
	GEV No.	101286	Ref. No. —
olive ID ø 6mm Qty 1 pcs			
	GEV No.	101300	Ref. No. —
union nut thread M16x1.5 tube ø 10mm			
	GEV No.	101450	Ref. No. —
olive for pipe ø 8mm L 12.7mm Qty 1 pcs ED ø 10mm			
	GEV No.	101451	Ref. No. —
union nut thread M16x1.5 tube ø 8mm			
	GEV No.	110081	Ref. No. —
knob ø 70mm shaft ø 8x6.5mm shaft flat universal			
	GEV No.	112206	Ref. No. —
knob dial plate silver gas tap PEL21/22/23 t.max.°C ED ø 63mm ID ø 45.5mm			

22S/O series



1

GEV No.	101086	Ref. No.	0000Y21400 0000Y21500
<b>description</b>	gas tap PEL type 22S/O gas inlet M20x1.5 (tube ø 12mm) bypass nozzle ø 0.35mm gas outlet M20x1.5 (tube ø 12/10mm) thermocouple connection M9x1 pilot connection M10x1 shaft ø 10x8mm shaft L 25/17mm shaft flat lower		
<b>For models:</b>	ACE0001, ADE0001, CP49G, CP89G		
<b>spare parts for</b>	101086		
	GEV No.	100259	Ref. No. —
bypass nozzle type PEL22 bore ø 0.35mm thread M6x0.5			
	GEV No.	101058	Ref. No. —
magnet unit L 39mm D1 ø 15.4mm D2 ø 13.5mm suitable for PEL22/EGA24197 standard			
	GEV No.	101201	Ref. No. —
gas tap front part shaft ø 10x8mm shaft L 25/17mm shaft flat upper/lower suitable for PEL22			
	GEV No.	101231	Ref. No. —
thermocouple nut T1: M9x1 T2: M18x1			
	GEV No.	101240	Ref. No. —
gas connection thread M20x1.5 tube ø 12/10mm for PEL gas taps with gasket and screws horizontal			
	GEV No.	101460	Ref. No. —
O-ring ø 12.37mm D1 ø 2.62mm suitable for PEL22			

spare parts for		101086	
	GEV No.	101461	Ref. No. —
screw kit suitable for PEL22 Qty 4 pcs			
<b>accessories for</b>	101086		
	GEV No.	100908	Ref. No. —
union screw thread M10x1 for pipe ø 4mm Qty 1 pcs			
	GEV No.	100909	Ref. No. —
union screw thread M10x1 for pipe ø 6mm Qty 1 pcs			
	GEV No.	101241	Ref. No. —
gas connection thread M20x1.5 tube ø 12/10mm for PEL gas taps vertical			
	GEV No.	101246	Ref. No. —
olive for pipe ø 4mm Qty 1 pcs			
	GEV No.	101248	Ref. No. —
olive for pipe ø 12mm Qty 1 pcs suitable for PEL			
	GEV No.	101249	Ref. No. —
olive for pipe ø 10mm Qty 1 pcs			
	GEV No.	101250	Ref. No. —
union nut thread M20x1.5 for pipe ø 10mm			
	GEV No.	101251	Ref. No. —
union nut thread M20x1.5 for pipe ø 12mm			
	GEV No.	101286	Ref. No. —
olive ID ø 6mm Qty 1 pcs			
	GEV No.	110080	Ref. No. —
knob ø 70mm shaft ø 10x8mm shaft flat universal			
	GEV No.	112206	Ref. No. —
knob dial plate silver gas tap PEL21/22/23 t.max.°C ED ø 63mm ID ø 45.5mm			

23S/V series

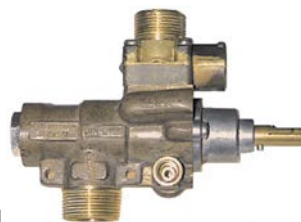

1







GEV No.	101093	Ref. No.	0000Y21300
<b>description</b>	gas tap PEL type 23S/V gas inlet M28x1.5 (tube ø 20mm) bypass nozzle ø 0.35mm thermocouple connection M10x1 pilot connection M10x1 shaft ø 10x8mm shaft L 25/17mm shaft flat lower		
<b>For models:</b>	ADL0006, ADL0007, ADL0013, AEL0004, AEL0005		
<b>spare parts for</b>	101093		
	GEV No.	100455	Ref. No. —
bypass nozzle type PEL23/24 bore ø 0.35mm thread M8x0.5			
	GEV No.	101059	Ref. No. —
magnet unit T1: M10x1 T2: M22x1 L 46mm ø 18mm suitable for PEL23S M10x1			

Table continues overleaf

spare parts for		101093	
	GEV No.	101204	Ref. No. —
gas tap front part shaft ø 10x8mm shaft L 25/17mm shaft flat upper/lower suitable for PEL235			
	GEV No.	101245	Ref. No. —
gas connection thread M24x1.5 tube ø 12/16mm vertical for PEL gas taps			
	GEV No.	101463	Ref. No. —
screw suitable for PEL235 Qty 4 pcs			
	GEV No.	528455	Ref. No. —
O-ring Viton thickness 2.62mm ID ø 18.72mm Qty 1 pcs			
accessories for		101093	
	GEV No.	100908	Ref. No. —
union screw thread M10x1 for pipe ø 4mm Qty 1 pcs			
	GEV No.	100909	Ref. No. —
union screw thread M10x1 for pipe ø 6mm Qty 1 pcs			
	GEV No.	101246	Ref. No. —
olive for pipe ø 4mm Qty 1 pcs			
	GEV No.	101252	Ref. No. —
union nut thread M24x1.5 for pipe ø 12mm			
	GEV No.	101253	Ref. No. —
union nut thread M24x1.5 PEL for pipe ø 16mm			
	GEV No.	101254	Ref. No. —
union nut thread M28x1.5 tube ø 20mm			
	GEV No.	101255	Ref. No. —
olive for pipe ø 12mm Qty 1 pcs			
	GEV No.	101256	Ref. No. —
olive for pipe ø 16mm Qty 1 pcs			
	GEV No.	101257	Ref. No. —
olive for pipe ø 20mm Qty 1 pcs			
	GEV No.	101286	Ref. No. —
olive ID ø 6mm Qty 1 pcs			
	GEV No.	110080	Ref. No. —
knob ø 70mm shaft ø 10x8mm shaft flat universal			
	GEV No.	112206	Ref. No. —
knob dial plate silver gas tap PEL21/22/23 t.max.°C ED ø 63mm ID ø 45.5mm			

SIRAL



GEV No.		101699		Ref. No.		062140	
<b>description</b>							
gas tap SIRAL gas inlet pipe flange ø16mm bypass nozzle ø 0.85mm gas outlet 1/4" (tube ø 8mm) front fixing thermocouple connection M8x1 shaft ø 8x6.5mm shaft L 23/12mm shaft flat upper							
<b>For models:</b>							
GY100G, GY40G, GY60G, GY80G, GYINO10G, GYROS-100G-9828, GYROS-10G-9842, GYROS-20G-9843, GYROS-40G-9825, GYROS-60G-9826, GYROS-80G-9827							
spare parts for		101699		GEV No.		101051	
				Ref. No.		—	
magnet unit L 27mm D1 ø 12.5mm D2 ø 8.5mm suitable for JUNKERS/EGA/MADEC/SABAF standard							
accessories for		101699		GEV No.		101277	
				Ref. No.		—	
olive ID ø 8mm Qty 1 pcs							
				GEV No.		101351	
				Ref. No.		—	
mounting strap for gas tap							
				GEV No.		520656	
				Ref. No.		—	
union nut thread 1/4" tube ø 6/8mm							

gas thermostats

SIT

630 Eurosit series

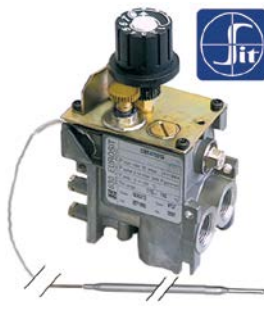

GEV No.		101188		Ref. No.		068165 X12900	
<b>description</b>							
gas thermostat type 630 Eurosit series t.max. 190°C 110-190°C gas inlet 3/8" gas outlet 3/8" thermocouple connection M9x1 pilot connection M10x1 probe ø 4mm probe L 202mm capillary pipe 1050mm SIT							
<b>For models:</b>							
ACC0001, ACC0002, ACC0006, ACC0007, ADC0001, ADC0002, AEC0007, AEC0008, CP1G, CP1GM, F121GT, F121GTM, F122GT, F47GTM, F47IRGT, F87GTM, F87IRGT, FRY121GTM-1191, FRY47IRGT-1162							
accessories for		101188		GEV No.		100904	
				Ref. No.		—	
locking screw M10x1 for pipe ø 4mm Qty 1 pcs							

Table continues overleaf





accessories for		101188		
GEV No.		100905	Ref. No.	—
	locking screw M10x1 for pipe ø 6mm Qty 1 pcs			
	olive for pipe ø 12mm L 9.5mm brass Qty 1 pcs suitable for universal			
	union screw thread 3/8" tube ø 12mm Qty 1 pcs			
	plug thread 3/8" with O-ring			

accessories for		101132		
GEV No.		101269	Ref. No.	—
	gas connection thread 1/2" angled with O-ring MINISIT 710			
	screw connection IT 3/8" ET 3/8" L 28mm			
	screw connection IT 1/2" ET 3/8" L 57mm			
	olive for pipe ø 12mm L 9.5mm brass Qty 1 pcs suitable for universal			
	olive for pipe ø 16mm Qty 1 pcs			
	union screw thread 1/2" for pipe ø 16mm Qty 1 pcs			
	union screw thread 3/8" tube ø 12mm Qty 1 pcs			
	knob suitable for Minisit ø 37mm			

710 Minisit series

<b>GEV No.</b>	101132	<b>Ref. No.</b>	X17400	
<b>description</b>	gas thermostat SIT type MINISIT 710 t.max. 340°C 100-340°C gas inlet 1/2" gas outlet 3/8" thermocouple connection M9x1 pilot connection M10x1 probe ø 5mm probe L 68mm capillary pipe 1050mm probe type type B1 pressure controller no pressure regulator or bar gland nut ignition gas no			
<b>spare parts for</b>	101132			
	GEV No.	101053	Ref. No.	—
	magnet unit T1: M9x1 T2: M24x1 L 45mm ø 17mm suitable for Minisit			
	GEV No.	102102	Ref. No.	—
	probe 100-340°C probe ø 5mm probe L 68mm capillary pipe 1750mm t.max. 340°C oven/grill probe type type B1 suitable for MINISIT 710			
<b>accessories for</b>	101132			
	GEV No.	100809	Ref. No.	—
	O-ring EPDM thickness 2mm ID ø 21mm Qty 1 pcs			
	GEV No.	100904	Ref. No.	—
	locking screw M10x1 for pipe ø 4mm Qty 1 pcs			
	GEV No.	100905	Ref. No.	—
	locking screw M10x1 for pipe ø 6mm Qty 1 pcs			
	GEV No.	101054	Ref. No.	—
	magnet unit T1: M10x1 T2: M24x1 L 45mm ø 17mm suitable for Minisit			
	GEV No.	101136	Ref. No.	—
	piezoelectric igniter suitable for Minisit with cover cap ø mm connection F6.3x0.8			
	GEV No.	101137	Ref. No.	—
	cover cap without piezoelectric igniter			
	GEV No.	101267	Ref. No.	—
	reducer IT 3/8" ET 1/2" L 21mm			
	GEV No.	101268	Ref. No.	—
	gas connection thread 3/8" angled with O-ring MINISIT 710			

PEL







24ST series









<b>GEV No.</b>	101076	<b>Ref. No.</b>	0000X11200	
<b>description</b>	gas thermostat PEL type 24ST 120-320°C gas inlet M20x1.5 (tube ø 12mm) bypass nozzle ø 0.35mm gas outlet M20x1.5 (tube ø 12/10mm) thermocouple connection M9x1 pilot connection M10x1 capillary pipe 1200mm probe ø 6mm probe L 100mm shaft ø 10x8mm shaft L 27/17mm shaft flat upper			
<b>For models:</b>	ACA2005, ACA2009, ACH3009, ACH3012			
<b>spare parts for</b>	101076			
	GEV No.	100455	Ref. No.	—
	bypass nozzle type PEL23/24 bore ø 0.35mm thread M8x0.5			
	GEV No.	101058	Ref. No.	—
	magnet unit L 39mm D1 ø 15.4mm D2 ø 13.5mm suitable for PEL22/EGA24197 standard			
	GEV No.	106200	Ref. No.	—
	nut thread M9x1 suitable for PEL 24/255			
<b>accessories for</b>	101076			
	GEV No.	100908	Ref. No.	—
	union screw thread M10x1 for pipe ø 4mm Qty 1 pcs			
	GEV No.	100909	Ref. No.	—
	union screw thread M10x1 for pipe ø 6mm Qty 1 pcs			

Table continues overleaf

accessories for		101076	
	GEV No.	101246	Ref. No. —
olive for pipe ø 4mm Qty 1 pcs			
	GEV No.	101248	Ref. No. —
olive for pipe ø 12mm Qty 1 pcs suitable for PEL			
	GEV No.	101249	Ref. No. —
olive for pipe ø 10mm Qty 1 pcs			
	GEV No.	101250	Ref. No. —
union nut thread M20x1.5 for pipe ø 10mm			
	GEV No.	101251	Ref. No. —
union nut thread M20x1.5 for pipe ø 12mm			
	GEV No.	101286	Ref. No. —
olive ID ø 6mm Qty 1 pcs			
	GEV No.	110079	Ref. No. —
knob dial plate gas thermostat 1-8 silver			
	GEV No.	110080	Ref. No. —
knob ø 70mm shaft ø 10x8mm shaft flat universal			

SABAF

			
			
GEV No.	101886	Ref. No.	068074
description	gas thermostat SABAF t.max. 300°C gas inlet pipe flange ø16mm bypass nozzle ø 0.37mm gas outlet M13x1 IT (tube ø 8mm) gas outlet 2 thermocouple connection M8x1 pilot connection capillary pipe 850mm probe ø 4mm probe L 140mm shaft ø 8x6.5mm shaft L 17/12mm shaft flat upper		
spare parts for 101886			
	GEV No.	101060	Ref. No. —
magnet unit standard L 39mm D1 ø 15.4mm D2 ø 11mm suitable for PEL20-21/JUNKERS/EGA			
	GEV No.	101376	Ref. No. —
gasket ID ø 8mm ED ø 12mm H 3/5mm			
accessories for 101886			
	GEV No.	101277	Ref. No. —
olive ID ø 8mm Qty 1 pcs			
	GEV No.	101477	Ref. No. —
union screw thread M13x1 tube ø 8mm Qty 1 pcs			
	GEV No.	101751	Ref. No. —
bracket			

			
			
GEV No.	101181	Ref. No.	X68053
description	gas thermostat SABAF t.max. 300°C gas inlet pipe flange ø16mm bypass nozzle ø 0.46mm gas outlet M13x1 IT (tube ø 8mm) gas outlet 2 thermocouple connection M8x1 pilot connection capillary pipe 850mm probe ø 4mm probe L 150mm shaft ø 6x4.6mm shaft L 45/27mm shaft flat upper		
For models: ACA2004, ACA2008			
spare parts for 101181			
	GEV No.	101060	Ref. No. —
magnet unit standard L 39mm D1 ø 15.4mm D2 ø 11mm suitable for PEL20-21/JUNKERS/EGA			
accessories for 101181			
	GEV No.	101277	Ref. No. —
olive ID ø 8mm Qty 1 pcs			
	GEV No.	101376	Ref. No. —
gasket ID ø 8mm ED ø 12mm H 3/5mm			
	GEV No.	101477	Ref. No. —
union screw thread M13x1 tube ø 8mm Qty 1 pcs			
	GEV No.	101751	Ref. No. —
bracket			
	GEV No.	110360	Ref. No. —
knob without symbol ø 65mm shaft ø 6x4.6mm shaft flat upper black			
	GEV No.	110603	Ref. No. —
knob dial plate gas thermostat t.max. 300°C 90-300°C			



## gas valves and ignition boxes

### gas control valves

SIT

TANDEM



1

<b>GEV No.</b>	101189	<b>Ref. No.</b>	068182
<b>description</b>	gas valve 230V 50Hz gas inlet 1/2" gas outlet 1/2" pilot connection M10x1 level slow ignition ignition times pressure range 3-50mbar power supply for modulator equiv. no. 0.830.040 suitable for Tandem		
<b>For models:</b>	CP67GM, F121GM, F122GTM, F47GM, F47IRG, F87GM, F87IRG, FRIT0001, FRY121G, FRY121G-1190, FRY121GM, FRY47IRG		
<b>accessories for</b>	101189		
	<b>GEV No.</b>	100904	<b>Ref. No.</b> —
	locking screw M10x1 for pipe ø 4mm Qty 1 pcs		
	<b>GEV No.</b>	100905	<b>Ref. No.</b> —
	locking screw M10x1 for pipe ø 6mm Qty 1 pcs		
	<b>GEV No.</b>	101274	<b>Ref. No.</b> —
	olive for pipe ø 16mm Qty 1 pcs		
	<b>GEV No.</b>	101275	<b>Ref. No.</b> —
	union screw thread 1/2" for pipe ø 16mm Qty 1 pcs		
	<b>GEV No.</b>	101925	<b>Ref. No.</b> —
	plug with O-ring thread M10x1 for pilot burner suitable for NOVASIT		
	<b>GEV No.</b>	102845	<b>Ref. No.</b> —
	gas connection angled 1/2" flange 32x32mm hole distance 24x24mm Tandem		
	<b>GEV No.</b>	102846	<b>Ref. No.</b> —
	gas connection straight 1/2" flange 32x32mm hole distance 24x24mm suitable for Tandem		
	<b>GEV No.</b>	102847	<b>Ref. No.</b> —
	O-ring		



1

<b>GEV No.</b>	106017	<b>Ref. No.</b>	068147
<b>description</b>	gas valve Tandem		
<b>For models:</b>	FRIT0001, FRY121G-1190		
<b>spare parts for</b>	106017		
	<b>GEV No.</b>	101379	<b>Ref. No.</b> —
	solenoid coil 230V 50Hz suitable for Tandem		
<b>accessories for</b>	106017		
	<b>GEV No.</b>	101274	<b>Ref. No.</b> —
	olive for pipe ø 16mm Qty 1 pcs		
	<b>GEV No.</b>	101275	<b>Ref. No.</b> —
	union screw thread 1/2" for pipe ø 16mm Qty 1 pcs		
	<b>GEV No.</b>	101936	<b>Ref. No.</b> —
	gasket with screw Tandem		
	<b>GEV No.</b>	102845	<b>Ref. No.</b> —
	gas connection angled 1/2" flange 32x32mm hole distance 24x24mm Tandem		
	<b>GEV No.</b>	102846	<b>Ref. No.</b> —
	gas connection straight 1/2" flange 32x32mm hole distance 24x24mm suitable for Tandem		

### ignition boxes

#### miscellaneous



1

<b>GEV No.</b>	102373	<b>Ref. No.</b>	074031 074032
<b>description</b>	ignition box IMIT type AC02EC electrodes 2 waiting time 2s safety time 10s 230V 50Hz		
<b>For models:</b>	CP47GM, CP67GM, F122GTM, F47GM, F47IRG, F87GM, F87IRG, FRIT0001, FRY121G, FRY121G-1190, FRY121GM, FRY47IRG, TOPFTGL, TOPFTGLC		



safety valves







SIT

400 series



1

<b>GEV No.</b>	101470	<b>Ref. No.</b>	Y21800
<b>description</b>	safety valve front fixing M12x1 pressure range 50mbar gas inlet 1/8" IT gas outlet 1/8" - M6x0.75 thermocouple connection M8x1 equiv. no. 0.400.088 suitable for SIT		
<b>For models:</b>	ADK2009, ADK2010, AEK2007, AEK2008		
<b>spare parts for</b>	101470		
	<b>GEV No.</b>	101052	<b>Ref. No.</b> —
	magnet unit L 43.5mm D1 ø 15.3mm D2 ø 10.5mm suitable for SIT M1		
<b>accessories for</b>	101470		
	<b>GEV No.</b>	101299	<b>Ref. No.</b> —
	nut thread M12x1		
	<b>GEV No.</b>	101499	<b>Ref. No.</b> —
	protection cap for safety valve thread M12x0.75 ID ø 18mm L 24mm aluminium		

<b>spare parts for</b>	106906		
	<b>GEV No.</b>	100885	<b>Ref. No.</b> —
	air mixing sleeve for pilot burner Qty 1 pcs		
	<b>GEV No.</b>	100916	<b>Ref. No.</b> —
	compression spring for pilot burner Qty 1 pcs		
	<b>GEV No.</b>	100917	<b>Ref. No.</b> —
	gasket for pilot burner Qty 1 pcs aluminium		
	<b>GEV No.</b>	100918	<b>Ref. No.</b> —
	screw for pilot burner		
	<b>GEV No.</b>	107162	<b>Ref. No.</b> —
	pilot burner cap SIT 3 flames Hmm Lmm Qty 1 pcs		
	<b>GEV No.</b>	107701	<b>Ref. No.</b> X19900
	pilot burner bottom part SIT 100 series nozzle ø 0.2mm		

<b>accessories for</b>	106906		
	<b>GEV No.</b>	100245	<b>Ref. No.</b> X19906
	pilot burner nozzle LPG code 20 bore ø 0.2mm Qty 1 pcs thread M8x0.75		
	<b>GEV No.</b>	100246	<b>Ref. No.</b> X19907
	pilot burner nozzle natural gas bore ø 0.35mm Qty 1 pcs thread M8x0.75		
	<b>GEV No.</b>	100904	<b>Ref. No.</b> —
	locking screw M10x1 for pipe ø 4mm Qty 1 pcs		
	<b>GEV No.</b>	100905	<b>Ref. No.</b> —
	locking screw M10x1 for pipe ø 6mm Qty 1 pcs		
	<b>GEV No.</b>	102110	<b>Ref. No.</b> —
	pilot tube copper pipe ø 4mm thickness 1mm L 3000mm		
	<b>GEV No.</b>	102111	<b>Ref. No.</b> —
	pilot tube copper pipe ø 6mm thickness 1mm L 3000mm		
	<b>GEV No.</b>	107171	<b>Ref. No.</b> —
	pilot burner nozzle SIT natural/liquid gas bore ø 0.25mm Qty 1 pcs		
	<b>GEV No.</b>	107700	<b>Ref. No.</b> —
	pilot burner bottom part SIT 100 series nozzle ø 0.25mm		
	<b>GEV No.</b>	107702	<b>Ref. No.</b> —
	pilot burner bottom part SIT 100 series nozzle ø 0.35mm		

ignition parts



pilot burners

SIT

100 series



1

<b>GEV No.</b>	106906	<b>Ref. No.</b>	068043 X13500
<b>description</b>	pilot burner SIT type 100 series 3 flames nozzle ø 0.2mm gas connection 6mm		
<b>For models:</b>	ABH1001, ABH1002, ACA2012, ACB0001, ACE0001, ACH1001, ACH1002, ACH1003, ACH1004, ADB0001, ADE0001, ADH1001, ADH1002, ADL0006, ADL0007, ADL0013, AEB0003, AEH1001, AEH1002, AEL0004, AEL0005, BM48G, CP1G, CP1GM, CP49G, CP89G, F121GT, F121GTM, F122GT, F47GTM, F47IRGT, F87GTM, F87IRGT, FRY121GTM-1191, FRY47IRGT-1162, FT87GC, FT87GLR, GFTL11070, GFTL4070, GFTL7570, GFTR11070, GFTR4070, GFTR7570, GLP11070, GLP4070, GLP7570, GMV11070, GMV4070, GMV7570, PC127GP... (Other models you can see in the webshop)		
<b>spare parts for</b>	106906		
	<b>GEV No.</b>	100245	<b>Ref. No.</b> X19906
	pilot burner nozzle LPG code 20 bore ø 0.2mm Qty 1 pcs thread M8x0.75		
	<b>GEV No.</b>	100855	<b>Ref. No.</b> —
	pilot burner bracket triple		



accessories

pilot burner bottom parts



<b>GEV No.</b>	107701	<b>Ref. No.</b>	X19900
<b>description</b>	pilot burner bottom part SIT 100 series nozzle $\phi$ 0.2mm		
<b>For models:</b>	ACA2001, ACA2002, ACA2003, ACA2012, ACJ0001, ACJ0003		

spare parts for 107701

	<b>GEV No.</b>	100245	<b>Ref. No.</b>	X19906
	<b>description</b>	pilot burner nozzle LPG code 20 bore $\phi$ 0.2mm Qty 1 pcs thread M8x0.75		
	<b>GEV No.</b>	100916	<b>Ref. No.</b>	—
	<b>description</b>	compression spring for pilot burner Qty 1 pcs		
	<b>GEV No.</b>	100917	<b>Ref. No.</b>	—
	<b>description</b>	gasket for pilot burner Qty 1 pcs aluminium		
	<b>GEV No.</b>	100918	<b>Ref. No.</b>	—
	<b>description</b>	screw for pilot burner		

accessories for 107701

	<b>GEV No.</b>	100246	<b>Ref. No.</b>	X19907
	<b>description</b>	pilot burner nozzle natural gas bore $\phi$ 0.35mm Qty 1 pcs thread M8x0.75		
	<b>GEV No.</b>	100904	<b>Ref. No.</b>	—
	<b>description</b>	locking screw M10x1 for pipe $\phi$ 4mm Qty 1 pcs		
	<b>GEV No.</b>	100905	<b>Ref. No.</b>	—
	<b>description</b>	locking screw M10x1 for pipe $\phi$ 6mm Qty 1 pcs		
	<b>GEV No.</b>	102110	<b>Ref. No.</b>	—
	<b>description</b>	pilot tube copper pipe $\phi$ 4mm thickness 1mm L 3000mm		
	<b>GEV No.</b>	102111	<b>Ref. No.</b>	—
	<b>description</b>	pilot tube copper pipe $\phi$ 6mm thickness 1mm L 3000mm		
	<b>GEV No.</b>	102742	<b>Ref. No.</b>	—
	<b>description</b>	pilot burner nozzle LPG code 25 bore $\phi$ 0.25mm Qty 1 pcs		

pilot burner nozzles

	<b>GEV No.</b>	100245	<b>Ref. No.</b>	X19906
	<b>description</b>	pilot burner nozzle SIT LPG code 20 bore $\phi$ 0.2mm Qty 1 pcs thread M8x0.75		
	<b>For models:</b>	ADA2009, ADC0001, ADC0002, ADE0001, ADH1001, ADH1002, AEC0007, AEC0008, AEH1001, AEH1002, CP49G, CP89G		

	<b>GEV No.</b>	100246	<b>Ref. No.</b>	X19907
	<b>description</b>	pilot burner nozzle natural gas bore $\phi$ 0.35mm Qty 1 pcs thread M8x0.75		
	<b>For models:</b>	ADA2009, ADC0001, ADC0002, ADE0001, AEC0007, AEC0008, CP49G, CP89G		

ignition electrodes

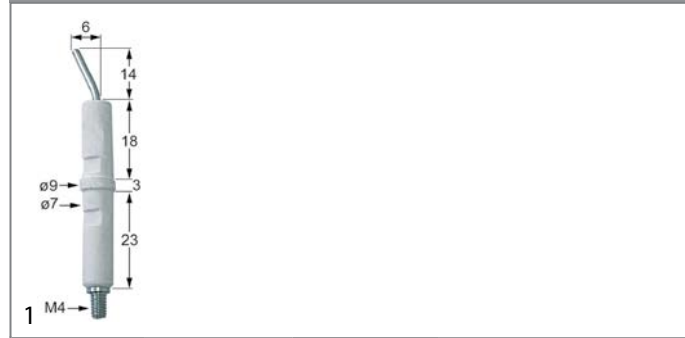

<b>GEV No.</b>	100706	<b>Ref. No.</b>	X14600
<b>description</b>	ignition electrode connection M4 Qty 1 pcs		
<b>For models:</b>	ABH1001, ABH1002, ACA2005, ACA2009, ACA2012, ACB0001, ACE0001, ACH1001, ACH1002, ACH1003, ACH1004, ADA2006, ADA2007, ADB0001, ADC0003, ADC0008, ADC0009, ADC0010, ADE0001, ADH1001, ADH1002, ADL0006, ADL0007, ADL0013, AEB0003, AEC0009, AEC0010, AEC0011, AEC0012, AEH1001, AEH1002, AEL0004, AEL0005, BM48G, CP49G, CP89G, F49G, F89G, SKPL1G, SKPL2G		

140 - 145 - 150 series

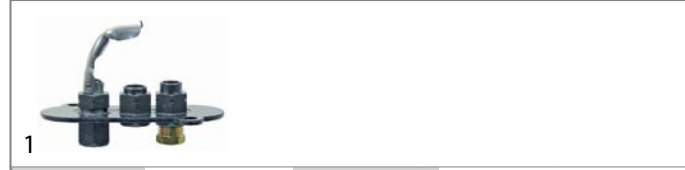

















<b>GEV No.</b>	100170	<b>Ref. No.</b>	X13000
<b>description</b>	pilot burner SIT type 150 series 1 flame nozzle $\phi$ mm gas connectionmm		
<b>For models:</b>	ABH3010, ABH3011, ABH3012, ABH3014, ABH3015, ABH3016, ABH3017, ABH3018, ACH3008, ACH3009, ACH3010, ACH3011, ACH3012, ACH3013, ACH3014, ACH3015, ACH3016, ACH3017, ADH3007, ADH3008, ADH3010, ADH3011, ADK2007, ADK2008, ADK2009, ADK2010, AEA2005, AEH3007, AEH3008, AEH3009, AEH3010, AEH3011, AEH3012, AEK2005, AEK2006, AEK2007, AEK2008, GFT49L, GFT49LC, GFT49R, GFT89L, GFT89LC, GFT89LR, KFT8GLR		





<b>spare parts for</b>	100170			
	<b>GEV No.</b>	100907	<b>Ref. No.</b>	—
	<b>description</b>	screw connection thread M10x1 Qty 1 pcs type SEF 1 $\phi$ mm for thermocouple		

<b>accessories for</b>	100170			
	<b>GEV No.</b>	100204	<b>Ref. No.</b>	—
	<b>description</b>	pilot burner nozzle SIT LPG code 14 bore $\phi$ 0.18/0.20mm Qty 1 pcs suitable for 140 series		
	<b>GEV No.</b>	100205	<b>Ref. No.</b>	X30000
	<b>description</b>	pilot burner nozzle SIT LPG code 19 bore $\phi$ 0.23/0.26mm Qty 1 pcs suitable for SIT 150 series		
	<b>GEV No.</b>	100206	<b>Ref. No.</b>	—
	<b>description</b>	pilot burner nozzle SIT natural gas code 36 bore $\phi$ 0.60/0.55mm Qty 1 pcs suitable for SIT 150 series		
	<b>GEV No.</b>	100207	<b>Ref. No.</b>	—
	<b>description</b>	pilot burner nozzle SIT natural gas code 27 bore $\phi$ 0.40/0.38mm suitable for SIT 140 series		

Table continues overleaf

accessories for		100170		
	GEV No.	100216	Ref. No.	—
pilot burner nozzle SIT natural gas code 38 bore ø 0.45mm Qty 1 pcs suitable for SIT 150 series				
	GEV No.	100701	Ref. No.	X13001
ignition electrode connection M4 Qty 1 pcs				
	GEV No.	100801	Ref. No.	—
gasket for pilot burner Qty 1 pcs				
	GEV No.	100897	Ref. No.	—
olive for pipe ø 4mm Qty 1 pcs for pilot burner				
	GEV No.	100898	Ref. No.	—
olive for pipe ø 6mm Qty 1 pcs for pilot burner				
	GEV No.	100906	Ref. No.	—
screw connection thread M10x1 for ignition electrode brass Qty 1 pcs WS 10				
	GEV No.	100908	Ref. No.	—
union screw thread M10x1 for pipe ø 4mm Qty 1 pcs				
	GEV No.	100909	Ref. No.	—
union screw thread M10x1 for pipe ø 6mm Qty 1 pcs				

160 series				
	1			
<b>GEV No.</b>	100056	<b>Ref. No.</b>	X17000	
<b>description</b>	pilot burner SIT type 160 series 3 flames nozzle ømm gas connectionmm			
<b>For models:</b>	ACK2001, BRG70			
<b>spare parts for</b>	100056			
	GEV No.	100907	Ref. No.	—
screw connection thread M10x1 Qty 1 pcs type SEF 1 ømm for thermocouple				
<b>accessories for</b>	100056			
	GEV No.	100202	Ref. No.	—
pilot burner nozzle natural gas code 41 Qty 1 pcs nozzle ø 0.41mm				
	GEV No.	100203	Ref. No.	—
pilot burner nozzle LPG code 25 Qty 1 pcs nozzle ø 0.25mm				
	GEV No.	100701	Ref. No.	X13001
ignition electrode connection M4 Qty 1 pcs				
	GEV No.	100801	Ref. No.	—
gasket for pilot burner Qty 1 pcs				
	GEV No.	100869	Ref. No.	—
pilot burner nozzle natural gas code 51 Qty 1 pcs suitable for 160 series nozzle ø 0.51mm				
	GEV No.	100870	Ref. No.	—
olive for pipe ø 4mm Qty 1 pcs suitable for 160 series for pilot burner				











accessories for		100056		
	GEV No.	100906	Ref. No.	—
screw connection thread M10x1 for ignition electrode brass Qty 1 pcs WS 10				
	GEV No.	100908	Ref. No.	—
union screw thread M10x1 for pipe ø 4mm Qty 1 pcs				
	GEV No.	100909	Ref. No.	—
union screw thread M10x1 for pipe ø 6mm Qty 1 pcs				
	GEV No.	101287	Ref. No.	—
olive for pipe ø 6mm Qty 1 pcs				
	GEV No.	102110	Ref. No.	—
pilot tube copper pipe ø 4mm thickness 1mm L 3000mm				
	GEV No.	102111	Ref. No.	—
pilot tube copper pipe ø 6mm thickness 1mm L 3000mm				
	GEV No.	107650	Ref. No.	—
pilot burner nozzle SIT LPG code 30 Qty 1 pcs				

producer-specific pilot burners

STAR 10				
	1			
<b>GEV No.</b>	100145	<b>Ref. No.</b>	0000X19000	
<b>description</b>	pilot burner SIT type 100 series 3 flames nozzle ø 0.2mm gas connectionmm			
<b>For models:</b>	ACC0001, ACC0002, ACC0006, ACC0007, ADC0001, ADC0002, AEC0007, AEC0008			
<b>spare parts for</b>	100145			
	GEV No.	100245	Ref. No.	X19906
pilot burner nozzle LPG code 20 bore ø 0.2mm Qty 1 pcs thread M8x0.75				
	GEV No.	100837	Ref. No.	—
pilot burner cap 3 flames H 24mm L 48mm Qty 1 pcs				
	GEV No.	100855	Ref. No.	—
pilot burner bracket triple				
	GEV No.	100881	Ref. No.	—
pilot burner bottom part PRO-GAS 100 series nozzle ø 0.2mm				
	GEV No.	100885	Ref. No.	—
air mixing sleeve for pilot burner Qty 1 pcs				
	GEV No.	100916	Ref. No.	—
compression spring for pilot burner Qty 1 pcs				

Table continues overleaf



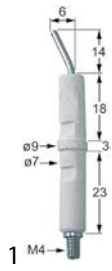

<b>spare parts for</b> 100145	
	GEV No. 100917 Ref. No. — gasket for pilot burner Qty 1 pcs aluminium
	GEV No. 100918 Ref. No. — screw for pilot burner
<b>accessories for</b> 100145	
	GEV No. 100246 Ref. No. X19907 pilot burner nozzle natural gas bore $\varnothing$ 0.35mm Qty 1 pcs thread M8x0.75
	GEV No. 100882 Ref. No. — pilot burner bottom part PRO-GAS 100 series nozzle $\varnothing$ 0.25mm
	GEV No. 100883 Ref. No. — pilot burner bottom part PRO-GAS 100 series nozzle $\varnothing$ 0.35mm
	GEV No. 100904 Ref. No. — locking screw M10x1 for pipe $\varnothing$ 4mm Qty 1 pcs
	GEV No. 100905 Ref. No. — locking screw M10x1 for pipe $\varnothing$ 6mm Qty 1 pcs
	GEV No. 102110 Ref. No. — pilot tube copper pipe $\varnothing$ 4mm thickness 1mm L 3000mm
	GEV No. 102111 Ref. No. — pilot tube copper pipe $\varnothing$ 6mm thickness 1mm L 3000mm
	GEV No. 102742 Ref. No. — pilot burner nozzle LPG code 25 bore $\varnothing$ 0.25mm Qty 1 pcs

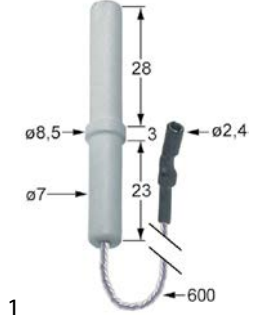
	
<b>GEV No.</b>	100706 Ref. No. X14600
<b>description</b>	ignition electrode connection M4 Qty 1 pcs
<b>For models:</b>	ABH1001, ABH1002, ACA2005, ACA2009, ACA2012, ACB0001, ACE0001, ACH1001, ACH1002, ACH1003, ACH1004, ADA2006, ADA2007, ADB0001, ADC0003, ADC0008, ADC0009, ADC0010, ADE0001, ADH1001, ADH1002, ADL0006, ADL0007, ADL0013, AEB0003, AEC0009, AEC0010, AEC0011, AEC0012, AEH1001, AEH1002, AEL0004, AEL0005, BM48G, CP49G, CP89G, F49G, F89G, SKPL1G, SKPL2G

	
<b>GEV No.</b>	100733 Ref. No. X14500
<b>description</b>	ignition electrode D1 $\varnothing$ 7mm D2 $\varnothing$ 8.5mm cable length 600mm BL1 28mm BL2 3mm BL3 23mm to clip connection $\varnothing$ 2.4mm
<b>For models:</b>	ACA2004, ACA2006, ACA2008, ACA2010, ACA2011

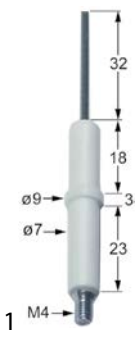
electrodes

	
<b>GEV No.</b>	100701 Ref. No. X13001
<b>description</b>	ignition electrode connection M4 Qty 1 pcs
<b>For models:</b>	ABH3010, ABH3011, ABH3012, ABH3014, ABH3015, ABH3016, ABH3017, ABH3018, ACH3008, ACH3009, ACH3010, ACH3011, ACH3012, ACH3013, ACH3014, ACH3015, ACH3016, ACH3017, ADA2017, ADH3007, ADH3008, ADH3010, ADH3011, ADK2007, ADK2008, ADK2009, ADK2010, AEA2005, AEH3007, AEH3008, AEH3009, AEH3010, AEH3011, AEH3012, AEK2005, AEK2006, AEK2007, AEK2008, GFT49L, GFT49LC, GFT49R, GFT89L, GFT89LC, GFT89LR, KFT8GLR
<b>accessories for</b> 100701	
	GEV No. 100906 Ref. No. — screw connection thread M10x1 for ignition electrode brass Qty 1 pcs WS 10

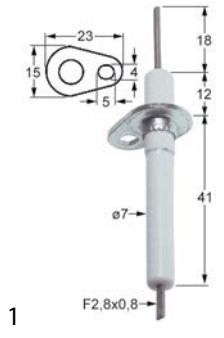
	
<b>GEV No.</b>	100818 Ref. No. X68041
<b>description</b>	ignition electrode flange length 23mm flange width 15mm D1 $\varnothing$ 7mm L1 18mm BL1 12mm BL2 41mm connection F 2.8x0.8mm fixing dimensions $\varnothing$ 5x4mm with flange
<b>For models:</b>	ACA2004, ACA2008

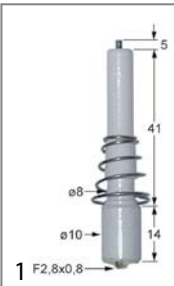

<b>GEV No.</b>	100729	<b>Ref. No.</b>	068032 X15000
<b>description</b>	ignition electrode L1 5mm D1 ø 8mm D2 ø 10mm BL1 41mm BL2 14mm connection F 2.8x0.8mm to clip with spring		
<b>For models:</b>	ABJ0001, ABJ0002, BSC4FG, BSC6FG, C127FE, C127FG, C2G, C3FG, C3G, C5FG, C5GFE, C87FE, C87FG, CREP1G, CREP1G400, CREP2G, GRMGZL, GR-MGZ-L-2129, GRMGZR, GR-MGZ-R-2128, HP4652G, HP8654G, PC127G, PC1G, PC2G, PC2G-4370, PC47G, PC4G, PC87G, TOP2G, TOPG		

### ignition cables

#### pre-assembled cables



<b>GEV No.</b>	100176	<b>Ref. No.</b>	E10000
<b>description</b>	ignition cable cable length 1000mm connection ø2.4mm / ø4mm permanent temperature 200°C		
<b>For models:</b>	ADL0006, ADL0007, ADL0013, AEL0004, AEL0005		



<b>GEV No.</b>	100036	<b>Ref. No.</b>	068033
<b>description</b>	ignition cable cable length 500mm connection F2.8mm / F2.8mm		
<b>For models:</b>	BSC4FG, BSC6FG, C127FE, C127FG, C2G, C3G, C87FE, C87FG, CP1G, CP1GM, CREP1G, CREP1G400, CREP2G, F121GT, F121GTM, F122GT, F47IRGT, F87IRGT, FRY121GTM-1191, FRY47IRGT-1162, FT1G, FT1GR40, FT87GC, GFTL11070, GFTL4070, GFTL7570, GFTR11070, GFTR4070, GFTR7570, GLP11070, GLP4070, GLP7570, GMV11070, GMV4070, GMV7570, GRMGZL, GR-MGZ-L-2129, GRMGZR, GR-MGZ-R-2128, HP4652G, HP8654G, PC127G, PC1G, PC2G, PC2G-4370, PC47G, PC4G, PC87G, TOP2G, TOPFT60GL...(Other models you can see in the webshop)		



<b>GEV No.</b>	100177	<b>Ref. No.</b>	X40500
<b>description</b>	ignition cable cable length 600mm		
<b>For models:</b>	ABJ0001, ABJ0002, ACE0001, ADK2007, ADK2008, ADK2009, ADK2010, AEK2005, AEK2006, AEK2007, AEK2008		



<b>GEV No.</b>	100015	<b>Ref. No.</b>	X40100
<b>description</b>	ignition cable cable length 600mm connection ø2.4mm / ø2.4mm		
<b>For models:</b>	ABH3010, ABH3011, ABH3012, ABH3014, ABH3015, ABH3016, ABH3017, ABH3018, ACB0001, ACC0001, ACC0002, ACC0006, ACC0007, ACH3008, ACH3009, ACH3010, ACH3011, ACH3012, ACH3013, ACH3014, ACH3015, ACH3016, ACH3017, ACK2001, ADB0001, ADH1001, ADH1002, AEB0003, AEH1001, AEH1002, AEH3007, AEH3008, AEH3009, AEH3010, AEH3011, AEH3012, BM48G, BRG70, KFT8GLR		

### piezoelectric igniters

#### mounting diameter 18mm



<b>GEV No.</b>	100003	<b>Ref. No.</b>	M00500
<b>description</b>	piezoelectric igniter body metal blowing mounting ø 18mm connection F2.8x0.8		
<b>For models:</b>	ABH1001, ABH1002, ABH3010, ABH3011, ABH3012, ABH3014, ABH3015, ABH3016, ABH3017, ABH3018, ABJ0001, ABJ0002, ACA2004, ACA2005, ACA2006, ACA2008, ACA2009, ACA2010, ACA2011, ACA2012, ACB0001, ACC0001, ACC0002, ACC0006, ACC0007, ACE0001, ACH1001, ACH1002, ACH1003, ACH1004, ACH3008, ACH3009, ACH3010, ACH3011, ACH3012, ACH3013, ACH3014, ACH3015, ACH3016, ACH3017, ADH3007, ADH3008, ADH3010, ADH3011, AEH3007, AEH3008, AEH3009, AEH3010, AEH3011, AEH3012...(Other models you can see in the webshop)		

### ignition units



<b>GEV No.</b>	101009	<b>Ref. No.</b>	068160
<b>description</b>	ignition unit outputs 2 1.5 V/DC dimensions 88x23x34mm mounting distance 73mm inlet F6.3x0.8 outlet F2.8x0.8 mounting ø 73mm		
<b>For models:</b>	C127FG, C2G, C87FP, CP1G, CP1GM, CREP1G, CREP1G400, CREP2G, F121GT, F121GTM, F122GT, F47GTM, F47IRGT, F87GTM, F87IRGT, FRY121GTM-1191, FRY47IRGT-1162, FT1G, FT1GC, FT1GC-4321, FT1GC-4364, FT1GL, FT1GR, FT1GR40, FT2GC, FT2GL, FT2GLC, FT2GLR, FT47GC, FT47GL, FT47GR, FT67GC, FT67GL, FT67GLR, FT87GC, FT87GLR, GFTL11070, GFTL4070, GFTL7570, GFTR11070, GFTR4070, GFTR7570, GLP11070, GLP4070, GLP7570, GMV4070, GMV7570, GRMGZL, GR-MGZ-L-2129, GRMGZR...(Other models you can see in the webshop)		
<b>accessories for</b>	101009		
	<b>GEV No.</b>	301195	<b>Ref. No.</b> 068163
	<b>description</b>	ignition switch for battery type AA 1.5V mounting ø 22mm built-in depth 42mm connection male faston 2.8mm/6.3mm red ignitionA protection IP40 ambient temperature max. 125/55°C	





<b>GEV No.</b>	101012	<b>Ref. No.</b>	068034
<b>description</b>	ignition unit outputs 2 230VAC dimensions 48x32x32mm mounting distance 56mm inlet F2.8x0.8 outlet F2.8x0.8 type ZIG2 50-60Hz		
<b>For models:</b>	BSC6FG, FT1GC-4521		







			
1			
<b>GEV No.</b>	101002	<b>Ref. No.</b>	068034 X50000
<b>description</b>	ignition unit outputs 2 230VAC dimensions 88x23x34mm mounting distance 73mm inlet F6.3x0.8 outlet F2.8x0.8 0.6VA 50/60Hz		
<b>For models:</b>	ADK2007, ADK2008, ADK2009, ADK2010, AEK2005, AEK2006, AEK2007, AEK2008		

			
2			
<b>GEV No.</b>	101031	<b>Ref. No.</b>	068161
<b>description</b>	ignition unit outputs 4 1.5 V/DC dimensions 111x23x34mm mounting distance 100mm inlet F6.3x0.8 outlet F2.8x0.8 mounting ø 100mm		
<b>For models:</b>	BSC4FE80, BSC4FG, C3G, C87FE, F87IRGT, GMV11070, HP8654G, PC127FTE, PC127FTG, PC2G, PC4G, PC87G, TOP2G		

			
1			
<b>GEV No.</b>	101019	<b>Ref. No.</b>	068162
<b>description</b>	ignition unit outputs 6 1.5 V/DC		
<b>For models:</b>	C127FE, C127FG, C5FG, C5GFE, C87FG, PC127G		

ignition switches

			
1			
<b>GEV No.</b>	301195	<b>Ref. No.</b>	068163
<b>description</b>	ignition switch for battery type AA 1.5V mounting ø 22mm built-in depth 42mm connection male faston 2.8mm/6.3mm red ignitionA protection IP40 ambient temperature max. 125/55°C		
<b>For models:</b>	BSC4FE80, BSC4FG, BSC6FG, C127FE, C127FG, C2G, C3G, C5FG, C5GFE, C87FE, C87FG, CP1G, CP1GM, CREP1G, CREP1G400, CREP2G, F121GT, F121GTM, F122GT, F47GTM, F47IRGT, F87GTM, F87IRGT, FRY121GTM-1191, FRY47IRGT-1162, FT1G, FT1GC, FT1GC-4321, FT1GC-4364, FT1GL, FT1GR, FT1GR40, FT2GC, FT2GL, FT2GLC, FT2GLR, FT47GC, FT47GL, FT47GR, FT67GC, FT67GL, FT67GLR, FT87GC, FT87GLR, GFTL11070, GFTL4070, GFTL7570, GFTR11070, GFTR4070, GFTR7570...(Other models you can see in the webshop)		
<b>accessories for</b>	301195		
	<b>GEV No.</b>	101009	<b>Ref. No.</b> 068160
	ignition unit outputs 2 1.5 V/DC dimensions 88x23x34mm mounting distance 73mm inlet F6.3x0.8 outlet F2.8x0.8 mounting ø 73mm		
	<b>GEV No.</b>	101031	<b>Ref. No.</b> 068161
	ignition unit outputs 4 1.5 V/DC dimensions 111x23x34mm mounting distance 100mm inlet F6.3x0.8 outlet F2.8x0.8 mounting ø 100mm		
	<b>GEV No.</b>	101032	<b>Ref. No.</b> —
	ignition unit outputs 6 1.5 V/DC dimensions 135x23x34mm mounting distance 123mm inlet F6.3x0.8 outlet F2.8x0.8 mounting ø 122mm		

thermocouples

plug-in thermocouples

plug-in thermocouples standard

with barrel socket ø6(6.5)mm

thermocouples SIT

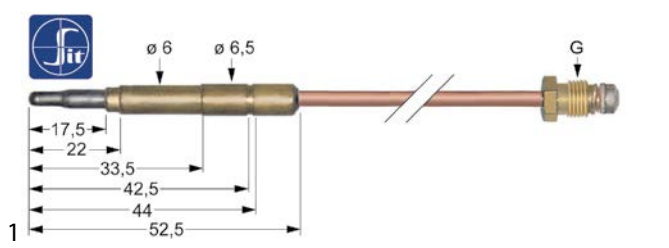

<b>GEV No.</b>	107601	<b>Ref. No.</b>	068159
<b>description</b>	thermocouple SIT M8x1 L 600mm plug connection ø6.0(6.5)mm		
<b>For models:</b>	F47GTM, F47IRGT, F87GTM, F87IRGT, FRY47IRGT-1162, GFTL11070, GFTL4070, GFTL7570, GFTR11070, GFTR4070, GFTR7570, GLP11070, GLP4070, GLP7570, GMV11070, GMV4070, GMV7570, GY100G, GY40G, GY60G, GY80G, GYROS-100G-9828, GYROS-40G-9825, GYROS-60G-9826, GYROS-80G-9827, PC49G, TOPFT60GL, TOPFT60GLC		

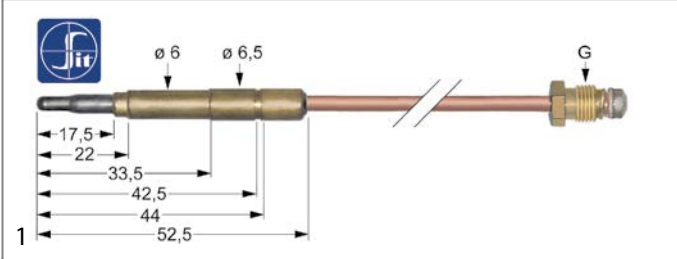

<b>GEV No.</b>	107614	<b>Ref. No.</b>	X14900
<b>description</b>	thermocouple SIT M9x1 L 1500mm plug connection ø6.0(6.5)mm		
<b>For models:</b>	ACA2005, ACA2009, ACA2012		

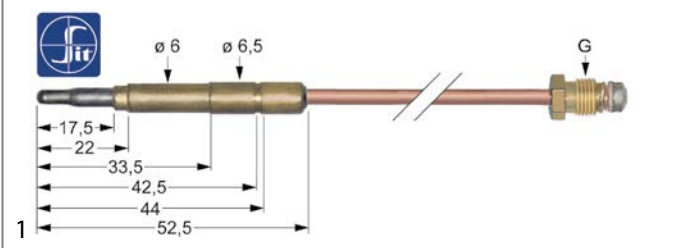

<b>GEV No.</b>	107608	<b>Ref. No.</b>	X13900
<b>description</b>	thermocouple SIT M9x1 L 500mm plug connection ø6.0(6.5)mm		
<b>For models:</b>	ABH1001, ABH1002, ACA2001, ACA2002, ACA2003, ACA2004, ACA2005, ACA2006, ACA2008, ACA2009, ACA2010, ACA2011, ACA2012, ACB0001, ACJ0001, ACJ0003, ACK2001, ADA2006, ADA2007, ADA2009, BRG70, SKPL1G, SKPL2G		

<b>GEV No.</b>	107609	<b>Ref. No.</b>	068167 X14100 X14200
<b>description</b>	thermocouple SIT M9x1 L 600mm plug connection $\phi$ 6.0(6.5)mm		
<b>For models:</b>	ABH3010, ABH3011, ABH3012, ABH3014, ABH3015, ABH3016, ABH3017, ABH3018, ACA2001, ACA2002, ACA2003, ACA2004, ACA2005, ACA2006, ACA2007, ACA2008, ACA2009, ACA2010, ACA2011, ACA2012, ACE0001, ACH1001, ACH1002, ACH1003, ACH1004, ACH3008, ACH3009, ACH3010, ACH3011, ACH3012, ACH3013, ACH3014, ACH3015, ACH3016, ACH3017, ACJ0001, ACJ0003, ADA2001, ADA2002, ADA2003, ADA2004, ADA2005, ADA2006, ADA2007, ADA2008, ADA2009, ADA2010, ADA2017, ADB0001, ADE0001...(Other models you can see in the webshop)		

<b>GEV No.</b>	107177	<b>Ref. No.</b>	X19100
<b>description</b>	thermocouple SIT with interrupter M9x1 L 600mm plug connection $\phi$ 6.0mm F 6.3mm		

threaded thermocouples

threaded thermocouples standard

with socket with thread M8x1

SIT

plug-in thermocouples with interruption

<b>GEV No.</b>	100172	<b>Ref. No.</b>	X14300
<b>description</b>	thermocouple SIT with interrupter ASA 11/32 L 400mm plug connection $\phi$ 6.0mm F 6.3mm		
<b>For models:</b>	ADH3007, ADH3008, ADH3010, ADH3011, ADK2007, ADK2008, ADK2009, ADK2010, AEH3007, AEH3008, AEH3009, AEH3010, AEH3011, AEH3012, AEK2005, AEK2006, AEK2007, AEK2008, GFT49L, GFT49LC, GFT49R, GFT89L, GFT89LC, GFT89LR, KFT8GLR		

<b>GEV No.</b>	107633	<b>Ref. No.</b>	068135
<b>description</b>	thermocouple SIT M8x1 L 1200mm M8x1		
<b>accessories for</b>	107633		
	<b>GEV No.</b>	102067	<b>Ref. No.</b> —
	nut thread M8x1 H 3mm brass Qty 1 pcs type SEF 1		

<b>GEV No.</b>	107164	<b>Ref. No.</b>	X14000
<b>description</b>	thermocouple SIT with interrupter M9x1 L 1000mm plug connection $\phi$ 6.0(6.5)mm soldering connection		
<b>For models:</b>	ADL0013, AEL0004		

<b>GEV No.</b>	107634	<b>Ref. No.</b>	068138 X68045
<b>description</b>	thermocouple SIT M8x1 L 1500mm M8x1		
<b>For models:</b>	ACA2004, ACA2008, C127FG, C2FG, C3G, C5FG, C87FG, SA650G, SAM650G, SAM650G-2623		
<b>accessories for</b>	107634		
	<b>GEV No.</b>	102067	<b>Ref. No.</b> —
	nut thread M8x1 H 3mm brass Qty 1 pcs type SEF 1		



<b>GEV No.</b>	107636	<b>Ref. No.</b>	X15700
<b>description</b>	thermocouple SIT M9x1 L 600mm M8x1		
<b>For models:</b>	ABJ0001, ABJ0002		
<b>accessories for</b>	107636		
	<b>GEV No.</b>	102067	<b>Ref. No.</b> —
nut thread M8x1 H 3mm brass Qty 1 pcs type SEF 1			

<b>accessories for</b>	103066		
	<b>GEV No.</b>	104101	<b>Ref. No.</b> 068097 M00600
burner holder for burner cap ø 80mm with nozzle holder with mixing sleeve			

<b>GEV No.</b>	104102	<b>Ref. No.</b>	068064 M00900
<b>description</b>	burner head for burner cap ø 100mm ext. ø 130		
<b>For models:</b>	ABJ0001, ABJ0002, BSC6FG, PC2G, PC2G-4370, TOP2G		

## gas burners

### hob burners

#### universal hob burners

##### GEV

<b>GEV No.</b>	106379	<b>Ref. No.</b>	N/A
<b>description</b>	air mixing tube for burner cap ø 80mm L 23mm D1 ø 20mm D2 ø 15.6mm D3 ø 14mm		





<b>GEV No.</b>	103068	<b>Ref. No.</b>	068067 M00400
<b>description</b>	burner cap ø 100mm		
<b>For models:</b>	ABJ0001, ABJ0002, BSC6FG, PC2G, PC2G-4370, TOP2G		
<b>accessories for</b>	103068		
	<b>GEV No.</b>	103067	<b>Ref. No.</b> 068070 M01100
burner ring for burner cap ø 100mm			
	<b>GEV No.</b>	104102	<b>Ref. No.</b> 068064 M00900
burner head for burner cap ø 100mm ext. ø 130			
	<b>GEV No.</b>	104103	<b>Ref. No.</b> 068063 M00700
burner holder suitable for burner ø100mm with nozzle holder			

<b>GEV No.</b>	103066	<b>Ref. No.</b>	068098 M00300
<b>description</b>	burner cap ø 80mm		
<b>For models:</b>	ABJ0001, ABJ0002, BSC6FG, PC2G, TOP2G		
<b>accessories for</b>	103066		
	<b>GEV No.</b>	103065	<b>Ref. No.</b> 068099 M01000
burner ring for burner cap ø 80mm			
	<b>GEV No.</b>	104100	<b>Ref. No.</b> 068085 M00800
burner head for burner cap ø 80mm			





<b>GEV No.</b>	104100	<b>Ref. No.</b>	068085 M00800
<b>description</b>	burner head for burner cap ø 80mm		
<b>For models:</b>	ABJ0001, ABJ0002, BSC6FG, PC2G, TOP2G		

<b>accessories for</b>	104100		
	<b>GEV No.</b>	103065	<b>Ref. No.</b> 068099 M01000
burner ring for burner cap ø 80mm			
	<b>GEV No.</b>	103066	<b>Ref. No.</b> 068098 M00300
burner cap ø 80mm			
	<b>GEV No.</b>	104103	<b>Ref. No.</b> 068063 M00700
burner holder suitable for burner ø100mm with nozzle holder			





<b>GEV No.</b>	104101	<b>Ref. No.</b>	068097 M00600
<b>description</b>	burner holder for burner cap ø 80mm with nozzle holder with mixing sleeve		
<b>For models:</b>	ABJ0001, ABJ0002, BSC6FG, PC2G, TOP2G		
<b>accessories for</b>	104101		
	<b>GEV No.</b>	103065	<b>Ref. No.</b> 068099 M01000
burner ring for burner cap ø 80mm			
	<b>GEV No.</b>	103066	<b>Ref. No.</b> 068098 M00300
burner cap ø 80mm			
	<b>GEV No.</b>	104100	<b>Ref. No.</b> 068085 M00800
burner head for burner cap ø 80mm			

			
1			
<b>GEV No.</b>	104103	<b>Ref. No.</b>	068063 M00700
<b>description</b>	burner holder suitable for burner ø100mm with nozzle holder		
<b>For models:</b>	ABJ0001, ABJ0002, BSC6FG, KT3VD, PC2G, PC2G-4370, TOP2G		
<b>accessories for</b>	104103		
	<b>GEV No.</b>	103067	<b>Ref. No.</b> 068070 M01100
burner ring for burner cap ø 100mm			
	<b>GEV No.</b>	103068	<b>Ref. No.</b> 068067 M00400
burner cap ø 100mm			
	<b>GEV No.</b>	104102	<b>Ref. No.</b> 068064 M00900
burner head for burner cap ø 100mm ext. ø 130			

			
1			
<b>GEV No.</b>	103067	<b>Ref. No.</b>	068070 M01100
<b>description</b>	burner ring for burner cap ø 100mm		
<b>For models:</b>	ABJ0001, ABJ0002, BSC6FG, PC2G, PC2G-4370, TOP2G		
<b>accessories for</b>	103067		
	<b>GEV No.</b>	103068	<b>Ref. No.</b> 068067 M00400
burner cap ø 100mm			
	<b>GEV No.</b>	104102	<b>Ref. No.</b> 068064 M00900
burner head for burner cap ø 100mm ext. ø 130			
	<b>GEV No.</b>	104103	<b>Ref. No.</b> 068063 M00700
burner holder suitable for burner ø100mm with nozzle holder			

			
1			
<b>GEV No.</b>	103065	<b>Ref. No.</b>	068099 M01000
<b>description</b>	burner ring for burner cap ø 80mm		
<b>For models:</b>	ABJ0001, ABJ0002, BSC6FG, PC2G, TOP2G		
<b>accessories for</b>	103065		
	<b>GEV No.</b>	103066	<b>Ref. No.</b> 068098 M00300
burner cap ø 80mm			
	<b>GEV No.</b>	104100	<b>Ref. No.</b> 068085 M00800
burner head for burner cap ø 80mm			
	<b>GEV No.</b>	104101	<b>Ref. No.</b> 068097 M00600
burner holder for burner cap ø 80mm with nozzle holder with mixing sleeve			

producer-specific hob burners			
STAR 10			
600 series			
			
1			
<b>GEV No.</b>	106379	<b>Ref. No.</b>	N/A
<b>description</b>	air mixing tube for burner cap ø 80mm L 23mm D1 ø 20mm D2 ø 15.6mm D3 ø 14mm		





			
1			
<b>GEV No.</b>	103068	<b>Ref. No.</b>	068067 M00400
<b>description</b>	burner cap ø 100mm		
<b>For models:</b>	ABJ0001, ABJ0002, BSC6FG, PC2G, PC2G-4370, TOP2G		
<b>accessories for</b>	103068		
	<b>GEV No.</b>	103067	<b>Ref. No.</b> 068070 M01100
burner ring for burner cap ø 100mm			
	<b>GEV No.</b>	104102	<b>Ref. No.</b> 068064 M00900
burner head for burner cap ø 100mm ext. ø 130			
	<b>GEV No.</b>	104103	<b>Ref. No.</b> 068063 M00700
burner holder suitable for burner ø100mm with nozzle holder			





			
1			
<b>GEV No.</b>	103066	<b>Ref. No.</b>	068098 M00300
<b>description</b>	burner cap ø 80mm		
<b>For models:</b>	ABJ0001, ABJ0002, BSC6FG, PC2G, TOP2G		
<b>accessories for</b>	103066		
	<b>GEV No.</b>	103065	<b>Ref. No.</b> 068099 M01000
burner ring for burner cap ø 80mm			
	<b>GEV No.</b>	104100	<b>Ref. No.</b> 068085 M00800
burner head for burner cap ø 80mm			
	<b>GEV No.</b>	104101	<b>Ref. No.</b> 068097 M00600
burner holder for burner cap ø 80mm with nozzle holder with mixing sleeve			

			
1			
<b>GEV No.</b>	104102	<b>Ref. No.</b>	068064 M00900
<b>description</b>	burner head for burner cap ø 100mm ext. ø 130		
<b>For models:</b>	ABJ0001, ABJ0002, BSC6FG, PC2G, PC2G-4370, TOP2G		



 <p>1</p>			
<b>GEV No.</b>	104100	<b>Ref. No.</b>	068085 M00800
<b>description</b>	burner head for burner cap ø 80mm		
<b>For models:</b>	ABJ0001, ABJ0002, BSC6FG, PC2G, TOP2G		
<b>accessories for</b>	104100		
	<b>GEV No.</b>	103065	<b>Ref. No.</b> 068099 M01000
burner ring for burner cap ø 80mm			
	<b>GEV No.</b>	103066	<b>Ref. No.</b> 068098 M00300
burner cap ø 80mm			
	<b>GEV No.</b>	104103	<b>Ref. No.</b> 068063 M00700
burner holder suitable for burner ø100mm with nozzle holder			

 <p>1</p>			
<b>GEV No.</b>	104101	<b>Ref. No.</b>	068097 M00600
<b>description</b>	burner holder for burner cap ø 80mm with nozzle holder with mixing sleeve		
<b>For models:</b>	ABJ0001, ABJ0002, BSC6FG, PC2G, TOP2G		
<b>accessories for</b>	104101		
	<b>GEV No.</b>	103065	<b>Ref. No.</b> 068099 M01000
burner ring for burner cap ø 80mm			
	<b>GEV No.</b>	103066	<b>Ref. No.</b> 068098 M00300
burner cap ø 80mm			
	<b>GEV No.</b>	104100	<b>Ref. No.</b> 068085 M00800
burner head for burner cap ø 80mm			

 <p>1</p>			
<b>GEV No.</b>	104103	<b>Ref. No.</b>	068063 M00700
<b>description</b>	burner holder suitable for burner ø100mm with nozzle holder		
<b>For models:</b>	ABJ0001, ABJ0002, BSC6FG, KT3VD, PC2G, PC2G-4370, TOP2G		
<b>accessories for</b>	104103		
	<b>GEV No.</b>	103067	<b>Ref. No.</b> 068070 M01100
burner ring for burner cap ø 100mm			
	<b>GEV No.</b>	103068	<b>Ref. No.</b> 068067 M00400
burner cap ø 100mm			
	<b>GEV No.</b>	104102	<b>Ref. No.</b> 068064 M00900
burner head for burner cap ø 100mm ext. ø 130			

 <p>1</p>			
<b>GEV No.</b>	103067	<b>Ref. No.</b>	068070 M01100
<b>description</b>	burner ring for burner cap ø 100mm		
<b>For models:</b>	ABJ0001, ABJ0002, BSC6FG, PC2G, PC2G-4370, TOP2G		
<b>accessories for</b>	103067		
	<b>GEV No.</b>	103068	<b>Ref. No.</b> 068067 M00400
burner cap ø 100mm			
	<b>GEV No.</b>	104102	<b>Ref. No.</b> 068064 M00900
burner head for burner cap ø 100mm ext. ø 130			
	<b>GEV No.</b>	104103	<b>Ref. No.</b> 068063 M00700
burner holder suitable for burner ø100mm with nozzle holder			

 <p>1</p>			
<b>GEV No.</b>	103065	<b>Ref. No.</b>	068099 M01000
<b>description</b>	burner ring for burner cap ø 80mm		
<b>For models:</b>	ABJ0001, ABJ0002, BSC6FG, PC2G, TOP2G		
<b>accessories for</b>	103065		
	<b>GEV No.</b>	103066	<b>Ref. No.</b> 068098 M00300
burner cap ø 80mm			
	<b>GEV No.</b>	104100	<b>Ref. No.</b> 068085 M00800
burner head for burner cap ø 80mm			
	<b>GEV No.</b>	104101	<b>Ref. No.</b> 068097 M00600
burner holder for burner cap ø 80mm with nozzle holder with mixing sleeve			





650 series

 <p>1</p>			
<b>GEV No.</b>	105018	<b>Ref. No.</b>	069201/A
<b>description</b>	burner cap ø 100mm seat ø 75mm		
<b>For models:</b>	BSC4FE80, BSC4FG, C127FE, C2FG, C3FG, C3G, C87FE, CREP1G, CREP1G400, CREP2G, FTG47, HP1G, HP2G, HP4652G, HP8654G, PC127FTE, PC127FTG, PC127G, PC47G, PC4G, PC87G		
<b>accessories for</b>	105018		
	<b>GEV No.</b>	105019	<b>Ref. No.</b> 069206
burner ring for burner cap ø 100mm			
	<b>GEV No.</b>	105031	<b>Ref. No.</b> 020824
gasket ø 80mm for burner cap ø 100mm ID ø 56mm thickness 2mm fibre			
	<b>GEV No.</b>	105033	<b>Ref. No.</b> 062150/A
nozzle holder			
	<b>GEV No.</b>	105034	<b>Ref. No.</b> 006911 alt
burner lower part for burner cap ø 100mm with venturi			

			
1			
<b>GEV No.</b>	105029	<b>Ref. No.</b>	069200/17 069200/A
<b>description</b>	burner cap ø 80mm		
<b>accessories for</b>	105029		
	<b>GEV No.</b>	105030	<b>Ref. No.</b> 069205
	burner ring for burner cap ø 80mm		
	<b>GEV No.</b>	105032	<b>Ref. No.</b> 006912
	burner lower part for burner cap ø 80mm with venturi		
	<b>GEV No.</b>	105033	<b>Ref. No.</b> 062150/A
	nozzle holder		
	<b>GEV No.</b>	105038	<b>Ref. No.</b> 020822
	gasket for burner cap ø 80mm		

			
1			
<b>GEV No.</b>	105940	<b>Ref. No.</b>	069113
<b>description</b>	burner head for burner cap ø 80mm		

			
1			
<b>GEV No.</b>	106945	<b>Ref. No.</b>	006911
<b>description</b>	burner lower part for burner cap ø 100mm new edition		

			
1			
<b>GEV No.</b>	105034	<b>Ref. No.</b>	006911 alt
<b>description</b>	burner lower part for burner cap ø 100mm with venturi		
<b>accessories for</b>	105034		
	<b>GEV No.</b>	105010	<b>Ref. No.</b> 069201
	burner cap ø 100mm seat ø 75mm		
	<b>GEV No.</b>	105016	<b>Ref. No.</b> 069111
	burner head for burner cap ø 100mm		
	<b>GEV No.</b>	105031	<b>Ref. No.</b> 020824
	gasket ø 80mm for burner cap ø 100mm ID ø 56mm thickness 2mm fibre		

			
1			
<b>GEV No.</b>	105032	<b>Ref. No.</b>	006912
<b>description</b>	burner lower part for burner cap ø 80mm with venturi		
<b>For models:</b>	BSC4FE80, HP4652G, HP8654G, PC127FTE, PC127FTG, PC1G40, PC2G, TOP2G, TOPG		
<b>accessories for</b>	105032		
	<b>GEV No.</b>	105029	<b>Ref. No.</b> 069200/17 069200/A
	burner cap ø 80mm		
	<b>GEV No.</b>	105030	<b>Ref. No.</b> 069205
	burner ring for burner cap ø 80mm		
	<b>GEV No.</b>	105033	<b>Ref. No.</b> 062150/A
	nozzle holder		
	<b>GEV No.</b>	105038	<b>Ref. No.</b> 020822
	gasket for burner cap ø 80mm		

			
1			
<b>GEV No.</b>	105019	<b>Ref. No.</b>	069206
<b>description</b>	burner ring for burner cap ø 100mm		
<b>accessories for</b>	105019		
	<b>GEV No.</b>	105018	<b>Ref. No.</b> 069201/A
	burner cap ø 100mm seat ø 75mm		
	<b>GEV No.</b>	105031	<b>Ref. No.</b> 020824
	gasket ø 80mm for burner cap ø 100mm ID ø 56mm thickness 2mm fibre		
	<b>GEV No.</b>	105033	<b>Ref. No.</b> 062150/A
	nozzle holder		
	<b>GEV No.</b>	105034	<b>Ref. No.</b> 006911 alt
	burner lower part for burner cap ø 100mm with venturi		





			
1			
<b>GEV No.</b>	105030	<b>Ref. No.</b>	069205
<b>description</b>	burner ring for burner cap ø 80mm		
<b>accessories for</b>	105030		
	<b>GEV No.</b>	105029	<b>Ref. No.</b> 069200/17 069200/A
	burner cap ø 80mm		
	<b>GEV No.</b>	105032	<b>Ref. No.</b> 006912
	burner lower part for burner cap ø 80mm with venturi		

Table continues overleaf



<b>accessories for</b>	105030			
	<b>GEV No.</b>	105033	<b>Ref. No.</b>	062150/A
	nozzle holder			
	<b>GEV No.</b>	105038	<b>Ref. No.</b>	020822
	gasket for burner cap ø 80mm			





<b>1</b>				
<b>GEV No.</b>	105038	<b>Ref. No.</b>	020822	
<b>description</b>	gasket for burner cap ø 80mm			
<b>accessories for</b>	105038			
	<b>GEV No.</b>	105029	<b>Ref. No.</b>	069200/17 069200/A
	burner cap ø 80mm			
	<b>GEV No.</b>	105030	<b>Ref. No.</b>	069205
	burner ring for burner cap ø 80mm			
	<b>GEV No.</b>	105032	<b>Ref. No.</b>	006912
	burner lower part for burner cap ø 80mm with venturi			
	<b>GEV No.</b>	105033	<b>Ref. No.</b>	062150/A
	nozzle holder			
	<b>GEV No.</b>	105879	<b>Ref. No.</b>	069200
	burner cap ø 80mm			
	<b>GEV No.</b>	105880	<b>Ref. No.</b>	—
	burner head for burner cap ø 80mm			
	<b>GEV No.</b>	105881	<b>Ref. No.</b>	069112
	burner lower part for burner cap ø 80mm			

<b>1</b>				
<b>GEV No.</b>	105031	<b>Ref. No.</b>	020824	
<b>description</b>	gasket ø 80mm for burner cap ø 100mm ID ø 56mm thickness 2mm fibre			
<b>accessories for</b>	105031			
	<b>GEV No.</b>	105010	<b>Ref. No.</b>	069201
	burner cap ø 100mm seat ø 75mm			
	<b>GEV No.</b>	105016	<b>Ref. No.</b>	069111
	burner head for burner cap ø 100mm			
	<b>GEV No.</b>	105017	<b>Ref. No.</b>	069110
	burner lower part ø 100mm			
	<b>GEV No.</b>	105018	<b>Ref. No.</b>	069201/A
	burner cap ø 100mm seat ø 75mm			
	<b>GEV No.</b>	105019	<b>Ref. No.</b>	069206
	burner ring for burner cap ø 100mm			
	<b>GEV No.</b>	105033	<b>Ref. No.</b>	062150/A
	nozzle holder			

<b>accessories for</b>	105031			
	<b>GEV No.</b>	105034	<b>Ref. No.</b>	006911 alt
	burner lower part for burner cap ø 100mm with venturi			





<b>1</b>				
<b>GEV No.</b>	105033	<b>Ref. No.</b>	062150/A	
<b>description</b>	nozzle holder			
<b>accessories for</b>	105033			
	<b>GEV No.</b>	105018	<b>Ref. No.</b>	069201/A
	burner cap ø 100mm seat ø 75mm			
	<b>GEV No.</b>	105019	<b>Ref. No.</b>	069206
	burner ring for burner cap ø 100mm			
	<b>GEV No.</b>	105029	<b>Ref. No.</b>	069200/17 069200/A
	burner cap ø 80mm			
	<b>GEV No.</b>	105030	<b>Ref. No.</b>	069205
	burner ring for burner cap ø 80mm			
	<b>GEV No.</b>	105032	<b>Ref. No.</b>	006912
	burner lower part for burner cap ø 80mm with venturi			
	<b>GEV No.</b>	105034	<b>Ref. No.</b>	006911 alt
	burner lower part for burner cap ø 100mm with venturi			
	<b>GEV No.</b>	105038	<b>Ref. No.</b>	020822
	gasket for burner cap ø 80mm			





700 series

<b>1</b>				
<b>GEV No.</b>	105010	<b>Ref. No.</b>	069201	
<b>description</b>	burner cap ø 100mm seat ø 75mm			
<b>For models:</b>	C2FG, C3FG, C3G			
<b>accessories for</b>	105010			
	<b>GEV No.</b>	105016	<b>Ref. No.</b>	069111
	burner head for burner cap ø 100mm			
	<b>GEV No.</b>	105031	<b>Ref. No.</b>	020824
	gasket ø 80mm for burner cap ø 100mm ID ø 56mm thickness 2mm fibre			
	<b>GEV No.</b>	105034	<b>Ref. No.</b>	006911 alt
	burner lower part for burner cap ø 100mm with venturi			









			
1			
<b>GEV No.</b>	105879	<b>Ref. No.</b>	069200
<b>description</b>	burner cap ø 80mm		

			
1			
<b>GEV No.</b>	105016	<b>Ref. No.</b>	069111
<b>description</b>	burner head for burner cap ø 100mm		
<b>accessories for</b>	105016		
	<b>GEV No.</b>	105010	<b>Ref. No.</b> 069201
burner cap ø 100mm seat ø 75mm			
	<b>GEV No.</b>	105031	<b>Ref. No.</b> 020824
gasket ø 80mm for burner cap ø 100mm ID ø 56mm thickness 2mm fibre			
	<b>GEV No.</b>	105034	<b>Ref. No.</b> 006911 alt
burner lower part for burner cap ø 100mm with venturi			

			
1			
<b>GEV No.</b>	105034	<b>Ref. No.</b>	006911 alt
<b>description</b>	burner lower part for burner cap ø 100mm with venturi		
<b>accessories for</b>	105034		
	<b>GEV No.</b>	105010	<b>Ref. No.</b> 069201
burner cap ø 100mm seat ø 75mm			
	<b>GEV No.</b>	105016	<b>Ref. No.</b> 069111
burner head for burner cap ø 100mm			
	<b>GEV No.</b>	105031	<b>Ref. No.</b> 020824
gasket ø 80mm for burner cap ø 100mm ID ø 56mm thickness 2mm fibre			

			
1			
<b>GEV No.</b>	105881	<b>Ref. No.</b>	069112
<b>description</b>	burner lower part for burner cap ø 80mm		

			
1			
<b>GEV No.</b>	105032	<b>Ref. No.</b>	006912
<b>description</b>	burner lower part for burner cap ø 80mm with venturi		
<b>For models:</b>	BSC4FE80, HP4652G, HP8654G, PC127FTE, PC127FTG, PC1G40, PC2G, TOP2G, TOPG		
<b>accessories for</b>	105032		
	<b>GEV No.</b>	105029	<b>Ref. No.</b> 069200/17 069200/A
burner cap ø 80mm			
	<b>GEV No.</b>	105030	<b>Ref. No.</b> 069205
burner ring for burner cap ø 80mm			
	<b>GEV No.</b>	105033	<b>Ref. No.</b> 062150/A
nozzle holder			
	<b>GEV No.</b>	105038	<b>Ref. No.</b> 020822
gasket for burner cap ø 80mm			

			
1			
<b>GEV No.</b>	105017	<b>Ref. No.</b>	069110
<b>description</b>	burner lower part ø 100mm		
<b>For models:</b>	GR-MGZ-L-2129, GR-MGZ-R-2128		

			
1			
<b>GEV No.</b>	105030	<b>Ref. No.</b>	069205
<b>description</b>	burner ring for burner cap ø 80mm		
<b>accessories for</b>	105030		
	<b>GEV No.</b>	105029	<b>Ref. No.</b> 069200/17 069200/A
burner cap ø 80mm			
	<b>GEV No.</b>	105032	<b>Ref. No.</b> 006912
burner lower part for burner cap ø 80mm with venturi			
	<b>GEV No.</b>	105033	<b>Ref. No.</b> 062150/A
nozzle holder			
	<b>GEV No.</b>	105038	<b>Ref. No.</b> 020822
gasket for burner cap ø 80mm			





 <p>1</p>			
<b>GEV No.</b>	105038	<b>Ref. No.</b>	020822
<b>description</b>	gasket for burner cap ø 80mm		
<b>accessories for</b>	105038		
	<b>GEV No.</b>	105029	<b>Ref. No.</b> 069200/17 069200/A
burner cap ø 80mm			
	<b>GEV No.</b>	105030	<b>Ref. No.</b> 069205
burner ring for burner cap ø 80mm			
	<b>GEV No.</b>	105032	<b>Ref. No.</b> 006912
burner lower part for burner cap ø 80mm with venturi			
	<b>GEV No.</b>	105033	<b>Ref. No.</b> 062150/A
nozzle holder			
	<b>GEV No.</b>	105879	<b>Ref. No.</b> 069200
burner cap ø 80mm			
	<b>GEV No.</b>	105880	<b>Ref. No.</b> —
burner head for burner cap ø 80mm			
	<b>GEV No.</b>	105881	<b>Ref. No.</b> 069112
burner lower part for burner cap ø 80mm			

 <p>1</p>			
<b>GEV No.</b>	105031	<b>Ref. No.</b>	020824
<b>description</b>	gasket ø 80mm for burner cap ø 100mm ID ø 56mm thickness 2mm fibre		
<b>accessories for</b>	105031		
	<b>GEV No.</b>	105010	<b>Ref. No.</b> 069201
burner cap ø 100mm seat ø 75mm			
	<b>GEV No.</b>	105016	<b>Ref. No.</b> 069111
burner head for burner cap ø 100mm			
	<b>GEV No.</b>	105017	<b>Ref. No.</b> 069110
burner lower part ø 100mm			
	<b>GEV No.</b>	105018	<b>Ref. No.</b> 069201/A
burner cap ø 100mm seat ø 75mm			
	<b>GEV No.</b>	105019	<b>Ref. No.</b> 069206
burner ring for burner cap ø 100mm			
	<b>GEV No.</b>	105033	<b>Ref. No.</b> 062150/A
nozzle holder			
	<b>GEV No.</b>	105034	<b>Ref. No.</b> 006911 alt
burner lower part for burner cap ø 100mm with venturi			

 <p>1</p>			
<b>GEV No.</b>	105020	<b>Ref. No.</b>	068171
<b>description</b>	venturi		

pan supports

 <p>1</p>			
<b>GEV No.</b>	210226	<b>Ref. No.</b>	059006
<b>description</b>	pan support W 340mm L 620mm		

accessories

pan supports

 <p>1</p>			
<b>GEV No.</b>	210163	<b>Ref. No.</b>	0550M48200
<b>description</b>	pan support		
<b>For models:</b>	ABJ0001, ABJ0002		

 <p>1</p>			
<b>GEV No.</b>	210226	<b>Ref. No.</b>	059006
<b>description</b>	pan support W 340mm L 620mm		

 <p>1</p>			
<b>GEV No.</b>	210161	<b>Ref. No.</b>	0550X25000
<b>description</b>	pan support W 385mm L 580mm		
<b>For models:</b>	ACA2001, ACA2002, ACA2003, ACA2004, ACA2006, ACA2008, ACA2010, ACA2011, ACA2012, ACJ0001, ACJ0003		



## bar burners

## bar burners



<b>GEV No.</b>	105102	<b>Ref. No.</b>	X68046
----------------	--------	-----------------	--------

**description** bar burner 1-row ø 27mm Wmm Hmm L 418mm oven

**For models:** ACB0001, ADB0001, AEB0003, BM48G

**spare parts for** 105102



GEV No. 104651

Ref. No. —

mounting flange for igniter and thermocouple



<b>GEV No.</b>	105115	<b>Ref. No.</b>	Y22200
----------------	--------	-----------------	--------

**description** bar burner 1-row ø 40mm Wmm Hmm L 500mm flange width 43mm flange length 43mm tilting bratt pan

**For models:** ADK2007, ADK2008, ADK2009, ADK2010, AEK2005, AEK2006, AEK2007, AEK2008



<b>GEV No.</b>	105260	<b>Ref. No.</b>	X20100
----------------	--------	-----------------	--------

**description** bar burner 2 row L 450mm W 300mm ømm H 50mm 8.5kW griddle

**For models:** ABH3014, ABH3015, ABH3016, ABH3017, ABH3018, ACH3015, ACH3016, ACH3017



<b>GEV No.</b>	105302	<b>Ref. No.</b>	Y22000
----------------	--------	-----------------	--------

**description** bar burner 3 row L 445mm W 280mm ømm H 40mm solid top

**For models:** AEA2005



<b>GEV No.</b>	105340	<b>Ref. No.</b>	X24100
----------------	--------	-----------------	--------

**description** bar burner 3 row L 480mm W 305mm ømm H 60mm mounting distance 280mm chargrill

**For models:** ABH1001, ABH1002, ACH1001, ACH1002, ACH1003, ACH1004, ADH1001, ADH1002, AEH1001, AEH1002, SKPL1G, SKPL2G



<b>GEV No.</b>	105303	<b>Ref. No.</b>	Y20100
----------------	--------	-----------------	--------

**description** bar burner 3 row L 630mm W 265mm ømm H 60mm griddle

**For models:** ADH3007, ADH3008, ADH3010, ADH3011, AEH3007, AEH3008, AEH3009, AEH3010, AEH3011, AEH3012, GFT49L, GFT49LC, GFT49R, GFT89L, GFT89LC, GFT89LR, KFT8GLR



<b>GEV No.</b>	105105	<b>Ref. No.</b>	X20400
----------------	--------	-----------------	--------

**description** bar burner angled L 600mm W 305mm ømm Hmm oven

**For models:** ACA2005, ACA2009, ADA2009



<b>GEV No.</b>	105103	<b>Ref. No.</b>	X68401
----------------	--------	-----------------	--------

**description** bar burner ø 27mm Wmm Hmm L 638mm oven

**For models:** ACA2004, ACA2008

**spare parts for** 105103



GEV No. 104651

Ref. No. —

mounting flange for igniter and thermocouple

**accessories for** 105103



GEV No. 104651

Ref. No. —

mounting flange for igniter and thermocouple





 <p>1</p>			
<b>GEV No.</b>	105110	<b>Ref. No.</b>	X20600
<b>description</b>	bar burner ø 40mm Wmm Hmm L 323mm tilting bratt pan flange ø 61mm		
<b>For models:</b>	ACK2001, BRG70		

 <p>1</p>			
<b>GEV No.</b>	105718	<b>Ref. No.</b>	E30100
<b>description</b>	bar burner ø 40mm Wmm Hmm L 395mm flange ø 61mm tilting bratt pan		
<b>For models:</b>	ADL0006, ADL0007, ADL0013, AEL0004, AEL0005		

 <p>1</p>			
<b>GEV No.</b>	105108	<b>Ref. No.</b>	X23800
<b>description</b>	bar burner ø 50mm Wmm Hmm L 350mm pasta cooker		
<b>For models:</b>	ACE0001		

 <p>1</p>			
<b>GEV No.</b>	105882	<b>Ref. No.</b>	068187
<b>description</b>	bar burner ømm W 150mm H 40mm L 685mm oven		

 <p>1</p>			
<b>GEV No.</b>	105255	<b>Ref. No.</b>	X20000
<b>description</b>	bar burner ømm W 41mm H 34mm L 490mm flange width 70mm 5.5kW griddle		
<b>For models:</b>	ABH3010, ABH3011, ABH3012, ACH3008, ACH3009, ACH3010, ACH3011, ACH3012, ACH3013, ACH3014		

 <p>1</p>			
<b>GEV No.</b>	105341	<b>Ref. No.</b>	B49900
<b>description</b>	lava rock grid L 450mm W 330mm		
<b>For models:</b>	ACH1002, ACH1004		

lava rock grids

 <p>1</p>			
<b>GEV No.</b>	105341	<b>Ref. No.</b>	B49900
<b>description</b>	lava rock grid L 450mm W 330mm		
<b>For models:</b>	ACH1002, ACH1004		

tube burners

 <p>1</p>			
<b>GEV No.</b>	105261	<b>Ref. No.</b>	0900X23100
<b>description</b>	tubular burner ø 74mm L 180mm W 75mm H 60mm for fryer round		
<b>For models:</b>	ACC0001, ACC0002, ACC0006, ACC0007, ADC0001, ADC0002, AEC0007, AEC0008		

ceramic burners

accessories

burner grids

 <p>1</p>			
<b>GEV No.</b>	210149	<b>Ref. No.</b>	056451
<b>description</b>	burner grid L 340mm W 215mm for gyro grill		



 <p>1</p>			
<b>GEV No.</b>	210153	<b>Ref. No.</b>	056452
<b>description</b>	burner grid L 500mm W 215mm for gyro grill		

			
1			
<b>GEV No.</b>	210129	<b>Ref. No.</b>	056454
<b>description</b>	burner grid L 660mm W 215mm for gyro grill		

			
1			
<b>GEV No.</b>	210154	<b>Ref. No.</b>	056453
<b>description</b>	burner grid L 660mm W 215mm for gyro grill		

accessories

nozzle holders

			
1			
<b>GEV No.</b>	105033	<b>Ref. No.</b>	062150/A
<b>description</b>	nozzle holder		
<b>accessories for</b>	105033		
	<b>GEV No.</b>	105038	<b>Ref. No.</b> 020822
	gasket for burner cap ø 80mm		

gas nozzles

main nozzles

gas nozzles M7x1

			
1			
<b>GEV No.</b>	100519	<b>Ref. No.</b>	X38300
<b>description</b>	gas injector thread M7x1 WS 10 bore ø 0.95mm		
<b>For models:</b>	ABJ0001, ABJ0002		

			
1			
<b>GEV No.</b>	100523	<b>Ref. No.</b>	X38800
<b>description</b>	gas injector thread M7x1 WS 10 bore ø 1.4mm		
<b>For models:</b>	ABJ0001, ABJ0002		

			
1			
<b>GEV No.</b>	100524	<b>Ref. No.</b>	X39300
<b>description</b>	gas injector thread M7x1 WS 10 bore ø 1.55mm		
<b>For models:</b>	ABJ0001, ABJ0002		

gas nozzles M10x1

			
1			
<b>GEV No.</b>	100420	<b>Ref. No.</b>	X33600
<b>description</b>	gas injector thread M10x1 WS 11 bore ø 0.95mm		
<b>For models:</b>	ACA2001, ACA2002, ACA2003, ACA2004, ACA2005, ACA2006, ACA2007, ACA2008, ACA2009, ACA2010, ACA2011, ACA2012, ACC0001, ACC0002, ACC0006, ACC0007, ACJ0001, ACJ0003, ADA2001, ADA2002, ADA2003, ADA2004, ADA2005, ADA2006, ADA2007, ADA2008, ADA2009, ADA2010, ADA2017, ADC0001, ADC0002, AEA2001, AEA2002, AEA2003, AEA2004, AEC0007, AEC0008, K2FZ		

			
1			
<b>GEV No.</b>	106490	<b>Ref. No.</b>	X34200
<b>description</b>	gas injector thread M10x1 WS 11 bore ø 1.25mm		
<b>For models:</b>	ABH3010, ABH3011, ABH3012, ACH3008, ACH3009, ACH3010, ACH3011, ACH3012, ACH3013, ACH3014, ADA2001, ADA2002, ADA2003, ADA2004, ADA2005, ADA2006, ADA2007, ADA2008, ADA2009, ADA2010, ADA2017, AEA2001, AEA2002, AEA2003, AEA2004, K2FZ		

			
1			
<b>GEV No.</b>	101997	<b>Ref. No.</b>	X34500
<b>description</b>	gas injector thread M10x1 WS 11 bore ø 1.4mm		
<b>For models:</b>	ADA2009		

			
1			
<b>GEV No.</b>	100793	<b>Ref. No.</b>	X34700
<b>description</b>	gas injector thread M10x1 WS 11 bore ø 1.5mm		
<b>For models:</b>	ACA2001, ACA2002, ACA2003, ACA2004, ACA2005, ACA2006, ACA2007, ACA2008, ACA2009, ACA2010, ACA2011, ACA2012, ACJ0001, ACJ0003, ADA2002, ADA2003, ADA2004, ADA2005, ADA2006, ADA2007, ADA2009, ADA2017, AEA2001, AEA2002, AEA2003, AEA2004		



pilot burner nozzles

pilot burner nozzles SIT

100 series



<b>GEV No.</b>	100245	<b>Ref. No.</b>	X19906
<b>description</b>	pilot burner nozzle LPG code 20 bore $\varnothing$ 0.2mm Qty 1 pcs thread M8x0.75		
<b>For models:</b>	ADA2009, ADC0001, ADC0002, ADE0001, ADH1001, ADH1002, AEC0007, AEC0008, AEH1001, AEH1002, CP49G, CP89G		



<b>GEV No.</b>	100246	<b>Ref. No.</b>	X19907
<b>description</b>	pilot burner nozzle natural gas bore $\varnothing$ 0.35mm Qty 1 pcs thread M8x0.75		
<b>For models:</b>	ADA2009, ADC0001, ADC0002, ADE0001, AEC0007, AEC0008, CP49G, CP89G		

140/150 series



<b>GEV No.</b>	100205	<b>Ref. No.</b>	X30000
<b>description</b>	pilot burner nozzle SIT LPG code 19 bore $\varnothing$ 0.23/0.26mm Qty 1 pcs suitable for SIT 150 series		
<b>For models:</b>	ABH3010, ABH3011, ABH3012, ABH3014, ABH3015, ABH3016, ABH3017, ABH3018, ACH3008, ACH3009, ACH3010, ACH3011, ACH3012, ACH3013, ACH3014, ACH3015, ACH3016, ACH3017, ADA2001, ADA2002, ADA2003, ADA2004, ADA2005, ADA2006, ADA2007, ADA2008, ADA2009, ADA2010, ADA2017, ADH3007, ADH3008, ADH3010, ADH3011, ADK2007, ADK2008, ADK2009, ADK2010, AEA2001, AEA2002, AEA2003, AEA2004, AEA2005, AEH3007, AEH3008, AEH3009, AEH3010, AEH3011, AEH3012, AEK2005, AEK2006...(Other models you can see in the webshop)		

bypass nozzles

bypass nozzles PEL20/21



<b>GEV No.</b>	100554	<b>Ref. No.</b>	X11000
<b>description</b>	bypass nozzle type PEL20/21 bore $\varnothing$ 0.45mm thread M5x0.5		
<b>For models:</b>	ADA2001, ADA2002, ADA2003, ADA2004, ADA2005, ADA2006, ADA2007, ADA2008, ADA2009, ADA2010, ADA2017, AEA2001, AEA2002, AEA2003, AEA2004, K2FZ		



<b>GEV No.</b>	100278	<b>Ref. No.</b>	X04800
<b>description</b>	bypass nozzle type PEL20/21 bore $\varnothing$ 0.75mm thread M5x0.5		
<b>For models:</b>	ADA2001, ADA2002, ADA2003, ADA2004, ADA2005, ADA2006, ADA2007, ADA2008, ADA2009, ADA2010, ADA2017, AEA2001, AEA2002, AEA2003, AEA2004, K2FZ		

auxiliary gas parts

screw connections

T-pieces



<b>GEV No.</b>	101833	<b>Ref. No.</b>	062155
<b>description</b>	T-piece		

consumables

lava rocks / ceramic briquettes



<b>GEV No.</b>	105342	<b>Ref. No.</b>	M30500
<b>description</b>	lava rocks content 9kg		
<b>For models:</b>	ABH1001, ABH1002, ACH1001, ACH1002, ACH1003, ACH1004, ADH1001, ADH1002, AEH1001, AEH1002, SKPL1G, SKPL2G		

equipment-specific units

for meat mincers

locking screws

locking screws



<b>GEV No.</b>	698092	<b>Ref. No.</b>	AM.F2115
<b>description</b>	locking screw thread M10 thread L 30mm handle $\varnothing$ 60mm plastic		
<b>For models:</b>	TG12, TG12R, TS12		

funnel trays



<b>GEV No.</b>	698077	<b>Ref. No.</b>	AM.F2038 AM.F2113
<b>description</b>	hopper filling pipe central L 275mm W 200mm H 50mm tube $\varnothing$ 52mm		
<b>For models:</b>	TG12, TG12R, TS8		



1

<b>GEV No.</b>	698076	<b>Ref. No.</b>	AM.F2207
<b>description</b>	hopper filling pipe central L 370mm W 250mm H 60mm tube ø 52mm		
<b>For models:</b>	TG22, TS22		

funnels



1

<b>GEV No.</b>	698085	<b>Ref. No.</b>	AM.F2149
<b>description</b>	funnel model 12 ø 15mm		
<b>For models:</b>	TG12, TG12R, TS12		



1

<b>GEV No.</b>	698086	<b>Ref. No.</b>	AM.F2150
<b>description</b>	funnel model 12 ø 20mm ED ø 65mm L 135mm		
<b>For models:</b>	TG12, TG12R, TS12		



1

<b>GEV No.</b>	698087	<b>Ref. No.</b>	AM.F2151
<b>description</b>	funnel model 12 ø 25mm		
<b>For models:</b>	TG12, TG12R, TS12		



1

<b>GEV No.</b>	698082	<b>Ref. No.</b>	AM.F2050
<b>description</b>	funnel model 8 ø 15mm		
<b>For models:</b>	TS8		



1

<b>GEV No.</b>	698083	<b>Ref. No.</b>	AM.F2051
<b>description</b>	funnel model 8 ø 20mm		
<b>For models:</b>	TS8		

grinder plates

ENTERPRISE

with 1 notch

with hub



1

<b>GEV No.</b>	696117	<b>Ref. No.</b>	AM.F2131 (ø 10mm)
<b>description</b>	grinder plate type ENTERPRISE size 12 hole ø 10mm with hub grooves 1 stainless steel ø 70mm		



1

<b>GEV No.</b>	696118	<b>Ref. No.</b>	AM.F2131 (ø 12mm)
<b>description</b>	grinder plate type ENTERPRISE size 12 hole ø 12mm with hub grooves 1 stainless steel ø 70mm		



1

<b>GEV No.</b>	696119	<b>Ref. No.</b>	AM.F2131 (ø 14mm)
<b>description</b>	grinder plate type ENTERPRISE size 12 hole ø 14mm with hub grooves 1 stainless steel ø 70mm		



1

<b>GEV No.</b>	696107	<b>Ref. No.</b>	AM.F2045 (ø 12mm)
<b>description</b>	grinder plate type ENTERPRISE size 8 hole ø 12mm with hub grooves 1 stainless steel ø 62mm		



1

<b>GEV No.</b>	696120	<b>Ref. No.</b>	AM.F2131 (ø 16mm)
<b>description</b>	grinder plate type ENTERPRISE size 12 hole ø 16mm with hub grooves 1 stainless steel ø 70mm		



1

<b>GEV No.</b>	696108	<b>Ref. No.</b>	AM.F2045 (ø 14mm)
<b>description</b>	grinder plate type ENTERPRISE size 8 hole ø 14mm with hub grooves 1 stainless steel ø 62mm		



1

<b>GEV No.</b>	696121	<b>Ref. No.</b>	AM.F2131 (ø 18mm)
<b>description</b>	grinder plate type ENTERPRISE size 12 hole ø 18mm with hub grooves 1 stainless steel ø 70mm		



1

<b>GEV No.</b>	696109	<b>Ref. No.</b>	AM.F2045 (ø 16mm)
<b>description</b>	grinder plate type ENTERPRISE size 8 hole ø 16mm with hub grooves 1 stainless steel ø 62mm		



1

<b>GEV No.</b>	696106	<b>Ref. No.</b>	AM.F2045 (ø 10mm)
<b>description</b>	grinder plate type ENTERPRISE size 8 hole ø 10mm with hub grooves 1 stainless steel ø 62mm		

with 2 notches

with hub



1

<b>GEV No.</b>	696111	<b>Ref. No.</b>	AM.F2131 (ø 2mm)
<b>description</b>	grinder plate type ENTERPRISE size 12 hole ø 2mm with hub grooves 2 stainless steel ø 70mm		



1

<b>GEV No.</b>	696113	<b>Ref. No.</b>	AM.F2131 (ø 3,5mm)
<b>description</b>	grinder plate type ENTERPRISE size 12 hole ø 3.5mm with hub grooves 2 stainless steel ø 70mm		



1

<b>GEV No.</b>	696116	<b>Ref. No.</b>	AM.F2131 (ø 8mm)
<b>description</b>	grinder plate type ENTERPRISE size 12 hole ø 8mm with hub grooves 2 stainless steel ø 70mm		



1

<b>GEV No.</b>	696112	<b>Ref. No.</b>	AM.F2131 (ø 3mm)
<b>description</b>	grinder plate type ENTERPRISE size 12 hole ø 3mm with hub grooves 2 stainless steel ø 70mm		



1

<b>GEV No.</b>	696102	<b>Ref. No.</b>	AM.F2045 (ø 3,5mm)
<b>description</b>	grinder plate type ENTERPRISE size 8 hole ø 3.5mm with hub grooves 2 stainless steel ø 62mm		



1

<b>GEV No.</b>	696114	<b>Ref. No.</b>	AM.F2131 (ø 4,5mm)
<b>description</b>	grinder plate type ENTERPRISE size 12 hole ø 4.5mm with hub grooves 2 stainless steel ø 70mm		



1

<b>GEV No.</b>	696101	<b>Ref. No.</b>	AM.F2045 (ø 3mm)
<b>description</b>	grinder plate type ENTERPRISE size 8 hole ø 3mm with hub grooves 2 stainless steel ø 62mm		



1

<b>GEV No.</b>	696115	<b>Ref. No.</b>	AM.F2131 (ø 6mm)
<b>description</b>	grinder plate type ENTERPRISE size 12 hole ø 6mm with hub grooves 2 stainless steel ø 70mm		



1

<b>GEV No.</b>	696103	<b>Ref. No.</b>	AM.F2045 (ø 4,5mm)
<b>description</b>	grinder plate type ENTERPRISE size 8 hole ø 4.5mm with hub grooves 2 stainless steel ø 62mm		





1

<b>GEV No.</b>	696104	<b>Ref. No.</b>	AM.F2045 (ø 6mm)
<b>description</b>	grinder plate type ENTERPRISE size 8 hole ø 6mm with hub grooves 2 stainless steel ø 62mm		



1

<b>GEV No.</b>	696105	<b>Ref. No.</b>	AM.F2045 (ø 8mm)
<b>description</b>	grinder plate type ENTERPRISE size 8 hole ø 8mm with hub grooves 2 stainless steel ø 62mm		

blades

ENTERPRISE



1

<b>GEV No.</b>	696022	<b>Ref. No.</b>	AM.F2130
<b>description</b>	knife type ENTERPRISE size 12 ø 62mm internal size 12x12mm stainless steel		
<b>For models:</b>	TG12, TG12R, TS12		



1

<b>GEV No.</b>	696021	<b>Ref. No.</b>	AM.F2044
<b>description</b>	knife type ENTERPRISE size 8 ø 55mm internal size 10x10mm stainless steel		
<b>For models:</b>	TS8		

ring nuts



1

<b>GEV No.</b>	698024	<b>Ref. No.</b>	AM.F2046
<b>description</b>	ring nut model 8 aluminium		
<b>For models:</b>	TS8		



1

<b>GEV No.</b>	698040	<b>Ref. No.</b>	AM.F2133
<b>description</b>	ring nut Unger model 12 ED ø 89mm thickness 27mm ID ø 64mm stainless steel thread M82x2		
<b>For models:</b>	TS12		



1

<b>GEV No.</b>	698039	<b>Ref. No.</b>	AM.F2132
<b>description</b>	ring nut Unger model 12 ID ø 78mm aluminium		
<b>For models:</b>	TG12, TG12R, TS12		



1

<b>GEV No.</b>	698057	<b>Ref. No.</b>	AM.F2220
<b>description</b>	ring nut Unger model 22 ID ø 73mm aluminium		
<b>For models:</b>	TG22, TS22		



1

<b>GEV No.</b>	698058	<b>Ref. No.</b>	AM.F2221
<b>description</b>	ring nut Unger model 22 ID ø 74mm stainless steel thread M94x2		
<b>For models:</b>	TG22, TS22		

augers

complete



1

<b>GEV No.</b>	698037	<b>Ref. No.</b>	AM.F2124
<b>description</b>	auger model 12 ø 53mm L 135mm stainless steel with spindle ENTERPRISE		
<b>For models:</b>	TG12, TG12R, TS12		



1

<b>GEV No.</b>	698035	<b>Ref. No.</b>	AM.F2122
<b>description</b>	auger model 12 ø 53mm L 140mm aluminium with spindle ENTERPRISE		
<b>For models:</b>	TG12, TG12R, TS12		



1

<b>GEV No.</b>	698036	<b>Ref. No.</b>	AM.F2123
<b>description</b>	auger model 12 ø 53mm L 150mm cast iron with spindle ENTERPRISE		
<b>For models:</b>	TG12, TG12R, TS12		



1

<b>GEV No.</b>	698053	<b>Ref. No.</b>	AM.F2214
<b>description</b>	auger model 22 ø 63mm L 150mm aluminium with spindle ENTERPRISE		
<b>For models:</b>	TG22, TS22		



1

<b>GEV No.</b>	698054	<b>Ref. No.</b>	AM.F2215
<b>description</b>	auger model 22 ø 63mm L 150mm cast iron with spindle ENTERPRISE		
<b>For models:</b>	TG22, TS22		



1

<b>GEV No.</b>	698055	<b>Ref. No.</b>	AM.F2216
<b>description</b>	auger model 22 ø 64mm L 150mm stainless steel with spindle ENTERPRISE		
<b>For models:</b>	TG22, TS22		



1

<b>GEV No.</b>	698021	<b>Ref. No.</b>	AM.F2041
<b>description</b>	auger model 8 ø 45mm L 117mm aluminium with spindle ENTERPRISE		
<b>For models:</b>	TS8		



augers chambers

inner parts



<b>GEV No.</b>	698032	<b>Ref. No.</b>	AM.F2117
<b>description</b>	auger chamber ENTERPRISE model 12 inlet ø 56mm cast iron		
<b>For models:</b>	TG12, TG12R, TS12		



<b>GEV No.</b>	698034	<b>Ref. No.</b>	AM.F2118
<b>description</b>	auger chamber ENTERPRISE model 12 inlet ø 61mm stainless steel		
<b>For models:</b>	TS12		



<b>GEV No.</b>	698050	<b>Ref. No.</b>	AM.F2212
<b>description</b>	auger chamber ENTERPRISE model 22 inlet ø 62mm aluminium		
<b>For models:</b>	TG22		



<b>GEV No.</b>	698051	<b>Ref. No.</b>	AM.F2210
<b>description</b>	auger chamber ENTERPRISE model 22 inlet ø 62mm cast iron		
<b>For models:</b>	TG22		



<b>GEV No.</b>	698052	<b>Ref. No.</b>	AM.F2211
<b>description</b>	auger chamber ENTERPRISE model 22 inlet ø 62mm stainless steel thread M94x2		
<b>For models:</b>	TG22		
<b>accessories for</b>	698052		

	<b>GEV No.</b>	690058	<b>Ref. No.</b>	—
	counter support for off-set 19mm mounting distance 14.25mm W 28mm L 52mm H 50mm type 6000/6004 no. 6000-020701			

plungers



<b>GEV No.</b>	698080	<b>Ref. No.</b>	AM.F2037 AM.F2114 AM.F2208
<b>description</b>	plunger ø 46mm L 120mm total length 240mm plastic hollow		
<b>For models:</b>	TG12, TG12R, TG22, TS12, TS22, TS8		

for vegetable slicers

miscellaneous



<b>GEV No.</b>	110703	<b>Ref. No.</b>	064013
<b>description</b>	cylindrical handle thread M10 ø 28mm L 87mm		
<b>For models:</b>	PIZZA41, PIZZA42, PIZZA62		

for cheese graters

miscellaneous



<b>GEV No.</b>	110703	<b>Ref. No.</b>	064013
<b>description</b>	cylindrical handle thread M10 ø 28mm L 87mm		
<b>For models:</b>	PIZZA41, PIZZA42, PIZZA62		

for dough mixers

flange bearings



<b>GEV No.</b>	693112	<b>Ref. No.</b>	X61400
<b>description</b>	flange bearing type UCF204 shaft ø 20mm 4 hole flange hole distance 64mm H 33mm flange length 86mm flange width 86mm hole ø 12mm flange F204 ball bearing UC204G2 FH 25.5mm		
<b>For models:</b>	ACK2001, ACK2003, BR70, BRG70		

## for display coolers

## glass panels

## glass panels



1

<b>GEV No.</b>	695167	<b>Ref. No.</b>	067038
<b>description</b>	glass panel L 240mm W 370mm thickness 8mm for vitrine		

## for deep fryers

## lids



1

<b>GEV No.</b>	970369	<b>Ref. No.</b>	B65300
<b>description</b>	lid for fryer		
<b>For models:</b>	ABC0003, ABC0005, ACC0003, ACC0008, ACC0009, ACC0010, AEC0001, AEC0002, SKF4E, SKF6E		

## sumps



1

<b>GEV No.</b>	695118	<b>Ref. No.</b>	058102
<b>description</b>	sump for fryer with hole L 320mm W 260mm H 200mm 8l		
<b>For models:</b>	F88M, F88T, F8M, F8T, FE8, FE88, FM8, FM8+8-1241, FM8-1240, FM88		

## for gyros grills

## glass panels



1

<b>GEV No.</b>	693053	<b>Ref. No.</b>	067023.1
<b>description</b>	glass panel L 180mm W 180mm thickness 4mm square		

## gyro slicers



1

<b>GEV No.</b>	691029	<b>Ref. No.</b>	009869.23
<b>description</b>	slicing unit		

## skewers



1

<b>GEV No.</b>	693653	<b>Ref. No.</b>	056456
<b>description</b>	skewer for gyro grill size 12x12mm L 460mm		

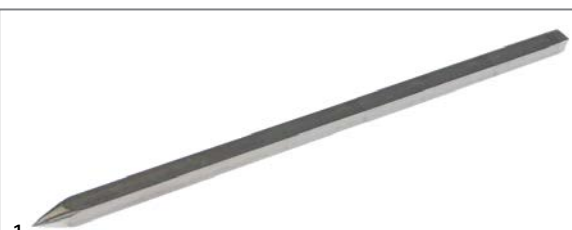

1

<b>GEV No.</b>	693654	<b>Ref. No.</b>	059017
<b>description</b>	skewer for gyro grill size 12x12mm L 465mm		



1

<b>GEV No.</b>	693655	<b>Ref. No.</b>	059018
<b>description</b>	skewer for gyro grill size 12x12mm L 615mm		



			
1			
<b>GEV No.</b>	693656	<b>Ref. No.</b>	059019
<b>description</b>	skewer for gyro grill size 12x12mm L 775mm		

			
1			
<b>GEV No.</b>	693657	<b>Ref. No.</b>	059020
<b>description</b>	skewer for gyro grill size 12x12mm L 965mm		

skewer plates			
			
1			
<b>GEV No.</b>	693649	<b>Ref. No.</b>	056422
<b>description</b>	skewer plate for gyro grill		

			
1			
<b>GEV No.</b>	693650	<b>Ref. No.</b>	098025
<b>description</b>	skewer plate for gyro grill		

cotter pins			
			
1			
<b>GEV No.</b>	693457	<b>Ref. No.</b>	020102
<b>description</b>	retainer clip L 73mm wire gauge ø 3mm zinc-coated steel Qty 1 pcs		
<b>For models:</b>	GY100E, GY100G, GY20EIR, GY30EIR, GY40E, GY40G, GY60E, GY60E-9830, GY60G, GY70G, GY80E, GY80E-9831, GY80EIR, GY80G, GY90EIR, GY90G, GYINO10E, GY-INO10E-9841, GYINO10G, GYINO30G, GYROS-100G-9828, GYROS-10G-9842, GYROS-20G-9843, GYROS-40G-9825, GYROS-60G-9826, GYROS-80G-9827		

for hot dog machines

lids			
			
1			
<b>GEV No.</b>	693098	<b>Ref. No.</b>	058502
<b>description</b>	lid		

glass cylinders			
			
1			
<b>GEV No.</b>	693002	<b>Ref. No.</b>	066006
<b>description</b>	glass cylinder ø 200mm Pyrex glass H 240mm		
<b>For models:</b>	STARHD, STARHD4, STARSW		

miscellaneous			
			
1			
<b>GEV No.</b>	693468	<b>Ref. No.</b>	057501
<b>description</b>	grid basket for hot dog grill ø 180mm H 210mm		

skewers			
			
1			
<b>GEV No.</b>	693094	<b>Ref. No.</b>	055804
<b>description</b>	bun spikes		
<b>For models:</b>	STARHD, STARHD4, STARSP4, STARSP6		

for tilting bratt pans

spindles			
			
1			
<b>GEV No.</b>	690546	<b>Ref. No.</b>	K49100
<b>description</b>	thread block thread Tr24x5 right-hand thread W 38mm bolt ø 20mm D 40mm H 40mm		
<b>For models:</b>	ADK2001, ADK2002, ADK2003, ADK2004, ADK2007, ADK2008, ADK2009, ADK2010, AEK2001, AEK2002, AEK2003, AEK2004, AEK2005, AEK2006, AEK2007, AEK2008		



<b>GEV No.</b>	690543	<b>Ref. No.</b>	X65400
<b>description</b>	threaded rod		
<b>For models:</b>	ACK2001, ACK2003, BRE70, BRG70		

for pizza ovens

glass panels



<b>GEV No.</b>	693123	<b>Ref. No.</b>	067020
<b>description</b>	glass panel L 123mm W 50mm thickness 5mm rectangular		

for salamander grills



<b>GEV No.</b>	693054	<b>Ref. No.</b>	055813
<b>description</b>	mechanism for salamander grill		

for toasters

pliers

pliers



<b>GEV No.</b>	690010	<b>Ref. No.</b>	PIN-T
<b>description</b>	plier for toaster H 180mm total length 100mm		

knobs

producer-specific knobs

STAR 10



<b>GEV No.</b>	111845	<b>Ref. No.</b>	082345
<b>description</b>	knob dial plate energy regulator 1-4 + MAX grey		



<b>GEV No.</b>	111844	<b>Ref. No.</b>	082335
<b>description</b>	knob dial plate energy regulator 1-4 + MAX yellow		



<b>GEV No.</b>	110496	<b>Ref. No.</b>	082348
<b>description</b>	knob dial plate energy regulator 1-6 / 7-position grey		



<b>GEV No.</b>	110495	<b>Ref. No.</b>	082338
<b>description</b>	knob dial plate energy regulator 1-6 / 7-position yellow		



<b>GEV No.</b>	111854	<b>Ref. No.</b>	082340
<b>description</b>	knob dial plate switch 0-1 grey		

1

<b>GEV No.</b>	110476	<b>Ref. No.</b>	082330
<b>description</b>	knob dial plate switch 0-1 yellow		



1

<b>GEV No.</b>	111851	<b>Ref. No.</b>	082307
<b>description</b>	knob dial plate gas tap with ignition flame yellow		



1

<b>GEV No.</b>	111853	<b>Ref. No.</b>	082333
<b>description</b>	knob dial plate thermostat 50-250°C yellow		



1

<b>GEV No.</b>	111841	<b>Ref. No.</b>	082316
<b>description</b>	knob dial plate gas tap without ignition flame		



1

<b>GEV No.</b>	111855	<b>Ref. No.</b>	082343
<b>description</b>	knob dial plate thermostat t.max. 250°C 50-250°C grey		



1

<b>GEV No.</b>	111883	<b>Ref. No.</b>	082306
<b>description</b>	knob dial plate gas tap without ignition flame grey		
<b>For models:</b>	BSC6FG, PC1G40, PC2G		



1

<b>GEV No.</b>	110491	<b>Ref. No.</b>	082331
<b>description</b>	knob dial plate thermostat t.max. 90°C 30-90°C yellow		



1

<b>GEV No.</b>	110484	<b>Ref. No.</b>	082310
<b>description</b>	knob dial plate switch 0-1		



1

<b>GEV No.</b>	111846	<b>Ref. No.</b>	082315
<b>description</b>	knob dial plate energy regulator 1-4 + MAX grey		



1

<b>GEV No.</b>	110403	<b>Ref. No.</b>	082300
<b>description</b>	knob dial plate switch 0-1 yellow		



1

<b>GEV No.</b>	111852	<b>Ref. No.</b>	082317
<b>description</b>	knob dial plate gas tap with ignition flame		



1

<b>GEV No.</b>	111842	<b>Ref. No.</b>	082308
<b>description</b>	knob dial plate switch 7-position yellow		



1

<b>GEV No.</b>	111849	<b>Ref. No.</b>	082313
<b>description</b>	knob dial plate thermostat t.max. 250°C 50-250°C		



1

<b>GEV No.</b>	111848	<b>Ref. No.</b>	082303
<b>description</b>	knob dial plate thermostat t.max. 250°C 50-250°C yellow		



1

<b>GEV No.</b>	110478	<b>Ref. No.</b>	082314
<b>description</b>	knob dial plate thermostat t.max. 300°C 50-300°C		



1

<b>GEV No.</b>	110490	<b>Ref. No.</b>	082311
<b>description</b>	knob dial plate thermostat t.max. 90°C 30-90°C		



1

<b>GEV No.</b>	110483	<b>Ref. No.</b>	082301
<b>description</b>	knob dial plate thermostat t.max. 90°C 30-90°C yellow		



1

<b>GEV No.</b>	110771	<b>Ref. No.</b>	0000X00800
<b>description</b>	knob gas tap with ignition flame ø 60mm shaft ø 8x6.5mm shaft flat upper black		
<b>For models:</b>	ABH1001, ABH1002, ABH3010, ABH3011, ABH3012, ABH3014, ABH3015, ABH3016, ABH3017, ABH3018, ACA2001, ACA2002, ACA2003, ACA2012, ACH1001, ACH1002, ACH1003, ACH1004, ACH3008, ACH3010, ACH3011, ACH3013, ACH3014, ACH3015, ACH3017, ACJ0001, ACJ0003, SKPL1G, SKPL2G		

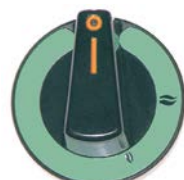

1

<b>GEV No.</b>	110049	<b>Ref. No.</b>	0000X00100
<b>description</b>	knob gas tap without ignition flame ø 60mm shaft ø 8x6.5mm shaft flat upper		
<b>For models:</b>	ABJ0001, ABJ0002, ACA2004, ACA2006, ACA2008, ACA2010, ACA2011		



1

<b>GEV No.</b>	110352	<b>Ref. No.</b>	0000X00900
<b>description</b>	knob gas thermostat 1-8 ø 60mm shaft ø 8x6.5mm shaft flat upper black		
<b>For models:</b>	ACA2004, ACA2008		



1

<b>GEV No.</b>	110774	<b>Ref. No.</b>	0000X03800 old version
<b>description</b>	knob oven ø 60mm shaft ø 6x4.6mm shaft flat lower black		



1

<b>GEV No.</b>	110775	<b>Ref. No.</b>	0000X01200
<b>description</b>	knob oven TH/BH/TH+BH ø 60mm shaft ø 6x4.6mm shaft flat upper black		
<b>For models:</b>	ACA1004, ACA1005, ACA1006, ACA2007		



1

<b>GEV No.</b>	110773	<b>Ref. No.</b>	0000X00600
<b>description</b>	knob switch 0-1 ø 60mm shaft ø 6x4.6mm shaft flat upper black		
<b>For models:</b>	ABK3001, ABK3002, ACK3001, ACK3002, ACK3003, ACK3004		



1

<b>GEV No.</b>	110770	<b>Ref. No.</b>	0000X01000
<b>description</b>	knob switch 4-position ø 60mm shaft ø 6x4.6mm shaft flat upper		
<b>For models:</b>	ACE0003, ACE0004, ACE0008		



1

<b>GEV No.</b>	110776	<b>Ref. No.</b>	0000X03700
<b>description</b>	knob thermostat t.max. 300°C 50-300°C ø 60mm shaft ø 6x4.6mm shaft flat upper black		
<b>For models:</b>	ACA1004, ACA1005, ACA1006, ACA2007		



1

<b>GEV No.</b>	110451	<b>Ref. No.</b>	0000X00500
<b>description</b>	knob switch 7-position ø 60mm shaft ø 6x4.6mm shaft flat upper black		
<b>For models:</b>	ABJ0003, ABJ0004, ACA1001, ACA1002, ACA1004, ACA1005, ACJ0005, ACJ0007, ACJ0008		



1

<b>GEV No.</b>	112136	<b>Ref. No.</b>	0000Y65011
<b>description</b>	knob switch 4-position t.max.°C ø 71mm shaft ø 6x4.6mm shaft flat upper black		
<b>For models:</b>	ADE0003, ADE0004, AEE0001, AEE0002		



1

<b>GEV No.</b>	110453	<b>Ref. No.</b>	0000X00400
<b>description</b>	knob thermostat t.max. 110°C 30-110°C ø 60mm shaft ø 6x4.6mm shaft flat upper black temperature range 30-110°C		
<b>For models:</b>	ACB0002, ACB0003, ACB0004, ACB0005		



1

<b>GEV No.</b>	112137	<b>Ref. No.</b>	0000Y65002
<b>description</b>	knob thermostat t.max. 195°C ø 71mm shaft ø 6x4.6mm shaft flat upper black temperature range 100-195°C		
<b>For models:</b>	AEC0001, AEC0002, AEC0003, AEC0004, AEC0005, AEC0006		



1

<b>GEV No.</b>	110455	<b>Ref. No.</b>	0000X00700
<b>description</b>	knob thermostat t.max. 195°C ø 60mm shaft ø 6x4.6mm shaft flat upper temperature range 100-195°C		
<b>For models:</b>	ABC0003, ABC0004, ABC0005, ACC0003, ACC0004, ACC0008, ACC0009, ACC0010, SKF2E4, SKF4E, SKF6E		



1

<b>GEV No.</b>	112135	<b>Ref. No.</b>	0000Y65004
<b>description</b>	knob thermostat t.max. 300°C ø 71mm shaft ø 6x4.6mm shaft flat upper black temperature range 50-300°C rotation 270°		
<b>For models:</b>	ADA1004, ADA1005, ADA1006, ADA2005, ADA2008, ADA2010, ADH3001, ADH3002, ADH3003, ADH3004, ADH3005, ADH3006, ADK2001, ADK2002, ADK2003, ADK2004, ADK2007, ADK2008, ADK2009, ADK2010, AEH3001, AEH3002, AEH3003, AEH3004, AEH3005, AEH3006, AEK2001, AEK2002, AEK2003, AEK2004, AEK2005, AEK2006, AEK2007, AEK2008, C89E, K4FFE		



1

<b>GEV No.</b>	110454	<b>Ref. No.</b>	0000X00300
<b>description</b>	knob thermostat t.max. 300°C 50-300°C ø 60mm shaft ø 6x4.6mm shaft flat upper		
<b>For models:</b>	ABH3001, ABH3002, ABH3003, ABH3004, ABH3005, ABH3006, ABH3007, ABH3008, ABH3009, ABK1001, ACA2006, ACA2010, ACA2011, ACH3001, ACH3002, ACH3003, ACH3004, ACH3005, ACH3006, ACH3007, ACH3018, ACH3019, ACH3020, ACK2003, BRE70, SKT40E, SKT40EC, SKT40ER		



1

<b>GEV No.</b>	110651	<b>Ref. No.</b>	RG.A14078
<b>description</b>	knob switch zero mark ø 50mm shaft ø 6x4.6mm shaft flat upper black		
<b>For models:</b>	WAFFLE1, WAFFLE2		



1

<b>GEV No.</b>	111923	<b>Ref. No.</b>	061030
<b>description</b>	knob switch zero mark ø 60mm		

**accessories for** 693113

	<b>GEV No.</b>	690968	<b>Ref. No.</b>	—
	roll pin ø 5mm L 20mm			



1

<b>GEV No.</b>	692431	<b>Ref. No.</b>	0900Y41900
<b>description</b>	hand wheel ø 200mm D1 ø 50mm bore ø 20mm thread groove width 8mm groove depth 12mm mounting distance 32mm L1 40mm L2 43mm handle length 65mm with folding handle		
<b>For models:</b>	ADK2001, ADK2003, ADK2007, ADK2009, AEK2001, AEK2003, AEK2005, AEK2007		

accessories

button springs



1

<b>GEV No.</b>	550132	<b>Ref. No.</b>	063009
<b>description</b>	knob spring ø 6x4.6mm Qty 10 pcs		
<b>For models:</b>	BM1375, BM140, BM1-40-4304, BM11, BM260, BM21, BM31, BM47, BM41, BM601, BM67, BMCR-4042, BMZ, BMZ200, BMZ2R, BMZ-4030, BMZR, BMZR200, BMZR-4035, BSC4FC, BS-C4FE-4563, BSC4FG, BSC4FV, C127E, C127FE, C127FG, C127FV, C1E, C2EF, C2G, C3E, C3EF, C3FG, C3G, C5FE, C5FG, C5GFE, C87E, C87FE, C87FG, C87FV, CG312E, CO511, CP1, CP1-4330, CP11, CP47GM, CP47M, CP67EM-7260, CP67EM-7560...(Other models you can see in the webshop)		

cylindrical handles

fixed



1

<b>GEV No.</b>	110703	<b>Ref. No.</b>	064013
<b>description</b>	cylindrical handle thread M10 ø 28mm L 87mm		
<b>For models:</b>	PIZZA41, PIZZA42, PIZZA62		

cone handles



1

<b>GEV No.</b>	693121	<b>Ref. No.</b>	065007
<b>description</b>	cone handle thread M8 ø 33mm L 82mm plastic black		
<b>For models:</b>	NGTL665, S110E-GIGA, S300E-GIGA, S350G-GIGA, SA650, SA650-2155, SA650G, SAM650, SAM650-2158, SAM650G, SAM650G-2623, ST400, ST650, ST650B, ST650G, ST900G, STA650KER		

mushroom cap handles



1

<b>GEV No.</b>	111782	<b>Ref. No.</b>	061003
<b>description</b>	mushroom cap handle thread M6 handle ø 25mm L 17mm plastic black		

handles and hand wheels

hand wheels

hand wheels



1

<b>GEV No.</b>	693113	<b>Ref. No.</b>	X18500	
<b>description</b>	hand wheel ø 150mm D1 ø 38mm bore ø 14mm thread groove width 5mm L1 38mm L2 40mm handle length 65mm with folding handle			
<b>For models:</b>	ACK2001, ACK2003, BRE70, BRG70			
<b>spare parts for</b>	693113			
	<b>GEV No.</b>	514255	<b>Ref. No.</b>	—
	folding handle ø 26mm total length 85mm seat ø 20mm shaft ø mm thread M6 with pin L 85mm			



## handle bars

### handle bars



1

<b>GEV No.</b>	690377	<b>Ref. No.</b>	065032
<b>description</b>	handle rod		

## handle rails

### handle rails



1

<b>GEV No.</b>	693790	<b>Ref. No.</b>	065016
<b>description</b>	handle alternative edition L 152mm W 69mm H 10mm SS		
<b>For models:</b>	GY80EIR, SP40Y, SP80Y		

## bracket handles



1

<b>GEV No.</b>	690083	<b>Ref. No.</b>	065005
<b>description</b>	pull handle L 110mm H 38mm mounting distance 94mm temp.-resist. 150°C		
<b>For models:</b>	GY100E, GY100G, GY40E, GY40G, GY60E, GY60E-9830, GY60G, GY70G, GY80E, GY80E-9831, GY80EIR, GY80G, GY90EIR, GY90G, GYROS-100G-9828, GYROS-40G-9825, GYROS-60G-9826, GYROS-80G-9827, STARHD, STARHD4, STARS4, STARS6, STARSW		

## accessories

### miscellaneous



1

<b>GEV No.</b>	693119	<b>Ref. No.</b>	055807
<b>description</b>	hand protection for griddle		



1

<b>GEV No.</b>	693120	<b>Ref. No.</b>	055814
<b>description</b>	hand protection for griddle		

## hinges

### oven hinges

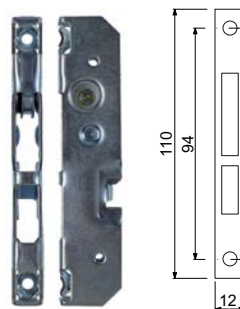

1

<b>GEV No.</b>	700003	<b>Ref. No.</b>	X68006
<b>description</b>	opposite support L 110mm W 12mm mounting distance 94mm		
<b>For models:</b>	ACA2004, ACA2006, ACA2008, ACA2010, ACA2011		

<b>GEV No.</b>	700013	<b>Ref. No.</b>	X68021
<b>description</b>	oven hinge mounting distance 118mm lug mounting 13mm lever length 119mm groove distance 13mm spring thickness 3.5mm mounting ear position left spring length 60mm L 154mm		
<b>For models:</b>	ACA2004, ACA2006, ACA2008, ACA2010, ACA2011		
<b>accessories for</b>	700013		
	<b>GEV No.</b>	700003	<b>Ref. No.</b> X68006
	opposite support L 110mm W 12mm mounting distance 94mm		

**accessories for** 700006

	<b>GEV No.</b>	700007	<b>Ref. No.</b>	X66100
	oven hinge mounting distance 173mm mounting distance 2 105mm lug mounting 14mm lever length 120mm groove distance 11mm spring thickness 3.5mm mounting ear position right spring length 112mm W 25mm			

<b>GEV No.</b>	700007	<b>Ref. No.</b>	X66100
<b>description</b>	oven hinge mounting distance 173mm mounting distance 2 105mm lug mounting 14mm lever length 120mm groove distance 11mm spring thickness 3.5mm mounting ear position right spring length 112mm W 25mm		
<b>For models:</b>	ACA1004, ACA1005, ACA1006, ACA2005, ACA2007, ACA2009, ACA2012, ADA1004, ADA1005, ADA1006, ADA2005, ADA2006, ADA2007, ADA2008, ADA2009, ADA2010, ADA2017, C89E, K4FFE		
<b>accessories for</b>	700007		
	<b>GEV No.</b>	700001	<b>Ref. No.</b> —
	opposite support L 118mm W 17mm mounting distance 94mm		

## fittings for catering equipment

### outlet taps

#### universal

<b>GEV No.</b>	540747	<b>Ref. No.</b>	062001
<b>description</b>	outlet tap chrome-plated brass angled W 30mm H 40mm thread 1/2" IT		
<b>For models:</b>	BM1, BM1375, BM140, BM1-40-4304, BM260, BMCR, BMCR-4042, BM-Z2R, BMZ2R200, BMZR, BMZR200, BMZR-4035, CP1, CP140, CP1-4330, CP1G, CP1GM, F10, F101, F1010, F10-1170, F101R, F102, F102R, F121, F12140, F121-4328, F121-4332, F121-4528, F121GT, F121M-4345, F122, F122M, F25, F25M, F88M, F88T, F8M, F8T, FM8, FM8+8-1241, FM8-1240, FM88, FRIT0001, FRY101, FRY102, FRY121G-1190, FRY122, FRY122M-1172, GFTL11070...(Other models you can see in the webshop)		

<b>GEV No.</b>	700014	<b>Ref. No.</b>	X68020
<b>description</b>	oven hinge mounting distance 118mm mounting distance 2mm lug mounting 13mm lever length 119mm groove distance 13mm spring thickness 3.5mm mounting ear position right spring length 60mm L 154mm		
<b>For models:</b>	ACA2004, ACA2006, ACA2008, ACA2010, ACA2011		
<b>accessories for</b>	700014		
	<b>GEV No.</b>	700003	<b>Ref. No.</b> X68006
	opposite support L 110mm W 12mm mounting distance 94mm		

<b>GEV No.</b>	700006	<b>Ref. No.</b>	X66000
<b>description</b>	oven hinge mounting distance 173mm mounting distance 2 105mm lug mounting 14mm lever length 120mm groove distance 11mm spring thickness 3.5mm mounting ear position left spring length 112mm W 25mm		
<b>For models:</b>	ACA1004, ACA1005, ACA1006, ACA2005, ACA2007, ACA2009, ACA2012, ADA1004, ADA1005, ADA1006, ADA2005, ADA2006, ADA2007, ADA2008, ADA2009, ADA2010, ADA2017, C89E, K4FFE		
<b>accessories for</b>	700006		
	<b>GEV No.</b>	700001	<b>Ref. No.</b> —
	opposite support L 118mm W 17mm mounting distance 94mm		



producer-specific

STAR 10



1

<b>GEV No.</b>	540730	<b>Ref. No.</b>	062055
<b>description</b>	ball valve connection 3/4" IT - 3/4" IT DN20 total length 70mm with lever handle handle length 95mm		
<b>For models:</b>	BM3GNI, BM47, BM4GNI, BM67, F4710, F4715, F6710, F8715, RG100, RG105, RG70		



1

<b>GEV No.</b>	514006	<b>Ref. No.</b>	062010
<b>description</b>	drain pipe L 200mm thread ø 22mm		
<b>For models:</b>	BM47, BM67, F121, F121GT, F25M, F4710, F6710, FRIT0001, FRY121G, FRY121G-1190, RG100, RG105, RG70, RG80		



1

<b>GEV No.</b>	540952	<b>Ref. No.</b>	062012
<b>description</b>	outlet tap L 84mm fryer lever handle grommet ø 30mm grommet length 29mm thread 3/4" IT handle length 81mm		
<b>For models:</b>	BM11, BM21, BM3GNI, BM31, BM4GNI, BM41, BM60I, CP1-4330, CP11, CP47GM, CP47M, CP67EM-7560, CP67M, CR32000C, F121GM, F121GT, F121GTM, F121M, F121M-4345, F4715, F47GM, F47GTM, F47IR, F47IRG, F47IRGT, F8715, F87GM, F87GTM, F87IR, F87IRG, F87IRGT, FR87IR, FRIT0001, FRY121G, FRY121G-1190, FRY121GM, FRY121GTM-1191, FRY121M-1171, FRY47IR-1164, FRY47IRGT-1162, RG100, RG80		

lid hinges







type RUBINETTERIE DEL FRIULI

for circular lids

lid hinges



1

<b>GEV No.</b>	540839	<b>Ref. No.</b>	E50000
<b>description</b>	lid hinge L 270mm mounting distance 139mm flange radius 470mm opening angle 80° spring thickness 5mm bore ø M16mm for circular lids		
<b>For models:</b>	ADL0001, ADL0002, ADL0006, ADL0007, ADL0013, AEL0001, AEL0002, AEL0004, AEL0005		
<b>spare parts for</b>	540839		
	<b>GEV No.</b>	514137	<b>Ref. No.</b> —
	spring guide for lid hinge ID ø 28mm ED ø 32mm L 225mm zinc-coated steel		
	<b>GEV No.</b>	514140	<b>Ref. No.</b> —
	lid hinge body lid radius 470mm		
	<b>GEV No.</b>	514144	<b>Ref. No.</b> —
	bracket for lid hinge		
	<b>GEV No.</b>	514145	<b>Ref. No.</b> —
	adjusting bush L 108mm ø 80/60mm		
	<b>GEV No.</b>	540854	<b>Ref. No.</b> —
	torsion spring ø 50.8mm wire gauge ø 5.1mm L1 34mm L2 104mm L3 29mm mounting pos. right		
	<b>GEV No.</b>	540855	<b>Ref. No.</b> —
	torsion spring ø 50.8mm wire gauge ø 5.1mm L1 34mm L2 104mm L3 29mm mounting pos. left		

filters

grease filters

baffle filters



1

<b>GEV No.</b>	106075	<b>Ref. No.</b>	055330
<b>description</b>	baffle filter W 560mm SS		

## equipment feet and end caps

## bolting feet



1

<b>GEV No.</b>	691814	<b>Ref. No.</b>	RG.A13003
<b>description</b>	equipment foot ø 22mm H 20mm bore ø 4mm Qty 1 pcs		
<b>For models:</b>	WAFFLE1, WAFFLE2		



1

<b>GEV No.</b>	693442	<b>Ref. No.</b>	064001
<b>description</b>	equipment foot ø 29mm H 15mm rubber bore ø 6mm Qty 1 pcs		

## miscellaneous

## with fixing plate

ø100mm



1

<b>GEV No.</b>	700307	<b>Ref. No.</b>	066031
<b>description</b>	swivel castor with brake ø 100mm plates fixing 75x70mm housing zinc-plated sheet steel hole distance 60x50mm H 135mm wheel width 27mm		

## baskets

## fryer baskets

## STAR 10



1

<b>GEV No.</b>	970215	<b>Ref. No.</b>	Y47700 Y48000
<b>description</b>	fryer basket L1 280mm W1 200mm H1 100mm chrome-plated steel		
<b>For models:</b>	ABC0003, ABC0005, ACC0003, ACC0008, ACC0009, ACC0010, AEC0001, AEC0002, SKF4E, SKF6E		



1

<b>GEV No.</b>	970214	<b>Ref. No.</b>	Y47900
<b>description</b>	fryer basket L1 295mm W1 100mm H1 105mm		
<b>For models:</b>	ABC0003, ABC0005, ACC0003, ACC0008, ACC0009, ACC0010, AEC0001, AEC0002, SKF4E, SKF6E		



1

<b>GEV No.</b>	970449	<b>Ref. No.</b>	X63100
<b>description</b>	fryer basket L1 300mm W1 110mm H1 110mm chrome-plated steel		
<b>For models:</b>	ABC0004, ACC0001, ACC0002, ACC0004, ACC0006, ACC0007, SKF2E4		



1

<b>GEV No.</b>	970217	<b>Ref. No.</b>	X62000
<b>description</b>	fryer basket L1 300mm W1 230mm H1 105mm		
<b>For models:</b>	ACC0001, ACC0002, ACC0006, ACC0007		

## crumb screens



1

<b>GEV No.</b>	970222	<b>Ref. No.</b>	Y47800
<b>description</b>	crumb screen L 303mm W 212mm suitable for fryer		
<b>For models:</b>	ABC0003, ABC0005, ACC0003, ACC0008, ACC0009, ACC0010, AEC0001, AEC0002, SKF4E, SKF6E		

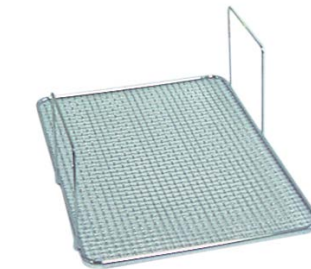

1

<b>GEV No.</b>	970219	<b>Ref. No.</b>	X62200
<b>description</b>	crumb screen L 337mm W 237mm fryer		
<b>For models:</b>	ACC0001, ACC0002, ACC0006, ACC0007		



wire baskets for hot dog machines



1

<b>GEV No.</b>	693468	<b>Ref. No.</b>	057501
<b>description</b>	grid basket for hot dog grill ø 180mm H 210mm		

shelves and shelf rails

grates

producer-specific



1

<b>GEV No.</b>	693443	<b>Ref. No.</b>	055809
<b>description</b>	chargrill grid W 400mm D 345mm SS wire gauge frame 8mm lengthwise wires gauge 3mm crossing wires 1		

shelf rails and supports

universal



1

<b>GEV No.</b>	690332	<b>Ref. No.</b>	9792
<b>description</b>	shelf support L 31/28mm W 22mm H 17mm SS with hook Qty 1 pcs		
<b>For models:</b>	COMP2GN-9805, COMP3E-9746, COMP3GN-9806, DIAM150-9770, DIAM40-9755, DIAM40BT-9748, DIAM75-2P-9798, DIAM75-9765, DIAM75BT-9815		
<b>accessories for</b>	690332		
	<b>GEV No.</b>	<b>Ref. No.</b>	—
	rack L 1000mm W 22mm H 4mm aperture 3x8mm hole distance 12.5mm stainless steel		

gaskets

gaskets for heated units

door seals

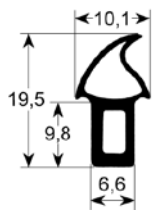

1

<b>GEV No.</b>	900544	<b>Ref. No.</b>	000X05600
<b>description</b>	door seal profile 2740 L 1350mm Qty 1		
<b>For models:</b>	ACA1004, ACA1005, ACA1006, ACA2005, ACA2007, ACA2009, ACA2012, ADA1004, ADA1005, ADA1006, ADA2005, ADA2008, ADA2009, ADA2010, C89E, K4FFE		

door seals with fixing hook



1

<b>GEV No.</b>	900509	<b>Ref. No.</b>	068203
<b>description</b>	door seal		
<b>For models:</b>	BSC4FE80, C87VFE		

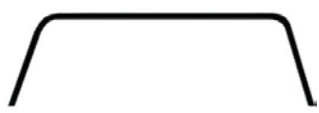

1

<b>GEV No.</b>	900231 <sup>1</sup>	<b>Ref. No.</b>	068201 X68201
<b>description</b>	door seal L 590mm W 300mm 3-sided long side open with mounting clip		
<b>For models:</b>	ACA2004, ACA2006, ACA2008, ACA2010, ACA2011, BSC6FG, C127FE, C127FG, C2FP, C3FP, C5FG, C5GFE, C87FE, C87FG, C87FP, C87FV		

<sup>1</sup>3-sided, long side open

O-rings

EPDM

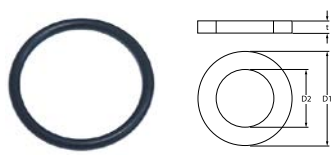

1

<b>GEV No.</b>	510899	<b>Ref. No.</b>	X05400
<b>description</b>	O-ring EPDM thickness 3.53mm ID ø 37.69mm Qty 1 pcs		
<b>For models:</b>	ACC0005, ACE0008, ADE0003, ADE0004, AEC0003, AEC0004, AEC0005, AEC0006, AEE0001, AEE0002		

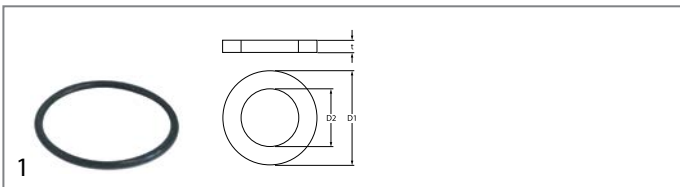

<b>GEV No.</b>	532545	<b>Ref. No.</b>	X05000
<b>description</b>	O-ring Viton thickness 3.53mm ID ø 49.21mm Qty 1 pcs		
<b>For models:</b>	ACC0005, ACE0008, ADE0003, ADE0004, AEC0003, AEC0004, AEC0005, AEC0006, AEE0001, AEE0002		

Viton

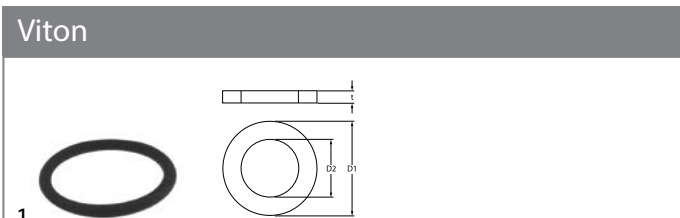

<b>GEV No.</b>	528155	<b>Ref. No.</b>	X05300
<b>description</b>	O-ring Viton thickness 3.53mm ID ø 32.93mm Qty 1 pcs		
<b>For models:</b>	ACC0005, ACE0008, ADE0003, ADE0004, AEC0003, AEC0004, AEC0005, AEC0006, AEE0001, AEE0002		

## springs

### torsion springs

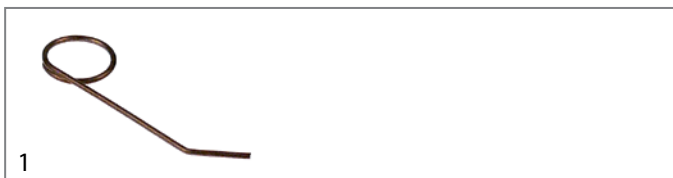

<b>GEV No.</b>	695168	<b>Ref. No.</b>	009451.53 009456.27
<b>description</b>	spring wire gauge ø 1.4mm L1 61mm		



<b>GEV No.</b>	700569	<b>Ref. No.</b>	002001
<b>description</b>	torsion spring ø 21.5mm L2 40mm wire gauge ø 3.3mm L1 100mm L3 45mm		
<b>For models:</b>	PANINIMC-2004		



<b>GEV No.</b>	690548	<b>Ref. No.</b>	Y71500
<b>description</b>	torsion spring ø 39mm wire gauge ø 7mm L1 281mm L2 31mm L3 24mm mounting pos. left		
<b>For models:</b>	ADK2001, ADK2002, ADK2003, ADK2004, ADK2007, ADK2008, ADK2009, ADK2010, AEK2001, AEK2002, AEK2003, AEK2004, AEK2005, AEK2006, AEK2007, AEK2008		



<b>GEV No.</b>	690549	<b>Ref. No.</b>	Y71800
<b>description</b>	torsion spring ø 39mm wire gauge ø 7mm L1 31mm L2 281mm L3 24mm mounting pos. left		
<b>For models:</b>	ADK2003, ADK2004, ADK2009, ADK2010, AEK2003, AEK2004, AEK2007, AEK2008		

## evaporation and condensing trays

### unheated condensing trays



<b>GEV No.</b>	750182	<b>Ref. No.</b>	Q32-0195
<b>description</b>	condensing tray L 540mm W 235mm H 70mm		
<b>For models:</b>	HD140A, HD70A		

## transmission technology and ball bearings

### drive belts

#### round belts



<b>GEV No.</b>	693875	<b>Ref. No.</b>	009453.51
<b>description</b>	round belt ø 8mm L 784mm		
<b>For models:</b>	STP40		





## kitchen accessories

### spillage trays

			
1			
<b>GEV No.</b>	698112	<b>Ref. No.</b>	AM.F2047
<b>description</b>	meat collecting tray L 255mm W 195mm H 50mm		

			
1			
<b>GEV No.</b>	698071	<b>Ref. No.</b>	AM.F2069
<b>description</b>	meat collecting tray ø 160mm Lmm Wmm H 60mm		
<b>For models:</b>	FGM113		

			
1			
<b>GEV No.</b>	698073	<b>Ref. No.</b>	AM.F2169
<b>description</b>	meat collecting tray ø 220mm Lmm Wmm H 90mm		
<b>For models:</b>	FGS106		

## valves and tank inlets

### ball valves

#### universal

#### ball valves with lever handle

			
1			
<b>GEV No.</b>	514325	<b>Ref. No.</b>	M75400
<b>description</b>	ball valve connection 1" IT - 1" IT DN25 total length 83mm with lever handle		
<b>For models:</b>	ACC0005, ACE0001, ADC0003, ADC0008, ADC0009, ADC0010, ADE0001, ADE0003, ADE0004, AEC0009, AEC0010, AEC0011, AEC0012, AEE0001, AEE0002, CP49G, CP89G, F49G, F89G		

			
1			
<b>GEV No.</b>	540730	<b>Ref. No.</b>	062055
<b>description</b>	ball valve connection 3/4" IT - 3/4" IT DN20 total length 70mm with lever handle handle length 95mm		
<b>For models:</b>	BM3GNI, BM47, BM4GNI, BM67, F4710, F4715, F6710, F8715, RG100, RG105, RG70		

### producer-specific

#### STAR 10

			
1			
<b>GEV No.</b>	514212	<b>Ref. No.</b>	0000X15300
<b>description</b>	ball valve total length 93mm handle length 95mm L 93mm inlet 3/4" ET lever handle grommet ø 22mm outlet ø22mm		
<b>For models:</b>	ACC0001, ACC0002, ACC0003, ADC0001, ADC0002, AEC0001, AEC0002, AEC0003, AEC0004, AEC0005, AEC0006, AEC0007, AEC0008		

### accessories





			
1			
<b>GEV No.</b>	514217	<b>Ref. No.</b>	M75700
<b>description</b>	handle for outlet tap		
<b>For models:</b>	ACE0001, ADE0001, ADE0003, ADE0004, AEE0001, AEE0002, CP49G, CP89G		

shut-off valves

universal



<b>GEV No.</b>	514370	<b>Ref. No.</b>	X18000
<b>description</b>	shut-off valve connection 1/2" 1/2" hot total length 54mm shaft ø M5x0.8mm		
<b>For models:</b>	ACE0001, ACE0003, ACE0004, ACE0008, ADB0001, ADB0002, ADB0003, ADE0001, ADE0003, ADE0004, ADK2001, ADK2002, ADK2003, ADK2004, ADK2008, ADK2010, AEB0001, AEB0002, AEB0003, AEE0001, AEE0002, AEK2001, AEK2002, AEK2003, AEK2004, AEK2006, AEK2008, BM48G, BM49E, BM89E, CP49G, CP89G		

<b>spare parts for</b>	514370			
	<b>GEV No.</b>	514085	<b>Ref. No.</b>	—
	rosette connection 26x19G chrome-plated total lengthmm mounting pos.			
	<b>GEV No.</b>	514086	<b>Ref. No.</b>	—
	hexagonal nut connection 26x19G brass total lengthmm mounting pos. H 6mm WS 34 Qty 1 pcs			
	<b>GEV No.</b>	540414	<b>Ref. No.</b>	—
	star handle connection hot total lengthmm mounting pos. shaft diameter 7x7mm ø 55mm 35 built-in depth 22mm			
	<b>GEV No.</b>	540415	<b>Ref. No.</b>	—
	star handle connection cold total lengthmm mounting pos. shaft diameter 7x7mm ø 55mm 35 built-in depth 22mm			
	<b>GEV No.</b>	540672	<b>Ref. No.</b>	—
	gasket suitable for tap head			



<b>GEV No.</b>	514208	<b>Ref. No.</b>	M75600
<b>description</b>	shut-off valve connection 1/2" 1/2" straight total length 64mm shaft ø 8x10mm		
<b>For models:</b>	ADK2007, ADK2009, AEK2005, AEK2007		

fastening material

fasteners

retainer clips



<b>GEV No.</b>	693457	<b>Ref. No.</b>	020102
<b>description</b>	retainer clip L 73mm wire gauge ø 3mm zinc-coated steel Qty 1 pcs		
<b>For models:</b>	GY100E, GY100G, GY20EIR, GY30EIR, GY40E, GY40G, GY60E, GY60E-9830, GY60G, GY70G, GY80E, GY80E-9831, GY80EIR, GY80G, GY90EIR, GY90G, GYINO10E, GY-INO10E-9841, GYINO10G, GYINO30G, GYROS-100G-9828, GYROS-10G-9842, GYROS-20G-9843, GYROS-40G-9825, GYROS-60G-9826, GYROS-80G-9827		

retaining rings

DIN 471



<b>GEV No.</b>	691621	<b>Ref. No.</b>	M29600
<b>description</b>	retaining ring shaft ø 40mm thickness 1.8mm steel DIN 471		

consumables

lava rocks / ceramic briquetts



<b>GEV No.</b>	105342	<b>Ref. No.</b>	M30500
<b>description</b>	lava rocks content 9kg		
<b>For models:</b>	ABH1001, ABH1002, ACH1001, ACH1002, ACH1003, ACH1004, ADH1001, ADH1002, AEH1001, AEH1002, SKPL1G, SKPL2G		

<b>B</b>			
ball valves	73	heating elements for fryers	4
bar burners	50	heating elements for griddles	6
bi-metal thermostats	12, 12	heating elements for gyros grills	6
<b>C</b>		heating elements for ovens	3
cam switches	19	heating elements for pasta cookers	7
capillary tube clips	17	heating elements for pizza ovens	8
castors and bumper angles	70	heating elements for refrigeration	7
ceramic burners	51	heating elements for salamanders/toasters	8
ceramic heaters	9	heating elements for tilting bratt pan	7
compressors	27	hob burners	43
condensing trays heated	28	hot air fans	28
consumables	74	hot plates	11
contactors	24	<b>I</b>	
control equipment	21	ignition boxes	35
control thermostats	12, 16	ignition cables	40
<b>D</b>		ignition switches	41
door seals	71	ignition units	40
door seals with fixing hook	71	immersion heating elements	9
<b>E</b>		indicator lights	21
electric accessories	29	indicator lights (complete)	21
electronic controllers	25	<b>L</b>	
energy regulators	12	lamps	21
<b>F</b>		lava rocks / ceramic briquetts	53, 74
fans	28	light bulbs	22
fasteners	74	linear lamps	23
fastening material	74	<b>M</b>	
fluorescent lamps	23, 23	mechanical timers	23
funnel trays	53	microswitches	18
<b>G</b>		motors	28
gas burners	43	<b>O</b>	
gas control valves	35	O-rings	71
gas nozzles	52	oven hinges	67
gas taps	30	oven lamps	23
gas thermostats	32	<b>P</b>	
gaskets for heated units	71	piezoelectric igniters	40
grates	71	pilot burners	36
<b>H</b>		probe clips	17
Hall sensors	25	probes	25
heating cables	9	pumps	29
heating elements	3	pumps for ice machines	29
heating elements for bain maries	3	push/momentary push switches	18
heating elements for charginills	8	<b>Q</b>	
heating elements for chip scuttles	4	quartz heating elements	9
heating elements for contact grills	7	<b>R</b>	
heating elements for convection	10	radiation heaters	10
		relays	24

residual heat indicators	23
retainer clips	74
retaining rings	74
rocker/momentary rocker switches	17

**S**

safety thermostats	15
safety valves	36
shelves and shelf rails	71
shut-off valves	74
solenoid valves	27
spillage trays	73
spring clips	17
switches and momentary switches	17

**T**

temperature probes	25
terminals	29
thermocouples	41
thermostats	12
timers	23
tube burners	51

**U**

universal probes	25
------------------	----

**V**

valves and tank inlets	73
------------------------	----