



GAS COMPONENTS



ELECTRIC COMPONENTS



WATER TECHNOLOGY



MECHANICAL COMPONENTS



TOOLS

Spare parts suitable for

STAR-MANUFACTURING

Find the complete and up-to-date range of products in our GEV Webshop



Manufacturer catalogue

The most important spare parts and accessories arranged clearly for every manufacturer

- ✓ Complete product range and all appliance data always up to date in the GEV Webshop
- ✓ Alphabetical Index at the end of the catalogue

GEV Webshop

www.gev-online.co.uk

www.gev-online.com



- 🔍 Add to Favourites
- 🔍 Sign In with email address and usual password
- 🔍 Easy-order – place several items in your basket at the same time
- 🔍 Quick Item search – no login needed



heating elements

heating elements for ovens

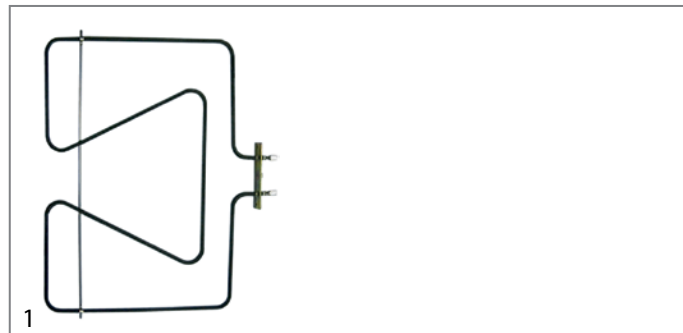

GEV No.	415775	Ref. No.	10013150430
description	heating element 1750W 230V heating circuits 1 L 326mm W 405mm L1 34mm L2 292mm W1 170mm W2 60mm flange length 100mm flange width 22mm hole distance 86mm tube ø 6.3mm connection male faston 6.3mm mounting pos. lower rectangular flange dry heating element oven mounting thread M4		

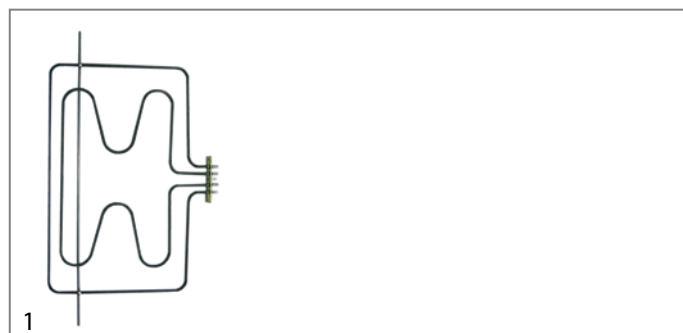

GEV No.	415774	Ref. No.	10013150420 16002032700
description	heating element 3050W 230V heating circuits 2 L 325mm W 474mm L1 40mm L2 285mm W1 237mm W2 60mm flange length 100mm flange width 22mm hole distance 85mm bridge length 620mm hole ø M4mm tube ø 6.3mm connection male faston 6.3mm mounting pos. upper rectangular flange dry heating element oven		

energy regulators

EGO

1-circuit

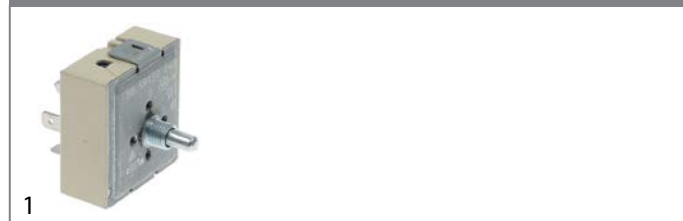

GEV No.	381491	Ref. No.	15138 200539 200544 2J-200539
description	energy regulator 120V 13A single-circuit turn direction left shaft ø 6.3x4.7mm shaft L 19mm mounting thread M4 no. 50.59.130.048		

GEV No.	380035	Ref. No.	200538 200545 2J-200538 5200 5230
description	energy regulator EGO 240V 13A single-circuit turn direction left shaft ø 6x4.6mm shaft L 19mm mounting thread 3/8"-24UNF power release 22-70% no. 50.59070.048 front fixing		

ROBERTSHAW

INF series

GEV No.	381550	Ref. No.	2J-6403
description	energy regulator ROBERTSHAW 240V 15A turn direction left shaft ø 6,3x4mm shaft L 16mm no. INF2401303		

thermostats

control and safety thermostats

INVENSYS / ROBERTSHAW

safety thermostats

GEV No.	390965	Ref. No.	2T-Z3209 9566 Y1668 Y3106 Z2845
description	safety thermostat switch-off temp. 232°C 1-poleA probe ø 7.93mm probe L 77mm capillary pipe 760mm capillary pipe isolatedmm gland nut shaft ømm probe SS		

1 electric components



switches and momentary switches

rocker/momentary rocker switches

37x21mm



1

GEV No.	348094	Ref. No.	2E-70851 WS-8706-28
description	momentary rocker switch mounting measurements 37x21mm black 2NO 250V 10A momentary connection male faston 6.3mm ambient temperature max. 125°C protection IP40		

push/momentary push switches

ø25mm



1

GEV No.	346002	Ref. No.	10013101580
description	momentary push switch mounting ø 25mm red 2NO 250V 16A connection male faston 6.3mm ambient temperature max. 85°C protection IP40		



1

GEV No.	346432	Ref. No.	10013101570
description	push switch mounting ø 25mm red 1NO 250V 16A connection male faston 6.3mm ambient temperature max. 85°C protection IP40		

cam switches

operation switches



1

GEV No.	300119	Ref. No.	10013000860
description	operation switch 6 operating positions 5NO 16A sequence 0-1-2-3-4-5 shaft ø 6x4.6mm shaft L 23mm connection male faston 6.3mm plastic ambient temperature max. 318°C		

lamps

indicator lights

indicator lights (complete)

ø12mm

with plug-in socket



1

GEV No.	580014	Ref. No.	150654 154024 156054 301013
description	indicator light ø 12mm 230V red		

ø13mm

with plug-in socket



1

GEV No.	359141	Ref. No.	10013000611 16001518000
description	indicator light ø 13mm red 230V connection male faston 6.3mm temp.-resist. 120°C Qty 1 pcs		

electric accessories

cables

accessories

protection hoses

miscellaneous



1

GEV No.	551308	Ref. No.	2E-Z2898
description	protection pipe suitable for contact grill ID ø 15mm ED ø 19mm mounting ø 21mm Qty 1m plastic/metal		



ignition parts

pilot burners

ROBERTSHAW

pilot burners

universal series with electrodes



1

GEV No.	107401	Ref. No.	2J-80201-25
description	pilot burner ROBERTSHAW type 3S-2 2 flames natural gas code 18 for pipe ø 1/4" CCT		
spare parts for	107401		
	GEV No.	Ref. No.	—
	100276		
	pilot burner nozzle natural gas code 18 suitable for ROBERTSHAW		



1

GEV No.	107400	Ref. No.	2J-80201-24
description	pilot burner ROBERTSHAW type 3SL-20 2 flames natural gas code 18 for pipe ø 1/4" CCT		
spare parts for	107400		
	GEV No.	Ref. No.	—
	100276		
	pilot burner nozzle natural gas code 18 suitable for ROBERTSHAW		

ignition units



1

GEV No.	101037	Ref. No.	10013234490 16001493104
description	ignition unit outputs 6		

thermocouples

thermocouple sets universal



1

GEV No.	102280	Ref. No.	2J-6726
description	thermocouple set ROBERTSHAW 5-piece L 18" - 455mm		



1

GEV No.	102281	Ref. No.	2J-Z4609
description	thermocouple set ROBERTSHAW 5-piece L 24" - 610mm		



1

GEV No.	103236	Ref. No.	2J-80504-03
description	thermocouple set ROBERTSHAW 5-piece L 60" - 1525mm ASA 11/32		

gas nozzles

chokes

AB



1

GEV No.	107807	Ref. No.	2V-6671
description	restrictor AB type AP7-2 gas inlet 1/8"x27 NPT (tube ø 5.4mm) gas outlet 7/16"x24 UNS (tube ø 1/4" CC)		

knobs

producer-specific knobs

STAR MFG



1

GEV No.	112885	Ref. No.	2R-Z4997
description	knob zero mark t.max.°C ø 59mm shaft ø 8.7x6mm black		

locks

edgmount latches

magnetic locks

miscellaneous



1

GEV No.	701661	Ref. No.	WS-63946
description	magnetic lock L 267mm mounting distance 1 117.5mm mounting distance 2 16mm non lockable suitable for ALTO SHAAM with screws		

hinges

oven hinges

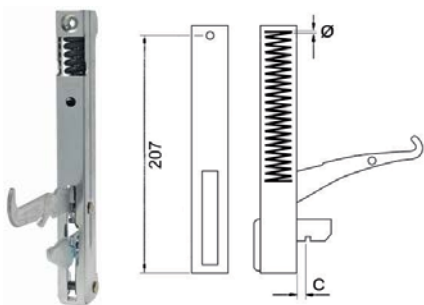

1

GEV No.	690037	Ref. No.	10013160490
description	oven hinge mounting distance 205mm mounting distance 2mm lug mountingmm lever length 119mm groove distance 13mm spring thickness 4.3mm mounting ear position spring length 103mm L 214mm		

pullouts

rollers

rollers



1

GEV No.	692927	Ref. No.	2P-30483 WS-50483
description	roller rollerø 23.2mm B1 6.5mm A 23.2mm B 6.5mm C 8mm D 1/4"-20UNC=ø6.35mm x 1.27mm E 13mm bearing ball bearing thread 1/4"-20UNC=ø6.35mm x 1.27 thread L 8mm Qty 1 pcs		

gaskets

gaskets for heated units

door seals



1

GEV No.	900511	Ref. No.	10013150180 14400162800
description	door seal profile 2910 L 1230mm Qty 1		

O-rings

silicone

ø1.78mm

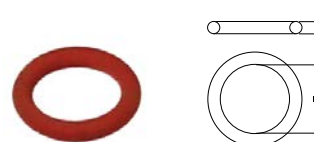

1

GEV No.	532508	Ref. No.	10013151140
description	O-ring silicone thickness 1.78mm ID ø 6.75mm Qty 1 pcs		

C

cables	4
cam switches	4

D

door seals	6
------------	---

E

edgemount latches	6
electric accessories	4
energy regulators	3

G

gas nozzles	5
gaskets for heated units	6

H

heating elements	3
heating elements for ovens	3

I

ignition units	5
indicator lights	4
indicator lights (complete)	4

L

lamps	4
-------	---

M

magnetic locks	6
miscellaneous	4

O

O-rings	6
oven hinges	6

P

pilot burners	5
protection hoses	4
push/momentary push switches	4

R

rocker/momentary rocker switches	4
----------------------------------	---

S

switches and momentary switches	4
---------------------------------	---

T

thermocouples	5
thermostats	3