



**GAS COMPONENTS**



**ELECTRIC COMPONENTS**



**WATER TECHNOLOGY**



**MECHANICAL COMPONENTS**



**TOOLS**

Spare parts suitable for

**SOLYMAC**

Find the complete and up-to-date range of products in our GEV Webshop



# Manufacturer catalogue

The most important spare parts and accessories arranged clearly for every manufacturer

- ✓ Complete product range and all appliance data always up to date in the GEV Webshop
- ✓ Alphabetical Index at the end of the catalogue

## GEV Webshop

[www.gev-online.co.uk](http://www.gev-online.co.uk)

[www.gev-online.com](http://www.gev-online.com)









- 🔍 Add to Favourites
- 🔍 Sign In with email address and usual password
- 🔍 Easy-order – place several items in your basket at the same time
- 🔍 Quick Item search – no login needed



## heating elements

### heating elements for bain maries

			
<b>GEV No.</b>	418448	<b>Ref. No.</b>	P31
<b>description</b>	heating element 900W 230V heating circuits 1 L 367mm W 122mm connection M4 tube ø 8.5mm 2 hole fixing thread M14x1 dry heating element bain marie mounting distance 113mm		
<b>spare parts for</b>	418448		
	<b>GEV No.</b>	510417	<b>Ref. No.</b> —
	flat gasket fibre ED ø 20mm ID ø 14mm thickness 2mm Qty 1 pcs		
	<b>GEV No.</b>	550261	<b>Ref. No.</b> —
	nut thread M14x1 H 4mm WS 19 SS Qty 1 pcs		
<b>accessories for</b>	418448		
	<b>GEV No.</b>	520228	<b>Ref. No.</b> —
	tooth lock washer ID ø 15.3mm ED ø 24mm steel Qty 1 pcs for thread M14		
	<b>GEV No.</b>	550262	<b>Ref. No.</b> —
	flat gasket copper ED ø 20mm ID ø 14mm thickness 2mm		

			
<b>GEV No.</b>	420186	<b>Ref. No.</b>	P40
<b>description</b>	heating element 7000W 230V heating circuits 3 L 393mm W 245mm H 210mm L1 78mm L2 315mm W1 78mm W2 84mm special fixing tube ø 8mm fryer heaters		

### heating elements for griddles

			
<b>GEV No.</b>	418451	<b>Ref. No.</b>	P37
<b>description</b>	heating element 1666W 230V heating circuits 1 L 435mm W 60mm H 74mm tube ø 8.5mm 2 hole fixing connection M4 thread M14x1.5 mounting distance 52mm connection length 72mm for griddle dry heating element		

### heating elements for fryers







#### 2 hole fixing

			
<b>GEV No.</b>	420184	<b>Ref. No.</b>	P59
<b>description</b>	heating element 3500W 230V heating circuits 1 L 294mm W 170mm H 208mm 2 hole fixing connection male faston 6.3mm fryer heaters L1 27mm L2 267mm W1 67mm W2 36mm tube ø 8mm thread M14x1.5 mounting distance 28mm windings 3 suitable for SOLYMAC		

### heating elements for pasta cookers

			
<b>GEV No.</b>	420187	<b>Ref. No.</b>	P34B
<b>description</b>	heating element 2000W 230V heating circuits 1 L 405mm W 46mm H 5mm 2 hole fixing connection M4 thread M12x1.25 tube ø 8.3mm		

### heating elements for pizza ovens

			
<b>GEV No.</b>	418450	<b>Ref. No.</b>	P48B
<b>description</b>	heating element 1200W 230V L 656mm W 110mm thread M14x1.5 mounting distance 102mm connection length 90mm connection M4 tube ø 8.5mm heating circuits 1 dry heating element 2 hole fixing		
<b>accessories for</b>	418450		
	<b>GEV No.</b>	510417	<b>Ref. No.</b> —
	flat gasket fibre ED ø 20mm ID ø 14mm thickness 2mm Qty 1 pcs		
	<b>GEV No.</b>	520228	<b>Ref. No.</b> —
	tooth lock washer ID ø 15.3mm ED ø 24mm steel Qty 1 pcs for thread M14		
	<b>GEV No.</b>	520230	<b>Ref. No.</b> —
	nut thread M14x1.5 H 5mm WS 19 zinc-coated steel Qty 1 pcs		
	<b>GEV No.</b>	521101	<b>Ref. No.</b> —
	nut thread M14x1.5 H 5mm WS 19 SS Qty 1 pcs		
	<b>GEV No.</b>	550262	<b>Ref. No.</b> —
	flat gasket copper ED ø 20mm ID ø 14mm thickness 2mm		





#### group 11

			
<b>GEV No.</b>	420185	<b>Ref. No.</b>	P41
<b>description</b>	heating element 12000W 230V heating circuits 3 L 415mm W 237mm H 213mm L1 85mm L2 330mm W1 80mm W2 77mm special fixing tube ø 8mm fryer heaters		

<b>GEV No.</b>	420183	<b>Ref. No.</b>	P33
<b>description</b>	heating element 1200W 230V L 785mm W 120mm thread M14x1.5 mounting distance 111.5mm connection M4 tube ø 8.5mm heating circuits 1 dry heating element 2 hole fixing for pizza oven		



<b>GEV No.</b>	418449	<b>Ref. No.</b>	P48A
<b>description</b>	heating element 800W 230V L 682mm W 102mm thread M14x1.5 mounting distance 94mm connection length 82mm connection M4 tube ø 8.5mm heating circuits 1 dry heating element 2 hole fixing		
<b>accessories for</b>	418449		
	<b>GEV No.</b>	510417	<b>Ref. No.</b> —
	flat gasket fibre ED ø 20mm ID ø 14mm thickness 2mm Qty 1 pcs		
	<b>GEV No.</b>	520228	<b>Ref. No.</b> —
	tooth lock washer ID ø 15.3mm ED ø 24mm steel Qty 1 pcs for thread M14		
	<b>GEV No.</b>	520230	<b>Ref. No.</b> —
	nut thread M14x1.5 H 5mm WS 19 zinc-coated steel Qty 1 pcs		
	<b>GEV No.</b>	521101	<b>Ref. No.</b> —
	nut thread M14x1.5 H 5mm WS 19 SS Qty 1 pcs		
	<b>GEV No.</b>	550262	<b>Ref. No.</b> —
	flat gasket copper ED ø 20mm ID ø 14mm thickness 2mm		



<b>GEV No.</b>	418447	<b>Ref. No.</b>	P30
<b>description</b>	heating element 900W 230V L 538mm W 88mm thread M14x1.5 mounting distance 80mm connection length 40mm connection M4 heating circuits 1 dry heating element 2 hole fixing		

## heating elements for salamanders/toast-





<b>GEV No.</b>	418452	<b>Ref. No.</b>	P35
<b>description</b>	heating element 1165W 230V L 392mm W 66mm 2 hole fixing thread M12x1.5 mounting distance 60mm connection M4 dry heating element tube ø 6.3mm salamander grill		

## ceramic heaters

## 245x60mm



<b>GEV No.</b>	415104	<b>Ref. No.</b>	P1169
<b>description</b>	ceramic emitter 1000W 230V cable beaded cord L 245mm W 60mm H 35mm		
<b>spare parts for</b>	415104		
	<b>GEV No.</b>	415109	<b>Ref. No.</b> —
	spring clip		
<b>accessories for</b>	415104		
	<b>GEV No.</b>	415110	<b>Ref. No.</b> —
	reflector L 245mm W 95mm H 31mm thickness 0.75mm hole ø 15x40mm		

## immersion heating elements



<b>GEV No.</b>	420188	<b>Ref. No.</b>	P47
<b>description</b>	heating element 3000W 230V heating circuits 1 L 350mm W 300mm connection M4 tube ø 10mm immersion heater for bain marie H 100mm connection distance 25mm		



<b>GEV No.</b>	418446	<b>Ref. No.</b>	P34
<b>description</b>	heating element 900W 230V heating circuits 1 L 420mm W 45mm thread M12x1 mounting distance 36mm tube ø 8.5mm 2 hole fixing immersion heater		



radiation heaters

square



1	<b>GEV No.</b>	490008	<b>Ref. No.</b>	P55
<b>description</b>	radiation heater L 300mm W 300mm 4000W 400V heating circuits 2 connections 3 square connection type male faston 6.3mm without pan detection EGO			
<b>spare parts for</b>	490008			
	<b>GEV No.</b>	499157	<b>Ref. No.</b>	—
	protection pipe for temperature probe ceramic L 297mm ED ø 7mm ID ø 5mm			

accessories



1	<b>GEV No.</b>	514493	<b>Ref. No.</b>	P604B+P604C+P604D
<b>description</b>	buffer suitable for heating element hole ø 11mm ø 315mm			

hot plates

round

with radiused edge

for domestic and commercial kitchens



1	<b>GEV No.</b>	490020	<b>Ref. No.</b>	P49B
<b>description</b>	hot plate ø 220mm 2600W 230V connection 4 screw clamps with 8mm spill ring			
<b>accessories for</b>	490020			
	<b>GEV No.</b>	550796	<b>Ref. No.</b>	—
	fixing plate for hot plate ø220mm			



1	<b>GEV No.</b>	490021	<b>Ref. No.</b>	P49A
<b>description</b>	hot plate ø 220mm 2600W 400V connection 4 screw clamps with 8mm spill ring			

energy regulators

EGO

1-circuit



1	<b>GEV No.</b>	380015	<b>Ref. No.</b>	P82
<b>description</b>	energy regulator 230V 13A single-circuit turn direction right shaft ø 6x4.6mm shaft L 23mm mounting thread M4 power release 6-100% no. 50.57021.010			

DIAMOND



1	<b>GEV No.</b>	380037	<b>Ref. No.</b>	P82
<b>description</b>	energy regulator 240V 13.5A turn direction right shaft ø 6x4.6mm shaft L 13mm mounting thread 3/8"-24UNF equiv. no. 35ERE101230V			



1	<b>GEV No.</b>	380038	<b>Ref. No.</b>	160210
<b>description</b>	energy regulator 24V 13.5A turn direction right shaft ø 6x4.6mm mounting thread 3/8"-24UNF equiv. no. 35ERE105024V voltage AC			

accessories

knobs



1	<b>GEV No.</b>	110075	<b>Ref. No.</b>	P82A
<b>description</b>	knob energy regulator 1-3 t.max.°C ø 50mm shaft ø 6x4.6mm shaft flat upper black			
<b>accessories for</b>	110075			
	<b>GEV No.</b>	110135	<b>Ref. No.</b>	—
	rosette knob up to ø 52mm			



## thermostats

## control and safety thermostats

EGO

control thermostats

55.10/19\_series



<b>GEV No.</b>	375468	<b>Ref. No.</b>	P77
----------------	--------	-----------------	-----

<b>description</b>	thermostat t.max. 180°C temperature range 80-180°C 1-pole 1NO 16A probe ø 6mm probe L 135mm capillary pipe 900mm capillary pipe isolatedmm gland nut M9x1 shaft ø 6x4.6mm shaft L 23mm shaft position upper rotation 270°
--------------------	---

55.34\_series



<b>GEV No.</b>	375143	<b>Ref. No.</b>	P76
----------------	--------	-----------------	-----

<b>description</b>	thermostat t.max. 110°C temperature range 32-110°C 3-pole 3NO 16A probe ø 6mm probe L 138mm capillary pipe 1480mm capillary pipe isolated 1100mm gland nut M9x1 shaft ø 6x4.6mm shaft L 23mm shaft position upper rotation 270°
--------------------	---



<b>GEV No.</b>	375417	<b>Ref. No.</b>	P77A
----------------	--------	-----------------	------

<b>description</b>	thermostat t.max. 200°C temperature range 65-200°C 3-pole 3NO 16A probe ø 6mm probe L 79mm capillary pipe 840mm capillary pipe isolatedmm gland nut M9x1 shaft ø 6x4.6mm shaft L 23mm rotation 270°
--------------------	---



<b>GEV No.</b>	375038	<b>Ref. No.</b>	P79
----------------	--------	-----------------	-----

<b>description</b>	thermostat t.max. 300°C temperature range 50-300°C 3-pole 3NO 16A probe ø 6mm probe L 79mm capillary pipe 1740mm capillary pipe isolated 800mm gland nut shaft ø 6x4.6mm shaft L 23mm shaft position upper rotation 270°
--------------------	--

<b>accessories for</b>	375038
------------------------	--------



<b>GEV No.</b>	110123	<b>Ref. No.</b>	—
<b>description</b>	knob thermostat t.max. 300°C ø 50mm shaft ø 6x4.6mm shaft flat upper black temperature range 50-300°C rotation 270°		

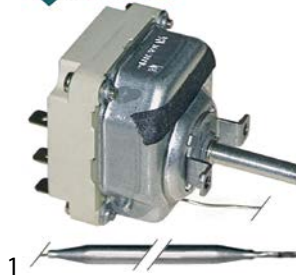

<b>GEV No.</b>	375026	<b>Ref. No.</b>	P80
----------------	--------	-----------------	-----

<b>description</b>	thermostat t.max. 350°C temperature range 100-350°C 3-pole 3NO 16A probe ø 6mm probe L 77mm capillary pipe 2430mm capillary pipe isolated 1100mm gland nut shaft ø 6x4.6mm shaft L 23mm shaft position upper rotation 270°
--------------------	--



<b>GEV No.</b>	390038	<b>Ref. No.</b>	P76ET
----------------	--------	-----------------	-------

<b>description</b>	thermostat t.max. 90°C temperature range 30-90°C 3-pole 3CO 16A probe ø 6mm probe L 215mm capillary pipe 900mm capillary pipe isolatedmm gland nut shaft Lmm
--------------------	--



safety thermostats

56\_ series



<b>GEV No.</b>	375432	<b>Ref. No.</b>	P78
----------------	--------	-----------------	-----

**description** safety thermostat switch-off temp. 230°C 1-pole 1NC 16A probe ø 6mm probe L 77mm capillary pipe 1160mm capillary pipe isolated 210mm gland nut M9x1 starting temperature 218°C probe

**accessories for** 375432

<b>GEV No.</b>	101860	<b>Ref. No.</b>	—
----------------	--------	-----------------	---

**description** nut thread M10x1 H 4mm WS 14 chrome-plated brass Qty 1 pcs

control thermostats with operation switch

55.34\_ series

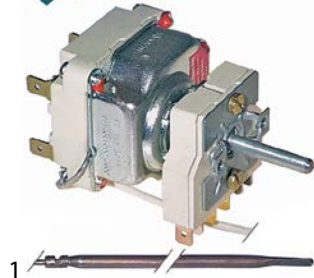

<b>GEV No.</b>	375246	<b>Ref. No.</b>	P709
----------------	--------	-----------------	------

**description** thermostat t.max. 645°C temperature range 100-615/645°C 2-pole 2NO 16A probe ø 4mm probe L 230mm capillary pipe 1100mm capillary pipe isolated 600mm gland nut shaft ø 6x4.6mm shaft L 25mm shaft position lower rotation 270° outer switch 2NO probe material copper

CAEM

safety thermostats



<b>GEV No.</b>	390877	<b>Ref. No.</b>	P1006
----------------	--------	-----------------	-------

**description** safety thermostat switch-off temp. 225°C 1-pole NC 16A probe ø 5mm probe L 80mm capillary pipe 900mm capillary pipe isolated 400mm gland nut M10x1 probe SS connection male faston 6.3mm

switches and momentary switches

rocker/momentary rocker switches

30x22mm



<b>GEV No.</b>	301135	<b>Ref. No.</b>	P67E
----------------	--------	-----------------	------

**description** momentary rocker switch mounting measurements 30x22mm orange 2NO 24V 16A illuminated connection male faston 6.3mm ambient temperature max. 100/55°C protection IP40

cam switches

4-position

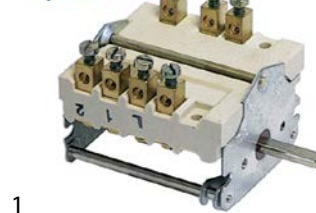

<b>GEV No.</b>	300103	<b>Ref. No.</b>	P86C
----------------	--------	-----------------	------

**description** cam switch 4 operating positions 1NO/2CO sequence 0-1-2-3 32A shaft ø 6x4.6mm shaft L 23mm connection screw ceramic

7-position



<b>GEV No.</b>	300025	<b>Ref. No.</b>	P87
----------------	--------	-----------------	-----

**description** cam switch 7 operating positions 1NO/2CO sequence 0-1-2-3-4-5-6 16A shaft ø 6x4.6mm shaft L 23mm connection screw 7-position ceramic

**accessories for** 300025

<b>GEV No.</b>	112172	<b>Ref. No.</b>	—
----------------	--------	-----------------	---

**description** knob universal ø 70mm black without adaptor/dial plate

<b>GEV No.</b>	112213	<b>Ref. No.</b>	—
----------------	--------	-----------------	---

**description** knob dial plate silver switch 7-position t.max.°C ED ø 63mm ID ø 45.5mm

<b>GEV No.</b>	112311	<b>Ref. No.</b>	—
----------------	--------	-----------------	---



**description** knob adapter shaft ø 6x4.6mm L 0mm with spring

## control equipment

### lamps







1

<b>GEV No.</b>	359606	<b>Ref. No.</b>	P91A
<b>description</b>	neon light bulb socket Ba9s 220V 2W clear ø 10mm L 28mm		
<b>accessories for</b>	359606		
	GEV No.	359832	Ref. No. —
	GEV No.	359853	Ref. No. —



1

<b>GEV No.</b>	359607	<b>Ref. No.</b>	P91
<b>description</b>	neon light bulb socket Ba9s 380V 2W clear ø 10mm L 28mm		
<b>accessories for</b>	359607		
	GEV No.	359060	Ref. No. —
	GEV No.	359063	Ref. No. —
	GEV No.	359064	Ref. No. —
	GEV No.	359685	Ref. No. —
	GEV No.	359832	Ref. No. —
	GEV No.	359853	Ref. No. —
	GEV No.	359988	Ref. No. —

## lamps

### indicator lights



#### indicator lights 3-piece (housing, lens and bulb)

lamps

neon light bulbs









1

<b>GEV No.</b>	359606	<b>Ref. No.</b>	P91A
<b>description</b>	neon light bulb socket Ba9s 220V 2W clear ø 10mm L 28mm		
<b>accessories for</b>	359606		
	GEV No.	359832	Ref. No. —
	GEV No.	359853	Ref. No. —



1

<b>GEV No.</b>	359607	<b>Ref. No.</b>	P91
<b>description</b>	neon light bulb socket Ba9s 380V 2W clear ø 10mm L 28mm		
<b>accessories for</b>	359607		
	GEV No.	359060	Ref. No. —
	GEV No.	359063	Ref. No. —
	GEV No.	359064	Ref. No. —
	GEV No.	359685	Ref. No. —
	GEV No.	359832	Ref. No. —
	GEV No.	359853	Ref. No. —
	GEV No.	359988	Ref. No. —





screw-on/push-on fit

neon light bulbs



1

<b>GEV No.</b>	359606	<b>Ref. No.</b>	P91A
<b>description</b>	neon light bulb socket Ba9s 220V 2W clear ø 10mm L 28mm		
<b>accessories for</b>	359606		
	<b>GEV No.</b>	359832	<b>Ref. No.</b> —
	lamp socket mounting measurements ø16.2mm socket Ba9s connection male faston 6.3mm		
	<b>GEV No.</b>	359853	<b>Ref. No.</b> —
	lamp socket mounting measurements ø18.2mm socket Ba9s connection male faston 6.3mm		



1

<b>GEV No.</b>	359607	<b>Ref. No.</b>	P91
<b>description</b>	neon light bulb socket Ba9s 380V 2W clear ø 10mm L 28mm		
<b>accessories for</b>	359607		
	<b>GEV No.</b>	359060	<b>Ref. No.</b> —
	lamp socket mounting measurements ø16.2mm socket E10 connection screw		
	<b>GEV No.</b>	359063	<b>Ref. No.</b> —
	lamp socket mounting measurements ø19.2mm socket E14 connection screw		
	<b>GEV No.</b>	359064	<b>Ref. No.</b> —
	lamp socket mounting measurements ø22.3mm socket E14 connection screw 250/380V ambient temperature at 1W 100°C ambient temperature at 2W 85°C		
	<b>GEV No.</b>	359685	<b>Ref. No.</b> —
	lamp socket mounting measurements ø16.2mm socket E10		
	<b>GEV No.</b>	359832	<b>Ref. No.</b> —
	lamp socket mounting measurements ø16.2mm socket Ba9s connection male faston 6.3mm		
	<b>GEV No.</b>	359853	<b>Ref. No.</b> —
	lamp socket mounting measurements ø18.2mm socket Ba9s connection male faston 6.3mm		
	<b>GEV No.</b>	359988	<b>Ref. No.</b> —
	lamp socket mounting measurements ø30.5mm 250V connection F6.3 temp.-resist. 55°C E14		

light bulbs

for ovens



1

<b>GEV No.</b>	359612	<b>Ref. No.</b>	AMPF
<b>description</b>	light bulb t.max. 300°C socket E14 25W 230V ø 25mm L 56mm lens L 30mm for oven lamp type Philips		

oven lamps

lamps

light bulbs



1

<b>GEV No.</b>	359612	<b>Ref. No.</b>	AMPF
<b>description</b>	light bulb t.max. 300°C socket E14 25W 230V ø 25mm L 56mm lens L 30mm for oven lamp type Philips		

electronic controllers

HONEYWELL

universal controllers

built-in version



1

<b>GEV No.</b>	379877	<b>Ref. No.</b>	P81A
<b>description</b>	electronic controller HONEYWELL type DC10N-400 mounting measurements 92x92mm 24/230V voltage AC TC (J) relay outputs 1 CO-10A(6) TC (J) universal built-in depth 55mm protection IP54 accuracy 1% built-in version defr. funct. no 0 up to +400°C display 3 digits		
<b>accessories for</b>	379877		
	<b>GEV No.</b>	379051	<b>Ref. No.</b> FS10
	temperature probe thermocouple J (Fe-CuNi) cable Vetrotex probe -50 up to +750°C cable -50 up to +350°C probe ø6x100mm cable length 3m without screw connection cable colours red/blue 2-wire		



## probes

### universal probes

#### temperature probes



<b>GEV No.</b>	375051	<b>Ref. No.</b>	N/A
<b>description</b>	temperature probe thermocouple J (Fe-CuNi) cable Vetrotex probe -50 up to +750°C cable -50 up to +350°C probe ø4x150mm cable length 1.5m 2-wire		



<b>GEV No.</b>	379051	<b>Ref. No.</b>	FS10
<b>description</b>	temperature probe thermocouple J (Fe-CuNi) cable Vetrotex probe -50 up to +750°C cable -50 up to +350°C probe ø6x100mm cable length 3m without screw connection cable colours red/blue 2-wire		

<b>accessories for</b>	379051			
	<b>GEV No.</b>	379877	<b>Ref. No.</b>	P81A
	electronic controller HONEYWELL type DC10N-400 mounting measurements 92x92mm 24/230V voltage AC TC (J) relay outputs 1 CO-10A(6) TC (J) universal built-in depth 55mm protection IP54 accuracy 1% built-in version defr. funct. no 0 up to +400°C display 3 digits			

## keypads

### front foils

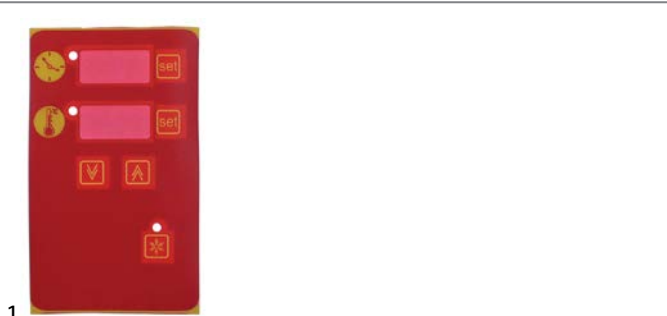

<b>GEV No.</b>	403015	<b>Ref. No.</b>	CFRPC10X
<b>description</b>	keypad foil L 167mm W 99mm		

## solenoïd valves

### solenoïd valves (water)

#### metal

#### PARKER

#### 3-way

#### VE-128 series

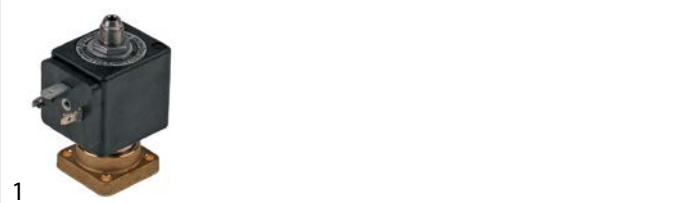



<b>GEV No.</b>	370057	<b>Ref. No.</b>	P74A
<b>description</b>	solenoïd valve 3-ways 230VAC body outer cone DN 1.2mm slide-on receptacle DIN -20° up to 140°C PARKER type series VE-128 coil type ZB09 membranes ruby p max 10bar brass flange 32x32mm		

<b>spare parts for</b>	370057			
	<b>GEV No.</b>	370062	<b>Ref. No.</b>	—
	solenoïd valve body PARKER 3-ways outer cone			

	<b>GEV No.</b>	371029	<b>Ref. No.</b>	—
	solenoïd coil PARKER 230VAC 9VA coil type ZB09 seat ø 14mm H 33mm W 34mm D 43mm			

<b>accessories for</b>	370057			
	<b>GEV No.</b>	371090	<b>Ref. No.</b>	—
	power socket plug type DIN 43650A screw			

	<b>GEV No.</b>	371095	<b>Ref. No.</b>	—
	O-ring Viton thickness 1.78mm ID ø 6.07mm Qty 1 pcs			

	<b>GEV No.</b>	371100	<b>Ref. No.</b>	—
	O-ring silicone thickness 1.78mm ID ø 6.07mm Qty 1 pcs			



## fans

### hot air fans

#### miscellaneous



1

<b>GEV No.</b>	601125	<b>Ref. No.</b>	EMMVR150
<b>description</b>	hot air fan 220-240V 45W 50/60Hz L1 70mm L2 11mm L3 25mm L4 87mm fan wheel ø 150mm FIME type C30R0479CLF		
<b>accessories for</b>	601125		
	<b>GEV No.</b>	550879	<b>Ref. No.</b> —
	insulation ø 130mm thickness 3mm hole ø 20mm for hot air fan		

## condensators & interference suppression filters

### operating capacitors

#### metal



1

<b>GEV No.</b>	365002	<b>Ref. No.</b>	FS16
<b>description</b>	operating capacitor capacity 4µF 400V tolerance 5% 50/60Hz ambient temperature max. -25 to +85°C ø 30mm L 75mm with cable M8 aluminium connection cable 300mm MKP protection IP65		

## gas taps

### PEL

#### 20N series



1

<b>GEV No.</b>	101398	<b>Ref. No.</b>	P66D
<b>description</b>	gas tap PEL type 20N gas inlet M16x1.5 (tube ø 10mm) bypass nozzle ø 0.35mm gas outlet M16x1.5 (tube ø 10/8mm) thermocouple connection pilot connection M10x1 shaft ø 8x6.5mm shaft L 22/15mm shaft flat upper		
<b>spare parts for</b>	101398		
	<b>GEV No.</b>	100408	<b>Ref. No.</b> —
	bypass nozzle type PEL20/21 bore ø 0.35mm thread M5x0.5		
	<b>GEV No.</b>	101205	<b>Ref. No.</b> —
	gas tap front part shaft ø 8x6.5mm shaft L 22/15mm shaft flat upper/lower suitable for PEL20		
<b>accessories for</b>	101398		
	<b>GEV No.</b>	101278	<b>Ref. No.</b> —
	olive for pipe ø 10mm Qty 1 pcs		
	<b>GEV No.</b>	101300	<b>Ref. No.</b> —
	union nut thread M16x1.5 tube ø 10mm		
	<b>GEV No.</b>	101450	<b>Ref. No.</b> —
	olive for pipe ø 8mm L 12.7mm Qty 1 pcs ED ø 10mm		
	<b>GEV No.</b>	101451	<b>Ref. No.</b> —
	union nut thread M16x1.5 tube ø 8mm		
	<b>GEV No.</b>	110081	<b>Ref. No.</b> —
	knob ø 70mm shaft ø 8x6.5mm shaft flat universal		
	<b>GEV No.</b>	110083	<b>Ref. No.</b> —
	knob dial plate gas tap without ignition flame silver		

#### 20S series



1







<b>GEV No.</b>	101491	<b>Ref. No.</b>	P67E
<b>description</b>	gas tap PEL type 20S gas inlet M16x1.5 (tube ø 10mm) bypass nozzle ø 0.35mm gas outlet M16x1.5 (tube ø 10/8mm) thermocouple connection M9x1 pilot connection shaft ø 8x6.5mm shaft L 22/15mm shaft flat lower		
<b>spare parts for</b>	101491		
	<b>GEV No.</b>	100408	<b>Ref. No.</b> —
	bypass nozzle type PEL20/21 bore ø 0.35mm thread M5x0.5		

Table continues overleaf

spare parts for		101491		
	GEV No.	101060	Ref. No.	—
magnet unit standard L 39mm D1 ø 15.4mm D2 ø 11mm suitable for PEL20-21/JUNKERS/EGA				
	GEV No.	101205	Ref. No.	—
gas tap front part shaft ø 8x6.5mm shaft L 22/15mm shaft flat upper/lower suitable for PEL20				
	GEV No.	101231	Ref. No.	—
thermocouple nut T1: M9x1 T2: M18x1				
accessories for		101491		
	GEV No.	101287	Ref. No.	—
olive for pipe ø 6mm Qty 1 pcs				
	GEV No.	101300	Ref. No.	—
union nut thread M16x1.5 tube ø 10mm				
	GEV No.	101450	Ref. No.	—
olive for pipe ø 8mm L 12.7mm Qty 1 pcs ED ø 10mm				
	GEV No.	101451	Ref. No.	—
union nut thread M16x1.5 tube ø 8mm				
	GEV No.	110081	Ref. No.	—
knob ø 70mm shaft ø 8x6.5mm shaft flat universal				
	GEV No.	110083	Ref. No.	—
knob dial plate gas tap without ignition flame silver				

21S series

 <p>1</p>				
GEV No.	101397	Ref. No.	P67C	
description	gas tap PEL type 21S gas inlet M16x1.5 (tube ø 10mm) bypass nozzle ø 0.35mm gas outlet M16x1.5 (tube ø 10/8mm) thermocouple connection M9x1 pilot connection M10x1 shaft ø 8x6.5mm shaft L 22/15mm shaft flat lower			
spare parts for		101397		
	GEV No.	100408	Ref. No.	—
bypass nozzle type PEL20/21 bore ø 0.35mm thread M5x0.5				
	GEV No.	101060	Ref. No.	—
magnet unit standard L 39mm D1 ø 15.4mm D2 ø 11mm suitable for PEL20-21/JUNKERS/EGA				
	GEV No.	101206	Ref. No.	—
gas tap front part shaft ø 8x6.5mm shaft L 22/15mm shaft flat upper/lower suitable for PEL21				
	GEV No.	101231	Ref. No.	—
thermocouple nut T1: M9x1 T2: M18x1				
accessories for		101397		
	GEV No.	100908	Ref. No.	—
union screw thread M10x1 for pipe ø 4mm Qty 1 pcs				

accessories for		101397		
	GEV No.	100909	Ref. No.	—
union screw thread M10x1 for pipe ø 6mm Qty 1 pcs				
	GEV No.	101246	Ref. No.	—
olive for pipe ø 4mm Qty 1 pcs				
	GEV No.	101278	Ref. No.	—
olive for pipe ø 10mm Qty 1 pcs				
	GEV No.	101286	Ref. No.	—
olive ID ø 6mm Qty 1 pcs				
	GEV No.	101300	Ref. No.	—
union nut thread M16x1.5 tube ø 10mm				
	GEV No.	101450	Ref. No.	—
olive for pipe ø 8mm L 12.7mm Qty 1 pcs ED ø 10mm				
	GEV No.	101451	Ref. No.	—
union nut thread M16x1.5 tube ø 8mm				
	GEV No.	110081	Ref. No.	—
knob ø 70mm shaft ø 8x6.5mm shaft flat universal				
	GEV No.	112206	Ref. No.	—
knob dial plate silver gas tap PEL21/22/23 t.max.°C ED ø 63mm ID ø 45.5mm				

22N/O series







 <p>1</p>				
GEV No.	101443	Ref. No.	P66C	
description	gas tap PEL type 22N/O gas inlet M20x1.5 (tube ø 12mm) bypass nozzle ø 0.35mm gas outlet M20x1.5 (tube ø 12/10mm) thermocouple connection pilot connection M10x1 shaft ø 10x8mm shaft L 25/17mm shaft flat lower			
spare parts for		101443		
	GEV No.	100259	Ref. No.	—
bypass nozzle type PEL22 bore ø 0.35mm thread M6x0.5				
	GEV No.	101201	Ref. No.	—
gas tap front part shaft ø 10x8mm shaft L 25/17mm shaft flat upper/lower suitable for PEL22				
	GEV No.	101240	Ref. No.	—
gas connection thread M20x1.5 tube ø 12/10mm for PEL gas taps with gasket and screws horizontal				
	GEV No.	101460	Ref. No.	—
O-ring ø 12.37mm D1 ø 2.62mm suitable for PEL22				
	GEV No.	101461	Ref. No.	—
screw kit suitable for PEL22 Qty 4 pcs				

Table continues overleaf



accessories for		101443		
GEV No.	100908	Ref. No.	—	
	union screw thread M10x1 for pipe ø 4mm Qty 1 pcs			
	union screw thread M10x1 for pipe ø 6mm Qty 1 pcs			
	olive for pipe ø 4mm Qty 1 pcs			
	olive for pipe ø 12mm Qty 1 pcs suitable for PEL			
	olive for pipe ø 10mm Qty 1 pcs			
	union nut thread M20x1.5 for pipe ø 10mm			
	union nut thread M20x1.5 for pipe ø 12mm			
	olive ID ø 6mm Qty 1 pcs			

accessories for		101086		
GEV No.	100908	Ref. No.	—	
	union screw thread M10x1 for pipe ø 4mm Qty 1 pcs			
	union screw thread M10x1 for pipe ø 6mm Qty 1 pcs			
	gas connection thread M20x1.5 tube ø 12/10mm for PEL gas taps vertical			
	olive for pipe ø 4mm Qty 1 pcs			
	olive for pipe ø 12mm Qty 1 pcs suitable for PEL			
	olive for pipe ø 10mm Qty 1 pcs			
	union nut thread M20x1.5 for pipe ø 10mm			
	union nut thread M20x1.5 for pipe ø 12mm			
	olive ID ø 6mm Qty 1 pcs			
	knob ø 70mm shaft ø 10x8mm shaft flat universal			
	knob dial plate silver gas tap PEL21/22/23 t.max.°C ED ø 63mm ID ø 45.5mm			

**22S/O series**



1

GEV No.	101086	Ref. No.	P67	
<b>description</b>	gas tap PEL type 22S/O gas inlet M20x1.5 (tube ø 12mm) bypass nozzle ø 0.35mm gas outlet M20x1.5 (tube ø 12/10mm) thermocouple connection M9x1 pilot connection M10x1 shaft ø 10x8mm shaft L 25/17mm shaft flat lower			
<b>spare parts for</b>	101086			
	GEV No.	100259	Ref. No.	—
	bypass nozzle type PEL22 bore ø 0.35mm thread M6x0.5			
	GEV No.	101058	Ref. No.	—
	magnet unit L 39mm D1 ø 15.4mm D2 ø 13.5mm suitable for PEL22/EGA24197 standard			
	GEV No.	101201	Ref. No.	—
	gas tap front part shaft ø 10x8mm shaft L 25/17mm shaft flat upper/lower suitable for PEL22			
	GEV No.	101231	Ref. No.	—
	thermocouple nut T1: M9x1 T2: M18x1			
	GEV No.	101240	Ref. No.	—
	gas connection thread M20x1.5 tube ø 12/10mm for PEL gas taps with gasket and screws horizontal			
	GEV No.	101460	Ref. No.	—
	O-ring ø 12.37mm D1 ø 2.62mm suitable for PEL22			
	GEV No.	101461	Ref. No.	—
	screw kit suitable for PEL22 Qty 4 pcs			



		1		
GEV No.	106384	Ref. No.	P67B	
<b>description</b>	gas tap PEL type 22S/O gas inlet M20x1.5 (tube ø 12mm) bypass nozzle ø 0mm gas outlet M20x1.5 (tube ø 12/10mm) thermocouple connection M9x1 pilot connection M10x1 shaft ø 10x8mm shaft L 25/17mm shaft flat lower			
<b>spare parts for</b>	106384			
	GEV No.	101058	Ref. No.	—
	magnet unit L 39mm D1 ø 15.4mm D2 ø 13.5mm suitable for PEL22/EGA24197 standard			
	GEV No.	101231	Ref. No.	—
	thermocouple nut T1: M9x1 T2: M18x1			
	GEV No.	106191	Ref. No.	—
	bypass nozzle type PEL22 bore ø 0mm thread M6x0.5			

Table continues overleaf

accessories for		106384		
GEV No.	101248	Ref. No.	—	
	olive for pipe ø 12mm Qty 1 pcs suitable for PEL			
GEV No.	101249	Ref. No.	—	
	olive for pipe ø 10mm Qty 1 pcs			
GEV No.	101250	Ref. No.	—	
	union nut thread M20x1.5 for pipe ø 10mm			
GEV No.	101251	Ref. No.	—	
	union nut thread M20x1.5 for pipe ø 12mm			

accessories for		109510		
GEV No.	101249	Ref. No.	—	
	olive for pipe ø 10mm Qty 1 pcs			
GEV No.	101250	Ref. No.	—	
	union nut thread M20x1.5 for pipe ø 10mm			
GEV No.	101251	Ref. No.	—	
	union nut thread M20x1.5 for pipe ø 12mm			
GEV No.	101286	Ref. No.	—	
	olive ID ø 6mm Qty 1 pcs			

1				
GEV No.	109510	Ref. No.	P67	
description	gas tap PEL type 225/O gas inlet M20x1.5 (tube ø 12mm) bypass nozzle ø 1.3mm gas outlet M20x1.5 (tube ø 12/10mm) thermocouple connection M8x1 pilot connection M10x1 shaft ø 10x8mm shaft L 25/17mm shaft flat right			
spare parts for	109510			
	GEV No.	100438	Ref. No.	—
	bypass nozzle type PEL22 bore ø 1.2mm thread M6x0.5			
	GEV No.	101058	Ref. No.	—
	magnet unit L 39mm D1 ø 15.4mm D2 ø 13.5mm suitable for PEL22/EGA24197 standard			
	GEV No.	101202	Ref. No.	—
	gas tap front part shaft ø 8x10mm shaft L 25/17mm shaft flat right/left suitable for PEL22			
	GEV No.	101230	Ref. No.	—
	thermocouple nut T1: M8x1 T2: M18x1 aluminium			
	GEV No.	101240	Ref. No.	—
	gas connection thread M20x1.5 tube ø 12/10mm for PEL gas taps with gasket and screws horizontal			
	GEV No.	101460	Ref. No.	—
	O-ring ø 12.37mm D1 ø 2.62mm suitable for PEL22			
	GEV No.	101461	Ref. No.	—
	screw kit suitable for PEL22 Qty 4 pcs			
accessories for		109510		
	GEV No.	100908	Ref. No.	—
	union screw thread M10x1 for pipe ø 4mm Qty 1 pcs			
	GEV No.	100909	Ref. No.	—
	union screw thread M10x1 for pipe ø 6mm Qty 1 pcs			
	GEV No.	101241	Ref. No.	—
	gas connection thread M20x1.5 tube ø 12/10mm for PEL gas taps vertical			
	GEV No.	101246	Ref. No.	—
	olive for pipe ø 4mm Qty 1 pcs			
	GEV No.	101248	Ref. No.	—
	olive for pipe ø 12mm Qty 1 pcs suitable for PEL			

## STN3R

1				
GEV No.	106178	Ref. No.	P66A	
description	gas tap STN3R gas inlet 3/8" (tube ø 10mm) bypass nozzle ø 0mm gas outlet 3/8" (tube ø 12mm) thermocouple connection pilot connection closed shaft ø 10x8mm shaft L 22/18mm shaft flat lower suitable for SOLYMAC			

1				
GEV No.	106179	Ref. No.	P66B	
description	gas tap STN3R gas inlet 3/8" (tube ø 8mm) gas outlet 3/8" (tube ø 8mm) shaft ø 8x10mm shaft L 60mm shaft flat lower suitable for SOLYMAC pilot connection M10x1 closed			





gas thermostats





SIT

710 Minisit series

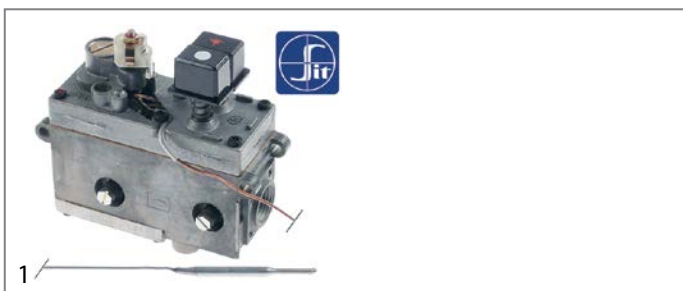

<b>GEV No.</b>	106931	<b>Ref. No.</b>	P68A
<b>description</b>	gas thermostat SIT type MINISIT 710 t.max. 310°C 70-310°C gas inlet 1/2" gas outlet 3/8" thermocouple connection M9x1 pilot connection M10x1 probe ø 4mm probe L 72mm capillary pipe 1300mm pressure controller no pressure regulator mbar gland nut 0710647 ignition gas 6mm probe material stainless steel		
<b>accessories for</b>	106931		
	<b>GEV No.</b>	101137	<b>Ref. No.</b> —
	cover cap without piezoelectric igniter		
	<b>GEV No.</b>	110068	<b>Ref. No.</b> P72E
	knob suitable for Minisit ø 37mm		



<b>GEV No.</b>	101132	<b>Ref. No.</b>	P68A
<b>description</b>	gas thermostat SIT type MINISIT 710 t.max. 340°C 100-340°C gas inlet 1/2" gas outlet 3/8" thermocouple connection M9x1 pilot connection M10x1 probe ø 5mm probe L 68mm capillary pipe 1050mm probe type type B1 pressure controller no pressure regulator mbar gland nut ignition gas no		
<b>spare parts for</b>	101132		
	<b>GEV No.</b>	101053	<b>Ref. No.</b> —
	magnet unit T1: M9x1 T2: M24x1 L 45mm ø 17mm suitable for Minisit		
	<b>GEV No.</b>	102102	<b>Ref. No.</b> —
	probe 100-340°C probe ø 5mm probe L 68mm capillary pipe 1750mm t.max. 340°C oven/grill probe type type B1 suitable for MINISIT 710		
<b>accessories for</b>	101132		
	<b>GEV No.</b>	100809	<b>Ref. No.</b> —
	O-ring EPDM thickness 2mm ID ø 21mm Qty 1 pcs		
	<b>GEV No.</b>	100904	<b>Ref. No.</b> —
	locking screw M10x1 for pipe ø 4mm Qty 1 pcs		
	<b>GEV No.</b>	100905	<b>Ref. No.</b> —
	locking screw M10x1 for pipe ø 6mm Qty 1 pcs		

<b>accessories for</b>	101132		
	<b>GEV No.</b>	101054	<b>Ref. No.</b> —
	magnet unit T1: M10x1 T2: M24x1 L 45mm ø 17mm suitable for Minisit		
	<b>GEV No.</b>	101136	<b>Ref. No.</b> —
	piezoelectric igniter suitable for Minisit with cover cap ømm connection F6.3x0.8		
	<b>GEV No.</b>	101137	<b>Ref. No.</b> —
	cover cap without piezoelectric igniter		
	<b>GEV No.</b>	101267	<b>Ref. No.</b> —
	reducer IT 3/8" ET 1/2" L 21mm		
	<b>GEV No.</b>	101268	<b>Ref. No.</b> —
	gas connection thread 3/8" angled with O-ring MINISIT 710		
	<b>GEV No.</b>	101269	<b>Ref. No.</b> —
	gas connection thread 1/2" angled with O-ring MINISIT 710		
	<b>GEV No.</b>	101270	<b>Ref. No.</b> —
	screw connection IT 3/8" ET 3/8" L 28mm		
	<b>GEV No.</b>	101272	<b>Ref. No.</b> —
	screw connection IT 1/2" ET 3/8" L 57mm		
	<b>GEV No.</b>	101273	<b>Ref. No.</b> —
	olive for pipe ø 12mm L 9.5mm brass Qty 1 pcs suitable for universal		
	<b>GEV No.</b>	101274	<b>Ref. No.</b> —
	olive for pipe ø 16mm Qty 1 pcs		
	<b>GEV No.</b>	101275	<b>Ref. No.</b> —
	union screw thread 1/2" for pipe ø 16mm Qty 1 pcs		
	<b>GEV No.</b>	101276	<b>Ref. No.</b> —
	union screw thread 3/8" tube ø 12mm Qty 1 pcs		
	<b>GEV No.</b>	110068	<b>Ref. No.</b> P72E
	knob suitable for Minisit ø 37mm		



<b>GEV No.</b>	102873	<b>Ref. No.</b>	P70/P300
<b>description</b>	gas thermostat SIT type MINISIT 710 t.max. 340°C 140-340°C gas inlet 1/2" gas outlet 3/8" thermocouple connection M9x1 probe ø 4mm probe L 72mm capillary pipe 1050mm probe type type C2 pressure controller no		
<b>spare parts for</b>	102873		
	<b>GEV No.</b>	100068	<b>Ref. No.</b> —
	pilot burner 2 flames gas connection 6mm		



Table continues overleaf



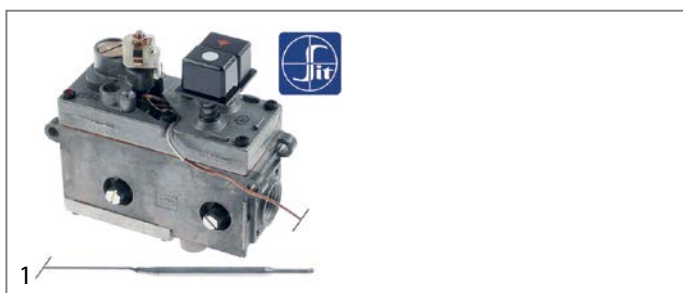

1 gas components

spare parts for		102873		
GEV No.	100809	Ref. No.	—	
	O-ring EPDM thickness 2mm ID ø 21mm Qty 1 pcs			
	GEV No.	101053	Ref. No.	—
magnet unit T1: M9x1 T2: M24x1 L 45mm ø 17mm suitable for Minisit				
	GEV No.	101137	Ref. No.	—
cover cap without piezoelectric igniter				
	GEV No.	101504	Ref. No.	—
gas connection thread 1/2" angled without O-ring MINISIT 710				
	GEV No.	101505	Ref. No.	—
gas connection thread 3/8" angled without O-ring MINISIT 710				
	GEV No.	101516	Ref. No.	—
flat-headed bolt thread M4 thread L 16mm SS DIN 7985/ISO 7045 Qty 1 pcs				
	GEV No.	101517	Ref. No.	—
flat-headed bolt thread M4 thread L 23mm				
	GEV No.	106226	Ref. No.	—
probe 140-380°C probe ø 4mm probe L 72mm capillary pipe 1050mm t.max. 380°C oven/grill probe type type C2 suitable for MINISIT 710				



GEV No.	101131	Ref. No.	P69	
<b>description</b>	gas thermostat without cap, button and angle SIT type MINISIT 710 t.max. 190°C 50-190°C gas inlet 1/2" gas outlet 3/8" thermocouple connection M9x1 pilot connection M10x1 probe ø 5mm probe L 98mm capillary pipe 1200mm probe type type A2 pressure controller no pressure regulator mbar gland nut			

spare parts for		101131		
GEV No.	101053	Ref. No.	—	
	magnet unit T1: M9x1 T2: M24x1 L 45mm ø 17mm suitable for Minisit			
	GEV No.	102103	Ref. No.	—
probe 60-200°C probe ø 5mm probe L 98mm capillary pipe 1050mm t.max. 200°C fryer probe type type A2 suitable for MINISIT 710				

accessories for		101131		
GEV No.	100809	Ref. No.	—	
	O-ring EPDM thickness 2mm ID ø 21mm Qty 1 pcs			
	GEV No.	100820	Ref. No.	—
gland duct ET M14x1.5 IT M10x0.75 probe ø max. 6.5mm WS 22				
	GEV No.	100904	Ref. No.	—
locking screw M10x1 for pipe ø 4mm Qty 1 pcs				
	GEV No.	100905	Ref. No.	—
locking screw M10x1 for pipe ø 6mm Qty 1 pcs				

accessories for		101131		
GEV No.	101054	Ref. No.	—	
	magnet unit T1: M10x1 T2: M24x1 L 45mm ø 17mm suitable for Minisit			
	GEV No.	101136	Ref. No.	—
piezoelectric igniter suitable for Minisit with cover cap ømm connection F6.3x0.8				
	GEV No.	101137	Ref. No.	—
cover cap without piezoelectric igniter				
	GEV No.	101267	Ref. No.	—
reducer IT 3/8" ET 1/2" L 21mm				
	GEV No.	101268	Ref. No.	—
gas connection thread 3/8" angled with O-ring MINISIT 710				
	GEV No.	101269	Ref. No.	—
gas connection thread 1/2" angled with O-ring MINISIT 710				
	GEV No.	101270	Ref. No.	—
screw connection IT 3/8" ET 3/8" L 28mm				
	GEV No.	101272	Ref. No.	—
screw connection IT 1/2" ET 3/8" L 57mm				
	GEV No.	101273	Ref. No.	—
olive for pipe ø 12mm L 9.5mm brass Qty 1 pcs suitable for universal				
	GEV No.	101274	Ref. No.	—
olive for pipe ø 16mm Qty 1 pcs				
	GEV No.	101275	Ref. No.	—
union screw thread 1/2" for pipe ø 16mm Qty 1 pcs				
	GEV No.	101276	Ref. No.	—
union screw thread 3/8" tube ø 12mm Qty 1 pcs				
	GEV No.	110068	Ref. No.	P72E
knob suitable for Minisit ø 37mm				

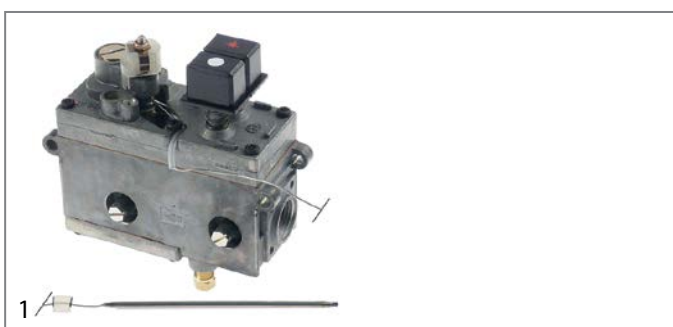





GEV No.	107237	Ref. No.	P69	
<b>description</b>	gas thermostat without cap, button and angle SIT type MINISIT 710 t.max. 210°C 70-210°C gas inlet 1/2" gas outlet 3/8" thermocouple connection M9x1 pilot connection M10x1 probe ø 4mm probe L 122mm capillary pipe 1300mm probe type pressure controller no pressure regulator mbar gland nut			
accessories for		107237		
	GEV No.	101137	Ref. No.	—
cover cap without piezoelectric igniter				

Table continues overleaf









accessories for		107237	
	GEV No.	101267	Ref. No. —
reducer IT 3/8" ET 1/2" L 21mm			
	GEV No.	101268	Ref. No. —
gas connection thread 3/8" angled with O-ring MINISIT 710			
	GEV No.	110068	Ref. No. P72E
knob suitable for Minisit ø 37mm			

**PEL**

**24STS series**



GEV No.	106382	Ref. No.	P70C
<b>description</b>	gas thermostat PEL type 24STS 110-310°C gas inlet flange bypass nozzle ø 0mm gas outlet flange thermocouple connection M9x1 pilot connection M10x1 capillary pipe 1200mm probe ø 6mm probe L 100mm shaft ø 10x8mm shaft L 27/17mm shaft flat upper		
<b>spare parts for</b>	106382		
	GEV No.	101058	Ref. No. —
magnet unit L 39mm D1 ø 15.4mm D2 ø 13.5mm suitable for PEL22/ EGA24197 standard			
	GEV No.	106200	Ref. No. —
nut thread M9x1 suitable for PEL 24/255			
	GEV No.	106201	Ref. No. —
bypass nozzle type PEL23/24 bore ø 0mm thread M8x0.5			
<b>accessories for</b>	106382		
	GEV No.	100908	Ref. No. —
union screw thread M10x1 for pipe ø 4mm Qty 1 pcs			
	GEV No.	100909	Ref. No. —
union screw thread M10x1 for pipe ø 6mm Qty 1 pcs			
	GEV No.	101235	Ref. No. —
gas connection thread M20x1.5 tube ø 12/10mm for PEL gas taps horizontal			
	GEV No.	101240	Ref. No. —
gas connection thread M20x1.5 tube ø 12/10mm for PEL gas taps with gasket and screws horizontal			
	GEV No.	101241	Ref. No. —
gas connection thread M20x1.5 tube ø 12/10mm for PEL gas taps vertical			
	GEV No.	101246	Ref. No. —
olive for pipe ø 4mm Qty 1 pcs			
	GEV No.	101248	Ref. No. —
olive for pipe ø 12mm Qty 1 pcs suitable for PEL			
	GEV No.	101249	Ref. No. —
olive for pipe ø 10mm Qty 1 pcs			

accessories for		106382	
	GEV No.	101250	Ref. No. —
union nut thread M20x1.5 for pipe ø 10mm			
	GEV No.	101251	Ref. No. —
union nut thread M20x1.5 for pipe ø 12mm			
	GEV No.	101286	Ref. No. —
olive ID ø 6mm Qty 1 pcs			
	GEV No.	101460	Ref. No. —
O-ring ø 12.37mm D1 ø 2.62mm suitable for PEL22			
	GEV No.	101461	Ref. No. —
screw kit suitable for PEL22 Qty 4 pcs			

accessories for		106392	
	GEV No.	106392	Ref. No. P70B
<b>description</b>	gas thermostat PEL type 24STS bypass nozzle ø 0/1.5/2.75mm thermocouple connection M9x1 capillary pipe 1200mm probe ø 6mm probe L 100mm shaft ø 10x8mm shaft L 27/17mm t.max. 350°C pipe input ø 14mm pipe output ø 14mm		
<b>spare parts for</b>	106392		
	GEV No.	100679	Ref. No. —
bypass nozzle type PEL23/24 bore ø 1.5mm thread M8x0.5			
	GEV No.	100909	Ref. No. —
union screw thread M10x1 for pipe ø 6mm Qty 1 pcs			
	GEV No.	101286	Ref. No. —
olive ID ø 6mm Qty 1 pcs			
	GEV No.	101365	Ref. No. —
gas connection thread M20x1.5 tube ø 12mm for PEL gas taps horizontal			
	GEV No.	101427	Ref. No. —
union nut thread M20x1.5 for pipe ø 14mm			
	GEV No.	101428	Ref. No. —
olive for pipe ø 14mm L 9mm Qty 1 pcs ED ø 16mm			
	GEV No.	101460	Ref. No. —
O-ring ø 12.37mm D1 ø 2.62mm suitable for PEL22			
	GEV No.	101461	Ref. No. —
screw kit suitable for PEL22 Qty 4 pcs			
	GEV No.	106393	Ref. No. —
bypass nozzle type PEL23/24 bore ø 2.75mm thread M8x0.5			





25ST series



<b>GEV No.</b>	101991	<b>Ref. No.</b>	P70D
<b>description</b>	gas thermostat PEL type 25ST 100-300°C gas inlet M16x1.5 (tube ø 10mm) bypass nozzle ø 0mm gas outlet M16x1.5 (tube ø 10/8mm) thermocouple connection M9x1 pilot connection M10x1 capillary pipe 1200mm probe ø 6mm probe L 100mm shaft ø 8x6.5mm shaft L 21/15mm shaft flat upper		
<b>spare parts for</b>	101991		
	<b>GEV No.</b>	101060	<b>Ref. No.</b> —
	magnet unit standard L 39mm D1 ø 15.4mm D2 ø 11mm suitable for PEL20-21/JUNKERS/EGA		
	<b>GEV No.</b>	106191	<b>Ref. No.</b> —
	bypass nozzle type PEL22 bore ø 0mm thread M6x0.5		
	<b>GEV No.</b>	106200	<b>Ref. No.</b> —
	nut thread M9x1 suitable for PEL 24/255		
<b>accessories for</b>	101991		
	<b>GEV No.</b>	100908	<b>Ref. No.</b> —
	union screw thread M10x1 for pipe ø 4mm Qty 1 pcs		
	<b>GEV No.</b>	100909	<b>Ref. No.</b> —
	union screw thread M10x1 for pipe ø 6mm Qty 1 pcs		
	<b>GEV No.</b>	101246	<b>Ref. No.</b> —
	olive for pipe ø 4mm Qty 1 pcs		
	<b>GEV No.</b>	101278	<b>Ref. No.</b> —
	olive for pipe ø 10mm Qty 1 pcs		
	<b>GEV No.</b>	101286	<b>Ref. No.</b> —
	olive ID ø 6mm Qty 1 pcs		
	<b>GEV No.</b>	101300	<b>Ref. No.</b> —
	union nut thread M16x1.5 tube ø 10mm		
	<b>GEV No.</b>	101450	<b>Ref. No.</b> —
	olive for pipe ø 8mm L 12.7mm Qty 1 pcs ED ø 10mm		
	<b>GEV No.</b>	101451	<b>Ref. No.</b> —
	union nut thread M16x1.5 tube ø 8mm		
	<b>GEV No.</b>	110079	<b>Ref. No.</b> —
	knob dial plate gas thermostat 1-8 silver		
	<b>GEV No.</b>	110081	<b>Ref. No.</b> —
	knob ø 70mm shaft ø 8x6.5mm shaft flat universal		

STN3R



<b>GEV No.</b>	106210	<b>Ref. No.</b>	P300 P70A
<b>description</b>	gas thermostat t.max. 450°C gas inlet 1/2" gas outlet 1/2" probe ø 6.5mm probe L 250mm capillary pipe 1200mm STN3R		
<b>spare parts for</b>	106210		
	<b>GEV No.</b>	106211	<b>Ref. No.</b> P72J
	knob suitable for STN3R		
	<b>GEV No.</b>	106212	<b>Ref. No.</b> P72D
	knob suitable for STN3R		

gas valves and ignition boxes  
gas control valves

SIT  
ELETTROSIT











<b>GEV No.</b>	101123	<b>Ref. No.</b>	P71
<b>description</b>	gas valve SIT type ELETTROSIT 230V gas inlet 3/4" gas outlet 3/4" thermocouple connection M9x1 pilot connection M10x1 bottom equiv. no. 0.810.138		
<b>spare parts for</b>	101123		
	<b>GEV No.</b>	101312	<b>Ref. No.</b> —
	microswitch		
	<b>GEV No.</b>	101352	<b>Ref. No.</b> —
	solenoid coil 230V 50Hz suitable for ELETTROSIT		
<b>accessories for</b>	101123		
	<b>GEV No.</b>	100006	<b>Ref. No.</b> —
	piezoelectric igniter suitable for ELETTROSIT body plastic blowing connection ø2.4mm ø 14mm		
	<b>GEV No.</b>	100904	<b>Ref. No.</b> —
	locking screw M10x1 for pipe ø 4mm Qty 1 pcs		
	<b>GEV No.</b>	100905	<b>Ref. No.</b> —
	locking screw M10x1 for pipe ø 6mm Qty 1 pcs		





Table continues overleaf



















<b>accessories for</b>	101123		
	GEV No.	101301	Ref. No. —
	gas connection thread 1/2" straight ELETTROSIT screw with O-ring		
	GEV No.	101303	Ref. No. —
	gas connection straight thread 3/4" ELETTROSIT		
	GEV No.	101309	Ref. No. —
	extension		

















## ignition parts

### pilot burners

<b>SIT</b>			
100 series			
	1		
<b>GEV No.</b>	106901	<b>Ref. No.</b>	P74 P74A
<b>description</b>	pilot burner SIT type 100 series 1 flame nozzle $\phi$ 0.2mm gas connection 6mm		
<b>spare parts for</b>	106901		
	GEV No.	100854	Ref. No. —
	pilot burner bracket double		
	GEV No.	100916	Ref. No. —
	compression spring for pilot burner Qty 1 pcs		
	GEV No.	100917	Ref. No. —
	gasket for pilot burner Qty 1 pcs aluminium		
	GEV No.	100918	Ref. No. —
	screw for pilot burner		
<b>accessories for</b>	106901		
	GEV No.	100904	Ref. No. —
	locking screw M10x1 for pipe $\phi$ 4mm Qty 1 pcs		
	GEV No.	100905	Ref. No. —
	locking screw M10x1 for pipe $\phi$ 6mm Qty 1 pcs		
	GEV No.	102110	Ref. No. —
	pilot tube copper pipe $\phi$ 4mm thickness 1mm L 3000mm		
	GEV No.	102111	Ref. No. —
	pilot tube copper pipe $\phi$ 6mm thickness 1mm L 3000mm		
	GEV No.	102742	Ref. No. —
	pilot burner nozzle LPG code 25 bore $\phi$ 0.25mm Qty 1 pcs		

	1		
<b>GEV No.</b>	106902	<b>Ref. No.</b>	P74A
<b>description</b>	pilot burner SIT type 100 series 2 flames nozzle $\phi$ 0.2mm gas connection 6mm		
<b>spare parts for</b>	106902		
	GEV No.	100245	Ref. No. P75C
	pilot burner nozzle LPG code 20 bore $\phi$ 0.2mm Qty 1 pcs thread M8x0.75		
	GEV No.	100842	Ref. No. —
	pilot burner cap 2 flames Qty 1 pcs		
	GEV No.	100885	Ref. No. —
	air mixing sleeve for pilot burner Qty 1 pcs		
	GEV No.	100916	Ref. No. —
	compression spring for pilot burner Qty 1 pcs		
	GEV No.	100917	Ref. No. —
	gasket for pilot burner Qty 1 pcs aluminium		
	GEV No.	100918	Ref. No. —
	screw for pilot burner		
	GEV No.	107161	Ref. No. —
	pilot burner cap SIT 2 flames Hmm Lmm Qty 1 pcs		
	GEV No.	107701	Ref. No. —
	pilot burner bottom part SIT 100 series nozzle $\phi$ 0.2mm		
<b>accessories for</b>	106902		
	GEV No.	100246	Ref. No. INJ3006 P75B
	pilot burner nozzle natural gas bore $\phi$ 0.35mm Qty 1 pcs thread M8x0.75		
	GEV No.	100904	Ref. No. —
	locking screw M10x1 for pipe $\phi$ 4mm Qty 1 pcs		
	GEV No.	100905	Ref. No. —
	locking screw M10x1 for pipe $\phi$ 6mm Qty 1 pcs		
	GEV No.	102110	Ref. No. —
	pilot tube copper pipe $\phi$ 4mm thickness 1mm L 3000mm		
	GEV No.	102111	Ref. No. —
	pilot tube copper pipe $\phi$ 6mm thickness 1mm L 3000mm		
	GEV No.	107171	Ref. No. —
	pilot burner nozzle SIT natural/liquid gas bore $\phi$ 0.25mm Qty 1 pcs		
	GEV No.	107700	Ref. No. —
	pilot burner bottom part SIT 100 series nozzle $\phi$ 0.25mm		
	GEV No.	107702	Ref. No. —
	pilot burner bottom part SIT 100 series nozzle $\phi$ 0.35mm		



			
<b>1</b>			
<b>GEV No.</b>	106906	<b>Ref. No.</b>	P74B
<b>description</b>	pilot burner SIT type 100 series 3 flames nozzle $\varnothing$ 0.2mm gas connection 6mm		
<b>spare parts for</b>	106906		
	<b>GEV No.</b>	100245	<b>Ref. No.</b> P75C
	pilot burner nozzle LPG code 20 bore $\varnothing$ 0.2mm Qty 1 pcs thread M8x0.75		
	<b>GEV No.</b>	100855	<b>Ref. No.</b> —
	pilot burner bracket triple		
	<b>GEV No.</b>	100885	<b>Ref. No.</b> —
	air mixing sleeve for pilot burner Qty 1 pcs		
	<b>GEV No.</b>	100916	<b>Ref. No.</b> —
	compression spring for pilot burner Qty 1 pcs		
	<b>GEV No.</b>	100917	<b>Ref. No.</b> —
	gasket for pilot burner Qty 1 pcs aluminium		
	<b>GEV No.</b>	100918	<b>Ref. No.</b> —
	screw for pilot burner		
	<b>GEV No.</b>	107162	<b>Ref. No.</b> —
	pilot burner cap SIT 3 flames Hmm Lmm Qty 1 pcs		
	<b>GEV No.</b>	107701	<b>Ref. No.</b> —
	pilot burner bottom part SIT 100 series nozzle $\varnothing$ 0.2mm		
<b>accessories for</b>	106906		
	<b>GEV No.</b>	100245	<b>Ref. No.</b> P75C
	pilot burner nozzle LPG code 20 bore $\varnothing$ 0.2mm Qty 1 pcs thread M8x0.75		
	<b>GEV No.</b>	100246	<b>Ref. No.</b> INJ3006 P75B
	pilot burner nozzle natural gas bore $\varnothing$ 0.35mm Qty 1 pcs thread M8x0.75		
	<b>GEV No.</b>	100904	<b>Ref. No.</b> —
	locking screw M10x1 for pipe $\varnothing$ 4mm Qty 1 pcs		
	<b>GEV No.</b>	100905	<b>Ref. No.</b> —
	locking screw M10x1 for pipe $\varnothing$ 6mm Qty 1 pcs		
	<b>GEV No.</b>	102110	<b>Ref. No.</b> —
	pilot tube copper pipe $\varnothing$ 4mm thickness 1mm L 3000mm		
	<b>GEV No.</b>	102111	<b>Ref. No.</b> —
	pilot tube copper pipe $\varnothing$ 6mm thickness 1mm L 3000mm		
	<b>GEV No.</b>	107171	<b>Ref. No.</b> —
	pilot burner nozzle SIT natural/liquid gas bore $\varnothing$ 0.25mm Qty 1 pcs		
	<b>GEV No.</b>	107700	<b>Ref. No.</b> —
	pilot burner bottom part SIT 100 series nozzle $\varnothing$ 0.25mm		

<b>accessories for</b>	106906		
	<b>GEV No.</b>	107702	<b>Ref. No.</b> —
	pilot burner bottom part SIT 100 series nozzle $\varnothing$ 0.35mm		

















			
<b>1</b>			
<b>GEV No.</b>	106907	<b>Ref. No.</b>	P74B
<b>description</b>	pilot burner SIT type 100 series 3 flames nozzle $\varnothing$ 0.35mm gas connection 6mm		
<b>spare parts for</b>	106907		
	<b>GEV No.</b>	100246	<b>Ref. No.</b> INJ3006 P75B
	pilot burner nozzle natural gas bore $\varnothing$ 0.35mm Qty 1 pcs thread M8x0.75		
	<b>GEV No.</b>	100855	<b>Ref. No.</b> —
	pilot burner bracket triple		
	<b>GEV No.</b>	100885	<b>Ref. No.</b> —
	air mixing sleeve for pilot burner Qty 1 pcs		
	<b>GEV No.</b>	100916	<b>Ref. No.</b> —
	compression spring for pilot burner Qty 1 pcs		
	<b>GEV No.</b>	100917	<b>Ref. No.</b> —
	gasket for pilot burner Qty 1 pcs aluminium		
	<b>GEV No.</b>	100918	<b>Ref. No.</b> —
	screw for pilot burner		
	<b>GEV No.</b>	107162	<b>Ref. No.</b> —
	pilot burner cap SIT 3 flames Hmm Lmm Qty 1 pcs		
	<b>GEV No.</b>	107702	<b>Ref. No.</b> —
	pilot burner bottom part SIT 100 series nozzle $\varnothing$ 0.35mm		
<b>accessories for</b>	106907		
	<b>GEV No.</b>	100245	<b>Ref. No.</b> P75C
	pilot burner nozzle LPG code 20 bore $\varnothing$ 0.2mm Qty 1 pcs thread M8x0.75		
	<b>GEV No.</b>	100904	<b>Ref. No.</b> —
	locking screw M10x1 for pipe $\varnothing$ 4mm Qty 1 pcs		
	<b>GEV No.</b>	100905	<b>Ref. No.</b> —
	locking screw M10x1 for pipe $\varnothing$ 6mm Qty 1 pcs		
	<b>GEV No.</b>	102110	<b>Ref. No.</b> —
	pilot tube copper pipe $\varnothing$ 4mm thickness 1mm L 3000mm		
	<b>GEV No.</b>	102111	<b>Ref. No.</b> —
	pilot tube copper pipe $\varnothing$ 6mm thickness 1mm L 3000mm		
	<b>GEV No.</b>	107171	<b>Ref. No.</b> —
	pilot burner nozzle SIT natural/liquid gas bore $\varnothing$ 0.25mm Qty 1 pcs		

Table continues overleaf







<b>accessories for</b> 106907	
	GEV No. 107700 Ref. No. —
pilot burner bottom part SIT 100 series nozzle ø 0.25mm	
	GEV No. 107701 Ref. No. —
pilot burner bottom part SIT 100 series nozzle ø 0.2mm	

<b>accessories for</b> 106388	
	GEV No. 100907 Ref. No. —
screw connection thread M10x1 Qty 1 pcs type SEF 1 ømm for thermocouple	
	GEV No. 101602 Ref. No. —
locking screw thread M10x1 for pipe ø 1/4" Qty 1 pcs	



<b>accessories</b>	
<b>pilot burner nozzles</b>	
	
1	
<b>GEV No.</b>	100245 <b>Ref. No.</b> P75C
<b>description</b>	pilot burner nozzle LPG code 20 bore ø 0.2mm Qty 1 pcs thread M8x0.75

	
1	
<b>GEV No.</b>	100246 <b>Ref. No.</b> INJ3006 P75B
<b>description</b>	pilot burner nozzle natural gas bore ø 0.35mm Qty 1 pcs thread M8x0.75

<b>ignition electrodes</b>	
	
1	
<b>GEV No.</b>	100707 <b>Ref. No.</b> P641
<b>description</b>	ignition electrode D1 ø 7mm D2 ø 9mm connection ø 2.4mm L1 14mm L2 6mm BL1 18mm BL2 3mm BL3 23mm to clip Qty 1 pcs

<b>Oxipilot 9000 series</b>	
<b>pilot burners</b>	
	
1	
<b>GEV No.</b>	106388 <b>Ref. No.</b> P74DB
<b>description</b>	pilot burner type Oxipilot 9000 series 2 flames natural gas nozzle no. 33 nozzle ø 0.33mm gas connection 6mm without ignition electrode bore ø 0.33mm
<b>accessories for</b> 106388	
	GEV No. 100904 Ref. No. —
locking screw M10x1 for pipe ø 4mm Qty 1 pcs	
	GEV No. 100905 Ref. No. —
locking screw M10x1 for pipe ø 6mm Qty 1 pcs	

<b>JUNKERS</b>	
<b>CB 505 series</b>	
<b>pilot burners</b>	
	
1	
<b>GEV No.</b>	106390 <b>Ref. No.</b> P74B800
<b>description</b>	pilot burner type CB 5051_ natural/liquid gas code 42/64 gas connection 6mm

<b>producer-specific pilot burners</b>	
<b>SOLYMAC</b>	
	
1	
<b>GEV No.</b>	106387 <b>Ref. No.</b> P1171A
<b>description</b>	pilot burner 1 flame gas connection 6mm without nozzle
<b>accessories for</b> 106387	
	GEV No. 106385 Ref. No. P1171C
pilot burner nozzle LPG code 22 bore ø 0.22mm thread M5x0.75 Qty 1 pcs brass	
	GEV No. 106386 Ref. No. P1171B
pilot burner nozzle natural gas code 40 bore ø 0.4mm thread M5x0.75 Qty 1 pcs brass	

	
1	
<b>GEV No.</b>	106385 <b>Ref. No.</b> P1171C
<b>description</b>	pilot burner nozzle LPG code 22 bore ø 0.22mm thread M5x0.75 Qty 1 pcs brass

	
1	
<b>GEV No.</b>	106386 <b>Ref. No.</b> P1171B
<b>description</b>	pilot burner nozzle natural gas code 40 bore ø 0.4mm thread M5x0.75 Qty 1 pcs brass

**electrodes**

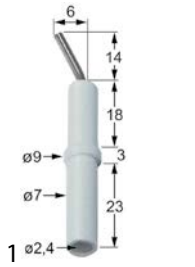

<b>GEV No.</b>	100707	<b>Ref. No.</b>	P641
<b>description</b>	ignition electrode D1 ø 7mm D2 ø 9mm connection ø 2.4mm L1 14mm L2 6mm BL1 18mm BL2 3mm BL3 23mm to clip Qty 1 pcs		

**thermocouples**

**plug-in thermocouples**

**plug-in thermocouples standard**

with barrel socket ø5mm - type Junkers with aluminised tip



<b>GEV No.</b>	102251	<b>Ref. No.</b>	P73 800/B
<b>description</b>	thermocouple M9x1 L 750mm plug connection ø 5.0mm		

with barrel socket ø6(6.5)mm

**thermocouples SIT**

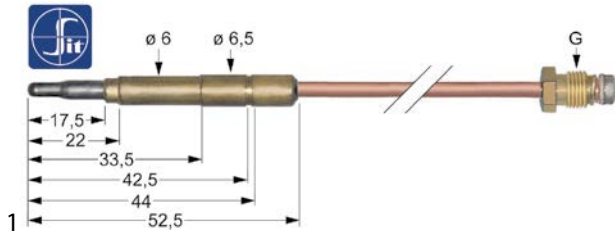

<b>GEV No.</b>	107614	<b>Ref. No.</b>	P73B
<b>description</b>	thermocouple SIT M9x1 L 1500mm plug connection ø 6.0(6.5)mm		

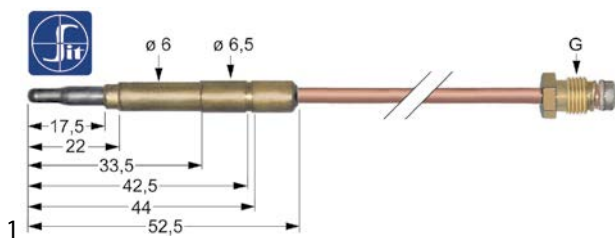

<b>GEV No.</b>	107606	<b>Ref. No.</b>	P73D
<b>description</b>	thermocouple SIT M9x1 L 320mm plug connection ø 6.0(6.5)mm		

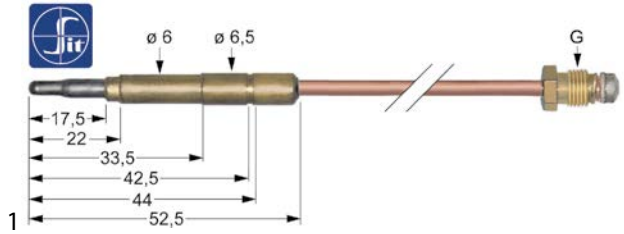

<b>GEV No.</b>	107608	<b>Ref. No.</b>	P73
<b>description</b>	thermocouple SIT M9x1 L 500mm plug connection ø 6.0(6.5)mm		

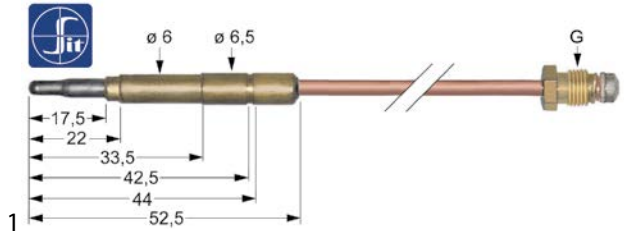

<b>GEV No.</b>	107611	<b>Ref. No.</b>	P73C
<b>description</b>	thermocouple SIT M9x1 L 850mm plug connection ø 6.0(6.5)mm		

**gas burners**

**hob burners**

**producer-specific hob burners**

**SOLYMAC**

**854 series**



<b>GEV No.</b>	107107	<b>Ref. No.</b>	P957
<b>description</b>	burner type 854 ø 80mm L 120mm complete		



<b>spare parts for</b>	107107			
	<b>GEV No.</b>	108004	<b>Ref. No.</b>	N/A
<b>description</b>				
burner cap ø 78mm 5kW mounting ø 72mm				





<b>GEV No.</b>	108004	<b>Ref. No.</b>	N/A
<b>description</b>	burner cap ø 78mm 5kW mounting ø 72mm		

<b>accessories for</b>	108004			
	<b>GEV No.</b>	108003	<b>Ref. No.</b>	N/A
<b>description</b>				
burner head for burner cap ø 78mm seat ø 35mm ID ø 30mm ED ø 83mm				





 <p>1</p>				
<b>GEV No.</b>	108003	<b>Ref. No.</b>	N/A	
<b>description</b>	burner head for burner cap ø 78mm seat ø 35mm ID ø 30mm ED ø 83mm			
<b>accessories for</b>	108003			
	<b>GEV No.</b>	108004	<b>Ref. No.</b>	N/A
	 <p>burner cap ø 78mm 5kW mounting ø 72mm</p>			



 <p>1</p>			
<b>GEV No.</b>	108078	<b>Ref. No.</b>	P2
<b>description</b>	burner cap ø 98mm mounting ø 97mm		

 <p>1</p>			
<b>GEV No.</b>	108014	<b>Ref. No.</b>	N/A
<b>description</b>	burner head ø 100mm seat ø 97mm		

861 series

 <p>1</p>			
<b>GEV No.</b>	107009	<b>Ref. No.</b>	N/A
<b>description</b>	burner type 861 ø 80mm L 185mm complete		

 <p>1</p>				
<b>GEV No.</b>	108010	<b>Ref. No.</b>	P1	
<b>description</b>	burner cap ø 78mm			
<b>accessories for</b>	108010			
	<b>GEV No.</b>	108003	<b>Ref. No.</b>	N/A
	 <p>burner head for burner cap ø 78mm seat ø 35mm ID ø 30mm ED ø 83mm</p>			

 <p>1</p>				
<b>GEV No.</b>	108003	<b>Ref. No.</b>	N/A	
<b>description</b>	burner head for burner cap ø 78mm seat ø 35mm ID ø 30mm ED ø 83mm			
<b>accessories for</b>	108003			
	<b>GEV No.</b>	108004	<b>Ref. No.</b>	N/A
	 <p>burner cap ø 78mm 5kW mounting ø 72mm</p>			

862 series

 <p>1</p>			
<b>GEV No.</b>	107119	<b>Ref. No.</b>	N/A
<b>description</b>	burner type 862 ø 100mm L 185mm complete		

<p>pan supports</p>  <p>1</p>			
<b>GEV No.</b>	210025	<b>Ref. No.</b>	P161
<b>description</b>	pan support W 320mm L 320mm		

 <p>1</p>			
<b>GEV No.</b>	210033	<b>Ref. No.</b>	P161832
<b>description</b>	pan support W 320mm L 320mm		

<p>accessories</p> <p>pan supports</p>  <p>1</p>			
<b>GEV No.</b>	210025	<b>Ref. No.</b>	P161
<b>description</b>	pan support W 320mm L 320mm		

 <p>1</p>			
<b>GEV No.</b>	210033	<b>Ref. No.</b>	P161832
<b>description</b>	pan support W 320mm L 320mm		



## bar burners

### bar burners



<b>GEV No.</b>	104469	<b>Ref. No.</b>	P22
<b>description</b>	bar burner 3 row L 435mm W 250mm ømm H 64mm chargrill		



<b>GEV No.</b>	104473	<b>Ref. No.</b>	P13
<b>description</b>	bar burner 3 row L 485mm W 200mm ømm H 150mm grill		



<b>GEV No.</b>	104471	<b>Ref. No.</b>	P14
<b>description</b>	bar burner 3 row L 580mm W 250mm ømm H 63mm chargrill		



<b>GEV No.</b>	104474	<b>Ref. No.</b>	P11
<b>description</b>	bar burner 4 row L 430mm W 370mm ømm H 190mm grill		



<b>GEV No.</b>	104472	<b>Ref. No.</b>	P10
<b>description</b>	bar burner 4 row L 525mm W 280mm ømm H 124mm griddle		

## gas nozzles

### main nozzles

#### gas nozzles 3/8"



<b>GEV No.</b>	106530	<b>Ref. No.</b>	P75D09
<b>description</b>	gas injector thread 3/8" WS 17 bore ø 0.95mm		



<b>GEV No.</b>	106534	<b>Ref. No.</b>	P75D120
<b>description</b>	gas injector thread 3/8" WS 17 bore ø 1.2mm		



<b>GEV No.</b>	106535	<b>Ref. No.</b>	P75D130
<b>description</b>	gas injector thread 3/8" WS 17 bore ø 1.3mm		



<b>GEV No.</b>	106537	<b>Ref. No.</b>	P75D150
<b>description</b>	gas injector thread 3/8" WS 17 bore ø 1.5mm		



<b>GEV No.</b>	106540	<b>Ref. No.</b>	P75D180
<b>description</b>	gas injector thread 3/8" WS 17 bore ø 1.8mm		



<b>GEV No.</b>	106531	<b>Ref. No.</b>	P75D100
<b>description</b>	gas injector thread 3/8" WS 17 bore ø 1mm		



<b>GEV No.</b>	106543	<b>Ref. No.</b>	P75D210
<b>description</b>	gas injector thread 3/8" WS 17 bore ø 2.1mm		



<b>GEV No.</b>	106544	<b>Ref. No.</b>	P75D220
<b>description</b>	gas injector thread 3/8" WS 17 bore ø 2.2mm		





<b>GEV No.</b>	106545	<b>Ref. No.</b>	P75D230
<b>description</b>	gas injector thread 3/8" WS 17 bore ø 2.3mm		



<b>GEV No.</b>	106547	<b>Ref. No.</b>	P75D250
<b>description</b>	gas injector thread 3/8" WS 17 bore ø 2.5mm		



<b>GEV No.</b>	106542	<b>Ref. No.</b>	P75D200
<b>description</b>	gas injector thread 3/8" WS 17 bore ø 2mm		

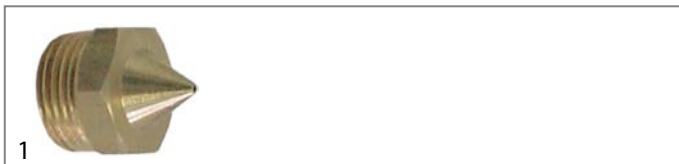

<b>GEV No.</b>	106556	<b>Ref. No.</b>	P75D330
<b>description</b>	gas injector thread 3/8" WS 17 bore ø 3.3mm		



<b>GEV No.</b>	106553	<b>Ref. No.</b>	P75D300
<b>description</b>	gas injector thread 3/8" WS 17 bore ø 3mm		

### pilot burner nozzles

#### pilot burner nozzles AEM



<b>GEV No.</b>	106385	<b>Ref. No.</b>	P1171C
<b>description</b>	pilot burner nozzle LPG code 22 bore ø 0.22mm thread M5x0.75 Qty 1 pcs brass		

### pilot burner nozzles SIT

#### 100 series

<b>GEV No.</b>	100245	<b>Ref. No.</b>	P75C
<b>description</b>	pilot burner nozzle LPG code 20 bore ø 0.2mm Qty 1 pcs thread M8x0.75		

<b>GEV No.</b>	100246	<b>Ref. No.</b>	INJ3006 P75B
<b>description</b>	pilot burner nozzle natural gas bore ø 0.35mm Qty 1 pcs thread M8x0.75		

### pilot burner nozzles (other)

#### SOLYMAC/CAPIC

<b>GEV No.</b>	106385	<b>Ref. No.</b>	P1171C
<b>description</b>	pilot burner nozzle LPG code 22 bore ø 0.22mm thread M5x0.75 Qty 1 pcs brass		

<b>GEV No.</b>	106386	<b>Ref. No.</b>	P1171B
<b>description</b>	pilot burner nozzle natural gas code 40 bore ø 0.4mm thread M5x0.75 Qty 1 pcs brass		

## auxiliary gas parts

### gas ball valves

#### miscellaneous

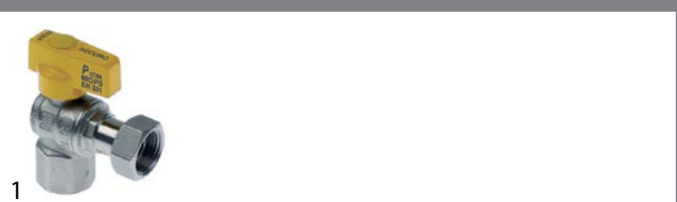

<b>GEV No.</b>	520586	<b>Ref. No.</b>	P1004
<b>description</b>	ball valve IT 1/2" L 55mm with safety handle angled W 28mm H 73mm handle ø 23mm wing handle EN 331		

## equipment-specific units

## for espresso machines

## aerators and air bleeders



1

<b>GEV No.</b>	529303	<b>Ref. No.</b>	P67E
----------------	--------	-----------------	------

<b>description</b>	aerator and air bleeder connection 1/4" only steam		
--------------------	--	--	--

<b>spare parts for</b>	529303		
------------------------	--------	--	--



<b>GEV No.</b>	528687	<b>Ref. No.</b>	—
----------------	--------	-----------------	---

<b>description</b>	O-ring Viton thickness 1.78mm ID ø 3.69mm Qty 1 pcs		
--------------------	---	--	--

## for convection ovens/combi-steamers

## spare parts and accessories



1

<b>GEV No.</b>	541859	<b>Ref. No.</b>	NU34
----------------	--------	-----------------	------

<b>description</b>	bush ID ø 14.5mm ext. ø 18/22 thickness 5.5mm		
--------------------	---	--	--

## knobs

## universal knobs



1

<b>GEV No.</b>	110075	<b>Ref. No.</b>	P82A
----------------	--------	-----------------	------

<b>description</b>	knob energy regulator 1-3 t.max.°C ø 50mm shaft ø 6x4.6mm shaft flat upper black		
--------------------	--	--	--

<b>accessories for</b>	110075		
------------------------	--------	--	--



<b>GEV No.</b>	110135	<b>Ref. No.</b>	—
----------------	--------	-----------------	---

<b>description</b>	rosette knob up to ø 52mm		
--------------------	---------------------------	--	--

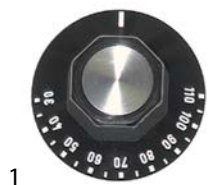

1

<b>GEV No.</b>	110119	<b>Ref. No.</b>	P76B
----------------	--------	-----------------	------

<b>description</b>	knob thermostat t.max. 110°C ø 50mm shaft ø 6x4.6mm shaft flat upper black temperature range 30-110°C rotation 270°		
--------------------	---	--	--

<b>accessories for</b>	110119		
------------------------	--------	--	--



<b>GEV No.</b>	110135	<b>Ref. No.</b>	—
----------------	--------	-----------------	---

<b>description</b>	rosette knob up to ø 52mm		
--------------------	---------------------------	--	--

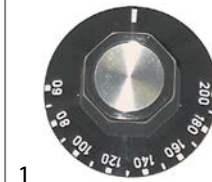

1

<b>GEV No.</b>	110121	<b>Ref. No.</b>	P80A
----------------	--------	-----------------	------

<b>description</b>	knob thermostat t.max. 200°C ø 50mm shaft ø 6x4.6mm shaft flat upper black temperature range 60-200°C rotation 270°		
--------------------	---	--	--

<b>accessories for</b>	110121		
------------------------	--------	--	--



<b>GEV No.</b>	110135	<b>Ref. No.</b>	—
----------------	--------	-----------------	---

<b>description</b>	rosette knob up to ø 52mm		
--------------------	---------------------------	--	--

## producer-specific knobs

## SOLYMAC



1

<b>GEV No.</b>	110075	<b>Ref. No.</b>	P82A
----------------	--------	-----------------	------

<b>description</b>	knob energy regulator 1-3 t.max.°C ø 50mm shaft ø 6x4.6mm shaft flat upper black		
--------------------	--	--	--

<b>accessories for</b>	110075		
------------------------	--------	--	--



<b>GEV No.</b>	110135	<b>Ref. No.</b>	—
----------------	--------	-----------------	---

<b>description</b>	rosette knob up to ø 52mm		
--------------------	---------------------------	--	--



1

<b>GEV No.</b>	112559	<b>Ref. No.</b>	P72B
----------------	--------	-----------------	------

<b>description</b>	knob switch zero mark t.max.°C temperature range°C ø 81mm shaft ø 10x8mm shaft flat lower black		
--------------------	---	--	--



1

<b>GEV No.</b>	110119	<b>Ref. No.</b>	P76B
----------------	--------	-----------------	------

<b>description</b>	knob thermostat t.max. 110°C ø 50mm shaft ø 6x4.6mm shaft flat upper black temperature range 30-110°C rotation 270°		
--------------------	---	--	--

<b>accessories for</b>	110119		
------------------------	--------	--	--



<b>GEV No.</b>	110135	<b>Ref. No.</b>	—
----------------	--------	-----------------	---

<b>description</b>	rosette knob up to ø 52mm		
--------------------	---------------------------	--	--

1			
<b>GEV No.</b>	110121	<b>Ref. No.</b>	P80A
<b>description</b>	knob thermostat t.max. 200°C ø 50mm shaft ø 6x4,6mm shaft flat upper black temperature range 60-200°C rotation 270°		
<b>accessories for</b>	110121		
		<b>GEV No.</b>	110135
		<b>Ref. No.</b>	—
	rosette knob up to ø 52mm		

## locks

### edgmount latches

#### handle latches

##### CAFF/FERMOD

1			
<b>GEV No.</b>	700060	<b>Ref. No.</b>	FS13
<b>description</b>	handle latch L 150mm mounting distance 133mm non lockable heated units G 791		
<b>accessories for</b>	700060		
		<b>GEV No.</b>	700061
		<b>Ref. No.</b>	—
	door catch L 58mm W 20mm H 35mm mounting distance 42mm chrome-plated brass for headed units		
		<b>GEV No.</b>	700062
		<b>Ref. No.</b>	—
	handle protection heated units		

## hinges

### edgmount hinges

#### CAFF/FERMOD

1			
<b>GEV No.</b>	700562	<b>Ref. No.</b>	FS14
<b>description</b>	edgmount hinge L 140mm W 31/24mm mounting distance 30/35mm hinging left/right without lift L1 37mm L2 36mm L3 45.5mm series G 361		
1			
<b>GEV No.</b>	700564	<b>Ref. No.</b>	FS14A
<b>description</b>	edgmount hinge L 96mm W 15mm mounting distance 64/32mm hinging left/right without lift series G 401		
1			
<b>GEV No.</b>	692669	<b>Ref. No.</b>	FS14A
<b>description</b>	edgmount hinge L 96mm W 15/17mm mounting distance 64/32mm hinging left/right without lift centre of rotation 14/23mm		



mechanical components, equipment accessories

## oven hinges

<b>GEV No.</b>	690037	<b>Ref. No.</b>	P1157
<b>description</b>	oven hinge mounting distance 205mm mounting distance 2mm lug mountingmm lever length 119mm groove distance 13mm spring thickness 4.3mm mounting ear position spring length 103mm L 214mm		

<b>accessories for</b>	540276		
	<b>GEV No.</b>	514251	<b>Ref. No.</b> —
	gasket fibre ED ø 46mm ID ø 38mm thickness 2mm Qty 1 pcs		

## shelves and shelf rails

### chargrill grids

<b>GEV No.</b>	210038	<b>Ref. No.</b>	P164
<b>description</b>	chargrill grid L 333mm W 317mm H 50mm cast iron		

## fittings for catering equipment

### drain taps

#### brass

#### drain taps

<b>GEV No.</b>	548001	<b>Ref. No.</b>	P61
<b>description</b>	drain tap 1 1/2" IT O-ring seal kettle connection with union nut A 80mm B1 68mm B2 132mm		
<b>spare parts for</b>	548001		
	<b>GEV No.</b>	505092	<b>Ref. No.</b> —
	O-ring EPDM thickness 5.34mm ID ø 43.82mm Qty 1 pcs		
	<b>GEV No.</b>	540213	<b>Ref. No.</b> —
	handle ID ø 5mm L 117mm		

## gaskets

### gaskets for heated units

#### window seals

<b>GEV No.</b>	900782	<b>Ref. No.</b>	MCGV0002
<b>description</b>	window gasket profile 1889 Qty supplied by meter		

#### door seals

<b>GEV No.</b>	901507 <sup>1</sup>	<b>Ref. No.</b>	FS12
<b>description</b>	door seal profile 2290 W 641mm L 782mm external size Qty 1 suitable for BOURGEOIS 3-sided (short side open)		

<sup>1</sup>3-sided (short side open)

<b>GEV No.</b>	901169	<b>Ref. No.</b>	MCGP0002
<b>description</b>	door seal profile 2948 Qty supplied by meter		

<b>GEV No.</b>	540276	<b>Ref. No.</b>	P61
<b>description</b>	drain tap connection with union nut thread 1 1/2"		
<b>spare parts for</b>	540276		
	<b>GEV No.</b>	532374	<b>Ref. No.</b> —
	O-ring silicone thickness 5.34mm ID ø 43.82mm Qty 10 pcs		

## sealing cords

### round

1



<b>GEV No.</b>	693737	<b>Ref. No.</b>	P95 P95A
<b>description</b>	sealing cord round ø 25mm braided L 5m Qty 1		

## springs

### torsion springs

1



<b>GEV No.</b>	514505	<b>Ref. No.</b>	P93G
<b>description</b>	torsion spring ø 30mm wire gauge ø 4.5mm L1 14mm L2 180mm L3 14mm mounting pos. left Qty 1 pcs		

1



<b>GEV No.</b>	514504	<b>Ref. No.</b>	P93D
<b>description</b>	torsion spring ø 30mm wire gauge ø 4.5mm L1 16mm L2 185mm L3 13mm mounting pos. right		

## dosing pumps





### membrane dosing pumps

#### self-priming with supporting pressure

#### OMNIWASH

1



<b>GEV No.</b>	361054	<b>Ref. No.</b>	P70C	
<b>description</b>	dosing pump rinse aid pressure connection ø 6mm suction connection ø 6mm auxiliary pressure connection 10mm			
<b>spare parts for</b>	361054			
	<b>GEV No.</b>	361308	<b>Ref. No.</b>	—
	membrane rinse aid pressure connection ømm suction connection ømm auxiliary pressure connectionmm			
	<b>GEV No.</b>	361348	<b>Ref. No.</b>	—
	lip valve rinse aid pressure connection ømm suction connection ømm auxiliary pressure connectionmm			
<b>accessories for</b>	361054			
	<b>GEV No.</b>	520252	<b>Ref. No.</b>	—
	nylon hose ID ø 6mm ED ø 8mm L 5m thickness 1mm operating p. 10bar burst p. 50bar t.max. 100°C white			
	<b>GEV No.</b>	520278	<b>Ref. No.</b>	—
	PVC hose ID ø 6mm ED ø 8mm L 2m thickness 1mm t.max. 60°C transparent			



<b>B</b>		
bar burners	24	
<b>C</b>		
cam switches	7	
ceramic heaters	4	
condensators & interference suppression filters	11	
control equipment	8	
control thermostats	6	
<b>D</b>		
door seals	28	
dosing pumps	29	
<b>E</b>		
edgemount hinges	27	
edgemount latches	27	
electronic controllers	9	
energy regulators	5	
<b>F</b>		
fans	11	
<b>G</b>		
gas ball valves	25	
gas burners	22	
gas control valves	18	
gas nozzles	24	
gas taps	11	
gas thermostats	15	
gaskets for heated units	28	
<b>H</b>		
handle latches	27	
heating elements	3	
heating elements for bain maries	3	
heating elements for fryers	3	
heating elements for griddles	3	
heating elements for pasta cookers	3	
heating elements for pizza ovens	3	
heating elements for salamanders/toasters	4	
hob burners	22	
hot air fans	11	
hot plates	5	
<b>I</b>		
immersion heating elements	4	
indicator lights	8	
<b>L</b>		
lamps	8	
light bulbs	9	
<b>N</b>		
neon light bulbs	8,9	
<b>O</b>		
operating capacitors	11	
oven hinges	28	
oven lamps	9	
<b>P</b>		
pilot burners	19	
probes	10	
<b>R</b>		
radiation heaters	5	
rocker/momentary rocker switches	7	
<b>S</b>		
safety thermostats	7	
sealing cords	29	
shelves and shelf rails	28	
solenoid valves	10	
switches and momentary switches	7	
<b>T</b>		
temperature probes	10	
thermocouples	22	
thermostats	6	
<b>U</b>		
universal probes	10	
<b>W</b>		
window seals	28	