



GAS COMPONENTS



ELECTRIC COMPONENTS



WATER TECHNOLOGY



MECHANICAL COMPONENTS



TOOLS

Spare parts suitable for

SIMAG

Find the complete and up-to-date range of products in our GEV Webshop



Manufacturer catalogue

The most important spare parts and accessories arranged clearly for every manufacturer

- ✓ Complete product range and all appliance data always up to date in the GEV Webshop
- ✓ Alphabetical Index at the end of the catalogue

GEV Webshop

www.gev-online.co.uk

www.gev-online.com



- 🔍 Add to Favourites
- 🔍 Sign In with email address and usual password
- 🔍 Easy-order – place several items in your basket at the same time
- 🔍 Quick Item search – no login needed



thermostats

control and safety thermostats

RANCO

safety thermostats

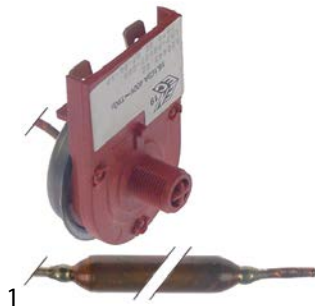

GEV No.	375832	Ref. No.	62044300 62044302
description	safety thermostat t.max. 70°C temperature range 0-70°C 1-pole 1NO 16A probe ø 8mm probe L 60mm capillary pipe 870mm capillary pipe isolatedmm gland nut shaft ømm shaft Lmm shaft position rotation° probe material copper switch-off temp. 70°C		
For models:	SD18, SD22, SD23, SD30, SDN25		

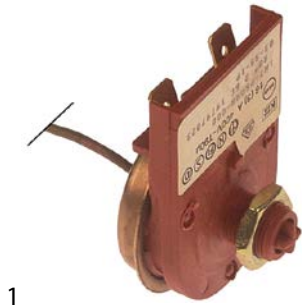

GEV No.	390583	Ref. No.	CM19797023
description	safety thermostat t.max. 80°C temperature range°C 1-pole 1NC 16A probe ø 9mm probe L 50mm capillary pipe 800mm capillary pipe isolatedmm gland nut shaft ømm shaft Lmm shaft position rotation° probe material copper with coiled probe screw connection M10x0.75 switch-off temp. 80°C		

refrigeration thermostats

universal with housing



GEV No.	390536	Ref. No.	Z1EL042
description	thermostat temperature range -35 up to +35°C probe ø6x110mm capillary pipe 1500mm PRODIGY at 400V 16A 1CO type TR/711-N		

DANFOSS

service thermostats DANFOSS

All Danfoss thermostats are supplied with fastening material application:

- 390552 - **fridges
- 390553 - **Refrigerators with defrosting push button
- 390554 - **/**Refrigerators with automatic defrosting
- 390555 - absorption refrigerators
- 390557 - Deep cooler with active signal
- 390558 - Freezing with passive signal
- 390559 - bottle cooler 390559



GEV No.	390559	Ref. No.	CM19797007 CM19797012
description	thermostat type 077B7008 capillary pipe 2000mm temperature range -8.5 up to +11.5°C probe ømm probe Lmm		

RANCO

K22 series



GEV No.	390201	Ref. No.	Z1EL012
description	thermostat RANCO type K22L2021 probe ømm probe Lmm capillary pipe 2500mm temperature range -16°C		



GEV No.	390207	Ref. No.	1EL011 62026414 Z1EL011
description	thermostat RANCO type K22L2030 probe ø 2mm probe Lmm capillary pipe 2000mm temperature range -13 up to -4°C		
For models:	SD22, SD23, SD40		



GEV No. 390646 **Ref. No.** 620263.03

description thermostat RANCO type K22-L1075 capillary pipe 2900mm probe ø9.5x107mm



GEV No. 390209 **Ref. No.** 62020100

description thermostat RANCO type K22L1020 probe ø 9mm probe L 40mm capillary pipe 2000mm temperature range -20.5 up to -1.5°C

For models: SD22, SD23, SD30, SDN25



GEV No. 390737 **Ref. No.** 620201.01

description thermostat RANCO type K22-L1074 probe ø 9mm probe L 42mm capillary pipe 1450mm temperature range -19 up to -1°C



GEV No. 390277 **Ref. No.** 630038.00

description thermostat RANCO type K22L3020 probe ø 9mm probe L 40mm capillary pipe 1600mm temperature range -26.5 up to -19.5°C



GEV No. 390279 **Ref. No.** 62012900

description thermostat RANCO type K22L3022 probe ø 9mm probe L 35mm capillary pipe 1600mm

K50 series



GEV No. 390254 **Ref. No.** 620209.00

description thermostat RANCO type K50P1135 probe ømm probe Lmm capillary pipe 2500mm T cold 1.5°C

For models: SD18, SD22, SD23, SD30



GEV No. 390581 **Ref. No.** CM19797026

description thermostat RANCO type K50-S3595 probe ø 2mm probe Lmm capillary pipe 2000mm

K55 series



GEV No. 390210 **Ref. No.** 62026302 Z1EL010

description thermostat RANCO type K55L1042 capillary pipe 1100mm temperature range +1.7 up to +9.5°C probe ø10x110mm

For models: SD23



GEV No. 390283 **Ref. No.** CM19797017

description thermostat RANCO type K55L5081 capillary pipe 1100mm temperature range°C probe ø10x110mm



RANCO



1

GEV No.	390284	Ref. No.	CM19797018
description	thermostat RANCO type K55L5082 capillary pipe 1500mm temperature range°C probe ø10x110mm		

RANCO



1

GEV No.	379516	Ref. No.	620264.02 62026415 62026416
description	thermostat RANCO type K61L1508 probe ø 2mm probe Lmm capillary pipe 1800mm		

K61 series

RANCO



1

GEV No.	390212	Ref. No.	620264.01 620264.10
description	thermostat RANCO type K61L1500 probe ømm probe Lmm capillary pipe 750mm T war -11.5°C T cold 22°C		

RANCO



1

GEV No.	390591	Ref. No.	62026415
description	thermostat RANCO type K61L1509 probe ø 2mm probe Lmm capillary pipe 2250mm		
For models:	SD18		

RANCO



1

GEV No.	390206	Ref. No.	620264.00
description	thermostat RANCO type K61L1501 probe ømm probe Lmm capillary pipe 1800mm		

switches and momentary switches

rocker/momentary rocker switches

30x11mm



1

GEV No.	301013	Ref. No.	62044201 62044202
description	rocker switch mounting measurements 30x11mm black 1CO 250V 16A connection male faston 6.3mm ambient temperature max. 85/125°C protection IP40		
For models:	SD18, SD22, SD23, SD30, SDN25		

RANCO



1

GEV No.	390586	Ref. No.	620264.11
description	thermostat RANCO type K61L1504 probe ø 2mm probe Lmm capillary pipe 1800mm T war 11.5°C T cold 22°C		

push/momentary push switches

19x13mm



1

GEV No.	347079 ¹	Ref. No.	620487.00
description	push switch mounting measurements 19x13mm green 2NO 250V 16A illuminated connection male faston 6.3mm ambient temperature max. 125°C protection IP65 with cover cap		

¹illuminated



toggle switches

M12x0.75



GEV No.	346526	Ref. No.	1200042601 620033 01 62003302 Z1EL031
description	toggle switch thread M12x0.75 1CO 250V 15A ON-ON male faston 6.3mm		

microswitches

lever actuated



GEV No.	345345	Ref. No.	CM19410207 CM25474578
description	microswitch with lever 250V 16A 1CO connection male faston 6.3mm L 78mm ambient temperature max. 85°C mounting distance 22mm type X662-88-J27 actuating force: 40g lever length 69mm		



GEV No.	345361	Ref. No.	CM19410205
description	microswitch with lever 250V 5A 1NO/1NC connection soldering connection ambient temperature max. 85°C type 83109004 lever length 43mm		

roller-lever actuated

microswitches



GEV No.	345253	Ref. No.	CM19410209
description	microswitch with handle with a switch 250V 15A 1CO connection male faston 6.3mm L 28mm L1 37mm ambient temperature max. 125°C mounting distance 22mm type RL6-1-F-GE-P12-5-L actuating force: 80g grey lever length 28mm		

heavy duty version



GEV No.	346874	Ref. No.	CM19410300
description	microswitch with handle with a switch 250V 16A 1CO connection screw L 29mm L1 49mm ambient temperature max. 85°C mounting distance 26mm type Z-15GW22-B actuating force: 120g lever length 25mm		

with mounting components



GEV No.	346876	Ref. No.	CM19410208
description	microswitch with handle with a switch 250V 16A 1CO connection male faston L 35mm L1 28mm ambient temperature max. 125°C mounting distance 22mm type V-166-1CR5 actuating force: 86g		

float switches



GEV No.	345365	Ref. No.	CM81409179
description	float switch 250V 16A 1CO male faston 6.3mm L 150mm ambient temperature max. 125°C mounting distance 23mm type EF83161.5 actuating force: 5g black		



GEV No.	347088	Ref. No.	CM81449091
description	float switch with plunger 250V 16A 1CO male faston 6.3mm L 130mm ambient temperature max. 125°C mounting distance 23mm type EF83161.5 actuating force: 5g black		

floats



GEV No.	695036	Ref. No.	66058500 783127.00
description	float for ice maker ø 75mm L 115mm H 40mm plastic		
For models:	SP405, SPR80		

touch sensitive light switches

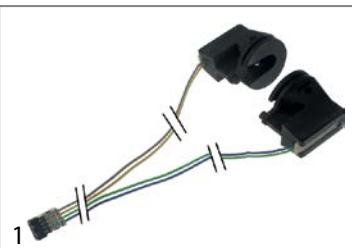

GEV No.	402039	Ref. No.	78508600 78508602R
description	light barrier		



1

GEV No.	402043	Ref. No.	650674.01 65067402 785086.00
description	light barrier L 180mm W 35mm H 46mm		
For models:	SP405, SPR80		



1

GEV No.	402009	Ref. No.	650674.00 650674.05 783167.01
description	light barrier L 310mm W 35mm H 47mm		

magnetic switches

36x13mm



1

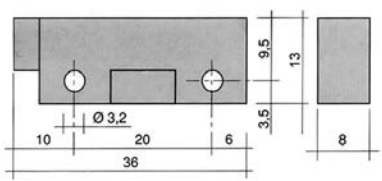

GEV No.	345118 ¹	Ref. No.	CM33210019
description	magnetic switch L 36mm W 13mm 1NO 250V 1A P max. 50W connection cable cable length 980mm		
accessories for	345118		
	GEV No.	345399	Ref. No. CM193550007 CM19355004
	magnet ø 3.3mm L 40mm H 8mm W 13mm hole distance 30mm M3		

¹with coded connector

accessories

magnets



1

GEV No.	347059	Ref. No.	CM19355007
description	magnet L 40mm H 8mm W 13.2mm hole distance 30mm		

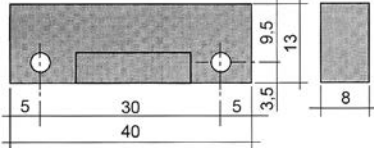
1

GEV No.	345399	Ref. No.	CM193550007 CM19355004
description	magnet ø 3.3mm L 40mm H 8mm W 13mm hole distance 30mm M3		

lamps

indicator lights

indicator lights (complete)

ø13mm

with plug-in socket



1

GEV No.	359141	Ref. No.	630091.11 630091.14
description	indicator light ø 13mm red 230V connection male faston 6.3mm temp.-resist. 120°C Qty 1 pcs		

timers

programme timers



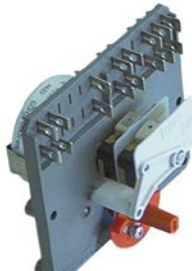

1

GEV No.	360163	Ref. No.	620244.02
description	timer FIBER P23 engines 1 chambers 1 operation time 15min 230V shaft L 30mm manuf. no. P235JR1J706 motor type M51BJ0R6400		
spare parts for	360163		
	GEV No.	360673	Ref. No. —
	motor kit pinion ø 6.8mm teeth 15 230V voltage AC 50/60Hz turn direction clockwise motor ø 48mm H 18.5mm motor type UDS-40NE1RNZ165 cable length 150mm with holder		





1

GEV No.	360162	Ref. No.	620244.09
description	timer FIBER P23 engines 1 chambers 2 operation time 12min 230V manuf. no. P235JR2J501 motor type M51BJ0R6400		
spare parts for	360162		
	GEV No.	360673	Ref. No. —
	motor kit pinion \varnothing 6.8mm teeth 15 230V voltage AC 50/60Hz turn direction clockwise motor \varnothing 48mm H 18.5mm motor type UDS-40NE1RNZ165 cable length 150mm with holder		



1

GEV No.	360051	Ref. No.	62043100
description	timer FIBER P36 engines 1 chambers 2 operation time 15min 230V shaft \varnothing mm shaft Lmm manuf. no. P365JR2J717 motor type M51B-J0R6400		
spare parts for	360051		
	GEV No.	360673	Ref. No. —
	motor kit pinion \varnothing 6.8mm teeth 15 230V voltage AC 50/60Hz turn direction clockwise motor \varnothing 48mm H 18.5mm motor type UDS-40NE1RNZ165 cable length 150mm with holder		



1

GEV No.	360371	Ref. No.	620441.02
description	timer FIBER P36 engines 1 chambers 2 operation time 8min 230V shaft \varnothing mm shaft Lmm manuf. no. P365JR2J236 motor type M51B-J0R6400		
For models:	SD30		
spare parts for	360371		
	GEV No.	360673	Ref. No. —
	motor kit pinion \varnothing 6.8mm teeth 15 230V voltage AC 50/60Hz turn direction clockwise motor \varnothing 48mm H 18.5mm motor type UDS-40NE1RNZ165 cable length 150mm with holder		

relays

power relays

with bracket mounting



1

GEV No.	380312	Ref. No.	62023702 CM19620107 Z1EL004
description	power relays FINDER 230VAC 10A 3CO connection male faston 4.8mm bracket mounting dimensions 52x32.2x36.5mm manuf. no. 60.63.8.230.0000		



1

GEV No.	380185	Ref. No.	CM19620103
description	power relays Italiana Relè 230VAC 30A 1NO connection F6.3 bracket mounting dimensions 36.5x32.2x51.8mm manuf. no. A10-230AC-FA		

time relays

time relays



1

GEV No.	360161	Ref. No.	Z1EL051
description	time relay FIBER R1655M607VO time range 0-6min 220VAC 6A/2A		



probes

producer-specific probes

probes



GEV No.	379628	Ref. No.	02003410.21
description	temperature probe 2x NTC 10K cable PVC probe -40 up to +110°C cable -10 up to 100°C connection coded plug thread probe ø6.5x45mm cable length 0.4/0.55m		



GEV No.	381337	Ref. No.	620519 01
description	temperature probe NTC 10kOhm cable PVC probe -40 up to +110°C cable -10 up to 100°C connection plug thread probe ø5x40mm cable length 1.5m		



GEV No.	402006	Ref. No.	620404.06 CM33580065
description	temperature probe PTC 2kOhm cable PVC probe -50 up to +150°C cable -10 up to 100°C connection plug thread probe ø5x60mm cable length 1.5m		



GEV No.	402007	Ref. No.	62040401
description	temperature probe PTC 2kOhm cable PVC probe -50 up to +150°C cable -10 up to 100°C connection plug thread probe ø5x60mm cable length 1.8m		



GEV No.	402008	Ref. No.	62040402
description	temperature probe PTC 2kOhm cable PVC probe -50 up to +150°C cable -10 up to 100°C connection plug thread probe ø6x50mm cable length 1.2m		



GEV No.	402191	Ref. No.	62040401 62040411 62040418
description	temperature probe PTC 2kOhm cable TPE probe -50 up to +150°C cable -40 up to +110°C connection plug thread probe ø5x20mm cable length 1.8m		
For models:	SP405, SPR80		



GEV No.	402005	Ref. No.	620404.00 62040410
description	temperature probe PTC 2kOhm cable TPE probe -50 up to +150°C cable -40 up to +110°C connection plug thread probe ø6x50mm cable length 1.6m		
For models:	SP405, SPR80		

Hall sensors



GEV No.	402044	Ref. No.	62040403
description	Hall sensor L 29mm W 26mm H 26mm mounting distance 10mm cable length 1250mm		
For models:	SP405, SPR80		

accessories

miscellaneous



GEV No.	402040	Ref. No.	62040404 62040413
description	cable for level electrode cable length 1800mm		
For models:	SP405, SPR80		

electronics

housing for PCBs



GEV No.	695663	Ref. No.	660546.00 CM29070021
description	housing PCB L 230mm W 142mm H 57mm		
For models:	SP405		



GEV No.	694206	Ref. No.	660547.00 660547.01 660547.02 CM19190403
description	lid PCB L 180mm W 110mm H 9mm		
For models:	SP405		
accessories for	694206		

GEV No.	694205	Ref. No.	—
description	housing PCB L 180mm W 110mm H 40mm		



1

GEV No.	694796	Ref. No.	CM29015057
description	lid PCB L 205mm W 125mm H 14mm plastic		

PCBs

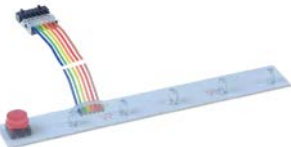

1

GEV No.	401805	Ref. No.	CM33580151
description	display PCB ice maker N201/N301//N501 L 170mm W 25mm		

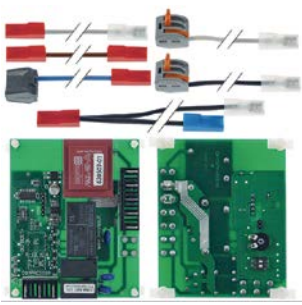

1

GEV No.	403687	Ref. No.	06076900 62044100
description	electronic timer for ice maker Simag mounting measurements 90x70mm 230		
For models:	SD22, SD23, SD30, SDN25		



1

GEV No.	403486	Ref. No.	62050700
description	electronic timer L 73mm W 73mm suitable for Simag H 30mm timer		

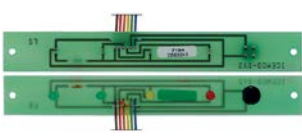

1

GEV No.	401801	Ref. No.	CM33580024
description	keypad PCB ice maker N200/N300/N500		



1

GEV No.	403499	Ref. No.	CM33580173
description	PCB 230V L 90mm W 60mm for ice maker		



1

GEV No.	402137	Ref. No.	02003707.21 11000539.21 11000539.51
description	PCB for float switch		



1

GEV No.	402003	Ref. No.	620403.05 620403.16 620403.17
description	PCB ice maker AC045/055		



1

GEV No.	403478	Ref. No.	620507-01
description	PCB ice maker L 90mm W 72mm suitable for Simag H 30mm		







1

GEV No.	401799	Ref. No.	CM33580150	
description	PCB ice maker N201/N301//N501 230V			
accessories for	401799			
	GEV No.	701450	Ref. No.	—
	connection cable L 1300mm 2-pole level sensor suitable for ice maker connection plug plug type coded plug			



			
1			
GEV No.	403881	Ref. No.	620462 11 620462 20
description	PCB L 200mm W 135mm		

central units

				
1				
GEV No.	402004	Ref. No.	06711.10 620403.09 62040303 620456.02 620462.02	
description	control box			
For models:	SP405, SPR80			
accessories for	402004			
	GEV No.	402005	Ref. No.	620404.00 62040410
	temperature probe PTC 2kOhm cable TPE probe -50 up to +150°C cable -40 up to +110°C connection plug thread probe ø6x50mm cable length 1.6m			
	GEV No.	402044	Ref. No.	62040403
	Hall sensor L 29mm W 26mm H 26mm mounting distance 10mm cable length 1250mm			
	GEV No.	402191	Ref. No.	62040401 62040411 62040418
	temperature probe PTC 2kOhm cable TPE probe -50 up to +150°C cable -40 up to +110°C connection plug thread probe ø5x20mm cable length 1.8m			

			
1			
GEV No.	401841	Ref. No.	0A037703.21 12002543.21 12002543.24 12002838.21 12002838.22 12002838.23 12002838.24 17002389.01
description	control box for ice-cube maker 24V 50-60Hz		

			
1			
GEV No.	403836	Ref. No.	81414543/0 CM81414543/0
description	control box ice maker suitable for ICEMATIC/SCOTSMAN/SIMAG		

			
1			
GEV No.	403837	Ref. No.	81400264/0 CM81400264/0
description	control box ice maker suitable for ICEMATIC/SCOTSMAN/SIMAG		

			
1			
GEV No.	402042	Ref. No.	001028.09 001028.09R 028640.98 060711.00 620403.01 620403.18 620403.20 620456.00 620462.00 620462.06
description	control box suitable for SFT 012		

			
1			
GEV No.	401832	Ref. No.	060711.30 785104.02R
description	control box with housing for ice-cube maker 230V		



solenoid valves

solenoid valves (water)

ELBI



1

GEV No.	370431	Ref. No.	CM19865518
description	solenoid valve single straight 230VAC inlet 3/4" outlet 11.5mm input/min output 2l/min DN10 t.max. 90°C ELBI plastic		



1

GEV No.	370414	Ref. No.	650105.54 CM19865502 Z11D003
description	solenoid valve single straight 230VAC inlet 3/4" outlet 11.5mm output 2l/min 50/60Hz t.max. 90°C ELBI plastic flow regulating valve outlet white		



1

GEV No.	370459	Ref. No.	Z11D003
description	solenoid valve single straight 230VAC inlet 3/4" outlet 11.5mm output 2l/min DN10 t.max. 90°C ELBI plastic flow regulating valve outlet white		



1

GEV No.	370421	Ref. No.	Z1CW030
description	solenoid valve double straight 230VAC inlet 3/4" outlet 11.5mm input 5.5l/min output 1/-l/min DN10 t.max. 90°C ELBI plastic flow regulating valve inlet yellow output A 2l/min flow regulating valve outlet A white		
For models:	SD23		



1

GEV No.	370461	Ref. No.	CM19865509
description	solenoid valve double straight 230VAC inlet 3/4" outlet 11.5mm input/min output -/4,7l/min DN10 t.max. 90°C ELBI plastic output B 4.7l/min flow regulating valve outlet B grey output A w/t membrane (constantly open)		



1

GEV No.	370433	Ref. No.	650105.62 650105.70 65010551
description	solenoid valve double straight 230VAC inlet 3/4" outlet 11.5mm input/min output 2/2.5l/min DN10 t.max. 90°C ELBI plastic output A 2l/min output B 2.5l/min flow regulating valve outlet A white flow regulating valve outlet B orange		
For models:	SD18, SD22, SD23, SD30, SDN25		

spare parts and accessories

reducers

outlet side



1

GEV No.	371261	Ref. No.	650105.20
description	reducer ELBI type EATON (INVENSYS) flow rate 1.2l/min pressure range 0 up to 10bar tolerance ±15/25% clear		
For models:	SD23, SD30		





1

GEV No.	371061	Ref. No.	640022.02
description	reducer ELBI type EATON (INVENSYS) flow rate 1.4l/min ø 7.2mm pressure range 0 up to 10bar tolerance ±15/25% clear		





			
1			
GEV No.	371262	Ref. No.	650105.21
description	reducer ELBI type EATON (INVENSYS) flow rate 2.5l/min pressure range 0 up to 10bar tolerance ±15/25% orange		
For models:	SD23, SD30		

			
1			
GEV No.	371263	Ref. No.	650105.22
description	reducer ELBI type EATON (INVENSYS) flow rate 4.7l/min pressure range 0 up to 10bar tolerance ±15/25% grey		

			
1			
GEV No.	371295	Ref. No.	640022.01
description	reducer flow rate 0.8l/min ø 7.2mm pressure range 0 up to 10bar tolerance ±15/25% black		

			
1			
GEV No.	371062	Ref. No.	640022.00
description	reducer flow rate 1.8l/min		

			
1			
GEV No.	371063	Ref. No.	640022.03 640022.04
description	reducer flow rate 2.5l/min ø 7.2mm pressure range 0 up to 10bar tolerance ±15/25% clear		

			
1			
GEV No.	371057	Ref. No.	650105.23
description	reducer type EATON (INVENSYS) flow rate 2l/min pressure range 0 up to 10bar tolerance ±15/25% white		

ROBERTSHAW/INVENSYS

medium temperature: 90°C 90°C 60°C
ambient temperature: 60°C 25°C 60°C
duty cycle: 40% 100% 100%

various

			
1			
GEV No.	371259	Ref. No.	198655.98 640406.01 CM19865532
description	solenoid valve single angled 230VAC inlet 11.5 outlet 11.5mm DN7 plastic		

RPE

special outlet

			
1			
GEV No.	370453	Ref. No.	060564.00 620460.00 620460.01 CM19865598
description	solenoid valve single angled 230VAC inlet 11.5mm outlet 11.5mm RPE		

TP



			
1			
GEV No.	370015	Ref. No.	620213.00
description	solenoid valve single angled 230VAC inlet 3/4" outlet 11.5mm DN10 TP		
accessories for	370015		
	GEV No.	371220	Ref. No. —
	reducer TP flow rate 3l/min red tolerance ±15%		

Table continues overleaf



accessories for		370015		
	GEV No.	371221	Ref. No.	—
reducer TP flow rate 5.5l/min yellow tolerance ±15%				
	GEV No.	371222	Ref. No.	—
reducer TP flow rate 6l/min grey tolerance ±15%				
	GEV No.	371223	Ref. No.	—
reducer TP flow rate 10l/min white tolerance ±15%				
	GEV No.	371224	Ref. No.	—
reducer TP flow rate 12l/min bronze tolerance ±15%				
	GEV No.	371225	Ref. No.	—
reducer TP flow rate 16l/min light brown tolerance ±15%				
	GEV No.	371226	Ref. No.	—
reducer TP flow rate 20l/min red tolerance ±15%				
	GEV No.	371230	Ref. No.	—
reducer TP flow rate 0.25l/min red tolerance ±25%				
	GEV No.	371231	Ref. No.	—
reducer TP flow rate 0.35l/min violet tolerance ±25%				
	GEV No.	371232	Ref. No.	—
reducer TP flow rate 0.5l/min orange tolerance ±25%				
	GEV No.	371233	Ref. No.	—
reducer TP flow rate 0.8l/min white tolerance ±25%				
	GEV No.	371234	Ref. No.	—
reducer TP flow rate 1l/min light blue tolerance ±25%				
	GEV No.	371235	Ref. No.	—
reducer TP flow rate 1.2l/min brown tolerance ±25%				
	GEV No.	371236	Ref. No.	—
reducer TP flow rate 1.5l/min light brown tolerance ±25%				
	GEV No.	371237	Ref. No.	—
reducer TP flow rate 2.5l/min yellow tolerance ±25%				
	GEV No.	371238	Ref. No.	—
reducer TP flow rate 3.4l/min dark green tolerance ±25%				
	GEV No.	371239	Ref. No.	—
reducer TP flow rate 5l/min black tolerance ±25%				
	GEV No.	371240	Ref. No.	—
reducer TP flow rate 8l/min blue tolerance ±20%				

solenoid valves with reducers



GEV No.	370452	Ref. No.	481928128177 481928128226
description	solenoid valve double angled 230VAC inlet 3/4" input 5.5l/min t.max. 90°C TP plastic flow regulating valve inlet yellow outlet 11.5mm output A 1.5l/min output B 1.5l/min flow regulating valve outlet A light brown flow regulating valve outlet B light brown		



GEV No.	370416	Ref. No.	CM19865530
description	solenoid valve double straight 230VAC inlet 3/4" input/min output 1.2/1.2l/min DN10 t.max. 90°C TP plastic outlet 11.5mm output A 1.2l/min output B 1.2l/min flow regulating valve outlet A dark brown flow regulating valve outlet B dark brown		







GEV No.	370422	Ref. No.	65010570
description	solenoid valve double straight 230VAC inlet 3/4" t.max. 90°C TP plastic outlet 11.5mm output A 2.5l/min flow regulating valve outlet A yellow flow regulating valve outlet B brown		

various





GEV No.	370496	Ref. No.	CM19865525
description	solenoid valve straight 220VAC outlet 14mm plastic inlet 14mm		

metal			
PARKER			
spare parts and accessories			
solenoid coils			
			
1			
GEV No.	371098	Ref. No.	62030628 62030648 63030628.01
description	solenoid coil 220-230VAC 50/60Hz seat ø 14mm cable length 1000mm 14W		
For models:	SD18, SD22, SD23, SD30, SDN25		

accessories for	370382			
	GEV No.	371090	Ref. No.	—
	power socket plug type DIN 43650A screw			
	GEV No.	371301	Ref. No.	—
	solenoid coil CASTEL 110VAC 8VA 50/60Hz seat ø 11.5mm connection DIN 43650A type HF2			
	GEV No.	371314	Ref. No.	—
	solenoid coil CASTEL 240VAC 8VA 50/60Hz seat ø 11.5mm			
	GEV No.	371321	Ref. No.	—
	solenoid coil CASTEL 12/24VAC 50/60Hz seat ø 11.5mm connection DIN 43650A type HF2			



drain valves

			
1			
GEV No.	371106	Ref. No.	11000514.30 1100514.01
description	drain solenoid valve 208/230V single inlet 17.5mm outlet 16mm EATON (INVENSYS) plastic		



			
1			
GEV No.	370691	Ref. No.	CM81454760
description	solenoid valve angled 220-240V kit inlet 17.5mm outlet 16mm		

solenoid valves (refrigeration)



CASTEL
valve bodies
STANDARD series
<i>suitable for refrigerants R22, R134a, R404A, R407C, R410A, R507</i>

				
1				
GEV No.	370382	Ref. No.	CM19863034	
description	solenoid valve body NC type 1028/M10S p max 45bar connection 10mm soldering connection DN 3mm -35 up to +105°C L 125mm refrigeration straight CASTEL			
accessories for	370382			
	GEV No.	371084	Ref. No.	—
	solenoid coil CASTEL 230VAC 8VA 50/60Hz connection cable 1000mm type CM2			

PARKER

valves				
				
1				
GEV No.	370415	Ref. No.	CM19863032 CM19863033	
description	solenoid valve straight 230V pressure range 0-10bar DN2.5 connection 4mm soldering connection PARKER refrigeration			
spare parts for	370415			
	GEV No.	371033	Ref. No.	—
	solenoid coil PARKER 230VAC 9VA coil type YB09 with cable seat ø 14mm			

valve bodies

				
1				
GEV No.	370536	Ref. No.	620306.07	
description	solenoid valve body p max 35bar connection 3/8" US PARKER for ice maker tube ø 10mm hot gas			
accessories for	370536			
	GEV No.	371098	Ref. No.	62030628 62030648 63030628.01
	solenoid coil 220-230VAC 50/60Hz seat ø 14mm cable length 1000mm 14W			

various

valves



GEV No.	370425	Ref. No.	Z1FR047
description	solenoid valve angled DN1.9 connection 6mm 230V		

valve bodies



GEV No.	370429	Ref. No.	62030627
description	solenoid valve body angled DN 2.5mm connection 6mm soldering connection refrigeration		
accessories for	370429		
	GEV No.	371098	Ref. No.
			62030628 62030648 63030628.01
	solenoid coil 220-230VAC 50/60Hz seat ø 14mm cable length 1000mm 14W		



GEV No.	370458	Ref. No.	62030614
description	solenoid valve body connection 6mm soldering connection refrigeration angled 90°		
For models:	SD22, SD23, SD30, SDN25		



GEV No.	370424	Ref. No.	62030622
description	solenoid valve body DN 1.9mm connection 6mm soldering connection refrigeration angled 90°		
For models:	SD23, SD30		



GEV No.	370454	Ref. No.	620306.46
description	solenoid valve body DN 3mm connection 6mm soldering connection refrigeration angled 90°		
accessories for	370454		
	GEV No.	371033	Ref. No.
			—
	solenoid coil PARKER 230VAC 9VA coil type YB09 with cable seat ø 14mm		

pressure switches

for refrigeration

SAGI NO MIYA



GEV No.	539002	Ref. No.	620075.02
description	pressure control switch pressure 16bar reset automatic type HTB-3UA12 connection 2.4mm		

JOHNSON CONTROLS



GEV No.	541116	Ref. No.	62007500 62007505 62049901 Z1EL005
description	pressure control HD switch pressure 10bar reset automatic switching diff. 1.1bar pressure range 7-29bar p max 38bar refrigeration type P20EA-9950C connection soldering connection 6.35mm CO JOHNSON CONTROLS pressure connection soldering connection 6.35mm		
For models:	SD18, SD22, SD23, SD30, SDN25		



GEV No.	541117	Ref. No.	620231.00 620231.01
description	pressure control HD switch pressure 24bar reset manual switching diff. 4.7bar pressure range 7-29bar p max 38bar refrigeration type P20GA-9950T connection male faston 6.3mm CO JOHNSON CONTROLS pressure connection soldering connection 6.35mm		



compressors

ACC/ZEL

R134A

HMBP monophase

High/Medium evaporation temperature above -20/-15 °C



GEV No.	605012	Ref. No.	670100.02 670105.07 CM19165497
description	compressor coolant R134a type GL45TB 220-240V 50Hz HMBP fully hermetic 8.4kg 1/6HP power input 342W cylinder capacity 4.5cm ³ CSIR H 175.5mmW 76W 101W 134W 175W 223W 278W 342W 413W test method ASHRAE ambient temperature max. 43°C		
For models:	SD18		

L'UNITE HERMETIQUE / TECUMSEH

R404A

LBP 3-phase

Lower evaporation temperature below -20°C



GEV No.	605187	Ref. No.	670099.15
description	compressor coolant R404A type TAJ2464Z 400V 50/60Hz LBP 22.5kg 1.5HP cylinder capacity 34.4cm ³ TRI H 282mm 1108W 1579W 1850W 2317W 2855WWWW test method EN 12900		

HMBP monophase

High/Medium evaporation temperature above -20/-15 °C



GEV No.	605065	Ref. No.	670099.05
description	compressor coolant R404A type CAJ4519Z 220-240V 50Hz HMBP 24kg 1.5HP cylinder capacity 34.4cm ³ CSR H 282mmWWW 1769W 2353W 3009W 3756W 4360W 5200W		
For models:	SP405		

fans

refrigeration fans





refrigeration motors universal

ELCO

N series - multi fit





GEV No.	601427	Ref. No.	62041902
description	fan motor ELCO 10W 230V 50/60Hz bearing slide bearing L1 49mm L2 59mm L3 86.5mm W 83mm connection cable 500mm 1300/1550rpm 5 mounting options VNT10-20/028		
For models:	SD18, SD22, SD23, SD30, SDN25, SPR80		

spare parts for	601427			
	GEV No.	560140	Ref. No.	—
	hexagonal nut thread M4 H 4.8mm SS WS 7 Qty 20 pcs DIN/ISO DIN 985 self-locking			
	GEV No.	560332	Ref. No.	—
	plain washer ID ø 4.3mm ED ø 9mm thickness 0.8mm SS Qty 1 pcs			
	GEV No.	560340	Ref. No.	—
	hexagonal nut thread M4 H 3.2mm WS 7 SS DIN/ISO DIN 934 / ISO 4032/8673 Qty 1 pcs			
	GEV No.	601413	Ref. No.	—
	fixing plate suitable for fanwheel ED ø 32mm shaft ø 7 mounting distance 26mm			

1

GEV No.	601430	Ref. No.	620419.00 CS1761101602
description	fan motor ELCO 5W 230V 50/60Hz bearing slide bearing L1 48mm L2 52mm L3 79.5mm W 83mm connection cable 500mm 1300/1550rpm 5 mounting options VNT5-13/027		
spare parts for	601430		
	GEV No.	560140	Ref. No. —
	hexagonal nut thread M4 H 4.8mm SS WS 7 Qty 20 pcs DIN/ISO DIN 985 self-locking		
	GEV No.	560332	Ref. No. —
	plain washer ID ø 4.3mm ED ø 9mm thickness 0.8mm SS Qty 1 pcs		
	GEV No.	560340	Ref. No. —
	hexagonal nut thread M4 H 3.2mm WS 7 SS DIN/ISO DIN 934 / ISO 4032/8673 Qty 1 pcs		
	GEV No.	601413	Ref. No. —
	fixing plate suitable for fanwheel ED ø 32mm shaft ø 7 mounting distance 26mm		

IMPORT
multi fit fan motors



1

GEV No.	601023	Ref. No.	620233.00 620419.04
description	fan motor 16W 230V 50-60Hz L1 45mm L2 61mm L3 92mm W 84mm cable length 500mm 1300rpm YZF16-25-18/26 5 mounting options bearing slide bearing		
For models:	SP405		

miscellaneous



1

GEV No.	601431	Ref. No.	60413.00 620300.06 620419.06 620419.07
description	fan motor 35W 230V		
For models:	SP405		



1

GEV No.	601524	Ref. No.	CM18562524
description	fan motor 35W 230V 50/60Hz L3 153mm W 83mm cable length 1600mm 1300rpm with capacitor capacitor 2.5µF		

accessories

fan wheels

aluminium

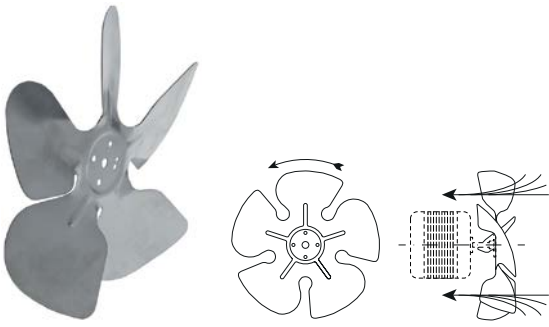

1

GEV No.	601070	Ref. No.	620007.05 620419.31
description	fan wheel sucking ø 200mm fan wheel mounting 25.4mm blade angle 28° W 38mm aluminium		

1

GEV No.	601282	Ref. No.	62041932
description	fan wheel sucking ø 200mm fan wheel mounting 25.4mm blade angle 34° W 44mm aluminium		
For models:	SD22, SD23, SD30, SDN25, SPR80		

1

GEV No.	601387	Ref. No.	620419.34
description	fan wheel sucking ø 254mm fan wheel mounting 25.4mm blade angle 34° W 50mm aluminium		
For models:	SP405		

1

GEV No.	601071	Ref. No.	62041931
description	fan wheel sucking ø 230mm fan wheel mounting 25.4mm blade angle 25° W 37mm aluminium		

1

GEV No.	601410	Ref. No.	6200000.03 620419.36
description	fan wheel sucking ø 300mm fan wheel mounting 25.4mm blade angle 28° W 45mm aluminium		

1

GEV No.	601283	Ref. No.	620419.33
description	fan wheel sucking ø 230mm fan wheel mounting 25.4mm blade angle 28° W 41mm aluminium		

cooling motors (complete)

1

GEV No.	500674	Ref. No.	Z1FR009
description	fan		
For models:	SD23		



cold air circulating fans (other)



1

GEV No.	601554	Ref. No.	620273.00 620273.03 620490.00
description	fan motor 230V 50-60Hz 100W W 105mm H 105mm D 220mm shaft L 80mm shaft ø 12mm EURO MOTORS type 10111-40100 cable length 1500mm 1100rpm		

for sumps



1

GEV No.	500410	Ref. No.	CM19440065
description	float motor LIP 11W 230V 50Hz 0.7rpm shaft ø 7mm shaft length 20mm W 72mm H 110mm 010		



1

GEV No.	500786	Ref. No.	CM81404024
description	float motor LIP 11W 230V 50Hz 1rpm shaft ø 8mm W 100mm H 90mm for ice maker L 130mm		
spare parts for	500786		
	GEV No.	695670	Ref. No. CM25260000
	disc for pan tilting ø 100mm shaft intake ø 7mm		



1

GEV No.	500409	Ref. No.	CM19440063
description	float motor LIP type 001 11W 220/240V voltage 50/60 0.7rpm shaft ø 7mm shaft length 20mm W 71mm H 62mm L 110mm		



1

GEV No.	500411	Ref. No.	CM19440057
description	gear motor BITRON type 97103 11W 230V 50Hz 0.7rpm shaft ø 7mm shaft length 30mm W 72mm H 60mm L 116mm		

motors

gear motors

for ice-cube maker

for paddles



1

GEV No.	501472	Ref. No.	IOM916103101
description	gear motor CROUZET type SP-1905-40 3W 230V 50-60Hz 2rpm shaft ø 5x4mm groove width 17mm shaft ø 4.7mm icemaker		



1

GEV No.	500407	Ref. No.	CM19440059
description	gear motor LIP type 123MR 8W 220/240V voltage AC 50/60Hz 50rpm turn direction counterclockwise shaft ø 4mm shaft intake ø 6.2mm groove width 2.3mm shaft L 8mm shaft ø 4mm W 74mm		

1

GEV No.	500412	Ref. No.	CM19440073
description	gear motor LIP type 021B 11W 230V 50Hz 1rpm shaft ø 7mm shaft length 20mm W 74mm D 67mm H 110mm for sump		



1

GEV No.	500752	Ref. No.	62043002
description	pump GRE 60W 230V 60Hz inlet ø 16mm outlet ø 21mm L 110mm rotation direction right for ice maker		

miscellaneous





1

GEV No.	499077	Ref. No.	79422513R
description	gear motor type 794225 220V voltage AC 50/60Hz shaft ø 22.2mm L 260mm W 150mm H 245mm for ice maker 120W		
For models:	SPR80		



1

GEV No.	500045	Ref. No.	060491.03 301001 62041500 Z11D009 Z11D039
description	pump GRE type 100W 230V 50Hz inlet ø 24mm outlet ø 21mm L 150mm rotation direction left for ice-cube maker total length 230mm		
For models:	SD23		
spare parts for	500045		
	GEV No.	Ref. No.	—
	 O-ring EPDM thickness 2.62mm ID ø 61.6mm Qty 10 pcs		
accessories for	500045		
	GEV No.	Ref. No.	Z11D043
	 insulation for pump		

pumps

pumps for ice machines



1

GEV No.	695417	Ref. No.	Z11D043
description	insulation for pump		
For models:	SD23		



1

GEV No.	501470	Ref. No.	620423.00
description	pump GRE type 100W 230V 50Hz outlet ø 13mm L 137mm rotation direction left icemaker		



1

GEV No.	500200	Ref. No.	Z11D005
description	pump GRE 100W 230V 50Hz inlet ø 24mm outlet ø 23mm L 145mm rotation direction right		



1

GEV No.	500597	Ref. No.	62043003
description	pump GRE type MH50F 60W 230V 50Hz outlet ø 21mm L 110mm rotation direction right for ice maker		



1

GEV No.	500772	Ref. No.	12002586.25
description	pump HARTELL type U21B 230V 50/60Hz outlet ø 19mm L 120mm rotation direction right for ice-cube maker 1/30HP		



1

GEV No.	500047	Ref. No.	62043300 793113.00 793113.27
description	pump REBO type MH30F1 30W 230V 50Hz outlet ø 12.7mm L 135mm rotation direction left		
For models:	SD18, SD22, SD23, SD30, SDN25		



1

GEV No.	500761	Ref. No.	620433.02 620433.07 793113.09
description	pump REBO type MH30F1 30W 230V 50Hz outlet ø 13mm L 135mm rotation direction right for ice maker		



1

GEV No.	501471	Ref. No.	793113.24R
description	pump REBO type MH50F 60W 220-240V 50Hz outlet ø 18.5mm L 136mm rotation direction left icemaker		



1

GEV No.	500204	Ref. No.	67000206
description	pump REBO type MH50F 60W 230V 50Hz inlet ø 19mm outlet ø 19mm L 125mm rotation direction right for ice-cube maker		



1

GEV No.	500048	Ref. No.	793113.03 793113.03R
description	pump REBO type MH50F 60W 230V 50Hz outlet ø 18mm L 137mm rotation direction right for ice maker		



1

GEV No.	500746	Ref. No.	620430.06
description	pump REBO type MH50F 60W 230V 50Hz outlet ø 20mm L 110mm rotation direction right for ice-cube maker		



1

GEV No.	500203	Ref. No.	060523.00 620430.00 670002.12 793146.00
description	pump REBO type MH50F 60W 230V 50Hz outlet ø 21mm L 110mm rotation direction right for ice maker		



			
1			
GEV No.	500046	Ref. No.	0A030625.02 670036.06
description	pump REBO type NR40 40W 230V 50Hz inlet ø 12mm outlet ø 12mm L 75mm rotation direction right for ice-cube maker		

condensators & interference suppression filters

operating capacitors

plastic			
			
1			
GEV No.	365018	Ref. No.	620167.24 620167.54
description	operating capacitor capacity 35µF 400V tolerance 5%Hz ambient temperature max. -25 to +85°C ø 45mm L 95mm M8 plastic connection male faston 6.3mm protection		
For models:	SP405		

			
1			
GEV No.	365031	Ref. No.	62029204
description	operating capacitor capacity 4µF 450V tolerance 5% 50/60Hz ambient temperature max. -25 to +85°C ø 31mm L 58mm M8 plastic connection male faston 6.3mm protection		
For models:	SPR80		

equipment-specific units

for ice-cube maker

drain systems			
drain fittings			
			
1			
GEV No.	696583	Ref. No.	CM 25685311
description	drain fitting ø 50mm thread 3/4 hose ø 21mm L 55mm straight for ice-cube maker		

filters			
			
1			
GEV No.	695769	Ref. No.	02002809.01 660211.01
description	drain filter thread 7/8" ø 32mm H 10mm		
For models:	SD18, SD23, SD30, SDN25, SPR80		

overflow pipes			
			
1			
GEV No.	696609	Ref. No.	66060100
description	overflow pipe for ice maker tube ø 20mm pipe length 24mm ED ø 24.5mm L 109mm		

			
1			
GEV No.	695047	Ref. No.	660219.01
description	overflow pipe L 78mm straight		
For models:	SD18, SD22, SD23, SD30, SPR80		

ice breakers			
			
1			
GEV No.	696436	Ref. No.	060293.02 060720.00 670041.00 754001.01 754001.02
description	ice breaker ID ø 26mm ED ø 51mm H 59mm brass with ball bearing		
For models:	SPR80		

ice chutes			
ice chutes			
			
1			
GEV No.	695595	Ref. No.	CM25250099
description	ice chute for door L 345mm W 205mm white		

slide grates

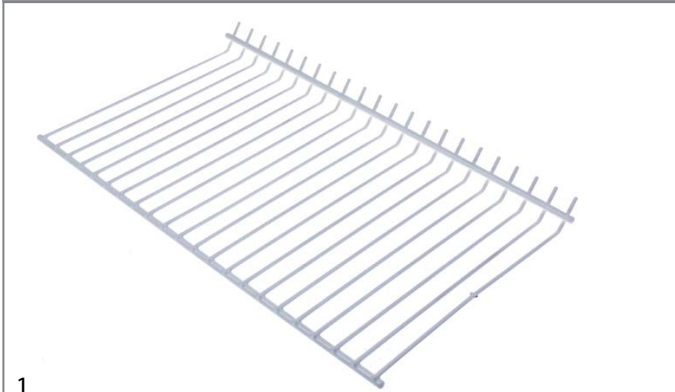

1

GEV No.	694273	Ref. No.	Z1AC003
description	slide grate for ice maker L 395mm W 235mm H 30mm		

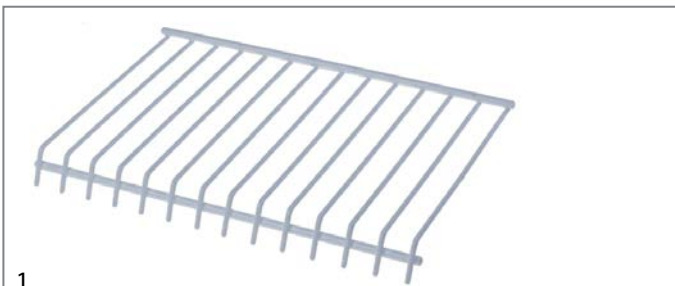

1

GEV No.	694145	Ref. No.	65070500 Z1AC050
description	slide grate for ice-cube maker L 250mm W 170mm H 25mm		
For models:	SD18, SD22, SD23, SDN25		

ice scoops



1

GEV No.	695244	Ref. No.	650146.00 65092300
description	ice scoop L 220mm W 114mm H 55mm		

spare parts and accessories



1

GEV No.	695020	Ref. No.	CM25654016
description	disc for pan tilting		

probes



1

GEV No.	694715	Ref. No.	12002760.21 IOM1011380.78
description	level electrode for ice-cube maker 1-pole cable length 100mm		



1

GEV No.	401764	Ref. No.	CM81453007 CM81453114 CM81453434
description	probe for ice thickness		



1

GEV No.	694714	Ref. No.	02003409.21 0537728.21 11000540.21
description	probe for water level 2-pole		



1

GEV No.	401837	Ref. No.	CM81453590 CM81453796
description	probe for water level 2-pole cable length 85mm		

spray systems

SIMAG

spray arms



1

GEV No.	695480	Ref. No.	65066503
description	spray arm for ice maker		



			
1			
GEV No.	695418	Ref. No.	4114654 65066518 Z1ZA043
description	spray arm L 242mm nozzles 6 for ice maker		
For models:	SD18, SD22, SD23		

			
1			
GEV No.	695463	Ref. No.	65066501
description	spray arm L 242mm nozzles 6 for ice maker		

			
1			
GEV No.	695850	Ref. No.	69573900
description	spray arm L 367mm nozzles 4 for ice maker		

			
1			
GEV No.	695420	Ref. No.	65056520 Z1ZA045
description	spray arm L 385mm nozzles 10 for ice maker		

			
1			
GEV No.	695422	Ref. No.	65066504 Z1ZA051
description	spray arm L 385mm nozzles 10 for ice maker		



			
1			
GEV No.	695419	Ref. No.	65066502 Z1A044
description	spray arm L 385mm nozzles 8 for ice maker		

			
1			
GEV No.	695421	Ref. No.	65066505 Z1ZA048
description	spray arm L 385mm nozzles 8 for ice maker		

			
1			
GEV No.	695477	Ref. No.	65066523
description	spray arm L 420mm nozzles 8 for ice maker		

			
1			
GEV No.	695478	Ref. No.	65066524
description	spray arm L 420mm nozzles 8 for ice maker		

			
1			
GEV No.	695065	Ref. No.	793127.00
description	spray arm L 435mm nozzles 4 for ice maker		

			
1			
GEV No.	695424	Ref. No.	65066506 Z1ZA049
description	spray arm L 570mm nozzles 12 for ice maker		
accessories for	695424		
	GEV No.	695000	Ref. No.
			660558.00 Z11D026
	nozzle for ice-cube maker		

			
1			
GEV No.	695423	Ref. No.	65066508 Z1ZA046
description	spray arm L 570mm nozzles 15 for ice maker		

spray units

			
1			
GEV No.	695442	Ref. No.	793129.05
description	spray system L 273mm W 147mm nozzles 6 complete for ice maker		

			
1			
GEV No.	695443	Ref. No.	793129.04
description	spray system L 273mm W 180mm nozzles 6 complete for ice maker		
spare parts for	695443		
	GEV No.	695063	Ref. No.
			—
	nozzle cap set 3-piece L 111mm W 30mm H 12mm		

			
1			
GEV No.	695444	Ref. No.	793117.00 793129.01
description	spray system L 285mm W 210mm nozzles 6 complete for ice maker		

accessories			
			
1			
GEV No.	695068	Ref. No.	11D010 66055700
description	end cap for ice maker insertion size 13x13mm		
For models:	SD18, SD22, SD23, SD30, SD40, SDN25		

			
1			
GEV No.	695060	Ref. No.	660155.03
description	nozzle for ice maker thread 3/8" ø 19.5mm H 13mm		

			
1			
GEV No.	695000	Ref. No.	660558.00 Z11D026
description	nozzle for ice-cube maker		
For models:	SD18, SD22, SD23, SD30, SDN25		

			
1			
GEV No.	695115	Ref. No.	060529.00 060529.01 660519.01 660519.02 660519.03
description	nozzle cap set for ice maker 3-piece L 110mm W 30mm H 12mm		

			
1			
GEV No.	695066	Ref. No.	660475.00
description	spray arm holder for ice maker H 150mm shaft ø 15mm		

			
1			
GEV No.	695061	Ref. No.	660296.02
description	swirl ice cube maker plastic ø 15mm Lmm Wmm H 3.4mm shaft ømm black		

doors			
bushes			
			
1			
GEV No.	695782	Ref. No.	660286.00
description	bush for door ED ø 12.5mm ID ø 8.2mm L 10.8mm plastic		

doors			
			
1			
GEV No.	695743	Ref. No.	CM81460184 CM81460326
description	door for ice maker W 1080mm H 275mm thickness 16mm		

			
1			
GEV No.	695458	Ref. No.	782078.00R
description	door for ice-cube maker W 345mm H 195mm thickness 14mm		

			
1			
GEV No.	695459	Ref. No.	782079.05R 782079.06
description	door for ice-cube maker W 420mm H 200mm thickness 18mm		

			
1			
GEV No.	695457	Ref. No.	781503.00R 792011.02R 79201101
description	door for ice-cube maker W 505mm H 270mm thickness 21mm		



1

GEV No.	695461	Ref. No.	060517.04 060517.05
description	door kit for ice-cube maker W 655mm H 260mm thickness 19mm		



1

GEV No.	696473	Ref. No.	782009.07 792009.09R
description	door W 600mm H 260mm thickness 17mm		



1

GEV No.	695460	Ref. No.	060517.00 060517.01
description	door with door guide for ice-cube maker W 485mm H 260mm thickness 19mm		

door guides



1

GEV No.	695448	Ref. No.	660523.01
description	door guides mounting pos. left L 215/240mm W 14mm		



1

GEV No.	695447	Ref. No.	660523.00
description	door guides mounting pos. right L 215/240mm W 14mm		

curtains

without holder



1

GEV No.	695726	Ref. No.	CM81401600
description	curtain for ice maker W 250mm H 70mm shaft length 270mm shaft ø 6mm		



1

GEV No.	695429	Ref. No.	78317100R
description	curtain for ice maker W 250mm H 70mm shaft length 280mm shaft ø 6mm		
For models:	SD18, SD22, SDN25		



1

GEV No.	695076	Ref. No.	784169.09 784169.09R
description	curtain for ice maker W 284mm H 83mm		



1

GEV No.	695438	Ref. No.	78445700R
description	curtain for ice maker W 293mm H 115mm shaft length 350mm shaft ø 6mm		



1

GEV No.	695075	Ref. No.	784169.01 784169.01R
description	curtain for ice maker W 305mm H 115mm shaft length 323mm shaft ø 6mm		

			
1			
GEV No.	695077	Ref. No.	784169.05 784250.03 784250.03R
description	curtain for ice maker W 570mm H 115mm shaft length 610mm shaft ø 6mm		

accessories
holders

			
1			
GEV No.	695080	Ref. No.	66038800
description	curtain holder for ice maker W 15mm H 80mm left		
For models:	SD18, SD22, SD23, SD30, SDN25		

			
1			
GEV No.	695079	Ref. No.	66038801
description	curtain holder for ice maker W 15mm H 80mm right		
For models:	SD18, SD22, SD23, SD30, SDN25		

lamellas

			
1			
GEV No.	695081	Ref. No.	66062900 Z1AC027
description	lamella for ice maker W 28mm H 71mm ø 6mm		
For models:	SD23		

pan mechanics

sumps

			
1			
GEV No.	695014	Ref. No.	CM81403005
description	sump complete for ice maker L 180mm W 125mm H 80mm shaft L 205mm N20 blue		

			
1			
GEV No.	696414	Ref. No.	CM81401621
description	sump complete for ice maker L 180mm W 125mm H 80mm shaft L 210mm N25 blue		

			
1			
GEV No.	695015	Ref. No.	CM81403007
description	sump complete for ice maker L 225mm W 165mm H 80mm shaft L 255mm for modell N30/N35 white		

			
1			
GEV No.	695017	Ref. No.	CM81413001
description	sump complete for ice maker L 275mm W 220mm H 75mm ICEMATIC white		

			
1			
GEV No.	695016	Ref. No.	CM81414519 CM81423003
description	sump complete for ice maker L 275mm W 220mm white		

			
1			
GEV No.	695019	Ref. No.	CM81442008
description	sump complete for ice maker L 690mm W 230mm H 65mm ICEMATIC		

			
1			
GEV No.	695018	Ref. No.	CM81423002
description	sump complete L 455mm W 180mm H 60mm ICEMATIC		





			
1			
GEV No.	695662	Ref. No.	CM25820125
description	water container for ice maker L 697mm W 260mm H 148mm white		

spare parts and accessories

			
1			
GEV No.	695646	Ref. No.	CM25726279
description	bracket for inner door L 44mm W 20mm H 18mm shaft intake ø 6.3mm mounting distance 30mm		

			
1			
GEV No.	695651	Ref. No.	CM25525419
description	bracket for pulser L 34mm W 15mm H 60mm		

			
1			
GEV No.	695415	Ref. No.	CM25726122
description	bracket for sump mounting pos. right ICEMATIC		

			
1			
GEV No.	695009	Ref. No.	CM25726115
description	bracket paddle L 50mm W 17mm H 23mm shaft intake ø 6.5mm mounting distance 30mm		

			
1			
GEV No.	695681	Ref. No.	CM25110914
description	bush for spindle ED ø 10mm ID ø 6.2mm L 20mm plastic ICEMATIC		

			
1			
GEV No.	695670	Ref. No.	CM25260000
description	disc for pan tilting ø 100mm shaft intake ø 7mm		

			
1			
GEV No.	695479	Ref. No.	CM81413043
description	disc for pan tilting ø 100mm shaft ø 7mm		

			
1			
GEV No.	695023	Ref. No.	CM25325953
description	guide for lever L 30mm W 12mm H 15mm		

			
1			
GEV No.	695025	Ref. No.	CM25440110 CM81403011
description	lever for sump L 143mm W 29mm H 37mm shaft intake ø 10mm plastic ICEMATIC		

			
1			
GEV No.	695027	Ref. No.	CM25545520
description	paddle ø 145mm shaft intake ø 6mm		

			
1			
GEV No.	696527	Ref. No.	CM25545521
description	paddle ø 145mm shaft intake ø 6mm shaft lengthmm 1		

			
1			
GEV No.	695026	Ref. No.	CM25560256
description	pin for lever L 38mm ø 4.5mm metal		

			
1			
GEV No.	695024	Ref. No.	CM25110911
description	roller for pan tilting ø 26.7mm shaft intake ø 8.1mm		

			
1			
GEV No.	695035	Ref. No.	CM25725433 CM25725439
description	shaft intake for paddle motor L 30mm W 17mm H 60mm shaft intake ø 4mm mounting distance 17mm		

1 

GEV No.	695004	Ref. No.	CM25030006
description	spindle for ice maker ø 6mm L 165mm SS		

1 

GEV No.	695005	Ref. No.	CM25030007
description	spindle for ice maker ø 6mm L 206mm		

1 

GEV No.	695006	Ref. No.	CM25030010
description	spindle for ice maker ø 6mm L 315mm SS		

1 

GEV No.	695007	Ref. No.	CM25030011
description	spindle for paddle L 495mm		

1 

GEV No.	695021	Ref. No.	cm25474600
description	torsion spring ø 20.8mm L1 23.2mm L2 37mm wire gauge ø 2.3mm for ice maker		

1 

GEV No.	695022	Ref. No.	CM25474602
description	torsion spring ø 21.2mm L1 26mm L2 37mm wire gauge ø 2.6mm for ice maker		

gear wheels

1 

GEV No.	691787	Ref. No.	651157.00
description	gear wheel ø 27/101mm shaft intake ø 13mm teeth 15/94		
For models:	SP405		

suction system

intake filters



1

GEV No.	695416	Ref. No.	Z1AC012
description	intake filter ø 36mm H 25mm		
For models:	SD23		

drive technology

gear wheels



1

GEV No.	694780	Ref. No.	651158.00
description	gear wheel ø 135mm shaft ø 25mm W 19mm teeth 83		
For models:	SP405		



1

GEV No.	695582	Ref. No.	65115600
description	gear wheel teeth 65 tooth width 14.5mm ED ø 74mm H 72mm shaft ø 12.7mm		
For models:	SP405		

gaskets

shaft gaskets



1

GEV No.	695589	Ref. No.	0200130021 64004000
description	shaft sealing ED ø 48mm ID ø 25mm H 22mm suitable for augers		
For models:	SPR80		



1

GEV No.	695428	Ref. No.	650402.00
description	shaft sealing for auger ED ø 45mm ID ø 30mm		
For models:	SP405		



miscellaneous

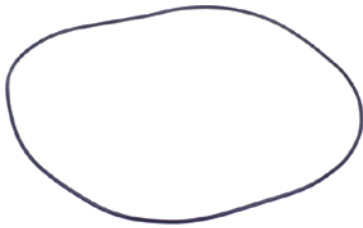

1

GEV No.	697879	Ref. No.	0a026103.01 13000617.38
description	O-ring NBR thickness 2.62mm ID ø 219mm Qty 1 pcs		
For models:	SP405		

insulation



1

GEV No.	694112	Ref. No.	060551.01 660509.02 660509.03
description	insulation for discharge chute L 190mm W 200mm H 175mm		

flaps



1

GEV No.	696392	Ref. No.	CM81453130
description	flap for ice maker W 493mm L 423mm for evaporator		



1

GEV No.	696610	Ref. No.	CM81453131
description	sump for ice maker W 500mm H 70mm L 540mm for evaporator		

mechanics for evaporators

holders



1

GEV No.	694437	Ref. No.	060527.00 060688.00 754008.01
description	bearing block for evaporator kit with holder mounting pos. lower		
For models:	SP405		

gear motors

gearboxes



1

GEV No.	695607	Ref. No.	3212002
description	housing for gearbox		

hoses

formed hoses

form L



1

GEV No.	695089	Ref. No.	Z1CE015
description	formed hose L-shape for ice-cube maker ID ø 12.5/22mm ED ø 18.5/27mm L 300mm W 30mm		



1

GEV No.	695092	Ref. No.	Z1CE016
description	formed hose L-shape for ice-cube maker ID ø 13/21mm ED ø 18/27mm L 345mm W 80mm		



1

GEV No.	695091	Ref. No.	61018901 Z1ID007
description	formed hose L-shape for ice-cube maker ID ø 24mm ED ø 27mm L 130mm W 105mm		

form S



1

GEV No.	695090	Ref. No.	Z1ID038
description	formed hose S-shape for ice-cube maker ID ø 16/20mm ED ø 21/25mm L 110mm W 75mm		
For models:	SD23		



1

GEV No.	695094	Ref. No.	61021500 Z1ID006
description	formed hose S-shape for ice-cube maker ID ø 16/20mm ED ø 21/26mm L 130mm W 70mm		



1

GEV No.	695093	Ref. No.	Z1ID037
description	formed hose S-shape for ice-cube maker ID ø 20/23mm ED ø 26/29mm L 115mm W 90mm		
For models:	SD23		

hose connectors

with thread



1

GEV No.	695051	Ref. No.	Z1AC028
description	hose connector		



1

GEV No.	695045	Ref. No.	660224.00
description	hose connector 3-way ID ø 15mm ED ø 21mm L 91mm		
For models:	SD18, SD22, SD23, SD30, SP405, SPR80		



1

GEV No.	695048	Ref. No.	Z1ID025
description	hose connector for ice-cube maker		
For models:	SD23		



1

GEV No.	695049	Ref. No.	Z1AD011
description	hose connector for ice-cube maker		
For models:	SD23		



1

GEV No.	695109	Ref. No.	Z1AC030
description	hose connector for ice-cube maker		
For models:	SD23		



1

GEV No.	695112	Ref. No.	Z1AC029
description	hose connector for ice-cube maker		
For models:	SD23		



1

GEV No.	695053	Ref. No.	66029100
description	hose connector for ice-cube maker straight grommet ø 11.5mm grommet length 16mm WS 27 thread L 15mm plastic T1: 3/4" T2: 5/8" UNF (3/8" SAE)		



1

GEV No.	695095	Ref. No.	Z1AC029
description	hose connector thread M22 hose ø 16mm plastic for ice-cube maker ID ø 16mm ED ø 22mm L 45mm		



without thread

			
1			
GEV No.	695050	Ref. No.	CM25690806
description	hose connector straight plastic L 70mm ø 21mm		

miscellaneous

			
1			
GEV No.	520447	Ref. No.	733204.00
description	double nipple thread 3/8" - 3/4" L1 24mm L2 12mm		
For models:	SP405, SPR80		

floats

container lids

			
1			
GEV No.	695038	Ref. No.	66036300
description	lid L 150mm W 102mm for float container		
For models:	SP405, SPR80		

float containers

			
1			
GEV No.	695037	Ref. No.	793126.01 793126.03
description	float container for ice maker plastic		
For models:	SP405, SPR80		

miscellaneous

			
1			
GEV No.	691665	Ref. No.	CM25726473
description	bracket for evaporator flap		

			
1			
GEV No.	695630	Ref. No.	06035900 06035902 65041200
description	coupling set ø 37mm		

			
1			
GEV No.	696607	Ref. No.	660483.00
description	flange icemaker H 20mm ED ø 60mm plastic		

			
1			
GEV No.	695660	Ref. No.	CM25300000
description	inlet spout for ice maker ICEMATIC		

			
1			
GEV No.	695417	Ref. No.	Z11D043
description	insulation for pump		
For models:	SD23		

			
1			
GEV No.	695046	Ref. No.	66053500
description	nut H 5mm thread M24x1.5 plastic		
For models:	SD18, SD22, SD23, SD30, SP405, SPR80		

			
1			
GEV No.	695113	Ref. No.	Z1AC014
description	plain washer for ice-cube maker plastic D1 ø 32mm D2 ø 25mm thickness 2mm		
For models:	SD23		



1

GEV No.	695110	Ref. No.	Z1AC013
description	plain washer for ice-cube maker plastic \varnothing 19mm		
For models:	SD23		



1

GEV No.	695764	Ref. No.	72421506
description	probe L 100mm ED \varnothing 4mm thread M3		
For models:	SP405, SPR80		

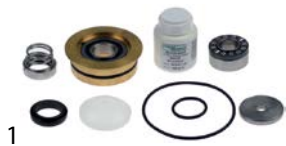

1

GEV No.	695587	Ref. No.	001028.08 060692.01
----------------	--------	-----------------	------------------------

description repair kit for ice maker

spare parts for 695587



GEV No.	695588	Ref. No.	—
description	bushing complete H 31.5mm ID \varnothing 30mm ED \varnothing 89mm mounting pos. lower		

valves

intake valves



1

GEV No.	696608	Ref. No.	IOM9131111.01
description	intake valve icemaker thread 14 plastic hose \varnothing 35mm W 76mm		



1

GEV No.	695685	Ref. No.	02002217.02 19864010
description	intake valve thread M11 L 130mm \varnothing 37mm plastic		

for dishwashers

door mechanics

door shafts



1

GEV No.	695575	Ref. No.	Z1AM017
description	door shaft \varnothing 10mm L 458mm icemaker		

hinges

piano hinges

producer-specific

CASTEL



1

GEV No.	701030	Ref. No.	CM19120045
description	hinge controllable L 43mm W 37mm hole \varnothing 4mm for ice container mounting distance 26/32mm plastic		

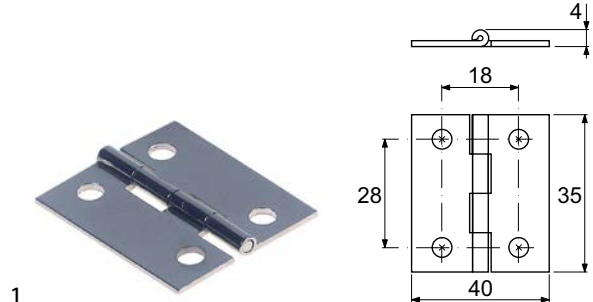

1

GEV No.	691804	Ref. No.	CM19120050
description	hinge L 40mm W 35mm H 4mm mounting distance 28mm hole \varnothing 5mm thickness 1.3mm brass ICEMATIC		

filters

air filters



1

GEV No.	694183	Ref. No.	02003485.01
description	air filter L 500mm W 500mm H 20mm		



equipment feet and end caps

end caps and plugs

for square pipes

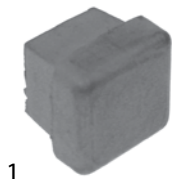

GEV No.	695068	Ref. No.	1ID010 66055700
description	end cap for ice maker insertion size 13x13mm		
For models:	SD18, SD22, SD23, SD30, SD40, SDN25		

gaskets

refrigeration gaskets

plug-in gaskets

profile 9151

We offer custom-made gaskets for this profile

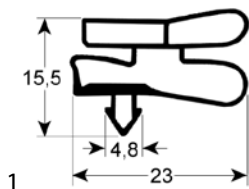

GEV No.	900368	Ref. No.	CM28175017
description	refrigeration gasket profile 9151 W 715mm L 1580mm plug size L1 1570mm W1 705mm external size		

O-rings

EPDM

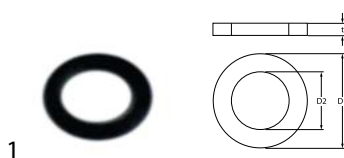

GEV No.	528485	Ref. No.	640100.00
description	O-ring EPDM thickness 1.78mm ID ϕ 6.07mm Qty 1 pcs		
For models:	SP405, SPR80		

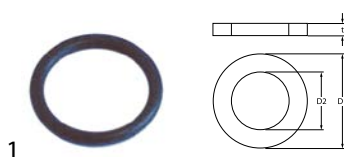

GEV No.	507309	Ref. No.	640081.00 940081.00
description	O-ring EPDM thickness 2.62mm ID ϕ 17.13mm Qty 1 pcs		

GEV No.	510769	Ref. No.	640041.01
description	O-ring EPDM thickness 2.62mm ID ϕ 25.07mm Qty 1 pcs		
For models:	SPR80		

GEV No.	532486	Ref. No.	Z1ID042
description	O-ring EPDM thickness 2.62mm ID ϕ 61.6mm Qty 1 pcs		
For models:	SD23		

GEV No.	511395	Ref. No.	13000617.54
description	O-ring EPDM thickness 2.62mm ID ϕ 71.12mm Qty 1 pcs		

GEV No.	361085	Ref. No.	CM41020448
description	O-ring EPDM thickness 2mm ID ϕ 8mm Qty 1 pcs		

GEV No.	511518	Ref. No.	3186143
description	O-ring EPDM thickness 3.53mm ID ϕ 23.4mm Qty 10 pcs		

GEV No.	510895	Ref. No.	640093.02
description	O-ring EPDM thickness 3.53mm ID ϕ 34.52mm Qty 1 pcs		
For models:	SP405		

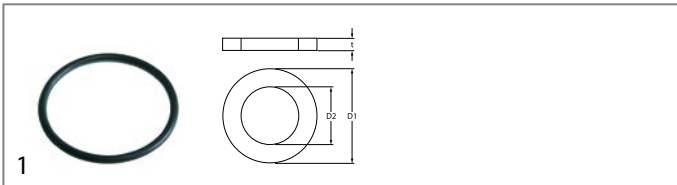

GEV No.	532114	Ref. No.	64004138
description	O-ring EPDM thickness 3.53mm ID ø 50.8mm Qty 10 pcs		

silicone

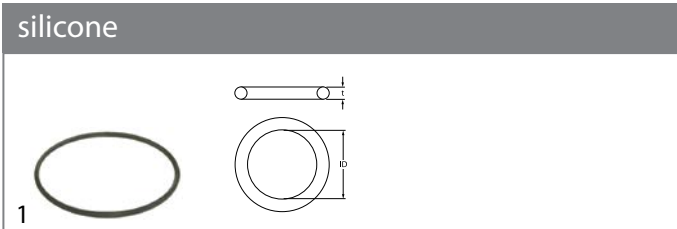

GEV No.	695064	Ref. No.	640041.20
description	O-ring silicone thickness 2mm ID ø 66.4mm Qty 1 pcs		

NBR

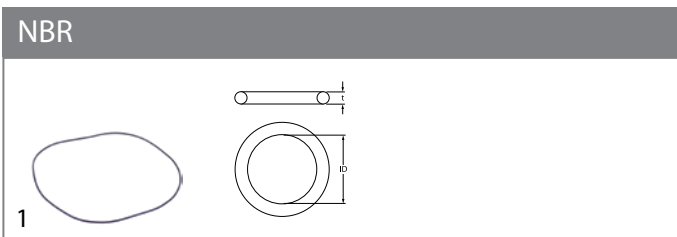

GEV No.	697879	Ref. No.	0a026103.01 13000617.38
description	O-ring NBR thickness 2.62mm ID ø 219mm Qty 1 pcs		
For models:	SP405		

sealing washers

rubber gaskets



GEV No.	520054 ¹	Ref. No.	640076.13
description	flat gasket rubber ED ø 23.5mm ID ø 14mm thickness 2.3mm Qty 10 pcs		
For models:	SD23		

¹Qty 10 pieces

foam rubber gaskets



GEV No.	508418	Ref. No.	CM19350201
description	foam rubber gasket W 15mm thickness 8mm self-adhesive Qty 1m		



GEV No.	901292	Ref. No.	13000595.00
description	foam rubber gasket W 15mm thickness 8mm self-adhesive Qty supplied by meter		

shaft gaskets

shaft gaskets



GEV No.	698239	Ref. No.	02003969.01 640083.00
description	shaft seal ID ø 11.91mm ED ø 18.24mm thickness 5mm		
For models:	SPR80		



GEV No.	511532	Ref. No.	02001606.00
description	shaft seal ID ø 15mm ED ø 25.5mm thickness 6.5mm for ice-cube maker		



GEV No.	511534	Ref. No.	64001901
description	shaft seal ID ø 22mm ED ø 32mm thickness 5.5mm		
For models:	SPR80		



GEV No.	511533	Ref. No.	02002853.01
description	shaft seal ID ø 25mm ED ø 34mm thickness 5mm for ice maker		



refrigeration cycle components

cooling water regulators

JOHNSON CONTROLS

			
GEV No.	541483	Ref. No.	62011100 79305600R CM19865611 Z1CW018
description	cooling water regulator 3/8" type V46AA-9950 connection 6mm soldering connection pressure range 5-18bar water pressure max. 10bar water temperature max. 90°C capillary pipe 750mm L 160mm 0.9kg		
For models:	SP405, SPR80		





valves

expansion valves

DANFOSS

valves

type TS2/TE2

			
GEV No.	750014	Ref. No.	CM81453620
description	expansion valve DANFOSS type TS2 coolant R404a/R507 angled 90° thermostatically controlled inlet 3/8" SAE outlet 1/2" SAE p max 34bar -40 up to +10°C capillary pipe 1500mm		
accessories for	750014		
	GEV No.	750020	Ref. No. —
	nozzle insert size 0X type 068-2002 T/TE 2 DANFOSS		
	GEV No.	750021	Ref. No. —
	nozzle insert size 00 type 068-2003 T/TE 2 DANFOSS		
	GEV No.	750022	Ref. No. —
	nozzle insert size 01 type 068-2010 T/TE 2 DANFOSS		
	GEV No.	750023	Ref. No. —
	nozzle insert size 02 type 068-2015 T/TE 2 DANFOSS		
	GEV No.	750024	Ref. No. —
	nozzle insert size 03 type 068-2006 T/TE 2 DANFOSS		
	GEV No.	750483	Ref. No. —
	nozzle insert size 04 type 068-2007 T2/TE2 DANFOSS		
	GEV No.	750484	Ref. No. —
	nozzle insert size 05 type 068-2008 T2/TE2 DANFOSS		

accessories for	750014		
	GEV No.	750485	Ref. No. —
	nozzle insert size 06 type 068-2009 T2/TE2 DANFOSS		

HONEYWELL

valves

			
GEV No.	750445	Ref. No.	62042755
description	expansion valve HONEYWELL type AMVX coolant R404a/R507 nozzle ø 2.5mm inlet 5/8" UNF (3/8" SAE) outlet 3/4" UNF (1/2" SAE) 7/16" UNF (1/4" SAE) p max 3bar capillary pipe 1200mm		

evaporators

for ice-cube maker

for flake ice maker

			
GEV No.	695752	Ref. No.	79430201R
description	evaporator for flake ice maker H 247mm ø 73mm		
For models:	SPR80		

accessories

housings

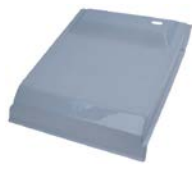
			
GEV No.	696383	Ref. No.	CM25820123/0
description	lid for evaporator for ice maker for N120 L 422mm W 336mm H 60mm		

condensers

condensers



1

GEV No.	750527	Ref. No.	19177073
description	condenser for ice maker W 525mm D 62mm H 490mm		



1

GEV No.	750125	Ref. No.	62043900
description	condenser W 290mm D 85mm H 260mm		

transmission technology and ball bearings

ball bearings

ball bearings inch



1

GEV No.	523001	Ref. No.	02000417.00 02000417.20 02000417.21 670011.01
description	ball bearing type SR14-2RS shaft \varnothing 7/8"mm ED \varnothing 1 7/8"mm W 3/8"mm		
For models:	SPR80		

miscellaneous



1

GEV No.	523514	Ref. No.	651058.00
description	ball bearing type L/3350 shaft \varnothing 25mm ED \varnothing 52mm W 33mm stainless steel		
For models:	SP405		

springs

torsion springs



1

GEV No.	695021	Ref. No.	cm25474600
description	torsion spring \varnothing 20.8mm L1 23.2mm L2 37mm wire gauge \varnothing 2.3mm for ice maker		



1

GEV No.	695022	Ref. No.	CM25474602
description	torsion spring \varnothing 21.2mm L1 26mm L2 37mm wire gauge \varnothing 2.6mm for ice maker		



hoses

drain hoses

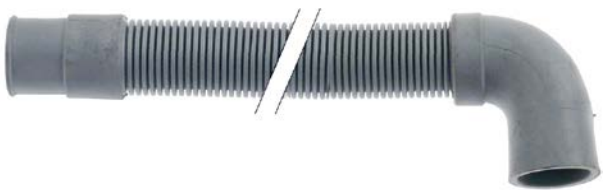

1

GEV No.	530473	Ref. No.	06051301 CM19810114
description	drain hose DN19 L 1900mm straight ø inside 19mm straight ext. ø 25mm elbow ø inside 23mm elbow ext. ø 27mm outer hose ø 24mm for ice maker		

fittings, hose and pipe connectors

fittings

double nipples



1

GEV No.	520447	Ref. No.	733204.00
description	double nipple thread 3/8" - 3/4" L1 24mm L2 12mm		
For models:	SP405, SPR80		

hose connectors

producer-specific



1

GEV No.	695053	Ref. No.	66029100
description	hose connector for ice-cube maker straight grommet ø 11.5mm grommet length 16mm WS 27 thread L 15mm plastic T1: 3/4" T2: 5/8" UNF (3/8" SAE)		



1



GEV No.	695050	Ref. No.	CM25690806
description	hose connector straight plastic L 70mm ø 21mm		

push-in fittings

JOHN GUEST



1

GEV No.	440652	Ref. No.	651224 04	
description	push-in fitting John Guest straight pipe connection 1/4" - 5/16"			
accessories for	440652			
	GEV No.	520976	Ref. No.	—
	hose 0,17" ext. ø 1/4" John Guest LLDPE blue			
	GEV No.	520977	Ref. No.	—
	hose ID ø 5mm ED ø 8mm John Guest thickness 1.5mm LLDPE blue			

fastening material

nuts

hexagonal nuts

hexagonal nuts metric (without norm)



1

GEV No.	695111	Ref. No.	Z1AC016
description	nut thread M18x1.5 H 7mm WS 27 brass Qty 1 pcs		
For models:	SD23		



1

GEV No.	695114	Ref. No.	Z1AC017
description	nut thread M24x1.5 H 7mm WS 30 brass Qty 1 pcs		
For models:	SD23		

washers

washers

miscellaneous



1

GEV No.	695113	Ref. No.	Z1AC014
description	plain washer for ice-cube maker plastic D1 ø 32mm D2 ø 25mm thickness 2mm		
For models:	SD23		

cleaning agents

descalers



1

GEV No.	802164	Ref. No.	100902
description	descaler 4.8l phosphoric acid for ice maker		



1

GEV No.	695110	Ref. No.	Z1AC013
description	plain washer for ice-cube maker plastic ø 19mm		
For models:	SD23		

consumables

lubricants

machine lubricants



1

GEV No.	890029	Ref. No.	060294.01
description	machine lubricant Mobilux EP004 can 500g for gearbox -25 up to +120°C		
description	<p>Mobilux EP004 - can 500g</p> <p>Suitable for lubricating enclosed gears and bearings in poorly sealed gear cases with the exception of electric motor bearings. Can also be used for many other industrial applications, e.g. gear cases and chains, in which conventional gear oils would escape due to leaks caused by worn or missing seals. Meets requirements of SEW 1008 hour gear test, DR.EM.2003 mod.</p> <p>Temperature resistance: -25°C to +120°C</p>		
For models:	SP405		

C			
cleaning agents	40		
compressors	17		
condensators & interference suppression filters	23		
consumables	40		
cooling water regulators	37		
D			
descalers	40		
double nipples	39		
drain hoses	39		
E			
end caps and plugs	35		
evaporators	37		
expansion valves	37		
F			
fans	17		
fastening material	39		
fittings	39		
float switches	6		
foam rubber gaskets	36		
H			
Hall sensors	9		
hexagonal nuts	39		
hose connectors	39		
hoses	39		
I			
indicator lights	7		
indicator lights (complete)	7		
L			
lamps	7		
lubricants	40		
M			
machine lubricants	40		
magnetic switches	7		
microswitches	6		
motors	20		
N			
nuts	39		
O			
operating capacitors	23		
O-rings	35		
P			
piano hinges	34		
plug-in gaskets	35		
pressure switches	16		
probes	9		
programme timers	7		
pumps	21		
pumps for ice machines	21		
push/momentary push switches	5		
push-in fittings	39		
R			
refrigeration cycle components	37		
refrigeration fans	17		
refrigeration gaskets	35		
refrigeration motors universal	17		
refrigeration thermostats	3		
relays	8		
rocker/momentary rocker switches	5		
S			
sealing washers	36		
shaft gaskets	36		
solenoid valves	12		
switches and momentary switches	5		
T			
thermostats	3		
time relays	8		
timers	7		
toggle switches	6		
touch sensitive light switches	6		
W			
washers	39		