



GAS COMPONENTS



ELECTRIC COMPONENTS



WATER TECHNOLOGY



MECHANICAL COMPONENTS



TOOLS

Spare parts suitable for

SILKO

Find the complete and up-to-date range of products in our GEV Webshop



Manufacturer catalogue

The most important spare parts and accessories arranged clearly for every manufacturer

- ✓ Complete product range and all appliance data always up to date in the GEV Webshop
- ✓ Alphabetical Index at the end of the catalogue

GEV Webshop

www.gev-online.co.uk

www.gev-online.com



- 🔍 Add to Favourites
- 🔍 Sign In with email address and usual password
- 🔍 Easy-order – place several items in your basket at the same time
- 🔍 Quick Item search – no login needed



heating elements

heating elements for ovens

1			
GEV No.	420111	Ref. No.	CR0681390
description	heating element 1500W 230V heating circuits 1 L 555mm W 210mm L1 70mm L2 485mm W1 88mm W2 33mm flange length 70mm flange width 22mm hole distance 56mm hole ø 5mm tube ø 8.5mm connection male faston 6.3mm connection length 17mm windings 3 flange connection dry heating element for oven		
For models:	ECE7-E, ECE94E, ECG94E, ECG96E, ECV94E		

1			
GEV No.	415131	Ref. No.	0101506 SIR0101506
description	heating element 2500W 240V L 515mm W 512mm L1 55mm L2 460mm W1 386mm W2 126mm flange length 160mm flange width 22mm hole distance 144mm hole ø 6mm tube ø 6.3mm connection male faston 6.3mm heating circuits 3 rectangular flange		

1			
GEV No.	415252	Ref. No.	0101505 SIR0101505
description	heating element 2750W 230/400V heating circuits 3 L 529mm W 620mm L1 30mm L2 499mm W1 247mm W2 127mm flange length 160mm flange width 22mm hole distance 145mm hole ø 7mm tube ø 6.3mm connection M4 rectangular flange dry heating element		
For models:	CCG9046P, CCG90662P, CCG9146, CCG9146-1, CCG91662, CCG91662-1, CCG91663, CCG91663-1, CCQ9046, CCQ9046V, CCQ90663, CE94EPQ, CFS9060, CFS9062, CFS9066, CG94EPS, CG96EPS, CTE9146, CTT9046, CTT90663R, CV94EPS, HE94EPS, HEY4EPS, TE94EPS, TG94EPS		

1			
GEV No.	415341	Ref. No.	0101556 SIR0101556
description	heating element 735W 230V L 387mm W 108mm H 25mm lug length 55mm lug width 29mm hole distance 140mm hole ø 5mm tube ø 6.3mm connection length 30mm connection M4 heating circuits 1 dry heating element bracket mounting		
For models:	CCG60652, CCG60653, CCT6046		

1			
GEV No.	415395	Ref. No.	0101553 SIR0101553
description	heating element 800W 240V L 540mm W 60mm flange length 100mm flange width 22mm hole distance 85mm tube ø 6.3mm connection length 10mm heating circuits 1 hole ø 5mm connection male faston 6.3mm rectangular flange dry heating element		



1			
GEV No.	415294	Ref. No.	0101554 SIR0101554 SIR0101554
description	heating element 900W 230V L 468mm W 112mm H 23mm lug length 60mm lug width 20mm hole distance 153mm hole ø 6mm tube ø 6.3mm heating circuits 1 dry heating element windings 1 rectangular flange oven		
For models:	CCG7046, CCG7046P, CCG70662P, CCG70663, CCG7246, CCG72662, CCG72663, CCQ7046, CCQ70663, CCT7046, CCT70663, CCT7246V, CE84EPQ, CG74EPS, CG76EPS, CG84EPS, CV74EPS, FORNO-ELETRICO-700, FORNO-ELETRICO-809		







heating elements for bain maries

1			
GEV No.	415091	Ref. No.	1037039513 MA1037039513
description	heating element 1000W 230V heating circuits 1 L 295mm W 85mm connection length 20mm connection M3 tube ø 6.5mm 2 hole fixing thread M14x1 immersion heater/dry heating element bain marie/chip scuttle L1 145mm L2 150mm H 18mm mounting distance 79mm		
For models:	CCW6220, CME6220, CME6230, CME6240, CSP6220, CW62TPS, ERP72, ME62TPS, ME63TPS, ME64TPS, RP62TPS		
spare parts for	415091		
		GEV No.	510417 Ref. No. —
			flat gasket fibre ED ø 20mm ID ø 14mm thickness 2mm Qty 1 pcs
accessories for	415091		
		GEV No.	520228 Ref. No. —
			tooth lock washer ID ø 15.3mm ED ø 24mm steel Qty 1 pcs for thread M14
		GEV No.	521133 Ref. No. —
			nut thread M14x1.5 H 6mm WS 19 zinc-coated steel Qty 1 pcs
		GEV No.	527169 Ref. No. —
			hexagonal nut thread M3 H 2.8mm WS 5.5 brass Qty 1 pcs
		GEV No.	550261 Ref. No. —
			nut thread M14x1 H 4mm WS 19 SS Qty 1 pcs
		GEV No.	550262 Ref. No. —
			flat gasket copper ED ø 20mm ID ø 14mm thickness 2mm

Table continues overleaf





accessories for 415091			
	GEV No.	560110	Ref. No. —
plain washer ID \varnothing 3.2mm ED \varnothing 7mm thickness 0.5mm SS Qty 20 pcs DIN 125A for thread M3			
	GEV No.	560130	Ref. No. —
hexagonal nut thread M3 H 2.4mm WS 5.5 SS DIN/ISO DIN 934 / ISO 4032/8673 Qty 20 pcs			

			
GEV No.	415130	Ref. No.	0109060 SIR0109060
description	heating element 1500W 230V heating circuits 1 L 412mm W 50mm connection M3 tube \varnothing 8.5mm 2 hole fixing thread 3/8" immersion heater mounting distance 42mm		
For models:	CCW6020, CME6020, CME6040, CME7020, CME7220, ME72TPS		
accessories for 415130			
	GEV No.	361183	Ref. No. —
nut thread 3/8" H 6mm nickel-plated brass WS 20 Qty 1 pcs			
	GEV No.	521137	Ref. No. —
flat gasket fibre ED \varnothing 20mm ID \varnothing 18mm thickness 1.5mm for thread 3/8" Qty 1 pcs			
	GEV No.	527169	Ref. No. —
hexagonal nut thread M3 H 2.8mm WS 5.5 brass Qty 1 pcs			
	GEV No.	560110	Ref. No. —
plain washer ID \varnothing 3.2mm ED \varnothing 7mm thickness 0.5mm SS Qty 20 pcs DIN 125A for thread M3			
	GEV No.	560130	Ref. No. —
hexagonal nut thread M3 H 2.4mm WS 5.5 SS DIN/ISO DIN 934 / ISO 4032/8673 Qty 20 pcs			

			
GEV No.	415992	Ref. No.	1634200 MA1634200
description	heating element 1800W 230V heating circuits 1 L 495mm W 90mm flange length 124mm flange width 30mm hole distance 108mm connection length 33mm connection M5 tube \varnothing 10mm rectangular flange hole \varnothing 4mm dry heating element bain marie		
For models:	EME7, EME92A, EME92G, EME92T, EME94A, EME94G, EME94T		

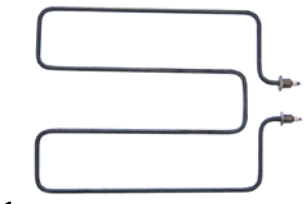
			
GEV No.	415143	Ref. No.	0101530 SIR0101530
description	heating element 2000W 230V heating circuits 1 L 436mm W 33mm connection M5 tube \varnothing 8.5mm expansion flange immersion heater flange 40x16mm		

			
GEV No.	415844	Ref. No.	0109061 SIR0109061
description	heating element 2600W 230V heating circuits 1 L 410mm W 300mm connection length 10mm connection M4 tube \varnothing 8.5mm 2 hole fixing thread 3/8" immersion heater L1 27mm L2 383mm W1 120mm W2 60mm mounting distance 50mm		
For models:	CME6030		
spare parts for 415844			
	GEV No.	521137	Ref. No. —
flat gasket fibre ED \varnothing 20mm ID \varnothing 18mm thickness 1.5mm for thread 3/8" Qty 1 pcs			
accessories for 415844			
	GEV No.	361183	Ref. No. —
nut thread 3/8" H 6mm nickel-plated brass WS 20 Qty 1 pcs			









heating elements for frying pans

			
GEV No.	416698	Ref. No.	1037317700 MA1037317700
description	heating element 1350W 230V L 460mm W 95mm connection M4 tube \varnothing 6.3mm dry heating element multi purpose roasting pan H 40mm connection distance 89mm		
For models:	CM72APS, CM82APS, ECM73, ECM93A		

heating elements for chip scuttles

			
GEV No.	416832	Ref. No.	0109049 SI0109049 SIR0109049
description	heating element 650W 230V heating circuits 1 L 276mm W 73mm flange length 115mm flange width 25mm hole distance 98mm connection length 24mm connection male faston 6.3mm tube \varnothing 8.5mm rectangular flange hole \varnothing 5mm dry heating element		
For models:	CS654, CSP6020, CSP7020, RP72TPS		



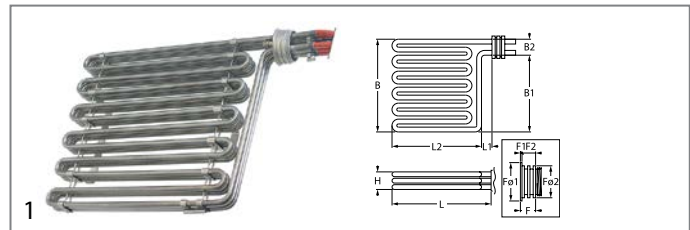

			
GEV No.	415091	Ref. No.	1037039513 MA1037039513
description	heating element 1000W 230V heating circuits 1 L 295mm W 85mm connection length 20mm connection M3 tube ø 6.5mm 2 hole fixing thread M14x1 immersion heater/dry heating element bain marie/ chip scuttle L1 145mm L2 150mm H 18mm mounting distance 79mm		
For models:	CCW6220, CME6220, CME6230, CME6240, CSP6220, CW62TPS, ERP72, ME62TPS, ME63TPS, ME64TPS, RP62TPS		
accessories for	415091		
	GEV No.	520228	Ref. No. —
	tooth lock washer ID ø 15.3mm ED ø 24mm steel Qty 1 pcs for thread M14		
	GEV No.	521133	Ref. No. —
	nut thread M14x1.5 H 6mm WS 19 zinc-coated steel Qty 1 pcs		
	GEV No.	527169	Ref. No. —
	hexagonal nut thread M3 H 2.8mm WS 5.5 brass Qty 1 pcs		
	GEV No.	550261	Ref. No. —
	nut thread M14x1 H 4mm WS 19 SS Qty 1 pcs		
	GEV No.	550262	Ref. No. —
	flat gasket copper ED ø 20mm ID ø 14mm thickness 2mm		
	GEV No.	560110	Ref. No. —
	plain washer ID ø 3.2mm ED ø 7mm thickness 0.5mm SS Qty 20 pcs DIN 125A for thread M3		
	GEV No.	560130	Ref. No. —
	hexagonal nut thread M3 H 2.4mm WS 5.5 SS DIN/ISO DIN 934 / ISO 4032/8673 Qty 20 pcs		

accessories for	416813		
	GEV No.	550662	Ref. No.
	ring nut thread M54x1.5 H 7mm		
			0105152 0108054 0108738 CM021600 MACM021600 SIR0108054 SIR0108738



GEV No.	416814	Ref. No.	0105151 CM032401 CM032401R MACM032401 MACM032401R SIR0105151
description	heating element 16500W 230/400V heating circuits 3 mounting pos. right L 400mm W 315mm H 36mm flange length 23mm flange length 1 2mm flange length 2 21mm flange ø1 63mm flange ø2 57.5mm sensor screw connection 2x M10x1 thermostat sleeve eccentric L1 15mm L2 378mm W1 282mm W2 33mm thread M54x1.5 windings 6 for o-ring ø 50.39mm tube ø 8.5mm cable length 280mm connection cable rotation flange immersion heater fryer connection length 75mm 2		
For models:	FE82118, FE82T18, FE84218, FE84T18, FE92118, FE94218, FEY2118, FEY4218		

accessories for	416814		
	GEV No.	106605	Ref. No.
	union screw thread M10x1 probe ø max. 4.5mm		
			0105033 CM012401 MACM012401 SIR0105033

	GEV No.	528687	Ref. No.
	O-ring Viton thickness 1.78mm ID ø 3.69mm Qty 1 pcs		
			0105034 CM097900 MACM097900 SIR0105034

	GEV No.	550496	Ref. No.
	O-ring Viton thickness 3.53mm ID ø 50.39mm Qty 1 pcs		
			0105021 CM099200 MACM099200 SIR0105021



	GEV No.	550662	Ref. No.
	ring nut thread M54x1.5 H 7mm		
			0105152 0108054 0108738 CM021600 MACM021600 SIR0108054 SIR0108738

heating elements for fryers

side connection

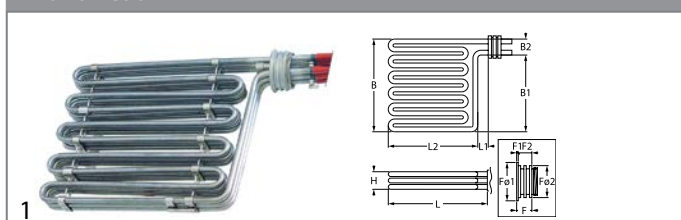
with thread



GEV No.	416813	Ref. No.	0105154
description	heating element 10500W 230/400V heating circuits 3 mounting pos. right L 320mm W 240mm H 32mm flange length 21mm flange length 1 2mm flange length 2 19mm flange ø1 63mm flange ø2 57.5mm sensor screw connection 2x M10x1 thermostat sleeve upper/lower L1 20mm L2 300mm W1 204mm W2 33mm thread M54x1.5 windings 5 tube ø 8.5mm cable length 460mm rotation flange fryer fryer connection length 90mm 2		
For models:	FE72112, FE74212		
accessories for	416813		
	GEV No.	550449	Ref. No. —
	special wrench for ring nut		
	GEV No.	550496	Ref. No.
	O-ring Viton thickness 3.53mm ID ø 50.39mm Qty 1 pcs		
			0105021 CM099200 MACM099200 SIR0105021

off-center connection

with thread

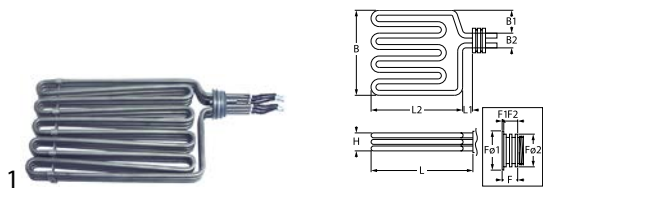

GEV No.	416070	Ref. No.	0108057 SIR0108057
----------------	--------	-----------------	-----------------------

description heating element 10200W 230/400V heating circuits 3 L 300mm W 180mm H 33mm flange length 19.5mm flange length 1 9.5mm flange length 2 9.8mm flange ø1 62mm flange ø2 57mm thermostat sleeves ø 6.5mm sensor screw connection 2x M10x1 thermostat sleeve upper/lower L1 18mm L2 282mm W1 30mm W2 35mm thread M54x1.5 windings 5 tube ø 8.5mm cable length 450mm rotation flange immersion heater fryer connection length 130mm 2

For models: CFE70115, CFE70115-2, CFE70115-M, CFE70215, CFE70215-2, CFE70215-M

spare parts for 416070

GEV No.	510243	Ref. No.	—
----------------	--------	-----------------	---

O-ring Viton thickness 3.53mm ID ø 55.56mm Qty 1 pcs

GEV No.	550496	Ref. No.	0105021 CM099200 MACM099200 SIR0105021
----------------	--------	-----------------	---

O-ring Viton thickness 3.53mm ID ø 50.39mm Qty 1 pcs

accessories for 416070

GEV No.	510243	Ref. No.	—
----------------	--------	-----------------	---

O-ring Viton thickness 3.53mm ID ø 55.56mm Qty 1 pcs

GEV No.	550662	Ref. No.	0105152 0108054 0108738 CM021600 MACM021600 SIR0108054 SIR0108738
----------------	--------	-----------------	---

ring nut thread M54x1.5 H 7mm

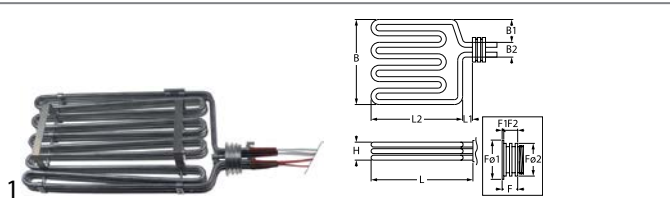

GEV No.	420113	Ref. No.	CR0583860 CR0583860R
----------------	--------	-----------------	-------------------------

description heating element 12000W 230V heating circuits 3 L 385mm W 205mm H 32mm flange length 21mm flange length 1 2mm flange length 2 19mm flange ø1 63mm flange ø2 54mm sensor screw connection 2x M10x1 thermostat sleeve upper/lower L1 20mm L2 365mm W1 45mm W2 32mm thread M54x1.5 tube ø 8.5mm cable length 300mm rotation flange immersion heater with probe intake ø 4mm for fryer

For models: EFE72115, EFE74215, EFE92115, EFE94215

accessories for 420113

GEV No.	532681	Ref. No.	CR0582140
----------------	--------	-----------------	-----------

O-ring Viton thickness 3.53mm ID ø 66.27mm Qty 1 pcs

GEV No.	550496	Ref. No.	0105021 CM099200 MACM099200 SIR0105021
----------------	--------	-----------------	---

O-ring Viton thickness 3.53mm ID ø 50.39mm Qty 1 pcs

accessories for 420113

GEV No.	550662	Ref. No.	0105152 0108054 0108738 CM021600 MACM021600 SIR0108054 SIR0108738
----------------	--------	-----------------	---

ring nut thread M54x1.5 H 7mm

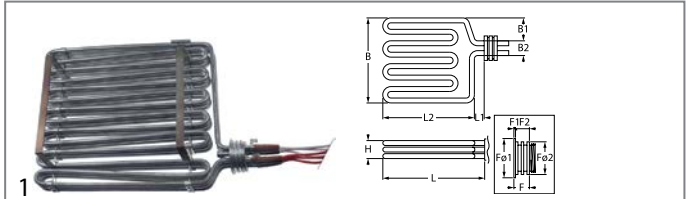

GEV No.	420112	Ref. No.	CR0583740 CR0583740R
----------------	--------	-----------------	-------------------------

description heating element 18000W 400V heating circuits 3 L 387mm W 305mm H 34mm flange length 21mm flange length 1 2.5mm flange length 2 18.5mm flange ø1 63mm flange ø2 54mm sensor screw connection 2x M10x1 thermostat sleeve upper/lower L1 25mm L2 362mm W1 45mm W2 32mm thread M54x1.5 tube ø 8.5mm cable length 350mm rotation flange immersion heater with probe intake ø 4mm for fryer

For models: EFE92122, EFE92122K, EFE94222, EFE94222K

accessories for 420112

GEV No.	550496	Ref. No.	0105021 CM099200 MACM099200 SIR0105021
----------------	--------	-----------------	---

O-ring Viton thickness 3.53mm ID ø 50.39mm Qty 1 pcs

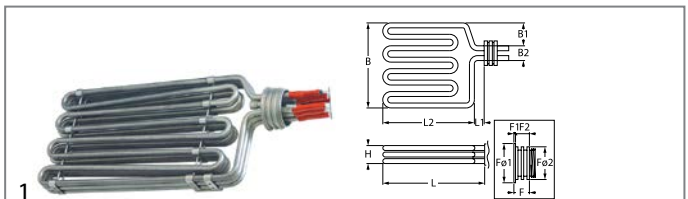

GEV No.	416812	Ref. No.	1037316601 1037316601R MA1037316601 MA1037316601R
----------------	--------	-----------------	--

description heating element 9000W 230/400V heating circuits 3 mounting pos. right L 360mm W 170mm H 35mm flange length 21mm flange length 1 2mm flange length 2 19mm flange ø1 63mm flange ø2 57.5mm thermostat sleeves ø 6.5mm sensor screw connection 2x M10x1 thermostat sleeve upper/lower L1 25mm L2 335mm W1 40mm W2 33mm thread M54x1.5 tube ø 8.7mm cable length 250mm rotation flange immersion heater with probe intake ø 4mm fryer code 3000 2

For models: EFE72110, EFE73210, EFE93210, FE72T10, FE74T10

accessories for 416812

GEV No.	550496	Ref. No.	0105021 CM099200 MACM099200 SIR0105021
----------------	--------	-----------------	---

O-ring Viton thickness 3.53mm ID ø 50.39mm Qty 1 pcs

GEV No.	550662	Ref. No.	0105152 0108054 0108738 CM021600 MACM021600 SIR0108054 SIR0108738
----------------	--------	-----------------	---

ring nut thread M54x1.5 H 7mm



center connection

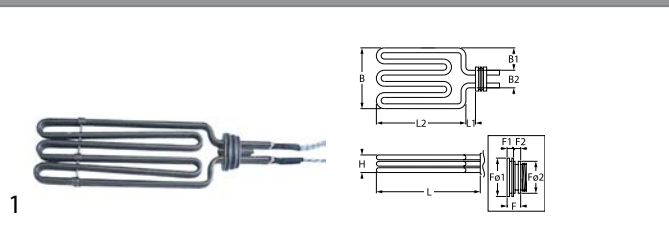

GEV No.	415297	Ref. No.	0108058 BN4185326002136 SI0108058 SIR0108058
description	heating element 6800W 230/400V heating circuits 3 L 299mm W 107mm H 35mm flange length 19.5mm flange length 1 9.5mm flange length 2 9.8mm flange ø1 62mm flange ø2 57mm thermostat sleeves ø 8.5mm sensor screw connection 2x M10x1 thermostat sleeve upper/lower L1 16mm L2 283mm W1 30mm W2 77mm thread M54x1.5 tube ø 8.5mm cable length 450mm rotation flange immersion heater		
For models:	CFE70110, CFE70110-2, CFE70210, CFE70210-2, CFE70210-M, CFE72210, CFE72215, CFE90210, CFE90210-2, FE72210, FE92210		
accessories for	415297		
	GEV No.	510243	Ref. No. —
	O-ring Viton thickness 3.53mm ID ø 55.56mm Qty 1 pcs		
	GEV No.	510245	Ref. No. 0108055 SIR0108055
	O-ring Viton thickness 3.53mm ID ø 50.8mm Qty 1 pcs		
	GEV No.	550447	Ref. No. —
	ring nut thread M54x1.5		

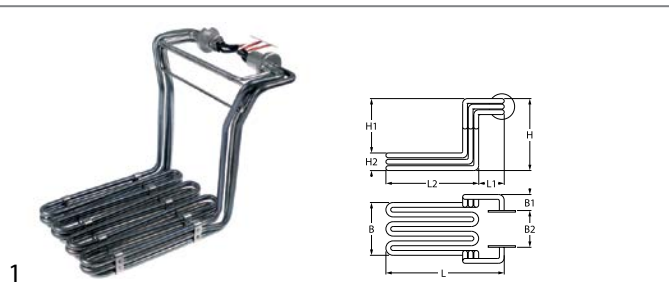

GEV No.	415257	Ref. No.	0109025 SIR0109025
description	heating element 6000W 230/400V heating circuits 3 L 300mm W 182mm H 252mm L1 65mm L2 235mm W1 59mm W2 134mm W3 250mm H1 220mm H2 32mm windings 12 flange ø 40mm rotation flange cable length 380mm fryer heaters mounting ø 25mm		
For models:	CFE60110, CFE60210, CFE70110-0, CFE72110-0, FE72T10		

2 hole fixing

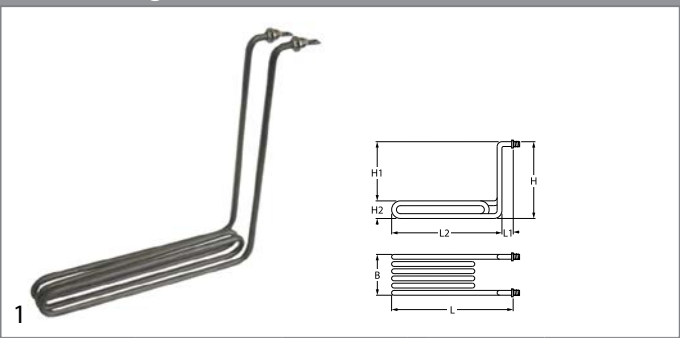



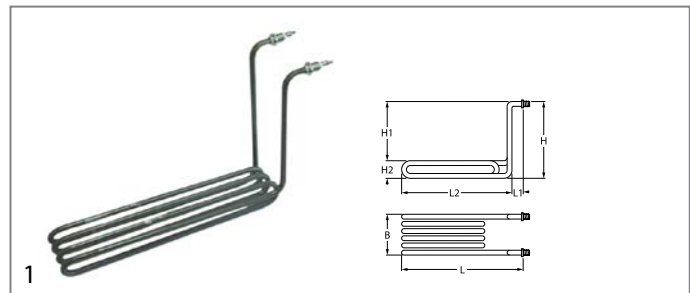

GEV No.	415207	Ref. No.	0108020 SIR0108020
description	heating element 2185W 230V heating circuits 1 L 325mm W 35mm H 320mm L1 29mm L2 292mm H1 275mm H2 42mm thread 1/4" mounting distance 27mm tube ø 8.5mm 2 hole fixing connection M5 connection length 22mm fryer heaters windings 3		
accessories for	415207		
	GEV No.	361182	Ref. No. —
	nut thread 1/4" H 5mm nickel-plated brass WS 17 Qty 1 pcs		
	GEV No.	510417	Ref. No. —
	flat gasket fibre ED ø 20mm ID ø 14mm thickness 2mm Qty 1 pcs		
	GEV No.	520228	Ref. No. —
	tooth lock washer ID ø 15.3mm ED ø 24mm steel Qty 1 pcs for thread M14		
	GEV No.	550262	Ref. No. —
	flat gasket copper ED ø 20mm ID ø 14mm thickness 2mm		



GEV No.	416055	Ref. No.	0109021 SIR0109021
description	heating element 3000W 230V heating circuits 1 L 335mm W 65mm H 223mm L1 20mm L2 315mm H1 180mm H2 40mm thread 1/4" mounting distance 57mm tube ø 8.5mm 2 hole fixing connection M4 connection length 26mm immersion heater windings 4		
For models:	CFE60110-5, CFE60110-9, CFE60210-5, CFE60210-9		
accessories for	416055		
	GEV No.	361182	Ref. No. —
	nut thread 1/4" H 5mm nickel-plated brass WS 17 Qty 1 pcs		
	GEV No.	510417	Ref. No. —
	flat gasket fibre ED ø 20mm ID ø 14mm thickness 2mm Qty 1 pcs		
	GEV No.	520228	Ref. No. —
	tooth lock washer ID ø 15.3mm ED ø 24mm steel Qty 1 pcs for thread M14		
	GEV No.	521103	Ref. No. —
	nut thread M4 H 3mm WS 7 brass Qty 20 pcs		

Table continues overleaf



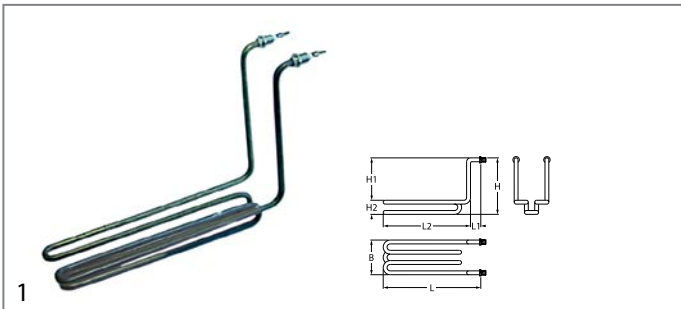

accessories for 416055			
	GEV No.	521104	Ref. No. —
washer ID ø 4.3mm ED ø 8mm thickness 0.5mm brass Qty 20 pcs for thread M4			
	GEV No.	550262	Ref. No. —
flat gasket copper ED ø 20mm ID ø 14mm thickness 2mm			
	GEV No.	560111	Ref. No. —
plain washer ID ø 4.3mm ED ø 9mm thickness 0.8mm SS Qty 20 pcs DIN 125A for thread M4			
	GEV No.	560131	Ref. No. —
hexagonal nut thread M4 H 3.2mm WS 7 SS DIN/ISO DIN 934 / ISO 4032/8673 Qty 20 pcs			



GEV No.	416054	Ref. No.	0109022 SIR0109022
description	heating element 1700W 230V heating circuits 1 L 320mm W 70mm H 215mm L1 25mm L2 295mm H1 177mm H2 38mm thread 1/4" mounting distance 62mm tube ø 8.5mm 2 hole fixing connection M4 immersion heater windings 3		
For models:	CFE60110-5, CFE60110-9, CFE60210-5, CFE60210-9		
accessories for 416054			
	GEV No.	361182	Ref. No. —
nut thread 1/4" H 5mm nickel-plated brass WS 17 Qty 1 pcs			
	GEV No.	510417	Ref. No. —
flat gasket fibre ED ø 20mm ID ø 14mm thickness 2mm Qty 1 pcs			
	GEV No.	520228	Ref. No. —
tooth lock washer ID ø 15.3mm ED ø 24mm steel Qty 1 pcs for thread M14			
	GEV No.	521103	Ref. No. —
nut thread M4 H 3mm WS 7 brass Qty 20 pcs			
	GEV No.	521104	Ref. No. —
washer ID ø 4.3mm ED ø 8mm thickness 0.5mm brass Qty 20 pcs for thread M4			
	GEV No.	550262	Ref. No. —
flat gasket copper ED ø 20mm ID ø 14mm thickness 2mm			
	GEV No.	560111	Ref. No. —
plain washer ID ø 4.3mm ED ø 9mm thickness 0.8mm SS Qty 20 pcs DIN 125A for thread M4			
	GEV No.	560131	Ref. No. —
hexagonal nut thread M4 H 3.2mm WS 7 SS DIN/ISO DIN 934 / ISO 4032/8673 Qty 20 pcs			

GEV No.	415712	Ref. No.	0101499 SIR0101499
description	heating element 1800W 230V heating circuits 1 L 294mm W 48mm H 290mm 2 hole fixing immersion heater L1 30mm L2 30mm L3 234mm H1 70mm H2 170mm H3 50mm tube ø 6.3mm thread 1/8" mounting distance 40mm		

heating elements for griddles

GEV No.	415076	Ref. No.	1037300713 MA1037300713
description	heating element 1300W 230V heating circuits 1 L 490mm W 78mm H 70mm tube ø 6.3mm W1 17mm W2 44mm connection M4 connection length 20mm dry heating element		
accessories for 415076			
	GEV No.	521103	Ref. No. —
nut thread M4 H 3mm WS 7 brass Qty 20 pcs			
	GEV No.	521104	Ref. No. —
washer ID ø 4.3mm ED ø 8mm thickness 0.5mm brass Qty 20 pcs for thread M4			
	GEV No.	560111	Ref. No. —
plain washer ID ø 4.3mm ED ø 9mm thickness 0.8mm SS Qty 20 pcs DIN 125A for thread M4			
	GEV No.	560131	Ref. No. —
hexagonal nut thread M4 H 3.2mm WS 7 SS DIN/ISO DIN 934 / ISO 4032/8673 Qty 20 pcs			







GEV No.	415369	Ref. No.	0101529 SIR0101529
description	heating element 1350W 230V heating circuits 1 L 435mm W 46mm Hmm tube ø 8.5mm 2 hole fixing connection M5 thread 1/4" mounting distance 38mm griddle dry heating element		
accessories for 415369			
	GEV No.	361182	Ref. No. —
nut thread 1/4" H 5mm nickel-plated brass WS 17 Qty 1 pcs			
	GEV No.	510417	Ref. No. —
flat gasket fibre ED ø 20mm ID ø 14mm thickness 2mm Qty 1 pcs			
	GEV No.	520228	Ref. No. —
tooth lock washer ID ø 15.3mm ED ø 24mm steel Qty 1 pcs for thread M14			
	GEV No.	550262	Ref. No. —
flat gasket copper ED ø 20mm ID ø 14mm thickness 2mm			

Table continues overleaf





accessories for 415369	
	GEV No. 560112 Ref. No. — plain washer ID ø 5.3mm ED ø 10mm thickness 1mm SS Qty 20 pcs DIN 125A for thread M5
	GEV No. 560132 Ref. No. — hexagonal nut thread M5 H 4mm WS 8 SS DIN/ISO DIN 934 / ISO 4032/8673 Qty 20 pcs

			
GEV No.	415651	Ref. No.	0109041 SI0109041 SIR0109041
description	heating element 1500W 230V heating circuits 1 L 425mm W 72mm H 53mm tube ø 8.5mm L1 22mm connection male faston 6.3mm connection distance 52mm dry heating element		
For models:	BE72ALC, BE72ALL, BE72ARR, BE72GLC, BE72GLL, BE72GRR, BE72TLC, BE72TLL, BE72TRR, BE74ALC, BE74ALL, BE74ALR, BE74ARC, BE74ARR, BE74GLC, BE74GLL, BE74GLR, BE74GMC, BE74GRR, BE74TLC, BE74TLL, BE74TLR, BE74TMC, BE74TRR, CGE6020, CGE6020C, CGE6020R, CGE6030, CGE6030C, CGE6030R, CGE6040, CGE6040C, CGE6040R, CGE7020, CGE7020C, CGE7020R, CGE7021, CGE7021C, CGE7021R, CGE7022, CGE7022C, CGE7022R, CGE7040, CGE7040C, CGE7040LR, CGE7040LRC, CGE7040R, CGE7041, CGE7041C, CGE7041LR...(Other models you can see in the webshop)		

			
GEV No.	415296	Ref. No.	0101563 SI0101563 SIR0101563
description	heating element 1580W 230V heating circuits 1 L 460mm W 65mm H 71mm tube ø 8.5mm L1 20mm L2 440mm connection male faston 6.3mm griddle connection distance 57mm dry heating element		
For models:	BE72ALC, BE72ALL, BE72ARR, BE72GLC, BE72GLL, BE72GRR, BE72TLC, BE72TLL, BE72TRR, BE74ALC, BE74ALL, BE74ALR, BE74ARC, BE74ARR, BE74GLC, BE74GLL, BE74GLR, BE74GMC, BE74GRR, BE74TLC, BE74TLL, BE74TLR, BE74TMC, BE74TRR, CGE6020, CGE6020C, CGE6020R, CGE6030, CGE6030C, CGE6030R, CGE6040, CGE6040C, CGE6040R, CGE7020, CGE7020C, CGE7020R, CGE7021, CGE7021C, CGE7021R, CGE7022, CGE7022C, CGE7022R, CGE7040, CGE7040C, CGE7040LR, CGE7040LRC, CGE7040R, CGE7041, CGE7041C, CGE7041LR...(Other models you can see in the webshop)		

			
GEV No.	420103	Ref. No.	CR0689240
description	heating element 1800W 230V heating circuits 1 L 460mm W 90mm H 78mm tube ø 8.5mm L1 33mm connection M5 connection length 18mm for griddle connection distance 81.5mm dry heating element		
For models:	EBE7		

			
GEV No.	420105	Ref. No.	CR0731580
description	heating element 2000W 230V heating circuits 1 L 480mm W 90mm H 42mm tube ø 8.5mm IRCA L1 50mm L2 430mm W1 49mm W2 20mm flange connection connection M5 hole distance 89mm flange length 100mm flange width 35mm hole ø 6mm windings 2 dry heating element		
For models:	EGVE7		

			
GEV No.	415254	Ref. No.	0101520 SIR0101520
description	heating element 2000W 230V heating circuits 1 L 550mm W 93mm H 72mm tube ø 8.5mm connection M5 connection length 22mm dry heating element		
For models:	BE94ALC, BE94ALL, BE94ALR, BE94AMC, BE94ARC, BE94ARR, BE- 94GLC, BE94GLL, BE94GLR, BE94GMC, BE94GRC, BE94GRR, BEY4TLC, BEY4TLL, BEY4TLR, BEY4TMC, BEY4TRC, BEY4TRR, CGE9040-0, CGE9040-1, CGE9040-2, CGE9040-3, CGE9040-4, CGE9040-5, CGE9041-0, CGE9041-1, CGE9041-2, CGE9041-3, CGE9041-4, CGE9041-5, CGE9042-0, CGE9042-1, CGE9042-2, CGE9042-3, CGE9042-4, CGE9042-5		

			
GEV No.	415253	Ref. No.	0101521 SI0101521 SIR0101521
description	heating element 2000W 240V heating circuits 1 L 548mm W 72mm H 70mm tube ø 8.5mm connection M5 connection length 23mm connection distance 65mm dry heating element		
For models:	BE92ALC, BE92ALL, BE92ARC, BE92ARR, BE92GLC, BE92GLL, BE92GRC, BE92GRR, BEY2TLC, BEY2TLL, BEY2TRC, BEY2TRR, CGE9020-0, CGE9020-1, CGE9020-2, CGE9020-3, CGE9021-0, CGE9021-1, CGE9021-2, CGE9021-3, CGE9022-0, CGE9022-1, CGE9022-2, CGE9022-3		

			
GEV No.	420102	Ref. No.	CR0730070
description	heating element 2500W 230V heating circuits 1 L 465mm W 155mm H 79mm tube ø 8.8mm L1 30mm connection M5 connection length 18mm for griddle connection distance 146mm dry heating element		
For models:	EBE7		

			
GEV No.	420109	Ref. No.	CR0582840
description	heating element 2500W 230V heating circuits 1 L 635mm W 90mm H 80mm L1 30mm connection M5 connection distance 81.5mm tube ø 8.5mm connection length 18mm dry heating element for griddle		
For models:	EBE92AL, EBE92ALC, EBE92AR, EBE92ARC, EBE92GL, EBE92GLC, EBE- 92GR, EBE92GRC, EBE92TL, EBE92TLC, EBE92TR, EBE92TRC, EBE94AL, EBE94ALC, EBE94ALR, EBE94AMC, EBE94AR, EBE94GL, EBE94GLC, EBE94GLR, EBE94GMC, EBE94GR, EBE94TL, EBE94TLC, EBE94TLR, EBE94TMC, EBE94TR		

			
GEV No.	420415	Ref. No.	CR0937830
description	heating element 2600W 230V heating circuits 1 L 480mm W 90mm H 42mm tube ø 8.5mm L1 50mm L2 430mm W1 49mm W2 20mm flange connection connection M5 hole distance 89mm flange length 100mm flange width 35mm hole ø 6mm windings 2 dry heating element		



			
GEV No.	420110	Ref. No.	CR0685730
description	heating element 3500W 230V heating circuits 1 L 635mm W 140mm H 80mm tube ø 8.5mm L1 35mm connection M5 connection length 18mm for griddle connection distance 131.5mm dry heating element		
For models:	EBE93AL, EBE93ALC, EBE93ALR, EBE93AMC, EBE93GL, EBE93GLC, EBE93GLR, EBE93GMC, EBE93TL, EBE93TLC, EBE93TLR, EBE93TMC		

heating elements for large hobs



			
GEV No.	418718	Ref. No.	0101519 SI0101519 SIR0101519
description	heating element 1500W 230V heating circuits 1 L 265mm W 100mm H 70mm tube ø 6mm mounting pos. windings 3		
For models:	CTE9141, CTE9142, CTE9142S, CTE9146, TE94, TE94APS, TE94EPS, TE94GPS, TEY4APS		

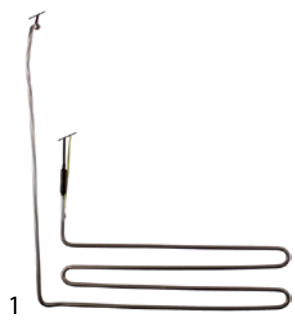

heating elements for refrigeration

heating elements for defrosting

			
GEV No.	418752	Ref. No.	1666355 BN1666355 FR6621230
description	heating element 350W 230V L 395mm W 450mm L1 45mm L2 360mm W1 360mm W2 95mm cable length 1000mm tube ø 6mm defrosting connection with cable		

heating elements for tilting bratt pan

			
GEV No.	415076	Ref. No.	1037300713 MA1037300713
description	heating element 1300W 230V heating circuits 1 L 490mm W 78mm H 70mm tube ø 6.3mm W1 17mm W2 44mm connection M4 connection length 20mm dry heating element		
accessories for	415076		
	GEV No.	521103	Ref. No. —
	nut thread M4 H 3mm WS 7 brass Qty 20 pcs		
	GEV No.	521104	Ref. No. —
	washer ID ø 4.3mm ED ø 8mm thickness 0.5mm brass Qty 20 pcs for thread M4		

accessories for	415076		
	GEV No.	560111	Ref. No. —
	plain washer ID ø 4.3mm ED ø 9mm thickness 0.8mm SS Qty 20 pcs DIN 125A for thread M4		
	GEV No.	560131	Ref. No. —
	hexagonal nut thread M4 H 3.2mm WS 7 SS DIN/ISO DIN 934 / ISO 4032/8673 Qty 20 pcs		

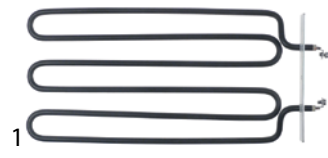
			
GEV No.	420107	Ref. No.	CR0732870
description	heating element 3300W 230V L 380mm W 185mm H 29mm connection M5 dry heating element heating circuits 1 tube ø 8.5mm L1 35mm L2 345mm W1 48mm W2 90mm flange connection flange length 170mm flange width 30mm hole ø 6mm windings 3		
For models:	ESE74		

			
GEV No.	420104	Ref. No.	CR0683221
description	heating element for tilting bratt pan 5000W 230V L 555mm W 180mm H 30mm connection M5 dry heating element heating circuits 1 tube ø 8.5mm L1 25mm L2 530mm W1 45mm W2 90mm flange connection flange length 170mm flange width 30mm hole ø 6.3mm windings 3		
For models:	ESE94CRA, ESE94CRM, ESE94FRA, ESE94FRM, ESE96CRA, ESE96FRA		

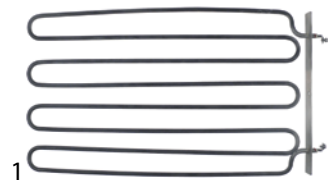



			
GEV No.	420106	Ref. No.	CR0684240
description	heating element for tilting bratt pan 6350W 230V L 550mm W 320mm H 24mm connection M5 dry heating element heating circuits 1 tube ø 8.5mm L1 45mm L2 505mm W1 48mm W2 225mm flange connection flange length 305mm flange width 30mm hole ø 6mm windings 4		
For models:	ESE94CRA, ESE94CRM, ESE94FRA, ESE94FRM, ESE96CRA, ESE96FRA		



			
GEV No.	415250	Ref. No.	0101527 SI0101527 SIR0101527
description	heating element grill 1650W 230V L 490mm W 42mm H 45mm connection M4 dry heating element heating circuits 1 tube ø 8.5mm 2 hole fixing thread 1/4" mounting distance 37mm		
For models:	CBE9060, CBE9060C, CGE9020, CGE9020C, CGE9020R, CGE9020RC, CGE9021, CGE9021C, CGE9021R, CGE9021RC, CGE9022, CGE9022C, CGE9022R, CGE9022RC, CGE9040, CGE9040C, CGE9040LR, CGE9040LRC, CGE9040R, CGE9040RC, CGE9041, CGE9041C, CGE9041LR, CGE9041LRC, CGE9041R, CGE9041RC, CGE9042, CGE9042C, CGE9042LR, CGE9042LRC, CGE9042R, CGE9042RC, SE84CRA, SE84CRM, SE84FRA, SE84FRM, SE84IRA, SE84IRM, SE94CRA, SE94CRM, SE94FRA, SE94FRM, SE94IRA, SE94IRM		







			
1			
GEV No.	415298	Ref. No.	0101526 SIO101526 SIR0101526
description	heating element tilting bratt pan 3400W 230V L 315mm W 195mm H 85mm connection M5 dry heating element heating circuits 1 tube ø 10mm W1 68mm W2 58mm		
For models:	CBE7050, CBE7050C, SE74CRM, SE74FRM, SE74IRM		

heating elements for pasta cookers

			
1			
GEV No.	415295	Ref. No.	0108111 SIR0108111
description	heating element 1840W 230V L 275mm W 70mm 2 hole fixing connection M4 thread 1/4" tube ø 8.5mm mounting distance 62mm pasta cooker immersion heater		
For models:	CNE70130, CNE70160, CNE72130, CNE72160, CNE90130, CNE90130-S, CNE90160, CNE90160S, CNE90160-S, CNE90230, DE72125, DE74170, DE94170, DEY4160		
accessories for	415295		
	GEV No.	361182	Ref. No. —
	nut thread 1/4" H 5mm nickel-plated brass WS 17 Qty 1 pcs		
	GEV No.	510417	Ref. No. —
	flat gasket fibre ED ø 20mm ID ø 14mm thickness 2mm Qty 1 pcs		
	GEV No.	520228	Ref. No. —
	tooth lock washer ID ø 15.3mm ED ø 24mm steel Qty 1 pcs for thread M14		
	GEV No.	550262	Ref. No. —
	flat gasket copper ED ø 20mm ID ø 14mm thickness 2mm		

			
1			
GEV No.	415902	Ref. No.	0109035 SIR0109035
description	heating element 2510W 230V L 295mm W 115mm Hmm 2 hole fixing connection male faston 6.3mm thread M14x1 tube ø 8.5mm		
For models:	CNE6030		
accessories for	415902		
	GEV No.	510417	Ref. No. —
	flat gasket fibre ED ø 20mm ID ø 14mm thickness 2mm Qty 1 pcs		
	GEV No.	520228	Ref. No. —
	tooth lock washer ID ø 15.3mm ED ø 24mm steel Qty 1 pcs for thread M14		

accessories for	415902		
	GEV No.	521133	Ref. No. —
	nut thread M14x1.5 H 6mm WS 19 zinc-coated steel Qty 1 pcs		
	GEV No.	550261	Ref. No. —
	nut thread M14x1 H 4mm WS 19 SS Qty 1 pcs		
	GEV No.	550262	Ref. No. —
	flat gasket copper ED ø 20mm ID ø 14mm thickness 2mm		

			
1			
GEV No.	420096	Ref. No.	CR0731030 CR0731030R
description	heating element 5600W 230V heating circuits 3 L 255mm W 210mm H 32mm rotation flange thread M54x1.5 tube ø 8.4mm L1 60mm L2 195mm W1 180mm W2 30mm cable length 1200mm windings 2 flange length 1 2mm flange length 2 20mm flange length 21mm flange ø1 63mm flange ø2 54mm for pasta cooker immersion heater		
For models:	EDE72128, EDE74228		

			
1			
GEV No.	415977	Ref. No.	0105199 MA1870000R SIR0105199
description	heating element 5670W 230V heating circuits 3 L 292mm W 225mm H 26mm rotation flange tube ø 6.3mm thermostat sleeves ø 9mm length thermostat sleeves 185mm L1 42mm L2 250mm W1 197mm W2 28mm cable length 460mm number of thermostat sleeves 1 connection length 50mm flange length 1 9mm flange length 2 15.5mm flange length 24.5mm flange ø1 43.8mm flange ø2 39.7mm thermostat sleeve centred, adjacent pasta cooker sensor screw connection M10x1		
For models:	DE72128, DE74228		





accessories for	415977		
	GEV No.	514016	Ref. No.
			0105170 MA1814500 SIR0105170
	flat gasket PTFE ED ø 45mm ID ø 40mm thickness 4mm Qty 1 pcs equiv. no. 1036500400/1814500 suitable for MARENO		
	GEV No.	514017	Ref. No.
			0105169 0105246 1814400 MA1814400 SIR0105169 SIR0105246
	O-ring silicone thickness 3.53mm ID ø 32.93mm Qty 1 pcs		
	GEV No.	514018	Ref. No. —
	bush		
	GEV No.	514020	Ref. No. —
	bush		





Table continues overleaf

accessories for		415977	
	GEV No.	514021	Ref. No. —
O-ring silicone thickness 3.53mm ID ø 49.21mm Qty 1 pcs			
	GEV No.	514022	Ref. No. —
nut thread 1½" H 12mm SS WS 59 Qty 1 pcs			
	GEV No.	540435	Ref. No. —
threaded rod thread M10 hollow			
	GEV No.	540436	Ref. No. —
hexagonal nut thread M10x1.25 H 4mm WS 13 brass Qty 1 pcs			
	GEV No.	540438	Ref. No. —
long nut thread M10 L 25mm WS 13 brass Qty 1 pcs			
	GEV No.	540439	Ref. No. —
distance washer			





GEV No.	415991	Ref. No.	0105168 1869900 MA1869900 MA1869900R SIR0105168
description	heating element 8499W 230V heating circuits 3 L 405mm W 225mm H 25mm rotation flange tube ø 6.3mm thermostat sleeves ø 9mm length thermostat sleeves 223mm L1 40mm L2 365mm W1 196mm W2 29mm cable length 1250mm number of thermostat sleeves 1 connection length 48mm flange length 1 9mm flange length 2 15.5mm flange length 24.5mm flange ø1 43.8mm flange ø2 39.7mm suitable for 900 series thermostat sleeve centred, adjacent pasta cooker sensor screw connection M10x1		
For models:	DE82140, DE82142, DE82T42, DE84240, DE84242, DE84T42, DE92142, DE94242, DEY2142, DEY4242		

accessories for		415991	
	GEV No.	514016	Ref. No. 0105170 MA1814500 SIR0105170
flat gasket PTFE ED ø 45mm ID ø 40mm thickness 4mm Qty 1 pcs equiv. no. 1036500400/1814500 suitable for MARENO			
	GEV No.	514017	Ref. No. 0105169 0105246 1814400 MA1814400 SIR0105169 SIR0105246
O-ring silicone thickness 3.53mm ID ø 32.93mm Qty 1 pcs			
	GEV No.	514018	Ref. No. —
bush			
	GEV No.	514019	Ref. No. —
threaded rod thread M8 L 45mm brass			
	GEV No.	514020	Ref. No. —
bush			
	GEV No.	514021	Ref. No. —
O-ring silicone thickness 3.53mm ID ø 49.21mm Qty 1 pcs			





accessories for		415991	
	GEV No.	514022	Ref. No. —
nut thread 1½" H 12mm SS WS 59 Qty 1 pcs			
	GEV No.	540435	Ref. No. —
threaded rod thread M10 hollow			
	GEV No.	540436	Ref. No. —
hexagonal nut thread M10x1.25 H 4mm WS 13 brass Qty 1 pcs			
	GEV No.	540438	Ref. No. —
long nut thread M10 L 25mm WS 13 brass Qty 1 pcs			
	GEV No.	540439	Ref. No. —
distance washer			



GEV No.	420098	Ref. No.	CR0582040 CR0582040R
description	heating element 8500W 230V heating circuits 3 L 378mm W 210mm H 32mm rotation flange thread M54x1.5 tube ø 8.4mm L1 68mm L2 310mm W1 178mm W2 32mm cable length 1250mm windings 3 flange length 1 2mm flange length 2 19mm flange length 21mm flange ø1 63mm flange ø2 54mm for pasta cooker immersion heater		
For models:	EDE92142, EDE93142, EDE94242		
accessories for	420098		
	GEV No.	514419	Ref. No. CR0586210
bracket for heating element L 68mm W 20mm H 28mm			
	GEV No.	550496	Ref. No. 0105021 CM099200 MACM099200 SIR0105021
O-ring Viton thickness 3.53mm ID ø 50.39mm Qty 1 pcs			



 <p>1</p>			
GEV No.	415971	Ref. No.	1870100 1870100R MA1870100 MA1870100R
description	heating element 9000W 230/415V heating circuits 3 L 245mm W 320mm H 25mm rotation flange tube ø 6.3mm thermostat sleeves ø 7mm length thermostat sleeves 210mm L1 55mm L2 190mm W1 28mm W2 292mm cable length 600mm number of thermostat sleeves 1 connection length 35mm flange length 1 9mm flange length 2 15.5mm flange length 24.5mm flange ø1 43.8mm flange ø2 39.7mm mounting pos. left suitable for 600 series thermostat sleeve centred, adjacent pasta cooker sensor screw connection M10x1		
For models:	CNE6230, DE63128		
accessories for	415971		
	GEV No.	514016	Ref. No. 0105170 MA1814500 SIR0105170
	flat gasket PTFE ED ø 45mm ID ø 40mm thickness 4mm Qty 1 pcs equiv. no. 1036500400/1814500 suitable for MARENO		
	GEV No.	514017	Ref. No. 0105169 0105246 1814400 MA1814400 SIR0105169 SIR0105246
	O-ring silicone thickness 3.53mm ID ø 32.93mm Qty 1 pcs		
	GEV No.	514018	Ref. No. —
	bush		
	GEV No.	514019	Ref. No. —
	threaded rod thread M8 L 45mm brass		
	GEV No.	514020	Ref. No. —
	bush		
	GEV No.	514021	Ref. No. —
	O-ring silicone thickness 3.53mm ID ø 49.21mm Qty 1 pcs		
	GEV No.	514022	Ref. No. —
	nut thread 1½" H 12mm SS WS 59 Qty 1 pcs		
	GEV No.	540435	Ref. No. —
	threaded rod thread M10 hollow		
	GEV No.	540436	Ref. No. —
	hexagonal nut thread M10x1.25 H 4mm WS 13 brass Qty 1 pcs		
	GEV No.	540438	Ref. No. —
	long nut thread M10 L 25mm WS 13 brass Qty 1 pcs		
	GEV No.	540439	Ref. No. —
	distance washer		

 <p>1</p>			
GEV No.	420097	Ref. No.	CR0688330
description	heating element 9000W 230V heating circuits 3 L 250mm W 325mm H 32mm rotation flange thread M54x1.5 tube ø 8.3mm L1 200mm L2 50mm W1 293mm W2 32mm cable length 1200mm windings 2 flange length 1 2mm flange length 2 19mm flange length 21mm flange ø1 63mm flange ø2 54mm for pasta cooker immersion heater		
For models:	EDE73142		
accessories for	420097		
	GEV No.	504230	Ref. No. —
	grub screw thread M5 L 8mm A2-A2L DIN 914/ISO 4027 WS 2.5 Qty 1 pcs		
	GEV No.	550496	Ref. No. 0105021 CM099200 MACM099200 SIR0105021
	O-ring Viton thickness 3.53mm ID ø 50.39mm Qty 1 pcs		
	GEV No.	550662	Ref. No. 0105152 0108054 0108738 CM021600 MACM021600 SIR0108054 SIR0108738
	ring nut thread M54x1.5 H 7mm		

heating elements for chargrills







 <p>1</p>			
GEV No.	420467	Ref. No.	CR0681360 CR0842340
description	heating element 3300W 230V L 620mm W 95mm H 40mm W1 20mm W2 48mm L1 15mm L2 30mm L3 575mm flange length 100mm flange width 35mm hole distance 88mm connection M5 heating circuits 1 tube ø 8.5mm connection length 45mm hole ø 6.5mm rectangular flange dry heating element		
For models:	EGVE92, EGVE94		
 <p>1</p>			
GEV No.	415762	Ref. No.	0101522 SIR0101522
description	heating element 850W 230V L 450mm W 45mm H 85mm thread 1/4" mounting distance 37mm tube ø 8.6mm connection M4 connection length 23mm 2 hole fixing dry heating element		
For models:	CRE6-20, CRE6-30		
accessories for	415762		
	GEV No.	361182	Ref. No. —
	nut thread 1/4" H 5mm nickel-plated brass WS 17 Qty 1 pcs		
	GEV No.	510417	Ref. No. —
	flat gasket fibre ED ø 20mm ID ø 14mm thickness 2mm Qty 1 pcs		



Table continues overleaf

accessories for 415762			
	GEV No.	520228	Ref. No. —
tooth lock washer ID ø 15.3mm ED ø 24mm steel Qty 1 pcs for thread M14			
	GEV No.	550262	Ref. No. —
flat gasket copper ED ø 20mm ID ø 14mm thickness 2mm			

			
GEV No.	415250	Ref. No.	0101527 SI0101527 SIR0101527
description	heating element grill 1650W 230V L 490mm W 42mm H 45mm connection M4 dry heating element heating circuits 1 tube ø 8.5mm 2 hole fixing thread 1/4" mounting distance 37mm		
For models:	CBE9060, CBE9060C, CGE9020, CGE9020C, CGE9020R, CGE9020RC, CGE9021, CGE9021C, CGE9021R, CGE9021RC, CGE9022, CGE9022C, CGE9022R, CGE9022RC, CGE9040, CGE9040C, CGE9040LR, CGE9040LRC, CGE9040R, CGE9040RC, CGE9041, CGE9041C, CGE9041LR, CGE9041LRC, CGE9041R, CGE9041RC, CGE9042, CGE9042C, CGE9042LR, CGE9042LRC, CGE9042R, CGE9042RC, SE84CRA, SE84CRM, SE84FRA, SE84FRM, SE84IRA, SE84IRM, SE94CRA, SE94CRM, SE94FRA, SE94FRM, SE94IRA, SE94IRM		

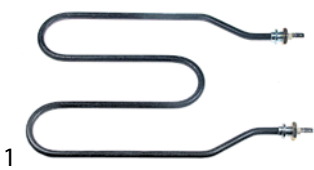
heating elements for plate warmers



			
GEV No.	416828	Ref. No.	0101532 SIR0101532
description	heating element 1000W 240V 2 hole fixing thread 1/4" L 295mm W 206mm connection male faston 6.3mm L1 85mm L3 205mm dry heating element tube ø 8.5mm W1 30mm W2 146mm mounting distance 138mm for heated cabinet		
For models:	CCG1045, CCG10652, CCG10653, CCG1085, CCG10852, CCG9046, CCG90663, CCG91653, CCG91653-1, CCG91663, CCG91663-1, CCQ9046, CCQ90663, CTT9045, CTT9046, CTT90652R, CTT90653R, CTT90663R		



			
GEV No.	416827	Ref. No.	0101494 SI0101494 SIR0101494
description	heating element 1100W 240V 2 hole fixing thread M10x1 L 375mm W 90mm heating circuits 1 connection plug-in connection 4mm L1 25mm L2 25mm L3 325mm dry heating element tube ø 6.3mm W1 23mm W2 44mm mounting distance 38mm for heated cabinet		
For models:	CCG6045, CCG60652, CCG60653, CCG7045, CCG7046, CCG70652, CCG70653, CCG70663, CCG72653, CCG72663, CCQ7046, CCQ70663, CCT7046, CCT70663, CTT72653, CTT72653L		
accessories for	416827		
	GEV No.	101860	Ref. No. —
nut thread M10x1 H 4mm WS 14 chrome-plated brass Qty 1 pcs			

heating cables

connection on both sides			
with male fastons			
			
GEV No.	417576	Ref. No.	FR6621641 FR996456
description	heating cable 45.3W 230V L 5000mm		

ceramic heaters

245x60mm			
			
GEV No.	415104	Ref. No.	0109050 SIR0109050
description	ceramic emitter 1000W 230V cable beaded cord L 245mm W 60mm H 35mm		
For models:	BER12, BER14, BER16, BER18, BER20, CNG70130, CNG70160, CNG70230, CNG72160, CNG72230, CPI70150, CPI90100AP, CPI90100A-P, CPI90100P, CPI90100-P, CPI90150AP, CPI90150A-P, CPI90150P, CPI90150-P, CSP6020, CSP7020, DG72125, DG74155, DG74225, PE9NI10, PE9NI15, PG7NI05, PG8AD10, PG8AD15, PG8AI10, PG8AI15, PG8ND10, PG8ND15, PG8NI10, PG8NI15, PG9AI10, PG9AI15, PG9NI10, PG9NI15, RP72TPS		
spare parts for	415104		
	GEV No.	415109	Ref. No. —
spring clip			
accessories for	415104		
	GEV No.	415110	Ref. No. —
reflector L 245mm W 95mm H 31mm thickness 0.75mm hole ø 15x40mm			

			
GEV No.	415103	Ref. No.	0109051 SIR0109051
description	ceramic emitter 650W 230V cable beaded cord L 245mm W 60mm H 35mm		
For models:	CSP6020, CSP7020, RP72TPS		
spare parts for	415103		
	GEV No.	415109	Ref. No. —
spring clip			
accessories for	415103		
	GEV No.	415110	Ref. No. —
reflector L 245mm W 95mm H 31mm thickness 0.75mm hole ø 15x40mm			



immersion heating elements

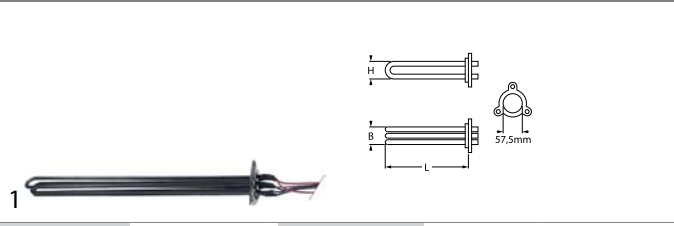

3 hole flange ø57.5mm



GEV No.	420101	Ref. No.	CR0589130 CR0589130R
description	heating element 10500W 400V heating circuits 3 L 580mm W 36mm H 42mm tube ø 8.4mm number of thermostat sleeves 0 cable length 700mm immersion heater 3 hole flange hole distance 73mm mounting ø 57.5mm hole ø 10mm		
For models:	EPE9110, EPE9110A, EPE9115, EPE9115A		
accessories for	420101		
		GEV No.	521146 Ref. No. —
	O-ring Viton thickness 5.34mm ID ø 56.52mm Qty 1 pcs		



GEV No.	420099	Ref. No.	CR0735010 CR0735010R
description	heating element 4800W 230V heating circuits 3 L 390mm W 36mm H 41mm tube ø 8.4mm number of thermostat sleeves 0 cable length 700mm immersion heater 3 hole flange hole distance 73mm mounting ø 57.5mm hole ø 10mm		
For models:	EPE7105		

GEV No.	420100	Ref. No.	CR0737000
description	heating element 8400W 230V heating circuits 3 L 490mm W 36mm H 40mm tube ø 8.4mm number of thermostat sleeves 0 cable length 700mm immersion heater 3 hole flange hole distance 73mm mounting ø 57.5mm hole ø 10mm		
For models:	EPE7108		

GEV No.	420074	Ref. No.	CR0682160 CR0682160R
description	heating element 260W 230V heating circuits 1 L 242mm W 18mm H 6.25mm tube ø 6.25mm thermostat sleeves ø 5mm length thermostat sleeves 230mm number of thermostat sleeves 1 thermostat sleeve centred, adjacent connection male faston 6.3mm connection length 35mm immersion heater flange with thread WS 32 thread 1"		
For models:	EPE7105, EPE7108, EPE9110, EPE9110A, EPE9115, EPE9115A, EPG7105, EPG7108, EPG9115, EPG9115A, EPG9110, EPG9110A		
spare parts for	420074		
		GEV No.	503158 Ref. No. —
	flat gasket FIBER ED ø 44mm ID ø 33mm thickness 2mm Qty 1 pcs		
accessories for	420074		
		GEV No.	507532 Ref. No. —
	nut thread 1" H 10mm WS 40 brass Qty 1 pcs		

GEV No.	415256	Ref. No.	0101493 S10101493 S1R0101493
description	heating element 7500W 230V heating circuits 3 L 480mm W 34mm H 32mm tube ø 6.3mm thermostat sleeves ø 7mm length thermostat sleeves 310mm number of thermostat sleeves 1 thermostat sleeve not clinging connection male faston 6.3mm connection length 52mm immersion heater flange with thread thread 1½"		
For models:	CPE90100, CPE90100A, CPE90150, CPE90150A, PE8A110, PE8A115, PE8N110, PE8N115, PE9A110, PE9A115, PE9N110, PE9N115		
spare parts for	415256		
		GEV No.	510406 Ref. No. —
	flat gasket fibre ED ø 60mm ID ø 48mm thickness 3mm for thread 1½" Qty 1 pcs		
accessories for	415256		
		GEV No.	510424 Ref. No. —
	gasket copper ED ø 55mm ID ø 48mm thickness 2.2mm Centellen for thread 1½"		
		GEV No.	520211 Ref. No. —
	reducer thread 2" ET - 1½" IT brass		
		GEV No.	520212 Ref. No. —
	hexagonal nut thread 1½" brass WS 60 H 8mm		
		GEV No.	550361 Ref. No. —
	blind flange ø 58mm thread 1½"		





2"			
			
1			
GEV No.	415299	Ref. No.	0101495 SIR0101495
description	heating element 6000W 230V heating circuits 3 L 320mm W 40mm H 44mm tube ø 8.5mm thermostat sleeves ø 5mm length thermostat sleeves 280mm connection M4 immersion heater flange with thread 2"		
For models:	CPE70150, CPE7-150, PE7NI05		
accessories for	415299		
	GEV No.	510407	Ref. No. —
	flat gasket fibre ED ø 78mm ID ø 60mm thickness 2mm for heating element for thread 2" Qty 1 pcs		



			
1			
GEV No.	415255	Ref. No.	0101810 SIR0101810
description	heating element 2520W 220V L 443mm W 64mm thread 1/4" mounting distance 46mm tube ø 8.5mm 2 hole fixing immersion heater connection M4		
accessories for	415255		
	GEV No.	521103	Ref. No. —
	nut thread M4 H 3mm WS 7 brass Qty 20 pcs		
	GEV No.	521104	Ref. No. —
	washer ID ø 4.3mm ED ø 8mm thickness 0.5mm brass Qty 20 pcs for thread M4		
	GEV No.	560111	Ref. No. —
	plain washer ID ø 4.3mm ED ø 9mm thickness 0.8mm SS Qty 20 pcs DIN 125A for thread M4		
	GEV No.	560131	Ref. No. —
	hexagonal nut thread M4 H 3.2mm WS 7 SS DIN/ISO DIN 934 / ISO 4032/8673 Qty 20 pcs		

2 connections			
straight			
			
1			
GEV No.	416817	Ref. No.	CR0682150
description	heating element 4000W 230V heating circuits 1 L 619mm W 150mm Hmm tube ø 8.5mm cable length 790mm connection length 18mm kettle suitable for 900 series		
For models:	EPE9D10, EPE9D15		

heating elements for convection

			
1			
GEV No.	415251	Ref. No.	0101564 65010200 LAR65010200 SIR0101564
description	heating element 2500W 230V heating circuits 1 ID ø 178mm ED ø 190mm L 242mm H 35mm L1 46mm W1 31mm H1 10mm H2 25mm flange length 70mm flange width 22mm hole distance 56mm connection male faston 6.3mm horizontal tube ø 6.3mm convection heating element hole ø 5mm rectangular flange		
For models:	BAC100, BAC100-A, BAC102, BAC120, BAC120-A, BAC122, BAC140, BAC140-A, BAC142, BAC160, BAC160-A, BAC162, BAC180, BAC180-A, BAC182, BAC200, BAC200-A, BAC202, BAM16D, BAM16S, BAM18D, BAM18S, BAM20D, BAM20S		
spare parts for	415251		
	GEV No.	510368	Ref. No. —
	gasket L 70mm W 23.5mm hole ø 5mm hole distance 56mm FIBER thickness 2mm for heating element		

radiation heaters

square			
			
1			
GEV No.	490008	Ref. No.	0101468 SIR0101468
description	radiation heater L 300mm W 300mm 4000W 400V heating circuits 2 connections 3 square connection type male faston 6.3mm without pan detection EGO		
For models:	CCQ9020, CCQ9020V, CCQ9020-V, CCQ9021, CCQ9021-V, CCQ9022, CCQ9022-V, CCQ9040, CCQ9040V, CCQ9040-V, CCQ9041, CCQ9041-V, CCQ9042, CCQ9042V, CCQ9042-V, CCQ9046, CCQ9046V, CCQ9046-V, CCQ9121V, CCQ9122V, CCQ9141V, CV92APS, CV92GPS, CV94APS, CV94EPS, CV94GPS, CVY2TPS, CVY4TPS		
spare parts for	490008		
	GEV No.	499157	Ref. No. —
	protection pipe for temperature probe ceramic L 297mm ED ø 7mm ID ø 5mm		

1-circuit			
			
GEV No.	490024	Ref. No.	0101465 SIR0101465
description	radiation heater ø 165mm 1200W 230V heating circuits 1 energy regulation with temperature signalization with heating coil connections 2+2 connection type male faston 6.3mm EGO		
For models:	CCT6020V, CCT6040V, CCT7020-V, CCT7021-V, CCT7022-V, CCT7040-V, CCT7041-V, CCT7042-V, CCT7046-V, CCT7220V, CCT7221V, CCT7222V, CCT7240V, CCT7241V, CCT7242V, CCT7246V, CV72APS, CV72GPS, CV72TPS, CV74APS, CV74EPS, CV74GPS, CV74TPS		

			
GEV No.	490025	Ref. No.	0101466 SIR0101466
description	radiation heater ø 200mm 1700W 230V heating circuits 1 energy regulation with temperature signalization with heating coil connections 2+2 connection type male faston 6.3mm EGO		
For models:	CCT6020V, CCT6040V, CCT7020-V, CCT7021-V, CCT7022-V, CCT7040-V, CCT7041-V, CCT7042-V, CCT7046-V, CCT7220V, CCT7221V, CCT7222V, CCT7240V, CCT7241V, CCT7242V, CCT7246V, CV72APS, CV72GPS, CV72TPS, CV74APS, CV74EPS, CV74GPS, CV74TPS		

accessories

ring nuts			
			
GEV No.	550662	Ref. No.	0105152 0108054 0108738 CM021600 MACM021600 SIR0108054 SIR0108738
description	ring nut thread M54x1.5 H 7mm		
For models:	CFE70110, CFE70110-2, CFE70115, CFE70115-2, CFE70115-M, CFE70210, CFE70210-2, CFE70210-M, CFE70215, CFE70215-2, CFE70215-M, CFE72210, CFE72215, CFE90120, CFE90120-2, CFE90210, CFE90210-2, CFE90220, CFE90220-2, EDE72128, EDE73142, EDE74228, EDE92142, EDE93142, EDE94242, EFE72110, EFE72115, EFE73210, EFE74215, EFE92115, EFE92122, EFE92122K, EFE93210, EFE94215, EFE94222, EFE94222K, FE72112, FE72210, FE72T10, FE74212, FE74T10, FE82118, FE82T18, FE84218, FE84T18, FE92118, FE92210, FE94218, FEY2118, FEY4218		
accessories for	550662		
	GEV No.	550449	Ref. No.
	 special wrench for ring nut		

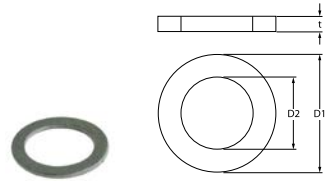
sealing washers			
fibre gaskets			
			
GEV No.	510404	Ref. No.	CR0682770
description	flat gasket fibre ED ø 44mm ID ø 34mm thickness 2mm Qty 1 pcs		

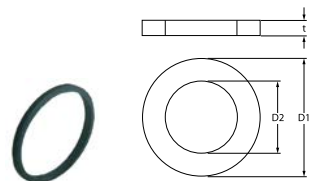
PTFE gaskets			
			
GEV No.	514016	Ref. No.	0105170 MA1814500 SIR0105170
description	flat gasket PTFE ED ø 45mm ID ø 40mm thickness 4mm Qty 1 pcs equiv. no. 1036500400/1814500 suitable for MARENO		
For models:	DE72128, DE74228, DE82140, DE84240, DE92142, DE94242, DEY2142, DEY4242		

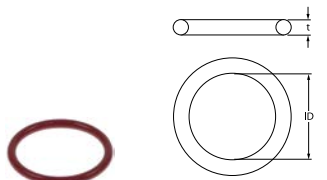
O-rings			
			
GEV No.	514017	Ref. No.	0105169 0105246 1814400 MA1814400 SIR0105169 SIR0105246
description	O-ring silicone thickness 3.53mm ID ø 32.93mm Qty 1 pcs		
For models:	CNE6230, DE63128, DE72128, DE74228, DE82140, DE82142, DE82T42, DE84240, DE84242, DE84T42, DE92142, DE94242, DEY2142, DEY4242		

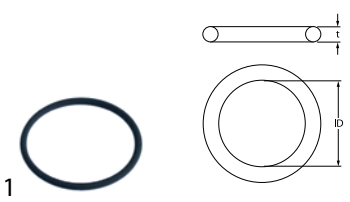

GEV No.	550496	Ref. No.	0105021 CM099200 MACM099200 SIR0105021
description	O-ring Viton thickness 3.53mm ID ø 50.39mm Qty 1 pcs		
For models:	CFE62110/1, CFE62210/1, EDE72128, EDE73142, EDE74228, EDE92142, EDE93142, EDE94242, EFE72110, EFE72115, EFE73210, EFE74215, EFE92115, EFE92122, EFE92122K, EFE93210, EFE94215, EFE94222, EFE94222K, FE62T10, FE64T10, FE72112, FE72206, FE72T10, FE74212, FE74T10, FE82118, FE82206, FE82T18, FE84218, FE84T18, FE92118, FE92206, FE94218, FEY2118, FEY2206, FEY4218		

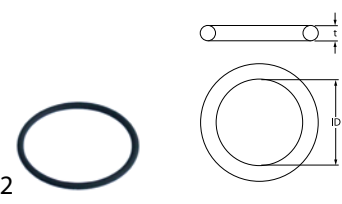

GEV No.	510245	Ref. No.	0108055 SIR0108055
description	O-ring Viton thickness 3.53mm ID ø 50.8mm Qty 1 pcs		
For models:	CFE70110, CFE70110-2, CFE70115, CFE70115-2, CFE70115-M, CFE70210, CFE70210-2, CFE70210-M, CFE70215, CFE70215-2, CFE70215-M, CFE72210, CFE72215, CFE90120, CFE90120-2, CFE90210, CFE90210-2, CFE90220, CFE90220-2, FE72210, FE92210		



GEV No.	514419	Ref. No.	CR0586210
description	bracket for heating element L 68mm W 20mm H 28mm		
For models:	EDE72128, EDE74228, EDE92142, EDE93142, EDE94242		

hot plates

square & rectangular

with radiused edge



GEV No.	490065	Ref. No.	0101474 SIR0101474
description	hot plate dimensions 220x220mm 2000W 230V with spill ring connection 4 screw clamps protector no square		



GEV No.	490066 ¹	Ref. No.	0101475 1712913 CR1078117R MA1712913 SIR0101475
description	hot plate dimensions 220x220mm 2600W 230V with spill ring connection 4 screw clamps protector yes square		
For models:	CCQ7020, CCQ7021, CCQ7022, CCQ7040, CCQ7041, CCQ7042, CCQ7046, CCQ7061, CCQ7062, CCQ70663, CCQ7220, CCQ7221, CCQ7222, CCQ7240, CCQ7241, CCQ7242, CCQ7246, CCQ7261, CCQ7262, CCT7020, CCT7021, CCT7022, CCT7040, CCT7041, CCT7042, CCT7046, CCT7061, CCT7062, CCT70663, CE72APQ, CE72APT, CE72GPQ, CE72GPT, CE72TPQ, CE72TPT, CE74APQ, CE74APT, CE74EPQ, CE74EPT, CE74GPQ, CE74GPT, CE74TPQ, CE74TPT, CE76APQ, CE76EPT, ECE74-Q		



GEV No.	490176 ¹	Ref. No.	0109190 SI0109190 SIR0109190
description	hot plate dimensions 220x220mm 2600W 440V with spill ring connection 4 screw clamps protector yes		



GEV No.	490056 ¹	Ref. No.	0101467 SIR0101467
description	hot plate dimensions 300x300mm 3000W 230V with spill ring connection 4 screw clamps protector yes square		
For models:	CCQ9020, CCQ9021, CCQ9022, CCQ9040, CCQ9041, CCQ9042, CCQ9046, CCQ9060, CCQ9061, CCQ9062, CCQ90663		

¹incl. protector

¹incl. protector

¹incl. protector



			
1			
GEV No.	490071 ¹	Ref. No.	0101476 1937300 MA1937300 MA1937300R SIR0101476
description	hot plate dimensions 300x300mm 4000W 230V with spill ring connection 4 screw clamps protector yes square		
For models:	CCQ9020, CCQ9021, CCQ9022, CCQ9040, CCQ9041, CCQ9042, CCQ9046, CE82APQ, CE82GPQ, CE82TPQ, CE84APQ, CE84EPQ, CE84GPQ, CE84TPQ, CE92APQ, CE92GPQ, CE92TPQ, CE94APQ, CE94EPQ, CE94GPQ, CE94TPQ, CEY2TPQ, CEY4TPQ, ECE92A, ECE92G, ECE92T, ECE94A, ECE94E, ECE94G, ECE94T		

¹incl. protector

<p>round with radiused edge for domestic and commercial kitchens</p> 			
1			
GEV No.	490018	Ref. No.	0101487 SIR0101487
description	hot plate ø 220mm 2000W 230V connection 4 screw clamps with 8mm spill ring		

			
1			
GEV No.	490020	Ref. No.	0101482 1832313 MA1832313 SIR0101482
description	hot plate ø 220mm 2600W 230V connection 4 screw clamps with 8mm spill ring		
For models:	CCQ7020, CCQ7021, CCQ7022, CCQ7040, CCQ7041, CCQ7042, CCQ7046, CCQ7061, CCQ7062, CCQ70663, CCT6020, CCT6040, CCT6046, CCT7020, CCT7021, CCT7022, CCT7040, CCT7041, CCT7042, CCT7046, CCT7061, CCT7062, CCT70663, CCT7220, CCT7221, CCT7222, CCT7240, CCT7241, CCT7242, CCT7246, CCT7261, CCT7262, CCT72662, CE72APQ, CE72APT, CE72GPQ, CE72GPT, CE72TPQ, CE72TPT, CE74APQ, CE74APT, CE74EPQ, CE74EPT, CE74GPQ, CE74GPT, CE74TPQ, CE74TPT, CE76APT, CE76EPQ, CE76EPT...(Other models you can see in the webshop)		
accessories for	490020		
	GEV No.	550796	Ref. No. —
	fixing plate for hot plate ø220mm		

energy regulators

EGO

1-circuit

			
1			
GEV No.	380015	Ref. No.	0105171 0108203 0108231 426710 65080250 LAR65080250 SIR0105171 SIR0108203 SIR0108231
description	energy regulator 230V 13A single-circuit turn direction right shaft ø 6x4.6mm shaft L 23mm mounting thread M4 power release 6-100% no. 50.57021.010		
For models:	BER12, BER14, BER16, BER18, BER20, CBE6030, CCQ9020, CCQ9020-V, CCQ9021, CCQ9021-V, CCQ9022, CCQ9022-V, CCQ9040, CCQ9040-V, CCQ9041, CCQ9041-V, CCQ9042, CCQ9042-V, CCQ9046, CCQ9046-V, CCT6020V, CCT6040V, CCT7020-V, CCT7021-V, CCT7022-V, CCT7040-V, CCT7041-V, CCT7042-V, CCT7046-V, CCT7220V, CCT7221V, CCT7222V, CCT7240V, CCT7241V, CCT7242V, CCT7246V, CNE6230, CPD90100, CPD90100A, CPD90150, CPD90150A, CRE6-20, CRE6220, CRE6230, CRE6-30, CSE-045, CSE-048, CSE-050, CSE-053, CSE-060...(Other models you can see in the webshop)		

2-circuit

			
1			
GEV No.	380027	Ref. No.	CM293900 MACM293900
description	energy regulator EGO 230V 13A dual circuit turn direction right shaft ø 6x4.6mm shaft L 23mm mounting thread M4 power release 6-70% no. 50.55021.100		
For models:	CV72APS, CV72GPS, CV72TPS, CV74APS, CV74EPS, CV74GPS, CV74TPS, CV82APS, CV82GPS, CV82TPS, CV84APS, CV84EPS, CV84GPS, CV84TPS, CV92APS, CV92GPS, CV94APS, CV94GPS, CVY2TPS, CVY4TPS, DE72128, DE74228, DE82140, DE82142, DE82T42, DE84240, DE84242, DE84T42, DE92142, DE94242, DEY2142, DEY4242, ECV74, EDE72128, EDE73142, EDE74228, EDE92142, EDE93142, EDE94242, EDG72128, EDG73142, EDG74228, EDG92142, EDG93142, EDG94242, EPE7105, EPE7108, EPE9D10, EPE9D15, EPE9I10...(Other models you can see in the webshop)		



thermostats

control and safety thermostats

EGO

control thermostats

55.10/19_series

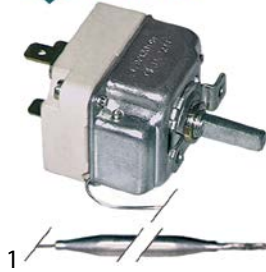

GEV No.	375055	Ref. No.	0101383 SIR0101383
description	thermostat t.max. 110°C temperature range 30-110°C 1-pole 1CO 16A probe ø 6mm probe L 130mm capillary pipe 1500mm capillary pipe isolated gland nut shaft L 23mm shaft position upper rotation 318° 250V		
For models:	CNE70160, CNE72160, DE74170		



GEV No.	375548	Ref. No.	CR0682740
description	thermostat t.max. 142°C temperature range fixed 142°C 1-pole 1CO 16A probe ø 4mm probe L 157mm capillary pipe 870mm capillary pipe isolated 870mm gland nut shaft ø 6x4.6mm shaft Lmm shaft position		
For models:	EPE7105, EPE7108, EPE9110, EPE9110A, EPE9115, EPE9115A, EPG7D05, EPG7105, EPG7108, EPG9115, EPG9115A, EPG9110A, EPG9110A		

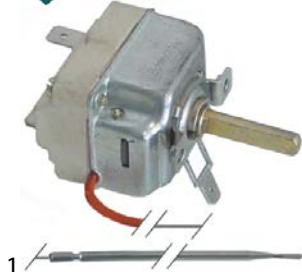

GEV No.	375341	Ref. No.	0102492 SIR0102492
description	thermostat t.max. 150°C temperature range 60-150°C 1-pole 1NO 16A probe ø 3mm probe L 219mm capillary pipe 900mm capillary pipe isolated 900mm gland nut shaft ø 6x4.6mm shaft L 23mm shaft position upper rotation 270°		
For models:	CNE90160, CNE90160S, CNE90160-S, CPE90100, CPE90100A, CPE90150, CPE90150A, CPI90100, CPI90100A, CPI90150, CPI90150A, DE94170, DEY4160, PE9A110, PE9A115, PE9N110, PE9N115		



GEV No.	375063	Ref. No.	0101385 0109054 SIR0101385 SIR0109054
description	thermostat t.max. 170°C temperature range 70-170°C 1-pole 1NO 16A probe ø 11mm probe L 28mm capillary pipe 900mm capillary pipe isolated 900mm gland nut shaft L 23mm shaft position upper rotation 270° screw-in probe probe thread M14x1		
For models:	CFG60110, CFG60210		
accessories for	375063		
	GEV No.	510417	Ref. No. —
	flat gasket fibre ED ø 20mm ID ø 14mm thickness 2mm Qty 1 pcs		
	GEV No.	510420	Ref. No. —
	gasket copper ED ø 19.9mm ID ø 14.3mm thickness 2mm Qty 1 pcs		
	GEV No.	521133	Ref. No. —
	nut thread M14x1.5 H 6mm WS 19 zinc-coated steel Qty 1 pcs		



GEV No.	375270	Ref. No.	0101377 SIO101377 SIR0101377
description	thermostat t.max. 295°C temperature range 45-295°C 1-pole 1NO 16A probe ø 4mm probe L 100mm capillary pipe 900mm capillary pipe isolated 350mm gland nut shaft L 23mm shaft position upper rotation 270°		
For models:	CBE7050, CBE7050C, CBE9060, CBE9060C, CBG9060C-I, CGE9020, CGE9020C, CGE9020R, CGE9020RC, CGE9021, CGE9021C, CGE9021R, CGE9021RC, CGE9022, CGE9022C, CGE9022R, CGE9022RC, CGE9040, CGE9040C, CGE9040LR, CGE9040LRC, CGE9040R, CGE9040RC, CGE9041, CGE9041C, CGE9041LR, CGE9041LRC, CGE9041R, CGE9041RC, CGE9042, CGE9042C, CGE9042LR, CGE9042LRC, CGE9042R, CGE9042RC, SE74CRM, SE74FRM, SE74IRM, SE84CRA, SE84CRM, SE84FRA, SE84FRM, SE84IRA, SE84IRM, SE94CRA, SE94CRM, SE94FRA, SE94FRM, SE94IRA, SE94IRM		



GEV No.	375184	Ref. No.	0101382 1037102300 MA1037102300 SIR0101382
description	thermostat t.max. 298°C temperature range 55-294°C 1-pole 1NO 16A probe ø 3.1mm probe L 226mm capillary pipe 870mm capillary pipe isolated 350mm gland nut shaft L 23mm shaft position upper probe material SS		
For models:	SE86CRA, SE86FRA, SE86IRA, SE96CRA, SE96FRA, SE96IRA, SG86CRA, SG86FRA, SG86IRA, SG96CRA, SG96FRA, SG96IRA		



GEV No.	375332	Ref. No.	0101390 1037118000 MA1037118000 SIR0101390
description	thermostat t.max. 55°C temperature range fixed 55°C 1-pole 1CO 16A probe ø 9/15mm probe L 22mm capillary pipe 1500mm capillary pipe isolated 800mm gland nut		
For models:	CRE6-20, CRE6220, CRE6230, CRE6-30, GE62TPS, GE63TPS		



GEV No.	375945	Ref. No.	CR0734520
description	thermostat t.max. 470°C temperature range 90-470°C 1-pole 1NO 16A probe ø 3.9mm probe L 163mm capillary pipe 870mm capillary pipe isolated 600mm shaft ø 4.5x6mm shaft L 23mm shaft position upper rotation 270°		
For models:	ETE74		



GEV No.	390040	Ref. No.	0101376 0101403 MA7800300 SIR0101376 SIR0101403
description	thermostat t.max. 90°C temperature range 30-90°C 1-pole 1CO 16A probe ø 6mm probe L 130mm capillary pipe 2040mm capillary pipe isolated 1940mm gland nut shaft ø 6x4.6mm shaft L 23mm shaft position upper rotation 270° probe material SS		
For models:	BAC100, BAC100-A, BAC102, BAC120, BAC120-A, BAC122, BAC140, BAC140-A, BAC142, BAC160, BAC160-A, BAC162, BAC180, BAC180-A, BAC182, BAC200, BAC200-A, BAC202, BAM16D, BAM16S, BAM18D, BAM18S, BAM20D, BAM20S, CCG6045, CCG60652, CCG60653, CCG7045, CCG7046, CCG70652, CCG70653, CCG70663, CCG72653, CCG72663, CCQ7046, CCQ70663, CCT7046, CCT70663, CCW6020, CME1021, CME1022, CME6020, CME6030, CME6040, CME7020, CME7021, CME7022, CME7041, CME7042, CME7220...(Other models you can see in the webshop)		



GEV No.	375247	Ref. No.	TERMO001
description	thermostat t.max. 500°C temperature range 75-500°C 1-pole 1NO 16A probe ø 4mm probe L 228mm capillary pipe 900mm capillary pipe isolatedmm gland nut shaft ø 6x4.6mm shaft L 23mm shaft position upper rotation 270°		



GEV No.	375539	Ref. No.	0101396 SIR0101396
description	thermostat t.max. 90°C temperature range 30-90°C 1-pole 1NO 16A probe ø 6mm probe L 130mm capillary pipe 2450mm capillary pipe isolatedmm gland nut shaft ø 6x4.6mm shaft L 23mm shaft position upper rotation 270°		
For models:	CCG1045, CCG10652, CCG10653, CCG1085, CCG10852, CCG9046, CCG90663, CCG91653, CCG91653-1, CCG91663, CCG91663-1, CCG9046, CCG90663, CTT9045, CTT9046, CTT90652R, CTT90653R, CTT90663R		

55.34_ series



GEV No.	375021	Ref. No.	0108112 SIR0108112
description	thermostat t.max. 110°C temperature range 32-110°C 3-pole 3CO 16A probe ø 6mm probe L 138mm capillary pipe 2980mm capillary pipe isolated 2200mm gland nut M9x1 shaft ø 6x4.6mm shaft L 23mm shaft position upper rotation 270°		
For models:	CNE70130, CNE72130, CNE90130, CNE90130-S, CNE90140, CNE90140-S, CNE90230, CNE90240, DE72125, DE92140, DE94240		

55.13_ series



GEV No.	375492	Ref. No.	0108014 SIR0108014
description	thermostat t.max. 190°C temperature range 94-190°C 1-pole 1NO 16A probe ø 6mm probe L 94mm capillary pipe 1090mm capillary pipe isolated 960mm gland nut M10x1 shaft ø 6x4.6mm shaft L 23mm shaft position upper rotation 310° probe material SS		
For models:	CFE70110, CFE70110-2, CFE70115, CFE70115-2, CFE70210, CFE70210-2, CFE70215, CFE70215-2, CFE72210, CFE72215, CFE90120, CFE90120-2, CFE90210, CFE90210-2, CFE90220, CFE90220-2, FE72210, FE92210		



GEV No.	375143	Ref. No.	0101388 SIR0101388
description	thermostat t.max. 110°C temperature range 32-110°C 3-pole 3NO 16A probe ø 6mm probe L 138mm capillary pipe 1480mm capillary pipe isolated 1100mm gland nut M9x1 shaft ø 6x4.6mm shaft L 23mm shaft position upper rotation 270°		

55.14_ series



GEV No.	375874	Ref. No.	1037117700 MA1037117700
description	thermostat t.max. 90°C temperature range 30-90°C 1-pole 1NO 16A probe ø 6mm probe L 74mm capillary pipe 900mm capillary pipe isolated 800mm gland nut M10x1 shaft ø 6x4.6mm shaft L 23mm shaft position 180° shaft position rotation 270°		
For models:	CCW6220, CME6220, CME6230, CME6240, CSP6220, CW62TPS, ERP72, ME62TPS, ME63TPS, ME64TPS, RP62TPS		



GEV No.	375097	Ref. No.	0109055 SIR0109055
description	thermostat t.max. 195°C temperature range 95-195°C 3-pole 3NO 16A probe ø 6mm probe L 117mm capillary pipe 1780mm capillary pipe isolated 1400mm gland nut M9x1 shaft ø 6x4.6mm shaft L 23mm shaft position upper rotation 270°		
For models:	CFE60110, CFE60110-5, CFE60110-9, CFE60210, CFE60210-5, CFE60210-9, CFE70110-0, CFE72110-0, FE72T10		



GEV No.	375559	Ref. No.	CR0686120
description	thermostat t.max. 230°C temperature range 95-230°C 3-pole 3NO 16A probe ø 4mm probe L 128mm capillary pipe 1250mm capillary pipe isolated 1000mm gland nut shaft ø 6x4.6mm shaft L 23mm shaft position upper rotation 270°		
For models:	EGVE7, EGVE92, EGVE94		



GEV No.	375192	Ref. No.	1309115 MA1309115
description	thermostat t.max. 300°C temperature range 50-300°C 3-pole 3NO 16A probe ø 3mm probe L 219mm capillary pipe 900mm capillary pipe isolated 1000mm gland nut shaft ø 6x4.6mm shaft L 23mm shaft position upper rotation 270°		
For models:	CBE6220, CM72APS, CM82APS, ECE7-E, ECE94E, ECG94E, ECG96E, ECM73, ECM93A, ECV94E, SE62TPS		



GEV No.	375272	Ref. No.	0101424 SI0101424 SIR0101424
description	thermostat t.max. 240°C temperature range 55-240°C 3-pole 3NO 16A probe ø 4mm probe L 91mm capillary pipe 880mm capillary pipe isolated 350mm gland nut shaft ø 6x4.6mm rotation 270°		
For models:	BE92ALC, BE92ALL, BE92ARC, BE92ARR, BE92GLC, BE92GLL, BE92GRC, BE92GRR, BE94ALC, BE94ALL, BE94ALR, BE94AMC, BE94ARC, BE94ARR, BE94GLC, BE94GLL, BE94GLR, BE94GMC, BE94GRC, BE94GRR, BEY2TLC, BEY2TLL, BEY2TRC, BEY2TRR, BEY4TLC, BEY4TLL, BEY4TLR, BEY4TMC, BEY4TRC, BEY4TRR, CGE9020-0, CGE9020-1, CGE9020-2, CGE9020-3, CGE9021-0, CGE9021-1, CGE9021-2, CGE9021-3, CGE9022-0, CGE9022-1, CGE9022-2, CGE9022-3, CGE9040-0, CGE9040-1, CGE9040-2, CGE9040-3, CGE9040-4, CGE9040-5, CGE9041-0, CGE9041-1...(Other models you can see in the webshop)		



GEV No.	375412	Ref. No.	0101384 BN6A044600 is not the 55.34064.030 SIR0101384
description	thermostat t.max. 320°C temperature range 50-320°C 3-pole 3NO 16A probe ø 3.1mm probe L 226mm capillary pipe 1480mm capillary pipe isolated 1400mm gland nut shaft ø 6x4.6mm shaft L 23mm shaft position upper rotation 318°		
For models:	BE72ALC, BE72ALL, BE72ARR, BE72GLC, BE72GLL, BE72GRR, BE72TLC, BE72TLL, BE72TRR, BE74ALC, BE74ALL, BE74ALR, BE74ARC, BE74ARR, BE74GLC, BE74GLL, BE74GLR, BE74GMC, BE74GRR, BE74TLC, BE74TLL, BE74TLR, BE74TMC, BE74TRR, CCG60652, CCG60653, CCG7046, CCG7046P, CCG70662P, CCG70663, CCG7246, CCG72662, CCG72663, CCG9046P, CCG90662P, CCG9146, CCG9146-1, CCG91662, CCG91662-1, CCG91663, CCG91663-1, CCQ7046, CCQ70663, CCQ9046, CCQ9046V, CCQ90663, CCT6046, CCT7046, CCT70663, CCT7246V...(Other models you can see in the webshop)		



GEV No.	375268	Ref. No.	0101373 SI0101373 SIR0101373
description	thermostat t.max. 295°C temperature range 75-295°C 3-pole 3NO 16A probe ø 4mm probe L 92mm capillary pipe 900mm capillary pipe isolated 350mm gland nut shaft ø 6x4.6mm shaft L 23mm shaft position upper rotation 270°		
For models:	BE72ALC, BE72ALL, BE72ARR, BE72GLC, BE72GLL, BE72GRR, BE72TLC, BE72TLL, BE72TRR, BE74ALC, BE74ALL, BE74ALR, BE74ARC, BE74ARR, BE74GLC, BE74GLL, BE74GLR, BE74GMC, BE74GRR, BE74TLC, BE74TLL, BE74TLR, BE74TMC, BE74TRR, CGE6020, CGE6020C, CGE6020R, CGE6030, CGE6030C, CGE6030R, CGE6040, CGE6040C, CGE6040R, CGE7020, CGE7020C, CGE7020R, CGE7021, CGE7021C, CGE7021R, CGE7022, CGE7022C, CGE7022R, CGE7040, CGE7040C, CGE7040LR, CGE7040LRC, CGE7040R, CGE7041, CGE7041C, CGE7041LR...(Other models you can see in the webshop)		



GEV No.	375944	Ref. No.	CR0582770
description	thermostat t.max. 350°C temperature range 100-350°C 3-pole 3NOA probe ø 3mm probe L 147mm capillary pipe 900mm capillary pipe isolatedmm gland nut shaft ø 6x4.6mm shaft L 26mm shaft position upper rotation 270° probe material SS		
For models:	EBE7, EBE92AL, EBE92ALC, EBE92AR, EBE92ARC, EBE92GL, EBE92GLC, EBE92GR, EBE92GRC, EBE92TL, EBE92TLC, EBE92TR, EBE92TRC, EBE93AL, EBE93ALC, EBE93ALR, EBE93AMC, EBE93GL, EBE93GLC, EBE93GLR, EBE93GMC, EBE93TL, EBE93TLC, EBE93TLR, EBE93TMC, EBE94AL, EBE94ALC, EBE94ALR, EBE94AMC, EBE94AR, EBE94GL, EBE94GLC, EBE94GLR, EBE94GMC, EBE94GR, EBE94TL, EBE94TLC, EBE94TLR, EBE94TMC, EBE94TR		





GEV No.	375278	Ref. No.	0101394 SIR0101394
description	safety thermostat switch-off temp. 142°C 1-pole 16A probe ø 6mm probe L 74mm capillary pipe 900mm capillary pipe isolated 900mm gland nut probe		
For models:	CNE70160, CNE72160, DE74170		

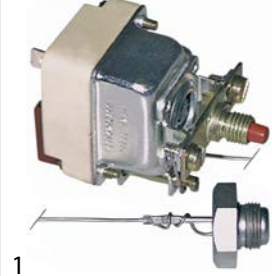

GEV No.	375411	Ref. No.	0101406 1037035015 MA1037035015 SIR0101406
description	thermostat t.max. 93°C temperature range 30-93°C 3-pole 3NO 16A probe ø 6mm probe L 129mm capillary pipe 1480mm capillary pipe isolated 1100mm gland nut M10x1 shaft ø 6x4.6mm shaft L 23mm shaft position upper rotation 270°		
For models:	CME9040, CME9041, CME9042, EME7, EME92A, EME92G, EME92T, EME94A, EME94G, EME94T, ME84GPS, ME94APS, ME94GPS, MEY4TPS		



GEV No.	375166	Ref. No.	0101386 SIR0101386
description	safety thermostat switch-off temp. 230°C 1-pole 0.5A probe ø 11mm probe L 16.5mm capillary pipe 850mm capillary pipe isolated 850mm gland nut probe screw-in probe probe thread M14x1		
accessories for	375166		
	GEV No.	521133	Ref. No. —
	nut thread M14x1.5 H 6mm WS 19 zinc-coated steel Qty 1 pcs		
	GEV No.	532520	Ref. No. —
	O-ring silicone thickness 2.62mm ID ø 15.08mm Qty 1 pcs		
	GEV No.	550261	Ref. No. —
	nut thread M14x1 H 4mm WS 19 SS Qty 1 pcs		

safety thermostats



55.10/19_series



GEV No.	375376	Ref. No.	0108038 SIR0108038
description	safety thermostat capillary pipe 870mm probe ø 6mm 1-pole probe L 133mm 0.5A capillary pipe isolatedmm gland nut M10x1 switch-off temp. 224°C probe		
For models:	CFG70115, CFG70215, CFG72215, CFG90120, CFG90210, CFG90210S, CFG90220, FG92210, FGY2210		



1

GEV No.	375282	Ref. No.	0109053 SIR0109053
description	safety thermostat switch-off temp. 230°C 1-pole 16A probe ø 11mm probe L 28mm capillary pipe 850mm capillary pipe isolated 830mm gland nut probe screw-in probe probe thread M14x1		
For models:	CFG60110, CFG60210		
accessories for	375282		
	GEV No.	507313	Ref. No. —
	O-ring EPDM thickness 2.62mm ID ø 13.95mm Qty 1 pcs		
	GEV No.	510420	Ref. No. —
	gasket copper ED ø 19.9mm ID ø 14.3mm thickness 2mm Qty 1 pcs		
	GEV No.	521133	Ref. No. —
	nut thread M14x1.5 H 6mm WS 19 zinc-coated steel Qty 1 pcs		



1

GEV No.	375352	Ref. No.	0109056 SIR0109056
description	safety thermostat switch-off temp. 245°C 1-pole 1NC 16A probe ø 6mm probe L 130mm capillary pipe 1200mm capillary pipe isolated 1200mm gland nut probe		
For models:	CFE60110, CFE60110-5, CFE60110-9, CFE60210, CFE60210-5, CFE60210-9, CFE70110-0, CFE72110-0, FE72T10		



1

GEV No.	375285	Ref. No.	0101387 SIR0101387
description	safety thermostat switch-off temp. 327°C 1-pole 1NC 16A probe ø 6mm probe L 77mm capillary pipe 870mm capillary pipe isolated gland nut probe SS		

55.14_series



1

GEV No.	375260	Ref. No.	0108011 SIR0108011
description	safety thermostat switch-off temp. 240°C 1-pole 16A probe ø 6mm probe L 77mm capillary pipe 1280mm capillary pipe isolated 1050mm gland nut M10x1 probe SS		

55.32_series



1

GEV No.	375537	Ref. No.	0101395 SIR0101395
description	safety thermostat switch-off temp. 120°C 1-pole 0.5A probe ø 4mm probe L 120mm capillary pipe 2500mm capillary pipe isolated 2500mm gland nut probe SS		
For models:	CCG1045, CCG10652, CCG10653, CCG1085, CCG10852, CCG9046, CCG90663, CCG91653, CCG91653-1, CCG91663, CCG91663-1, CCQ9046, CCQ90663, CTT9045, CTT9046, CTT90652R, CTT90653R, CTT90663R		



1

GEV No.	375947	Ref. No.	CR0585120
description	safety thermostat switch-off temp. 120°C 3-pole 20A probe ø 6mm probe L 94mm capillary pipe 900mm capillary pipe isolated 850mm gland nut starting temperature 111°C probe		
For models:	EME7, EME92A, EME92G, EME92T, EME94A, EME94G, EME94T		

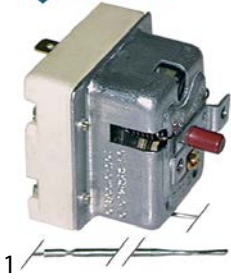

GEV No.	375275	Ref. No.	0101404 SIR0101404
description	safety thermostat switch-off temp. 125°C 1-pole 0.5A probe ø 4mm probe L 120mm capillary pipe 900mm capillary pipe isolated 900mm gland nut probe SS		
For models:	CCG6045, CCG60652, CCG60653, CCG7045, CCG7046, CCG70652, CCG70653, CCG70663, CCG72653, CCG72663, CCQ7046, CCQ70663, CCT7046, CCT70663, CTT72653, CTT72653L		

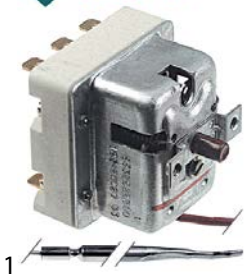

GEV No.	375541	Ref. No.	0101407 SIR0101407
description	safety thermostat switch-off temp. 125°C 3-pole 0.5A probe ø 4mm probe L 120mm capillary pipe 900mm capillary pipe isolated 900mm gland nut probe SS		
For models:	CME9020, CME9021, CME9022, CME9040, CME9041, CME9042, ME82GPS, ME84GPS, ME92APS, ME92GPS, ME94APS, ME94GPS, MEY2TPS, MEY4TPS		



GEV No.	375199	Ref. No.	1878900 MA1878900
description	safety thermostat switch-off temp. 132°C 3-pole 2x20/1x0.5A probe ø 6mm probe L 77mm capillary pipe 890mm capillary pipe isolated mm gland nut M10x1 probe SS		
For models:	CNE6230, DE63128, DE72128, DE74228, DE82140, DE82142, DE82T42, DE84240, DE84242, DE84T42, DE92142, DE94242, DEY2142, DEY4242, EDE92142, EDE93142, EDE94242		

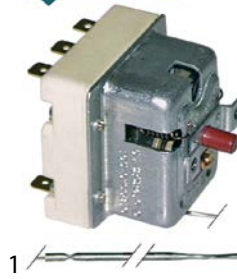

GEV No.	375281	Ref. No.	0102493 SI0102493 SIR0102493
description	safety thermostat switch-off temp. 150°C 3-pole 0.5A probe ø 3mm probe L 188mm capillary pipe 1100mm capillary pipe isolated mm gland nut probe SS		
For models:	CNE90160, CNE90160S, CNE90160-S, CPE70150, CPE7-150, CPE90100, CPE90100A, CPE90150, CPE90150A, CPI70150, CPI90100, CPI90100A, CPI90100AP, CPI90100A-P, CPI90100P, CPI90100-P, CPI90150, CPI90150A, CPI90150AP, CPI90150A-P, CPI90150P, CPI90150-P, DE94170, DEY4160, PE7NI05, PE8AI10, PE8AI15, PE8NI10, PE8NI15, PE9AI10, PE9AI15, PE9NI10, PE9NI15, PG7ND05, PG7NI05, PG8AD10, PG8AD15, PG8AI10, PG8AI15, PG8ND10, PG8ND15, PG8NI10, PG8NI15, PG9AD10, PG9AD15, PG9AI10, PG9AI15, PG9ND10, PG9ND15, PG9NI10...(Other models you can see in the webshop)		

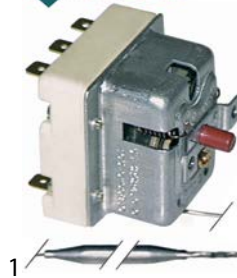

GEV No.	375277	Ref. No.	0108113 SIR0108113
description	safety thermostat switch-off temp. 150°C 3-pole 3NC 20A probe ø 6mm probe L 79mm capillary pipe 900mm capillary pipe isolated 700mm gland nut probe		
For models:	CNE70130, CNE72130, CNE90130, CNE90130-S, CNE90140, CNE90140-S, CNE90230, CNE90240, DE72125, DE92140, DE94240		



GEV No.	375984	Ref. No.	0108066
description	safety thermostat switch-off temp. 225°C 3-pole 3NC 20A probe ø 6mm probe L 94mm capillary pipe 900mm capillary pipe isolated 670mm gland nut M10x1 probe SS		
For models:	CFE90120, CFE90120-2, CFE90220, CFE90220-2		



GEV No.	375445	Ref. No.	CM097701 MACM097701
description	safety thermostat switch-off temp. 230°C 3-pole 2x20/1x0.5A probe ø 4mm probe L 120mm capillary pipe 900mm capillary pipe isolated 700mm gland nut probe		
For models:	EFE72110, EFE72115, EFE73210, EFE74215, EFE92115, EFE92122, EFE92122K, EFE93210, EFE94215, EFE94222, EFE94222K, EFG72108, EFG72110, EFG72115, EFG73208T, EFG73210, EFG74215, EFG92115, EFG92115S, EFG92123, EFG92123K, EFG93210, EFG94215, EFG94215S, EFG94223, EFG94223K		



GEV No.	375258	Ref. No.	0108065 SIR0108065
description	safety thermostat switch-off temp. 232°C 3-pole 20A probe ø 6mm probe L 94mm capillary pipe 900mm capillary pipe isolated 670mm gland nut M10x1 probe SS		
For models:	CFE70110, CFE70110-2, CFE70115, CFE70115-2, CFE70115-M, CFE70210, CFE70210-2, CFE70210-M, CFE70215, CFE70215-2, CFE70215-M, CFE72210, CFE72215, CFE90210, CFE90210-2, FE72210, FE92210		



GEV No.	375359	Ref. No.	0105030 CM097700 SIR0105030
description	safety thermostat switch-off temp. 230°C 3-pole 2x20/1x0.5A probe ø 4mm probe L 120mm capillary pipe 900mm capillary pipe isolated 900mm gland nut probe kettle		
For models:	CFE62110/1, CFE62210/1, FE62T10, FE64T10, FE72112, FE72206, FE74212, FE82118, FE82206, FE82T18, FE84218, FE84T18, FE92118, FE92206, FE94218, FEY2118, FEY2206, FEY4218, FG72115, FG72206, FG74215, FG82122, FG82206, FG82T22, FG84222, FG84T22, FG92122, FG92206, FG94222, FGY2122, FGY2206, FGY4222		



GEV No.	375536	Ref. No.	0108061 SIR0108061
description	safety thermostat switch-off temp. 245°C 3-pole 20A probe ø 6mm probe L 75mm capillary pipe 900mm capillary pipe isolated 670mm gland nut M10x1 probe SS		



GEV No.	375538	Ref. No.	0108025 (NML)
description	safety thermostat switch-off temp. 230°C 3-pole probe		



GEV No.	375284	Ref. No.	0101425 SI0101425 SIR0101425
description	safety thermostat switch-off temp. 280°C 3-pole 20A probe ø 4mm probe L 120mm capillary pipe 900mm capillary pipe isolated 900mm gland nut probe		
For models:	BE92ALC, BE92ALL, BE92ARC, BE92ARR, BE92GLC, BE92GLL, BE92GRC, BE92GRR, BE94ALC, BE94ALL, BE94ALR, BE94AMC, BE94ARC, BE94ARR, BE94GLC, BE94GLL, BE94GLR, BE94GMC, BE94GRC, BE94GRR, BEY2TLC, BEY2TLL, BEY2TRC, BEY2TRR, BEY4TLC, BEY4TLL, BEY4TLR, BEY4TMC, BEY4TRC, BEY4TRR, BG92ALC, BG92ARC, BG92GLC, BG92GRC, BG94ALC, BG94AMC, BG94ARC, BG94GLC, BG94GMC, BG94GRC, BGY2TLC, BGY2TRC, BGY4TLC, BGY4TMC, BGY4TRC, CGE9020-0, CGE9020-1, CGE9020-2, CGE9020-3, CGE9021-0...(Other models you can see in the webshop)		

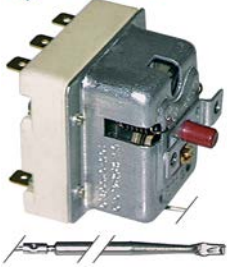

GEV No.	375279	Ref. No.	0101372 SIR0101372
description	safety thermostat switch-off temp. 345°C 3-pole 20A probe ø 4mm probe L 120mm capillary pipe 900mm capillary pipe isolated 900mm gland nut probe SS		
For models:	BE72ALC, BE72ALL, BE72ARR, BE72GLC, BE72GLL, BE72GRR, BE72TLC, BE72TLL, BE72TRR, BE74ALC, BE74ALL, BE74ALR, BE74ARC, BE74ARR, BE74GLC, BE74GLL, BE74GLR, BE74GMC, BE74GRR, BE74TLC, BE74TLL, BE74TLR, BE74TMC, BE74TRR, CGE6020, CGE6020C, CGE6020R, CGE6030, CGE6030C, CGE6030R, CGE6040, CGE6040C, CGE6040R, CGE7020, CGE7020C, CGE7020R, CGE7021, CGE7021C, CGE7021R, CGE7022, CGE7022C, CGE7022R, CGE7040, CGE7040C, CGE7040LR, CGE7040LRC, CGE7040R, CGE7041, CGE7041C, CGE7041LR...(Other models you can see in the webshop)		



GEV No.	375187	Ref. No.	0105052 1878500 MA1878500
description	safety thermostat switch-off temp. 360°C 3-pole 3NC 2x20/1x0.5A probe ø 6mm probe L 79mm capillary pipe 890mm capillary pipe isolatedmm gland nut probe SS		
For models:	BG62TLC, BG63TLC, BG64TLC, BG74TRR, BG82GLC, BG82TLC, BG84ALC, BG84AMC, BG84GLC, BG84GMC, BG84TLC, BG84TMC, CGG6220C, CGG6230C, CGG6240C, CM72APS, CM82APS, EBE7, EBE92AL, EBE92ALC, EBE92AR, EBE92ARC, EBE92GL, EBE92GLC, EBE92GR, EBE92GRC, EBE92TL, EBE92TLC, EBE92TR, EBE92TRC, EBE93AL, EBE93ALC, EBE93ALR, EBE93AMC, EBE93GL, EBE93GLC, EBE93GLR, EBE93GMC, EBE93TL, EBE93TLC, EBE93TLR, EBE93TMC, EBE94AL, EBE94ALC, EBE94ALR, EBE94AMC, EBE94AR, EBE94GL, EBE94GLC, EBE94GLR...(Other models you can see in the webshop)		



GEV No.	375392	Ref. No.	0101375 SIR0101375
description	safety thermostat switch-off temp. 360°C 3-pole 1CO/2NC 20A probe ø 4mm probe L 120mm capillary pipe 1490mm capillary pipe isolated 1450mm gland nut probe SS		
For models:	BE72ALC, BE72ALL, BE72ARR, BE72GLC, BE72GLL, BE72GRR, BE72TLC, BE72TLL, BE72TRR, BE74ALC, BE74ALL, BE74ALR, BE74ARC, BE74ARR, BE74GLC, BE74GLL, BE74GLR, BE74GMC, BE74GRR, BE74TLC, BE74TLL, BE74TLR, BE74TMC, BE74TRR, BG72GLC, BG72TLC, BG74GLC, BG74GMC, CBE7050, CBE7050C, CBE9060, CBE9060C, CBG9060C-I, CCG60652, CCG60653, CCG7046, CCG7046P, CCG70662P, CCG70663, CCG7246, CCG72662, CCG72663, CCG9046P, CCG90662P, CCG9146, CCG9146-1, CCG91662, CCG91662-1, CCG91663, CCG91663-1...(Other models you can see in the webshop)		



GEV No.	375283	Ref. No.	0101401 SIR0101401
description	safety thermostat switch-off temp. 360°C 3-pole capillary pipe isolatedmm gland nut probe		
For models:	CGG6020C, CGG6030C, CGG6040C		



GEV No.	375890	Ref. No.	0101371 SIR0101371
description	safety thermostat switch-off temp. 650°C 3-pole starting temperature 624°C		
For models:	CTE9141, CTE9142, CTE9142S, CTE9146, TE94APS, TE94EPS, TE94GPS, TEY4APS		

control thermostats with operation switch

55.10/19_series



GEV No.	375180	Ref. No.	0109170 CR0589660 SIR0109170
description	thermostat t.max. 185°C temperature range 99-185°C 1-pole 1NO 0.5A probe ø 4mm probe L 235mm capillary pipe 870mm capillary pipe isolated 700mm gland nut shaft ø 6x4.6mm shaft L 23mm shaft position rotation 270° outer switch 2NO		
For models:	EFE72110, EFE72115, EFE73210, EFE74215, EFE92115, EFE92122, EFE93210, EFE94215, EFE94222		



GEV No.	375331	Ref. No.	0105028 CM097800 MACM097800 SIR0105028
description	thermostat t.max. 189°C temperature range 62-189°C 1-pole 1NO 0.5A probe ø 4mm probe L 116mm capillary pipe 900mm capillary pipe isolated 700mm gland nut shaft ø 6x4.6mm shaft L 23mm shaft position upper rotation 270° outer switch 2NO		
For models:	CFE62110/1, CFE62210/1, FE62T10, FE64T10, FE72112, FE72206, FE72T10, FE74212, FE74T10, FE82118, FE82206, FE82T18, FE84218, FE84T18, FE92118, FE92206, FE94218, FEY2118, FEY2206, FEY4218, FG82122, FG82T22, FG84222, FG84T22, FG92122, FG94222, FGY2122, FGY4222		



GEV No.	375946	Ref. No.	CR0581280
description	thermostat t.max. 350°C temperature range 100-350°C 1-pole 1NO 16A probe ø 3mm probe L 145mm capillary pipe 900mm capillary pipe isolated 800mm gland nut shaft ø 4.5x6mm shaft L 25mm shaft position upper rotation 275° outer switch 2NC		
For models:	ESE74, ESE94CRA, ESE94CRM, ESE94FRA, ESE94FRM, ESE96CRA, ESE96FRA, ESG94CRA, ESG94CRM, ESG94FRA, ESG94FRM, ESG96CRA, ESG96FRA		

55.34_series



GEV No.	375140	Ref. No.	CR0688650
description	thermostat t.max. 650°C temperature range 50°C/50-600°C/70-650°C 3-pole 3NO 16A probe ø 4mm probe L 228mm capillary pipe 1200mm capillary pipe isolated 1200mm gland nut shaft ø 6x4.6mm shaft L 23mm shaft position left rotation 318° outer switch 2NO		
For models:	ECV92A, ECV92G, ECV92T, ECV94A, ECV94E, ECV94G, ECV94T		

accessories

probe clips

spring clips

for safety thermostat

GEV No.	551080	Ref. No.	0105032 1033515800 MA1033515800 SIR0105032
description	probe clip for pipe ø 8.5mm for probe ø 4mm Qty 1 pcs		
For models:	CFE62110/1, CFE62210/1, EFE72110, EFE72115, EFE73210, EFE74215, EFE92115, EFE92122, EFE92122K, EFE93210, EFE94215, EFE94222, EFE94222K, FE62T10, FE64T10, FE72112, FE72206, FE72T10, FE74212, FE74T10, FE82118, FE82206, FE84218, FE92118, FE92206, FE94218, FEY2118, FEY2206, FEY4218		

GEV No.	357082	Ref. No.	CR0685490
description	spring clip for probe L 22mm W 19mm		
For models:	EGVE7		





gland nut accessories

locking screws

			
1			
GEV No.	106605	Ref. No.	0105033 CM012401 MACM012401 SIR0105033
description	union screw thread M10x1 probe ø max. 4.5mm		
For models:	CFE62110/1, CFE62210/1, EFE72115, EFE74215, EFE92115, EFE92122, EFE92122K, EFE93210, EFE94215, EFE94222, EFE94222K, EFG72108, EFG72110, EFG72115, EFG73208T, EFG73210, EFG74215, EFG92115, EFG92115S, EFG92123, EFG92123K, EFG93210, EFG94215, EFG94215S, EFG94223, EFG94223K, FE62T10, FE64T10, FE72112, FE72206, FE72T10, FE74212, FE74T10, FE82118, FE82206, FE82T18, FE84218, FE84T18, FE92118, FE92206, FE94218, FEY2118, FEY2206, FEY4218, FG72115, FG72206, FG74215, FG82122, FG82206, FG82T22... (Other models you can see in the webshop)		

connecting bows

			
1			
GEV No.	550060	Ref. No.	0101378 921200 MA921200 SIR0101378
description	connecting bow long for thermostat Qty 1 pcs		
For models:	BE72ALC, BE72ALL, BE72ARR, BE72GLC, BE72GLL, BE72GRR, BE72TLC, BE72TLL, BE72TRR, BE74ALC, BE74ALL, BE74ALR, BE74ARC, BE74ARR, BE74GLC, BE74GLL, BE74GLR, BE74GMC, BE74GRR, BE74TLC, BE74TLL, BE74TLR, BE74TMC, BE74TRR, BE82ALC, BE82ALL, BE82ARR, BE82GLC, BE82GLL, BE82GRR, BE82TLC, BE82TLL, BE82TRR, BE84ALC, BE84ALL, BE84ALR, BE84AMC, BE84ARR, BE84GLC, BE84GLL, BE84GLR, BE84GMC, BE84GRR, BE84TLC, BE84TLL, BE84TLR, BE84TMC, BE84TRR, BE92ALC, BE92ALL... (Other models you can see in the webshop)		

			
1			
GEV No.	301003	Ref. No.	0109015 SIR0109015
description	rocker switch mounting measurements 30x22mm green 2NO 250V 16A illuminated 0-I connection male faston 6.3mm ambient temperature max. 125/55°C protection IP65		
For models:	BAC100, BAC100-A, BAC102, BAC120, BAC120-A, BAC122, BAC140, BAC140-A, BAC142, BAC160, BAC160-A, BAC162, BAC180, BAC180-A, BAC182, BAC200, BAC200-A, BAC202, BAM16D, BAM16S, BAM18D, BAM18S, BAM20D, BAM20S, CCW6020, CFG60110, CFG60210, CME6020, CME6030, CME6040, CME7020, CME7021, CME7022, CME7041, CME7042, CME7220, CME7221, CME7222, CME7241, CME7242, CRE6-20, CRE6-30, CSP6020, CSP7020, ME72APS, ME72GPS, ME72TPS, ME74APS, ME74GPS, RP72TPS... (Other models you can see in the webshop)		
accessories for	301003		
		GEV No.	301036
		Ref. No.	—
	protective cover internal size 30x22mm for rocker switch mounting measurementsmm		



push/momentary push switches

<p>ø25mm</p> 			
1			
GEV No.	345038	Ref. No.	0101188 CR0410290 SIR0101188
description	momentary push switch mounting ø 25mm black 2NO 250V 16A connection male faston 6.3mm ambient temperature max. 85°C protection IP40		
For models:	CCG1045, CCG10652, CCG10653, CCG1085, CCG10852, CCG7001, CCG7020, CCG7021, CCG7022, CCG7040, CCG7041, CCG7042, CCG7045, CCG7046, CCG7061, CCG7062, CCG70652, CCG70653, CCG70663, CCG7201, CCG7220, CCG7221, CCG7222, CCG7240, CCG7241, CCG7242, CCG7245, CCG7246, CCG7261, CCG7262, CCG72652, CCG72653, CCG72662, CCG72663, CCG9046, CCG90663, CCG9145, CCG9145-1, CCG91652, CCG91652-1, CCG91653, CCG91653-1, CCG9185, CCG9185-1, CCG91852, CCG91852-1, CFS9050, CFS9052, CFS9055, CG76GPS... (Other models you can see in the webshop)		

switches and momentary switches

rocker/momentary rocker switches

<p>30x22mm</p> 			
1			
GEV No.	347791	Ref. No.	4640500 MA4640500
description	rocker switch mounting measurements 30x22mm green 2NO 230V 20A illuminated 0-I connection male faston 6.3mm ambient temperature max. 125/55°C protection IP65 with rubber collar		
For models:	CCW6220, CME6220, CME6230, CME6240, CRE6220, CRE6230, CSP6220, CW62TPS, GE62TPS, GE63TPS, ME62TPS, ME63TPS, ME64TPS, RP62TPS		

			
1			
GEV No.	345039	Ref. No.	CR0410310
description	protective cover round ED ø 33mm external size 23mm internal size 21mm H 12mm clear mounting ø 25mm		
For models:	EME92A, EME92G, EME92T, EME94A, EME94G, EME94T, ESE94CRA, ESE94CRM, ESE94FRA, ESE94FRM, ESE96CRA, ESE96FRA, ESG94CRA, ESG94CRM, ESG94FRA, ESG94FRM, ESG96CRA, ESG96FRA		
accessories for	345039		
		GEV No.	345001
		Ref. No.	—
	momentary push switch mounting ø 25mm yellow 1NO/indicator light 250V 16A cover connection male faston 6.3mm ambient temperature max. 85°C protection IP65		



microswitches

lever actuated



1

GEV No.	345254	Ref. No.	0105025 1037111300 MA1037111300 SIR0105025
description	microswitch with lever 250V 16A 1CO connection male faston 6.3mm ambient temperature max. 120°C mounting distance 22mm actuating force: 60g lever length 58mm		
For models:	CFE62110/1, CFE62210/1, EFE72110, EFE72115, EFE73210, EFE74215, EFE92115, EFE92122, EFE92122K, EFE93210, EFE94215, EFE94222, EFE94222K, ESE74, ESE94CRA, ESE94CRM, ESE94FRA, ESE94FRM, ESE96CRA, ESE96FRA, ESG94CRA, ESG94CRM, ESG94FRA, ESG94FRM, ESG96CRA, ESG96FRA, FE62T10, FE64T10, FE72112, FE72206, FE72T10, FE74212, FE74T10, FE82118, FE82206, FE82T18, FE84218, FE84T18, FE92118, FE92206, FE94218, FEY2118, FEY2206, FEY4218		



1

GEV No.	345345	Ref. No.	0108059 SIR0108059
description	microswitch with lever 250V 16A 1CO connection male faston 6.3mm L 78mm ambient temperature max. 85°C mounting distance 22mm type X662-88-J27 actuating force: 40g lever length 69mm		
For models:	CFE70110, CFE70110-2, CFE70115, CFE70115-2, CFE70115-M, CFE70210, CFE70210-2, CFE70210-M, CFE70215, CFE70215-2, CFE70215-M, CFE72210, CFE72215, CFE90120, CFE90120-2, CFE90210, CFE90210-2, CFE90220, CFE90220-2, FE72210, FE92210		



1

GEV No.	345044	Ref. No.	0101181 SIR0101181
description	microswitch with lever 250V 16A 1CO connection male faston 6.3mm ambient temperature max. 85°C mounting distance 25mm type C99ZP3 actuating force: 25g lever length 71mm		
For models:	CBE7050, CBE7050C, SE74CRM, SE74FRM, SE74IRM, SE84CRM, SE84FRM, SE84IRM		

pin-plunger actuated

M12



1

GEV No.	345350	Ref. No.	0101180 0103452 LAR65260530 LAR65260540 SIR0101180 SIR0103452
description	microswitch with plunger mounting distance 22mm thread M12x0.75 thread L 16mm 250V 16A 1CO connection male faston 6.3mm stroke 4mm ambient temperature max. 125°C type EF83161.3 actuating force: 66g		
For models:	CFE60110, CFE60210, CFE70110-0, CFE72110-0, FE72T10		
accessories for	345350		
	GEV No.	345351	Ref. No. —
	 nut thread M12x0.75 H 1.6mm WS 14 chrome-plated brass Qty 1 pcs		

with push button

gas ignition



1

GEV No.	100010	Ref. No.	0101184 SIR0101184
description	microswitch with push button 250V 10A 1CO connection male faston 6.3mm ambient temperature max. 85°C mounting distance 22mm actuating force: 360g thread L 15mm thread M10x0.75		
For models:	CME7021, CME7022, CME7041, CME7042, CME7221, CME7222, CME7241, CME7242, ME72APS, ME72GPS, ME74APS, ME74GPS		

position switches

SIEMENS

3SE2 series

position switches (complete)



1

GEV No.	345349	Ref. No.	0101177 SIR0101177
description	position switch with lever		
For models:	CBE9060, CBE9060C, CBG9060C-I, SE84CRA, SE84FRA, SE84IRA, SE94CRA, SE94CRM, SE94FRA, SE94FRM, SE94IRA, SE94IRM, SG84CRA, SG84IRA, SG94CRA, SG94FRA, SG94IRA		



cam switches

on/off



GEV No.	300088	Ref. No.	0108007 SIR0108007
description	cam switch 2 operating positions 4NO sequence 0-1 16A shaft ø 6x4.6mm shaft L 23mm connection male faston 6.3mm ceramic		
For models:	CFE70115, CFE70115-2, CFE70115-M, CFE70210-M, CFE70215, CFE70215-2, CFE70215-M, CFE72215, CFE90210, CFE90210-2, FE92210		



GEV No.	300074	Ref. No.	0101380 SIO101380 SIR0101380
description	cam switch 4 operating positions 2NO sequence 0-1-0-1 16A shaft ø 6x4.6mm shaft L 23mm connection male faston 6.3mm ceramic		
For models:	CBE9060, CBE9060C, CBG9060C-I, CCG1045, CCG10652, CCG10653, CCG1085, CCG10852, CCG60652, CCG60653, CCG7045, CCG7046, CCG70652, CCG70653, CCG70663, CCG72653, CCG72663, CCG9046, CCG90663, CCG91653, CCG91653-1, CCG91663, CCG91663-1, CCQ7046, CCQ70663, CCQ9046, CCQ90663, CCT7046, CCT70663, CGE9020, CGE9020C, CGE9020R, CGE9020RC, CGE9021, CGE9021C, CGE9021R, CGE9021RC, CGE9022, CGE9022C, CGE9022R, CGE9022RC, CGE9040, CGE9040C, CGE9040LR, CGE9040LRC, CGE9040R, CGE9040RC, CGE9041, CGE9041C, CGE9041LR...(Other models you can see in the webshop)		



GEV No.	300021	Ref. No.	1230100 MA1230100
description	cam switch 4 operating positions 4NO sequence 0-1-0-1 16A shaft ø 6x4.6mm shaft L 23mm connection screw ceramic		
For models:	EFE92122K, EFE94222K, EFG92123K, EFG94223K, EME7, EME92A, EME92G, EME92T, EME94A, EME94G, EME94T, ERP72		



GEV No.	300095	Ref. No.	0109058 SIR0109058
description	cam switch ON-OFF connection screw clamp		
For models:	CFE60110-5, CFE60110-9, CFE60210-5, CFE60210-9		

4-position



GEV No.	300104	Ref. No.	0101400 SIR0101400
description	cam switch 4 operating positions 3NO/1CO sequence 0-1-2-3 32A shaft ø 6x4.6mm shaft L 23mm connection screw ceramic		
For models:	CNE6030		

7-position





GEV No.	300025	Ref. No.	0101423 1616100 MA1616100 SIR0101423
description	cam switch 7 operating positions 1NO/2CO sequence 0-1-2-3-4-5-6 16A shaft ø 6x4.6mm shaft L 23mm connection screw 7-position ceramic		
For models:	CCQ7020, CCQ7021, CCQ7022, CCQ7040, CCQ7041, CCQ7042, CCQ7046, CCQ7061, CCQ7062, CCQ70663, CCQ7220, CCQ7221, CCQ7222, CCQ7240, CCQ7241, CCQ7242, CCQ7246, CCQ7261, CCQ7262, CCQ9020, CCQ9021, CCQ9022, CCQ9040, CCQ9041, CCQ9042, CCQ9046, CCQ9060, CCQ9061, CCQ9062, CCQ90663, CCT6020, CCT6040, CCT6046, CCT7020, CCT7021, CCT7022, CCT7040, CCT7041, CCT7042, CCT7046, CCT7061, CCT7062, CCT70663, CCT7220, CCT7221, CCT7222, CCT7240, CCT7241, CCT7242, CCT7246...(Other models you can see in the webshop)		

accessories for	300025			
	GEV No.	112172	Ref. No.	—
	knob universal ø 70mm black without adaptor/dial plate			
	GEV No.	112213	Ref. No.	—
	knob dial plate silver switch 7-position t.max.°C°C ED ø 63mm ID ø 45.5mm			

Table continues overleaf



accessories for	300025		
	GEV No.	112311	Ref. No. —
	knob adapter shaft ø 6x4.6mm L 0mm with spring		

			
1			
GEV No.	300106	Ref. No.	0101399 1937800 MA1937800 SIR0101399
description	cam switch 7 operating positions 1NO/2CO sequence 0-1-2-3-4-5-6 32A shaft ø 6x4.6mm shaft L 23mm connection screw 7-position shaft flat upper		
For models:	CCQ9020, CCQ9021, CCQ9022, CCQ9040, CCQ9041, CCQ9042, CCQ9046, CE82APQ, CE82GPQ, CE82TPQ, CE84APQ, CE84EPQ, CE84PQ, CE84TPQ, CE92APQ, CE92GPQ, CE92TPQ, CE94APQ, CE94EPQ, CE94GPQ, CE94TPQ, CEY2TPQ, CEY4TPQ		

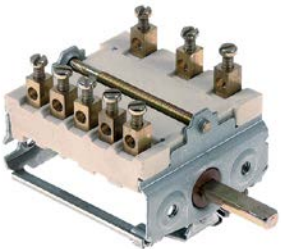
3 operating positions			
			
1			
GEV No.	347015	Ref. No.	0101420 SIR0101420
description	cam switch 3 operating positions sequence 0-1-2 shaft ø 6x4.6mm connection screw connection		
For models:	CTE9141, CTE9142, CTE9142S, CTE9146, TE94APS, TE94EPS, TE94GPS, TEY4APS		

4 operating positions			
			
1			
GEV No.	300081	Ref. No.	0101397 1309000 MA1309000 SIR0101397
description	cam switch 4 operating positions 3NO/2CO sequence 0-1-2-3 16A shaft ø 6x4.6mm shaft L 23mm connection screw		
For models:	CCG60652, CCG60653, CCG7046, CCG7046P, CCG70662P, CCG70663, CCG7246, CCG72662, CCG72663, CCG9146, CCG9146-1, CCG91662, CCG91662-1, CCG91663-1, CCQ7046, CCQ70663, CCT7046, CCT70663, CCT7246V, CE84EPQ, CG74EPS, CG76EPS, CG84EPS, CV74EPS, ECE7-E, ECE94E, ECG94E, ECG96E, ECV94E		

			
1			
GEV No.	300239	Ref. No.	CR0581810
description	operation switch 4 operating positions 4NO sequence 0-1-2-3 16A shaft ø 6x4.6mm shaft L 23mm connection male faston 6.3mm plastic		
For models:	EDE72128, EDE73142, EDE74228, EDE92142, EDE93142, EDE94242, EDG72128, EDG73142, EDG74228, EDG92142, EDG93142, EDG94242, EPE50, EPE7108, EPE9D10, EPE9D15, EPE9I10, EPE9I10A, EPE9I15, EPE9I15A, EPG50, EPG7108, EPG9D10, EPG9D10A, EPG9D15, EPG9D15A, EPG9I15, EPG9I15A, EPGB9I10, EPGB9I10A		

operation switches			
			
1			
GEV No.	300002	Ref. No.	0101398 6A046001 BN6A046001 SIR0101398
description	cam switch 2 operating positions 4NO 16A sequence 0-1 shaft ø 6x4.6mm shaft L 23mm connection male faston 6.3mm ceramic		
For models:	BE72ALC, BE72ALL, BE72ARR, BE72GLC, BE72GLL, BE72GRR, BE72TLC, BE72TLL, BE72TRR, BE74ALC, BE74ALL, BE74ALR, BE74ARC, BE74ARR, BE74GLC, BE74GLL, BE74GLR, BE74GMC, BE74GRR, BE74TLC, BE74TLL, BE74TLR, BE74TMC, BE74TRR, CCG9046P, CCG90662P, CCG9146, CCG9146-1, CCG91662, CCG91662-1, CCG91663, CCG91663-1, CCQ9046, CCQ9046V, CCQ90663, CE94EPQ, CFS9060, CFS9062, CFS9066, CG94EPS, CG96EPS, CGE6020, CGE6020C, CGE6020R, CGE6030, CGE6030C, CGE6030R, CGE6040, CGE6040C, CGE6040R...		
	(Other models you can see in the webshop)		

			
1			
GEV No.	300166	Ref. No.	0108026 SIR0108026
description	cam switch 2 operating positions 4NO 16A sequence 0-1 shaft ø 6x4.6mm shaft L 23mm connection male faston 6.3mm ceramic 4-pole ambient temperature max. 318°C		
For models:	CFE70110, CFE70110-2, CFE70210, CFE70210-2, CFE72210, CNE70130, CNE72130, DE72125, FE72210		



1

GEV No.	300080	Ref. No.	0101379 65085010 710300 MA710300 R65085010 SIR0101379
description	cam switch 2 operating positions 4NO 16A sequence 0-1 shaft ø 6x4.6mm shaft L 23mm connection screw operation switch ceramic ambient temperature max. 150°C		
For models:	BE82ALC, BE82ALL, BE82ARR, BE82GLC, BE82GLL, BE82GRR, BE82TLC, BE82TLL, BE82TRR, BE84ALC, BE84ALL, BE84ALR, BE84AMC, BE84ARR, BE84GLC, BE84GLL, BE84GLR, BE84GMC, BE84GRR, BE84TLC, BE84TLL, BE84TLR, BE84TMC, BE84TRR, BE92ALC, BE92ALL, BE92ARC, BE92ARR, BE92GLC, BE92GLL, BE92GRC, BE92GRR, BE94ALC, BE94ALL, BE94ALR, BE94AMC, BE94ARC, BE94ARR, BE94GLC, BE94GLL, BE94GLR, BE94GMC, BE94GRC, BE94GRR, BEY2TLC, BEY2TLL, BEY2TRC, BEY2TRR, BEY4TLC, BEY4TLL...(Other models you can see in the webshop)		
accessories for	300080		
	GEV No.	551456	Ref. No. —
gasket for switch ED ø 14mm ID ø 2.5mm thickness 3.5mm white			

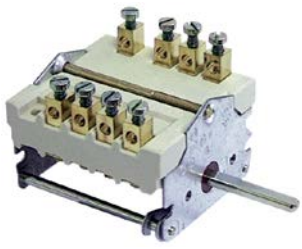

1

GEV No.	300107	Ref. No.	0108074 SIR0108074
description	cam switch 2 operating positions operation switch 32A sequence 0-1 shaft ø 6x4.6mm shaft L 23mm connection screw ceramic		
For models:	CFE70110, CFE70110-2, CFE70210, CFE70210-2, CFE90210, CFE90210-2		



1

GEV No.	300180	Ref. No.	CR0686110
description	cam switch 2 operating positions operation switch 32A sequence 0-1 shaft ø 6x4.6mm shaft L 23mm connection screw ceramic		
For models:	EBE7, EBE92AL, EBE92ALC, EBE92AR, EBE92ARC, EBE92GL, EBE92GLC, EBE92GR, EBE92GRC, EBE92TL, EBE92TLC, EBE92TR, EBE92TRC, EBE93AL, EBE93ALC, EBE93ALR, EBE93AMC, EBE93GL, EBE93GLC, EBE93GLR, EBE93GMC, EBE93TL, EBE93TLC, EBE93TLR, EBE93TMC, EBE94AL, EBE94ALC, EBE94ALR, EBE94AMC, EBE94AR, EBE94GL, EBE94GLC, EBE94GLR, EBE94GMC, EBE94GR, EBE94TL, EBE94TLC, EBE94TLR, EBE94TMC, EBE94TR, EGVE92, EGVE94		



1

GEV No.	300091	Ref. No.	0109057 SIR0109057
description	operation switch EGO 2 operating positions 2NO 16A sequence 0-1 shaft ø 6x4.6mm shaft L 23mm connection screw ceramic		
For models:	CFE60110, CFE60210		

rotary switches

BREMAS

A3200 series



1

GEV No.	345817	Ref. No.	0108008 SIR0108008
description	rotary switch 2 0-1 sets of contacts 4 type CS0327690 600V 32A shaft ø 5x5mm shaft L 26mm shaft square connection screw		
For models:	CFE70115, CFE70115-2, CFE70215, CFE70215-2, CFE72215, CFE90120, CFE90120-2, CFE90220, CFE90220-2		

control equipment

MOELLER/EATON

switches (complete)

push/momentary push switches



1

GEV No.	346172	Ref. No.	0101392 SIR0101392
description	momentary push switch mounting measurements ø22mm red complete		
For models:	CPE70150, CPE7-150, PE7NI05		



SIEMENS

3SB series ø22mm old

rotary switches



GEV No.	345526	Ref. No.	0102505 SI0102505 SIR0102505
description	rotary selector mounting measurements ø22mm sequence 0-1 latching black		
For models:	CPE90100, CPE90100A, CPE90150, CPE90150A, PE7NI05, PE8AI10, PE8AI15, PE8NI10, PE8NI15, PE9AI10, PE9AI15, PE9NI10, PE9NI15		

3SB series ø22mm new



GEV No.	346630	Ref. No.	CR0413790
description	contact block SIEMENS 3SB3400-0B 1NO max 400V 10A black		
accessories for	346630		
	GEV No.	347520	Ref. No. —
	push button mounting measurements ø22mm non-illuminated black		



GEV No.	346602	Ref. No.	CR0687390
description	contact block SIEMENS 3SB3400-0D 2NO max 400V 10A black		
For models:	ESE94CRA, ESE94CRM, ESE94FRA, ESE94FRM, ESE96CRA, ESE96FRA, ESG94CRA, ESG94CRM, ESG94FRA, ESG94FRM, ESG96CRA, ESG96FRA		

switches (complete)



GEV No.	346174	Ref. No.	0102474 SIR0102474
description	momentary push switch mounting measurements ø22mm		
For models:	CBG9060C-I, CPD90100, CPD90100A, CPD90150, CPD90150A, CPI90100, CPI90100A, CPI90150, CPI90150A, PG9AD10, PG9AD15, PG9AI10, PG9AI15, PG9ND10, PG9ND15, PG9NI10, PG9NI15		







GEV No.	345316	Ref. No.	0102475 SIR0102475
description	momentary push switch mounting measurements ø22mm complete		
For models:	CBE9060, CBE9060C, CBG9060C-I, SE94CRA, SE94CRM, SE94FRA, SE94FRM, SE94IRA, SE94IRM		

rotary switches





GEV No.	346629	Ref. No.	CR0413380
description	rotary selector mounting measurements ø22mm black momentary sequence 1-0-2		
For models:	ESE94CRA, ESE94CRM, ESE94FRA, ESE94FRM, ESE96CRA, ESE96FRA, ESG94CRA, ESG94CRM, ESG94FRA, ESG94FRM, ESG96CRA, ESG96FRA, SE84CRA, SE84FRA, SE84IRA, SE94CRA, SE94FRA, SE94IRA, SG84CRA, SG84IRA, SG94CRA, SG94FRA, SG94IRA		

accessories for	346629		
	GEV No.	346602	Ref. No. CR0687390
	contact block SIEMENS 3SB3400-0D 2NO max 400V 10A black		
	GEV No.	346603	Ref. No. —
	contact block SIEMENS 3SB3400-0E 2NC max 400V 10A black		
	GEV No.	346630	Ref. No. CR0413790
	contact block SIEMENS 3SB3400-0B 1NO max 400V 10A black		
	GEV No.	346631	Ref. No. —
	contact block SIEMENS 3SB3400-0C 1NC max 400V 10A black		
	GEV No.	346632	Ref. No. —
	contact block SIEMENS 3SB3400-0D 1NC/1NO max 400V 10A black		

lamps



GEV No.	359606	Ref. No.	0102476 SIR0102476
description	neon light bulb socket Ba9s 220V 2W clear ø 10mm L 28mm		
For models:	CPD90100, CPD90100A, CPD90150, CPD90150A, CPI90100, CPI90100A, CPI90150, CPI90150A		

accessories for	359606		
	GEV No.	359832	Ref. No. —
	lamp socket mounting measurements ø16.2mm socket Ba9s connection male faston 6.3mm		
	GEV No.	359853	Ref. No. —
	lamp socket mounting measurements ø18.2mm socket Ba9s connection male faston 6.3mm		



encoders and potentiometers

			
1			
GEV No.	402055	Ref. No.	0101932 SIR0101932
description	potentiometer 22KOhm		
For models:	CTE9141, CTE9142, CTE9142S, CTE9146, TE94APS, TE94EPS, TE94GPS, TEY4APS		



lamps

indicator lights

indicator lights 3-piece (housing, lens and bulb)

lamps

neon light bulbs

			
1			
GEV No.	359606	Ref. No.	0102476 SIR0102476
description	neon light bulb socket Ba9s 220V 2W clear ø 10mm L 28mm		
For models:	CPD90100, CPD90100A, CPD90150, CPD90150A, CPI90100, CPI90100A, CPI90150, CPI90150A		
accessories for	359606		
	GEV No.	359832	Ref. No. —
	lamp socket mounting measurements ø16.2mm socket Ba9s connection male faston 6.3mm		
	GEV No.	359853	Ref. No. —
	lamp socket mounting measurements ø18.2mm socket Ba9s connection male faston 6.3mm		

indicator lights (complete)

ø10mm

with screw socket

			
1			
GEV No.	359378	Ref. No.	1037300810 MA1037300810
description	indicator light ø 10mm 230V green connection male faston 6.3mm socket screw base		
For models:	BE62TLC, BE62TLL, BE62TRR, BE63TLC, BE63TLL, BE63TLR, BE65TLC, BE65TLL, BE65TLR, CBE6220, CCT6220, CCT6220V, CCT6230, CCT6230V, CE62TPT, CE64TPT, CFE62110/1, CFE62210/1, CGE6220, CGE6220C, CGE6220R, CGE6230, CGE6230C, CGE6230LR, CGE6250, CGE6250LR, CGE6250LRC, CV62TPS, CV64TPS, FE62T10, FE64T10, SE62TPS		

			
1			
GEV No.	359380	Ref. No.	CR0682520
description	indicator light ø 10mm 230V red connection male faston 6.3mm socket screw base		
For models:	ECV92A, ECV92G, ECV92T, ECV94A, ECV94E, ECV94G, ECV94T, EPE7105, EPE7108, EPE9110, EPE9110A, EPE9115, EPE9115A, EPG7105, EPG7108, EPG9115, EPG9115A, EPGB9110, EPGB9110A, ETE74		

			
1			
GEV No.	359379	Ref. No.	CR0587500
description	indicator light ø 10mm 230V yellow connection male faston 6.3mm socket screw base		
For models:	EBE7, EBE92AL, EBE92ALC, EBE92AR, EBE92ARC, EBE92GL, EBE92GLC, EBE92GR, EBE92GRC, EBE92TL, EBE92TLC, EBE92TR, EBE92TRC, EBE93AL, EBE93ALC, EBE93ALR, EBE93AMC, EBE93GL, EBE93GLC, EBE93GLR, EBE93GMC, EBE93TL, EBE93TLC, EBE93TLR, EBE93TMC, EBE94AL, EBE94ALC, EBE94ALR, EBE94AMC, EBE94AR, EBE94GL, EBE94GLC, EBE94GLR, EBE94GMC, EBE94GR, EBE94TL, EBE94TLC, EBE94TLR, EBE94TMC, EBE94TR, ECE74E, ECE74-Q, ECE92A, ECE92G, ECE92T, ECE94A, ECE94E, ECE94G, ECE94T, ECG94E...(Other models you can see in the webshop)		

with plug-in socket

			
1			
GEV No.	359140	Ref. No.	1037300910 MA1037300910
description	indicator light ø 10mm yellow 230V connection male faston 6.3mm Qty 1 pcs		
For models:	BE62TLC, BE62TLL, BE62TRR, BE63TLC, BE63TLL, BE63TLR, BE65TLC, BE65TLL, BE65TLR, CCW6220, CFE62110/1, CFE62210/1, CGE6220, CGE6220C, CGE6220R, CGE6230, CGE6230C, CGE6230LR, CGE6250, CGE6250LR, CGE6250LRC, CME6220, CME6230, CME6240, CNE6230, CRE6220, CRE6230, CSP6220, CW62TPS, DE63128, ECE7-E, FE62T10, FE64T10, GE62TPS, GE63TPS, ME62TPS, ME63TPS, ME64TPS, RP62TPS, SG86CRA, SG86FRA, SG86IRA, SG96CRA, SG96FRA, SG96IRA		

ø12mm

with screw socket

			
1			
GEV No.	359048	Ref. No.	0101170 SIR0101170
description	indicator light ø 12mm 230V yellow connection male faston 6.3mm		

			
1			
GEV No.	359027	Ref. No.	0101171 SIR0101171
description	indicator light ø 12mm 250V green connection male faston 6.3mm		





			
1			
GEV No.	359291	Ref. No.	0101169 SI0101169 SIR0101169
description	indicator light ø 12mm 400V green connection male faston 6.3mm		
For models:	BE72ALC, BE72ALL, BE72ARR, BE72GLC, BE72GLL, BE72GRR, BE72TLC, BE72TLL, BE72TRR, BE74ALC, BE74ALL, BE74ALR, BE74ARC, BE74ARR, BE74GLC, BE74GLL, BE74GLR, BE74GMC, BE74GRR, BE74TLC, BE74TLL, BE74TLR, BE74TMC, BE74TRR, BE82ALC, BE82ALL, BE82ARR, BE82GLC, BE82GLL, BE82GRR, BE82TLC, BE82TLL, BE82TRR, BE84ALC, BE84ALL, BE84ALR, BE84AMC, BE84ARR, BE84GLC, BE84GLL, BE84GLR, BE84GMC, BE84GRR, BE84TLC, BE84TLL, BE84TLR, BE84TMC, BE84TRR, BE92ALC, BE92ALL...(Other models you can see in the webshop)		

			
1			
GEV No.	359292	Ref. No.	0101168 SIR0101168
description	indicator light ø 12mm 400V red connection male faston 6.3mm		

			
1			
GEV No.	359290	Ref. No.	0101167 65270220 LA65270220 LAR65270220 SIR0101167
description	indicator light ø 12mm 400V yellow connection male faston 6.3mm		
For models:	BAC100, BAC100-A, BAC102, BAC120, BAC120-A, BAC122, BAC140, BAC140-A, BAC142, BAC160, BAC160-A, BAC162, BAC180, BAC180-A, BAC182, BAC200, BAC200-A, BAC202, BAM16D, BAM16S, BAM18D, BAM18S, BAM20D, BAM20S, BE72ALC, BE72ALL, BE72ARR, BE72GLC, BE72GLL, BE72GRR, BE72TLC, BE72TLL, BE72TRR, BE74ALC, BE74ALL, BE74ALR, BE74ARC, BE74ARR, BE74GLC, BE74GLL, BE74GLR, BE74GMC, BE74GRR, BE74TLC, BE74TLL, BE74TLR, BE74TMC, BE74TRR, BE82ALC, BE82ALL...(Other models you can see in the webshop)		

screw-on/push-on fit

neon light bulbs

			
1			
GEV No.	359606	Ref. No.	0102476 SIR0102476
description	neon light bulb socket Ba9s 220V 2W clear ø 10mm L 28mm		
For models:	CPD90100, CPD90100A, CPD90150, CPD90150A, CPI90100, CPI90100A, CPI90150, CPI90150A		
accessories for	359606		
			
GEV No.	359832	Ref. No.	—
description	lamp socket mounting measurements ø16.2mm socket Ba9s connection male faston 6.3mm		
			
GEV No.	359853	Ref. No.	—
description	lamp socket mounting measurements ø18.2mm socket Ba9s connection male faston 6.3mm		

alarm devices

buzzers

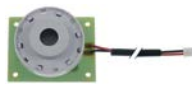
			
1			
GEV No.	350086	Ref. No.	LA65301440 LAR65301440 RA919008 SIRRA919008
description	buzzer 12VDC connection cable 200mm PCB buzzer 20dB		
For models:	CTE9141, CTE9142, CTE9142S, CTE9146, DP018T, DP112T, DPC20T, DPC40T, DX018T, DX110T, DX112T, DXC20T, DXC40T, MDP112T, MDPC20T, MDPC40T, MDX112T, MDXC20T, MDXC40T, MZP110T, MZPC20T, MZPC40T, MZX110T, MZXC20T, MZXC40T, TE94APS, TE94EPS, TE94GPS, TEY4APS, ZP018S, ZP018T, ZP110T, ZP112T, ZPC20T, ZPC40T, ZX018S, ZX018T, ZX105A, ZX105D, ZX110A, ZX110T, ZX112S, ZX210A, ZXC20T, ZXC40A, ZXC40T		

contactors

ABB

power contactors

			
1			
GEV No.	381011	Ref. No.	0101332 SI0101332 SIR0101332
description	power contactor resistive load 16A 230VAC (AC3/400V) 9A/4kW main contacts 2NO/2NC auxiliary contacts connection screw connection type B6-22-00		
For models:	CTE9141, CTE9142, CTE9142S, CTE9146, TE94APS, TE94EPS, TE94GPS, TEY4APS		



GENERAL ELECTRIC (AEG)

power contactors





GEV No.	380263	Ref. No.	0101330 SIR0101330
description	power contactor resistive load 32A 230VAC (AC3/400V) 17A/7.5kW main contacts 4NO auxiliary contacts connection screw connection type AEG LS7K 400A type GE CL00A 310		
For models:	CBE7050, CBE7050C, CBE9060, CBE9060C, CFE60110, CFE60210, CFE70110-0, CFE72110-0, CGE9020, CGE9020C, CGE9020R, CGE9020RC, CGE9021, CGE9021C, CGE9021R, CGE9021RC, CGE9022, CGE9022C, CGE9022R, CGE9022RC, CGE9040, CGE9040C, CGE9040LR, CGE9040LRC, CGE9040R, CGE9040RC, CGE9041, CGE9041C, CGE9041LR, CGE9041LRC, CGE9041R, CGE9041RC, CGE9042, CGE9042C, CGE9042LR, CGE9042LRC, CGE9042R, CGE9042RC, CNE70160, CNE72160, CNE90160, CNE90160S, CNE90160-S, CPE90100, CPE90100A, CPE90150, CPE90150A, CRE6-20, CRE6-30, DE74170...(Other models you can see in the webshop)		

LOVATO

power contactors



GEV No.	380855	Ref. No.	0108075 SIR0108075
description	power contactor resistive load 25A 230VAC (AC3/400V) 4.2kW main contacts 3NO auxiliary contacts 1NO		
For models:	CFE70110, CFE70110-2, CFE70115, CFE70115-2, CFE70115-M, CFE70210, CFE70210-2, CFE70210-M, CFE70215, CFE70215-2, CFE70215-M, CFE72210, CFE72215, CFE90120, CFE90120-2, CFE90210, CFE90210-2, CFE90220, CFE90220-2, FE72210, FE92210		
accessories for	380855		
	GEV No.	380055	Ref. No. —
	RC circuit voltage AC/DC suitable for BF09-32 rated 240V		
	GEV No.	380118	Ref. No. —
	auxiliary contact contacts 1NO/1NC AC1 10A for contactors BF series connection screw type G480/11		

ISKRA (FANAL)

power contactors



GEV No.	380219	Ref. No.	0101328 SIR0101328
description	power contactor resistive load 25A 230VAC (AC3/400V) 17A/7.5kW main contacts 3NO auxiliary contacts 1NC connection screw connection type Fanal DSL16 01 type ISKRA KNL16 01		
accessories for	380219		
	GEV No.	381379	Ref. No. —
	overload switch connection screw setting range 11.3-16A for contactors KNL16 type BR16 11.3-16A		

SIEMENS

power contactors



GEV No.	381387	Ref. No.	CM187301 MACM187301
description	power contactor resistive load 22A 230VAC (AC3/400V) 4kW main contacts 3NO auxiliary contacts 1NO connection screw connection type 3RT2016-1AP01		



1

GEV No.	380389	Ref. No.	CM187300 MACM187300
description	power contactor resistive load 22A 230VAC (AC3/400V) 9A/4kW main contacts 3NO auxiliary contacts 1NO connection screw connection type 3RT10-16-1AP01		
For models:	CFE62110/1, CFE62210/1, CNE6230, CRE6220, CRE6230, DE63128, DE72128, DE74228, DE82140, DE82142, DE82T42, DE84240, DE84242, DE84T42, DE92142, DE94242, DEY2142, DEY4242, EDE72128, EDE74228, EDE92142, EDE93142, EDE94242, EFE72110, EFE72115, EFE73210, EFE74215, EFE92115, EFE92122, EFE92122K, EFE93210, EFE94215, EFE94222, EFE94222K, EPE7105, EPE7108, EPE9D10, EPE9D15, EPE9110, EPE9110A, EPE9115, EPE9115A, ESE74, FE62T10, FE64T10, FE72112, FE72206, FE74212, FE82206, FE92206...(Other models you can see in the webshop)		



2

GEV No.	380390	Ref. No.	0105031 CM187400 CM187401 MACM187400 MACM187401 SIR0105031
description	power contactor resistive load 40A 230VAC (AC3/400V) 12A/5.5kW main contacts 3NO auxiliary contacts connection screw connection type 3RT10-24-1AL20 50/60Hz		
For models:	EFE92122, EFE92122K, EFE94222, EFE94222K, ESE94CRA, ESE94CRM, ESE94FRA, ESE94FRM, ESE96CRA, ESE96FRA, FE82118, FE82T18, FE84218, FE84T18, FE92118, FE94218, FEY2118, FEY4218, SE86CRA, SE86FRA, SE86IRA, SE96CRA, SE96FRA, SE96IRA		

relays

power relays

with bracket mounting

1

GEV No.	380815	Ref. No.	CR0687240
description	power relays 230VAC 16A 2NO connection male faston 6.3mm flange dimensions 36x38x68mm		
For models:	ESE94CRA, ESE94CRM, ESE94FRA, ESE94FRM, ESE96CRA, ESE96FRA, ESG94CRA, ESG94CRM, ESG94FRA, ESG94FRM, ESG96CRA, ESG96FRA		

with male contacts

bullet connectors, 8 contacts

1

GEV No.	380951	Ref. No.	0683840 CR0683840
description	power relays FINDER 230VAC 10A 2CO connection plug-in connection round 8-pole manuf. no. 60.12.4.101.0040 90.26/ZVE8 250V		
For models:	EPE7105, EPE7108, EPE9110, EPE9110A, EPE9115, EPE9115A, EPG7105, EPG7108, EPG9115, EPG9115A, EPG9110, EPG9110A		

relay sockets

1

GEV No.	380638	Ref. No.	2609500 MA2609500
description	relay socket 8-pole dimensions 51x41x23mm 250V 10A FINDER manuf. no. 90.26		
For models:	EPE7105, EPE7108, EPE9110, EPE9110A, EPE9115, EPE9115A, EPG7105, EPG7108, EPG9115, EPG9115A, EPG9110, EPG9110A		



electric components

level relays

GICAR



1			
GEV No.	400018	Ref. No.	0102477 SI0102477 SIR0102477
description	level relay 230V voltage AC connection F6.3 type RL30/3ES/F/G		
For models:	CPE90100, CPE90100A, CPE90150, CPE90150A, CPI90100, CPI90100A, CPI90150, CPI90150A, PE7NI05, PE8AI10, PE8AI15, PE8NI10, PE8NI15, PE9AI10, PE9AI15, PE9NI10, PE9NI15		

electronic controllers

EVCO - EVERY CONTROL

universal controllers

built-in version



1			
GEV No.	400175	Ref. No.	0108072 SIR0108072
description	electronic controller EVERY CONTROL		
For models:	CFE70115-M, CFE70210-M, CFE70215-M		

transformers

encapsulated transformers

with screw connection



1			
GEV No.	402950	Ref. No.	CR0684780
description	transformer primary 230V secondary 24V 100VA connection screw 50/60Hz type 192		
For models:	ESE94CRA, ESE94CRM, ESE94FRA, ESE94FRM, ESE96CRA, ESE96FRA, ESG94CRA, ESG94CRM, ESG94FRA, ESG94FRM, ESG96CRA, ESG96FRA		

refrigeration controllers

built-in version



1			
GEV No.	379820	Ref. No.	1681114 BN1681114
description	electronic controller EVERY CONTROL type EVC20S35N7ALX30 mounting measurements 165x45mm 230V voltage AC NTC relay outputs 3 NO-16A(5) NO-8A(4) CO-8A(4) NTC NTC DI for fridge front measurementsmm built-in depth 56mm protection IP00 yes yes yes -40° up to 105°C display 4 digits		



1			
GEV No.	379850	Ref. No.	1681118 936092 BN1681118 FR936092
description	electronic controller EVERY CONTROL type EVC20S35N7ALX40 mounting measurements 165x45mm 230V voltage AC NTC relay outputs 4 NO-16A(5) NO-8A(4) CO-8A(4) NO-8A(4) NTC NTC DI DI for fridge front measurementsmm built-in depth 56mm protection IP00 yes yes yes -40 up to +99°C display 4 digits		



probes

universal probes

temperature probes



GEV No.	379064	Ref. No.	995562 FR995562
description	temperature probe PTC 1kOhm cable silicone probe -50 up to +150°C cable -50 up to +180°C probe ø6x40mm cable length 3m without screw connection 2-wire		

core probes

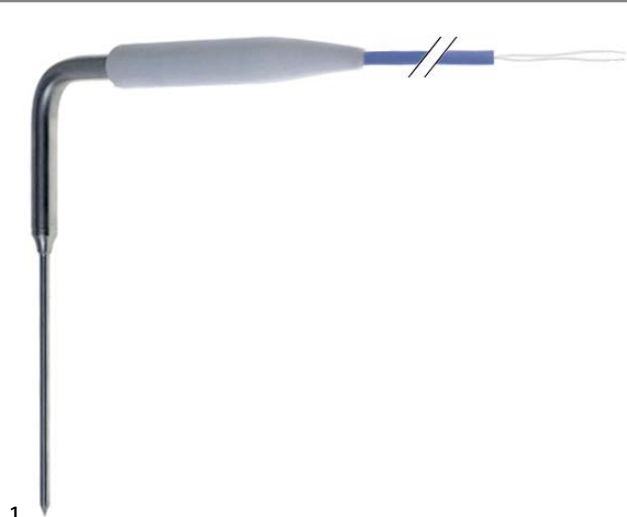

GEV No.	378392	Ref. No.	996452 FR996452
description	core temperature probe Pt1000 universal angled probe -40 up to +120°C cable -10 up to 100°C cable PVC probe ø4x100mm cable length 5m 2-wire resistance at 0°C 10000hm for blast chiller		

producer-specific probes

probes



GEV No.	379711	Ref. No.	RA932001 SIRA932001 SIRRA932001
description	temperature probe PTC 1kOhm cable silicone probe -50 up to +150°C cable -50 up to +180°C connection coded plug thread probe ø6x40mm cable length 3.5m		
For models:	10-teglie-GN-MISTI-FR-STD, 10-teglie-GN-MISTI-FR-TOP, 10-teglie-GN-MISTI-IT-STD, 10-teglie-GN-MISTI-IT-TOP, 10-teglie-GN-MISTI-TX-STD, 10-teglie-GN-positivi-FR-STD, 10-teglie-GN-positivi-FR-TOP, 10-teglie-GN-positivi-IT, 10-teglie-GN-positivi-IT-STD, 10-teglie-GN-positivi-IT-TOP, 10-teglie-GN-positivi-TX-STD, 12-teglie-PA-MISTI-FR-STD, 12-teglie-PA-MISTI-FR-TOP, 12-teglie-PA-MISTI-IT-STD, 12-teglie-PA-MISTI-IT-TOP, 12-teglie-PA-positivi-FR-STD, 12-teglie-PA-positivi-FR-TOP, 12-teglie-PA-positivi-IT-STD, 12-teglie-PA-positivi-IT-TOP, 14-teglie-GN-MISTI-FR-dep-STD, 14-teglie-GN-MISTI-FR-dep-TOP, 14-teglie-GN-MISTI-FR-STD, 14-teglie-GN-MISTI-FR-TOP, 14-teglie-GN-MISTI-IT-dep-STD, 14-teglie-GN-MISTI-IT-dep-TOP, 14-teglie-GN-MISTI-IT-STD, 14-teglie-GN-MISTI-IT-TOP, 14-teglie-GN-MISTI-TX-STD, 14-teglie-GN-positivi-FR, 14-teglie-GN-positivi-FR-dep-STD, 14-teglie-GN-positivi-FR-dep-TOP, 14-teglie-GN-positivi-FR-STD, 14-teglie-GN-positivi-FR-TOP, 14-teglie-GN-positivi-IT-dep-STD, 14-teglie-GN-positivi-IT-dep-TOP, 14-teglie-GN-positivi-IT-STD, 14-teglie-GN-positivi-IT-TOP, 14-teglie-GN-positivi-TX-STD, 15-teglie-PA-MISTI-FR-STD, 15-teglie-PA-MISTI-TX-STD, 17-teglie-PA-MISTI-FR-dep, 17-teglie-PA-MISTI-FR-dep-TOP, 17-teglie-PA-MISTI-FR-STD, 17-teglie-PA-MISTI-FR-TOP, 17-teglie-PA-MISTI-IT-dep, 17-teglie-PA-MISTI-IT-dep-TOP, 17-teglie-PA-MISTI-IT-STD, 17-teglie-PA-MISTI-IT-TOP, 17-teglie-PA-positivi-FR-dep-STD, 17-teglie-PA-positivi-FR-dep-TOP...(Other models you can see in the webshop)		



GEV No.	378129	Ref. No.	0100167 SIR0100167
description	temperature probe thermocouple K (NiCr-Ni) cable Vetrotex probe -50 up to 1150°C cable -50 up to +350°C connection 2-wire thread M8 probe ø3-5x140mm cable length 2.1m		
For models:	CTE9141, CTE9142, CTE9142S, CTE9146, TE94APS, TE94EPS, TE94GPS, TEY4APS		

→ electric components



core probes

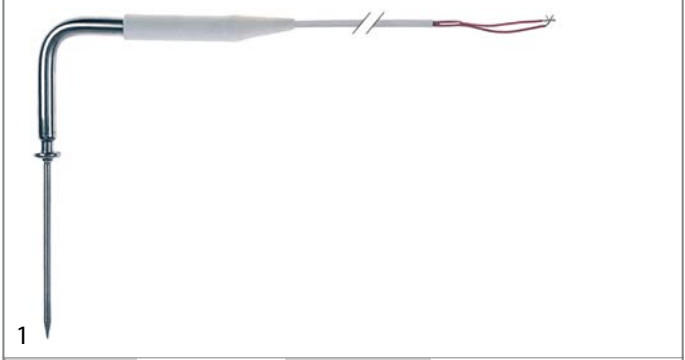

GEV No.	379544	Ref. No.	RA930013 SIRA930013 SIRRA930013
description	core temperature probe Pt1000 cable silicone probe -40 up to +120°C cable -50 up to +180°C connection 2-wire probe ø4x100mm thread cable length 3.6m handle ø 16mm handle length 120mm		
For models:	10-teglie-GN-MISTI-FR-STD, 10-teglie-GN-MISTI-IT-STD, 10-teglie-GN-MISTI-TX-STD, 10-teglie-GN-positivi-FR-STD, 10-teglie-GN-positivi-IT, 10-teglie-GN-positivi-IT-STD, 10-teglie-GN-positivi-TX-STD, 12-teglie-PA-MISTI-FR-STD, 12-teglie-PA-MISTI-IT-STD, 12-teglie-PA-positivi-FR-STD, 12-teglie-PA-positivi-IT-STD, 14-teglie-GN-MISTI-FR-dep-STD, 14-teglie-GN-MISTI-FR-STD, 14-teglie-GN-MISTI-IT-dep-STD, 14-teglie-GN-MISTI-IT-STD, 14-teglie-GN-MISTI-TX-STD, 14-teglie-GN-positivi-FR-STD, 14-teglie-GN-positivi-FR-dep-STD, 14-teglie-GN-positivi-FR-STD, 14-teglie-GN-positivi-IT-dep-STD, 14-teglie-GN-positivi-IT-STD, 14-teglie-GN-positivi-TX-STD, 15-teglie-PA-MISTI-FR-STD, 15-teglie-PA-MISTI-TX-STD, 17-teglie-PA-MISTI-FR-dep, 17-teglie-PA-MISTI-FR-STD, 17-teglie-PA-MISTI-IT-dep, 17-teglie-PA-MISTI-IT-STD, 17-teglie-PA-positivi-FR-dep-STD, 17-teglie-PA-positivi-FR-STD, 17-teglie-PA-positivi-IT-dep-STD, 17-teglie-PA-positivi-IT-STD, 20-teglie-GN-misti-FR-STD, 20-teglie-GN-positivi-FR-STD, 20-teglie-GN-positivi-IT-STD, 21-teglie-PA-MISTI-TX-STD		

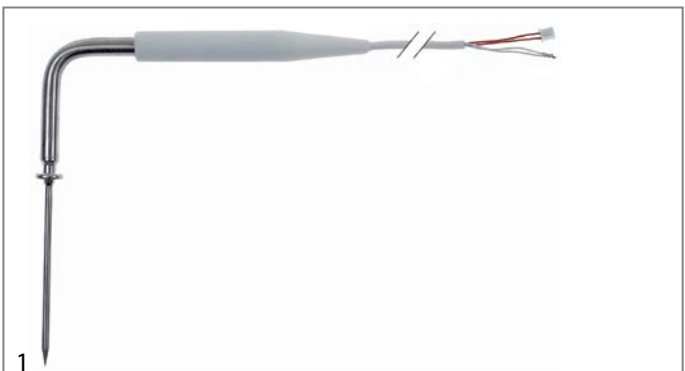

GEV No.	379757	Ref. No.	RA930014 SIRA930014 SIRRA930014
description	core temperature probe Pt1000 cable silicone probe -40 up to +120°C cable -50 up to +180°C connection 2-wire probe ø4x100mm thread cable length 3.6m handle ø 16mm handle length 125mm		
For models:	10-teglie-GN-MISTI-FR-TOP, 10-teglie-GN-MISTI-IT-TOP, 10-teglie-GN-positivi-FR-TOP, 10-teglie-GN-positivi-IT-TOP, 12-teglie-PA-MISTI-FR-TOP, 12-teglie-PA-MISTI-IT-TOP, 12-teglie-PA-positivi-FR-TOP, 12-teglie-PA-positivi-IT-TOP, 14-teglie-GN-MISTI-FR-dep-TOP, 14-teglie-GN-MISTI-FR-TOP, 14-teglie-GN-MISTI-IT-dep-TOP, 14-teglie-GN-MISTI-IT-TOP, 14-teglie-GN-positivi-FR-dep-TOP, 14-teglie-GN-positivi-FR-TOP, 14-teglie-GN-positivi-IT-dep-TOP, 14-teglie-GN-positivi-IT-TOP, 17-teglie-PA-MISTI-FR-dep-TOP, 17-teglie-PA-MISTI-FR-TOP, 17-teglie-PA-MISTI-IT-dep-TOP, 17-teglie-PA-MISTI-IT-TOP, 17-teglie-PA-positivi-FR-dep-TOP, 17-teglie-PA-positivi-FR-TOP, 17-teglie-PA-positivi-IT-dep-TOP, 17-teglie-PA-positivi-IT-TOP, 20-teglie-GN-positivi-FR-TOP, 20-teglie-GN-positivi-IT-TOP		

electronics

PCBs



GEV No.	400687	Ref. No.	CM295800 MACM295800
description	keypad PCB fryer EFE....K		
For models:	EFE92122K, EFE94222K, EFG92123K, EFG94223K		



GEV No.	402056	Ref. No.	0101930 SIR0101930
description	PCB		
For models:	CTE9141, CTE9142, CTE9142S, CTE9146, TE94APS, TE94EPS, TE94GPS, TEY4APS		

keypads

front foils



GEV No.	504294	Ref. No.	CR0588380
description	keypad foil suitable for 900 series L 92mm W 54mm buttons 4		
For models:	EFE92122K, EFE94222K		



solenoid valves

solenoid valves (water)

ELBI

angled



GEV No.	370833	Ref. No.	CR0682320 CR0682320R
description	solenoid valve single angled 230VAC inlet 3/4" outlet 11.5mm input 18.5-20l/min DN10 ELBI		
For models:	EME92A, EME92G, EME92T, EME94A, EME94G, EME94T, EPE50, EPE7108, EPE9D10, EPE9D15, EPE9I10, EPE9I10A, EPE9I15, EPE9I15A, EPG50, EPG7108, EPG9D10, EPG9D10A, EPG9D15, EPG9D15A, EPG9I15, EPG9I15A, EPG9I10, EPG9I10A, ESE94CRA, ESE94CRM, ESE94FRA, ESE94FRM, ESE96CRA, ESE96FRA, ESG94CRA, ESG94CRM, ESG94FRM, ESG96CRA, ESG96FRA		

RPE

solenoid valves with reducers

2-fold



GEV No.	374000	Ref. No.	CR0586050 CR0586050R CR1220370R
description	solenoid valve double straight 230VAC inlet 3/4" outlet 11.5mm input 10-12l/min DN10 t.max. 90°C RPE flow regulating valve inlet white output A 0.32-0.42l/min flow regulating valve outlet A dark green		
For models:	EDE72128, EDE73142, EDE74228, EDE92142, EDE93142, EDE94242, EDG72128, EDG73142, EDG74228, EDG92142, EDG93142, EDG94242		
accessories for	374000		
	GEV No.	Ref. No.	—
	371256		
	reducer RPE flow rate 10-12l/min pressure range 0.5-10bar white		





TP



GEV No.	370015	Ref. No.	0101341 SIR0101341
description	solenoid valve single angled 230VAC inlet 3/4" outlet 11.5mm DN10 TP		
For models:	CBE9060, CBE9060C, CBG9060C-I, CME7021, CME7022, CME7041, CME7042, CME7221, CME7222, CME7241, CME7242, CRE6-20, CRE6-30, ME72APS, ME72GPS, ME74APS, ME74GPS, PE8A110, PE8A115, PE8NI10, PE8NI15, PE9A110, PE9A115, PE9NI10, PE9NI15, SE94CRA, SE94CRM, SE94FRA, SE94FRM, SE94IRA, SE94IRM, SG94CRA, SG94FRA, SG94IRA		
accessories for	370015		
	GEV No.	Ref. No.	—
	371220		
	reducer TP flow rate 3l/min red tolerance ±15%		
	GEV No.	Ref. No.	—
	371221		
	reducer TP flow rate 5.5l/min yellow tolerance ±15%		
	GEV No.	Ref. No.	—
	371222		
	reducer TP flow rate 6l/min grey tolerance ±15%		
	GEV No.	Ref. No.	—
	371223		
	reducer TP flow rate 10l/min white tolerance ±15%		
	GEV No.	Ref. No.	—
	371224		
	reducer TP flow rate 12l/min bronze tolerance ±15%		
	GEV No.	Ref. No.	—
	371225		
	reducer TP flow rate 16l/min light brown tolerance ±15%		
	GEV No.	Ref. No.	—
	371226		
	reducer TP flow rate 20l/min red tolerance ±15%		
	GEV No.	Ref. No.	—
	371230		
	reducer TP flow rate 0.25l/min red tolerance ±25%		
	GEV No.	Ref. No.	—
	371231		
	reducer TP flow rate 0.35l/min violet tolerance ±25%		
	GEV No.	Ref. No.	—
	371232		
	reducer TP flow rate 0.5l/min orange tolerance ±25%		
	GEV No.	Ref. No.	—
	371233		
	reducer TP flow rate 0.8l/min white tolerance ±25%		
	GEV No.	Ref. No.	—
	371234		
	reducer TP flow rate 1l/min light blue tolerance ±25%		
	GEV No.	Ref. No.	—
	371235		
	reducer TP flow rate 1.2l/min brown tolerance ±25%		
	GEV No.	Ref. No.	—
	371236		
	reducer TP flow rate 1.5l/min light brown tolerance ±25%		

Table continues overleaf



accessories for		370015	
	GEV No.	371237	Ref. No. —
reducer TP flow rate 2.5l/min yellow tolerance ±25%			
	GEV No.	371238	Ref. No. —
reducer TP flow rate 3.4l/min dark green tolerance ±25%			
	GEV No.	371239	Ref. No. —
reducer TP flow rate 5l/min black tolerance ±25%			
	GEV No.	371240	Ref. No. —
reducer TP flow rate 8l/min blue tolerance ±20%			

metal

SIRAI

2-way

L139-B series



1

GEV No.	370700	Ref. No.	0102486 LAR65110100 SIR0102486
description	solenoid valve brass 2-ways 230VAC inlet 1/4" outlet 1/4" connection 1/4" L 40mm DN 4.5mm t.max. 90°C -10 up to +90°C SIRAI type series L139 coil type Z130A p max 8bar p min 0bar valve set L139B08 50Hz		
For models:	CPE90100, CPE90100A, CPE90150, CPE90150A, CPI90100, CPI90100A, CPI90150, CPI90150A, PE9A110, PE9A115, PE9NI10, PE9NI15		

pressure switches

for warewashing

ø 58mm with male faston 6.3mm

with connection horizontal



1

GEV No.	541830	Ref. No.	CR0585951
description	pressure control pressure range 260/230mbar connection 6mm ø 58mm pressure connection ø 6mm		
For models:	EDE72128, EDE73142, EDE74228, EDE92142, EDE93142, EDE94242, EDG72128, EDG73142, EDG74228, EDG92142, EDG93142, EDG94242		
accessories for	541830		
	GEV No.	541831	Ref. No. CR0731840
bracket metal for pressure switch mounting distance 38.5mm			

accessories



1

GEV No.	541831	Ref. No.	CR0731840
description	bracket metal for pressure switch mounting distance 38.5mm		

for gas equipment



1

GEV No.	541051	Ref. No.	0102485 SIR0102485
description	pressure control ø 45mm pressure range adjustable 10-50mbar pressure connection vertical gas technology connection 1/4" pressure connection ø 1/4"mm		
For models:	CBG9060C-I, CPD90100, CPD90100A, CPD90150, CPD90150A, CPI90100, CPI90100A, CPI90150, CPI90150A		

for steam control



1

GEV No.	541795	Ref. No.	CR0587800
description	pressure control ø 45mm pressure connection vertical steam control pressure range -1 up to +1bar connection male faston 6.3mm BECK pressure connection 3/8"		
For models:	EPE7105, EPE7108, EPE9110, EPE9110A, EPE9115, EPE9115A, EPG7105, EPG7108, EPG9115, EPG9115A, EPG9110, EPG9110A		

electrodes



1

GEV No.	400171	Ref. No.	0102478 65324720 LAR65324720 SIR0102478
description	level electrode 1/4" total length 350mm probe L 325mm insulated probe length 26mm connection male faston 6.3mm stainless steel ø 2.5mm		
For models:	CPE90100, CPE90100A, CPE90150, CPE90150A, CPI90100, CPI90100A, CPI90150, CPI90150A, PE7NI05, PE8A110, PE8A115, PE8NI10, PE8NI15, PE9A110, PE9A115, PE9NI10, PE9NI15		





fans

axial fans

import



1

GEV No.	601080 ¹	Ref. No.	CM303000 MACM303000
description	axial fan L 119mm W 119mm H 38mm 230VAC 50/60Hz 23/20W bearing ball bearing connection male faston 2.8mm metal ADDA fan wheel ø 110mm temp.-resist. 70°C		
For models:	EFG92123K, EFG94223K, ETE74		
accessories for	601080		
	GEV No.	550898	Ref. No. —
	connecting cable cable length 2000mm connection F 2.8 connection distance 7.9mm for axial flow fan		
	GEV No.	692519	Ref. No. —
	guard L 120mm W 120mm plastic		

¹with ball bearings

refrigeration fans

cold air circulating fans (complete)

ebm-papst

A2E series

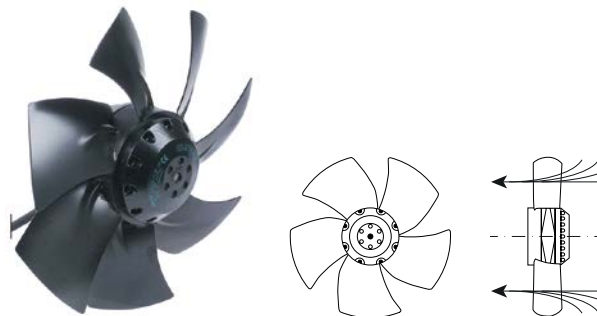

1

GEV No.	601750	Ref. No.	RA880002 SIRA880002 SIRRA880002
description	fan A2E250-AL06-09 fan wheel ø 250mm blades 7 230V 50/60Hz 120/160W 2500rpm cable length 200mm ebm-papst sucking suitable capacitor 3µF		
For models:	14-teglie-GN-MISTI-FR-dep-STD, 14-teglie-GN-MISTI-FR-dep-TOP, 14-teglie-GN-MISTI-FR-STD, 14-teglie-GN-MISTI-FR-TOP, 14-teglie-GN-MISTI-IT-dep-STD, 14-teglie-GN-MISTI-IT-dep-TOP, 14-teglie-GN-MISTI-IT-STD, 14-teglie-GN-MISTI-IT-TOP, 14-teglie-GN-MISTI-TX-STD, 14-teglie-GN-positivi-FR, 14-teglie-GN-positivi-FR-dep-STD, 14-teglie-GN-positivi-FR-dep-TOP, 14-teglie-GN-positivi-FR-STD, 14-teglie-GN-positivi-FR-TOP, 14-teglie-GN-positivi-IT-dep-STD, 14-teglie-GN-positivi-IT-dep-TOP, 14-teglie-GN-positivi-IT-STD, 14-teglie-GN-positivi-IT-TOP, 14-teglie-GN-positivi-TX-STD, 15-teglie-PA-MISTI-FR-STD, 17-teglie-PA-MISTI-FR-dep, 17-teglie-PA-MISTI-FR-dep-TOP, 17-teglie-PA-MISTI-FR-STD, 17-teglie-PA-MISTI-FR-TOP, 17-teglie-PA-MISTI-IT-dep, 17-teglie-PA-MISTI-IT-dep-TOP, 17-teglie-PA-MISTI-IT-STD, 17-teglie-PA-MISTI-IT-TOP, 17-teglie-PA-positivi-FR-dep-STD, 17-teglie-PA-positivi-FR-dep-TOP, 17-teglie-PA-positivi-FR-STD, 17-teglie-PA-positivi-FR-TOP, 17-teglie-PA-positivi-IT-dep-STD, 17-teglie-PA-positivi-IT-dep-TOP, 17-teglie-PA-positivi-IT-STD, 17-teglie-PA-positivi-IT-TOP, 20-teglie-GN-misti-FR-STD, 20-teglie-GN-misti-FR-TOP, 20-teglie-GN-misti-IT-STD, 20-teglie-GN-misti-IT-TOP, 20-teglie-GN-positivi-FR-STD, 20-teglie-GN-positivi-FR-TOP, 20-teglie-GN-positivi-IT-STD, 20-teglie-GN-positivi-IT-TOP, 21-teglie-PA-MISTI-TX-STD, 3-teglie-GN-positivi-FR-STD, 3-teglie-GN-positivi-TX-STD, 5-teglie-GN-positivi-FR-dep-STD, 5-teglie-GN-positivi-FR-STD, 5-teglie-GN-positivi-FR-TOP...(Other models you can see in the webshop)		
accessories for	601750		
	GEV No.	365137	Ref. No. —
	capacitor capacity 3µF 450V tolerance 5% 50/60Hz ambient temperature max. -25 to +85°C ø 25mm L 56mm M8 plastic connection cable 250mm 416.17.77GF protection		

→ electric components



A4E series

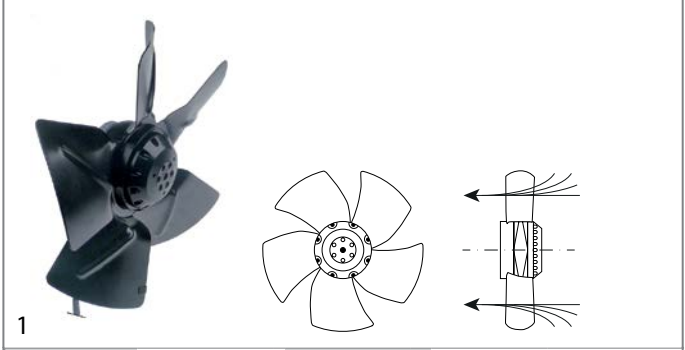

GEV No.	601623	Ref. No.	RA880046 SIRA880046 SIRRA880046
description	fan A4E315-AC08-19 fan wheel ø 315mm blades 5 230V 50Hz 95W 1370rpm cable length 450mm ebm-papst sucking suitable capacitor 3µF		
For models:	10-teglie-GN-MISTI-FR-STD, 10-teglie-GN-MISTI-FR-TOP, 10-teglie-GN-MISTI-IT-STD, 10-teglie-GN-MISTI-IT-TOP, 10-teglie-GN-MISTI-TX-STD, 10-teglie-GN-positivi-FR-STD, 10-teglie-GN-positivi-FR-TOP, 10-teglie-GN-positivi-IT, 10-teglie-GN-positivi-IT-TOP, 10-teglie-GN-positivi-TX-STD, 10-teglie-GN-positivi-TX-TOP, 10-teglie-GN-positivi-TX-IT-STD, 10-teglie-GN-positivi-TX-IT-TOP, 12-teglie-PA-MISTI-FR-STD, 12-teglie-PA-MISTI-FR-TOP, 12-teglie-PA-MISTI-IT-STD, 12-teglie-PA-MISTI-IT-TOP, 12-teglie-PA-positivi-FR-STD, 12-teglie-PA-positivi-FR-TOP, 12-teglie-PA-positivi-IT-STD, 12-teglie-PA-positivi-IT-TOP, 15-teglie-PA-MISTI-TX-STD, 3-teglie-GN-misti-FR-STD, 3-teglie-GN-misti-TX-STD, 5-teglie-dep-GN-misti-FR-STD, 5-teglie-dep-GN-misti-IT-STD, 5-teglie-GN-misti-FR-STD, 5-teglie-GN-misti-FR-TOP, 5-teglie-GN-misti-IT-STD, 5-teglie-GN-misti-IT-TOP, 5-teglie-GN-misti-TX-STD, 5-teglie-PA-misti-FR-STD, 6-teglie-PA-misti-FR-STD, 6-teglie-PA-misti-FR-TOP, 6-teglie-PA-misti-IT-STD, 6-teglie-PA-misti-IT-TOP, 6-teglie-PA-misti-TX-STD		
accessories for	601623		
		GEV No.	365137
		Ref. No.	—
	capacitor capacity 3µF 450V tolerance 5% 50/60Hz ambient temperature max. -25 to +85°C ø 25mm L 56mm M8 plastic connection cable 250mm 416.17.77GF protection		

cross flow fans

COPREL

with moulded coils





GEV No.	601434	Ref. No.	FR6670311 FR935581
description	cross flow fan COPREL FFR roller ø 60mm roller length 300mm laminated core thickness 30mm motor position right 230V/50Hz 43W refrigeration bearing rubber connection cable 1800mm coil type moulded -10 up to +60°C		

hot air fans

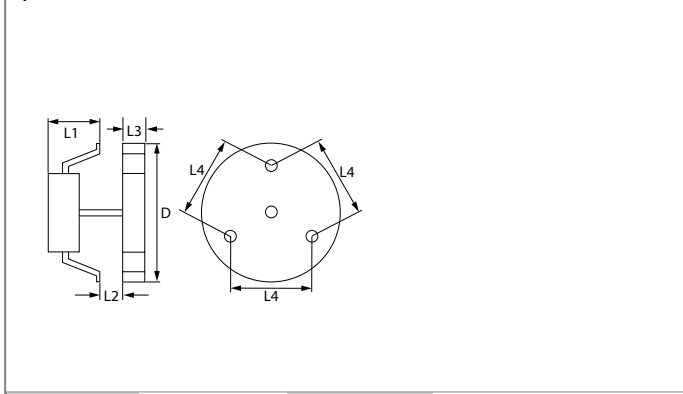
miscellaneous



GEV No.	601696	Ref. No.	0101342 4330800 MA4330800 SIR0101342
description	hot air fan 230V 40W 50/60Hz L1 70mm L2 11mm L3 29mm L4 87mm fan wheel ø 155mm with ball bearing		
For models:	BAC100, BAC100-A, BAC102, BAC120, BAC120-A, BAC122, BAC140, BAC140-A, BAC142, BAC160, BAC160-A, BAC162, BAC180, BAC180-A, BAC182, BAC200, BAC200-A, BAC202, BAM16D, BAM16S, BAM18D, BAM18S, BAM20D, BAM20S		
spare parts for	601696		
		GEV No.	550879
		Ref. No.	—
	insulation ø 130mm thickness 3mm hole ø 20mm for hot air fan		
		GEV No.	601261
		Ref. No.	—
	fan wheel ø 154mm W 25mm shaft intake ø 6x5mm chrome-plated blades 7		

motors

gear motors

for tilting bratt pans



GEV No.	600000	Ref. No.	CM056300 MACM056300
description	gear motor NERI type M63B4 120W 230V voltage DC 50Hz 1360rpm shaft ø 14mm L 308mm W 140mm H 170mm for tilting bratt pan		
For models:	SE84CRA, SE84FRA, SE84IRA, SE86CRA, SE86FRA, SE86IRA, SE94CRA, SE94FRA, SE94IRA, SE96CRA, SE96FRA, SE96IRA, SG84CRA, SG84IRA, SG94CRA, SG94FRA, SG94IRA		



fuses

thermal fuses

			
GEV No.	358095	Ref. No.	CR0841170
description	thermal fuse switch-off temp. 110°C nominal 10A Qty 1 pcs		
For models:	ETE74		

electric accessories

cables

accessories

cable glands

threaded cable glands

screw connections

			
GEV No.	550971	Ref. No.	1037115100 MA1037115100
description	cable gland thread PG16 cable ø 14mm mounting ø 22.5mm Qty 1 pcs plastic WS 27		
For models:	BE62TLC, BE62TLL, BE62TRR, BE63TLC, BE63TLL, BE63TLR, BE65TLC, BE65TLL, BE65TLR, CBE6220, CGE6220, CGE6220C, CGE6220R, CGE6230, CGE6230C, CGE6230LR, CGE6250, CGE6250LR, CGE6250LRC, CME6220, CME6230, CME6240, CRE6220, CRE6230, CSP6220, ECIW72, EDE72128, EDE73142, EDE74228, EDG72128, EDG73142, EDG74228, EFE72110, EFE73210, ERP72, GE62TPS, GE63TPS, ME62TPS, ME63TPS, ME64TPS, RP62TPS, SE62TPS		

fastening nuts

			
GEV No.	550972	Ref. No.	1037115200 MA1037115200
description	nut thread PG16 WS 30 plastic Qty 1 pcs thickness 6mm mounting ømm cable ømm		
For models:	BE62TLC, BE62TLL, BE62TRR, BE63TLC, BE63TLL, BE63TLR, BE65TLC, BE65TLL, BE65TLR, CBE6220, CGE6220, CGE6220C, CGE6220R, CGE6230, CGE6230C, CGE6230LR, CGE6250, CGE6250LR, CGE6250LRC, CME6220, CME6230, CME6240, CRE6220, CRE6230, CSP6220, ECIW72, EDE72128, EDE73142, EDE74228, EDG72128, EDG73142, EDG74228, EFE72110, EFE73210, ERP72, GE62TPS, GE63TPS, ME62TPS, ME63TPS, ME64TPS, RP62TPS, SE62TPS		

terminals

porcelain clamps

			
GEV No.	550115	Ref. No.	1037117600 MA1037117600
description	porcelain terminal block 2-pole 10mm ² max. 30A max 450V L 37mm W 37mm H 23mm mounting distancemm Qty 1 pcs		
For models:	ERP72		

connection terminals with screw/faston connections

			
GEV No.	550534 ¹	Ref. No.	CR0588180
description	power terminal block 3-pole max. 40A max 450V connection ø6mm ² / F6.3 temp.-resist. 150°C cross section 6mm ² mounting distance 67mm with ground lug		
For models:	EDG72128, EDG73142, EDG74228, EDG92142, EDG93142, EDG94242, EPG7D05, EPG7I05, EPG7I08, EPG9D10, EPG9D10A, EPG9D15, EPG9D15A, EPG9I15, EPG9I15A, EPG9B9I10, EPG9B9I10A, EPGD05, ERP72, ESG94CRA, ESG94CRM, ESG94FRA, ESG94FRM, ESG96CRA, ESG96FRA		

¹with ground lug

			
GEV No.	550411	Ref. No.	1037104000 MA1037104000
description	power terminal block 6-pole max. 40A max 450V connection ø6mm ² / F6.3 temp.-resist. 150°C cross section 6mm ²		
For models:	BE62TLC, BE62TLL, BE62TRR, BE63TLC, BE63TLL, BE63TLR, BE65TLC, BE65TLL, BE65TLR, CBE6220, CCT6220, CCT6220V, CCT6230, CCT6230V, CCW6220, CE62TPT, CE64TPT, CFE62110/1, CFE62210/1, CGE6220, CGE6220C, CGE6220R, CGE6230, CGE6230C, CGE6230LR, CGE6250, CGE6250LR, CGE6250LRC, CME6220, CME6230, CME6240, CRE6220, CRE6230, CSP6220, CV62TPS, CV64TPS, CW62TPS, EME7, FE62T10, FE64T10, GE62TPS, GE63TPS, ME62TPS, ME63TPS, ME64TPS, RP62TPS, SE62TPS		



			
1			
GEV No.	550977 ¹	Ref. No.	CR0588170
description	power terminal block 6-pole max. 40A max 450V connection $\phi 6\text{mm}^2$ / F6.3 temp.-resist. 150°C cross section 6mm^2 with ground lug		
For models:	EBE7, EBE92AL, EBE92ALC, EBE92AR, EBE92ARC, EBE92GL, EBE92GLC, EBE92GR, EBE92GRC, EBE92TL, EBE92TLC, EBE92TR, EBE92TRC, EBE93AL, EBE93ALC, EBE93ALR, EBE93AMC, EBE93GL, EBE93GLC, EBE93GLR, EBE93GMC, EBE93TL, EBE93TLC, EBE93TLR, EBE93TMC, EBE94AL, EBE94ALC, EBE94ALR, EBE94AMC, EBE94AR, EBE94GL, EBE94GLC, EBE94GLR, EBE94GMC, EBE94GR, EBE94TL, EBE94TLC, EBE94TLR, EBE94TMC, EBE94TR, ECE74E, ECE74-Q, ECE92A, ECE92G, ECE92T, ECE94A, ECE94E, ECE94G, ECE94T, ECM73...(Other models you can see in the webshop)		

¹with ground lug

rail-mounted terminals

miscellaneous

			
1			
GEV No.	551079	Ref. No.	20802799 MA20802799
description	rail-mounted terminal 6mm^2 yellow/green for DIN rail 35mm H 35mm 1-pole		
For models:	ECI72, ECI74, ECIW72, EPE7I08		

various

			
1			
GEV No.	693955	Ref. No.	1878400 MA1878400
description	terminal grounding cable		
For models:	BE62TLC, BE62TLL, BE62TRR, BE63TLC, BE63TLL, BE63TLR, BE65TLC, BE65TLL, BE65TLR, CBE6220, CCT6220V, CCT6230V, CCW6220, CGE6220, CGE6220C, CGE6220R, CGE6230, CGE6230C, CGE6230LR, CGE6250, CGE6250LR, CGE6250LRC, CME6220, CME6230, CME6240, CRE6220, CRE6230, CSP6220, CV62TPS, CV64TPS, CW62TPS, EBE7, EBE92AL, EBE92ALC, EBE92AR, EBE92ARC, EBE92GL, EBE92GLC, EBE92GR, EBE92GRC, EBE92TL, EBE92TLC, EBE92TR, EBE92TRC, EBE93AL, EBE93ALC, EBE93ALR, EBE93AMC, EBE93GL, EBE93GLC...(Other models you can see in the webshop)		

gas taps



PEL

20S series





1			
GEV No.	101094	Ref. No.	0100730 SIR0100730
description	gas tap PEL type 20S gas inlet M16x1.5 (tube $\phi 10\text{mm}$) bypass nozzle $\phi 0.35\text{mm}$ gas outlet M16x1.5 (tube $\phi 10/8\text{mm}$) thermocouple connection M8x1 pilot connection shaft $\phi 8 \times 6.5\text{mm}$ shaft L 22/15mm shaft flat lower		
For models:	CCG1041, CCG1042, CCG1045, CCG1061, CCG1062, CCG10652, CCG10653, CCG1081, CCG1082, CCG1085, CCG10852, CCG6020, CCG6040, CCG6045, CCG6046, CCG7001, CCG7020, CCG7021, CCG7022, CCG7040, CCG7041, CCG7042, CCG7045, CCG7046, CCG7061, CCG7062, CCG70652, CCG70653, CCG70663, CCG7201, CCG7220, CCG7221, CCG7222, CCG7240, CCG7241, CCG7242, CCG7245, CCG7246, CCG7261, CCG7262, CCG72652, CCG72653, CCG72662, CCG72663, CCG9020, CCG9021, CCG9022, CCG9040, CCG9041, CCG9042...(Other models you can see in the webshop)		











spare parts for 101094





GEV No.	100408	Ref. No.	—
			
bypass nozzle type PEL20/21 bore $\phi 0.35\text{mm}$ thread M5x0.5			
GEV No.	101060	Ref. No.	0100752 SI0100752 SIR0100752
			
magnet unit standard L 39mm D1 $\phi 15.4\text{mm}$ D2 $\phi 11\text{mm}$ suitable for PEL20-21/JUNKERS/EGA			
GEV No.	101205	Ref. No.	0100753 SI0100753 SIR0100753
			
gas tap front part shaft $\phi 8 \times 6.5\text{mm}$ shaft L 22/15mm shaft flat upper/lower suitable for PEL20			

accessories for 101094

GEV No.	101230	Ref. No.	—
			
thermocouple nut T1: M8x1 T2: M18x1 aluminium			
GEV No.	101278	Ref. No.	0100775 86720 MA86720 SIR0100775
			
olive for pipe $\phi 10\text{mm}$ Qty 1 pcs			
GEV No.	101300	Ref. No.	0100774 SIR0100774
			
union nut thread M16x1.5 tube $\phi 10\text{mm}$			
GEV No.	101450	Ref. No.	—
			
olive for pipe $\phi 8\text{mm}$ L 12.7mm Qty 1 pcs ED $\phi 10\text{mm}$			
GEV No.	101451	Ref. No.	—
			
union nut thread M16x1.5 tube $\phi 8\text{mm}$			
GEV No.	110081	Ref. No.	—
			
knob $\phi 70\text{mm}$ shaft $\phi 8 \times 6.5\text{mm}$ shaft flat universal			
GEV No.	110083	Ref. No.	—
			
knob dial plate gas tap without ignition flame silver			



21S series			
			
1			
GEV No.	101397	Ref. No.	0100731 CM226800 MACM226800 SIR0100731
description	gas tap PEL type 21S gas inlet M16x1.5 (tube ø 10mm) bypass nozzle ø 0.35mm gas outlet M16x1.5 (tube ø 10/8mm) thermocouple connection M9x1 pilot connection M10x1 shaft ø 8x6.5mm shaft L 22/15mm shaft flat lower		
For models:	BG82ALL, BG82ARR, BG82GLL, BG82GRR, BG82TLL, BG82TRR, BG84ALL, BG84ALR, BG84ARR, BG84GLL, BG84GLR, BG84GRR, BG84TLR, BG84TLR, BG84TRR, CCG1041P, CCG1042P, CCG1045P, CCG1061P, CCG1062P, CCG10652P, CCG1081P, CCG1082P, CCG1085P, CCG7001P, CCG7020P, CCG7021P, CCG7022P, CCG7040P, CCG7041P, CCG7042P, CCG7045P, CCG7046P, CCG7061P, CCG7062P, CCG70652P, CCG70662P, CCG9020P, CCG9021P, CCG9022P, CCG9040P, CCG9041P, CCG9042P, CCG9045P, CCG9046P, CCG9060P, CCG9061P, CCG9062P, CCG90652P, CCG90662P...(Other models you can see in the webshop)		
spare parts for	101397		
	GEV No.	100408	Ref. No. —
	bypass nozzle type PEL20/21 bore ø 0.35mm thread M5x0.5		
	GEV No.	101060	Ref. No. 0100752 SIO100752 SIR0100752
	magnet unit standard L 39mm D1 ø 15.4mm D2 ø 11mm suitable for PEL20-21/JUNKERS/EGA		
	GEV No.	101206	Ref. No. —
	gas tap front part shaft ø 8x6.5mm shaft L 22/15mm shaft flat upper/lower suitable for PEL21		
	GEV No.	101231	Ref. No. —
	thermocouple nut T1: M9x1 T2: M18x1		
accessories for	101397		
	GEV No.	100908	Ref. No. 0100777 673500 MA673500 SIR0100777
	union screw thread M10x1 for pipe ø 4mm Qty 1 pcs		
	GEV No.	100909	Ref. No. 0100744 SIR0100744
	union screw thread M10x1 for pipe ø 6mm Qty 1 pcs		
	GEV No.	101246	Ref. No. 0100778 673600 MA673600 SIR0100778
	olive for pipe ø 4mm Qty 1 pcs		
	GEV No.	101278	Ref. No. 0100775 86720 MA86720 SIR0100775
	olive for pipe ø 10mm Qty 1 pcs		
	GEV No.	101286	Ref. No. 0100743 0100745 LA62070023 LAR62070023 SIR0100743
	olive ID ø 6mm Qty 1 pcs		
	GEV No.	101300	Ref. No. 0100774 SIR0100774
	union nut thread M16x1.5 tube ø 10mm		

accessories for 101397			
	GEV No.	101450	Ref. No. —
	olive for pipe ø 8mm L 12.7mm Qty 1 pcs ED ø 10mm		
	GEV No.	101451	Ref. No. —
	union nut thread M16x1.5 tube ø 8mm		
	GEV No.	110081	Ref. No. —
	knob ø 70mm shaft ø 8x6.5mm shaft flat universal		
	GEV No.	112206	Ref. No. —
	knob dial plate silver gas tap PEL21/22/23 t.max. °C ED ø 63mm ID ø 45.5mm		











1			
			
GEV No.	101913	Ref. No.	1031501300 MA1031501300
description	gas tap PEL type 21S gas inlet M16x1.5 (tube ø 10mm) bypass nozzle ø 0.9mm gas outlet M16x1.5 (tube ø 10/8mm) thermocouple connection M8x1 pilot connection M10x1 shaft ø 6x4.6mm shaft L 35/28mm shaft flat right		
For models:	CCG6220/1, CCG6230/1, CCG6245-1, CCG62652-1, CG62TPS, CG64FPS, CG64TPS, CG66FPS, CRG6220, CRG6240, GG62TGP, GG64TGP		
spare parts for	101913		
	GEV No.	100528	Ref. No. 1033720200 1889000 MA1033720200 MA1889000
	bypass nozzle type PEL20/21 bore ø 0.9mm thread M5x0.5		
	GEV No.	101060	Ref. No. 0100752 SIO100752 SIR0100752
	magnet unit standard L 39mm D1 ø 15.4mm D2 ø 11mm suitable for PEL20-21/JUNKERS/EGA		
	GEV No.	101230	Ref. No. —
	thermocouple nut T1: M8x1 T2: M18x1 aluminium		
	GEV No.	101877	Ref. No. —
	gas tap front part shaft ø 6x4.6mm type PEL21		
accessories for	101913		
	GEV No.	100908	Ref. No. 0100777 673500 MA673500 SIR0100777
	union screw thread M10x1 for pipe ø 4mm Qty 1 pcs		
	GEV No.	100909	Ref. No. 0100744 SIR0100744
	union screw thread M10x1 for pipe ø 6mm Qty 1 pcs		
	GEV No.	101246	Ref. No. 0100778 673600 MA673600 SIR0100778
	olive for pipe ø 4mm Qty 1 pcs		
	GEV No.	101278	Ref. No. 0100775 86720 MA86720 SIR0100775
	olive for pipe ø 10mm Qty 1 pcs		

Table continues overleaf

accessories for		101913	
	GEV No.	101286	Ref. No.
			0100743 0100745 LA62070023 LAR62070023 SIR0100743
olive ID ø 6mm Qty 1 pcs			
	GEV No.	101300	Ref. No.
			0100774 SIR0100774
union nut thread M16x1.5 tube ø 10mm			
	GEV No.	101450	Ref. No.
			—
olive for pipe ø 8mm L 12.7mm Qty 1 pcs ED ø 10mm			
	GEV No.	101451	Ref. No.
			—
union nut thread M16x1.5 tube ø 8mm			
	GEV No.	110078	Ref. No.
			—
knob without symbol ø 70mm shaft ø 6x4.6mm shaft flat universal			
	GEV No.	112206	Ref. No.
			—
knob dial plate silver gas tap PEL21/22/23 t.max.°C ED ø 63mm ID ø 45.5mm			

			
1			
GEV No.	101824	Ref. No.	CR0580450
description	gas tap PEL type 21S gas inlet pipe flange ø21mm bypass nozzle ø 0.9mm gas outlet M16x1.5 (tube ø 10/8mm) thermocouple connection M9x1 pilot connection M10x1 shaft ø 8x6.5mm shaft L 22/15mm shaft flat upper pipe input ø 9mm		
For models:	EBG7, EBG92AL, EBG92AR, EBG92GL, EBG92GR, EBG92TL, EBG92TR, EBG93AL, EBG93ALR, EBG93GL, EBG93GLR, EBG93TL, EBG93TLR, EBG94AL, EBG94ALR, EBG94AR, EBG94GL, EBG94GLR, EBG94GR, EBG94TL, EBG94TLR, EBG94TR, ECG7, ECG92A, ECG92G, ECG92T, ECG94A, ECG94E, ECG94F, ECG94G, ECG94T, ECG96A, ECG96E, ECG96F, ECG96G, ECG96H, ECG96T, ECG98A, ECG98F, ECG98G, ETG74GL-R		

22S/O series

			
1			
GEV No.	101086	Ref. No.	0100732 1888600 MA1888600 SIR0100732
description	gas tap PEL type 22S/O gas inlet M20x1.5 (tube ø 12mm) bypass nozzle ø 0.35mm gas outlet M20x1.5 (tube ø 12/10mm) thermocouple connection M9x1 pilot connection M10x1 shaft ø 10x8mm shaft L 25/17mm shaft flat lower		
For models:	BG92ALL, BG92ARR, BG92GLL, BG92GRR, BG94ALL, BG94ALR, BG94ARR, BG94GLL, BG94GLR, BG94GRR, BGY2TLL, BGY2TRR, BGY4TLL, BGY4TLR, BGY4TRR, CGG9020-0, CGG9020-2, CGG9021-0, CGG9021-2, CGG9022-0, CGG9022-2, CGG9040-0, CGG9040-2, CGG9040-4, CGG9041-0, CGG9041-2, CGG9041-4, CGG9042-0, CGG9042-2, CGG9042-4, CPD70150, CPI70150, CRG7022, CRG7042, CRG7222, CRG7242, CRG9022, CRG9022S, CRG9042, CRG9042S, CSG-063, CSG-076, CTT7040, CTT7041, CTT7042, CTT7045, CTT70652L, CTT70653L, CTT72653L, DG72128...(Other models you can see in the webshop)		
spare parts for	101086		
	GEV No.	100259	Ref. No.
			—
bypass nozzle type PEL22 bore ø 0.35mm thread M6x0.5			
	GEV No.	101058	Ref. No.
			0100757 SIR0100757
magnet unit L 39mm D1 ø 15.4mm D2 ø 13.5mm suitable for PEL22/EGA24197 standard			
	GEV No.	101201	Ref. No.
			—
gas tap front part shaft ø 10x8mm shaft L 25/17mm shaft flat upper/lower suitable for PEL22			
	GEV No.	101231	Ref. No.
			—
thermocouple nut T1: M9x1 T2: M18x1			
	GEV No.	101240	Ref. No.
			—
gas connection thread M20x1.5 tube ø 12/10mm for PEL gas taps with gasket and screws horizontal			
	GEV No.	101460	Ref. No.
			—
O-ring ø 12.37mm D1 ø 2.62mm suitable for PEL22			
	GEV No.	101461	Ref. No.
			—
screw kit suitable for PEL22 Qty 4 pcs			
accessories for	101086		
	GEV No.	100908	Ref. No.
			0100777 673500 MA673500 SIR0100777
union screw thread M10x1 for pipe ø 4mm Qty 1 pcs			
	GEV No.	100909	Ref. No.
			0100744 SIR0100744
union screw thread M10x1 for pipe ø 6mm Qty 1 pcs			
	GEV No.	101241	Ref. No.
			—
gas connection thread M20x1.5 tube ø 12/10mm for PEL gas taps vertical			
	GEV No.	101246	Ref. No.
			0100778 673600 MA673600 SIR0100778
olive for pipe ø 4mm Qty 1 pcs			
	GEV No.	101248	Ref. No.
			673300 MA673300
olive for pipe ø 12mm Qty 1 pcs suitable for PEL			











Table continues overleaf



accessories for		101086	
	GEV No.	101249	Ref. No. 0100780 SIR0100780
olive for pipe ø 10mm Qty 1 pcs			
	GEV No.	101250	Ref. No. 673200 MA673200
union nut thread M20x1.5 for pipe ø 10mm			
	GEV No.	101251	Ref. No. 673100 MA673100
union nut thread M20x1.5 for pipe ø 12mm			
	GEV No.	101286	Ref. No. 0100743 0100745 LA62070023 LAR62070023 SIR0100743
olive ID ø 6mm Qty 1 pcs			
	GEV No.	110080	Ref. No. —
knob ø 70mm shaft ø 10x8mm shaft flat universal			
	GEV No.	112206	Ref. No. —
knob dial plate silver gas tap PEL21/22/23 t.max.°C ED ø 63mm ID ø 45.5mm			

22S/V series

			
1			
GEV No.	101457	Ref. No.	100513
description	gas tap alternatives to JUNKERS type CH110 gas inlet M20x1.5 (tube ø 12mm) bypass nozzle ø 0.35mm gas outlet M20x1.5 (tube ø 12/10mm) thermocouple connection M8x1 pilot connection M10x1 shaft ø 10mm shaft L 25mm shaft flat with pipe outlet		
spare parts for	101457		
	GEV No.	100259	Ref. No. —
bypass nozzle type PEL22 bore ø 0.35mm thread M6x0.5			
	GEV No.	100908	Ref. No. 0100777 673500 MA673500 SIR0100777
union screw thread M10x1 for pipe ø 4mm Qty 1 pcs			
	GEV No.	101058	Ref. No. 0100757 SIR0100757
magnet unit L 39mm D1 ø 15.4mm D2 ø 13.5mm suitable for PEL22/EGA24197 standard			
	GEV No.	101200	Ref. No. —
gas tap front part shaft ø 10mm shaft L 25mm shaft flat suitable for 22S/O			
	GEV No.	101230	Ref. No. —
thermocouple nut T1: M8x1 T2: M18x1 aluminium			
	GEV No.	101241	Ref. No. —
gas connection thread M20x1.5 tube ø 12/10mm for PEL gas taps vertical			
	GEV No.	101246	Ref. No. 0100778 673600 MA673600 SIR0100778
olive for pipe ø 4mm Qty 1 pcs			

spare parts for		101457	
	GEV No.	101460	Ref. No. —
O-ring ø 12.37mm D1 ø 2.62mm suitable for PEL22			
	GEV No.	101461	Ref. No. —
screw kit suitable for PEL22 Qty 4 pcs			
accessories for		101457	
	GEV No.	100945	Ref. No. —
roll pin ø 3.2mm L 10mm			
	GEV No.	101218	Ref. No. —
shaft extension JUNKERS			
	GEV No.	101219	Ref. No. —
shaft extension L 25mm JUNKERS			
	GEV No.	101231	Ref. No. —
thermocouple nut T1: M9x1 T2: M18x1			
	GEV No.	101248	Ref. No. 673300 MA673300
olive for pipe ø 12mm Qty 1 pcs suitable for PEL			
	GEV No.	101249	Ref. No. 0100780 SIR0100780
olive for pipe ø 10mm Qty 1 pcs			
	GEV No.	101250	Ref. No. 673200 MA673200
union nut thread M20x1.5 for pipe ø 10mm			
	GEV No.	101251	Ref. No. 673100 MA673100
union nut thread M20x1.5 for pipe ø 12mm			
	GEV No.	101290	Ref. No. —
thermocouple nut T1: M10x1 T2: M18x1 suitable for PEL20/21			
	GEV No.	110064	Ref. No. —
knob			
	GEV No.	110066	Ref. No. —
knob screw			
	GEV No.	550396	Ref. No. —
shaft extension L 25mm JUNKERS			



















			
1			
GEV No.	101087	Ref. No.	0100733 SIR0100733
description	gas tap PEL type 22S/V gas inlet M20x1.5 (tube ø 12mm) bypass nozzle ø 0.35mm gas outlet M20x1.5 (tube ø 12/10mm) thermocouple connection M9x1 pilot connection M10x1 shaft ø 10x8mm shaft L 25/17mm shaft flat upper		
spare parts for	101087		
	GEV No.	100259	Ref. No. —
bypass nozzle type PEL22 bore ø 0.35mm thread M6x0.5			

Table continues overleaf

spare parts for		101087	
	GEV No.	101058	Ref. No. 0100757 SIR0100757
magnet unit L 39mm D1 ø 15.4mm D2 ø 13.5mm suitable for PEL22/ EGA24197 standard			
	GEV No.	101201	Ref. No. —
gas tap front part shaft ø 10x8mm shaft L 25/17mm shaft flat upper/ lower suitable for PEL22			
	GEV No.	101231	Ref. No. —
thermocouple nut T1: M9x1 T2: M18x1			
	GEV No.	101241	Ref. No. —
gas connection thread M20x1.5 tube ø 12/10mm for PEL gas taps vertical			
	GEV No.	101460	Ref. No. —
O-ring ø 12.37mm D1 ø 2.62mm suitable for PEL22			
	GEV No.	101461	Ref. No. —
screw kit suitable for PEL22 Qty 4 pcs			
accessories for		101087	
	GEV No.	100908	Ref. No. 0100777 673500 MA673500 SIR0100777
union screw thread M10x1 for pipe ø 4mm Qty 1 pcs			
	GEV No.	100909	Ref. No. 0100744 SIR0100744
union screw thread M10x1 for pipe ø 6mm Qty 1 pcs			
	GEV No.	101240	Ref. No. —
gas connection thread M20x1.5 tube ø 12/10mm for PEL gas taps with gasket and screws horizontal			
	GEV No.	101246	Ref. No. 0100778 673600 MA673600 SIR0100778
olive for pipe ø 4mm Qty 1 pcs			
	GEV No.	101248	Ref. No. 673300 MA673300
olive for pipe ø 12mm Qty 1 pcs suitable for PEL			
	GEV No.	101249	Ref. No. 0100780 SIR0100780
olive for pipe ø 10mm Qty 1 pcs			
	GEV No.	101250	Ref. No. 673200 MA673200
union nut thread M20x1.5 for pipe ø 10mm			
	GEV No.	101251	Ref. No. 673100 MA673100
union nut thread M20x1.5 for pipe ø 12mm			
	GEV No.	101286	Ref. No. 0100743 0100745 LAR62070023 LAR62070023 SIR0100743
olive ID ø 6mm Qty 1 pcs			
	GEV No.	110080	Ref. No. —
knob ø 70mm shaft ø 10x8mm shaft flat universal			
	GEV No.	112206	Ref. No. —
knob dial plate silver gas tap PEL21/22/23 t.max.°C ED ø 63mm ID ø 45.5mm			

23S/O series



spare parts for		101092	
	GEV No.	100455	Ref. No. —
bypass nozzle type PEL23/24 bore ø 0.35mm thread M8x0.5			
	GEV No.	101059	Ref. No. —
magnet unit T1: M10x1 T2: M22x1 L 46mm ø 18mm suitable for PEL23S M10x1			
	GEV No.	101204	Ref. No. —
gas tap front part shaft ø 10x8mm shaft L 25/17mm shaft flat upper/ lower suitable for PEL23S			
	GEV No.	101244	Ref. No. —
gas connection thread M24x1.5 tube ø 12/16mm horizontal for PEL gas taps			
	GEV No.	101463	Ref. No. —
screw suitable for PEL23S Qty 4 pcs			
	GEV No.	528455	Ref. No. —
O-ring Viton thickness 2.62mm ID ø 18.72mm Qty 1 pcs			
accessories for		101092	
	GEV No.	100908	Ref. No. 0100777 673500 MA673500 SIR0100777
union screw thread M10x1 for pipe ø 4mm Qty 1 pcs			
	GEV No.	100909	Ref. No. 0100744 SIR0100744
union screw thread M10x1 for pipe ø 6mm Qty 1 pcs			
	GEV No.	101246	Ref. No. 0100778 673600 MA673600 SIR0100778
olive for pipe ø 4mm Qty 1 pcs			
	GEV No.	101252	Ref. No. —
union nut thread M24x1.5 for pipe ø 12mm			
	GEV No.	101253	Ref. No. —
union nut thread M24x1.5 PEL for pipe ø 16mm			
	GEV No.	101254	Ref. No. —
union nut thread M28x1.5 tube ø 20mm			

Table continues overleaf



accessories for		101092	
	GEV No.	101255	Ref. No. —
olive for pipe ø 12mm Qty 1 pcs			
	GEV No.	101256	Ref. No. —
olive for pipe ø 16mm Qty 1 pcs			
	GEV No.	101257	Ref. No. —
olive for pipe ø 20mm Qty 1 pcs			
	GEV No.	101286	Ref. No. 0100743 0100745 LA62070023 LAR62070023 SIR0100743
olive ID ø 6mm Qty 1 pcs			
	GEV No.	110080	Ref. No. —
knob ø 70mm shaft ø 10x8mm shaft flat universal			
	GEV No.	112206	Ref. No. —
knob dial plate silver gas tap PEL21/22/23 t.max.°C ED ø 63mm ID ø 45.5mm			

23S/V series			
1			
GEV No.	101093	Ref. No.	0100734 SIR0100734
description	gas tap PEL type 23S/V gas inlet M28x1.5 (tube ø 20mm) bypass nozzle ø 0.35mm thermocouple connection M10x1 pilot connection M10x1 shaft ø 10x8mm shaft L 25/17mm shaft flat lower		
For models:	CNG50150, CNG50160, CTT1041, CTT1042, CTT1045, CTT9040, CTT9041, CTT9042, CTT9045, CTT9046, CTT90652R, CTT90663R, DGP4150, DGPT160, TG94APS, TG94EPS, TG94FPS, TG94GPS, TG96FPS, TGP4APS, TGP4FPS, TGP4GPS, TGY4TPS		
spare parts for	101093		
	GEV No.	100455	Ref. No. —
bypass nozzle type PEL23/24 bore ø 0.35mm thread M8x0.5			
	GEV No.	101059	Ref. No. —
magnet unit T1: M10x1 T2: M22x1 L 46mm ø 18mm suitable for PEL23S M10x1			
	GEV No.	101204	Ref. No. —
gas tap front part shaft ø 10x8mm shaft L 25/17mm shaft flat upper/lower suitable for PEL23S			
	GEV No.	101245	Ref. No. —
gas connection thread M24x1.5 tube ø 12/16mm vertical for PEL gas taps			
	GEV No.	101463	Ref. No. —
screw suitable for PEL23S Qty 4 pcs			
	GEV No.	528455	Ref. No. —
O-ring Viton thickness 2.62mm ID ø 18.72mm Qty 1 pcs			



















accessories for		101093	
	GEV No.	100908	Ref. No. 0100777 673500 MA673500 SIR0100777
union screw thread M10x1 for pipe ø 4mm Qty 1 pcs			
	GEV No.	100909	Ref. No. 0100744 SIR0100744
union screw thread M10x1 for pipe ø 6mm Qty 1 pcs			
	GEV No.	101246	Ref. No. 0100778 673600 MA673600 SIR0100778
olive for pipe ø 4mm Qty 1 pcs			
	GEV No.	101252	Ref. No. —
union nut thread M24x1.5 for pipe ø 12mm			
	GEV No.	101253	Ref. No. —
union nut thread M24x1.5 PEL for pipe ø 16mm			
	GEV No.	101254	Ref. No. —
union nut thread M28x1.5 tube ø 20mm			
	GEV No.	101255	Ref. No. —
olive for pipe ø 12mm Qty 1 pcs			
	GEV No.	101256	Ref. No. —
olive for pipe ø 16mm Qty 1 pcs			
	GEV No.	101257	Ref. No. —
olive for pipe ø 20mm Qty 1 pcs			
	GEV No.	101286	Ref. No. 0100743 0100745 LA62070023 LAR62070023 SIR0100743
olive ID ø 6mm Qty 1 pcs			
	GEV No.	110080	Ref. No. —
knob ø 70mm shaft ø 10x8mm shaft flat universal			
	GEV No.	112206	Ref. No. —
knob dial plate silver gas tap PEL21/22/23 t.max.°C ED ø 63mm ID ø 45.5mm			

alternatives to JUNKERS

1			
GEV No.	101457	Ref. No.	100513
description	gas tap alternatives to JUNKERS type CH110 gas inlet M20x1.5 (tube ø 12mm) bypass nozzle ø 0.35mm gas outlet M20x1.5 (tube ø 12/10mm) thermocouple connection M8x1 pilot connection M10x1 shaft ø 10mm shaft L 25mm shaft flat with pipe outlet		
spare parts for	101457		
	GEV No.	100259	Ref. No. —
bypass nozzle type PEL22 bore ø 0.35mm thread M6x0.5			

Table continues overleaf



spare parts for		101457	
	GEV No.	100908	Ref. No.
			0100777 673500 MA673500 SIR0100777
union screw thread M10x1 for pipe ø4mm Qty 1 pcs			
	GEV No.	101058	Ref. No.
			0100757 SIR0100757
magnet unit L 39mm D1 ø 15.4mm D2 ø 13.5mm suitable for PEL22/EGA24197 standard			
	GEV No.	101200	Ref. No.
			—
gas tap front part shaft ø 10mm shaft L 25mm shaft flat suitable for 22S/O			
	GEV No.	101230	Ref. No.
			—
thermocouple nut T1: M8x1 T2: M18x1 aluminium			
	GEV No.	101241	Ref. No.
			—
gas connection thread M20x1.5 tube ø 12/10mm for PEL gas taps vertical			
	GEV No.	101246	Ref. No.
			0100778 673600 MA673600 SIR0100778
olive for pipe ø 4mm Qty 1 pcs			
	GEV No.	101460	Ref. No.
			—
O-ring ø 12.37mm D1 ø 2.62mm suitable for PEL22			
	GEV No.	101461	Ref. No.
			—
screw kit suitable for PEL22 Qty 4 pcs			
accessories for		101457	
	GEV No.	100945	Ref. No.
			—
roll pin ø 3.2mm L 10mm			
	GEV No.	101218	Ref. No.
			—
shaft extension JUNKERS			
	GEV No.	101219	Ref. No.
			—
shaft extension L 25mm JUNKERS			
	GEV No.	101231	Ref. No.
			—
thermocouple nut T1: M9x1 T2: M18x1			
	GEV No.	101248	Ref. No.
			673300 MA673300
olive for pipe ø 12mm Qty 1 pcs suitable for PEL			
	GEV No.	101249	Ref. No.
			0100780 SIR0100780
olive for pipe ø 10mm Qty 1 pcs			
	GEV No.	101250	Ref. No.
			673200 MA673200
union nut thread M20x1.5 for pipe ø 10mm			
	GEV No.	101251	Ref. No.
			673100 MA673100
union nut thread M20x1.5 for pipe ø 12mm			
	GEV No.	101290	Ref. No.
			—
thermocouple nut T1: M10x1 T2: M18x1 suitable for PEL20/21			
	GEV No.	110064	Ref. No.
			—
knob			
	GEV No.	110066	Ref. No.
			—
knob screw			

accessories for		101457	
	GEV No.	550396	Ref. No.
			—
shaft extension L 25mm JUNKERS			

gas thermostats







SIT

630 Eurosit series



1			
GEV No.	103310	Ref. No.	CR0979080
description	gas thermostat type 630 Eurosit series 110-190°C		



1			
GEV No.	101413	Ref. No.	0100880 KVL0008 SIR0100880 SIRKVL0008
description	gas thermostat type 630 Eurosit series t.max. 100°C 30-100°C gas inlet 3/8" gas outlet 3/8" thermocouple connection M9x1 pilot connection M10x1 probe ø 5mm probe L 122mm capillary pipe 1050mm SIT		
For models:	CMG7021, CMG7022, CMG7041, CMG7042, CMG9021, CMG9022, CMG9041, CMG9042, MG92APS, MG92GPS, MG94APS, MG94GPS		
accessories for		101413	
	GEV No.	100904	Ref. No.
			1394700 MA1394700
locking screw M10x1 for pipe ø 4mm Qty 1 pcs			
	GEV No.	100905	Ref. No.
			—
locking screw M10x1 for pipe ø 6mm Qty 1 pcs			
	GEV No.	101273	Ref. No.
			—
olive for pipe ø 12mm L 9.5mm brass Qty 1 pcs suitable for universal			
	GEV No.	101276	Ref. No.
			—
union screw thread 3/8" tube ø 12mm Qty 1 pcs			
	GEV No.	101333	Ref. No.
			—
plug thread 3/8" with O-ring			



1

GEV No.	103076	Ref. No.	CR0508680
description	gas thermostat type 630 Eurosit series t.max. 190°C 110-190°C gas inlet 3/8" gas outlet 3/8" thermocouple connection M9x1 pilot connection M10x1 probe ø 4mm probe L 202mm capillary pipe 1050mm SIT		
For models:	EFG72108, EFG72110, EFG72115, EFG73208T, EFG73210, EFG74215, EFG92115, EFG92115S, EFG92123, EFG93210, EFG94215, EFG94215S, EFG94223		











1

GEV No.	101409	Ref. No.	0100879 1031504800 MA1031504800 SIR0100879
description	gas thermostat type 630 Eurosit series t.max. 280°C 40-280°C gas inlet 3/8" gas outlet 3/8" thermocouple connection M9x1 pilot connection M10x1 probe ø 4mm probe L 72mm capillary pipe 1050mm SIT		
For models:	BG62TLC, BG63TLC, BG64TLC, BG72GLC, BG72TLC, BG74GLC, BG74GMC, BG74TLC, BG74TMC, BG92ALC, BG92ARC, BG92GLC, BG92GRC, BG94ALC, BG94AMC, BG94ARC, BG94GLC, BG94GMC, BG94GRC, BGY2TLC, BGY2TRC, BGY4TLC, BGY4TMC, BGY4TRC, CCG7001, CCG7001P, CCG7201, CG76HPS, CG86HPS, CGG6020C, CGG6030C, CGG6040C, CGG6220C, CGG6230C, CGG6240C, CGG7020C, CGG7021C, CGG7040C, CGG7040LRC, CGG7041C, CGG7041LRC, CGG7221C, CGG7240C, CGG7240LRC, CGG7241C, CGG9020-1, CGG9020-3, CGG9021-1, CGG9021-3, CGG9022-1...(Other models you can see in the webshop)		
spare parts for	101409		
	GEV No.	101333	Ref. No. —
	plug thread 3/8" with O-ring		
accessories for	101409		
	GEV No.	100904	Ref. No. 1394700 MA1394700
	locking screw M10x1 for pipe ø 4mm Qty 1 pcs		
	GEV No.	100905	Ref. No. —
	locking screw M10x1 for pipe ø 6mm Qty 1 pcs		
	GEV No.	101273	Ref. No. —
	olive for pipe ø 12mm L 9.5mm brass Qty 1 pcs suitable for universal		
	GEV No.	101276	Ref. No. —
	union screw thread 3/8" tube ø 12mm Qty 1 pcs		



1

GEV No.	101915	Ref. No.	BN826920012 KVL0007
description	gas thermostat type 630 Eurosit series t.max. 320°C 80-320°C gas inlet 3/8" gas outlet 3/8" thermocouple connection M9x1 pilot connection M10x1 probe ø 4mm probe L 72mm capillary pipe 1050mm SIT		
For models:	BG72GLC, BG72TLC, BG74GLC, BG74GMC, CGG6020C, CGG6030C, CGG6040C, CGG7020C, CGG7040C, CGG7040LRC, CGG7041C, CGG7041LRC, CGG7221C, CGG7241C		
accessories for	101915		
	GEV No.	100825	Ref. No. —
	gas tap spindle shaft ø 8x6.5mm shaft L 22/14mm suitable for EUROSIT		
	GEV No.	100904	Ref. No. 1394700 MA1394700
	locking screw M10x1 for pipe ø 4mm Qty 1 pcs		
	GEV No.	100905	Ref. No. —
	locking screw M10x1 for pipe ø 6mm Qty 1 pcs		
	GEV No.	100949	Ref. No. —
	gasket suitable for 630 Eurosit series		
	GEV No.	101273	Ref. No. —
	olive for pipe ø 12mm L 9.5mm brass Qty 1 pcs suitable for universal		
	GEV No.	101276	Ref. No. —
	union screw thread 3/8" tube ø 12mm Qty 1 pcs		
	GEV No.	101333	Ref. No. —
	plug thread 3/8" with O-ring		
	GEV No.	101390	Ref. No. —
	gas tap spindle shaft ø 6x4.6mm shaft L 32/15mm gas tap with ignition flame suitable for ZANUSSI, MARENO for gas thermostat EUROSIT		
	GEV No.	101392	Ref. No. —
	adapter suitable for 630 Eurosit series		
	GEV No.	110357	Ref. No. —
	gas tap spindle shaft ø 8x6.5mm shaft L 36/12mm suitable for 630 Eurosit series		
	GEV No.	110358	Ref. No. —
	adapter shaft ø 10x8mm shaft L 29/18mm suitable for 630 Eurosit series		



			
GEV No.	101125	Ref. No.	0100873 1887600 KVL0001 KVL0003 KVL0004 KVL0006 MA1887600 SIR0100873 SIRKVL0001 SIRKVL0003 SIRKVL0004 SIRKVL0006
description	gas thermostat type 630 Eurosit series t.max. 340°C 100-340°C gas inlet 3/8" gas outlet 3/8" thermocouple connection M9x1 pilot connection M10x1 probe ø 4mm probe L 72mm capillary pipe 1050mm SIT		
For models:	BG62TLC, BG62TLL, BG62TRR, BG63TLC, BG63TLL, BG63TLR, BG64TLC, BG64TLL, BG64TLR, BG72GLL, BG72GRR, BG72TLL, BG72TRR, BG74GLL, BG74GLR, BG74GRR, BG74TLL, BG74TLR, BG74TRR, BG82GLC, BG82TLC, BG84ALC, BG84AMC, BG84GLC, BG84GMC, BG84TLC, BG84TMC, CBG7050, CBG7050C, CBG9060CP, CBG9060C-P, CBG9060P, CCG1045, CCG1045P, CCG10652, CCG10652P, CCG10653, CCG1085, CCG10852, CCG1085P, CCG6045, CCG7045, CCG7045P, CCG70652, CCG70652P, CCG70653, CCG7245, CCG72652, CCG72653, CCG9045P... (Other models you can see in the webshop)		
accessories for	101125		
	GEV No.	100825	Ref. No. —
	gas tap spindle shaft ø 8x6.5mm shaft L 22/14mm suitable for EUROSIT		
	GEV No.	100904	Ref. No. 1394700 MA1394700
	locking screw M10x1 for pipe ø 4mm Qty 1 pcs		
	GEV No.	100905	Ref. No. —
	locking screw M10x1 for pipe ø 6mm Qty 1 pcs		
	GEV No.	100949	Ref. No. —
	gasket suitable for 630 Eurosit series		
	GEV No.	101273	Ref. No. —
	olive for pipe ø 12mm L 9.5mm brass Qty 1 pcs suitable for universal		
	GEV No.	101276	Ref. No. —
	union screw thread 3/8" tube ø 12mm Qty 1 pcs		
	GEV No.	101333	Ref. No. —
	plug thread 3/8" with O-ring		
	GEV No.	101390	Ref. No. —
	gas tap spindle shaft ø 6x4.6mm shaft L 32/15mm gas tap with ignition flame suitable for ZANUSSI, MARENO for gas thermostat EUROSIT		
	GEV No.	101392	Ref. No. —
	adapter suitable for 630 Eurosit series		
	GEV No.	110357	Ref. No. —
	gas tap spindle shaft ø 8x6.5mm shaft L 36/12mm suitable for 630 Eurosit series		

accessories for	101125		
	GEV No.	110358	Ref. No. —
	adapter shaft ø 10x8mm shaft L 29/18mm suitable for 630 Eurosit series		

			
GEV No.	101700	Ref. No.	CR0585670
description	gas thermostat type 630 Eurosit series t.max. 340°C 100-340°C gas inlet 3/8" gas outlet 3/8" thermocouple connection M9x1 pilot connection M10x1 probe ø 4mm probe L 72mm capillary pipe 1050mm SIT		
For models:	EBG7-CROMO, EBG92ALC, EBG92ARC, EBG92GLC, EBG92GRC, EBG92TLC, EBG92TRC, EBG93ALC, EBG93AMC, EBG93GLC, EBG93GMC, EBG93TLC, EBG93TMC, EBG94ALC, EBG94AMC, EBG94GLC, EBG94GMC, EBG94TLC, EBG94TMC, ECG7-FG, ECG94F, ECG96F, ECG96H, ECG98F, ESG74, ETG74, ETG94F, ETG94FL, ETG96F, ETG96FC, ETG96FL		
accessories for	101700		
	GEV No.	100904	Ref. No. 1394700 MA1394700
	locking screw M10x1 for pipe ø 4mm Qty 1 pcs		
	GEV No.	100905	Ref. No. —
	locking screw M10x1 for pipe ø 6mm Qty 1 pcs		
	GEV No.	101273	Ref. No. —
	olive for pipe ø 12mm L 9.5mm brass Qty 1 pcs suitable for universal		
	GEV No.	101276	Ref. No. —
	union screw thread 3/8" tube ø 12mm Qty 1 pcs		
	GEV No.	101333	Ref. No. —
	plug thread 3/8" with O-ring		



710 Minisit series



GEV No.	101912 ¹	Ref. No.	0100871 SIR0100871
description	gas thermostat SIT type MINISIT 710 t.max. 190°C 50-190°C gas inlet 1/2" gas outlet 3/8" thermocouple connection M9x1 pilot connection M10x1 probe ø 14.4mm probe L 14.5mm capillary pipe 1050mm probe type type F1 pressure controller yes pressure regulator 3-18mbar gland nut		
spare parts for	101912		
	GEV No.	101053	Ref. No. —
	magnet unit T1: M9x1 T2: M24x1 L 45mm ø 17mm suitable for Minisit		
accessories for	101912		
	GEV No.	100809	Ref. No. —
	O-ring EPDM thickness 2mm ID ø 21mm Qty 1 pcs		
	GEV No.	100904	Ref. No. 1394700 MA1394700
	locking screw M10x1 for pipe ø 4mm Qty 1 pcs		
	GEV No.	100905	Ref. No. —
	locking screw M10x1 for pipe ø 6mm Qty 1 pcs		
	GEV No.	101054	Ref. No. —
	magnet unit T1: M10x1 T2: M24x1 L 45mm ø 17mm suitable for Minisit		
	GEV No.	101136	Ref. No. 0100857 SI0100857 SIR0100857
	piezoelectric igniter suitable for Minisit with cover cap ømm connection F6.3x0.8		
	GEV No.	101137	Ref. No. —
	cover cap without piezoelectric igniter		
	GEV No.	101267	Ref. No. —
	reducer IT 3/8" ET 1/2" L 21mm		
	GEV No.	101268	Ref. No. —
	gas connection thread 3/8" angled with O-ring MINISIT 710		
	GEV No.	101269	Ref. No. —
	gas connection thread 1/2" angled with O-ring MINISIT 710		
	GEV No.	101270	Ref. No. —
	screw connection IT 3/8" ET 3/8" L 28mm		
	GEV No.	101272	Ref. No. —
	screw connection IT 1/2" ET 3/8" L 57mm		
	GEV No.	101273	Ref. No. —
	olive for pipe ø 12mm L 9.5mm brass Qty 1 pcs suitable for universal		

¹probe thread 1/4"

accessories for	101912		
	GEV No.	101274	Ref. No. —
	olive for pipe ø 16mm Qty 1 pcs		
	GEV No.	101275	Ref. No. —
	union screw thread 1/2" for pipe ø 16mm Qty 1 pcs		
	GEV No.	101276	Ref. No. —
	union screw thread 3/8" tube ø 12mm Qty 1 pcs		
	GEV No.	110068	Ref. No. 0100856 1393500 MA1393500 SIR0100856
	knob suitable for Minisit ø 37mm		
	GEV No.	361182	Ref. No. —
	nut thread 1/4" H 5mm nickel-plated brass WS 17 Qty 1 pcs		
	GEV No.	532520	Ref. No. —
	O-ring silicone thickness 2.62mm ID ø 15.08mm Qty 1 pcs		

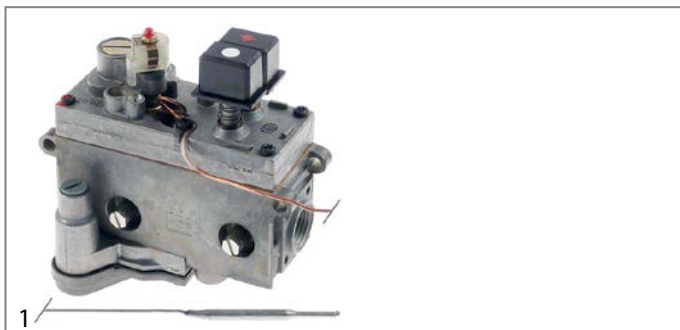









GEV No.	101438	Ref. No.	0100855 SIR0100855
description	gas thermostat SIT type MINISIT 710 t.max. 340°C 100-340°C gas inlet 1/2" gas outlet 3/8" thermocouple connection M9x1 pilot connection M10x1 probe ø 5mm probe L 68mm capillary pipe 1050mm probe type type B1 pressure controller yes pressure regulator 3-18mbar gland nut		
spare parts for	101438		
	GEV No.	101053	Ref. No. —
	magnet unit T1: M9x1 T2: M24x1 L 45mm ø 17mm suitable for Minisit		
	GEV No.	102102	Ref. No. —
	probe 100-340°C probe ø 5mm probe L 68mm capillary pipe 1750mm t.max. 340°C oven/grill probe type type B1 suitable for MINISIT 710		
accessories for	101438		
	GEV No.	100809	Ref. No. —
	O-ring EPDM thickness 2mm ID ø 21mm Qty 1 pcs		
	GEV No.	100904	Ref. No. 1394700 MA1394700
	locking screw M10x1 for pipe ø 4mm Qty 1 pcs		
	GEV No.	100905	Ref. No. —
	locking screw M10x1 for pipe ø 6mm Qty 1 pcs		
	GEV No.	101054	Ref. No. —
	magnet unit T1: M10x1 T2: M24x1 L 45mm ø 17mm suitable for Minisit		

Table continues overleaf

accessories for		101438	
	GEV No.	101136	Ref. No. 0100857 SIO100857 SIR0100857
piezoelectric igniter suitable for Minisit with cover cap 6mm connection F6.3x0.8			
	GEV No.	101137	Ref. No. —
cover cap without piezoelectric igniter			
	GEV No.	101267	Ref. No. —
reducer IT 3/8" ET 1/2" L 21mm			
	GEV No.	101268	Ref. No. —
gas connection thread 3/8" angled with O-ring MINISIT 710			
	GEV No.	101269	Ref. No. —
gas connection thread 1/2" angled with O-ring MINISIT 710			
	GEV No.	101270	Ref. No. —
screw connection IT 3/8" ET 3/8" L 28mm			
	GEV No.	101272	Ref. No. —
screw connection IT 1/2" ET 3/8" L 57mm			
	GEV No.	101273	Ref. No. —
olive for pipe ø 12mm L 9.5mm brass Qty 1 pcs suitable for universal			
	GEV No.	101274	Ref. No. —
olive for pipe ø 16mm Qty 1 pcs			
	GEV No.	101275	Ref. No. —
union screw thread 1/2" for pipe ø 16mm Qty 1 pcs			
	GEV No.	101276	Ref. No. —
union screw thread 3/8" tube ø 12mm Qty 1 pcs			
	GEV No.	110068	Ref. No. 0100856 1393500 MA1393500 SIR0100856
knob suitable for Minisit ø 37mm			

			
GEV No.	101131	Ref. No.	0108030 SIR0108030
description	gas thermostat without cap, button and angle SIT type MINISIT 710 t.max. 190°C 50-190°C gas inlet 1/2" gas outlet 3/8" thermocouple connection M9x1 pilot connection M10x1 probe ø 5mm probe L 98mm capillary pipe 1200mm probe type type A2 pressure controller no pressure regulator mbar gland nut		
For models:	CFG70115, CFG70215, CFG72215, CFG90120, CFG90210, CFG90210S, CFG90220, FG92210, FGY2210		
spare parts for	101131		
	GEV No.	101053	Ref. No. —
magnet unit T1: M9x1 T2: M24x1 L 45mm ø 17mm suitable for Minisit			

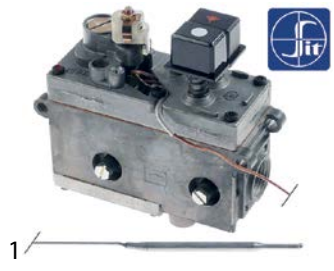
spare parts for		101131	
	GEV No.	102103	Ref. No. —
probe 60-200°C probe ø 5mm probe L 98mm capillary pipe 1050mm t.max. 200°C fryer probe type type A2 suitable for MINISIT 710			
accessories for		101131	
	GEV No.	100809	Ref. No. —
O-ring EPDM thickness 2mm ID ø 21mm Qty 1 pcs			
	GEV No.	100820	Ref. No. —
gland duct ET M14x1.5 IT M10x0.75 probe ø max. 6.5mm WS 22			
	GEV No.	100904	Ref. No. 1394700 MA1394700
locking screw M10x1 for pipe ø 4mm Qty 1 pcs			
	GEV No.	100905	Ref. No. —
locking screw M10x1 for pipe ø 6mm Qty 1 pcs			
	GEV No.	101054	Ref. No. —
magnet unit T1: M10x1 T2: M24x1 L 45mm ø 17mm suitable for Minisit			
	GEV No.	101136	Ref. No. 0100857 SIO100857 SIR0100857
piezoelectric igniter suitable for Minisit with cover cap 6mm connection F6.3x0.8			
	GEV No.	101137	Ref. No. —
cover cap without piezoelectric igniter			
	GEV No.	101267	Ref. No. —
reducer IT 3/8" ET 1/2" L 21mm			
	GEV No.	101268	Ref. No. —
gas connection thread 3/8" angled with O-ring MINISIT 710			
	GEV No.	101269	Ref. No. —
gas connection thread 1/2" angled with O-ring MINISIT 710			
	GEV No.	101270	Ref. No. —
screw connection IT 3/8" ET 3/8" L 28mm			
	GEV No.	101272	Ref. No. —
screw connection IT 1/2" ET 3/8" L 57mm			
	GEV No.	101273	Ref. No. —
olive for pipe ø 12mm L 9.5mm brass Qty 1 pcs suitable for universal			
	GEV No.	101274	Ref. No. —
olive for pipe ø 16mm Qty 1 pcs			
	GEV No.	101275	Ref. No. —
union screw thread 1/2" for pipe ø 16mm Qty 1 pcs			
	GEV No.	101276	Ref. No. —
union screw thread 3/8" tube ø 12mm Qty 1 pcs			
	GEV No.	110068	Ref. No. 0100856 1393500 MA1393500 SIR0100856
knob suitable for Minisit ø 37mm			



accessories			
probes			
GEV No.	102104 ¹	Ref. No.	0100853
description	probe 110-190°C probe ø 11mm probe thread 1/4" probe L 26mm capillary pipe 1050mm t.max. 190°C fryer probe type type F3 suitable for MINISIT 710		
accessories for	102104		
	GEV No.	361182	Ref. No. —
	nut thread 1/4" H 5mm nickel-plated brass WS 17 Qty 1 pcs		
	GEV No.	510420	Ref. No. —
	gasket copper ED ø 19.9mm ID ø 14.3mm thickness 2mm Qty 1 pcs		
	GEV No.	529251	Ref. No. —
	O-ring EPDM thickness 2.62mm ID ø 15.08mm Qty 1 pcs		

¹probe thread 1/4"

PEL

24ST series



GEV No.	101076	Ref. No.	0100724 SIR0100724
description	gas thermostat PEL type 24ST 120-320°C gas inlet M20x1.5 (tube ø 12mm) bypass nozzle ø 0.35mm gas outlet M20x1.5 (tube ø 12/10mm) thermocouple connection M9x1 pilot connection M10x1 capillary pipe 1200mm probe ø 6mm probe L 100mm shaft ø 10x8mm shaft L 27/17mm shaft flat upper		
spare parts for	101076		
	GEV No.	100455	Ref. No. —
	bypass nozzle type PEL23/24 bore ø 0.35mm thread M8x0.5		
	GEV No.	101058	Ref. No. 0100757 SIR0100757
	magnet unit L 39mm D1 ø 15.4mm D2 ø 13.5mm suitable for PEL22/EGA24197 standard		
	GEV No.	106200	Ref. No. —
	nut thread M9x1 suitable for PEL 24/25S		
accessories for	101076		
	GEV No.	100908	Ref. No. 0100777 673500 MA673500 SIR0100777
	union screw thread M10x1 for pipe ø 4mm Qty 1 pcs		
	GEV No.	100909	Ref. No. 0100744 SIR0100744
	union screw thread M10x1 for pipe ø 6mm Qty 1 pcs		

accessories for 101076			
	GEV No.	101246	Ref. No. 0100778 673600 MA673600 SIR0100778
	olive for pipe ø 4mm Qty 1 pcs		
	GEV No.	101248	Ref. No. 673300 MA673300
	olive for pipe ø 12mm Qty 1 pcs suitable for PEL		
	GEV No.	101249	Ref. No. 0100780 SIR0100780
	olive for pipe ø 10mm Qty 1 pcs		
	GEV No.	101250	Ref. No. 673200 MA673200
	union nut thread M20x1.5 for pipe ø 10mm		
	GEV No.	101251	Ref. No. 673100 MA673100
	union nut thread M20x1.5 for pipe ø 12mm		
	GEV No.	101286	Ref. No. 0100743 0100745 LA62070023 LAR62070023 SIR0100743
	olive ID ø 6mm Qty 1 pcs		
	GEV No.	110079	Ref. No. —
	knob dial plate gas thermostat 1-8 silver		
	GEV No.	110080	Ref. No. —
	knob ø 70mm shaft ø 10x8mm shaft flat universal		

gas valves and ignition boxes

gas control valves

HONEYWELL











GEV No.	106012	Ref. No.	LAR63020170
description	gas valve type VK4115V 220-240V 50/60Hz gas inlet flange 32x32mm gas outlet flange 32x32mm thermocouple connection pilot connection pressure range 15-60mbar max 60mbar operator type HONEYWELL flange 32x32mm		
For models:	GMT06D, GVT10D		
accessories for	106012		
	GEV No.	102845	Ref. No. —
	gas connection angled 1/2" flange 32x32mm hole distance 24x24mm Tandem		
	GEV No.	102846	Ref. No. —
	gas connection straight 1/2" flange 32x32mm hole distance 24x24mm suitable for Tandem		

SIT







ELETTROSIT













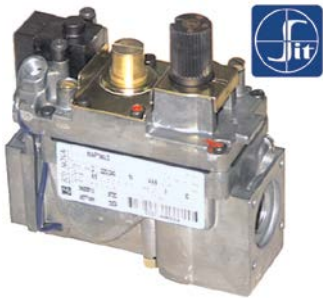

GEV No.	101127	Ref. No.	0100883 LAR63025030 SIR0100883
description	gas valve SIT type ELETTROSIT 230V gas inlet 3/4" gas outlet 3/4" thermocouple connection M9x1 pilot connection M10x1 lateral equiv. no. 0.810.175		
spare parts for	101127		
	GEV No.	101312	Ref. No. 0109011 CR0507660 LAR63060010 R63060010 SIR0109011
	microswitch		
	GEV No.	101352	Ref. No. —
	solenoid coil 230V 50Hz suitable for ELETTROSIT		
accessories for	101127		
	GEV No.	100006	Ref. No. —
	piezoelectric igniter suitable for ELETTROSIT body plastic blowing connection ø2.4mm ø 14mm		
	GEV No.	100904	Ref. No. 1394700 MA1394700
	locking screw M10x1 for pipe ø 4mm Qty 1 pcs		
	GEV No.	100905	Ref. No. —
	locking screw M10x1 for pipe ø 6mm Qty 1 pcs		
	GEV No.	101301	Ref. No. —
	gas connection thread 1/2" straight ELETTROSIT screw with O-ring		
	GEV No.	101303	Ref. No. —
	gas connection straight thread 3/4" ELETTROSIT		
	GEV No.	101309	Ref. No. —
	extension		

NOVASIT



GEV No.	101187	Ref. No.	0105082 MA1870800 SIR0105082
description	gas valve SIT series Novasit 820 0.17VHz gas inlet 1/2" gas outlet 1/2" thermocouple connection M9x1 pilot connection M10x1 ignition pressurebar pressure range 5-50mbar pressure regulator connection blind equiv. no. 0.820.301 supply Operator millivolt		
For models:	FG82122, FG84222, FG92122, FG94222, FGY2122, FGY4222		
spare parts for	101187		
	GEV No.	101065	Ref. No. —
	magnet unit with cable L 44mm D1 ø 30mm D2 ø 20mm suitable for NOVASIT		
accessories for	101187		
	GEV No.	100110	Ref. No. —
	pilot burner SIT type 190 series 3 flames nozzle ømm gas connectionmm		
	GEV No.	101305	Ref. No. —
	gas connection straight 1/2" flange 45x45mm ELETTROSIT/V4400/4600/4605 suitable for SIT/HONEYWELL hole distance 36x36mm		
	GEV No.	101306	Ref. No. —
	gas connection angled flange 45x45mm hole distance 36x36mm 1/2" ELETTROSIT/V4400/4600/4605 screw with O-ring suitable for SIT/HONEYWELL		
	GEV No.	101307	Ref. No. —
	gas connection straight flange 45x45mm hole distance 36x36mm 3/4" ELETTROSIT/V4400/4600/4605 screw with O-ring suitable for SIT/HONEYWELL		
	GEV No.	101308	Ref. No. —
	gas connection angled flange 45x45mm hole distance 36x36mm 3/4" ELETTROSIT/V4400/4600/4605 screw with O-ring suitable for SIT/HONEYWELL		
	GEV No.	102116	Ref. No. 0105109 SIR0105109
	thermopile ROBERTSHAW L 900mm probe ø 9mm probe L 57mm 250-750mV screw connection 7/16"		



			
1			
GEV No.	101162	Ref. No.	0109010 MA2863300 SIR0109010
description	gas valve SIT series Novasit 820 230V 50Hz gas inlet 1/2" gas outlet 1/2" thermocouple connection M9x1 pilot connection M10x1 ignition pressure 3-5mbar pressure range 3-30mbar pressure regulator connection blind equiv. no. 0.820.010		
For models:	CFG60110, CFG60210		
spare parts for	101162		
	GEV No.	101065	Ref. No. —
	magnet unit with cable L 44mm D1 ø 30mm D2 ø 20mm suitable for NOVASIT		
	GEV No.	101313	Ref. No. —
	solenoid coil 230V 50Hz		
accessories for	101162		
	GEV No.	100006	Ref. No. —
	piezoelectric igniter suitable for ELETTROSIT body plastic blowing connection ø2.4mm ø 14mm		
	GEV No.	101305	Ref. No. —
	gas connection straight 1/2" flange 45x45mm ELETTROSIT/V4400/4600/4605 suitable for SIT/HONEYWELL hole distance 36x36mm		
	GEV No.	101306	Ref. No. —
	gas connection angled flange 45x45mm hole distance 36x36mm 1/2" ELETTROSIT/V4400/4600/4605 screw with O-ring suitable for SIT/HONEYWELL		
	GEV No.	101307	Ref. No. —
	gas connection straight flange 45x45mm hole distance 36x36mm 3/4" ELETTROSIT/V4400/4600/4605 screw with O-ring suitable for SIT/HONEYWELL		
	GEV No.	101308	Ref. No. —
	gas connection angled flange 45x45mm hole distance 36x36mm 3/4" ELETTROSIT/V4400/4600/4605 screw with O-ring suitable for SIT/HONEYWELL		
	GEV No.	101312	Ref. No. 0109011 CR0507660 LAR63060010 R63060010 SIR0109011
	microswitch		
	GEV No.	101314	Ref. No. —
	solenoid coil 24V 50Hz		
	GEV No.	101317	Ref. No. 1874000 1880600 MA1874000 MA1880600
	plug with cable L 1000mm suitable for NOVASIT		
	GEV No.	101318	Ref. No. —
	cover cap for solenoid coil suitable for NOVASIT		













			
1			
GEV No.	101908	Ref. No.	1871200 MA1871200
description	gas valve SIT series Novasit 820 230V 50Hz gas inlet 1/2" gas outlet 1/2" thermocouple connection M9x1 pilot connection M10x1 ignition pressurebar pressure regulator connection blind equiv. no. 0.820.018 output pilot burner M10x1 input pressure max. 60bar setting range 3-30bar		
For models:	EDG72128, EDG73142, EDG74228, EDG92142, EDG93142, EDG94242, EFG92123K, EFG94223K, EPG7D05, EPG7I05, EPG7I08, EPG9D10, EPG9D10A, EPG9D15, EPG9D15A, EPG9I15, EPG9I15A, EPG9B9I10, EPG9B9I10A, EPGD05, ESG94CRA, ESG94CRM, ESG94FRA, ESG94FRM, ESG96CRA, ESG96FRA, SG86CRA, SG86FRA, SG86IRA, SG96CRA, SG96FRA, SG96IRA		
spare parts for	101908		
	GEV No.	101065	Ref. No. —
	magnet unit with cable L 44mm D1 ø 30mm D2 ø 20mm suitable for NOVASIT		
	GEV No.	101313	Ref. No. —
	solenoid coil 230V 50Hz		
accessories for	101908		
	GEV No.	100006	Ref. No. —
	piezoelectric igniter suitable for ELETTROSIT body plastic blowing connection ø2.4mm ø 14mm		
	GEV No.	101305	Ref. No. —
	gas connection straight 1/2" flange 45x45mm ELETTROSIT/V4400/4600/4605 suitable for SIT/HONEYWELL hole distance 36x36mm		
	GEV No.	101306	Ref. No. —
	gas connection angled flange 45x45mm hole distance 36x36mm 1/2" ELETTROSIT/V4400/4600/4605 screw with O-ring suitable for SIT/HONEYWELL		
	GEV No.	101307	Ref. No. —
	gas connection straight flange 45x45mm hole distance 36x36mm 3/4" ELETTROSIT/V4400/4600/4605 screw with O-ring suitable for SIT/HONEYWELL		
	GEV No.	101308	Ref. No. —
	gas connection angled flange 45x45mm hole distance 36x36mm 3/4" ELETTROSIT/V4400/4600/4605 screw with O-ring suitable for SIT/HONEYWELL		
	GEV No.	101312	Ref. No. 0109011 CR0507660 LAR63060010 R63060010 SIR0109011
	microswitch		
	GEV No.	101314	Ref. No. —
	solenoid coil 24V 50Hz		
	GEV No.	101317	Ref. No. 1874000 1880600 MA1874000 MA1880600
	plug with cable L 1000mm suitable for NOVASIT		

Table continues overleaf







1 gas components

accessories for		101908		
	GEV No.	101318	Ref. No.	—
	cover cap for solenoid coil suitable for NOVASIT			

accessories			
			
GEV No.	101312	Ref. No.	0109011 CR0507660 LAR63060010 SIR0109011
description	microswitch		
For models:	CFG60110, CFG60210, EDG72128, EDG74228, EFG92123K, EFG94223K, EPG7D05, EPG7I05, EPG7I08, EPG9D10, EPG9D10A, EPG9D15, EPG9D15A, EPG9I15, EPG9I15A, EPG9B110, EPG9B110A, EPGD05, ESG94CRA, ESG94CRM, ESG94FRA, ESG94FRM, ESG96CRA, ESG96FRA		

			
GEV No.	101317	Ref. No.	1874000 1880600 MA1874000 MA1880600
description	plug with cable L 1000mm suitable for NOVASIT		
For models:	EDG72128, EDG74228, EFG92123K, EFG94223K, EPG7D05, EPG7I05, EPG7I08, EPG9D10, EPG9D10A, EPG9D15, EPG9D15A, EPG9I15, EPG9I15A, EPG9B110, EPG9B110A, EPGD05, ESG94CRA, ESG94CRM, ESG94FRA, ESG94FRM, ESG96CRA, ESG96FRA, SG86CRA, SG86FRA, SG86IRA, SG96CRA, SG96FRA, SG96IRA		

TANDEM				
				
GEV No.	101684	Ref. No.	0102481 SIR0102481	
description	gas valve 230V 50Hz gas inlet 1/2" gas outlet 1/2" pilot connection level slow ignition standard ignition time 3-7s pressure range 3-50mbar power supply for modulator type SIT equiv. no. 0.830.034			
For models:	CBG9060C-I, CPD90100, CPD90100A, CPD90150, CPD90150A, CPI90100, CPI90100A, CPI90150, CPI90150A			
spare parts for	101684			
	GEV No.	101379	Ref. No.	—
solenoid coil 230V 50Hz suitable for Tandem				

accessories for		101684		
	GEV No.	101274	Ref. No.	—
	olive for pipe ø 16mm Qty 1 pcs			
	GEV No.	101275	Ref. No.	—
	union screw thread 1/2" for pipe ø 16mm Qty 1 pcs			
	GEV No.	102845	Ref. No.	—
	gas connection angled 1/2" flange 32x32mm hole distance 24x24mm Tandem			
	GEV No.	102846	Ref. No.	—
	gas connection straight 1/2" flange 32x32mm hole distance 24x24mm suitable for Tandem			
	GEV No.	102847	Ref. No.	—
	O-ring			

ignition parts



























pilot burners				
SIT				
100 series				
				
GEV No.	106904	Ref. No.	0100821 SIR0100821	
description	pilot burner SIT type 100 series 1 flame nozzle ø 0.2mm gas connection 6mm			
spare parts for	106904			
	GEV No.	100245	Ref. No.	0100829 1415100 MA1415100 SIR0100829
	pilot burner nozzle LPG code 20 bore ø 0.2mm Qty 1 pcs thread M8x0.75			
	GEV No.	100855	Ref. No.	—
	pilot burner bracket triple			
	GEV No.	100885	Ref. No.	0101151 SIR0101151
	air mixing sleeve for pilot burner Qty 1 pcs			
	GEV No.	100916	Ref. No.	—
	compression spring for pilot burner Qty 1 pcs			
	GEV No.	100917	Ref. No.	—
	gasket for pilot burner Qty 1 pcs aluminium			
	GEV No.	100918	Ref. No.	—
	screw for pilot burner			
	GEV No.	107160	Ref. No.	—
	pilot burner cap SIT 1 flame Hmm Lmm Qty 1 pcs			
	GEV No.	107166	Ref. No.	—
	pilot burner head SIT 1 flame Hmm Lmm Qty 1 pcs			

Table continues overleaf



















spare parts for 106904				
	GEV No.	107701	Ref. No.	—
pilot burner bottom part SIT 100 series nozzle ø 0.2mm				
accessories for 106904				
	GEV No.	100246	Ref. No.	—
pilot burner nozzle natural gas bore ø 0.35mm Qty 1 pcs thread M8x0.75				
	GEV No.	100904	Ref. No.	1394700 MA1394700
locking screw M10x1 for pipe ø 4mm Qty 1 pcs				
	GEV No.	100905	Ref. No.	—
locking screw M10x1 for pipe ø 6mm Qty 1 pcs				
	GEV No.	102110	Ref. No.	—
pilot tube copper pipe ø 4mm thickness 1mm L 3000mm				
	GEV No.	102111	Ref. No.	—
pilot tube copper pipe ø 6mm thickness 1mm L 3000mm				
	GEV No.	107171	Ref. No.	0101153 0105143 1842300 MA1842300 SIR0101153 SIR0105143
pilot burner nozzle SIT natural/liquid gas bore ø 0.25mm Qty 1 pcs				
	GEV No.	107700	Ref. No.	0101152 SIO101152 SIR0101152
pilot burner bottom part SIT 100 series nozzle ø 0.25mm				
	GEV No.	107702	Ref. No.	—
pilot burner bottom part SIT 100 series nozzle ø 0.35mm				

 <p>1</p>				
GEV No.	106906	Ref. No.	0100822 0100824 6A013200 BN6A013200 LAR63050020 SIR0100822 SIR0100824	
description	pilot burner SIT type 100 series 3 flames nozzle ø 0.2mm gas connection 6mm			
For models:	BG92ALC, BG92ALL, BG92ARC, BG92ARR, BG92GLC, BG92GLL, BG92GRC, BG92GRR, BG94ALC, BG94ALL, BG94ALR, BG94AMC, BG94ARC, BG94ARR, BG94GLC, BG94GLL, BG94GLR, BG94GMC, BG94GRC, BG94GRR, BGY2TLC, BGY2TLL, BGY2TRC, BGY2TRR, BGY4TLC, BGY4TLL, BGY4TLR, BGY4TMC, BGY4TRC, BGY4TRR, CBG7050, CBG9060CP, CBG9060C-P, CBG9060P, CCG6045, CCG7045, CCG7045P, CCG70652, CCG70652P, CCG70653, CCG7245, CCG72652, CCG72653, CFG70115, CFG70215, CFG72215, CFG90120, CFG90210, CFG90210S, CFG90220...(Other models you can see in the webshop)			
spare parts for 106906				
	GEV No.	100245	Ref. No.	0100829 1415100 MA1415100 SIR0100829
pilot burner nozzle LPG code 20 bore ø 0.2mm Qty 1 pcs thread M8x0.75				

spare parts for 106906				
	GEV No.	100855	Ref. No.	—
pilot burner bracket triple				
	GEV No.	100885	Ref. No.	0101151 SIR0101151
air mixing sleeve for pilot burner Qty 1 pcs				
	GEV No.	100916	Ref. No.	—
compression spring for pilot burner Qty 1 pcs				
	GEV No.	100917	Ref. No.	—
gasket for pilot burner Qty 1 pcs aluminium				
	GEV No.	100918	Ref. No.	—
screw for pilot burner				
	GEV No.	107162	Ref. No.	—
pilot burner cap SIT 3 flames Hmm Lmm Qty 1 pcs				
	GEV No.	107701	Ref. No.	—
pilot burner bottom part SIT 100 series nozzle ø 0.2mm				
accessories for 106906				
	GEV No.	100245	Ref. No.	0100829 1415100 MA1415100 SIR0100829
pilot burner nozzle LPG code 20 bore ø 0.2mm Qty 1 pcs thread M8x0.75				
	GEV No.	100246	Ref. No.	—
pilot burner nozzle natural gas bore ø 0.35mm Qty 1 pcs thread M8x0.75				
	GEV No.	100904	Ref. No.	1394700 MA1394700
locking screw M10x1 for pipe ø 4mm Qty 1 pcs				
	GEV No.	100905	Ref. No.	—
locking screw M10x1 for pipe ø 6mm Qty 1 pcs				
	GEV No.	102110	Ref. No.	—
pilot tube copper pipe ø 4mm thickness 1mm L 3000mm				
	GEV No.	102111	Ref. No.	—
pilot tube copper pipe ø 6mm thickness 1mm L 3000mm				
	GEV No.	107171	Ref. No.	0101153 0105143 1842300 MA1842300 SIR0101153 SIR0105143
pilot burner nozzle SIT natural/liquid gas bore ø 0.25mm Qty 1 pcs				
	GEV No.	107700	Ref. No.	0101152 SIO101152 SIR0101152
pilot burner bottom part SIT 100 series nozzle ø 0.25mm				
	GEV No.	107702	Ref. No.	—
pilot burner bottom part SIT 100 series nozzle ø 0.35mm				



			
1			
GEV No.	106907	Ref. No.	CR0588730
description	pilot burner SIT type 100 series 3 flames nozzle ϕ 0.35mm gas connection 6mm		
For models:	EGVG92, EGVG94, EGVG7		
spare parts for	106907		
	GEV No.	100246	Ref. No. —
	pilot burner nozzle natural gas bore ϕ 0.35mm Qty 1 pcs thread M8x0.75		
	GEV No.	100855	Ref. No. —
	pilot burner bracket triple		
	GEV No.	100885	Ref. No. 0101151 SIR0101151
	air mixing sleeve for pilot burner Qty 1 pcs		
	GEV No.	100916	Ref. No. —
	compression spring for pilot burner Qty 1 pcs		
	GEV No.	100917	Ref. No. —
	gasket for pilot burner Qty 1 pcs aluminium		
	GEV No.	100918	Ref. No. —
	screw for pilot burner		
	GEV No.	107162	Ref. No. —
	pilot burner cap SIT 3 flames Hmm Lmm Qty 1 pcs		
	GEV No.	107702	Ref. No. —
	pilot burner bottom part SIT 100 series nozzle ϕ 0.35mm		
accessories for	106907		
	GEV No.	100245	Ref. No. 0100829 1415100 MA1415100 SIR0100829
	pilot burner nozzle LPG code 20 bore ϕ 0.2mm Qty 1 pcs thread M8x0.75		
	GEV No.	100904	Ref. No. 1394700 MA1394700
	locking screw M10x1 for pipe ϕ 4mm Qty 1 pcs		
	GEV No.	100905	Ref. No. —
	locking screw M10x1 for pipe ϕ 6mm Qty 1 pcs		
	GEV No.	102110	Ref. No. —
	pilot tube copper pipe ϕ 4mm thickness 1mm L 3000mm		
	GEV No.	102111	Ref. No. —
	pilot tube copper pipe ϕ 6mm thickness 1mm L 3000mm		
	GEV No.	107171	Ref. No. 0101153 0105143 1842300 MA1842300 SIR0101153 SIR0105143
	pilot burner nozzle SIT natural/liquid gas bore ϕ 0.25mm Qty 1 pcs		

accessories for	106907		
	GEV No.	107700	Ref. No. 0101152 SIO101152 SIR0101152
	pilot burner bottom part SIT 100 series nozzle ϕ 0.25mm		
	GEV No.	107701	Ref. No. —
	pilot burner bottom part SIT 100 series nozzle ϕ 0.2mm		

accessories

pilot burner bottom parts













			
1			
GEV No.	107700	Ref. No.	0101152 SIO101152 SIR0101152
description	pilot burner bottom part SIT 100 series nozzle ϕ 0.25mm		
For models:	CCG1041P, CCG1042P, CCG1045P, CCG1061P, CCG1062P, CCG10652P, CCG1081P, CCG1082P, CCG1085P, CCG7001P, CCG7020P, CCG7021P, CCG7022P, CCG7040P, CCG7041P, CCG7042P, CCG7045P, CCG7046P, CCG7061P, CCG7062P, CCG70652P, CCG70662P, CCG9020P, CCG9021P, CCG9022P, CCG9040P, CCG9041P, CCG9042P, CCG9045P, CCG9046P, CCG9060P, CCG9061P, CCG9062P, CCG90652P, CCG90662P, CCG9081P, CCG9082P, CCG9085P, CCG9085-P, CG72APS, CG72GPS, CG72TPS, CG74APS, CG74EPS, CG74FPS, CG74GPS, CG74TPS, CG76APS, CG76EPS, CG76FPS...(Other models you can see in the webshop)		
spare parts for	107700		
	GEV No.	100916	Ref. No. —
	compression spring for pilot burner Qty 1 pcs		
	GEV No.	100917	Ref. No. —
	gasket for pilot burner Qty 1 pcs aluminium		
	GEV No.	100918	Ref. No. —
	screw for pilot burner		
	GEV No.	102742	Ref. No. —
	pilot burner nozzle LPG code 25 bore ϕ 0.25mm Qty 1 pcs		
accessories for	107700		
	GEV No.	100245	Ref. No. 0100829 1415100 MA1415100 SIR0100829
	pilot burner nozzle LPG code 20 bore ϕ 0.2mm Qty 1 pcs thread M8x0.75		
	GEV No.	100246	Ref. No. —
	pilot burner nozzle natural gas bore ϕ 0.35mm Qty 1 pcs thread M8x0.75		
	GEV No.	100904	Ref. No. 1394700 MA1394700
	locking screw M10x1 for pipe ϕ 4mm Qty 1 pcs		
	GEV No.	100905	Ref. No. —
	locking screw M10x1 for pipe ϕ 6mm Qty 1 pcs		
	GEV No.	102110	Ref. No. —
	pilot tube copper pipe ϕ 4mm thickness 1mm L 3000mm		

Table continues overleaf



accessories for 107700	
GEV No.	102111
Ref. No.	—
pilot tube copper pipe ø 6mm thickness 1mm L 3000mm	

pilot burner nozzles			
			
GEV No.	100245	Ref. No.	0100829 1415100 MA1415100 SIR0100829
description	pilot burner nozzle LPG code 20 bore ø 0.2mm Qty 1 pcs thread M8x0.75		
For models:	BG92ALC, BG92ALL, BG92ARC, BG92ARR, BG92GLC, BG92GLL, BG92GRC, BG92GRR, BG94ALC, BG94ALL, BG94ALR, BG94AMC, BG94ARC, BG94ARR, BG94GLC, BG94GLL, BG94GLR, BG94GMC, BG94GRC, BG94GRR, BGY2TLC, BGY2TLL, BGY2TRC, BGY2TRR, BGY4TLC, BGY4TLL, BGY4TLR, BGY4TMC, BGY4TRC, BGY4TRR, CBG7050, CBG7050C, CBG9060CP, CBG9060P, CCG1041P, CCG1042P, CCG1045P, CCG1061P, CCG1062P, CCG10652P, CCG1081P, CCG1082P, CCG1085P, CCG6045, CCG7001P, CCG7020P, CCG7021P, CCG7022P, CCG7040P, CCG7041P...(Other models you can see in the webshop)		

			
GEV No.	102972	Ref. No.	0100823 1996200 CR0684580 MA1996200 SIR0100823
description	pilot burner nozzle natural gas code 40 bore ø 0.4mm Qty 1 pcs		
For models:	BG92ALC, BG92ALL, BG92ARC, BG92ARR, BG92GLC, BG92GLL, BG92GRC, BG92GRR, BG94ALC, BG94ALL, BG94ALR, BG94AMC, BG94ARC, BG94ARR, BG94GLC, BG94GLL, BG94GLR, BG94GMC, BG94GRC, BG94GRR, BGY2TLC, BGY2TLL, BGY2TRC, BGY2TRR, BGY4TLC, BGY4TLL, BGY4TLR, BGY4TMC, BGY4TRC, BGY4TRR, CBG7050, CBG7050C, CBG9060CP, CBG9060P, CCG6045, CCG7045P, CCG70652P, CCG7245, CCG72652, CCG72653, CG74FPS, CG74FPS, CG84FPS, CG86FPS, CG88APS, CG88FPS, CG88GPS, CGG9020-0, CGG9020-1, CGG9020-2...(Other models you can see in the webshop)		

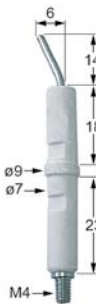









ignition electrodes			
			
GEV No.	100706	Ref. No.	0100832 224211 MA224211 SIR0100832
description	ignition electrode connection M4 Qty 1 pcs		
For models:	CBG7050, CBG9060CP, CBG9060C-P, CBG9060P, CCG6045, CCG7045, CCG7045P, CCG70652, CCG70652P, CCG70653, CCG7245, CCG72652, CCG72653, CFG70115, CFG70215, CFG72215, CFG90120, CFG90210, CFG90210S, CFG90220, CG74FPS, CG76FPS, CG84FPS, CG86FPS, CG88APS, CG88FPS, CG88GPS, CNG50150, CNG50160, CNG70130, CNG70160, CNG70230, CNG72160, CNG72230, CNG90130, CNG90130-S, CNG90140, CNG90140-S, CNG90160, CNG90160S, CNG90160-S, CNG90230, CNG90240, CTT652L, CTT653L, CTT7040L, CTT7040R, CTT7041L, CTT7041R, CTT7042L...(Other models you can see in the webshop)		





miscellaneous			
			
GEV No.	100885	Ref. No.	0101151 SIR0101151
description	air mixing sleeve for pilot burner Qty 1 pcs		
For models:	CCG1041P, CCG1042P, CCG1045P, CCG1061P, CCG1062P, CCG10652P, CCG1081P, CCG1082P, CCG1085P, CCG7001P, CCG7001P, CCG7020P, CCG7021P, CCG7022P, CCG7040P, CCG7041P, CCG7042P, CCG7045P, CCG7046P, CCG7061P, CCG7062P, CCG70652P, CCG70662P, CCG7201, CCG9020P, CCG9021P, CCG9022P, CCG9040P, CCG9041P, CCG9042P, CCG9045P, CCG9046P, CCG9060P, CCG9061P, CCG9062P, CCG90652P, CCG90662P, CCG9081P, CCG9082P, CCG9085P, CCG9085-P, CG72APS, CG72GPS, CG72TPS, CG74APS, CG74EPS, CG74FPS, CG74GPS, CG74TPS, CG76APS...(Other models you can see in the webshop)		

140 - 145 -150 series			
			
GEV No.	106943 ¹	Ref. No.	1887700 MA1887700
description	pilot burner SIT type 140 series 1 flame nozzle ømm gas connectionmm		
For models:	CRG6220, CRG6240, EGL72, EGL74, FG72206, FG82206, FG92206, FGY2206, GG62TGP, GG64TGP, GL72AGC, GL72AGP, GL72GGC, GL72GGP, GL72TGC, GL72TGP, GL74AGC, GL74AGP, GL74GGC, GL74GGP, GL74TGC, GL74TGP, GL92AGM, GL92AGM-2, GL92GGM, GL94AGM, GL94AGM-2, GL94GGM, GLY2AGC, GLY2TGM, GLY4AGC, GLY4TGM		
spare parts for	106943		
	GEV No.	100907	Ref. No.
			0100742 0100817 1891700 MA1891700 SIR0100742 SIR0100817
			
	screw connection thread M10x1 Qty 1 pcs type SEF 1 ømm for thermocouple		

¹incl. thermocouple fitting



			
GEV No.	107114 ¹	Ref. No.	0109047 1031504700 CM029000 MA1031504700 MACM029000 SIR0109047
description	pilot burner SIT type 140 series 2 flames nozzle ømm gas connecti-onmm		
For models:	BG62TLC, BG62TLL, BG62TRR, BG63TLC, BG63TLL, BG63TLR, BG64TLC, BG64TLL, BG64TLR, BG72GLC, BG72GLL, BG72GRR, BG72TLC, BG72TLL, BG72TRR, BG74GLC, BG74GLL, BG74GLR, BG74GMC, BG74GRR, BG74TLL, BG74TLR, BG74TRR, CGE6020, CGE6020R, CGG6020, CGG6020C, CGG6020R, CGG6030, CGG6030C, CGG6030R, CGG6040, CGG6040C, CGG6040R, CGG6220, CGG6220C, CGG6220R, CGG6230, CGG6230C, CGG6230LR, CGG6240, CGG6240C, CGG6240LR, CGG7020, CGG7020C, CGG7020R, CGG7021, CGG7021C, CGG7021R, CGG7040... (Other models you can see in the webshop)		
accessories for	107114		
	GEV No.	100204	Ref. No. 1888000 MA1888000
	pilot burner nozzle SIT LPG code 14 bore ø 0.18/0.20mm Qty 1 pcs suitable for 140 series		
	GEV No.	100205	Ref. No. 1033722000 BN822140380 MA1033722000
	pilot burner nozzle SIT LPG code 19 bore ø 0.23/0.26mm Qty 1 pcs suitable for SIT 150 series		
	GEV No.	100206	Ref. No. —
	pilot burner nozzle SIT natural gas code 36 bore ø 0.60/0.55mm Qty 1 pcs suitable for SIT 150 series		
	GEV No.	100207	Ref. No. 1887800 MA1887800
	pilot burner nozzle SIT natural gas code 27 bore ø 0.40/0.38mm suitable for SIT 140 series		
	GEV No.	100216	Ref. No. —
	pilot burner nozzle SIT natural gas code 38 bore ø 0.45mm Qty 1 pcs suitable for SIT 150 series		
	GEV No.	100701	Ref. No. 0100830 0100831 0108194 1888300 1949900 MA1888300 MA1949900 SIR0100830 SIR0100831 SIR0108194
	ignition electrode connection M4 Qty 1 pcs		
	GEV No.	100801	Ref. No. —
	gasket for pilot burner Qty 1 pcs		
	GEV No.	100897	Ref. No. 1888100 MA1888100
	olive for pipe ø 4mm Qty 1 pcs for pilot burner		
	GEV No.	100898	Ref. No. —
	olive for pipe ø 6mm Qty 1 pcs for pilot burner		
	GEV No.	100906	Ref. No. 0100807 1888400 MA1888400 SIR0100807
	screw connection thread M10x1 for ignition electrode brass Qty 1 pcs WS 10		

accessories for	107114		
	GEV No.	100908	Ref. No. 0100777 673500 MA673500 SIR0100777
	union screw thread M10x1 for pipe ø 4mm Qty 1 pcs		
	GEV No.	100909	Ref. No. 0100744 SIR0100744
	union screw thread M10x1 for pipe ø 6mm Qty 1 pcs		
	GEV No.	102110	Ref. No. —
	pilot tube copper pipe ø 4mm thickness 1mm L 3000mm		
	GEV No.	102111	Ref. No. —
	pilot tube copper pipe ø 6mm thickness 1mm L 3000mm		













160 series			
			
GEV No.	100109	Ref. No.	CM040800 MACM040800
description	pilot burner SIT type 160 series 1 flame nozzle ømm gas connecti-onmm		
For models:	DG72128, DG74228, DG82140, DG82142, DG82T42, DG84240, DG84242, DG84T42, DG92142, DG94242, DGY2142, DGY4242, ECG7-FG, ECG94F, ECG96F, ECG96H, ECG98F, EC-MAXI-OVEN-GAS, EDG72128, EDG74228, EDG92142, EDG93142, EDG94242, EFG72108, EFG72110, EFG72115, EFG73208T, EFG73210, EFG74215, EFG92115, EFG92115S, EFG92123, EFG92123K, EFG93210, EFG94215, EFG94215S, EFG94223, EFG94223K, EPG7D05, EPG7I05, EPG7I08, EPG9D10, EPG9D10A, EPG9D15, EPG9D15A, EPG9I15, EPG9I15A, EPG9I10, EPG9I10A, EPGD05...(Other models you can see in the webshop)		
accessories for	100109		
	GEV No.	100907	Ref. No. 0100742 0100817 1891700 MA1891700 SIR0100742 SIR0100817
	screw connection thread M10x1 Qty 1 pcs type SEF 1 ømm for thermocouple		
accessories for	100109		
	GEV No.	100202	Ref. No. —
	pilot burner nozzle natural gas code 41 Qty 1 pcs nozzle ø 0.41mm		
	GEV No.	100203	Ref. No. —
	pilot burner nozzle LPG code 25 Qty 1 pcs nozzle ø 0.25mm		
	GEV No.	100701	Ref. No. 0100830 0100831 0108194 1888300 1949900 MA1888300 MA1949900 SIR0100830 SIR0100831 SIR0108194
	ignition electrode connection M4 Qty 1 pcs		
	GEV No.	100801	Ref. No. —
	gasket for pilot burner Qty 1 pcs		











Table continues overleaf

¹incl. thermocouple fitting

















accessories for		100109	
	GEV No.	100869	Ref. No. —
pilot burner nozzle natural gas code 51 Qty 1 pcs suitable for 160 series nozzle ø 0.51mm			
	GEV No.	100906	Ref. No. 0100807 1888400 MA1888400 SIR0100807
screw connection thread M10x1 for ignition electrode brass Qty 1 pcs WS 10			
	GEV No.	100908	Ref. No. 0100777 673500 MA673500 SIR0100777
union screw thread M10x1 for pipe ø 4mm Qty 1 pcs			
	GEV No.	100909	Ref. No. 0100744 SIR0100744
union screw thread M10x1 for pipe ø 6mm Qty 1 pcs			
	GEV No.	101282	Ref. No. —
olive for pipe ø 4mm L 7.4mm Qty 1 pcs			
	GEV No.	101287	Ref. No. —
olive for pipe ø 6mm Qty 1 pcs			
	GEV No.	102110	Ref. No. —
pilot tube copper pipe ø 4mm thickness 1mm L 3000mm			
	GEV No.	102111	Ref. No. —
pilot tube copper pipe ø 6mm thickness 1mm L 3000mm			
	GEV No.	107650	Ref. No. 0100802 CR0410100 SIR0100802
pilot burner nozzle SIT LPG code 30 Qty 1 pcs			

 <p>1</p>			
GEV No.	100053	Ref. No.	0100800 0100825 SIO100800 SIR0100800 SIR0100825
description	pilot burner SIT type 160 series 2 flames nozzle ømm gas connecti-onmm		
spare parts for	100053		
	GEV No.	100907	Ref. No. 0100742 0100817 1891700 MA1891700 SIR0100742 SIR0100817
screw connection thread M10x1 Qty 1 pcs type SEF 1 ømm for thermocouple			
accessories for	100053		
	GEV No.	100202	Ref. No. —
pilot burner nozzle natural gas code 41 Qty 1 pcs nozzle ø 0.41mm			
	GEV No.	100203	Ref. No. —
pilot burner nozzle LPG code 25 Qty 1 pcs nozzle ø 0.25mm			

accessories for		100053	
	GEV No.	100701	Ref. No. 0100830 0100831 0108194 1888300 1949900 MA1888300 MA1949900 SIR0100830 SIR0100831 SIR0108194
ignition electrode connection M4 Qty 1 pcs			
	GEV No.	100801	Ref. No. —
gasket for pilot burner Qty 1 pcs			
	GEV No.	100869	Ref. No. —
pilot burner nozzle natural gas code 51 Qty 1 pcs suitable for 160 series nozzle ø 0.51mm			
	GEV No.	100906	Ref. No. 0100807 1888400 MA1888400 SIR0100807
screw connection thread M10x1 for ignition electrode brass Qty 1 pcs WS 10			
	GEV No.	100908	Ref. No. 0100777 673500 MA673500 SIR0100777
union screw thread M10x1 for pipe ø 4mm Qty 1 pcs			
	GEV No.	100909	Ref. No. 0100744 SIR0100744
union screw thread M10x1 for pipe ø 6mm Qty 1 pcs			
	GEV No.	101282	Ref. No. —
olive for pipe ø 4mm L 7.4mm Qty 1 pcs			
	GEV No.	101287	Ref. No. —
olive for pipe ø 6mm Qty 1 pcs			
	GEV No.	102110	Ref. No. —
pilot tube copper pipe ø 4mm thickness 1mm L 3000mm			
	GEV No.	102111	Ref. No. —
pilot tube copper pipe ø 6mm thickness 1mm L 3000mm			
	GEV No.	107650	Ref. No. 0100802 CR0410100 SIR0100802
pilot burner nozzle SIT LPG code 30 Qty 1 pcs			



				
GEV No.	100054	Ref. No.	0100799 0100826 SIR0100799 SIR0100826	
description	pilot burner SIT type 160 series 2 flames nozzle ømm gas connectionmm			
spare parts for	100054			
	GEV No.	100907	Ref. No. 0100742 0100817 1891700 MA1891700 SIR0100742 SIR0100817	
screw connection thread M10x1 Qty 1 pcs type SEF 1 ømm for thermocouple				
accessories for	100054			
	GEV No.	100202	Ref. No.	—
pilot burner nozzle natural gas code 41 Qty 1 pcs nozzle ø 0.41mm				
	GEV No.	100203	Ref. No.	—
pilot burner nozzle LPG code 25 Qty 1 pcs nozzle ø 0.25mm				
	GEV No.	100701	Ref. No.	0100830 0100831 0108194 1888300 1949900 MA1888300 MA1949900 SIR0100830 SIR0100831 SIR0108194
ignition electrode connection M4 Qty 1 pcs				
	GEV No.	100801	Ref. No.	—
gasket for pilot burner Qty 1 pcs				
	GEV No.	100869	Ref. No.	—
pilot burner nozzle natural gas code 51 Qty 1 pcs suitable for 160 series nozzle ø 0.51mm				
	GEV No.	100906	Ref. No.	0100807 1888400 MA1888400 SIR0100807
screw connection thread M10x1 for ignition electrode brass Qty 1 pcs WS 10				
	GEV No.	100908	Ref. No.	0100777 673500 MA673500 SIR0100777
union screw thread M10x1 for pipe ø 4mm Qty 1 pcs				
	GEV No.	100909	Ref. No.	0100744 SIR0100744
union screw thread M10x1 for pipe ø 6mm Qty 1 pcs				
	GEV No.	101282	Ref. No.	—
olive for pipe ø 4mm L 7.4mm Qty 1 pcs				
	GEV No.	101287	Ref. No.	—
olive for pipe ø 6mm Qty 1 pcs				
	GEV No.	102110	Ref. No.	—
pilot tube copper pipe ø 4mm thickness 1mm L 3000mm				

accessories for	100054			
	GEV No.	102111	Ref. No.	—
pilot tube copper pipe ø 6mm thickness 1mm L 3000mm				
	GEV No.	107650	Ref. No.	0100802 CR0410100 SIR0100802
pilot burner nozzle SIT LPG code 30 Qty 1 pcs				

POLIDORO

pilot burners





















				
GEV No.	100051	Ref. No.	0108109 SIR0108109	
description	pilot burner POLIDORO 3 flames code gas connectionmm			
For models:	CRG7022, CRG7042, CRG7222, CRG7242, CRG9022, CRG9022S, CRG9042, CRG9042S, GL92AGC, GL94AGC, GLY2AGC, GLY4AGC			
spare parts for	100051			
	GEV No.	100907	Ref. No.	0100742 0100817 1891700 MA1891700 SIR0100742 SIR0100817
screw connection thread M10x1 Qty 1 pcs type SEF 1 ømm for thermocouple				
accessories for	100051			
	GEV No.	100000	Ref. No.	—
pilot burner nozzle POLIDORO LPG code 22 bore ø 0.22mm Qty 1 pcs				
	GEV No.	100208	Ref. No.	—
pilot burner nozzle POLIDORO LPG code 20 bore ø 0.2mm Qty 1 pcs				
	GEV No.	100209	Ref. No.	0101048 SI0101048 SIR0101048
pilot burner nozzle POLIDORO natural gas code 40 bore ø 0.4mm Qty 1 pcs				
	GEV No.	100701	Ref. No.	0100830 0100831 0108194 1888300 1949900 MA1888300 MA1949900 SIR0100830 SIR0100831 SIR0108194
ignition electrode connection M4 Qty 1 pcs				
	GEV No.	100906	Ref. No.	0100807 1888400 MA1888400 SIR0100807
screw connection thread M10x1 for ignition electrode brass Qty 1 pcs WS 10				
	GEV No.	100907	Ref. No.	0100742 0100817 1891700 MA1891700 SIR0100742 SIR0100817
screw connection thread M10x1 Qty 1 pcs type SEF 1 ømm for thermocouple				

Table continues overleaf



accessories for		100051	
	GEV No.	100908	Ref. No. 0100777 673500 MA673500 SIR0100777
union screw thread M10x1 for pipe ø 4mm Qty 1 pcs			
	GEV No.	100909	Ref. No. 0100744 SIR0100744
union screw thread M10x1 for pipe ø 6mm Qty 1 pcs			
	GEV No.	102110	Ref. No. —
pilot tube copper pipe ø 4mm thickness 1mm L 3000mm			
	GEV No.	102111	Ref. No. —
pilot tube copper pipe ø 6mm thickness 1mm L 3000mm			
	GEV No.	102508	Ref. No. —
union screw thread M10x1 for pipe ø 4mm Qty 5 pcs			
	GEV No.	102509	Ref. No. —
union screw thread M10x1 for pipe ø 6mm Qty 5 pcs			
	GEV No.	102699	Ref. No. —
pilot burner nozzle POLIDORO natural gas code 25.2 bore ø 2x0.25mm Qty 1 pcs 2 bores			
	GEV No.	102795	Ref. No. —
olive for pipe ø 4mm Qty 1 pcs			
	GEV No.	102797	Ref. No. —
olive for pipe ø 6mm Qty 1 pcs			
	GEV No.	106703	Ref. No. —
pilot burner nozzle POLIDORO natural gas code 27.2 bore ø 2x0.27mm Qty 1 pcs			
	GEV No.	106704	Ref. No. —
pilot burner nozzle POLIDORO LPG code 16.2 bore ø 2x0.16mm Qty 1 pcs			
	GEV No.	106763	Ref. No. —
pilot burner nozzle POLIDORO natural gas code 27.2A bore ø 2x 0.27mm Qty 1 pcs			
	GEV No.	106859	Ref. No. —
pilot burner nozzle POLIDORO LPG code 24 bore ø 0.24mm Qty 1 pcs			









			
GEV No.	100076	Ref. No.	0101047 SIR0101047
description	pilot burner POLIDORO 3 flames natural gas code 29.2 gas connection 6mm		
For models:	CCG1045, CCG1045P, CCG10652, CCG10652P, CCG10653, CCG1085, CCG10852, CCG1085P, CCG7001, CCG7001P, CCG7201, CCG9045P, CCG9046, CCG90652P, CCG90663, CCG9085P, CCG9085-P, CCG9145, CCG9145-1, CCG91652, CCG91652-1, CCG91653, CCG91653-1, CCG9185, CCG9185-1, CCG91852, CCG91852-1, CFS9050, CFS9052, CFS9055, CG76HPS, CG86HPS, CG94FPS, CG96FPS, CG98FPS, CGG9020, CGG9020C, CGG9020R, CGG9020RC, CGG9021, CGG9021C, CGG9021R, CGG9021RC, CGG9040, CGG9040C, CGG9040LR, CGG9040LRC, CGG9040R, CGG9040RC, CGG9041...(Other models you can see in the webshop)		
spare parts for	100076		
	GEV No.	100907	Ref. No. 0100742 0100817 1891700 MA1891700 SIR0100742 SIR0100817
screw connection thread M10x1 Qty 1 pcs type SEF 1 ømm for thermocouple			
accessories for	100076		
	GEV No.	100000	Ref. No. —
pilot burner nozzle POLIDORO LPG code 22 bore ø 0.22mm Qty 1 pcs			
	GEV No.	100208	Ref. No. —
pilot burner nozzle POLIDORO LPG code 20 bore ø 0.2mm Qty 1 pcs			
	GEV No.	100209	Ref. No. 0101048 SIO101048 SIR0101048
pilot burner nozzle POLIDORO natural gas code 40 bore ø 0.4mm Qty 1 pcs			
	GEV No.	100701	Ref. No. 0100830 0100831 0108194 1888300 1949900 MA1888300 MA1949900 SIR0100830 SIR0100831 SIR0108194
ignition electrode connection M4 Qty 1 pcs			
	GEV No.	100906	Ref. No. 0100807 1888400 MA1888400 SIR0100807
screw connection thread M10x1 for ignition electrode brass Qty 1 pcs WS 10			
	GEV No.	100907	Ref. No. 0100742 0100817 1891700 MA1891700 SIR0100742 SIR0100817
screw connection thread M10x1 Qty 1 pcs type SEF 1 ømm for thermocouple			
	GEV No.	100908	Ref. No. 0100777 673500 MA673500 SIR0100777
union screw thread M10x1 for pipe ø 4mm Qty 1 pcs			

Table continues overleaf

accessories for		100076	
	GEV No.	100909	Ref. No. 0100744 SIR0100744
union screw thread M10x1 for pipe ø 6mm Qty 1 pcs			
	GEV No.	102110	Ref. No. —
pilot tube copper pipe ø 4mm thickness 1mm L 3000mm			
	GEV No.	102111	Ref. No. —
pilot tube copper pipe ø 6mm thickness 1mm L 3000mm			
	GEV No.	102508	Ref. No. —
union screw thread M10x1 for pipe ø 4mm Qty 5 pcs			
	GEV No.	102509	Ref. No. —
union screw thread M10x1 for pipe ø 6mm Qty 5 pcs			
	GEV No.	102699	Ref. No. —
pilot burner nozzle POLIDORO natural gas code 25.2 bore ø 2x0.25mm Qty 1 pcs 2 bores			
	GEV No.	102795	Ref. No. —
olive for pipe ø 4mm Qty 1 pcs			
	GEV No.	102797	Ref. No. —
olive for pipe ø 6mm Qty 1 pcs			
	GEV No.	106703	Ref. No. —
pilot burner nozzle POLIDORO natural gas code 27.2 bore ø 2x0.27mm Qty 1 pcs			
	GEV No.	106704	Ref. No. —
pilot burner nozzle POLIDORO LPG code 16.2 bore ø 2x0.16mm Qty 1 pcs			
	GEV No.	106763	Ref. No. —
pilot burner nozzle POLIDORO natural gas code 27.2A bore ø 2x0.27mm Qty 1 pcs			
	GEV No.	106859	Ref. No. —
pilot burner nozzle POLIDORO LPG code 24 bore ø 0.24mm Qty 1 pcs			

producer-specific pilot burners















SILKO

650/ 700 / 809 / 909 / 1100 series













1

GEV No.	100145	Ref. No.	0109087 SIR0109087
description	pilot burner SIT type 100 series 3 flames nozzle ø 0.2mm gas connectionmm		
For models:	CFG60110, CFG60210		
spare parts for	100145		
	GEV No.	100245	Ref. No. 0100829 1415100 MA1415100 SIR0100829
pilot burner nozzle LPG code 20 bore ø 0.2mm Qty 1 pcs thread M8x0.75			

spare parts for		100145	
	GEV No.	100837	Ref. No. —
pilot burner cap 3 flames H 24mm L 48mm Qty 1 pcs			
	GEV No.	100855	Ref. No. —
pilot burner bracket triple			
	GEV No.	100881	Ref. No. —
pilot burner bottom part PRO-GAS 100 series nozzle ø 0.2mm			
	GEV No.	100885	Ref. No. 0101151 SIR0101151
air mixing sleeve for pilot burner Qty 1 pcs			
	GEV No.	100916	Ref. No. —
compression spring for pilot burner Qty 1 pcs			
	GEV No.	100917	Ref. No. —
gasket for pilot burner Qty 1 pcs aluminium			
	GEV No.	100918	Ref. No. —
screw for pilot burner			
accessories for		100145	
	GEV No.	100246	Ref. No. —
pilot burner nozzle natural gas bore ø 0.35mm Qty 1 pcs thread M8x0.75			
	GEV No.	100882	Ref. No. —
pilot burner bottom part PRO-GAS 100 series nozzle ø 0.25mm			
	GEV No.	100883	Ref. No. —
pilot burner bottom part PRO-GAS 100 series nozzle ø 0.35mm			
	GEV No.	100904	Ref. No. 1394700 MA1394700
locking screw M10x1 for pipe ø 4mm Qty 1 pcs			
	GEV No.	100905	Ref. No. —
locking screw M10x1 for pipe ø 6mm Qty 1 pcs			
	GEV No.	102110	Ref. No. —
pilot tube copper pipe ø 4mm thickness 1mm L 3000mm			
	GEV No.	102111	Ref. No. —
pilot tube copper pipe ø 6mm thickness 1mm L 3000mm			
	GEV No.	102742	Ref. No. —
pilot burner nozzle LPG code 25 bore ø 0.25mm Qty 1 pcs			



 <p>1</p>			
GEV No.	107700	Ref. No.	0101152 SI0101152 SIR0101152
description	pilot burner bottom part SIT 100 series nozzle \varnothing 0.25mm		
For models:	CCG1041P, CCG1042P, CCG1045P, CCG1061P, CCG1062P, CCG10652P, CCG1081P, CCG1082P, CCG1085P, CCG7001P, CCG7020P, CCG7021P, CCG7022P, CCG7040P, CCG7041P, CCG7042P, CCG7045P, CCG7046P, CCG7061P, CCG7062P, CCG70652P, CCG70662P, CCG9020P, CCG9021P, CCG9022P, CCG9040P, CCG9041P, CCG9042P, CCG9045P, CCG9046P, CCG9060P, CCG9061P, CCG9062P, CCG90652P, CCG90662P, CCG9081P, CCG9082P, CCG9085P, CCG9085-P, CG72APS, CG72GPS, CG72TPS, CG74APS, CG74EPS, CG74FPS, CG74GPS, CG74TPS, CG76APS, CG76EPS, CG76FPS...(Other models you can see in the webshop)		
spare parts for	107700		
	GEV No.	100916	Ref. No. —
compression spring for pilot burner Qty 1 pcs			
	GEV No.	100917	Ref. No. —
gasket for pilot burner Qty 1 pcs aluminium			
	GEV No.	100918	Ref. No. —
screw for pilot burner			
accessories for	107700		
	GEV No.	100245	Ref. No. 0100829 1415100 MA1415100 SIR0100829
pilot burner nozzle LPG code 20 bore \varnothing 0.2mm Qty 1 pcs thread M8x0.75			
	GEV No.	100246	Ref. No. —
pilot burner nozzle natural gas bore \varnothing 0.35mm Qty 1 pcs thread M8x0.75			
	GEV No.	100904	Ref. No. 1394700 MA1394700
locking screw M10x1 for pipe \varnothing 4mm Qty 1 pcs			
	GEV No.	100905	Ref. No. —
locking screw M10x1 for pipe \varnothing 6mm Qty 1 pcs			
	GEV No.	102110	Ref. No. —
pilot tube copper pipe \varnothing 4mm thickness 1mm L 3000mm			
	GEV No.	102111	Ref. No. —
pilot tube copper pipe \varnothing 6mm thickness 1mm L 3000mm			

700 / 900 / NP70 / NP90 series			
 <p>1</p>			
GEV No.	103074	Ref. No.	CR0586451
description	venturi for burner cap \varnothing 102mm with pilot burner suitable for 900 series		
For models:	ECG92A, ECG92G, ECG92T, ECG94A, ECG94E, ECG94F, ECG94G, ECG94T, ECG96A, ECG96E, ECG96F, ECG96G, ECG96H, ECG96T, ECG98A, ECG98F, ECG98G		

 <p>1</p>			
GEV No.	107422	Ref. No.	CR0586441
description	venturi for burner cap \varnothing 64mm with pilot burner suitable for 900 series		
For models:	ECG7, ECG92A, ECG92G, ECG92T, ECG94A, ECG94E, ECG94F, ECG94G, ECG94T, ECG96A, ECG96E, ECG96F, ECG96G, ECG96H, ECG96T, ECG98A, ECG98F, ECG98G		
accessories for	107422		
	GEV No.	103071	Ref. No. CR0580010
burner cap \varnothing 64mm H 26mm suitable for 900 series			
	GEV No.	103072	Ref. No. CR0580030
burner head for burner cap \varnothing 64mm H 37mm suitable for 900 series			
	GEV No.	103075	Ref. No. CR0581700
nozzle holder \varnothing 34mm H 150mm suitable for 900 series			
	GEV No.	103083	Ref. No. 8204760 SI8204760 SIR8204760
gasket L 77mm W 69mm thickness 2mm graphite for Venturi suitable for 900 series			

accessories universal

ignition electrode holders



GEV No.	107206	Ref. No.	9300544 SI9300544 SIR9300544
description	ignition electrode support for igniter for burner type E		
For models:	CCG9020, CCG9021, CCG9022, CCG9040, CCG9041, CCG9042, CCG9046, CCG9060, CCG9061, CCG9062, CCG90663, CCG9081, CCG9082, CCG9120, CCG9121, CCG9122, CCG9140, CCG9140-1, CCG9141, CCG9141-1, CCG9142, CCG9142-1, CCG9145, CCG9145-1, CCG9146, CCG9146-1, CCG9160, CCG9160-1, CCG9161, CCG9161-1, CCG9162, CCG9162-1, CCG91652, CCG91652-1, CCG91653, CCG91653-1, CCG91662, CCG91662-1, CCG91663, CCG91663-1, CCG9181, CCG9181-1, CCG9182, CCG9182-1, CCG9185, CCG9185-1, CCG91852, CCG91852-1, CFF1GPA, CFF1GPS		

electrodes



GEV No.	100701	Ref. No.	0100830 0100831 0108194 1888300 1949900 MA1888300 MA1949900 SIR0100830 SIR0100831 SIR0108194
description	ignition electrode connection M4 Qty 1 pcs		
For models:	BG62TLC, BG62TLL, BG62TRR, BG63TLC, BG63TLL, BG63TLR, BG64TLC, BG64TLL, BG64TLR, BG72GLC, BG72GLL, BG72GRR, BG72TLC, BG72TLL, BG72TRR, BG74GLC, BG74GLL, BG74GLR, BG74GMC, BG74GRR, BG74TLL, BG74TLR, BG74TRR, BG82ALL, BG82ARR, BG82GLC, BG82GLL, BG82GRR, BG82TLC, BG82TLL, BG82TRR, BG84ALC, BG84ALL, BG84ALR, BG84AMC, BG84ARR, BG84GLC, BG84GLL, BG84GLR, BG84GMC, BG84GRR, BG84TLC, BG84TLL, BG84TLR, BG84TMC, BG84TRR, CCG1045, CCG10652, CCG10653, CCG1085...(Other models you can see in the webshop)		

accessories for	100701
------------------------	--------

	GEV No.	100906	Ref. No.	0100807 1888400 MA1888400 SIR0100807
screw connection thread M10x1 for ignition electrode brass Qty 1 pcs WS 10				

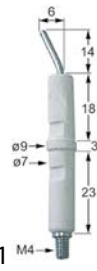

GEV No.	100706	Ref. No.	0100832 224211 MA224211 SIR0100832
description	ignition electrode connection M4 Qty 1 pcs		
For models:	CBG7050, CBG9060CP, CBG9060C-P, CBG9060P, CCG6045, CCG7045, CCG7045P, CCG70652, CCG70652P, CCG70653, CCG7245, CCG72652, CCG72653, CFG70115, CFG70215, CFG72215, CFG90120, CFG90210, CFG90210S, CFG90220, CG74FPS, CG76FPS, CG84FPS, CG86FPS, CG88APS, CG88FPS, CG88GPS, CNG50150, CNG50160, CNG70130, CNG70160, CNG70230, CNG72160, CNG72230, CNG90130, CNG90130-S, CNG90140, CNG90140-S, CNG90160, CNG90160S, CNG90160-S, CNG90230, CNG90240, CTT652L, CTT653L, CTT7040L, CTT7040R, CTT7041L, CTT7041R, CTT7042L...(Other models you can see in the webshop)		



GEV No.	100728	Ref. No.	0101221 SIR0101221
description	ignition electrode D1 ø 10mm cable length 1420mm to clip		

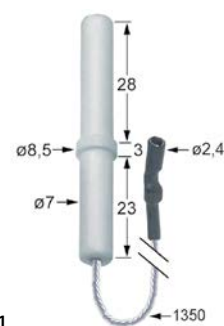

GEV No.	100747	Ref. No.	9300540 SI9300540 SIR9300540
description	ignition electrode D1 ø 7mm D2 ø 8.5mm cable length 1350mm BL1 28mm BL2 3mm BL3 23mm connection ø 2.4mm		
For models:	CCG1041, CCG1042, CCG1045, CCG1061, CCG1062, CCG10652, CCG10653, CCG1081, CCG1082, CCG1085, CCG10852, CCG7001, CCG7020, CCG7021, CCG7022, CCG7040, CCG7041, CCG7042, CCG7045, CCG7046, CCG7061, CCG7062, CCG70652, CCG70653, CCG70663, CCG7201, CCG7220, CCG7221, CCG7222, CCG7261, CCG7262, CCG72652, CCG72653, CCG72662, CCG72663, CCG9020, CCG9021, CCG9022, CCG9040, CCG9041, CCG9042, CCG9046, CCG9060, CCG9061, CCG9062, CCG90663, CCG9081, CCG9082, CCG9120, CCG9121...(Other models you can see in the webshop)		

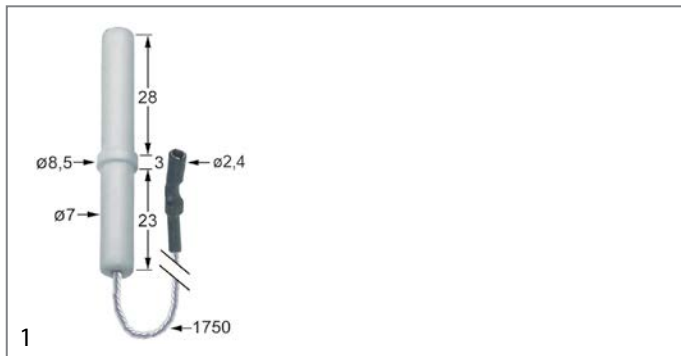

GEV No.	100732	Ref. No.	9300539 S19300539 SIR9300539
description	ignition electrode D1 ø 7mm D2 ø 8.5mm cable length 1750mm BL1 28mm BL2 3mm BL3 23mm to clip connection ø 2.4mm		
For models:	CCG1041, CCG1042, CCG1045, CCG1061, CCG1062, CCG10652, CCG10653, CCG1081, CCG1082, CCG1085, CCG10852, CCG9020, CCG9021, CCG9022, CCG9040, CCG9041, CCG9042, CCG9046, CCG9060, CCG9061, CCG9062, CCG90663, CCG9081, CCG9082, CCG9120, CCG9121, CCG9122, CCG9140, CCG9140-1, CCG9141, CCG9141-1, CCG9142, CCG9142-1, CCG9145, CCG9145-1, CCG9146, CCG9146-1, CCG9160, CCG9160-1, CCG9161, CCG9161-1, CCG9162, CCG9162-1, CCG91652, CCG91652-1, CCG91653, CCG91653-1, CCG91662, CCG91662-1, CCG91663...(Other models you can see in the webshop)		

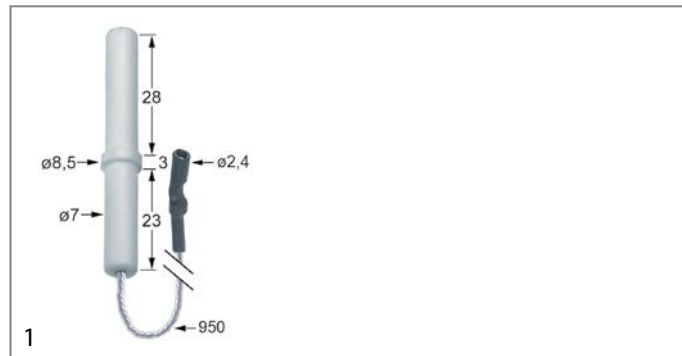

GEV No.	100746	Ref. No.	9300541 S19300541 SIR9300541
description	ignition electrode D1 ø 7mm D2 ø 8.5mm cable length 950mm BL1 28mm BL2 3mm BL3 23mm connection ø 2.4mm		
For models:	CCG1041, CCG1042, CCG1045, CCG1061, CCG1062, CCG10652, CCG10653, CCG1081, CCG1082, CCG1085, CCG10852, CCG7001, CCG7020, CCG7021, CCG7022, CCG7040, CCG7041, CCG7042, CCG7045, CCG7046, CCG7061, CCG7062, CCG70652, CCG70653, CCG70663, CCG7201, CCG7261, CCG7262, CCG72652, CCG72653, CCG72662, CCG72663, CCG9020, CCG9021, CCG9022, CCG9040, CCG9041, CCG9042, CCG9046, CCG9060, CCG9061, CCG9062, CCG90663, CCG9081, CCG9082, CCG9120, CCG9121, CCG9122, CCG9140, CCG9140-1...(Other models you can see in the webshop)		

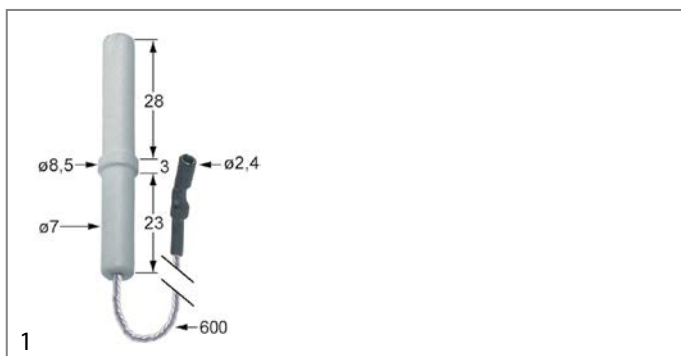

GEV No.	100733	Ref. No.	0100834 SI0100834 SIR0100834
description	ignition electrode D1 ø 7mm D2 ø 8.5mm cable length 600mm BL1 28mm BL2 3mm BL3 23mm to clip connection ø 2.4mm		
For models:	CFF1GPA, CFF1GPS, CFF1TPA, CFF1TPS, CFF2TPA, CFF2TPS, CFF3TPA, CFF3TPS		

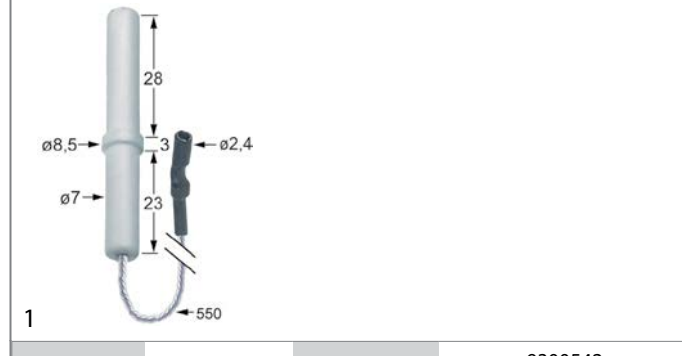

GEV No.	100745	Ref. No.	9300542 S19300542 SIR9300542
description	ignition electrode D1 ø 7mm D2 ø 8.5mm connection F2.8x0.8 cable length 550mm BL1 29mm BL2 3mm BL3 23mm to clip		
For models:	CCG1041, CCG1042, CCG1045, CCG1061, CCG1062, CCG10652, CCG10653, CCG1081, CCG1082, CCG1085, CCG10852, CCG7001, CCG7020, CCG7021, CCG7022, CCG7040, CCG7041, CCG7042, CCG7045, CCG7046, CCG7061, CCG7062, CCG70652, CCG70653, CCG70663, CCG7201, CCG7220, CCG7221, CCG7222, CCG7240, CCG7241, CCG7242, CCG7245, CCG7246, CCG7261, CCG7262, CCG72652, CCG72653, CCG72662, CCG72663, CCG9020, CCG9021, CCG9022, CCG9040, CCG9041, CCG9042, CCG9046, CCG9060, CCG9061, CCG9062...(Other models you can see in the webshop)		



GEV No.	100709	Ref. No.	0100369 BN6A001457 SI0100369 SIR0100369
description	ignition electrode D1 ø 7mm D2 ø 9mm connection M4 L1 13mm L2 13mm L3 23mm BL1 18mm BL2 3mm BL3 23mm to clip		
For models:	BG92ALC, BG92ALL, BG92ARC, BG92ARR, BG92GLC, BG92GLL, BG92GRC, BG92GRR, BG94ALC, BG94ALL, BG94ALR, BG94AMC, BG94ARC, BG94ARR, BG94GLC, BG94GLL, BG94GLR, BG94GMC, BG94GRC, BG94GRR, BGY2TLC, BGY2TLL, BGY2TRC, BGY2TRR, BGY4TLC, BGY4TLL, BGY4TLR, BGY4TMC, BGY4TRC, BGY4TRR, CCG9020-0, CCG9020-1, CCG9020-2, CCG9020-3, CCG9021-0, CCG9021-1, CCG9021-2, CCG9021-3, CCG9022-0, CCG9022-1, CCG9022-2, CCG9022-3, CCG9040-0, CCG9040-1, CCG9040-2, CCG9040-3, CCG9040-4, CCG9040-5, CCG9041-0, CCG9041-1...(Other models you can see in the webshop)		

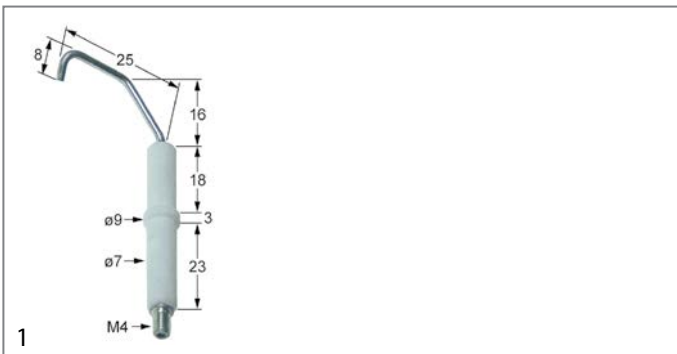

GEV No.	100822	Ref. No.	0109027 SIR0109027
description	ignition electrode D1 ø 7mm D2 ø 9mm connection M4 L1 16mm L2 25mm L3 8mm BL1 18mm BL2 3mm BL3 23mm to clip		
For models:	CFG60110, CFG60210		



GEV No.	102314	Ref. No.	CR0687080
description	ignition electrode D1 ø 7mm D2 ø 9mm connection M4 L1 2mm BL1 28mm BL2 3mm BL3 23mm to clip		
For models:	ECG7, ECG92A, ECG92G, ECG92T, ECG94A, ECG94E, ECG94F, ECG94G, ECG94T, ECG96A, ECG96E, ECG96F, ECG96G, ECG96H, ECG96T, ECG98A, ECG98F, ECG98G		

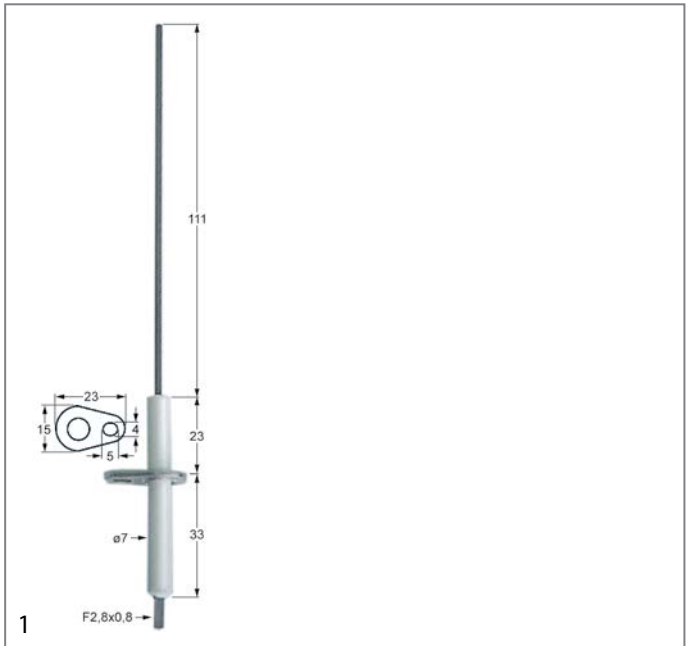

GEV No.	400172	Ref. No.	0102479 63050060 LA63050060 LAR63050060 SIR0102479
description	ignition electrode flange length 23mm flange width 15mm D1 ø 7mm L1 111mm BL1 23mm BL2 33mm connection F2.8x0.8 with flange		
For models:	CBG9060C-I, CPD90100, CPD90100A, CPD90150, CPD90150A, CPI90100, CPI90100A, CPI90150, CPI90150A		

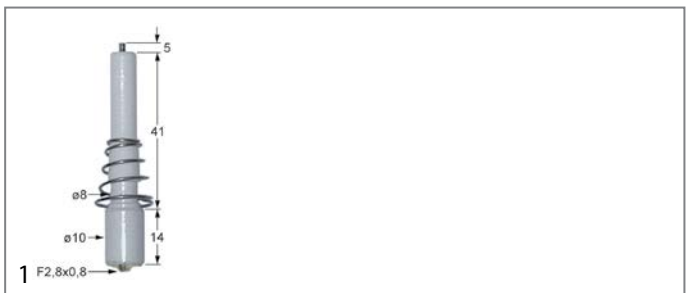



GEV No.	100729	Ref. No.	0100833 SIR0100833
description	ignition electrode L1 5mm D1 ø 8mm D2 ø 10mm BL1 41mm BL2 14mm connection F 2.8x0.8mm to clip with spring		
For models:	CCG6020, CCG6040, CCG6045, CCG6046		





 <p>1</p>			
GEV No.	100906	Ref. No.	0100807 1888400 MA1888400 SIR0100807
description	screw connection thread M10x1 for ignition electrode brass Qty 1 pcs WS 10		
For models:	BG62TLC, BG62TLL, BG62TRR, BG63TLC, BG63TLL, BG63TLR, BG64TLC, BG64TLL, BG64TLR, BG72GLC, BG72GLL, BG72GRR, BG72TLC, BG72TLL, BG72TRR, BG74GLC, BG74GLL, BG74GLR, BG74GLM, BG74GRR, BG74TLC, BG74TLL, BG74TLR, BG74TMC, BG74TRR, BG82ALL, BG82ARR, BG82GLC, BG82GLL, BG82GRR, BG82TLC, BG82TLL, BG82TRR, BG84ALC, BG84ALL, BG84ALR, BG84AMC, BG84ARR, BG84GLC, BG84GLL, BG84GLR, BG84GMC, BG84GRR, BG84TLC, BG84TLL, BG84TLR, BG84TMC, BG84TRR, CG86HPS, CGG6220...(Other models you can see in the webshop)		

 <p>2</p>			
GEV No.	101454	Ref. No.	0100620 0100741 SI0100620 SIR0100620 SIR0100741
description	union screw for igniter thread M10x1 ID ø 7mm L 15mm		
For models:	CCG1041, CCG1042, CCG1045, CCG1045P, CCG1061, CCG1062, CCG10652, CCG10652P, CCG10653, CCG1081, CCG1082, CCG1085, CCG10852, CCG1085P, CCG7001, CCG7001P, CCG7020, CCG7021, CCG7022, CCG7040, CCG7041, CCG7042, CCG7045, CCG7046, CCG7061, CCG7062, CCG70652, CCG70653, CCG70663, CCG7201, CCG7220, CCG7221, CCG7222, CCG7240, CCG7241, CCG7242, CCG7245, CCG7246, CCG7261, CCG7262, CCG72652, CCG72653, CCG72662, CCG72663, CCG9020, CCG9021, CCG9022, CCG9040, CCG9041, CCG9042...(Other models you can see in the webshop)		

 <p>1</p>			
GEV No.	100176	Ref. No.	0101628 SIR0101628
description	ignition cable cable length 1000mm connection ø2.4mm / ø4mm permanent temperature 200°C		
For models:	CNG90160, CNG90160S, CNG90160-S, CPD70150, CPI70150, DG94160, DGY4160, PG7ND05, PG7NI05, PG8AD10, PG8AD15, PG8AI10, PG8AI15, PG8ND10, PG8ND15, PG8NI10, PG8NI15, SG74CRM, SG74IRM, SG84CRA, SG84CRM, SG84IRA, SG84IRM		

 <p>1</p>			
GEV No.	100026	Ref. No.	0100858 BN2532997 SIR0100858
description	ignition cable cable length 1000mm connection ø4mm / F6.3mm		
For models:	CFG70115, CFG70215, CFG72215, CFG90120, CFG90210, CFG90210S, CFG90220, FG92210, FGY2210		

 <p>1</p>			
GEV No.	102158	Ref. No.	0101632 SIR0101632
description	ignition cable cable length 1750mm connection ø4mm / F2.8mm		
For models:	CCG6045, CCG7001, CCG7001P, CCG7045, CCG7045P, CCG70652, CCG70652P, CCG70653, CCG7201, CCG7245, CCG72652, CCG72653, CFG60110, CFG60210, CG74FPS, CG76FPS, CG76HPS, CTT7045, CTT7045L, CTT7045R, CTT70652, CTT70652L, CTT72653, CTT72653L, TG74FPL, TG74FPR, TG74FPS, TG76FPC, TG76FPS		

 <p>1</p>			
GEV No.	100197	Ref. No.	0101681 BN8220191 SIR0101681
description	ignition cable cable length 600mm connection F2.8mm / ø2.4mm		
For models:	CCG6020, CCG6040, CCG6045, CCG6046		

 <p>1</p>			
GEV No.	100186	Ref. No.	1936300 MA1936300
description	ignition cable cable length 600mm connection ø2.4mm / lug M4		
For models:	BG62TLC, BG62TLL, BG62TRR, BG63TLC, BG63TLL, BG63TLR, BG64TLC, BG64TLL, BG64TLR, BMG-40, BMG-60, CFG62110, CFG62210, CCG6220, CCG6220C, CCG6220R, CCG6230, CCG6230C, CCG6230LR, CCG6240, CCG6240C, CCG6240LR, CRG6220, CRG6240, EBG7, EBG7-CROMO, EBG92AL, EBG92ALC, EBG92AR, EBG92ARC, EBG92GL, EBG92GLC, EBG92GR, EBG92GRC, EBG92TL, EBG92TLC, EBG92TR, EBG92TRC, EBG93AL, EBG93ALC, EBG93ALR, EBG93AMC, EBG93GL, EBG93GLC, EBG93GLR, EBG93GMC, EBG93TL, EBG93TLC, EBG93TLR, EBG93TMC...(Other models you can see in the webshop)		

 <p>1</p>			
GEV No.	100199	Ref. No.	0101631 SIR0101631
description	ignition cable cable length 600mm connection ø4mm / F2.8mm		

ignition cables

pre-assembled cables

 <p>1</p>			
GEV No.	102164	Ref. No.	9303415 SIR9303415
description	ignition cable cable length 1000mm connection F6.3mm / lug M4		
For models:	CPD90100AP, CPD90100A-P, CPD90100P, CPD90150AP, CPD90150A-P, CPD9015-P, CPI90100AP, CPI90100A-P, CPI90100P, CPI90100-P, CPI90150AP, CPI90150A-P, CPI90150P, CPI90150-P, PG8AD10, PG8AD15, PG8AI10, PG8AI15, PG8NI10, PG8NI15, PG9AD10, PG9AD15, PG9AI10, PG9AI15, PG9ND10, PG9ND15, PG9NI10, PG9NI15		

			
GEV No.	100019	Ref. No.	0108189 0109082 1936400 9303461 BN4185326050610 CR0688770 MA1936400 SIR0109082 SIR9303461
description	ignition cable cable length 900mm connection ø2.4mm / ø4mm		
For models:	BG72GLC, BG72GLL, BG72GRR, BG72TLC, BG72TLL, BG72TRR, BG74GLC, BG74GLL, BG74GLR, BG74GMC, BG74GRR, BG74TLL, BG74TLR, BG74TRR, BG82ALL, BG82ARR, BG82GLC, BG82GLL, BG82GRR, BG82TLC, BG82TLL, BG82TRR, BG84ALC, BG84ALL, BG84ALR, BG84AMC, BG84ARR, BG84GLC, BG84GLL, BG84GLR, BG84GMC, BG84GRR, BG84TLC, BG84TLL, BG84TLR, BG84TMC, BG84TRR, BG92ALC, BG92ALL, BG92ARC, BG92ARR, BG92GLC, BG92GLL, BG92GRC, BG92GRR, BG94ALC, BG94ALL, BG94ALR, BG94AMC, BG94ARC...(Other models you can see in the webshop)		

			
GEV No.	102155	Ref. No.	0101629 9303074 SIR9303074 SIR0101629 SIR9303074
description	ignition cable cable length 900mm connection ø4mm / F2.8mm		
For models:	CCG9046, CCG90663, CCG9145, CCG9145-1, CCG91652, CCG91652-1, CCG91653, CCG91653-1, CCG9185, CCG9185-1, CCG91852, CCG91852-1, CFS9050, CFS9052, CFS9055, CCG9020, CCG9020C, CG9020R, CG9020RC, CCG9021, CCG9021C, CCG9021R, CCG9021RC, CCG9040, CCG9040C, CCG9040LR, CCG9040LRC, CCG9040R, CCG9040RC, CCG9041, CCG9041C, CCG9041LR, CCG9041LRC, CCG9041R, CCG9041RC, CNG50150, CNG50160, CTT1041, CTT1042, CTT1045, CTT652L, CTT653L, CTT7040, CTT7040L, CTT7040R, CTT7041, CTT7041L, CTT7041R, CTT7042, CTT7042L...(Other models you can see in the webshop)		

piezoelectric igniters

mounting diameter 18mm

			
GEV No.	100003	Ref. No.	0100898 1936100 MA1936100 SIR0100898
description	piezoelectric igniter body metal blowing mounting ø 18mm connection F2.8x0.8		
For models:	BG62TLC, BG62TLL, BG62TRR, BG63TLC, BG63TLL, BG63TLR, BG64TLC, BG64TLL, BG64TLR, BG72ALL, BG72ARR, BG72GLL, BG72GRR, BG72TLL, BG72TRR, BG74ALL, BG74ALR, BG74ARC, BG74GLL, BG74GLR, BG74GRR, BG74TLL, BG74TLR, BG74TRR, BMG-40, BMG-60, CCG6245-1, CCG62652-1, CCG6262110, CCG62210, CG64FPS, CG66FPS, CCG6220, CCG6220C, CCG6220R, CCG6230, CCG6230C, CCG6230LR, CCG6240, CCG6240C, CCG6240LR, CRG6220, CRG6240, DG72128, DG74228, DG82140, DG82142, DG82T42, DG84240, DG84242...(Other models you can see in the webshop)		

			
GEV No.	100009	Ref. No.	0100895 BN6A041105 SIR0100895
description	piezoelectric igniter body plastic blowing mounting ø 18mm connection ø2.4mm front measurements 26mm M18x1.5		
For models:	BG72GLC, BG72GLL, BG72GRR, BG72TLC, BG72TLL, BG72TRR, BG74GLC, BG74GLL, BG74GLR, BG74GMC, BG74GRR, BG74TLL, BG74TLR, BG74TRR, BG82ALL, BG82ARR, BG82GLC, BG82GLL, BG82GRR, BG82TLC, BG82TLL, BG82TRR, BG84ALC, BG84ALL, BG84ALR, BG84AMC, BG84ARR, BG84GLC, BG84GLL, BG84GLR, BG84GMC, BG84GRR, BG84TLC, BG84TLL, BG84TLR, BG84TMC, BG84TRR, CBG7050, CBG7050C, CCG6020, CCG6040, CCG6045, CCG6046, CFF1GPA, CFF1GPS, CFF1TPA, CFF1TPS, CFF2TPA, CFF2TPS, CFF3TPA...(Other models you can see in the webshop)		
accessories for	100009		
	GEV No.	101339	Ref. No. —
cover cap for piezoelectric igniter			
	GEV No.	106869	Ref. No. 0108555 CM136000 MACM136000 SIR0108555
cover cap for piezoelectric igniter ID ø 22mm ED ø 35mm H 25mm			
	GEV No.	107931	Ref. No. —
cover cap for piezoelectric igniter ID ø 21mm ED ø 36mm			

mounting diameter 22mm

			
GEV No.	100008	Ref. No.	0100893 SIO100893 SIR0100893
description	piezoelectric igniter body plastic blowing mounting ø 22mm connection ø2mm cable lengthmm		
For models:	BG92ALC, BG92ALL, BG92ARC, BG92ARR, BG92GLC, BG92GLL, BG92GRC, BG92GRR, BG94ALC, BG94ALL, BG94ALR, BG94AMC, BG94ARC, BG94ARR, BG94GLC, BG94GLL, BG94GLR, BG94GMC, BG94GRC, BG94GRR, BGY2TLC, BGY2TLL, BGY2TRC, BGY2TRR, BGY4TLC, BGY4TLL, BGY4TLR, BGY4TMC, BGY4TRC, BGY4TRR, CBG9060CP, CBG9060C-P, CBG9060P, CCG1045P, CCG10652P, CCG1085P, CCG9045P, CCG90652P, CCG9085P, CCG9085-P, CG84FPS, CG86FPS, CG86HPS, CG88APS, CG88FPS, CG88GPS, CG94FPS, CG96FPS, CG98FPS, CCG9020-0...(Other models you can see in the webshop)		



miscellaneous



1			
GEV No.	nla ¹	Ref. No.	0102509 SIR0102509
description	piezoelectric igniter suitable for Minisit connection F6.3x0.8 ømm		
For models:	CPD90100AP, CPD90100A-P, CPD90100P, CPD90150AP, CPD90150A-P, CPD9015-P, CPI90100AP, CPI90100A-P, CPI90100P, CPI90100-P, CPI90150AP, CPI90150A-P, CPI90150P, CPI90150-P, PG9AD10, PG9AD15, PG9AI10, PG9AI15, PG9ND10, PG9ND15, PG9NI10, PG9NI15		

¹no longer available



1			
GEV No.	nla ¹	Ref. No.	0100857 SI0100857 SIR0100857
description	piezoelectric igniter suitable for Minisit with cover cap ømm connection F6.3x0.8		
For models:	CFG70115, CFG70215, CFG72215, CFG90120, CFG90210, CFG90210S, CFG90220, FG92210, FGY2210		
spare parts for	101136		
	GEV No.	100001	Ref. No. 0102509 SIR0102509
	piezoelectric igniter suitable for Minisit connection F6.3x0.8 ømm		

¹no longer available

accessories



1			
GEV No.	106869	Ref. No.	0108555 CM136000 MACM136000 SIR0108555
description	cover cap for piezoelectric igniter ID ø 22mm ED ø 35mm H 25mm		
For models:	EBG7, EBG7-CROMO, EBG92AL, EBG92ALC, EBG92AR, EBG92ARC, EBG92GL, EBG92GLC, EBG92GR, EBG92GRC, EBG92TL, EBG92TLC, EBG92TR, EBG92TRC, EBG93AL, EBG93ALC, EBG93ALR, EBG93AMC, EBG93GL, EBG93GLC, EBG93GLR, EBG93GMC, EBG93TL, EBG93TLC, EBG93TLR, EBG93TMC, EBG94AL, EBG94ALC, EBG94ALR, EBG94AMC, EBG94AR, EBG94GL, EBG94GLC, EBG94GLR, EBG94GMC, EBG94GR, EBG94TL, EBG94TLC, EBG94TLR, EBG94TMC, EBG94TR, ECG7, ECG7-FG, ECG92A, ECG92G, ECG92T, ECG94A, ECG94E, ECG94F, ECG94G...(Other models you can see in the webshop)		



1			
GEV No.	106868	Ref. No.	CM136100 MACM136100
description	disc for piezoelectric igniter ID ø 18mm ED ø 32mm H 4mm		
For models:	EC-MAXI-OVEN-GAS, EFG93210, EGL72, EGL74, EVGV7		

ignition units





1			
GEV No.	102485	Ref. No.	2971400 BN6A050100 MA2971400
description	ignition unit outputs 2 220-240VAC 0.6VA 50-60Hz		
For models:	EDG73142, EDG92142, EDG93142, EDG94242, EFG92123K, EFG94223K, EPG7D05, EPG7105, EPG7108, EPG9D10, EPG9D10A, EPG9D15, EPG9D15A, EPG9115, EPG9115A, EPG9B9110, EPG9B9110A, EPGD05, ESG94CRA, ESG94CRM, ESG94FRA, ESG94FRM, ESG96CRA, ESG96FRA		



1			
GEV No.	101002	Ref. No.	0101193 0101196 0101197 SIR0101193 SIR0101196 SIR0101197
description	ignition unit outputs 2 230VAC dimensions 88x23x34mm mounting distance 73mm inlet F6.3x0.8 outlet F2.8x0.8 0.6VA 50/60Hz		
For models:	CCG1041, CCG1042, CCG1045, CCG1061, CCG1062, CCG10652, CCG10653, CCG1081, CCG1082, CCG1085, CCG10852, CCG7001, CCG7020, CCG7021, CCG7022, CCG7040, CCG7041, CCG7042, CCG7045, CCG7046, CCG7061, CCG7062, CCG70652, CCG70653, CCG70663, CCG7201, CCG7220, CCG7221, CCG7222, CCG7240, CCG7241, CCG7242, CCG7245, CCG7246, CCG7261, CCG7262, CCG72652, CCG72653, CCG72662, CCG72663, CCG9020, CCG9021, CCG9022, CCG9040, CCG9041, CCG9042, CCG9046, CCG9060, CCG9061, CCG9062...(Other models you can see in the webshop)		



1			
GEV No.	101023	Ref. No.	0101194 SI0101194 SIR0101194
description	ignition unit outputs 4 230VAC dimensions 111x28x34mm mounting distance 98mm inlet F6.3x0.8 outlet F2.8x0.8 type ZAG4 0.3VA 50-60Hz		
For models:	CCG7001, CCG7020, CCG7021, CCG7022, CCG7040, CCG7041, CCG7042, CCG7045, CCG7046, CCG7061, CCG7062, CCG70652, CCG70653, CCG70663, CCG7201, CCG7240, CCG7241, CCG7242, CCG7245, CCG7246, CCG7261, CCG7262, CCG72652, CCG72653, CCG72662, CCG72663, CCG9020, CCG9021, CCG9022, CCG9040, CCG9041, CCG9042, CCG9046, CCG9060, CCG9061, CCG9062, CCG90663, CCG9081, CCG9082, CCG9140, CCG9140-1, CCG9141, CCG9141-1, CCG9142, CCG9142-1, CCG9145, CCG9145-1, CCG9146, CCG9146-1, CCG9160...(Other models you can see in the webshop)		
accessories for	101023		
	GEV No.	103257	Ref. No. —
	ignition unit outputs 4 230VAC dimensions 111x28x34mm mounting distance 98mm inlet F6.3x0.8 outlet F2.8x0.8 type FZ4 set 6-piece 0.3VA 50-60Hz		

			
GEV No.	101024	Ref. No.	0101195 SIR0101195
description	ignition unit outputs 6 230VAC dimensions 112x22x34mm mounting distance 98mm inlet F6.3x0.8 outlet F2.8x0.8 type ZAG6 0.3VA 50/60Hz t.max. -20 up to +125°C		
For models:	CCG1041, CCG1042, CCG1045, CCG1061, CCG1062, CCG10652, CCG10653, CCG1081, CCG1082, CCG1085, CCG10852, CCG7001, CCG7020, CCG7021, CCG7022, CCG7040, CCG7041, CCG7042, CCG7045, CCG7046, CCG7061, CCG7062, CCG70652, CCG70653, CCG70663, CCG7201, CCG7261, CCG7262, CCG72652, CCG72653, CCG72662, CCG72663, CCG9020, CCG9021, CCG9022, CCG9040, CCG9041, CCG9042, CCG9046, CCG9060, CCG9061, CCG9062, CCG90663, CCG9081, CCG9082, CCG9160, CCG9160-1, CCG9161, CCG9161-1, CCG9162...(Other models you can see in the webshop)		

ignition switches

			
GEV No.	345038	Ref. No.	0101188 CR0410290 SIR0101188
description	momentary push switch mounting ø 25mm black 2NO 250V 16A connection male faston 6.3mm ambient temperature max. 85°C protection IP40		
For models:	CCG1045, CCG10652, CCG10653, CCG1085, CCG10852, CCG7001, CCG7020, CCG7021, CCG7022, CCG7040, CCG7041, CCG7042, CCG7045, CCG7046, CCG7061, CCG7062, CCG70652, CCG70653, CCG70663, CCG7201, CCG7220, CCG7221, CCG7222, CCG7240, CCG7241, CCG7242, CCG7245, CCG7246, CCG7261, CCG7262, CCG72652, CCG72653, CCG72662, CCG72663, CCG9046, CCG90663, CCG9145, CCG9145-1, CCG91652, CCG91652-1, CCG91653, CCG91653-1, CCG9185, CCG9185-1, CCG91852, CCG91852-1, CFS9050, CFS9052, CFS9055, CG76GPS...(Other models you can see in the webshop)		

thermocouples

plug-in thermocouples

plug-in thermocouples standard

with barrel socket ø6(6.5)mm

thermocouples SIT

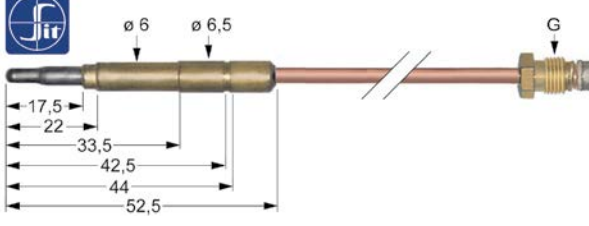
			
GEV No.	107619	Ref. No.	0100816 SIR0100816
description	thermocouple SIT M10x1 L 1000mm plug connection ø6.0(6.5)mm		
For models:	CPD90100AP, CPD90100A-P, CPD90100P, CPD90150AP, CPD90150A-P, CPD9015-P, PG9AD10, PG9AD15, PG9ND10, PG9ND15		

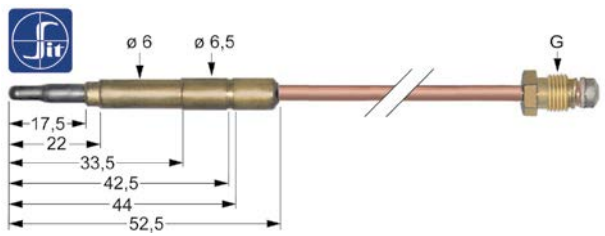
			
GEV No.	107621	Ref. No.	0100815 SIO100815 SIR0100815
description	thermocouple SIT M10x1 L 1500mm plug connection ø6.0(6.5)mm		

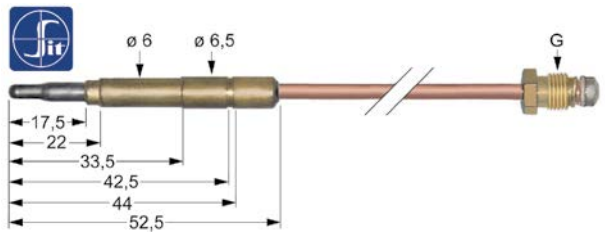
			
GEV No.	107614	Ref. No.	0100818 63040030 LAR63040030 SIO100818 SIR0100818
description	thermocouple SIT M9x1 L 1500mm plug connection ø6.0(6.5)mm		
For models:	CCG6045, CCG7001P, CCG7045, CCG7045P, CCG70652, CCG70652P, CCG70653, CCG7201, CCG7245, CCG72652, CCG72653, CG74FPS, CG76FPS, CG76HPS, CG84FPS, CG86FPS, CG86HPS, CG88APS, CG88FPS, CG88GPS, CPD90100AP, CPD90100P, CPD90150AP, CPD9015-P, CTT7045, CTT7045L, CTT7045R, CTT70652, CTT70652L, CTT72653, CTT72653L, PG8ND10, PG8ND15, PG9AD10, PG9AD15, PG9ND10, PG9ND15, TG74FPL, TG74FPR, TG74FPS, TG76FPC, TG76FPS, TG84FPS		

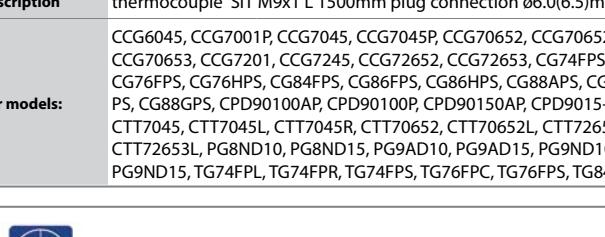
			
GEV No.	107608	Ref. No.	0100808 1031504300 6A011912 BN6A011912 MA1031504300 SIR0100808
description	thermocouple SIT M9x1 L 500mm plug connection ø6.0(6.5)mm		
For models:	BG62TLC, BG62TLL, BG62TRR, BG63TLC, BG63TLL, BG63TLR, BG64TLC, BG64TLL, BG64TLR, BG72GLC, BG72GLL, BG72GRR, BG72TLC, BG72TLL, BG72TRR, BG74GLC, BG74GLL, BG74GLR, BG74GMC, BG74GRR, BG74TLL, BG74TLR, BG74TRR, BG92ALC, BG92ALL, BG92ARC, BG92ARR, BG92GLC, BG92GLL, BG92GRC, BG92GRR, BGY2TLC, BGY2TLL, BGY2TRC, BGY2TRR, CBG9060CP, CBG9060C-P, CBG9060P, CCG1041, CCG1041P, CCG1042, CCG1042P, CCG1045, CCG1045P, CCG1061, CCG1061P, CCG1062, CCG1062P, CCG10652, CCG10652P...(Other models you can see in the webshop)		

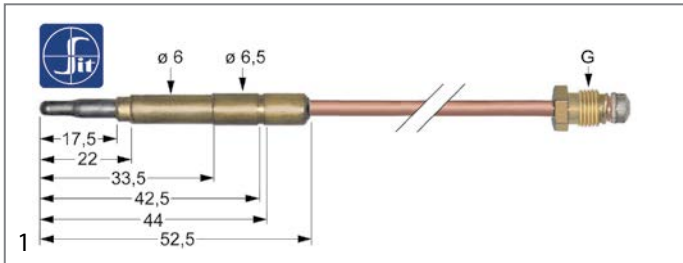

GEV No.	107611	Ref. No.	0100809 0105056 CM029100 MACM029100 SIR0100809
description	thermocouple SIT M9x1 L 850mm plug connection ø6.0(6.5)mm		
For models:	BG74TRR, BG82ALL, BG82ARR, BG82GLC, BG82GLL, BG82GRR, BG82TLC, BG82TLL, BG82TRR, BG84ALC, BG84ALL, BG84ALR, BG84AMC, BG84ARR, BG84GLC, BG84GLL, BG84GLR, BG84GMC, BG84GRR, BG84TLC, BG84TLL, BG84TLR, BG84TMC, BG84TRR, BG94ALC, BG94ALL, BG94ALR, BG94AMC, BG94ARC, BG94ARR, BG94GLC, BG94GLL, BG94GLR, BG94GMC, BG94GRC, BG94GRR, BGY4TLC, BGY4TLL, BGY4TLR, BGY4TMC, BGY4TRC, BGY4TRR, CBG7050, CCG1041P, CCG1042P, CCG1045, CCG1045P, CCG1061P, CCG1062P, CCG10652... (Other models you can see in the webshop)		

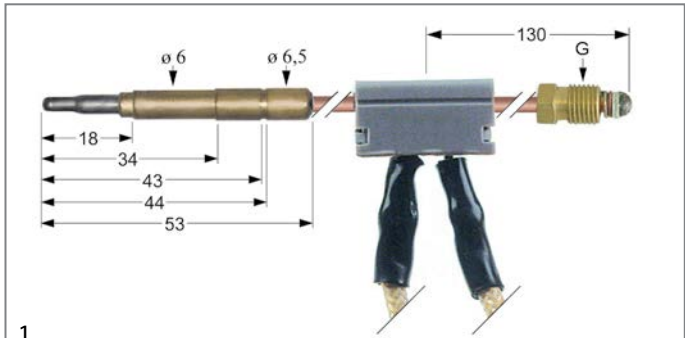

GEV No.	102247	Ref. No.	1950100 MA1950100
description	thermocouple with interrupter M9x1 L 600mm plug connection ø6.0mm cable 700mm		
For models:	EBG7-CROMO, EBG92ALC, EBG92ARC, EBG92GLC, EBG92GRC, EBG92TLC, EBG92TRC, EBG93ALC, EBG93AMC, EBG93GLC, EBG93GMC, EBG93TLC, EBG93TMC, EBG94ALC, EBG94AMC, EBG94GLC, EBG94GMC, EBG94TLC, EBG94TMC, EFG72108, EFG72110, EFG72115, EFG73208T, EFG73210, EFG74215, EFG92115, EFG92115S, EFG92123, EFG92123K, EFG93210, EFG94215, EFG94215S, EFG94223, EFG94223K, EFG94223, EFG94223K, FG72115, FG72206, FG74215, FG82122, FG82206, FG82T22, FG84222, FG84T22, FG92122, FG92206, FG94222, FGY2122, FGY2206, FGY4222, SG86CRA, SG86FRA... (Other models you can see in the webshop)		

plug-in thermocouples with interruption

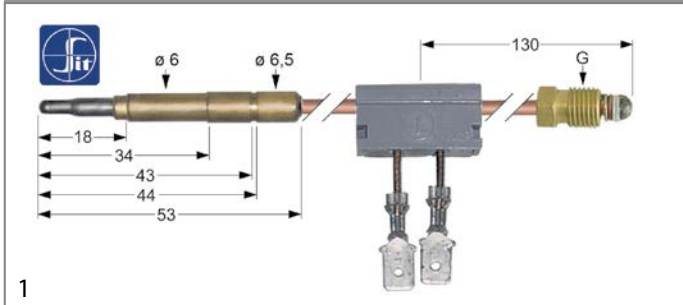

GEV No.	107177	Ref. No.	0100797 0100810 SIR0100797 SIR0100810
description	thermocouple SIT with interrupter M9x1 L 600mm plug connection ø6.0mm F 6.3mm		
For models:	CFG60110, CFG60210, CFG70115, CFG70215, CNG70130, CNG70160, CNG70230, CNG72160, CNG72230, CPI70150, CPI90100AP, CPI90100A-P, CPI90100-P, CPI90150A-P, CPI90150-P, DG72125, DG74155, DG74225, PG7NI05, PG8AD10, PG8AD15, PG8AI10, PG8AI15, PG8ND10, PG8ND15, PG8NI10, PG8NI15, PG9AD10, PG9AD15, PG9AI10, PG9AI15, PG9ND10, PG9ND15, PG9NI10, PG9NI15		

threaded thermocouples

threaded thermocouples standard
with socket with thread M8x1

SIT

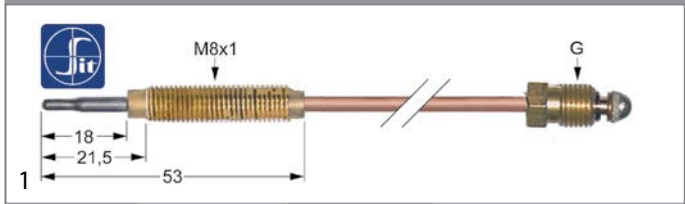

GEV No.	107627	Ref. No.	641500 MA641500
description	thermocouple SIT M8x1 L 220mm M8x1		

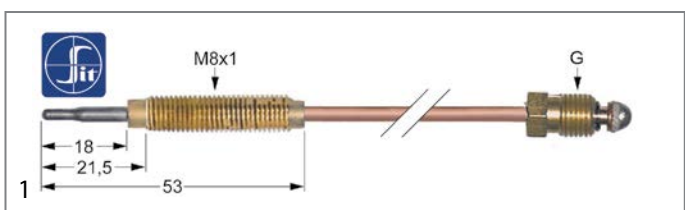

GEV No.	107636	Ref. No.	0100812 SIR0100812
description	thermocouple SIT M9x1 L 600mm M8x1		
For models:	CCG6020, CCG6040, CCG6045, CCG6046		
accessories for	107636		

	GEV No.	102067	Ref. No.	—
nut thread M8x1 H 3mm brass Qty 1 pcs type SEF 1				



thermopiles

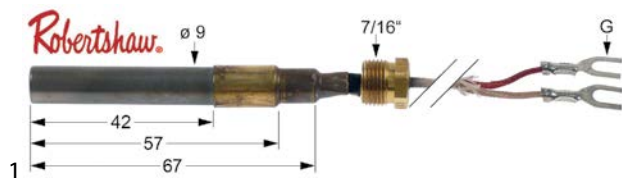

GEV No.	102116	Ref. No.	0105109 SIR0105109
description	thermopile ROBERTSHAW L 900mm probe ø 9mm probe L 57mm 250-750mV screw connection 7/16"		
For models:	FG82122, FG84222, FG92122, FG94222, FGY2122, FGY4222		

accessories

interrupters



GEV No.	101265	Ref. No.	0100835 63040210 LAR63040210 SIR0100835
description	interrupter thread M9x1		
For models:	BG92ALC, BG92ARC, BG92GLC, BG92GRC, BG94ALC, BG94AMC, BG94ARC, BG94GLC, BG94GMC, BG94GRC, BGY2TLC, BGY2TRC, BGY4TLC, BGY4TMC, BGY4TRC, CFG90120, CFG90210, CFG90210S, CFG90220, CCG9020-1, CCG9020-3, CCG9021-1, CCG9021-3, CCG9022-1, CCG9022-3, CCG9040-1, CCG9040-3, CCG9040-5, CCG9041-1, CCG9041-3, CCG9041-5, CCG9042-1, CCG9042-3, CCG9042-5, FG92210, FGY2210		

miscellaneous



GEV No.	107207	Ref. No.	9300545 S19300545 SIR9300545
description	bracket for thermocouple for burner type E		
For models:	CCG9020, CCG9021, CCG9022, CCG9040, CCG9041, CCG9042, CCG9046, CCG9060, CCG9061, CCG9062, CCG90663, CCG9081, CCG9082, CCG9120, CCG9121, CCG9122, CCG9140, CCG9140-1, CCG9141, CCG9141-1, CCG9142, CCG9142-1, CCG9145, CCG9145-1, CCG9146, CCG9146-1, CCG9160, CCG9160-1, CCG9161, CCG9161-1, CCG9162, CCG9162-1, CCG91652, CCG91652-1, CCG91653, CCG91653-1, CCG91662, CCG91662-1, CCG91663, CCG91663-1, CCG9181, CCG9181-1, CCG9182, CCG9182-1, CCG9185, CCG9185-1, CCG91852, CCG91852-1, CFF1GPA, CFF1GPS		

gas burners

hob burners

universal hob burners

GEV



GEV No.	103068	Ref. No.	0100248 SIR0100248	
description	burner cap ø 100mm			
For models:	CCG6020, CCG6040, CCG6045, CCG6046			
accessories for	103068			
	GEV No.	103067	Ref. No.	0100247 SIR0100247
burner ring for burner cap ø 100mm				
	GEV No.	104102	Ref. No.	0100261 SIR0100261
burner head for burner cap ø 100mm ext. ø 130				
	GEV No.	104103	Ref. No.	0100258 SIR0100258
burner holder suitable for burner ø100mm with nozzle holder				





GEV No.	103066	Ref. No.	0100250 SIR0100250	
description	burner cap ø 80mm			
For models:	CCG6020, CCG6040, CCG6045, CCG6046			
accessories for	103066			
	GEV No.	103065	Ref. No.	0100249 1032009500 MA1032009500 SIR0100249
burner ring for burner cap ø 80mm				
	GEV No.	104100	Ref. No.	0100259 SIR0100259
burner head for burner cap ø 80mm				
	GEV No.	104101	Ref. No.	0100260 SIR0100260
burner holder for burner cap ø 80mm with nozzle holder with mixing sleeve				







GEV No.	104102	Ref. No.	0100261 SIR0100261
description	burner head for burner cap ø 100mm ext. ø 130		
For models:	CCG6020, CCG6040, CCG6045, CCG6046		



 <p>1</p>			
GEV No.	104100	Ref. No.	0100259 SIR0100259
description	burner head for burner cap ø 80mm		
For models:	CCG6020, CCG6040, CCG6045, CCG6046		
accessories for	104100		
	GEV No.	103065	Ref. No. 0100249 1032009500 MA1032009500 SIR0100249
burner ring for burner cap ø 80mm			
	GEV No.	103066	Ref. No. 0100250 SIR0100250
burner cap ø 80mm			
	GEV No.	104103	Ref. No. 0100258 SIR0100258
burner holder suitable for burner ø100mm with nozzle holder			

 <p>1</p>			
GEV No.	104101	Ref. No.	0100260 SIR0100260
description	burner holder for burner cap ø 80mm with nozzle holder with mixing sleeve		
For models:	CCG6020, CCG6040, CCG6045, CCG6046		
accessories for	104101		
	GEV No.	103065	Ref. No. 0100249 1032009500 MA1032009500 SIR0100249
burner ring for burner cap ø 80mm			
	GEV No.	103066	Ref. No. 0100250 SIR0100250
burner cap ø 80mm			
	GEV No.	104100	Ref. No. 0100259 SIR0100259
burner head for burner cap ø 80mm			

 <p>1</p>			
GEV No.	104103	Ref. No.	0100258 SIR0100258
description	burner holder suitable for burner ø100mm with nozzle holder		
For models:	CCG6020, CCG6040, CCG6045, CCG6046		
accessories for	104103		
	GEV No.	103067	Ref. No. 0100247 SIR0100247
burner ring for burner cap ø 100mm			
	GEV No.	103068	Ref. No. 0100248 SIR0100248
burner cap ø 100mm			
	GEV No.	104102	Ref. No. 0100261 SIR0100261
burner head for burner cap ø 100mm ext. ø 130			





 <p>1</p>			
GEV No.	103067	Ref. No.	0100247 SIR0100247
description	burner ring for burner cap ø 100mm		
For models:	CCG6020, CCG6040, CCG6045, CCG6046		
accessories for	103067		
	GEV No.	103068	Ref. No. 0100248 SIR0100248
burner cap ø 100mm			
	GEV No.	104102	Ref. No. 0100261 SIR0100261
burner head for burner cap ø 100mm ext. ø 130			
	GEV No.	104103	Ref. No. 0100258 SIR0100258
burner holder suitable for burner ø100mm with nozzle holder			

 <p>1</p>			
GEV No.	103065	Ref. No.	0100249 1032009500 MA1032009500 SIR0100249
description	burner ring for burner cap ø 80mm		
For models:	CCG6020, CCG6040, CCG6045, CCG6046		
accessories for	103065		
	GEV No.	103066	Ref. No. 0100250 SIR0100250
burner cap ø 80mm			
	GEV No.	104100	Ref. No. 0100259 SIR0100259
burner head for burner cap ø 80mm			
	GEV No.	104101	Ref. No. 0100260 SIR0100260
burner holder for burner cap ø 80mm with nozzle holder with mixing sleeve			

producer-specific hob burners

SILKO





650 (1) series

 <p>1</p>			
GEV No.	103068	Ref. No.	0100248 SIR0100248
description	burner cap ø 100mm		
For models:	CCG6020, CCG6040, CCG6045, CCG6046		
accessories for	103068		
	GEV No.	103067	Ref. No. 0100247 SIR0100247
burner ring for burner cap ø 100mm			
	GEV No.	104102	Ref. No. 0100261 SIR0100261
burner head for burner cap ø 100mm ext. ø 130			
	GEV No.	104103	Ref. No. 0100258 SIR0100258
burner holder suitable for burner ø100mm with nozzle holder			

			
1			
GEV No.	103066	Ref. No.	0100250 SIR0100250
description	burner cap ø 80mm		
For models:	CCG6020, CCG6040, CCG6045, CCG6046		
accessories for	103066		
	GEV No.	103065	Ref. No. 0100249 1032009500 MA1032009500 SIR0100249
burner ring for burner cap ø 80mm			
	GEV No.	104100	Ref. No. 0100259 SIR0100259
burner head for burner cap ø 80mm			
	GEV No.	104101	Ref. No. 0100260 SIR0100260
burner holder for burner cap ø 80mm with nozzle holder with mixing sleeve			

			
1			
GEV No.	104102	Ref. No.	0100261 SIR0100261
description	burner head for burner cap ø 100mm ext. ø 130		
For models:	CCG6020, CCG6040, CCG6045, CCG6046		





			
1			
GEV No.	104100	Ref. No.	0100259 SIR0100259
description	burner head for burner cap ø 80mm		
For models:	CCG6020, CCG6040, CCG6045, CCG6046		
accessories for	104100		
	GEV No.	103065	Ref. No. 0100249 1032009500 MA1032009500 SIR0100249
burner ring for burner cap ø 80mm			
	GEV No.	103066	Ref. No. 0100250 SIR0100250
burner cap ø 80mm			
	GEV No.	104103	Ref. No. 0100258 SIR0100258
burner holder suitable for burner ø100mm with nozzle holder			

			
1			
GEV No.	104101	Ref. No.	0100260 SIR0100260
description	burner holder for burner cap ø 80mm with nozzle holder with mixing sleeve		
For models:	CCG6020, CCG6040, CCG6045, CCG6046		
accessories for	104101		
	GEV No.	103065	Ref. No. 0100249 1032009500 MA1032009500 SIR0100249
burner ring for burner cap ø 80mm			
	GEV No.	103066	Ref. No. 0100250 SIR0100250
burner cap ø 80mm			
	GEV No.	104100	Ref. No. 0100259 SIR0100259
burner head for burner cap ø 80mm			

			
1			
GEV No.	104103	Ref. No.	0100258 SIR0100258
description	burner holder suitable for burner ø100mm with nozzle holder		
For models:	CCG6020, CCG6040, CCG6045, CCG6046		
accessories for	104103		
	GEV No.	103067	Ref. No. 0100247 SIR0100247
burner ring for burner cap ø 100mm			
	GEV No.	103068	Ref. No. 0100248 SIR0100248
burner cap ø 100mm			
	GEV No.	104102	Ref. No. 0100261 SIR0100261
burner head for burner cap ø 100mm ext. ø 130			



			
1			
GEV No.	103067	Ref. No.	0100247 SIR0100247
description	burner ring for burner cap ø 100mm		
For models:	CCG6020, CCG6040, CCG6045, CCG6046		
accessories for	103067		
	GEV No.	103068	Ref. No. 0100248 SIR0100248
burner cap ø 100mm			
	GEV No.	104102	Ref. No. 0100261 SIR0100261
burner head for burner cap ø 100mm ext. ø 130			
	GEV No.	104103	Ref. No. 0100258 SIR0100258
burner holder suitable for burner ø100mm with nozzle holder			











 1			
GEV No.	103065	Ref. No.	0100249 1032009500 MA1032009500 SIR0100249
description	burner ring for burner cap ø 80mm		
For models:	CCG6020, CCG6040, CCG6045, CCG6046		
accessories for	103065		
	GEV No.	103066	Ref. No. 0100250 SIR0100250
burner cap ø 80mm			
	GEV No.	104100	Ref. No. 0100259 SIR0100259
burner head for burner cap ø 80mm			
	GEV No.	104101	Ref. No. 0100260 SIR0100260
burner holder for burner cap ø 80mm with nozzle holder with mixing sleeve			

650, 700, 909 (2) series

 1			
GEV No.	104012	Ref. No.	0100257 SIR0100257
description	air mixing sleeve ø 38mm H 35mm		
accessories for	104012		
	GEV No.	103008	Ref. No. 0100244 SIR0100244
burner cap ø 90mm			
	GEV No.	103009	Ref. No. 0100246 SIR0100246
burner cap ø 130mm			
	GEV No.	104008	Ref. No. 0100232 SIR0100232
burner head for burner cap ø 90mm			
	GEV No.	104009	Ref. No. 0100234 SIR0100234
burner head ø 130mm			
	GEV No.	104010	Ref. No. —
burner holder with nozzle holder			
	GEV No.	104011	Ref. No. 0100256 SIR0100256
venturi			

 1			
GEV No.	103009	Ref. No.	0100246 SIR0100246
description	burner cap ø 130mm		
accessories for	103009		
	GEV No.	104009	Ref. No. 0100234 SIR0100234
burner head ø 130mm			



accessories for	103009		
	GEV No.	104010	Ref. No. —
burner holder with nozzle holder			
	GEV No.	104011	Ref. No. 0100256 SIR0100256
venturi			
	GEV No.	104012	Ref. No. 0100257 SIR0100257
air mixing sleeve ø 38mm H 35mm			





 1			
GEV No.	103008	Ref. No.	0100244 SIR0100244
description	burner cap ø 90mm		
accessories for	103008		
	GEV No.	104008	Ref. No. 0100232 SIR0100232
burner head for burner cap ø 90mm			
	GEV No.	104010	Ref. No. —
burner holder with nozzle holder			
	GEV No.	104011	Ref. No. 0100256 SIR0100256
venturi			
	GEV No.	104012	Ref. No. 0100257 SIR0100257
air mixing sleeve ø 38mm H 35mm			

 1			
GEV No.	104008	Ref. No.	0100232 SIR0100232
description	burner head for burner cap ø 90mm		
accessories for	104008		
	GEV No.	103008	Ref. No. 0100244 SIR0100244
burner cap ø 90mm			
	GEV No.	104010	Ref. No. —
burner holder with nozzle holder			
	GEV No.	104011	Ref. No. 0100256 SIR0100256
venturi			
	GEV No.	104012	Ref. No. 0100257 SIR0100257
air mixing sleeve ø 38mm H 35mm			

			
1			
GEV No.	104009	Ref. No.	0100234 SIR0100234
description	burner head ø 130mm		
accessories for	104009		
	GEV No.	103008	Ref. No.
			0100244 SIR0100244
	burner cap ø 90mm		
	GEV No.	104010	Ref. No.
			—
	burner holder with nozzle holder		
	GEV No.	104011	Ref. No.
			0100256 SIR0100256
	venturi		
	GEV No.	104012	Ref. No.
			0100257 SIR0100257
	air mixing sleeve ø 38mm H 35mm		

			
1			
GEV No.	105294	Ref. No.	0100255 2510603 BN2510603 SIR0100255
description	burner holder with nozzle holder		
accessories for	105294		
	GEV No.	104056	Ref. No.
			—
	air mixing sleeve		
	GEV No.	105291	Ref. No.
			—
	burner head for burner cap ø 70mm 3.5kW		
	GEV No.	105292	Ref. No.
			—
	burner cap ø 70mm 3.5kW		
	GEV No.	105293	Ref. No.
			—
	venturi		
	GEV No.	105296	Ref. No.
			—
	cover for pilot burner suitable for 700 series Qty 1 pcs		

			
1			
GEV No.	104011	Ref. No.	0100256 SIR0100256
description	venturi		
accessories for	104011		
	GEV No.	103008	Ref. No.
			0100244 SIR0100244
	burner cap ø 90mm		

accessories for	104011		
	GEV No.	103009	Ref. No.
			0100246 SIR0100246
	burner cap ø 130mm		
	GEV No.	104008	Ref. No.
			0100232 SIR0100232
	burner head for burner cap ø 90mm		
	GEV No.	104009	Ref. No.
			0100234 SIR0100234
	burner head ø 130mm		
	GEV No.	104010	Ref. No.
			—
	burner holder with nozzle holder		
	GEV No.	104012	Ref. No.
			0100257 SIR0100257
	air mixing sleeve ø 38mm H 35mm		









700, 909, 1100 (1) series			
			
1			
GEV No.	105300	Ref. No.	0100253 SIO100253 SIR0100253
description	burner cap ø 120mm 7kW with central hole ID ø 64mm		
For models:	CCG1041, CCG1041P, CCG1042, CCG1042P, CCG1045, CCG1045P, CCG1061, CCG1061P, CCG1062, CCG1062P, CCG10652, CCG10652P, CCG10653, CCG1081, CCG1081P, CCG1082, CCG1082P, CCG1085, CCG10852, CCG1085P, CCG9020, CCG9020P, CCG9021, CCG9021P, CCG9022, CCG9022P, CCG9040, CCG9040P, CCG9041, CCG9041P, CCG9042, CCG9042P, CCG9045P, CCG9046, CCG9046P, CCG9060, CCG9060P, CCG9061, CCG9061P, CCG9062, CCG9062P, CCG90652P, CCG90662P, CCG90663, CCG9081, CCG9081P, CCG9082, CCG9082P, CCG9085P, CCG9085-P..(Other models you can see in the webshop)		
accessories for	105300		
	GEV No.	100907	Ref. No.
			0100742 0100817 1891700 MA1891700 SIR0100742 SIR0100817
	screw connection thread M10x1 Qty 1 pcs type SEF 1 ømm for thermocouple		
	GEV No.	101452	Ref. No.
			LB839-00 SIRLB839-00
	ignition electrode support for burner type C/D suitable for 900 series		
	GEV No.	101453	Ref. No.
			LB838-00 SIRLB838-00
	bracket for thermocouple gas range for burner type C/D suitable for 900 series		
	GEV No.	101454	Ref. No.
			0100620 0100741 SIO100620 SIR0100620 SIR0100741
	union screw for igniter thread M10x1 ID ø 7mm L 15mm		
	GEV No.	104108	Ref. No.
			0100767 MA1031504900 SIR0100767
	nozzle holder nozzle mounting M10x1 tube ø 10mm gas inlet M16x1.5 gas outlet M14x1		
	GEV No.	104294	Ref. No.
			0100216 0100300 SIO100300 SIR0100216 SIR0100300
	burner head E for burner cap ø 120mm 8.3kW		

Table continues overleaf



accessories for 105300					
	<table border="1"> <tr> <td>GEV No.</td> <td>105301</td> <td>Ref. No.</td> <td>0100217 0100303 SIO100303 SIR0100217 SIR0100303</td> </tr> </table>	GEV No.	105301	Ref. No.	0100217 0100303 SIO100303 SIR0100217 SIR0100303
GEV No.	105301	Ref. No.	0100217 0100303 SIO100303 SIR0100217 SIR0100303		
venturi for burner cap ø 120mm 7kW					

	1		
GEV No.	103069	Ref. No.	0100252 SIO100252 SIR0100252

description	burner cap ø 80mm 4.3kW with central hole
For models:	CCG7001, CCG7001P, CCG7020, CCG7020P, CCG7021, CCG7021P, CCG7022, CCG7022P, CCG7040, CCG7040P, CCG7041, CCG7041P, CCG7042, CCG7042P, CCG7045, CCG7045P, CCG7046, CCG7046P, CCG7061, CCG7061P, CCG7062, CCG7062P, CCG70652, CCG70652P, CCG70653, CCG70662P, CCG70663, CCG7201, CCG7220, CCG7221, CCG7222, CCG7240, CCG7241, CCG7242, CCG7245, CCG7246, CCG7261, CCG7262, CCG72652, CCG72653, CCG72662, CCG72663, CCG9020, CCG9021, CCG9022, CCG9040, CCG9040P, CCG9041, CCG9041P, CCG9042...(Other models you can see in the webshop)

accessories for 103069					
	<table border="1"> <tr> <td>GEV No.</td> <td>100907</td> <td>Ref. No.</td> <td>0100742 0100817 1891700 MA1891700 SIR0100742 SIR0100817</td> </tr> </table>	GEV No.	100907	Ref. No.	0100742 0100817 1891700 MA1891700 SIR0100742 SIR0100817
GEV No.	100907	Ref. No.	0100742 0100817 1891700 MA1891700 SIR0100742 SIR0100817		

screw connection thread M10x1 Qty 1 pcs type SEF 1 ømm for thermocouple	
---	--

	<table border="1"> <tr> <td>GEV No.</td> <td>101452</td> <td>Ref. No.</td> <td>LB839-00 SIRLB839-00</td> </tr> </table>	GEV No.	101452	Ref. No.	LB839-00 SIRLB839-00
GEV No.	101452	Ref. No.	LB839-00 SIRLB839-00		

ignition electrode support for burner type C/D suitable for 900 series	
--	--

	<table border="1"> <tr> <td>GEV No.</td> <td>101453</td> <td>Ref. No.</td> <td>LB838-00 SIRLB838-00</td> </tr> </table>	GEV No.	101453	Ref. No.	LB838-00 SIRLB838-00
GEV No.	101453	Ref. No.	LB838-00 SIRLB838-00		

bracket for thermocouple gas range for burner type C/D suitable for 900 series	
--	--

	<table border="1"> <tr> <td>GEV No.</td> <td>101454</td> <td>Ref. No.</td> <td>0100620 0100741 SIO100620 SIR0100620 SIR0100741</td> </tr> </table>	GEV No.	101454	Ref. No.	0100620 0100741 SIO100620 SIR0100620 SIR0100741
GEV No.	101454	Ref. No.	0100620 0100741 SIO100620 SIR0100620 SIR0100741		

union screw for igniter thread M10x1 ID ø 7mm L 15mm	
--	--

	<table border="1"> <tr> <td>GEV No.</td> <td>104104</td> <td>Ref. No.</td> <td>0100208 0100298 SIO100298 SIR0100208 SIR0100298</td> </tr> </table>	GEV No.	104104	Ref. No.	0100208 0100298 SIO100298 SIR0100208 SIR0100298
GEV No.	104104	Ref. No.	0100208 0100298 SIO100298 SIR0100208 SIR0100298		

burner head for burner cap ø 80mm 3.5kW code 100212	
---	--

	<table border="1"> <tr> <td>GEV No.</td> <td>104105</td> <td>Ref. No.</td> <td>0100206 0100301 SIO100301 SIR0100206 SIR0100301</td> </tr> </table>	GEV No.	104105	Ref. No.	0100206 0100301 SIO100301 SIR0100206 SIR0100301
GEV No.	104105	Ref. No.	0100206 0100301 SIO100301 SIR0100206 SIR0100301		

burner lower part for burner cap ø 80mm 3.5kW	
---	--

	<table border="1"> <tr> <td>GEV No.</td> <td>104108</td> <td>Ref. No.</td> <td>0100767 MA1031504900 SIR0100767</td> </tr> </table>	GEV No.	104108	Ref. No.	0100767 MA1031504900 SIR0100767
GEV No.	104108	Ref. No.	0100767 MA1031504900 SIR0100767		

nozzle holder nozzle mounting M10x1 tube ø 10mm gas inlet M16x1.5 gas outlet M14x1	
--	--

	<table border="1"> <tr> <td>GEV No.</td> <td>105297</td> <td>Ref. No.</td> <td>—</td> </tr> </table>	GEV No.	105297	Ref. No.	—
GEV No.	105297	Ref. No.	—		

burner head for burner cap ø 80mm 4.3kW for pilot burner	
--	--

	1
---	---

GEV No.	103070	Ref. No.	0100251 SIO100251 SIR0100251
----------------	--------	-----------------	------------------------------------

description	burner cap ø 95mm 6.4kW with central hole
--------------------	---

For models:	CCG1041, CCG1041P, CCG1042, CCG1042P, CCG1045, CCG1045P, CCG1061, CCG1061P, CCG1062, CCG1062P, CCG10652, CCG10652P, CCG10653, CCG1081, CCG1081P, CCG1082, CCG1082P, CCG1085, CCG10852, CCG1085P, CCG7001, CCG7001P, CCG7020, CCG7020P, CCG7021, CCG7021P, CCG7022, CCG7022P, CCG7040, CCG7040P, CCG7041, CCG7041P, CCG7042, CCG7042P, CCG7045, CCG7045P, CCG7046, CCG7046P, CCG7061, CCG7061P, CCG7062, CCG7062P, CCG70652, CCG70652P, CCG70653, CCG70662P, CCG70663, CCG7201, CCG7220, CCG7221...(Other models you can see in the webshop)
--------------------	---

accessories for 103070	
-------------------------------	--

	<table border="1"> <tr> <td>GEV No.</td> <td>100907</td> <td>Ref. No.</td> <td>0100742 0100817 1891700 MA1891700 SIR0100742 SIR0100817</td> </tr> </table>	GEV No.	100907	Ref. No.	0100742 0100817 1891700 MA1891700 SIR0100742 SIR0100817
GEV No.	100907	Ref. No.	0100742 0100817 1891700 MA1891700 SIR0100742 SIR0100817		

screw connection thread M10x1 Qty 1 pcs type SEF 1 ømm for thermocouple	
---	--

	<table border="1"> <tr> <td>GEV No.</td> <td>101452</td> <td>Ref. No.</td> <td>LB839-00 SIRLB839-00</td> </tr> </table>	GEV No.	101452	Ref. No.	LB839-00 SIRLB839-00
GEV No.	101452	Ref. No.	LB839-00 SIRLB839-00		

ignition electrode support for burner type C/D suitable for 900 series	
--	--

	<table border="1"> <tr> <td>GEV No.</td> <td>101453</td> <td>Ref. No.</td> <td>LB838-00 SIRLB838-00</td> </tr> </table>	GEV No.	101453	Ref. No.	LB838-00 SIRLB838-00
GEV No.	101453	Ref. No.	LB838-00 SIRLB838-00		

bracket for thermocouple gas range for burner type C/D suitable for 900 series	
--	--

	<table border="1"> <tr> <td>GEV No.</td> <td>101454</td> <td>Ref. No.</td> <td>0100620 0100741 SIO100620 SIR0100620 SIR0100741</td> </tr> </table>	GEV No.	101454	Ref. No.	0100620 0100741 SIO100620 SIR0100620 SIR0100741
GEV No.	101454	Ref. No.	0100620 0100741 SIO100620 SIR0100620 SIR0100741		

union screw for igniter thread M10x1 ID ø 7mm L 15mm	
--	--

	<table border="1"> <tr> <td>GEV No.</td> <td>104106</td> <td>Ref. No.</td> <td>0100209 0100299 SIO100299 SIR0100209 SIR0100299</td> </tr> </table>	GEV No.	104106	Ref. No.	0100209 0100299 SIO100299 SIR0100209 SIR0100299
GEV No.	104106	Ref. No.	0100209 0100299 SIO100299 SIR0100209 SIR0100299		

burner head for burner cap ø 100mm 5.5kW for igniter	
--	--

	<table border="1"> <tr> <td>GEV No.</td> <td>104107</td> <td>Ref. No.</td> <td>0100207 0100302 SIO100302 SIR0100207 SIR0100302</td> </tr> </table>	GEV No.	104107	Ref. No.	0100207 0100302 SIO100302 SIR0100207 SIR0100302
GEV No.	104107	Ref. No.	0100207 0100302 SIO100302 SIR0100207 SIR0100302		

burner lower part for burner cap ø 100mm 6.4kW	
--	--

	<table border="1"> <tr> <td>GEV No.</td> <td>104108</td> <td>Ref. No.</td> <td>0100767 MA1031504900 SIR0100767</td> </tr> </table>	GEV No.	104108	Ref. No.	0100767 MA1031504900 SIR0100767
GEV No.	104108	Ref. No.	0100767 MA1031504900 SIR0100767		



nozzle holder nozzle mounting M10x1 tube ø 10mm gas inlet M16x1.5 gas outlet M14x1	
--	--



			
1			
GEV No.	104294	Ref. No.	0100216 0100300 SI0100300 SIR0100216 SIR0100300
description	burner head E for burner cap ø 120mm 8.3kW		
For models:	CCG1041, CCG1042, CCG1045, CCG1061, CCG1062, CCG10652, CCG10653, CCG1081, CCG1082, CCG1085, CCG10852, CCG9020, CCG9021, CCG9022, CCG9040, CCG9041, CCG9042, CCG9046, CCG9060, CCG9061, CCG9062, CCG90663, CCG9081, CCG9082, CCG9120, CCG9121, CCG9122, CCG9140, CCG9140-1, CCG9141, CCG9141-1, CCG9145, CCG9145-1, CCG9146, CCG9146-1, CCG9160, CCG9160-1, CCG9161, CCG9161-1, CCG9162, CCG9162-1, CCG91652, CCG91652-1, CCG91653, CCG91653-1, CCG91662, CCG91662-1, CCG91663, CCG91663-1, CCG9181...(Other models you can see in the webshop)		

			
2			
GEV No.	104106	Ref. No.	0100209 0100299 SI0100299 SIR0100209 SIR0100299
description	burner head for burner cap ø 100mm 5.5kW for igniter		
For models:	CCG1041, CCG1042, CCG1045, CCG1061, CCG1062, CCG10652, CCG10653, CCG1081, CCG1082, CCG1085, CCG10852, CCG7001, CCG7020, CCG7021, CCG7022, CCG7040, CCG7041, CCG7042, CCG7045, CCG7046, CCG7061, CCG7062, CCG70652, CCG70653, CCG70663, CCG7201, CCG7220, CCG7221, CCG7222, CCG7240, CCG7241, CCG7242, CCG7245, CCG7246, CCG7261, CCG7262, CCG72652, CCG72653, CCG72662, CCG72663, CCG9020, CCG9021, CCG9022, CCG9040, CCG9041, CCG9042, CCG9046, CCG9060, CCG9061, CCG9062...(Other models you can see in the webshop)		

accessories for 104106			
	GEV No.	100907	Ref. No. 0100742 0100817 1891700 MA1891700 SIR0100742 SIR0100817
screw connection thread M10x1 Qty 1 pcs type SEF 1 ømm for thermocouple			
	GEV No.	101452	Ref. No. LB839-00 SIRLB839-00
ignition electrode support for burner type C/D suitable for 900 series			
	GEV No.	101453	Ref. No. LB838-00 SIRLB838-00
bracket for thermocouple gas range for burner type C/D suitable for 900 series			
	GEV No.	101454	Ref. No. 0100620 0100741 SI0100620 SIR0100620 SIR0100741
union screw for igniter thread M10x1 ID ø 7mm L 15mm			
	GEV No.	103070	Ref. No. 0100251 SI0100251 SIR0100251
burner cap ø 95mm 6.4kW with central hole			

accessories for 104106			
	GEV No.	104107	Ref. No. 0100207 0100302 SI0100302 SIR0100207 SIR0100302
burner lower part for burner cap ø 100mm 6.4kW			
	GEV No.	104108	Ref. No. 0100767 MA1031504900 SIR0100767
nozzle holder nozzle mounting M10x1 tube ø 10mm gas inlet M16x1.5 gas outlet M14x1			

			
1			
GEV No.	106994	Ref. No.	0100224 SI0100224 SIR0100224
description	burner head for burner cap ø 120mm 7kW		
For models:	CCG1041P, CCG1042P, CCG1045P, CCG1061P, CCG1062P, CCG10652P, CCG1081P, CCG1082P, CCG1085P, CCG9020P, CCG9021P, CCG9022P, CCG9040P, CCG9041P, CCG9042P, CCG9045P, CCG9046P, CCG9060P, CCG9061P, CCG9062P, CCG90652P, CCG90662P, CCG9081P, CCG9082P, CCG9085P, CCG9085-P, CG82APS, CG82GPS, CG82TPS, CG84APS, CG84EPS, CG84FPS, CG84GPS, CG84TPS, CG86APS, CG86FPS, CG86G-PS, CG86HPS, CG86TPS, CG88APS, CG88FPS, CG88GPS, CG92APS, CG92GPS, CG94APS, CG94EPS, CG94FPS, CG94GPS, CG96APS, CG96EPS...(Other models you can see in the webshop)		
accessories for 106994			
	GEV No.	105300	Ref. No. 0100253 SI0100253 SIR0100253
burner cap ø 120mm 7kW with central hole ID ø 64mm			













			
1			
GEV No.	104104	Ref. No.	0100208 0100298 SI0100298 SIR0100208 SIR0100298
description	burner head for burner cap ø 80mm 3.5kW code 100212		
For models:	CCG7001, CCG7020, CCG7021, CCG7022, CCG7040, CCG7041, CCG7042, CCG7045, CCG7046, CCG7061, CCG7062, CCG70652, CCG70653, CCG70663, CCG7201, CCG7220, CCG7221, CCG7222, CCG7240, CCG7241, CCG7242, CCG7245, CCG7246, CCG7261, CCG7262, CCG72652, CCG72653, CCG72662, CCG72663, CCG9020, CCG9021, CCG9022, CCG9040, CCG9041, CCG9042, CCG9046, CCG9060, CCG9061, CCG9062, CCG90663, CCG9081, CCG9082, CCG9140, CCG9141, CCG9142, CCG9145, CCG9146, CCG9160, CCG9161, CCG9162...(Other models you can see in the webshop)		
accessories for 104104			
	GEV No.	100907	Ref. No. 0100742 0100817 1891700 MA1891700 SIR0100742 SIR0100817
screw connection thread M10x1 Qty 1 pcs type SEF 1 ømm for thermocouple			
	GEV No.	101452	Ref. No. LB839-00 SIRLB839-00
ignition electrode support for burner type C/D suitable for 900 series			

Table continues overleaf















accessories for 104104				
	GEV No.	101453	Ref. No.	LB838-00 SIRLB838-00
bracket for thermocouple gas range for burner type C/D suitable for 900 series				
	GEV No.	101454	Ref. No.	0100620 0100741 SI0100620 SIR0100620 SIR0100741
union screw for igniter thread M10x1 ID ø 7mm L 15mm				
	GEV No.	103069	Ref. No.	0100252 SI0100252 SIR0100252
burner cap ø 80mm 4.3kW with central hole				
	GEV No.	104105	Ref. No.	0100206 0100301 SI0100301 SIR0100206 SIR0100301
burner lower part for burner cap ø 80mm 3.5kW				
	GEV No.	104108	Ref. No.	0100767 MA1031504900 SIR0100767
nozzle holder nozzle mounting M10x1 tube ø 10mm gas inlet M16x1.5 gas outlet M14x1				

				
GEV No.	107882	Ref. No.	0100223 SI0100223 SIR0100223	
description	burner head for burner cap ø 95mm 5.5kW			
For models:	CCG1041P, CCG1042P, CCG1045P, CCG1061P, CCG1062P, CCG10652P, CCG1081P, CCG1082P, CCG1085P, CCG7001P, CCG7020P, CCG7021P, CCG7022P, CCG7040P, CCG7041P, CCG7042P, CCG7045P, CCG7046P, CCG7061P, CCG7062P, CCG70652P, CCG70662P, CCG9020P, CCG9021P, CCG9022P, CCG9040P, CCG9041P, CCG9042P, CCG9045P, CCG9046P, CCG9060P, CCG9061P, CCG9062P, CCG90652P, CCG90662P, CCG9081P, CCG9082P, CCG9085P, CCG9085-P, CG72APS, CG72GPS, CG72TPS, CG74APS, CG74EPS, CG74FPS, CG74GPS, CG74TPS, CG76APS, CG76EPS, CG76FPS...(Other models you can see in the webshop)			
accessories for 107882				
	GEV No.	103070	Ref. No.	0100251 SI0100251 SIR0100251
burner cap ø 95mm 6.4kW with central hole				

				
GEV No.	104107	Ref. No.	0100207 0100302 SI0100302 SIR0100207 SIR0100302	
description	burner lower part for burner cap ø 100mm 6.4kW			
For models:	CCG1041, CCG1041P, CCG1042, CCG1042P, CCG1045, CCG1045P, CCG1061, CCG1061P, CCG1062, CCG1062P, CCG10652, CCG10652P, CCG10653, CCG1081, CCG1081P, CCG1082, CCG1082P, CCG1085, CCG10852, CCG1085P, CCG7001, CCG7001P, CCG7020, CCG7020P, CCG7021, CCG7021P, CCG7022, CCG7022P, CCG7040, CCG7040P, CCG7041, CCG7041P, CCG7042, CCG7042P, CCG7045, CCG7045P, CCG7046, CCG7046P, CCG7061, CCG7061P, CCG7062, CCG7062P, CCG70652, CCG70652P, CCG70653, CCG70662P, CCG70663, CCG7201, CCG7220, CCG7221...(Other models you can see in the webshop)			
accessories for 104107				
	GEV No.	100907	Ref. No.	0100742 0100817 1891700 MA1891700 SIR0100742 SIR0100817
screw connection thread M10x1 Qty 1 pcs type SEF 1 ømm for thermocouple				
	GEV No.	101452	Ref. No.	LB839-00 SIRLB839-00
ignition electrode support for burner type C/D suitable for 900 series				
	GEV No.	101453	Ref. No.	LB838-00 SIRLB838-00
bracket for thermocouple gas range for burner type C/D suitable for 900 series				
	GEV No.	101454	Ref. No.	0100620 0100741 SI0100620 SIR0100620 SIR0100741
union screw for igniter thread M10x1 ID ø 7mm L 15mm				
	GEV No.	103070	Ref. No.	0100251 SI0100251 SIR0100251
burner cap ø 95mm 6.4kW with central hole				
	GEV No.	104106	Ref. No.	0100209 0100299 SI0100299 SIR0100209 SIR0100299
burner head for burner cap ø 100mm 5.5kW for igniter				
	GEV No.	104108	Ref. No.	0100767 MA1031504900 SIR0100767
nozzle holder nozzle mounting M10x1 tube ø 10mm gas inlet M16x1.5 gas outlet M14x1				



			
GEV No.	104105	Ref. No.	0100206 0100301 SI0100301 SIR0100206 SIR0100301
description	burner lower part for burner cap ø 80mm 3.5kW		
For models:	CCG7001, CCG7001P, CCG7020, CCG7020P, CCG7021, CCG7021P, CCG7022, CCG7022P, CCG7040, CCG7040P, CCG7041, CCG7041P, CCG7042, CCG7042P, CCG7045, CCG7045P, CCG7046, CCG7046P, CCG7061, CCG7061P, CCG7062, CCG7062P, CCG70652, CCG70652P, CCG70653, CCG70662P, CCG70663, CCG7201, CCG7220, CCG7221, CCG7222, CCG7240, CCG7241, CCG7242, CCG7245, CCG7246, CCG7261, CCG7262, CCG72652, CCG72653, CCG72662, CCG72663, CCG9020, CCG9021, CCG9022, CCG9040, CCG9040P, CCG9041, CCG9041P, CCG9042...(Other models you can see in the webshop)		
accessories for	104105		
	GEV No.	100907	Ref. No. 0100742 0100817 1891700 MA1891700 SIR0100742 SIR0100817
	screw connection thread M10x1 Qty 1 pcs type SEF 1 ømm for thermocouple		
	GEV No.	101452	Ref. No. LB839-00 SIRLB839-00
	ignition electrode support for burner type C/D suitable for 900 series		
	GEV No.	101453	Ref. No. LB838-00 SIRLB838-00
	bracket for thermocouple gas range for burner type C/D suitable for 900 series		
	GEV No.	101454	Ref. No. 0100620 0100741 SI0100620 SIR0100620 SIR0100741
	union screw for igniter thread M10x1 ID ø 7mm L 15mm		
	GEV No.	103069	Ref. No. 0100252 SI0100252 SIR0100252
	burner cap ø 80mm 4.3kW with central hole		
	GEV No.	104104	Ref. No. 0100208 0100298 SI0100298 SIR0100208 SIR0100298
	burner head for burner cap ø 80mm 3.5kW code 100212		
	GEV No.	104108	Ref. No. 0100767 MA1031504900 SIR0100767
	nozzle holder nozzle mounting M10x1 tube ø 10mm gas inlet M16x1.5 gas outlet M14x1		
	GEV No.	105297	Ref. No. —
	burner head for burner cap ø 80mm 4.3kW for pilot burner		

			
GEV No.	104108	Ref. No.	0100767 MA1031504900 SIR0100767
description	nozzle holder nozzle mounting M10x1 tube ø 10mm gas inlet M16x1.5 gas outlet M14x1		
For models:	BG72GLC, BG72GLL, BG72GRR, BG72TLC, BG72TLL, BG72TRR, BG74GLC, BG74GLL, BG74GLR, BG74GMC, BG74GRR, BG74TLC, BG74TLL, BG74TLR, BG74TMC, BG74TRR, CCG1041, CCG1041P, CCG1042, CCG1042P, CCG1045, CCG1045P, CCG1061, CCG1061P, CCG1062, CCG1062P, CCG10652, CCG10652P, CCG10653, CCG1081, CCG1081P, CCG1082, CCG1082P, CCG1085, CCG10852, CCG1085P, CCG6045, CCG7001, CCG7001P, CCG7020, CCG7020P, CCG7021, CCG7021P, CCG7022, CCG7022P, CCG7040, CCG7040P, CCG7041, CCG7041P, CCG7042...(Other models you can see in the webshop)		
accessories for	104108		
	GEV No.	102382	Ref. No. —
	nut thread M14x1 H 3.5mm WS 18 brass Qty 1 pcs		
	GEV No.	104105	Ref. No. 0100206 0100301 SI0100301 SIR0100206 SIR0100301
	burner lower part for burner cap ø 80mm 3.5kW		
	GEV No.	104107	Ref. No. 0100207 0100302 SI0100302 SIR0100207 SIR0100302
	burner lower part for burner cap ø 100mm 6.4kW		





			
GEV No.	105301	Ref. No.	0100217 0100303 SI0100303 SIR0100217 SIR0100303
description	venturi for burner cap ø 120mm 7kW		
For models:	CCG1041, CCG1041P, CCG1042, CCG1042P, CCG1045, CCG1045P, CCG1061, CCG1061P, CCG1062, CCG1062P, CCG10652, CCG10652P, CCG10653, CCG1081, CCG1081P, CCG1082, CCG1082P, CCG1085, CCG10852, CCG1085P, CCG9020, CCG9020P, CCG9021, CCG9021P, CCG9022, CCG9022P, CCG9040, CCG9040P, CCG9041, CCG9041P, CCG9042, CCG9042P, CCG9045P, CCG9046, CCG9046P, CCG9060, CCG9060P, CCG9061, CCG9061P, CCG9062, CCG9062P, CCG90652P, CCG90662P, CCG90663, CCG9081, CCG9081P, CCG9082, CCG9082P, CCG9085P, CCG9085-P...(Other models you can see in the webshop)		
accessories for	105301		
	GEV No.	100885	Ref. No. 0101151 SIR0101151
	air mixing sleeve for pilot burner Qty 1 pcs		
	GEV No.	100907	Ref. No. 0100742 0100817 1891700 MA1891700 SIR0100742 SIR0100817
	screw connection thread M10x1 Qty 1 pcs type SEF 1 ømm for thermocouple		

Table continues overleaf



accessories for		105301	
	GEV No.	101454	Ref. No. 0100620 0100741 SIO100620 SIR0100620 SIR0100741
union screw for igniter thread M10x1 ID ø 7mm L 15mm			
	GEV No.	104108	Ref. No. 0100767 MA1031504900 SIR0100767
nozzle holder nozzle mounting M10x1 tube ø 10mm gas inlet M16x1.5 gas outlet M14x1			
	GEV No.	104294	Ref. No. 0100216 0100300 SIO100300 SIR0100216 SIR0100300
burner head E for burner cap ø 120mm 8.3kW			
	GEV No.	105300	Ref. No. 0100253 SIO100253 SIR0100253
burner cap ø 120mm 7kW with central hole ID ø 64mm			
	GEV No.	106994	Ref. No. 0100224 SIO100224 SIR0100224
burner head for burner cap ø 120mm 7kW			
	GEV No.	107206	Ref. No. 9300544 SIR9300544 SIR9300544
ignition electrode support for igniter for burner type E			
	GEV No.	107207	Ref. No. 9300545 SIR9300545 SIR9300545
bracket for thermocouple for burner type E			

900 series

	1		
GEV No.	103064	Ref. No.	CR0580020
description burner cap ø 102mm H 28mm suitable for 900 series			
For models: ECG92A, ECG92G, ECG92T, ECG94A, ECG94E, ECG94F, ECG94G, ECG94T, ECG96A, ECG96E, ECG96F, ECG96G, ECG96H, ECG96T, ECG98A, ECG98F, ECG98G			

	1		
GEV No.	103071	Ref. No.	CR0580010
description burner cap ø 64mm H 26mm suitable for 900 series			
For models: ECG7, ECG92A, ECG92G, ECG92T, ECG94A, ECG94E, ECG94F, ECG94G, ECG94T, ECG96A, ECG96E, ECG96F, ECG96G, ECG96H, ECG96T, ECG98A, ECG98F, ECG98G			

	1		
GEV No.	103073	Ref. No.	CR0580040
description burner head for burner cap ø 102mm H 37mm suitable for 900 series			
For models: ECG92A, ECG92G, ECG92T, ECG94A, ECG94E, ECG94F, ECG94G, ECG94T, ECG96A, ECG96E, ECG96F, ECG96G, ECG96H, ECG96T, ECG98A, ECG98F, ECG98G			

	1		
GEV No.	103072	Ref. No.	CR0580030
description burner head for burner cap ø 64mm H 37mm suitable for 900 series			
For models: ECG7, ECG92A, ECG92G, ECG92T, ECG94A, ECG94E, ECG94F, ECG94G, ECG94T, ECG96A, ECG96E, ECG96F, ECG96G, ECG96H, ECG96T, ECG98A, ECG98F, ECG98G			

	1		
GEV No.	103083	Ref. No.	8204760 SIR8204760 SIR8204760
description gasket L 77mm W 69mm thickness 2mm graphite for Venturi suitable for 900 series			
For models: ECG92A, ECG92G, ECG92T, ECG94A, ECG94E, ECG94F, ECG94G, ECG94T, ECG96A, ECG96E, ECG96F, ECG96G, ECG96H, ECG96T, ECG98A, ECG98F, ECG98G			

	1		
GEV No.	103075	Ref. No.	CR0581700
description nozzle holder ø 34mm H 150mm suitable for 900 series			
For models: ECG7, ECG92A, ECG92G, ECG92T, ECG94A, ECG94E, ECG94F, ECG94G, ECG94T, ECG96A, ECG96E, ECG96F, ECG96G, ECG96H, ECG96T, ECG98A, ECG98F, ECG98G			

	1		
GEV No.	103074	Ref. No.	CR0586451
description venturi for burner cap ø 102mm with pilot burner suitable for 900 series			
For models: ECG92A, ECG92G, ECG92T, ECG94A, ECG94E, ECG94F, ECG94G, ECG94T, ECG96A, ECG96E, ECG96F, ECG96G, ECG96H, ECG96T, ECG98A, ECG98F, ECG98G			

			
1			
GEV No.	107422	Ref. No.	CR0586441
description	venturi for burner cap ø 64mm with pilot burner suitable for 900 series		
For models:	ECG7, ECG92A, ECG92G, ECG92T, ECG94A, ECG94E, ECG94F, ECG94G, ECG94T, ECG96A, ECG96E, ECG96F, ECG96G, ECG96H, ECG96T, ECG98A, ECG98F, ECG98G		
accessories for	107422		
	GEV No.	103071	Ref. No. CR0580010
	burner cap ø 64mm H 26mm suitable for 900 series		
	GEV No.	103072	Ref. No. CR0580030
	burner head for burner cap ø 64mm H 37mm suitable for 900 series		
	GEV No.	103075	Ref. No. CR0581700
	nozzle holder ø 34mm H 150mm suitable for 900 series		
	GEV No.	103083	Ref. No. 8204760 S18204760 S1R8204760
	gasket L 77mm W 69mm thickness 2mm graphite for Venturi suitable for 900 series		

pan supports			
			
1			
GEV No.	210187	Ref. No.	6200291
description	pan support W 365mm L 585mm		
For models:	CCG6020, CCG6040, CCG6045, CCG6046		

			
1			
GEV No.	210156	Ref. No.	0101807 0101808 SI0101807 SIRO101807 SIRO101808
description	pan support W 380mm L 575mm		
For models:	CCG7001, CCG7001P, CCG7020, CCG7020P, CCG7021, CCG7021P, CCG7022, CCG7022P, CCG7040, CCG7040P, CCG7041, CCG7041P, CCG7042, CCG7042P, CCG7045, CCG7045P, CCG7046, CCG7046P, CCG7061, CCG7061P, CCG7062, CCG7062P, CCG70652, CCG70652P, CCG70653, CCG70662P, CCG70663, CCG7201, CCG7220, CCG7221, CCG7222, CCG7240, CCG7241, CCG7242, CCG7245, CCG7246, CCG7261, CCG7262, CCG72652, CCG72653, CCG72662, CCG72663, CG72APS, CG72GPS, CG72TPS, CG74APS, CG74EPS, CG74FPS, CG74GPS, CG74TPS, CG74TPS...(Other models you can see in the webshop)		

reducers for pan supports			
			
1			
GEV No.	210050	Ref. No.	0101080 SI0101080 SIRO101080
description	reducer for pan support L 260mm W 260mm chrome-plated steel suitable for universal		
For models:	CCG1041, CCG1042, CCG1045, CCG1061, CCG1062, CCG10652, CCG10653, CCG1081, CCG1082, CCG1085, CCG10852, CCG7001, CCG7001P, CCG7020, CCG7021, CCG7022, CCG7040, CCG7041, CCG7042, CCG7045, CCG7046, CCG7061, CCG7062, CCG70652, CCG70653, CCG70663, CCG7201, CCG7220, CCG7221, CCG7222, CCG7240, CCG7241, CCG7242, CCG7245, CCG7246, CCG7261, CCG7262, CCG72652, CCG72653, CCG72662, CCG72663, CCG9020, CCG9021, CCG9022, CCG9040, CCG9041, CCG9042, CCG9046, CCG9060, CCG9061...(Other models you can see in the webshop)		

			
1			
GEV No.	210001	Ref. No.	MA86400 N/A
description	reducer for pan support L 265mm W 265mm SS suitable for universal		

			
1			
GEV No.	210004	Ref. No.	0101082 SIRO101082
description	reducer for pan support L 360mm W 160mm 700 series		

spillage trays			
			
1			
GEV No.	210250	Ref. No.	LB847-00 SIRLB847-00
description	drain tray L 550mm W 355mm H 70mm		
For models:	CCG7001P, CCG7020, CCG7020P, CCG7021, CCG7021P, CCG7022, CCG7022P, CCG7040, CCG7040P, CCG7041, CCG7041P, CCG7042, CCG7042P, CCG7045, CCG7045P, CCG7046, CCG7046P, CCG7061, CCG7061P, CCG7062, CCG7062P, CCG70652, CCG70652P, CCG70653, CCG70662P, CCG70663, CCG7201, CCG7221, CCG7222, CCG7240, CCG7241, CCG7242, CCG7245, CCG7246, CCG7261, CCG7262, CCG72652, CCG72653, CCG72662, CCG72663, CG72APS, CG72GPS, CG72TPS, CG74APS, CG74EPS, CG74FPS, CG74GPS, CG74TPS, CG76APS, CG76EPS...(Other models you can see in the webshop)		



accessories

reducers for pan supports

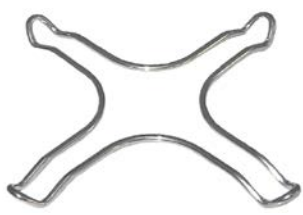

1

GEV No.	210050	Ref. No.	0101080 SI0101080 SIR0101080
description	reducer for pan support L 260mm W 260mm chrome-plated steel suitable for universal		
For models:	CCG1041, CCG1042, CCG1045, CCG1061, CCG1062, CCG10652, CCG10653, CCG1081, CCG1082, CCG1085, CCG10852, CCG7001, CCG7001P, CCG7020, CCG7021, CCG7022, CCG7040, CCG7041, CCG7042, CCG7045, CCG7046, CCG7061, CCG7062, CCG70652, CCG70653, CCG70663, CCG7201, CCG7220, CCG7221, CCG7222, CCG7240, CCG7241, CCG7242, CCG7245, CCG7246, CCG7261, CCG7262, CCG72652, CCG72653, CCG72662, CCG72663, CCG9020, CCG9021, CCG9022, CCG9040, CCG9041, CCG9042, CCG9046, CCG9060, CCG9061...(Other models you can see in the webshop)		



1

GEV No.	210001	Ref. No.	MA86400 N/A
description	reducer for pan support L 265mm W 265mm SS suitable for universal		



1

GEV No.	210004	Ref. No.	0101082 SIR0101082
description	reducer for pan support L 360mm W 160mm 700 series		

pan supports



1

GEV No.	210163	Ref. No.	0101829 SIR0101829
description	pan support		



1

GEV No.	210151	Ref. No.	1032101100 1032101101 MA1032101100 MA1032101101
description	pan support W 295mm L 545mm gas range		
For models:	CCG6230/1, CG64TPS		



1

GEV No.	210150	Ref. No.	1032101000 1032101001 MA1032101000 MA1032101001
description	pan support W 340mm L 545mm		
For models:	CCG6220/1, CCG6245-1, CCG62652-1, CG62TPS, CG64FPS, CG66FPS		



1

GEV No.	210187	Ref. No.	6200291
description	pan support W 365mm L 585mm		
For models:	CCG6020, CCG6040, CCG6045, CCG6046		



1



GEV No.	210156	Ref. No.	0101807 0101808 SI0101807 SIR0101807 SIR0101808
description	pan support W 380mm L 575mm		
For models:	CCG7001, CCG7001P, CCG7020, CCG7020P, CCG7021, CCG7021P, CCG7022, CCG7022P, CCG7040, CCG7040P, CCG7041, CCG7041P, CCG7042, CCG7042P, CCG7045, CCG7045P, CCG7046, CCG7046P, CCG7061, CCG7061P, CCG7062, CCG7062P, CCG70652, CCG70652P, CCG70653, CCG70662P, CCG70663, CCG7201, CCG7220, CCG7221, CCG7222, CCG7240, CCG7241, CCG7242, CCG7245, CCG7246, CCG7261, CCG7262, CCG72652, CCG72653, CCG72662, CCG72663, CG72APS, CG72GPS, CG72TPS, CG74APS, CG74EPS, CG74FPS, CG74G-PS, CG74TPS...(Other models you can see in the webshop)		



spillage trays

			
1			
GEV No.	210250	Ref. No.	LB847-00 SIRLB847-00
description	drain tray L 550mm W 355mm H 70mm		
For models:	CCG7001P, CCG7020, CCG7020P, CCG7021, CCG7021P, CCG7022, CCG7022P, CCG7040, CCG7040P, CCG7041, CCG7041P, CCG7042, CCG7042P, CCG7045, CCG7045P, CCG7046, CCG7046P, CCG7061, CCG7061P, CCG7062, CCG7062P, CCG70652, CCG70652P, CCG70653, CCG70662P, CCG70663, CCG7201, CCG7221, CCG7222, CCG7240, CCG7241, CCG7242, CCG7245, CCG7246, CCG7261, CCG7262, CCG72652, CCG72653, CCG72662, CCG72663, CG72APS, CG72GPS, CG72TPS, CG74APS, CG74EPS, CG74FPS, CG74GPS, CG74TPS, CG76APS, CG76EPS...(Other models you can see in the webshop)		

air mixers

			
1			
GEV No.	104012	Ref. No.	0100257 SIR0100257
description	air mixing sleeve \varnothing 38mm H 35mm		
accessories for	104012		
	GEV No.	104008	Ref. No.
			0100232 SIR0100232
	burner head for burner cap \varnothing 90mm		
	GEV No.	104011	Ref. No.
			0100256 SIR0100256
	venturi		

bar burners

bar burners

			
1			
GEV No.	105543	Ref. No.	0100267 LA63010010 LAR63010010 SIR0100267
description	bar burner 1-row \varnothing 40mm Wmm Hmm L 420mm flange width 43mm flange length 43mm bain marie		

			
1			
GEV No.	105253	Ref. No.	0100284 SI0100284 SIR0100284
description	bar burner 1-row \varnothing 40mm Wmm Hmm L 547mm griddle flange \varnothing 61mm		
For models:	BG92ALC, BG92ALL, BG92ARC, BG92ARR, BG92GLC, BG92GLL, BG92GRC, BG92GRR, BG94ALC, BG94ALL, BG94ALR, BG94AMC, BG94ARC, BG94ARR, BG94GLC, BG94GLL, BG94GLR, BG94GMC, BG94GRC, BG94GRR, BGY2TLC, BGY2TLL, BGY2TRC, BGY2TRR, BGY4TLC, BGY4TLL, BGY4TLR, BGY4TMC, BGY4TRC, BGY4TRR, CCG9020-0, CCG9020-1, CCG9020-2, CCG9020-3, CCG9021-0, CCG9021-1, CCG9021-2, CCG9021-3, CCG9022-0, CCG9022-1, CCG9022-2, CCG9022-3, CCG9040-0, CCG9040-1, CCG9040-2, CCG9040-3, CCG9040-4, CCG9040-5, CCG9041-0, CCG9041-1...(Other models you can see in the webshop)		

			
1			
GEV No.	105260	Ref. No.	0109045 SIR0109045
description	bar burner 2 row L 450mm W 300mm \varnothing mm H 50mm 8.5kW griddle		
For models:	CGG6030, CGG6030C, CGG6030R		

			
1			
GEV No.	105491	Ref. No.	0105050 MACM033503
description	bar burner 2 row L 665mm W 190mm \varnothing mm H 55mm griddle chrome-plated		
For models:	BG74TRR, BG82ALL, BG82ARR, BG82GLC, BG82GLL, BG82GRR, BG82TLC, BG82TLL, BG82TRR, BG84ALC, BG84ALL, BG84ALR, BG84AMC, BG84ARR, BG84GLC, BG84GLL, BG84GLR, BG84GMC, BG84GRR, BG84TLC, BG84TLL, BG84TLR, BG84TMC, BG84TRR		

			
1			
GEV No.	105549	Ref. No.	0108175 SIR0108175
description	bar burner 3 row		
For models:	CRG9022, CRG9022S, CRG9042, CRG9042S, GL92AGC, GL94AGC, GLY2AGC, GLY4AGC		



			
1			
GEV No.	105548	Ref. No.	0108191 SIR0108191
description	bar burner 3 row L 415mm W 248mm ømm H 145mm chargrill		
For models:	CRG7022, CRG7042, CRG7222, CRG7242		

			
1			
GEV No.	105537	Ref. No.	0100277 SIO100277 SIR0100277
description	bar burner angled L 570mm W 310mm ømm Hmm oven		
For models:	CCG7045, CCG7045P, CCG70652, CCG70652P, CCG70653, CCG7245, CCG72652, CCG72653, CG74FPS, CG76FPS, CG84FPS, CG86FPS, CG88APS, CG88FPS, CG88GPS, CTT7045, CTT7045L, CTT7045R, CTT70652, CTT70652L, CTT72653, CTT72653L, TG74FPL, TG74FPR, TG74FPS, TG76FPC, TG76FPS, TG84FPS		

			
1			
GEV No.	105542	Ref. No.	0108100 SIR0108100
description	bar burner ø 40mm Wmm Hmm L 300mm flange width 43mm flange length 43mm pasta cooker		

			
1			
GEV No.	105257	Ref. No.	0100280 SIO100280 SIR0100280
description	bar burner ø 40mm Wmm Hmm L 397mm kettle flange ø 61mm mounting distance 45mm		
For models:	CBG9060C-I, CBG9060CP, CBG9060C-P, CBG9060P, CCG6045, CMG7041, CMG7042, CMG9021, CMG9022, CMG9041, CMG9042, CPD70150, CPD90100, CPD90100A, CPD90100AP, CPD90100A-P, CPD90100P, CPD90150, CPD90150A, CPD90150AP, CPD90150A-P, CPD9015-P, CPI70150, CPI90100, CPI90100A, CPI90100AP, CPI90100A-P, CPI90100P, CPI90150, CPI90150A, CPI90150AP, CPI90150A-P, CPI90150P, CPI90150-P, MG92APS, MG92GPS, MG94APS, MG94GPS, PG7ND05, PG7NI05, PG8AD10, PG8AD15, PG8AI10, PG8AI15, PG8ND10, PG8ND15, PG8NI10, PG8NI15, PG9AD10...(Other models you can see in the webshop)		

			
1			
GEV No.	105498	Ref. No.	CM088200 MACM088200
description	bar burner ø 50mm Wmm Hmm L 308mm flange width 71mm flange ø 75mm pasta cooker		
For models:	DG72128, DG74228, EPG7D05, EPG7I05, EPG7I08, EPGD05		

			
1			
GEV No.	105547	Ref. No.	0100268 SIR0100268
description	bar burner ø 50mm Wmm Hmm L 432mm flange width 71mm fryer flange ø 75mm		

			
1			
GEV No.	105523	Ref. No.	0105117 CM088100 MACM088100
description	bar burner ø 50mm Wmm Hmm L 475mm flange ø 75mm		
For models:	DG82140, DG82142, DG82T42, DG84240, DG84242, DG84T42, DG92142, DG94242, DGY2142, DGY4242, EDG73142, EDG92142, EDG93142, EDG94242, EPG9D10, EPG9D10A, EPG9D15, EPG9D15A, EPG9I15, EPG9I15A, EPGB9I10, EPGB9I10A		

			
1			
GEV No.	103077	Ref. No.	CR0684490
description	bar burner ø 50mm Wmm Hmm L 490mm flange width 52mm flange length 75mm fryer		
For models:	EFG72110, EFG72115, EFG73210, EFG74215, EFG92115, EFG92115S, EFG93210, EFG94215, EFG94215S		



			
1			
GEV No.	105250	Ref. No.	0101051 SIR0101051
description	bar burner ø 50mm Wmm Hmm L 610mm flange width 71mm gas range flange ø 75mm		
For models:	CCG9045P, CCG9046, CCG90652P, CCG90663, CCG9085P, CCG9085-P, CCG9145, CCG9145-1, CCG91652, CCG91652-1, CCG91653, CCG91653-1, CCG9185, CCG9185-1, CCG91852, CCG91852-1, CFS9050, CFS9052, CFS9055, CG86HPS, CG94FPS, CG96FPS, CG98FPS, CTT9045, CTT90652R, CTT90653R, CTT90663R, HG94FPS, HGY4FPS, TG94FPS, TG96FPS		

			
1			
GEV No.	105254	Ref. No.	0100296 SIR0100296
description	bar burner ø 60mm Wmm Hmm L 315mm flange width 67mm flange length 67mm pasta cooker		
For models:	CNG70130, CNG70230, CNG72230, CNG90130, CNG90130-S, CNG90140, CNG90140-S, CNG90230, CNG90240, DG72125, DG74225, DG92140, DG94240		

			
1			
GEV No.	105255	Ref. No.	0109046 SIR0109046
description	bar burner ømm W 41mm H 34mm L 490mm flange width 70mm 5.5kW griddle		
For models:	BG72GLC, BG72GLL, BG72GRR, BG72TLC, BG72TLL, BG72TRR, BG74GLC, BG74GLL, BG74GLR, BG74GMC, BG74GRR, BG74TLC, BG74TLL, BG74TLR, BG74TMC, BG74TRR, CGE6020, CGE6020R, CCG6020, CCG6020C, CCG6020R, CCG6040, CCG6040C, CCG6040R, CCG7020, CCG7020C, CCG7020R, CCG7021, CCG7021C, CCG7021R, CCG7040, CCG7040C, CCG7040LR, CCG7040LRC, CCG7040R, CCG7041, CCG7041C, CCG7041LR, CCG7041LRC, CCG7041R, CCG7220R, CCG7221, CCG7221C, CCG7240, CCG7240C, CCG7240LR, CCG7240LRC, CCG7240R, CCG7241, CCG7241C...(Other models you can see in the webshop)		

			
1			
GEV No.	105256	Ref. No.	0100279 SIR0100279
description	bar burner tilting bratt pan		
For models:	CBG7050, CBG7050C, SG74CRM, SG74IRM		

tube burners

			
1			
GEV No.	105544	Ref. No.	0108045 SIR0108045
description	tubular burner for fryer oval		
For models:	CFG70115, CFG70215, CFG72215, CFG90120, CFG90210, CFG90210S, CFG90220, FG92210, FGY2210		

			
1			
GEV No.	105528	Ref. No.	0108046 SIR0108046
description	tubular burner L 295mm W 55mm H 70mm mounting pos. centre/right for fryer oval		
For models:	CFG70115, CFG70215, CFG72215, CFG90120, CFG90220		

			
1			
GEV No.	105261	Ref. No.	0109016 SIR0109016
description	tubular burner ø 74mm L 180mm W 75mm H 60mm for fryer round		
For models:	CFG60110, CFG60210		







solid top burners

			
GEV No.	105251	Ref. No.	0100294 SIO100294 SIR0100294
description	solid top burner ø 120mm H 102mm L 340mm		
For models:	CTT1041, CTT1042, CTT1045, CTT7040, CTT7041, CTT7042, CTT7045, CTT70652L, CTT70653L, CTT72653L, CTT9040, CTT9041, CTT9042, CTT9045, CTT9046, CTT90652R, CTT90663R, ETG94A, ETG94AL, ETG94F, ETG94FL, ETG94G, ETG94GL, ETG94T, ETG94TPL, ETG96F, ETG96FC, ETG96FL, TG74APS, TG74FPS, TG74GPS, TG74TPS, TG76FPS, TG94APS, TG94EPS, TG94FPS, TG94GPS, TG96FPS, TGP4APS, TGP4FPS, TGP4GPS, TGY4TPS		

			
GEV No.	105534	Ref. No.	0100282 SIO100282 SIR0100282
description	solid top burner ø 122mm H1 27mm H2 63mm L 285mm		
For models:	CTT652L, CTT653L, CTT7040L, CTT7040R, CTT7041L, CTT7041R, CTT7042L, CTT7042R, CTT7045L, CTT7045R, CTT70652, CTT70653, CTT72653, TG74APL, TG74APR, TG74FPL, TG74GPL, TG74GPR, TG74TPL, TG74TPR, TG76FPC		
accessories for	105534		
	GEV No.	101278	Ref. No.
			0100775 86720 MA86720 SIR0100775
	olive for pipe ø 10mm Qty 1 pcs		
	GEV No.	101300	Ref. No.
			0100774 SIR0100774
	union nut thread M16x1.5 tube ø 10mm		
	GEV No.	102773	Ref. No.
			0101046 SIR0101046
	gas injector thread M10x1 WS 11 bore ø 1.65mm G20-25		
	GEV No.	106285	Ref. No.
			0100907 SIO100907 SIR0100907
	gas injector thread M10x1 WS 11 bore ø 1.15mm		
	GEV No.	106503	Ref. No.
			—
	gas injector thread M10x1 WS 11 bore ø 1.1mm		

accessories

nozzle holders

			
GEV No.	104108	Ref. No.	0100767 MA1031504900 SIR0100767
description	nozzle holder nozzle mounting M10x1 tube ø 10mm gas inlet M16x1.5 gas outlet M14x1		
For models:	BG72GLC, BG72GLL, BG72GRR, BG72TLC, BG72TLL, BG72TRR, BG74GLC, BG74GLL, BG74GLR, BG74GMC, BG74GRR, BG74TLC, BG74TLL, BG74TLR, BG74TMC, BG74TRR, CCG1041, CCG1041P, CCG1042, CCG1042P, CCG1045, CCG1045P, CCG1061, CCG1061P, CCG1062, CCG1062P, CCG10652, CCG10652P, CCG10653, CCG1081, CCG1081P, CCG1082, CCG1082P, CCG1085, CCG10852, CCG1085P, CCG6045, CCG7001, CCG7001P, CCG7020, CCG7020P, CCG7021, CCG7021P, CCG7022, CCG7022P, CCG7040, CCG7040P, CCG7041, CCG7041P, CCG7042...(Other models you can see in the webshop)		
accessories for	104108		
	GEV No.	102382	Ref. No.
			—
	nut thread M14x1 H 3.5mm WS 18 brass Qty 1 pcs		
	GEV No.	104105	Ref. No.
			0100206 0100301 SIO100301 SIR0100206 SIR0100301
	burner lower part for burner cap ø 80mm 3.5kW		
	GEV No.	104107	Ref. No.
			0100207 0100302 SIO100302 SIR0100207 SIR0100302
	burner lower part for burner cap ø 100mm 6.4kW		

gas nozzles

main nozzles

gas nozzles M7x1

			
GEV No.	100976	Ref. No.	0101052 SIR0101052
description	gas injector thread M7x1 WS 10 bore ø 0.7mm		
For models:	CCG6020, CCG6040, CCG6045, CCG6046		



1

GEV No.	100517	Ref. No.	0101043 SIR0101043
description	gas injector thread M7x1 WS 10 bore ø 0.8mm		
For models:	CCG6020, CCG6040, CCG6045, CCG6046		



1

GEV No.	100519	Ref. No.	0101044 SIR0101044
description	gas injector thread M7x1 WS 10 bore ø 0.95mm		
For models:	CCG6020, CCG6040, CCG6045, CCG6046		



1

GEV No.	104547	Ref. No.	0101059 SIR0101059
description	gas injector thread M7x1 WS 10 bore ø 1.25mm		
For models:	CCG6020, CCG6040, CCG6045, CCG6046		



1

GEV No.	100520	Ref. No.	0101029 SIR0101029
description	gas injector thread M7x1 WS 10 bore ø 1.2mm		



1

GEV No.	100523	Ref. No.	0101038 SIR0101038
description	gas injector thread M7x1 WS 10 bore ø 1.4mm		



1

GEV No.	104548	Ref. No.	0101058 SIR0101058
description	gas injector thread M7x1 WS 10 bore ø 1.5mm		
For models:	CCG6020, CCG6040, CCG6045, CCG6046		

gas nozzles M9x1



1

GEV No.	100500	Ref. No.	0100917 SIR0100917
description	gas injector thread M9x1 WS 10 bore ø 0.85mm		



1

GEV No.	100501	Ref. No.	0100918 SIR0100918
description	gas injector thread M9x1 WS 10 bore ø 0.95mm		



1

GEV No.	100504	Ref. No.	0100912 SIR0100912
description	gas injector thread M9x1 WS 10 bore ø 1.15mm		



1

GEV No.	100507	Ref. No.	0100940 SIR0100940
description	gas injector thread M9x1 WS 10 bore ø 1.35mm		



1

GEV No.	100508	Ref. No.	0100921 SIR0100921
description	gas injector thread M9x1 WS 10 bore ø 1.45mm		



1

GEV No.	100510	Ref. No.	0100922 SIR0100922
description	gas injector thread M9x1 WS 10 bore ø 1.8mm		





			
1			
GEV No.	100502	Ref. No.	0100919 SIR0100919
description	gas injector thread M9x1 WS 10 bore ø 1mm		

gas nozzles M10x1

			
1			
GEV No.	100635	Ref. No.	0100933 0100955 SI0100955 SIR0100955
description	gas injector thread M10x1 WS 11 bore ø 0.85mm inner peaked		
For models:	CBG7050, CBG7050C, SG74IRM		

			
1			
GEV No.	100646	Ref. No.	0100971 SIR0100971
description	gas injector thread M10x1 WS 11 bore ø 1.2mm inner peaked		

			
1			
GEV No.	100641	Ref. No.	0100953 SIR0100953
description	gas injector thread M10x1 WS 11 bore ø 1.35mm inner peaked		
For models:	CBG7050, CBG7050C, CPD90100, CPD90100A, CPD90100AP, CPD90100A-P, CPD90100P, CPD90150, CPD90150A, CPD90150AP, CPD90150A-P, CPD9015-P, CPI90100, CPI90100A, CPI90100AP, CPI90100A-P, CPI90100P, CPI90100-P, CPI90150, CPI90150A, CPI90150AP, CPI90150A-P, CPI90150P, CPI90150-P, PG9AD10, PG9AD15, PG9AI10, PG9AI15, PG9ND10, PG9ND15, PG9NI10, PG9NI15, SG74IRM		

			
1			
GEV No.	106306	Ref. No.	0100987 0102029 SIR0100987 SIR0102029
description	gas injector thread M10x1 WS 11 bore ø 1.45mm code 145		
For models:	CCG9045P, CCG9046, CCG90652P, CCG90663, CCG9085P, CCG9085-P, CCG9145, CCG9145-1, CCG91652, CCG91652-1, CCG91653, CCG91653-1, CCG9185, CCG9185-1, CCG91852, CCG91852-1, CFS9050, CFS9052, CFS9055, CG94FPS, CG96FPS, CG98FPS, CCG9040, CCG9040C, CCG9040LR, CCG9040LRC, CCG9040R, CCG9040RC, CCG9041, CCG9041C, CCG9041LR, CCG9041LRC, CCG9041R, CG9041RC, CTT9045, CTT90652R, CTT90653R, CTT90663R, HG94FPS, HGY4FPS, TG94FPS, TG96FPS		

			
1			
GEV No.	100642	Ref. No.	0102024 SI0102024 SIR0102024
description	gas injector thread M10x1 WS 11 bore ø 1.4mm inner peaked		
For models:	CBG7050, CBG7050C, CCG7001, CCG7001P, CCG7201, CG76HPS, CG86HPS, PG8AD10, PG8AD15, PG8AI10, PG8AI15, PG8ND10, PG8ND15, PG8NI10, PG8NI15, SG74IRM		

			
1			
GEV No.	106595	Ref. No.	CR0508730
description	gas injector thread M10x1 bore ø 0.83mm L 30mm WS 12		
For models:	EFG72108, EFG73208T		

			
1			
GEV No.	100150	Ref. No.	1491100 MA1491100
description	gas injector thread M10x1 bore ø 0.95mm L 30mm WS 12		
For models:	EFG72108, EFG73208T		

			
1			
GEV No.	100670	Ref. No.	1695400 MA1695400
description	gas injector thread M10x1 bore ø 0.9mm L 30mm WS 12		
For models:	EFG72108, EFG73208T		

			
1			
GEV No.	101974	Ref. No.	2715400 MA2715400
description	gas injector thread M10x1 bore ø 1.35mm L 30mm WS 12		
For models:	BMG-40, BMG-60, CFG62110, CFG62210, EFG72108, EFG72115, EFG73208T, EFG74215, EFG92115, EFG92115S, EFG94215, EFG94215S, FG62T08, FG64T08		

			
1			
GEV No.	100156	Ref. No.	1421700 MA1421700
description	gas injector thread M10x1 bore ø 1.3mm L 30mm WS 12		
For models:	EGL72, EGL74, EPG7D05, EPG7I08, ETG74		

			
1			
GEV No.	100155	Ref. No.	2902500 MA2902500
description	gas injector thread M10x1 bore ø 1.45mm L 30mm WS 12		
For models:	BMG-40, BMG-60, ECG7-FG, ECG94F, ECG96F, ECG96H, ECG98F, EDG72128, EDG74228, EFG72108, EFG73208T, EFG92123, EFG94223, EPG7I05, EPG9D10, EPG9D10A, EPG9D15, EPG9D15A, EPG9I15, EPG9I15A, EPG9I10, EPG9I10A, EPGD05, ETG94F, ETG94FL, ETG96F, ETG96FC, ETG96FL		

			
2			
GEV No.	100816	Ref. No.	2715300 MA2715300
description	gas injector thread M10x1 bore ø 1.5mm WS 12		
For models:	BMG-40, BMG-60, EFG72108, EFG73208T, EFG92123K, EFG94223K, EPG7D05, EPG7I08, ETG74, ETG94A, ETG94AL, ETG94F, ETG94FL, ETG94G, ETG94GL, ETG94T, ETG94TPL, ETG96F, ETG96FC, ETG96FL		

			
1			
GEV No.	100153	Ref. No.	1631200 MA1631200
description	gas injector thread M10x1 bore ø 1.6mm L 30mm WS 12		
For models:	BMG-40, BMG-60, EC-MAXI-OVEN-GAS, EFG72108, EFG72110, EFG73208T, EFG73210, EFG92123K, EFG93210, EFG94223K, EPG7I05, EPGD05		

			
1			
GEV No.	106401	Ref. No.	795800 MA795800
description	gas injector thread M10x1 bore ø 2.2mm L 30mm WS 12		
For models:	BMG-40, BMG-60, EFG72115, EFG74215, EFG92115, EFG92115S, EFG94215, EFG94215S, EGL72, EGL74, ETG74		

			
1			
GEV No.	102702	Ref. No.	0101027 SIR0101027
description	gas injector thread M10x1 WS 11 bore ø 0.85mm		
For models:	CCG6020, CCG6040, CCG6045, CCG6046		

			
1			
GEV No.	102705	Ref. No.	0102011 SIR0102011
description	gas injector thread M10x1 WS 11 bore ø 0.8mm		
For models:	CCG7001, CCG7020, CCG7021, CCG7022, CCG7040, CCG7041, CCG7042, CCG7045, CCG7046, CCG7061, CCG7062, CCG70652, CCG70653, CCG70663, CCG7201, CCG7220, CCG7221, CCG7222, CCG7240, CCG7241, CCG7242, CCG7245, CCG7246, CCG7261, CCG7262, CCG72652, CCG72653, CCG72662, CCG72663, CCG9020, CCG9021, CCG9022, CCG9040, CCG9041, CCG9042, CCG9046, CCG9060, CCG9061, CCG9062, CCG90663, CCG9081, CCG9082, CCG9140, CCG9141, CCG9142, CCG9145, CCG9146, CCG9160, CCG9161, CCG9162...(Other models you can see in the webshop)		

			
1			
GEV No.	100420	Ref. No.	0100909 0102013 SIR0100909 SIR0102013
description	gas injector thread M10x1 WS 11 bore ø 0.95mm		
For models:	CCG1041, CCG1041P, CCG1042, CCG1042P, CCG1045, CCG1045P, CCG1061, CCG1061P, CCG1062, CCG1062P, CCG10652, CCG10652P, CCG10653, CCG1081, CCG1081P, CCG1082, CCG1082P, CCG1085, CCG10852, CCG1085P, CCG6045, CCG7001P, CCG7020P, CCG7021P, CCG7022P, CCG7040P, CCG7041P, CCG7042P, CCG7045P, CCG7046P, CCG7061P, CCG7062P, CCG70652P, CCG70662P, CCG7201, CCG7220, CCG7221, CCG7222, CCG7240, CCG7241, CCG7242, CCG7245, CCG7246, CCG7261, CCG7262, CCG72652, CCG72653, CCG72662, CCG72663, CCG9020...(Other models you can see in the webshop)		

			
1			
GEV No.	106295	Ref. No.	0102010 SIR0102010 SIR0102010
description	gas injector thread M10x1 WS 11 bore ø 0.9mm code 90		
For models:	CCG7001, CCG7001P, CCG7020, CCG7020P, CCG7021, CCG7021P, CCG7022, CCG7022P, CCG7040, CCG7040P, CCG7041, CCG7041P, CCG7042, CCG7042P, CCG7045, CCG7045P, CCG7046, CCG7046P, CCG7061, CCG7061P, CCG7062, CCG7062P, CCG70652, CCG70652P, CCG70653, CCG70662P, CCG70663, CCG7201, CCG7220, CCG7221, CCG7222, CCG7240, CCG7241, CCG7242, CCG7245, CCG7246, CCG7261, CCG7262, CCG72652, CCG72653, CCG72662, CCG72663, CCG9020, CCG9021, CCG9022, CCG9040, CCG9040P, CCG9041, CCG9041P, CCG9042...(Other models you can see in the webshop)		





			
1			
GEV No.	106494	Ref. No.	0100944 SIR0100944
description	gas injector thread M10x1 WS 11 bore ø 1.05mm		
For models:	BG72GLC, BG72GLL, BG72GRR, BG72TLC, BG72TLL, BG72TRR, BG74GLC, BG74GLL, BG74GLR, BG74GMC, BG74GRR, BG74TLC, BG74TLL, BG74TLR, BG74TMC, BG74TRR, CGG7020, CGG7020C, CGG7020R, CGG7021, CGG7021C, CGG7021R, CGG7040, CGG7040C, CGG7040LR, CGG7040LRC, CGG7040R, CGG7041, CGG7041C, CGG7041LR, CGG7041LRC, CGG7041R, CGG7220R, CGG7221, CGG7221C, CGG7240, CGG7240C, CGG7240LR, CGG7240LRC, CGG7240R, CGG7241, CGG7241C, CGG7241LR, CGG7241R		

			
1			
GEV No.	102704	Ref. No.	0101034 SIO101034 SIR0101034
description	gas injector thread M10x1 WS 11 bore ø 1.2mm		
For models:	BG72ALL, BG72ARR, BG72GLC, BG72GLL, BG72GRR, BG72TLC, BG72TLL, BG72TRR, BG74ALL, BG74ALR, BG74ARC, BG74GLC, BG74GLL, BG74GLR, BG74GMC, BG74GRR, BG74TLC, BG74TLL, BG74TLR, BG74TMC, BG74TRR, BG92ALC, BG92ALL, BG92ARC, BG92ARR, BG92GLC, BG92GLL, BG92GRC, BG92GRR, BG94ALC, BG94ALL, BG94ALR, BG94AMC, BG94ARC, BG94ARR, BG94GLC, BG94GLL, BG94GLR, BG94GMC, BG94GRC, BG94GRR, BGY2TLC, BGY2TLL, BGY2TRC, BGY2TRR, BGY4TLC, BGY4TLL, BGY4TLR, BGY4TMC, BGY4TRC... (Other models you can see in the webshop)		

			
2			
GEV No.	106285	Ref. No.	0100907 SIO100907 SIR0100907
description	gas injector thread M10x1 WS 11 bore ø 1.15mm		
For models:	BG94ALC, BG94ALL, BG94ALR, BG94AMC, BG94ARC, BG94ARR, BG94GLC, BG94GLL, BG94GLR, BG94GMC, BG94GRC, BG94GRR, BGY4TLC, BGY4TLL, BGY4TLR, BGY4TMC, BGY4TRC, BGY4TRR, CCG1041, CCG1041P, CCG1042, CCG1042P, CCG1045, CCG1045P, CCG1061, CCG1061P, CCG1062, CCG1062P, CCG10652, CCG10652P, CCG10653, CCG1081, CCG1081P, CCG1082, CCG1082P, CCG1085, CCG1085P, CCG7001, CCG7001P, CCG7020, CCG7020P, CCG7021, CCG7021P, CCG7022, CCG7022P, CCG7040, CCG7040P, CCG7041, CCG7041P... (Other models you can see in the webshop)		

			
1			
GEV No.	106296	Ref. No.	0101019 SIO101019 SIR0101019
description	gas injector thread M10x1 WS 11 bore ø 1.3mm code 130		
For models:	BG92ALC, BG92ALL, BG92ARC, BG92ARR, BG92GLC, BG92GLL, BG92GRC, BG92GRR, BGY2TLC, BGY2TLL, BGY2TRC, BGY2TRR, CCG1041, CCG1041P, CCG1042, CCG1042P, CCG1045, CCG1045P, CCG1061, CCG1061P, CCG1062, CCG1062P, CCG10652, CCG10652P, CCG10653, CCG1081, CCG1081P, CCG1082, CCG1082P, CCG1085, CCG1085P, CCG10852, CCG1085P, CCG9020, CCG9020P, CCG9021, CCG9021P, CCG9022, CCG9022P, CCG9040, CCG9040P, CCG9041, CCG9041P, CCG9042, CCG9042P, CCG9045P, CCG9046, CCG9046P, CCG9060, CCG9060P, CCG9061... (Other models you can see in the webshop)		

			
1			
GEV No.	106490	Ref. No.	0109074 SIR0109074
description	gas injector thread M10x1 WS 11 bore ø 1.25mm		
For models:	BG92ALC, BG92ALL, BG92ARC, BG92ARR, BG92GLC, BG92GLL, BG92GRC, BG92GRR, BG94ALC, BG94ALL, BG94ALR, BG94AMC, BG94ARC, BG94ARR, BG94GLC, BG94GLL, BG94GLR, BG94GMC, BG94GRC, BG94GRR, BGY2TLC, BGY2TLL, BGY2TRC, BGY2TRR, BGY4TLC, BGY4TLL, BGY4TLR, BGY4TMC, BGY4TRC, BGY4TRR, CGG6030, CGG6030C, CGG6030R, CGG9020-0, CGG9020-1, CGG9020-2, CGG9020-3, CGG9021-0, CGG9021-1, CGG9021-2, CGG9021-3, CGG9022-0, CGG9022-1, CGG9022-2, CGG9022-3, CGG9040-0, CGG9040-1, CGG9040-2, CGG9040-3, CGG9040-4... (Other models you can see in the webshop)		

			
1			
GEV No.	102774	Ref. No.	0100905 SIO100905 SIR0100905
description	gas injector thread M10x1 WS 11 bore ø 1.45mm		
For models:	CCG7001, CCG7020, CCG7021, CCG7022, CCG7040, CCG7041, CCG7042, CCG7045, CCG7046, CCG7061, CCG7062, CCG70652, CCG70653, CCG70663, CCG7201, CCG7220, CCG7221, CCG7222, CCG7240, CCG7241, CCG7242, CCG7245, CCG7246, CCG7261, CCG7262, CCG72652, CCG72653, CCG72662, CCG72663, CCG9020, CCG9021, CCG9022, CCG9040, CCG9041, CCG9042, CCG9046, CCG9060, CCG9061, CCG9062, CCG90663, CCG9081, CCG9082, CCG9140, CCG9141, CCG9142, CCG9145, CCG9146, CCG9160, CCG9161, CCG9162... (Other models you can see in the webshop)		

			
1			
GEV No.	102706	Ref. No.	0101054 SIR0101054
description	gas injector thread M10x1 WS 11 bore ø 1.55mm		
For models:	CCG6020, CCG6040, CCG6045, CCG6046		



GEV No.	102773	Ref. No.	0101046 SIR0101046
description	gas injector thread M10x1 WS 11 bore ø 1.65mm G20-25		
For models:	CTT652L, CTT653L, CTT7040, CTT7040L, CTT7040R, CTT7041, CTT7041L, CTT7041R, CTT7042, CTT7042L, CTT7042R, CTT7045L, CTT7045R, CTT70652, CTT70652L, CTT70653, CTT70653L, TG74APL, TG74APR, TG74FPL, TG74GPL, TG74GPR, TG74TPL, TG74TPR, TG76FPC		



GEV No.	106493	Ref. No.	0100932 SIO100932 SIR0100932
description	gas injector thread M10x1 WS 11 bore ø 1.75mm		
For models:	CCG1041P, CCG1042P, CCG1045P, CCG1061P, CCG1062P, CCG10652P, CCG1081P, CCG1082P, CCG1085P, CCG7001P, CCG7020P, CCG7021P, CCG7022P, CCG7040P, CCG7041P, CCG7042P, CCG7045P, CCG7046P, CCG7061P, CCG7062P, CCG70652P, CCG70662P, CCG9020P, CCG9021P, CCG9022P, CCG9040P, CCG9041P, CCG9042P, CCG9045P, CCG9046P, CCG9060P, CCG9061P, CCG9062P, CCG90652P, CCG90662P, CCG9081P, CCG9082P, CCG9085P, CCG9085-P, CG72APS, CG72GPS, CG72TPS, CG74APS, CG74EPS, CG74FPS, CG74GPS, CG74TPS, CG76APS, CG76EPS, CG76FPS...(Other models you can see in the webshop)		



GEV No.	106440	Ref. No.	0100906 SIR0100906
description	gas injector thread M10x1 WS 11 bore ø 1.85mm		
For models:	CCG1041, CCG1042, CCG1045, CCG1061, CCG1062, CCG10652, CCG10653, CCG1081, CCG1082, CCG1085, CCG10852, CCG7001, CCG7020, CCG7021, CCG7022, CCG7040, CCG7041, CCG7042, CCG7045, CCG7046, CCG7061, CCG7062, CCG70652, CCG70653, CCG70663, CCG7201, CCG7220, CCG7221, CCG7222, CCG7240, CCG7241, CCG7242, CCG7245, CCG7246, CCG7261, CCG7262, CCG72652, CCG72653, CCG72662, CCG72663, CCG9020, CCG9021, CCG9022, CCG9040, CCG9041, CCG9042, CCG9046, CCG9060, CCG9061, CCG9062...(Other models you can see in the webshop)		



GEV No.	102984	Ref. No.	0102012 SIR0102012
description	gas injector thread M10x1 WS 11 bore ø 1.8mm		
For models:	CCG1041, CCG1041P, CCG1042, CCG1042P, CCG1045, CCG1045P, CCG1061, CCG1061P, CCG1062, CCG1062P, CCG10652, CCG10652P, CCG10653, CCG1081, CCG1081P, CCG1082, CCG1082P, CCG1085, CCG10852, CCG1085P, CCG6045, CCG7001, CCG7001P, CCG7020, CCG7020P, CCG7021, CCG7021P, CCG7022, CCG7022P, CCG7040, CCG7040P, CCG7041, CCG7041P, CCG7042, CCG7042P, CCG7045, CCG7045P, CCG7046, CCG7046P, CCG7061, CCG7061P, CCG7062, CCG7062P, CCG70652, CCG70652P, CCG70653, CCG70662P, CCG70663, CCG7201, CCG7220...(Other models you can see in the webshop)		



GEV No.	106498	Ref. No.	0109075 SIR0109075
description	gas injector thread M10x1 WS 11 bore ø 1.95mm		
For models:	BG72GLC, BG72GLL, BG72GRR, BG72TLC, BG72TLL, BG72TRR, BG74GLC, BG74GLL, BG74GLR, BG74GMC, BG74GRR, BG74TLC, BG74TLL, BG74TLR, BG74TMC, BG74TRR, CCG6045, CGE6020, CGE6020R, CCG6020, CCG6020C, CCG6020R, CCG6040, CCG6040C, CCG6040R, CCG7020, CCG7020C, CCG7020R, CCG7021, CCG7021C, CCG7021R, CCG7040, CCG7040C, CCG7040LR, CCG7040LRC, CCG7040R, CCG7041, CCG7041C, CCG7041LR, CCG7041LRC, CCG7041R, CCG7220R, CCG7221, CCG7221C, CCG7240, CCG7240C, CCG7240LR, CCG7240LRC, CCG7240R, CCG7241...(Other models you can see in the webshop)		



GEV No.	102703	Ref. No.	0102030 SIO102030 SIR0102030
description	gas injector thread M10x1 WS 11 bore ø 1.9mm		
For models:	BG72GLC, BG72GLL, BG72GRR, BG72TLC, BG72TLL, BG72TRR, BG74GLC, BG74GLL, BG74GLR, BG74GMC, BG74GRR, BG74TLC, BG74TLL, BG74TLR, BG74TMC, BG74TRR, CCG1041P, CCG1042P, CCG1045P, CCG1061P, CCG1062P, CCG10652P, CCG1081P, CCG1082P, CCG1085P, CCG7001P, CCG7020P, CCG7021P, CCG7022P, CCG7040P, CCG7041P, CCG7042P, CCG7045P, CCG7046P, CCG7061P, CCG7062P, CCG70652P, CCG70662P, CCG9020P, CCG9021P, CCG9022P, CCG9040P, CCG9041P, CCG9042P, CCG9045P, CCG9046P, CCG9060P, CCG9061P, CCG9062P, CCG90652P...(Other models you can see in the webshop)		



GEV No.	106284	Ref. No.	0101012 SIO101012 SIR0101012
description	gas injector thread M10x1 WS 11 bore ø 2.15mm		
For models:	CCG7045P, CCG70652P, CCG7245, CCG72652, CCG72653, CG74FPS, CG76FPS, CG84FPS, CG86FPS, CG88APS, CG88FPS, CG88GPS, CTT7045, CTT7045L, CTT7045R, CTT70652, CTT70652L, CTT72653, CTT72653L, TG74FPL, TG74FPR, TG74FPS, TG76FPC, TG76FPS, TG84FPS		





GEV No.	106495	Ref. No.	0101021 SIR0101021
description	gas injector thread M10x1 WS 11 bore ø 2.25mm		
For models:	BG94ALC, BG94ALL, BG94ALR, BG94AMC, BG94ARC, BG94ARR, BG94GLC, BG94GLL, BG94GLR, BG94GMC, BG94GRC, BG94GRR, BGY4TLC, BGY4TLL, BGY4TLR, BGY4TMC, BGY4TRC, BGY4TRR, CCG6030, CCG6030C, CCG6030R, CCG9040-0, CCG9040-1, CCG9040-2, CCG9040-3, CCG9040-4, CCG9040-5, CCG9041-0, CCG9041-1, CCG9041-2, CCG9041-3, CCG9041-4, CCG9041-5, CCG9042-0, CCG9042-1, CCG9042-2, CCG9042-3, CCG9042-4, CCG9042-5		



			
1			
GEV No.	106496	Ref. No.	0102014 SIR0102014
description	gas injector thread M10x1 WS 11 bore ø 2.2mm		
For models:	CCG1041, CCG1041P, CCG1042, CCG1042P, CCG1045, CCG1045P, CCG1061, CCG1061P, CCG1062, CCG1062P, CCG10652, CCG10652P, CCG10653, CCG1081, CCG1081P, CCG1082, CCG1082P, CCG1085, CCG10852, CCG1085P, CCG7045P, CCG70652P, CCG7245, CCG72652, CCG72653, CCG9020, CCG9020P, CCG9021, CCG9021P, CCG9022, CCG9022P, CCG9040, CCG9040P, CCG9041, CCG9041P, CCG9042, CCG9042P, CCG9045P, CCG9046, CCG9046P, CCG9060, CCG9060P, CCG9061, CCG9061P, CCG9062, CCG9062P, CCG90652P, CCG90662P, CCG90663, CCG9081...(Other models you can see in the webshop)		

			
1			
GEV No.	100472	Ref. No.	0100931 522111 MA522111 SIR0100931
description	gas injector thread M10x1 WS 12 bore ø 1.4mm		
For models:	CCG7001P, CCG7020P, CCG7021P, CCG7022P, CCG7040P, CCG7041P, CCG7042P, CCG7045P, CCG7046P, CCG7061P, CCG7062P, CCG70652P, CCG70662P, CCG7245, CCG72652, CCG72653, CCG9040P, CCG9041P, CCG9042P, CCG9045P, CCG9046P, CCG9060P, CCG9061P, CCG9062P, CCG90652P, CCG90662P, CCG9081P, CCG9082P, CCG9085P, CCG9085-P, CG72APS, CG72GPS, CG72TPS, CG74APS, CG74EPS, CG74FPS, CG74G-PS, CG74TPS, CG76APS, CG76EPS, CG76FPS, CG76GPS, CG76HPS, CG84APS, CG84EPS, CG84FPS, CG84GPS, CG84TPS, CG86APS, CG86F-PS...(Other models you can see in the webshop)		

			
1			
GEV No.	100794	Ref. No.	0101036 SIR0101036
description	gas injector thread M10x1 WS 11 bore ø 2.35mm natural gas gas pressure 20mbar		
For models:	CCG7045P, CCG70652P, CCG7245, CCG72652, CCG72653, CG74F-PS, CG76FPS, CG84FPS, CG86FPS, CG88APS, CG88FPS, CG88GPS, CTT7045, CTT7045L, CTT7045R, CTT70652, CTT70652L, CTT72653, CTT72653L, TG74FPL, TG74FPR, TG74FPS, TG76FPC, TG76FPS, TG84FPS		

			
1			
GEV No.	100484	Ref. No.	523411 MA523411
description	gas injector thread M10x1 WS 12 bore ø 2.05mm		
For models:	CRG6220, CRG6240, EVGV7, GG62TGP, GG64TGP		

			
1			
GEV No.	106497	Ref. No.	0109073 SIR0109073
description	gas injector thread M10x1 WS 11 bore ø 2.4mm		
For models:	CGG6030, CGG6030C, CGG6030R, CNG90140, CNG90140-S, CNG90240, DG92140, DG94240		

			
1			
GEV No.	100485	Ref. No.	523711 MA523711
description	gas injector thread M10x1 WS 12 bore ø 2.2mm		
For models:	CRG6220, CRG6240, EBG7, EBG92AL, EBG92AR, EBG92GL, EBG92GR, EBG92TL, EBG92TR, EBG93AL, EBG93ALR, EBG93GL, EBG93GLR, EBG93TL, EBG93TLR, EBG94AL, EBG94ALR, EBG94AR, EBG94GL, EBG94GLR, EBG94GR, EBG94TL, EBG94TLR, EBG94TR, EVGV7, GG62TGP, GG64TGP		

			
1			
GEV No.	100469	Ref. No.	0105133 521611 MA521611 SIR0105133
description	gas injector thread M10x1 WS 12 bore ø 1.15mm		
For models:	CCG6245-1, CCG62652-1, CG64FPS, CG66FPS, CRG6220, CRG6240, EBG7, EBG92AL, EBG92AR, EBG92GL, EBG92GR, EBG92TL, EBG92TR, EBG93AL, EBG93ALR, EBG93GL, EBG93GLR, EBG93TL, EBG93TLR, EBG94AL, EBG94ALR, EBG94AR, EBG94GL, EBG94GLR, EBG94GR, EBG94TL, EBG94TLR, EBG94TR, ECG7, FG82122, FG84222, FG92122, FG94222, FGY2122, FGY4222, GG62TGP, GG64TGP		

			
1			
GEV No.	100489	Ref. No.	CR0586800
description	gas injector thread M10x1 WS 12 bore ø 2.6mm		
For models:	ECG92A, ECG92G, ECG92T, ECG94A, ECG94E, ECG94F, ECG94G, ECG94T, ECG96A, ECG96E, ECG96F, ECG96G, ECG96H, ECG96T, ECG98A, ECG98F, ECG98G		

			
1			
GEV No.	100483	Ref. No.	523311 MA523311
description	gas injector thread M10x1 WS 12 bore ø 2mm		
For models:	EBG7, EBG92AL, EBG92AR, EBG92GL, EBG92GR, EBG92TL, EBG92TR, EBG93AL, EBG93ALR, EBG93GL, EBG93GLR, EBG93TL, EBG93TLR, EBG94AL, EBG94ALR, EBG94AR, EBG94GL, EBG94GLR, EBG94GR, EBG94TL, EBG94TLR, EBG94TR		

			
1			
GEV No.	102819	Ref. No.	0102034 SIR0102034
description	gas injector thread M10x1 WS 12 bore ø 1.1mm		
For models:	CCG6045, CGE6020, CGE6020R, CGG6020, CGG6020C, CGG6020R, CGG6040, CGG6040C, CGG6040R		

pilot burner nozzles

pilot burner nozzles POLIDORO

			
1			
GEV No.	100209	Ref. No.	0101048 SI0101048 SIR0101048
description	pilot burner nozzle POLIDORO natural gas code 40 bore ø 0.4mm Qty 1 pcs		
For models:	CCG1045, CCG1045P, CCG10652, CCG10652P, CCG10653, CCG1085, CCG10852, CCG1085P, CCG7001, CCG7001P, CCG7201, CCG9045P, CCG9046, CCG90652P, CCG90663, CCG9085P, CCG9085-P, CCG9145, CCG9145-1, CCG91652, CCG91652-1, CCG91653, CCG91653-1, CCG9185, CCG9185-1, CCG91852, CCG91852-1, CFS9050, CFS9052, CFS9055, CG76HPS, CG86HPS, CG94FPS, CG96FPS, CG98FPS, CGG9020, CGG9020C, CGG9020R, CGG9020RC, CGG9021, CGG9021C, CGG9021R, CGG9021RC, CGG9040, CGG9040C, CGG9040LR, CGG9040LRC, CGG9040R, CGG9040RC, CGG9041...(Other models you can see in the webshop)		

pilot burner nozzles SIT

100 series

			
1			
GEV No.	100245	Ref. No.	0100829 1415100 MA1415100 SIR0100829
description	pilot burner nozzle LPG code 20 bore ø 0.2mm Qty 1 pcs thread M8x0.75		
For models:	BG92ALC, BG92ALL, BG92ARC, BG92ARR, BG92GLC, BG92GLL, BG92GRC, BG92GRR, BG94ALC, BG94ALL, BG94ALR, BG94AMC, BG94ARC, BG94ARR, BG94GLC, BG94GLL, BG94GLR, BG94GMC, BG94GRC, BG94GRR, BGY2TLC, BGY2TLL, BGY2TRC, BGY2TRR, BGY4TLC, BGY4TLL, BGY4TLR, BGY4TMC, BGY4TRC, BGY4TRR, CBG7050, CBG7050C, CBG9060CP, CBG9060P, CCG1041P, CCG1042P, CCG1045P, CCG1061P, CCG1062P, CCG10652P, CCG1081P, CCG1082P, CCG1085P, CCG6045, CCG7001P, CCG7020P, CCG7021P, CCG7022P, CCG7040P, CCG7041P...(Other models you can see in the webshop)		

			
1			
GEV No.	102972	Ref. No.	0100823 1996200 CRO684580 MA1996200 SIR0100823
description	pilot burner nozzle natural gas code 40 bore ø 0.4mm Qty 1 pcs		
For models:	BG92ALC, BG92ALL, BG92ARC, BG92ARR, BG92GLC, BG92GLL, BG92GRC, BG92GRR, BG94ALC, BG94ALL, BG94ALR, BG94AMC, BG94ARC, BG94ARR, BG94GLC, BG94GLL, BG94GLR, BG94GMC, BG94GRC, BG94GRR, BGY2TLC, BGY2TLL, BGY2TRC, BGY2TRR, BGY4TLC, BGY4TLL, BGY4TLR, BGY4TMC, BGY4TRC, BGY4TRR, CBG7050, CBG7050C, CBG9060CP, CBG9060P, CCG6045, CCG7045P, CCG70652P, CCG7245, CCG72652, CCG72653, CG74FPS, CG76FPS, CG84FPS, CG86FPS, CG88APS, CG88FPS, CG88GPS, CGG9020-0, CGG9020-1, CGG9020-2...(Other models you can see in the webshop)		

			
1			
GEV No.	107171	Ref. No.	0101153 0105143 1842300 MA1842300 SIR0101153 SIR0105143
description	pilot burner nozzle SIT natural/liquid gas bore ø 0.25mm Qty 1 pcs		
For models:	CCG1041P, CCG1042P, CCG1045P, CCG1061P, CCG1062P, CCG10652P, CCG1081P, CCG1082P, CCG1085P, CCG7001P, CCG7020P, CCG7021P, CCG7022P, CCG7040P, CCG7041P, CCG7042P, CCG7045P, CCG7046P, CCG7061P, CCG7062P, CCG70652P, CCG70662P, CCG9020P, CCG9021P, CCG9022P, CCG9040P, CCG9041P, CCG9042P, CCG9045P, CCG9046P, CCG9060P, CCG9061P, CCG9062P, CCG90652P, CCG90662P, CCG9081P, CCG9082P, CCG9085P, CCG9085-P, CG72APS, CG72GPS, CG72TPS, CG74APS, CG74EPS, CG74FPS, CG74GPS, CG74TPS, CG76APS, CG76EPS, CG76FPS...(Other models you can see in the webshop)		

140/150 series

			
1			
GEV No.	100204	Ref. No.	1888000 MA1888000
description	pilot burner nozzle SIT LPG code 14 bore ø 0.18/0.20mm Qty 1 pcs suitable for 140 series		
For models:	CRG6220, CRG6240, EBG7, EBG7-CROMO, EBG92AL, EBG92ALC, EBG92AR, EBG92ARC, EBG92GL, EBG92GLC, EBG92GR, EBG92GRC, EBG92TL, EBG92TLC, EBG92TR, EBG92TRC, EBG93AL, EBG93ALC, EBG93ALR, EBG93AMC, EBG93GL, EBG93GLC, EBG93GLR, EBG93GMC, EBG93TL, EBG93TLC, EBG93TLR, EBG93TMC, EBG94AL, EBG94ALC, EBG94ALR, EBG94AMC, EBG94AR, EBG94GL, EBG94GLC, EBG94GLR, EBG94GMC, EBG94GR, EBG94TL, EBG94TLC, EBG94TLR, EBG94TMC, EBG94TR, EDG73142, EGL72, EGL74, ESG74, ESG94CRA, ESG94CRM, ESG94FRA...(Other models you can see in the webshop)		

			
1			
GEV No.	100205	Ref. No.	1033722000 BN822140380 MA1033722000
description	pilot burner nozzle SIT LPG code 19 bore ø 0.23/0.26mm Qty 1 pcs suitable for SIT 150 series		
For models:	BG62TLC, BG62TLL, BG62TRR, BG63TLC, BG63TLL, BG63TLR, BG64TLC, BG64TLL, BG64TLR, CGG6220, CGG6220C, CGG6220R, CGG6230, CGG6230C, CGG6230LR, CGG6240, CGG6240C, CGG6240LR		



			
GEV No.	100207	Ref. No.	1887800 MA1887800
description	pilot burner nozzle SIT natural gas code 27 bore ø 0.40/0.38mm suitable for SIT 140 series		
For models:	BG62TLC, BG62TLL, BG62TRR, BG63TLC, BG63TLL, BG63TLR, BG64TLC, BG64TLL, BG64TLR, BG72ALL, BG72ARR, BG72GLL, BG72GRR, BG72TLL, BG72TRR, BG74ALL, BG74ALR, BG74ARC, BG74GLL, BG74GLR, BG74GRR, BG74TLL, BG74TLR, BG74TRR, CGG6220, CGG6220C, CGG6220R, CGG6230, CGG6230C, CGG6230LR, CGG6240, CGG6240C, CGG6240LR, CRG6220, CRG6240, EBG7, EBG7-CROMO, EBG92AL, EBG92ALC, EBG92AR, EBG92ARC, EBG92GL, EBG92GLC, EBG92GR, EBG92GRC, EBG92TL, EBG92TLC, EBG92TR, EBG92TRC, EBG93AL... (Other models you can see in the webshop)		

			
GEV No.	107650	Ref. No.	0100802 CR0410100 SIR0100802
description	pilot burner nozzle SIT LPG code 30 Qty 1 pcs		
For models:	ECG7, ECG92A, ECG92G, ECG92T, ECG94A, ECG94E, ECG94F, ECG94G, ECG94T, ECG96A, ECG96E, ECG96F, ECG96G, ECG96H, ECG96T, ECG98A, ECG98F, ECG98G, EDG92142, EDG93142, EDG94242, EFG72108, EFG72110, EFG72115, EFG73208T, EFG73210, EFG74215, EFG92115, EFG92115S, EFG92123, EFG92123K, EFG93210, EFG94215, EFG94215S, EFG94223, EFG94223K, EPG9D10, EPG9D10A, EPG9D15, EPG9D15A, EPG9115, EPG9115A, EPG9110, EPG9110A		

			
GEV No.	103288	Ref. No.	1887900 MA1887900
description	pilot burner nozzle SIT natural gas code 50 bore ø 0.50mm suitable for 140 series		
For models:	CRG6220, CRG6240, EDG73142, EGL72, EGL74, ETG74, ETG74GL-R, ETG94A, ETG94AL, ETG94F, ETG94FL, ETG94G, ETG94GL, ETG94T, ETG94TPL, ETG96F, ETG96FC, ETG96FL, GG62TGP, GG64TGP		

			
GEV No.	107174	Ref. No.	0100803 1033719700 MA1033719700 SIR0100803
description	pilot burner nozzle SIT natural gas code 41 Qty 1 pcs		
For models:	CCG6220/1, CCG6230/1, CCG6245-1, CCG62652-1, CG62TPS, CG64FPS, CG64TPS, CG66FPS, ECG7-FG, ECG94F, ECG96F, ECG96H, ECG98F, EC-MAXI-OVEN-GAS, EDG92142, EDG93142, EDG94242, EFG72108, EFG72110, EFG72115, EFG73208T, EFG73210, EFG74215, EFG92115, EFG92115S, EFG92123, EFG92123K, EFG93210, EFG94215, EFG94215S, EFG94223, EFG94223K, EPG7D05, EPG7105, EPG7108, EPG9D10, EPG9D10A, EPG9D15, EPG9D15A, EPG9115, EPG9115A, EPG9110, EPG9110A, EPGD05, ETG94F, ETG94FL, ETG96F, ETG96FC, ETG96FL		

160 series

			
GEV No.	107649	Ref. No.	1033719600 MA1033719600
description	pilot burner nozzle SIT LPG code 20 Qty 1 pcs		
For models:	CCG6220/1, CCG6230/1, CCG6245-1, CCG62652-1, CG62TPS, CG64FPS, CG64TPS, CG66FPS, ECG7, ECG7-FG, ECG92A, ECG92G, ECG92T, ECG94A, ECG94E, ECG94F, ECG94G, ECG94T, ECG96A, ECG96E, ECG96F, ECG96G, ECG96H, ECG96T, ECG98A, ECG98F, ECG98G, EPG7D05, EPG7105, EPG7108, EPGD05, ETG94F, ETG94FL, ETG96F, ETG96FC, ETG96FL		

bypass nozzles

bypass nozzles PEL20/21

			
GEV No.	100554	Ref. No.	0102059 BN6A023722 SIR0102059
description	bypass nozzle type PEL20/21 bore ø 0.45mm thread M5x0.5		

			
GEV No.	107172	Ref. No.	1874700 MA1874700
description	pilot burner nozzle SIT LPG code 25 Qty 1 pcs		
For models:	ECG7-FG, ECG94F, ECG96F, ECG96H, ECG98F, EC-MAXI-OVEN-GAS, EDG92142, EDG93142, EDG94242, EFG72108, EFG72110, EFG72115, EFG73208T, EFG73210, EFG74215, EFG92115, EFG92115S, EFG92123, EFG92123K, EFG93210, EFG94215, EFG94215S, EFG94223, EFG94223K, EPG7D05, EPG7105, EPG7108, EPG9D10, EPG9D10A, EPG9D15, EPG9D15A, EPG9115, EPG9115A, EPG9110, EPG9110A, EPGD05, ETG94F, ETG94FL, ETG96F, ETG96FC, ETG96FL		

			
GEV No.	100548	Ref. No.	CR0586840
description	bypass nozzle type PEL20/21 bore ø 0.65mm thread M5x0.5		
For models:	ECG7, ECG92A, ECG92G, ECG92T, ECG94A, ECG94E, ECG94F, ECG94G, ECG94T, ECG96A, ECG96E, ECG96F, ECG96G, ECG96H, ECG96T, ECG98A, ECG98F, ECG98G		

			
GEV No.	100551	Ref. No.	0102063 BN41822450520 SIRO102063
description	bypass nozzle type PEL20/21 bore ø 0.6mm thread M5x0.5		
For models:	CCG1041, CCG1041P, CCG1042, CCG1042P, CCG1045, CCG1045P, CCG1061, CCG1061P, CCG1062, CCG1062P, CCG10652, CCG10652P, CCG10653, CCG1081, CCG1081P, CCG1082, CCG1082P, CCG1085, CCG10852, CCG1085P, CCG7001, CCG7001P, CCG7020, CCG7020P, CCG7021, CCG7021P, CCG7022, CCG7022P, CCG7040, CCG7040P, CCG7041, CCG7041P, CCG7042, CCG7042P, CCG7045, CCG7045P, CCG7046, CCG7046P, CCG7061, CCG7061P, CCG7062, CCG7062P, CCG70652, CCG70652P, CCG70653, CCG70662P, CCG70663, CCG7201, CCG7220, CCG7221...(Other models you can see in the webshop)		

			
GEV No.	100552	Ref. No.	0102067 1884200 MA1884200 SIRO102067
description	bypass nozzle type PEL20/21 bore ø 0.7mm thread M5x0.5		
For models:	CCG1041, CCG1041P, CCG1042, CCG1042P, CCG1045, CCG1045P, CCG1061, CCG1061P, CCG1062, CCG1062P, CCG10652, CCG10652P, CCG10653, CCG1081, CCG1081P, CCG1082, CCG1082P, CCG1085, CCG10852, CCG1085P, CCG6245-1, CCG62652-1, CCG7001, CCG7020, CCG7021, CCG7022, CCG7040, CCG7041, CCG7042, CCG7045, CCG7046, CCG7061, CCG7062, CCG70652, CCG70653, CCG70663, CCG7201, CCG7220, CCG7221, CCG7222, CCG7240, CCG7241, CCG7242, CCG7245, CCG7246, CCG7261, CCG7262, CCG72652, CCG72653, CCG72662...(Other models you can see in the webshop)		

			
GEV No.	100528	Ref. No.	1033720200 1889000 MA1033720200 MA1889000
description	bypass nozzle type PEL20/21 bore ø 0.9mm thread M5x0.5		
For models:	CCG6245-1, CCG62652-1, CG64FPS, CG66FPS, CRG6220, CRG6240, ECG7, ECG92A, ECG92G, ECG92T, ECG94A, ECG94E, ECG94F, ECG94G, ECG94T, ECG96A, ECG96E, ECG96F, ECG96G, ECG96H, ECG96T, ECG98A, ECG98F, ECG98G, EGL72, EGL74, GG62TGP, GG64TGP		

			
GEV No.	100530	Ref. No.	0102061 SI0102061 SIRO102061
description	bypass nozzle type PEL20/21 bore ø 1.1mm thread M5x0.5		
For models:	CCG1041, CCG1042, CCG1045, CCG1061, CCG1062, CCG10652, CCG10653, CCG1081, CCG1082, CCG1085, CCG10852, CCG7001, CCG7020, CCG7021, CCG7022, CCG7040, CCG7041, CCG7042, CCG7045, CCG7046, CCG7061, CCG7062, CCG70652, CCG70653, CCG70663, CCG7201, CCG7220, CCG7221, CCG7222, CCG7240, CCG7241, CCG7242, CCG7245, CCG7246, CCG7261, CCG7262, CCG72652, CCG72653, CCG72662, CCG72663, CCG9020, CCG9021, CCG9022, CCG9040, CCG9041, CCG9042, CCG9046, CCG9060, CCG9061, CCG9062...(Other models you can see in the webshop)		

			
GEV No.	100532	Ref. No.	0102065 SIRO102065
description	bypass nozzle type PEL20/21 bore ø 1.2mm thread M5x0.5		
For models:	CCG1041, CCG1042, CCG1045, CCG1061, CCG1062, CCG10652, CCG10653, CCG1081, CCG1082, CCG1085, CCG10852, CCG7001, CCG7020, CCG7021, CCG7022, CCG7040, CCG7041, CCG7042, CCG7045, CCG7046, CCG7061, CCG7062, CCG70652, CCG70653, CCG70663, CCG7201, CCG7220, CCG7221, CCG7222, CCG7240, CCG7241, CCG7242, CCG7245, CCG7246, CCG7261, CCG7262, CCG72652, CCG72653, CCG72662, CCG72663, CCG9020, CCG9021, CCG9022, CCG9040, CCG9041, CCG9042, CCG9046, CCG9060, CCG9061, CCG9062...(Other models you can see in the webshop)		

			
GEV No.	100534	Ref. No.	1883400 MA1883400
description	bypass nozzle type PEL20/21 bore ø 1.4mm thread M5x0.5		
For models:	CRG6220, CRG6240, ETG74GL-R, GG62TGP, GG64TGP		

			
GEV No.	100529	Ref. No.	0102060 1889100 MA1889100 SIRO102060
description	bypass nozzle type PEL20/21 bore ø 1mm thread M5x0.5		
For models:	CCG7001, CCG7020, CCG7021, CCG7022, CCG7040, CCG7041, CCG7042, CCG7045, CCG7046, CCG7061, CCG7062, CCG70652, CCG70653, CCG70663, CCG7201, CCG7220, CCG7221, CCG7222, CCG7240, CCG7241, CCG7242, CCG7245, CCG7246, CCG7261, CCG7262, CCG72652, CCG72653, CCG72662, CCG72663, CCG9020, CCG9021, CCG9022, CCG9040, CCG9041, CCG9042, CCG9046, CCG9060, CCG9061, CCG9062, CCG90663, CCG9081, CCG9082, CCG9140, CCG9141, CCG9142, CCG9145, CCG9146, CCG9160, CCG9161, CCG9162...(Other models you can see in the webshop)		

			
GEV No.	106871	Ref. No.	CR0586570
description	bypass nozzle type PEL20/21 bore ø 2.2mm thread M5x0.5		
For models:	EBG7, EBG92AL, EBG92AR, EBG92GL, EBG92GR, EBG92TL, EBG92TR, EBG93AL, EBG93ALR, EBG93GL, EBG93GLR, EBG93TL, EBG93TLR, EBG94AL, EBG94ALR, EBG94AR, EBG94GL, EBG94GLR, EBG94GR, EBG94TL, EBG94TLR, EBG94TR		

bypass nozzles PEL22			
			
GEV No.	100435	Ref. No.	1884100 MA1884100
description	bypass nozzle type PEL22 bore ø 1.05mm thread M6x0.5		
For models:	EGVG92, EGVG94, ETG74, EGVG7		





			
1			
GEV No.	106870	Ref. No.	CR0683130
description	bypass nozzle type PEL22 bore ø 1.35mm thread M6x0.5		
For models:	ETG94A, ETG94AL, ETG94F, ETG94FL, ETG94G, ETG94GL, ETG94T, ETG94TPL, ETG96F, ETG96FC, ETG96FL		

bypass nozzles PEL23/24			
			
1			
GEV No.	100265	Ref. No.	1883800 MA1883800
description	bypass nozzle type PEL23/24 bore ø 1.8mm thread M8x0.5		
For models:	EGVG92, EGVG94, ETG74, ETG94A, ETG94AL, ETG94F, ETG94FL, ETG94G, ETG94GL, ETG94T, ETG94TPL, ETG96F, ETG96FC, ETG96FL, EVGV7		



auxiliary gas parts

screw connections



olives			
			
1			
GEV No.	101249	Ref. No.	0100780 SIR0100780
description	olive for pipe ø 10mm Qty 1 pcs		
For models:	DG72128, DG74228, DG82140, DG82142, DG82T42, DG84240, DG84242, DG84T42, DG92142, DG94242, DGY2142, DGY4242, TG84APS, TG84FPS, TG84GPS, TG84TPS		
accessories for	101249		
	GEV No.	101250	Ref. No.
			673200 MA673200
	union nut thread M20x1.5 for pipe ø 10mm		

			
1			
GEV No.	101278	Ref. No.	0100775 86720 MA86720 SIR0100775
description	olive for pipe ø 10mm Qty 1 pcs		
For models:	BG62TLC, BG62TLL, BG62TRR, BG63TLC, BG63TLL, BG63TLR, BG64TLC, BG64TLL, BG64TLR, BG72GLC, BG72GLL, BG72GRR, BG72TLC, BG72TLL, BG72TRR, BG74GLC, BG74GLL, BG74GLR, BG74GMC, BG74GRR, BG74TLC, BG74TLL, BG74TLR, BG74TMC, BG74TRR, BG82ALL, BG82ARR, BG82GLC, BG82GLL, BG82GRR, BG82TLC, BG82TLL, BG82TRR, BG84ALC, BG84ALL, BG84ALR, BG84AMC, BG84ARR, BG84GLC, BG84GLL, BG84GLR, BG84GMC, BG84GRR, BG84TLC, BG84TLL, BG84TLR, BG84TMC, BG84TRR, BMG-40, BMG-60...(Other models you can see in the webshop)		
accessories for	101278		
	GEV No.	100943	Ref. No.
			—
	union nut thread M17x1 tube ø 10mm		
	GEV No.	101300	Ref. No.
			0100774 SIR0100774
	union nut thread M16x1.5 tube ø 10mm		

accessories for	101278		
	GEV No.	101478	Ref. No.
			—
	union nut thread 3/8" for pipe ø 10mm		

			
1			
GEV No.	101248	Ref. No.	673300 MA673300
description	olive for pipe ø 12mm Qty 1 pcs suitable for PEL		
For models:	EDG72128, EDG73142, EDG74228, EDG92142, EDG93142, EDG94242, EGVG92, EGVG94, EPG7D05, EPG7I05, EPG7I08, EPG9D10, EPG9D10A, EPG9D15, EPG9D15A, EPG9I15, EPG9I15A, EPG9B10, EPG9B10A, EPGD05, ESE74, ESG74, ETG74, ETG94A, ETG94AL, ETG94F, ETG94FL, ETG94G, ETG94GL, ETG94T, ETG94TPL, ETG96F, ETG96FC, ETG96FL, EVGV7		
accessories for	101248		
	GEV No.	101251	Ref. No.
			673100 MA673100
	union nut thread M20x1.5 for pipe ø 12mm		

			
1			
GEV No.	106598	Ref. No.	MA866200
description	olive for pipe ø 18mm Qty 1 pcs ED ø 21mm		



			
1			
GEV No.	101246	Ref. No.	0100778 673600 MA673600 SIR0100778
description	olive for pipe ø 4mm Qty 1 pcs		
For models:	BG72GLC, BG72GLL, BG72GRR, BG72TLC, BG72TLL, BG72TRR, BG74GLC, BG74GLL, BG74GLR, BG74GMC, BG74GRR, BG74TLC, BG74TLL, BG74TLR, BG74TMC, BG74TRR, BG82ALL, BG82ARR, BG82GLC, BG82GLL, BG82GRR, BG82TLC, BG82TLL, BG82TRR, BG84ALC, BG84ALL, BG84ALR, BG84AMC, BG84ARR, BG84GLC, BG84GLL, BG84GLR, BG84GMC, BG84GRR, BG84TLC, BG84TLL, BG84TLR, BG84TMC, BG84TRR, CCG6045, CCG6220/1, CCG6230/1, CCG6245-1, CCG62652-1, CCG7045, CCG7045P, CCG70652, CCG70652P, CCG70653, CCG7245...(Other models you can see in the webshop)		
accessories for	101246		
	GEV No.	100908	Ref. No.
			0100777 673500 MA673500 SIR0100777
	union screw thread M10x1 for pipe ø 4mm Qty 1 pcs		



1 gas components







			
1			
GEV No.	100897	Ref. No.	1888100 MA1888100
description	olive for pipe ø 4mm Qty 1 pcs for pilot burner		
For models:	BG62TLC, BG62TLL, BG62TRR, BG63TLC, BG63TLL, BG63TLR, BG64TLC, BG64TLL, BG64TLR, CGG6220, CGG6220C, CGG6220R, CGG6230, CGG6230C, CGG6230LR, CGG6240, CGG6240C, CGG6240LR, EBG7, EBG7-CROMO, EBG92AL, EBG92ALC, EBG92AR, EBG92ARC, EBG92GL, EBG92GLC, EBG92GR, EBG92GRC, EBG92TL, EBG92TLC, EBG92TR, EBG92TRC, EBG93AL, EBG93ALC, EBG93ALR, EBG93AMC, EBG93GL, EBG93GLC, EBG93GLR, EBG93GMC, EBG93TL, EBG93TLC, EBG93TLR, EBG93TMC, EBG94AL, EBG94ALC, EBG94ALR, EBG94AMC, EBG94AR, EBG94GL...(Other models you can see in the webshop)		

			
2			
GEV No.	101857	Ref. No.	0100806 SIR0100806
description	olive for pipe ø 6mm Qty 1 pcs suitable for 160 series for pilot burner		

				
1				
GEV No.	101286	Ref. No.	0100743 0100745 LA62070023 LAR62070023 SIR0100743	
description	olive ID ø 6mm Qty 1 pcs			
For models:	BG92ALC, BG92ALL, BG92ARC, BG92ARR, BG92GLC, BG92GLL, BG92GRC, BG92GRR, BG94ALC, BG94ALL, BG94ALR, BG94AMC, BG94ARC, BG94ARR, BG94GLC, BG94GLL, BG94GLR, BG94GMC, BG94GRC, BG94GRR, BGY2TLC, BGY2TLL, BGY2TRC, BGY2TRR, BGY4TLC, BGY4TLL, BGY4TLR, BGY4TMC, BGY4TRC, BGY4TRR, CBG7050, CBG7050C, CBG9060CP, CBG9060C-P, CBG9060P, CCG1041P, CCG1042P, CCG1045, CCG1045P, CCG1061P, CCG1062P, CCG10652, CCG10652P, CCG10653, CCG1081P, CCG1082P, CCG1085, CCG10852, CCG1085P, CCG7001...(Other models you can see in the webshop)			
accessories for	101286			
	GEV No.	100909	Ref. No.	0100744 SIR0100744
	union screw thread M10x1 for pipe ø 6mm Qty 1 pcs			
	GEV No.	101464	Ref. No.	—
	union nut thread M12x1 for pipe ø 6mm			

union nuts				
				
1				
GEV No.	101300	Ref. No.	0100774 SIR0100774	
description	union nut thread M16x1.5 tube ø 10mm			
For models:	BG74TRR, BG82ALL, BG82ARR, BG82GLC, BG82GLL, BG82GRR, BG82TLC, BG82TLL, BG82TRR, BG84ALC, BG84ALL, BG84ALR, BG84AMC, BG84ARR, BG84GLC, BG84GLL, BG84GLR, BG84GMC, BG84GRR, BG84TLC, BG84TLL, BG84TLR, BG84TMC, BG84TRR, CCG1041, CCG1041P, CCG1042, CCG1042P, CCG1045, CCG1045P, CCG1061, CCG1061P, CCG1062, CCG1062P, CCG10652, CCG10652P, CCG10653, CCG1081, CCG1081P, CCG1082, CCG1082P, CCG1085, CCG10852, CCG1085P, CCG6045, CCG7001, CCG7001P, CCG7020, CCG7020P, CCG7021...(Other models you can see in the webshop)			
accessories for	101300			
	GEV No.	101278	Ref. No.	0100775 86720 MA86720 SIR0100775
	olive for pipe ø 10mm Qty 1 pcs			

				
1				
GEV No.	101250	Ref. No.	673200 MA673200	
description	union nut thread M20x1.5 for pipe ø 10mm			
For models:	EGVG92, EGVG94, ETG74, ETG94A, ETG94AL, ETG94F, ETG94FL, ETG94G, ETG94GL, ETG94T, ETG94TPL, ETG96F, ETG96FC, ETG96FL, EVGV7			
accessories for	101250			
	GEV No.	101249	Ref. No.	0100780 SIR0100780
	olive for pipe ø 10mm Qty 1 pcs			

				
1				
GEV No.	101251	Ref. No.	673100 MA673100	
description	union nut thread M20x1.5 for pipe ø 12mm			
For models:	EDG72128, EDG73142, EDG74228, EDG92142, EDG93142, EDG94242, EGVG92, EGVG94, EPG7D05, EPG7105, EPG7108, EPG9D10, EPG9D10A, EPG9D15, EPG9D15A, EPG9115, EPG9115A, EPG9110A, EPG9110A, EPGD05, ESE74, ESG74, ESG94CRA, ESG94CRM, ESG94FRA, ESG94FRM, ESG96CRA, ESG96FRA, ETG74, ETG94A, ETG94AL, ETG94F, ETG94FL, ETG94G, ETG94GL, ETG94T, ETG94TPL, ETG96F, ETG96FC, ETG96FL, EVGV7			
accessories for	101251			
	GEV No.	101248	Ref. No.	673300 MA673300
	olive for pipe ø 12mm Qty 1 pcs suitable for PEL			









union screws

 <p>1</p>			
GEV No.	100904	Ref. No.	1394700 MA1394700
description	locking screw M10x1 for pipe ø 4mm Qty 1 pcs		
For models:	BG62TLC, BG62TLL, BG62TRR, BG63TLC, BG63TLL, BG63TLR, BG64TLC, BG64TLL, BG64TLR, BMG-40, BMG-60, CFG62110, CFG62210, CGG6220, CGG6220C, CGG6220R, CGG6230, CGG6230C, CGG6230LR, CGG6240, CGG6240C, CGG6240LR, EBG7-CROMO, EBG92ALC, EBG92ARC, EBG92GLC, EBG92GRC, EBG92TLC, EBG92TRC, EBG93ALC, EBG93AMC, EBG93GLC, EBG93GMC, EBG93TLC, EBG93TMC, EBG94ALC, EBG94AMC, EBG94GLC, EBG94GMC, EBG94TLC, EBG94TMC, ECG7-FG, ECG94F, ECG96F, ECG96H, ECG98F, EC-MAXI-OVEN-GAS, EFG72108, EFG72110, EFG72115...(Other models you can see in the webshop)		

 <p>1</p>			
GEV No.	100906	Ref. No.	0100807 1888400 MA1888400 SIR0100807
description	screw connection thread M10x1 for ignition electrode brass Qty 1 pcs WS 10		
For models:	BG62TLC, BG62TLL, BG62TRR, BG63TLC, BG63TLL, BG63TLR, BG64TLC, BG64TLL, BG64TLR, BG72GLC, BG72GLL, BG72GRR, BG72TLC, BG72TLL, BG72TRR, BG74GLC, BG74GLL, BG74GLR, BG74GMC, BG74GRR, BG74TLC, BG74TLL, BG74TLR, BG74TMC, BG74TRR, BG82ALL, BG82ARR, BG82GLC, BG82GLL, BG82GRR, BG82TLC, BG82TLL, BG82TRR, BG84ALC, BG84ALL, BG84ALR, BG84AMC, BG84ARR, BG84GLC, BG84GLL, BG84GLR, BG84GMC, BG84GRR, BG84TLC, BG84TLL, BG84TLR, BG84TMC, BG84TRR, CG86HPS, CGG6220...(Other models you can see in the webshop)		

 <p>1</p>			
GEV No.	100907	Ref. No.	0100742 0100817 1891700 MA1891700 SIR0100742 SIR0100817
description	screw connection thread M10x1 Qty 1 pcs type SEF 1 ømm for thermocouple		
For models:	BG62TLC, BG62TLL, BG62TRR, BG63TLC, BG63TLL, BG63TLR, BG64TLC, BG64TLL, BG64TLR, BG72GLC, BG72GLL, BG72GRR, BG72TLC, BG72TLL, BG72TRR, BG74GLC, BG74GLL, BG74GLR, BG74GMC, BG74GRR, BG74TLC, BG74TLL, BG74TLR, BG74TMC, BG74TRR, BG82GLC, BG82TLC, BG84ALC, BG84AMC, BG84GLC, BG84GMC, BG84TLC, BG84TMC, CCG1041, CCG1041P, CCG1042, CCG1042P, CCG1045, CCG1045P, CCG1061, CCG1061P, CCG1062, CCG1062P, CCG10652, CCG10652P, CCG10653, CCG1081, CCG1081P, CCG1082, CCG1082P...(Other models you can see in the webshop)		

 <p>1</p>			
GEV No.	106597	Ref. No.	MA866000
description	union screw thread 3/4" for pipe ø 18mm L 20mm Qty 1 pcs WS 27		

 <p>1</p>			
GEV No.	100908	Ref. No.	0100777 673500 MA673500 SIR0100777
description	union screw thread M10x1 for pipe ø 4mm Qty 1 pcs		
For models:	BG62TLC, BG62TLL, BG62TRR, BG63TLC, BG63TLL, BG63TLR, BG64TLC, BG64TLL, BG64TLR, BG72GLC, BG72GLL, BG72GRR, BG72TLC, BG72TLL, BG72TRR, BG74GLC, BG74GLL, BG74GLR, BG74GMC, BG74GRR, BG74TLC, BG74TLL, BG74TLR, BG74TMC, BG74TRR, BG82ALL, BG82ARR, BG82GLC, BG82GLL, BG82GRR, BG82TLC, BG82TLL, BG82TRR, BG84ALC, BG84ALL, BG84ALR, BG84AMC, BG84ARR, BG84GLC, BG84GLL, BG84GLR, BG84GMC, BG84GRR, BG84TLC, BG84TLL, BG84TLR, BG84TMC, BG84TRR, CCG6045, CCG6220/1...(Other models you can see in the webshop)		
accessories for	100908		
	 GEV No. 100897 Ref. No. 1888100 MA1888100 olive for pipe ø 4mm Qty 1 pcs for pilot burner		
	 GEV No. 101246 Ref. No. 0100778 673600 MA673600 SIR0100778 olive for pipe ø 4mm Qty 1 pcs		
	 GEV No. 101280 Ref. No. — olive for pipe ø 4mm Qty 1 pcs		
	 GEV No. 101282 Ref. No. — olive for pipe ø 4mm L 7.4mm Qty 1 pcs		







 <p>1</p>			
GEV No.	100909	Ref. No.	0100744 SIR0100744
description	union screw thread M10x1 for pipe ø 6mm Qty 1 pcs		
For models:	BG92ALC, BG92ALL, BG92ARC, BG92ARR, BG92GLC, BG92GLL, BG92GRC, BG92GRR, BG94ALC, BG94ALL, BG94ALR, BG94AMC, BG94ARC, BG94ARR, BG94GLC, BG94GLL, BG94GLR, BG94GMC, BG94GRC, BG94GRR, BGY2TLC, BGY2TLL, BGY2TRC, BGY2TRR, BGY4TLC, BGY4TLL, BGY4TLR, BGY4TMC, BGY4TRC, BGY4TRR, CBG7050, CBG9060CP, CBG9060C-P, CBG9060P, CCG1041P, CCG1042P, CCG1045, CCG1045P, CCG1061P, CCG1062P, CCG10652, CCG10652P, CCG10653, CCG1081P, CCG1082P, CCG1085, CCG10852, CCG1085P, CCG7001, CCG7001P...(Other models you can see in the webshop)		
accessories for	100909		
	 GEV No. 100898 Ref. No. — olive for pipe ø 6mm Qty 1 pcs for pilot burner		

Table continues overleaf



accessories for		100909	
	GEV No.	101286	Ref. No.
			0100743 0100745 LA62070023 LAR62070023 SIR0100743
	olive ID ø 6mm Qty 1 pcs		
	GEV No.	101287	Ref. No.
	olive for pipe ø 6mm Qty 1 pcs		
	GEV No.	101288	Ref. No.
	olive for pipe ø 6mm L 6mm aluminium Qty 1 pcs ED ø 8.5mm		

	1		
GEV No.	103237	Ref. No.	459500 MA459500
description	union screw thread M14x1.5 for pipe ø 10mm Qty 1 pcs		
For models:	BG62TLC, BG62TLL, BG62TRR, BG63TLC, BG63TLL, BG63TLR, BG64TLC, BG64TLL, BG64TLR, BMG-40, BMG-60, CFG62110, CFG62210, CGG6220, CGG6220C, CGG6220R, CGG6230, CGG6230C, CGG6230LR, CGG6240, CGG6240C, CGG6240LR, ECG7, ECG92A, ECG92G, ECG92T, ECG94A, ECG94E, ECG94F, ECG94G, ECG94T, ECG96A, ECG96E, ECG96F, ECG96G, ECG96H, ECG96T, ECG98A, ECG98F, ECG98G, FG62T08, FG64T08		

pressure switches

	1		
GEV No.	541051	Ref. No.	0102485 SIR0102485
description	pressure control ø 45mm pressure range adjustable 10-50mbar pressure connection vertical gas technology connection 1/4" pressure connection ø 1/4"mm		
For models:	CBG9060C-I, CPD90100, CPD90100A, CPD90150, CPD90150A, CPI90100, CPI90100A, CPI90150, CPI90150A		

equipment-specific units

for dough mixers

flange bearings



	1		
GEV No.	693112	Ref. No.	0100430 SIO100430 SIR0100430
description	flange bearing type UCF204 shaft ø 20mm 4 hole flange hole distance 64mm H 33mm flange length 86mm flange width 86mm hole ø 12mm flange F204 ball bearing UC204G2 FH 25.5mm		
For models:	CBE7050, CBE7050C, CBE9060, CBE9060C, CBG7050, CBG9060C-I, CBG9060CP, CBG9060C-P, CBG9060P, SE74CRM, SE74FRM, SE74IRM, SE84CRM, SE84FRM, SE84IRM, SE94CRA, SE94CRM, SE94FRA, SE94FRM, SE94IRA, SE94IRM, SG74CRM, SG74IRM, SG84CRM, SG84IRM, SG94CRA, SG94CRM, SG94FRA, SG94FRM, SG94IRA, SG94IRM		

for griddles

housing and bezels

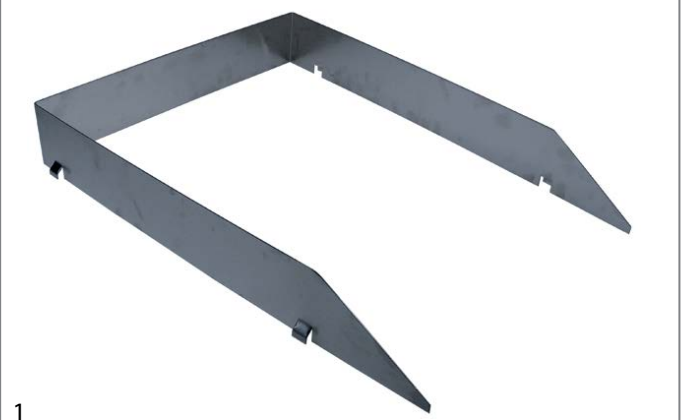

	1		
GEV No.	691349	Ref. No.	1044314900 MA1044314900
description	spraying protection L 520mm W 390mm H 75mm		
For models:	BE62TLC, BE62TLL, BE62TRR, BG62TLC, BG62TLL, BG62TRR, CGE6220, CGE6220C, CGE6220R, CGG6220, CGG6220C, CGG6220R		

drain stoppers



1

GEV No.	691330	Ref. No.	1033705600 MA1033705600
description	outflow plug for grease drain ø 32mm L 50mm ID ø 17.8mm ED ø 25.5mm		
For models:	BG62TLC, BG62TLL, BG62TRR, BG63TLC, BG63TLL, BG63TLR, BG64TLC, BG64TLL, BG64TLR, CGG6220, CGG6220C, CGG6220R, CGG6230, CGG6230C, CGG6230LR, CGG6240, CGG6240C, CGG6240LR		

for convection ovens/combi-steamers

pipes



1

GEV No.	520970	Ref. No.	LAR62180022
description	drain pipe flexible L 135mm ID ø 18mm ED ø 27.5mm connection 3/4" ET - 3/4" IT SS for combi-steamer		
For models:	GMT06D		

for tilting bratt pans

spare parts and accessories



1

GEV No.	514232	Ref. No.	CM051403 MACM051403
description	bush left tilting bratt pan type series 700 kettle series 900		
For models:	EPE50, EPG50, PE8AI10, PE8AI15, PE8NI10, PE8NI15, PE9AI10, PE9AI15, PE9NI10, PE9NI15, PG8AD10, PG8AD15, PG8AI10, PG8AI15, PG8ND10, PG8ND15, PG8NI10, PG8NI15, PG9AD10, PG9AD15, PG9AI10, PG9AI15, PG9ND10, PG9ND15, PG9NI10, PG9NI15, SE84CRA, SE84CRM, SE84FRA, SE84FRM, SE84IRA, SE84IRM, SE86CRA, SE86FRA, SE86IRA, SE96CRA, SE96FRA, SE96IRA, SG84CRA, SG84CRM, SG84IRA, SG84IRM		



1

GEV No.	514229	Ref. No.	CM192101 MACM192101
description	bush right tilting bratt pan type series 700 kettle series 900		
For models:	EPE50, EPE7108, EPG50, EPG7108, PE8AI10, PE8AI15, PE8NI10, PE8NI15, PE9AI10, PE9AI15, PE9NI10, PE9NI15, PG8AD10, PG8AD15, PG8AI10, PG8AI15, PG8ND10, PG8ND15, PG8NI10, PG8NI15, PG9AD10, PG9AD15, PG9AI10, PG9AI15, PG9ND10, PG9ND15, PG9NI10, PG9NI15, SE84CRA, SE84CRM, SE84FRA, SE84FRM, SE84IRA, SE84IRM, SE86CRA, SE86FRA, SE86IRA, SE96CRA, SE96FRA, SE96IRA, SG84CRA, SG84CRM, SG84IRA, SG84IRM		



1

GEV No.	514227	Ref. No.	CM051604 MACM051604
description	hinge bolt kettle type series 700/900 tilting bratt pan		
For models:	EPE50, EPE7108, EPG50, EPG7108, PE8AI10, PE8AI15, PE8NI10, PE8NI15, PE9AI10, PE9AI15, PE9NI10, PE9NI15, PG8AD10, PG8AD15, PG8AI10, PG8AI15, PG8ND10, PG8ND15, PG8NI10, PG8NI15, PG9AD10, PG9AD15, PG9AI10, PG9AI15, PG9ND10, PG9ND15, PG9NI10, PG9NI15, SE84CRA, SE84CRM, SE84FRA, SE84FRM, SE84IRA, SE84IRM, SG84CRA, SG84CRM, SG84IRA, SG84IRM		

spindles



1

GEV No.	693127	Ref. No.	LC333-04 SIRLC333-04
description	threaded part		
For models:	CBE7050, CBE7050C, CBE9060, CBE9060C, CBG7050, CBG7050C, CBG9060C-I, CBG9060CP, CBG9060C-P, CBG9060P, SE74CRM, SE74FRM, SE74IRM, SE84CRA, SE84CRM, SE84FRA, SE84FRM, SE84IRA, SE84IRM, SE94CRA, SE94CRM, SE94FRA, SE94FRM, SE94IRA, SE94IRM, SG74CRM, SG74FRM, SG84CRA, SG84CRM, SG84IRA, SG84IRM, SG94CRA, SG94CRM, SG94FRA, SG94FRM, SG94IRA, SG94IRM		



1

GEV No.	693129	Ref. No.	0100436 SIR0100436
description	threaded rod		

1 			
GEV No.	693128	Ref. No.	LC335-01 SIRLC335-01
description	threaded rod L 350mm		
For models:	CBE7050, CBE7050C, CBE9060, CBE9060C, CBG7050, CBG7050C, CBG9060C-I, CBG9060CP, CBG9060C-P, CBG9060P, SE74CRM, SE74FRM, SE74IRM, SE84CRA, SE84CRM, SE84FRA, SE84FRM, SE84IRA, SE84IRM, SE94CRA, SE94CRM, SE94FRA, SE94FRM, SE94IRA, SE94IRM, SG74CRM, SG74IRM, SG84CRA, SG84CRM, SG84IRA, SG84IRM, SG94CRA, SG94CRM, SG94FRA, SG94FRM, SG94IRA, SG94IRM		

miscellaneous

1 			
GEV No.	693130	Ref. No.	9203699 SI9203699 SIR9203699
description	spindle		
For models:	CBE9060, CBE9060C, CBG9060C-I, CBG9060CP, CBG9060C-P, CBG9060P, SE94CRA, SE94CRM, SE94FRA, SE94FRM, SE94IRA, SE94IRM, SG94CRA, SG94CRM, SG94FRA, SG94FRM, SG94IRA, SG94IRM		

for boiling pans

spare parts and accessories

1 			
GEV No.	514232	Ref. No.	CM051403 MACM051403
description	bush left tilting bratt pan type series 700 kettle series 900		
For models:	EPE50, EPG50, PE8AI10, PE8AI15, PE8NI10, PE8NI15, PE9AI10, PE9AI15, PE9NI10, PE9NI15, PG8AD10, PG8AD15, PG8AI10, PG8AI15, PG8ND10, PG8ND15, PG8NI10, PG8NI15, PG9AD10, PG9AD15, PG9AI10, PG9AI15, PG9ND10, PG9ND15, PG9NI10, PG9NI15, SE84CRA, SE84CRM, SE84FRA, SE84FRM, SE84IRA, SE84IRM, SE86CRA, SE86FRA, SE86IRA, SE96CRA, SE96FRA, SE96IRA, SG84CRA, SG84CRM, SG84IRA, SG84IRM		

1 			
GEV No.	514229	Ref. No.	CM192101 MACM192101
description	bush right tilting bratt pan type series 700 kettle series 900		
For models:	EPE50, EPE7I08, EPG50, EPG7I08, PE8AI10, PE8AI15, PE8NI10, PE8NI15, PE9AI10, PE9AI15, PE9NI10, PE9NI15, PG8AD10, PG8AD15, PG8AI10, PG8AI15, PG8ND10, PG8ND15, PG8NI10, PG8NI15, PG9AD10, PG9AD15, PG9AI10, PG9AI15, PG9ND10, PG9ND15, PG9NI10, PG9NI15, SE84CRA, SE84CRM, SE84FRA, SE84FRM, SE84IRA, SE84IRM, SE86CRA, SE86FRA, SE86IRA, SE96CRA, SE96FRA, SE96IRA, SG84CRA, SG84CRM, SG84IRA, SG84IRM		

1 			
GEV No.	514227	Ref. No.	CM051604 MACM051604
description	hinge bolt kettle type series 700/900 tilting bratt pan		
For models:	EPE50, EPE7I08, EPG50, EPG7I08, PE8AI10, PE8AI15, PE8NI10, PE8NI15, PE9AI10, PE9AI15, PE9NI10, PE9NI15, PG8AD10, PG8AD15, PG8AI10, PG8AI15, PG8ND10, PG8ND15, PG8NI10, PG8NI15, PG9AD10, PG9AD15, PG9AI10, PG9AI15, PG9ND10, PG9ND15, PG9NI10, PG9NI15, SE84CRA, SE84CRM, SE84FRA, SE84FRM, SE84IRA, SE84IRM, SG84CRA, SG84CRM, SG84IRA, SG84IRM		

level glasses

complete

1 			
GEV No.	540706	Ref. No.	0100586 0108086 SIR0100586 SIR0108086
description	level glass hole distance 76mm mounting thread M10 L 107mm W 28mm plastic/SS for kettle model ELESA HCX-76-BW-SST		
For models:	CPE70150, CPE7-150, PE7NI05		





knobs

producer-specific knobs

SILKO

			
1			
GEV No.	110035	Ref. No.	0101211+0101940 SIR0101211+SIR0101940
description	knob gas tap with ignition flame ø 65mm shaft ø 10x8mm shaft flat lower		

			
1			
GEV No.	110729	Ref. No.	0101965+0101940 SIR0101965+SIR0101940
description	knob gas tap with ignition flame ø 65mm shaft ø 10x8mm shaft flat lower		

			
1			
GEV No.	111521	Ref. No.	0101227+0101940 SIR0101227+SIR0101940
description	knob gas tap with ignition flame ø 65mm shaft ø 10x8mm shaft flat upper		

			
1			
GEV No.	111513	Ref. No.	0101954+0101940 SIR0101954+SIR0101940
description	knob gas tap with ignition flame ø 65mm shaft ø 8x6.5mm shaft flat lower		

			
1			
GEV No.	110723	Ref. No.	0101234 0101953+0101940 SIR0101234 SIR0101953+SIR0101940
description	knob gas tap without ignition flame ø 65mm shaft ø 8x6.5mm shaft flat lower black		

			
1			
GEV No.	110730	Ref. No.	0101967+0101940 SIR0101967+SIR0101940
description	knob gas thermostat 1-7 ø 65mm shaft ø 10x8mm shaft flat upper		

			
1			
GEV No.	110726	Ref. No.	0101208 0101959+0101940 SIR0101208 SIR0101959+SIR0101940
description	knob switch 0-1-0-1 ø 65mm shaft ø 6x4.6mm shaft flat lower black		
For models:	CFE60110-5, CFE60110-9, CFE60210-5, CFE60210-9		

			
1			
GEV No.	110720	Ref. No.	0101210 0101957+0101940 SIR0101210 SIR0101957+SIR0101940
description	knob switch 7-position ø 65mm shaft ø 6x4.6mm shaft flat lower		
For models:	CCT6020, CCT6040, CCT6046, CRE6-20, CRE6-30		



			
1			
GEV No.	111529	Ref. No.	0101964+0101940 SIR0101964+SIR0101940
description	knob thermostat t.max. 100°C temperature range 0-100°C ø 64mm shaft ø 6x4.6mm shaft flat lower		

			
1			
GEV No.	110727	Ref. No.	0101963+0101940 SIR0101963+SIR0101940
description	knob thermostat t.max. 295°C temperature range 45-295°C ø 65mm shaft ø 6x4.6mm shaft flat lower rotation 270° black		

			
1			
GEV No.	110724	Ref. No.	0101806 0101962+0101940 SIR0101806 SIR0101962+SIR0101940
description	knob thermostat t.max. 90°C temperature range 30-90°C ø 65mm shaft ø 6x4.6mm shaft flat lower		

			
1			
GEV No.	112051	Ref. No.	0101968 1036609400 MA1036609400 SIR0101968
description	cover cap yellow		
For models:	BE62TLC, BE62TLL, BE62TRR, BE63TLC, BE63TLL, BE63TLR, BE65TLC, BE65TLL, BE65TLR, CBE6220, CCG6220/1, CCG6230/1, CCG6245-1, CCG62652-1, CCT6220, CCT6220V, CCT6230, CCT6230V, CCW6220, CE62TPT, CE64TPT, CFE62110/1, CFE62210/1, CG62TPS, CG64FPS, CG64TPS, CG66FPS, CGE6220, CGE6220C, CGE6220R, CGE6230, CGE6230C, CGE6230LR, CGE6250, CGE6250LR, CGE6250LRC, CME6220, CME6230, CME6240, CNE6230, CSP6220, CV62TPS, CV64TPS, CW62TPS, DE63128, FE62T10, FE64T10, ME62TPS, ME63TPS, ME64TPS...(Other models you can see in the webshop)		

			
1			
GEV No.	111185	Ref. No.	0101954 SIR0101954
description	knob gas tap with ignition flame ø 65mm shaft ø 8x6.5mm shaft flat lower black		
For models:	BG82ALL, BG82ARR, BG82GLL, BG82GRR, BG82TLL, BG82TRR, BG84ALL, BG84ALR, BG84ARR, BG84GLL, BG84GLR, BG84GRR, BG84TLR, BG84TLR, BG84TRR, CCG7020P, CCG7021P, CCG7022P, CCG9020P, CCG9021P, CCG9022P, CCG9040P, CCG9041P, CCG9042P, CCG9045P, CCG9046P, CCG9060P, CCG9061P, CCG9062P, CCG90652P, CCG90662P, CCG9081P, CCG9082P, CCG9085P, CCG9085-P, CG72APS, CG72GPS, CG72TPS, CG82APS, CG82GPS, CG82TPS, CG86APS, CG86FPS, CG86GPS, CG86HPS, CG86TPS, CG88APS, CG88FPS, CG88GPS, CG92APS...(Other models you can see in the webshop)		
accessories for	111185		
		GEV No.	111964
		Ref. No.	0101940 1036609200 MA1036609200 SIR0101940
	knob dial plate t.max.°C temperature range°C		



			
1			
GEV No.	111182	Ref. No.	0101211 0101965 SIO101965 SIR0101211 SIR0101965
description	knob gas tap with ignition flame t.max.°C temperature range°C ø 65mm shaft ø 10x8mm shaft flat lower black		
For models:	BG92ALL, BG92ARR, BG92GLL, BG92GRR, BG94ALL, BG94ALR, BG94ARR, BG94GLL, BG94GLR, BG94GRR, BGY2TLL, BGY2TRR, BGY4TLL, BGY4TLR, BGY4TRR, CCG9020-0, CCG9020-2, CCG9021-0, CCG9021-2, CCG9022-0, CCG9022-2, CCG9040-0, CCG9040-2, CCG9040-4, CCG9041-0, CCG9041-2, CCG9041-4, CCG9042-0, CCG9042-2, CCG9042-4, CNG50150, CNG50160, CNG70160, CNG72160, CNG90160, CNG90160S, CNG90160-S, CPD70150, CPD90100AP, CPD90100A-P, CPD90100P, CPD90150AP, CPD90150A-P, CPD9015-P, CPI70150, CPI90100AP, CPI90100A-P, CPI90100P, CPI90100-P, CPI90150AP...(Other models you can see in the webshop)		
accessories for	111182		
		GEV No.	111964
		Ref. No.	0101940 1036609200 MA1036609200 SIR0101940
	knob dial plate t.max.°C temperature range°C		
		GEV No.	112051
		Ref. No.	0101968 1036609400 MA1036609400 SIR0101968
	cover cap yellow		







			
1			
GEV No.	111178	Ref. No.	0101204 0101953 SIR0101204 SIR0101953
description	knob gas tap without ignition flame ø 65mm shaft ø 8x6.5mm shaft flat lower black		
For models:	CCG1041, CCG1042, CCG1045, CCG1061, CCG1062, CCG10652, CCG10653, CCG1081, CCG1082, CCG1085, CCG10852, CCG6020, CCG6040, CCG6045, CCG6046, CCG7001, CCG7020, CCG7021, CCG7022, CCG7040, CCG7041, CCG7042, CCG7045, CCG7046, CCG7061, CCG7062, CCG70652, CCG70653, CCG70663, CCG7201, CCG7220, CCG7221, CCG7240, CCG7241, CCG7242, CCG7245, CCG7246, CCG7261, CCG7262, CCG72652, CCG72653, CCG72662, CCG72663, CCG9020, CCG9021, CCG9022, CCG9040, CCG9041, CCG9042, CCG9046...(Other models you can see in the webshop)		
accessories for	111178		
			
GEV No.	111964	Ref. No.	0101940 1036609200 MA1036609200 SIR0101940
knob dial plate t.max.°C temperature range°C			

			
1			
GEV No.	111183	Ref. No.	0101802 0101967 SIR0101802 SIR0101967
description	knob gas thermostat 1-7 ø 65mm shaft ø 10x8mm shaft flat upper		
For models:	CBG9060C-P, CBG9060P, CCG1045, CCG1045P, CCG10652, CCG10652P, CCG10653, CCG1085, CCG10852, CCG1085P, CCG9045P, CCG9046, CCG90652P, CCG90663, CCG9085P, CCG9085-P, CCG9145, CCG9145-1, CCG91652, CCG91652-1, CCG91653, CCG91653-1, CCG9185, CCG9185-1, CCG91852, CCG91852-1, CFS9050, CFS9052, CFS9055, CG94FPS, CG96FPS, CG98FPS, CCG9020, CCG9020C, CCG9020R, CG9020RC, CCG9021, CCG9021C, CCG9021R, CCG9021RC, CCG9040, CCG9040C, CCG9040LR, CCG9040LRC, CCG9040R, CCG9040RC, CCG9041, CCG9041C, CCG9041LR, CCG9041LRC...(Other models you can see in the webshop)		
accessories for	111183		
			
GEV No.	111964	Ref. No.	0101940 1036609200 MA1036609200 SIR0101940
knob dial plate t.max.°C temperature range°C			

			
1			
GEV No.	112050	Ref. No.	0101966 SIR0101966
description	knob gas thermostat 1-7 t.max.°C temperature range°C ø 65mm shaft ø 10x8mm shaft flat upper black		

			
1			
GEV No.	111176	Ref. No.	0101223 0101957 SIR0101223 SIR0101957
description	knob switch 7-position ø 65mm shaft ø 6x4.6mm shaft flat lower black		
For models:	BER12, BER14, BER16, BER18, BER20, CCQ7020, CCQ7021, CCQ7022, CCQ7040, CCQ7041, CCQ7042, CCQ7046, CCQ7061, CCQ7062, CCQ70663, CCQ7220, CCQ7221, CCQ7222, CCQ7240, CCQ7241, CCQ7242, CCQ7246, CCQ7261, CCQ7262, CCQ9020, CCQ9021, CCQ9022, CCQ9040, CCQ9041, CCQ9042, CCQ9046, CCQ9060, CCQ9061, CCQ9062, CCQ90663, CCT6020, CCT6040, CCT6046, CCT7020, CCT7021, CCT7022, CCT7040, CCT7041, CCT7042, CCT7046, CCT7061, CCT7062, CCT70663, CCT7220, CCT7221...(Other models you can see in the webshop)		
accessories for	111176		
			
GEV No.	111964	Ref. No.	0101940 1036609200 MA1036609200 SIR0101940
knob dial plate t.max.°C temperature range°C			

			
1			
GEV No.	111195	Ref. No.	0101964 SIR0101964
description	knob thermostat t.max. 100°C temperature range 30-100°C ø 64mm shaft ø 6x4.6mm shaft flat lower rotation 270° black		
For models:	CPE90100, CPE90100A, CPE90150, CPE90150A, CPI90100, CPI90100A, CPI90150, CPI90150A, PE9AI10, PE9AI15, PE9NI10, PE9NI15		
accessories for	111195		
			
GEV No.	111964	Ref. No.	0101940 1036609200 MA1036609200 SIR0101940
knob dial plate t.max.°C temperature range°C			

 <p>1</p>							
GEV No.	111197	Ref. No.	0101206 0101958 SIR0101206 SIR0101958				
description	knob thermostat t.max. 110°C temperature range 30-110°C ø 65mm shaft ø 6x4.6mm shaft flat lower black						
For models:	CCW6020, CME6020, CME6030, CME6040, CNE70130, CNE72130, CNE90130, CNE90130-S, CNE90140, CNE90140-S, CNE90160, CNE90160S, CNE90160-S, CNE90230, CNE90240, CSP6020, DE72125, DE92140, DE94170, DE94240, DEY4160						
accessories for	111197						
 <table border="1"> <tr> <td>GEV No.</td> <td>111964</td> <td>Ref. No.</td> <td>0101940 1036609200 MA1036609200 SIR0101940</td> </tr> </table> <p>knob dial plate t.max.°C temperature range°C</p>				GEV No.	111964	Ref. No.	0101940 1036609200 MA1036609200 SIR0101940
GEV No.	111964	Ref. No.	0101940 1036609200 MA1036609200 SIR0101940				

 <p>1</p>							
GEV No.	111188	Ref. No.	0101956 SIR0101956				
description	knob thermostat t.max. 310°C temperature range 50-310°C ø 65mm shaft ø 6x4.6mm shaft flat lower black						
For models:	BE72ALC, BE72ALL, BE72ARR, BE72GLC, BE72GLL, BE72GRR, BE72TLC, BE72TLL, BE72TRR, BE74ALC, BE74ALL, BE74ALR, BE74ARC, BE74ARR, BE74GLC, BE74GLL, BE74GLR, BE74GMC, BE74GRR, BE74TLC, BE74TLL, BE74TLR, BE74TMC, BE74TRR, CBE6030, CCG60652, CCG60653, CCG7046, CCG7046P, CCG70662P, CCG70663, CCG7246, CCG72662, CCG72663, CCG9046P, CCG90662P, CCG9146, CCG9146-1, CCG91662, CCG91662-1, CCG91663, CCG91663-1, CCQ7046, CCQ70663, CCQ9020, CCQ9020V, CCQ9020-V, CCQ9021, CCQ9021-V, CCQ9022... (Other models you can see in the webshop)						
accessories for	111188						
 <table border="1"> <tr> <td>GEV No.</td> <td>111964</td> <td>Ref. No.</td> <td>0101940 1036609200 MA1036609200 SIR0101940</td> </tr> </table> <p>knob dial plate t.max.°C temperature range°C</p>				GEV No.	111964	Ref. No.	0101940 1036609200 MA1036609200 SIR0101940
GEV No.	111964	Ref. No.	0101940 1036609200 MA1036609200 SIR0101940				

 <p>1</p>							
GEV No.	111179	Ref. No.	0101962 SIR0101962				
description	knob thermostat t.max. 90°C temperature range 30-90°C ø 65mm shaft ø 6x4.6mm shaft flat lower rotation 270°						
For models:	BAC100, BAC100-A, BAC102, BAC120, BAC120-A, BAC122, BAC140, BAC140-A, BAC142, BAC160, BAC160-A, BAC162, BAC180, BAC180-A, BAC182, BAC200, BAC200-A, BAC202, BAM16D, BAM16S, BAM18D, BAM18S, BAM20D, BAM20S, CCG1045, CCG10652, CCG10653, CCG1085, CCG10852, CCG6045, CCG60652, CCG60653, CCG7045, CCG7046, CCG70652, CCG70653, CCG70663, CCG72653, CCG72663, CCG9046, CCG90663, CCG91653, CCG91653-1, CCG91663, CCG91663-1, CCQ7046, CCQ70663, CCQ9046, CCQ90663, CCT7046...(Other models you can see in the webshop)						
accessories for	111179						
 <table border="1"> <tr> <td>GEV No.</td> <td>111964</td> <td>Ref. No.</td> <td>0101940 1036609200 MA1036609200 SIR0101940</td> </tr> </table> <p>knob dial plate t.max.°C temperature range°C</p>				GEV No.	111964	Ref. No.	0101940 1036609200 MA1036609200 SIR0101940
GEV No.	111964	Ref. No.	0101940 1036609200 MA1036609200 SIR0101940				

 <p>1</p>			
GEV No.	111964	Ref. No.	0101940 1036609200 MA1036609200 SIR0101940
description	knob dial plate t.max.°C temperature range°C		
For models:	BE62TLC, BE62TLL, BE62TRR, BE63TLC, BE63TLL, BE63TLR, BE65TLC, BE65TLL, BE65TLR, CBE6220, CCG6220/1, CCG6230/1, CCG6245-1, CCG62652-1, CCT6220, CCT6220V, CCT6230, CCT6230V, CCW6220, CE62TPT, CE64TPT, CFE62110/1, CFE62210/1, CG62TPS, CG64FPPS, CG64TPS, CG66FPPS, CGE6220, CGE6220C, CGE6220R, CGE6230, CGE6230C, CGE6230LR, CGE6250, CGE6250LR, CGE6250LRC, CME6220, CME6230, CME6240, CNE6230, CSP6220, CV62TPS, CV64TPS, CW62TPS, DE63128, FE62T10, FE64T10, ME62TPS, ME63TPS, ME64TPS...(Other models you can see in the webshop)		

 <p>1</p>			
GEV No.	111524	Ref. No.	0101794+0101795 SIR0101794+SIR0101795
description	knob		

			
1			
GEV No.	111515	Ref. No.	0101787+0101795 SIR0101787+SIR0101795
description	knob gas tap with ignition flame ø 73mm shaft ø 10x8mm shaft flat lower		

			
1			
GEV No.	111514	Ref. No.	0101798+0101795 SIR0101798+SIR0101795
description	knob gas tap with ignition flame ø 73mm shaft ø 8x6.5mm shaft flat lower		

			
1			
GEV No.	111512	Ref. No.	0101786+0101795 SIR0101786+SIR0101795
description	knob gas tap without ignition flame ø 50mm shaft ø 8x6.5mm shaft flat upper black		

			
1			
GEV No.	111523	Ref. No.	0101802+0101795 SIR0101802+SIR0101795
description	knob gas thermostat 1-7 ø 73mm shaft ø 10x8mm shaft flat upper black		

			
1			
GEV No.	111522	Ref. No.	0101785+0101795 SIR0101785+SIR0101795
description	knob gas thermostat ø 73mm shaft ø 10x8mm shaft flat upper		

			
1			
GEV No.	111359	Ref. No.	0101792 SIR0101792 SIR0101792
description	knob switch 0-1-0-1 ø 73mm shaft ø 6x4.6mm shaft flat upper black		
For models:	CFE60110-5, CFE60110-9, CFE60210-5, CFE60210-9, CFE70115, CFE70115-2, CFE70115-M, CFE70210-M, CFE70215, CFE70215-2, CFE70215-M, CFE72215, CFE90120, CFE90120-2, CFE90210, CFE90210-2, CFE90220, CFE90220-2, CM72APS, CM82APS, FE92210, SE84CRA, SE84FRA, SE84IRA, SG84CRA, SG84IRA, SG94CRA, SG94FRA, SG94IRA		

			
1			
GEV No.	111527	Ref. No.	0101792+0101795 SIR0101792+SIR0101795
description	knob switch 0-1-0-1 ø 73mm shaft ø 6x4.6mm shaft flat upper black		

			
1			
GEV No.	111519	Ref. No.	0101788+0101795 SIR0101788+SIR0101795
description	knob switch 4-position ø 73mm shaft ø 6x4.6mm shaft flat upper		

			
1			
GEV No.	111530	Ref. No.	0102497+0101795 SIR0102497+SIR0101795
description	knob thermostat t.max. 100°C temperature range 0-100°C ø 73mm shaft ø 6x4.6mm shaft flat lower		

			
1			
GEV No.	111525	Ref. No.	0101791+0101795 SIR0101791+SIR0101795
description	knob thermostat t.max. 110°C temperature range 0-110°C ø 73mm shaft ø 6x4.6mm shaft flat lower		



1

GEV No.	111517	Ref. No.	0101789+0101795 SIR0101789+SIR0101795
description	knob thermostat t.max. 310°C temperature range 0-310°C ø 73mm shaft ø 6x4.6mm shaft flat lower thermostat		



1

GEV No.	111520	Ref. No.	0101797+0101795 SIR0101797+SIR0101795
description	knob thermostat t.max. 90°C temperature range 30-90°C ø 73mm shaft ø 6x4.6mm shaft flat lower		



1

GEV No.	112531	Ref. No.	0101949 SIR0101949
description	knob energy regulator 1-9 ø 73mm shaft ø 6x4.6mm shaft flat lower black		
For models:	CTE9141, CTE9142, CTE9142S, CTE9146, TE94APS, TE94EPS, TE94GPS, TEY4APS		



1

GEV No.	111187	Ref. No.	0101787 SIR0101787	
description	knob gas tap with ignition flame ø 73mm shaft ø 10x8mm shaft flat lower black			
For models:	BG92ALL, BG92ARR, BG92GLL, BG92GRR, BG94ALL, BG94ALR, BG94ARR, BG94GLL, BG94GLR, BG94GRR, BGY2TLL, BGY2TRR, BGY4TLL, BGY4TLR, BGY4TRR, CCG9020-0, CCG9020-2, CCG9021-0, CCG9021-2, CCG9022-0, CCG9022-2, CCG9040-0, CCG9040-2, CCG9040-4, CCG9041-0, CCG9041-2, CCG9041-4, CCG9042-0, CCG9042-2, CCG9042-4, CNG50150, CNG50160, CNG72160, CNG90160, CNG90160S, CNG90160-S, CPD70150, CPD90100AP, CPD90100A-P, CPD90100P, CPD90150AP, CPD90150A-P, CPD9015-P, CPI70150, CPI90100AP, CPI90100A-P, CPI90100P, CPI90100-P, CPI90150AP, CPI90150A-P...(Other models you can see in the webshop)			
accessories for	111187			
	GEV No.	111965	Ref. No.	0101795 1039122300 MA1039122300 SIR0101795
knob dial plate t.max.°C temperature range°C				



1

GEV No.	111186	Ref. No.	0101798 SIR0101798	
description	knob gas tap with ignition flame ø 73mm shaft ø 8x6.5mm shaft flat lower black			
For models:	BG82ALL, BG82ARR, BG82GLL, BG82GRR, BG82TLL, BG82TRR, BG84ALL, BG84ALR, BG84ARR, BG84GLL, BG84GLR, BG84GRR, BG84TLL, BG84TLR, BG84TRR, CCG1041P, CCG1042P, CCG1045P, CCG1061P, CCG1062P, CCG10652P, CCG1081P, CCG1082P, CCG1085P, CCG7001P, CCG7020P, CCG7021P, CCG7022P, CCG7040P, CCG7041P, CCG7042P, CCG7045P, CCG7046P, CCG7061P, CCG7062P, CCG70652P, CCG70662P, CCG9020P, CCG9021P, CCG9022P, CCG9040P, CCG9041P, CCG9042P, CCG9045P, CCG9046P, CCG9060P, CCG9061P, CCG9062P, CCG90652P, CCG90662P...(Other models you can see in the webshop)			
accessories for	111186			
	GEV No.	111965	Ref. No.	0101795 1039122300 MA1039122300 SIR0101795
knob dial plate t.max.°C temperature range°C				



1

GEV No.	111184	Ref. No.	0101786 SIO101786 SIR0101786	
description	knob gas tap without ignition flame t.max.°C temperature range°C ø 73mm shaft ø 8x6.5mm shaft flat lower black S-shape			
For models:	CCG1041, CCG1042, CCG1045, CCG1061, CCG1062, CCG10652, CCG10653, CCG1081, CCG1082, CCG1085, CCG10852, CCG6020, CCG6040, CCG6045, CCG6046, CCG7001, CCG7020, CCG7021, CCG7022, CCG7040, CCG7041, CCG7042, CCG7045, CCG7046, CCG7061, CCG7062, CCG70652, CCG70653, CCG70663, CCG7201, CCG7220, CCG7221, CCG7240, CCG7241, CCG7242, CCG7245, CCG7246, CCG7261, CCG7262, CCG72652, CCG72653, CCG72662, CCG72663, CCG9020, CCG9021, CCG9022, CCG9040, CCG9041, CCG9042, CCG9046...(Other models you can see in the webshop)			
accessories for	111184			
	GEV No.	111965	Ref. No.	0101795 1039122300 MA1039122300 SIR0101795
knob dial plate t.max.°C temperature range°C				





1

GEV No.	112532	Ref. No.	0101946 SIR0101946
description	knob switch 0-1-2 ø 73mm shaft ø 6x4.6mm shaft flat lower black		
For models:	CTE9141, CTE9142, CTE9142S, CTE9146, TE94APS, TE94EPS, TE94GPS, TEY4APS		



 <p>1</p>			
GEV No.	111189	Ref. No.	0101788 SIR0101788
description	knob switch 4-position ø 73mm shaft ø 6x4.6mm shaft flat upper black		
For models:	CCG60652, CCG60653, CCG7046, CCG7046P, CCG70662P, CCG70663, CCG7246, CCG72662, CCG72663, CCG9046P, CCG90662P, CCG9146, CCG9146-1, CCG91662, CCG91662-1, CCG91663, CCG91663-1, CCQ7046, CCQ70663, CCQ9046, CCQ9046V, CCQ90663, CCT6046, CCT7046, CCT70663, CCT7246V, CE84EPO, CE94EPO, CFS9060, CFS9062, CFS9066, CG74EPS, CG76EPS, CG84EPS, CG94EPS, CG96EPS, CTT9046, CTT90663R, CV74EPS, CV94EPS, HE94EPS, HEY4EPS, TG94EPS		
accessories for	111189		
	GEV No.	111965	Ref. No. 0101795 1039122300 MA1039122300 SIR0101795
knob dial plate t.max.°C temperature range°C			

 <p>1</p>			
GEV No.	111193	Ref. No.	0101791 SIR0101791
description	knob thermostat t.max. 110°C temperature range 0-110°C ø 73mm shaft ø 6x4.6mm shaft flat lower rotation 270° black		
For models:	CNE70130, CNE72130, CNE90130, CNE90130-S, CNE90140, CNE90140-S, CNE90160, CNE90160S, CNE90160-S, CNE90230, CNE90240, DE72125, DE72128, DE74228, DE92140, DE92142, DE94170, DE94240, DE94242, DEY2142, DEY4160, DEY4242		
accessories for	111193		
	GEV No.	111965	Ref. No. 0101795 1039122300 MA1039122300 SIR0101795
knob dial plate t.max.°C temperature range°C			

 <p>1</p>			
GEV No.	110423	Ref. No.	0101790 SIR0101790
description	knob switch 7-position t.max.°C temperature range°C ø 73mm shaft ø 6x4.6mm shaft flat lower		
For models:	BER12, BER14, BER16, BER18, BER20, CCQ7020, CCQ7021, CCQ7022, CCQ7040, CCQ7041, CCQ7042, CCQ7046, CCQ7061, CCQ7062, CCQ7063, CCQ7220, CCQ7221, CCQ7222, CCQ7240, CCQ7241, CCQ7242, CCQ7246, CCQ7261, CCQ7262, CCQ9020, CCQ9021, CCQ9022, CCQ9040, CCQ9041, CCQ9042, CCQ9046, CCQ9060, CCQ9061, CCQ9062, CCQ90663, CCT6020, CCT6040, CCT6046, CCT7020, CCT7021, CCT7022, CCT7040, CCT7041, CCT7042, CCT7046, CCT7061, CCT7062, CCT70663, CCT7220, CCT7221...(Other models you can see in the webshop)		

 <p>1</p>			
GEV No.	111528	Ref. No.	0101799 SIR0101799
description	knob thermostat t.max. 295°C temperature range 0-295°C ø 73mm shaft ø 6x4.6mm shaft flat lower rotation 270° black		
For models:	BE72ALC, BE72ALL, BE72ARR, BE72GLC, BE72GLL, BE72GRR, BE72TLC, BE72TLL, BE72TRR, BE74ALC, BE74ALL, BE74ALR, BE74ARC, BE74ARR, BE74GLC, BE74GLL, BE74GLR, BE74GMC, BE74GRR, BE74TLC, BE74TLL, BE74TLR, BE74TMC, BE74TRR, BE82ALC, BE82ALL, BE82ARR, BE82GLC, BE82GLL, BE82GRR, BE82TLC, BE82TLL, BE82TRR, BE84ALC, BE84ALL, BE84ALR, BE84AMC, BE84ARR, BE84GLC, BE84GLL, BE84GLR, BE84GMC, BE84GRR, BE84TLC, BE84TLL, BE84TLR, BE84TMC, BE84TRR, BE92ALC, BE92ALL...(Other models you can see in the webshop)		

 <p>1</p>			
GEV No.	111196	Ref. No.	0102497 SIR0102497
description	knob thermostat t.max. 100°C temperature range 0-100°C ø 73mm shaft ø 6x4.6mm shaft flat lower rotation 270° black		
For models:	CPE90100, CPE90100A, CPE90150, CPE90150A, CPI90100, CPI90100A, CPI90150, CPI90150A, PE7NI05, PE8AI10, PE8AI15, PE8NI10, PE8NI15, PE9AI10, PE9AI15, PE9NI10, PE9NI15		
accessories for	111196		
	GEV No.	111965	Ref. No. 0101795 1039122300 MA1039122300 SIR0101795
knob dial plate t.max.°C temperature range°C			

 <p>1</p>			
GEV No.	111208	Ref. No.	0101789 SIR0101789
description	knob thermostat t.max. 310°C temperature range 0-310°C ø 73mm shaft ø 6x4.6mm shaft flat lower		
For models:	BE72ALC, BE72ALL, BE72ARR, BE72GLC, BE72GLL, BE72GRR, BE72TLC, BE72TLL, BE72TRR, BE74ALC, BE74ALL, BE74ALR, BE74ARC, BE74ARR, BE74GLC, BE74GLL, BE74GLR, BE74GMC, BE74GRR, BE74TLC, BE74TLL, BE74TLR, BE74TMC, BE74TRR, CBE6030, CCG60652, CCG60653, CCG7046, CCG7046P, CCG70662P, CCG70663, CCG7246, CCG72662, CCG72663, CCG9046P, CCG90662P, CCG9146, CCG9146-1, CCG91662, CCG91662-1, CCG91663, CCG91663-1, CCQ7046, CCQ70663, CCQ9020, CCQ9020V, CCQ9020-V, CCQ9021, CCQ9021-V, CCQ9022...(Other models you can see in the webshop)		



1

GEV No.	111190	Ref. No.	0101797 SIR0101797
description	knob thermostat t.max. 90°C temperature range 30-90°C ø 73mm shaft ø 6x4.6mm shaft flat lower rotation 270° black		
For models:	BAC100, BAC100-A, BAC102, BAC120, BAC120-A, BAC122, BAC140, BAC140-A, BAC142, BAC160, BAC160-A, BAC162, BAC180, BAC180-A, BAC182, BAC200, BAC200-A, BAC202, BAM16D, BAM16S, BAM18D, BAM18S, BAM20D, BAM20S, CCG1045, CCG10652, CCG10653, CCG1085, CCG10852, CCG6045, CCG60652, CCG60653, CCG7045, CCG7046, CCG70652, CCG70653, CCG70663, CCG72653, CCG72663, CCG9046, CCG90663, CCG91653, CCG91653-1, CCG91663, CCG91663-1, CCQ7046, CCQ70663, CCQ9046, CCQ90663, CCT7046...(Other models you can see in the webshop)		
accessories for	111190		
	GEV No.	111965	Ref. No. 0101795 1039122300 MA1039122300 SIR0101795
knob dial plate t.max.°C temperature range°C			



1

GEV No.	111965	Ref. No.	0101795 1039122300 MA1039122300 SIR0101795
description	knob dial plate t.max.°C temperature range°C		
For models:	BE62TLC, BE62TLL, BE62TRR, BE63TLC, BE63TLL, BE63TLR, BE65TLC, BE65TLL, BE65TLR, CBE6220, CCG6220/1, CCG6230/1, CCG6245-1, CCG62652-1, CCT6220, CCT6220V, CCT6230, CCT6230V, CCW6220, CE62TPT, CE64TPT, CFE62110/1, CFE62210/1, CG62TPS, CG64FPS, CG64TPS, CG66FPS, CGE6220, CGE6220C, CGE6220R, CGE6230, CGE6230C, CGE6230LR, CGE6250, CGE6250LR, CGE6250LRC, CME6220, CME6230, CME6240, CNE6230, CSP6220, CV62TPS, CV64TPS, CW62TPS, DE63128, FE62T10, FE64T10, ME62TPS, ME63TPS, ME64TPS...(Other models you can see in the webshop)		



1

GEV No.	110060	Ref. No.	0101213 SIR0101213
description	knob switch 0-1-0-1 ø 60mm shaft ø 6x4.6mm shaft flat upper black		





1

GEV No.	110058	Ref. No.	0101219 SIR0101219
description	knob thermostat t.max. 110°C temperature range 30-110°C ø 60mm shaft ø 6x4.6mm shaft flat horizontal		





1

GEV No.	112709	Ref. No.	1036609900 MA1036609900
description	cover cap t.max.°C grey for knob		
For models:	CRE6220, CRE6230, CRG6220, CRG6240, GE62TPS, GE63TPS, GG62TGP, GG64TGP		
accessories for	112709		
	GEV No.	112527	Ref. No. 1036712600 MA1036712600
knob gas tap with ignition flame t.max.°C temperature range°C ø 45mm shaft ø 6x4.6mm shaft flat lower black			



1

GEV No.	112527	Ref. No.	1036712600 MA1036712600
description	knob gas tap with ignition flame t.max.°C temperature range°C ø 45mm shaft ø 6x4.6mm shaft flat lower black		
For models:	CRG6220, CRG6240, GG62TGP, GG64TGP		
accessories for	112527		
	GEV No.	112709	Ref. No. 1036609900 MA1036609900
cover cap t.max.°C grey for knob			





1



GEV No.	111221	Ref. No.	0101232 SIR0101232
description	knob ø 61mm gas tap with ignition flame		



 <p>1</p>			
GEV No.	580140	Ref. No.	CR0585250 TAB_M
description	knob switch zero mark ø 76mm shaft ø 10x8mm black		
For models:	EBE92AL, EBE92ALC, EBE92AR, EBE92ARC, EBE92GL, EBE92GLC, EBE92GR, EBE92GRC, EBE92TL, EBE92TLC, EBE92TR, EBE92TRC, EBE93AL, EBE93ALC, EBE93ALR, EBE93AMC, EBE93GL, EBE93GLC, EBE93GLR, EBE93GMC, EBE93TL, EBE93TLC, EBE93TLR, EBE93TMC, EBE94AL, EBE94ALC, EBE94ALR, EBE94AMC, EBE94AR, EBE94GL, EBE94GLC, EBE94GLR, EBE94GMC, EBE94GR, EBE94TL, EBE94TLC, EBE94TLR, EBE94TMC, EBE94TR, EBG92AL, EBG92AR, EBG92GL, EBG92GR, EBG92TL, EBG92TR, EBG93AL, EBG93ALR, EBG93GL, EBG93GLR, EBG93TL...(Other models you can see in the webshop)		

 <p>1</p>			
GEV No.	580137	Ref. No.	CR0585220
description	knob switch zero mark shaft ø 6x4.6mm shaft flat upper black		
accessories for	580137		
	GEV No.	550132	Ref. No. —
knob spring ø 6x4.6mm Qty 10 pcs			

miscellaneous

 <p>Image not available</p> <p>1</p>			
GEV No.	111191	Ref. No.	0101785 SIR0101785
description	knob		
accessories for	111191		
	GEV No.	111965	Ref. No. 0101795 1039122300 MA1039122300 SIR0101795
knob dial plate t.max.°C temperature range°C			

accessories

fascias

 <p>1</p>			
GEV No.	111422	Ref. No.	CR0680110
description	control panel gas thermostat t.max. 300°C 100-300°C ø 94mm		

handles and hand wheels

hand wheels

hand wheels

 <p>1</p>			
GEV No.	693113	Ref. No.	LC336-00 SIRLC336-00
description	hand wheel ø 150mm D1 ø 38mm bore ø 14mm thread groove width 5mm L1 38mm L2 40mm handle length 65mm with folding handle		
For models:	CBE7050, CBE7050C, CBG7050, CBG7050C, SE74CRM, SE74FRM, SE74IRM, SG74CRM, SG74IRM		
spare parts for	693113		
	GEV No.	514255	Ref. No. —
folding handle ø 26mm total length 85mm seat ø 20mm shaft ømm thread M6 with pin L 85mm			
accessories for	693113		
	GEV No.	690968	Ref. No. —
roll pin ø 5mm L 20mm			

 <p>1</p>			
GEV No.	690854	Ref. No.	0100480 SIR0100480
description	hand wheel ø 200mm D1 ø 40mm bore ø 6mm depth of bore 30mm thread M10x1.5 groove widthmm L1 25mm L2 55mm handle length-mm without handle		
accessories for	690854		
	GEV No.	690856	Ref. No. 0100481 SI0100481 SIR0100481
folding handle ø 28mm total length 105mm seat ø 21mm shaft ø 8mm thread M6 with shaft and pin L 105mm			



GEV No.	692430	Ref. No.	9203665 S19203665 SIR9203665
description	hand wheel ø 200mm D1 ø 50mm bore ø 20mm thread groove width 6mm groove depth 13mm mounting distance 30mm L1 47mm L2 50mm handle length 90mm with folding handle		
For models:	CBE9060, CBE9060C, CBG9060C-I, CBG9060CP, CBG9060C-P, CBG9060P, SE84CRM, SE84FRM, SE84IRM, SE94CRM, SE94FRM, SE94IRM, SG84CRM, SG84IRM, SG94CRM, SG94FRM, SG94IRM		

spare parts and accessories



GEV No.	690855	Ref. No.	0100483 SIR0100483
description	folding handle ø 25mm seat ø 19mm shaft ø 8mm thread M6 with shaft and pin L 82mm		



GEV No.	690856	Ref. No.	0100481 S10100481 SIR0100481
description	folding handle ø 28mm total length 105mm seat ø 21mm shaft ø 8mm thread M6 with shaft and pin L 105mm		

bracket handles



GEV No.	691327	Ref. No.	0101243 CM073100 MACM073100 SIR0101243
description	pull handle L 119mm H 37mm mounting distance 105mm handle M6		
For models:	CEN6220, CEN6220C, CEN6230, CEN6230C, CFE90120, CFE90120-2, CFE90210, CFE90210-2, CFE90220, CFE90220-2, CFG70115, CFG70215, CFG72215, CFG90120, CFG90210, CFG90210S, CFG90220, CNE70130, CNE70160, CNE72130, CNE72160, CNE90130, CNE90130-S, CNE90140, CNE90140-S, CNE90160, CNE90160S, CNE90160-S, CNE90230, CNE90240, CNG50150, CNG50160, CNG90130, CNG90130-S, CNG90140, CNG90140-S, CNG90160, CNG90160S, CNG90160-S, CNG90230, CNG90240, DE72125, DE74170, DE92140, DE94170, DE94240, DEY4160, DG92140, DG94160, DG94240...(Other models you can see in the webshop)		

hinges

spring assisted hinges

universal

CAFF/FERMOD

group 2

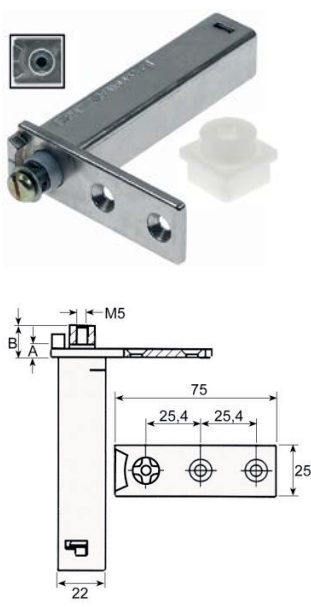



GEV No.	690494	Ref. No.	4837000 MA4837000
description	spring assisted hinge series 175 mounting pos. left/right torx L 75mm W 25.6mm H 100mm A 4mm B 11mm mounting measurements 22x22mm intake torx refrigeration units mounting distance 25mm		



oven hinges



GEV No.	700001	Ref. No.	0100343 1304500 MA1304500 SIR0100343
description	opposite support L 118mm W 17mm mounting distance 94mm		
For models:	CCG1041, CCG1042, CCG1045, CCG1045P, CCG1061, CCG1062, CCG10652, CCG10652P, CCG10653, CCG1081, CCG1082, CCG1085, CCG10852, CCG1085P, CCG6020, CCG6040, CCG6045, CCG6046, CCG6245-1, CCG62652-1, CCG7001, CCG7001P, CCG7020, CCG7021, CCG7022, CCG7040, CCG7041, CCG7042, CCG7045, CCG7045P, CCG7046, CCG7046P, CCG7061, CCG7062, CCG70652, CCG70652P, CCG70653, CCG70662P, CCG70663, CCG7201, CCG7245, CCG7246, CCG72652, CCG72653, CCG72662, CCG72663, CCG9020, CCG9021, CCG9022, CCG9040...(Other models you can see in the webshop)		

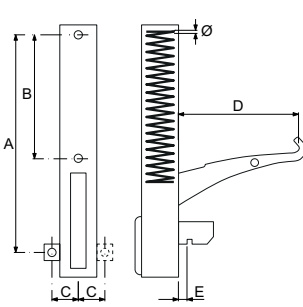

 <p>1</p>			
GEV No.	700006	Ref. No.	0100346 SIR0100346
description	oven hinge mounting distance 173mm mounting distance 2 105mm lug mounting 14mm lever length 120mm groove distance 11mm spring thickness 3.5mm mounting ear position left spring length 112mm W 25mm		
For models:	CCG1041, CCG1042, CCG1045, CCG1045P, CCG1061, CCG1062, CCG10652, CCG10652P, CCG10653, CCG1081, CCG1082, CCG1085, CCG10852, CCG1085P, CCG6020, CCG6040, CCG6045, CCG6046, CCG7020, CCG7021, CCG7022, CCG7040, CCG7041, CCG7042, CCG7045, CCG7045P, CCG7046, CCG7046P, CCG7061, CCG7062, CCG70652, CCG70652P, CCG70653, CCG70662P, CCG70663, CCG7245, CCG7246, CCG72652, CCG72653, CCG72662, CCG72663, CCG9020, CCG9021, CCG9022, CCG9040, CCG9041, CCG9042, CCG9045P, CCG9046, CCG9046P...(Other models you can see in the webshop)		
accessories for	700006		
	GEV No.	700001	Ref. No. 0100343 1304500 MA1304500 SIR0100343
	opposite support L 118mm W 17mm mounting distance 94mm		
	GEV No.	700007	Ref. No. 0100345 BN6A035920 SIR0100345
	oven hinge mounting distance 173mm mounting distance 2 105mm lug mounting 14mm lever length 120mm groove distance 11mm spring thickness 3.5mm mounting ear position right spring length 112mm W 25mm		

  <p>1</p>			
GEV No.	700007	Ref. No.	0100345 BN6A035920 SIR0100345
description	oven hinge mounting distance 173mm mounting distance 2 105mm lug mounting 14mm lever length 120mm groove distance 11mm spring thickness 3.5mm mounting ear position right spring length 112mm W 25mm		
For models:	CCG1041, CCG1042, CCG1045, CCG1045P, CCG1061, CCG1062, CCG10652, CCG10652P, CCG10653, CCG1081, CCG1082, CCG1085, CCG10852, CCG1085P, CCG6020, CCG6040, CCG6045, CCG6046, CCG7020, CCG7021, CCG7022, CCG7040, CCG7041, CCG7042, CCG7045, CCG7045P, CCG7046, CCG7046P, CCG7061, CCG7062, CCG70652, CCG70652P, CCG70653, CCG70662P, CCG70663, CCG7245, CCG7246, CCG72652, CCG72653, CCG72662, CCG72663, CCG9020, CCG9021, CCG9022, CCG9040, CCG9041, CCG9042, CCG9045P, CCG9046, CCG9046P...(Other models you can see in the webshop)		
accessories for	700007		
	GEV No.	700001	Ref. No. 0100343 1304500 MA1304500 SIR0100343
	opposite support L 118mm W 17mm mounting distance 94mm		

accessories for	700007		
	GEV No.	700006	Ref. No. 0100346 SIR0100346
	oven hinge mounting distance 173mm mounting distance 2 105mm lug mounting 14mm lever length 120mm groove distance 11mm spring thickness 3.5mm mounting ear position left spring length 112mm W 25mm		

miscellaneous

 <p>1</p>			
GEV No.	700716	Ref. No.	0100344 SIR0100344
description	hinge for kettle		

accessories

miscellaneous

 <p>1</p>			
GEV No.	694495	Ref. No.	CM219300 MACM219300
description	distance washer for lid hinge for tilting bratt pan ID ø 18.2mm ED ø 20mm L 20mm stainless steel		
For models:	SE84CRA, SE84CRM, SE84FRA, SE84FRM, SE84IRA, SE84IRM, SE86CRA, SE86FRA, SE86IRA, SE86IRM, SE96CRA, SE96FRA, SE96IRA, SE96IRM, SG84CRA, SG84CRM, SG84IRA, SG84IRM		

 <p>1</p>			
GEV No.	514231	Ref. No.	CM051503 MACM051503
description	hinge pin tilting bratt pan kettle type series 700/900		
For models:	EPE50, EPE7108, EPG50, EPG7108, PE8A110, PE8A115, PE8NI10, PE8NI15, PE9A110, PE9A115, PE9NI10, PE9NI15, PG8AD10, PG8AD15, PG8A110, PG8A115, PG8ND10, PG8ND15, PG8NI10, PG8NI15, PG9AD10, PG9AD15, PG9A110, PG9A115, PG9ND10, PG9ND15, PG9NI10, PG9NI15, SE84CRA, SE84CRM, SE84FRA, SE84FRM, SE84IRA, SE84IRM, SE86CRA, SE86FRA, SE86IRA, SE86IRM, SE96CRA, SE96FRA, SE96IRA, SE96IRM, SG84CRA, SG84CRM, SG84IRA, SG84IRM		

fittings for catering equipment

aerators and air bleeders

			
1			
GEV No.	540827	Ref. No.	0100573 BN6A021600 SIR0100573
description	aerator and air bleeder thread 3/4" ET chrome-plated L 45mm ø 36mm		

			
1			
GEV No.	540824	Ref. No.	0100568 SIR0100568
description	pressure compensation valve thread 1/4" ET WS 19 chrome-plated L 18mm		
For models:	CPE70150, CPE7-150, PE7NI05		

lid hinges

miscellaneous



spare parts

			
1			
GEV No.	691659	Ref. No.	CM192301 MACM192301
description	extension for lid hinge ø 18mm L 209mm since 2003		
For models:	SE84CRA, SE84CRM, SE84FRA, SE84FRM, SE84IRA, SE84IRM, SG84CRA, SG84CRM, SG84IRA, SG84IRM		

drain taps

brass

drain taps

			
1			
GEV No.	540131	Ref. No.	0100541 MA1677800 SIR0100541
description	drain tap 1 1/4" IT chrome-plated brass		
spare parts for	540131		
	GEV No.	540213	Ref. No. —
	handle ID ø 5mm L 117mm		
	GEV No.	540461	Ref. No. —
	shim for drain tap		
	GEV No.	540464	Ref. No. —
	nut for drain tap thread 1 1/2"		

			
1			
GEV No.	540275	Ref. No.	0100531 BN6A021000 CM128900 MACM128900 SIR0100531
description	drain tap 2" IT with union nut A 90mm B 151mm B1 80mm chrome-plated brass		
For models:	CPD90100, CPD90100A, CPD90100AP, CPD90100A-P, CPD90100P, CPD90150, CPD90150A, CPD90150AP, CPD90150A-P, CPD9015-P, CPE90100, CPE90100A, CPE90150, CPE90150A, CPI90100, CPI90100A, CPI90100AP, CPI90100A-P, CPI90100P, CPI90100-P, CPI90150, CPI90150A, CPI90150AP, CPI90150A-P, CPI90150P, CPI90150-P, PE8AI10, PE8AI15, PE8NI10, PE8NI15, PE9AI10, PE9AI15, PE9NI10, PE9NI15, PG8AD10, PG8AD15, PG8AI10, PG8AI15, PG8ND10, PG8ND15, PG8NI10, PG8NI15, PG9AD10, PG9AD15, PG9AI10, PG9AI15, PG9ND10, PG9ND15, PG9NI10, PG9NI15		
spare parts for	540275		
	GEV No.	540214	Ref. No. —
	handle ID ø 6mm L 145mm		
accessories for	540275		
	GEV No.	529484	Ref. No. —
	flat gasket fibre ED ø 58mm ID ø 50mm thickness 2mm Qty 1 pcs		

Table continues overleaf



accessories for 540275			
	GEV No. 542448	Ref. No.	—
gasket silicone 60x49x2 for drain tap 2"			



GEV No. 540276	Ref. No.	0100532 SIR0100532	
description drain tap connection with union nut thread 1 1/2"			
For models: CPD70150, CPE70150, CPE7-150, CPI70150, PE7NI05, PG7ND05, PG7NI05			
spare parts for 540276			
	GEV No. 532374	Ref. No.	—
O-ring silicone thickness 5.34mm ID ø 43.82mm Qty 10 pcs			
accessories for 540276			
	GEV No. 514251	Ref. No.	—
gasket fibre ED ø 46mm ID ø 38mm thickness 2mm Qty 1 pcs			

accessories

GEV No. 699248	Ref. No.	77121900 MA77121900	
description O-ring set silicone 2" for drain tap Qty 3 pcs			
For models: EPE9D10, EPE9D15, EPE9I10, EPE9I10A, EPE9I15, EPE9I15A, EPG9D10, EPG9D10A, EPG9D15, EPG9D15A, EPG9I15, EPG9I15A, EPGB9I10, EPGB9I10A			

safety fittings

accessories

GEV No. 540816	Ref. No.	0100571 SIR0100571	
description fitting support thread 1 1/4"			
For models: CPE70150, CPE7-150, PE7NI05			

GEV No. 540821	Ref. No.	0100578 SIR0100578	
description fitting support thread 1 1/4"			

GEV No. 540860	Ref. No.	0100580 SIR0100580	
description fitting support thread 3/4" ET suitable for manometer			

GEV No. 540836	Ref. No.	0100575 BN6A021700 SIR0100575	
description funnel thread 1/2" with shut-off valve			
For models: CPE70150, CPE7-150, PE7NI05			

GEV No. 540830	Ref. No.	0100577 SIR0100577	
description pressure gauge tap IT 1/4" ET 1/4"			

GEV No. 540829	Ref. No.	0100579 SIR0100579	
description manometer siphon thread 1/2"			
For models: CPE70150, CPE7-150, PE7NI05			

safety valves



1

GEV No.	540721	Ref. No.	0100587 0100589 BN6A021510 SIR0100587 SIR0100589
description	safety valve triggering pressure 0.5bar M88 thread 1¼"		
For models:	CPE70150, CPE7-150, PE7NI05		
accessories for	540721		
	GEV No.	541501	Ref. No. —
reducer for safety fitting IT 1¼" ET 3/4"			

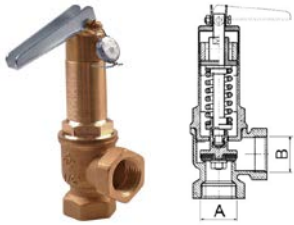

1

GEV No.	540909	Ref. No.	0102494 327900 MA327900 SIR0102494
description	safety valve T1: 1/2" T2: 1/2" triggering pressure 0.5bar		
For models:	CPD90100A, CPD90100AP, CPD90100A-P, CPD90150A, CPD90150AP, CPD90150A-P, CPE90100A, CPE90150A, CPI90100A, CPI90100AP, CPI90150A, CPI90150AP, EPE9D10, EPE9D15, EPE9I10, EPE9I10A, EPE9I15, EPE9I15A, EPG9D10, EPG9D10A, EPG9D15, EPG9D15A, EPG9I15, EPG9I15A, EPG9I10, EPG9I10A, PE8AI10, PE8AI15, PE8NI10, PE8NI15, PE9AI10, PE9AI15, PG8AD10, PG8AD15, PG8AI10, PG8AI15, PG8ND10, PG8ND15, PG8NI10, PG8NI15, PG9AD10, PG9AD15, PG9AI10, PG9AI15, PG9ND10, PG9ND15, PG9NI10, PG9NI15		

equipment feet and end caps

bolting feet



1

GEV No.	514009	Ref. No.	1036021600 1036021613 MA1036021600 MA1036021613
description	equipment foot L 50mm W 29mm H 25mm bore ø 10mm mounting distance 40mm Qty 1 pcs		
For models:	BG62TLC, BG62TLL, BG62TRR, BG63TLC, BG63TLL, BG63TLR, BG64TLC, BG64TLL, BG64TLR, BMG-40, BMG-60, CBE6220, CCT6220V, CCT6230V, CCW6220, CEN6220, CEN6220C, CEN6230, CEN6230C, CFG62110, CFG62210, CGG6220, CGG6220C, CGG6220R, CGG6230, CGG6230C, CGG6230LR, CGG6240, CGG6240C, CGG6240LR, CLA6230, CME6220, CME6230, CME6240, CNE6230, CRE6220, CRE6230, CRG6220, CRG6240, CSP6220, CV62TPS, CV64TPS, CW62TPS, DE63128, EL63TPS, EN62T1C, EN62TPS, EN63T1C, EN63TPS, FG62T08...(Other models you can see in the webshop)		

baskets

fryer baskets

SILKO



1

GEV No.	970451	Ref. No.	0109091 SIR0109091
description	fryer basket L1 280mm W1 100mm H1 100mm chrome-plated steel		
For models:	CFE60110, CFE60210, CFE70110-0, CFE72110-0, FE72T10		



1

GEV No.	970215	Ref. No.	0109089 SIR0109089
description	fryer basket L1 280mm W1 200mm H1 100mm chrome-plated steel		
For models:	CFE60110, CFE60210, CFE70110-0, CFE72110-0, FE72T10		



1

GEV No.	970138	Ref. No.	0101100 0101114 SIR0101100 SIR0101114
description	fryer basket L1 290mm W1 135mm H1 120mm L2 490mm H2 175mm H3 220mm chrome-plated steel		
For models:	CFE70110, CFE70110-2, CFE70210, CFE70210-2, CFE70210-M, CFE72210, CFE90210, CFE90210-2, CFG90210, CFG90210S, FE72210, FE92210, FG92210, FGY2210		





1

GEV No.	970357	Ref. No.	0101098 SIR0101098
description	fryer basket L1 290mm W1 165mm H1 120mm chrome-plated steel		





			
1			
GEV No.	970367	Ref. No.	0101116 SIR0101116
description	fryer basket L1 290mm W1 230mm H1 120mm		

			
1			
GEV No.	970217	Ref. No.	0109005 SIR0109005
description	fryer basket L1 300mm W1 230mm H1 105mm		
For models:	CFE60110-5, CFE60110-9, CFE60210-5, CFE60210-9, CFG60110, CFG60210		

			
1			
GEV No.	970356	Ref. No.	0101099 SIR0101099
description	fryer basket L1 290mm W1 230mm H1 120mm chrome-plated steel		
For models:	CFE70115, CFE70115-2, CFE70115-M, CFE70215, CFE70215-2, CFE70215-M, CFE72215, CFG70115, CFG70215, CFG72215		

			
1			
GEV No.	970352	Ref. No.	0105040 CM030200 MACM030200 SIR0105040
description	fryer basket L1 360mm W1 160mm H1 120mm chrome-plated steel		
For models:	FE82118, FE84218, FE92118, FE94218, FEY2118, FEY4218, FG82122, FG84222, FG92122, FG94222, FGY2122, FGY4222		

			
1			
GEV No.	970358	Ref. No.	0101102 SI0101102 SIR0101102
description	fryer basket L1 290mm W1 330mm H1 120mm L2 507mm H2 175mm H3 220mm chrome-plated steel		
For models:	CFE90120, CFE90120-2, CFE90220, CFE90220-2, CFG90120, CFG90220		

			
1			
GEV No.	970920	Ref. No.	CR0686180
description	fryer basket W1 225mm L1 360mm H1 120mm L2 630mm H2 220mm chrome-plated steel		
For models:	EFE72115, EFE74215, EFE92115, EFE94215, EFG72110, EFG72115, EFG73210, EFG74215, EFG92115, EFG92115S, EFG93210, EFG94215, EFG94215S		

 <p>Image not available</p>			
1			
GEV No.	970137	Ref. No.	0109090 SIR0109090
description	fryer basket L1 295mm W1 200mm H1 105mm		
For models:	CFE60110, CFE60210, CFE70110-0, CFE72110-0, FE72T10		

pasta baskets

SILKO

			
1			
GEV No.	970205	Ref. No.	0101125 SIR0101125
description	pasta basket L1 165mm W1 300mm H1 230mm H3 415mm stainless steel		
For models:	CNE90140, CNE90140-S, CNG90140, CNG90140-S, DE92140, DG92140		

1 

GEV No.	970204	Ref. No.	0101122 SI0101122 SIR0101122
description	pasta basket L1 300mm W1 150mm H1 215mm		
For models:	CNE70130, CNE70160, CNE72130, CNE72160, CNE90130, CNE90130-S, CNE90140, CNE90140-S, CNE90160, CNE90160S, CNE90160-S, CNE90230, CNE90240, CNG70130, CNG70160, CNG70230, CNG72160, CNG72230, CNG90130, CNG90130-S, CNG90140, CNG90140-S, CNG90160, CNG90160S, CNG90160-S, CNG90230, CNG90240, DE72125, DE74170, DE92140, DE94170, DE94240, DEY4160, DG72125, DG74155, DG74225, DG92140, DG94160, DG94240, DGY4160		

crumb screens

1 

GEV No.	970222	Ref. No.	0109092 SIR0109092
description	crumb screen L 303mm W 212mm suitable for fryer		
For models:	CFE60110, CFE60210, CFE70110-0, CFE72110-0, FE72T10		

shelves and shelf rails

grates

universal

with upstand

1 

GEV No.	970626	Ref. No.	1440065530 BN1440065530
description	grate W 650mm D 530mm GN 2/1 plastic-coated steel with hinge camp crossing wires 2 grey suitable for refrigerator		

gaskets

refrigeration gaskets

plug-in gaskets

profile 9048

We offer custom-made gaskets for this profile

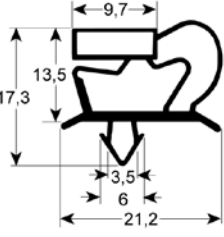
1 

GEV No.	901704	Ref. No.	RA190101 SIRRA190101
description	refrigeration gasket profile 9048 W 280mm L 400mm plug size		

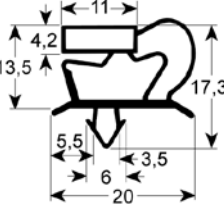
1 

GEV No.	901777	Ref. No.	0102466 SIR0102466
description	refrigeration gasket profile 9048 W 310mm L 410mm plug size		

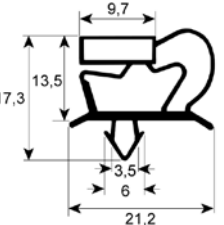
1 

GEV No.	901415	Ref. No.	SIR227017971
description	refrigeration gasket profile 9048 W 350mm L 675mm plug size		

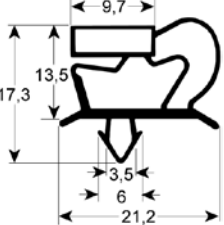
1 

GEV No.	901700	Ref. No.	RA 190100 RA190010 SIRA190010 SIRRA 190100
description	refrigeration gasket profile 9048 W 400mm L 597mm plug size		

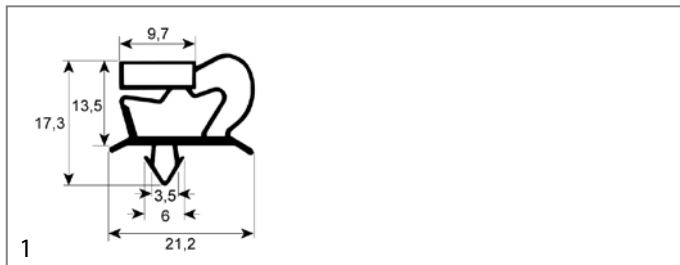

GEV No.	901214	Ref. No.	FR995948old
description	refrigeration gasket profile 9048 W 435mm L 695mm plug size		

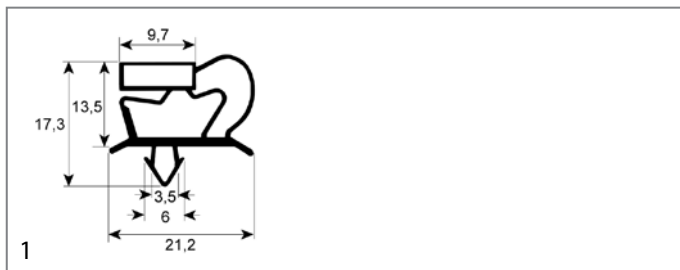

GEV No.	901212	Ref. No.	FR995950old
description	refrigeration gasket profile 9048 W 695mm L 1210mm plug size		

profile 9783

We offer custom-made gaskets for this profile

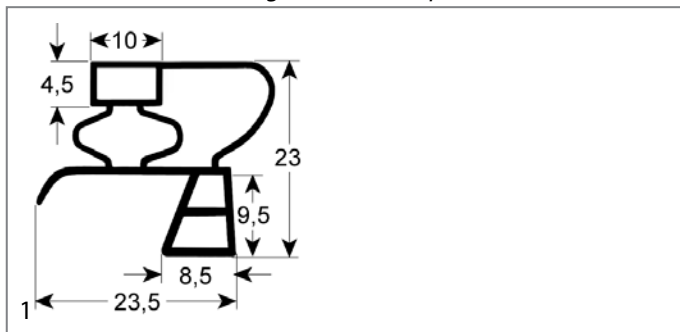

GEV No.	902306	Ref. No.	N/A
description	refrigeration gasket profile 9783 Wmm L 2500mm		

gaskets for heated units

door seals

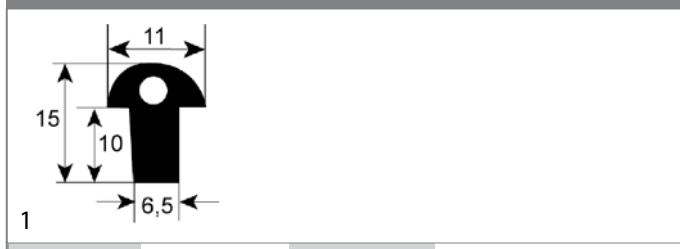

GEV No.	900727	Ref. No.	LB848-00 SIR0103245 SIRLB848-00
description	door seal profile 2930 Qty supplied by meter		
For models:	CCG6020, CCG6040, CCG6045, CCG6046, CCG7001, CCG7001P, CCG7201, CCG7245, CCG7246, CCG72652, CCG72653, CCG72662, CCG72663, CCQ7046, CCQ70663, CCT6046, CCT7046, CCT70663, CCT7246V, CG76HPS, CG86HPS, CV74EPS		

O-rings

EPDM

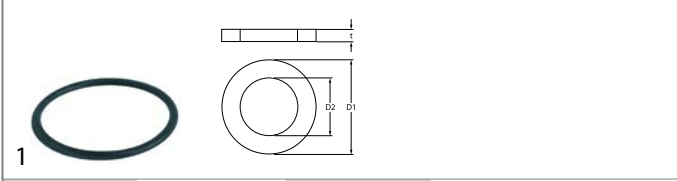

GEV No.	532118	Ref. No.	0108056 SIR0108056
description	O-ring EPDM thickness 3.53mm ID ø 55.56mm Qty 10 pcs		
For models:	CFE70110, CFE70110-2, CFE70115, CFE70115-2, CFE70115-M, CFE70210, CFE70210-2, CFE70210-M, CFE70215, CFE70215-2, CFE70215-M, CFE72210, CFE72215, CFE90120, CFE90120-2, CFE90210, CFE90210-2, CFE90220, CFE90220-2, FE72210, FE92210		

silicone

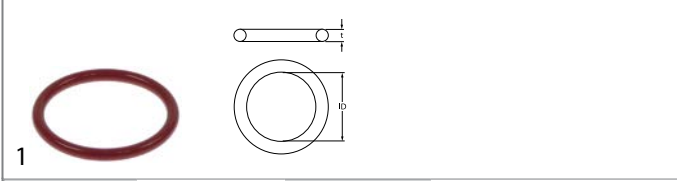

GEV No.	514017	Ref. No.	0105169 0105246 1814400 MA1814400 SIR0105169 SIR0105246
description	O-ring silicone thickness 3.53mm ID ø 32.93mm Qty 1 pcs		
For models:	CNE6230, DE63128, DE72128, DE74228, DE82140, DE82142, DE82T42, DE84240, DE84242, DE84T42, DE92142, DE94242, DEY2142, DEY4242		

Viton

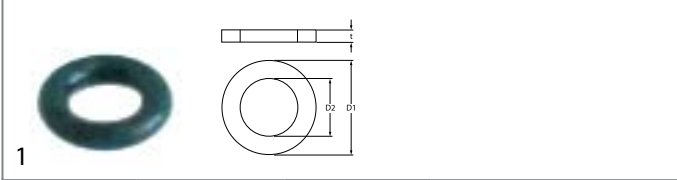

GEV No.	528687	Ref. No.	0105034 CM097900 MACM097900 SIR0105034
description	O-ring Viton thickness 1.78mm ID ø 3.69mm Qty 1 pcs		
For models:	CFE62110/1, CFE62210/1, EFE72110, EFE72115, EFE73210, EFE74215, EFE92115, EFE92122, EFE92122K, EFE93210, EFE94215, EFE94222, EFE94222K, EFG72108, EFG72110, EFG72115, EFG73208T, EFG73210, EFG74215, EFG92115, EFG92115S, EFG92123, EFG92123K, EFG93210, EFG94215, EFG94215S, EFG94223, EFG94223K, FE62T10, FE64T10, FE72112, FE72206, FE72T10, FE74212, FE74T10, FE82118, FE82206, FE82T18, FE84218, FE84T18, FE92118, FE92206, FE94218, FEY2118, FEY2206, FEY4218, FG72115, FG72206, FG74215, FG82122...(Other models you can see in the webshop)		



GEV No.	550496	Ref. No.	0105021 CM099200 MACM099200 SIR0105021
description	O-ring Viton thickness 3.53mm ID ø 50.39mm Qty 1 pcs		
For models:	CFE62110/1, CFE62210/1, EDE72128, EDE73142, EDE74228, EDE92142, EDE93142, EDE94242, EFE72110, EFE72115, EFE73210, EFE74215, EFE92115, EFE92122, EFE92122K, EFE93210, EFE94215, EFE94222, EFE94222K, FE62T10, FE64T10, FE72112, FE72206, FE72T10, FE74212, FE74T10, FE82118, FE82206, FE82T18, FE84218, FE84T18, FE92118, FE92206, FE94218, FEY2118, FEY2206, FEY4218		

PTFE gaskets



GEV No.	514016	Ref. No.	0105170 MA1814500 SIR0105170
description	flat gasket PTFE ED ø 45mm ID ø 40mm thickness 4mm Qty 1 pcs equiv. no. 1036500400/1814500 suitable for MARENO		
For models:	DE72128, DE74228, DE82140, DE84240, DE92142, DE94242, DEY2142, DEY4242		

silicone gaskets



GEV No.	691332	Ref. No.	2993700 MA2993700
description	flat gasket silicone ED ø 13.8mm ID ø 6mm thickness 1.5mm Qty 1 pcs		
For models:	CBE6220, CCT6220V, CCT6230V, CCW6220, CFE62110/1, CFE62210/1, CM72APS, CM82APS, CME6220, CME6230, CME6240, CNE6230, CRE6220, CRE6230, CSP6220, CV62TPS, CV64TPS, CW62TPS, DE63128, ERP72, FE62T10, FE64T10, FE72206, FE82206, FE92206, FEY2206, GE62TPS, GE63TPS, ME62TPS, ME63TPS, ME64TPS, RP62TPS, SE62TPS, SG86CRA, SG86FRA, SG86IRA, SG96CRA, SG96FRA, SG96IRA		

transmission technology and ball bearings

ball bearings

flange bearings



GEV No.	693112	Ref. No.	0100430 SI0100430 SIR0100430
description	flange bearing type UCF204 shaft ø 20mm 4 hole flange hole distance 64mm H 33mm flange length 86mm flange width 86mm hole ø 12mm flange F204 ball bearing UC204G2 FH 25.5mm		
For models:	CBE7050, CBE7050C, CBE9060, CBE9060C, CBG7050, CBG9060C-I, CBG9060CP, CBG9060C-P, CBG9060P, SE74CRM, SE74FRM, SE74IRM, SE84CRM, SE84FRM, SE84IRM, SE94CRA, SE94CRM, SE94FRA, SE94FRM, SE94IRA, SE94IRM, SG74CRM, SG74IRM, SG84CRM, SG84IRM, SG94CRA, SG94CRM, SG94FRA, SG94FRM, SG94IRA, SG94IRM		



GEV No.	510245	Ref. No.	0108055 SIR0108055
description	O-ring Viton thickness 3.53mm ID ø 50.8mm Qty 1 pcs		
For models:	CFE70110, CFE70110-2, CFE70115, CFE70115-2, CFE70115-M, CFE70210, CFE70210-2, CFE70210-M, CFE70215, CFE70215-2, CFE70215-M, CFE72210, CFE72215, CFE90120, CFE90120-2, CFE90210, CFE90210-2, CFE90220, CFE90220-2, FE72210, FE92210		

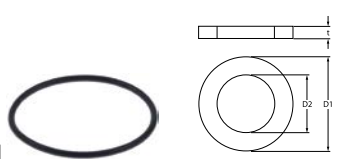

GEV No.	532681	Ref. No.	CR0582140
description	O-ring Viton thickness 3.53mm ID ø 66.27mm Qty 1 pcs		
For models:	EDE72128, EDE73142, EDE74228, EDE92142, EDE93142, EDE94242, EFE72115, EFE74215, EFE92115, EFE92122, EFE92122K, EFE94215, EFE94222, EFE94222K		

sealing washers

fibre gaskets



GEV No.	510404	Ref. No.	CR0682770
description	flat gasket fibre ED ø 44mm ID ø 34mm thickness 2mm Qty 1 pcs		





springs

torsion springs

			
GEV No.	514226	Ref. No.	139732 MA139732
description	torsion spring ø 32.3mm L2 192mm wire gauge ø 5.9mm L1 14mm kettle type series 700 series 900		
For models:	EPE50, EPG50, PE8AI10, PE8AI15, PE8NI10, PE8NI15, PE9AI10, PE9AI15, PE9NI10, PE9NI15, PG8AD10, PG8AD15, PG8AI10, PG8AI15, PG8ND10, PG8ND15, PG8NI10, PG8NI15, PG9AD10, PG9AD15, PG9AI10, PG9AI15, PG9ND10, PG9ND15, PG9NI10, PG9NI15, SE84CRA, SE84CRM, SE84FRA, SE84FRM, SE84IRA, SE84IRM, SE86CRA, SE86FRA, SE86IRA, SE96CRA, SE96FRA, SE96IRA, SG84CRA, SG84CRM, SG84IRA, SG84IRM		

manometers

			
GEV No.	541334	Ref. No.	0102491 41853310148 BN41853310148 SIR0102491
description	manometer ø 60mm pressure range 0 up to 1bar thread 1/8" marking 0.5 kettle connection on the backside		
For models:	CPE90100, CPE90100A, CPE90150, CPE90150A, CPI70150, CPI90100, CPI90100A, CPI90100AP, CPI90100A-P, CPI90100P, CPI90100-P, CPI90150, CPI90150A, CPI90150AP, CPI90150A-P, CPI90150P, CPI90150-P, PE7NI05, PE8AI10, PE8AI15, PE8NI10, PE8NI15, PE9AI10, PE9AI15, PE9NI10, PE9NI15, PG7ND05, PG7NI05, PG8AD10, PG8AD15, PG8AI10, PG8AI15, PG8ND10, PG8ND15, PG8NI10, PG8NI15, PG9AD10, PG9AD15, PG9AI10, PG9AI15, PG9ND10, PG9ND15, PG9NI10, PG9NI15		

			
GEV No.	541062	Ref. No.	0100576 BN6A021900 SIR0100576
description	manometer ø 63mm pressure range 0 up to 1bar connection marking adjustable kettle thread 1/4"		
For models:	CPE70150, CPE7-150, PE7NI05		
spare parts for	541062		
	GEV No.	Ref. No.	—
	 glass panel ø 58mm thickness 2mm		

water taps

spare parts

not for webshop

spare parts

fittings

			
GEV No.	540907	Ref. No.	0102747 SI0102747 SIR0102747
description	monobloc tap spout height with outletmm		
For models:	PE8AI10, PE8AI15, PE8NI10, PE8NI15, PG8AD10, PG8AD15, PG8AI10, PG8AI15, PG8ND10, PG8ND15, PG8NI10, PG8NI15		



dosing pumps

membrane dosing pumps

self-priming

LANG

accessories

			
GEV No.	101286	Ref. No.	0100743 0100745 LA62070023 LAR62070023 SIR0100743
description	olive ID ø 6mm Qty 1 pcs		
For models:	BG92ALC, BG92ALL, BG92ARC, BG92ARR, BG92GLC, BG92GLL, BG92GRC, BG92GRR, BG94ALC, BG94ALL, BG94ALR, BG94AMC, BG94ARC, BG94ARR, BG94GLC, BG94GLL, BG94GLR, BG94GMC, BG94GRC, BG94GRR, BGY2TLC, BGY2TLL, BGY2TRC, BGY2TRR, BGY4TLC, BGY4TLL, BGY4TLR, BGY4TMC, BGY4TRC, BGY4TRR, CBG7050, CBG7050C, CBG9060CP, CBG9060C-P, CBG9060P, CCG1041P, CCG1042P, CCG1045, CCG1045P, CCG1061P, CCG1062P, CCG10652, CCG10652P, CCG10653, CCG1081P, CCG1082P, CCG1085, CCG10852, CCG1085P, CCG7001...(Other models you can see in the webshop)		
accessories for	101286		
	GEV No.	Ref. No.	0100744 SIR0100744
	 union screw thread M10x1 for pipe ø 6mm Qty 1 pcs		
	GEV No.	Ref. No.	—
	 union nut thread M12x1 for pipe ø 6mm		

fittings, hose and pipe connectors

hose connectors

plastic



1

GEV No.	362011	Ref. No.	LA62090538 LAR62090538
description	hose connector plastic straight thread 1/4" hose ø 8x6mm Qty 1 pcs		

push-in fittings

JOHN GUEST



1

GEV No.	440019	Ref. No.	LA62090548 LAR62090548
description	push-in fitting John Guest straight pipe connection ø6mm grommet ø 10mm		
For models:	EMT06P		
accessories for	440019		
	GEV No.	Ref. No.	—
	hose thickness 1mm LLDPE blue ID ø 4mm ED ø 6mm operating pressure at 20°C 16bar		

valves and tank inlets

ball valves

universal

ball valves with butterfly handle



1

GEV No.	540658	Ref. No.	0100593 SIR0100593
description	ball valve connection 3/4" IT - 3/4" IT DN20 total length 69mm		
For models:	BAM16D, BAM16S, BAM18D, BAM18S, BAM20D, BAM20S, CME7021, CME7022, CME7041, CME7042, CME7221, CME7222, CME7241, CME7242, CME9020, CME9040, ME72APS, ME72GPS, ME74APS, ME74GPS, ME82GPS, ME84GPS, MEY2TPS, MEY4TPS		

ball valves with lever handle



1

GEV No.	540758	Ref. No.	0100605 BN6A023010 SIR0100605
description	ball valve connection 1" IT - 1" ET DN25 total length 90mm with lever handle handle length 95mm		
For models:	CNE90130, CNE90130-S, CNE90140, CNE90140-S, CNE90160, CNE90160S, CNE90160-S, CNE90230, CNE90240, CNG50150, CNG50160, CNG70130, CNG70160, CNG70230, CNG72160, CNG72230, CNG90130, CNG90130-S, CNG90140, CNG90140-S, CNG90160, CNG90160S, CNG90160-S, CNG90230, CNG90240, DE92140, DE94170, DE94240, DEY4160, DG72125, DG74155, DG74225, DG92140, DG94160, DG94240, DGP4150, DGPT160, DGY4160		



1

GEV No.	520282	Ref. No.	0100590 0108062 SIR0100590 SIR0108062
description	ball valve connection 1" IT - 1" IT DN25 total length 67mm with lever handle		
For models:	CFE70110, CFE70110-2, CFE70115, CFE70115-2, CFE70115-M, CFE70210, CFE70210-2, CFE70210-M, CFE70215, CFE70215-2, CFE70215-M, CFE72210, CFE72215, CFE90120, CFE90120-2, CFE90210, CFE90210-2, CFE90220, CFE90220-2, CFG70115, CFG70215, CFG72215, CFG90120, CFG90210, CFG90210S, CFG90220, CNE70130, CNE70160, CNE72130, CNE72160, DE72125, DE72128, DE74170, DE74228, DE82140, DE82142, DE82T42, DE84240, DE84242, DE84T42, DE92142, DE94242, DEY2142, DEY4242, DG72128, DG74228, DG82140, DG82142, DG82T42, DG84240...(Other models you can see in the webshop)		



1

GEV No.	514325	Ref. No.	0108002 MA1950700 SIR0108002
description	ball valve connection 1" IT - 1" IT DN25 total length 83mm with lever handle		





shut-off valves

producer-specific

SILKO







GEV No.	540656	Ref. No.	0100540 0102613 SIO102613 SIR0100540 SIR0102613
description	shut-off valve connection 1/2" straight total length 54mm rosette thread G2 26x19G L1 34mm L2 27mm		
For models:	CBE7050, CBE7050C, CBG7050, CBG7050C, CBG9060CP, CBG9060C-P, CBG9060P, CME1021, CME1022, CME9020, CME9021, CME9022, CME9040, CME9041, CME9042, CMG7041, CMG7042, CMG9021, CMG9022, CMG9041, CMG9042, CNE6030, CNE70130, CNE70160, CNE72130, CNE72160, CNE90130, CNE90130-S, CNE90140, CNE90140-S, CNE90160, CNE90160S, CNE90160-S, CNE90230, CNE90240, CNG50150, CNG50160, CNG70130, CNG70160, CNG70230, CNG72160, CNG72230, CNG90130, CNG90130-S, CNG90140, CNG90140-S, CNG90160, CNG90160S, CNG90160-S, CNG90230... (Other models you can see in the webshop)		
spare parts for	540656		
	GEV No.	514085	Ref. No. —
	rosette connection 26x19G chrome-plated total lengthmm mounting pos.		
	GEV No.	514086	Ref. No. —
	hexagonal nut connection 26x19G brass total lengthmm mounting pos. H 6mm WS 34 Qty 1 pcs		

drain systems and wash basins

drain fittings

universal



GEV No.	515041	Ref. No.	0100555 1138600 MA1138600 SIR0100555
description	drain fitting size 3/4" usable heightmm overall height 30mm ED ø 38mm chrome-plated brass		
For models:	BAM16D, BAM16S, BAM18D, BAM18S, BAM20D, BAM20S, CME1021, CME1022, CME7021, CME7022, CME7041, CME7042, CME7221, CME7222, CME7241, CME7242, CME9020, CME9021, CME9022, CME9040, CME9041, CME9042, CMG7041, CMG7042, CMG9021, CMG9022, CMG9041, CMG9042, ME72APS, ME72GPS, ME74APS, ME74GPS, ME82GPS, ME84GPS, ME92APS, ME92GPS, ME94APS, ME94GPS, MEP2APS, MEP2GPS, MEY2TPS, MEY4TPS, MG92APS, MG92GPS, MG94APS, MG94GPS		
accessories for	515041		
	GEV No.	515047	Ref. No. —
	standpipe size 3/4" usable height 28mm overall height 54mm ED ø 20mm chrome-plated brass with O-ring		
	GEV No.	515048	Ref. No. —
	standpipe size 3/4" usable height 48mm overall height 74mm ED ø 20mm chrome-plated brass with O-ring		
	GEV No.	515049	Ref. No. —
	standpipe size 3/4" usable height 68mm overall height 94mm ED ø 20mm chrome-plated brass with O-ring		
	GEV No.	515050	Ref. No. —
	standpipe size 3/4" usable height 98mm overall height 124mm ED ø 20mm chrome-plated brass with O-ring		

standpipes

3/4"







GEV No.	515041	Ref. No.	0100555 1138600 MA1138600 SIR0100555
description	drain fitting size 3/4" usable heightmm overall height 30mm ED ø 38mm chrome-plated brass		
For models:	BAM16D, BAM16S, BAM18D, BAM18S, BAM20D, BAM20S, CME1021, CME1022, CME7021, CME7022, CME7041, CME7042, CME7221, CME7222, CME7241, CME7242, CME9020, CME9021, CME9022, CME9040, CME9041, CME9042, CMG7041, CMG7042, CMG9021, CMG9022, CMG9041, CMG9042, ME72APS, ME72GPS, ME74APS, ME74GPS, ME82GPS, ME84GPS, ME92APS, ME92GPS, ME94APS, ME94GPS, MEP2APS, MEP2GPS, MEY2TPS, MEY4TPS, MG92APS, MG92GPS, MG94APS, MG94GPS		
accessories for	515041		
	GEV No.	515047	Ref. No. —
	standpipe size 3/4" usable height 28mm overall height 54mm ED ø 20mm chrome-plated brass with O-ring		

Table continues overleaf

accessories for	515041		
	GEV No.	515048	Ref. No. —
	standpipe size 3/4" usable height 48mm overall height 74mm ED ø 20mm chrome-plated brass with O-ring		
	GEV No.	515049	Ref. No. —
	standpipe size 3/4" usable height 68mm overall height 94mm ED ø 20mm chrome-plated brass with O-ring		
	GEV No.	515050	Ref. No. —
	standpipe size 3/4" usable height 98mm overall height 124mm ED ø 20mm chrome-plated brass with O-ring		

ancillary products

clamps

hose clamps

DIN 3017 - W2



1

GEV No.	520112	Ref. No.	LAR61630011
description	hose clamp ø 12-20mm width 9mm Qty 10 pcs DIN 3017		
For models:	EMT06P, GMT06D, GVT10D		

tools

cleaning tools

scrapers



1

GEV No.	705008	Ref. No.	2510513 BN2510513
description	scraper for griddle		
spare parts for	705008		
	GEV No.	705021	Ref. No. —
	spare blades for scraper Qty 10 pcs		

	1		
GEV No.	705009	Ref. No.	1030000600 2510513 (old version) BN2510513 (old version) MA1030000600
description	scraper for griddle W 80mm		
For models:	BG62TLC, BG62TLL, BG62TRR, BG63TLC, BG63TLL, BG63TLR, BG64TLC, BG64TLL, BG64TLR, CGG6220, CGG6220C, CGG6220R, CGG6230, CGG6230C, CGG6230LR, CGG6240, CGG6240C, CGG6240LR, CM72APS, CM82APS, EBE7, EBG7, EBG7-CROMO, ECM73		

fastening material

fasteners

clamps

hose clamps

DIN 3017 - W2



1

GEV No.	520112	Ref. No.	LAR61630011
description	hose clamp ø 12-20mm width 9mm Qty 10 pcs DIN 3017		
For models:	EMT06P, GMT06D, GVT10D		

consumables

fuses

thermal fuses



1

GEV No.	358095	Ref. No.	CR0841170
description	thermal fuse switch-off temp. 110°C nominal 10A Qty 1 pcs		
For models:	ETE74		

A			
alarm devices	37	heating elements	3
axial fans	45	heating elements for bain maries	3
B		heating elements for chargrills	13
ball valves	130	heating elements for chip scuttles	4
bar burners	92	heating elements for convection	16
C		heating elements for defrosting	10
cable glands	47	heating elements for fryers	5
cables	47	heating elements for frying pans	4
cam switches	32	heating elements for griddles	8
ceramic heaters	14	heating elements for large hobs	10
clamps	132, 132	heating elements for ovens	3
cleaning tools	132	heating elements for pasta cookers	11
cold air circulating fans (complete)	45	heating elements for plate warmers	14
consumables	132	heating elements for refrigeration	10
contactors	37	heating elements for tilting bratt pan	10
control equipment	34	hob burners	80
control thermostats	20	hose clamps	132, 132
core probes	41	hose connectors	130
cross flow fans	46	hot air fans	46
D		hot plates	18
door seals	127	I	
dosing pumps	129	ignition cables	75
drain fittings	131	ignition switches	78
drain systems and wash basins	131	ignition units	77
E		immersion heating elements	15
electric accessories	47	indicator lights	36
electrodes	44	indicator lights (complete)	36
electronic controllers	40	L	
energy regulators	19	lamps	36
F		M	
fans	45	microswitches	31
fasteners	132	motors	46
fastening material	132	N	
fuses	47, 132	neon light bulbs	36, 37
G		O	
gas burners	80	O-rings	127
gas control valves	59	oven hinges	120
gas nozzles	95	P	
gas taps	48	piezoelectric igniters	76
gas thermostats	54	pilot burners	62
gaskets for heated units	127	plug-in gaskets	126
grates	126	position switches	31
H		pressure switches	44, 108
heating cables	14	probe clips	29
		probes	41
		push/momentary push switches	30
		push-in fittings	130

R

radiation heaters	16
refrigeration fans	45
refrigeration gaskets	126
relays	39
rocker/momentary rocker switches	30
rotary switches	34

S

safety thermostats	24
sealing washers	128
shelves and shelf rails	126
shut-off valves	131
solenoid valves	43
solid top burners	95
spring assisted hinges	120
spring clips	29
standpipes	131
switches and momentary switches	30

T

temperature probes	41
terminals	47
thermal fuses	132
thermocouples	78
thermostats	20
threaded cable glands	47
tools	132
transformers	40
tube burners	94

U

universal probes	41
------------------	----

V

valves and tank inlets	130
------------------------	-----

W

water taps	129
------------	-----