



GAS COMPONENTS



ELECTRIC COMPONENTS



WATER TECHNOLOGY



MECHANICAL COMPONENTS



TOOLS

Spare parts suitable for

SHARP

Find the complete and up-to-date range of products in our GEV Webshop



Manufacturer catalogue

The most important spare parts and accessories arranged clearly for every manufacturer

- ✓ Complete product range and all appliance data always up to date in the GEV Webshop
- ✓ Alphabetical Index at the end of the catalogue

GEV Webshop

www.gev-online.co.uk

www.gev-online.com



- 🔍 Add to Favourites
- 🔍 Sign In with email address and usual password
- 🔍 Easy-order – place several items in your basket at the same time
- 🔍 Quick Item search – no login needed





thermostats

bi-metal thermostats

bi-metal thermostats

 <p>1</p>			
GEV No.	390632	Ref. No.	RTHM-A122WRZZ
description	bi-metal thermostat hole distance 23.5mm switch-off temp. 125°C 1NC 1-poleAV connection F6.3 2 hole fixing		

 <p>1</p>			
GEV No.	390634	Ref. No.	RTHM-A120WRE0
description	bi-metal thermostat hole distance 23.5mm switch-off temp. 145°C 1NC 1-pole 16A 250V connection F6.3 2 hole fixing		

 <p>1</p>			
GEV No.	390635	Ref. No.	QFS-TA014WRE0
description	bi-metal thermostat hole distance 24mm switch-off temp. 150°C NC 1-pole 15A connection F6.3 2 hole fixing		

switches and momentary switches

microswitches

pin-plunger actuated

 <p>1</p>			
GEV No.	347043	Ref. No.	QSW-MA086WRE0 QSW-MA111WRE0
description	microswitch with plunger 250V 16A 1NC connection male faston 4.8mm ambient temperature max. 105°C mounting distance 22mm type V-16G-2C25 actuating force: 140g black		

encoders and potentiometers

 <p>1</p>			
GEV No.	401677	Ref. No.	DPWBFC373WRKZ DPWBFC373WRKZ1
description	encoder for microwaves		

 <p>1</p>			
GEV No.	401678	Ref. No.	RVR-BA018WRE0
description	encoder for microwaves		

lamps

microwave lamps

light bulbs

 <p>1</p>			
GEV No.	359549	Ref. No.	RLMPTA028WRE0 RLMPTA078WRE0
description	light bulb socket E14 220-240V 25W ø 25mm L 60mm Qty 1 pcs for microwave		

magnetrons

 <p>1</p>			
GEV No.	402121	Ref. No.	2M240H(L2) RV-MZA299WRE0
description	Magnetron type 2M240H(L2)		

 <p>1</p>			
GEV No.	402119	Ref. No.	2M281-39K 2M281H(L) RV-MZA335WRZZ
description	Magnetron type 2M281H(L)		



1			
GEV No.	402120	Ref. No.	2M282H(L) RV-MZA322WREZ
description	Magnetron type 2M282H(L)		

1			
GEV No.	402128	Ref. No.	RTRN-A742WRZZ
description	HV transformer primary 235V 50Hz type RTRN-A742WRZZ for microwaves		

transformers

open transformers

with cable connection

1			
GEV No.	402131	Ref. No.	RTRNPA005WRZZ
description	transformer primary 230VAC secondary 12VAC 60VA secondary A H 50mm L 45mm W 74mm connection cable 50/60Hz type RTRNPA-005WRZZ		

HV transformers

1			
GEV No.	402130	Ref. No.	RTRN-A717WRZZ
description	HV transformer primary 230/240V 50Hz type RTRN-A717WRZZ for microwaves		

1			
GEV No.	402129	Ref. No.	RTRN-A741WRZZ
description	HV transformer primary 235V 50Hz type RTRN-A741WRZZ for microwaves		

probes

producer-specific probes

1			
GEV No.	379521	Ref. No.	FH-HZA070WRE0
description	temperature probe Pt100 cable glass fibre probe -100 up to 450°C cable -50 up to +350°C connection coded plug thread probe ø3.5x-10mm cable length 0.2m		

electronics

electronics accessories

1			
GEV No.	401044	Ref. No.	GMADIA067WRF0
description	disc H 36mm W 82mm plastic		

rectifiers

1			
GEV No.	401888	Ref. No.	FW-QZA117WRK0
description	rectifier for microwave		

PCBs

1			
GEV No.	401024	Ref. No.	DPWBFC157WRKZ
description	display PCB microwave R15 type DPWBFC157WRKZ		



1

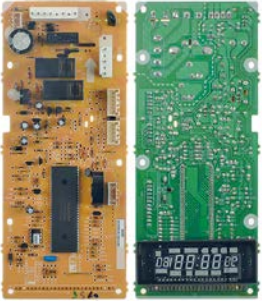

GEV No.	401014	Ref. No.	DPWBFC482WRKZ DPWBFC482WRKZ1
description	display PCB microwave R23		

1



GEV No.	401043	Ref. No.	DPWBFC484WRKZ
description	display PCB microwave R25		

1



GEV No.	401045	Ref. No.	DPWBFC366WRKZ DPWBFC366WRKZ1
description	display PCB microwave R25		

1



GEV No.	401048	Ref. No.	FPWBFA367WRKZ
description	PCB microwave R15 type FPWBFA367		

1



GEV No.	401046	Ref. No.	FPWBFA335WRE0
description	PCB microwave R23 type 06XA335A		

1



GEV No.	401047	Ref. No.	DPWBFC372WRKZ
description	PCB microwave R25 type AA18J6FC372		

keypads

membrane keypads

1

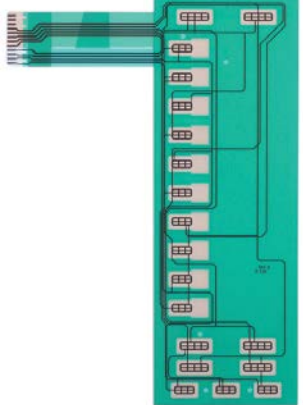

GEV No.	402162	Ref. No.	QSWKA041DRZZ
description	membrane keypad L 242mm W 86mm		

control panel



1			
GEV No.	401866	Ref. No.	FPNLCB774WRKZ
description	control panel		

fans

radial fans

miscellaneous



1			
GEV No.	601167	Ref. No.	FMOTEA482WRKZ
description	radial fan 230V voltage AC 50Hz H1 129mm L1 131mm D1 ø 75mm W1 103mm W2 44mm H2 57mm W3 61mm H3 61mm for microwaves		

motors

gear motors

for microwaves



1			
GEV No.	601969	Ref. No.	RMOTDA310WRZZ
description	gear motor ELENYSYS type SM16 HK36M0HZ 3.5W 220-240V voltage AC 50-60Hz 10-12rpm shaft ø 6.5x4.5mm for microwaves ø 49mm		

condensators & interference suppression filters

HV capacitors



1			
GEV No.	365087	Ref. No.	RC-QZA264WRE0 RC-QZA391WRZZ
description	HV capacitor for microwave 0.94µF type RC-QZA391WRZZ 2300V 50/60Hz double connection male faston 6.3mm L 94mm H 38mm W 66mm dependent on equipment aluminium Qty 1 pcs		



1			
GEV No.	365088	Ref. No.	RC-QZA320WRZZ RC-QZA393WRZZ
description	HV capacitor for microwave 1.07µF type RC-QZA393WRZZ 2300V 50/60Hz double connection male faston 6.3mm L 98mm H 37mm W 65mm dependent on equipment aluminium Qty 1 pcs		

fuses

fine fuses



1			
GEV No.	358610	Ref. No.	QFS-CA026WRZZ
description	fine fuse size ø5x20mm 10A fast-acting rated 250V Qty 10 pcs		

various



1			
GEV No.	358140	Ref. No.	QFS-CA017WRE0
description	fuse size ø6.3x32mmmm 017A		

fine fuse holders



1			
GEV No.	358834	Ref. No.	QFS-IA002WRE0 QFS-IA010WRZZ QFS-IA010WRZZ EHKE57
description	fuse holder for fine fuse ø6.3x32mm suitable fuse ø6.3x32mm ø 15mm 0.8A rated 5KV L 230mm connection F6.3 with fuse 0.8A fast-acting		



 <p>1</p>			
GEV No.	358006	Ref. No.	QFS-IA004 QFS-IA004WRE0
description	fuse holder for ø6.3x32mm rated 5KV with fuse 0.6A fast acting		

equipment-specific units

for microwaves

housings

outer parts

 <p>1</p>			
GEV No.	112544	Ref. No.	JBTN-A896WRM0
description	push button W 60mm H 26mm silver		

inner parts

 <p>1</p>			
GEV No.	694265	Ref. No.	FCOVPA032WRKZ FCOVPA036WRKZ Fcovpao32wrkz PCOVPA351WRFO
description	cooking chamber ceiling L 326mm W 323mm H 40mm		

 <p>1</p>			
GEV No.	112545	Ref. No.	JBTN-B263WRTZ
description	push button set W 91mm H 35mm for microwaves silver		

 <p>1</p>			
GEV No.	691603	Ref. No.	PCUSUA404WRP0 PCUSUA404WRPO
description	suppressor L 8mm ø 14mm for push-button		

ceramic plates

 <p>1</p>			
GEV No.	691039	Ref. No.	FGLSPA062WRE0
description	ceramic plate L 335mm W 330mm for microwaves		

doors

films

 <p>1</p>			
GEV No.	691993	Ref. No.	PSHEPA428WRE0 PSHEPA520WRE0
description	film L 288mm W 178mm self-adhesive for door inside		



tension springs

 <p>1</p>			
GEV No.	691600	Ref. No.	MSPRCA097WRE0
description	tension spring ø 9mm for cam total length 47mm wire gauge ø 1mm		

handles and hand wheels

bracket handles

 <p>1</p>			
GEV No.	691598	Ref. No.	FHNDMA011WRY0
description	actuator L 173mm W 15mm for pull handle		

 <p>1</p>			
GEV No.	691597	Ref. No.	JHNDMA039WRM0 JHNDMA039WRMO
description	pull handle L 195mm H 51mm mounting distance 180mm for microwaves handle M4		
spare parts for	691597		
	GEV No.	691598	Ref. No.
			FHNDMA-011WRY0
	actuator L 173mm W 15mm for pull handle		

equipment feet and end caps

equipment feet with stem



1

GEV No.	700391	Ref. No.	GLEGPA074WRE0
description	equipment foot ø 20mm H 12mm mounting ø 7.5mm overall height 18mm plastic Qty 1 pcs		

springs

tension springs



1

GEV No.	691600	Ref. No.	MSPRCA097WRE0
description	tension spring ø 9mm for cam total length 47mm wire gauge ø 1mm		

consumables

fuses

fine fuses



1

GEV No.	358610	Ref. No.	QFS-CA026WRZZ
description	fine fuse size ø5x20mm 10A fast-acting rated 250V Qty 10 pcs		



1

GEV No.	358140	Ref. No.	QFS-CA017WRE0
description	fuse size ø6.3x32mmmm 017A		

fine fuse holders



1

GEV No.	358006	Ref. No.	QFS-IA004 QFS-IA004WRE0
description	fuse holder for ø6.3x32mm rated 5KV with fuse 0.6A fast acting		

B

bi-metal thermostats 3, 3

C

condensators & interference suppression filters 6

consumables 8

F

fans 6

fine fuses 8

fuses 6, 8

H

HV capacitors 6

L

lamps 3

M

magnetrons 3

microswitches 3

microwave lamps 3

motors 6

P

probes 4

R

radial fans 6

S

switches and momentary switches 3

T

thermostats 3

transformers 4