



GAS COMPONENTS



ELECTRIC COMPONENTS



WATER TECHNOLOGY



MECHANICAL COMPONENTS



TOOLS

Spare parts suitable for

SANTOS

Find the complete and up-to-date range of products in our GEV Webshop



Manufacturer catalogue

The most important spare parts and accessories arranged clearly for every manufacturer

- ✓ Complete product range and all appliance data always up to date in the GEV Webshop
- ✓ Alphabetical Index at the end of the catalogue

GEV Webshop

www.gev-online.co.uk

www.gev-online.com



- 🔍 Add to Favourites
- 🔍 Sign In with email address and usual password
- 🔍 Easy-order – place several items in your basket at the same time
- 🔍 Quick Item search – no login needed



switches and momentary switches

rocker/momentary rocker switches

30x22mm

labelled



1

GEV No.	301006	Ref. No.	40670 55670 60670
description	rocker switch mounting measurements 30x22mm orange 2NO 250V 16A illuminated connection male faston 6.3mm ambient temperature max. 125/55°C protection IP65 with cover cap		
For models:	N40A-Snr-238645-360811, Nr40A-Snr-217500-268355, Nr40A-Snr-268356-272259, Nr40A-Snr-272260-289551, Nr40A-Snr-360812-639299, Nr40A-Snr-639300-, Nr40-Snr-289552-338644, Nr55, Nr55-Snr-598198-639299, Nr55-Snr-639300-, Nr60-Snr-576986-646551, Nr60-Snr-646552-		
accessories for	301006		
	GEV No.	301036	Ref. No. —
	protective cover internal size 30x22mm for rocker switch mounting measurementsmm		

microswitches

lever actuated



1

GEV No.	345742	Ref. No.	40752A
description	microswitch with lever 250V 16A 1CO connection male faston 6.3mm L 55mm ambient temperature max. 120°C mounting distance 22mm actuating force: 75g lever length 46mm		
For models:	N40A-Snr-238645-360811, Nr40APP, Nr40A-Snr-217500-268355, Nr40A-Snr-268356-272259, Nr40A-Snr-272260-289551, Nr40A-Snr-360812-639299, Nr40A-Snr-639300-, Nr40-Snr-289552-338644		

pin-plunger actuated



1

GEV No.	345326	Ref. No.	27309 48374
description	microswitch with plunger 250V 16A 1NO connection male faston 6.3mm ambient temperature max. 85°C mounting distance 22mm type XP52Z11 actuating force: 350g red stroke 15mm		
For models:	Nr27-Snr-000000-164272, Nr27-Snr-164272-275588, Nr27-Snr-275588-383714, Nr27-Snr-383715-, Nr48		



1

GEV No.	527603	Ref. No.	55800
description	microswitch set 30V 0.3A 1NO connection male faston 4.8mm ambient temperature max. 85°C		
For models:	Nr55, Nr55-Snr-598198-639299, Nr55-Snr-639300-		

rotary switches

GOTTAK



1

GEV No.	347179	Ref. No.	06612
description	rotary switch 2 0-1-0-1 sets of contacts 1 250V 16A shaft ø 6x4mm shaft L 25mm shaft oval connection male faston 2 operating positions for coffee grinder		
For models:	Nr6-249928-, Nr6-Snr-249929-264559, Nr6-Snr-264560-339744, Nr6-Snr-385437-		
accessories for	347179		
	GEV No.	527598	Ref. No. 06614
	knob ø 35mm shaft ø 6x4.6mm shaft flat lateral		

electronics

PCBs



1

GEV No.	402205	Ref. No.	55730
description	display PCB for dosing pump L 95mm W 60mm		
For models:	Nr55-Snr-598198-639299, Nr55-Snr-639300-		



1

GEV No.	402206	Ref. No.	55632
description	PCB for dosing pump L 98mm W 72mm 220/240V		
For models:	Nr55-Snr-598198-639299		



1

GEV No.	402204	Ref. No.	60620
description	PCB for dosing pump L 98mm W 72mm 230V		
For models:	Nr60-Snr-576986-646551, Nr60-Snr-646552-		

keypads

front foils



GEV No.	402203	Ref. No.	55704
description	keypad foil for dosing pump L 98mm W 29mm buttons 4		
For models:	Nr55, Nr55-Snr-598198-639299, Nr55-Snr-639300-		

accessories



GEV No.	527595	Ref. No.	55810
description	button L 30mm W 25mm for dosing pump		
For models:	Nr55, Nr55-Snr-598198-639299, Nr55-Snr-639300-		

compressors

accessories

starting relays

klixons



GEV No.	380890	Ref. No.	06606 40606
description	start relay 2CR3-142 230V connection F6.3		
For models:	N40A-Snr-238645-360811, Nr40A-Snr-217500-268355, Nr40A-Snr-268356-272259, Nr40A-Snr-272260-289551, Nr40A-Snr-360812-639299, Nr40A-Snr-639300-, Nr40-Snr-289552-338644, Nr6, Nr6-249928-, Nr6-Snr-249929-264559, Nr6-Snr-264560-339744, Nr6-Snr-385437-		



GEV No.	380893	Ref. No.	09409
description	start relay 2CR4-175 230V connection F6.3		



GEV No.	380904	Ref. No.	09409
description	start relay 4CR-1-675 220V mounting distance 55mm F6.3		
For models:	Nr9-Snr-119318-, Nr9-Snr-288850-, Nr9-Snr-347841-449742, Nr9-Snr-449743-		



GEV No.	381360	Ref. No.	28505
description	start relay Klixon 4CR-1-730 220/240V voltage AC		
For models:	Nr28_Version1, Nr28-Snr-170543-, Nr28-Snr-170544-290190, Nr28-Snr-290191-		

condensators & interference suppression filters

starting capacitors

starting capacitors



GEV No.	365106	Ref. No.	06609 40609
description	starting capacitor 100µF 250V 50/60Hz duty cycle 3s 04P.47804S ø 46mm L 85mm plastic connection male faston 6.3mm		
For models:	N40A-Snr-238645-360811, Nr40A-Snr-217500-268355, Nr40A-Snr-268356-272259, Nr40A-Snr-272260-289551, Nr40A-Snr-360812-639299, Nr40A-Snr-639300-, Nr40-Snr-289552-338644, Nr6-249928-, Nr6-Snr-249929-264559, Nr6-Snr-264560-339744, Nr6-Snr-385437-		

fuses

overload switches



GEV No.	358013	Ref. No.	06752A 40616
description	overload switch 1-pole drop-away current 3A rated 220/240V type 106-P10-3A		
For models:	N40A-Snr-238645-360811, Nr40A-Snr-217500-268355, Nr40A-Snr-360812-639299, Nr40A-Snr-639300-		



GEV No.	358014	Ref. No.	55616
description	overload switch 1-pole drop-away current 5A rated 220/240V type 106-P10-5A		
For models:	Nr55, Nr55-Snr-598198-639299, Nr55-Snr-639300-		



 <p>1</p>			
GEV No.	358137	Ref. No.	27505 48605 50730
description	switch drop-away current 4A		
For models:	Nr27-Snr-275588-383714, Nr27-Snr-383715-, Nr48, Nr50-Snr-000000-661901, Nr50-Snr-661901-		

electronic components

accessories

 <p>1</p>			
GEV No.	527596	Ref. No.	55711
description	bracket for PCB L 103mm W 71mm plastic		
For models:	Nr55, Nr55-Snr-598198-639299, Nr55-Snr-639300-		

equipment-specific units

for planetary mixers

miscellaneous

 <p>1</p>			
GEV No.	697861	Ref. No.	27200
description	safety switch suitable for SANTOS		
For models:	Nr27-Snr-000000-164272, Nr27-Snr-164272-275588, Nr27-Snr-354091-383714		

for bar blender

blenders

jar components

gaskets

 <p>1</p>			
GEV No.	650274	Ref. No.	37104 37109
description	lid gasket rubber D1 ø 170mm D2 ø 200mm thickness 16mm capacity 4l		
For models:	Nr37-Snr-116617-164864, Nr37-Snr-164865-256894, Nr37-Snr-256895-		

blades

blades with adaptor (complete)

 <p>1</p>			
GEV No.	650289	Ref. No.	37170 37180
description	slicing unit complete for mixer ø 86.5mm		
For models:	Nr37-Snr-116617-164864, Nr37-Snr-164865-256894, Nr37-Snr-256895-		

miscellaneous

 <p>1</p>			
GEV No.	650291	Ref. No.	37176
description	V-ring ømm Lmm thread ID ø 14mm ED ø 20mm IT H 5.5mm WS Qty pcs thicknessmm		
For models:	Nr37-Snr-116617-164864, Nr37-Snr-164865-256894, Nr37-Snr-256895-		

actuators

group 2

 <p>1</p>			
GEV No.	650287	Ref. No.	37196
description	coupling for knife ø 52mm H 20mm teeth 12		
For models:	Nr37-Snr-256895-		

 <p>1</p>			
GEV No.	650286	Ref. No.	33245
description	coupling for motor ø 29.5mm H 11mm teeth 12 no. 33		
For models:	Nr33-Snr-260269-339386, Nr33-Snr-339387-		



1

GEV No.	650284	Ref. No.	37340
----------------	--------	-----------------	-------

description	coupling for motor \varnothing 40.5mm H 12mm teeth 12
--------------------	---



1

GEV No.	650285	Ref. No.	37330
----------------	--------	-----------------	-------

description	coupling for motor \varnothing 41mm H 12mm teeth 12
--------------------	---

For models:	Nr37-Snr-256895-
--------------------	------------------



1

GEV No.	650288	Ref. No.	37199
----------------	--------	-----------------	-------

description	coupling set for mixer \varnothing mm Hmm teeth
--------------------	---

spare parts for	650288
------------------------	--------



GEV No.	650285	Ref. No.	37330
----------------	--------	-----------------	-------

description	coupling for motor \varnothing 41mm H 12mm teeth 12
--------------------	---



GEV No.	650287	Ref. No.	37196
----------------	--------	-----------------	-------

description	coupling for knife \varnothing 52mm H 20mm teeth 12
--------------------	---

mixers

miscellaneous



1

GEV No.	650279	Ref. No.	37184
----------------	--------	-----------------	-------

description	gasket for knife Lmm Wmm ID \varnothing 76mm ED \varnothing 85mm H 7.8mm
--------------------	--

For models:	Nr37-Snr-116617-164864, Nr37-Snr-164865-256894, Nr37-Snr-256895-
--------------------	--

for hand blenders

spare parts and accessories



1

GEV No.	692756	Ref. No.	33107
----------------	--------	-----------------	-------

description	slicing unit \varnothing 70mm
--------------------	---------------------------------

For models:	Nr33-Snr-000000-116000, Nr33-Snr-116000-229284, Nr33-Snr-229284-260268, Nr33-Snr-260269-339386
--------------------	--

for juicers/centrifuges

lids



1

GEV No.	650227	Ref. No.	50151
----------------	--------	-----------------	-------

description	lid for juicer suitable for SANTOS N50
--------------------	--

For models:	Nr50-Snr-000000-661901, Nr50-Snr-661901-
--------------------	--

couplings



1

GEV No.	650233	Ref. No.	33240
----------------	--------	-----------------	-------

description	coupling set \varnothing 37mm H 15mm
--------------------	--

For models:	Nr33-Snr-260269-339386, Nr33-Snr-339387-
--------------------	--

actuators



1

GEV No.	650229	Ref. No.	58350
----------------	--------	-----------------	-------

description	mixer coupling with accessories \varnothing 82mm H 54mm ID \varnothing 15mm with screw
--------------------	--

For models:	Nr58, Nr58-Snr-652469-696539, Nr58-Snr-697619-
--------------------	--



1

GEV No.	650282	Ref. No.	50400
description	mixer coupling with screw ø 82mm H 53mm ID ø 15mm IT		
For models:	Nr50-Snr-000000-661901, Nr50-Snr-661901-		
spare parts for	650282		
	GEV No.	650280	Ref. No. 50411 58361
	rubber gasket		



1

GEV No.	650281	Ref. No.	58360
description	mixer coupling without accessories ø 82mm H 54mm IT ID ø 15mm		
For models:	Nr58, Nr58-Snr-652469-696539, Nr58-Snr-697619-		
spare parts for	650281		
	GEV No.	650280	Ref. No. 50411 58361
	rubber gasket		

centrifuge baskets

grating discs



1

GEV No.	696410	Ref. No.	50210
description	grating disc for juicer ø 111mm seat ø 8x10mm		
For models:	Nr50-Snr-000000-661901, Nr50-Snr-661901-		



1

GEV No.	696433	Ref. No.	28202
description	grating disc for juicer ø 165mm seat ø 7mm		
For models:	Nr28_Version1, Nr28-Snr-170543-, Nr28-Snr-170544-290190, Nr28-Snr-290191-		



1

GEV No.	650228	Ref. No.	28201
description	grating disc SS complete ø 165mm H 2.5mm suitable for SANTOS		
For models:	Nr28_Version1, Nr28-Snr-170543-, Nr28-Snr-170544-290190, Nr28-Snr-290191-		



1

GEV No.	650230	Ref. No.	58202
description	grating disc SS ø 165mm H 2.5mm		
For models:	Nr58, Nr58-Snr-652469-696539, Nr58-Snr-697619-		

centrifuge baskets



1

GEV No.	698331	Ref. No.	50200
description	centrifuge basket plastic/SS complete ø 205mm H 125mm		
For models:	Nr50-Snr-000000-661901, Nr50-Snr-661901-		



1

GEV No.	650234	Ref. No.	28200
description	centrifuge basket SS complete ø 259mm H 126mm		
For models:	Nr28_Version1, Nr28-Snr-170543-, Nr28-Snr-170544-290190, Nr28-Snr-290191-		

miscellaneous



1

GEV No.	650270	Ref. No.	50950
description	container for juicer NR50		
For models:	Nr50-Snr-000000-661901, Nr50-Snr-661901-		



1

GEV No.	650280	Ref. No.	50411 58361
description	rubber gasket		
For models:	Nr50-Snr-000000-661901, Nr50-Snr-661901-, Nr58, Nr58-Snr-652469-696539, Nr58-Snr-697619-		

plungers



1

GEV No.	650231	Ref. No.	28100
description	plunger ø 60mm L 158mm total length 204mm		
For models:	Nr28_Version1, Nr28-Snr-170543-, Nr28-Snr-170544-290190, Nr28-Snr-290191-		



1

GEV No.	650276	Ref. No.	58100 68100
description	plunger ø 75.5mm L 155mm total length 250mm for citrus juicers		
For models:	Nr58, Nr58-Snr-652469-696539, Nr58-Snr-697619-		



1

GEV No.	650275	Ref. No.	50101
description	plunger ø 76mm L 160mm total length 175mm for juicer		
For models:	Nr50-Snr-000000-661901, Nr50-Snr-661901-		

for citrus juicers

levers



1

GEV No.	650290	Ref. No.	10100
description	press lever for citrus juicers complete Lmm Wmm thread hole ømm no.10		
For models:	Nr10-Snr-000000-101050, Nr10-Snr-101051-402800, Nr10-Snr-402801-, Nr10-Snr-673752-		

juicer insert



1

GEV No.	650235	Ref. No.	11201
description	filter for citrus juicers ø 155mm H 23mm plastic		
For models:	Nr11, Nr11-Snr-201132-, Nr11-Snr-201133-, Nr11-Snr-472893-, Nr11-Snr-472894-606107, Nr11-Snr-606108-		





			
1			
GEV No.	650237	Ref. No.	11103
description	juicer insert for citrus juicers ø 81mm H 52mm plastic		
For models:	Nr11-Snr-472893-, Nr11-Snr-472894-606107, Nr11-Snr-606108-		

			
1			
GEV No.	694599	Ref. No.	50230
description	bracket ø 150mm H 56mm		
For models:	Nr50-Snr-000000-661901, Nr50-Snr-661901-		

			
1			
GEV No.	650277	Ref. No.	11150 29150
description	juicer insert for citrus juicers ø 81mm H 55mm plastic		
For models:	Nr11-Snr-472894-606107, Nr11-Snr-606108-		

			
1			
GEV No.	650273	Ref. No.	11204 11204NJ
description	drain tray for citrus juicers with outlet ø 165mm H 125mm plastic yellow		
For models:	Nr11, Nr11-Snr-201132-, Nr11-Snr-201133-, Nr11-Snr-472893-, Nr11-Snr-472894-606107, Nr11-Snr-606108-		

			
1			
GEV No.	650278	Ref. No.	52200
description	juicer insert for citrus juicers ø 81mm H 55mm plastic		
For models:	Nr52		

			
1			
GEV No.	650232	Ref. No.	10606
description	pin ø 5mm L 18mm SS		
For models:	Nr10-Snr-000000-101050, Nr10-Snr-101051-402800, Nr10-Snr-402801-, Nr10-Snr-673752-		

			
1			
GEV No.	650236	Ref. No.	11101
description	juicer insert for citrus juicers ø 82mm H 55mm plastic		
For models:	Nr11, Nr11-Snr-472894-606107, Nr11-Snr-606108-		

for coffee grinders

grinding burrs

grinding burrs straight

standard

			
1			
GEV No.	650206	Ref. No.	10200
description	juicer insert with filter for juice extractor ø 110mm H 75mm SS		
For models:	Nr10-Snr-000000-101050, Nr10-Snr-101051-402800, Nr10-Snr-402801-, Nr10-Snr-673752-		

			
1			
GEV No.	527238	Ref. No.	00001B 01222+01227 06205+06302 2x55205 2x60205 40205+40302
description	grinding burrs pair turn direction left D1 ø 63.5mm ID ø 35.5mm H 9mm tooth spacing 3.5mm hole ø 5.5mm bore ø 8.5mm mounting ø 47.5 straight suitable for SANTOS teeth 50		

miscellaneous			
			
1			
GEV No.	694290	Ref. No.	50230
description	bracket ø 150mm H 56mm		

			
1			
GEV No.	527604	Ref. No.	00001B 06205+06302 2x55205 2x60205 40205+40302
description	grinding burrs pair turn direction left D1 ø 63.5mm ID ø 35.8mm H 9mm tooth spacing 4mm hole ø 5.5mm bore ø 8.5mm mounting ø 47		

grinding burrs holders

			
1			
GEV No.	527575	Ref. No.	06300 40300 60300
description	grinding burr holder turn direction left D1 ø 63.5mm D2 ø 70mm H 32mm with grinding burr mounting pos. lower		
For models:	N40A-Snr-238645-360811, Nr40APPM, Nr40A-Snr-217500-268355, Nr40A-Snr-268356-272259, Nr40A-Snr-272260-289551, Nr40A-Snr-360812-639299, Nr40A-Snr-639300-, Nr40-Snr-289552-338644, Nr6, Nr60-Snr-576986-646551, Nr60-Snr-646552-, Nr6-249928-, Nr6-Snr-249929-264559, Nr6-Snr-264560-339744, Nr6-Snr-385437-		

			
1			
GEV No.	527597	Ref. No.	55300
description	grinding burr holder turn direction right D1 ø 82mm D2 ø 12mm H 76.5mm complete mounting pos. lower		
For models:	Nr55, Nr55-Snr-598198-639299		

spillage trays

			
1			
GEV No.	527486	Ref. No.	40662B 55662 60662
description	drain tray L 200mm W 160mm for dosing pump		
For models:	Nr40A-Snr-360812-639299, Nr40A-Snr-639300-, Nr55, Nr55-Snr-598198-639299, Nr55-Snr-639300-, Nr60-Snr-576986-646551, Nr60-Snr-646552-		

dosing containers

wipers

			
1			
GEV No.	527493	Ref. No.	40790 60790
description	wiper for dosing container W 110mm H 72mm thread M6 stainless steel		
For models:	N40A-Snr-238645-360811, Nr40A-Snr-360812-639299, Nr40A-Snr-639300-, Nr60-Snr-576986-646551, Nr60-Snr-646552-		

dosing containers (complete)

			
1			
GEV No.	527580	Ref. No.	40800
description	dosing unit complete ø 120mm suitable for Mod. 40		
For models:	N40A-Snr-238645-360811, Nr40A-Snr-360812-639299, Nr40A-Snr-639300-		



1

GEV No.	527579	Ref. No.	60800
description	dosing unit complete ø 120mm suitable for Mod. 60		
For models:	Nr60-Snr-576986-646551, Nr60-Snr-646552-		



1

GEV No.	527489	Ref. No.	40830
description	dosing unit with lever mounting pos. right ø 120mm H 90mm plastic for Mod. 40		
For models:	Nr40A-Snr-360812-639299, Nr40A-Snr-639300-		

dosing container lids



1

GEV No.	527491	Ref. No.	06701 40701
description	lid for dosing container ø 118mm		
For models:	N40A-Snr-238645-360811, Nr22-Snr-000000-264449, Nr22-Snr-264449-, Nr40APPM, Nr40A-Snr-217500-268355, Nr40A-Snr-268356-272259, Nr40A-Snr-272260-289551, Nr40A-Snr-360812-639299, Nr40A-Snr-639300-, Nr40-Snr-289552-338644, Nr6, Nr6-249928-, Nr6-Snr-249929-264559, Nr6-Snr-264560-339744, Nr6-Snr-385437-		

springs

group 1



1

GEV No.	527498	Ref. No.	40716 60716
description	compression spring ø 5mm L 12mm wire gauge ø 0.5mm		
For models:	N40A-Snr-238645-360811, Nr40APPM, Nr40A-Snr-217500-268355, Nr40A-Snr-268356-272259, Nr40A-Snr-272260-289551, Nr40A-Snr-360812-639299, Nr40A-Snr-639300-, Nr40-Snr-289552-338644, Nr60-Snr-576986-646551, Nr60-Snr-646552-, Nr6-Snr-385437-		

dosing units



1

GEV No.	527605	Ref. No.	60830
description	dosing unit with lever mounting pos. right ø 120mm H 117mm plastic for Mod. 60		
For models:	Nr60-Snr-576986-646551, Nr60-Snr-646552-		



1

GEV No.	527497	Ref. No.	40715 60715
description	torsion spring ø 35mm L2 22mm wire gauge ø 1.5mm L1 22mm L3 22mm		
For models:	N40A-Snr-238645-360811, Nr40APPM, Nr40A-Snr-217500-268355, Nr40A-Snr-268356-272259, Nr40A-Snr-272260-289551, Nr40A-Snr-360812-639299, Nr40A-Snr-639300-, Nr40-Snr-289552-338644, Nr60-Snr-576986-646551, Nr60-Snr-646552-, Nr6-Snr-385437-		

glass panels



1

GEV No.	527585	Ref. No.	40702
description	glass panel for dosing container L 370mm H 43mm plexiglas		
For models:	N40A-Snr-238645-360811, Nr40APPM, Nr40A-Snr-217500-268355, Nr40A-Snr-268356-272259, Nr40A-Snr-272260-289551, Nr40A-Snr-360812-639299, Nr40A-Snr-639300-, Nr40-Snr-289552-338644		

levers

levers



1

GEV No.	527492	Ref. No.	40718 60718
description	lever for dosing unit hole ø 12mm brass		
For models:	N40A-Snr-238645-360811, Nr40APPM, Nr40A-Snr-217500-268355, Nr40A-Snr-268356-272259, Nr40A-Snr-272260-289551, Nr40A-Snr-360812-639299, Nr40A-Snr-639300-, Nr40-Snr-289552-338644, Nr60-Snr-576986-646551, Nr60-Snr-646552-, Nr6-Snr-385437-		

stoppers



1

GEV No.	527574	Ref. No.	40745 60745
description	stopper for lever D1 ø 12mm D2 ø 7mm H 7.5mm rubber		
For models:	N40A-Snr-238645-360811, Nr40APPM, Nr40A-Snr-217500-268355, Nr40A-Snr-268356-272259, Nr40A-Snr-272260-289551, Nr40A-Snr-360812-639299, Nr40A-Snr-639300-, Nr40-Snr-289552-338644, Nr60-Snr-576986-646551, Nr60-Snr-646552-, Nr6-Snr-385437-		



1

GEV No.	527499	Ref. No.	40746 60746
description	stopper for lever D1 ø 17mm D2 ø 7mm H 4mm rubber		
For models:	N40A-Snr-238645-360811, Nr40APPM, Nr40A-Snr-360812-639299, Nr40A-Snr-639300-, Nr60-Snr-576986-646551, Nr60-Snr-646552-, Nr6-Snr-385437-		

coffee powder dispenser



1

GEV No.	527594	Ref. No.	55760
description	coffee discharge chute angled perforation ø 5mm hole distance 38mm plastic for dosing pump		

coffee presses

components

springs



1

GEV No.	527587	Ref. No.	55847 56847 60847
description	compression spring ø 26.5mm L 80mm wire gauge ø 1.3mm for coffee press		
For models:	Nr55, Nr55-Snr-598198-639299, Nr55-Snr-639300-, Nr56, Nr56-Snr-580964-, Nr60-Snr-576986-646551, Nr60-Snr-646552-		

pressers



1

GEV No.	525090	Ref. No.	40707 55841A
description	coffee press ø 53mm H 17mm plastic		
For models:	Nr40A-Snr-217500-268355, Nr40A-Snr-268356-272259, Nr40A-Snr-272260-289551, Nr40-Snr-289552-338644		



1

GEV No.	527582	Ref. No.	40707B 55841 60841
description	coffee press ø 55mm H 19mm plastic		
For models:	N40A-Snr-238645-360811, Nr40APPM, Nr40A-Snr-360812-639299, Nr40A-Snr-639300-, Nr55, Nr55-Snr-598198-639299, Nr55-Snr-639300-, Nr60-Snr-576986-646551, Nr60-Snr-646552-		



1

GEV No.	525091	Ref. No.	40707C 55841C
description	coffee press ø 57mm H 16mm plastic		

coffee presses



1

GEV No.	527589	Ref. No.	60840
description	coffee press complete ø 55mm H 128mm plastic		
For models:	Nr60-Snr-576986-646551, Nr60-Snr-646552-		



			
1			
GEV No.	527588	Ref. No.	55840
description	coffee press complete ø 55mm H 129mm plastic		
For models:	Nr55, Nr55-Snr-598198-639299, Nr55-Snr-639300-		

			
1			
GEV No.	527606	Ref. No.	06705 06706+06707+06708+06709
description	coffee press complete ø 56mm L 68mm H 60mm plastic		
For models:	Nr22-Snr-000000-264449, Nr22-Snr-264449-, Nr6, Nr6-249928-, Nr6-Snr-249929-264559, Nr6-Snr-264560-339744		

			
1			
GEV No.	527487	Ref. No.	40705
description	coffee press ø 55mm L 70mm H 72mm		
For models:	N40A-Snr-238645-360811, Nr40A-Snr-217500-268355, Nr40A-Snr-268356-272259, Nr40A-Snr-272260-289551, Nr40A-Snr-360812-639299, Nr40A-Snr-639300-, Nr40-Snr-289552-338644		

automatic grinding

automatic grinding

			
1			
GEV No.	527488	Ref. No.	40860A
description	ring for dosing container with microswitch ø 122mm H 30mm plastic		
For models:	N40A-Snr-238645-360811, Nr40A-Snr-360812-639299		

			
1			
GEV No.	527581	Ref. No.	06750A
description	ring for dosing container with microswitch ø 122mm H 30mm plastic		

miscellaneous

			
1			
GEV No.	527599	Ref. No.	55755
description	lamella for dosing unit L 47mm W 14mm thickness 0.1mm		
For models:	Nr55, Nr55-Snr-598198-639299, Nr55-Snr-639300-		

ratches

ratches

			
1			
GEV No.	527496	Ref. No.	40772 60772
description	ratchet for dosing unit ø 30mm int. ø 1 12mm		
For models:	N40A-Snr-238645-360811, Nr40APPM, Nr40A-Snr-268356-272259, Nr40A-Snr-272260-289551, Nr40A-Snr-360812-639299, Nr40A-Snr-639300-, Nr40-Snr-289552-338644, Nr60-Snr-576986-646551, Nr60-Snr-646552-, Nr6-Snr-385437-		

stars

complete

			
1			
GEV No.	527490	Ref. No.	40730B 60730
description	star complete ø 112mm shaft ø 7		
For models:	N40A-Snr-238645-360811, Nr40APPM, Nr40A-Snr-360812-639299, Nr40A-Snr-639300-, Nr60-Snr-576986-646551, Nr60-Snr-646552-, Nr6-Snr-385437-		

accessories

			
1			
GEV No.	560360	Ref. No.	06788 40788 60788
description	long nut thread M4 L 20mm WS 10 SS Qty 1 pcs		
For models:	N40A-Snr-238645-360811, Nr40APPM, Nr40A-Snr-360812-639299, Nr40A-Snr-639300-, Nr60-Snr-576986-646551, Nr60-Snr-646552-, Nr6-Snr-385437-		

spindles



GEV No.	527494	Ref. No.	40777B 60742+60774
description	spindle for dosing container shaft length 112mm T1: M4 T2: M6 handle ø 25mm shaft ø 6		
For models:	N40A-Snr-238645-360811, Nr6-Snr-385437-		



GEV No.	527495	Ref. No.	06771 40771 60771
description	spindle for dosing unit shaft ø 12/16mm shaft length 50mm		
For models:	N40A-Snr-238645-360811, Nr22-Snr-264449-, Nr40APPM, Nr40A-Snr-360812-639299, Nr40A-Snr-639300-, Nr60-Snr-576986-646551, Nr60-Snr-646552-, Nr6-Snr-264560-339744, Nr6-Snr-385437-		



GEV No.	527578	Ref. No.	40717 60717
description	spindle for dosing unit shaft ø 5mm shaft length 26mm		
For models:	N40A-Snr-238645-360811, Nr40APPM, Nr40A-Snr-217500-268355, Nr40A-Snr-268356-272259, Nr40A-Snr-272260-289551, Nr40A-Snr-360812-639299, Nr40A-Snr-639300-, Nr40-Snr-289552-338644, Nr60-Snr-576986-646551, Nr60-Snr-646552-, Nr6-Snr-385437-		

adjustment mechanism

lockable adjustment



GEV No.	527577	Ref. No.	06310 40310 55310 60310
description	push button L 33mm W 30mm shaft ø 10mm shaft length 34mm with spring		
For models:	N40A-Snr-238645-360811, Nr40APPM, Nr40A-Snr-217500-268355, Nr40A-Snr-268356-272259, Nr40A-Snr-272260-289551, Nr40A-Snr-360812-639299, Nr40A-Snr-639300-, Nr40-Snr-289552-338644, Nr55, Nr55-Snr-598198-639299, Nr55-Snr-639300-, Nr6, Nr60-Snr-576986-646551, Nr60-Snr-646552-, Nr6-249928-, Nr6-Snr-249929-264559, Nr6-Snr-264560-339744, Nr6-Snr-385437-		

setting rings



GEV No.	527601	Ref. No.	06201 40201
description	grinding burr holder mounting ø 85mm ø 121mm ID ø 36mm H 42mm mounting pos. upper		
For models:	N40A-Snr-238645-360811, Nr40APPM, Nr40A-Snr-217500-268355, Nr40A-Snr-268356-272259, Nr40A-Snr-272260-289551, Nr40A-Snr-360812-639299, Nr40A-Snr-639300-, Nr40-Snr-289552-338644, Nr6, Nr6-249928-, Nr6-Snr-249929-264559, Nr6-Snr-264560-339744, Nr6-Snr-385437-		



GEV No.	527576	Ref. No.	40200 55200 60200
description	grinding burr holder with grinding burr mounting ø 85mm ø 121mm ID ø 36mm H 50mm mounting pos. upper		
For models:	N40A-Snr-238645-360811, Nr40APPM, Nr40A-Snr-217500-268355, Nr40A-Snr-268356-272259, Nr40A-Snr-272260-289551, Nr40A-Snr-360812-639299, Nr40A-Snr-639300-, Nr40-Snr-289552-338644, Nr55, Nr55-Snr-598198-639299, Nr55-Snr-639300-, Nr60-Snr-576986-646551, Nr60-Snr-646552-		

coffee beans containers

container lids



GEV No.	527482	Ref. No.	40101 55101 60101
description	lid for coffee beans container L 302mm W 180mm		
For models:	N40A-Snr-238645-360811, Nr40APPM, Nr40A-Snr-217500-268355, Nr40A-Snr-268356-272259, Nr40A-Snr-272260-289551, Nr40A-Snr-360812-639299, Nr40A-Snr-639300-, Nr40-Snr-289552-338644, Nr55, Nr55-Snr-598198-639299, Nr55-Snr-639300-, Nr60-Snr-576986-646551, Nr60-Snr-646552-		



GEV No.	527485	Ref. No.	06101
description	lid for coffee beans container ø 206mm		
For models:	Nr6, Nr6-249928-, Nr6-Snr-249929-264559, Nr6-Snr-264560-339744, Nr6-Snr-385437-		



coffee beans containers



1			
GEV No.	527484	Ref. No.	40100 55100 60100
description	coffee beans container L 310mm W 190mm H 250mm seat ø 60mm		
For models:	N40A-Snr-238645-360811, Nr40APPM, Nr40A-Snr-217500-268355, Nr40A-Snr-268356-272259, Nr40A-Snr-272260-289551, Nr40A-Snr-360812-639299, Nr40A-Snr-639300-, Nr40-Snr-289552-338644, Nr55, Nr55-Snr-598198-639299, Nr55-Snr-639300-, Nr60-Snr-576986-646551, Nr60-Snr-646552-		



1			
GEV No.	527483	Ref. No.	06100
description	coffee beans container ø 215mm H 240mm seat ø 65mm		
For models:	Nr6, Nr6-249928-, Nr6-Snr-249929-264559, Nr6-Snr-264560-339744, Nr6-Snr-385437-		

support for filter holder

1			
GEV No.	527593	Ref. No.	60424
description	filter holder support for dosing pump L 175mm W 80mm H 42mm		
For models:	Nr60-Snr-576986-646551, Nr60-Snr-646552-		

1			
GEV No.	527584	Ref. No.	40654
description	filter holder support L 130mm W 120mm H 82mm aluminium		
For models:	N40A-Snr-238645-360811, Nr40A-Snr-217500-268355, Nr40A-Snr-268356-272259, Nr40A-Snr-272260-289551, Nr40A-Snr-360812-639299, Nr40A-Snr-639300-, Nr40-Snr-289552-338644		

1			
GEV No.	527583	Ref. No.	06602
description	filter holder support L 68mm W 64mm H 52mm aluminium		
For models:	Nr22-Snr-000000-264449, Nr22-Snr-264449-, Nr6, Nr6-249928-, Nr6-Snr-249929-264559, Nr6-Snr-264560-339744, Nr6-Snr-385437-		

for drink dispensers

drain taps

1			
GEV No.	650283	Ref. No.	34105C
description	outlet tap complete for dispenser L 70mm W 75mm H 150mm black no. 34		
For models:	Nr34-1-1Bowl, Nr34-2-2Bowls_Version2, Nr34-3-3Bowls		

containers

group 2

1			
GEV No.	650271	Ref. No.	34102 34102C
description	container without lid L 430mm W 190mm ømm H 210mm seat ø 110mm container capacity 12l no. 34 for dispenser		
For models:	Nr34-1-1Bowl, Nr34-2-2Bowls_Version1, Nr34-2-2Bowls_Version2, Nr34-3-3Bowls		
accessories for	650271		
	GEV No.	Ref. No.	34103
	gasket for container ED ø 123mm ID ø 87mm no. 34 for dispenser		

accessories



1

GEV No.	650272	Ref. No.	34103
description	gasket for container ED ø 123mm ID ø 87mm no. 34 for dispenser		
For models:	Nr34-1-1Bowl, Nr34-2-2Bowls_Version1, Nr34-2-2Bowls_Version2, Nr34-3-3Bowls		

holders



1

GEV No.	650107	Ref. No.	34104
description	bracket L 75mm W 70mm H 60mm plastic		
For models:	Nr34-1-1Bowl, Nr34-2-2Bowls_Version1, Nr34-2-2Bowls_Version2, Nr34-3-3Bowls		

knobs

miscellaneous



1

GEV No.	527598	Ref. No.	06614
description	knob ø 35mm shaft ø 6x4.6mm shaft flat lateral		
For models:	Nr6, Nr6-249928-, Nr6-Snr-249929-264559, Nr6-Snr-264560-339744, Nr6-Snr-385437-		

equipment feet and end caps

bolting feet



1

GEV No.	692091	Ref. No.	10907
description	equipment foot ø 21mm H 10mm bore ø 4mm Qty 1 pcs MD50		
For models:	Nr10-Snr-000000-101050, Nr10-Snr-101051-402800, Nr10-Snr-402801-, Nr10-Snr-673752-		

gaskets

O-rings

EPDM

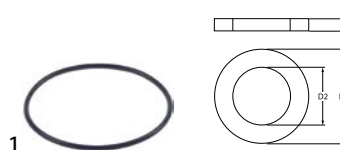

1

GEV No.	532708	Ref. No.	50417
description	O-ring EPDM thickness 2.5mm ID ø 62mm Qty 1 pcs		
For models:	Nr50-Snr-000000-661901, Nr50-Snr-661901-		

miscellaneous



1

GEV No.	532709	Ref. No.	34110
description	O-ring EPDM thickness 2.7mm ID ø 12.2mm Qty 1 pcs		
For models:	Nr34-1-1Bowl, Nr34-2-2Bowls_Version1, Nr34-2-2Bowls_Version2, Nr34-3-3Bowls		

shaft gaskets

v-rings



1

GEV No.	650291	Ref. No.	37176
description	V-ring ømm Lmm thread ID ø 14mm ED ø 20mm IT H 5.5mm WS Qty pcs thicknessmm		
For models:	Nr37-Snr-116617-164864, Nr37-Snr-164865-256894, Nr37-Snr-256895-		

shaft gaskets



1

GEV No.	694287	Ref. No.	28897
description	shaft seal ID ø 16mm ED ø 26mm thickness 7mm		
For models:	Nr28_Version1, Nr28-Snr-170543-, Nr28-Snr-170544-290190, Nr28-Snr-290191-		



special gaskets

miscellaneous



1

GEV No.	650272	Ref. No.	34103
description	gasket for container ED ø 123mm ID ø 87mm no. 34 for dispenser		
For models:	Nr34-1-1Bowls, Nr34-2-2Bowls_Version1, Nr34-2-2Bowls_Version2, Nr34-3-3Bowls		



1

GEV No.	650279	Ref. No.	37184
description	gasket for knife Lmm Wmm ID ø 76mm ED ø 85mm H 7.8mm		
For models:	Nr37-Snr-116617-164864, Nr37-Snr-164865-256894, Nr37-Snr-256895-		



1

GEV No.	650274	Ref. No.	37104 37109
description	lid gasket rubber D1 ø 170mm D2 ø 200mm thickness 16mm capacity 4l		
For models:	Nr37-Snr-116617-164864, Nr37-Snr-164865-256894, Nr37-Snr-256895-		



1

GEV No.	650280	Ref. No.	50411 58361
description	rubber gasket		
For models:	Nr50-Snr-000000-661901, Nr50-Snr-661901-, Nr58, Nr58-Snr-652469-696539, Nr58-Snr-697619-		

springs

torsion springs



1

GEV No.	527497	Ref. No.	40715 60715
description	torsion spring ø 35mm L2 22mm wire gauge ø 1.5mm L1 22mm L3 22mm		
For models:	N40A-Snr-238645-360811, Nr40APPM, Nr40A-Snr-217500-268355, Nr40A-Snr-268356-272259, Nr40A-Snr-272260-289551, Nr40A-Snr-360812-639299, Nr40A-Snr-639300-, Nr40-Snr-289552-338644, Nr60-Snr-576986-646551, Nr60-Snr-646552-, Nr6-Snr-385437-		

compression springs



1

GEV No.	527587	Ref. No.	55847 56847 60847
description	compression spring ø 26.5mm L 80mm wire gauge ø 1.3mm for coffee press		
For models:	Nr55, Nr55-Snr-598198-639299, Nr55-Snr-639300-, Nr56, Nr56-Snr-580964-, Nr60-Snr-576986-646551, Nr60-Snr-646552-		



1

GEV No.	527498	Ref. No.	40716 60716
description	compression spring ø 5mm L 12mm wire gauge ø 0.5mm		
For models:	N40A-Snr-238645-360811, Nr40APPM, Nr40A-Snr-217500-268355, Nr40A-Snr-268356-272259, Nr40A-Snr-272260-289551, Nr40A-Snr-360812-639299, Nr40A-Snr-639300-, Nr40-Snr-289552-338644, Nr60-Snr-576986-646551, Nr60-Snr-646552-, Nr6-Snr-385437-		

fastening material

screws

flat-headed bolts



1

GEV No.	560361	Ref. No.	06206 40206
description	flat-headed bolt thread M4 thread L 10mm 7500 Qty 1 pcs head ø 8mm head thickness 3mm WS T25 for grind stone		
For models:	N40A-Snr-238645-360811, Nr40APPM, Nr40A-Snr-217500-268355, Nr40A-Snr-268356-272259, Nr40A-Snr-272260-289551, Nr40A-Snr-360812-639299, Nr40A-Snr-639300-, Nr40-Snr-289552-338644, Nr6, Nr6-249928-, Nr6-Snr-249929-264559, Nr6-Snr-264560-339744, Nr6-Snr-385437-		

hexagonal screws



1

GEV No.	560083	Ref. No.	11323
description	hexagonal screw thread M5 thread L 10mm SS WS 8 Qty 20 pcs DIN 933 / ISO 4017		
For models:	Nr11, Nr11-Snr-201132-, Nr11-Snr-201133-, Nr11-Snr-472893-, Nr11-Snr-472894-606107, Nr11-Snr-606108-		

grub screws

DIN 916/ISO 4029



1

GEV No.	560366	Ref. No.	28890
description	grub screw thread M6 L 20mm SS intake internal hexagon WS 3 Qty 1 pcs		
For models:	Nr28_Version1, Nr28-Snr-170543-, Nr28-Snr-170544-290190, Nr28-Snr-290191-		

nuts

cap nuts



1

GEV No.	560137	Ref. No.	28878
description	cap nuts thread M6 WS 10 SS Qty 20 pcs DIN/ISO DIN 1587		
For models:	Nr28_Version1, Nr28-Snr-170543-, Nr28-Snr-170544-290190, Nr28-Snr-290191-		

long nuts



1

GEV No.	560360	Ref. No.	06788 40788 60788
description	long nut thread M4 L 20mm WS 10 SS Qty 1 pcs		
For models:	N40A-Snr-238645-360811, Nr40APPM, Nr40A-Snr-360812-639299, Nr40A-Snr-639300-, Nr60-Snr-576986-646551, Nr60-Snr-646552-, Nr6-Snr-385437-		

washers

washers

miscellaneous



1

GEV No.	560362	Ref. No.	40780 60780
description	plain washer ID ø 12mm ED ø 18mm thickness 0.6mm Qty 1 pcs for coffee grinder		
For models:	N40A-Snr-238645-360811, Nr40APPM, Nr40A-Snr-360812-639299, Nr40A-Snr-639300-, Nr60-Snr-576986-646551, Nr60-Snr-646552-		



1

GEV No.	560363	Ref. No.	40714 60714
description	plain washer ID ø 16.8mm ED ø 34mm thickness 1mm Qty 1 pcs for coffee grinder		
For models:	N40A-Snr-238645-360811, Nr40APPM, Nr40A-Snr-217500-268355, Nr40A-Snr-268356-272259, Nr40A-Snr-272260-289551, Nr40A-Snr-360812-639299, Nr40A-Snr-639300-, Nr40-Snr-289552-338644, Nr60-Snr-576986-646551, Nr60-Snr-646552-, Nr6-Snr-385437-		

tooth lock washers

DIN 6798A



1

GEV No.	560126	Ref. No.	11324
description	tooth lock washer ID ø 5.2mm ED ø 10mm SS DIN/ISO DIN 6798A Qty 20 pcs for thread M5		
For models:	Nr11, Nr11-Snr-201132-, Nr11-Snr-201133-, Nr11-Snr-472893-, Nr11-Snr-472894-606107, Nr11-Snr-606108-		

fasteners

slot nuts



1

GEV No.	527600	Ref. No.	40775 60775
description	slot nut W 2mm H 2.6mm L 7.6mm for dosing unit		
For models:	N40A-Snr-238645-360811, Nr40APPM, Nr40A-Snr-268356-272259, Nr40A-Snr-272260-289551, Nr40A-Snr-360812-639299, Nr40A-Snr-639300-, Nr40-Snr-289552-338644, Nr60-Snr-576986-646551, Nr60-Snr-646552-		



retaining rings			
DIN 471			
GEV No.	516222	Ref. No.	40776 60776
description	retaining ring shaft ø 12mm thickness 1mm SS DIN 471		
For models:	N40A-Snr-238645-360811, Nr40APPM, Nr40A-Snr-268356-272259, Nr40A-Snr-272260-289551, Nr40A-Snr-360812-639299, Nr40A-Snr-639300-, Nr40-Snr-289552-338644, Nr60-Snr-576986-646551, Nr60-Snr-646552-, Nr6-Snr-385437-		

roll pins			
GEV No.	560367	Ref. No.	28871
description	roll pin ø 5mm L 25mm		
For models:	Nr28_Version1, Nr28-Snr-170543-, Nr28-Snr-170544-290190, Nr28-Snr-290191-		

C

cap nuts	18
compressors	4
condensators & interference suppression filters	4

F

fasteners	18
fastening material	17
flat-headed bolts	17
fuses	4

G

grub screws	18
-------------	----

H

hexagonal screws	18
------------------	----

L

long nuts	18
-----------	----

M

microswitches	3
---------------	---

N

nuts	18
------	----

O

O-rings	16
---------	----

R

retaining rings	19
rocker/momentary rocker switches	3
roll pins	19
rotary switches	3

S

screws	17
shaft gaskets	16
slot nuts	18
starting capacitors	4
switches and momentary switches	3

T

tooth lock washers	18
--------------------	----

W

washers	18
---------	----