



GAS COMPONENTS



ELECTRIC COMPONENTS



WATER TECHNOLOGY



MECHANICAL COMPONENTS



TOOLS

Spare parts suitable for

SV-ITALIA

Find the complete and up-to-date range of products in our GEV Webshop



Manufacturer catalogue

The most important spare parts and accessories arranged clearly for every manufacturer

- ✓ Complete product range and all appliance data always up to date in the GEV Webshop
- ✓ Alphabetical Index at the end of the catalogue

GEV Webshop

www.gev-online.co.uk

www.gev-online.com







- 🔍 Add to Favourites
- 🔍 Sign In with email address and usual password
- 🔍 Easy-order – place several items in your basket at the same time
- 🔍 Quick Item search – no login needed





heating elements

heating elements for coffee machine

			
1			
GEV No.	417415	Ref. No.	SV1GR002+SVTMG010
description	heating element 1800W 230V heating circuits 2 mounting ϕ 39.5mm hole distance 58mm L 165mm W 27mm H 60mm L1 35mm L2 60mm L3 70mm H1 25mm H2 35mm hole ϕ 10mm tube ϕ 8mm connection M3 immersion heater 3 hole flange suitable for S.V. ITALIA		
accessories for	417415		
	GEV No.	527169	Ref. No. —
	hexagonal nut thread M3 H 2.8mm WS 5.5 brass Qty 1 pcs		
	GEV No.	528740	Ref. No. SVTMG010
	gasket ID ϕ 44mm PTFE thickness 3.5mm hole ϕ 9.5mm hole distance 58mm suitable for ITALCREM, VISACREM for heating element coffee machine parts		

			
1			
GEV No.	417416	Ref. No.	SV2GR002 SV2GR002+SVTMG010
description	heating element 2500W 230V heating circuits 2 mounting ϕ 39.5mm hole distance 57mm L 275mm W 35mm H 63mm L1 35mm L2 50mm L3 185mm H1 24mm H2 39mm hole ϕ 10mm tube ϕ 6.3mm connection M4 dry heating element 3 hole flange suitable for S.V. ITALIA with PTFE gasket		

			
1			
GEV No.	417417	Ref. No.	SV2GR003 SV2GR003+SVTMG010
description	heating element 3000W 230V heating circuits 2 mounting ϕ 39.5mm hole distance 57.5mm L 343mm W 34mm H 62mm L1 30mm L2 53mm L3 260mm H1 24mm H2 38mm hole ϕ 10mm tube ϕ 6.3mm connection M4 immersion heater 3 hole flange suitable for S.V. ITALIA with PTFE gasket		

			
1			
GEV No.	417418	Ref. No.	SV3GR002
description	heating element 5000W 230V heating circuits 2 mounting ϕ 39mm hole distance 57mm L 500mm W 34mm H 60mm L1 37mm L2 73mm L3 390mm H1 24mm H2 36mm hole ϕ 10mm tube ϕ 6.3mm connection M4 immersion heater 3 hole flange suitable for S.V. ITALIA		

accessories

flange gaskets





			
1			
GEV No.	528740	Ref. No.	SVTMG010
description	gasket ID ϕ 44mm PTFE thickness 3.5mm hole ϕ 9.5mm hole distance 58mm suitable for ITALCREM, VISACREM for heating element coffee machine parts		

switches and momentary switches

rocker/momentary rocker switches

<h4>30x22mm</h4>			
			
1			
GEV No.	301060	Ref. No.	SVTMI003
description	rocker switch mounting measurements 30x22mm red 2NO 250V 16A illuminated connection male faston 6.3mm ambient temperature max. 125/55°C protection IP40		

push/momentary push switches

<h4>28.5x28.5mm</h4>			
			
1			
GEV No.	347319	Ref. No.	SVTMI002
description	push switch mounting measurements 28.5x28.5mm green/red 2NO 250V 16A cup connection male faston 6.3mm ambient temperature max. 150°C protection IP40 with indicator		
spare parts for	347319		
	GEV No.	345604	Ref. No. —
	element holder single mounting measurements 28.5x28.5mm black for push buttons 23x23mm		
	GEV No.	345720	Ref. No. —
	switch 2NO 250V 16A connection male faston 6.3mm		
	GEV No.	346251	Ref. No. —
	rotary disc orange/green disc ϕ 20.6mm		

ϕ 25mm

			
1			
GEV No.	346316	Ref. No.	SVMNI001
description	push switch mounting ϕ 25mm black 2NO 250V 16A connection male faston 6.3mm ambient temperature max. 85°C protection IP40		

rotary switches

BREMAS

accessories



1			
GEV No.	111369	Ref. No.	SVTMM023
description	knob ø 28/48mm shaft ø 5x5mm black H 22mm L 40mm		

GIOVENZANA

rotary switches



1			
GEV No.	347648 ¹	Ref. No.	SVTMC012
description	rotary switch 3 0-1-2 sets of contacts 6 type CS20 690V 20A shaft ø 8x7mm shaft L 15mm shaft star-shaped connection screw		

¹incl. knob and dial plate

lamps

indicator lights

indicator lights 2-piece (lens and indicator lamp)

indicator light lenses

ø 6mm (type SQ-20)



1			
GEV No.	359803	Ref. No.	SVECG006
description	indicator light lens green Qty 1 pcs ø 6mm		



1			
GEV No.	359805	Ref. No.	SVECG003
description	indicator light lens red Qty 1 pcs ø 6mm		

indicator lights (complete)

ø 6mm



1			
GEV No.	357016	Ref. No.	SVECS010
description	indicator light ø 6mm 230V green connection grip connection temp.-resist. 120°C		



1			
GEV No.	357017	Ref. No.	SVECS011
description	indicator light ø 6mm 230V red connection grip connection temp.-resist. 120°C		

ø13mm

with plug-in socket



1			
GEV No.	357015	Ref. No.	SVTMS004
description	indicator light ø 13mm green 250V connection push-in		



1			
GEV No.	357018	Ref. No.	Z300E007
description	indicator light ø 13mm yellow 250V connection male faston 6.3mm temp.-resist. 120°C push-in		

relays

level relays

miscellaneous



1			
GEV No.	402668	Ref. No.	SVTMR015 SVTMR041
description	level controller 230V voltage AC 50/60Hz		

electronics

PCBs



1			
GEV No.	402665	Ref. No.	SVMND001
description	display suitable for S.V. ITALIA model ELLIPSE		



			
1			
GEV No.	402662	Ref. No.	SVMNP006
description	keypad PCB suitable for S.V. ITALIA buttons 1		

			
1			
GEV No.	402663	Ref. No.	SVMNP005
description	keypad PCB suitable for S.V. ITALIA buttons 2		

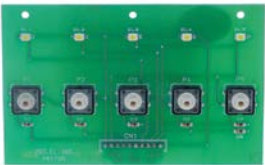
			
1			
GEV No.	402664	Ref. No.	SVMNP004
description	keypad PCB suitable for S.V. ITALIA buttons 5		

central units

			
1			
GEV No.	402669	Ref. No.	SVECC001
description	central unit 230V 50/60Hz 2 groups type SDE3C SV2A voltage AC		

			
1			
GEV No.	402670	Ref. No.	SVECC008
description	central unit 230V 50/60Hz 3 groups type SDE3C SV3A voltage AC		

			
1			
GEV No.	403077	Ref. No.	SVECC029
description	central unit 230V 50/60Hz 3 groups type SDE3D SV3LA voltage AC		

			
1			
GEV No.	402673	Ref. No.	SVMN3GC005
description	central unit 230V 50/60Hz 3 groups type SDE3C SV3A voltage 50/60		

			
1			
GEV No.	402672	Ref. No.	SVMN3GC003
description	central unit 230V 50/60Hz 3 groups type SDE3S SV3AA voltage AC		

			
1			
GEV No.	402671	Ref. No.	SV3GC012
description	central unit 230V 50/60Hz type SDE3D SV3A voltage AC		



keypads

front foils

1			
GEV No.	402658	Ref. No.	SVMNE005
description	keypad foil black/red suitable for S.V. ITALIA L 32.5mm W 19.5mm buttons 1		

1			
GEV No.	402657	Ref. No.	SVMNE004
description	keypad foil glue-on black/white suitable for S.V. ITALIA L 44mm W 20mm buttons 2		

1			
GEV No.	402659	Ref. No.	SVMNE003
description	keypad foil glue-on black/white/red suitable for S.V. ITALIA L 118mm W 19.5mm buttons 5		

keypad units

1			
GEV No.	402667	Ref. No.	SVTMP032
description	keypad unit buttons 5 silver/black L 120mm W 50mm		

1			
GEV No.	402666	Ref. No.	SVECP003
description	keypad unit buttons 6 silver/blue L 120mm W 50mm		

accessories

1			
GEV No.	402661	Ref. No.	SVMNT006
description	push button large black suitable for S.V. ITALIA		



1			
GEV No.	402660	Ref. No.	SVMNT002
description	push button small black suitable for S.V. ITALIA		

solenoid valves

solenoid valves (water)

metal

LUCIFER

2-way

121F series





1			
GEV No.	370599	Ref. No.	SVTME001
description	solenoid valve 2-ways 230VAC DN 3mm slide-on receptacle DIN -10 up to 140°C PARKER type series 121F coil type DZ06S6 membranes ruby p max 10bar 60Hz flange 32x32mm brass		

ODE

solenoid valves steam (water)

21A1 series



1				
GEV No.	370093	Ref. No.	SVTME001	
description	solenoid valve 2/2-ways 230VAC body 25-F39 DN 2.5mm slide-on receptacle DIN -10 up to 140°C ODE type series 21A1 coil type BDA membranes FKM p max 14bar 50/60Hz silicone flange 32x32mm			
spare parts for	370093			
	GEV No.	371150	Ref. No.	—
	solenoid coil ODE 230VAC 16VA coil type BDV seat ø 13.5mm 750Ohm			
accessories for	370093			
	GEV No.	371090	Ref. No.	—
	power socket plug type DIN 43650A screw			



electrodes

1



GEV No.	400790	Ref. No.	SVMNS009
description	level electrode 1/4" total length 125mm probe L 98mm insulated probe length 26mm connection male faston 6.3mm stainless steel ø 3mm rubber		

1



GEV No.	401157	Ref. No.	SVTMS002
description	level electrode 1/4" total length 150mm probe L 122mm insulated probe length 26mm connection male faston 6.3mm stainless steel ø 2.5mm		

equipment-specific units

for espresso machines

filter holders

filter holders standard

filter holders (complete)

1



GEV No.	525265	Ref. No.	SVTMP014
description	filter holder single suitable for S.V. ITALIA 1-way ID ø 61.6mm outlet distance mm mounting ø 83.3		

filters

for 1 cup

1



GEV No.	525267	Ref. No.	SVTMF012
description	coffee filter ø 70mm mounting ø 60mm H 20.5mm cups 1 amount of coffee 6g perforation ø 0.25mm		

1



GEV No.	525268	Ref. No.	SVTMF002
description	coffee filter ø 70mm mounting ø 60mm H 24.5mm cups 1 amount of coffee 7g perforation ø 0.3mm		

for 2 cups

1



GEV No.	529014	Ref. No.	SVTMF011
description	coffee filter ø 70mm mounting ø 60mm H 21mm cups 2 amount of coffee 12g perforation ø 0.3mm round		

1



GEV No.	525270	Ref. No.	SVTMF003
description	coffee filter ø 70mm mounting ø 60mm H 25mm cups 2 amount of coffee 14g perforation ø 0.3mm		

blind filters

1



GEV No.	529102	Ref. No.	SVTMF004
description	blind filter ø 70mm mounting ø 60mm H 17mm		

brewing units

shower screens

flat

1



GEV No.	529228	Ref. No.	SVECD001
description	shower screen ø 51.6mm hole ø 6.2mm		

with upstand



1

GEV No.	529080	Ref. No.	SVTMD003
description	shower screen ø 58mm H 20mm		

filter holder gaskets

flat

with internal notch



1

GEV No.	525257	Ref. No.	SVTMS013
description	filter holder gasket D1 ø 73.3mm D2 ø 57.3mm H 7.5mm with inside notch rubber Qty 1 pcs		



1

GEV No.	525258	Ref. No.	SVTMS024
description	filter holder gasket D1 ø 73.3mm D2 ø 57.3mm H 8.1mm with inside notch Qty 1 pcs		

brewing units manual

components

gaskets



1

GEV No.	526856	Ref. No.	SVTMP021
description	gasket D1 ø 13mm ID ø 4mm thickness 4mm Viton		

components

nozzles

with thread



1

GEV No.	528486	Ref. No.	SVMNG005
description	nozzle bore ø 0.7mm thread M6x0.75 L 9mm WS 7		



1

GEV No.	525250	Ref. No.	SVECG010
description	nozzle bore ø 0.8mm thread M6x0.75 L 9mm		



1

GEV No.	525490	Ref. No.	TM-INIE707
description	nozzle bore ø 1.25mm thread M6x0.75 L 9mm		

screws



1

GEV No.	560420	Ref. No.	ZVITE026
description	countersunk screw thread M5 L 14mm SS DIN 965/ISO 7046 Qty 1 pcs intake Phillips head ø 9mm		

gaskets

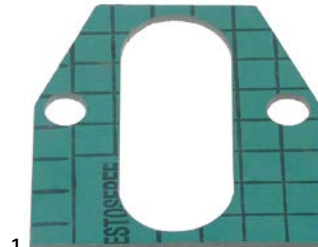

1

GEV No.	525241	Ref. No.	SVTMG016
description	group gasket L 76mm W 70mm thickness 2mm aperture 10mm hole distance 54mm suitable for S.V. ITALIA fibre		

safety valves

safety valves

3/8"



1

GEV No.	531210	Ref. No.	SVTMV007
description	safety valve connection 3/8" triggering pressure 1.5bar approval CE		

expansion valves

with hose connection



1

GEV No.	526452	Ref. No.	SVTMV009
description	expansion valve T1: 1/4" ET hose ø 9.5mm BL 42mm		

drain pans

drain pans



1

GEV No.	525262	Ref. No.	SVTMV010
description	drain pan rectangular suitable for S.V. ITALIA		



1

GEV No.	525263	Ref. No.	SVMNV002
description	drain pan round suitable for S.V. ITALIA		

aerators and air bleeders



1

GEV No.	527981	Ref. No.	SVTMV001
description	aerator and air bleeder connection 1/4"		

steam/water taps

steam/water taps



1

GEV No.	525245	Ref. No.	SVECC010
description	steam/water tap inlet 1/4" outlet 3/8" shaft 5.8 shaft L 16mm suitable for S.V. ITALIA		



1

GEV No.	525244	Ref. No.	SVTMR024
description	steam/water tap inlet 3/8" outlet 3/8" shaft 8x6 shaft L 26mm suitable for S.V. ITALIA		

components

gaskets



1

GEV No.	526856	Ref. No.	SVTMP021
description	gasket D1 ø 13mm ID ø 4mm thickness 4mm Viton		

pressure rings



1

GEV No.	525251	Ref. No.	RUBS/L-R001
description	press ring for steam-/water-tap D1 ø 10.7mm D2 ø 8.1mm thickness 2mm 3pcs		

springs



1

GEV No.	526443	Ref. No.	SVECM007
description	compression spring ø 12mm L 15.5mm wire gauge ø 1.5mm		

steam/water pipes

steam pipes



1

GEV No.	525247	Ref. No.	SVECL003
----------------	--------	-----------------	----------

description steam pipe thread 3/8" H 155mm L 205mm ϕ 14.3mm tube ϕ 10mm suitable for S.V. ITALIA

accessories for 525247

GEV No.	525042	Ref. No.	SVTMP033
----------------	--------	-----------------	----------



tube handle for pipe ϕ 10mm ϕ 13.5mm L 50mm rubber



1

GEV No.	525246	Ref. No.	SVTML003
----------------	--------	-----------------	----------

description steam pipe thread 3/8" H 190mm L 220mm ϕ 14.3mm tube ϕ 10mm suitable for S.V. ITALIA

accessories for 525246

GEV No.	525042	Ref. No.	SVTMP033
----------------	--------	-----------------	----------



tube handle for pipe ϕ 10mm ϕ 13.5mm L 50mm rubber

nozzles for water pipes

nozzles for water pipes



1

GEV No.	525260	Ref. No.	SVECS015
----------------	--------	-----------------	----------

description nozzle D1 ϕ 23.5mm H 30mm thread M10x1 suitable for S.V. ITALIA series JOLLY int. ϕ 1.9mm int. ϕ 2.14mm



1

GEV No.	525095	Ref. No.	SVMNS015
----------------	--------	-----------------	----------

description nozzle D1 ϕ 24mm H 30mm thread M10x1 int. ϕ 1.9mm

tap aerators



1

GEV No.	529608	Ref. No.	SVTMS027
----------------	--------	-----------------	----------

description tap aerator D1 ϕ 23mm H 15mm thread M22x1

water pipes



1

GEV No.	525261	Ref. No.	SVECL001
----------------	--------	-----------------	----------

description water pipe thread 1/4" ϕ 23.5mm L 103mm tube ϕ 8mm suitable for S.V. ITALIA

accessories

bushes



1

GEV No.	529705	Ref. No.	SVTMS014
----------------	--------	-----------------	----------

description bush D1 ϕ 8.3mm D2 ϕ 12mm H 6mm brass ID ϕ 7mm

gaskets



1

GEV No.	526392	Ref. No.	SVTMO007
----------------	--------	-----------------	----------

description flat gasket Viton ED ϕ 21mm ID ϕ 15mm thickness 2mm Qty 1 pcs



1

GEV No.	528402	Ref. No.	SVTMG013
----------------	--------	-----------------	----------

description O-ring Viton thickness 2.62mm ID ϕ 10.78mm Qty 1 pcs

tube handles



1

GEV No.	525042	Ref. No.	SVTMP033
----------------	--------	-----------------	----------

description tube handle for pipe ϕ 10mm ϕ 13.5mm L 50mm rubber

miscellaneous



1

GEV No.	525254	Ref. No.	SVTMA008
----------------	--------	-----------------	----------

description set for steam pipe bush, spring, gasket, O-ring, disc

fine filters

fine filters



1

GEV No.	528357	Ref. No.	TM-FIL8522
----------------	--------	-----------------	------------

description fine filter ϕ 8.5mm H 22mm



1			
GEV No.	529979	Ref. No.	SVECF013
description	fine filter ø 8.8mm H 22mm		

intake valves

accessories

valves

1			
GEV No.	525249	Ref. No.	SVTMA007
description	valve for filling valve L 60.5mm		

level glasses

level glasses

level glass pipes

1			
GEV No.	525240	Ref. No.	SVTMV005
description	water level tube ø 11mm H 140mm ID ø 8mm marking Min/Max blue		

non-return valves

pistons

1			
GEV No.	525248	Ref. No.	SVTMV011
description	piston for non-return valve triangular ø 13mm L 19.5mm		

knobs

steam/water taps

steam/water taps

1			
GEV No.	111377	Ref. No.	SVECM008
description	knob ø 41mm L 50mm thread Tr18x2 black with rosette		

1			
GEV No.	111381	Ref. No.	SVMNM002
description	knob ø 55mm L 56mm shaft ø 8.3mm black		

1			
GEV No.	111378	Ref. No.	SVTMM004 SVTMM005
description	knob water ø 53mm L 53mm shaft flat upper black		

knob dial plates

1			
GEV No.	111275	Ref. No.	SVECT047
description	symbol steam ø 32mm L 28mm		

miscellaneous

1			
GEV No.	111369	Ref. No.	SVTMM023
description	knob ø 28/48mm shaft ø 5x5mm black H 22mm L 40mm		

accessories

button springs

1			
GEV No.	111380	Ref. No.	SVTMC011
description	knob spring L 12mm W 8mm H 2mm Qty 1 pcs		

gaskets

O-rings

EPDM

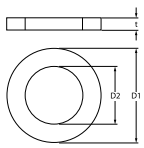
1			
GEV No.	510302	Ref. No.	SVECOR006
description	O-ring EPDM ID ø 12.42mm thickness 1.78mm Qty 1 pcs		

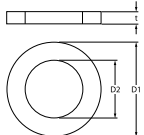
1			
GEV No.	525255	Ref. No.	SVTMO001
description	O-ring EPDM thickness 1.9mm ID ø 7.2mm Qty 1 pcs		

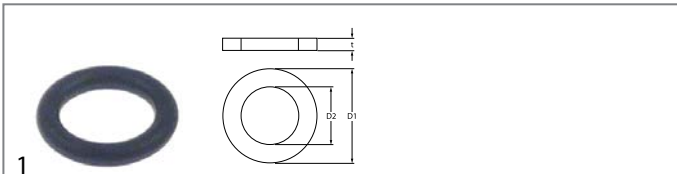

1

GEV No.	525259	Ref. No.	SVECOR008
description	O-ring EPDM thickness 1.9mm ID ø 7.6mm Qty 1 pcs		

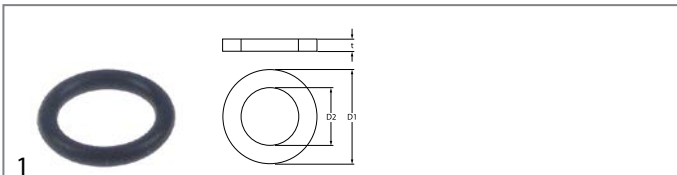

1

GEV No.	525256	Ref. No.	SVTMO006
description	O-ring EPDM thickness 1.9mm ID ø 9.2mm Qty 1 pcs		

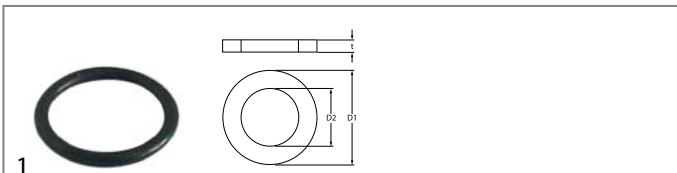

1

GEV No.	504590	Ref. No.	SVMNO002
description	O-ring EPDM thickness 2.62mm ID ø 18.72mm Qty 1 pcs		

Viton

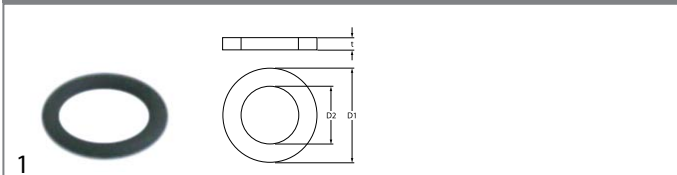

1

GEV No.	528402	Ref. No.	SVTMG013
description	O-ring Viton thickness 2.62mm ID ø 10.78mm Qty 1 pcs		

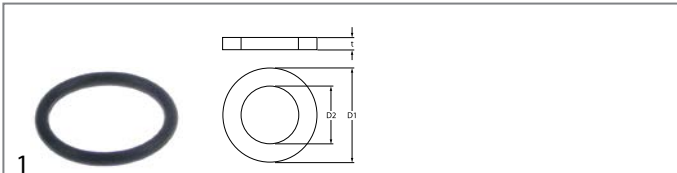

1

GEV No.	532560	Ref. No.	TM-OR128
description	O-ring Viton thickness 2.62mm ID ø 20.63mm Qty 1 pcs		

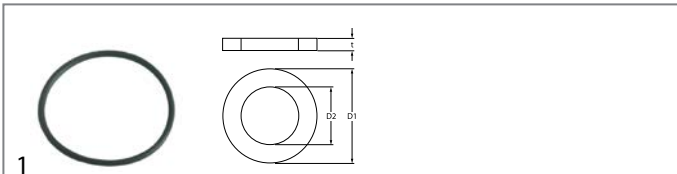

1

GEV No.	528413	Ref. No.	SVECOR003
description	O-ring Viton thickness 2.62mm ID ø 47.3mm Qty 1 pcs		

sealing washers

copper gaskets

DIN-7603-A



1

GEV No.	528698	Ref. No.	RUBS/L-R003
description	flat gasket copper ED ø 24mm ID ø 20mm thickness 1mm		

PTFE gaskets



1

GEV No.	525253	Ref. No.	SVTMG032
description	flat gasket PTFE ED ø 18mm ID ø 13mm thickness 2mm Qty 1 pcs		



1

GEV No.	531198	Ref. No.	SVTMO007
description	flat gasket PTFE ED ø 20.5mm ID ø 15mm thickness 2mm Qty 1 pcs		



1

GEV No.	525252	Ref. No.	SVECG009
description	flat gasket PTFE ED ø 20mm ID ø 16.5mm thickness 2mm Qty 1 pcs		



1

GEV No.	525611	Ref. No.	TM-GUATF22172
description	flat gasket PTFE ED ø 22mm ID ø 17mm thickness 2mm Qty 1 pcs		



1

GEV No.	526013	Ref. No.	SVECOR005
description	flat gasket PTFE ED ø 22mm ID ø 17mm thickness 2mm Qty 1 pcs		



1

GEV No.	526014	Ref. No.	TM-GUATF35302
description	flat gasket PTFE ED ø 35mm ID ø 30mm thickness 2mm Qty 1 pcs		



Viton gaskets

			
1			
GEV No.	526392	Ref. No.	SVTMO007
description	flat gasket Viton ED ø 21mm ID ø 15mm thickness 2mm Qty 1 pcs		

special gaskets

group gaskets

			
1			
GEV No.	525241	Ref. No.	SVTMG016
description	group gasket L 76mm W 70mm thickness 2mm aperture 10mm hole distance 54mm suitable for S.V. ITALIA fibre		

springs

compression springs

			
1			
GEV No.	525242	Ref. No.	SVMNM008
description	compression spring ø 10.8mm L 57mm wire gauge ø 1mm windings 11		

			
1			
GEV No.	528284	Ref. No.	SVTMM024
description	compression spring ø 11mm L 26mm wire gauge ø 1.3mm		

			
1			
GEV No.	525243	Ref. No.	SVTMM022
description	compression spring ø 12.5mm L 30mm wire gauge ø 1.8mm windings 7		

			
1			
GEV No.	526443	Ref. No.	SVECM007
description	compression spring ø 12mm L 15.5mm wire gauge ø 1.5mm		

			
1			
GEV No.	527992	Ref. No.	SVTMM020
description	compression spring ø 8mm L 32mm wire gauge ø 0.5mm		

manometers

			
1			
GEV No.	541765	Ref. No.	SVTMM019
description	manometer double scale ø 63mm pressure range 0-2.5 / 0-15bar connection on the backside thread 1/8"		

			
1			
GEV No.	531285	Ref. No.	SVTMM034
description	manometer ø 63mm pressure range 0-3 / 0-15bar connection on the backside thread 1/8"		

fastening material

screws

countersunk screws

			
1			
GEV No.	560420	Ref. No.	ZVITE026
description	countersunk screw thread M5 L 14mm SS DIN 965/ISO 7046 Qty 1 pcs intake Phillips head ø 9mm		

C

countersunk screws 13

E

electrodes 7

F

fastening material 13

H

heating elements 3

heating elements for coffee machine 3

I

indicator lights 4

indicator lights (complete) 4

L

lamps 4

O

O-rings 11

P

push/momentary push switches 3

R

relays 4

rocker/momentary rocker switches 3

rotary switches 4

S

screws 13

sealing washers 12

solenoid valves 6

switches and momentary switches 3