



GAS COMPONENTS



ELECTRIC COMPONENTS



WATER TECHNOLOGY



MECHANICAL COMPONENTS



TOOLS

Spare parts suitable for

SPM

Find the complete and up-to-date range of products in our GEV Webshop



Manufacturer catalogue

The most important spare parts and accessories arranged clearly for every manufacturer

- ✓ Complete product range and all appliance data always up to date in the GEV Webshop
- ✓ Alphabetical Index at the end of the catalogue

GEV Webshop

www.gev-online.co.uk

www.gev-online.com



- 🔍 Add to Favourites
- 🔍 Sign In with email address and usual password
- 🔍 Easy-order – place several items in your basket at the same time
- 🔍 Quick Item search – no login needed



thermostats

refrigeration thermostats

RANCO

K50 series

RANCO



1

GEV No.	390849	Ref. No.	04.BA0031.001
description	thermostat RANCO type K50-L3231/002 probe ø 1.9mm probe Lmm capillary pipe 1200mm		

switches and momentary switches

microswitches

lever actuated



1

GEV No.	650198	Ref. No.	04.BA0070.001
description	microswitch OMRON 250V 16A connection male faston for SPM		

timers

programme timers



1

GEV No.	379838	Ref. No.	04.BA0133.001
description	timer GICAR 9.2.20.96G00 electronic engines chambers operation time 230V 50/60Hz shaft ømm shaft Lmm		

electronics

PCBs



1

GEV No.	650200	Ref. No.	04.GT0003.40K
description	control PCB fast opening suitable for SPM		

solenoid valves

solenoid valves (water)

metal

CEME

accessories



1

GEV No.	371154	Ref. No.	04.ZZ0166.001
description	solenoid coil connection male faston 6.3mm CEME 50Hz 230V H 30mm seat ø 10mm voltage AC		

fans

axial fans

import



1

GEV No.	601130 ¹	Ref. No.	05.BA0012.002	
description	axial fan L 80mm W 80mm H 25mm 230VAC 50/60Hz 13/14W bearing ball bearing connection male faston 2.8mm metal ADDA fan wheel ø 75mm temp.-resist. 70°C airflow 30.6m ³ /h			
accessories for	601130			
	GEV No.	550898	Ref. No.	—
	connecting cable cable length 2000mm connection F 2.8 connection distance 7.9mm for axial flow fan			

¹with ball bearings



refrigeration fans

refrigeration motors universal

ELCO

N series - multi fit



1

GEV No.	601528	Ref. No.	04.BB0002.001
description	fan motor ELCO 16W 230V 50/60Hz bearing slide bearing L1 48mm L2 64mm L3 91.5mm W 83mm connection cable 500mm 1300/1550rpm 5 mounting options VNT16-25/029		
spare parts for	601528		
	GEV No.	601413	Ref. No. —
	fixing plate suitable for fanwheel ED ø 32mm shaft ø 7 mounting distance 26mm		

miscellaneous



1

GEV No.	601823	Ref. No.	04.BC0044.001
description	fan motor 8W 230V 50Hz L1 50mm L3 88mm cable length 550mm 1900rpm EURO MOTORS 83-2008/1 with capacitor bearing slide bearing capacitor 1.5µF		

motors

gear motors

for drink dispensers



1

GEV No.	501440	Ref. No.	04.BA0003.001
description	gear motor ELCO 230V 50Hz 32rpm shaft ø 6x12mm L 225mm W 70mm H 105mm for drink dispenser		

equipment-specific units

for drink dispensers

drain taps

drain taps



1

GEV No.	650203	Ref. No.	05.GC0004.001
description	tap SPM		



1

GEV No.	650192	Ref. No.	05.BA0007.001
description	tap white SPM		

control parts



1

GEV No.	650145	Ref. No.	02.BA0003.001
description	lever L 58mm W 45mm H 110mm white		

springs



1

GEV No.	650146	Ref. No.	04.BA0021.001
description	compression spring ø 20.5mm L 76mm wire gauge ø 1.7mm windings 7		

pistons

			
1			
GEV No.	650148	Ref. No.	02.BA0004.001
description	piston D1 ø 14.5mm D2 ø 24mm D3 ø 20.5mm L 132mm		

miscellaneous

			
1			
GEV No.	650149	Ref. No.	02.BA0053.001 ZZ.VA0004.001
description	pin ø 4mm L 30mm SS		

			
1			
GEV No.	650144	Ref. No.	02.BA0002.001
description	valve body for outlet tap		

transmission technology and ball bearings

flanges

			
1			
GEV No.	650186	Ref. No.	04.CA0019.001
description	flange for mixer UGOLINI		

gear wheels

			
1			
GEV No.	650193	Ref. No.	ZZ.ZZ0001.002
description	gear wheel ø 42.3mm W 28mm SPM		

			
1			
GEV No.	650196	Ref. No.	ZZ.ZZ0002.001
description	gear wheel with bearing SPM		

			
1			
GEV No.	650197	Ref. No.	ZZ.ZZ0001.001
description	gear wheel with bearing SPM		

containers

group 1

			
1			
GEV No.	650190	Ref. No.	02.GT0015.001
description	housing SPM		

accessories

			
1			
GEV No.	650199	Ref. No.	02.GT0023.001
description	lid SPM		

lids

			
1			
GEV No.	650204	Ref. No.	02.BA0006.001
description	lid suitable for SPM		

accessories



1

GEV No.	650194	Ref. No.	02.BA0061.001
----------------	--------	-----------------	---------------

description	mounting wrench for lid SPM		
--------------------	-----------------------------	--	--

gaskets



1

GEV No.	650147	Ref. No.	02.BA0025.001
----------------	--------	-----------------	---------------

description	gasket for auger D1 ø 21mm D2 ø 24mm ID ø 9mm H 18mm silicone		
--------------------	---	--	--



1

GEV No.	650159	Ref. No.	02.BA0009.001
----------------	--------	-----------------	---------------

description	gasket for container D1 ø 160mm ID ø 135mm H 20mm silicone		
--------------------	--	--	--

augers



1

GEV No.	650158	Ref. No.	02.BA0020.002 02.BA0266.001 02.BA0266.SLU
----------------	--------	-----------------	---

description	auger for drink dispenser L 340mm ø 150mm		
--------------------	---	--	--



1

GEV No.	650201	Ref. No.	02.GT0037.001
----------------	--------	-----------------	---------------

description	auger SPM		
--------------------	-----------	--	--



1

GEV No.	650191	Ref. No.	02.GT0036.001
----------------	--------	-----------------	---------------

description	auger SPM L 270mm ø 152mm		
--------------------	---------------------------	--	--

miscellaneous



1

GEV No.	650195	Ref. No.	02.BA0034.001
----------------	--------	-----------------	---------------

description	nut left SPM		
--------------------	--------------	--	--

gaskets

O-rings

EPDM

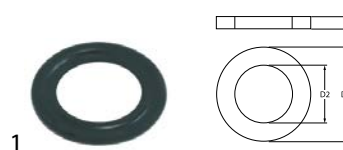

1

GEV No.	532630	Ref. No.	04.BA0026.001
----------------	--------	-----------------	---------------

description	O-ring EPDM thickness 3.53mm ID ø 15.47mm Qty 1 pcs CODE 04061		
--------------------	--	--	--

springs

compression springs



1

GEV No.	650146	Ref. No.	04.BA0021.001
----------------	--------	-----------------	---------------

description	compression spring ø 20.5mm L 76mm wire gauge ø 1.7mm windings 7		
--------------------	--	--	--

fastening material

fasteners

pins



1

GEV No.	650149	Ref. No.	02.BA0053.001 ZZ.VA0004.001
----------------	--------	-----------------	--------------------------------

description	pin ø 4mm L 30mm SS		
--------------------	---------------------	--	--

A

axial fans 3

F

fans 3

fasteners 6

fastening material 6

M

microswitches 3

motors 4

O

O-rings 6

P

pins 6

programme timers 3

R

refrigeration fans 4

refrigeration motors universal 4

refrigeration thermostats 3

S

solenoid valves 3

switches and momentary switches 3

T

thermostats 3

timers 3