



GAS COMPONENTS



ELECTRIC COMPONENTS



WATER TECHNOLOGY



MECHANICAL COMPONENTS



TOOLS

Spare parts suitable for

SF-MASCHINEN

Find the complete and up-to-date range of products in our GEV Webshop



Manufacturer catalogue

The most important spare parts and accessories arranged clearly for every manufacturer

- ✓ Complete product range and all appliance data always up to date in the GEV Webshop
- ✓ Alphabetical Index at the end of the catalogue

GEV Webshop

www.gev-online.co.uk

www.gev-online.com



- 🔍 Add to Favourites
- 🔍 Sign In with email address and usual password
- 🔍 Easy-order – place several items in your basket at the same time
- 🔍 Quick Item search – no login needed



thermostats

control and safety thermostats

RANCO

safety thermostats

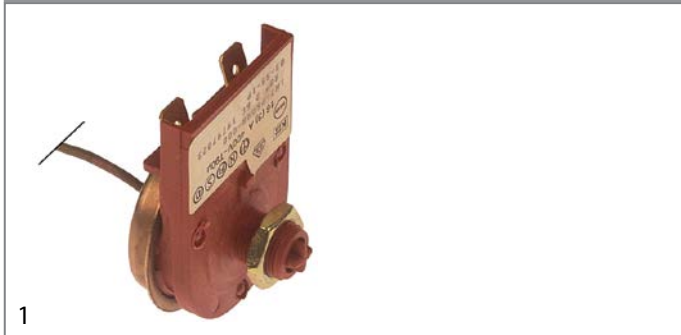

GEV No.	390583	Ref. No.	I-237
description	safety thermostat t.max. 80°C temperature range°C 1-pole 1NC 16A probe ø 9mm probe L 50mm capillary pipe 800mm capillary pipe isolatedmm gland nut shaft ømm shaft Lmm shaft position rotation° probe material copper with coiled probe screw connection M10x0.75 switch-off temp. 80°C		
For models:	N5W		

refrigeration thermostats

RANCO

K22 series

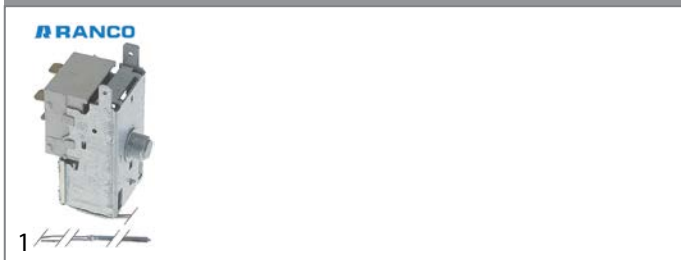

GEV No.	390582	Ref. No.	I-238
description	thermostat RANCO type K22-L1529 probe ø 7mm probe L 108mm capillary pipe 1400mm		
For models:	N6, N7		

K50 series

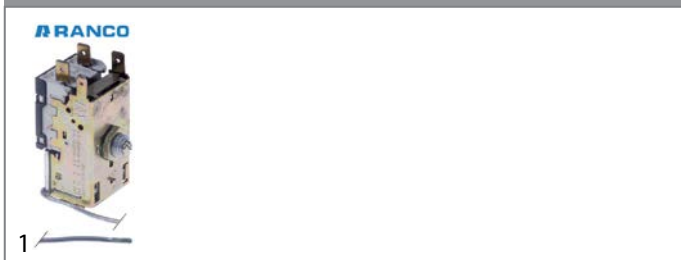

GEV No.	390642	Ref. No.	I-1058
description	thermostat RANCO type K50-L3218 probe ø 2mm probe Lmm capillary pipe 1230mm refrigeration 1NO M10x0.75		

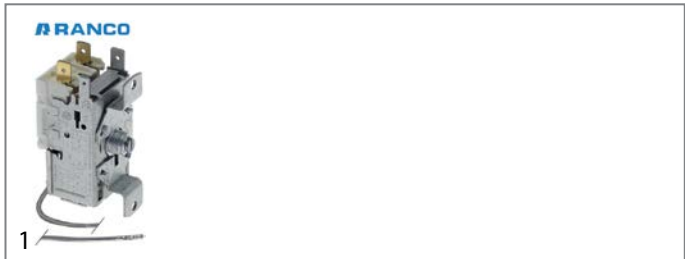

GEV No.	390581	Ref. No.	I-35
description	thermostat RANCO type K50-S3595 probe ø 2mm probe Lmm capillary pipe 2000mm		
For models:	N30		

K55 series

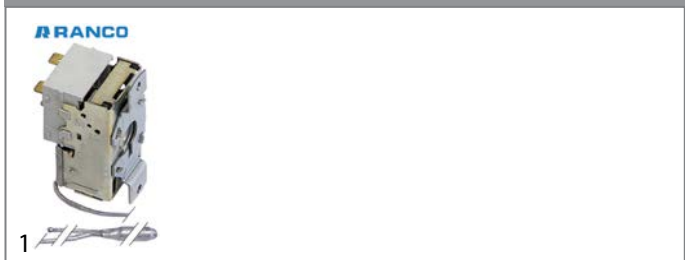

GEV No.	390284	Ref. No.	I-264
description	thermostat RANCO type K55L5082 capillary pipe 1500mm temperature range°C probe ø10x110mm		
For models:	N1, N12, N12W, N1W, N2, N2W, N3, N3W, N4, N5W, N6, N65, N6W, N7, N70, N75, N7W, N80		

K61 series

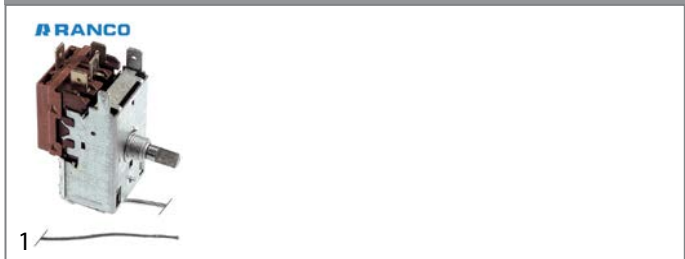

GEV No.	390212	Ref. No.	I-352
description	thermostat RANCO type K61L1500 probe ømm probe Lmm capillary pipe 750mm T war -11.5°C T cold 22°C		

accessories

probe clips

clamps

for thermostat

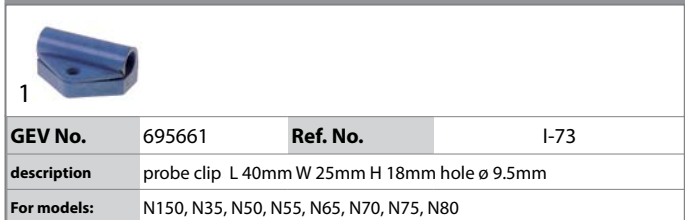

GEV No.	695661	Ref. No.	I-73
description	probe clip L 40mm W 25mm H 18mm hole ø 9.5mm		
For models:	N150, N35, N50, N55, N65, N70, N75, N80		



switches and momentary switches

rocker/momentary rocker switches

30x11mm



1

GEV No.	301013	Ref. No.	I-279
description	rocker switch mounting measurements 30x11mm black 1CO 250V 16A connection male faston 6.3mm ambient temperature max. 85/125°C protection IP40		
For models:	N3		

push/momentary push switches

ø 7mm



1

GEV No.	347069	Ref. No.	I-1682
description	momentary push switch mounting ø 7mm red 1NO 24V 4A with cable 500mm connection cable ambient temperature max. 85°C protection IP40 for ice maker		

toggle switches

M12x0.75



1

GEV No.	347068	Ref. No.	I-386
description	toggle switch thread M12x0.75 2NO 250V 16A ON-OFF-ON male faston 6.3mm with neutral position		
For models:	N250M, N500M		

microswitches

lever actuated



1

GEV No.	345345	Ref. No.	I-388
description	microswitch with lever 250V 16A 1CO connection male faston 6.3mm L 78mm ambient temperature max. 85°C mounting distance 22mm type X662-88-J27 actuating force: 40g lever length 69mm		
For models:	N250M		



1

GEV No.	346875	Ref. No.	I-229
description	microswitch 3 with lever 250V 15A 1CO connection screw L 112mm L1 49mm ambient temperature max. 125°C mounting distance 25mm type Z-15HW24-B actuating force: 5g lever length 125mm		
For models:	N1, N12, N12W, N1W, N2, N2W, N3, N3W, N4, N5W, N6, N6W, N7, N7W		



1

GEV No.	345270	Ref. No.	I-229
description	microswitch with lever 250V 16A 1CO connection male faston 6.3mm ambient temperature max. 85°C mounting distance 25mm type C99ZP3 actuating force: 30g lever length 140mm		

roller-lever actuated

microswitches



1

GEV No.	345253	Ref. No.	I-177
description	microswitch with handle with a switch 250V 15A 1CO connection male faston 6.3mm L 28mm L1 37mm ambient temperature max. 125°C mounting distance 22mm type RL6-1-F-GE-P12-5-L actuating force: 80g grey lever length 28mm		
For models:	N150, N20, N25, N50, N55, N65, N70, N80		

heavy duty version



1

GEV No.	346874	Ref. No.	I-175
description	microswitch with handle with a switch 250V 16A 1CO connection screw L 29mm L1 49mm ambient temperature max. 85°C mounting distance 26mm type Z-15GW22-B actuating force: 120g lever length 25mm		
For models:	N1, N12, N12W, N1W, N2, N2W, N3, N3W, N4, N5W, N6, N6W, N7, N75, N7W		



with mounting components



1

GEV No.	346876	Ref. No.	I-176
description	microswitch with handle with a switch 250V 16A 1CO connection male faston L 35mm L1 28mm ambient temperature max. 125°C mounting distance 22mm type V-166-1CR5 actuating force: 86g		
For models:	N20, N25		

float switches



1

GEV No.	345365	Ref. No.	I-230
description	float switch 250V 16A 1CO male faston 6.3mm L 150mm ambient temperature max. 125°C mounting distance 23mm type EF83161.5 actuating force: 5g black		
For models:	N20, N25, N35, N50, N55, N65, N70, N75, N80		



1

GEV No.	347088	Ref. No.	I-228
description	float switch with plunger 250V 16A 1CO male faston 6.3mm L 130mm ambient temperature max. 125°C mounting distance 23mm type EF83161.5 actuating force: 5g black		
For models:	N1, N12, N12W, N150, N1W, N2, N2W, N3, N3W, N4, N5W, N6, N6W, N7, N7W		

magnetic switches

36x13mm



1

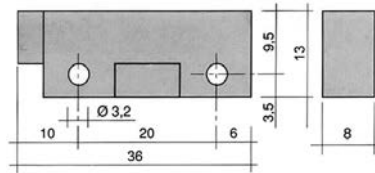

GEV No.	345118 ¹	Ref. No.	I-359
description	magnetic switch L 36mm W 13mm 1NO 250V 1A P max. 50W connection cable cable length 980mm		
For models:	N500M		
accessories for	345118		
GEV No.	345399	Ref. No.	I-324
description	magnet ø 3.3mm L 40mm H 8mm W 13mm hole distance 30mm M3		

¹with coded connector

accessories

magnets



1

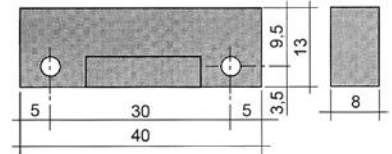



GEV No.	345399	Ref. No.	I-324
description	magnet ø 3.3mm L 40mm H 8mm W 13mm hole distance 30mm M3		

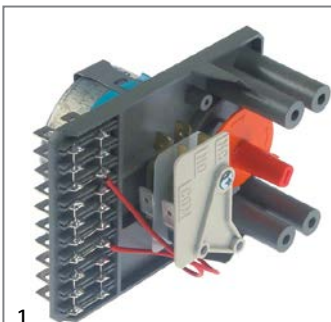

timers

programme timers



GEV No.	360370	Ref. No.	I-263
description	timer FIBER P36 engines 1 chambers 2 operation time 12min 230V 50-60Hz shaft ømm shaft Lmm manuf. no. P365JR2J536 motor type M51BJ0R6400		
spare parts for	360370		
	GEV No.	360673	Ref. No. —
	motor kit pinion ø 6.8mm teeth 15 230V voltage AC 50/60Hz turn direction clockwise motor ø 48mm H 18.5mm motor type UDS-40NE1RNZ165 cable length 150mm with holder		

contactors

GENERAL ELECTRIC (AEG)

power contactors



GEV No.	380859	Ref. No.	I-385
description	power contactor resistive load 25A 230VAC (AC3/400V) 12A/5.5kW main contacts 3NO auxiliary contacts 1NC connection screw connection type AEG LS701E		
For models:	N250M		

LOVATO

power contactors



GEV No.	380579	Ref. No.	I-1673
description	power contactor resistive load 16A 230VAC (AC3/400V) 9A/4kW main contacts 3NO auxiliary contacts 1NO connection screw connection type 11MC9102205060		

relays

power relays

with bracket mounting



GEV No.	380312	Ref. No.	I-202
description	power relays FINDER 230VAC 10A 3CO connection male faston 4.8mm bracket mounting dimensions 52x32.2x36.5mm manuf. no. 60.63.8.230.0000		
For models:	N150, N20, N25, N35, N50, N55, N65, N70, N75, N80		





GEV No.	380185	Ref. No.	I-362
description	power relays Italiana Relè 230VAC 30A 1NO connection F6.3 bracket mounting dimensions 36.5x32.2x51.8mm manuf. no. A10-230AC-FA		

with male contacts

bullet connectors, 8 contacts



GEV No.	380134	Ref. No.	I-203
description	power relays Italiana Relè 230VAC 10A 2CO connection plug-in connection round 8-pole manuf. no. C42-230VAC 90.26/ZVE8 250V		
For models:	N1, N12, N12W, N1W, N2, N2W, N3, N3W, N4, N5W, N6, N6W, N7, N7W		
accessories for	380134		
	GEV No.	380137	Ref. No. —
	relay socket 8-pole connection plug-in connection round 8-pole dimensions 65x28x40mm 380V voltage AC 10A Italiana Relè manuf. no. ZVE8		
	GEV No.	380638	Ref. No. I-204
	relay socket 8-pole dimensions 51x41x23mm 250V 10A FINDER manuf. no. 90.26		



relay sockets



1

GEV No.	380638	Ref. No.	I-204
description	relay socket 8-pole dimensions 51x41x23mm 250V 10A FINDER manuf. no. 90.26		
For models:	N1, N12, N12W, N1W, N2, N2W, N3, N3W, N4, N5W, N6, N6W, N7, N7W		

miscellaneous



1

GEV No.	380580	Ref. No.	I-379
description	relay connection with cable for pump		
For models:	N500M		

probes

Hall sensors

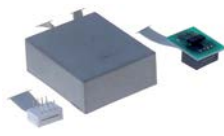

1

GEV No.	402141	Ref. No.	I-1636
description	Hall sensor cable length 550mm		



1

GEV No.	402140	Ref. No.	I-1637
description	Hall sensor double L 29mm W 26mm H 26mm mounting distance 10mm cable length 700mm		



1

GEV No.	402146	Ref. No.	I-1638
description	Hall sensor L 29mm W 26mm H 26mm mounting distance 10mm cable length 700mm		

electronics

PCBs

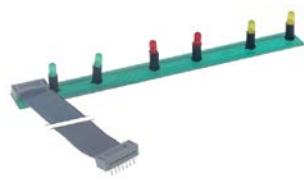

1

GEV No.	401806	Ref. No.	I-1666
description	display PCB		

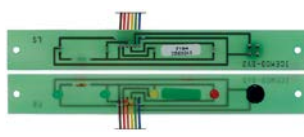

1

GEV No.	401801	Ref. No.	I-384
description	keypad PCB ice maker N200/N300/N500		
For models:	N250M, N500M		



1

GEV No.	401823	Ref. No.	I-358
description	PCB for ice-cube maker		
For models:	N500M		

solenoid valves

solenoid valves (water)

ELBI



1

GEV No.	370414	Ref. No.	I-173
description	solenoid valve single straight 230VAC inlet 3/4" outlet 11.5mm output 2l/min 50/60Hz t.max. 90°C ELBI plastic flow regulating valve outlet white		
For models:	N1, N12, N12W, N150, N2, N20, N25, N3, N35, N50, N55, N5W, N65, N6W, N70, N75, N80		



1

GEV No.	370461	Ref. No.	I-174
description	solenoid valve double straight 230VAC inlet 3/4" outlet 11.5mm input/min output -/4,7l/min DN10 t.max. 90°C ELBI plastic output B 4.7l/min flow regulating valve outlet B grey output A w/t membrane (constantly open)		
For models:	N12W, N150, N1W, N20, N25, N2W, N3, N3W, N55, N5W, N65, N70, N75, N80		

TP

solenoid valves with reducers



1

GEV No.	370416	Ref. No.	I-170
description	solenoid valve double straight 230VAC inlet 3/4" input/min output 1.2/1.2l/min DN10 t.max. 90°C TP plastic outlet 11.5mm output A 1.2l/min output B 1.2l/min flow regulating valve outlet A dark brown flow regulating valve outlet B dark brown		
For models:	N1, N1W, N2, N20, N25, N2W		

various



1

GEV No.	370496	Ref. No.	I-361
description	solenoid valve straight 220VAC outlet 14mm plastic inlet 14mm		
For models:	N250M, N500M		

solenoid valves (refrigeration)

PARKER

valves



1

GEV No.	370415	Ref. No.	I-172	
description	solenoid valve straight 230V pressure range 0-10bar DN2.5 connection 4mm soldering connection PARKER refrigeration			
For models:	N150, N20, N25, N3, N35, N3W, N4, N50, N55, N6W, N7, N70, N7W, N80			
spare parts for	370415			
	GEV No.	371033	Ref. No.	—
	solenoid coil PARKER 230VAC 9VA coil type YB09 with cable seat ø 14mm			

pressure switches

for refrigeration

DANFOSS



1

GEV No.	541462	Ref. No.	I-42
description	pressure control DANFOSS type KP5 60-1171 pressure connection vertical HD refrigeration reset automatic switching diff. 1.8-6bar pressure range 8-32bar connection 7/16" UNF (1/4" SAE)		
For models:	N12, N12W, N20, N25, N3, N30, N35, N3W, N4, N50, N55, N5W, N6, N65, N6W, N7, N70, N75, N7W		



compressors

ACC/ZEL

R134A

HMBP monophase

High/Medium evaporation temperature above -20/-15 °C



1

GEV No.	605012	Ref. No.	I-130
description	compressor coolant R134a type GL45TB 220-240V 50Hz HMBP fully hermetic 8.4kg 1/6HP power input 342W cylinder capacity 4.5cm ³ CSIR H 175.5mmW 76W 101W 134W 175W 223W 278W 342W 413W test method ASHRAE ambient temperature max. 43°C		
For models:	N3, N3W		

L'UNITE HERMETIQUE / TECUMSEH

R134A

HMBP monophase

High/Medium evaporation temperature above -20/-15 °C



1

GEV No.	605098	Ref. No.	I-132
description	compressor coolant R134a type AE4460Y-FZ 220-240V 50Hz HMBP fully hermetic 12.2kg 1/2HP cylinder capacity 15.09cm ³ CSR H 211mmWWW 660W 838W 1040W 1280W 1540W 1840W test method EN 12900		
For models:	N5W		

fans

refrigeration fans

refrigeration motors universal

ELCO

N series - standard



1

GEV No.	601527	Ref. No.	I-370
description	fan motor 16W 230V 50/60Hz W 84mm 1300rpm VN16-38		
For models:	N250M		

miscellaneous



1

GEV No.	601524	Ref. No.	I-563
description	fan motor 35W 230V 50/60Hz L3 153mm W 83mm cable length 1600mm 1300rpm with capacitor capacitor 2.5µF		



1

GEV No.	601545	Ref. No.	1013 I-1013
description	fan motor 7W 220-240V 50-60Hz L3 101mm W 85mm		

spare parts for	601545			
	GEV No.	601413	Ref. No.	—
	fixing plate suitable for fanwheel ED ø 32mm shaft ø 7 mounting distance 26mm			

cooling motors (complete)



GEV No.	601557	Ref. No.	I-160
description	fan 230V 5W 50-60Hz fan wheel ø 200mm feet depth 60mm L 83mm W 92mm H 66mm blade angle 28° connection with cable mounting distance 75mm		
For models:	N1, N1W, N2, N2W, N3, N35, N3W, N4		

cooling motors (various)

refrigeration motors with foot



GEV No.	601546	Ref. No.	1513 1514 I-1513 I-1514 I-161
description	fan motor 10/11W 230-240V 50-60Hz W 85mm feet depth 86mm		
For models:	N6, N65, N6W, N7, N75, N80		



GEV No.	601418	Ref. No.	I-162
description	fan motor 10W 230V 50Hz L1 48mm L2 70mm L3 85mm W 83mm feet depth 72mm cable length 500mm connection with plug		
For models:	N12, N150, N50, N55, N70		

motors

gear motors

for ice-cube maker

for paddles



GEV No.	500407	Ref. No.	I-184
description	gear motor LIP type 123MR 8W 220/240V voltage AC 50/60Hz 50rpm turn direction counterclockwise shaft ø 4mm shaft intake ø 6.2mm groove width 2.3mm shaft L 8mm shaft ø 4mm W 74mm		
For models:	N1, N12, N12W, N150, N1W, N2, N20, N25, N2W, N3, N35, N3W, N4, N50, N55, N5W, N6, N65, N6W, N7, N70, N75, N7W, N80		

for sumps



GEV No.	500410	Ref. No.	I-309
description	float motor LIP 11W 230V 50Hz 0.7rpm shaft ø 7mm shaft length 20mm W 72mm H 110mm Ø10		
For models:	N150, N50, N55, N65, N70, N75, N80		



GEV No.	500786	Ref. No.	I-308	
description	float motor LIP 11W 230V 50Hz 1rpm shaft ø 8mm W 100mm H 90mm for ice maker L 130mm			
For models:	N20, N25			
spare parts for	500786			
	GEV No.	695670	Ref. No.	I-217
disc for pan tilting ø 100mm shaft intake ø 7mm				



			
1			
GEV No.	500409	Ref. No.	I-303
description	float motor LIP type 001 11W 220/240V voltage 50/60 0.7rpm shaft ø 7mm shaft length 20mm W 71mm H 62mm L 110mm		
For models:	N1, N1W, N2, N2W, N3, N3W		

			
1			
GEV No.	500756	Ref. No.	I-306
description	gear motor LIP type 10 11W 220/240V voltage AC 50/60Hz 0.7rpm shaft ø 8mm W 118mm H 88mm for ice maker L 130mm		
For models:	N12, N150, N4, N6, N7		

			
1			
GEV No.	500411	Ref. No.	I-305
description	gear motor BITRON type 97103 11W 230V 50Hz 0.7rpm shaft ø 7mm shaft length 30mm W 72mm H 60mm L 116mm		
For models:	N12, N4, N6, N7		

pumps

pumps for ice machines

			
1			
GEV No.	500412	Ref. No.	I-307
description	gear motor LIP type 021B 11W 230V 50Hz 1rpm shaft ø 7mm shaft length 20mm W 74mm D 67mm H 110mm for sump		
For models:	N20, N25		

			
1			
GEV No.	500781	Ref. No.	1029 I-1029
description	fan motor 11W 230V 50-60Hz L 83mm W 83mm H 75mm shaft ø 7mm		

			
1			
GEV No.	499089	Ref. No.	I-310
description	gear motor LIP type 10 11W 220/240V 50/60Hz 0.7rpm shaft ø 8mm for ice maker		
For models:	N50, N55, N65, N70, N75, N80		

			
1			
GEV No.	500761	Ref. No.	I-364
description	pump REBO type MH30F1 30W 230V 50Hz outlet ø 13mm L 135mm rotation direction right for ice maker		
For models:	N250M, N500M		

			
1			
GEV No.	500754	Ref. No.	I-396
description	pump REBO type MH50F 50W 230V 50Hz outlet ø 18mm L 135mm for ice maker		



pumps for drink dispensers

pump motors



1

GEV No.	500781	Ref. No.	1029 I-1029
description	fan motor 11W 230V 50-60Hz L 83mm W 83mm H 75mm shaft ø 7mm		

condensators & interference suppression filters

operating capacitors

plastic



1

GEV No.	365031	Ref. No.	I-1658
description	operating capacitor capacity 4µF 450V tolerance 5% 50/60Hz ambient temperature max. -25 to +85°C ø 31mm L 58mm M8 plastic connection male faston 6.3mm protection		

electric accessories

cables

ribbon cables

group 7



1

GEV No.	694212	Ref. No.	I-10
description	ribbon cable 3-pole L 150mm for test		
For models:	N30, N6, N6W, N7, N7W		

equipment-specific units

for ice-cube maker

ice chutes

ice chutes



1

GEV No.	695595	Ref. No.	I-102
description	ice chute for door L 345mm W 205mm white		
For models:	N1, N1W, N20, N25		



1

GEV No.	695665	Ref. No.	I-1640
description	inner door for ice maker L 595mm W 210mm H 95mm white		
For models:	N70		

slide grates



1

GEV No.	695684	Ref. No.	I-21
description	slide grate for ice maker L 170mm W 150mm		
For models:	N30		



1			
GEV No.	695686	Ref. No.	I-22
description	slide grate for ice maker L 170mm W 260mm		
For models:	N30, N50		



1			
GEV No.	695687	Ref. No.	I-23
description	slide grate for ice maker L 170mm W 440mm		
For models:	N30, N65, N70, N75, N80		



1			
GEV No.	696384	Ref. No.	I-20
description	slide grate for ice-cube maker L 195mm W 114mm H 83mm		
For models:	N20, N25, N30		

ice scoops



1			
GEV No.	691802	Ref. No.	I-50
description	ice scoop L 240mm W 150mm H 92mm		
For models:	N2, N250M, N2W		

spare parts and accessories

1			
GEV No.	695020	Ref. No.	I-214
description	disc for pan tilting		
For models:	N1, N12, N12W, N150, N1W, N2, N20, N25, N2W, N3, N35, N3W, N4, N50, N55, N5W, N6, N65, N6W, N7, N70, N7W, N80		

probes

1			
GEV No.	401764	Ref. No.	I-374
description	probe for ice thickness		
For models:	N250M		

doors

bushes

1			
GEV No.	695700	Ref. No.	I-32
description	bush for door ED ø 8mm ID ø 4.4mm L 9mm plastic		
For models:	N30, N35, N50, N55, N80		



1			
GEV No.	695883	Ref. No.	I-40
description	spacer ring for door L 3.6mm stainless steel D1 ø 8mm D2 ø 10mm M4 with thread		
For models:	N1, N12, N12W, N150, N1W, N3, N30, N3W, N4, N5W, N6, N6W, N7, N7W		

magnets

1			
GEV No.	691806	Ref. No.	I-267
description	door magnet ø 22mm Lmm thread M5 thread L 10mm		
For models:	N150		



1

GEV No.	691808	Ref. No.	I-268
description	door magnet with disc ø 12mm L 13mm thread thread Lmm		
For models:	N1, N1W, N2, N20, N25, N2W, N35, N50, N55, N65, N70, N75, N80		

doors



1

GEV No.	695679	Ref. No.	I-52
description	door complete for ice-cube maker W 448mm H 347mm thickness 20mm		
For models:	N12, N6, N6W, N7, N7W		



1

GEV No.	696654	Ref. No.	I-56
description	door for ice maker W 680mm H 345mm thickness 20mm		
For models:	N30, N65, N75, N80		



1

GEV No.	695794	Ref. No.	I-53
description	door for ice maker W 880mm H 310mm thickness 20mm complete		
For models:	N12, N12W, N150		



1

GEV No.	695717	Ref. No.	I-53
description	door for ice-cube maker W 880mm H 310mm		

door frames



1

GEV No.	695668	Ref. No.	I-272
description	door frame W 430mm H 440mm thickness 30mm		
For models:	N50, N75		

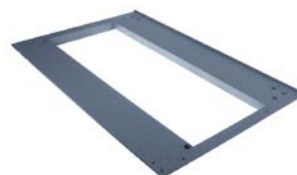

1

GEV No.	695682	Ref. No.	I-273
description	frame W 655mm H 440mm thickness 30mm		
For models:	N65, N70, N80		

door shafts



1

GEV No.	695701	Ref. No.	I-254
description	door shaft		
For models:	N20, N25, N75		



1

GEV No.	695667	Ref. No.	I-236
description	door shaft for ice maker ø 4mm L 1025mm stainless steel		
For models:	N5W		



1

GEV No.	695706	Ref. No.	I-258
description	door shaft for ice maker ø 4mm L 485mm stainless steel		



1

GEV No.	695710	Ref. No.	I-235
description	door shaft for ice maker ø 4mm L 755mm stainless steel		
For models:	N4, N5W		



1

GEV No.	695703	Ref. No.	I-253
description	door shaft for ice maker ø 6mm L 360mm stainless steel		



1

GEV No.	695704	Ref. No.	I-252
description	door shaft for ice maker ø 6mm L 585mm stainless steel		



1

GEV No.	695711	Ref. No.	I-271
description	door shaft for ice maker ø 6mm L 890mm thread M4 stainless steel		
For models:	N12, N150		

curtains

without holder



1

GEV No.	695726	Ref. No.	I-423
description	curtain for ice maker W 250mm H 70mm shaft length 270mm shaft ø 6mm		

pan mechanics

sumps



1

GEV No.	695014	Ref. No.	I-299
description	sump complete for ice maker L 180mm W 125mm H 80mm shaft L 205mm N20 blue		
For models:	N20, N25		



1

GEV No.	695015	Ref. No.	I-300
description	sump complete for ice maker L 225mm W 165mm H 80mm shaft L 255mm for modell N30/N35 white		



1

GEV No.	695017	Ref. No.	I-301
description	sump complete for ice maker L 275mm W 220mm H 75mm ICEMATIC white		
For models:	N50, N55		



1

GEV No.	695016	Ref. No.	I-293
description	sump complete for ice maker L 275mm W 220mm white		
For models:	N65		



1

GEV No.	695019	Ref. No.	I-298
description	sump complete for ice maker L 690mm W 230mm H 65mm ICEMATIC		



1

GEV No.	695018	Ref. No.	I-302
description	sump complete L 455mm W 180mm H 60mm ICEMATIC		
For models:	N70, N75, N80		



1

GEV No.	695657	Ref. No.	I-298
description	sump for ice maker L 690mm W 230mm H 75mm		
For models:	N12, N12W, N150		

spare parts and accessories



1

GEV No.	695720	Ref. No.	I-312
description	bracket for float motor L 92mm W 92mm metal		
For models:	N1, N12, N12W, N1W, N2, N20, N25, N2W, N3, N35, N3W, N4, N50, N55, N5W, N6, N6W, N7, N70, N7W, N80		



1

GEV No.	695646	Ref. No.	I-88
description	bracket for inner door L 44mm W 20mm H 18mm shaft intake ø 6.3mm mounting distance 30mm		
For models:	N1, N1W, N2, N20, N25, N2W, N50, N70		



1

GEV No.	695651	Ref. No.	I-89
description	bracket for pulser L 34mm W 15mm H 60mm		
For models:	N250M, N50, N55, N65, N70, N80		



1

GEV No.	695414	Ref. No.	I-287
description	bracket for sump mounting pos. left L 237mm W 15mm H 50mm ICEMATIC		
For models:	N1, N12, N12W, N150, N1W, N2, N20, N25, N2W, N3, N35, N3W, N4, N50, N55, N5W, N6, N65, N6W, N7, N70, N75, N7W, N80		



1

GEV No.	695415	Ref. No.	I-288
description	bracket for sump mounting pos. right ICEMATIC		
For models:	N20, N25, N35, N50, N55, N65, N70, N75, N80		



1

GEV No.	695009	Ref. No.	I-158
description	bracket paddle L 50mm W 17mm H 23mm shaft intake ø 6.5mm mounting distance 30mm		
For models:	N1, N12, N12W, N150, N1W, N2, N20, N25, N2W, N3, N35, N3W, N4, N50, N55, N5W, N6, N65, N6W, N7, N70, N7W, N80		



1

GEV No.	695681	Ref. No.	I-255 I-43
description	bush for spindle ED ø 10mm ID ø 6.2mm L 20mm plastic ICEMATIC		
For models:	N1, N12, N12W, N1W, N2, N20, N25, N2W, N3, N35, N3W, N4, N50, N55, N5W, N6, N65, N6W, N7, N70, N75, N7W, N80		



1

GEV No.	695670	Ref. No.	I-217
description	disc for pan tilting ø 100mm shaft intake ø 7mm		
For models:	N20, N25, N75		



1

GEV No.	695479	Ref. No.	I-218
description	disc for pan tilting ø 100mm shaft ø 7mm		
For models:	N150, N50, N55, N65, N70, N75, N80		



1

GEV No.	695023	Ref. No.	I-75
description	guide for lever L 30mm W 12mm H 15mm		
For models:	N1, N12, N12W, N150, N1W, N20, N25, N3, N35, N3W, N4, N50, N55, N5W, N6, N65, N6W, N7, N70, N7W, N80		





1

GEV No.	695025	Ref. No.	I-92
description	lever for sump L 143mm W 29mm H 37mm shaft intake ø 10mm plastic ICEMATIC		
For models:	N1, N1W, N20, N25, N3W, N4, N5W, N6, N65, N6W, N7, N70, N7W, N80		





			
1			
GEV No.	695645	Ref. No.	I-94
description	lever for sump L 143mm W 38mm H 29mm SS		
For models:	N12, N12W, N150		

			
1			
GEV No.	695653	Ref. No.	I-95
description	lever for sump L 90mm W 20mm shaft intake ø 10mm		
For models:	N12, N150		

			
1			
GEV No.	696527	Ref. No.	I-182
description	paddle ø 145mm shaft intake ø 6mm shaft lengthmm 1		
For models:	N1, N12, N12W, N150, N1W, N2, N20, N25, N2W, N3, N35, N3W, N4, N50, N55, N5W, N6, N65, N6W, N7, N70, N75, N7W, N80		

			
1			
GEV No.	695026	Ref. No.	I-257
description	pin for lever L 38mm ø 4.5mm metal		
For models:	N1, N12, N12W, N150, N1W, N2, N20, N25, N3, N35, N3W, N4, N5W, N6, N65, N6W, N7, N70, N75, N7W, N80		

			
1			
GEV No.	695024	Ref. No.	I-205
description	roller for pan tilting ø 26.7mm shaft intake ø 8.1mm		
For models:	N1, N12, N12W, N150, N1W, N2, N20, N25, N2W, N3, N35, N3W, N4, N50, N55, N5W, N6, N65, N6W, N7, N70, N75, N7W, N80		

			
1			
GEV No.	695035	Ref. No.	I-157
description	shaft intake for paddle motor L 30mm W 17mm H 60mm shaft intake ø 4mm mounting distance 17mm		
For models:	N1, N12, N12W, N150, N1W, N2, N20, N25, N2W, N3, N35, N3W, N4, N50, N55, N5W, N6, N6W, N7, N70, N75, N7W, N80		

			
1			
GEV No.	695882	Ref. No.	I-44
description	spacer ring for spindle ED ø 12mm ID ø 6.2mm L 2mm rubber		
For models:	N30		

			
1			
GEV No.	695004	Ref. No.	I-190
description	spindle for ice maker ø 6mm L 165mm SS		
For models:	N20, N25		

			
1			
GEV No.	695005	Ref. No.	I-191
description	spindle for ice maker ø 6mm L 206mm		

			
1			
GEV No.	695006	Ref. No.	I-192
description	spindle for ice maker ø 6mm L 315mm SS		
For models:	N50		

			
1			
GEV No.	695007	Ref. No.	I-193
description	spindle for paddle L 495mm		
For models:	N65, N70, N75, N80		

			
1			
GEV No.	695008	Ref. No.	I-189
description	spindle for paddle L 740mm		
For models:	N12, N12W, N150		

			
1			
GEV No.	695674	Ref. No.	I-64
description	tension spring for sump ø 13mm wire gauge ø 1.7mm L1 80mm		
For models:	N12, N150		

			
1			
GEV No.	695021	Ref. No.	I-62
description	torsion spring ø 20.8mm L1 23.2mm L2 37mm wire gauge ø 2.3mm for ice maker		
For models:	N1, N1W, N20, N25, N3W, N4, N5W, N6, N65, N6W, N7, N7W		

			
1			
GEV No.	695022	Ref. No.	I-61
description	torsion spring ø 21.2mm L1 26mm L2 37mm wire gauge ø 2.6mm for ice maker		
For models:	N30		



1

GEV No.	695676	Ref. No.	I-63
description	torsion spring ø 23.5mm L1 29mm L2 38mm wire gauge ø 3mm for ice maker		
For models:	N12, N12W, N150, N30		

suction system

drain pans



1

GEV No.	695666	Ref. No.	I-315
description	sump for ice maker L 220mm W 34mm H 290mm		
For models:	N35, N50, N55, N65, N70, N80		
accessories for	695666		
	GEV No.	695713	Ref. No. I-81
	guard for drain pan		

housing and bezels



1

GEV No.	695884	Ref. No.	I-9
description	cover for thermostat L 73mm W 60mm H 100mm		
For models:	N150, N3, N30, N3W, N4, N5W		



1

GEV No.	694146	Ref. No.	I-68
description	front panel L 450mm W 42mm H 175mm		
For models:	N50		



1

GEV No.	694139	Ref. No.	I-1740
description	housing for pump L 206mm W 82mm H 115mm		



1

GEV No.	694181	Ref. No.	80 I-80
description	ventilation grille for ice-cube maker L 680mm W 23mm H 360mm		
For models:	N70, N80		



1

GEV No.	695699	Ref. No.	I-165
description	ventilation grille plastic grey H 195mm L 230mm		
For models:	N20, N25		

flaps



1

GEV No.	695693	Ref. No.	I-1481
description	flap for ice maker W 493mm L 423mm for evaporator		
spare parts for	695693		



GEV No.	347059	Ref. No.	—
	magnet L 40mm H 8mm W 13.2mm hole distance 30mm		



1

GEV No.	696392	Ref. No.	I-381
description	flap for ice maker W 493mm L 423mm for evaporator		



1

GEV No.	696610	Ref. No.	I-382
description	sump for ice maker W 500mm H 70mm L 540mm for evaporator		
For models:	N250M, N500M		

hoses

formed hoses

form S



1

GEV No.	695885	Ref. No.	I-11
description	formed hose S-shape for ice-cube maker ID ø 20mm ED ø 25mm L 800mm W 130mm H 80mm		
For models:	N12, N150, N30		

miscellaneous



1

GEV No.	695813	Ref. No.	I-355
description	formed hose ID ø 11mm ED ø 15mm L 500mm W 110mm		

hose connectors

without thread



1

GEV No.	695050	Ref. No.	I-14
description	hose connector straight plastic L 70mm ø 21mm		
For models:	N20, N25, N250M, N30, N35, N50, N500M, N55, N70, N80		

miscellaneous



1

GEV No.	530769	Ref. No.	I-387
description	silicone hose for ice-cube maker ID ø 14mm ED ø 20mm L 650mm		
For models:	N250M		

miscellaneous



1

GEV No.	691665	Ref. No.	I-363
description	bracket for evaporator flap		
For models:	N250M, N500M		



1

GEV No.	696621	Ref. No.	I-34
description	bush L 9mm W 14mm H 19mm ID ø 4.5mm plastic		
For models:	N30		



1

GEV No.	695733	Ref. No.	I-1657
description	cap for ice maker H 18mm ID ø 56mm ED ø 61mm		



1

GEV No.	696652	Ref. No.	I-219
description	distance washer for ice maker H 1.5mm ID ø 4mm ED ø 10mm SS Qty 1 pcs		
For models:	N1, N12, N12W, N150, N1W, N20, N25, N3, N3W, N4, N5W, N6, N6W, N7, N7W		



GEV No. 695719 **Ref. No.** I-1611

description gasket for ice maker L 80mm W 36mm silicone



GEV No. 695713 **Ref. No.** I-81

description guard for drain pan

For models: N1, N12, N12W, N150, N1W, N3, N3W, N4, N5W, N6, N6W, N7, N7W



GEV No. 695660 **Ref. No.** I-317

description inlet spout for ice maker ICEMATIC

For models: N20, N25, N35, N50, N55, N65, N70, N75, N80



GEV No. 691807 **Ref. No.** I-357

description outflow plug for water container L 12mm ø 12mm

For models: N250M, N500M



GEV No. 695661 **Ref. No.** I-73

description probe clip L 40mm W 25mm H 18mm hole ø 9.5mm

For models: N150, N35, N50, N55, N65, N70, N75, N80



GEV No. 695585 **Ref. No.** I-1607

description threaded rod thread M4 L1 130mm L2 22mm



GEV No. 695730 **Ref. No.** I-356

description water level tube for ice maker L 20mm W 19mm H 130mm

valves

intake valves



GEV No. 695685 **Ref. No.** I-372

description intake valve thread M11 L 130mm ø 37mm plastic

For models: N250M, N500M

hinges

piano hinges

producer-specific

CASTEL

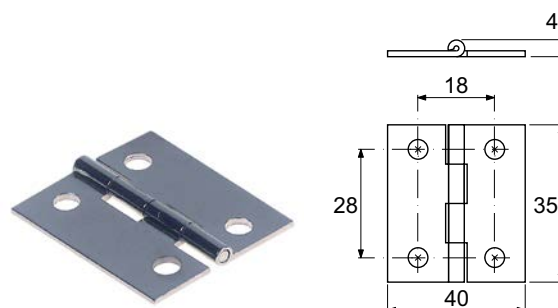

GEV No. 691804 **Ref. No.** I-212

description hinge L 40mm W 35mm H 4mm mounting distance 28mm hole ø 5mm thickness 1.3mm brass ICEMATIC

For models: N1, N1W, N2, N20, N25, N2W, N35, N50, N55, N65, N70, N80

miscellaneous



GEV No. 695727 **Ref. No.** I-211

description hinge

For models: N75



equipment feet and end caps

equipment feet

with screw mounting

components



1

GEV No.	701093	Ref. No.	I-96
description	equipment foot tube \varnothing 47mm H 68mm plastic thread 1¼" ET		
For models:	N150, N50, N55, N70, N80		

with fixing plate



1

GEV No.	691803	Ref. No.	I-289
description	equipment foot tube \varnothing 68mm plate size 45x50mm hole distance H 175-190mm plastic Qty 1 pcs		

components



1

GEV No.	701093	Ref. No.	I-96
description	equipment foot tube \varnothing 47mm H 68mm plastic thread 1¼" ET		
For models:	N150, N50, N55, N70, N80		

miscellaneous



1

GEV No.	695677	Ref. No.	I-65
description	equipment foot tube \varnothing 46/68mm H 175-190mm plastic thread 1¼" IT		
For models:	N1, N12, N12W, N150, N1W, N2, N2W, N3, N30, N35, N3W, N4, N50, N55, N5W, N6, N6W, N7, N70, N75, N7W, N80		

gaskets

O-rings

EPDM



1

GEV No.	532534	Ref. No.	I-1678
description	O-ring EPDM thickness 3.53mm ID \varnothing 82.14mm Qty 1 pcs		
For models:	F100, F500		

Viton



1

GEV No.	528250	Ref. No.	I-1087
description	O-ring Viton thickness 2mm ID \varnothing 8mm Qty 1 pcs		

foam rubber gaskets



1

GEV No.	691329	Ref. No.	I-207
description	foam rubber gasket W 10mm thickness 5mm self-adhesive Qty supplied by meter		

shaft gaskets

shaft gaskets



GEV No.	511532	Ref. No.	I-1691
description	shaft seal ID ø 15mm ED ø 25.5mm thickness 6.5mm for ice-cube maker		
For models:	SF500		



GEV No.	750128	Ref. No.	I-285
description	evaporator for ice-cube maker 35 cubes L 295mm W 185mm H 60mm overall height 130mm		
For models:	N50		

refrigeration cycle components

cooling water regulators

JOHNSON CONTROLS



GEV No.	541189	Ref. No.	I-150
description	cooling water regulator 3/8" type V46AA-9608 connection 7/16" UNF (1/4" SAE) pressure range 5-18bar water pressure max. 10bar water temperature max. 90°C capillary pipe 750mm L 160mm 0.9kg		
For models:	N1, N12, N12W, N150, N1W, N2, N250M, N2W, N3, N3W, N4, N50, N500M, N55, N5W, N6, N6W, N7, N70, N75, N7W, N80		

for flake ice maker



GEV No.	695712	Ref. No.	I-1721
description	evaporator for flake ice maker W 180mm H 225mm ø 90mm		
For models:	F100		

condensers

condensers



GEV No.	750090	Ref. No.	I-143
description	condenser for ice maker W 665mm D 113mm H 285mm		
For models:	N4, N5W		

evaporators

for ice-cube maker

for ice cube maker



GEV No.	750127	Ref. No.	I-283
description	evaporator for ice-cube maker 15 cubes L 185mm W 155mm H 60mm total length 400mm overall width 225mm overall height 115mm		
For models:	N20, N25		



condensers water-cooled



1

GEV No.	695718	Ref. No.	I-146
description	condenser for ice maker W 190mm H 220mm L 100mm		
For models:	N20, N25		



1

GEV No.	695022	Ref. No.	I-61
description	torsion spring ø 21.2mm L1 26mm L2 37mm wire gauge ø 2.6mm for ice maker		
For models:	N30		



1

GEV No.	695676	Ref. No.	I-63
description	torsion spring ø 23.5mm L1 29mm L2 38mm wire gauge ø 3mm for ice maker		
For models:	N12, N12W, N150, N30		

transmission technology and ball bearings

ball bearings

miscellaneous



1

GEV No.	523003	Ref. No.	I-1701
description	ball bearing shaft ø 30mm ED ø 62mm W 16mm		
For models:	SF500		

tension springs



1

GEV No.	695674	Ref. No.	I-64
description	tension spring for sump ø 13mm wire gauge ø 1.7mm L1 80mm		
For models:	N12, N150		

springs

torsion springs



1

GEV No.	695021	Ref. No.	I-62
description	torsion spring ø 20.8mm L1 23.2mm L2 37mm wire gauge ø 2.3mm for ice maker		
For models:	N1, N1W, N20, N25, N3W, N4, N5W, N6, N65, N6W, N7, N7W		

hoses

industrial hoses

silicone hoses

without fabric

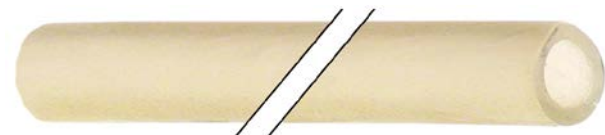

1

GEV No.	530769	Ref. No.	I-387
description	silicone hose for ice-cube maker ID ø 14mm ED ø 20mm L 650mm		
For models:	N250M		



fittings, hose and pipe connectors

hose connectors

producer-specific



1

GEV No.	695050	Ref. No.	I-14
description	hose connector straight plastic L 70mm ø 21mm		
For models:	N20, N25, N250M, N30, N35, N50, N500M, N55, N70, N80		

ancillary products

clamps

double wire clamps



1

GEV No.	520406	Ref. No.	I-89
description	hose clamp ø 28mm wire gauge ø 2.5mm Qty 1 pcs		

fastening material

screws

sheet metal screws



1

GEV No.	560059	Ref. No.	I-224
description	sheet-metal screw ø 4.2mm L 38mm SS Qty 20 pcs 7983		
For models:	N1, N12, N12W, N150, N1W, N3, N3W, N4, N5W, N6, N6W, N7, N7W		

flat-headed bolts



1

GEV No.	560063	Ref. No.	I-221
description	flat-headed bolt thread M4 thread L 16mm SS DIN 7985/ISO 7045 Qty 20 pcs intake Phillips head ø 8mm head thickness 2mm		
For models:	N150, N250M, N35, N50, N55, N70, N80		



1

GEV No.	560058	Ref. No.	I-232
description	flat-headed bolt thread M4 thread L 45mm SS Qty 20 pcs intake Phillips		
For models:	N20, N25, N35, N50, N55, N70, N80		

grub screws

miscellaneous



1

GEV No.	560458	Ref. No.	I-256
description	grub screw thread M4 L 5mm intake slotted Qty 1 pcs		
For models:	N20, N25, N35, N50, N55, N65, N70, N80		

fasteners

clamps

double wire clamps



1

GEV No.	520406	Ref. No.	I-89
description	hose clamp ø 28mm wire gauge ø 2.5mm Qty 1 pcs		

retaining rings

DIN 472



1

GEV No.	523002	Ref. No.	I-1684
description	retaining ring bore ø 45mm thickness 1.6mm steel DIN 472		
For models:	F100, F500		

roll pins



1

GEV No.	692013	Ref. No.	I-66
description	roll pin ø 3mm L 16mm		
For models:	N1, N12, N12W, N150, N20, N25, N3, N35, N3W, N4, N50, N55, N5W, N6, N65, N6W, N7, N70, N7W, N80		

C			
cables	12		
clamps	3, 24, 24		
compressors	9		
condensators & interference suppression filters	12		
contactors	6		
cooling water regulators	22		
D			
double wire clamps	24, 24		
E			
electric accessories	12		
evaporators	22		
F			
fans	9		
fasteners	24		
fastening material	24		
flat-headed bolts	24		
float switches	5		
foam rubber gaskets	21		
G			
grub screws	24		
H			
Hall sensors	7		
hose connectors	24		
hoses	23		
I			
industrial hoses	23		
M			
magnetic switches	5		
microswitches	4		
motors	10		
O			
operating capacitors	12		
O-rings	21		
P			
piano hinges	20		
pressure switches	8		
probe clips	3		
probes	7		
programme timers	6		
pumps	11		
pumps for drink dispensers	12		
pumps for ice machines	11		
		push/momentary push switches	4
R			
		refrigeration cycle components	22
		refrigeration fans	9
		refrigeration motors universal	9
		refrigeration thermostats	3
		relays	6
		retaining rings	24
		ribbon cables	12
		rocker/momentary rocker switches	4
		roll pins	24
S			
		screws	24
		shaft gaskets	22
		sheet metal screws	24
		silicone hoses	23
		solenoid valves	7
		switches and momentary switches	4
T			
		thermostats	3
		timers	6
		toggle switches	4