



GAS COMPONENTS



ELECTRIC COMPONENTS



WATER TECHNOLOGY



MECHANICAL COMPONENTS



TOOLS

Spare parts suitable for

ROSINOX

Find the complete and up-to-date range of products in our GEV Webshop



Manufacturer catalogue

The most important spare parts and accessories arranged clearly for every manufacturer

- ✓ Complete product range and all appliance data always up to date in the GEV Webshop
- ✓ Alphabetical Index at the end of the catalogue

GEV Webshop

www.gev-online.co.uk

www.gev-online.com



- 🔍 Add to Favourites
- 🔍 Sign In with email address and usual password
- 🔍 Easy-order – place several items in your basket at the same time
- 🔍 Quick Item search – no login needed







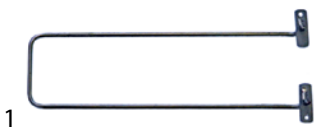

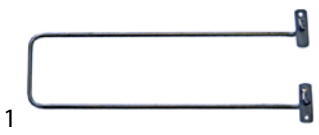

heating elements

heating elements for ovens

			
1			
GEV No.	415341	Ref. No.	94805777 RX94805777
description	heating element 735W 230V L 387mm W 108mm H 25mm lug length 55mm lug width 29mm hole distance 140mm hole ø 5mm tube ø 6.3mm connection length 30mm connection M4 heating circuits 1 dry heating element bracket mounting		

			
1			
GEV No.	415294	Ref. No.	94806460 RX94806460
description	heating element 900W 230V L 468mm W 112mm H 23mm lug length 60mm lug width 20mm hole distance 153mm hole ø 6mm tube ø 6.3mm heating circuits 1 dry heating element windings 1 rectangular flange oven		

heating elements for bain maries

			
1			
GEV No.	415091	Ref. No.	94812669 RX94812669
description	heating element 1000W 230V heating circuits 1 L 295mm W 85mm connection length 20mm connection M3 tube ø 6.5mm 2 hole fixing thread M14x1 immersion heater/dry heating element bain marie/ chip scuttle L1 145mm L2 150mm H 18mm mounting distance 79mm		
spare parts for	415091		
	GEV No.	510417	Ref. No. —
	flat gasket fibre ED ø 20mm ID ø 14mm thickness 2mm Qty 1 pcs		
accessories for	415091		
	GEV No.	520228	Ref. No. —
	tooth lock washer ID ø 15.3mm ED ø 24mm steel Qty 1 pcs for thread M14		
	GEV No.	521133	Ref. No. —
	nut thread M14x1.5 H 6mm WS 19 zinc-coated steel Qty 1 pcs		
	GEV No.	527169	Ref. No. —
	hexagonal nut thread M3 H 2.8mm WS 5.5 brass Qty 1 pcs		
	GEV No.	550261	Ref. No. —
	nut thread M14x1 H 4mm WS 19 SS Qty 1 pcs		
	GEV No.	550262	Ref. No. —
	flat gasket copper ED ø 20mm ID ø 14mm thickness 2mm		
	GEV No.	560110	Ref. No. —
	plain washer ID ø 3.2mm ED ø 7mm thickness 0.5mm SS Qty 20 pcs DIN 125A for thread M3		
	GEV No.	560130	Ref. No. —
	hexagonal nut thread M3 H 2.4mm WS 5.5 SS DIN/ISO DIN 934 / ISO 4032/8673 Qty 20 pcs		

heating elements for chip scuttles

			
1			
GEV No.	416832	Ref. No.	RX94812603
description	heating element 650W 230V heating circuits 1 L 276mm W 73mm flange length 115mm flange width 25mm hole distance 98mm connection length 24mm connection male faston 6.3mm tube ø 8.5mm rectangular flange hole ø 5mm dry heating element		

			
1			
GEV No.	415091	Ref. No.	94812669 RX94812669
description	heating element 1000W 230V heating circuits 1 L 295mm W 85mm connection length 20mm connection M3 tube ø 6.5mm 2 hole fixing thread M14x1 immersion heater/dry heating element bain marie/ chip scuttle L1 145mm L2 150mm H 18mm mounting distance 79mm		
spare parts for	415091		
	GEV No.	510417	Ref. No. —
	flat gasket fibre ED ø 20mm ID ø 14mm thickness 2mm Qty 1 pcs		
accessories for	415091		
	GEV No.	520228	Ref. No. —
	tooth lock washer ID ø 15.3mm ED ø 24mm steel Qty 1 pcs for thread M14		
	GEV No.	521133	Ref. No. —
	nut thread M14x1.5 H 6mm WS 19 zinc-coated steel Qty 1 pcs		
	GEV No.	527169	Ref. No. —
	hexagonal nut thread M3 H 2.8mm WS 5.5 brass Qty 1 pcs		
	GEV No.	550261	Ref. No. —
	nut thread M14x1 H 4mm WS 19 SS Qty 1 pcs		
	GEV No.	550262	Ref. No. —
	flat gasket copper ED ø 20mm ID ø 14mm thickness 2mm		
	GEV No.	560110	Ref. No. —
	plain washer ID ø 3.2mm ED ø 7mm thickness 0.5mm SS Qty 20 pcs DIN 125A for thread M3		
	GEV No.	560130	Ref. No. —
	hexagonal nut thread M3 H 2.4mm WS 5.5 SS DIN/ISO DIN 934 / ISO 4032/8673 Qty 20 pcs		



heating elements for fryers

side connection

with thread

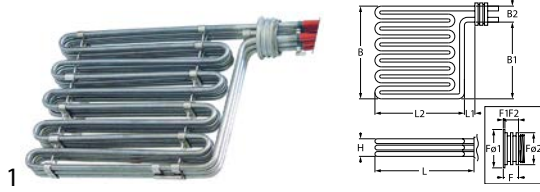

GEV No.	416813	Ref. No.	94812639 RX94812639
----------------	--------	-----------------	------------------------

description heating element 10500W 230/400V heating circuits 3 mounting pos. right L 320mm W 240mm H 32mm flange length 21mm flange length 1 2mm flange length 2 19mm flange ø1 63mm flange ø2 57.5mm sensor screw connection 2x M10x1 thermostat sleeve upper/lower L1 20mm L2 300mm W1 204mm W2 33mm thread M54x1.5 windings 5 tube ø 8.5mm cable length 460mm rotation flange fryer fryer connection length 90mm 2

accessories for 416813

GEV No.	550449	Ref. No.	—
----------------	--------	-----------------	---



special wrench for ring nut

GEV No.	550496	Ref. No.	RX94812518
----------------	--------	-----------------	------------



O-ring Viton thickness 3.53mm ID ø 50.39mm Qty 1 pcs

GEV No.	550662	Ref. No.	94805330 94812677 RX94805330 RX94812677
----------------	--------	-----------------	--



ring nut thread M54x1.5 H 7mm

off-center connection

with thread

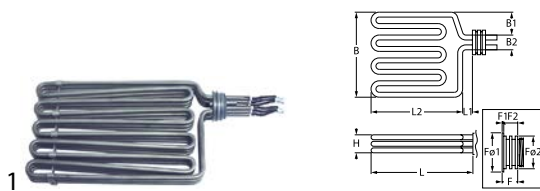

GEV No.	416070	Ref. No.	94805397 RX94805397
----------------	--------	-----------------	------------------------

description heating element 10200W 230/400V heating circuits 3 L 300mm W 180mm H 33mm flange length 19.5mm flange length 1 9.5mm flange length 2 9.8mm flange ø1 62mm flange ø2 57mm thermostat sleeves ø 6.5mm sensor screw connection 2x M10x1 thermostat sleeve upper/lower L1 18mm L2 282mm W1 30mm W2 35mm thread M54x1.5 windings 5 tube ø 8.5mm cable length 450mm rotation flange immersion heater fryer connection length 130mm 2

spare parts for 416070

GEV No.	510243	Ref. No.	—
----------------	--------	-----------------	---



O-ring Viton thickness 3.53mm ID ø 55.56mm Qty 1 pcs

GEV No.	550496	Ref. No.	RX94812518
----------------	--------	-----------------	------------



O-ring Viton thickness 3.53mm ID ø 50.39mm Qty 1 pcs

accessories for 416070

GEV No.	510243	Ref. No.	—
----------------	--------	-----------------	---



O-ring Viton thickness 3.53mm ID ø 55.56mm Qty 1 pcs

accessories for	416070			
	GEV No.	550662	Ref. No.	94805330 94812677 RX94805330 RX94812677
				ring nut thread M54x1.5 H 7mm

center connection



GEV No.	415297	Ref. No.	94806916 RX94806916
----------------	--------	-----------------	------------------------

description heating element 6800W 230/400V heating circuits 3 L 299mm W 107mm H 35mm flange length 19.5mm flange length 1 9.5mm flange length 2 9.8mm flange ø1 62mm flange ø2 57mm thermostat sleeves ø 8.5mm sensor screw connection 2x M10x1 thermostat sleeve upper/lower L1 16mm L2 283mm W1 30mm W2 77mm thread M54x1.5 tube ø 8.5mm cable length 450mm rotation flange immersion heater

accessories for 415297

GEV No.	510243	Ref. No.	—
----------------	--------	-----------------	---



O-ring Viton thickness 3.53mm ID ø 55.56mm Qty 1 pcs

GEV No.	510245	Ref. No.	—
----------------	--------	-----------------	---



O-ring Viton thickness 3.53mm ID ø 50.8mm Qty 1 pcs

GEV No.	550447	Ref. No.	—
----------------	--------	-----------------	---



ring nut thread M54x1.5

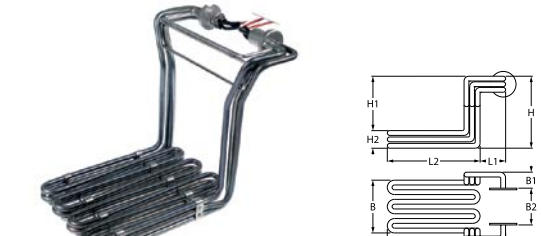

GEV No.	415257	Ref. No.	94812636 RX94812636
----------------	--------	-----------------	------------------------

description heating element 6000W 230/400V heating circuits 3 L 300mm W 182mm H 252mm L1 65mm L2 235mm W1 59mm W2 134mm W3 250mm H1 220mm H2 32mm windings 12 flange ø 40mm rotation flange cable length 380mm fryer heaters mounting ø 25mm

heating elements for griddles



GEV No.	420406	Ref. No.	RX94035706
----------------	--------	-----------------	------------

description heating element 1000W 230-240V heating circuits 1 L 69mm W 268mm H 85mm



			
GEV No.	415651	Ref. No.	RX94805678
description	heating element 1500W 230V heating circuits 1 L 425mm W 72mm H 53mm tube ø 8.5mm L1 22mm connection male faston 6.3mm connection distance 52mm dry heating element		

			
GEV No.	415296	Ref. No.	RX94814020
description	heating element 1580W 230V heating circuits 1 L 460mm W 65mm H 71mm tube ø 8.5mm L1 20mm L2 440mm connection male faston 6.3mm griddle connection distance 57mm dry heating element		

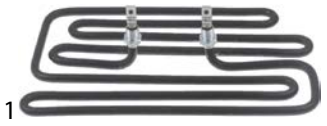
			
GEV No.	419124	Ref. No.	94001872 RX94001872
description	heating element 2000W 230V heating circuits 1 L 270mm W 150mm H 40mm tube ø 8.5mm connection M4 thread M12x1 mounting distance 70mm connection length 35mm		

			
GEV No.	419125	Ref. No.	9400180 94001807 RX94001807
description	heating element 2000W 230V heating circuits 1 L 270mm W 190mm H 40mm tube ø 8.5mm thread M12x1 mounting distance 68mm connection length 35mm		

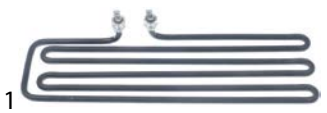
			
GEV No.	420246	Ref. No.	9400193 94001930 RX94001930
description	heating element 2400W 230V heating circuits 1 L 425mm W 115mm H 40mm tube ø 10mm 2 hole fixing connection M4 thread 1/4" mounting distance 46mm dry heating element		

heating elements for tilting bratt pan

			
GEV No.	415250	Ref. No.	94800224 RX94800224
description	heating element gril 1650W 230V L 490mm W 42mm H 45mm connection M4 dry heating element heating circuits 1 tube ø 8.5mm 2 hole fixing thread 1/4" mounting distance 37mm		

			
GEV No.	415298	Ref. No.	94806718 RX94806718
description	heating element tilting bratt pan 3400W 230V L 315mm W 195mm H 85mm connection M5 dry heating element heating circuits 1 tube ø 10mm W1 68mm W2 58mm		

heating elements for pasta cookers













				
GEV No.	415977	Ref. No.	94812607 RX94812607	
description	heating element 5670W 230V heating circuits 3 L 292mm W 225mm H 26mm rotation flange tube ø 6.3mm thermostat sleeves ø 9mm length thermostat sleeves 185mm L1 42mm L2 250mm W1 197mm W2 28mm cable length 460mm number of thermostat sleeves 1 connection length 50mm flange length 1 9mm flange length 2 15.5mm flange length 24.5mm flange ø1 43.8mm flange ø2 39.7mm thermostat sleeve centred, adjacent pasta cooker sensor screw connection M10x1			
accessories for	415977			
	GEV No.	514016	Ref. No.	—
	flat gasket PTFE ED ø 45mm ID ø 40mm thickness 4mm Qty 1 pcs equiv. no. 1036500400/1814500 suitable for MARENO			
	GEV No.	514017	Ref. No.	94803079 94803616 94812605 RX94803079 RX94803616 RX94812605
	O-ring silicone thickness 3.53mm ID ø 32.93mm Qty 1 pcs			
	GEV No.	514018	Ref. No.	94812604 RX94812604
	bush			
	GEV No.	514020	Ref. No.	—
	bush			
	GEV No.	514021	Ref. No.	—
	O-ring silicone thickness 3.53mm ID ø 49.21mm Qty 1 pcs			
	GEV No.	514022	Ref. No.	—
	nut thread 1½" H 12mm SS WS 59 Qty 1 pcs			
	GEV No.	540435	Ref. No.	—
	threaded rod thread M10 hollow			
	GEV No.	540436	Ref. No.	—
	hexagonal nut thread M10x1.25 H 4mm WS 13 brass Qty 1 pcs			

Table continues overleaf





accessories for	415977			
	GEV No.	540438	Ref. No.	—
	long nut thread M10 L 25mm WS 13 brass Qty 1 pcs			
	GEV No.	540439	Ref. No.	—
	distance washer			

heating elements for chargrills

	1		
GEV No.	415250	Ref. No.	94800224 RX94800224
description	heating element grill 1650W 230V L 490mm W 42mm H 45mm connection M4 dry heating element heating circuits 1 tube ø 8.5mm 2 hole fixing thread 1/4" mounting distance 37mm		

heating elements for plate warmers



	1			
GEV No.	416827	Ref. No.	94805223 RX94805223	
description	heating element 1100W 240V 2 hole fixing thread M10x1 L 375mm W 90mm heating circuits 1 connection plug-in connection 4mm L1 25mm L2 25mm L3 325mm dry heating element tube ø 6.3mm W1 23mm W2 44mm mounting distance 38mm for heated cabinet			
accessories for	416827			
	GEV No.	101860	Ref. No.	—
	nut thread M10x1 H 4mm WS 14 chrome-plated brass Qty 1 pcs			

ceramic heaters

245x60mm

	1			
GEV No.	415103	Ref. No.	94805876 RX94805876	
description	ceramic emitter 650W 230V cable beaded cord L 245mm W 60mm H 35mm			
spare parts for	415103			
	GEV No.	415109	Ref. No.	—
	spring clip			
accessories for	415103			
	GEV No.	415110	Ref. No.	—
	reflector L 245mm W 95mm H 31mm thickness 0.75mm hole ø 15x40mm			

quartz heating elements

	1			
GEV No.	421000	Ref. No.	RX94933597	
description	quartz heating element 650W 230/240V L 542mm W 121mm H 30mm threaded connection screw clamp heating circuits 1			
spare parts for	421000			
	GEV No.	415103	Ref. No.	94805876 RX94805876
	ceramic emitter 650W 230V cable beaded cord L 245mm W 60mm H 35mm			

coil heating elements

	1		
GEV No.	419039	Ref. No.	94808623 RX94808623
description	heating element 2000/2180W 230/240V L 395mm W 93mm thread 3/8" connection M6 connection length 45mm dishwasher dry heating element heating circuits 1 2 hole fixing		

	1		
GEV No.	420330	Ref. No.	RX94803905
description	heating element 2000W 240V L 454mm W 210mm ø 27.5mm thread M14x1 connection M4 for drying warewashing heating circuits 1 2 hole fixing		

	1		
GEV No.	417640	Ref. No.	94803913 RX94803913
description	heating element 3000W 230V L 455mm W 212mm ø 28mm thread M15x1 heating circuits 1 screw		



immersion heating elements

3 hole flange ø38.5mm

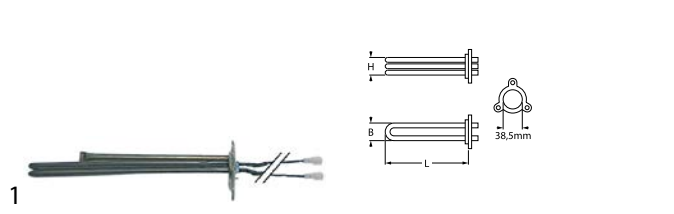

GEV No.	415261	Ref. No.	94808169 RX94808169
description	heating element 2400W 230V mounting ø 38.5mm heating circuits 1 L 242mm W 31mm H 22mm number of thermostat sleeves 1 thermostat sleeves ø 7.5mm length thermostat sleeves 180mm thermostat sleeve eccentric, non clinging tube ø 6.3mm hole distance 57mm hole ø 10mm cable length 130mm 3 hole flange connection male faston 6.3mm immersion heater		
spare parts for	415261		
	GEV No.	521120	Ref. No. —
	O-ring EPDM thickness 5.34mm ID ø 37.47mm Qty 1 pcs		
accessories for	415261		
	GEV No.	532577	Ref. No. —
	O-ring EPDM thickness 5.34mm ID ø 40.65mm Qty 1 pcs		

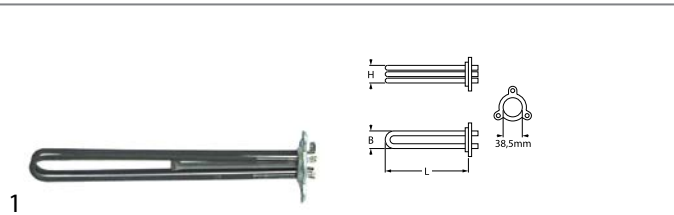

GEV No.	415167	Ref. No.	94801222 RX94801222
description	heating element 3000W 230V mounting ø 38.5mm heating circuits 2 L 300mm W 21mm H 35mm number of thermostat sleeves 1 thermostat sleeves ø 6.5mm length thermostat sleeves 53mm thermostat sleeve not clinging tube ø 6.3mm hole distance 57mm hole ø 10mm 3 hole flange connection male faston 6.3mm immersion heater		
spare parts for	415167		
	GEV No.	521120	Ref. No. —
	O-ring EPDM thickness 5.34mm ID ø 37.47mm Qty 1 pcs		
accessories for	415167		
	GEV No.	532577	Ref. No. —
	O-ring EPDM thickness 5.34mm ID ø 40.65mm Qty 1 pcs		

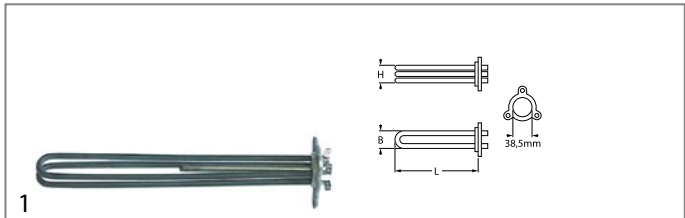

GEV No.	415278	Ref. No.	94801339 RX94801339
description	heating element 4000W 230V mounting ø 38.5mm heating circuits 2 L 290mm W 20mm H 34mm number of thermostat sleeves 1 thermostat sleeves ø 7mm length thermostat sleeves 148mm thermostat sleeve not clinging tube ø 6.3mm hole distance 57mm hole ø 10mm 3 hole flange connection male faston 6.3mm immersion heater		
spare parts for	415278		
	GEV No.	521120	Ref. No. —
	O-ring EPDM thickness 5.34mm ID ø 37.47mm Qty 1 pcs		
accessories for	415278		
	GEV No.	532577	Ref. No. —
	O-ring EPDM thickness 5.34mm ID ø 40.65mm Qty 1 pcs		

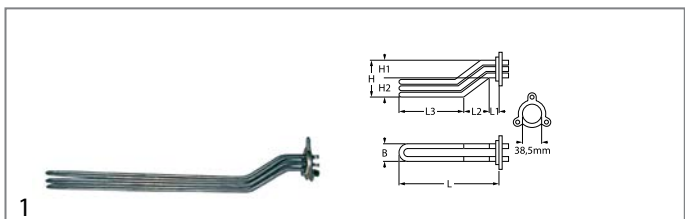

GEV No.	415277	Ref. No.	94802949 RX94802949
description	heating element 6000W 230V mounting ø 38.5mm heating circuits 3 L 360mm W 34mm H 55mm L1 35mm L2 70mm L3 255mm H1 27mm H2 28mm hole distance 57mm hole ø 10mm tube ø 6.3mm connection male faston 6.3mm immersion heater 3 hole flange		
accessories for	415277		
	GEV No.	532577	Ref. No. —
	O-ring EPDM thickness 5.34mm ID ø 40.65mm Qty 1 pcs		

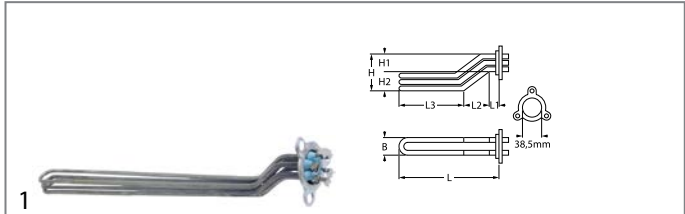



GEV No.	416269	Ref. No.	94800760 RX94800760
description	heating element 8000W 230V mounting ø 38.5mm heating circuits 3 L 545mm W 32mm H 60mm L1 38mm L2 55mm L3 447mm H1 27mm H2 33mm hole distance 57mm hole ø 10mm tube ø 6.3mm connection male faston 6.3mm immersion heater 3 hole flange		
accessories for	416269		
	GEV No.	532577	Ref. No. —
	O-ring EPDM thickness 5.34mm ID ø 40.65mm Qty 1 pcs		

→ electric components



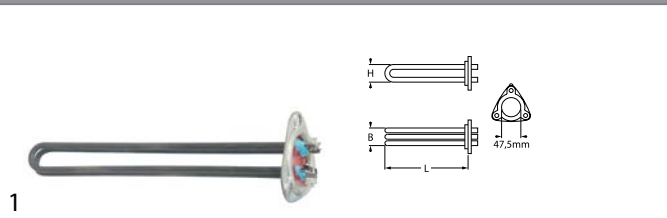



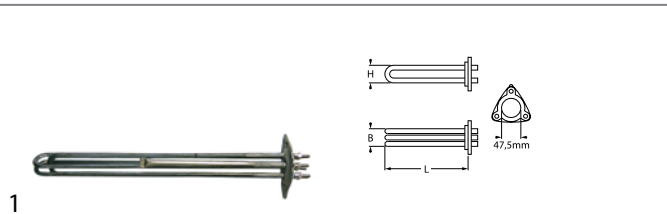

3 hole flange ø47.5mm





GEV No.	416390	Ref. No.	94813775 RX94813775
description	heating element 3200W 230V mounting ø 47.5mm heating circuits 2 L 302mm W 37mm H 20mm tube ø 6.3mm hole distance 63mm hole ø 8/10mm connection length 10mm connection male faston 6.3mm 3 hole flange immersion heater		
accessories for	416390		
	GEV No.	510408	Ref. No. RX94807781
	O-ring EPDM thickness 5.34mm ID ø 47mm Qty 1 pcs		
	GEV No.	510562	Ref. No. —
	O-ring silicone thickness 5.34mm ID ø 47mm Qty 1 pcs		

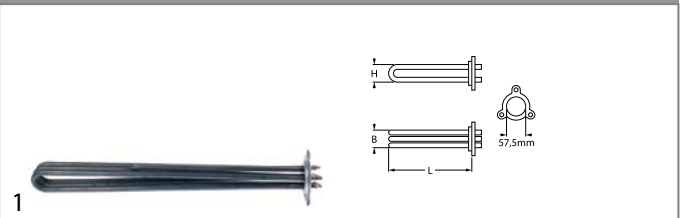

GEV No.	415001	Ref. No.	94803475 RX94803475
description	heating element 4500W 230V mounting ø 47.5mm heating circuits 3 L 316mm W 35mm H 34mm number of thermostat sleeves 1 thermostat sleeves ø 7mm length thermostat sleeves 180mm thermostat sleeve eccentric, non clinging tube ø 6.3mm hole distance 62mm hole ø 8mm connection M4 3 hole flange immersion heater		
spare parts for	415001		
	GEV No.	510408	Ref. No. RX94807781
	O-ring EPDM thickness 5.34mm ID ø 47mm Qty 1 pcs		
accessories for	415001		
	GEV No.	510562	Ref. No. —
	O-ring silicone thickness 5.34mm ID ø 47mm Qty 1 pcs		
	GEV No.	521103	Ref. No. —
	nut thread M4 H 3mm WS 7 brass Qty 20 pcs		
	GEV No.	521104	Ref. No. —
	washer ID ø 4.3mm ED ø 8mm thickness 0.5mm brass Qty 20 pcs for thread M4		
	GEV No.	560111	Ref. No. —
	plain washer ID ø 4.3mm ED ø 9mm thickness 0.8mm SS Qty 20 pcs DIN 125A for thread M4		
	GEV No.	560131	Ref. No. —
	hexagonal nut thread M4 H 3.2mm WS 7 SS DIN/ISO DIN 934 / ISO 4032/8673 Qty 20 pcs		

3 hole flange ø57.5mm



GEV No.	418624	Ref. No.	94801602 RX94801602
description	heating element 10000W 230/400V mounting ø 57.5mm heating circuits 3 L 480mm W 35mm H 43mm number of thermostat sleeves 1 thermostat sleeves ø 7mm length thermostat sleeves 285mm tube ø 8.5mm hole distance 72mm hole ø 8mm immersion heater		
spare parts for	418624		
	GEV No.	510409	Ref. No. RX94807294
	O-ring EPDM thickness 5.34mm ID ø 56.52mm Qty 1 pcs		

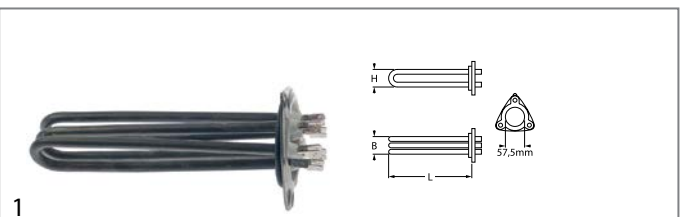

GEV No.	419191	Ref. No.	RX94810124
description	heating element 3000-3270W 230-240V mounting ø 57.5mm heating circuits 3 L 195mm W 35mm H 40mm with O-ring		

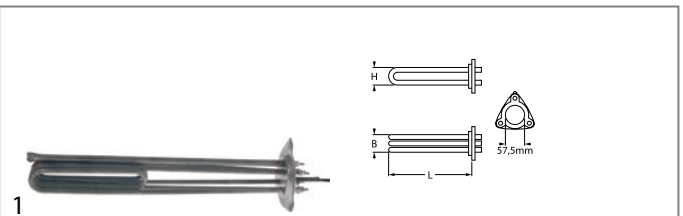

GEV No.	415846	Ref. No.	94803574 RX94803574
description	heating element 4000W 230V mounting ø 57.5mm heating circuits 3 L 327mm W 36mm H 42mm number of thermostat sleeves 1 thermostat sleeves ø 7mm length thermostat sleeves 320mm thermostat sleeve eccentric, non clinging tube ø 6.3mm hole distance 72mm hole ø 8mm connection M4 3 hole flange immersion heater		

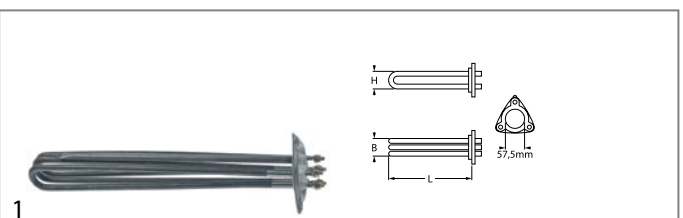



GEV No.	415021	Ref. No.	RX94813728
description	heating element 6000W 230V mounting ø 57.5mm heating circuits 3 L 343mm W 37mm H 50mm number of thermostat sleeves 1 thermostat sleeves ø 7mm length thermostat sleeves 294mm thermostat sleeve not clinging tube ø 8.5mm hole distance 72mm hole ø 8mm connection M5 3 hole flange		
spare parts for	415021		
	GEV No.	510409	Ref. No. RX94807294
	O-ring EPDM thickness 5.34mm ID ø 56.52mm Qty 1 pcs		

Table continues overleaf



accessories for	415021			
	GEV No.	550002	Ref. No.	—
	tension strap H 10mm L 21mm W 10mm hole ϕ 6.5mm for heating element			

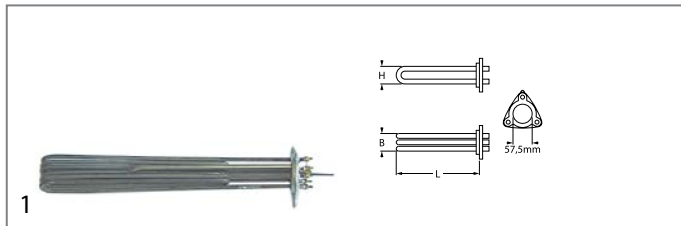

GEV No.	415039	Ref. No.	94803442 RX94803442
----------------	--------	-----------------	------------------------

description heating element 8000W 230V mounting ϕ 57.5mm heating circuits 3 L 375mm W 41mm H 42mm number of thermostat sleeves 1 thermostat sleeves ϕ 7mm length thermostat sleeves 230mm thermostat sleeve upper centre not clinging tube ϕ 6mm hole distance 73mm hole ϕ 10mm connection length 30mm connection M4 3 hole flange immersion heater

spare parts for	415039		
------------------------	--------	--	--

	GEV No.	510409	Ref. No.	RX94807294
	O-ring EPDM thickness 5.34mm ID ϕ 56.52mm Qty 1 pcs			

accessories for	415039		
------------------------	--------	--	--

	GEV No.	521103	Ref. No.	—
	nut thread M4 H 3mm WS 7 brass Qty 20 pcs			

	GEV No.	521104	Ref. No.	—
	washer ID ϕ 4.3mm ED ϕ 8mm thickness 0.5mm brass Qty 20 pcs for thread M4			

	GEV No.	560111	Ref. No.	—
	plain washer ID ϕ 4.3mm ED ϕ 9mm thickness 0.8mm SS Qty 20 pcs DIN 125A for thread M4			

	GEV No.	560131	Ref. No.	—
	hexagonal nut thread M4 H 3.2mm WS 7 SS DIN/ISO DIN 934 / ISO 4032/8673 Qty 20 pcs			

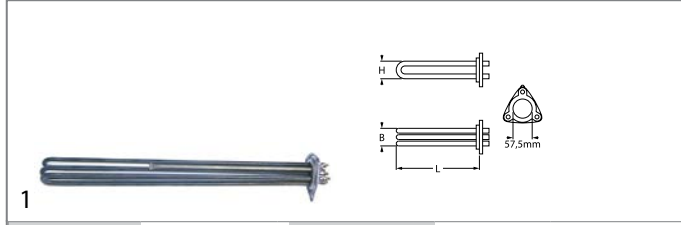

GEV No.	415022	Ref. No.	94814034 RX94814034
----------------	--------	-----------------	------------------------

description heating element 9000W 230/400V mounting ϕ 57.5mm heating circuits 3 L 475mm W 36mm H 43mm number of thermostat sleeves 1 thermostat sleeves ϕ 7mm length thermostat sleeves 300mm thermostat sleeve eccentric, non clinging tube ϕ 10mm hole distance 73mm hole ϕ 10mm connection length 30mm connection M5 3 hole flange immersion heater

spare parts for	415022		
------------------------	--------	--	--

	GEV No.	510409	Ref. No.	RX94807294
	O-ring EPDM thickness 5.34mm ID ϕ 56.52mm Qty 1 pcs			

with compression flange 62 x 26mm

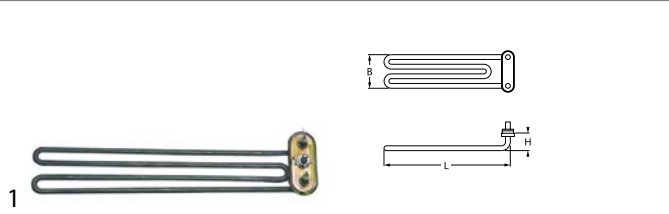

GEV No.	415268	Ref. No.	94808383 RX94808383
----------------	--------	-----------------	------------------------

description heating element 1850-2020W 230-240V heating circuits 1 expansion flange flange 62x26mm L 245mm W 40mm H 25mm tube ϕ 6.5mm connection male faston 6.3mm immersion heater

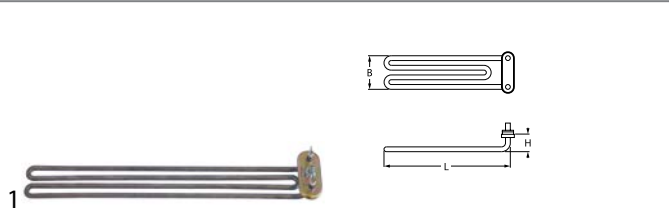

GEV No.	415270	Ref. No.	RX94808391
----------------	--------	-----------------	------------

description heating element 2700W 230V heating circuits 1 compression flange flange 62x26mm L 335mm W 43mm H 25mm tube ϕ 6.3mm connection male faston 6.3mm immersion heater

with compression flange 70 x 26mm

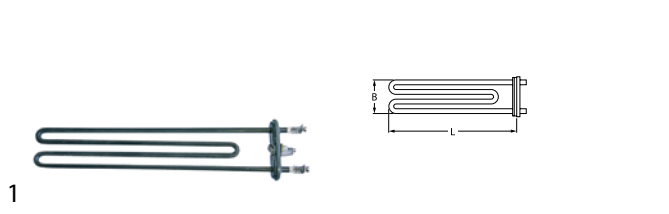

GEV No.	415000	Ref. No.	94803855 RX94803855
----------------	--------	-----------------	------------------------

description heating element 2900W 230V heating circuits 1 flange 70x26mm L 272mm W 51mm H mm tube ϕ 6.3mm connection M4 immersion heater compression flange

spare parts for	415000		
------------------------	--------	--	--



	GEV No.	521128	Ref. No.	94803665 RX94803665
	gasket L 66mm W 21mm ϕ mm for heating element suitable for ELETTOBAR, WOLK			

accessories for	415000		
------------------------	--------	--	--



	GEV No.	521128	Ref. No.	94803665 RX94803665
	gasket L 66mm W 21mm ϕ mm for heating element suitable for ELETTOBAR, WOLK			







with expansion flange 70 x 18mm



			
1			
GEV No.	415465	Ref. No.	27318591 RX27318591
description	heating element 3000W 230V heating circuits 2 flange 70x18mm L 365mm W 65mm connection male faston 6.3mm tube ø 8.5mm immersion heater expansion flange		
accessories for	415465		
	GEV No.	379078	Ref. No. —
	temperature probe thermocouple K (NiCr-Ni) cable silicone probe -50 up to 1150°C cable -50 up to +180°C connection 2-wire thread probe ø1.5x100mm cable length 1.8m		







			
1			
GEV No.	415016	Ref. No.	94813777 RX94813777
description	heating element 3000W 230V heating circuits 3 flange 70x18mm L 398mm W 60mm H 24mm connection male faston 6.3mm immersion heater expansion flange tube ø 6.3mm		

			
1			
GEV No.	415466	Ref. No.	27318583 RX27318583
description	heating element 6000W 230V heating circuits 2 flange 70x18mm L 365mm W 65mm connection male faston 6.3mm tube ø 8.5mm immersion heater expansion flange connection length 32mm		
accessories for	415466		
	GEV No.	379078	Ref. No. —
	temperature probe thermocouple K (NiCr-Ni) cable silicone probe -50 up to 1150°C cable -50 up to +180°C connection 2-wire thread probe ø1.5x100mm cable length 1.8m		

with round flange ø47.5mm

			
1			
GEV No.	415269	Ref. No.	RX94807146
description	heating element 2700W 230V heating circuits 3 mounting ø 47.5mm L 257mm W 28mm H 45mm round flange connection male faston 6.3mm immersion heater tube ø 6.3mm H1 11mm H2 34mm connection length 28mm		
accessories for	415269		
	GEV No.	510408	Ref. No. RX94807781
	O-ring EPDM thickness 5.34mm ID ø 47mm Qty 1 pcs		
	GEV No.	510562	Ref. No. —
	O-ring silicone thickness 5.34mm ID ø 47mm Qty 1 pcs		
	GEV No.	520235	Ref. No. 94807955 RX94807955
	3 hole flange hole distance 70.5mm perforation ø 6.5mm ID ø 53.5mm		
	GEV No.	520236	Ref. No. —
	flange for heating element ID ø 50mm ED ø 90mm hole ø 6.5mm 3 holes		

accessories for	415269		
	GEV No.	550002	Ref. No. —
	tension strap H 10mm L 21mm W 10mm hole ø 6.5mm for heating element		
	GEV No.	550362	Ref. No. —
	blind flange ø 64mm mounting ø 47.5mm		

			
1			
GEV No.	415262	Ref. No.	94808375 RX94808375
description	heating element 3000W 230V heating circuits 3 mounting ø 47.5mm L 260mm W 40mm H 36mm round flange connection male faston 6.3mm immersion heater tube ø 6.3mm thermostat sleeves ø 7mm number of thermostat sleeves 1 length thermostat sleeves 250mm thermostat sleeve upper centre not clinging		
accessories for	415262		
	GEV No.	510408	Ref. No. RX94807781
	O-ring EPDM thickness 5.34mm ID ø 47mm Qty 1 pcs		
	GEV No.	510562	Ref. No. —
	O-ring silicone thickness 5.34mm ID ø 47mm Qty 1 pcs		
	GEV No.	520235	Ref. No. 94807955 RX94807955
	3 hole flange hole distance 70.5mm perforation ø 6.5mm ID ø 53.5mm		
	GEV No.	520236	Ref. No. —
	flange for heating element ID ø 50mm ED ø 90mm hole ø 6.5mm 3 holes		
	GEV No.	550002	Ref. No. —
	tension strap H 10mm L 21mm W 10mm hole ø 6.5mm for heating element		
	GEV No.	550362	Ref. No. —
	blind flange ø 64mm mounting ø 47.5mm		









			
1			
GEV No.	415263	Ref. No.	RX94810462
description	heating element 4500W 230V heating circuits 3 mounting ø 47.5mm L 375mm W 38mm H 46mm round flange connection male faston 6.3mm immersion heater tube ø 6.3mm thermostat sleeves ø 7mm number of thermostat sleeves 1 length thermostat sleeves 240mm thermostat sleeve not clinging		
accessories for	415263		
	GEV No.	510408	Ref. No. RX94807781
	O-ring EPDM thickness 5.34mm ID ø 47mm Qty 1 pcs		
	GEV No.	520235	Ref. No. 94807955 RX94807955
	3 hole flange hole distance 70.5mm perforation ø 6.5mm ID ø 53.5mm		
	GEV No.	520236	Ref. No. —
	flange for heating element ID ø 50mm ED ø 90mm hole ø 6.5mm 3 holes		
	GEV No.	521012	Ref. No. —
	gasket graphite ED ø 15mm ID ø 5mm thickness 1.2mm Qty 1 pcs		

Table continues overleaf









accessories for	415263		
	GEV No.	550002	Ref. No. —
	tension strap H 10mm L 21mm W 10mm hole ø 6.5mm for heating element		
	GEV No.	550362	Ref. No. —
	blind flange ø 64mm mounting ø 47.5mm		





with round flange ø57.5mm



	1		
GEV No.	416279	Ref. No.	94808631 RX94808631
description	heating element 12000W 230V heating circuits 3 mounting ø 57.5mm L 470mm W 48mm H 34mm round flange connection M5 immersion heater tube ø 8.5mm connection length 30mm thermostat sleeves ø 7mm number of thermostat sleeves 1 length thermostat sleeves 295mm thermostat sleeve eccentric, non clinging		
accessories for	416279		
	GEV No.	550002	Ref. No. —
	tension strap H 10mm L 21mm W 10mm hole ø 6.5mm for heating element		

	1		
GEV No.	420055	Ref. No.	RX94808789
description	heating element 14000W 230V heating circuits 3 L 480mm W 36mm H 44mm connection M5 tube ø 8.5mm thermostat sleeves ø 7.7mm number of thermostat sleeves 1 length thermostat sleeves 280mm		

	1		
GEV No.	415264	Ref. No.	94807286 RX94807286
description	heating element 6000W 230V heating circuits 3 mounting ø 57.5mm L 480mm W 33mm H 42mm round flange connection M5 immersion heater tube ø 8.5mm connection length 19mm thermostat sleeves ø 7.5mm number of thermostat sleeves 1 length thermostat sleeves 268mm thermostat sleeve not clinging		
spare parts for	415264		
	GEV No.	510409	Ref. No. RX94807294
	O-ring EPDM thickness 5.34mm ID ø 56.52mm Qty 1 pcs		
accessories for	415264		
	GEV No.	550002	Ref. No. —
	tension strap H 10mm L 21mm W 10mm hole ø 6.5mm for heating element		

	1		
GEV No.	415265	Ref. No.	RX94807963
description	heating element 9000W 230V heating circuits 3 mounting ø 57.5mm L 470mm W 35mm H 41mm round flange connection M5 immersion heater tube ø 8.5mm connection length upper centre not clinging-mm thermostat sleeves ø 7.5mm number of thermostat sleeves 1 length thermostat sleeves 295mm		
spare parts for	415265		
	GEV No.	510409	Ref. No. RX94807294
	O-ring EPDM thickness 5.34mm ID ø 56.52mm Qty 1 pcs		
accessories for	415265		
	GEV No.	550002	Ref. No. —
	tension strap H 10mm L 21mm W 10mm hole ø 6.5mm for heating element		

1"			
	1		
GEV No.	415196	Ref. No.	94801438 RX94801438
description	heating element 2000W 230V heating circuits 2 thread 1" L 305mm W 34mm H 45mm H1 22mm H2 23mm tube ø 6.3mm connection male faston 6.3mm immersion heater flange with thread WS 30		
accessories for	415196		
	GEV No.	510404	Ref. No. —
	flat gasket fibre ED ø 44mm ID ø 34mm thickness 2mm Qty 1 pcs		
	GEV No.	510422	Ref. No. —
	gasket copper ED ø 37.7mm ID ø 32.5mm thickness 2.7mm for thread 1"		
	GEV No.	520233	Ref. No. —
	nut thread 1" H 6mm brass WS 47 Qty 1 pcs		

1¼"			
	1		
GEV No.	415153	Ref. No.	94807138 RX94807138
description	heating element 5700W 230V heating circuits 3 thread 1¼" L 300mm W 85mm H 42mm L1 120mm L2 180mm W1 29mm W2 28mm H1 21mm H2 21mm tube ø 6.3mm connection male faston 6.3mm connection length 40mm flange with thread immersion heater		
spare parts for	415153		
	GEV No.	510405	Ref. No. —
	flat gasket fibre ED ø 56mm ID ø 42mm thickness 2mm for thread 1¼" Qty 1 pcs		
accessories for	415153		
	GEV No.	520232	Ref. No. —
	nut thread 1¼" H 5mm nickel-plated brass WS 47 Qty 1 pcs		
	GEV No.	528021	Ref. No. —
	flat gasket PTFE ED ø 53mm ID ø 42.5mm thickness 3mm Qty 1 pcs equiv. no. 12001/02286 suitable for Astoria/Aurora/Brasilia/Wega		

2"			
	1		
GEV No.	415299	Ref. No.	94806106 RX94806106
description	heating element 6000W 230V heating circuits 3 L 320mm W 40mm H 44mm tube ø 8.5mm thermostat sleeves ø 5mm length thermostat sleeves 280mm connection M4 immersion heater flange with thread 2"		
accessories for	415299		
	GEV No.	510407	Ref. No. —
	flat gasket fibre ED ø 78mm ID ø 60mm thickness 2mm for heating element for thread 2" Qty 1 pcs		



1

GEV No.	415666	Ref. No.	94803566 RX94803566
description	heating element 1100W 230V heating circuits 1 L 151mm W 56mm Hmm thread 1/8" mounting distance 50mm tube ø 6.3mm 2 hole fixing immersion heater connection male faston 6.3mm		



1

GEV No.	415665	Ref. No.	94803053 94803400 RX94803053 RX94803400
description	heating element 2750/3250W 220/240V heating circuits 1 L 380mm W 110mm H 30mm thread M10x1 mounting distance 75mm tube ø 6.5mm connection M4 immersion heater 2 hole fixing		

spare parts for 415665

	GEV No.	510893	Ref. No.	94807765 RX94807765
O-ring EPDM thickness 2.62mm ID ø 9.92mm Qty 1 pcs				

accessories for 415665

	GEV No.	510416	Ref. No.	—
flat gasket fibre ED ø 19mm ID ø 10.5mm thickness 1.5mm for thread M10 Qty 1 pcs				

	GEV No.	520231	Ref. No.	—
nut thread M10x1 H 6mm WS 14 zinc-coated steel Qty 1 pcs				

	GEV No.	521103	Ref. No.	—
nut thread M4 H 3mm WS 7 brass Qty 20 pcs				

	GEV No.	521104	Ref. No.	—
washer ID ø 4.3mm ED ø 8mm thickness 0.5mm brass Qty 20 pcs for thread M4				

	GEV No.	521129	Ref. No.	—
nut thread M10 H 6mm SS WS 17 Qty 1 pcs DIN/ISO DIN 439				

	GEV No.	560111	Ref. No.	—
plain washer ID ø 4.3mm ED ø 9mm thickness 0.8mm SS Qty 20 pcs DIN 125A for thread M4				

	GEV No.	560131	Ref. No.	—
hexagonal nut thread M4 H 3.2mm WS 7 SS DIN/ISO DIN 934 / ISO 4032/8673 Qty 20 pcs				



1

GEV No.	420245	Ref. No.	94050010 RX94050010
description	heating element 3600W 240V heating circuits 1 L 143mm W 335mm connection M4 tube ø 8.3mm thread M12x1 2 hole fixing immersion heater/dry heating element mounting distance 327mm		



1

GEV No.	420247	Ref. No.	9403055 94030558 RX94030558
description	heating element 4200W 240V heating circuits 1 L 580mm W 165mm H 53mm tube ø 10mm connection M4 dry heating element 2 hole fixing		



1

GEV No.	420244	Ref. No.	9400462 94004629 RX94004629
description	heating element 4950W 230V heating circuits 1 L 540mm W 33mm H 33mm tube ø 8.5mm connection M4 immersion heater 2 hole fixing L1 30mm L2 510mm thread M14x1.5 mounting distance 25mm		

heating elements for convection



1

GEV No.	415251	Ref. No.	94806387 RX94806387
description	heating element 2500W 230V heating circuits 1 ID ø 178mm ED ø 190mm L 242mm H 35mm L1 46mm W1 31mm H1 10mm H2 25mm flange length 70mm flange width 22mm hole distance 56mm connection male faston 6.3mm horizontal tube ø 6.3mm convection heating element hole ø 5mm rectangular flange		

spare parts for 415251

	GEV No.	510368	Ref. No.	—
gasket L 70mm W 23.5mm hole ø 5mm hole distance 56mm FIBER thickness 2mm for heating element				



1

GEV No.	418131	Ref. No.	RX94814229
description	heating element 6000W 230V heating circuits 3 ID ø 217mm ED ø 231mm L 271mm H 90mm L1 41mm W1 103mm H1 24mm H2 66mm flange length 140mm flange width 22mm hole distance 63mm tube ø 6.3mm convection heating element hole ø 5mm rectangular flange		

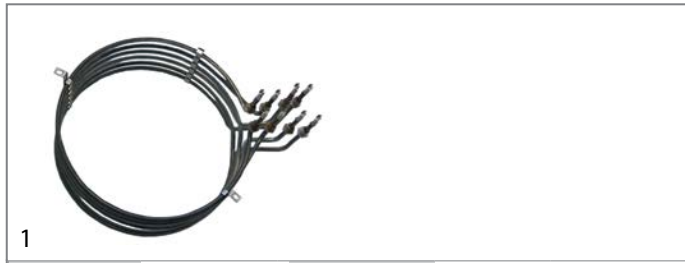





1			
GEV No.	415911	Ref. No.	27307982 RX27307982
description	heating element 9000W 230V heating circuits 4 ID ø 310mm ED ø 333mm L 410mm H 115mm L1 77mm W1 75mm H1 15mm H2 100mm thread M14x1.5 8 hole fixing connection male faston 6.3mm tube ø 8.5mm convection heating element		
accessories for	415911		
	GEV No.	510417	Ref. No. —
	flat gasket fibre ED ø 20mm ID ø 14mm thickness 2mm Qty 1 pcs		
	GEV No.	520228	Ref. No. —
	tooth lock washer ID ø 15.3mm ED ø 24mm steel Qty 1 pcs for thread M14		
	GEV No.	520230	Ref. No. —
	nut thread M14x1.5 H 5mm WS 19 zinc-coated steel Qty 1 pcs		
	GEV No.	521101	Ref. No. —
	nut thread M14x1.5 H 5mm WS 19 SS Qty 1 pcs		
	GEV No.	550262	Ref. No. —
	flat gasket copper ED ø 20mm ID ø 14mm thickness 2mm		



1			
GEV No.	419201	Ref. No.	Rx94032695
description	heating element 1667W 230V heating circuits 1 L 405mm W 295mm L1 30mm L2 377mm W2 32mm tube ø 8mm thread M12 W1 262mm		



1			
GEV No.	415469	Ref. No.	27307974 RX27307974
description	heating element 2000W 220V heating circuits 1 L 95mm W 520mm connection length 24mm connection male faston 6.3mm tube ø 6.3mm thread M14x1.5 2 hole fixing convection heating element mounting distance 514mm		
accessories for	415469		
	GEV No.	510417	Ref. No. —
	flat gasket fibre ED ø 20mm ID ø 14mm thickness 2mm Qty 1 pcs		
	GEV No.	520228	Ref. No. —
	tooth lock washer ID ø 15.3mm ED ø 24mm steel Qty 1 pcs for thread M14		
	GEV No.	520230	Ref. No. —
	nut thread M14x1.5 H 5mm WS 19 zinc-coated steel Qty 1 pcs		

accessories for	415469		
	GEV No.	521101	Ref. No. —
	nut thread M14x1.5 H 5mm WS 19 SS Qty 1 pcs		
	GEV No.	550262	Ref. No. —
	flat gasket copper ED ø 20mm ID ø 14mm thickness 2mm		



1			
GEV No.	415554	Ref. No.	27307966 RX27307966
description	heating element 2500W 230V heating circuits 1 L 148mm W 534mm connection male faston 6.3mm tube ø 6.3mm thread M14x1.5 2 hole fixing convection heating element mounting distance 528mm		

spare parts for	415554		
	GEV No.	510420	Ref. No. —
	gasket copper ED ø 19.9mm ID ø 14.3mm thickness 2mm Qty 1 pcs		

accessories for	415554		
	GEV No.	510417	Ref. No. —
	flat gasket fibre ED ø 20mm ID ø 14mm thickness 2mm Qty 1 pcs		
	GEV No.	520228	Ref. No. —
	tooth lock washer ID ø 15.3mm ED ø 24mm steel Qty 1 pcs for thread M14		
	GEV No.	520230	Ref. No. —
	nut thread M14x1.5 H 5mm WS 19 zinc-coated steel Qty 1 pcs		
	GEV No.	521101	Ref. No. —
	nut thread M14x1.5 H 5mm WS 19 SS Qty 1 pcs		
	GEV No.	550262	Ref. No. —
	flat gasket copper ED ø 20mm ID ø 14mm thickness 2mm		

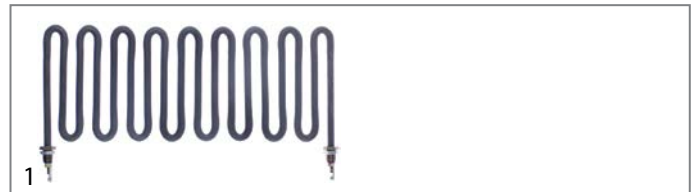

1			
GEV No.	420245	Ref. No.	94050010 RX94050010
description	heating element 3600W 240V heating circuits 1 L 143mm W 335mm connection M4 tube ø 8.3mm thread M12x1 2 hole fixing immersion heater/dry heating element mounting distance 327mm		



radiation heaters

1-circuit



1

GEV No.	490024	Ref. No.	94806171 RX94806171
description	radiation heater ø 165mm 1200W 230V heating circuits 1 energy regulation with temperature signalization with heating coil connections 2+2 connection type male faston 6.3mm EGO		

hot plates

square & rectangular

with radiused edge



1

GEV No.	490066 ¹	Ref. No.	94806866 RX94806866
description	hot plate dimensions 220x220mm 2600W 230V with spill ring connection 4 screw clamps protector yes square		

¹incl. protector

round

with radiused edge

for domestic and commercial kitchens



1

GEV No.	490016	Ref. No.	RX94012804
description	hot plate ø 180mm 2000W 230V connection 4 screw clamps with 8mm spill ring		



1

GEV No.	490020	Ref. No.	94012796 RX94012796
description	hot plate ø 220mm 2600W 230V connection 4 screw clamps with 8mm spill ring		
accessories for	490020		
	GEV No.	Ref. No.	—
	550796		
	fixing plate for hot plate ø220mm		



1

GEV No.	490062	Ref. No.	RX94012770
description	hot plate ø 300mm 3500W 220V connection 4 screw clamps with 8mm spill ring		

energy regulators

EGO

1-circuit



1

GEV No.	380001	Ref. No.	RX94045299
description	energy regulator 230V 12A single-circuit turn direction right		



1

GEV No.	380015	Ref. No.	94812641 RX94812641
description	energy regulator 230V 13A single-circuit turn direction right shaft ø 6x4.6mm shaft L 23mm mounting thread M4 power release 6-100% no. 50.57021.010		

DIAMOND



1

GEV No.	380037	Ref. No.	RX94027786
description	energy regulator 240V 13.5A turn direction right shaft ø 6x4.6mm shaft L 13mm mounting thread 3/8"-24UNF equiv. no. 35ERE101230V		



1

GEV No.	380039	Ref. No.	RX24848012
description	energy regulator 400V 13.5A turn direction right shaft ø 6x4.6mm mounting thread 3/8"-24UNF equiv. no. 35ERE104400V		
accessories for	380039		
	GEV No.	Ref. No.	—
	361181		
	nut thread 1/8" H 4.5mm nickel-plated brass WS 14 Qty 1 pcs		

thermostats

bi-metal thermostats

safety bi-metal thermostats



1

GEV No.	390480	Ref. No.	RX94808326
description	bi-metal safety thermostat hole distance 23.8mm switch-off temp. 105°C 1NC 1-pole 16A connection F6.3 2 hole fixing		



1

GEV No.	390318	Ref. No.	94803111 RX94803111
description	bi-metal safety thermostat switch-off temp. 95°C 1-pole 2 hole fixing		

bi-metal thermostats



1

GEV No.	390025	Ref. No.	94813739 RX94813739	
description	bi-metal thermostat hole distance 40mm switch-off temp. 55/42°C NC/NO 2-pole 16A 250V connection F6.3 2 hole fixing			
accessories for	390025			
	GEV No.	512154	Ref. No.	94813740 RX94813740
	gasket for thermostat ID ø 20mm equiv. no. 200494/H200494 hole distance 41mm suitable for COMENDA, HOONVED			

control and safety thermostats

EGO

control thermostats

55.10/19_ series



1

GEV No.	376014	Ref. No.	RX94016615
description	thermostat t.max. 110°C temperature range 0-110°C 1-pole 1NO 16A probe ø 6mm probe L 140mm capillary pipe 875mm capillary pipe isolated 780mm gland nut M9x1 shaft ø 6x4.6mm shaft L 23mm shaft position upper		



1

GEV No.	376011	Ref. No.	9401668 94016680 RX94016680
description	thermostat t.max. 200°C temperature range 150-200°C 1-pole 1NO 16A probe ø 6mm probe L 79mm capillary pipe 860mm capillary pipe isolated 610mm gland nut M9x1 shaft ø 6x4.6mm shaft L 23mm shaft position upper		

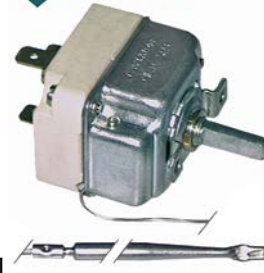

1

GEV No.	375270	Ref. No.	RX94812577
description	thermostat t.max. 295°C temperature range 45-295°C 1-pole 1NO 16A probe ø 4mm probe L 100mm capillary pipe 900mm capillary pipe isolated 350mm gland nut shaft L 23mm shaft position upper rotation 270°		



1

GEV No.	376010	Ref. No.	RX94024957
description	thermostat t.max. 320°C temperature range 50-320°C 1-pole 1NO 16A probe ø 3mm probe L 226mm capillary pipe 880mm capillary pipe isolated 865mm gland nut shaft ø 6x4.6mm shaft L 23mm shaft position upper rotation 270°		



GEV No.	375231	Ref. No.	94805249 RX94805249
description	thermostat t.max. 90°C temperature range 30-90°C 1-pole 1NO 16A probe ø 6mm probe L 130mm capillary pipe 900mm capillary pipe isolated 600mm gland nut M9x1 shaft L 18mm shaft position upper rotation 270°		

55.13_ series



GEV No.	375401	Ref. No.	24848269 RX24848269
description	thermostat t.max. 185°C temperature range 97-185°C 1-pole 1NO 16A probe ø 6mm probe L 87mm capillary pipe 1430mm capillary pipe isolated 1100mm gland nut M9x1 shaft ø 6x4.6mm shaft L 23mm shaft position upper rotation 270°		



GEV No.	375492	Ref. No.	94805371 RX94805371
description	thermostat t.max. 190°C temperature range 94-190°C 1-pole 1NO 16A probe ø 6mm probe L 94mm capillary pipe 1090mm capillary pipe isolated 960mm gland nut M10x1 shaft ø 6x4.6mm shaft L 23mm shaft position upper rotation 310° probe material SS		



GEV No.	375085	Ref. No.	24848145 RX24848145
description	thermostat t.max. 90°C temperature range 0-90°C 1-pole 1CO 16A probe ø 3.1mm probe L 247mm capillary pipe 1430mm capillary pipe isolated 1400mm gland nut shaft ø 6x4.6mm shaft L 18mm shaft position upper probe material SS		

55.17_ series



GEV No.	375672	Ref. No.	RX94804655
description	thermostat t.max. 320°C temperature range 50-320°C 1-pole 1NO 16A probe ø 3.03mm probe L 178mm capillary pipe 840mm capillary pipe isolated 840mm gland nut shaft ø 6x4.6mm shaft L 23mm shaft position upper rotation 270°		

55.34_ series



GEV No.	375602	Ref. No.	RX94805421
description	thermostat t.max. 120°C temperature range 45-120°C 3-pole 3CO 16A probe ø 6mm probe L 140mm capillary pipe 900mm capillary pipe isolated 870mm gland nut shaft ø 6x4.6mm shaft L 23mm shaft position upper rotation 270°		



GEV No.	375097	Ref. No.	94804978 RX94804978
description	thermostat t.max. 195°C temperature range 95-195°C 3-pole 3NO 16A probe ø 6mm probe L 117mm capillary pipe 1780mm capillary pipe isolated 1400mm gland nut M9x1 shaft ø 6x4.6mm shaft L 23mm shaft position upper rotation 270°		



GEV No.	375192	Ref. No.	94805645 RX94805645
description	thermostat t.max. 300°C temperature range 50-300°C 3-pole 3NO 16A probe ø 3mm probe L 219mm capillary pipe 900mm capillary pipe isolated 900mm gland nut shaft ø 6x4.6mm shaft L 23mm shaft position upper rotation 270°		



GEV No.	375417	Ref. No.	RX24845588
description	thermostat t.max. 200°C temperature range 65-200°C 3-pole 3NO 16A probe ø 6mm probe L 79mm capillary pipe 840mm capillary pipe isolated 840mm gland nut M9x1 shaft ø 6x4.6mm shaft L 23mm rotation 270°		



GEV No.	375038	Ref. No.	94032588 RX94032588
description	thermostat t.max. 300°C temperature range 50-300°C 3-pole 3NO 16A probe ø 6mm probe L 79mm capillary pipe 1740mm capillary pipe isolated 800mm gland nut shaft ø 6x4.6mm shaft L 23mm shaft position upper rotation 270°		
accessories for	375038		
	GEV No.	110123	Ref. No. —
	knob thermostat t.max. 300°C ø 50mm shaft ø 6x4.6mm shaft flat upper black temperature range 50-300°C rotation 270°		



GEV No.	376009	Ref. No.	RX94016698
description	thermostat t.max. 200°C temperature range 68-200°C 3-pole 3NO 16A probe ø 6mm probe L 79mm capillary pipe 2390mm capillary pipe isolated 1600mm gland nut M9x1 shaft ø 6x4.6mm shaft L 23mm shaft position upper rotation 270°		

safety thermostats

51_ series



GEV No.	375268	Ref. No.	94812621 RX94812621
description	thermostat t.max. 295°C temperature range 75-295°C 3-pole 3NO 16A probe ø 4mm probe L 92mm capillary pipe 900mm capillary pipe isolated 350mm gland nut shaft ø 6x4.6mm shaft L 23mm shaft position upper rotation 270°		



GEV No.	375090	Ref. No.	24848111 RX24848111
description	safety thermostat switch-off temp. 365°C 2-pole 16A probe ø 4mm probe L 120mm capillary pipe 1170mm capillary pipe isolated 1100mm gland nut probe SS		

55.10/19_series



GEV No.	375376	Ref. No.	RX94805702
description	safety thermostat capillary pipe 870mm probe ø 6mm 1-pole probe L 133mm 0.5A capillary pipe isolated gland nut M10x1 switch-off temp. 224°C probe		



GEV No.	375352	Ref. No.	RX94804986
description	safety thermostat switch-off temp. 245°C 1-pole 1NC 16A probe ø 6mm probe L 130mm capillary pipe 1200mm capillary pipe isolated 1200mm gland nut probe		

55.12_series



GEV No.	375776	Ref. No.	24848343 RX24848343
description	safety thermostat switch-off temp. 135°C 1-pole 10A probe ø 6mm probe L 87mm capillary pipe 1440mm capillary pipe isolated 1400mm gland nut probe SS		

55.13_series



GEV No.	376079	Ref. No.	94016599 RX94016599 RX94046363
description	safety thermostat switch-off temp. 215°C probe ø 6mm probe L 89mm capillary pipe 900mm capillary pipe isolated 760mm probe SS		

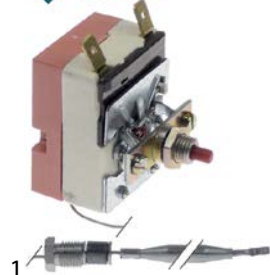

GEV No.	390801	Ref. No.	RX94050911
description	thermostat switch-off temp. 140°C 1-pole 16A probe ø 6mm probe L 78mm capillary pipe 1500mm capillary pipe isolated gland nut probe connection male faston 6.3mm		

55.32_series



GEV No.	390424	Ref. No.	RX94800505
description	safety thermostat switch-off temp. 110°C 3-pole 20A probe ø 6mm probe L 74mm capillary pipe 2000mm capillary pipe isolated 2000mm gland nut probe		



GEV No.	375275	Ref. No.	94805231 RX94805231
description	safety thermostat switch-off temp. 125°C 1-pole 0.5A probe ø 4mm probe L 120mm capillary pipe 900mm capillary pipe isolated 900mm gland nut probe SS		



GEV No.	375277	Ref. No.	94805413 RX94805413
description	safety thermostat switch-off temp. 150°C 3-pole 3NC 20A probe ø 6mm probe L 79mm capillary pipe 900mm capillary pipe isolated 700mm gland nut probe		



GEV No.	375199	Ref. No.	94812642 RX94812642
description	safety thermostat switch-off temp. 132°C 3-pole 2x20/1x0.5A probe ø 6mm probe L 77mm capillary pipe 890mm capillary pipe isolated-mm gland nut M10x1 probe SS		



GEV No.	375445	Ref. No.	RX94812559
description	safety thermostat switch-off temp. 230°C 3-pole 2x20/1x0.5A probe ø 4mm probe L 120mm capillary pipe 900mm capillary pipe isolated 700mm gland nut probe		

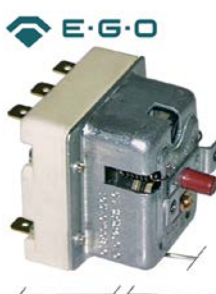

GEV No.	375281	Ref. No.	94812646 RX94812646
description	safety thermostat switch-off temp. 150°C 3-pole 0.5A probe ø 3mm probe L 188mm capillary pipe 1100mm capillary pipe isolatedmm gland nut probe SS		



GEV No.	375258	Ref. No.	94812594 RX94812594
description	safety thermostat switch-off temp. 232°C 3-pole 20A probe ø 6mm probe L 94mm capillary pipe 900mm capillary pipe isolated 670mm gland nut M10x1 probe SS		



GEV No.	375279	Ref. No.	RX94812622
description	safety thermostat switch-off temp. 345°C 3-pole 20A probe ø 4mm probe L 120mm capillary pipe 900mm capillary pipe isolated 900mm gland nut probe SS		

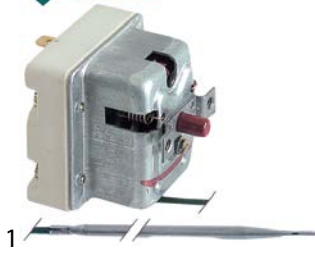

GEV No.	375344	Ref. No.	94800158 RX94800158
description	safety thermostat switch-off temp. 360°C 1-pole 0.5A probe ø 4mm probe L 120mm capillary pipe 1500mm capillary pipe isolated 1500mm gland nut probe		



GEV No.	375684	Ref. No.	94814230 RX94814230
description	safety thermostat switch-off temp. 360°C 1-pole 20A probe ø 11mm probe L 16mm capillary pipe 900mm capillary pipe isolated 900mm gland nut probe screw-in probe probe thread M14x1		

control thermostats with operation switch

55.10/19_series

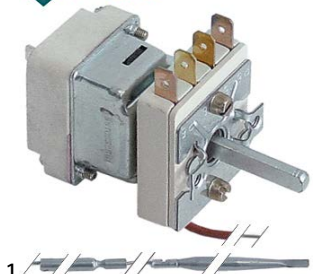

GEV No.	375331	Ref. No.	RX94812560
description	thermostat t.max. 189°C temperature range 62-189°C 1-pole 1NO 0.5A probe ø 4mm probe L 116mm capillary pipe 900mm capillary pipe isolated 700mm gland nut shaft ø 6x4.6mm shaft L 23mm shaft position upper rotation 270° outer switch 2NO		

55.34_series

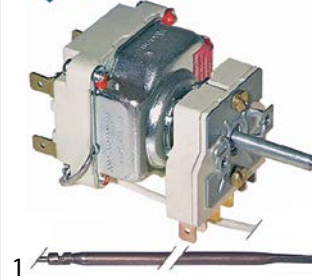

GEV No.	375246	Ref. No.	RX94090032
description	thermostat t.max. 645°C temperature range 100-615/645°C 2-pole 2NO 16A probe ø 4mm probe L 230mm capillary pipe 1100mm capillary pipe isolated 600mm gland nut shaft ø 6x4.6mm shaft L 25mm shaft position lower rotation 270° outer switch 2NO probe material copper		

IMIT / TEMPOMATIC / ARTERMO

control thermostats



GEV No.	390193	Ref. No.	RX94801099
description	thermostat t.max. 56°C temperature range 0-90°C 1-pole 1CO 16A probe ø 6.5mm probe L 95mm capillary pipe 1500mm capillary pipe isolated 1500mm gland nut shaft ømm shaft Lmm shaft position rotation 270° probe material copper		







GEV No.	390314	Ref. No.	94803095 RX94803095
description	thermostat t.max. 60°C temperature range fixed 60°C-pole 1CO 15A probe ø 6.5mm probe L 95mm capillary pipe 2000mm capillary pipe isolated 1950mm gland nut shaft ømm shaft Lmm shaft position rotation° probe material copper		



GEV No.	390421	Ref. No.	94803103 RX94803103
description	thermostat t.max. 85°C temperature range 0-90°C 1-pole 1CO 16A probe ø 6.5mm probe L 95mm capillary pipe 1500mm capillary pipe isolated 1450mm gland nut shaft ømm shaft Lmm shaft position rotation 270° probe material copper		





			
GEV No.	390425	Ref. No.	94803129 RX94803129
description	thermostat t.max. 85°C temperature range fixed 60°C 1-pole 1CO 16A probe ø 9.5mm probe L 37mm capillary pipe 600mm capillary pipe isolated 600mm gland nut shaft ømm shaft Lmm shaft position rotation° screw-in probe probe thread M14x1 probe material SS		
accessories for	390425		
	GEV No.	510417	Ref. No. —
	flat gasket fibre ED ø 20mm ID ø 14mm thickness 2mm Qty 1 pcs		
	GEV No.	511472	Ref. No. —
	nut thread 3/8" H 4mm brass WS 21 Qty 1 pcs		

			
GEV No.	390812	Ref. No.	RX94807732
description	thermostat t.max. 87°C temperature range fixes 87°C 1-pole 1CO 16A probe ø 6.5mm probe L 97mm capillary pipe 1500mm capillary pipe isolatedmm gland nut shaft Lmm rotation 270° 250V contacts male faston 6.3mm		

			
GEV No.	390460	Ref. No.	RX94807732
description	thermostat t.max. 90°C temperature range 30-90°C 1-pole 1CO 16A probe ø 6.5mm probe L 95mm capillary pipe 2000mm capillary pipe isolated 1950mm gland nut shaft ømm shaft Lmm shaft position rotation 270° probe material copper		

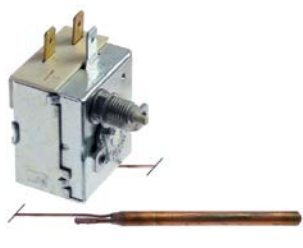
safety thermostats

			
GEV No.	390023	Ref. No.	RX94813555
description	safety thermostat switch-off temp. 90-110°C 1-pole 16A probe ø 6.5mm probe L 90mm capillary pipe 1000mm capillary pipe isolatedmm gland nut probe		

			
GEV No.	390770	Ref. No.	RX94803137
description	safety thermostat switch-off temp. 90-110°C 1-pole 1CO 16/0.5A probe ø 6.5mm probe L 90mm capillary pipe 2000mm capillary pipe isolated 1950mm gland nut probe		

JUMO control thermostats

			
GEV No.	376012	Ref. No.	RX94016573
description	thermostat t.max. 200°C temperature range 0-200°C 1-pole 1CO 6A probe ø 6mm probe L 114mm capillary pipe 1000mm capillary pipe isolatedmm gland nut shaft ø6x4.6mm shaft L 13mm		

			
GEV No.	376013	Ref. No.	RX94016581
description	thermostat t.max. 400°C temperature range 20-400°C 1-pole 1CO 6A probe ø 8mm probe L 138mm capillary pipe 1450mm capillary pipe isolatedmm gland nut shaft ø 6x4.6mm shaft L 18mm		



CAMPINI

control thermostats



GEV No.	375934	Ref. No.	RX94813996
description	thermostat t.max. 280°C temperature range 50-280°C 1-pole 1NO 16A probe ø 3mm probe L 185mm capillary pipe 960mm capillary pipe isolated 700mm gland nut shaft ø 6x4.6mm shaft L 23mm shaft position upper rotation 270° probe material SS 250V		

various

safety thermostats

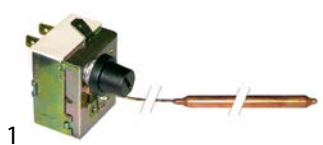

GEV No.	390194	Ref. No.	RX94807430
description	safety thermostat switch-off temp. 90-110°C 1-pole 16A probe ø 6.5mm probe L 87mm capillary pipe 1500mm capillary pipe isolated 1497mm connection male faston 6.3mm adjustable		

accessories

gland nut accessories

ducts



GEV No.	100820	Ref. No.	RX94008893
description	gland duct ET M14x1.5 IT M10x0.75 probe ø max. 6.5mm WS 22		

locking screws



GEV No.	106605	Ref. No.	94812566 RX94812566
description	union screw thread M10x1 probe ø max. 4.5mm		

switches and momentary switches

rocker/momentary rocker switches

30x22mm



GEV No.	301003	Ref. No.	94805496 RX94805496
description	rocker switch mounting measurements 30x22mm green 2NO 250V 16A illuminated 0-I connection male faston 6.3mm ambient temperature max. 125/55°C protection IP65		

accessories for



GEV No.	301036	Ref. No.	—
description	protective cover internal size 30x22mm for rocker switch mounting measurementsmm		

blank



GEV No.	345982	Ref. No.	94809506 RX94809506
description	rocker switch mounting measurements 30x22mm green 2CO 250V 16A illuminated connection male faston 6.3mm ambient temperature max. 125/55°C protection IP65 with cover cap		

accessories for



GEV No.	301036	Ref. No.	—
description	protective cover internal size 30x22mm for rocker switch mounting measurementsmm		

labelled



GEV No.	345981	Ref. No.	94809514 RX94809514
description	rocker switch mounting measurements 30x22mm green 2NO 250V 16A illuminated 0-I connection male faston 6.3mm ambient temperature max. 125/55°C protection IP65 with cover cap		

accessories for





GEV No.	301036	Ref. No.	—
description	protective cover internal size 30x22mm for rocker switch mounting measurementsmm		





push/momentary push switches

28.5x28.5mm

 <p>1</p>			
GEV No.	345226	Ref. No.	94801032 RX94801032
description	momentary push switch mounting measurements 28.5x28.5mm grey 1NO 250V 16A connection male faston 6.3mm ambient temperature max. 150°C protection IP40		

 <p>1</p>			
GEV No.	345979	Ref. No.	94808482 RX94808482
description	push switch mounting measurements 28.5x28.5mm blue 2CO 250V 16A connection male faston 6.3mm ambient temperature max. 150°C protection IP40		

 <p>1</p>			
GEV No.	345925	Ref. No.	94801388 RX94801388
description	push switch mounting measurements 28.5x28.5mm blue/green 1CO 250V 16A rinsing connection male faston 6.3mm ambient temperature max. 150°C protection IP40 with indicator		

 <p>1</p>			
GEV No.	345924	Ref. No.	94801396 RX94801396
description	push switch mounting measurements 28.5x28.5mm green/red 1CO 250V 16A main switch connection male faston 6.3mm ambient temperature max. 150°C protection IP40 with indicator green/red		

 <p>1</p>			
GEV No.	345143	Ref. No.	RX94801560
description	push switch mounting measurements 28.5x28.5mm green/red 2CO 250V 16A main switch connection male faston 6.3mm ambient temperature max. 150°C protection IP40 with indicator		

 <p>1</p>			
GEV No.	345975	Ref. No.	94808466 RX94808466
description	push switch mounting measurements 28.5x28.5mm green/red 2NO 250V 16A main switch connection male faston 6.3mm ambient temperature max. 150°C protection IP40 with indicator green/red		

28.5x77.5mm

 <p>1</p>			
GEV No.	345867	Ref. No.	RX94808334
description	switch combination latching mounting measurements 28.5x77.5mm green 2CO/indicator light/1NO 250V 16A START/indicator light/on-off connection male faston 6.3mm ambient temperature max. 85°C protection IP40		

 <p>1</p>			
GEV No.	345866	Ref. No.	RX94808359
description	switch combination latching mounting measurements 28.5x77.5mm green 2NO/1NO/indicator light 250V 16A START/indicator light/on-off connection male faston 6.3mm ambient temperature max. 85°C protection IP40		

 <p>1</p>			
GEV No.	345869	Ref. No.	RX94808342
description	switch combination momentary mounting measurements 28.5x77.5mm green 1NO/indicator light/indicator light 250V 16A temperature/regeneration connection male faston 6.3mm ambient temperature max. 85°C protection IP40		

 <p>1</p>			
GEV No.	345870	Ref. No.	RX94810629
description	switch combination momentary mounting measurements 28.5x77.5mm green 2NO/1NO/indicator light 250V 16A drain/temperature/regeneration connection male faston 6.3mm ambient temperature max. 85°C protection IP40		







			
1			
GEV No.	345868	Ref. No.	94808367 RX94808367
description	switch combination momentary mounting measurements 28.5x77.5mm green 2NO/indicator light 250V 16A drain/temperature connection male faston 6.3mm ambient temperature max. 85°C protection IP40		

ø18.2mm			
			
1			
GEV No.	346508	Ref. No.	26645481 RX26645481
description	momentary push switch mounting ø 18.2mm black 1NC/1NO 250V 2A connection screw ambient temperature max. 85°C protection IP40		

ø25mm			
			
1			
GEV No.	345038	Ref. No.	94805173 RX94805173
description	momentary push switch mounting ø 25mm black 2NO 250V 16A connection male faston 6.3mm ambient temperature max. 85°C protection IP40		

accessories			
protective covers			
			
1			
GEV No.	698490	Ref. No.	RX94029824
description	cover ED ø 17mm suitable for 345047		



toggle switches			
M12x0.75			
			
1			
GEV No.	346519	Ref. No.	RX94026036
description	toggle switch thread M12x0.75 2NO 250V 15A ON-OFF male faston 6.3mm		
accessories for	346519		
	GEV No.	346525	Ref. No. —
	protection cap L 23.5mm W 17.3mm protection cap rubber thread M11		
	GEV No.	347197	Ref. No. —
	bezel ON-OFF for toggle switch M12		

microswitches			
lever actuated			
			
1			
GEV No.	345254	Ref. No.	94812476 RX94812476
description	microswitch with lever 250V 16A 1CO connection male faston 6.3mm ambient temperature max. 120°C mounting distance 22mm actuating force: 60g lever length 58mm		



			
1			
GEV No.	345257	Ref. No.	RX94810935
description	microswitch with lever 250V 16A 1CO connection male faston 6.3mm L 29mm L1 33mm ambient temperature max. 120°C mounting distance 22mm actuating force: 130g lever length 31.5mm		

			
1			
GEV No.	345345	Ref. No.	94805348 RX94805348
description	microswitch with lever 250V 16A 1CO connection male faston 6.3mm L 78mm ambient temperature max. 85°C mounting distance 22mm type X662-88-J27 actuating force: 40g lever length 69mm		

			
1			
GEV No.	345311	Ref. No.	94803293 RX94803293
description	microswitch with lever 250V 16A 1NO connection male faston 6.3mm ambient temperature max. 85°C type TYFE22 lever length 41mm		

pin-plunger actuated			
M12			
			
1			
GEV No.	345350	Ref. No.	RX94806130
description	microswitch with plunger mounting distance 22mm thread M12x0.75 thread L 16mm 250V 16A 1CO connection male faston 6.3mm stroke 4mm ambient temperature max. 125°C type EF83161.3 actuating force: 66g		
accessories for	345350		
	GEV No.	345351	Ref. No. —
	nut thread M12x0.75 H 1.6mm WS 14 chrome-plated brass Qty 1 pcs		





M16			
			
1			
GEV No.	345047	Ref. No.	RX94050119
description	microswitch with plunger thread M16x1 thread L 27mm 250V 5A 1NO connection cable stroke 5mm ambient temperature max. 85°C with cable type 837333 actuating force: 400g		
accessories for	345047		
			
GEV No.	698490	Ref. No.	RX94029824
description	cover ED ø 17mm suitable for 345047		

roller actuated			
roller 90°			
			
1			
GEV No.	347096	Ref. No.	94807229 RX94807229
description	microswitch with roller plunger 250V 20A 1CO connection screw L1 49mm ambient temperature max. 125°C thread L 14.5mm thread M12x1 mounting distance 25mm actuating force: 370g type Z15G1318		

position switches			
PIZZATO			
FD series			
			
1			
GEV No.	345075	Ref. No.	94813727 94813807 RX94813727 RX94813807
description	position switch cast aluminum 1NO/1NC 400V 3A L 141mm W 40mm H 35mm protection IP67 actuating force: 300g screw connection PG13.5 mounting distance 30x60mm type FD503		

FR series			
			
1			
GEV No.	345181	Ref. No.	94807872 RX94807872
description	position switch plastic 1NC/1NO 400V 3A L 92mm W 31mm H 31mm protection IP67 actuating force: 450g screw connection PG13.5 mounting distance 22mm screw		

miscellaneous			
			
1			
GEV No.	348022	Ref. No.	RX94019163
description	safety switch plastic 1NO/1NC 600V 10A L 44mm W 23mm H 35mm protection IP44 actuating force: 53g screw connection mounting distance 25mm type XC1ZP2905 SCHNEIDER ELECTRIC		

system switches (ROLD)			
			
1			
GEV No.	346201	Ref. No.	94804119 RX94804119
description	element holder mounting measurements 28.5x77.5mm grey three-fold element holder		

			
1			
GEV No.	345601	Ref. No.	94813812 RX94813812
description	indicator lamp holder V ø 11mm		

			
1			
GEV No.	345546	Ref. No.	RX94813820
description	momentary switch unit 1CO 250V 16A connection male faston 6.3mm		

			
1			
GEV No.	347193	Ref. No.	94810898 RX94810898
description	momentary switch unit 1NO 250V 16A connection male faston 6.3mm		



			
1			
GEV No.	346816	Ref. No.	94804127 RX94804127
description	push button ø 23mm black		

			
1			
GEV No.	347590	Ref. No.	RX94814065
description	push button size 23x23mm green drain pump		



			
1			
GEV No.	346221	Ref. No.	RX94814066
description	push button size 23x23mm green ON-OFF with lens		

			
1			
GEV No.	345605	Ref. No.	94804143 94810976 RX94804143 RX94810976
description	switch 2CO 250V 16A connection male faston 6.3mm		

cam switches

on/off

			
1			
GEV No.	300088	Ref. No.	94805363 RX94805363
description	cam switch 2 operating positions 4NO sequence 0-1 16A shaft ø 6x4.6mm shaft L 23mm connection male faston 6.3mm ceramic		

				
1				
GEV No.	300020	Ref. No.	94805256 RX94805256	
description	cam switch 4 operating positions 2NO sequence 0-1-0-1 16A shaft ø 6x4.6mm shaft L 23mm connection screw ceramic			
accessories for	300020			
	GEV No.	110135	Ref. No.	—
	rosette knob up to ø 52mm			
	GEV No.	110231	Ref. No.	—
	knob switch 0-1-0-1 t.max.°C ø 50mm shaft ø 6x4.6mm shaft flat upper black			

			
1			
GEV No.	300102	Ref. No.	RX94014842
description	cam switch 4 operating positions 4NO sequence 0-1-0-1 32A shaft ø 6x4.6mm shaft L 23mm connection screw ceramic		

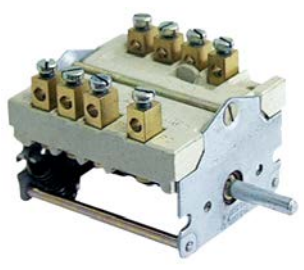
			
1			
GEV No.	300095	Ref. No.	94804994 RX94804994
description	cam switch ON-OFF connection screw clamp		



4-position



1

GEV No.	300103	Ref. No.	RX273349196
description	cam switch 4 operating positions 1NO/2CO sequence 0-1-2-3 32A shaft \varnothing 6x4.6mm shaft L 23mm connection screw ceramic		



1

GEV No.	300106	Ref. No.	RX94015021
description	cam switch 7 operating positions 1NO/2CO sequence 0-1-2-3-4-5-6 32A shaft \varnothing 6x4.6mm shaft L 23mm connection screw 7-position shaft flat upper		



1

GEV No.	300104	Ref. No.	RX27334937
description	cam switch 4 operating positions 3NO/1CO sequence 0-1-2-3 32A shaft \varnothing 6x4.6mm shaft L 23mm connection screw ceramic		

4 operating positions



1

GEV No.	300049	Ref. No.	27338144 RX27338144
description	cam switch 4 operating positions 8NO sequence 0-1-2-3 16A shaft \varnothing 6x4.6mm shaft L 17mm connection male faston 6.3mm		

7-position



1

GEV No.	300025	Ref. No.	RX94015013
description	cam switch 7 operating positions 1NO/2CO sequence 0-1-2-3-4-5-6 16A shaft \varnothing 6x4.6mm shaft L 23mm connection screw 7-position ceramic		

accessories for 300025



GEV No.	112172	Ref. No.	—
knob universal \varnothing 70mm black without adaptor/dial plate			



GEV No.	112213	Ref. No.	—
knob dial plate silver switch 7-position t.max.°C ED \varnothing 63mm ID \varnothing 45.5mm			



GEV No.	112311	Ref. No.	—
knob adapter shaft \varnothing 6x4.6mm L 0mm with spring			

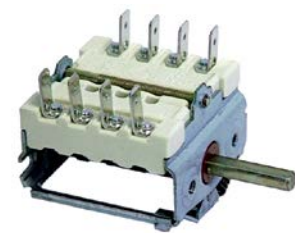

1

GEV No.	300184	Ref. No.	94806478 RX94806478
description	cam switch 4 operating positions sequence 0-3-2-1 shaft \varnothing 6x4.6mm connection male faston 4-pole		

6 operating positions

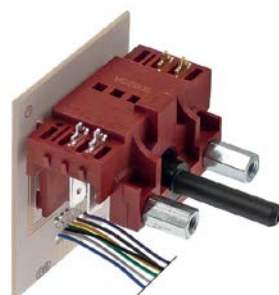

1

GEV No.	300051	Ref. No.	27338136 RX27338136
description	cam switch 6 operating positions 2NO sequence 1-0-2-3-4-5 6A shaft \varnothing 6x4.6mm shaft L 33mm connection male faston 6.3mm plastic		



with potentiometer



1

GEV No.	345119	Ref. No.	RX94814321
description	cam switch 2 operating positions 2NO sequence 0-1 16A shaft \varnothing 6x4.6mm shaft L 23mm connection soldering connection operation switch cable lengthmm 10kOhm plastic with potentiometer		
accessories for	345119		
	GEV No.	301214	Ref. No. —
	cam switch 2 operating positions operation switch 16A sequence 0-1 shaft \varnothing 6x4.6mm shaft L 33mm connection male faston 6.3mm plastic ambient temperature max. 150°C		

operation switches



1

GEV No.	300002	Ref. No.	RX94806098
description	cam switch 2 operating positions 4NO 16A sequence 0-1 shaft \varnothing 6x4.6mm shaft L 23mm connection male faston 6.3mm ceramic		



1

GEV No.	300166	Ref. No.	94805405 RX94805405
description	cam switch 2 operating positions 4NO 16A sequence 0-1 shaft \varnothing 6x4.6mm shaft L 23mm connection male faston 6.3mm ceramic 4-pole ambient temperature max. 318°C		



1

GEV No.	300080	Ref. No.	94805892 RX94805892
description	cam switch 2 operating positions 4NO 16A sequence 0-1 shaft \varnothing 6x4.6mm shaft L 23mm connection screw operation switch ceramic ambient temperature max. 150°C		
accessories for	300080		
	GEV No.	551456	Ref. No. —
	gasket for switch ED \varnothing 14mm ID \varnothing 2.5mm thickness 3.5mm white		



1

GEV No.	300200	Ref. No.	RX94015070
description	operation switch 2 operating positions 2NO 16A sequence 0-1 shaft \varnothing 6x4.6mm shaft L 23mm connection male faston 6.3mm operation switch ceramic		

rotary switches

BREMAS

A1200 series



1

GEV No.	345912	Ref. No.	RX94814307
description	rotary switch		



1

GEV No.	345019	Ref. No.	94809944 RX94809944
description	rotary switch sets of contacts 2 2 0-1 type CA0120002 380V 12A shaft \varnothing 5x5mm shaft L 23mm shaft square connection screw		



1

GEV No.	345913	Ref. No.	RX94807120
description	rotary switch sets of contacts 4 4 1-2-3-4 type CS012M014 400V 12A shaft \varnothing 5x5mm shaft L 23mm shaft square with knob connection screw		

A1700 series



1

GEV No.	345007	Ref. No.	94813779 RX94813779
description	rotary switch 4 0-1-2-3 sets of contacts 6 type CS0178766 400V 20A shaft \varnothing 5x5mm shaft L 25mm shaft square connection screw		



TELEMECANIQUE (Schneider Electric)



1			
GEV No.	300047	Ref. No.	27338060 RX27338060
description	rotary switch 4 operating positions 9-pole		

producer-specific rotary switches

DIHR / KROMO



1			
GEV No.	345913	Ref. No.	RX94807120
description	rotary switch sets of contacts 4 4 1-2-3-4 type CS012M014 400V 12A shaft \varnothing 5x5mm shaft L 23mm shaft square with knob connection screw		

magnetic switches

36x13mm

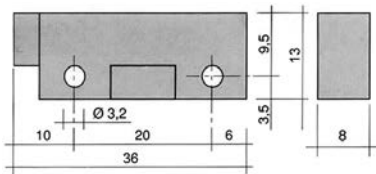

1			
GEV No.	345335	Ref. No.	RX94813862
description	magnetic switch L 36mm W 13mm 1NO 250V 0.04A P max. 10W connection cable cable length 960mm		
accessories for	345335		
	GEV No.	Ref. No.	—
	519049		
	magnet \varnothing mm L 63mm H 10.7mm W 18.8mm hole distance 52mm M2 hole \varnothing 2mm		

40x13mm

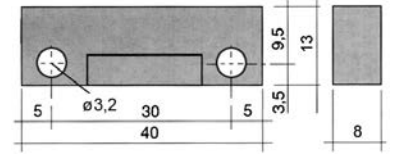

1			
GEV No.	345990	Ref. No.	94808292 RX94808292
description	magnetic switch L 40mm W 13mm 1NO 250V 0.04A P max. 10W connection male faston 6.3mm cable length 2000mm		

65x20mm

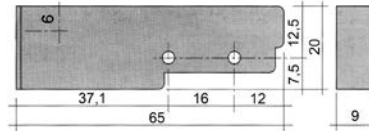

1			
GEV No.	345122 ¹	Ref. No.	94813853 RX94813853
description	magnetic switch L 65mm W 20mm 1NO 24V 8A P max. 192W connection male faston 6.3mm cable length 344mm		

¹with coded connector

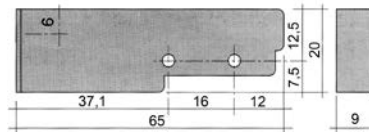

1			
GEV No.	345116	Ref. No.	RX94807161
description	magnetic switch L 65mm W 20mm 1NO 250V 0.4A P max. 100W connection cable cable length 3000mm		
accessories for	345116		
	GEV No.	Ref. No.	—
	345399		
	magnet \varnothing 3.3mm L 40mm H 8mm W 13mm hole distance 30mm M3		

ø 6mm



1

GEV No.	345202	Ref. No.	94803301 RX94803301
description	magnetic switch 250V 0.04A P max. 10W probe L 29mm 1NO connection plug cable length 1400mm		

ø 9mm



1

GEV No.	345991	Ref. No.	RX94810835 RX94813966
description	magnetic switch 250V 0.04A P max. 10W probe L 30mm 1NO connection cable cable length 2000mm		

M8x0.75

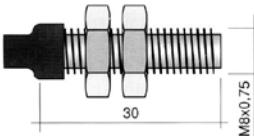



1

GEV No.	345631	Ref. No.	94803285 RX94803285
description	magnetic switch thread M8x0.75 1NO 250V 1A P max. 50W connection cable cable length 2000mm		

accessories

magnets



1

GEV No.	347702	Ref. No.	RX94807420
description	magnet H 10mm ED ø 12mm		

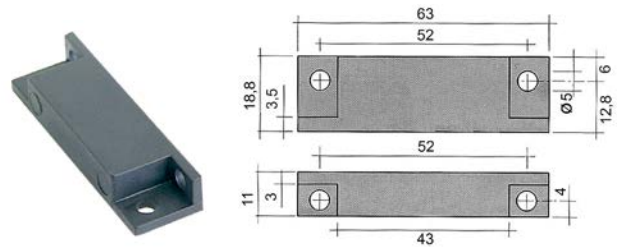

1

GEV No.	345336	Ref. No.	94809266 RX94809266
description	magnet ø 4.8mm L 63mm H 11mm W 18.8mm hole distance 51mm M4		

magnetic holders



1

GEV No.	524076	Ref. No.	94807410 RX94807410	
description	magnet holder internal size 13mm H 60mm for dishwasher			
accessories for	524076			
	GEV No.	524655	Ref. No.	—
	screw cap for magnet holder thread M16x1.25 SS WS 19			

control equipment

MOELLER/EATON

switches (complete)

push/momentary push switches



1

GEV No.	343005	Ref. No.	RX94062072
description	momentary push switch mounting measurements ø22mm black 1NO arrow momentary		

ERSCE

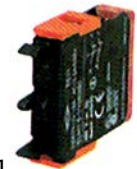

1

GEV No.	346659	Ref. No.	94808961 RX94808961
description	contact block ERSCE C02 2NC max 400V 10(4)A red/red		



1

GEV No.	346658	Ref. No.	94808953 RX94808953
description	contact block ERSCE C02 2NO max 400V 10(4)A green/green		

JKN (Square D)

rotary switches



1

GEV No.	110260	Ref. No.	27338078 RX27338078
description	rotary selector mounting measurements ø22mm		
accessories for	110260		
		GEV No.	110261
		Ref. No.	—
	rotary selector		

TELEMECANIQUE (EFA)

XB2 series
switches (complete)



1

GEV No.	345933	Ref. No.	94800893 RX94800893
description	rotary selector mounting measurements ø22mm		

rotary switches



1

GEV No.	345223	Ref. No.	94800885 RX94800885
description	rotary selector mounting measurements ø22mm black latching sequence 1-0-2		

XB4 series



1

GEV No.	347497	Ref. No.	RX94808979
description	contact block 2NC colour coding red		



1

GEV No.	347496	Ref. No.	94808987 RX94808987
description	contact block 2NO colour coding green		

signal element



1

GEV No.	347700	Ref. No.	RX94810587
description	signal element mounting measurements ø22mm green metal		



1

GEV No.	347730	Ref. No.	94814003 RX94814003
description	signal element mounting measurements ø22mm metal		



1

GEV No.	347727	Ref. No.	RX94810579
description	signal element mounting measurements ø22mm red metal		



1

GEV No.	347728	Ref. No.	RX94810561
description	signal element mounting measurements ø22mm yellow metal		



ZB2 series

push buttons



1

GEV No.	347934	Ref. No.	94801909 RX94801909
description	push button mounting measurements ø22mm black		

miscellaneous



1

GEV No.	347698	Ref. No.	94808656 RX94808656
description	push button mounting measurements ø22mm black metal		



1

GEV No.	347699	Ref. No.	94809399 RX94809399
description	rotary selector mounting measurements ø22mm black metal		

lamps



1

GEV No.	359807	Ref. No.	RX94809894
description	light bulb socket Ba9s 24V 2W ø 10mm L 28mm clear		

encoders and potentiometers



1

GEV No.	345119	Ref. No.	RX94814321
description	cam switch 2 operating positions 2NO sequence 0-1 16A shaft ø 6x4.6mm shaft L 23mm connection soldering connection operation switch cable lengthmm 10kOhm plastic with potentiometer		
accessories for	345119		
	GEV No.	301214	Ref. No. —
	cam switch 2 operating positions operation switch 16A sequence 0-1 shaft ø 6x4.6mm shaft L 33mm connection male faston 6.3mm plastic ambient temperature max. 150°C		



1

GEV No.	401338	Ref. No.	RX94814233
description	encoder		



1

GEV No.	403273	Ref. No.	94813831 RX94813831
description	encoder rotation 135° shaft ø 6mm shaft L 5mm cycle ø 26mm		



1

GEV No.	300247	Ref. No.	94050333 RX94050333
description	potentiometer 2.2KOhm rotation 270° shaft ø 6mm shaft L 16mm thread M10x0.75 plug type coded cable length 150mm		

lamps

indicator lights

indicator lights 2-piece (lens and indicator lamp)

indicator lamps for socket type SRZ / SDK / SDY / SFK



1

GEV No.	359130	Ref. No.	94801073 94809845 RX94801073 RX94809845
description	indicator lamp 230V clear connection male faston 6.3mm ø 8mm		





1

GEV No.	359132	Ref. No.	94813811 RX94813811
description	indicator lamp green 250V connection male faston 6.3mm protection IP54 ambient temperature max. 85°C		













indicator lights 3-piece (housing, lens and bulb)			
lamps			
light bulbs			
			
1			
GEV No.	359598	Ref. No.	27610302 RX27610302
description	light bulb socket Ba15d 230V 5-7W ø 16mm L 35mm		

			
1			
GEV No.	359608	Ref. No.	27610153 RX27610153
description	light bulb socket E14 10/15W 230V ø 16mm L 51mm lens L 31mm Qty 1 pcs		

			
1			
GEV No.	359597	Ref. No.	27610286 RX27610286
description	light bulb socket T10 24V 2W ø 10mm L 28mm		

			
1			
GEV No.	359807	Ref. No.	RX94809894
description	light bulb socket Ba9s 24V 2W ø 10mm L 28mm clear		

neon light bulbs				
				
1				
GEV No.	359585	Ref. No.	RX27610179	
description	neon light bulb socket E10 230V green ø 10mm L 28mm			
accessories for	359585			
	GEV No.	359060	Ref. No.	—
	lamp socket mounting measurements ø16.2mm socket E10 connection screw			
	GEV No.	359685	Ref. No.	—
	lamp socket mounting measurements ø16.2mm socket E10			

				
1				
GEV No.	359000	Ref. No.	RX94801891	
description	neon light bulb socket Ba9s 24V 3W clear ø 10mm L 24mm			
accessories for	359000			
	GEV No.	359060	Ref. No.	—
	lamp socket mounting measurements ø16.2mm socket E10 connection screw			
	GEV No.	359063	Ref. No.	—
	lamp socket mounting measurements ø19.2mm socket E14 connection screw			
	GEV No.	359064	Ref. No.	—
	lamp socket mounting measurements ø22.3mm socket E14 connection screw 250/380V ambient temperature at 1W 100°C ambient temperature at 2W 85°C			
	GEV No.	359685	Ref. No.	—
	lamp socket mounting measurements ø16.2mm socket E10			
	GEV No.	359832	Ref. No.	—
	lamp socket mounting measurements ø16.2mm socket Ba9s connection male faston 6.3mm			
	GEV No.	359853	Ref. No.	—
	lamp socket mounting measurements ø18.2mm socket Ba9s connection male faston 6.3mm			
	GEV No.	359988	Ref. No.	—
	lamp socket mounting measurements ø30.5mm 250V connection F6.3 temp.-resist. 55°C E14			

indicator lights (complete)			
ø10mm			
with screw socket			
			
1			
GEV No.	360111	Ref. No.	94808722 RX94808722
description	indicator light ø 10mm 24V red cable length 200mm socket screw base		

			
1			
GEV No.	360502	Ref. No.	94808730 RX94808730
description	indicator light ø 10mm 24V yellow cable length 200mm socket screw base		

with plug-in socket			
			
1			
GEV No.	359140	Ref. No.	94812468 RX94812468
description	indicator light ø 10mm yellow 230V connection male faston 6.3mm Qty 1 pcs		

ø12mm

with screw socket

			
1			
GEV No.	359048	Ref. No.	RX94806353
description	indicator light ø 12mm 230V yellow connection male faston 6.3mm		

			
1			
GEV No.	359291	Ref. No.	RX94806346
description	indicator light ø 12mm 400V green connection male faston 6.3mm		

			
1			
GEV No.	359893	Ref. No.	RX94005832
description	indicator light ø 12mm 400V green connection cable 200mm		

ø13mm

with plug-in socket

			
1			
GEV No.	359045	Ref. No.	94801529 RX94801529
description	indicator light ø 13mm clear 230V connection male faston 6.3mm temp.-resist. 120°C Qty 1 pcs		

			
1			
GEV No.	359141	Ref. No.	94801511 RX94801511
description	indicator light ø 13mm red 230V connection male faston 6.3mm temp.-resist. 120°C Qty 1 pcs		

			
1			
GEV No.	359143	Ref. No.	94801537 RX94801537
description	indicator light ø 13mm yellow 230V connection male faston 6.3mm temp.-resist. 120°C Qty 1 pcs		

28.5x28.5mm

lamps (complete)

			
1			
GEV No.	345978	Ref. No.	94808474 RX94808474
description	indicator light mounting measurements 28.5x28.5mm 230V green		

			
1			
GEV No.	345926	Ref. No.	94801404 RX94801404
description	indicator light housings mounting measurements 28.5x28.5mm orange connection cycle		

			
1			
GEV No.	345927	Ref. No.	94801370 RX94801370
description	indicator light housings mounting measurements 28.5x28.5mm red level		

			
1			
GEV No.	359799	Ref. No.	94801065 RX94801065
description	indicator light housings mounting measurements 28.5x28.5mm red		



			
1			
GEV No.	359798	Ref. No.	94801057 RX94801057
description	indicator light housings mounting measurements 28.5x28.5mm yellow		

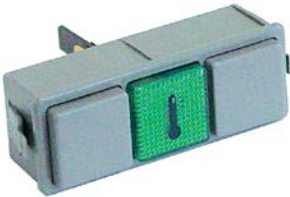

28.5x77.5mm



 <p>1</p>			
GEV No.	345873	Ref. No.	94810280 RX94810280
description	indicator light mounting measurements 28.5x77.5mm 230V green connection male faston 6.3mm protection IP40 ambient temperature max. 85°C		



30x22mm





 <p>1</p>			
GEV No.	345985	Ref. No.	94809498 RX94809498
description	indicator light mounting measurements 30x22mm 230V green		
accessories for	345985		
		GEV No.	301036 Ref. No. —
	protective cover internal size 30x22mm for rocker switch mounting measurementsmm		

screw-on/push-on fit

neon light bulbs

 <p>1</p>			
GEV No.	359585	Ref. No.	RX27610179
description	neon light bulb socket E10 230V green ø 10mm L 28mm		
accessories for	359585		
		GEV No.	359060 Ref. No. —
	lamp socket mounting measurements ø16.2mm socket E10 connection screw		
		GEV No.	359685 Ref. No. —
	lamp socket mounting measurements ø16.2mm socket E10		

 <p>1</p>			
GEV No.	359000	Ref. No.	RX94801891
description	neon light bulb socket Ba9s 24V 3W clear ø 10mm L 24mm		
accessories for	359000		
		GEV No.	359060 Ref. No. —
	lamp socket mounting measurements ø16.2mm socket E10 connection screw		
		GEV No.	359063 Ref. No. —
	lamp socket mounting measurements ø19.2mm socket E14 connection screw		

accessories for	359000		
		GEV No.	359064 Ref. No. —
	lamp socket mounting measurements ø22.3mm socket E14 connection screw 250/380V ambient temperature at 1W 100°C ambient temperature at 2W 85°C		
		GEV No.	359685 Ref. No. —
	lamp socket mounting measurements ø16.2mm socket E10		
		GEV No.	359832 Ref. No. —
	lamp socket mounting measurements ø16.2mm socket Ba9s connection male faston 6.3mm		
		GEV No.	359853 Ref. No. —
	lamp socket mounting measurements ø18.2mm socket Ba9s connection male faston 6.3mm		
		GEV No.	359988 Ref. No. —
	lamp socket mounting measurements ø30.5mm 250V connection F6.3 temp.-resist. 55°C E14		

light bulbs

for ovens

 <p>1</p>			
GEV No.	359610	Ref. No.	RX27610120
description	light bulb t.max. 300°C socket E14 15W 230V ø 22mm L 47mm lens L 20mm for oven lamp type Philips		

for indicator lights

 <p>1</p>			
GEV No.	359598	Ref. No.	27610302 RX27610302
description	light bulb socket Ba15d 230V 5-7W ø 16mm L 35mm		

 <p>1</p>			
GEV No.	359608	Ref. No.	27610153 RX27610153
description	light bulb socket E14 10/15W 230V ø 16mm L 51mm lens L 31mm Qty 1 pcs		

 <p>1</p>			
GEV No.	359597	Ref. No.	27610286 RX27610286
description	light bulb socket T10 24V 2W ø 10mm L 28mm		



GEV No.	359807	Ref. No.	RX94809894
description	light bulb socket Ba9s 24V 2W ø 10mm L 28mm clear		

oven lamps

universal oven lamps

mounting diameter 35.5mm

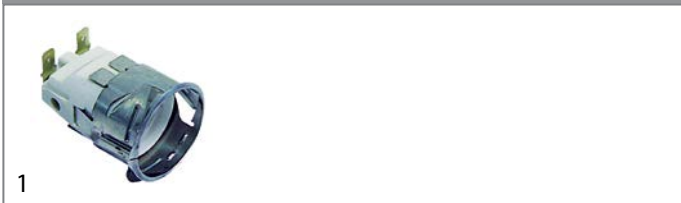

GEV No.	359701	Ref. No.	27610104 RX27610104
description	lamp socket socket E14 220-230V mounting ø 35.5mm connection male faston 6.3mm 15W		

accessories for 359701

	GEV No.	359705	Ref. No.	—
oven lamp glass thr.ø 33.5mm ø 52mm hard glas temp.-resist. 350°C				

	GEV No.	359709	Ref. No.	RX27610112
oven lamp glass thr.ø 33.5mm ø 42mm hard glas temp.-resist. 350°C				

	GEV No.	359721	Ref. No.	RX24390700
gasket silicone ED ø 48mm ID ø 39.5mm thickness 5mm Qty 1 pcs				

	GEV No.	359942	Ref. No.	—
oven lamp glass thr.ø 33.5mm ø 41mm hard glas temp.-resist. 350°C				



GEV No.	359709	Ref. No.	RX27610112
description	oven lamp glass thr.ø 33.5mm ø 42mm hard glas temp.-resist. 350°C		



GEV No.	359721	Ref. No.	RX24390700
description	gasket silicone ED ø 48mm ID ø 39.5mm thickness 5mm Qty 1 pcs		

55x70mm



GEV No.	359375	Ref. No.	94814234 RX94814234
description	lamp socket complete without lamp socket E14 mounting measurements 55x70mm		

lamps

light bulbs



GEV No.	359610	Ref. No.	RX27610120
description	light bulb t.max. 300°C socket E14 15W 230V ø 22mm L 47mm lens L 20mm for oven lamp type Philips		

timers

programme timers



GEV No.	360273	Ref. No.	94807630 RX94807630
description	timer CDC 11803 engines 1 chambers 3 operation time 18min 230V shaft ømm shaft Lmm manif. no. 11803F1 / 16064/A motor type M48R ATS		

spare parts for 360273

	GEV No.	360118	Ref. No.	—
motor CDC pinion ø 4.9mm teeth 10 230V voltage AC 50/60Hz turn direction right motor ø 47mm H 19.3mm motor type M48R ATS for timer cable length 260mm 1.9/2.5W				



GEV No.	360310	Ref. No.	94801578 RX94801578
description	timer CDC 4804M engines 1 chambers 4 operation time 120s 230V shaft ømm shaft Lmm manif. no. 4804M1 / 29828 motor type M48R ATS		

spare parts for 360310

	GEV No.	360118	Ref. No.	—
motor CDC pinion ø 4.9mm teeth 10 230V voltage AC 50/60Hz turn direction right motor ø 47mm H 19.3mm motor type M48R ATS for timer cable length 260mm 1.9/2.5W				





1

GEV No.	360389	Ref. No.	94813971 RX94813971
description	timer CDC 4904F engines 1 chambers 4 operation time 5min 230V shaft ømm shaft Lmm manuf. no. 4904F3 / 10300122 motor type M48L ATS		
spare parts for	360389		
	GEV No.	360083	Ref. No. —
	motor CDC pinion ø 4.9mm teeth 10 230V turn direction left motor ø 47mm H 19.3mm motor type M48L ATS for timer		





1

GEV No.	360308	Ref. No.	94802634 RX94802634
description	timer CDC 7803 engines 1 chambers 3 operation time 18min 230V shaft ømm shaft Lmm manuf. no. 7803F1 / 26880 motor type M37RN		
spare parts for	360308		
	GEV No.	360119	Ref. No. —
	motor CDC pinion ø 5.4mm teeth 12 230V turn direction right motor ø 37mm motor type M37RN for timer		





1

GEV No.	360133	Ref. No.	94803921 RX94803921
description	timer CDC 7804DV engines 2 chambers 4 operation time 60s / 20min 230V shaft ømm shaft Lmm manuf. no. 7804DV / 360133 motor type M37RN/M37LN		
spare parts for	360133		
	GEV No.	360119	Ref. No. —
	motor CDC pinion ø 5.4mm teeth 12 230V turn direction right motor ø 37mm motor type M37RN for timer		
	GEV No.	360131	Ref. No. —
	motor CDC pinion ø 5.4mm teeth 12 230V turn direction left motor ø 37mm motor type M37LN for timer		



1

GEV No.	360293	Ref. No.	94810896 RX94810896
description	timer CDC 7804DV engines 2 chambers 4 operation time 6s / 3min 230V shaft ømm shaft Lmm manuf. no. 7804DV / 30001027 motor type M37RN/M37LN		
spare parts for	360293		
	GEV No.	360119	Ref. No. —
	motor CDC pinion ø 5.4mm teeth 12 230V turn direction right motor ø 37mm motor type M37RN for timer		
	GEV No.	360131	Ref. No. —
	motor CDC pinion ø 5.4mm teeth 12 230V turn direction left motor ø 37mm motor type M37LN for timer		





1

GEV No.	360077	Ref. No.	94807620 RX94807620
description	timer CROUZET engines 1 chambers 2 operation time 120s 230V shaft ømm shaft Lmm manuf. no. 627/5261 motor type 82340		



1

GEV No.	360435	Ref. No.	RX94807112
description	timer FIBER P25 engines 1 chambers 4 operation time 6min 230V 50Hz shaft ømm shaft Lmm motor type M51BJ0L6400		
spare parts for	360435		
	GEV No.	360674	Ref. No. —
	motor kit pinion ø 6.8mm teeth 15 230V voltage AC 50/60Hz turn direction counterclockwise motor ø 48mm H 18.5mm motor type UDS40NE1RNZ165 cable length 150mm with holder		



1

GEV No.	360086	Ref. No.	94813748 RX94813748
description	timer FIBER P26 engines 1 chambers 4 operation time 120s 230V shaft ø6mm shaft Lmm manif. no. P265J04H315 motor type M61B40R6400		



1

GEV No.	360036	Ref. No.	94801412 RX94801412
description	timer FIBER P39 engines 1 chambers 3 operation time 120s 230V shaft ø 6x4.6mm shaft L 16mm manif. no. P395J03H301 motor type M51BJ0L6400		
spare parts for	360036		
	GEV No.	360674	Ref. No. —
motor kit pinion ø 6.8mm teeth 15 230V voltage AC 50/60Hz turn direction counterclockwise motor ø 48mm H 18.5mm motor type UDS40NE1RNZ165 cable length 150mm with holder			

electric timers



1

GEV No.	350001	Ref. No.	27298066 RX27298066
description	timer 2CO at 250V 16A permanent position yes impulse electric shaft ø 6x4.6mm shaft L 22mm mounting distance 28mm connection rear 2-pole operation time 120min		

with time spread



1

GEV No.	350074	Ref. No.	RX27298215
description	timer MS65 operation time 120min time spread 30min 1CO/2NO/1NC at 250V 16A permanent position yes impulse electric shaft ø 6x4.6mm shaft L 22mm mounting distance 28mm connection lateral Invensys 4-pole shaft position lower°		

mechanical timers



1

GEV No.	350095	Ref. No.	RX94027836
description	timer C53 4-pole operation time 120min impulse mechanical 2NO/2NC at 250V 16A permanent position no shaft ø6mm shaftmm shaft L 24mm mounting distance 28mm connection lateral front measurements 72x72mm		



1

GEV No.	350093	Ref. No.	RX94027869
description	timer C53 4-pole operation time 30min impulse mechanical 2NO/2NC at 250V 16A permanent position no shaft ø6mm shaftmm shaft L 24mm mounting distance 28mm connection lateral front measurements 72x72mm		

alarm devices

buzzers



1

GEV No.	350050	Ref. No.	94027794 RX94027794
description	buzzer 230VAC connection male faston 6.3mm screw mounting thread M4 60dB		



contactors

GENERAL ELECTRIC (AEG)

power contactors

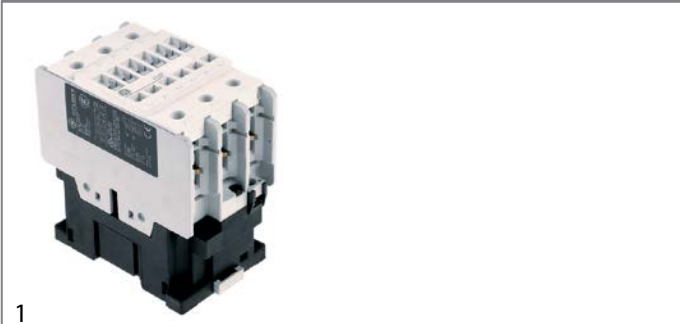

1

GEV No.	380267	Ref. No.	27400308 RX27400308
description	power contactor resistive load 110A 230VAC (AC3/400V) 65A/30kW main contacts 3NO auxiliary contacts connection screw connection type AEG LS30K 00A type GE CL07A 300		
accessories for	380267		
	GEV No.	380268	Ref. No. —
	auxiliary contact contacts 1NO for contactors CL+LS_K connection screw AC-12 10A type AEG HS07K 10 type GE BCLF 10		
	GEV No.	380269	Ref. No. —
	auxiliary contact contacts 1NC AC15 6A for contactors CL+LS_K connection screw AC-12 10A type AEG HS07K 01 type GE BCLF 01		
	GEV No.	380270	Ref. No. —
	auxiliary contact contacts 1NO/1NC for contactors CL+LS_K connection screw AC-12 10A type AEG HS08K 11 type GE BCLL 11		
	GEV No.	380271	Ref. No. —
	auxiliary contact contacts 2NO for contactors CL+LS_K connection screw AC-12 10A type AEG HS08K 20 type GE BCLL 20		



1

GEV No.	380239	Ref. No.	94804408 94813830 RX94804408 RX94813830
description	power contactor resistive load 20A 230VAC (AC3/400V) 8.4A/4kW main contacts 3NO auxiliary contacts 1NC connection screw connection type LS05 01A type AEG LS05 01A type GE MC1A 301A		

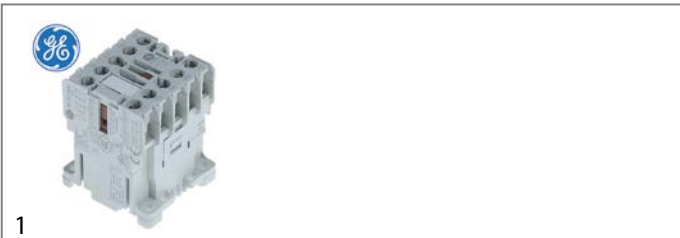

1

GEV No.	380238	Ref. No.	94814048 RX94814048
description	power contactor resistive load 20A 230VAC (AC3/400V) 8.4A/4kW main contacts 3NO auxiliary contacts 1NO connection screw connection type LS0510A type AEG LS0510A type GE MC1A 310A		



1

GEV No.	380839	Ref. No.	94808698 RX94808698
description	power contactor resistive load 20A 24VAC (AC3/400V) 9A/4kW main contacts 3NO auxiliary contacts 1NO connection screw connection type LS0510A type AEG LS0510A type GE MC1A 310A		



1

GEV No.	380244	Ref. No.	27400324 RX27400324
description	power contactor resistive load 25A 230VAC (AC3/400V) 9A/4kW main contacts 3NO auxiliary contacts 1NO connection screw connection type AEG LS4K 10A type GE CL00A 310		



1

GEV No.	381136	Ref. No.	94808920 RX94808920
description	power contactor resistive load 25A 24VAC (AC3/400V) 12A/5.5kW main contacts 3NO auxiliary contacts 1NO connection screw connection type AEG type GE CL01A310T1		



1

GEV No.	380671	Ref. No.	94808938 RX94808938
description	power contactor resistive load 45A 24VAC (AC3/400V) 25A/11kW main contacts 3NO auxiliary contacts connection screw connection type AEG LS11K 00A type GE CL25A300T1		





1

GEV No.	380265	Ref. No.	27400282 RX27400282
description	power contactor resistive load 60A 230VAC (AC3/400V) 32A/16kW main contacts 3NO auxiliary contacts 1NO connection screw connection type AEG LS15K 00A type GE CL04A 310 H 98mm L 87mm W 55mm		



1

GEV No.	380939	Ref. No.	94814091 RX94814091
description	motor protection circuit breaker type GPS1BSAJ setting range 4-6.3A DIN rail connection screw		



1

GEV No.	380266	Ref. No.	27400290 RX27400290
description	power contactor resistive load 90A 230VAC (AC3/400V) 22kW main contacts 3NO connection screw type AEG LS22K 00A type GE CL06A 300		

LOVATO

power contactors



1

GEV No.	380964	Ref. No.	94807062 RX94807062
description	power contactor resistive load 20A 230VAC (AC3/400V) 9A/4kW main contacts 4NO auxiliary contacts connection screw connection type 11BG09T4A230		

motor protection circuit breakers



1

GEV No.	380940	Ref. No.	94810902 RX94810902
description	motor protection circuit breaker type GPS1BSAH setting range 2.5-4A DIN rail contacts screw clamp		

TELEMECANIQUE (Schneider Electric)

power contactors



1

GEV No.	380979	Ref. No.	RX94019155
description	power contactor resistive load 40A 230VAC (AC3/400V) 25A/11kW main contacts 3NO auxiliary contacts 1NO/1NC connection screw connection type LC1D25P7		



relays

power relays

with DIN rail mounting

upper



1

GEV No.	380180	Ref. No.	RX94814289
description	power relays FINDER 230VAC 16A 3CO connection male faston 6.3mm DIN rail manuf. no. 62.83.8.230.4007		

with bracket mounting



1

GEV No.	380312	Ref. No.	94804291 RX94804291
description	power relays FINDER 230VAC 10A 3CO connection male faston 4.8mm bracket mounting dimensions 52x32.2x36.5mm manuf. no. 60.63.8.230.0000		

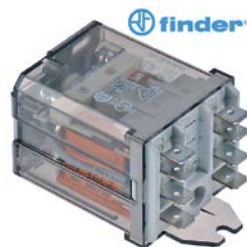

1

GEV No.	380139	Ref. No.	94807054 94813866 RX94807054 RX94813866
description	power relays FINDER 230VAC 16A 2CO connection F6.3 bracket mounting dimensions 68x38.2x35.8mm manuf. no. 62.82.8.230.0000		



1

GEV No.	380311	Ref. No.	94804853 RX94804853
description	power relays Italiana Relè 230VAC 20A 1NC/1NO connection F6.3 bracket mounting manuf. no. A1B-230AC-FA		

plug-in/print relays



1

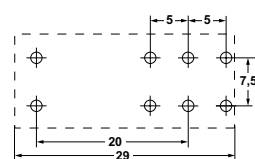

GEV No.	381151	Ref. No.	94807070 RX94807070
description	print relay 24VAC 2CO 2-pole at 250V 8A connection pins raster size 5mm FINDER manuf. no. 40.52.8.024.0000 95.65/95.75		

relay sockets



1

GEV No.	380137	Ref. No.	94800943 RX94800943	
description	relay socket 8-pole connection plug-in connection round 8-pole dimensions 65x28x40mm 380V voltage AC 10A Italiana Relè manuf. no. ZVE8			
accessories for	380137			
	GEV No.	380805	Ref. No.	—
	support bracket			



level relays

GICAR



GEV No.	400048	Ref. No.	94801545 RX94801545
description	level relay 1CO 230V voltage AC connection plug-in connection round 8-pole type 27434		

time relays

time relays



GEV No.	360465	Ref. No.	RX94802766
description	time relay FIBER T45 time range 0s-120h 230VAC 5/2A mounting measurements 45x45mm 2CO		
accessories for	360465		
	GEV No.	360485	Ref. No. —
	mounting frame L 72mm W 72mm for time relay for model E47,E48,E58,E59,T45,C58,C59		



GEV No.	380319	Ref. No.	27470236 RX27470236
description	time relay pickup-delayed 0.06-150s		

electronic controllers

DIXELL

refrigeration controllers

built-in version



GEV No.	378249	Ref. No.	RX94807021
description	electronic controller DIXELL XR20C-1P3C0 mounting measurements 71x29mm 24V voltage AC/DC NTC/PTC relay outputs 1 CO-8A(3) NTC/PTC DI protection IP54 -50 up to +150°C display 3½ digits		

electronic thermometers

built-in version



GEV No.	378046	Ref. No.	94810546 RX94810546
description	thermometer DIXELL XT11S mounting measurements 58x25.5mm 24V voltage AC/DC NTC 0 up to +60°C display 2½ digit 1 Templn1 NTC DigiIn1 defr. funct. front measurements 31x64mm		

EVCO - EVERY CONTROL

universal controllers

built-in version



GEV No.	379029	Ref. No.	94806361 RX94806361
description	electronic controller EVERY CONTROL 230V voltage AC fryer type EC8		



miscellaneous

universal controllers

			
1			
GEV No.	379020	Ref. No.	24848236 RX24848236
description	electronic controller Pt100 steam control		

probes

universal probes

temperature probes

			
1			
GEV No.	379161	Ref. No.	94810538 RX94810538
description	temperature probe NTC 10kOhm cable thermoplastic probe -40 up to +110°C cable -40 up to +110°C probe ø6x14mm cable length 3m without screw connection 2-wire		

			
1			
GEV No.	379130 ¹	Ref. No.	94814231 RX94814231
description	temperature probe Pt100 cable Vetrotex probe -200 up to +600°C cable -50 up to +350°C probe ø6x100mm cable length 1.4m without screw connection 3-wire resistance at 0°C 1000Ohm		

¹3-wire

			
1			
GEV No.	379199	Ref. No.	RX94807179
description	temperature probe PTC 1kOhm cable PVC probe -50 up to +150°C cable -10 up to 100°C probe ø6x30mm cable length 5m without screw connection 2-wire		

			
1			
GEV No.	379831	Ref. No.	94050341 RX94050341
description	temperature probe thermocouple J (Fe-CuNi) cable Vetrotex probe -50 up to +750°C cable -50 up to +350°C probe ø4x100mm cable length 1m cable colours black/white 2-wire		

producer-specific probes

probes

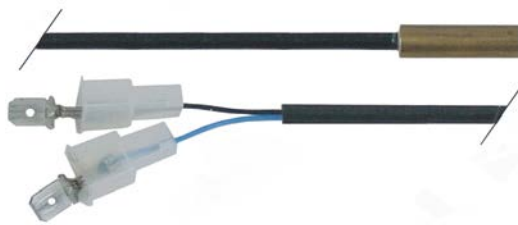
			
1			
GEV No.	379908	Ref. No.	RX94813768
description	temperature probe NTC		

			
1			
GEV No.	378314	Ref. No.	94814005 RX94814005
description	temperature probe NTC 10kOhm cable silicone probe -40 up to +110°C cable -50 up to +180°C connection coded plug thread probe ø5x30mm cable length 0.35m		

			
1			
GEV No.	378268	Ref. No.	94808763 RX94808763
description	temperature probe NTC cable silicone probe -40 up to +110°C cable -50 up to +180°C connection coded plug thread probe ø6x15mm cable length 1.1m		

			
1			
GEV No.	379075	Ref. No.	24849093 RX24849093
description	temperature probe Pt100 cable silicone probe -100 up to 450°C cable -50 up to +180°C connection 2-wire thread M6 probe ø4x100mm cable length 1.5m		

			
1			
GEV No.	379070	Ref. No.	24849036 RX24849036
description	temperature probe Pt100 cable silicone probe -50 up to +250°C cable -50 up to +180°C connection 2-wire thread probe ø4x75mm cable length 1.7m		

			
1			
GEV No.	378413	Ref. No.	RX94046186
description	temperature probe thermocouple J (Fe-CuNi) cable Vetrotex probe -50 up to +750°C cable -50 up to +350°C connection 2-wire thread probe ø3x280mm cable length 3.5m		



core probes			
1 			
GEV No.	381425	Ref. No.	24849135 24849168 RX24849135 RX24849168
description	core temperature probe Pt100 cable PTFE probe -40 up to +250°C cable -40 up to +250°C connection 2-wire probe ø3.2x100mm thread M12 cable length 2.8m handle ø 10mm handle length 80mm		

electronics

PCBs

1 			
GEV No.	400107	Ref. No.	27450238 RX27450238
description	control PCB combi-steamer CM101 edition CM v. 4.91-97		

1 			
GEV No.	404019	Ref. No.	RX94035037 RX94070732
description	control PCB fryer 230V 50Hz heating		

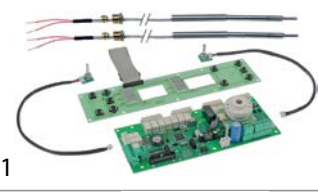
1 			
GEV No.	401661	Ref. No.	94814232 94814236 RX94814232 RX94814236
description	keypad PCB combi-steamer MVE04 kit		

1 			
GEV No.	403231	Ref. No.	RX94814055
description	keypad PCB dishwasher 80E/81E L 155mm W 100mm with display H 25mm buttons 6		

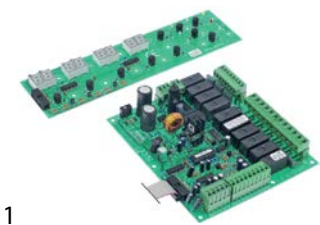
1 			
GEV No.	403221	Ref. No.	94813997 RX94813997
description	main PCB dishwasher AX 250/300/310/320/330 L 168mm W 148mm for display PCB Qty 1 pcs		

1 			
GEV No.	400110	Ref. No.	27450220 RX27450220
description	PCB combi-steamer level control		

1 			
GEV No.	403130	Ref. No.	9402358 94023587 RX94023587
description	PCB combi-steamer TVTS L 90mm W 70mm level control		



1

GEV No.	402881	Ref. No.	94813861 RX94813861
description	PCB dishwasher CE-GE L 126mm W 63mm suitable for COMENDA		



1

GEV No.	402677	Ref. No.	RX94814079
description	PCB dishwasher DS40/DS50 L 161mm W 90mm		



1

GEV No.	402676	Ref. No.	RX94814039
description	PCB dishwasher HT11/12 L 102mm W 62mm timer		



1

GEV No.	402695	Ref. No.	94813816 RX94813816
description	PCB dishwasher L 145mm W 105mm HOONVED		



1

GEV No.	698492	Ref. No.	873513894 RX94019130
description	PCB level regulator combi-steamer suitable for ROSINOX level control		

central units



1

GEV No.	402683	Ref. No.	RX94807104
description	control box timer operation time 3/6/9min		



1

GEV No.	402681	Ref. No.	94814285 RX94814285
description	control box timer run-time 50/120/180s		



1

GEV No.	402684	Ref. No.	RX94814040
description	control box without EPROM		



1

GEV No.	379026	Ref. No.	RX94814050
description	electronic timer for dishwasher		



keypads

front foils



GEV No.	694697	Ref. No.	RX94044752
description	front foil combi-steamer TVTS suitable for ROSINOX L 600mm W 118mm		



GEV No.	402685	Ref. No.	94814049 RX94814049
description	keypad foil dishwasher H63/373E/144E L 134mm W 79mm buttons 6		



GEV No.	505300	Ref. No.	94034345 RX94034345
description	keypad foil fryer blue L 148mm W 91mm buttons 4		

keypad units



GEV No.	402913	Ref. No.	94814041 RX94814041
description	keypad unit dishwasher 37E/80E/81E/18ER/19E buttons 6 suitable for Dihr L 145mm W 90mm with cable		

solenoid valves

solenoid valves (water)

ELBI

1

GEV No.	373020	Ref. No.	94809795 RX94809795
description	solenoid valve double angled 230VAC inlet 3/4" outlet 14mm input 10l/min DN10 t.max. 90°C duty cycle 100% ELBI flow regulating valve inlet white		

MÜLLER

medium temperature: 90°C
duty cycle: 100%

with cable connection

1

GEV No.	370006	Ref. No.	RX24720054	
description	solenoid valve triple straight 230VAC inlet 3/4" outlet 12.5mm DN10 t.max. 90°C duty cycle 100% MÜLLER cable length 2000mm			
spare parts for	370006			
	GEV No.	370132	Ref. No.	—
	solenoid valve body triple straight inlet 3/4" outlet 11.5mm DN10 t.max. 90°C duty cycle 100% MÜLLER 230V			
	GEV No.	371002	Ref. No.	—
	solenoid valve holder MÜLLER flange support			
	GEV No.	371009	Ref. No.	—
	compression spring for solenoid coil			
	GEV No.	371010	Ref. No.	—
	solenoid coil 230VAC connection with cable cable length 2000mm			
	GEV No.	371011	Ref. No.	—
	spare parts kit membrane with long star star hight 8mm MÜLLER			
	GEV No.	371122	Ref. No.	—
	solenoid valve filter ø 19mm H 10mm suitable for MÜLLER			
	GEV No.	501161	Ref. No.	—
	tap head for solenoid valve holder for solenoid coils			
accessories for	370006			
	GEV No.	371017	Ref. No.	—
	solenoid coil MÜLLER 230VAC connection male faston 6.3mm			
	GEV No.	371037	Ref. No.	—
	solenoid coil 24VAC 50/60Hz connection male faston 6.3mm			

Table continues overleaf



accessories for	370006		
	GEV No.	371038	Ref. No. —
	solenoid coil 230VAC connection appliance plug		

ROBERTSHAW/INVENSYS







medium temperature: 90°C 90°C 60°C
 ambient temperature: 60°C 25°C 60°C
 duty cycle: 40% 100% 100%

	1		
GEV No.	370371	Ref. No.	RX24720054
description	solenoid valve double straight 230VAC inlet 3/4" outlet 11.5mm DN10 EATON (INVENSYS) cable length 2000mm		

RPE

	1		
GEV No.	374060	Ref. No.	RX94813972
description	solenoid valve single angled 24V inlet 3/4" outlet 13mm DN10 duty cycle 100% RPE polyamide		

TP

	1		
GEV No.	370021	Ref. No.	RX94807480
description	solenoid valve double straight 230VAC inlet 3/4" outlet 11.5mm DN10 TP flow regulating valve inlet white		
spare parts for	370021		
	GEV No.	371013	Ref. No. —
	solenoid coil TP 230VAC 50/60Hz		
accessories for	370021		
	GEV No.	371220	Ref. No. —
	reducer TP flow rate 3l/min red tolerance ±15%		
	GEV No.	371221	Ref. No. —
	reducer TP flow rate 5.5l/min yellow tolerance ±15%		
	GEV No.	371222	Ref. No. —
	reducer TP flow rate 6l/min grey tolerance ±15%		
	GEV No.	371223	Ref. No. —
	reducer TP flow rate 10l/min white tolerance ±15%		
	GEV No.	371224	Ref. No. —
	reducer TP flow rate 12l/min bronze tolerance ±15%		

accessories for	370021		
	GEV No.	371225	Ref. No. —
	reducer TP flow rate 16l/min light brown tolerance ±15%		
	GEV No.	371226	Ref. No. —
	reducer TP flow rate 20l/min red tolerance ±15%		
	GEV No.	371230	Ref. No. —
	reducer TP flow rate 0.25l/min red tolerance ±25%		
	GEV No.	371231	Ref. No. —
	reducer TP flow rate 0.35l/min violet tolerance ±25%		
	GEV No.	371232	Ref. No. —
	reducer TP flow rate 0.5l/min orange tolerance ±25%		
	GEV No.	371233	Ref. No. —
	reducer TP flow rate 0.8l/min white tolerance ±25%		
	GEV No.	371234	Ref. No. —
	reducer TP flow rate 1l/min light blue tolerance ±25%		
	GEV No.	371235	Ref. No. —
	reducer TP flow rate 1.2l/min brown tolerance ±25%		
	GEV No.	371236	Ref. No. —
	reducer TP flow rate 1.5l/min light brown tolerance ±25%		
	GEV No.	371237	Ref. No. —
	reducer TP flow rate 2.5l/min yellow tolerance ±25%		
	GEV No.	371238	Ref. No. 94810058 RX94810058
	reducer TP flow rate 3.4l/min dark green tolerance ±25%		
	GEV No.	371239	Ref. No. —
	reducer TP flow rate 5l/min black tolerance ±25%		
	GEV No.	371240	Ref. No. —
	reducer TP flow rate 8l/min blue tolerance ±20%		





















	1		
GEV No.	370017	Ref. No.	94805520 RX94805520
description	solenoid valve single straight 230VAC inlet 3/4" outlet 11.5mm DN10 TP p max 10bar		
spare parts for	370017		
	GEV No.	371013	Ref. No. —
	solenoid coil TP 230VAC 50/60Hz		
accessories for	370017		
	GEV No.	371220	Ref. No. —
	reducer TP flow rate 3l/min red tolerance ±15%		

Table continues overleaf

accessories for		370017	
	GEV No.	371221	Ref. No. —
reducer TP flow rate 5.5l/min yellow tolerance ±15%			
	GEV No.	371222	Ref. No. —
reducer TP flow rate 6l/min grey tolerance ±15%			
	GEV No.	371223	Ref. No. —
reducer TP flow rate 10l/min white tolerance ±15%			
	GEV No.	371224	Ref. No. —
reducer TP flow rate 12l/min bronze tolerance ±15%			
	GEV No.	371225	Ref. No. —
reducer TP flow rate 16l/min light brown tolerance ±15%			
	GEV No.	371226	Ref. No. —
reducer TP flow rate 20l/min red tolerance ±15%			
	GEV No.	371230	Ref. No. —
reducer TP flow rate 0.25l/min red tolerance ±25%			
	GEV No.	371231	Ref. No. —
reducer TP flow rate 0.35l/min violet tolerance ±25%			
	GEV No.	371232	Ref. No. —
reducer TP flow rate 0.5l/min orange tolerance ±25%			
	GEV No.	371233	Ref. No. —
reducer TP flow rate 0.8l/min white tolerance ±25%			
	GEV No.	371234	Ref. No. —
reducer TP flow rate 1l/min light blue tolerance ±25%			
	GEV No.	371235	Ref. No. —
reducer TP flow rate 1.2l/min brown tolerance ±25%			
	GEV No.	371236	Ref. No. —
reducer TP flow rate 1.5l/min light brown tolerance ±25%			
	GEV No.	371237	Ref. No. —
reducer TP flow rate 2.5l/min yellow tolerance ±25%			
	GEV No.	371238	Ref. No. 94810058 RX94810058
reducer TP flow rate 3.4l/min dark green tolerance ±25%			
	GEV No.	371239	Ref. No. —
reducer TP flow rate 5l/min black tolerance ±25%			
	GEV No.	371240	Ref. No. —
reducer TP flow rate 8l/min blue tolerance ±20%			









































  1			
GEV No.	370018	Ref. No.	94809282 RX94809282
description	solenoid valve single straight 230VAC inlet 3/4" outlet 14mm DN10 TP		
spare parts for	370018		
	GEV No.	371013	Ref. No. —
solenoid coil TP 230VAC 50/60Hz			
accessories for	370018		
	GEV No.	371220	Ref. No. —
reducer TP flow rate 3l/min red tolerance ±15%			
	GEV No.	371221	Ref. No. —
reducer TP flow rate 5.5l/min yellow tolerance ±15%			
	GEV No.	371222	Ref. No. —
reducer TP flow rate 6l/min grey tolerance ±15%			
	GEV No.	371223	Ref. No. —
reducer TP flow rate 10l/min white tolerance ±15%			
	GEV No.	371224	Ref. No. —
reducer TP flow rate 12l/min bronze tolerance ±15%			
	GEV No.	371225	Ref. No. —
reducer TP flow rate 16l/min light brown tolerance ±15%			
	GEV No.	371226	Ref. No. —
reducer TP flow rate 20l/min red tolerance ±15%			
	GEV No.	371230	Ref. No. —
reducer TP flow rate 0.25l/min red tolerance ±25%			
	GEV No.	371231	Ref. No. —
reducer TP flow rate 0.35l/min violet tolerance ±25%			
	GEV No.	371232	Ref. No. —
reducer TP flow rate 0.5l/min orange tolerance ±25%			
	GEV No.	371233	Ref. No. —
reducer TP flow rate 0.8l/min white tolerance ±25%			
	GEV No.	371234	Ref. No. —
reducer TP flow rate 1l/min light blue tolerance ±25%			
	GEV No.	371235	Ref. No. —
reducer TP flow rate 1.2l/min brown tolerance ±25%			
	GEV No.	371236	Ref. No. —
reducer TP flow rate 1.5l/min light brown tolerance ±25%			

Table continues overleaf



accessories for		370018		
	GEV No.	371237	Ref. No.	—
reducer TP flow rate 2.5l/min yellow tolerance ±25%				
	GEV No.	371238	Ref. No.	94810058 RX94810058
reducer TP flow rate 3.4l/min dark green tolerance ±25%				
	GEV No.	371239	Ref. No.	—
reducer TP flow rate 5l/min black tolerance ±25%				
	GEV No.	371240	Ref. No.	—
reducer TP flow rate 8l/min blue tolerance ±20%				

  1				
GEV No.	370015	Ref. No.	94805520 RX94805520	
description	solenoid valve single angled 230VAC inlet 3/4" outlet 11.5mm DN10 TP			
accessories for		370015		
	GEV No.	371220	Ref. No.	—
reducer TP flow rate 3l/min red tolerance ±15%				
	GEV No.	371221	Ref. No.	—
reducer TP flow rate 5.5l/min yellow tolerance ±15%				
	GEV No.	371222	Ref. No.	—
reducer TP flow rate 6l/min grey tolerance ±15%				
	GEV No.	371223	Ref. No.	—
reducer TP flow rate 10l/min white tolerance ±15%				
	GEV No.	371224	Ref. No.	—
reducer TP flow rate 12l/min bronze tolerance ±15%				
	GEV No.	371225	Ref. No.	—
reducer TP flow rate 16l/min light brown tolerance ±15%				
	GEV No.	371226	Ref. No.	—
reducer TP flow rate 20l/min red tolerance ±15%				
	GEV No.	371230	Ref. No.	—
reducer TP flow rate 0.25l/min red tolerance ±25%				
	GEV No.	371231	Ref. No.	—
reducer TP flow rate 0.35l/min violet tolerance ±25%				
	GEV No.	371232	Ref. No.	—
reducer TP flow rate 0.5l/min orange tolerance ±25%				
	GEV No.	371233	Ref. No.	—
reducer TP flow rate 0.8l/min white tolerance ±25%				
	GEV No.	371234	Ref. No.	—
reducer TP flow rate 1l/min light blue tolerance ±25%				

accessories for		370015		
	GEV No.	371235	Ref. No.	—
reducer TP flow rate 1.2l/min brown tolerance ±25%				
	GEV No.	371236	Ref. No.	—
reducer TP flow rate 1.5l/min light brown tolerance ±25%				
	GEV No.	371237	Ref. No.	—
reducer TP flow rate 2.5l/min yellow tolerance ±25%				
	GEV No.	371238	Ref. No.	94810058 RX94810058
reducer TP flow rate 3.4l/min dark green tolerance ±25%				
	GEV No.	371239	Ref. No.	—
reducer TP flow rate 5l/min black tolerance ±25%				
	GEV No.	371240	Ref. No.	—
reducer TP flow rate 8l/min blue tolerance ±20%				

solenoid valves with reducers

 1				
GEV No.	370628	Ref. No.	94050168 RX94050168	
description	solenoid valve double straight 230VAC inlet 3/4" input 16l/min DN10 TP plastic outlet 11.5mm			

spare parts and accessories

reducers

outlet side

 1				
GEV No.	371238	Ref. No.	94810058 RX94810058	
description	reducer TP flow rate 3.4l/min dark green tolerance ±25%			



metal

ASCO

solenoid valves steam (water)

2-way



1

GEV No.	370728	Ref. No.	94804036 RX94804036
description	solenoid valve 2-ways 24VAC inlet 1/2" IT outlet 1/2" IT connection 1/2" L 62mm DN 12mm t.max. 85°C slide-on receptacle DIN -10 up to +90°C Asco type series E238C coil type 43005421 membranes NBR p max 10bar p min 0.3bar 50/60Hz brass		

LUCIFER

spare parts and accessories

solenoid coils



1

GEV No.	371258	Ref. No.	RX27440049
description	solenoid coil 220VAC 14VA coil type EZ92A7		

PARKER

3-way

121 KS8358 series



1

GEV No.	370709	Ref. No.	94052347 RX94052347
description	solenoid valve brass 3-ways 230V voltage AC connection 1/4" IT L 77mm coil type 4818653D		



SIRAI

2-way

L180-B series



1

GEV No.	370329	Ref. No.	94807864 RX94807864	
description	solenoid valve 2-ways 24VAC inlet 1/2" outlet 1/2" connection 1/2" L 66mm DN 13.5mm slide-on receptacle compact -10 up to +90°C SIRAI type series L180-B coil type Z610A membranes NBR (water) p max 12bar p min 0.35bar			
spare parts for	370329			
	GEV No.	371070	Ref. No.	—
	solenoid coil 24VAC 10VA SIRAI coil type Z610A seat ø 10mm			
	GEV No.	371171	Ref. No.	—
	membrane series L180-B membrane type NBR (water)			
accessories for	370329			
	GEV No.	371091	Ref. No.	—
	power socket plug type DIN 43650B cable lengthmm small			

solenoid valves (various)



1

GEV No.	370832	Ref. No.	9401620 94016201 RX9401620 RX94016201
description	solenoid valve 2-ways 230VAC inlet 1/4" IT outlet 1/4" IT L 43mm p max 7bar		

pressure switches

for warewashing

ø 58mm with male faston 6.3mm

with connection horizontal



1

GEV No.	541105	Ref. No.	94803426 RX94803426
description	pressure control pressure range 180/70mbar connection 6mm ø 58mm pressure connection horizontal warewashing		

1

GEV No.	541619	Ref. No.	RX94807187
description	pressure control pressure range 250/40mbar connection 6mm ø 58mm pressure connection ø 6mm		



1

GEV No.	541311	Ref. No.	94807369 RX94807369
description	pressure control pressure range 76/38mbar connection 6mm ø 58mm pressure connection horizontal warewashing pressure connection ø 6mm		



1

GEV No.	541045	Ref. No.	94801289 RX94801289
description	pressure control pressure range 28/12mbar connection 6mm ø 58mm pressure connection horizontal warewashing		



1

GEV No.	541312	Ref. No.	RX94810911
description	pressure control pressure range 86/59mbar connection 6mm ø 58mm pressure connection horizontal warewashing pressure connection ø 6mm		



1

GEV No.	541140	Ref. No.	94807500 RX94807500
description	pressure control pressure range 55/30mbar connection 6mm ø 58mm pressure connection horizontal warewashing		



1

GEV No.	541017	Ref. No.	94801461 RX94801461
description	pressure control with mounting strap pressure range 40/20mbar connection 6mm ø 58mm pressure connection horizontal warewashing		



1

GEV No.	541003	Ref. No.	94804630 RX94804630
description	pressure control pressure range 55/35mbar connection 6mm ø 58mm pressure connection horizontal warewashing pressure connection ø 6mm		

for steam control



1

GEV No.	541074	Ref. No.	94814247 RX94814247
description	pressure control ø 45mm triggering pressure 0.5bar reset pressure 0.35bar pressure connection vertical steam control pressure range 0.35/0.51 bar connection 1/8" pressure connection 1/8"		



1

GEV No.	541024	Ref. No.	94813806 RX94813806
description	pressure control pressure range 60/40mbar connection 6mm ø 58mm pressure connection horizontal warewashing pressure connection ø 6mm		





1

GEV No.	541878	Ref. No.	9401489 94014891 RX94014891
description	pressure control steam control pressure range 0.2-1bar connection 1/4" HONEYWELL pressure connection 1/4" IT		





electrodes



			
1			
GEV No.	512072	Ref. No.	94800901 RX94800901
description	level electrode 1/2" total length 78.5mm probe L 63mm insulated probe length 54mm connection M5x0.8 plastic ø 26mm		

			
1			
GEV No.	403131	Ref. No.	9402351 94023512 RX94023512
description	level electrode 1/4" total length 330mm probe L 270mm insulated probe length 24mm connection M4 ø 4mm		

			
1			
GEV No.	400171	Ref. No.	RX94812665
description	level electrode 1/4" total length 350mm probe L 325mm insulated probe length 26mm connection male faston 6.3mm stainless steel ø 2.5mm		

			
1			
GEV No.	400021	Ref. No.	24849150 RX24849150
description	level electrode PG9 total length 110mm probe L 70/47/24mm insulated probe length 62/38/16mm with 3 probes connection grip connection		

			
1			
GEV No.	400022	Ref. No.	24849143 RX24849143
description	level electrode PG9 total length 135mm probe L 89/59/28mm insulated probe length 80mm with 3 probes connection grip connection		

accessories for	400022		
	GEV No.	379729	Ref. No.
			—
	connection cable L 1230mm 4-pole for level electrode plug type coded		
	GEV No.	550574	Ref. No.
			—
	nut thread PG9 H 3mm WS 28 nickel-plated brass Qty 1 pcs mounting ømm cable ømm		

fans

refrigeration fans

cold air circulating fans (complete)

COPREL

MAP series



GEV No.	601056	Ref. No.	94805652 RX94805652
description	fan blowing 230V 9W 50/60Hz fan wheel ø 96mm shaft L 21mm connection with cable for saladette hole distance 135mm ED ø 145mm mounting ø 110mm built-in depth 85mm		

hot air motors

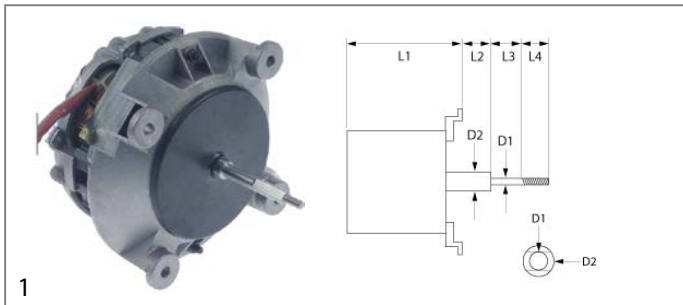

GEV No.	601856	Ref. No.	RX94814228
description	fan motor 230V 1 phase 50Hz 0.075kW 2650rpm speeds 1 L1 85mm L2 30mm L3 23mm L4 12mm D1 ø 8x6mm D2 ø 8mm 0.6A suitable capacitor 5µF/400V		

accessories for	601856		
	GEV No.	365017	Ref. No.
			94807807 RX94807807
	operating capacitor capacity 5µF 450V tolerance 5% 50/60Hz ambient temperature max. -25 to +85°C ø 28mm L 54mm M8 plastic connection male faston 6.3mm 16.10.08 protection		

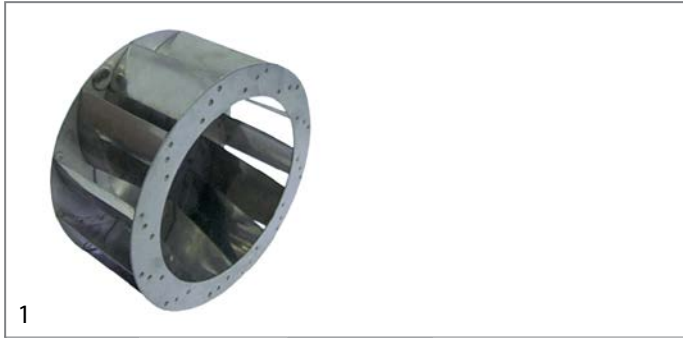

GEV No.	601049	Ref. No.	27490051 RX27490051
description	fan wheel D1 ø 280mm H1 125mm blades 12 D2 ø 11mm D3 ø 16mm H2 37mm		





1

GEV No.	601503	Ref. No.	RX94050051
description	fan wheel D1 ø 350mm H1 125mm blades 12 D2 ø 13mm D3 ø 16mm		
accessories for	601503		
	GEV No.	500505	Ref. No. —
description	fan motor 220-240/380-415V 3 phase 50/60Hz 0.16-0.26kW 1440/1700rpm speeds 2 L1 140mm L2 27mm L3 35mm M10R IT 1.2/0.7A Cos(f) 0.63 type L7zAw4D-014 D1 ø 17mm D2 ø 13mm		

motors

gear motors

for dishwashers



1

GEV No.	601861	Ref. No.	94812161 RX94812161
description	gear motor FIR type 71-B5 180W 400V voltage AC 50/60Hz 3 phase 900/1100rpm shaft ø 14mm L 227mm for transport system without gearbox		

hot air fans

miscellaneous

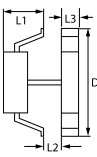
1

GEV No.	602149	Ref. No.	94813983 RX94813983
description	fan motor 230/400V 0.55W type N552		



1

GEV No.	501405	Ref. No.	RX94808672
description	motor without gearbox 180/220W 230/400-280/480V 50/60Hz 3 phase 1.2/0.7-1.15/0.67A shaft ø 11mm shaft length 26mm flange ø 89mm 1340/1608rpm type MS63B-4 ø 119mm H 163mm L 215mm E.M.C. for drying 0.18/0.22kW		

motors

for dishwashers



1

GEV No.	501477	Ref. No.	94807590 RX94807590
description	motor 260W 400V 50Hz 0.8A shaft ø 14mm shaft length 40mm flange ø 156mm 900rpm ø 140mm H 215mm OLYMPIA 0.26kW		

accessories

fan wheels for hot air fans



1

GEV No.	602003	Ref. No.	RX94442209
description	fan wheel ø 235mm blades 8 W 55mm shaft intake ø 8mm		



1

GEV No.	501405	Ref. No.	RX94808672
description	motor without gearbox 180/220W 230/400-280/480V 50/60Hz 3 phase 1.2/0.7-1.15/0.67A shaft ø 11mm shaft length 26mm flange ø 89mm 1340/1608rpm type MS63B-4 ø 119mm H 163mm L 215mm E.M.C. for drying 0.18/0.22kW		

pumps



wash and rinse pumps

ALBA (C&A)

pumps



1

GEV No.	500371	Ref. No.	94801453 RX94801453
description	pump inlet ø 62mm outlet ø 52mm type C2532 230/400V 50Hz 3 phase 0.88kW 1.2HP L 315mm rotation direction left ALBA PUMPS (C&A)		
spare parts for	500371		
	GEV No.	508395	Ref. No. —
	pump cover ALBA PUMPS (C&A) inlet ø 62mm outlet ø 52mm turn direction left ø 180mm ID ø 150mm inner height 38mm		
	GEV No.	510693	Ref. No. —
	mechanical shaft seal for shaft ø 12mm slide ring ext. ø 24mm slide ring H 15.5mm slide ring int. ø 11mm counter ring mounting ø 24mm height counter ring 8mm counter ring int. ø 13.5mm		

FIR

pumps

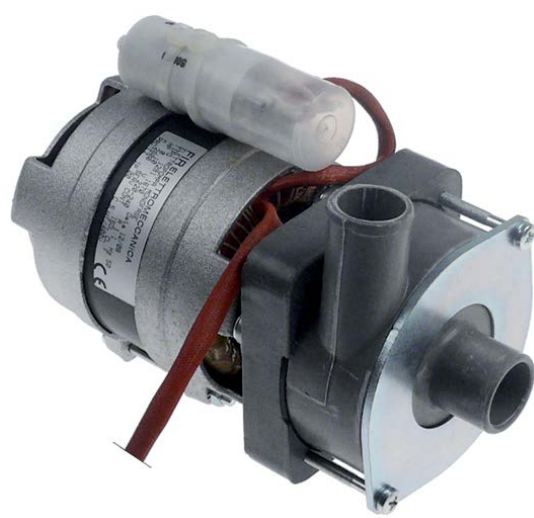

1

GEV No.	499004	Ref. No.	94813993 RX94813993
description	pump inlet ø 28mm outlet ø 26mm type 1291.1670 230V 50Hz 1 phase 0.07kW 0.1HP L 195mm rotation direction right capacitor 5µF FIR		
spare parts for	499004		
	GEV No.	365017	Ref. No. 94807807 RX94807807
	operating capacitor capacity 5µF 450V tolerance 5% 50/60Hz ambient temperature max. -25 to +85°C ø 28mm L 54mm M8 plastic connection male faston 6.3mm 16.10.08 protection		



1

GEV No.	500463	Ref. No.	94801248 RX94801248
description	pump inlet ø 45mm outlet ø 30mm type 2253 230V 50Hz 1 phase 0.24kW 0.33HP L 160mm rotation direction right FIR		
spare parts for	500463		
	GEV No.	521148	Ref. No. —
	pump cover pump type Fir 2253(500.463)		



1

GEV No.	499123	Ref. No.	94813734 RX94813734
description	pump inlet ø 45mm outlet ø 40mm type 4296.2350 230V 50Hz 1 phase 0.75kW L 250mm rotation direction right capacitor 16µF FIR		
spare parts for	499123		
	GEV No.	365021	Ref. No. —
	operating capacitor capacity 16µF 425V tolerance 5% 50/60Hz ambient temperature max. -25 to +85°C ø 35mm L 73mm single M8 plastic connection male faston 6.3mm 416.10.99 protection		
	GEV No.	510608	Ref. No. RX94813934
	impellor ø 93mm H 32mm shaft intake ø 9/8mm blades 6 inner height 11mm		
	GEV No.	510692	Ref. No. —
	mechanical shaft seal for shaft ø 11mm slide ring ext. ø 24mm slide ring H 13mm counter ring mounting ø 26mm height counter ring 8mm counter ring int. ø 14mm		
	GEV No.	521539	Ref. No. —
	pump cover FIR inlet ø 45mm outlet ø 40mm auxiliary pressure connection 10mm supporting pressure open turn direction right ø 160mm ID ø 125mm inner height 25mm		
	GEV No.	521702	Ref. No. —
	pump cover gasket thickness 3.5x4.5mm Qty 1 pcs		



1

GEV No.	500527	Ref. No.	94810909 RX94810909
description	pump inlet ø 60mm outlet ø 50/30mm type 2233.B140 230V 50Hz 1 phase 0.55kW 0.75HP L 210mm rotation direction right capacitor 12.5µF FIR inlet ø 60mm		
spare parts for	500527		
	GEV No.	365014	Ref. No. 94814010 RX94814010
	operating capacitor capacity 12.5µF 450V tolerance 5%Hz ambient temperature max. -25 to +85°C ø 35mm L 70mm M8 plastic connection male faston 6.3mm 45S.C3DS.12.5 protection		
	GEV No.	510552	Ref. No. 94813933 RX94813933
	pump cover gasket pump type 1292-2/3942/3981/3911/3983		
	GEV No.	510608	Ref. No. RX94813934
	impellor ø 93mm H 32mm shaft intake ø 9/8mm blades 6 inner height 11mm		
	GEV No.	510692	Ref. No. —
	mechanical shaft seal for shaft ø 11mm slide ring ext. ø 24mm slide ring H 13mm counter ring mounting ø 26mm height counter ring 8mm counter ring int. ø 14mm		



1





GEV No.	499139	Ref. No.	94809324 RX94809324
description	pump inlet ø 62mm outlet ø 62mm type 2275.2722 230/400V 50Hz 3 phase 2.6kW L 400mm rotation direction right FIR		
spare parts for	499139		
	GEV No.	510687	Ref. No. —
	mechanical shaft seal for shaft ø 18mm height counter ring 8mm ID ø 17mm ED ø 39mm H 15mm mounting ø 42mm int. ø 121mm		





Table continues overleaf

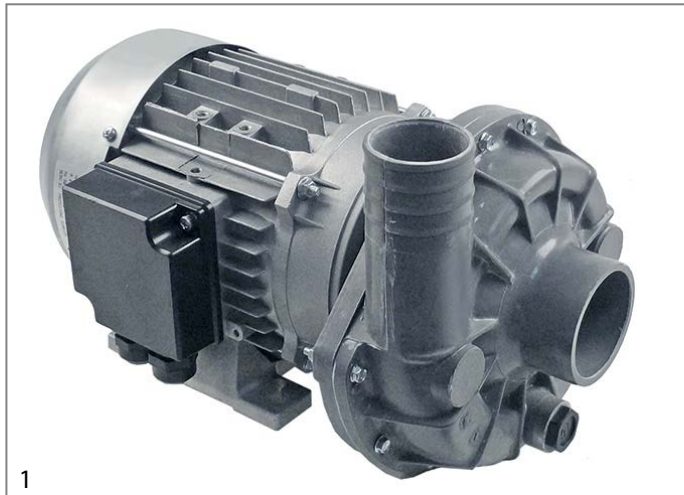

spare parts for 499139				
	GEV No.	521026	Ref. No.	94809290 RX94809290
pump cover gasket ID ø 182.5mm thickness 5x4.5mm				
	GEV No.	521028	Ref. No.	—
pump cover FIR inlet ø 62mm outlet ø 62mm turn direction right ø 215mm ID ø 175mm inner height 40mm				
	GEV No.	521277	Ref. No.	94809308 RX94809308
impellor ø 135mm H 39mm pump type Fir 2275 - 3.6HP thread M14L				
	GEV No.	524676	Ref. No.	—
fan wheel ø 160mm shaft intake ø 24mm plastic blades 12 W 30mm				







1

GEV No.	500023	Ref. No.	RX94807203	
description	pump inlet ø 63mm outlet ø 47mm type 1225.2725 230/400V 50Hz 3 phase 1.1kW 1.5HP L 335mm rotation direction right FIR			
spare parts for 500023				
	GEV No.	510602	Ref. No.	94809571 RX94809571
impellor ø 110mm H 34mm rotation direction right thread M8L shaft ø 28mm seat ø 12.2mm blades 6				
	GEV No.	510693	Ref. No.	—
mechanical shaft seal for shaft ø 12mm slide ring ext. ø 24mm slide ring H 15.5mm slide ring int. ø 11mm counter ring mounting ø 24mm height counter ring 8mm counter ring int. ø 13.5mm				
	GEV No.	521513	Ref. No.	—
pump cover FIR inlet ø 63mm outlet ø 47mm turn direction right ID ø 150mm inner height 32mm				
	GEV No.	524416	Ref. No.	—
pump cover gasket thickness 4x4mm Qty 1 pcs				



1

GEV No.	500570	Ref. No.	94804002 RX94804002	
description	pump inlet ø 63mm outlet ø 47mm type 422512725 230/400V 50Hz 3 phase 1.1kW 1.5HP L 285mm rotation direction right FIR			
spare parts for 500570				
	GEV No.	510693	Ref. No.	—
mechanical shaft seal for shaft ø 12mm slide ring ext. ø 24mm slide ring H 15.5mm slide ring int. ø 11mm counter ring mounting ø 24mm height counter ring 8mm counter ring int. ø 13.5mm				
	GEV No.	521082	Ref. No.	—
impellor ø 96mm H 32mm rotation direction right thread M8L				
	GEV No.	521513	Ref. No.	—
pump cover FIR inlet ø 63mm outlet ø 47mm turn direction right ID ø 150mm inner height 32mm				
	GEV No.	524416	Ref. No.	—
pump cover gasket thickness 4x4mm Qty 1 pcs				



1









GEV No.	500031	Ref. No.	94807682 RX94807682	
description	pump inlet ø 63mm outlet ø 53mm type 1205.2528 230/400V 50Hz 3 phase 2kW 2.7HP L 330mm rotation direction left FIR			
spare parts for 500031				
	GEV No.	510357	Ref. No.	RX94814088
impellor ø 124mm H 34/16mm thread M8R blades 6				
	GEV No.	510523	Ref. No.	—
fan wheel ø 142mm shaft intake ø 15mm blades 12				

Table continues overleaf



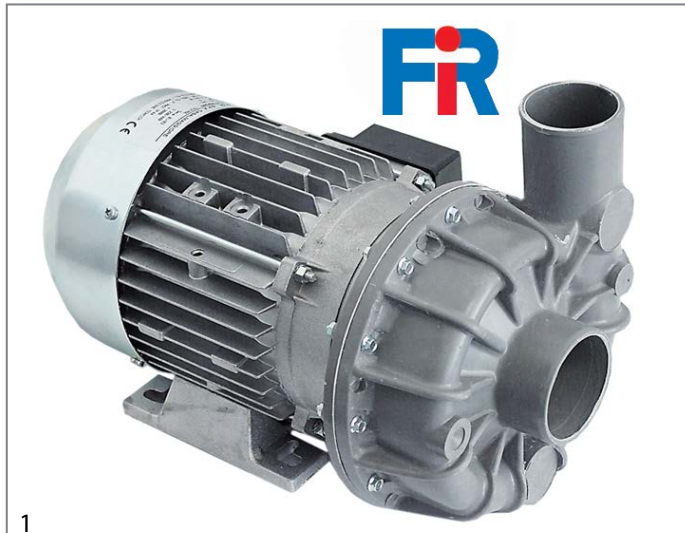



spare parts for 500031				
	GEV No.	510531	Ref. No.	—
pump cover FIR inlet ø 63mm outlet ø 53mm auxiliary pressure connection M16x1.5mm supporting pressure open turn direction left ø 185mm ID ø 150mm inner height 37mm				
	GEV No.	510693	Ref. No.	—
mechanical shaft seal for shaft ø 12mm slide ring ext. ø 24mm slide ring H 15.5mm slide ring int. ø 11mm counter ring mounting ø 24mm height counter ring 8mm counter ring int. ø 13.5mm				
	GEV No.	524416	Ref. No.	—
pump cover gasket thickness 4x4mm Qty 1 pcs				







1				
GEV No.	500111	Ref. No.	94813504 RX94813504	
description pump inlet ø 63mm outlet ø 53mm type 1241.2500 230/400V 50Hz 3 phase 1.1kW 1.5HP L 330mm rotation direction left FIR				
spare parts for 500111				
	GEV No.	510531	Ref. No.	—
pump cover FIR inlet ø 63mm outlet ø 53mm auxiliary pressure connection M16x1.5mm supporting pressure open turn direction left ø 185mm ID ø 150mm inner height 37mm				
	GEV No.	510612	Ref. No.	—
impellor ø 110mm H 34mm M8R				
	GEV No.	510693	Ref. No.	—
mechanical shaft seal for shaft ø 12mm slide ring ext. ø 24mm slide ring H 15.5mm slide ring int. ø 11mm counter ring mounting ø 24mm height counter ring 8mm counter ring int. ø 13.5mm				
	GEV No.	524416	Ref. No.	—
pump cover gasket thickness 4x4mm Qty 1 pcs				

LGB



1				
GEV No.	500511	Ref. No.	94813781 RX94813781	
description pump inlet ø 30mm outlet ø 29mm type ZF140SX 230V 50Hz 1 phase 0.36kW 0.5HP L 190mm rotation direction right LGB				
spare parts for 500511				
	GEV No.	365017	Ref. No.	94807807 RX94807807
operating capacitor capacity 5µF 450V tolerance 5% 50/60Hz ambient temperature max. -25 to +85°C ø 28mm L 54mm M8 plastic connection male faston 6.3mm 16.10.08 protection				
	GEV No.	510703	Ref. No.	94804085 RX94804085
mechanical shaft seal for shaft ø 13mm slide ring H 13mm height counter ring 5.5mm ED ø 26mm				
	GEV No.	521230	Ref. No.	RX94813790
impellor ø 86mm H 16mm M7L				
	GEV No.	521526	Ref. No.	—
pump cover LGB inlet ø 30mm outlet ø 30mm auxiliary pressure connection 12mm supporting pressure open turn direction right ø 117mm ID ø 95mm inner height 19mm				
	GEV No.	521706	Ref. No.	—
pump cover gasket				







1			
GEV No.	500384	Ref. No.	94813975 RX94813975
description	pump inlet ø 30mm outlet ø 30mm type ZF160SX 230V 50Hz 1 phase 0.41kW 0.55HP L 180mm rotation direction right capacitor 12.5µF LGB		
spare parts for	500384		
	GEV No.	365014	Ref. No. 94814010 RX94814010
	operating capacitor capacity 12.5µF 450V tolerance 5%Hz ambient temperature max. -25 to +85°C ø 35mm L 70mm M8 plastic connection male faston 6.3mm 45S.C3DS.12.5 protection		
	GEV No.	510703	Ref. No. 94804085 RX94804085
	mechanical shaft seal for shaft ø 13mm slide ring H 13mm height counter ring 5.5mm ED ø 26mm		
	GEV No.	521527	Ref. No. —
	pump cover LGB inlet ø 30mm outlet ø 30mm		
	GEV No.	521701	Ref. No. —
	pump cover gasket		
	GEV No.	521707	Ref. No. —
	pump cover gasket		



1			
GEV No.	500156	Ref. No.	94803723 RX94803723
description	pump inlet ø 50mm outlet ø 50mm type ZF400SX 230V 50Hz 1 phase 0.6kW 0.8HP L 210mm rotation direction right capacitor 16µF LGB		
spare parts for	500156		
	GEV No.	509020	Ref. No. 94812278 RX94812278
	impeller ø 104mm H 25mm M8L		
	GEV No.	510703	Ref. No. 94804085 RX94804085
	mechanical shaft seal for shaft ø 13mm slide ring H 13mm height counter ring 5.5mm ED ø 26mm		
	GEV No.	521548	Ref. No. —
	pump cover LGB inlet ø 50mm outlet ø 50mm		
	GEV No.	521734	Ref. No. —
	pump cover bottom part		
	GEV No.	523509	Ref. No. —
	deep-groove ball bearing type 6201-2RS shaft ø 12mm ED ø 32mm W 10mm with sealing discs deep-groove ball bearing DIN 625-1		
	GEV No.	532623	Ref. No. —
	O-ring EPDM thickness 2.62mm ID ø 120.32mm Qty 1 pcs		
accessories for	500156		
	GEV No.	365021	Ref. No. —
	operating capacitor capacity 16µF 425V tolerance 5% 50/60Hz ambient temperature max. -25 to +85°C ø 35mm L 73mm single M8 plastic connection male faston 6.3mm 416.10.99 protection		







1

GEV No.	500377	Ref. No.	94800745 RX94800745
description	pump inlet ø 61mm outlet ø 52mm type ZF800DX 230/400V 50Hz 3 phase 2kW 2.72HP L 330mm rotation direction left LGB		
spare parts for	500377		
	GEV No.	510551	Ref. No. —
	pump cover gasket ID ø 158.3mm pump type 1214/1293/1225/2243/1226/1204/3473/1241 thickness 3.53mm EPDM Qty 1 pcs		
	GEV No.	510694	Ref. No. —
	mechanical shaft seal for shaft ø 13mm height counter ring 8mm ID ø 11.5mm H 16mm mounting ø 24/26mm int. ø 1 14mm		
	GEV No.	521276	Ref. No. —
	impellor ø 120mm H 39mm pump type ZF800DX shaft intake ø 12mm rotation direction left thread M8R pump for ZF800DX blades 6		
	GEV No.	521516	Ref. No. —
	pump cover LGB inlet ø 62mm outlet ø 52mm auxiliary pressure connection 12mm supporting pressure closed turn direction left ø 190mm ID ø 150mm inner height 40mm		



1

GEV No.	500379	Ref. No.	94813979 RX94813979
description	pump inlet ø 62mm outlet ø 50mm type ZF650SX 230/400V 50Hz 3 phase 1.35kW 1.8HP L 335mm rotation direction right LGB		
spare parts for	500379		
	GEV No.	510551	Ref. No. —
	pump cover gasket ID ø 158.3mm pump type 1214/1293/1225/2243/1226/1204/3473/1241 thickness 3.53mm EPDM Qty 1 pcs		
	GEV No.	510694	Ref. No. —
	mechanical shaft seal for shaft ø 13mm height counter ring 8mm ID ø 11.5mm H 16mm mounting ø 24/26mm int. ø 1 14mm		
	GEV No.	521240	Ref. No. 94803996 RX94803996
	impellor ø 110mm H 32mm rotation direction left thread M8L shaft ø 20mm shaft length 10mm seat ø 8.2mm blades 6		

spare parts for	500379		
	GEV No.	521536	Ref. No. —
	pump cover ALBA / LGB inlet ø 62mm outlet ø 50mm auxiliary pressure connection 12mm supporting pressure closed turn direction right ø 180mm ID ø 150mm inner height 38mm		



1

GEV No.	500122	Ref. No.	94801453 RX94801453
description	pump inlet ø 62mm outlet ø 52mm type AM5225DX 230/400V 50Hz 3 phase 1.2kW 1.6HP L 300mm rotation direction left LGB		
spare parts for	500122		
	GEV No.	501495	Ref. No. —
	cover plastic for terminal box for pump LGB		
	GEV No.	510551	Ref. No. —
	pump cover gasket ID ø 158.3mm pump type 1214/1293/1225/2243/1226/1204/3473/1241 thickness 3.53mm EPDM Qty 1 pcs		
	GEV No.	510694	Ref. No. —
	mechanical shaft seal for shaft ø 13mm height counter ring 8mm ID ø 11.5mm H 16mm mounting ø 24/26mm int. ø 1 14mm		
	GEV No.	521236	Ref. No. —
	impellor ø 105mm H 32mm M8R		
	GEV No.	521516	Ref. No. —
	pump cover LGB inlet ø 62mm outlet ø 52mm auxiliary pressure connection 12mm supporting pressure closed turn direction left ø 190mm ID ø 150mm inner height 40mm		

LOWARA

pumps







1			
GEV No.	500386	Ref. No.	94813490 RX94813490
description	pump inlet \varnothing 1 1/4" IT outlet \varnothing 1" IT type CEA70/5/A 230 220-240/380-415V 50Hz 0.88kW LOWARA 0.75HP		

OLYMPIA

pumps



1			
GEV No.	500521	Ref. No.	94808565 RX94808565
description	pump inlet \varnothing 1" IT outlet \varnothing 26mm type T33 230V 50Hz 1 phase 0.25kW 0.34HP L 225mm rotation direction right capacitor 5 μ F auxiliary pressure connection 11mm supporting pressure closed OLYMPIA		

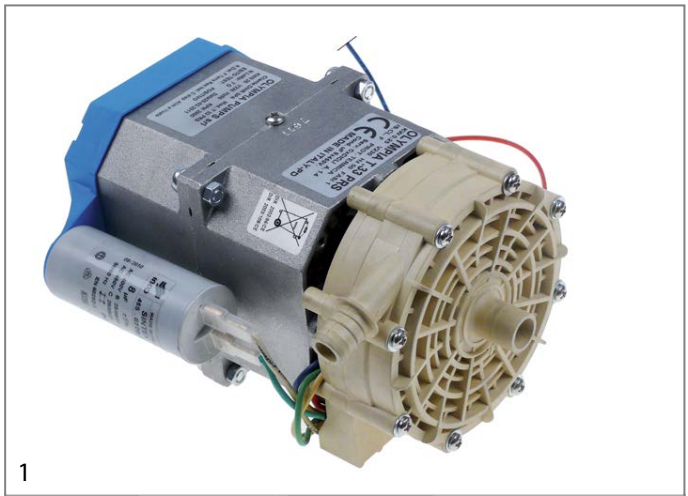

spare parts for 500521			
	GEV No.	365017	Ref. No. 94807807 RX94807807
	operating capacitor capacity 5 μ F 450V tolerance 5% 50/60Hz ambient temperature max. -25 to +85°C \varnothing 28mm L 54mm M8 plastic connection male faston 6.3mm 16.10.08 protection		
	GEV No.	510693	Ref. No.
	mechanical shaft seal for shaft \varnothing 12mm slide ring ext. \varnothing 24mm slide ring H 15.5mm slide ring int. \varnothing 11mm counter ring mounting \varnothing 24mm height counter ring 8mm counter ring int. \varnothing 13.5mm		
	GEV No.	521256	Ref. No.
	impellor \varnothing 74mm H 14mm thread M10L shaft \varnothing 12mm shaft length 7.5mm blades 8		
	GEV No.	521554	Ref. No.
	pump cover OLYMPIA inlet 1" \varnothing 90mm ID \varnothing 66mm inner height 5mm		
	GEV No.	521724	Ref. No.
	O-ring EPDM thickness 1.78mm ID \varnothing 72.75mm Qty 1 pcs		

spare parts for 500521			
	GEV No.	528800	Ref. No.
	O-ring EPDM thickness 2.62mm ID \varnothing 75.87mm Qty 1 pcs		









1	GEV No.	499095	Ref. No.	RX94814080
	description	pump inlet \varnothing 15mm outlet \varnothing 14mm type T.33PRS 230V 50Hz 1 phase 0.25kW L 185mm rotation direction right capacitor 8 μ F OLYMPIA		
spare parts for 499095				
	GEV No.	365013	Ref. No.	—
	operating capacitor capacity 8 μ F 400V tolerance 5%Hz ambient temperature max. -25 to +85°C \varnothing 31.5mm L 55mm M8 plastic connection male faston 6.3mm protection			
	GEV No.	510693	Ref. No.	—
	mechanical shaft seal for shaft \varnothing 12mm slide ring ext. \varnothing 24mm slide ring H 15.5mm slide ring int. \varnothing 11mm counter ring mounting \varnothing 24mm height counter ring 8mm counter ring int. \varnothing 13.5mm			
	GEV No.	521165	Ref. No.	—
	pump cover OLYMPIA inlet \varnothing 15mm outlet \varnothing 13mm pump type R63. T33 PRS			
	GEV No.	521166	Ref. No.	—
	impellor \varnothing 90mm H 9mm pump type R63.T33 PRS thread M10R shaft \varnothing 12mm shaft length 8mm			
	GEV No.	525022	Ref. No.	—
	O-ring EPDM thickness 1.78mm ID \varnothing 75.92mm Qty 1 pcs			





GEV No.	499318	Ref. No.	94807799 RX94807799
description	pump inlet ø 28mm outlet ø 28mm type L63.T19 230V 50Hz 1 phase 0.19kW L 185mm rotation direction right capacitor 5µF OLYMPIA inlet ø 28mm outlet ø 28mm		
spare parts for	499318		
	GEV No.	365017	Ref. No. 94807807 RX94807807
	operating capacitor capacity 5µF 450V tolerance 5% 50/60Hz ambient temperature max. -25 to +85°C ø 28mm L 54mm M8 plastic connection male faston 6.3mm 16.10.08 protection		
	GEV No.	510693	Ref. No. —
	mechanical shaft seal for shaft ø 12mm slide ring ext. ø 24mm slide ring H 15.5mm slide ring int. ø 11mm counter ring mounting ø 24mm height counter ring 8mm counter ring int. ø 13.5mm		
	GEV No.	521163	Ref. No. —
	pump cover OLYMPIA inlet ø 28mm outlet ø 26mm pump type L63.T19		
	GEV No.	521164	Ref. No. —
	impellor ø 64mm H 15mm pump type L63.T19 thread M7L shaft ø 12mm shaft length 30mm		
	GEV No.	521724	Ref. No. —
	O-ring EPDM thickness 1.78mm ID ø 72.75mm Qty 1 pcs		



GEV No.	500199	Ref. No.	94804150 RX94804150
description	pump inlet ø 32mm outlet ø 30/24mm type T80 230V 50Hz 1 phase 0.25kW 0.34HP L 205mm rotation direction left capacitor 5µF OLYMPIA		
spare parts for	500199		
	GEV No.	365017	Ref. No. 94807807 RX94807807
	operating capacitor capacity 5µF 450V tolerance 5% 50/60Hz ambient temperature max. -25 to +85°C ø 28mm L 54mm M8 plastic connection male faston 6.3mm 16.10.08 protection		
	GEV No.	510693	Ref. No. —
	mechanical shaft seal for shaft ø 12mm slide ring ext. ø 24mm slide ring H 15.5mm slide ring int. ø 11mm counter ring mounting ø 24mm height counter ring 8mm counter ring int. ø 13.5mm		
	GEV No.	521151	Ref. No. —
	impellor ø 71mm H 19mm pump type OLYMPIA thread M10R shaft ø 12mm shaft length 8mm		
	GEV No.	521178	Ref. No. —
	pump casing OLYMPIA outlet ø 30/24mm pump type T80		
	GEV No.	521552	Ref. No. —
	pump cover OLYMPIA inlet ø 32mm outlet ø 30/24mm ø 103mm ID ø 93mm		
	GEV No.	521703	Ref. No. —
	pump cover gasket EPDM thickness 2.5mm ID ø 75mm Qty 1 pcs		









1

GEV No.	500525	Ref. No.	94807096 RX94807096
description	pump inlet \varnothing 50mm outlet \varnothing 30mm type T7 230V 50Hz 1 phase 0.52kW 0.71HP L 230mm rotation direction right capacitor 12.5 μ F OLYMPIA		
spare parts for	500525		
	GEV No.	365014	Ref. No. 94814010 RX94814010
	operating capacitor capacity 12.5 μ F 450V tolerance 5%Hz ambient temperature max. -25 to +85°C \varnothing 35mm L 70mm M8 plastic connection male faston 6.3mm 455.C3D5.12.5 protection		
	GEV No.	510554	Ref. No. —
	O-ring EPDM thickness 2mm ID \varnothing 120mm Qty 1 pcs		
	GEV No.	510693	Ref. No. —
	mechanical shaft seal for shaft \varnothing 12mm slide ring ext. \varnothing 24mm slide ring H 15.5mm slide ring int. \varnothing 11mm counter ring mounting \varnothing 24mm height counter ring 8mm counter ring int. \varnothing 13.5mm		
	GEV No.	517368	Ref. No. RX94810637
	impellor \varnothing 102mm H 21mm rotation direction right thread M10L suitable for Dihr blades 8		
	GEV No.	521556	Ref. No. 94810645 RX94810645
	pump cover OLYMPIA inlet \varnothing 50mm outlet \varnothing 30mm outlet 2 \varnothing 30 auxiliary pressure connection 10mm supporting pressure open turn direction right \varnothing 130mm ID \varnothing 124mm inner height 20mm		







1

GEV No.	500530	Ref. No.	94807260 RX94807260
description	pump inlet \varnothing 60mm outlet \varnothing 48mm type T15 230V 50Hz 1 phase 1.1kW 1.5HP L 305mm rotation direction right OLYMPIA		
spare parts for	500530		
	GEV No.	365021	Ref. No. —
	operating capacitor capacity 16 μ F 425V tolerance 5% 50/60Hz ambient temperature max. -25 to +85°C \varnothing 35mm L 73mm single M8 plastic connection male faston 6.3mm 416.10.99 protection		
	GEV No.	510693	Ref. No. —
	mechanical shaft seal for shaft \varnothing 12mm slide ring ext. \varnothing 24mm slide ring H 15.5mm slide ring int. \varnothing 11mm counter ring mounting \varnothing 24mm height counter ring 8mm counter ring int. \varnothing 13.5mm		
	GEV No.	521039	Ref. No. —
	fanwheel cover ID \varnothing 156mm ED \varnothing 161mm H 76mm for wash pump		
	GEV No.	521262	Ref. No. 94809068 RX94809068
	impellor \varnothing 102mm H 19mm rotation direction right thread M10L blades 6		
	GEV No.	521559	Ref. No. 94809050 RX94809050
	pump cover OLYMPIA inlet \varnothing 60mm outlet \varnothing 48mm outlet 2 \varnothing 31 auxiliary pressure connection 10mm supporting pressure open turn direction right \varnothing 170mm ID \varnothing 150mm inner height 22mm		
	GEV No.	521727	Ref. No. 94809035 RX94809035
	pump cover gasket EPDM thickness 1.78mm ID \varnothing 145mm Qty 1 pcs		



GEV No.	499259	Ref. No.	94808995 RX94808995
description	pump inlet \varnothing 62mm outlet \varnothing 52mm type MEC.T120DX 220-240/380-415V 50Hz 3 phase 0.89kW 1.2HP L 310mm rotation direction left OLYMPIA		
spare parts for	499259		
	GEV No.	510693	Ref. No. —
	mechanical shaft seal for shaft \varnothing 12mm slide ring ext. \varnothing 24mm slide ring H 15.5mm slide ring int. \varnothing 11mm counter ring mounting \varnothing 24mm height counter ring 8mm counter ring int. \varnothing 13.5mm		
	GEV No.	521152	Ref. No. —
	pump cover OLYMPIA inlet 62 \varnothing 190mm		
	GEV No.	521153	Ref. No. —
	pump casing OLYMPIA outlet \varnothing 52mm		
	GEV No.	521154	Ref. No. —
	O-ring ID \varnothing 152.7mm thickness 2.62mm EPDM Qty 1 pcs		
	GEV No.	521172	Ref. No. —
	impellor \varnothing 107mm H 28mm pump type MEC.T120DX thread M8R		

spare parts for	499226		
	GEV No.	521152	Ref. No. —
	pump cover OLYMPIA inlet 62 \varnothing 190mm		
	GEV No.	521153	Ref. No. —
	pump casing OLYMPIA outlet \varnothing 52mm		
	GEV No.	521154	Ref. No. —
	O-ring ID \varnothing 152.7mm thickness 2.62mm EPDM Qty 1 pcs		
	GEV No.	521155	Ref. No. —
	impellor \varnothing 107mm H 34mm pump type OLYMPIA thread M8L blades 6		
accessories for	499226		
	GEV No.	542157	Ref. No. —
	bracket for wash pump L 267mm W 132mm H 43mm		

booster pumps I

	1		
GEV No.	500060	Ref. No.	94810946 RX94810946
description	pump inlet \varnothing 1" outlet \varnothing 1" type PQM60 230V 50Hz 1 phase 0.37kW PEDRELLO		
accessories for	500060		
	GEV No.	365015	Ref. No. —
	operating capacitor capacity 10 μ F 400V tolerance 5%Hz ambient temperature max. -25 to +85°C \varnothing 35.5mm L 59mm M8 plastic connection male faston 6.3mm protection		







GEV No.	499226	Ref. No.	RX94807203 RX94810405
description	pump inlet \varnothing 62mm outlet \varnothing 52mm type MEC80.T200SX 230/400V 50Hz 3 phase 1.5kW 2HP L 340mm rotation direction right OLYMPIA		
spare parts for	499226		
	GEV No.	510693	Ref. No. —
	mechanical shaft seal for shaft \varnothing 12mm slide ring ext. \varnothing 24mm slide ring H 15.5mm slide ring int. \varnothing 11mm counter ring mounting \varnothing 24mm height counter ring 8mm counter ring int. \varnothing 13.5mm		

	1		
GEV No.	500358	Ref. No.	94803046 94814082 RX94803046 RX94814082
description	pump inlet \varnothing 3/8" outlet \varnothing 3/8" type PS46 230V 50Hz 0.45kW \varnothing 100mm L 200mm capacitor 10 μ F LGB		
spare parts for	500358		
	GEV No.	510713	Ref. No. —
	slide ring for shaft \varnothing 12mm ED \varnothing 24mm H 16mm		
	GEV No.	510723	Ref. No. —
	counter ring H 8mm ED \varnothing 26mm ID \varnothing 13.5mm for mechanical shaft seal		

Table continues overleaf



spare parts for 500358			
	GEV No.	698400	Ref. No. —
pump cover gasket pump type PS46 thickness 2mm ID ø 66mm Qty 1 pcs			
accessories for 500358			
	GEV No.	365015	Ref. No. —
operating capacitor capacity 10µF 400V tolerance 5%Hz ambient temperature max. -25 to +85°C ø 35.5mm L 59mm M8 plastic connection male faston 6.3mm protection			
	GEV No.	511279	Ref. No. —
hose connector brass straight thread 3/8" hose ø 12mm Qty 1 pcs			
	GEV No.	520202	Ref. No. —
hose connector nickel-plated brass straight thread 3/8" hose ø 12mm Qty 1 pcs			
	GEV No.	520677	Ref. No. —
hose connector brass straight thread 3/8" hose ø 13mm Qty 1 pcs			

drain pumps

HANNING

			
1			
GEV No.	499286	Ref. No.	RX94813829
description	drain pump inlet ø 30mm outlet ø 24mm 220-240V 30W 50Hz HANNING type DPS25-131		

			
1			
GEV No.	500044	Ref. No.	RX27500297
description	drain pump inlet ø 30mm outlet ø 24mm 230V 100W 50Hz HANNING type BE28B4-017		
spare parts for 500044			
	GEV No.	510168	Ref. No. —
fan wheel shaft intake ø 5mm ø 62mm H 14mm			

booster pumps II

accessories

			
1			
GEV No.	365017	Ref. No.	94807807 RX94807807
description	operating capacitor capacity 5µF 450V tolerance 5% 50/60Hz ambient temperature max. -25 to +85°C ø 28mm L 54mm M8 plastic connection male faston 6.3mm 16.10.08 protection		

condensators & interference suppression filters

operating capacitors

			
1			
GEV No.	365014	Ref. No.	94814010 RX94814010
description	operating capacitor capacity 12.5µF 450V tolerance 5%Hz ambient temperature max. -25 to +85°C ø 35mm L 70mm M8 plastic connection male faston 6.3mm 45S.C3DS.12.5 protection		

			
1			
GEV No.	365017	Ref. No.	94807807 RX94807807
description	operating capacitor capacity 5µF 450V tolerance 5% 50/60Hz ambient temperature max. -25 to +85°C ø 28mm L 54mm M8 plastic connection male faston 6.3mm 16.10.08 protection		

filters

interference suppression filters

			
1			
GEV No.	365047	Ref. No.	94808409 RX94808409
description	interference suppression filter capacity 0.33µF(X2)+2x0.015µF		



fuses

fine fuses

			
1			
GEV No.	358677	Ref. No.	RX27630268
description	fine fuse size ø5x20mm 4A fast-acting rated 250V Qty 10 pcs		

			
1			
GEV No.	358607	Ref. No.	27630086 RX27630086
description	fine fuse size ø5x20mm 6.3A slow-acting rated 250V Qty 10 pcs		

fine fuse holders

			
1			
GEV No.	550105	Ref. No.	27630110 RX27630110
description	rail-mounted terminal WIELAND type WK10/SIU 5X20 /V0 suitable fuse ø5x20mm 1.0-16mm ² 10A rated 250V		

screw locks

fuse holders



			
1			
GEV No.	358059	Ref. No.	27635200 RX27635200
description	fuse holder suitable fuse D01 ø 24mm mounting ø 14mm 1-pole-pole 16A rated 400V L 30mm		

electric accessories

cables

accessories

protection hoses

				
1				
GEV No.	550036	Ref. No.	RX94044806	
description	protective metal tube PG13.5 ID ø 16mm ED ø 19mm zinc-coated steel Qty 10m			
accessories for	550036			
	GEV No.	550301	Ref. No.	—
				
	screw connection for protection hose PG13.5 ID ø 14.5mm ED ømm nickel-plated brass Qty 5 pieces			

cable glands

threaded cable glands

screw connections

			
1			
GEV No.	550569	Ref. No.	RX94038320
description	cable gland thread PG11 cable ø 8.0-10.0mm mounting ø 18.6mm nickel-plated brass Qty 1 pcs		

fastening nuts

			
1			
GEV No.	550575	Ref. No.	94010881 R95010881 RX94010881
description	nut thread PG11 H 3mm WS 21 nickel-plated brass Qty 1 pcs		

terminals

porcelain clamps

			
1			
GEV No.	550116	Ref. No.	RX94018090
description	porcelain terminal block 3-pole 10mm ² hole distance 16mm max. 30A max 450V L 52mm W 30mm H 23mm mounting distance 16mm Qty 1 pcs		

connection terminals with screw/faston connections

			
1			
GEV No.	550411	Ref. No.	94810223 RX94810223
description	power terminal block 6-pole max. 40A max 450V connection ø6mm ² / F6.3 temp.-resist. 150°C cross section 6mm ²		



rail-mounted terminals

WIELAND

rail-mounted terminals type 9700A



1

GEV No.	550376	Ref. No.	27045137 RX27045137
description	rail-mounted terminal WIELAND type 9700A/16 S35 2.5-35mm ² top-hat rail 35mm grey W 16mm L 59mm		

fuse terminal blocks

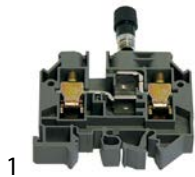

1

GEV No.	550105	Ref. No.	27630110 RX27630110
description	rail-mounted terminal WIELAND type WK10/SIU 5X20 /V0 suitable fuse ϕ 5x20mm 1.0-16mm ² 10A rated 250V		

gas taps

PEL

20S series



1

GEV No.	101094	Ref. No.	94805017 RX94805017
description	gas tap PEL type 20S gas inlet M16x1.5 (tube ϕ 10mm) bypass nozzle ϕ 0.35mm gas outlet M16x1.5 (tube ϕ 10/8mm) thermocouple connection M8x1 pilot connection shaft ϕ 8x6.5mm shaft L 22/15mm shaft flat lower		

spare parts for 101094

	GEV No.	100408	Ref. No.	—
bypass nozzle type PEL20/21 bore ϕ 0.35mm thread M5x0.5				





	GEV No.	101060	Ref. No.	—
magnet unit standard L 39mm D1 ϕ 15.4mm D2 ϕ 11mm suitable for PEL20-21/JUNKERS/EGA				

	GEV No.	101205	Ref. No.	—
gas tap front part shaft ϕ 8x6.5mm shaft L 22/15mm shaft flat upper/lower suitable for PEL20				

	GEV No.	101230	Ref. No.	—
thermocouple nut T1: M8x1 T2: M18x1 aluminium				

accessories for 101094

	GEV No.	101278	Ref. No.	—
olive for pipe ϕ 10mm Qty 1 pcs				

accessories for	101094			
	GEV No.	101300	Ref. No.	—
union nut thread M16x1.5 tube ϕ 10mm				
	GEV No.	101450	Ref. No.	—
olive for pipe ϕ 8mm L 12.7mm Qty 1 pcs ED ϕ 10mm				
	GEV No.	101451	Ref. No.	—
union nut thread M16x1.5 tube ϕ 8mm				
	GEV No.	110081	Ref. No.	—
knob ϕ 70mm shaft ϕ 8x6.5mm shaft flat universal				
	GEV No.	110083	Ref. No.	—
knob dial plate gas tap without ignition flame silver				

21N series





1

GEV No.	109124	Ref. No.	9402050 94020500 RX94020500
----------------	--------	-----------------	-----------------------------------

description gas tap PEL type 21N gas inlet M16x1.5 (tube ϕ 10mm) bypass nozzle ϕ 0mm gas outlet M16x1.5 (tube ϕ 10/8mm) thermocouple connection pilot connection M10x1 shaft ϕ 6x4.6mm shaft L 40/16mm shaft flat lower

spare parts for 109124

	GEV No.	100909	Ref. No.	—
union screw thread M10x1 for pipe ϕ 6mm Qty 1 pcs				

	GEV No.	101278	Ref. No.	—
olive for pipe ϕ 10mm Qty 1 pcs				

	GEV No.	101300	Ref. No.	—
union nut thread M16x1.5 tube ϕ 10mm				

accessories for 109124

	GEV No.	100909	Ref. No.	—
union screw thread M10x1 for pipe ϕ 6mm Qty 1 pcs				

	GEV No.	101278	Ref. No.	—
olive for pipe ϕ 10mm Qty 1 pcs				

	GEV No.	101300	Ref. No.	—
union nut thread M16x1.5 tube ϕ 10mm				





21S series







			
1			
GEV No.	101397	Ref. No.	94805868 RX94805868
description	gas tap PEL type 21S gas inlet M16x1.5 (tube ø 10mm) bypass nozzle ø 0.35mm gas outlet M16x1.5 (tube ø 10/8mm) thermocouple connection M9x1 pilot connection M10x1 shaft ø 8x6.5mm shaft L 22/15mm shaft flat lower		
spare parts for	101397		
	GEV No.	100408	Ref. No. —
	bypass nozzle type PEL20/21 bore ø 0.35mm thread M5x0.5		
	GEV No.	101060	Ref. No. —
	magnet unit standard L 39mm D1 ø 15.4mm D2 ø 11mm suitable for PEL20-21/JUNKERS/EGA		
	GEV No.	101206	Ref. No. —
	gas tap front part shaft ø 8x6.5mm shaft L 22/15mm shaft flat upper/lower suitable for PEL21		
	GEV No.	101231	Ref. No. —
	thermocouple nut T1: M9x1 T2: M18x1		
accessories for	101397		
	GEV No.	100908	Ref. No. 94812587 RX94812587
	union screw thread M10x1 for pipe ø 4mm Qty 1 pcs		
	GEV No.	100909	Ref. No. —
	union screw thread M10x1 for pipe ø 6mm Qty 1 pcs		
	GEV No.	101246	Ref. No. 94812588 RX94812588
	olive for pipe ø 4mm Qty 1 pcs		
	GEV No.	101278	Ref. No. —
	olive for pipe ø 10mm Qty 1 pcs		
	GEV No.	101286	Ref. No. —
	olive ID ø 6mm Qty 1 pcs		
	GEV No.	101300	Ref. No. —
	union nut thread M16x1.5 tube ø 10mm		
	GEV No.	101450	Ref. No. —
	olive for pipe ø 8mm L 12.7mm Qty 1 pcs ED ø 10mm		
	GEV No.	101451	Ref. No. —
	union nut thread M16x1.5 tube ø 8mm		
	GEV No.	110081	Ref. No. —
	knob ø 70mm shaft ø 8x6.5mm shaft flat universal		
	GEV No.	112206	Ref. No. —
	knob dial plate silver gas tap PEL21/22/23 t.max.°C ED ø 63mm ID ø 45.5mm		

			
1			
GEV No.	109125	Ref. No.	9402051 94020518 RX94020518
description	gas tap PEL type 21S gas inlet M16x1.5 (tube ø 10mm) bypass nozzle ø 0mm gas outlet M16x1.5 (tube ø 10/8mm) thermocouple connection M9x1 pilot connection M10x1 shaft ø 6x4.6mm shaft L 40/16mm shaft flat lower		
spare parts for	109125		
	GEV No.	100909	Ref. No. —
	union screw thread M10x1 for pipe ø 6mm Qty 1 pcs		
	GEV No.	101060	Ref. No. —
	magnet unit standard L 39mm D1 ø 15.4mm D2 ø 11mm suitable for PEL20-21/JUNKERS/EGA		
	GEV No.	101231	Ref. No. —
	thermocouple nut T1: M9x1 T2: M18x1		
	GEV No.	101278	Ref. No. —
	olive for pipe ø 10mm Qty 1 pcs		
	GEV No.	101286	Ref. No. —
	olive ID ø 6mm Qty 1 pcs		
	GEV No.	101300	Ref. No. —
	union nut thread M16x1.5 tube ø 10mm		
	GEV No.	106202	Ref. No. —
	bypass nozzle type PEL20/21 bore ø 0mm thread M5x0.5		
accessories for	109125		
	GEV No.	100909	Ref. No. —
	union screw thread M10x1 for pipe ø 6mm Qty 1 pcs		
	GEV No.	101231	Ref. No. —
	thermocouple nut T1: M9x1 T2: M18x1		
	GEV No.	101278	Ref. No. —
	olive for pipe ø 10mm Qty 1 pcs		
	GEV No.	101286	Ref. No. —
	olive ID ø 6mm Qty 1 pcs		
	GEV No.	101300	Ref. No. —
	union nut thread M16x1.5 tube ø 10mm		

22S/O series

			
GEV No.	101086	Ref. No.	RX94805298
description	gas tap PEL type 22S/O gas inlet M20x1.5 (tube ø 12mm) bypass nozzle ø 0.35mm gas outlet M20x1.5 (tube ø 12/10mm) thermocouple connection M9x1 pilot connection M10x1 shaft ø 10x8mm shaft L 25/17mm shaft flat lower		
spare parts for	101086		
	GEV No.	100259	Ref. No. —
	bypass nozzle type PEL22 bore ø 0.35mm thread M6x0.5		
	GEV No.	101058	Ref. No. 244761275 RX244761275
	magnet unit L 39mm D1 ø 15.4mm D2 ø 13.5mm suitable for PEL22/EGA24197 standard		
	GEV No.	101201	Ref. No. —
	gas tap front part shaft ø 10x8mm shaft L 25/17mm shaft flat upper/lower suitable for PEL22		
	GEV No.	101231	Ref. No. —
	thermocouple nut T1: M9x1 T2: M18x1		
	GEV No.	101240	Ref. No. —
	gas connection thread M20x1.5 tube ø 12/10mm for PEL gas taps with gasket and screws horizontal		
	GEV No.	101460	Ref. No. —
	O-ring ø 12.37mm D1 ø 2.62mm suitable for PEL22		
	GEV No.	101461	Ref. No. —
	screw kit suitable for PEL22 Qty 4 pcs		
accessories for	101086		
	GEV No.	100908	Ref. No. 94812587 RX94812587
	union screw thread M10x1 for pipe ø 4mm Qty 1 pcs		
	GEV No.	100909	Ref. No. —
	union screw thread M10x1 for pipe ø 6mm Qty 1 pcs		
	GEV No.	101241	Ref. No. —
	gas connection thread M20x1.5 tube ø 12/10mm for PEL gas taps vertical		
	GEV No.	101246	Ref. No. 94812588 RX94812588
	olive for pipe ø 4mm Qty 1 pcs		
	GEV No.	101248	Ref. No. 94810978 RX94810978
	olive for pipe ø 12mm Qty 1 pcs suitable for PEL		
	GEV No.	101249	Ref. No. —
	olive for pipe ø 10mm Qty 1 pcs		
	GEV No.	101250	Ref. No. —
	union nut thread M20x1.5 for pipe ø 10mm		
	GEV No.	101251	Ref. No. —
	union nut thread M20x1.5 for pipe ø 12mm		
	GEV No.	101286	Ref. No. —
	olive ID ø 6mm Qty 1 pcs		

accessories for	101086		
	GEV No.	110080	Ref. No. —
	knob ø 70mm shaft ø 10x8mm shaft flat universal		
	GEV No.	112206	Ref. No. —
	knob dial plate silver gas tap PEL21/22/23 t.max.°C ED ø 63mm ID ø 45.5mm		

			
GEV No.	106159	Ref. No.	RX94020484
description	gas tap PEL type 22S/O gas inlet M20x1.5 (tube ø 12mm) bypass nozzle ø 0.35mm gas outlet M20x1.5 (tube ø 12/10mm) thermocouple connection M9x1 pilot connection M10x1 shaft ø 8x8mm shaft L 46/21mm shaft flat diagonal		
spare parts for	106159		
	GEV No.	101058	Ref. No. 244761275 RX244761275
	magnet unit L 39mm D1 ø 15.4mm D2 ø 13.5mm suitable for PEL22/EGA24197 standard		
	GEV No.	101231	Ref. No. —
	thermocouple nut T1: M9x1 T2: M18x1		
accessories for	106159		
	GEV No.	101248	Ref. No. 94810978 RX94810978
	olive for pipe ø 12mm Qty 1 pcs suitable for PEL		
	GEV No.	101249	Ref. No. —
	olive for pipe ø 10mm Qty 1 pcs		
	GEV No.	101250	Ref. No. —
	union nut thread M20x1.5 for pipe ø 10mm		
	GEV No.	101251	Ref. No. —
	union nut thread M20x1.5 for pipe ø 12mm		

23S/O series



			
GEV No.	101092	Ref. No.	94805462 RX94805462
description	gas tap PEL type 23S/O gas inlet M28x1.5 (tube ø 20mm) bypass nozzle ø 0.35mm gas outlet M24x1.5 (tube ø 16mm) thermocouple connection M10x1 pilot connection M10x1 shaft ø 10x8mm shaft L 25/17mm shaft flat upper		
spare parts for	101092		
	GEV No.	100455	Ref. No. —
	bypass nozzle type PEL23/24 bore ø 0.35mm thread M8x0.5		

Table continues overleaf





spare parts for		101092	
	GEV No.	101059	Ref. No. RX244761276
magnet unit T1: M10x1 T2: M22x1 L 46mm ø 18mm suitable for PEL23S M10x1			
	GEV No.	101204	Ref. No. —
gas tap front part shaft ø 10x8mm shaft L 25/17mm shaft flat upper/lower suitable for PEL23S			
	GEV No.	101244	Ref. No. —
gas connection thread M24x1.5 tube ø 12/16mm horizontal for PEL gas taps			
	GEV No.	101463	Ref. No. —
screw suitable for PEL23S Qty 4 pcs			
	GEV No.	528455	Ref. No. —
O-ring Viton thickness 2.62mm ID ø 18.72mm Qty 1 pcs			
accessories for		101092	
	GEV No.	100908	Ref. No. 94812587 RX94812587
union screw thread M10x1 for pipe ø 4mm Qty 1 pcs			
	GEV No.	100909	Ref. No. —
union screw thread M10x1 for pipe ø 6mm Qty 1 pcs			
	GEV No.	101246	Ref. No. 94812588 RX94812588
olive for pipe ø 4mm Qty 1 pcs			
	GEV No.	101252	Ref. No. —
union nut thread M24x1.5 for pipe ø 12mm			
	GEV No.	101253	Ref. No. —
union nut thread M24x1.5 PEL for pipe ø 16mm			
	GEV No.	101254	Ref. No. —
union nut thread M28x1.5 tube ø 20mm			
	GEV No.	101255	Ref. No. —
olive for pipe ø 12mm Qty 1 pcs			
	GEV No.	101256	Ref. No. —
olive for pipe ø 16mm Qty 1 pcs			
	GEV No.	101257	Ref. No. —
olive for pipe ø 20mm Qty 1 pcs			
	GEV No.	101286	Ref. No. —
olive ID ø 6mm Qty 1 pcs			
	GEV No.	110080	Ref. No. —
knob ø 70mm shaft ø 10x8mm shaft flat universal			
	GEV No.	112206	Ref. No. —
knob dial plate silver gas tap PEL21/22/23 t.max.°C ED ø 63mm ID ø 45.5mm			

			
1			
GEV No.	109123	Ref. No.	9402049 94020492 RX94020492
description	gas tap PEL type 23S/O gas inlet M28x1.5 (tube ø 20mm) bypass nozzle ø 0mm gas outlet M24x1.5 (tube ø 16mm) thermocouple connection M9x1 pilot connection M10x1 shaft ø 8x8mm shaft L 46/21mm shaft flat diagonal		
spare parts for		109123	
	GEV No.	100909	Ref. No. —
union screw thread M10x1 for pipe ø 6mm Qty 1 pcs			
	GEV No.	101253	Ref. No. —
union nut thread M24x1.5 PEL for pipe ø 16mm			
	GEV No.	101254	Ref. No. —
union nut thread M28x1.5 tube ø 20mm			
	GEV No.	101256	Ref. No. —
olive for pipe ø 16mm Qty 1 pcs			
	GEV No.	101257	Ref. No. —
olive for pipe ø 20mm Qty 1 pcs			
	GEV No.	101286	Ref. No. —
olive ID ø 6mm Qty 1 pcs			
accessories for		109123	
	GEV No.	100909	Ref. No. —
union screw thread M10x1 for pipe ø 6mm Qty 1 pcs			
	GEV No.	101253	Ref. No. —
union nut thread M24x1.5 PEL for pipe ø 16mm			
	GEV No.	101254	Ref. No. —
union nut thread M28x1.5 tube ø 20mm			
	GEV No.	101256	Ref. No. —
olive for pipe ø 16mm Qty 1 pcs			
	GEV No.	101257	Ref. No. —
olive for pipe ø 20mm Qty 1 pcs			
	GEV No.	101286	Ref. No. —
olive ID ø 6mm Qty 1 pcs			



miscellaneous

			
1			
GEV No.	109121	Ref. No.	94019874 RX94019874
description	gas tap gas inlet pipe flange ø23mm bypass nozzle ø 0.45mm gas outlet M14x1.5 (tube ø 6mm) external nozzle ømm pilot connection thermocouple connection shaft ø 6x4.6mm shaft L 35/24mm shaft flat upper		

			
1			
GEV No.	101409	Ref. No.	RX94805660

description	gas thermostat type 630 Eurosit series t.max. 280°C 40-280°C gas inlet 3/8" gas outlet 3/8" thermocouple connection M9x1 pilot connection M10x1 probe ø 4mm probe L 72mm capillary pipe 1050mm SIT		
--------------------	--	--	--

spare parts for	101409		
------------------------	--------	--	--

	GEV No.	101333	Ref. No.	—
	plug thread 3/8" with O-ring			

accessories for	101409		
------------------------	--------	--	--

	GEV No.	100904	Ref. No.	—
	locking screw M10x1 for pipe ø 4mm Qty 1 pcs			

	GEV No.	100905	Ref. No.	—
	locking screw M10x1 for pipe ø 6mm Qty 1 pcs			

	GEV No.	101273	Ref. No.	—
	olive for pipe ø 12mm L 9.5mm brass Qty 1 pcs suitable for universal			

	GEV No.	101276	Ref. No.	—
	union screw thread 3/8" tube ø 12mm Qty 1 pcs			

gas thermostats

SIT

630 Eurosit series

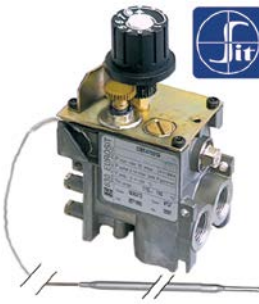
			
1			

GEV No.	101188	Ref. No.	94812670 RX94812670
description	gas thermostat type 630 Eurosit series t.max. 190°C 110-190°C gas inlet 3/8" gas outlet 3/8" thermocouple connection M9x1 pilot connection M10x1 probe ø 4mm probe L 202mm capillary pipe 1050mm SIT		

accessories for	101188		
------------------------	--------	--	--

	GEV No.	100904	Ref. No.	—
	locking screw M10x1 for pipe ø 4mm Qty 1 pcs			

	GEV No.	100905	Ref. No.	—
	locking screw M10x1 for pipe ø 6mm Qty 1 pcs			

	GEV No.	101273	Ref. No.	—
	olive for pipe ø 12mm L 9.5mm brass Qty 1 pcs suitable for universal			

	GEV No.	101276	Ref. No.	—
	union screw thread 3/8" tube ø 12mm Qty 1 pcs			

	GEV No.	101333	Ref. No.	—
	plug thread 3/8" with O-ring			

			
1			

GEV No.	101125	Ref. No.	94044054 RX94044054
----------------	--------	-----------------	------------------------

description	gas thermostat type 630 Eurosit series t.max. 340°C 100-340°C gas inlet 3/8" gas outlet 3/8" thermocouple connection M9x1 pilot connection M10x1 probe ø 4mm probe L 72mm capillary pipe 1050mm SIT		
--------------------	---	--	--

accessories for	101125		
------------------------	--------	--	--

	GEV No.	100825	Ref. No.	—
	gas tap spindle shaft ø 8x6.5mm shaft L 22/14mm suitable for EUROSIT			

	GEV No.	100904	Ref. No.	—
	locking screw M10x1 for pipe ø 4mm Qty 1 pcs			

	GEV No.	100905	Ref. No.	—
	locking screw M10x1 for pipe ø 6mm Qty 1 pcs			

	GEV No.	100949	Ref. No.	—
	gasket suitable for 630 Eurosit series			

Table continues overleaf



accessories for		101125		
GEV No.		101273	Ref. No.	—
	olive for pipe ø 12mm L 9.5mm brass Qty 1 pcs suitable for universal			
	union screw thread 3/8" tube ø 12mm Qty 1 pcs			
	plug thread 3/8" with O-ring			
	gas tap spindle shaft ø 6x4.6mm shaft L 32/15mm gas tap with ignition flame suitable for ZANUSSI, MARENO for gas thermostat EUROSIT			
	adapter suitable for 630 Eurosit series			
	gas tap spindle shaft ø 8x6.5mm shaft L 36/12mm suitable for 630 Eurosit series			
	adapter shaft ø 10x8mm shaft L 29/18mm suitable for 630 Eurosit series			

accessories for		101135		
GEV No.		101054	Ref. No.	—
	magnet unit T1: M10x1 T2: M24x1 L 45mm ø 17mm suitable for Minisit			
	piezoelectric igniter suitable for Minisit with cover cap ømm connection F6.3x0.8			
	cover cap without piezoelectric igniter			
	reducer IT 3/8" ET 1/2" L 21mm			
	gas connection thread 3/8" angled with O-ring MINISIT 710			
	gas connection thread 1/2" angled with O-ring MINISIT 710			
	screw connection IT 3/8" ET 3/8" L 28mm			
	screw connection IT 1/2" ET 3/8" L 57mm			
	olive for pipe ø 12mm L 9.5mm brass Qty 1 pcs suitable for universal			
	olive for pipe ø 16mm Qty 1 pcs			
	union screw thread 1/2" for pipe ø 16mm Qty 1 pcs			
	union screw thread 3/8" tube ø 12mm Qty 1 pcs			
	knob suitable for Minisit ø 37mm			RX26645036

710 Minisit series

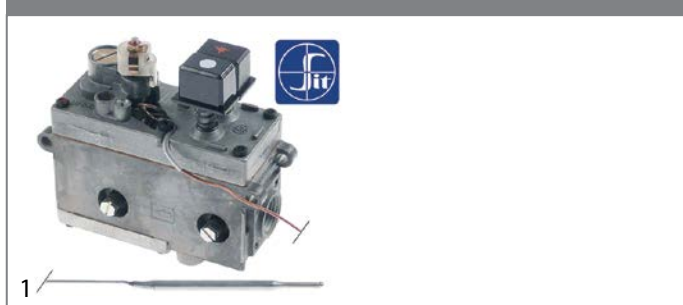





GEV No.	101135	Ref. No.	94805793 RX94805793	
description	gas thermostat SIT type MINISIT 710 t.max. 190°C 110-190°C gas inlet 1/2" gas outlet 3/8" thermocouple connection M9x1 pilot connection M10x1 probe ø 6mm probe L 102mm capillary pipe 1050mm probe type type A3 pressure controller no pressure regulator mbar gland nut			
spare parts for	101135			
	GEV No.	101053	Ref. No.	N/A
	GEV No.	102118	Ref. No.	—
accessories for	101135			
	GEV No.	100809	Ref. No.	—
	GEV No.	100820	Ref. No.	RX94008893
	GEV No.	100904	Ref. No.	—
	GEV No.	100905	Ref. No.	—

GEV No.	106931	Ref. No.	94024916 RX94024916	
description	gas thermostat SIT type MINISIT 710 t.max. 310°C 70-310°C gas inlet 1/2" gas outlet 3/8" thermocouple connection M9x1 pilot connection M10x1 probe ø 4mm probe L 72mm capillary pipe 1300mm pressure controller no pressure regulator mbar gland nut 0710647 ignition gas 6mm probe material stainless steel			
accessories for	106931			
	GEV No.	101137	Ref. No.	—

Table continues overleaf

accessories for 106931			
	GEV No.	110068	Ref. No. RX26645036
knob suitable for Minisit ø 37mm			















GEV No.	107237	Ref. No.	N/A
description	gas thermostat without cap, button and angle SIT type MINISIT 710 t.max. 210°C 70-210°C gas inlet 1/2" gas outlet 3/8" thermocouple connection M9x1 pilot connection M10x1 probe ø 4mm probe L 122mm capillary pipe 1300mm probe type pressure controller no pressure regulator bar gland nut		
accessories for 107237			
	GEV No.	101137	Ref. No. —
cover cap without piezoelectric igniter			
	GEV No.	101267	Ref. No. —
reducer IT 3/8" ET 1/2" L 21mm			
	GEV No.	101268	Ref. No. —
gas connection thread 3/8" angled with O-ring MINISIT 710			
	GEV No.	110068	Ref. No. RX26645036
knob suitable for Minisit ø 37mm			

PEL

24ST series





GEV No.	101076	Ref. No.	94806536 RX94806536
description	gas thermostat PEL type 24ST 120-320°C gas inlet M20x1.5 (tube ø 12mm) bypass nozzle ø 0.35mm gas outlet M20x1.5 (tube ø 12/10mm) thermocouple connection M9x1 pilot connection M10x1 capillary pipe 1200mm probe ø 6mm probe L 100mm shaft ø 10x8mm shaft L 27/17mm shaft flat upper		
spare parts for 101076			
	GEV No.	100455	Ref. No. —
bypass nozzle type PEL23/24 bore ø 0.35mm thread M8x0.5			
	GEV No.	101058	Ref. No. 244761275 RX244761275
magnet unit L 39mm D1 ø 15.4mm D2 ø 13.5mm suitable for PEL22/ EGA24197 standard			
	GEV No.	106200	Ref. No. —
nut thread M9x1 suitable for PEL 24/25S			

accessories for 101076			
	GEV No.	100908	Ref. No. 94812587 RX94812587
union screw thread M10x1 for pipe ø 4mm Qty 1 pcs			
	GEV No.	100909	Ref. No. —
union screw thread M10x1 for pipe ø 6mm Qty 1 pcs			
	GEV No.	101246	Ref. No. 94812588 RX94812588
olive for pipe ø 4mm Qty 1 pcs			
	GEV No.	101248	Ref. No. 94810978 RX94810978
olive for pipe ø 12mm Qty 1 pcs suitable for PEL			
	GEV No.	101249	Ref. No. —
olive for pipe ø 10mm Qty 1 pcs			
	GEV No.	101250	Ref. No. —
union nut thread M20x1.5 for pipe ø 10mm			
	GEV No.	101251	Ref. No. —
union nut thread M20x1.5 for pipe ø 12mm			
	GEV No.	101286	Ref. No. —
olive ID ø 6mm Qty 1 pcs			
	GEV No.	110079	Ref. No. —
knob dial plate gas thermostat 1-8 silver			
	GEV No.	110080	Ref. No. —
knob ø 70mm shaft ø 10x8mm shaft flat universal			

ROBERTSHAW



GEV No.	580062	Ref. No.	RX24801326
description	gas thermostat type BJW 93-287°C 200-550°F gas inlet flange (tube ø 5/16") bypass nozzle ømm gas outlet 3/8" NPT thermocouple connection pilot connection 5/16" UNEF capillary pipe 48" - 1220mm probe ø 3/16" - 4.7mm probe L 11 1/4" - 285mm ROBERTSHAW pipe input ø 7/16" pipe output ø 7/16"		
accessories for 580062			
	GEV No.	106659	Ref. No. —
gas connection suitable for thermostat			
	GEV No.	112547	Ref. No. —
knob gas thermostat t.max. 500°F 200-500°F ø 49mm shaft ømm shaft flat ROBERTSHAW black			



gas valves and ignition boxes



gas control valves

ROBERTSHAW

millivolt controlled valves



1





GEV No.	106123	Ref. No.	RX24867038
description	gas valve supply Operator millivolt gas inlet 3/4" NPT gas outlet 3/4" NPT thermocouple connection pilot connection 1/4" CCT pressure regulator mbar type 7000BMV-S7CL pressure controller no suitable for ROBERTSHAW		
spare parts for	106123		
	GEV No.	106109	Ref. No. —
	locking screw thread 7/16"-24 UNS for pipe ø 1/4" L 16mm brass Qty 1 pcs WS 7/16" (11.113mm) hole ø 6.4mm		
	GEV No.	580033	Ref. No. RX26645069
	knob suitable for ROBERTSHAW		





SIT

ELETTROSIT



1

GEV No.	101127	Ref. No.	RX94024965
description	gas valve SIT type ELETTROSIT 230V gas inlet 3/4" gas outlet 3/4" thermocouple connection M9x1 pilot connection M10x1 lateral equiv. no. 0.810.175		
spare parts for	101127		
	GEV No.	101312	Ref. No. 94034683 RX94034683
	microswitch		
	GEV No.	101352	Ref. No. —
	solenoid coil 230V 50Hz suitable for ELETTROSIT		
accessories for	101127		
	GEV No.	100006	Ref. No. —
	piezoelectric igniter suitable for ELETTROSIT body plastic blowing connection ø2.4mm ø 14mm		
	GEV No.	100904	Ref. No. —
	locking screw M10x1 for pipe ø 4mm Qty 1 pcs		

accessories for	101127		
	GEV No.	100905	Ref. No. —
	locking screw M10x1 for pipe ø 6mm Qty 1 pcs		
	GEV No.	101301	Ref. No. —
	gas connection thread 1/2" straight ELETTROSIT screw with O-ring		
	GEV No.	101303	Ref. No. —
	gas connection straight thread 3/4" ELETTROSIT		
	GEV No.	101309	Ref. No. —
	extension		

NOVASIT

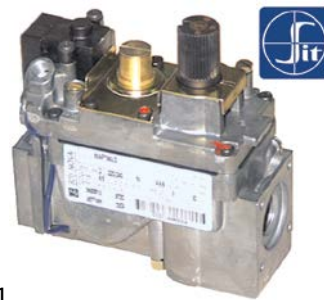

1











GEV No.	101162	Ref. No.	9402374 RX94023744
description	gas valve SIT series Novasit 820 230V 50Hz gas inlet 1/2" gas outlet 1/2" thermocouple connection M9x1 pilot connection M10x1 ignition pressure 3-5mbar pressure range 3-30mbar pressure regulator connection blind equiv. no. 0.820.010		
spare parts for	101162		
	GEV No.	101065	Ref. No. —
	magnet unit with cable L 44mm D1 ø 30mm D2 ø 20mm suitable for NOVASIT		
	GEV No.	101313	Ref. No. —
	solenoid coil 230V 50Hz		
accessories for	101162		
	GEV No.	100006	Ref. No. —
	piezoelectric igniter suitable for ELETTROSIT body plastic blowing connection ø2.4mm ø 14mm		
	GEV No.	101305	Ref. No. —
	gas connection straight 1/2" flange 45x45mm ELETTROSIT/V4400/4600/4605 suitable for SIT/HONEYWELL hole distance 36x36mm		
	GEV No.	101306	Ref. No. —
	gas connection angled flange 45x45mm hole distance 36x36mm 1/2" ELETTROSIT/V4400/4600/4605 screw with O-ring suitable for SIT/HONEYWELL		
	GEV No.	101307	Ref. No. —
	gas connection straight flange 45x45mm hole distance 36x36mm 3/4" ELETTROSIT/V4400/4600/4605 screw with O-ring suitable for SIT/HONEYWELL		
	GEV No.	101308	Ref. No. —
	gas connection angled flange 45x45mm hole distance 36x36mm 3/4" ELETTROSIT/V4400/4600/4605 screw with O-ring suitable for SIT/HONEYWELL		
	GEV No.	101312	Ref. No. 94034683 RX94034683
	microswitch		

Table continues overleaf

accessories for		101162		
GEV No.	101314	Ref. No.	—	
	solenoid coil 24V 50Hz			
GEV No.	101317	Ref. No.	—	
	plug with cable L 1000mm suitable for NOVASIT			
GEV No.	101318	Ref. No.	—	
	cover cap for solenoid coil suitable for NOVASIT			

ignition boxes

HONEYWELL

Honeywell



1	GEV No.	104598	Ref. No.	RX94045529
description ignition box HONEYWELL type S4565XXXXX electrodes 3 waiting times safety time 10s 220-240V 4VA 50/60Hz				





ignition parts



pilot burners

SIT

100 series



1	GEV No.	106906	Ref. No.	94034659 RX94027471 RX94034659
description pilot burner SIT type 100 series 3 flames nozzle \varnothing 0.2mm gas connection 6mm				
spare parts for		106906		
GEV No.	100245	Ref. No.	—	
	pilot burner nozzle LPG code 20 bore \varnothing 0.2mm Qty 1 pcs thread M8x0.75			
GEV No.	100855	Ref. No.	RX94028602 RX94028604	
	pilot burner bracket triple			
GEV No.	100885	Ref. No.	—	
	air mixing sleeve for pilot burner Qty 1 pcs			
GEV No.	100916	Ref. No.	—	
	compression spring for pilot burner Qty 1 pcs			
GEV No.	100917	Ref. No.	—	
	gasket for pilot burner Qty 1 pcs aluminium			

spare parts for		106906		
GEV No.	100918	Ref. No.	—	
	screw for pilot burner			
GEV No.	107162	Ref. No.	—	
	pilot burner cap SIT 3 flames Hmm Lmm Qty 1 pcs			
GEV No.	107701	Ref. No.	—	
	pilot burner bottom part SIT 100 series nozzle \varnothing 0.2mm			

accessories for		106906		
GEV No.	100245	Ref. No.	—	
	pilot burner nozzle LPG code 20 bore \varnothing 0.2mm Qty 1 pcs thread M8x0.75			
GEV No.	100246	Ref. No.	—	
	pilot burner nozzle natural gas bore \varnothing 0.35mm Qty 1 pcs thread M8x0.75			
GEV No.	100904	Ref. No.	—	
	locking screw M10x1 for pipe \varnothing 4mm Qty 1 pcs			
GEV No.	100905	Ref. No.	—	
	locking screw M10x1 for pipe \varnothing 6mm Qty 1 pcs			
GEV No.	102110	Ref. No.	—	
	pilot tube copper pipe \varnothing 4mm thickness 1mm L 3000mm			
GEV No.	102111	Ref. No.	—	
	pilot tube copper pipe \varnothing 6mm thickness 1mm L 3000mm			
GEV No.	107171	Ref. No.	94812644 RX94812644	
	pilot burner nozzle SIT natural/liquid gas bore \varnothing 0.25mm Qty 1 pcs			
GEV No.	107700	Ref. No.	—	
	pilot burner bottom part SIT 100 series nozzle \varnothing 0.25mm			
GEV No.	107702	Ref. No.	—	
	pilot burner bottom part SIT 100 series nozzle \varnothing 0.35mm			





accessories

pilot burner caps



1	GEV No.	100837	Ref. No.	RX94034634
description pilot burner cap 3 flames H 24mm L 48mm Qty 1 pcs				

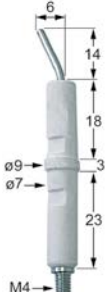

pilot burner brackets			
universal			
 <p>1</p>			
GEV No.	100855	Ref. No.	RX94028602 RX94028604
description	pilot burner bracket triple		
accessories for	100855		
			
GEV No.	100855	Ref. No.	RX94028602 RX94028604
description	pilot burner bracket triple		
			
GEV No.	100886	Ref. No.	—
description	pilot burner bracket suitable for 100 series 3-piece		
			
GEV No.	100888	Ref. No.	—
description	screw bolt for pilot burner		

ignition electrodes			
 <p>1</p>			
GEV No.	100706	Ref. No.	RX94034642 RX94805207
description	ignition electrode connection M4 Qty 1 pcs		

 <p>1</p>			
GEV No.	100707	Ref. No.	94027729 RX94027729
description	ignition electrode D1 ø 7mm D2 ø 9mm connection ø2.4mm L1 14mm L2 6mm BL1 18mm BL2 3mm BL3 23mm to clip Qty 1 pcs		

140 - 145 -150 series			
 <p>1</p>			
GEV No.	107114 ¹	Ref. No.	94805041 RX94805041
description	pilot burner SIT type 140 series 2 flames nozzle ømm gas connectionmm		
spare parts for	107114		
			
GEV No.	100907	Ref. No.	94805090 RX94805090
description	screw connection thread M10x1 Qty 1 pcs type SEF 1 ømm for thermocouple		
accessories for	107114		
			
GEV No.	100204	Ref. No.	—
description	pilot burner nozzle SIT LPG code 14 bore ø 0.18/0.20mm Qty 1 pcs suitable for 140 series		
			
GEV No.	100205	Ref. No.	RX822140380
description	pilot burner nozzle SIT LPG code 19 bore ø 0.23/0.26mm Qty 1 pcs suitable for SIT 150 series		
			
GEV No.	100206	Ref. No.	—
description	pilot burner nozzle SIT natural gas code 36 bore ø 0.60/0.55mm Qty 1 pcs suitable for SIT 150 series		
			
GEV No.	100207	Ref. No.	RX822140120
description	pilot burner nozzle SIT natural gas code 27 bore ø 0.40/0.38mm suitable for SIT 140 series		
			
GEV No.	100216	Ref. No.	—
description	pilot burner nozzle SIT natural gas code 38 bore ø 0.45mm Qty 1 pcs suitable for SIT 150 series		
			
GEV No.	100701	Ref. No.	RX94805066 RX94805306 RX94805686
description	ignition electrode connection M4 Qty 1 pcs		
			
GEV No.	100801	Ref. No.	—
description	gasket for pilot burner Qty 1 pcs		
			
GEV No.	100897	Ref. No.	—
description	olive for pipe ø 4mm Qty 1 pcs for pilot burner		
			
GEV No.	100898	Ref. No.	—
description	olive for pipe ø 6mm Qty 1 pcs for pilot burner		
			
GEV No.	100906	Ref. No.	94805082 RX94805082
description	screw connection thread M10x1 for ignition electrode brass Qty 1 pcs WS 10		
			
GEV No.	100908	Ref. No.	94812587 RX94812587
description	union screw thread M10x1 for pipe ø 4mm Qty 1 pcs		
			
GEV No.	100909	Ref. No.	—
description	union screw thread M10x1 for pipe ø 6mm Qty 1 pcs		
			
GEV No.	102110	Ref. No.	—
description	pilot tube copper pipe ø 4mm thickness 1mm L 3000mm		
			
GEV No.	102111	Ref. No.	—
description	pilot tube copper pipe ø 6mm thickness 1mm L 3000mm		

¹incl. thermocouple fitting



POLIDORO

pilot burners



GEV No.	102295	Ref. No.	94034485 RX94034485
description	pilot burner POLIDORO 3 flames code gas connection 4mm		
spare parts for	102295		
	GEV No.	100907	Ref. No. 94805090 RX94805090
	screw connection thread M10x1 Qty 1 pcs type SEF 1 ømm for thermocouple		
accessories for	102295		
	GEV No.	100208	Ref. No. —
	pilot burner nozzle POLIDORO LPG code 20 bore ø 0.2mm Qty 1 pcs		
	GEV No.	100209	Ref. No. —
	pilot burner nozzle POLIDORO natural gas code 40 bore ø 0.4mm Qty 1 pcs		
	GEV No.	100701	Ref. No. RX94805066 RX94805306 RX94805686
	ignition electrode connection M4 Qty 1 pcs		
	GEV No.	100906	Ref. No. 94805082 RX94805082
	screw connection thread M10x1 for ignition electrode brass Qty 1 pcs WS 10		
	GEV No.	100908	Ref. No. 94812587 RX94812587
	union screw thread M10x1 for pipe ø 4mm Qty 1 pcs		
	GEV No.	100909	Ref. No. —
	union screw thread M10x1 for pipe ø 6mm Qty 1 pcs		
	GEV No.	101280	Ref. No. —
	olive for pipe ø 4mm Qty 1 pcs		
	GEV No.	101287	Ref. No. —
	olive for pipe ø 6mm Qty 1 pcs		
	GEV No.	102110	Ref. No. —
	pilot tube copper pipe ø 4mm thickness 1mm L 3000mm		
	GEV No.	102111	Ref. No. —
	pilot tube copper pipe ø 6mm thickness 1mm L 3000mm		

AEM

pilot burners



GEV No.	107529	Ref. No.	RX94044476
description	pilot burner 1 flame LPG nozzle ø 0.22mm gas connection 6mm		



GEV No.	107528	Ref. No.	RX94044477
description	pilot burner 1 flame natural gas nozzle ø 0.4mm gas connection 6mm		

producer-specific pilot burners

ROSINOX



GEV No.	107529	Ref. No.	RX94044476
description	pilot burner 1 flame LPG nozzle ø 0.22mm gas connection 6mm		



GEV No.	107528	Ref. No.	RX94044477
description	pilot burner 1 flame natural gas nozzle ø 0.4mm gas connection 6mm		



electrodes

GEV No.	100701	Ref. No.	RX94805066 RX94805306 RX94805686
description	ignition electrode connection M4 Qty 1 pcs		
accessories for	100701		
	GEV No.	100906	Ref. No. 94805082 RX94805082
description	screw connection thread M10x1 for ignition electrode brass Qty 1 pcs WS 10		

GEV No.	100706	Ref. No.	RX94034642 RX94805207
description	ignition electrode connection M4 Qty 1 pcs		

GEV No.	102907	Ref. No.	9404421 RX94044214
description	ignition electrode D1 ø 7mm connection F 2.8x0.8mm L1 6mm L2 6mm L3 16mm BL1 50mm to clip		

GEV No.	100732	Ref. No.	RX94805157
description	ignition electrode D1 ø 7mm D2 ø 8.5mm cable length 1750mm BL1 28mm BL2 3mm BL3 23mm to clip connection ø 2.4mm		

GEV No.	100733	Ref. No.	94805132 RX94805132
description	ignition electrode D1 ø 7mm D2 ø 8.5mm cable length 600mm BL1 28mm BL2 3mm BL3 23mm to clip connection ø 2.4mm		

GEV No.	100746	Ref. No.	RX94805140
description	ignition electrode D1 ø 7mm D2 ø 8.5mm cable length 950mm BL1 28mm BL2 3mm BL3 23mm connection ø 2.4mm		

GEV No.	102314	Ref. No.	94034493 RX94034493
description	ignition electrode D1 ø 7mm D2 ø 9mm connection M4 L1 2mm BL1 28mm BL2 3mm BL3 23mm to clip		

GEV No.	100707	Ref. No.	94027729 RX94027729
description	ignition electrode D1 ø 7mm D2 ø 9mm connection ø2.4mm L1 14mm L2 6mm BL1 18mm BL2 3mm BL3 23mm to clip Qty 1 pcs		

GEV No.	100729	Ref. No.	RX94805033
description	ignition electrode L1 5mm D1 ø 8mm D2 ø 10mm BL1 41mm BL2 14mm connection F 2.8x0.8mm to clip with spring		

GEV No.	106525	Ref. No.	94814239 RX94814239
description	ignition electrode set Qty 2 flange length 23mm flange width 15/17mm D1 ø 7/9.5mm L1 80/45mm BL1 33/48mm BL2 57/47mm connection F2.8x0.8 fixing dimensions ø4.5mm		

GEV No.	106516	Ref. No.	RX94805066 RX94805306 RX94805686
description	monitoring electrode D1 ø 7mm D2 ø 8mm connection M4 L1 19mm BL1 18mm BL2 3mm BL3 22mm		

GEV No.	109120	Ref. No.	94051521 RX94051521
description	monitoring electrode flange length 48mm D1 ø 8mm flange width 22.5mm L1 62mm BL1 11mm BL2 8mm connection male faston 6.3mm		

GEV No.	100906	Ref. No.	94805082 RX94805082
description	screw connection thread M10x1 for ignition electrode brass Qty 1 pcs WS 10		

ignition cables

pre-assembled cables

GEV No.	100176	Ref. No.	94805322 RX94805322
description	ignition cable cable length 1000mm connection ø2.4mm / ø4mm permanent temperature 200°C		

GEV No.	107591	Ref. No.	RX94045460
description	ignition cable cable length 1500mm connection F2.8mm / F2.8mm 6mm ² silicone		

GEV No.	102158	Ref. No.	94805199 RX94805199
description	ignition cable cable length 1750mm connection ø4mm / F2.8mm		

GEV No.	100019	Ref. No.	94805694 RX94805694
description	ignition cable cable length 900mm connection ø2.4mm / ø4mm		



piezoelectric igniters

mounting diameter 18mm



GEV No.	100009	Ref. No.	RX94061157 RX94805009
description	piezoelectric igniter body plastic blowing mounting ø 18mm connection ø2.4mm front measurements 26mm M18x1.5		
accessories for	100009		
	GEV No.	101339	Ref. No. —
	cover cap for piezoelectric igniter		
	GEV No.	106869	Ref. No. —
	cover cap for piezoelectric igniter ID ø 22mm ED ø 35mm H 25mm		
	GEV No.	107931	Ref. No. —
	cover cap for piezoelectric igniter ID ø 21mm ED ø 36mm		

ignition units



GEV No.	101002	Ref. No.	RX94027802
description	ignition unit outputs 2 230VAC dimensions 88x23x34mm mounting distance 73mm inlet F6.3x0.8 outlet F2.8x0.8 0.6VA 50/60Hz		

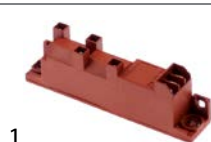

GEV No.	102388	Ref. No.	94039229 94805116 RX94039229 RX94805116
description	ignition unit outputs 4 230VAC dimensions 111x23x34mm mounting distance 100mm inlet F6.3x0.8 outlet F2.8x0.8 type WAC-T4 0.6VA 50/60Hz		

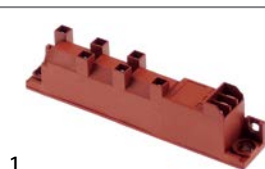

GEV No.	102389	Ref. No.	94805124 RX94805124
description	ignition unit outputs 6 230VAC dimensions 135x23x34mm mounting distance 123mm inlet F6.3x0.8 outlet F2.8x0.8 0.6VA 50/60Hz		

ignition switches



GEV No.	345038	Ref. No.	94805173 RX94805173
description	momentary push switch mounting ø 25mm black 2NO 250V 16A connection male faston 6.3mm ambient temperature max. 85°C protection IP40		

thermocouples

plug-in thermocouples

plug-in thermocouples standard

with barrel socket ø6(6.5)mm

thermocouples SIT

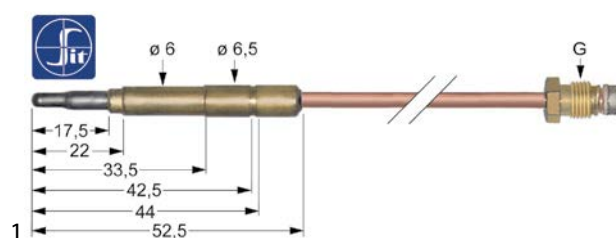

GEV No.	107612	Ref. No.	RX94024973
description	thermocouple SIT M9x1 L 1000mm plug connection ø6.0(6.5)mm		

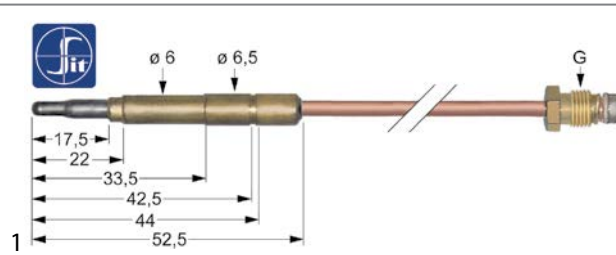

GEV No.	107614	Ref. No.	RX94015112
description	thermocouple SIT M9x1 L 1500mm plug connection ø6.0(6.5)mm		

thermocouples with aluminised tip

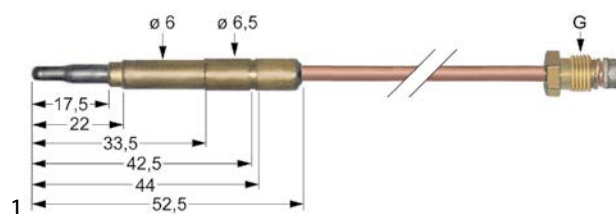

GEV No.	102043	Ref. No.	RX94024973
description	thermocouple M9x1 L 1000mm plug connection ø6.0(6.5)mm		



threaded thermocouples

threaded thermocouples standard

with socket with thread M8x1

SIT

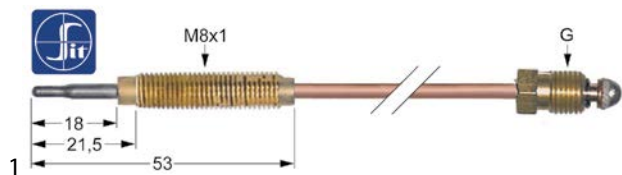

GEV No.	107636	Ref. No.	94805025 RX94805025	
description	thermocouple SIT M9x1 L 600mm M8x1			
accessories for	107636			
	GEV No.	102067	Ref. No.	—
	nut thread M8x1 H 3mm brass Qty 1 pcs type SEF 1			

thermopiles

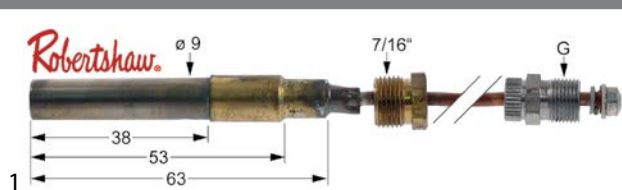

GEV No.	580035	Ref. No.	RX24802365
description	thermopile L 36" - 915mm probe ø 9mm probe L 38mm 250-750mV screw connection 7/16" connection 3/8" NEF		

gas burners

hob burners

universal hob burners

GEV



GEV No.	103068	Ref. No.	RX94805587	
description	burner cap ø 100mm			
accessories for	103068			
	GEV No.	103067	Ref. No.	94805595 RX94805595
	burner ring for burner cap ø 100mm			
	GEV No.	104102	Ref. No.	RX94805603
	burner head for burner cap ø 100mm ext. ø 130			
	GEV No.	104103	Ref. No.	RX94806627
	burner holder suitable for burner ø100mm with nozzle holder			





GEV No.	103066	Ref. No.	RX94805553	
description	burner cap ø 80mm			
accessories for	103066			
	GEV No.	103065	Ref. No.	RX94805561
	burner ring for burner cap ø 80mm			
	GEV No.	104100	Ref. No.	RX94805579
	burner head for burner cap ø 80mm			
	GEV No.	104101	Ref. No.	—
	burner holder for burner cap ø 80mm with nozzle holder with mixing sleeve			





GEV No.	104102	Ref. No.	RX94805603
description	burner head for burner cap ø 100mm ext. ø 130		

GEV No.	104100	Ref. No.	RX94805579	
description	burner head for burner cap ø 80mm			
accessories for	104100			
	GEV No.	103065	Ref. No.	RX94805561
	burner ring for burner cap ø 80mm			
	GEV No.	103066	Ref. No.	RX94805553
	burner cap ø 80mm			
	GEV No.	104103	Ref. No.	RX94806627
	burner holder suitable for burner ø100mm with nozzle holder			

GEV No.	104103	Ref. No.	RX94806627	
description	burner holder suitable for burner ø100mm with nozzle holder			
accessories for	104103			
	GEV No.	103067	Ref. No.	94805595 RX94805595
	burner ring for burner cap ø 100mm			
	GEV No.	103068	Ref. No.	RX94805587
	burner cap ø 100mm			
	GEV No.	104102	Ref. No.	RX94805603
	burner head for burner cap ø 100mm ext. ø 130			



			
1			
GEV No.	103067	Ref. No.	94805595 RX94805595
description	burner ring for burner cap ø 100mm		
accessories for	103067		
	GEV No.	103068	Ref. No. RX94805587
	burner cap ø 100mm		
	GEV No.	104102	Ref. No. RX94805603
	burner head for burner cap ø 100mm ext. ø 130		
	GEV No.	104103	Ref. No. RX94806627
	burner holder suitable for burner ø100mm with nozzle holder		

			
1			
GEV No.	103065	Ref. No.	RX94805561
description	burner ring for burner cap ø 80mm		
accessories for	103065		
	GEV No.	103066	Ref. No. RX94805553
	burner cap ø 80mm		
	GEV No.	104100	Ref. No. RX94805579
	burner head for burner cap ø 80mm		
	GEV No.	104101	Ref. No. —
	burner holder for burner cap ø 80mm with nozzle holder with mixing sleeve		

			
1			
GEV No.	107332	Ref. No.	94034675 RX94034675
description	burner for burner cap ø 98mm 6kW complete		
spare parts for	107332		
	GEV No.	108015	Ref. No. 9480004 RX94800265
	burner cap ø 100mm mounting ø 97mm		

			
1			
GEV No.	108015	Ref. No.	9480004 RX94800265
description	burner cap ø 100mm mounting ø 97mm		

			
1			
GEV No.	107333	Ref. No.	9780003 RX94800257
description	burner cap ø 78mm 5kW		

producer-specific hob burners

ROSINOX



Era Chef series

			
1			
GEV No.	107334	Ref. No.	94034667 RX94034667
description	burner for burner cap ø 78mm 5kW complete		





Chef 700 series





			
1			
GEV No.	103069	Ref. No.	RX94800182
description	burner cap ø 80mm 4.3kW with central hole		
accessories for	103069		
	GEV No.	100907	Ref. No. 94805090 RX94805090
	screw connection thread M10x1 Qty 1 pcs type SEF 1 ømm for thermocouple		
	GEV No.	101452	Ref. No. 94806049 RX94806049
	ignition electrode support for burner type C/D suitable for 900 series		
	GEV No.	101453	Ref. No. 94806411 RX94806411
	bracket for thermocouple gas range for burner type C/D suitable for 900 series		
	GEV No.	101454	Ref. No. —
	union screw for igniter thread M10x1 ID ø 7mm L 15mm		
	GEV No.	104104	Ref. No. 94800125 RX94800125
	burner head for burner cap ø 80mm 3.5kW code 100212		









Table continues overleaf

accessories for 103069				
	GEV No.	104105	Ref. No.	94806841 RX94806841
burner lower part for burner cap ø 80mm 3.5kW				
	GEV No.	104108	Ref. No.	—
nozzle holder nozzle mounting M10x1 tube ø 10mm gas inlet M16x1.5 gas outlet M14x1				
	GEV No.	105297	Ref. No.	—
burner head for burner cap ø 80mm 4.3kW for pilot burner				

				
1				
GEV No.	103070	Ref. No.	RX94800174	
description	burner cap ø 95mm 6.4kW with central hole			
accessories for 103070				
	GEV No.	100907	Ref. No.	94805090 RX94805090
screw connection thread M10x1 Qty 1 pcs type SEF 1 ømm for thermocouple				
	GEV No.	101452	Ref. No.	94806049 RX94806049
ignition electrode support for burner type C/D suitable for 900 series				
	GEV No.	101453	Ref. No.	94806411 RX94806411
bracket for thermocouple gas range for burner type C/D suitable for 900 series				
	GEV No.	101454	Ref. No.	—
union screw for igniter thread M10x1 ID ø 7mm L 15mm				
	GEV No.	104106	Ref. No.	94800166 RX94800166
burner head for burner cap ø 100mm 5.5kW for igniter				
	GEV No.	104107	Ref. No.	94806437 RX94806437
burner lower part for burner cap ø 100mm 6.4kW				
	GEV No.	104108	Ref. No.	—
nozzle holder nozzle mounting M10x1 tube ø 10mm gas inlet M16x1.5 gas outlet M14x1				

				
1				
GEV No.	104106	Ref. No.	94800166 RX94800166	
description	burner head for burner cap ø 100mm 5.5kW for igniter			
accessories for 104106				
	GEV No.	100907	Ref. No.	94805090 RX94805090
screw connection thread M10x1 Qty 1 pcs type SEF 1 ømm for thermocouple				
	GEV No.	101452	Ref. No.	94806049 RX94806049
ignition electrode support for burner type C/D suitable for 900 series				
	GEV No.	101453	Ref. No.	94806411 RX94806411
bracket for thermocouple gas range for burner type C/D suitable for 900 series				

accessories for 104106				
	GEV No.	101454	Ref. No.	—
union screw for igniter thread M10x1 ID ø 7mm L 15mm				
	GEV No.	103070	Ref. No.	RX94800174
burner cap ø 95mm 6.4kW with central hole				
	GEV No.	104107	Ref. No.	94806437 RX94806437
burner lower part for burner cap ø 100mm 6.4kW				
	GEV No.	104108	Ref. No.	—
nozzle holder nozzle mounting M10x1 tube ø 10mm gas inlet M16x1.5 gas outlet M14x1				

				
1				
GEV No.	104104	Ref. No.	94800125 RX94800125	
description	burner head for burner cap ø 80mm 3.5kW code 100212			
accessories for 104104				
	GEV No.	100907	Ref. No.	94805090 RX94805090
screw connection thread M10x1 Qty 1 pcs type SEF 1 ømm for thermocouple				
	GEV No.	101452	Ref. No.	94806049 RX94806049
ignition electrode support for burner type C/D suitable for 900 series				
	GEV No.	101453	Ref. No.	94806411 RX94806411
bracket for thermocouple gas range for burner type C/D suitable for 900 series				
	GEV No.	101454	Ref. No.	—
union screw for igniter thread M10x1 ID ø 7mm L 15mm				
	GEV No.	103069	Ref. No.	RX94800182
burner cap ø 80mm 4.3kW with central hole				
	GEV No.	104105	Ref. No.	94806841 RX94806841
burner lower part for burner cap ø 80mm 3.5kW				
	GEV No.	104108	Ref. No.	—
nozzle holder nozzle mounting M10x1 tube ø 10mm gas inlet M16x1.5 gas outlet M14x1				



				
1				
GEV No.	104107	Ref. No.	94806437 RX94806437	
description	burner lower part for burner cap ø 100mm 6.4kW			
accessories for 104107				
	GEV No.	100907	Ref. No.	94805090 RX94805090
screw connection thread M10x1 Qty 1 pcs type SEF 1 ømm for thermocouple				

Table continues overleaf



accessories for 104107			
	GEV No.	101452	Ref. No. 94806049 RX94806049
ignition electrode support for burner type C/D suitable for 900 series			
	GEV No.	101453	Ref. No. 94806411 RX94806411
bracket for thermocouple gas range for burner type C/D suitable for 900 series			
	GEV No.	101454	Ref. No. —
union screw for igniter thread M10x1 ID ø 7mm L 15mm			
	GEV No.	103070	Ref. No. RX94800174
burner cap ø 95mm 6.4kW with central hole			
	GEV No.	104106	Ref. No. 94800166 RX94800166
burner head for burner cap ø 100mm 5.5kW for igniter			
	GEV No.	104108	Ref. No. —
nozzle holder nozzle mounting M10x1 tube ø 10mm gas inlet M16x1.5 gas outlet M14x1			

			
1			
GEV No.	104105	Ref. No.	94806841 RX94806841
description	burner lower part for burner cap ø 80mm 3.5kW		
accessories for 104105			
	GEV No.	100907	Ref. No. 94805090 RX94805090
screw connection thread M10x1 Qty 1 pcs type SEF 1 ømm for thermocouple			
	GEV No.	101452	Ref. No. 94806049 RX94806049
ignition electrode support for burner type C/D suitable for 900 series			
	GEV No.	101453	Ref. No. 94806411 RX94806411
bracket for thermocouple gas range for burner type C/D suitable for 900 series			
	GEV No.	101454	Ref. No. —
union screw for igniter thread M10x1 ID ø 7mm L 15mm			
	GEV No.	103069	Ref. No. RX94800182
burner cap ø 80mm 4.3kW with central hole			
	GEV No.	104104	Ref. No. 94800125 RX94800125
burner head for burner cap ø 80mm 3.5kW code 100212			
	GEV No.	104108	Ref. No. —
nozzle holder nozzle mounting M10x1 tube ø 10mm gas inlet M16x1.5 gas outlet M14x1			
	GEV No.	105297	Ref. No. —
burner head for burner cap ø 80mm 4.3kW for pilot burner			

Rosi Chef, Royal Chef, Maxi Chef series			
			
1			
GEV No.	107197	Ref. No.	94044420 RX94044420
description	burner cap ø 120mm		
accessories for 107197			
	GEV No.	107196	Ref. No. 94044422 RX94044422
burner head for burner cap ø 120mm 10kW H 38mm			
	GEV No.	107198	Ref. No. 94044423 RX94044423
burner lower part for burner cap ø 100/120mm 4.5/7/10kW H 85mm			

			
1			
GEV No.	108078	Ref. No.	RX94044419
description	burner cap ø 98mm mounting ø 97mm		

			
1			
GEV No.	107195	Ref. No.	94044421 RX94044421
description	burner head for burner cap ø 100mm 7kW H 37mm		
accessories for 107195			
	GEV No.	107198	Ref. No. 94044423 RX94044423
burner lower part for burner cap ø 100/120mm 4.5/7/10kW H 85mm			

			
1			
GEV No.	107196	Ref. No.	94044422 RX94044422
description	burner head for burner cap ø 120mm 10kW H 38mm		
accessories for 107196			
	GEV No.	107197	Ref. No. 94044420 RX94044420
burner cap ø 120mm			
	GEV No.	107198	Ref. No. 94044423 RX94044423
burner lower part for burner cap ø 100/120mm 4.5/7/10kW H 85mm			



1

GEV No.	107199	Ref. No.	94044469 RX94044469
description	burner lower part for burner cap ø 100/120mm 4.5/7/10kW H 105mm		



1

GEV No.	107198	Ref. No.	94044423 RX94044423	
description	burner lower part for burner cap ø 100/120mm 4.5/7/10kW H 85mm			
accessories for	107198			
	GEV No.	107195	Ref. No.	94044421 RX94044421
burner head for burner cap ø 100mm 7kW H 37mm				
	GEV No.	107196	Ref. No.	94044422 RX94044422
burner head for burner cap ø 120mm 10kW H 38mm				
	GEV No.	107197	Ref. No.	94044420 RX94044420
burner cap ø 120mm				

solid tops



1

GEV No.	107055	Ref. No.	N/A	
description	burner type 1020 ø 80mm L 120mm complete			
spare parts for	107055			
	GEV No.	108031	Ref. No.	—
burner cap ø 78mm with central hole				
	GEV No.	108041	Ref. No.	N/A
burner head ø 84mm seat ø 72mm with central hole				
	GEV No.	108052	Ref. No.	—
nozzle holder size 4/5 thread M26x1				
	GEV No.	108064	Ref. No.	—
air mixing tube size 4/5				



1

GEV No.	108041	Ref. No.	N/A	
description	burner head ø 84mm seat ø 72mm with central hole			
accessories for	108041			
	GEV No.	108031	Ref. No.	—
burner cap ø 78mm with central hole				

accessories

reducers for pan supports



1

GEV No.	210001	Ref. No.	94806759 RX94806759
description	reducer for pan support L 265mm W 265mm SS suitable for universal		

pan supports



1

GEV No.	210264	Ref. No.	RX94039872 RX94070427
description	pan support W 307mm L 388mm H 36mm suitable for ROSINOX		

bar burners

bar burners





1

GEV No.	105494	Ref. No.	94814483 RX94814483
description	bar burner 2 row L 525mm W 200mm ømm H 65mm chargrill		



			
1			
GEV No.	105537	Ref. No.	94812661 RX94812661
description	bar burner angled L 570mm W 310mm ømm Hmm oven		

			
1			
GEV No.	109118	Ref. No.	9456104 RX9400674 RX94006749 RX94561040
description	bar burner L 190mm W 41mm ømm H 56mm flange width 53mm flange length 73mm fryer		

			
1			
GEV No.	109119	Ref. No.	9400671 94006715 RX94006715
description	bar burner L 510mm W 42mm ømm H 57mm flange width 53mm flange length 73mm frying pan		

			
1			
GEV No.	104659	Ref. No.	94494564 RX94494564
description	bar burner ømm W 41.5mm H 56mm L 512mm flange width 53mm flange length 27mm frying pan		

tube burners

			
1			
GEV No.	105527	Ref. No.	94805710 RX94805710
description	tubular burner L 295mm W 55mm H 70mm mounting pos. left for fryer oval		

accessories

nozzle holders

			
1			
GEV No.	104629	Ref. No.	9401873 94018736 RX94018736
description	nozzle holder ID ø 10mm screw pipe fitting M18x1.5 ET 3/8" M13x1 tube ø 12mm		

gas nozzles

main nozzles

gas nozzles 3/8"

			
1			
GEV No.	106543	Ref. No.	RX94033859
description	gas injector thread 3/8" WS 17 bore ø 2.1mm		

gas nozzles M7x1

			
1			
GEV No.	100517	Ref. No.	94812640 RX94812640
description	gas injector thread M7x1 WS 10 bore ø 0.8mm		

			
1			
GEV No.	100519	Ref. No.	94806668 RX94806668
description	gas injector thread M7x1 WS 10 bore ø 0.95mm		

gas nozzles M10x1

			
1			
GEV No.	100635	Ref. No.	RX94812593
description	gas injector thread M10x1 WS 11 bore ø 0.85mm inner peaked		





			
GEV No.	100641	Ref. No.	94806833 RX94806833
description	gas injector thread M10x1 WS 11 bore ø 1.35mm inner peaked		

			
GEV No.	106466	Ref. No.	94806874 RX94806874
description	gas injector thread M10x1 WS 12 bore ø 1.15mm		

			
GEV No.	106453	Ref. No.	RX94033859
description	gas injector thread M10x1 WS 12 bore ø 1.4mm		

			
GEV No.	106295	Ref. No.	94806882 RX94806882
description	gas injector thread M10x1 WS 11 bore ø 0.9mm code 90		

			
GEV No.	102704	Ref. No.	94806890 RX94806890
description	gas injector thread M10x1 WS 11 bore ø 1.2mm		

			
GEV No.	102774	Ref. No.	94812558 RX94812558
description	gas injector thread M10x1 WS 11 bore ø 1.45mm		

			
GEV No.	101997	Ref. No.	94812697 RX94812697
description	gas injector thread M10x1 WS 11 bore ø 1.4mm		

			
GEV No.	102773	Ref. No.	RX94812556
description	gas injector thread M10x1 WS 11 bore ø 1.65mm G20-25		

			
GEV No.	102984	Ref. No.	94812557 RX94812557
description	gas injector thread M10x1 WS 11 bore ø 1.8mm		

			
GEV No.	102703	Ref. No.	94812654 RX94812654
description	gas injector thread M10x1 WS 11 bore ø 1.9mm		

			
GEV No.	106284	Ref. No.	94812555 RX94812555
description	gas injector thread M10x1 WS 11 bore ø 2.15mm		

gas nozzles M13x1			
			
GEV No.	107475	Ref. No.	RX94034154
description	gas injector thread M13x1 bore ø 1.85mm WS 13 code 185		



pilot burner nozzles

pilot burner nozzles AEM



1

GEV No.	109126	Ref. No.	94814111 RX94814111
description	pilot burner nozzle natural gas bore ø 0.4mm code 40 thread 7/32" (28G) WS 6 Qty 1 pcs		



1

GEV No.	106427	Ref. No.	9481411 RX94814110
description	pilot burner nozzle natural/liquid gas bore ø 0.3mm code 30 thread 7/32" (28G) WS 6		

pilot burner nozzles POLIDORO



1

GEV No.	106703	Ref. No.	RX94034519
description	pilot burner nozzle POLIDORO natural gas code 27.2 bore ø 2x0.27mm Qty 1 pcs		

pilot burner nozzles SIT

100 series



1

GEV No.	107171	Ref. No.	94812644 RX94812644
description	pilot burner nozzle SIT natural/liquid gas bore ø 0.25mm Qty 1 pcs		

140/150 series



1

GEV No.	100205	Ref. No.	RX822140380
description	pilot burner nozzle SIT LPG code 19 bore ø 0.23/0.26mm Qty 1 pcs suitable for SIT 150 series		



1

GEV No.	100207	Ref. No.	RX822140120
description	pilot burner nozzle SIT natural gas code 27 bore ø 0.40/0.38mm suitable for SIT 140 series		

auxiliary gas parts

screw connections

olives



1

GEV No.	101248	Ref. No.	94810978 RX94810978	
description	olive for pipe ø 12mm Qty 1 pcs suitable for PEL			
accessories for	101248			
	GEV No.	101251	Ref. No.	—
	union nut thread M20x1.5 for pipe ø 12mm			



1

GEV No.	101246	Ref. No.	94812588 RX94812588	
description	olive for pipe ø 4mm Qty 1 pcs			
accessories for	101246			
	GEV No.	100908	Ref. No.	94812587 RX94812587
	union screw thread M10x1 for pipe ø 4mm Qty 1 pcs			

union screws



1

GEV No.	100906	Ref. No.	94805082 RX94805082
description	screw connection thread M10x1 for ignition electrode brass Qty 1 pcs WS 10		



1



GEV No.	100907	Ref. No.	94805090 RX94805090
description	screw connection thread M10x1 Qty 1 pcs type SEF 1 ømm for thermocouple		



1

GEV No.	106597	Ref. No.	94812690 RX94812690
description	union screw thread 3/4" for pipe ø 18mm L 20mm Qty 1 pcs WS 27		



			
1			
GEV No.	100908	Ref. No.	94812587 RX94812587
description	union screw thread M10x1 for pipe ø 4mm Qty 1 pcs		
accessories for	100908		
	GEV No.	100897	Ref. No. —
olive for pipe ø 4mm Qty 1 pcs for pilot burner			
	GEV No.	101246	Ref. No. 94812588 RX94812588
olive for pipe ø 4mm Qty 1 pcs			
	GEV No.	101280	Ref. No. —
olive for pipe ø 4mm Qty 1 pcs			
	GEV No.	101282	Ref. No. —
olive for pipe ø 4mm L 7.4mm Qty 1 pcs			

angle pieces

			
1			
GEV No.	531261	Ref. No.	RX94025293
description	angle piece thread 1/2" ET - 1/2" ET brass		

equipment-specific units

for dough mixers

flange bearings

			
1			
GEV No.	693112	Ref. No.	RX94806544
description	flange bearing type UCF204 shaft ø 20mm 4 hole flange hole distance 64mm H 33mm flange length 86mm flange width 86mm hole ø 12mm flange F204 ball bearing UC204G2 FH 25.5mm		

for espresso machines

brewing units

filter holder gaskets

O-rings

			
1			
GEV No.	510409	Ref. No.	RX94807294
description	O-ring EPDM thickness 5.34mm ID ø 56.52mm Qty 1 pcs		

steam/water taps

steam/water pipes

accessories

gaskets

			
1			
GEV No.	510893	Ref. No.	94807765 RX94807765
description	O-ring EPDM thickness 2.62mm ID ø 9.92mm Qty 1 pcs		

for coffee grinders

			
1			
GEV No.	345019	Ref. No.	94809944 RX94809944
description	rotary switch sets of contacts 2 2 0-1 type CA0120002 380V 12A shaft ø 5x5mm shaft L 23mm shaft square connection screw		



for pyroceram ranges

ceramic hobs

ceramic glass plates

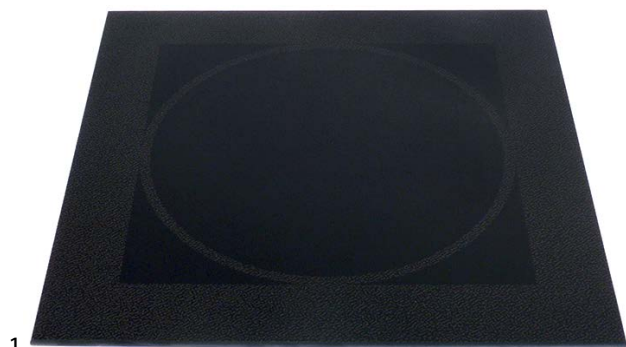

1			
GEV No.	694698	Ref. No.	94090016 RX94090016
description	ceramic plate L 370mm W 370mm thickness 6mm		

for convection ovens/combi-steamers

spare parts and accessories



1			
GEV No.	698483	Ref. No.	RX94003753
description	bearing bolt L 17mm ø 12.2mm WS 15 ext. ø M8		



1			
GEV No.	512418	Ref. No.	RX94050556
description	cotter pin D1 ø 8.6mm hole ø 5.5mm Qty 1 pcs total length 40.4mm		



1			
GEV No.	512417	Ref. No.	RX94020211
description	hexagonal nut WS 16 thread M10 black suitable for ROSINOX Qty 1m		

miscellaneous



1			
GEV No.	510558	Ref. No.	24556078 RX24556078
description	connection for pump		



1			
GEV No.	694527	Ref. No.	24390627 RX24390627
description	gasket rubber ED ø 57mm ID ø 39mm thickness 4mm for combi-steamer Qty 1 pcs suitable for RATIONAL		

for tilting bratt pans

spindles



1			
GEV No.	693127	Ref. No.	94806569 RX94806569
description	threaded part		



1			
GEV No.	693128	Ref. No.	94806551 RX94806551
description	threaded rod L 350mm		

for boiling pans

level controllers



1			
GEV No.	698489	Ref. No.	RX94045667 RX94445582
description	level tank metal bore ø 11.5mm L 257mm W 30mm H 50mm		

level glasses

complete



1

GEV No.	540706	Ref. No.	RX94800216
description	level glass hole distance 76mm mounting thread M10 L 107mm W 28mm plastic/SS for kettle model ELESA HCX-76-BW-SST		

miscellaneous

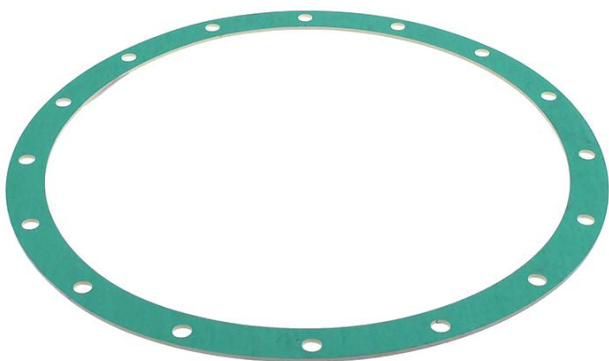

1

GEV No.	698486	Ref. No.	RX94013612
description	gasket ext. \varnothing 390 ID \varnothing 340mm bores 16 hole \varnothing 10mm		

for ovens

housing and bezels



1

GEV No.	698493	Ref. No.	RX94545373
description	sheet L 142mm W 30mm H 82mm for ignition electrode		

miscellaneous



1

GEV No.	696492	Ref. No.	94001971 RX94001971
description	stop for oven door L 137mm W 76mm H 3mm		

for dishwashers

containers

salt tanks



1

GEV No.	517398	Ref. No.	RX94810355
description	flat gasket rubber ED \varnothing 82mm ID \varnothing 66mm thickness 4mm for salt tank Qty 1 pcs		



1







GEV No.	510929	Ref. No.	94808755 RX94808755	
description	salt tank \varnothing 120mm H 117mm hose \varnothing 10mm mounting \varnothing 70mm overall height 157mm			
spare parts for	510929			
	GEV No.	506015	Ref. No.	94810256 RX94810256
	O-ring EPDM thickness 3.53mm ID \varnothing 39.69mm Qty 1 pcs			
	GEV No.	510018	Ref. No.	—
	nut \varnothing 92mm H 10.5mm for salt tank ID \varnothing 64mm			
	GEV No.	524177	Ref. No.	—
	lid \varnothing 69mm H 20mm for salt tank ID \varnothing 50mm			
accessories for	510929			
	GEV No.	510071	Ref. No.	—
	flat gasket rubber ED \varnothing 81mm ID \varnothing 68mm thickness 3mm for salt tank Qty 1 pcs			
	GEV No.	510654	Ref. No.	—
	gasket H 6mm D1 \varnothing 82mm D2 \varnothing 68mm			

Table continues overleaf



accessories for	510929		
	GEV No.	510883	Ref. No. —
	gasket rubber ED ø 86mm ID ø 66mm thickness 2mm for salt tank Qty 1 pcs		

boilers

boilers for dishwashers

	1		
GEV No.	517402	Ref. No.	94810306 RX94810306
description	boiler		

	1		
GEV No.	518583	Ref. No.	RX94804416
description	boiler ø 110mm L 295mm		



	1		
GEV No.	517295	Ref. No.	94810913 RX94810913
description	boiler ø 113mm L 370mm		

	1		
GEV No.	517300	Ref. No.	94810660 RX94810660
description	boiler ø 140mm L 390mm		

	1		
GEV No.	518377	Ref. No.	94804051 RX94804051
description	boiler ø 150mm L 360mm		

	1		
GEV No.	524450	Ref. No.	RX94814261
description	boiler ø 150mm L 445mm inlet ø 11		

	1		
GEV No.	512000	Ref. No.	94814267 RX94814267
description	boiler ø 150mm L 500mm		

	1		
GEV No.	517394	Ref. No.	94810314 RX94810314
description	boiler ø 160mm L 530mm with insulation		
spare parts for	517394		
	GEV No.	517336	Ref. No. —
	insulating mat boiler L 500mm W 155mm		
	GEV No.	517337	Ref. No. —
	insulating mat boiler ø 160mm		

	1		
GEV No.	517302	Ref. No.	94807930 RX94807930
description	boiler with insulation ø 160mm L 500mm		
accessories for	517302		
	GEV No.	517337	Ref. No. —
	insulating mat boiler ø 160mm		

			
1			
GEV No.	517303	Ref. No.	94810957 RX94810957
description	boiler with insulation ø 160mm L 530mm flange 4 hole flange inlet ø 12		

accessories

			
1			
GEV No.	517125	Ref. No.	94809787 RX94809787
description	hose connector		

softener cartridges

softening columns

			
1			
GEV No.	530000	Ref. No.	RX94801297
description	softener 4-fold L 380mm W 180mm		

housing and bezels



fascias

			
1			
GEV No.	996014	Ref. No.	94814090 RX94814090
description	cover for boiler H 40mm ø 125mm		

miscellaneous

			
1			
GEV No.	517400	Ref. No.	RX94810876
description	bearing for door rubber ID ø 12mm mounting pos. left		

			
1			
GEV No.	698297	Ref. No.	RX94814294
description	duct ID ø 35mm ED ø 51mm thickness 14mm		

			
1			
GEV No.	524076	Ref. No.	94807410 RX94807410
description	magnet holder internal size 13mm H 60mm for dishwasher		
accessories for	524076		
	GEV No.	524655	Ref. No.
			—
	screw cap for magnet holder thread M16x1.25 SS WS 19		

gearboxes

			
1			
GEV No.	518634	Ref. No.	94804317 RX94804317
description	gearbox motor shaft ø 14mm flange ø 160mm drive shaft ø 25mm type VF49A60		





hood mechanics for dishwashers

bolts

			
1			
GEV No.	510988	Ref. No.	94813785 RX94813785
description	bolt for hood joint		

bushes

			
1			
GEV No.	512423	Ref. No.	RX94814308
description	bush for hood handle		

			
1			
GEV No.	517282	Ref. No.	94809373 RX94809373
description	cylinder liner hood mechanics		

spring holders

			
1			
GEV No.	517285	Ref. No.	94810934 RX94810934
description	spring holder		

guide bars

			
1			
GEV No.	517358	Ref. No.	RX94814004
description	guide bar L 600mm for hood mechanics		

			
1			
GEV No.	517378	Ref. No.	RX94814059
description	guide bar L 650mm mounting pos. left for hood mechanics thickness 25mm		

			
1			
GEV No.	513019	Ref. No.	RX94814058
description	guide bar L 695mm mounting pos. right thickness 25mm		

			
1			
GEV No.	524800	Ref. No.	RX94814042
description	guide bar L 700mm for hood W 26mm H 21mm		

rollers

			
1			
GEV No.	524805	Ref. No.	RX94810936
description	roller ø 23mm H 9.6mm for hood mechanics plastic white hole ø 8mm		

miscellaneous

			
1			
GEV No.	517283	Ref. No.	RX94809381
description	roller for hood handle		

basket guides

guide bars





			
1			
GEV No.	517813	Ref. No.	94814102 RX94814102
description	basket guide mounting pos. left/right L 450mm W 3.5mm H 37.5mm		

air traps

air traps



1

GEV No.	510347	Ref. No.	94813804 RX94813804
description	air trap		
spare parts for	510347		
	GEV No.	510877	Ref. No. —
	flat gasket rubber ED ø 18mm ID ø 10mm thickness 3mm Qty 1 pcs		
	GEV No.	560197	Ref. No. —
	nut thread M10 H 8mm WS 17 SS DIN/ISO DIN 934 / ISO 4032/8673 Qty 1 pcs		
accessories for	510347		
	GEV No.	510877	Ref. No. —
	flat gasket rubber ED ø 18mm ID ø 10mm thickness 3mm Qty 1 pcs		
	GEV No.	560197	Ref. No. —
	nut thread M10 H 8mm WS 17 SS DIN/ISO DIN 934 / ISO 4032/8673 Qty 1 pcs		









1

GEV No.	510757	Ref. No.	RX94804838
description	air trap		



1

GEV No.	510759	Ref. No.	94802857 RX94802857
description	air trap		
spare parts for	510759		
	GEV No.	502036	Ref. No. —
	O-ring EPDM thickness 2.62mm ID ø 28.25mm Qty 1 pcs		
	GEV No.	510760	Ref. No. 94801479 RX94801479
	hose connector		
	GEV No.	510761	Ref. No. 94801495 RX94801495
	flat gasket rubber D1 ø 38mm D2 ø 25mm thickness 2mm Qty 1 pcs		
accessories for	510759		
	GEV No.	510760	Ref. No. 94801479 RX94801479
	hose connector		
	GEV No.	510761	Ref. No. 94801495 RX94801495
	flat gasket rubber D1 ø 38mm D2 ø 25mm thickness 2mm Qty 1 pcs		
	GEV No.	512283	Ref. No. —
	flat gasket rubber D1 ø 38.5mm D2 ø 24.5mm thickness 2mm Qty 1 pcs		





1

GEV No.	517308	Ref. No.	94809852 RX94809852
description	air trap H 65mm		





1

GEV No.	517170	Ref. No.	94809886 RX94809886
description	air trap H 75mm		
accessories for	517170		
	GEV No.	517173	Ref. No. 94810941 RX94810941
	flat gasket FIBER ED ø 14mm ID ø 8mm thickness 1.5mm Qty 1 pcs		
	GEV No.	517174	Ref. No. —
	nut thread M8 H 6.5mm WS 13 SS DIN/ISO DIN 934 / ISO 4032/8673 Qty 1 pcs		



1

GEV No.	517171	Ref. No.	RX94809878
description	air trap L 90mm W 55mm H 31mm		
accessories for	517171		
	GEV No.	517173	Ref. No. 94810941 RX94810941
	flat gasket FIBER ED ø 14mm ID ø 8mm thickness 1.5mm Qty 1 pcs		
	GEV No.	517174	Ref. No. —
	nut thread M8 H 6.5mm WS 13 SS DIN/ISO DIN 934 / ISO 4032/8673 Qty 1 pcs		



1

GEV No.	516218	Ref. No.	94812400 RX94812400
description	air trap ø 34mm		

air trap accessories



1

GEV No.	510761	Ref. No.	94801495 RX94801495
description	flat gasket rubber D1 ø 38mm D2 ø 25mm thickness 2mm Qty 1 pcs		





			
1			
GEV No.	510760	Ref. No.	94801479 RX94801479
description	hose connector		

mechanics for flight type dishwashers

			
1			
GEV No.	524455	Ref. No.	94810893 RX94810893
description	drive shaft for transport system L 225mm ø 120mm suitable for Dihr		
accessories for	524455		
	GEV No.	524456	Ref. No.
			94807195 RX94807195
	roller for drive shaft L 27.3mm ø 30mm hole ø 12.5mm suitable for Dihr		

			
1			
GEV No.	698412	Ref. No.	94813961 RX94813961
description	gear wheel teeth 8 shaft intake ø 20mm ø 133mm tooth width 11mm plastic W 40mm for transport system suitable for dishwasher		

			
1			
GEV No.	524456	Ref. No.	94807195 RX94807195
description	roller for drive shaft L 27.3mm ø 30mm hole ø 12.5mm suitable for Dihr		
accessories for	524456		
	GEV No.	524455	Ref. No.
			94810893 RX94810893
	drive shaft for transport system L 225mm ø 120mm suitable for Dihr		

			
1			
GEV No.	524511	Ref. No.	RX94804663
description	roller for transport system W 20mm ED ø 24.5mm hole ø 8mm		

			
1			
GEV No.	517371	Ref. No.	RX94807971
description	roller L 22mm ø 24.5mm hole ø 8mm suitable for Dihr		

			
1			
GEV No.	517356	Ref. No.	94809688 RX94809688
description	spacer for spindle ø 32mm		

			
1			
GEV No.	524971	Ref. No.	94814000 RX94814000
description	tappet for dishwasher L 75mm W 36mm H 90mm hole ø 9mm suitable for Dihr		

backflow preventers

			
1			
GEV No.	516101	Ref. No.	94813738 RX94813738
description	backflow preventer dishwasher hose ø 12mm		
spare parts for	516101		
	GEV No.	506367	Ref. No.
			—
	flat gasket rubber ED ø 40mm ID ø 28mm thickness 1.8mm Qty 1 pcs		

door mechanics

			
1			
GEV No.	518355	Ref. No.	94812350 RX94812350
description	door pin stop rod		

1 

GEV No.	512370	Ref. No.	94813839 RX94813839
description	door pin tie bar		

1 

GEV No.	517269	Ref. No.	94809431 RX94809431
description	door pin tie bar		

1 

GEV No.	512026	Ref. No.	94813842 RX94813842
description	tie bar L 235mm thread M5		

threaded shafts

1 

GEV No.	512371	Ref. No.	94813838 RX94813838
description	threaded part threaded part		

sliding plates

1 

GEV No.	517264	Ref. No.	94810769 RX94810769
description	sliding plate sliding plate		

1 



GEV No.	518356	Ref. No.	94804028 RX94804028
description	sliding plate sliding plate		

hinges



1 

GEV No.	517268	Ref. No.	RX94809449
description	bush ID ø 8mm H 9mm bush thread M11x1 WS 13		

1 

GEV No.	517267	Ref. No.	94809423 RX94809423	
description	door hinge hinge mounting pos. left			
accessories for	517267			
	GEV No.	517266	Ref. No.	94809415 RX94809415
	door hinge hinge mounting pos. right			
	GEV No.	517268	Ref. No.	RX94809449
	bush ID ø 8mm H 9mm bush thread M11x1 WS 13			

1 

GEV No.	517266	Ref. No.	94809415 RX94809415	
description	door hinge hinge mounting pos. right			
accessories for	517266			
	GEV No.	517267	Ref. No.	94809423 RX94809423
	door hinge hinge mounting pos. left			
	GEV No.	517268	Ref. No.	RX94809449
	bush ID ø 8mm H 9mm bush thread M11x1 WS 13			

hinge pins

1 

GEV No.	511375	Ref. No.	RX94814270
description	hinge pin ø 6mm D1 ø 4mm L 55mm thread M4 stainless steel		

door guides

1 

GEV No.	508421	Ref. No.	94814063 RX94814063
description	opposite support conversion kit		



door bumpers



1			
GEV No.	510957	Ref. No.	94813763 RX94813763
description	door bumper end stop		



1			
GEV No.	518354	Ref. No.	94804010 RX94804010
description	door bumper slotted hole disc		

locks



1			
GEV No.	512369	Ref. No.	94801024 RX94801024
description	counterpart door catch		



1			
GEV No.	512160	Ref. No.	94801008 RX94801008
description	door catch		

accessories for 512160



GEV No.	512369	Ref. No.	94801024 RX94801024
counterpart door catch			



1			
GEV No.	517275	Ref. No.	94808300 RX94808300
description	door catch catch		



1			
GEV No.	510008	Ref. No.	94813865 RX94813865
description	door catch for dishwasher		

miscellaneous



1			
GEV No.	524955	Ref. No.	RX94810868
description	bearing for door ID ø 12mm H 22mm L 32mm W 9mm mounting pos. right		

screw connections



1			
GEV No.	512074	Ref. No.	94813714 RX94813714
description	nut thread 1/2" H 7mm WS 27 plastic Qty 1 pcs		



1			
GEV No.	506027	Ref. No.	94810944 RX94810944
description	nut thread 2" for intake body		



1			
GEV No.	517007	Ref. No.	94808151 RX94808151
description	screw connection		



1

GEV No.	512177	Ref. No.	94813796 RX94813796
description	screw connection thread 1/4" H 27mm Qty 1 pcs		



1

GEV No.	512178	Ref. No.	94813798 RX94813798
description	screw connection thread M16x1.25 H 31mm Qty 1 pcs		

curtains

curtains

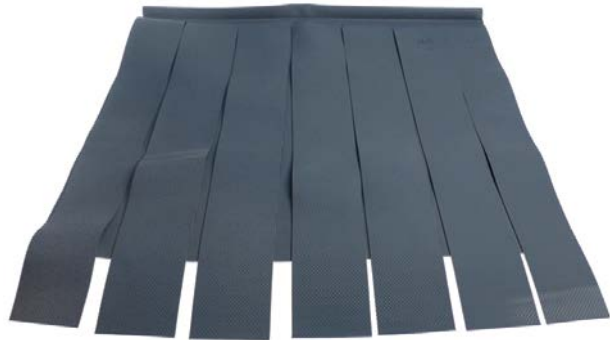

1

GEV No.	533006	Ref. No.	RX94807039
description	curtain W 545mm H 590mm LANG thickness 1.6mm		

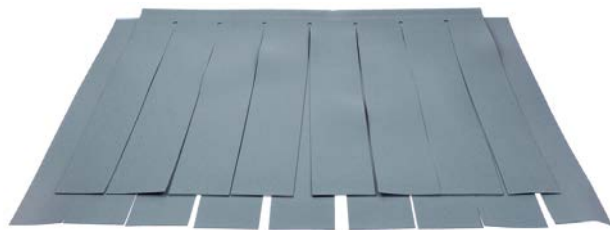

1

GEV No.	524801	Ref. No.	RX94807278
description	curtain W 620mm H 500mm plastic thickness 1.4mm for dishwasher		

curtain rods



1

GEV No.	533017	Ref. No.	RX94807385
description	curtain rod L 635mm ø 8mm		

washing and rinsing systems



1

GEV No.	519033	Ref. No.	94800794 RX94800794
description	bush for rinse arm		



1

GEV No.	511240	Ref. No.	RX94813750
description	bush for wash arm		



1

GEV No.	511434	Ref. No.	RX94813751
description	bush for wash arm		



1

GEV No.	512047	Ref. No.	94801131 RX94801131
description	bush for wash arm		



1

GEV No.	512053	Ref. No.	94813724 RX94813724
description	bush for wash arm		





			
1			
GEV No.	512062	Ref. No.	94813850 RX94813850
description	bush for wash arm		

			
1			
GEV No.	517682	Ref. No.	RX94810033
description	bush for wash arm mounting pos. upper H 52mm thread 1¼" D1 ø 54mm D2 ø 41mm Qty 1 pcs		

			
1			
GEV No.	512064	Ref. No.	94814258 RX94814258
description	bush for wash arm		

			
1			
GEV No.	517341	Ref. No.	94813969 RX94813969
description	bush ID ø 16mm ED ø 48mm		

			
1			
GEV No.	512275	Ref. No.	RX94813851
description	bush for wash arm		



			
1			
GEV No.	512211	Ref. No.	94813743 RX94813743
description	bushing for rinse arm		

			
1			
GEV No.	512383	Ref. No.	94802915 RX94802915
description	bush for wash arm		

			
1			
GEV No.	517094	Ref. No.	94813981 RX94813981
description	cover for rinse arm shaft H 108mm D1 ø 28mm		

			
1			
GEV No.	517086	Ref. No.	RX94808110
description	bush for wash arm		

			
1			
GEV No.	517130	Ref. No.	RX94814012
description	cover wash arm support mounting pos. lower		

			
1			
GEV No.	519167	Ref. No.	94800810 RX94800810
description	bush for wash arm		
accessories for	519167		
			
GEV No.	519087	Ref. No.	94800687 RX94800687
description	locknut for wash arm		

			
1			
GEV No.	517629	Ref. No.	RX94802824
description	disc for rinse arm ø 12/18mm		

			
1			
GEV No.	517628	Ref. No.	RX94801644
description	disc for rinse arm ø 16mm		

			
1			
GEV No.	517374	Ref. No.	94808235 RX94808235
description	duct D1 ø 20mm D2 ø 14mm L 17mm int. ø 1 10mm		

			
1			
GEV No.	517114	Ref. No.	94810949 RX94810949
description	extension for wash arm support		

			
1			
GEV No.	512259	Ref. No.	94802980 RX94802980
description	flange for wash arm support		

			
1			
GEV No.	517095	Ref. No.	94810986 RX94810986
description	flange ø 60mm		

			
1			
GEV No.	530430	Ref. No.	RX94813982
description	gasket for rinse pipe rubber ø 33mm ID ø 24mm thickness 11mm for Silanos		

			
1			
GEV No.	505314	Ref. No.	94801735 RX94801735
description	gasket for wash arm thickness 1mm L 74.5mm W 42mm		

			
1			
GEV No.	512257	Ref. No.	94813825 RX94813825
description	knurled nut thread M10L ø 30mm H 6.5mm SS		

			
1			
GEV No.	512212	Ref. No.	94813745 RX94813745
description	knurled nut thread M10x1.5 ø 30mm H 6.4mm SS		

			
1			
GEV No.	519087	Ref. No.	94800687 RX94800687
description	locknut for wash arm		

			
1			
GEV No.	518238	Ref. No.	94803434 RX94803434
description	manifold ø 12mm L 98mm		

			
1			
GEV No.	517070	Ref. No.	94810960 RX94810960
description	nut for wash arm		

			
1			
GEV No.	517154	Ref. No.	94810925 RX94810925
description	nut mounting pos. upper for wash arm support		





 <p>1</p>			
GEV No.	517010	Ref. No.	94808797 RX94808797
description	rinse arm complete		

 <p>1</p>			
GEV No.	519197	Ref. No.	RX94800695
description	rinse arm shaft		

 <p>1</p>			
GEV No.	517155	Ref. No.	94814017 RX94814017
description	rinse arm support for stationary arms mounting pos. upper		

 <p>1</p>			
GEV No.	517161	Ref. No.	94810744 RX94810744
description	rinse arm support mounting pos. upper		

 <p>1</p>			
GEV No.	512280	Ref. No.	94813823 RX94813823
description	rinse pipe		

 <p>1</p>			
GEV No.	517113	Ref. No.	94810948 RX94810948
description	rinse pipe		

 <p>1</p>			
GEV No.	517116	Ref. No.	94807740 RX94807740
description	rinse pipe		

 <p>1</p>			
GEV No.	517119	Ref. No.	RX94814026
description	rinse pipe		

 <p>1</p>			
GEV No.	517132	Ref. No.	94814013 RX94814013
description	rinse pipe		

 <p>1</p>			
GEV No.	517153	Ref. No.	94809456 RX94809456
description	rinse pipe		

 <p>1</p>			
GEV No.	517157	Ref. No.	94814016 RX94814016
description	rinse pipe		

 <p>1</p>			
GEV No.	518471	Ref. No.	94804572 RX94804572
description	rinse pipe		

 <p>1</p>			
GEV No.	517140	Ref. No.	94814072 RX94814072
description	rinse pipe mounting pos. lower		

 <p>1</p>			
GEV No.	512197	Ref. No.	94813786 RX94813786
description	rinse pipe mounting pos. lower ø 10/12mm L 270mm		

 <p>1</p>			
GEV No.	524514	Ref. No.	94813795 RX94813795
description	rinse pipe mounting pos. upper ø 12mm L 265mm		

 <p>1</p>			
GEV No.	518003	Ref. No.	94803962 RX94803962
description	screw cap		

			
1			
GEV No.	517115	Ref. No.	94814413 RX94814413
description	spacer piece		

			
1			
GEV No.	512043	Ref. No.	94813680 RX94813680
description	throttle disc		

			
1			
GEV No.	517139	Ref. No.	94813954 RX94813954
description	throttle disc		

			
1			
GEV No.	519085	Ref. No.	94800802 RX94800802
description	Thumb screw ø 34mm thread M6		

			
1			
GEV No.	510112	Ref. No.	94803970 RX94803970
description	Thumb screw thread M10 thread L 10mm ø 22mm H 4.5mm SS		

			
1			
GEV No.	512307	Ref. No.	94801198 RX94801198
description	wash arm bearing		

			
1			
GEV No.	517071	Ref. No.	94809522 RX94809522
description	wash arm bearing		



			
1			
GEV No.	517118	Ref. No.	94810116 RX94810116
description	wash arm support mounting pos. lower		

			
1			
GEV No.	517382	Ref. No.	94814300 RX94814300
description	wash pipe L 635mm stainless steel suitable for Dihr		

knobs

producer-specific knobs

ROSINOX

			
1			
GEV No.	111479	Ref. No.	9403093 94030939 RX94030939
description	knob ø 38mm shaft ø 16x16mm chrome		
accessories for	111479		
	GEV No.	111481	Ref. No.
			9400687 94006871 RX94006871
knob adapter shaft ø 8x8mm for water tap			



accessories

fascias



GEV No.	111811	Ref. No.	94812686 RX94812686
description	bezel ø 72.5mm		
accessories for	111811		
	GEV No.	560056	Ref. No. —
clamping washer nominal-ø 4mm ED ø 10mm spring steel			

knob adaptors



GEV No.	111482	Ref. No.	9400683 94006830 RX94006830
description	knob adaptor shaft ø 6x4.6mm for gas tap		



GEV No.	111481	Ref. No.	9400687 94006871 RX94006871
description	knob adaptor shaft ø 8x8mm for water tap		

handles and hand wheels

hand wheels

hand wheels



GEV No.	693113	Ref. No.	94806020 RX94806020
description	hand wheel ø 150mm D1 ø 38mm bore ø 14mm thread groove width 5mm L1 38mm L2 40mm handle length 65mm with folding handle		
spare parts for	693113		
	GEV No.	514255	Ref. No. —
folding handle ø 26mm total length 85mm seat ø 20mm shaft ømm thread M6 with pin L 85mm			
accessories for	693113		
	GEV No.	690968	Ref. No. —
roll pin ø 5mm L 20mm			



GEV No.	692684	Ref. No.	RX94030871
description	hand wheel ø 200mm D1 ø 50mm bore ø 16mm handle length 79mm with folding handle		

ball handles



GEV No.	693474	Ref. No.	RX94027398
description	ball handle ø 40mm bore ø conical 12mm for drive into black		
accessories for	693474		
	GEV No.	696529	Ref. No. RX94037900
lever for ball handle thread M8x1.25 ø 12/14mm angled 90° SS			

handle rails

handle rails



GEV No.	704000	Ref. No.	RX94026275
description	handle plastic L 138mm W 52mm H 25mm black hole distance 110mm Qty 1 pcs		

levers

without handle





GEV No.	696529	Ref. No.	RX94037900
description	lever for ball handle thread M8x1.25 ø 12/14mm angled 90° SS		
accessories for	696529		
	GEV No.	693474	Ref. No. RX94027398
ball handle ø 40mm bore ø conical 12mm for drive into black			

hand cranks



GEV No.	580073	Ref. No.	9403051 94030517 RX94030517
description	hand crank bore \varnothing 16mm total length 128mm lever length 65mm seat \varnothing 24mm		
accessories for	580073		
	GEV No.	511947	Ref. No. 9403064 94030640 RX94030640
gasket suitable for ROSINOX for hand wheel external height 7mm Qty 1m ED \varnothing 36mm ID \varnothing 18mm rubber thickness 2.5mm			

STUV





	GEV No.	700098	Ref. No.	26728212 RX26728212
description	door catch mounting pos. right off-set 38mm L 110mm H 74mm W 33mm mounting distance 68/68mm series 1750			
spare parts for	700098			
	GEV No.	690136	Ref. No.	RX22705073
accessories for	700098			
	GEV No.	514281	Ref. No.	—
base plate L 110mm W 35mm for door catch thickness 10mm				

edgemount latches

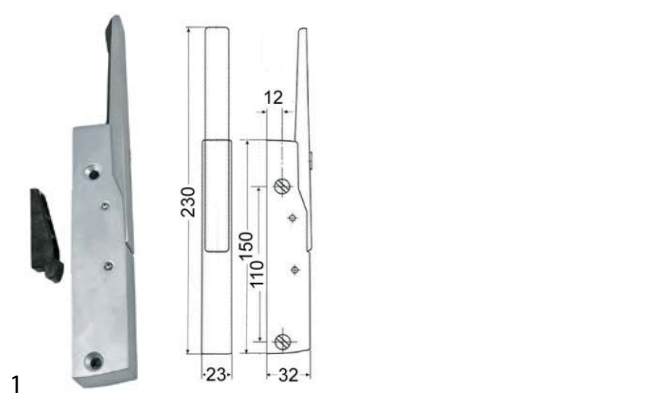
handle latches

CAFF/FERMOD





	GEV No.	690455	Ref. No.	RX94026184
description	handle latch L 150mm mounting distance 110mm matt chrome-plated non lockable refrigeration units 570 R-L complete with door catch			
spare parts for	690455			
	GEV No.	690429	Ref. No.	—
door catch CT 25.5mm				
accessories for	690455			
	GEV No.	690428	Ref. No.	N/A
door catch H 51mm W 13.9mm mounting distance 30mm plastic CT 16.5mm				
	GEV No.	690445	Ref. No.	—
base plate H 2mm				
	GEV No.	690446	Ref. No.	—
base plate H 5mm L 56mm W 18mm				

locks

turning lever locks



universal

RAHRBACH

	GEV No.	700098	Ref. No.	26728212 RX26728212
description	door catch mounting pos. right off-set 38mm L 110mm H 74mm W 33mm mounting distance 68/68mm series 1750			
spare parts for	700098			
	GEV No.	690136	Ref. No.	RX22705073
accessories for	700098			
	GEV No.	514281	Ref. No.	—
base plate L 110mm W 35mm for door catch thickness 10mm				

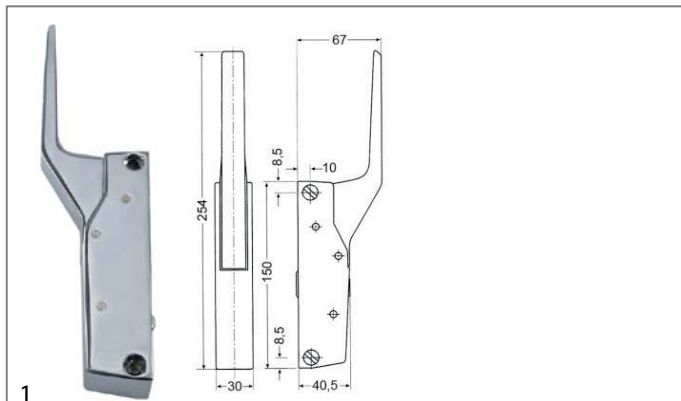
	GEV No.	690136	Ref. No.	RX22705073
description	sliding plate mounting pos. right L 28mm H 3mm W 21mm H2 12.5mm			



GEV No.	700060	Ref. No.	RX94026168
description	handle latch L 150mm mounting distance 133mm non lockable heated units G 791		
accessories for	700060		
	GEV No.	700061	Ref. No. —
	door catch L 58mm W 20mm H 35mm mounting distance 42mm chrome-plated brass for headed units		
	GEV No.	700062	Ref. No. —
	handle protection heated units		

STUV
3.30.016x.x series

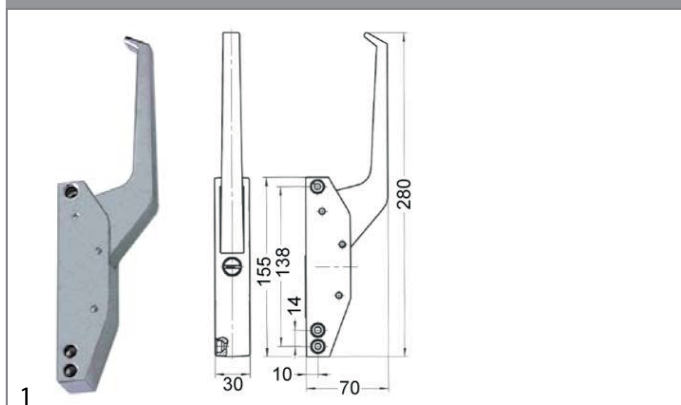

GEV No.	700063	Ref. No.	RX26728030
description	handle latch L 155mm mounting distance 124/138mm non lockable refrigeration units 3.30.0164		
accessories for	700063		
	GEV No.	700064	Ref. No. RX26728022
	door catch H 40mm L 28mm W 22mm		

door catches



GEV No.	700064	Ref. No.	RX26728022
description	door catch H 40mm L 28mm W 22mm		

GEV No.	690428	Ref. No.	N/A
description	door catch H 51mm W 13.9mm mounting distance 30mm plastic CT 16.5mm		

walk-in fridge catches

STUV

3.31.015x.x series



GEV No.	700072	Ref. No.	26728261 RX26728261
description	door catch H 17mm L 84mm W 53mm mounting distance 68mm zinc die cast with wedge heated units		

snap locks

producer-specific

ROSINOX

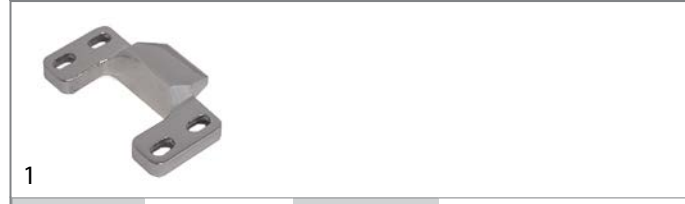

GEV No.	700072	Ref. No.	26728261 RX26728261
description	door catch H 17mm L 84mm W 53mm mounting distance 68mm zinc die cast with wedge heated units		



GEV No.	690101	Ref. No.	26728253 RX26728253
description	snap lock L 85mm W 40mm mounting distance 68mm heated units H 63mm type 1750 series		

hinges

oven hinges

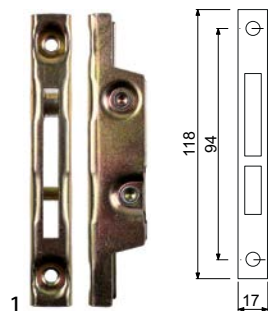

GEV No.	700001	Ref. No.	RX94805280
description	opposite support L 118mm W 17mm mounting distance 94mm		



GEV No.	700006	Ref. No.	94805272 RX94805272
----------------	--------	-----------------	------------------------

description oven hinge mounting distance 173mm mounting distance 2 105mm lug mounting 14mm lever length 120mm groove distance 11mm spring thickness 3.5mm mounting ear position left spring length 112mm W 25mm

accessories for 700006



GEV No.	700001	Ref. No.	RX94805280
opposite support L 118mm W 17mm mounting distance 94mm			



GEV No.	700007	Ref. No.	RX94805264
oven hinge mounting distance 173mm mounting distance 2 105mm lug mounting 14mm lever length 120mm groove distance 11mm spring thickness 3.5mm mounting ear position right spring length 112mm W 25mm			

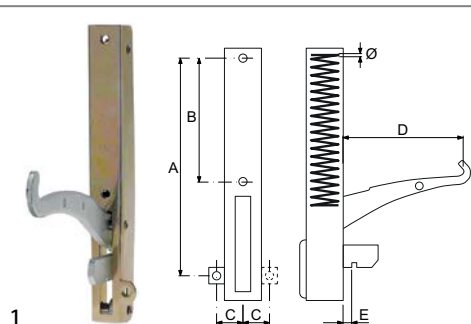

GEV No.	700007	Ref. No.	RX94805264
----------------	--------	-----------------	------------

description oven hinge mounting distance 173mm mounting distance 2 105mm lug mounting 14mm lever length 120mm groove distance 11mm spring thickness 3.5mm mounting ear position right spring length 112mm W 25mm

accessories for 700007



GEV No.	700001	Ref. No.	RX94805280
opposite support L 118mm W 17mm mounting distance 94mm			

miscellaneous



GEV No.	701170	Ref. No.	94002011 RX94002011
description	hinge L 111mm W 95mm mounting distance 90mm mounting pos. right		

fittings for catering equipment

aerators and air bleeders



GEV No.	540824	Ref. No.	94806056 RX94806056
description	pressure compensation valve thread 1/4" ET WS 19 chrome-plated L 18mm		

drain taps

brass



drain taps



GEV No.	548001	Ref. No.	RX94020237
----------------	--------	-----------------	------------

description drain tap 1 1/2" IT O-ring seal kettle connection with union nut A 80mm B1 68mm B2 132mm

spare parts for 548001

	GEV No.	505092	Ref. No.	—
O-ring EPDM thickness 5.34mm ID \varnothing 43.82mm Qty 1 pcs				
	GEV No.	540213	Ref. No.	—
handle ID \varnothing 5mm L 117mm				



safety fittings

accessories



GEV No.	540836	Ref. No.	94812552 RX94812552
description	funnel thread 1/2" with shut-off valve		

safety valves



GEV No.	540721	Ref. No.	94812663 RX94812663
description	safety valve triggering pressure 0.5bar M88 thread 1 1/4"		

accessories for 540721



GEV No.	541501	Ref. No.	—
description	reducer for safety fitting IT 1 1/4" ET 3/4"		

equipment feet and end caps

equipment feet

with screw mounting



GEV No.	513287	Ref. No.	RX94809563
description	equipment foot tube ø 60mm thread M12 thread L 33mm H 155-235mm SS size 2" Qty 1 pcs		

screw-in feet



GEV No.	701292	Ref. No.	RX94810928
description	equipment foot thread M10 thread L 23mm ø 38mm H 12.5mm WS 17 Qty 1 pcs		



GEV No.	691652	Ref. No.	RX94800992
description	equipment foot thread M10 thread L 25mm H 8mm ø 25mm overall height 33mm WS 25 Qty 1 pcs		



GEV No.	695601	Ref. No.	RX94813949
description	equipment foot thread M17 thread L 23mm ø 24mm H 11mm plastic WS 24 Qty 1 pcs		



GEV No.	696536	Ref. No.	94813950 RX94813950
description	equipment foot thread M17 thread L 30mm ø 17mm H 20mm plastic WS 24 Qty 1 pcs		

baskets

fryer baskets

ROSINOX



GEV No.	970880	Ref. No.	RX94030194
description	fryer basket W1 165mm L1 295mm H1 210mm plastic		



GEV No.	970850	Ref. No.	RX94037660
description	fryer basket W1 280mm L1 395mm H1 145mm plastic		

crumb screens



GEV No.	970851	Ref. No.	RX94037686
description	crumb screen L 460mm W 300mm H 6.5mm		

warewashing baskets

accessories

cutlery inserts



GEV No.	976013	Ref. No.	94804689 RX94804689
description	cutlery insert L 105mm W 105mm ømm H 140mm		

sliding corners



GEV No.	970001	Ref. No.	94807401 RX94807401
description	sliding corner wire gauge ø 5mm L 120mm W 120mm H 12mm L-shape		

gaskets

refrigeration gaskets

plug-in gaskets

profile 9048

We offer custom-made gaskets for this profile

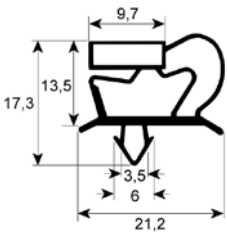

GEV No.	900695	Ref. No.	RX94814475
description	refrigeration gasket profile 9048 W 375mm L 400mm plug size		

gaskets for heated units

window seals

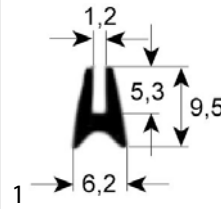

GEV No.	698487	Ref. No.	RX94062544
description	window gasket profile 1530 L 1215mm suitable for ROSINOX		

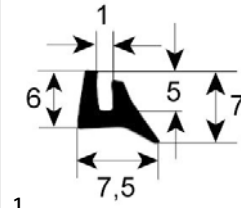

GEV No.	900056	Ref. No.	RX24390502
description	window gasket profile 1570 Qty supplied by meter		

door seals

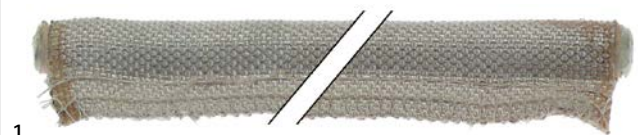

GEV No.	902283	Ref. No.	RX94025962
description	door seal L 1300mm suitable for ROSINOX		

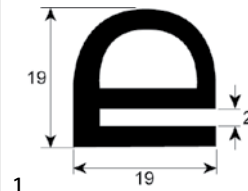

GEV No.	900174	Ref. No.	RX24390288
description	door seal profile 2210 L 4200mm Qty 1		

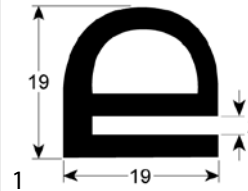

GEV No.	902238	Ref. No.	RX24390288
description	door seal profile 2210 L 4200mm Qty 1		

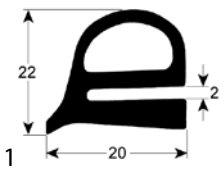

GEV No.	901561	Ref. No.	9405030 94050309 RX94050309
description	door seal profile 2228 Qty supplied by meter		

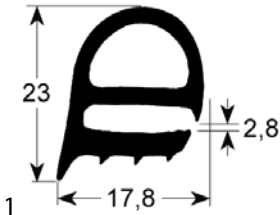

GEV No.	902240	Ref. No.	24390379 RX24390379
description	door seal profile 2230 W 470mm L 485mm external size Qty 1		

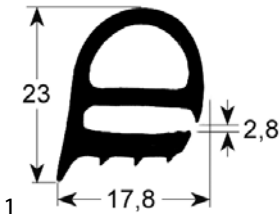

GEV No.	902241	Ref. No.	24390338 RX24390338
description	door seal profile 2230 W 480mm L 725mm external size Qty 1		

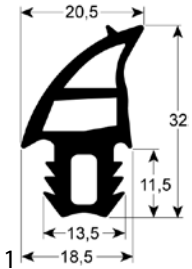

GEV No.	902492	Ref. No.	RX94820003
description	door seal profile 2736 W 695mm L 1000mm outer plug size Qty 1 suitable for ELOMA 12-21 silicone		



GEV No.	900489	Ref. No.	94814225 RX94814225
description	door seal profile 2770/2771 H 440mm W 600mm outer plug size Qty 1		

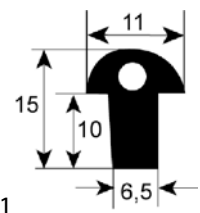

GEV No.	900727	Ref. No.	RX94806445
description	door seal profile 2930 Qty supplied by meter		

gaskets for tray rack trolleys

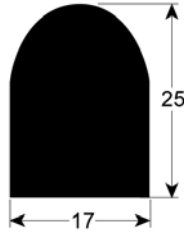

GEV No.	902225	Ref. No.	RX24390510
description	tray rack trolley gasket profile 4020 L 1100mm Qty 1 silicone foam		

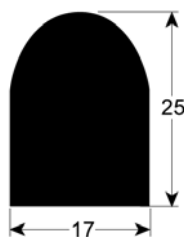

GEV No.	900055	Ref. No.	24390510 RX24390510
description	tray rack trolley gasket profile 4020 Qty supplied by meter silicone foam		

O-rings

EPDM



GEV No.	361304	Ref. No.	94801156 RX94801156
description	O-ring EPDM ID ø 11.11mm thickness 1.78mm Qty 1 pcs for type DIB3E/DIB5E		



GEV No.	510302	Ref. No.	94809639 94813757 RX94809639 RX94813757
description	O-ring EPDM ID ø 12.42mm thickness 1.78mm Qty 1 pcs		

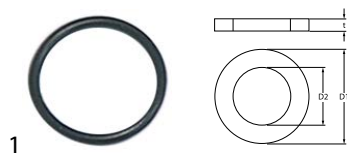

GEV No.	510322	Ref. No.	94801214 RX94801214
description	O-ring EPDM thickness 1.78mm ID ø 17.17mm Qty 1 pcs		

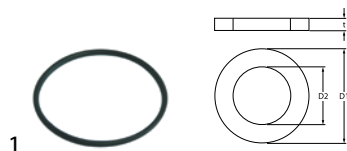

GEV No.	510824	Ref. No.	94807450 RX94807450
description	O-ring EPDM thickness 1.78mm ID ø 20.35mm Qty 1 pcs		

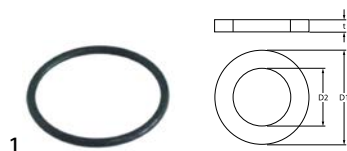

GEV No.	517045	Ref. No.	94807550 RX94807550
description	O-ring EPDM thickness 1.78mm ID ø 21.95mm Qty 1 pcs		

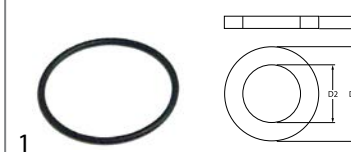

GEV No.	513057	Ref. No.	94801727 RX94801727
description	O-ring EPDM thickness 1.78mm ID ø 28.3mm Qty 1 pcs		

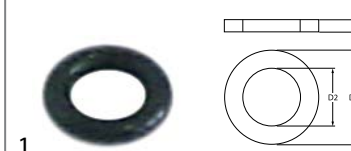

GEV No.	517035	Ref. No.	RX94809555
description	O-ring EPDM thickness 1.78mm ID ø 4.48mm Qty 1 pcs		



GEV No.	510303	Ref. No.	94800778 RX94800778
description	O-ring EPDM thickness 1.78mm ID ø 6.75mm Qty 1 pcs		



GEV No.	510177	Ref. No.	94809761 RX94809761
description	O-ring EPDM thickness 1.78mm ID ø 7.66mm Qty 1 pcs		

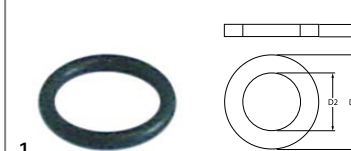

GEV No.	504574	Ref. No.	RX94813741 RX94813762
description	O-ring EPDM thickness 1.78mm ID ø 9.25mm Qty 1 pcs		

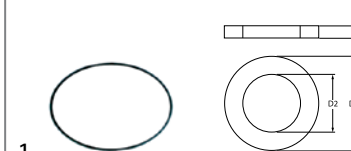

GEV No.	510556	Ref. No.	RX94813788
description	O-ring EPDM thickness 1.78mm ID ø 94.97mm Qty 1 pcs pump type T110		

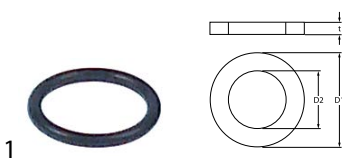
GEV No.	511237	Ref. No.	94813756 RX94813756
description	O-ring EPDM thickness 1mm ID \varnothing 7mm Qty 1 pcs		

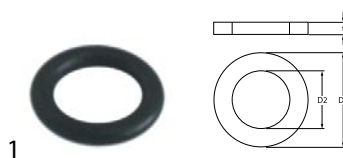

GEV No.	528583	Ref. No.	94813760 RX94813760
description	O-ring EPDM thickness 2.62mm ID \varnothing 9.13mm Qty 1 pcs		



GEV No.	517104	Ref. No.	RX94807440
description	O-ring EPDM thickness 2.62mm ID \varnothing 31.42mm Qty 1 pcs		

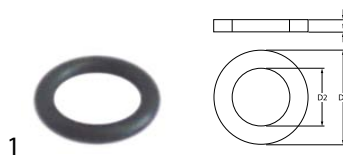

GEV No.	528487	Ref. No.	94812680 RX94812680
description	O-ring EPDM thickness 2.62mm ID \varnothing 9.19mm Qty 1 pcs		

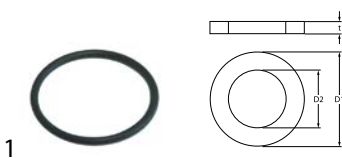

GEV No.	517004	Ref. No.	94807773 RX94807773
description	O-ring EPDM thickness 2.62mm ID \varnothing 34.6mm Qty 1 pcs		

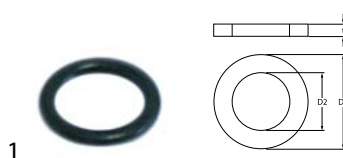

GEV No.	510893	Ref. No.	94807765 RX94807765
description	O-ring EPDM thickness 2.62mm ID \varnothing 9.92mm Qty 1 pcs		



GEV No.	512056	Ref. No.	94814259 RX94814259
description	O-ring EPDM thickness 2.62mm ID \varnothing 50.47mm Qty 1 pcs		

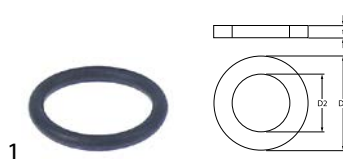

GEV No.	517087	Ref. No.	94807351 RX94807351
description	O-ring EPDM thickness 3.53mm ID \varnothing 23.4mm Qty 1 pcs		



GEV No.	512114	Ref. No.	94802535 RX94802535
description	O-ring EPDM thickness 2.62mm ID \varnothing 55.25mm Qty 1 pcs		



GEV No.	510895	Ref. No.	94813951 RX94813951
description	O-ring EPDM thickness 3.53mm ID \varnothing 34.52mm Qty 1 pcs		



GEV No.	512235	Ref. No.	94801123 RX94801123
description	O-ring EPDM thickness 2.62mm ID \varnothing 88.57mm Qty 1 pcs		

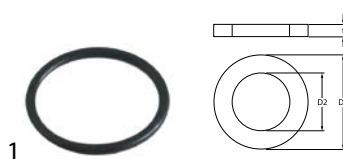

GEV No.	506015	Ref. No.	94810256 RX94810256
description	O-ring EPDM thickness 3.53mm ID \varnothing 39.69mm Qty 1 pcs		

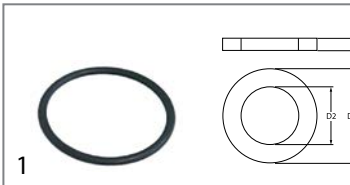

GEV No.	524148	Ref. No.	94800703 RX94800703
description	O-ring EPDM thickness 3.53mm ID ø 40.86mm Qty 1 pcs		

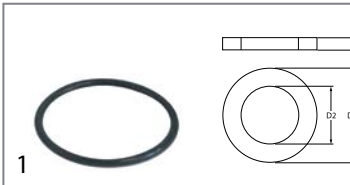

GEV No.	518175	Ref. No.	94806924 94812565 RX94806924 RX94812565
description	O-ring EPDM thickness 3.53mm ID ø 49.21mm Qty 1 pcs		

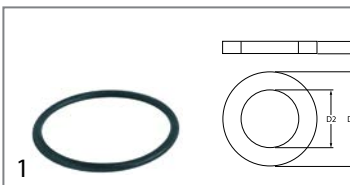

GEV No.	532118	Ref. No.	RX94806155
description	O-ring EPDM thickness 3.53mm ID ø 55.56mm Qty 10 pcs		

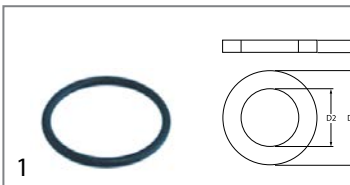

GEV No.	510563	Ref. No.	94801487 RX94801487
description	O-ring EPDM thickness 3mm ID ø 28mm Qty 1 pcs		

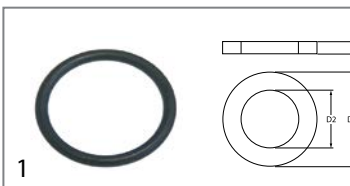

GEV No.	510408	Ref. No.	RX94807781
description	O-ring EPDM thickness 5.34mm ID ø 47mm Qty 1 pcs		

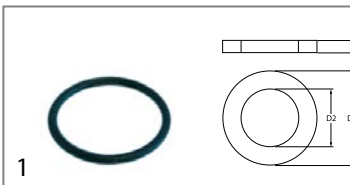

GEV No.	510409	Ref. No.	RX94807294
description	O-ring EPDM thickness 5.34mm ID ø 56.52mm Qty 1 pcs		



GEV No.	532653	Ref. No.	94808599 RX94808599
description	O-ring EPDM thickness 5mm ID ø 20mm Qty 1 pcs		

silicone

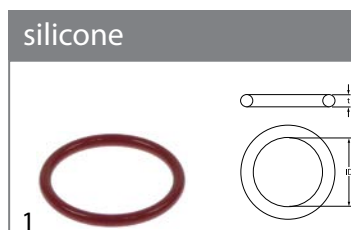

GEV No.	514017	Ref. No.	94803079 94803616 94812605 RX94803079 RX94803616 RX94812605
description	O-ring silicone thickness 3.53mm ID ø 32.93mm Qty 1 pcs		

Viton

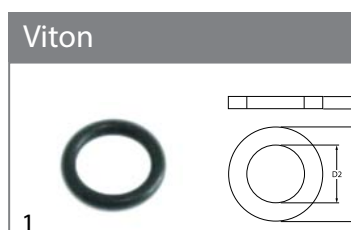

GEV No.	528246	Ref. No.	94814266 RX94814266
description	O-ring Viton thickness 1.78mm ID ø 8.73mm Qty 1 pcs		

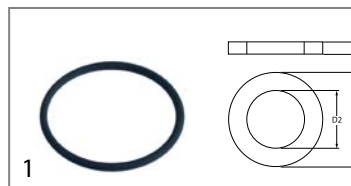

GEV No.	550496	Ref. No.	RX94812518
description	O-ring Viton thickness 3.53mm ID ø 50.39mm Qty 1 pcs		

NBR

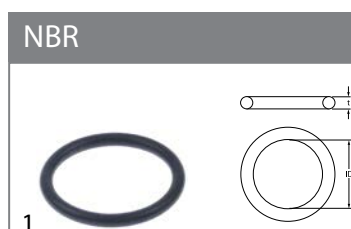



GEV No.	532654	Ref. No.	94813976 RX94813976
description	O-ring NBR thickness 3.6mm ID ø 30.8mm Qty 1 pcs		



sealing washers

fibre gaskets

			
1			
GEV No.	517173	Ref. No.	94810941 RX94810941
description	flat gasket FIBER ED ø 14mm ID ø 8mm thickness 1.5mm Qty 1 pcs		

			
1			
GEV No.	508017	Ref. No.	94813967 RX94813967
description	flat gasket FIBER ED ø 24mm ID ø 17mm thickness 2mm Qty 1 pcs		

			
1			
GEV No.	506072	Ref. No.	94808870 RX94808870
description	flat gasket fibre ED ø 38mm ID ø 27mm thickness 2mm outflow for thread 1¼" Qty 1 pcs		

rubber gaskets

			
1			
GEV No.	505313	Ref. No.	94813799 RX94813799
description	flat gasket Neoprene ED ø 50mm ID ø 35mm thickness 4mm Qty 1 pcs		

			
1			
GEV No.	510761	Ref. No.	94801495 RX94801495
description	flat gasket rubber D1 ø 38mm D2 ø 25mm thickness 2mm Qty 1 pcs		

			
1			
GEV No.	512376	Ref. No.	94802659 RX94802659
description	flat gasket rubber ED ø 18mm ID ø 10mm thickness 2mm Qty 1 pcs		

			
1			
GEV No.	512073	Ref. No.	94802212 RX94802212
description	flat gasket rubber ED ø 31mm ID ø 22mm thickness 2mm Qty 1 pcs		

			
1			
GEV No.	519341	Ref. No.	RX94807245
description	flat gasket rubber ED ø 40mm ID ø 5.5mm thickness 2mm Qty 1 pcs		

			
1			
GEV No.	512346	Ref. No.	RX94801446
description	flat gasket rubber ED ø 44mm ID ø 32mm thickness 2.5mm Qty 1 pcs		

			
1			
GEV No.	517181	Ref. No.	94807520 RX94807520
description	flat gasket rubber ED ø 44mm ID ø 32mm thickness 3mm Qty 1 pcs		

			
1			
GEV No.	513059	Ref. No.	94804325 94804895 RX94804325 RX94804895
description	flat gasket rubber ED ø 52mm ID ø 40mm thickness 3mm Qty 1 pcs		

			
1			
GEV No.	512295	Ref. No.	94814256 RX94814256
description	flat gasket rubber ED ø 65mm ID ø 50mm thickness 3mm Qty 1 pcs equiv. no. 25260 suitable for HOONVED		

			
1			
GEV No.	517205	Ref. No.	RX94808037
description	flat gasket rubber ED ø 75mm ID ø 58mm thickness 3mm Qty 1 pcs		

			
1			
GEV No.	517398	Ref. No.	RX94810355
description	flat gasket rubber ED ø 82mm ID ø 66mm thickness 4mm for salt tank Qty 1 pcs		

			
1			
GEV No.	517194	Ref. No.	94813987 RX94813987
description	flat gasket rubber ED ø 95mm ID ø 75mm thickness 3mm Qty 1 pcs		

			
1			
GEV No.	694527	Ref. No.	24390627 RX24390627
description	gasket rubber ED ø 57mm ID ø 39mm thickness 4mm for combi-steamer Qty 1 pcs suitable for RATIONAL		

silicone gaskets			
			
1			
GEV No.	507520	Ref. No.	94813931 RX94813931
description	gasket silicone ED ø 38mm ID ø 30mm thickness 4mm Qty 1 pcs for wash arm		

			
1			
GEV No.	359721	Ref. No.	RX24390700
description	gasket silicone ED ø 48mm ID ø 39.5mm thickness 5mm Qty 1 pcs		

foam rubber gaskets			
			
1			
GEV No.	505307	Ref. No.	94813780 RX94813780
description	foam rubber gasket W 15mm thickness 5mm suitable for HOONVED with layer		

sealing cords

round			
			
1			
GEV No.	510572	Ref. No.	RX24390296
description	sealing cord ø 10mm greased L 0.2m Qty 1		

			
1			
GEV No.	694699	Ref. No.	RX94051653
description	sealing cord round ø 16mm braided L 1.4m Qty 1		

special gaskets

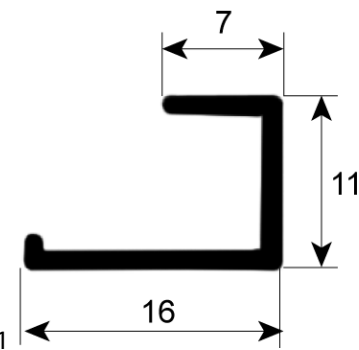
door seals for dishwashers			
			
1			
GEV No.	518246	Ref. No.	94804523 RX94804523
description	door seal L 395mm dishwasher suitable for ELETTOBAR, WOLK equiv. no. 437057		

miscellaneous

			
1			
GEV No.	698485	Ref. No.	RX94814199
description	flat gasket external height 9mm ED ø 69mm ID ø 55mm heating		

			
1			
GEV No.	530430	Ref. No.	RX94813982
description	gasket for rinse pipe rubber ø 33mm ID ø 24mm thickness 11mm for Silanos		



			
1			
GEV No.	505314	Ref. No.	94801735 RX94801735
description	gasket for wash arm thickness 1mm L 74.5mm W 42mm		

			
1			
GEV No.	510566	Ref. No.	24390320 RX24390320
description	gasket suitable for RATIONAL equiv. no. 50120537 L 70mm W 70mm electrode thickness 4mm		

			
1			
GEV No.	510671	Ref. No.	RX24390544
description	gasket suitable for RATIONAL for drain Qty 1m ED ϕ 124mm ID ϕ 51mm rubber thickness 4mm hole distance 87mm		

			
1			
GEV No.	511947	Ref. No.	9403064 94030640 RX94030640
description	gasket suitable for ROSINOX for hand wheel external hight 7mm Qty 1m ED ϕ 36mm ID ϕ 18mm rubber thickness 2.5mm		

			
1			
GEV No.	901562	Ref. No.	9401347 94013471 RX94013471
description	gasket suitable for ROSINOX for switch L 50mm W 20mm Qty 1m silicone thickness 1.5mm hole distance 28mm		

			
1			
GEV No.	698484	Ref. No.	RX94050440
description	lid gasket L 223mm W 148mm ROSINOX		

thermostat gaskets

			
1			
GEV No.	512154	Ref. No.	94813740 RX94813740
description	gasket for thermostat ID ϕ 20mm equiv. no. 200494/H200494 hole distance 41mm suitable for COMENDA, HOONVED		

gaskets for wash arm support

			
1			
GEV No.	518025	Ref. No.	94804234 RX94804234
description	gasket D1 ϕ 50mm D2 ϕ 82mm thickness 2mm with 6 holes wash arm support equiv. no. 437014 suitable for COLGED		

			
1			
GEV No.	518339	Ref. No.	94804929 RX94804929
description	gasket D2 ϕ 50mm thickness 2mm with 3 screw holes wash arm support equiv. no. 437064 suitable for COLGED hole ϕ 50mm hole distance 67mm		

springs

torsion springs



GEV No.	690095	Ref. No.	94814244 RX94814244
description	torsion spring ø 6mm L2 15mm wire gauge ø 0.9mm L1 2x6mm L3 15mm Qty 1 pcs for closing hub		

compression springs



GEV No.	512102	Ref. No.	94814268 RX94814268
description	compression spring		



GEV No.	512108	Ref. No.	94801263 RX94801263
description	compression spring ø 41mm L 60mm wire gauge ø 2mm		

spring compressors



GEV No.	517160	Ref. No.	RX94810915
description	spring compressor thread M10		

roller springs

roller springs



GEV No.	517419	Ref. No.	RX94810728
description	roller spring complete incl. holder type BBSR 22		



GEV No.	517321	Ref. No.	RX94807580
description	roller spring type BBSR 23 W 51mm ID ø 45mm lug length 50mm		

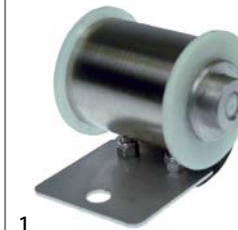

GEV No.	517315	Ref. No.	RX94807570
description	roller spring W 50mm ID ømm lug length 49mm		
accessories for	517315		



GEV No.	517314	Ref. No.	94809712 RX94809712
description	spring holder for roller spring ø 29mm Lmm Wmm H 9mm		

accessories

holders



GEV No.	517314	Ref. No.	94809712 RX94809712
description	spring holder for roller spring ø 29mm Lmm Wmm H 9mm		

tension springs



GEV No.	698482	Ref. No.	RX94025038
description	spring ø 23.9mm total length 235mm wire gauge ø 3.5mm Qty 1 pcs		





GEV No.	517273	Ref. No.	94814305 RX94814305
description	tension spring ø 10mm total length 225mm wire gauge ø 1.5mm mounting pos. upper		





GEV No.	501296	Ref. No.	RX94810850
description	tension spring ø 12mm total length 275mm wire gauge ø 1.6mm		



1 			
GEV No.	517259	Ref. No.	94814098 RX94814098
description	tension spring ø 15.3mm total length 130mm wire gauge ø 2mm for door		

1 			
GEV No.	512033	Ref. No.	RX94813845
description	tension spring ø 21.6mm total length 190mm wire gauge ø 3mm L1 121.5mm		

1 			
GEV No.	517286	Ref. No.	RX94808557
description	tension spring ø 35mm total length 865mm wire gauge ø 5mm		

1 			
GEV No.	517287	Ref. No.	RX94813999
description	tension spring ø 38.8mm total length 663mm wire gauge ø 4.2mm		

1 			
GEV No.	517048	Ref. No.	RX94810914
description	tension spring ø 39.7mm total length 305mm wire gauge ø 5mm mounting pos. lateral		

manometers

1 			
GEV No.	541876	Ref. No.	RX94809357
description	manometer ø 49mm pressure range 0-4bar connection lower marking adjustable thread 1/4"		

1 			
GEV No.	541334	Ref. No.	94812660 RX94812660
description	manometer ø 60mm pressure range 0 up to 1bar thread 1/8" marking 0.5 kettle connection on the backside		

hose reels and spray guns

spray guns

1 			
GEV No.	520729	Ref. No.	25177072 RX25177072
description	shower hose connections 1/2" L 2800mm SS operating p. 10bar burst p. 90bar t.max. 90°C approval DVGW with flexible fabric		

dosing pumps

membrane dosing pumps

self-priming

SEKO

spare parts

1 			
GEV No.	361304	Ref. No.	94801156 RX94801156
description	O-ring EPDM ID ø 11.11mm thickness 1.78mm Qty 1 pcs for type DIB3E/DIB5E		

various



1 				
GEV No.	361015	Ref. No.	RX94807690	
description	dosing pump membrane dosing pump rinse aid inlet 6x8mm outlet 4x6mm pressure connection ø 4x6mm suction connection ø 6x8mm			
spare parts for	361015			
	GEV No.	361132	Ref. No.	—
	membrane dosing pump			
	GEV No.	510298	Ref. No.	—
	lip valve dosing pump suitable for DB2/DS5			

self-priming with supporting pressure

DIHR







1

GEV No.	361744	Ref. No.	94808748 RX94808748
description	dosing pump type DW with auxiliary pressure connection rinse aid inlet 4mm outlet 8mm suction connection ø 4mm auxiliary pressure connection 10mm		
spare parts for	361744		
	GEV No.	520026	Ref. No. —
	PVC hose ID ø 4mm ED ø 6mm L 10m thickness 1mm t.max. 60°C transparent		
	GEV No.	520090	Ref. No. —
	PVC hose ID ø 4mm ED ø 6mm L 2m thickness 1mm t.max. 60°C transparent		

HOONVED



1

GEV No.	361010	Ref. No.	94801271 RX94801271
description	dosing pump rinse aid pressure connection ø 4x6mm suction connection ø 4mm auxiliary pressure connection 10mm HOONVED		
spare parts for	361010		
	GEV No.	361383	Ref. No. —
	lip valve rinse aid pressure connection ømm suction connection ømm auxiliary pressure connectionmm		
	GEV No.	361384	Ref. No. —
	membrane rinse aid pressure connection ømm suction connection ømm auxiliary pressure connectionmm		
accessories for	361010		
	GEV No.	520090	Ref. No. —
	PVC hose ID ø 4mm ED ø 6mm L 2m thickness 1mm t.max. 60°C transparent		
	GEV No.	520091	Ref. No. —
	nylon hose ID ø 4mm ED ø 6mm L 2m thickness 1mm operating p. 10bar burst p. 50bar t.max. 100°C transparent		



1

GEV No.	361387	Ref. No.	94813747 RX94813747
description	dosing pump rinse aid pressure connection ø 8mm suction connection ø 4mm auxiliary pressure connection 10mm		
spare parts for	361387		
	GEV No.	361383	Ref. No. —
	lip valve rinse aid pressure connection ømm suction connection ømm auxiliary pressure connectionmm		
	GEV No.	361384	Ref. No. —
	membrane rinse aid pressure connection ømm suction connection ømm auxiliary pressure connectionmm		
	GEV No.	508008	Ref. No. —
	O-ring EPDM thickness 2.62mm ID ø 15.88mm Qty 1 pcs		
accessories for	361387		
	GEV No.	520022	Ref. No. —
	PVC hose ID ø 8mm ED ø 12mm L 10m thickness 2mm t.max. 60°C transparent		
	GEV No.	520090	Ref. No. —
	PVC hose ID ø 4mm ED ø 6mm L 2m thickness 1mm t.max. 60°C transparent		

SEKO



1

GEV No.	361304	Ref. No.	94801156 RX94801156
description	O-ring EPDM ID ø 11.11mm thickness 1.78mm Qty 1 pcs for type DIB3E/DIB5E		

accessories



1

GEV No.	361829	Ref. No.	RX94810173 RX94810181
description	container filter complete plastic hose ø 5mm		



container filters with non-return valve

1



GEV No.	361058	Ref. No.	94045172 RX94045172
description	container filter with non-return valve SS hose ϕ 4x6mm ϕ 20mm L 56mm		

1



GEV No.	518068	Ref. No.	94804044 RX94804044
description	drain hose DN34 L 2000mm elbow ϕ inside 50mm elbow ext. ϕ 59mm inner hose ϕ 35mm outer hose ϕ 42mm PVC		



hoses

supply hoses

stainless steel flexi hoses

universal hoses

1

GEV No.	520633	Ref. No.	RX94814124
description	flex hose SS braid straight-straight DN10 connections 1/2" L 2000mm approval DVGW operating p. 10bar test pressure 32bar burst p. 95bar		

1



GEV No.	507207	Ref. No.	94802717 RX94802717
description	drain hose DN24 L 1500mm A int. ϕ 24mm A ext. ϕ 28mm B int. ϕ 24mm B ext. ϕ 28mm outer hose ϕ 28mm		

1



GEV No.	530613	Ref. No.	94813844 RX94813844
description	drain hose DN19 L 3000mm straight ϕ inside 21mm straight ext. ϕ 27mm elbow ϕ inside 21mm elbow ext. ϕ 27mm outer hose ϕ 20mm		

pre-rinse hoses

stainless steel flexi hoses

1



GEV No.	520729	Ref. No.	25177072 RX25177072
description	shower hose connections 1/2" L 2800mm SS operating p. 10bar burst p. 90bar t.max. 90°C approval DVGW with flexible fabric		

1



GEV No.	530819	Ref. No.	94812310 RX94812310
description	drain hose DN20 L 2500mm straight ϕ inside 19mm straight ext. ϕ 24mm elbow ϕ inside 22mm elbow ext. ϕ 27mm outer hose ϕ 24mm		

drain hoses

1



GEV No.	530587	Ref. No.	94813841 RX94813841
description	drain hose DN28 L 2000mm straight ϕ inside 32mm straight ext. ϕ 40mm outer hose ϕ 35mm		

industrial hoses

Niplaflex hoses

1



GEV No.	530562	Ref. No.	RX94813948
description	pressure hose ID ϕ 13mm ED ϕ 21mm L 5m operating p. 10bar burst p. 30bar t.max. 110°C		



pressure control hoses



1

GEV No.	530560	Ref. No.	94813947 RX94813947
description	pressure control hose ID ø 5mm ED ø 9mm L 5m operating p. 30bar burst p. 90bar temp.-resist. 60°C		

formed hoses

straight



1

GEV No.	518380	Ref. No.	94804077 RX94804077
description	formed hose ext. ø 53 ID ø 43mm L 65mm dishwasher straight mounting pos. upper equiv. no. 127036		



1

GEV No.	530603	Ref. No.	RX24556094
description	steam hose ID ø 60mm ED ø 68mm L 120mm Qty 1 for combi-steamer		

form L



1

GEV No.	512129	Ref. No.	94802089 RX94802089
description	formed hose end piece A ext. ø 75mm end piece A int. ø 59mm AD2 ø 75mm ø end piece B 59mm warewashing L-shape equiv. no. 29532		



1

GEV No.	517228	Ref. No.	24685141 94809811 RX24685141 RX94809811
description	formed hose warewashing L-shape equiv. no. 15032/A		



1

GEV No.	517245	Ref. No.	94814085 RX94814085
description	formed hose warewashing L-shape equiv. no. 15033/A mounting pos. lower		



1

GEV No.	517248	Ref. No.	94809803 RX94809803
description	formed hose warewashing L-shape equiv. no. 16170/M mounting pos. upper		



1

GEV No.	517236	Ref. No.	94808839 RX94808839
description	formed hose warewashing L-shape equiv. no. 3002020		

with branch



1

GEV No.	517364	Ref. No.	RX94814008
description	formed hose ext. ø 58 D1 ø 50mm D2 ø 35mm L 455mm black Qty 1		

form S



1

GEV No.	512130	Ref. No.	94802071 RX94802071
description	formed hose ID ø 50mm S-shape warewashing equiv. no. 25227		



1

GEV No.	517237	Ref. No.	94810132 RX94810132
description	formed hose S-shape warewashing equiv. no. 10200124/A		



1

GEV No.	517227	Ref. No.	RX94814077
description	formed hose S-shape warewashing equiv. no. 25032		



1

GEV No.	517226	Ref. No.	94813962 RX94813962
description	formed hose S-shape warewashing equiv. no. 25032/A		

form U



1

GEV No.	518517	Ref. No.	94804879 RX94804879
description	formed hose for drain pump D1 ø 28mm D2 ø 21mm warewashing U-shape		



1

GEV No.	517255	Ref. No.	94811007 RX94811007
description	formed hose warewashing U-shape equiv. no. 560008 mounting pos. upper		



miscellaneous



1			
GEV No.	517256	Ref. No.	26630038 94809092 RX26630038 RX94809092
description	formed hose warewashing equiv. no. 150048/A mounting pos. upper		



1			
GEV No.	517243	Ref. No.	94813963 RX94813963
description	formed hose warewashing equiv. no. 150049 mounting pos. lower		

fittings, hose and pipe connectors

hose connectors

without screw connection



1			
GEV No.	501210	Ref. No.	94809241 RX94809241
description	Y-piece plastic hose ø 10-10-10mm		

fittings

reducers



1			
GEV No.	520177	Ref. No.	94814405 RX94814405
description	reducer thread 1/4" ET - 1/8" IT nickel-plated brass total length 13mm WS 17		

angle pieces



1			
GEV No.	531261	Ref. No.	RX94025293
description	angle piece thread 1/2" ET - 1/2" ET brass		



1			
GEV No.	510464	Ref. No.	RX94813797
description	angle piece thread 1/4" IT - 3/8" IT brass		

T-pieces

nickel-plated brass



1			
GEV No.	520340	Ref. No.	94814314 RX94814314
description	T-piece thread 1/4" IT - 1/4" IT - 1/4" IT nickel-plated brass L 46mm		



hose connectors

brass



GEV No.	513253	Ref. No.	RX94804549
description	hose connector brass angled thread 1/4" hose ø 12mm Qty 1 pcs		

nickel-plated brass



GEV No.	520203	Ref. No.	94813992 RX94813992
description	hose connector nickel-plated brass straight thread 1/2" hose ø 12mm Qty 1 pcs		



GEV No.	520201	Ref. No.	94813991 RX94813991
description	hose connector nickel-plated brass straight thread 1/4" hose ø 12mm Qty 1 pcs		

producer-specific



GEV No.	512025	Ref. No.	RX94813769
description	hose connector thread M16x1.25 for hose ID 11mm		

valves and tank inlets

ball valves

universal

ball valves with butterfly handle



GEV No.	540658	Ref. No.	RX94032687
description	ball valve connection 3/4" IT - 3/4" IT DN20 total length 69mm		

ball valves with lever handle



GEV No.	520282	Ref. No.	94812667 RX94812667
description	ball valve connection 1" IT - 1" IT DN25 total length 67mm with lever handle		

drain systems and wash basins

drain fittings

universal

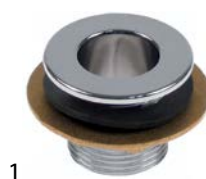

GEV No.	515041	Ref. No.	RX94806775	
description	drain fitting size 3/4" usable heightmm overall height 30mm ED ø 38mm chrome-plated brass			
accessories for	515041			
	GEV No.	515047	Ref. No.	—
	standpipe size 3/4" usable height 28mm overall height 54mm ED ø 20mm chrome-plated brass with O-ring			
	GEV No.	515048	Ref. No.	—
	standpipe size 3/4" usable height 48mm overall height 74mm ED ø 20mm chrome-plated brass with O-ring			
	GEV No.	515049	Ref. No.	—
	standpipe size 3/4" usable height 68mm overall height 94mm ED ø 20mm chrome-plated brass with O-ring			
	GEV No.	515050	Ref. No.	—
	standpipe size 3/4" usable height 98mm overall height 124mm ED ø 20mm chrome-plated brass with O-ring			







standpipes

3/4"



1

GEV No.	515041	Ref. No.	RX94806775
description	drain fitting size 3/4" usable heightmm overall height 30mm ED ø 38mm chrome-plated brass		
accessories for	515041		
	GEV No.	515047	Ref. No. —
	standpipe size 3/4" usable height 28mm overall height 54mm ED ø 20mm chrome-plated brass with O-ring		
	GEV No.	515048	Ref. No. —
	standpipe size 3/4" usable height 48mm overall height 74mm ED ø 20mm chrome-plated brass with O-ring		
	GEV No.	515049	Ref. No. —
	standpipe size 3/4" usable height 68mm overall height 94mm ED ø 20mm chrome-plated brass with O-ring		
	GEV No.	515050	Ref. No. —
	standpipe size 3/4" usable height 98mm overall height 124mm ED ø 20mm chrome-plated brass with O-ring		

supply filters



1

GEV No.	520262	Ref. No.	94024528 RX94024528
description	supply filter thread 3/4" IT - 3/4" IT total length 70mm red brass DN20 mesh opening 0.4mm		



1

GEV No.	520898	Ref. No.	RX26612523
description	screen ø 26mm H 52mm suitable for supply filter Caleffi 1"		



1

GEV No.	520790	Ref. No.	94808912 RX94808912
description	supply filter thread 3/4" IT - 3/4" ET total length 72mm nickel-plated brass H 66mm W 46mm		

water cycle components

pressure reduction valves

pressure reduction valves

universal



1

GEV No.	520789	Ref. No.	94810967 RX94810967
description	pressure reduction valve Caleffi series 5362 connection 1/2" default setting 3bar setting range 0.5 up to 6bar p max 25bar t.max. 80°C brass DVGW/SVGW/WRAS/ACS		

ancillary products

clamps

hose clamps

DIN 3017 - W2



1

GEV No.	520118	Ref. No.	94814009 RX94814009
description	hose clamp ø 50-70mm width 9mm Qty 5 pcs DIN 3017		





tools

cleaning tools

scrapers

			
1			
GEV No.	801816	Ref. No.	RX94806502
description	scraper 1x scraper		

			
1			
GEV No.	705008	Ref. No.	RX94806502
description	scraper for griddle		
spare parts for	705008		
	GEV No.	Ref. No.	—
	 spare blades for scraper Qty 10 pcs		

measuring equipment

thermometers

built-in thermometers

			
1			
GEV No.	541095	Ref. No.	94801818 94803277 RX94801818 RX94803277
description	thermometer mounting measurements 58x25.5mm 0 up to +120°C capillary pipe 3000mm probe ø 6.5mm probe L 20mm		

fastening material

screws

hexagonal screws

			
1			
GEV No.	506446	Ref. No.	94016375 RX94016375
description	hexagonal screw thread M8 thread L 40mm SS WS 13 Qty 1 pcs DIN 933 / ISO 4017		

cylinder head bolts

DIN 912/ISO 4762

			
1			
GEV No.	560402	Ref. No.	RX94803210
description	cylinder head bolt thread M5 thread L 10mm L 15.5mm WS 4 SS Qty 1 pcs intake hexagonal DIN 912/ISO 4762		

grub screws

DIN 914/ISO 4027

			
1			
GEV No.	504230	Ref. No.	94814482 RX94814482
description	grub screw thread M5 L 8mm A2-A2L DIN 914/ISO 4027 WS 2.5 Qty 1 pcs		

miscellaneous

			
1			
GEV No.	560458	Ref. No.	94027281 RX94027281
description	grub screw thread M4 L 5mm intake slotted Qty 1 pcs		

knurled screws

			
1			
GEV No.	510112	Ref. No.	94803970 RX94803970
description	Thumb screw thread M10 thread L 10mm ø 22mm H 4.5mm SS		

			
1			
GEV No.	517039	Ref. No.	94809910 RX94809910
description	Thumb screw thread M8x1.25 thread L 8mm ø 30mm H 3mm SS mounting pos. lower		

nuts

knurled nuts



1

GEV No.	512257	Ref. No.	94813825 RX94813825
----------------	--------	-----------------	------------------------

description knurled nut thread M10L ø 30mm H 6.5mm SS



1

GEV No.	512212	Ref. No.	94813745 RX94813745
----------------	--------	-----------------	------------------------

description knurled nut thread M10x1.5 ø 30mm H 6.4mm SS



1

GEV No.	510346	Ref. No.	94813742 RX94813742
----------------	--------	-----------------	------------------------

description knurled nut thread M17x1 ø 35mm H 6mm SS

hexagonal nuts

hexagonal nuts metric (without norm)



1

GEV No.	512416	Ref. No.	RX94007069
----------------	--------	-----------------	------------

description hexagonal nut thread M28x1.5 H 8mm WS 46 brass Qty 1 pcs

hexagonal nuts inch thread



1

GEV No.	517180	Ref. No.	94807530 RX94807530
----------------	--------	-----------------	------------------------

description nut thread 1" H 5mm WS 36 SS Qty 1 pcs



1

GEV No.	513025	Ref. No.	94803178 94804168 RX94803178 RX94804168
----------------	--------	-----------------	--

description nut thread 1/2" nickel-plated brass H 7.5mm WS 27 Qty 1 pcs



1

GEV No.	520499	Ref. No.	94810881 RX94810881
----------------	--------	-----------------	------------------------

description nut thread 1 1/4" H 6mm WS 50 brass Qty 1 pcs



1

GEV No.	503042	Ref. No.	94804812 RX94804812
----------------	--------	-----------------	------------------------

description nut thread 3/8" H 6mm brass WS 22 Qty 1 pcs

hexagonal nuts with PG thread



1

GEV No.	550575	Ref. No.	94010881 R95010881 RX94010881
----------------	--------	-----------------	-------------------------------------

description nut thread PG11 H 3mm WS 21 nickel-plated brass Qty 1 pcs

washers

spring washers



1

GEV No.	696429	Ref. No.	26160135 RX26160135
----------------	--------	-----------------	------------------------

description spring washer ID ø 20.5mm ED ø 40mm steel Qty 1 pcs

washers

DIN 125A



1

GEV No.	560112	Ref. No.	94813766 RX94813766
----------------	--------	-----------------	------------------------

description plain washer ID ø 5.3mm ED ø 10mm thickness 1mm SS Qty 20 pcs
DIN 125A for thread M5





1

GEV No.	560333	Ref. No.	RX94801651
----------------	--------	-----------------	------------

description plain washer ID ø 6.4mm ED ø 12mm thickness 1.6mm SS Qty 1 pcs
DIN 125A for thread M6





miscellaneous			
 1			
GEV No.	513223	Ref. No.	94804614 RX94804614
description	disc		

 1			
GEV No.	512041	Ref. No.	94801420 RX94801420
description	plain washer ID ø 14mm ED ø 23.5mm thickness 2mm plastic Qty 1 pcs for wash arm		

fasteners

slot nuts			
 1			
GEV No.	692006	Ref. No.	RX94004355
description	slot nut W 5mm H 5mm L 20mm		

 1			
GEV No.	560285	Ref. No.	94810964 RX94810964
description	slot nut W 8mm H 7mm L 30mm		

clamps			
hose clamps			
DIN 3017 - W2			
 1			
GEV No.	520118	Ref. No.	94814009 RX94814009
description	hose clamp ø 50-70mm width 9mm Qty 5 pcs DIN 3017		

retaining rings			
DIN 471			
 1			
GEV No.	512260	Ref. No.	94813826 RX94813826
description	retaining ring shaft ø 14mm thickness 1.2mm steel DIN 471		

DIN 6799			
 1			
GEV No.	507015	Ref. No.	94803012 RX94803012
description	retaining ring E D1 ø 7mm D2 ø 14mm SS DIN 6799 thickness 0.9mm for shaft ø 8-11mm		

consumables

sealants and adhesives			
high temperature silicone			
 1			
GEV No.	890050	Ref. No.	RX94032679
description	high temperature silicone NOVASIL S76 acetoxy-curing -40 up to +265°C t.max. 280°C anthracite cartridge 310ml		
description	Novasil S56 - cartridge 310ml - anthracite - Developed for applications in the home appliance industry: - Gluing of oven door seals - Gluing of mounting brackets for cooker fascias, oven door seals and handles - Attachment of elastic seals, e.g. to oven doors Temperature resistance: -40°C to +265°C		

fuses			
fine fuses			
 1			
GEV No.	358677	Ref. No.	RX27630268
description	fine fuse size ø5x20mm 4A fast-acting rated 250V Qty 10 pcs		



1

GEV No.	358607	Ref. No.	27630086 RX27630086
description	fine fuse size ø5x20mm 6.3A slow-acting rated 250V Qty 10 pcs		

A			
alarm devices	38		
B			
ball valves	123		
bar burners	84		
bi-metal thermostats	15, 15		
booster pumps I	63		
booster pumps II	64		
C			
cable glands	65		
cables	65		
cam switches	26		
ceramic heaters	6		
clamps	124, 127		
cleaning tools	125		
coil heating elements	6		
cold air circulating fans (complete)	52		
condensators & interference suppression filters	64		
consumables	127		
contactors	39		
container filters	118		
control equipment	30		
control thermostats	15, 20, 21		
cylinder head bolts	125		
D			
door catches	105		
door seals	108		
door seals for dishwashers	114		
dosing pumps	117		
drain fittings	123		
drain hoses	119		
drain pumps	64		
drain systems and wash basins	123		
E			
edgemount latches	104		
electric accessories	65		
electric timers	38		
electrodes	52		
electronic controllers	42		
energy regulators	14		
F			
fans	52		
fasteners	127		
fastening material	125		
filters	64		
fine fuses	127		
fittings	122		
		foam rubber gaskets	114
		formed hoses	120
		fuses	65, 127
G			
		gas burners	80
		gas control valves	73
		gas nozzles	85
		gas taps	66
		gas thermostats	70
		gaskets for heated units	108
		gaskets for tray rack trolleys	109
		gaskets for wash arm support	115
		grub screws	125
H			
		handle latches	104
		heating elements	3
		heating elements for bain maries	3
		heating elements for charrills	6
		heating elements for chip scuttles	3
		heating elements for convection	12
		heating elements for fryers	4
		heating elements for griddles	4
		heating elements for ovens	3
		heating elements for pasta cookers	5
		heating elements for plate warmers	6
		heating elements for tilting bratt pan	5
		hexagonal nuts	126
		hexagonal screws	125
		high temperature silicone	127
		hob burners	80
		hose clamps	124, 127
		hose connectors	122, 123
		hoses	119
		hot air fans	53
		hot air motors	52
		hot plates	14
I			
		ignition boxes	74
		ignition cables	78
		ignition switches	79
		ignition units	79
		immersion heating elements	7
		indicator lights	32
		indicator lights (complete)	33
		industrial hoses	119
K			
		knurled nuts	126
		knurled screws	125

L

lamps	32
light bulbs	35

M

magnetic switches	29
measuring equipment	125
mechanical timers	38
microswitches	24
motors	53

N

neon light bulbs	33, 35
Niplaflex hoses	119
nuts	126

O

operating capacitors	64
O-rings	110
oven hinges	106
oven lamps	36

P

piezoelectric igniters	79
pilot burners	74
plug-in gaskets	108
position switches	25
pre-rinse hoses	119
pressure control hoses	120
pressure reduction valves	124, 124
pressure switches	50
probes	43
programme timers	36
protection hoses	65
pumps	54
push/momentary push switches	23

Q

quartz heating elements	6
-------------------------	---

R

radiation heaters	14
reducers	122
refrigeration fans	52
refrigeration gaskets	108
relays	41
retaining rings	127
rocker/momentary rocker switches	22
rotary switches	28

S

safety bi-metal thermostats	15
-----------------------------	----

safety thermostats	17, 21
screws	125
sealants and adhesives	127
sealing cords	114
sealing washers	113
silicone	127
slot nuts	127
snap locks	105
solenoid valves	46
spray guns	117
spring washers	126
stainless steel flexi hoses	119, 119
standpipes	124
supply filters	124, 124
supply hoses	119
switches and momentary switches	22
system switches (ROLD)	25

T

temperature probes	43
terminals	65
thermocouples	79
thermostat gaskets	115
thermostats	15
threaded cable glands	65
time relays	42
timers	36
toggle switches	24
tools	125
tube burners	85
turning lever locks	104

U

universal hoses	119
universal probes	43

V

valves and tank inlets	123
------------------------	-----

W

walk-in fridge catches	105
wash and rinse pumps	54
washers	126
water cycle components	124
window seals	108