



**GAS COMPONENTS**



**ELECTRIC COMPONENTS**



**WATER TECHNOLOGY**



**MECHANICAL COMPONENTS**



**TOOLS**

Spare parts suitable for

**RETIGO**

Find the complete and up-to-date range of products in our GEV Webshop



# Manufacturer catalogue

The most important spare parts and accessories arranged clearly for every manufacturer

- ✓ Complete product range and all appliance data always up to date in the GEV Webshop
- ✓ Alphabetical Index at the end of the catalogue

## GEV Webshop

[www.gev-online.co.uk](http://www.gev-online.co.uk)

[www.gev-online.com](http://www.gev-online.com)



- 🔍 Add to Favourites
- 🔍 Sign In with email address and usual password
- 🔍 Easy-order – place several items in your basket at the same time
- 🔍 Quick Item search – no login needed



## heating elements

### immersion heating elements

#### miscellaneous



<b>GEV No.</b>	420360	<b>Ref. No.</b>	AX24-0008 AX24-0008+AX24-0002 EX24-0008
<b>description</b>	heating element 12000W 230V heating circuits 3 L 330mm W 42mm H 65mm number of thermostat sleeves 1 thermostat sleeves ø 3.5mm length thermostat sleeves 80mm thermostat sleeve eccentric, clinging tube ø 8.4mm hole distance 65/77mm hole ø 8mm connection M4 flange immersion heater flange width 83mm flange length 95mm		
<b>For models:</b>	B1011b, B1221b, B2011b, B2021b, O1011b, O1221b, O2011b, O2021b		
<b>accessories for</b>	420360		
	<b>GEV No.</b>	520580	<b>Ref. No.</b> AX24-0002
	gasket rubber L 96mm W 84mm thickness 5mm hole ø 7mm hole distance 65x78mm		



<b>GEV No.</b>	417542	<b>Ref. No.</b>	AX24-0006 AX24-0006+AX24-0002
<b>description</b>	heating element 3x3000W 230V heating circuits 3 L 305mm W 68mm H 40mm number of thermostat sleeves 1 thermostat sleeves ø 3.3mm length thermostat sleeves 970mm thermostat sleeve upper right tube ø 8.5mm hole distance 77x67mm hole ø 7.9mm connection screw immersion heater flange width 95mm flange length 83mm with gasket		
<b>For models:</b>	B611b, O611b		
<b>accessories for</b>	417542		
	<b>GEV No.</b>	520580	<b>Ref. No.</b> AX24-0002
	gasket rubber L 96mm W 84mm thickness 5mm hole ø 7mm hole distance 65x78mm		



<b>GEV No.</b>	419143	<b>Ref. No.</b>	EX24-0006
<b>description</b>	heating element 9000W 230V heating circuits 3 L 305mm W 45mm H 65mm number of thermostat sleeves 1 thermostat sleeves ø 2.5mm length thermostat sleeves 90mm hole distance 65x78mm hole ø 8mm connection length 33mm connection M4 rectangular flange immersion heater		
<b>accessories for</b>	419143		
	<b>GEV No.</b>	520580	<b>Ref. No.</b> AX24-0002
	gasket rubber L 96mm W 84mm thickness 5mm hole ø 7mm hole distance 65x78mm		

### heating elements for convection



<b>GEV No.</b>	417545	<b>Ref. No.</b>	AX00-0007 AX00-0007+AX00-0008
<b>description</b>	heating element 16000W 230V heating circuits 3 ID ø 380mm ED ø 430mm L 460mm H 98mm L1 45mm W1 187mm H1 18mm H2 80mm flange length 210mm flange width 24mm connection screw connection length 90mm tube ø 8.5mm convection heating element hole ø 7.6mm rectangular flange combi-steamer		
<b>For models:</b>	B1011b, B1011i, B1221b, B1221i, B2011b, B2011i, O1011b, O1011i, O1221b, O1221i, O2011b, O2011i		
<b>accessories for</b>	417545		
	<b>GEV No.</b>	521127	<b>Ref. No.</b> AX00-0008
	gasket L 210mm W 24mm thickness 2mm for heating element		



<b>GEV No.</b>	417546	<b>Ref. No.</b>	AX00-0018
<b>description</b>	heating element 29000W 230V heating circuits 6 ID ø 430mm ED ø 530mm L 530mm H 130mm L1 20mm W1 100mm H1 21mm H2 150mm flange length 130mm flange width 90mm hole distance 55mm connection screw connection length 85mm tube ø 8.5mm convection heating element hole ø 7.6mm rectangular flange combi-steamer		
<b>For models:</b>	B2021b, B2021i, O2021b, O2021i		

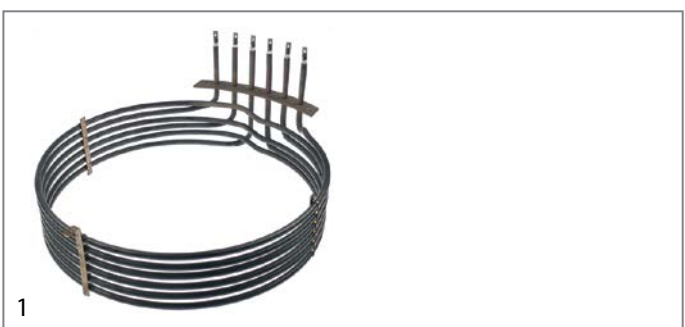

<b>GEV No.</b>	417544	<b>Ref. No.</b>	AX00-0005 AX00-0005+AX00-0008
<b>description</b>	heating element 3x3000W 230V heating circuits 3 ID ø 375mm ED ø 400mm L 455mm H 200mm L1 45mm W1 160mm H1 20mm H2 110mm flange length 210mm flange width 25mm hole distance 30mm connection screw connection length 90mm tube ø 8.5mm convection heating element hole ø 7.6mm rectangular flange combi-steamer		
<b>For models:</b>	B611b, B611i, O611b, O611i		
<b>accessories for</b>	417544		
	<b>GEV No.</b>	521127	<b>Ref. No.</b> AX00-0008
	gasket L 210mm W 24mm thickness 2mm for heating element		





<b>GEV No.</b>	417541	<b>Ref. No.</b>	AX00-0016 AX00-0016+AX00-0017
<b>description</b>	heating element 4800W 230V heating circuits 3 ID ø 205mm ED ø 250mm L 290mm H 45mm L1 45mm W1 95mm H1 5mm H2 30mm flange length 110mm flange width 20mm hole distance 35mm connection screw connection length 100mm tube ø 6.4mm convection heating element rectangular flange combi-steamer		
<b>For models:</b>	B623i, O623i		

accessories

flange gaskets

	<b>GEV No.</b>	551258	<b>Ref. No.</b> AX00-0020
<b>description</b>	gasket L 130mm W 88mm D1 ø 7mm D2 ø 11mm 12 holes thickness 2mm for combi-steamer suitable for 417546		
<b>For models:</b>	B2021b, B2021i, O2021b, O2021i		

	<b>GEV No.</b>	521072	<b>Ref. No.</b> AX00-0017
<b>description</b>	gasket L 112mm W 22mm D1 ø 10mm D2 ø 5.5mm graphite thickness 2mm for heating element suitable for RETIGO		
<b>For models:</b>	B623i, O623i		

	<b>GEV No.</b>	521127	<b>Ref. No.</b> AX00-0008
<b>description</b>	gasket L 210mm W 24mm thickness 2mm for heating element		
<b>For models:</b>	B1011b, B1011i, B1221b, B1221i, B2011b, B2011i, B611b, B611i, O1011b, O1011i, O1221b, O1221i, O2011b, O2011i, O611b, O611i		

	<b>GEV No.</b>	520580	<b>Ref. No.</b> AX24-0002
<b>description</b>	gasket rubber L 96mm W 84mm thickness 5mm hole ø 7mm hole distance 65x78mm		
<b>For models:</b>	B1011b, B1221b, B2011b, B2021b, B611b, O1011b, O1221b, O2011b, O2021b, O611b		

thermostats

control and safety thermostats

JUMO

safety thermostats



<b>GEV No.</b>	390922	<b>Ref. No.</b>	EA04-0011
<b>description</b>	safety thermostat switch-off temp. 140°C 1-pole 1CO 16A probe ø 5mm probe L 96mm capillary pipe 990mm capillary pipe isolated 880mm gland nut probe copper		
<b>For models:</b>	B1011b, B1221b, B2011b, B2021b, B611b, O1011b, O1221b, O2011b, O2021b, O611b		

1

<b>GEV No.</b>	390923	<b>Ref. No.</b>	EA04-0012
<b>description</b>	safety thermostat switch-off temp. 365°C temperature range°C 1-pole 1CO 16A probe ø 4mm probe L 107mm capillary pipe 1190mm capillary pipe isolated 1015mm gland nut shaft ømm screw connection M14x1		
<b>For models:</b>	B1011b, B1011i, B1221b, B1221i, B2011b, B2011i, B2021b, B2021i, B611b, B611i, B623i, O1011b, O1011i, O1221b, O1221i, O2011b, O2011i, O2021b, O2021i, O611b, O611i, O623i		

23x19mm

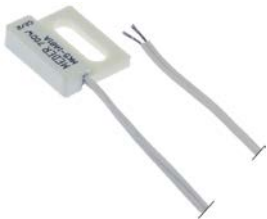

1

<b>GEV No.</b>	347948	<b>Ref. No.</b>	EA01-0001
<b>description</b>	magnetic switch L 23mm W 19mm 1NC connection cable cable length 700mm 700W		

## switches and momentary switches

### magnetic switches

23x14mm

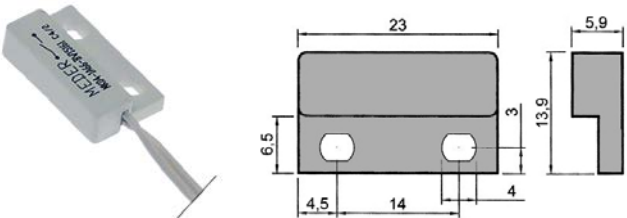

1

<b>GEV No.</b>	347995	<b>Ref. No.</b>	EA01-0015
<b>description</b>	magnetic switch L 23mm W 14mm 1NO 180V 0.5A P max. 10W connection cable cable length 500mm		
<b>For models:</b>	B1011b, B1011i, B611b, B611i, B623i, O1011b, O1011i, O611b, O611i, O623i		

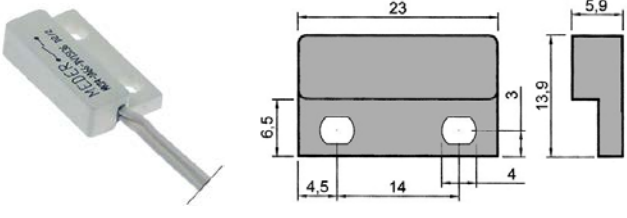

1

<b>GEV No.</b>	347994	<b>Ref. No.</b>	EA01-0015
<b>description</b>	magnetic switch L 23mm W 14mm 1NO 180V 0.5A P max. 10W connection cable cable length 700mm		

## lamps

### screw-on/push-on fit

#### halogen lamp

for socket G4 / G6.35 / G9



1

<b>GEV No.</b>	357193	<b>Ref. No.</b>	EA13-0100
<b>description</b>	halogen lamp socket G4 12V 20W temp.-resist. 300°C OSRAM HALOSTAR OVEN		



1

<b>GEV No.</b>	359599	<b>Ref. No.</b>	EA13-0100
<b>description</b>	halogen lamp socket G4 12V 20W temp.-resist. 500°C		
<b>For models:</b>	B1011b, B1011i, B1221b, B1221i, B2011b, B2011i, B2021b, B2021i, B611b, B611i, B623i, O1011b, O1011i, O1221b, O1221i, O2011b, O2011i, O2021b, O2021i, O611b, O611i, O623i		

### oven lamps

#### producer-specific oven lamps



#### RETIGO



1

<b>GEV No.</b>	357183	<b>Ref. No.</b>	AX07-0002
<b>description</b>	gasket graphite ø 37mm ID ø 31mm thickness 1.5mm for bulb socket		
<b>accessories for</b>	357183		
<b>GEV No.</b>	357182	<b>Ref. No.</b>	AX07-0001
<b>description</b>	lamp glass ø 37mm thickness 3mm		





			
1			
<b>GEV No.</b>	357182	<b>Ref. No.</b>	AX07-0001
<b>description</b>	lamp glass ø 37mm thickness 3mm		
<b>accessories for</b>	357182		
	<b>GEV No.</b>	357183	<b>Ref. No.</b> AX07-0002
	gasket graphite ø 37mm ID ø 31mm thickness 1.5mm for bulb socket		

			
1			
<b>GEV No.</b>	359922	<b>Ref. No.</b>	EA13-0101
<b>description</b>	lamp socket with 2 hole fixing 25V socket G4 connection cable 140mm ø 17mm H 10mm mounting distance 11.5mm cable material silicone		
<b>For models:</b>	B1011b, B1011i, B1221b, B1221i, B2011b, B2011i, B2021b, B2021i, B611b, B611i, B623i, O1011b, O1011i, O1221b, O1221i, O2011b, O2011i, O2021b, O2021i, O611b, O611i, O623i		

			
1			
<b>GEV No.</b>	680000	<b>Ref. No.</b>	AX07-0005 AX07-0006
<b>description</b>	gasket rubber ø 92mm ID ø 58mm thickness 7.6mm cavity lighting suitable for RETIGO		
<b>For models:</b>	B1011b, B1011i, B1221b, B1221i, B2011b, B2011i, B2021b, B2021i, B611b, B611i, B623i, O1011b, O1011i, O1221b, O1221i, O2011b, O2011i, O2021b, O2021i, O611b, O611i, O623i		

			
1			
<b>GEV No.</b>	680001	<b>Ref. No.</b>	AX07-0004
<b>description</b>	lamp glass ø 69mm thickness 2.9mm		
<b>For models:</b>	B1011b, B1011i, B1221b, B1221i, B2011b, B2011i, B2021b, B2021i, B611b, B611i, B623i, O1011b, O1011i, O1221b, O1221i, O2011b, O2011i, O2021b, O2021i, O611b, O611i, O623i		

			
1			
<b>GEV No.</b>	359922	<b>Ref. No.</b>	EA13-0101
<b>description</b>	lamp socket with 2 hole fixing 25V socket G4 connection cable 140mm ø 17mm H 10mm mounting distance 11.5mm cable material silicone		
<b>For models:</b>	B1011b, B1011i, B1221b, B1221i, B2011b, B2011i, B2021b, B2021i, B611b, B611i, B623i, O1011b, O1011i, O1221b, O1221i, O2011b, O2011i, O2021b, O2021i, O611b, O611i, O623i		

lamps			
halogen lamps			
for socket G4 / G6.35 / G9			
			
1			
<b>GEV No.</b>	357193	<b>Ref. No.</b>	EA13-0100
<b>description</b>	halogen lamp socket G4 12V 20W temp.-resist. 300°C OSRAM HALOSTAR OVEN		

			
1			
<b>GEV No.</b>	359599	<b>Ref. No.</b>	EA13-0100
<b>description</b>	halogen lamp socket G4 12V 20W temp.-resist. 500°C		
<b>For models:</b>	B1011b, B1011i, B1221b, B1221i, B2011b, B2011i, B2021b, B2021i, B611b, B611i, B623i, O1011b, O1011i, O1221b, O1221i, O2011b, O2011i, O2021b, O2021i, O611b, O611i, O623i		

## alarm devices

loudspeakers			
			
1			
<b>GEV No.</b>	350208	<b>Ref. No.</b>	AA11-9903
<b>description</b>	loudspeaker ø 50mm built-in depth 15mm 80hm 0.5W connection plug cable length 1360mm		

			
1			
<b>GEV No.</b>	350209	<b>Ref. No.</b>	AA11-9904
<b>description</b>	loudspeaker ø 50mm built-in depth 15mm 80hm 0.5W connection plug cable length 1740mm		

			
1			
<b>GEV No.</b>	350207	<b>Ref. No.</b>	AA11-9902
<b>description</b>	loudspeaker ø 50mm built-in depth 16mm 80hm 0.5W connection plug cable length 340mm		



			
1			
<b>GEV No.</b>	350211	<b>Ref. No.</b>	EA13-0151
<b>description</b>	loudspeaker ø 50mm built-in depth 16mm 8Ohm 0.5W connection soldering connection cable lengthmm		
<b>For models:</b>	B1011b, B1011i, B1221b, B1221i, B2011b, B2011i, B2021b, B2021i, B611b, B611i, B623i, O1011b, O1011i, O1221b, O1221i, O2011b, O2011i, O2021b, O2021i, O611b, O611i, O623i		

			
1			
<b>GEV No.</b>	380976	<b>Ref. No.</b>	EA02-0003
<b>description</b>	power contactor resistive load 32A 230VAC (AC3/400V) 18A/7.5kW main contacts 3NO auxiliary contacts 1NO/1NC connection screw connection		

## contactors

### TELEMECANIQUE (Schneider Electric)

#### power contactors

			
1			
<b>GEV No.</b>	381010	<b>Ref. No.</b>	EA02-0002
<b>description</b>	power contactor resistive load 20A 230VAC (AC3/400V) 6A/2.2kW main contacts 2x3NO auxiliary contacts 2x1NO connection screw connection type LC2K0610P7		
<b>For models:</b>	O1011b, O1011i, O1221b, O1221i, O2011b, O2011i, O2021b, O2021i, O611b, O611i		

			
1			
<b>GEV No.</b>	380979	<b>Ref. No.</b>	EA02-0004
<b>description</b>	power contactor resistive load 40A 230VAC (AC3/400V) 25A/11kW main contacts 3NO auxiliary contacts 1NO/1NC connection screw connection type LC1D25P7		
<b>For models:</b>	B1011b, B1011i, B611b, B611i, O1011b, O1011i, O611b, O611i		

			
1			
<b>GEV No.</b>	380965	<b>Ref. No.</b>	EA02-0001
<b>description</b>	power contactor resistive load 20A 230VAC (AC3/400V) 6A/2.2kW main contacts 3NO auxiliary contacts 1NO connection screw connection type LC1K0610P7+		
<b>For models:</b>	B623i, O623i		

			
1			
<b>GEV No.</b>	380982	<b>Ref. No.</b>	EA02-0006
<b>description</b>	power contactor resistive load 80A 230VAC (AC3/400V) 50A/22kW main contacts 3NO auxiliary contacts 1NO/1NC connection screw connection type LC1D50P7		
<b>For models:</b>	B1221b, B1221i, B2011b, B2011i, B2021b, B2021i, O1221b, O1221i, O2011b, O2011i, O2021b, O2021i		



## solid state relays

### CELDUC



1

<b>GEV No.</b>	402974	<b>Ref. No.</b>	EA02-0203 EA02-203
<b>description</b>	solid state relay CELDUC 2 phase 50A 24-600V 10-30VDC L 58mm W 45mm plug screw type SOB965660		
<b>For models:</b>	B1011b, B1011i, B1221b, B1221i, B2011b, B2011i, B2021b, B2021i, B611b, B611i, B623i, O1011b, O1011i, O1221b, O1221i, O2011b, O2011i, O2021b, O2021i, O611b, O611i, O623i		

## heat-conducting foils



1

<b>GEV No.</b>	403355	<b>Ref. No.</b>	EA02-0204
<b>description</b>	heat-conducting foil L 37mm W 37mm		

## relays

### plug-in/print relays

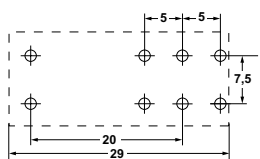

1

<b>GEV No.</b>	380333	<b>Ref. No.</b>	EA01-0104
<b>description</b>	print relay 230VAC 2CO at 250V 8A connection pins raster size 5mm FINDER manif. no. 40.52.8.230.0000 95.65/95.75		
<b>accessories for</b>	380333		
	<b>GEV No.</b>	380340	<b>Ref. No.</b> —
	relay socket dimensions 62x36x15mm 250V voltage AC 10A Italiana Relè manif. no. ZMEM/5		
	<b>GEV No.</b>	380505	<b>Ref. No.</b> —
	relay socket 2CO 40.52 dimensions 81.9x15.5x75mm 250V voltage AC 10A FINDER manif. no. 95.95.3		
	<b>GEV No.</b>	381181	<b>Ref. No.</b> —
	relay socket 2-pole 40.51/40.52/40.61 connection screw clamp dimensions 15.8x78.6mm 250V voltage AC 10A FINDER manif. no. 95.75		

## relay sockets

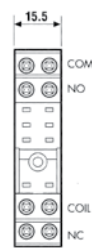

1

<b>GEV No.</b>	381241	<b>Ref. No.</b>	EA13-0103
<b>description</b>	relay socket DIN rail connection screw dimensions 80x46x15mm 300V voltage AC 10A FINDER manif. no. 95.85.3 95.85.3		

## transformers

### toroidal core transformers



1

<b>GEV No.</b>	403333	<b>Ref. No.</b>	EA13-0010
<b>description</b>	transformer primary 230VAC secondary 11.5VAC 20VA connection cable 200mm 50Hz type toroid temperature restriction 120°C ambient temperature max. 40°C		
<b>For models:</b>	B623i, O623i		



1

<b>GEV No.</b>	403336	<b>Ref. No.</b>	EA13-0011
<b>description</b>	transformer primary 230VAC secondary 11.5VAC 40VA connection cable 200mm 50Hz		
<b>For models:</b>	B1011b, B1011i, B611b, B611i, O1011b, O1011i, O611b, O611i		

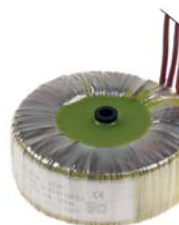

1

<b>GEV No.</b>	403340	<b>Ref. No.</b>	EA13-0009
<b>description</b>	transformer primary 230VAC secondary 11.5VAC 63VA connection cable 200mm 50Hz type toroid		
<b>For models:</b>	B1221b, B1221i, B2011b, B2011i, B2021b, B2021i, O1221b, O1221i, O2011b, O2011i, O2021b, O2021i		





encapsulated transformers

with screw connection



1	<b>GEV No.</b>	403352	<b>Ref. No.</b>	EA13-0008
<b>description</b>	transformer primary 230VAC secondary 17VAC 20VA secondary 1.17A connection screw 50-60Hz type 704077 DIN rail temperature restriction 125°C ambient temperature max. 40°C			
<b>For models:</b>	B1011b, B1011i, B1221b, B1221i, B2011b, B2011i, B2021b, B2021i, B611b, B611i, B623i, O1011b, O1011i, O1221b, O1221i, O2011b, O2011i, O2021b, O2021i, O611b, O611i, O623i			

probes

producer-specific probes

probes

1	<b>GEV No.</b>	378348	<b>Ref. No.</b>	EA10-0007
<b>description</b>	temperature probe Pt100 cable silicone probe -100 up to 450°C cable -50 up to +180°C connection plug thread M10x1.5 probe ø6x30mm cable length 1.5m			

1	<b>GEV No.</b>	378350	<b>Ref. No.</b>	EA10-0006
<b>description</b>	temperature probe Pt100 cable silicone probe -100 up to 450°C cable -50 up to +180°C connection plug thread probe ø4.5x25mm cable length 1.5m			

1	<b>GEV No.</b>	381239	<b>Ref. No.</b>	EA10-0104
<b>description</b>	temperature probe thermocouple K (NiCr-Ni) cable PTFE probe -50 up to 1150°C cable -40 up to +250°C connection coded plug thread probe ø2x4mm cable length 1.5m			
<b>For models:</b>	B1011b, B1011i, B1221b, B1221i, B2011b, B2021b, B611b, B611i, B623i, O1011b, O1011i, O1221b, O1221i, O2011b, O2021b, O611b, O611i, O623i			

1	<b>GEV No.</b>	381240	<b>Ref. No.</b>	EA10-0105
<b>description</b>	temperature probe thermocouple K (NiCr-Ni) cable PTFE probe -50 up to 1150°C cable -40 up to +250°C connection coded plug thread probe ø2x7mm cable length 2m			
<b>For models:</b>	B2011b, B2011i, B2021b, B2021i, O2011b, O2011i, O2021b, O2021i			

1	<b>GEV No.</b>	381238	<b>Ref. No.</b>	EA10-0103
<b>description</b>	temperature probe thermocouple K (NiCr-Ni) cable silicone probe -50 up to 1150°C cable -50 up to +180°C connection coded plug thread probe ø1.9x140mm cable length 1.4m			
<b>For models:</b>	B1011b, B1011i, B1221b, B1221i, B2011b, B2011i, B2021b, B2021i, B611b, B611i, B623i, O1011b, O1011i, O1221b, O1221i, O2011b, O2011i, O2021b, O2021i, O611b, O611i, O623i			

core probes

1	<b>GEV No.</b>	378349 <sup>1</sup>	<b>Ref. No.</b>	EA10-0069
<b>description</b>	core temperature probe Pt100 cable PTFE probe -40 up to +250°C cable -40 up to +250°C connection coded plug probe ø4.5x125mm thread M12x1.75 cable length 1m handle ø 14mm handle length 58mm			

<sup>1</sup>multipoint probe

1	<b>GEV No.</b>	378359	<b>Ref. No.</b>	EA10-0055
<b>description</b>	core temperature probe Pt100 cable PTFE probe -40 up to +250°C cable -40 up to +250°C connection coded plug probe ø4x115mm thread M12x1.75 cable length 1.5m handle ø 14mm handle length 58mm			

1

<b>GEV No.</b>	378677	<b>Ref. No.</b>	EA10-0058
<b>description</b>	core temperature probe Pt100 cable PTFE probe -40 up to +250°C cable -40 up to +250°C connection coded plug probe ø4x125mm thread M12x1.75 cable length 0.8m handle ø 14mm handle length 58mm		



1

<b>GEV No.</b>	381237	<b>Ref. No.</b>	EA10-0111 EA10-0116
<b>description</b>	core temperature probe thermocouple K (NiCr-Ni) cable PTFE probe -40 up to +250°C cable -40 up to +250°C connection coded plug probe ø3.9x170mm thread M16x2 cable length 1.4m handle ømm handle length 50mm		
<b>For models:</b>	O1011b, O1011i, O611b, O611i, O623i		



1

<b>GEV No.</b>	381234 <sup>1</sup>	<b>Ref. No.</b>	EA10-0113 EA10-0118
<b>description</b>	core temperature probe thermocouple K (NiCr-Ni) cable PTFE probe -40 up to +250°C cable -40 up to +250°C connection coded plug probe ø3.9x170mm thread M16x2 cable length 1.4m handle ømm handle length 50mm		
<b>For models:</b>	B1011b, B1011i, B611b, B611i, B623i		



1

<b>GEV No.</b>	381235 <sup>1</sup>	<b>Ref. No.</b>	EA10-0119
<b>description</b>	core temperature probe thermocouple K (NiCr-Ni) cable PTFE probe -40 up to +250°C cable -40 up to +250°C connection coded plug probe ø3.9x170mm thread M16x2 cable length 1.8m handle ømm handle length 50mm		

<sup>1</sup>multipoint probe

<sup>1</sup>multipoint probe



1

<b>GEV No.</b>	381236	<b>Ref. No.</b>	EA10-0117
<b>description</b>	core temperature probe thermocouple K (NiCr-Ni) cable PTFE probe -40 up to +250°C cable -40 up to +250°C connection coded plug probe ø3.9x170mm thread M16x2 cable length 2.1m handle ømm handle length 50mm		



1

<b>GEV No.</b>	403937	<b>Ref. No.</b>	EA14-0041
<b>description</b>	display combi-steamer L 95mm W 72mm		



1

<b>GEV No.</b>	404012	<b>Ref. No.</b>	XC10-2100
<b>description</b>	display combi-steamer Orange FreeScale 2011 L 17mm W 13mm model XC10-2100 with control H 50mm type orange		
<b>For models:</b>	O1011b, O1011i, O1221b, O1221i, O2011b, O2011i, O2021b, O2021i, O611b, O611i, O623i		

## electronics

### frequency converters

#### accessories



1

<b>GEV No.</b>	403356	<b>Ref. No.</b>	EA16-0041
<b>description</b>	braking resistor for frequency converter L 78mm W 29mm H 16mm 20-60W cable length 170mm VW3TR342150RJ 150Ohm		
<b>For models:</b>	B1011b, B1011i, B1221b, B1221i, B2011b, B2011i, B2021b, B2021i, B611b, B611i		

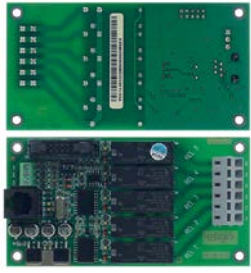

1

<b>GEV No.</b>	403936	<b>Ref. No.</b>	EA14-0032
<b>description</b>	electronic controller for cleaning system L 112mm W 60mm		

#### PCBs



1

<b>GEV No.</b>	404013	<b>Ref. No.</b>	XC10-2000
<b>description</b>	display combi-steamer Blue FreeScale2011 L 170mm W 130mm suitable for RETIGO model XC10-2000-10 with control H 50mm type blue		
<b>For models:</b>	B1011b, B1011i, B1221b, B1221i, B2011b, B2011i, B2021b, B2021i, B611b, B611i, B623i		

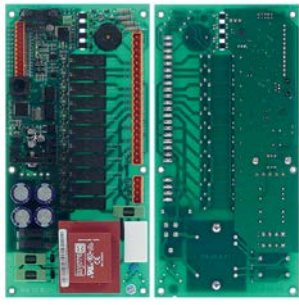

1

<b>GEV No.</b>	403938	<b>Ref. No.</b>	EA14-0043
<b>description</b>	power PCB combi-steamer L 230mm W 115mm		



1

<b>GEV No.</b>	404014	<b>Ref. No.</b>	EA14-0080
<b>description</b>	relay PCB combi-steamer B1011/B2011 L 200mm W 115mm model RP20B.15 with ribbon cable H 30mm		
<b>For models:</b>	B1011b, B1011i, B1221b, B1221i, B2011b, B2011i, B2021b, B2021i, B611b, B611i, B623i, O1011b, O1011i, O1221b, O1221i, O2011b, O2011i, O2021b, O2021i, O611b, O611i, O623i		

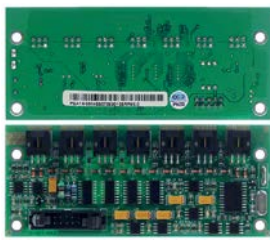

1

<b>GEV No.</b>	404029	<b>Ref. No.</b>	EA14-0014
<b>description</b>	relay PCB combi-steamer L 112mm W 47mm		

## solenoïd valves

### solenoïd valves (water)

#### ROBERTSHAW/INVENSYS

medium temperature: 90°C 90°C 60°C  
 ambient temperature: 60°C 25°C 60°C  
 duty cycle: 40% 100% 100%



1

<b>GEV No.</b>	372021	<b>Ref. No.</b>	EA12-0050
<b>description</b>	solenoid valve double straight 230VAC inlet 3/4" outlet 11.5mm DN10 EATON (INVENSYS)		
<b>For models:</b>	B1011b, B1011i, B611b, B611i, B623i, O1011b, O1011i, O1221b, O1221i, O2011b, O2011i, O2021b, O2021i, O611b, O611i, O623i		





1

<b>GEV No.</b>	372003	<b>Ref. No.</b>	EA12-0051
<b>description</b>	solenoid valve single straight 230VAC inlet 3/4" outlet 10mm DN10 EATON (INVENSYS)		
<b>For models:</b>	O623i		



1

<b>GEV No.</b>	372018	<b>Ref. No.</b>	EA12-0050	
<b>description</b>	solenoid valve single straight 230VAC inlet 3/4" outlet 14mm DN10 EATON (INVENSYS) flow regulating valve outlet flow regulating valve inlet white			
<b>spare parts for</b>	372018			
	<b>GEV No.</b>	371122	<b>Ref. No.</b>	—
	solenoid valve filter ø 19mm H 10mm suitable for MÜLLER			
	<b>GEV No.</b>	371131	<b>Ref. No.</b>	—
	solenoid coil 230VAC			



1

<b>GEV No.</b>	372025	<b>Ref. No.</b>	EA12-0056
<b>description</b>	solenoid valve triple straight 230VAC inlet 3/4" outlet 11.5mm DN10 EATON (INVENSYS)		
<b>For models:</b>	B1011b, B1011i, B1221b, B1221i, B2011b, B2011i, B2021b, B2021i, B611b, B611i, O1221b, O1221i, O2011b, O2011i, O2021b, O2021i		

#### RPE

#### reducers

#### outlet side



1

<b>GEV No.</b>	371247	<b>Ref. No.</b>	EA12-0303
<b>description</b>	reducer RPE flow rate 1-1.25l/min white		
<b>For models:</b>	B1011b, B1011i, B1221b, B1221i, B2011b, B2021b, B2021i, B611b, B611i, O1011b, O1011i, O1221b, O1221i, O2011b, O2021b, O2021i, O611b, O611i		

## electrodes



1

<b>GEV No.</b>	403295	<b>Ref. No.</b>	AC24-0101
<b>description</b>	level electrode M16x1 total length 205mm probe L 148mm insulated probe length 8mm connection 3-wire cable length 40mm		



1

<b>GEV No.</b>	403353	<b>Ref. No.</b>	AC24-0602
<b>description</b>	level electrode push-in total length 225mm probe L 185mm insulated probe length 170mm triple connection bullet connector ø 15mm level suitable for RETIGO for 611/1011/1221/2011 edition boiler		
<b>For models:</b>	B1011b, B1221b, B2011b, B2021b, B611b, O1011b, O1221b, O2011b, O2021b, O611b		



**fans**

**axial fans**

**import**



1

<b>GEV No.</b>	601909 <sup>1</sup>	<b>Ref. No.</b>	ZA21-0007
<b>description</b>	axial fan L 119mm W 119mm H 38mm 220-240 50/60Hz 31/29W bearing ball bearing connection male faston 2.8mm		
<b>For models:</b>	B1011b, B1011i, B1221b, B1221i, B2011b, B2011i, B2021b, B2021i, B611b, B611i, B623i, O1011b, O1011i, O1221b, O1221i, O2011b, O2011i, O2021b, O2021i, O611b, O611i, O623i		

<sup>1</sup>with ball bearings

**hot air motors**

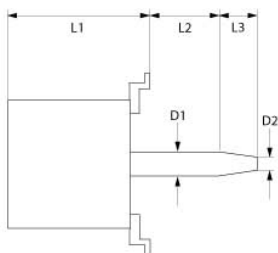

1

<b>GEV No.</b>	499311	<b>Ref. No.</b>	AA11-0016 EA11-0014 EA11-14
<b>description</b>	fan motor 440V 3 phase 50Hz 0.3kW 1410rpm speeds 1 L1 130mm L2 22mm L3 38mm M10 1.2/0.7A at 50Hz 1410rpm D1 ø 17mm D2 ø 13.5mm		
<b>For models:</b>	B1011b, B1011i, B1221b, B1221i, B2011b, B2011i, B2021b, B2021i, B611b, B611i, O1011b, O1011i, O1221b, O1221i, O2011b, O2011i, O2021b, O2021i, O611b, O611i		



1

<b>GEV No.</b>	602002	<b>Ref. No.</b>	AX09-0004
<b>description</b>	fan wheel D1 ø 175mm H1 38.5mm blades 9 D2 ø 8mm D3 ø 8mm H2 10mm H3 12mm		
<b>For models:</b>	B623i, O623i		



1

<b>GEV No.</b>	602000	<b>Ref. No.</b>	AX09-0006
<b>description</b>	fan wheel D1 ø 320mm H1 110mm blades 12 D2 ø 13mm D3 ø 16.4mm H2 12mm H3 18mm		
<b>For models:</b>	B1221b, B1221i, B2021b, B2021i, O1221b, O1221i, O2021b, O2021i		



1

<b>GEV No.</b>	602001	<b>Ref. No.</b>	AX09-0001
<b>description</b>	fan wheel D1 ø 320mm H1 83mm blades 12 D2 ø 13mm D3 ø 16.4mm H2 12mm H3 18mm		
<b>For models:</b>	B1011b, B1011i, B2011b, B2011i, B611b, B611i, O1011b, O1011i, O2011b, O2011i, O611b, O611i		



1

<b>GEV No.</b>	551259	<b>Ref. No.</b>	AX00-0006
<b>description</b>	gasket motor shaft gasket ID ø 16.5mm ED ø 29mm thickness 4.2mm		
<b>For models:</b>	B1011b, B1011i, B1221b, B1221i, B2011b, B2011i, B2021b, B2021i, B611b, B611i, O1011b, O1011i, O1221b, O1221i, O2011b, O2011i, O2021b, O2021i, O611b, O611i		



1

<b>GEV No.</b>	551261	<b>Ref. No.</b>	AX00-0011
<b>description</b>	gasket motor shaft gasket ID ø 8.5mm ED ø 20mm		
<b>For models:</b>	B623i, O623i		



1

<b>GEV No.</b>	694684	<b>Ref. No.</b>	EA05-0201
<b>description</b>	motor supply line for hot air motors shielded conductor 3PH/PE L 1040mm for model 6011, 1011 ED ø 8.5mm		



1

<b>GEV No.</b>	694685	<b>Ref. No.</b>	EA05-0202
<b>description</b>	motor supply line for hot air motors shielded conductor 3PH/PE L 600mm for model 1221 ED ø 8.5mm Qty 2 pcs		



1

<b>GEV No.</b>	694686	<b>Ref. No.</b>	EA05-0203
<b>description</b>	motor supply line for hot air motors shielded conductor 3PH/PE L 900mm L 1.3m for model 2011 ED ø 8.5mm Qty 2 pcs		

hot air fans

HANNING



1

<b>GEV No.</b>	601910	<b>Ref. No.</b>	EA11-0004
<b>description</b>	hot air fan 220-240V 125W 0.46/0.56A 3600rpm L1 115mm L2 3mm L3 12mm L4 95mm fan wheel ø 100mm HANNING		
<b>For models:</b>	B623i, O623i		

radial fans

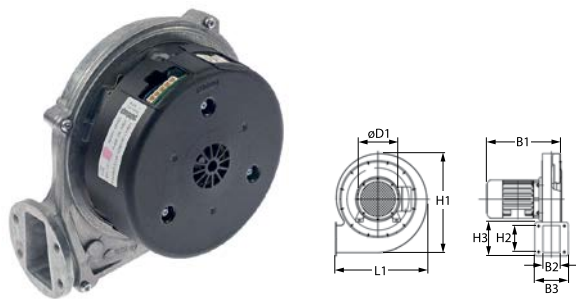

1

<b>GEV No.</b>	692477	<b>Ref. No.</b>	ZA21-0008
<b>description</b>	radial fan 230V voltage AC 50Hz H1 150mm L1 170mm D1 ø 80mm W1 90mm W2 28mm H2 49mm W3 65mm H3 65mm		

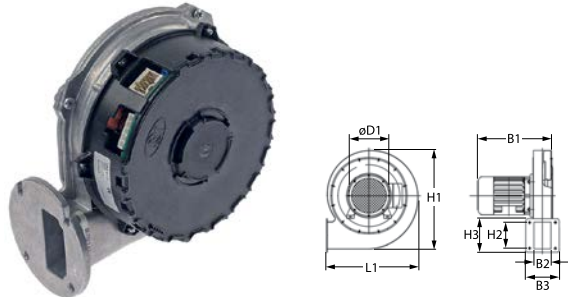

1

<b>GEV No.</b>	692478	<b>Ref. No.</b>	ZA21-0009
<b>description</b>	radial fan 230V voltage AC 50Hz H1 165mm L1 170mm D1 ø 80mm W1 80mm W2 23mm H2 46mm W3 83mm H3 83mm		

motors

gear motors

for ovens

for flues



1

<b>GEV No.</b>	602072	<b>Ref. No.</b>	AC25-0112/S AC25-0311/S
<b>description</b>	gear motor 5W 220-240V voltage AC 50/60Hz 3/3.6rpm shaft ømm L 84mm W 70mm H 54.4mm		



1

<b>GEV No.</b>	601912	<b>Ref. No.</b>	EA11-0012
<b>description</b>	gear motor FIBER type P245J01C128 230V voltage AC 50Hz shaft ø 6.3mm L 71.5mm W 56.5mm H 46.5mm motor type M51BJ0L0000/ M51BJ0R0000		
<b>For models:</b>	B1011b, B1011i, B1221b, B1221i, B2011i, B2021b, B2021i, B611b, B611i, B623i		



pumps

drain pumps

HANNING



1

<b>GEV No.</b>	499328	<b>Ref. No.</b>	EA10-0005 EA12-0005
<b>description</b>	pump 25W 220-240V inlet ø 30mm outlet ø 24mm 50Hz type DP020-028 HANNING		

PLASET



1

<b>GEV No.</b>	499312	<b>Ref. No.</b>	EA12-0001
<b>description</b>	pump inlet ø 30mm outlet ø 22mm 220/240V 34W 50Hz PLASET type 50763		
<b>For models:</b>	B1011b, B1011i, B1221b, B1221i, B2011b, B2011i, B2021b, B2021i, B611b, B611i, B623i, O1011b, O1221b, O2011b, O2021b, O611b		

accessories

pump covers



1

<b>GEV No.</b>	500303	<b>Ref. No.</b>	ZA14-0105
<b>description</b>	body inlet ø 24mm outlet ø 22mm suitable for drain pump		
<b>For models:</b>	B1221b, B1221i, B2011b, B2011i, B2021b, B2021i		

condensators & interference suppression filters

operating capacitors

metal



1

<b>GEV No.</b>	365191	<b>Ref. No.</b>	EA13-0301
<b>description</b>	operating capacitor capacity 3µF 400V tolerance 5% 60Hz ambient temperature max. -40 up to +85°C ø 30mm L 85mm M8 aluminium connection cable 400mm MLR25L40303063		
<b>For models:</b>	B623i, O623i		

filters

line filters

with housing



1

<b>GEV No.</b>	403358	<b>Ref. No.</b>	EA13-0057
<b>description</b>	line filter type FC61113 400V 50-60Hz three-phase connection cable length 500mm mounting DIN rail		
<b>For models:</b>	B1011b, B1011i, B611b, B611i, B623i, O1221b, O1221i, O2011b, O2011i, O2021b, O2021i, O623i		



1

<b>GEV No.</b>	403357	<b>Ref. No.</b>	EA13-0058
<b>description</b>	line filter type FC61113b 400V 50-60Hz conductor 3 connection cable 500mm L 70mm ømm H 34mm W 50mm DIN rail plastic Qty 1 pcs		
<b>For models:</b>	B1221b, B1221i, B2011b, B2011i, B2021b, B2021i, O1011b, O1011i, O611b, O611i		



1

<b>GEV No.</b>	365189	<b>Ref. No.</b>	EA13-0109
<b>description</b>	line filter type SKY2FN3 230V 50-60Hz conductor 2 with E connection spring terminal L 90mm ømm H 40mm W 52mm DIN rail plastic Qty 1 pcs		
<b>For models:</b>	B1011b, B1011i, B1221b, B1221i, B2011b, B2011i, B2021b, B2021i, B611b, B611i		





			
1			
<b>GEV No.</b>	365190	<b>Ref. No.</b>	EA13-0056
<b>description</b>	line filter type TS8111022B 250V 50-60Hz conductor 2 with E connection cable 300mm L 41mm ømm H 38mm W 18mm DIN rail plastic Qty 1 pcs		
<b>For models:</b>	B1221b, B1221i, B2011b, B2011i, B2021b, B2021i, B623i, O1221b, O1221i, O2011b, O2011i, O2021b, O2021i, O623i		

## fuses

### line circuit breakers

#### miscellaneous

			
1			
<b>GEV No.</b>	381233	<b>Ref. No.</b>	EA03-0016
<b>description</b>	line circuit breaker 1-pole 6A tripping type D rated 230/400V connection screw mounting DIN rail 1 phase		
<b>For models:</b>	B1011b, B1011i, B1221b, B1221i, B2011b, B2011i, B2021b, B2021i, B611b, B611i, B623i, O623i		

			
1			
<b>GEV No.</b>	381232	<b>Ref. No.</b>	EA03-0018
<b>description</b>	line circuit breaker 3-pole 6A tripping type D rated 400V connection screw mounting DIN rail 3 phase		
<b>For models:</b>	O1011b, O1011i, O1221b, O1221i, O2011b, O2011i, O2021b, O2021i, O611b, O611i		

## electric accessories

### terminals

#### PCB terminal blocks

			
1			
<b>GEV No.</b>	551256	<b>Ref. No.</b>	EA07-1310
<b>description</b>	PCB terminal block 10-pole max. 16A max 400V raster size 5mm		

			
1			
<b>GEV No.</b>	551257	<b>Ref. No.</b>	EA07-1014
<b>description</b>	PCB terminal block 14-pole max. 1A max 240V raster size 3mm		

			
1			
<b>GEV No.</b>	551255	<b>Ref. No.</b>	EA07-1309
<b>description</b>	PCB terminal block 9-pole max. 16A max 400V raster size 5mm		

## electronic components

### varistors



			
1			
<b>GEV No.</b>	403354	<b>Ref. No.</b>	EA05-0200
<b>description</b>	varistor		

## gas valves and ignition boxes

### gas control valves

#### SIT

#### SIGMA

			
1			
<b>GEV No.</b>	106009	<b>Ref. No.</b>	ZA12-0003
<b>description</b>	gas valve 230V 50Hz gas inlet 3/4" gas outlet 3/4" pressure range 0.5-12mbar Sigma equiv. no. 0.848.037		
<b>spare parts for</b>	106009		
	<b>GEV No.</b>	106214	<b>Ref. No.</b>
	solenoid coil 230V 50Hz Sigma		
<b>accessories for</b>	106009		
	<b>GEV No.</b>	107222	<b>Ref. No.</b>
	plug for solenoid valve 3-pole cable length 1070mm		





ignition boxes

BRAHMA

BRAHMA



1

<b>GEV No.</b>	103193	<b>Ref. No.</b>	EA01-0203
<b>description</b>	ignition box BRAHMA type SM592N.2 electrodes 1 waiting time 1.5s safety time 10s 230V 7VA 50-60Hz with reset button		

ignition parts

electrodes

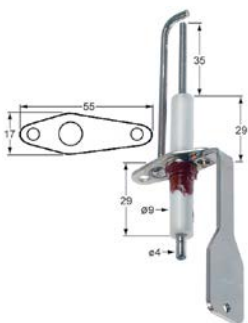

1

<b>GEV No.</b>	103191	<b>Ref. No.</b>	AC31-0903
<b>description</b>	ignition electrode flange length 55mm flange width 17mm D1 ø 9mm L1 35mm BL1 29mm BL2 29mm connection ø 4mm		
<b>spare parts for</b>	103191		
	<b>GEV No.</b>	<b>Ref. No.</b>	<b>AX31-0044</b>
	692511		
	gasket for ignition electrode Qty 1 RETIGO AC31-0903		
<b>accessories for</b>	103191		
	<b>GEV No.</b>	<b>Ref. No.</b>	<b>AX31-0044</b>
	692511		
	gasket for ignition electrode Qty 1 RETIGO AC31-0903		

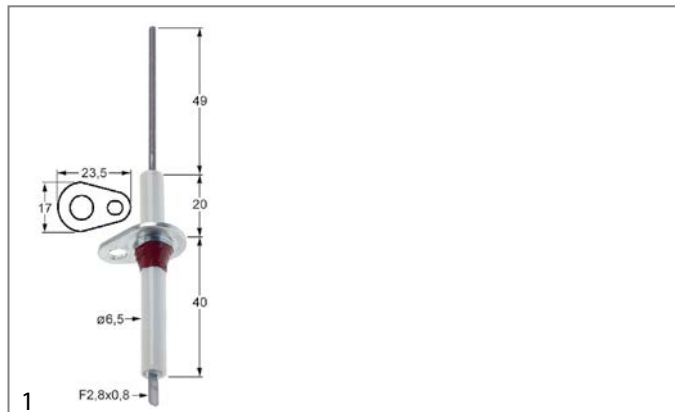

1

<b>GEV No.</b>	103188	<b>Ref. No.</b>	AT31-0029
<b>description</b>	monitoring electrode flange length 23.5mm D1 ø 6.5mm flange width 17mm L1 49mm BL1 20mm BL2 40mm connection male faston 2.8mm		
<b>accessories for</b>	103188		
	<b>GEV No.</b>	<b>Ref. No.</b>	<b>AX31-0045</b>
	692512		
	gasket for flame monitoring Qty 1 RETIGO		



1

<b>GEV No.</b>	103189	<b>Ref. No.</b>	ZA22-0153
<b>description</b>	monitoring electrode flange length 23.5mm D1 ø 6.8mm flange width 17mm L1 55mm L2 19mm BL1 46mm BL2 10mm connection screw		



1

<b>GEV No.</b>	103268	<b>Ref. No.</b>	AA31-0014
<b>description</b>	monitoring electrode flange length 23.5mm D1 ø 6.8mm flange width 17mm L1 64mm L2 26mm BL1 54.5mm BL2 18mm connection screw		

### ignition cables

various



<b>GEV No.</b>	103192	<b>Ref. No.</b>	EA05-0077
<b>description</b>	ignition cable cable length 880mm connection bullet connector 3.6 1mm <sup>2</sup> ED ø 4.8mm insulation PTFE conductor silver plated white 0.150hm		

### ignition units

BRAHMA



<b>GEV No.</b>	103194	<b>Ref. No.</b>	EA13-0013
<b>description</b>	ignition unit outputs 1 220-240VAC dimensions 85x70x35mm mounting distance 60mm inlet cable outlet ø4mm type TC1SVCS 25VA 50/60Hz BRAHMA equiv. no. 15911250		

### gas burners

#### burners for convection ovens



<b>GEV No.</b>	104656	<b>Ref. No.</b>	ZA22-0003
<b>description</b>	burner 38kW W 140mm L 315mm H 120mm		

**spare parts for** 104656



<b>GEV No.</b>	103191	<b>Ref. No.</b>	AC31-0903
<b>description</b>	ignition electrode flange length 55mm flange width 17mm D1 ø 9mm L1 35mm BL1 29mm BL2 29mm connection ø 4mm		



<b>GEV No.</b>	692509	<b>Ref. No.</b>	AP31-0100 KP31-0100
<b>description</b>	frame for burner RETIGO ZA22-0003 size 320x136mm Qty 1		



<b>GEV No.</b>	692510	<b>Ref. No.</b>	AT31-0047 ZA13-3040
<b>description</b>	gasket for burner RETIGO ZA22-0003 Qty 1m		



<b>GEV No.</b>	692511	<b>Ref. No.</b>	AX31-0044
<b>description</b>	gasket for ignition electrode Qty 1 RETIGO AC31-0903		

**accessories for** 104656



<b>GEV No.</b>	692509	<b>Ref. No.</b>	AP31-0100 KP31-0100
<b>description</b>	frame for burner RETIGO ZA22-0003 size 320x136mm Qty 1		



<b>GEV No.</b>	692510	<b>Ref. No.</b>	AT31-0047 ZA13-3040
<b>description</b>	gasket for burner RETIGO ZA22-0003 Qty 1m		

### equipment-specific units

#### for ice-cube maker

hoses

formed hoses

straight

silicone hoses



<b>GEV No.</b>	530062	<b>Ref. No.</b>	ZA11-0805
<b>description</b>	silicone hose ID ø 16mm ED ø 23mm L 1m t.max. 200°C transparent		

#### for convection ovens/combi-steamers

drain units

accessories



<b>GEV No.</b>	694681	<b>Ref. No.</b>	AC02-2202
<b>description</b>	strainer insert ED ø 118mm H 13.5mm spring holder SS		
<b>For models:</b>	B1011b, B1011i, B1221b, B1221i, B2011b, B2011i, B2021b, B2021i, B611b, B611i, B623i, O1011b, O1011i, O1221b, O1221i, O2011b, O2011i, O2021b, O2021i, O611b, O611i, O623i		

#### steam pipes



<b>GEV No.</b>	530920	<b>Ref. No.</b>	ZA10-0500
<b>description</b>	steam hose silicone L 68mm ID ø 38mm ED ø 46mm for combi-steamer steam generator		

#### injection nozzles



<b>GEV No.</b>	542109	<b>Ref. No.</b>	AT00-0056
<b>description</b>	nozzle bore ø 0.7mm D1 ø 12mm brass mounting pos. inside hose 07 TYC D12-8		
<b>For models:</b>	B1011i, B1221i, B2011i, B2021i, B611i, B623i, O1011i, O1221i, O2011i, O2021i, O611i, O623i		

injection pipes



1

<b>GEV No.</b>	696859	<b>Ref. No.</b>	AC12-0100
<b>description</b>	injection pipe for combi-steamer ED ø 10mm ID ø 6mm L 250mm		



1

<b>GEV No.</b>	692485	<b>Ref. No.</b>	AC12-1000
<b>description</b>	injection pipe L 350mm H 130mm ID ø 8mm ED ø 12mm		
<b>For models:</b>	B2021b, B2021i, O2021b, O2021i		



1

<b>GEV No.</b>	692480	<b>Ref. No.</b>	AC12-0800
<b>description</b>	injection pipe L 185mm H 45mm ID ø 12mm ED ø 8mm		
<b>For models:</b>	B623i, O623i		



1

<b>GEV No.</b>	692483	<b>Ref. No.</b>	AC12-1100
<b>description</b>	injection pipe L 190mm H 125mm ID ø 8mm ED ø 12mm		



1

<b>GEV No.</b>	692484	<b>Ref. No.</b>	AC12-0900 AC12-1300
<b>description</b>	injection pipe L 235mm H 130mm ID ø 8mm ED ø 12mm		
<b>For models:</b>	B1221b, B1221i, O1221b, O1221i		



1

<b>GEV No.</b>	692482	<b>Ref. No.</b>	AC12-0700
<b>description</b>	injection pipe L 243mm H 115mm ID ø 8mm ED ø 12mm		
<b>For models:</b>	B1011b, B1011i, B2011b, B2011i, B611b, B611i, O1011b, O1011i, O2011b, O2011i, O611b, O611i		

front panels





1

<b>GEV No.</b>	694705	<b>Ref. No.</b>	AC21-1406/S/CH1
<b>description</b>	front panel for combi-steamer L 1580mm W 190mm H 60mm SS with accessories RETIGO		
<b>For models:</b>	O2011b, O2011i		





1

<b>GEV No.</b>	694704	<b>Ref. No.</b>	AC21-1506/S/CH1
<b>description</b>	front panel for combi-steamer L 530mm W 190mm H 60mm SS with accessories RETIGO		
<b>For models:</b>	O623i		
<b>accessories for</b>	694704		
	<b>GEV No.</b>	360594	<b>Ref. No.</b> EA05-0052
	USB cable A mounting screw mounting bush 1.5m		
	<b>GEV No.</b>	360607	<b>Ref. No.</b> AX21-0001+AX21-
	USB cover plastic A mounting screw mounting bush grey		





1

<b>GEV No.</b>	694703	<b>Ref. No.</b>	AC21-1206/S/CH1
<b>description</b>	front panel for combi-steamer L 700mm W 190mm H 60mm SS with accessories RETIGO		
<b>For models:</b>	O611b, O611i		
<b>accessories for</b>	694703		
	<b>GEV No.</b>	360594	<b>Ref. No.</b> EA05-0052
	USB cable A mounting screw mounting bush 1.5m		

<b>accessories for</b>	694703		
	<b>GEV No.</b>	360607	<b>Ref. No.</b> AX21-0001+AX21-
	USB cover plastic A mounting screw mounting bush grey		



1

<b>GEV No.</b>	694702	<b>Ref. No.</b>	AC21-1205/S/CH1
<b>description</b>	front panel for combi-steamer L 700mm W 190mm H 60mm SS with accessories RETIGO for touch screen		
<b>For models:</b>	B611b, B611i		
<b>accessories for</b>	694702		
	<b>GEV No.</b>	360594	<b>Ref. No.</b> EA05-0052
	USB cable A mounting screw mounting bush 1.5m		
	<b>GEV No.</b>	360607	<b>Ref. No.</b> AX21-0001+AX21-
	USB cover plastic A mounting screw mounting bush grey		
	<b>GEV No.</b>	404013	<b>Ref. No.</b> XC10-2000
	display combi-steamer Blue FreeScale2011 L 170mm W 130mm suitable for RETIGO model XC10-2000-10 with control H 50mm type blue		



<b>GEV No.</b>	694770	<b>Ref. No.</b>	AC21-1305/S/CH1
<b>description</b>	front panel for combi-steamer L 960mm W 190mm H 60mm SS with accessories RETIGO for touch screen		
<b>For models:</b>	B1011b, B1011i		

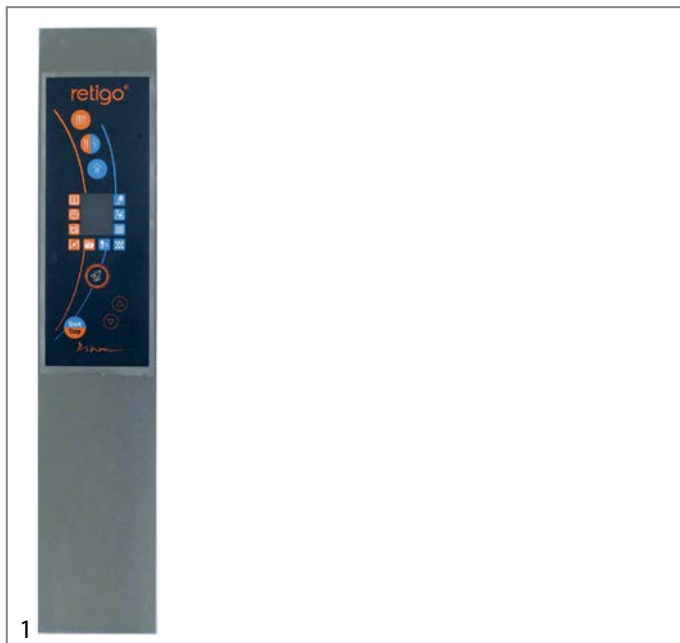

<b>GEV No.</b>	694771	<b>Ref. No.</b>	AC21-1306/CH1
<b>description</b>	front panel for combi-steamer L 960mm W 190mm H 60mm SS with accessories RETIGO without touch screen		
<b>For models:</b>	O1011b, O1011i		

cleaning system

nozzles

			
1			
<b>GEV No.</b>	694682	<b>Ref. No.</b>	AA32-0050 AT32-0052
<b>description</b>	nozzle hole ø 6.45mm H 17.8mm metal ED ø 52mm ID ø 44.6mm		
<b>For models:</b>	B1011b, B1011i, B1221b, B1221i, B2011b, B2011i, B2021b, B2021i, B611b, B611i, B623i		

hoses

			
1			
<b>GEV No.</b>	698469	<b>Ref. No.</b>	ATOO-0006
<b>description</b>	hose ID ø 48mm ED ø 54mm L 83mm		

			
1			
<b>GEV No.</b>	530920	<b>Ref. No.</b>	ZA10-0500
<b>description</b>	steam hose silicone L 68mm ID ø 38mm ED ø 46mm for combi-steamer steam generator		

door mechanics

accessories





			
1			
<b>GEV No.</b>	694683	<b>Ref. No.</b>	AX03-0076
<b>description</b>	stop ø 14mm rubber ID ø 7.5mm H 14mm		
<b>For models:</b>	B1011b, B1011i, B1221b, B1221i, B2011b, B2011i, B2021b, B2021i, B611b, B611i, B623i, O1011b, O1011i, O1221b, O1221i, O2011b, O2011i, O2021b, O2021i, O611b, O611i, O623i		

			
1			
<b>GEV No.</b>	694680	<b>Ref. No.</b>	ZA13-0516
<b>description</b>	stop ø 22.25mm rubber ID ø 14.75mm H 7.3mm		
<b>For models:</b>	B1011b, B1011i, B611b, B611i, B623i, O1011b, O1011i, O611b, O611i, O623i		

## heat exchangers







1

<b>GEV No.</b>	692505	<b>Ref. No.</b>	AC31-1700 AC31-4600
<b>description</b>	heat exchanger for combi-steamer RETIGO model 1011		
<b>accessories for</b>	692505		
	<b>GEV No.</b>	103191	<b>Ref. No.</b> AC31-0903
	ignition electrode flange length 55mm flange width 17mm D1 ø 9mm L1 35mm BL1 29mm BL2 29mm connection ø 4mm		
	<b>GEV No.</b>	103268	<b>Ref. No.</b> AA31-0014
	monitoring electrode flange length 23.5mm D1 ø 6.8mm flange width 17mm L1 64mm L2 26mm BL1 54.5mm BL2 18mm connection screw		
	<b>GEV No.</b>	692515	<b>Ref. No.</b> AX31-0043
	gasket for heat exchanger Qty 1 MICA		
	<b>GEV No.</b>	692516	<b>Ref. No.</b> KP31-0049
	gasket for heat exchanger brass for model Qty 1		
	<b>GEV No.</b>	692518	<b>Ref. No.</b> AX31-0011
	gasket for gas supply Qty 1 silicone		







1

<b>GEV No.</b>	692550	<b>Ref. No.</b>	AC31-3850
<b>description</b>	heat exchanger for combi-steamer RETIGO model 2011 L 2040mm short		
<b>accessories for</b>	692550		
	<b>GEV No.</b>	103191	<b>Ref. No.</b> AC31-0903
	ignition electrode flange length 55mm flange width 17mm D1 ø 9mm L1 35mm BL1 29mm BL2 29mm connection ø 4mm		
	<b>GEV No.</b>	103268	<b>Ref. No.</b> AA31-0014
	monitoring electrode flange length 23.5mm D1 ø 6.8mm flange width 17mm L1 64mm L2 26mm BL1 54.5mm BL2 18mm connection screw		
	<b>GEV No.</b>	692515	<b>Ref. No.</b> AX31-0043
	gasket for heat exchanger Qty 1 MICA		
	<b>GEV No.</b>	692516	<b>Ref. No.</b> KP31-0049
	gasket for heat exchanger brass for model Qty 1		
	<b>GEV No.</b>	692518	<b>Ref. No.</b> AX31-0011
	gasket for gas supply Qty 1 silicone		



1

<b>GEV No.</b>	692551	<b>Ref. No.</b>	AC31-3750
<b>description</b>	heat exchanger for combi-steamer RETIGO model 2011 L 2500mm LANG		
<b>accessories for</b>	692551		
	<b>GEV No.</b>	103191	<b>Ref. No.</b> AC31-0903
	ignition electrode flange length 55mm flange width 17mm D1 ø 9mm L1 35mm BL1 29mm BL2 29mm connection ø 4mm		
	<b>GEV No.</b>	103268	<b>Ref. No.</b> AA31-0014
	monitoring electrode flange length 23.5mm D1 ø 6.8mm flange width 17mm L1 64mm L2 26mm BL1 54.5mm BL2 18mm connection screw		
	<b>GEV No.</b>	692515	<b>Ref. No.</b> AX31-0043
	gasket for heat exchanger Qty 1 MICA		
	<b>GEV No.</b>	692516	<b>Ref. No.</b> KP31-0049
	gasket for heat exchanger brass for model Qty 1		
	<b>GEV No.</b>	692518	<b>Ref. No.</b> AX31-0011
	gasket for gas supply Qty 1 silicone		



1

<b>GEV No.</b>	692506	<b>Ref. No.</b>	AC31-1800 AC31-4700
<b>description</b>	heat exchanger for combi-steamer RETIGO model 611		

## miscellaneous





1

<b>GEV No.</b>	692513	<b>Ref. No.</b>	KP31-0153
<b>description</b>	bracket PAD 1 SS mounting pos. underneath burn chamber		



1

<b>GEV No.</b>	692514	<b>Ref. No.</b>	AP31-0152 KP31-0152
<b>description</b>	bracket PAD 2 SS mounting pos. uinderneath burne chamber W 335mm H 160mm		
<b>accessories for</b>	692514		
	<b>GEV No.</b>	692509	<b>Ref. No.</b> AP31-0100 KP31-0100
	frame for burner RETIGO ZA22-0003 size 320x136mm Qty 1		
	<b>GEV No.</b>	692510	<b>Ref. No.</b> AT31-0047 ZA13-3040
	gasket for burner RETIGO ZA22-0003 Qty 1m		









1

	<b>GEV No.</b>	698467	<b>Ref. No.</b>	AT00-0002
<b>description</b>	bracket plastic for spray gun ø 21.5mm			
<b>For models:</b>	B1011b, B1011i, B1221b, B1221i, B2011b, B2011i, B2021b, B2021i, B611b, B611i, B623i, O1011b, O1011i, O1221b, O1221i, O2011b, O2011i, O2021b, O2021i, O611b, O611i, O623i			

1

	<b>GEV No.</b>	692508	<b>Ref. No.</b>	AC31-5000 AC31-5100
<b>description</b>	burner chamber RETIGO for 611 and 1011 L 400mm W 200mm H 230mm complete, but without gaskets not compatible with AC31-5000			

1

	<b>GEV No.</b>	692548	<b>Ref. No.</b>	20 AISI 316L AC31-4000
<b>description</b>	burner chamber RETIGO L 480mm W 160mm H 230mm complete, but without gaskets 20 AISI 316L			
<b>accessories for</b>	692548			
	<b>GEV No.</b>	103191	<b>Ref. No.</b>	AC31-0903
	ignition electrode flange length 55mm flange width 17mm D1 ø 9mm L1 35mm BL1 29mm BL2 29mm connection ø 4mm			
	<b>GEV No.</b>	103268	<b>Ref. No.</b>	AA31-0014
	monitoring electrode flange length 23.5mm D1 ø 6.8mm flange width 17mm L1 64mm L2 26mm BL1 54.5mm BL2 18mm connection screw			
	<b>GEV No.</b>	692515	<b>Ref. No.</b>	AX31-0043
	gasket for heat exchanger Qty 1 MICA			
	<b>GEV No.</b>	692516	<b>Ref. No.</b>	KP31-0049
	gasket for heat exchanger brass for model Qty 1			
	<b>GEV No.</b>	692518	<b>Ref. No.</b>	AX31-0011
	gasket for gas supply Qty 1 silicone			
	<b>GEV No.</b>	692550	<b>Ref. No.</b>	AC31-3850
	heat exchanger for combi-steamer RETIGO model 2011 L 2040mm short			
	<b>GEV No.</b>	692551	<b>Ref. No.</b>	AC31-3750
	heat exchanger for combi-steamer RETIGO model 2011 L 2500mm LANG			



1

	<b>GEV No.</b>	601914	<b>Ref. No.</b>	AA25-1002
<b>description</b>	flap kit for combi-steamer with cable with cover cap			
<b>spare parts for</b>	601914			
	<b>GEV No.</b>	602072	<b>Ref. No.</b>	AC25-0112/S AC25-0311/S
	gear motor 5W 220-240V voltage AC 50/60Hz 3/3.6rpm shaft ømm L 84mm W 70mm H 54.4mm			

Table continues overleaf

<b>spare parts for</b>	601914		
	<b>GEV No.</b>	750400	<b>Ref. No.</b> AC25-0105
	pressure compensation valve for combi-steamer D1 ø 50mm D2 ø 84.5mm hole ø 50mm H 55mm		



<b>GEV No.</b>	601913	<b>Ref. No.</b>	AC25-0100 V15-001-030
<b>description</b>	flap kit for combi-steamer with cover cap		
<b>For models:</b>	B1011b, B1011i, B1221b, B1221i, B2011i, B2021b, B2021i, B611b, B611i, B623i, O2011i		
<b>spare parts for</b>	601913		
	<b>GEV No.</b>	602072	<b>Ref. No.</b> AC25-0112/S AC25-0311/S
	gear motor 5W 220-240V voltage AC 50/60Hz 3/3.6rpm shaft ømm L 84mm W 70mm H 54.4mm		
	<b>GEV No.</b>	750400	<b>Ref. No.</b> AC25-0105
	pressure compensation valve for combi-steamer D1 ø 50mm D2 ø 84.5mm hole ø 50mm H 55mm		

<b>GEV No.</b>	696592	<b>Ref. No.</b>	AC00-2500
<b>description</b>	hose connector bore ø 10mm D1 ø 10mm D2 ø 25mm SS thread M16		
<b>For models:</b>	B1011b, B1011i, B1221b, B1221i, B2011b, B2011i, B2021b, B2021i, B611b, B611i, B623i, O1011b, O1011i, O1221b, O1221i, O2011b, O2011i, O2021b, O2021i, O611b, O611i, O623i		

<b>GEV No.</b>	750400	<b>Ref. No.</b>	AC25-0105
<b>description</b>	pressure compensation valve for combi-steamer D1 ø 50mm D2 ø 84.5mm hole ø 50mm H 55mm		
<b>For models:</b>	B1011b, B1011i, B1221b, B1221i, B2011i, B2021b, B2021i, B611b, B611i, B623i, O1011b, O1011i, O1221b, O1221i, O2011i, O2021b, O2021i, O611b, O611i, O623i		

<b>GEV No.</b>	692479	<b>Ref. No.</b>	AX04-0001
<b>description</b>	rubber gasket rubber W 9.7mm ø 55mm for hose 379mm hole ø 38mm H 15mm		
<b>For models:</b>	B623i, O623i		

<b>GEV No.</b>	692481	<b>Ref. No.</b>	AX04-0002
<b>description</b>	rubber gasket rubber W 9.7mm ø 65mm hole ø 48mm H 15mm		
<b>For models:</b>	B1011b, B1011i, B1221b, B1221i, B2011b, B2011i, B2021b, B2021i, B611b, B611i, O1011b, O1011i, O1221b, O1221i, O2011b, O2011i, O2021b, O2021i, O611b, O611i		



## locks

### handle latches

#### producer-specific

#### RETIGO

<b>GEV No.</b>	696590	<b>Ref. No.</b>	AX08-0020
<b>description</b>	bezel for door handle suitable for combi-steamer ø 47mm black H 24mm hole ø 36mm		
<b>For models:</b>	B1011b, B1011i, B611b, B611i, B623i, O1011b, O1011i, O611b, O611i, O623i		

<b>GEV No.</b>	692486	<b>Ref. No.</b>	ZA20-0901
<b>description</b>	catch clamp length 54mm BL 31mm for off-set 66-76mm		
<b>For models:</b>	B1011b, B1011i, B611b, B611i, B623i, O1011b, O1011i, O611b, O611i, O623i		
<b>spare parts for</b>	692486		
	<b>GEV No.</b>	514450	<b>Ref. No.</b> AX08-0024
	spring for door handle ø 6mm L 61mm W 27.5mm		
	<b>GEV No.</b>	692907	<b>Ref. No.</b> ZA20-0910
	spring holder L 20mm W 18mm H 8mm mounting pos. catch ø 4mm		





 <p>1</p>			
<b>GEV No.</b>	694067	<b>Ref. No.</b>	ZA20-0902
<b>description</b>	door catch with spigot 1-stage L 26mm total length 51mm thread M8		
<b>For models:</b>	B1011b, B1011i, B611b, B611i, B623i, O1011b, O1011i, O611b, O611i, O623i		

 <p>1</p>			
<b>GEV No.</b>	694066	<b>Ref. No.</b>	ZA20-0903
<b>description</b>	door catch with spigot 2-stage L 28mm W 14mm H 15mm H1 16mm total length 51mm thread M8 thread L 23mm stainless steel		
<b>For models:</b>	B1011b, B1011i, B611b, B611i, B623i, O1011b, O1011i, O611b, O611i, O623i		

 <p>1</p>			
<b>GEV No.</b>	696588	<b>Ref. No.</b>	AC08-0700
<b>description</b>	door handle L 190mm W 35mm H 60mm handle ø 60.5mm spring length 50mm screw mounting black/silver plastic flange 50mm		
<b>For models:</b>	B1011b, B1011i, B611b, B611i, B623i, O1011b, O1011i, O611b, O611i, O623i		
<b>spare parts for</b>	696588		
	<b>GEV No.</b>	514450	<b>Ref. No.</b> AX08-0024
	spring for door handle ø 6mm L 61mm W 27.5mm		
	<b>GEV No.</b>	692486	<b>Ref. No.</b> ZA20-0901
	catch clamp length 54mm BL 31mm for off-set 66-76mm		
	<b>GEV No.</b>	696587	<b>Ref. No.</b> AX08-0021
	door handle L 195mm W 38mm handle ø 60mm hole ø 8mm		
<b>accessories for</b>	696588		
	<b>GEV No.</b>	694066	<b>Ref. No.</b> ZA20-0903
	door catch with spigot 2-stage L 28mm W 14mm H 15mm H1 16mm total length 51mm thread M8 thread L 23mm stainless steel		
	<b>GEV No.</b>	694067	<b>Ref. No.</b> ZA20-0902
	door catch with spigot 1-stage L 26mm total length 51mm thread M8		
	<b>GEV No.</b>	696590	<b>Ref. No.</b> AX08-0020
	bezel for door handle suitable for combi-steamer ø 47mm black H 24mm hole ø 36mm		

 <p>1</p>			
<b>GEV No.</b>	696587	<b>Ref. No.</b>	AX08-0021
<b>description</b>	door handle L 195mm W 38mm handle ø 60mm hole ø 8mm		
<b>For models:</b>	B1011b, B1011i, B611b, B611i, B623i, O1011b, O1011i, O611b, O611i, O623i		

 <p>1</p>			
<b>GEV No.</b>	692907	<b>Ref. No.</b>	ZA20-0910
<b>description</b>	spring holder L 20mm W 18mm H 8mm mounting pos. catch ø 4mm		

## hinges

### door bearing

 <p>1</p>			
<b>GEV No.</b>	514534	<b>Ref. No.</b>	AAX03-0074 AP03-0135
<b>description</b>	bracket L 37mm W 25mm H 20mm mounting distance 15mm for glass plate		

 <p>1</p>			
<b>GEV No.</b>	514533	<b>Ref. No.</b>	AT03-0024
<b>description</b>	hinge bearing L 20mm W 20mm H 13mm ø 5mm without bolt for glass plate		

## filters

### grease filters

#### grease filter

 <p>1</p>			
<b>GEV No.</b>	970831	<b>Ref. No.</b>	ZA17-0010
<b>description</b>	grease filter W 135mm H 155mm thickness 9mm SS layers 7 outer grids 2 inner grids 5		
<b>For models:</b>	B1011b, B1011i, B1221b, B1221i, B2011b, B2011i, B2021b, B2021i, B611b, B611i, B623i, O1011b, O1011i, O1221b, O1221i, O2011b, O2011i, O2021b, O2021i, O611b, O611i, O623i		

## equipment feet and end caps

## equipment feet

## with screw mounting



<b>GEV No.</b>	701310	<b>Ref. No.</b>	AA00-0027 ZA15-0005
<b>description</b>	equipment foot tube ø 40mm thread M10 thread L 15mm H 80-110mm SS size 1 1/2" Qty 1 pcs		
<b>For models:</b>	B623i, O623i		



<b>GEV No.</b>	701309	<b>Ref. No.</b>	AA00-0026 ZA15-0002
<b>description</b>	equipment foot tube ø 52mm thread M10 thread Lmm H 86-110mm SS size 2" Qty 1 pcs		
<b>For models:</b>	B1011b, B1011i, B611b, B611i, O1011b, O1011i, O611b, O611i		

## with fixing plate



<b>GEV No.</b>	701308	<b>Ref. No.</b>	ZA15-0008
<b>description</b>	equipment foot tube ø 58mm plate size 85x85mm hole distance 85mm H 208-315mm SS size 2 1/4" Qty 1 pcs		
<b>For models:</b>	B1221b, B1221i, B2011b, B2011i, B2021b, B2021i, O1221b, O1221i, O2011b, O2011i, O2021b, O2021i		

## bolting feet



<b>GEV No.</b>	701311	<b>Ref. No.</b>	AC09-0400
<b>description</b>	equipment foot ø 60.5mm H 40mm SS bore ø M10mm Qty 1 pcs		

## STEINCO

## with bolt hole

## plastic



<b>GEV No.</b>	701306	<b>Ref. No.</b>	ZA16-0003
<b>description</b>	swivel castor ø 100mm bolt hole bolt hole ø 10.3mm housing plastic capacity 90kg bearing ball bearing wheel body polypropylene tread thermoplastic H 135mm wheel width 30mm Qty 1 pcs		
<b>For models:</b>	B1221b, B1221i, B2011b, B2011i, B2021b, B2021i, O1221b, O1221i, O2011b, O2011i, O2021b, O2021i		



<b>GEV No.</b>	701307 <sup>1</sup>	<b>Ref. No.</b>	ZA16-0004
<b>description</b>	swivel castor with swivel brake ø 100mm bolt hole bolt hole ø 10.3mm housing plastic capacity 90kg bearing ball bearing wheel body polypropylene tread thermoplastic H 135mm wheel width 30mm Qty 1 pcs		
<b>For models:</b>	B1221b, B1221i, B2011b, B2011i, B2021b, B2021i, O1221b, O1221i, O2011b, O2011i, O2021b, O2021i		

<sup>1</sup>with swivel brake



**gaskets**

**gaskets for heated units**

**door seals**

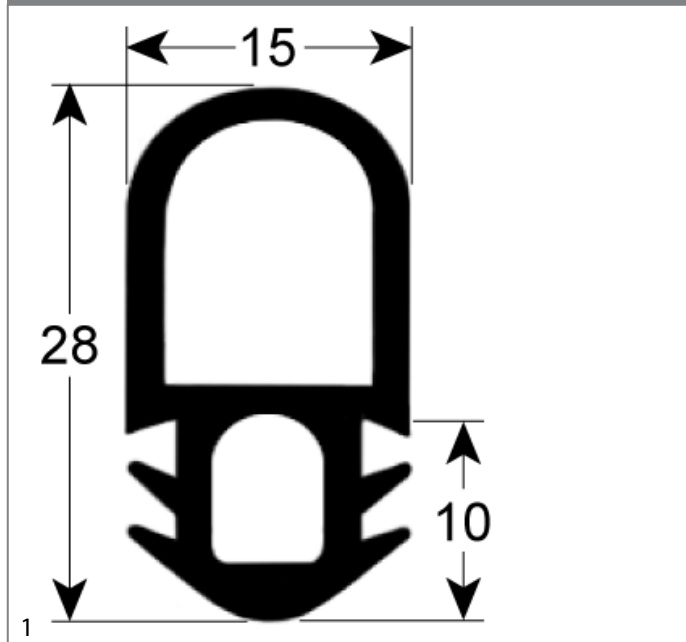

<b>GEV No.</b>	901461	<b>Ref. No.</b>	AX00-0002
<b>description</b>	door seal profile 2052 W 505mm L 620mm external size		



<b>GEV No.</b>	901701	<b>Ref. No.</b>	AX00-0003
<b>description</b>	door seal profile 2052 W 615mm L 755mm external size		

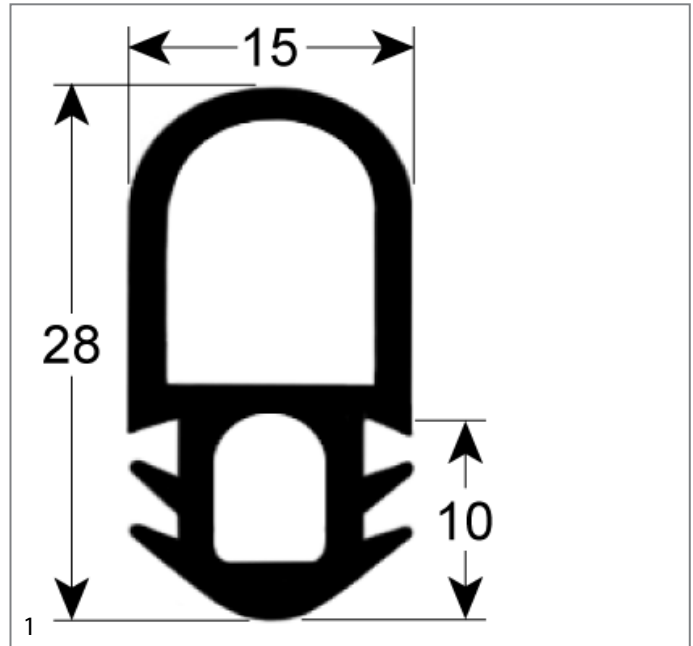

<b>GEV No.</b>	902552	<b>Ref. No.</b>	AX00-0004
<b>description</b>	door seal profile 2052 W 660mm L 1420mm external size Qty 1		

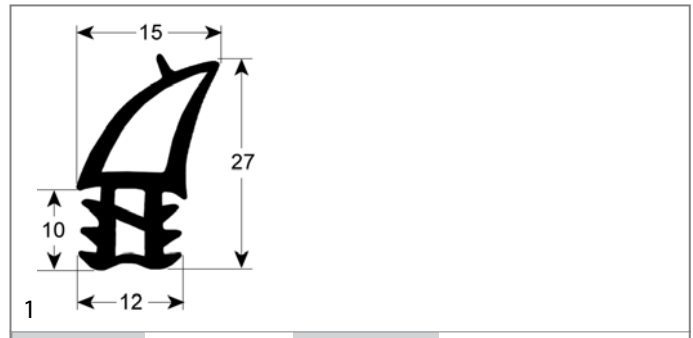

<b>GEV No.</b>	901720	<b>Ref. No.</b>	AX00-0034
<b>description</b>	door seal profile 2729 W 405mm L 405mm external size Qty 1 suitable for RETIGO		
<b>For models:</b>	B623i, O623i		

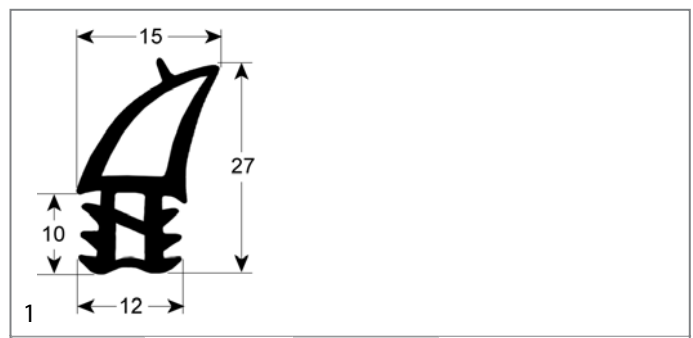

<b>GEV No.</b>	901717	<b>Ref. No.</b>	AX00-0031 AX00-0038
<b>description</b>	door seal profile 2729 W 620mm L 1380mm external size Qty 1 suitable for RETIGO		
<b>For models:</b>	B2011b, B2011i, B2021b, B2021i, O2011b, O2011i, O2021b, O2021i		

<b>GEV No.</b>	901721	<b>Ref. No.</b>	AX00-0035
<b>description</b>	door seal profile 2729 W 620mm L 490mm external size Qty 1 suitable for RETIGO		
<b>For models:</b>	B611b, B611i, O611b, O611i		

<b>GEV No.</b>	901719	<b>Ref. No.</b>	AX00-0036
<b>description</b>	door seal profile 2729 W 620mm L 755mm external size Qty 1 suitable for RETIGO		
<b>For models:</b>	B1011b, B1011i, O1011b, O1011i		

<b>GEV No.</b>	901718	<b>Ref. No.</b>	AX00-0037
<b>description</b>	door seal profile 2729 W 620mm L 930mm external size Qty 1 suitable for RETIGO		
<b>For models:</b>	B1221b, B1221i, O1221b, O1221i		

### gaskets for tray rack trolleys

<b>GEV No.</b>	901722	<b>Ref. No.</b>	AX03-0078
<b>description</b>	tray rack trolley gasket L 645mm W 44mm suitable for RETIGO		
<b>For models:</b>	B1221b, B1221i, B2011b, B2011i, B2021b, B2021i, O1221b, O1221i, O2011b, O2011i, O2021b, O2021i		

### O-rings

#### PTFE

<b>GEV No.</b>	696591	<b>Ref. No.</b>	ZA13-1549
<b>description</b>	O-ring silicone thickness 5.5mm ID ø 48.75mm		
<b>For models:</b>	B1011b, B1011i, B1221b, B1221i, B2011b, B2011i, B2021b, B2021i, B611b, B611i, B623i, O1011b, O1011i, O1221b, O1221i, O2011b, O2011i, O2021b, O2021i, O611b, O611i, O623i		

### miscellaneous

<b>GEV No.</b>	692509	<b>Ref. No.</b>	AP31-0100 KP31-0100
<b>description</b>	frame for burner RETIGO ZA22-0003 size 320x136mm Qty 1		
<b>accessories for</b>	692509		

<b>GEV No.</b>	692510	<b>Ref. No.</b>	AT31-0047 ZA13-3040
<b>description</b>	gasket for burner RETIGO ZA22-0003 Qty 1m		

<b>GEV No.</b>	692510	<b>Ref. No.</b>	AT31-0047 ZA13-3040
<b>description</b>	gasket for burner RETIGO ZA22-0003 Qty 1m		
<b>accessories for</b>	692510		

<b>GEV No.</b>	692509	<b>Ref. No.</b>	AP31-0100 KP31-0100
<b>description</b>	frame for burner RETIGO ZA22-0003 size 320x136mm Qty 1		

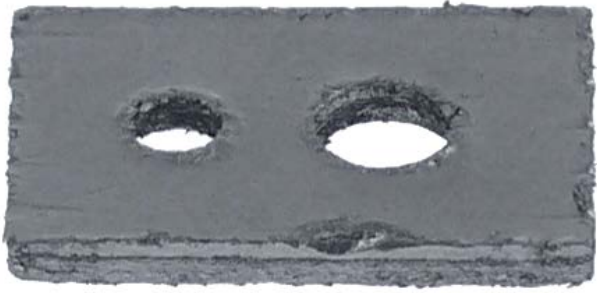

1

<b>GEV No.</b>	692512	<b>Ref. No.</b>	AX31-0045
<b>description</b>	gasket for flame monitoring Qty 1 RETIGO		



1

<b>GEV No.</b>	692516	<b>Ref. No.</b>	KP31-0049
<b>description</b>	gasket for heat exchanger brass for model Qty 1		

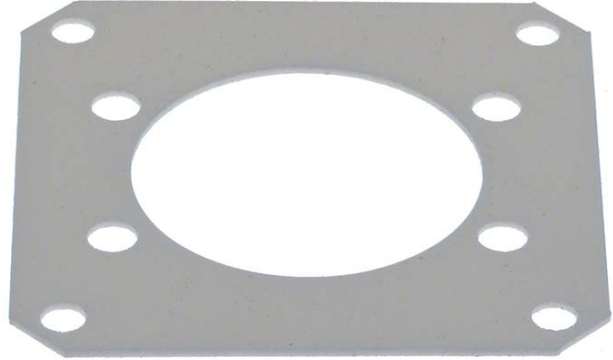

1

<b>GEV No.</b>	692517	<b>Ref. No.</b>	AX31-0010
<b>description</b>	gasket for gas mixing compartment Qty 1 for type 611 and 1011		



1

<b>GEV No.</b>	692515	<b>Ref. No.</b>	AX31-0043
<b>description</b>	gasket for heat exchanger Qty 1 MICA		

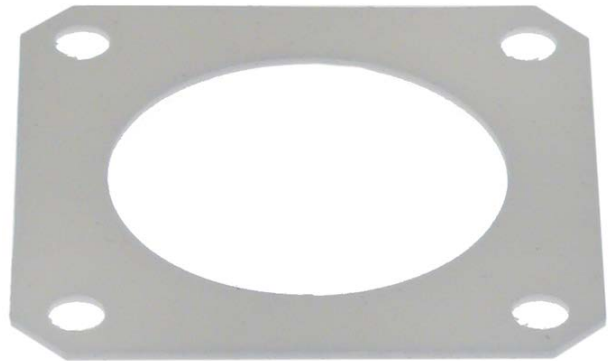

1

<b>GEV No.</b>	692518	<b>Ref. No.</b>	AX31-0011
<b>description</b>	gasket for gas supply Qty 1 silicone		

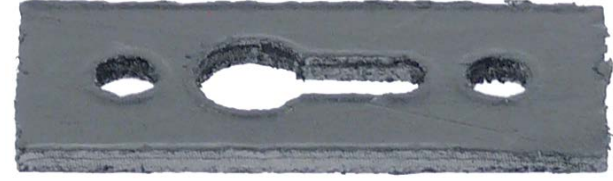

1

<b>GEV No.</b>	692511	<b>Ref. No.</b>	AX31-0044
<b>description</b>	gasket for ignition electrode Qty 1 RETIGO AC31-0903		

### springs

#### miscellaneous



1

<b>GEV No.</b>	514450	<b>Ref. No.</b>	AX08-0024
<b>description</b>	spring for door handle ø 6mm L 61mm W 27.5mm		



1

<b>GEV No.</b>	701316	<b>Ref. No.</b>	AC08-0208
<b>description</b>	spring clip U-shape door lock shaft diametermm ømm L 40mm W 50mm Hmm wire gauge ø 0.8mm		
<b>For models:</b>	B1221b, B1221i, B2011b, B2011i, B2021b, B2021i, O1221b, O1221i, O2011b, O2011i, O2021b, O2021i		

tension springs



1

<b>GEV No.</b>	701659	<b>Ref. No.</b>	AX08-0012
<b>description</b>	tension spring for door mechanism ø 7mm total length 44mm wire gauge ø 0.9mm for combi-steamer		

manometers



1

<b>GEV No.</b>	541998	<b>Ref. No.</b>	ZA12-0401 ZA12-0409
<b>description</b>	manometer ø 40mm pressure range 0-1bar connection 1/8"		
<b>For models:</b>	B1011i, B1221i, B2011i, B2021i, B611i, B623i, O1011i, O1221i, O2011i, O2021i, O611i, O623i		

hose reels and spray guns

spray guns





1

<b>GEV No.</b>	542038	<b>Ref. No.</b>	ZA15-0100
<b>description</b>	spray gun for appliances 3/8" IT L 135mm		
<b>For models:</b>	B1011b, B1011i, B1221b, B1221i, B2011b, B2011i, B2021b, B2021i, B611b, B611i, B623i, O1011b, O1011i, O1221b, O1221i, O2011b, O2011i, O2021b, O2021i, O611b, O611i, O623i		



1

<b>GEV No.</b>	698468	<b>Ref. No.</b>	AA26-1002	
<b>description</b>	spray gun for appliances incl. accessories			
<b>spare parts for</b>	698468			
	<b>GEV No.</b>	542038	<b>Ref. No.</b>	ZA15-0100
	spray gun for appliances 3/8" IT L 135mm			
	<b>GEV No.</b>	698467	<b>Ref. No.</b>	AT00-0002
	bracket plastic for spray gun ø 21.5mm			



1

<b>GEV No.</b>	520892	<b>Ref. No.</b>	ZA11-0902
<b>description</b>	shower hose connections 3/8" L 1600mm EPDM t.max. 110°C burst p. 10bar for combi-steamer		
<b>For models:</b>	B1011b, B1011i, B611b, B611i, B623i, O1011b, O1011i, O611b, O611i, O623i		



1

<b>GEV No.</b>	520891	<b>Ref. No.</b>	ZA11-0904
<b>description</b>	shower hose connections 3/8" L 2100mm EPDM t.max. 110°C burst p. 10bar for combi-steamer		
<b>For models:</b>	B1221b, B1221i, B2011b, B2011i, B2021b, B2021i, O1221b, O1221i, O2011b, O2011i, O2021b, O2021i		



**hoses**

**industrial hoses**

PVC hoses

PVC braided hoses



1

<b>GEV No.</b>	570163	<b>Ref. No.</b>	AA26-0101
<b>description</b>	PVC braided hose ID ø 10mm ED ø 17.2mm L 350m thickness 3.6mm PVC combi-steamer transparent Qty 1		



1

<b>GEV No.</b>	570162	<b>Ref. No.</b>	AA26-0100
<b>description</b>	PVC braided hose ID ø 10mm ED ø 17.2mm L 440m thickness 3.6mm PVC combi-steamer transparent Qty 1		



1

<b>GEV No.</b>	570164	<b>Ref. No.</b>	AA26-0104
<b>description</b>	PVC braided hose ID ø 10mm ED ø 17.2mm L 90m thickness 3.6mm PVC combi-steamer transparent Qty 1		

**silicone hoses**

without fabric



1

<b>GEV No.</b>	530062	<b>Ref. No.</b>	ZA11-0805
<b>description</b>	silicone hose ID ø 16mm ED ø 23mm L 1m t.max. 200°C transparent		

with fabric

with monofilament braid



1

<b>GEV No.</b>	530435	<b>Ref. No.</b>	ZA11-0803
<b>description</b>	silicone hose L 1m ID ø 10mm ED ø 17mm with monofilament braid thickness 3.5mm operating p. 4bar t.max. 200°C clear		
<b>For models:</b>	B2011i, O2011i		

**formed hoses**

straight



1

<b>GEV No.</b>	530920	<b>Ref. No.</b>	ZA10-0500
<b>description</b>	steam hose silicone L 68mm ID ø 38mm ED ø 46mm for combi-steamer steam generator		

**water cycle components**

**pressure reduction valves**

pressure reduction valves

producer-specific



1

<b>GEV No.</b>	541184	<b>Ref. No.</b>	ZA12-0201 ZA12-02012
<b>description</b>	pressure controller Metal Work series Bit MRA connection 1/4" default settingbar setting range 0-2bar p max 13bar t.max. 50°C plastic		
<b>For models:</b>	B1011i, B1221i, B2011i, B2021i, B611i, B623i, O1011i, O1221i, O2011i, O2021i, O611i, O623i		



1

<b>GEV No.</b>	520958	<b>Ref. No.</b>	ZA12-0207
<b>description</b>	pressure reduction valve Norgren connection 1/4 / 1/8 default settingbar setting range 0.1-2bar		





<b>A</b>			
alarm devices	6		
axial fans	13		
<b>C</b>			
castors and bumper angles	26		
condensators & interference suppression filters	15		
contactors	7		
<b>D</b>			
door seals	27		
drain pumps	15		
<b>E</b>			
electric accessories	16		
electrodes	12		
<b>F</b>			
fans	13		
filters	15		
formed hoses	31		
fuses	16		
<b>G</b>			
gas burners	18		
gas control valves	16		
gaskets for heated units	27		
gaskets for tray rack trolleys	28		
<b>H</b>			
halogen lamp	5		
heating elements	3		
heating elements for convection	3		
hoses	31		
hot air fans	14		
hot air motors	13		
<b>I</b>			
ignition boxes	17		
ignition cables	18		
ignition units	18		
immersion heating elements	3		
industrial hoses	31		
<b>L</b>			
lamps	5		
<b>M</b>			
magnetic switches	5		
motors	14		
<b>O</b>			
operating capacitors	15		
O-rings	28		
oven lamps	5		
<b>P</b>			
pressure reduction valves	31, 31		
probes	9		
pumps	15		
PVC hoses	31		
<b>R</b>			
radial fans	14		
relays	8		
<b>S</b>			
safety thermostats	4		
silicone hoses	31		
solenoid valves	12		
solid state relays	8		
spray guns	30		
switches and momentary switches	5		
<b>T</b>			
terminals	16		
thermostats	4		
transformers	8		
<b>W</b>			
water cycle components	31		