



**GAS COMPONENTS**



**ELECTRIC COMPONENTS**



**WATER TECHNOLOGY**



**MECHANICAL COMPONENTS**



**TOOLS**

Spare parts suitable for

**REPAGAS**

Find the complete and up-to-date range of products in our GEV Webshop



# Manufacturer catalogue

The most important spare parts and accessories arranged clearly for every manufacturer

- ✓ Complete product range and all appliance data always up to date in the GEV Webshop
- ✓ Alphabetical Index at the end of the catalogue

## GEV Webshop

[www.gev-online.co.uk](http://www.gev-online.co.uk)

[www.gev-online.com](http://www.gev-online.com)



- 🔍 Add to Favourites
- 🔍 Sign In with email address and usual password
- 🔍 Easy-order – place several items in your basket at the same time
- 🔍 Quick Item search – no login needed



## heating elements





### heating elements for bain maries

			
<b>GEV No.</b>	420216	<b>Ref. No.</b>	007410 22300016
<b>description</b>	heating element 1500W 230V heating circuits 1 L 490mm W 92mm connection screw tube ø 8mm 2 hole fixing thread M12x1.25 immersion heater for bain marie mounting distance 84mm		

### heating elements for fryers

#### 2 hole fixing

			
<b>GEV No.</b>	415920	<b>Ref. No.</b>	8500013
<b>description</b>	heating element 2800W 230V heating circuits 1 L 280mm W 160mm H 185mm thread 1/4" tube ø 8.5mm windings 4 connection M4 2 hole fixing fryer heaters		
<b>accessories for</b>	415920		
	<b>GEV No.</b>	510417	<b>Ref. No.</b> —
	flat gasket fibre ED ø 20mm ID ø 14mm thickness 2mm Qty 1 pcs		
	<b>GEV No.</b>	520228	<b>Ref. No.</b> —
	tooth lock washer ID ø 15.3mm ED ø 24mm steel Qty 1 pcs for thread M14		
	<b>GEV No.</b>	520230	<b>Ref. No.</b> 00112127 010106
	nut thread M14x1.5 H 5mm WS 19 zinc-coated steel Qty 1 pcs		
	<b>GEV No.</b>	521101	<b>Ref. No.</b> —
	nut thread M14x1.5 H 5mm WS 19 SS Qty 1 pcs		
	<b>GEV No.</b>	521103	<b>Ref. No.</b> —
	nut thread M4 H 3mm WS 7 brass Qty 20 pcs		
	<b>GEV No.</b>	521104	<b>Ref. No.</b> —
	washer ID ø 4.3mm ED ø 8mm thickness 0.5mm brass Qty 20 pcs for thread M4		
	<b>GEV No.</b>	550262	<b>Ref. No.</b> —
	flat gasket copper ED ø 20mm ID ø 14mm thickness 2mm		
	<b>GEV No.</b>	560111	<b>Ref. No.</b> —
	plain washer ID ø 4.3mm ED ø 9mm thickness 0.8mm SS Qty 20 pcs DIN 125A for thread M4		
	<b>GEV No.</b>	560131	<b>Ref. No.</b> —
	hexagonal nut thread M4 H 3.2mm WS 7 SS DIN/ISO DIN 934 / ISO 4032/8673 Qty 20 pcs		

			
<b>GEV No.</b>	415921	<b>Ref. No.</b>	8700024
<b>description</b>	heating element 1260W 230V heating circuits 1 L 320mm W 48mm H 220mm L1 22mm L2 298mm thread 1/4" tube ø 8.5mm windings 2 2 hole fixing connection M4 fryer heaters		
<b>accessories for</b>	415921		
	<b>GEV No.</b>	521103	<b>Ref. No.</b> —
	nut thread M4 H 3mm WS 7 brass Qty 20 pcs		
	<b>GEV No.</b>	521104	<b>Ref. No.</b> —
	washer ID ø 4.3mm ED ø 8mm thickness 0.5mm brass Qty 20 pcs for thread M4		
	<b>GEV No.</b>	560111	<b>Ref. No.</b> —
	plain washer ID ø 4.3mm ED ø 9mm thickness 0.8mm SS Qty 20 pcs DIN 125A for thread M4		
	<b>GEV No.</b>	560131	<b>Ref. No.</b> —
	hexagonal nut thread M4 H 3.2mm WS 7 SS DIN/ISO DIN 934 / ISO 4032/8673 Qty 20 pcs		

#### group 7

			
<b>GEV No.</b>	420210	<b>Ref. No.</b>	16300008
<b>description</b>	heating element 1600W 230V heating circuits 1 L 283mm W 75mm H 200mm 2 hole fixing connection male faston 6.3mm immersion heater L1 10mm L2 273mm W1 12.5mm W2 50mm H1 20mm H2 180mm tube ø 8.5mm thread 1/4" mounting distance 41.5mm windings 2		





			
<b>GEV No.</b>	416783	<b>Ref. No.</b>	1140011
<b>description</b>	heating element 5500W 230V heating circuits 1 L 250mm W 60mm H 250mm L1 22mm L2 375mm H1 206mm H2 44mm thread M14x1.5 tube ø 8.5mm 2 hole fixing connection M4 fryer heaters windings 6		
<b>accessories for</b>	416783		
	<b>GEV No.</b>	521103	<b>Ref. No.</b> —
	nut thread M4 H 3mm WS 7 brass Qty 20 pcs		

Table continues overleaf





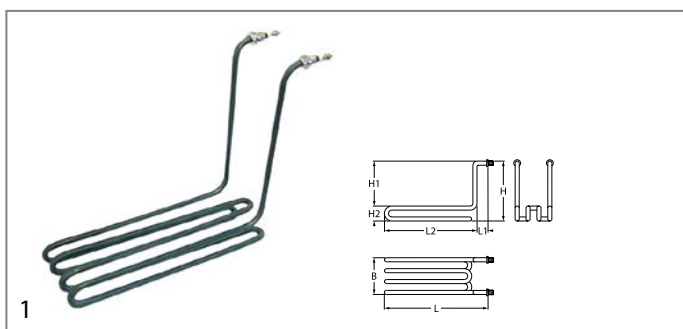

<b>accessories for</b> 416783			
	GEV No.	521104	Ref. No. —
washer ID $\varnothing$ 4.3mm ED $\varnothing$ 8mm thickness 0.5mm brass Qty 20 pcs for thread M4			
	GEV No.	560111	Ref. No. —
plain washer ID $\varnothing$ 4.3mm ED $\varnothing$ 9mm thickness 0.8mm SS Qty 20 pcs DIN 125A for thread M4			
	GEV No.	560131	Ref. No. —
hexagonal nut thread M4 H 3.2mm WS 7 SS DIN/ISO DIN 934 / ISO 4032/8673 Qty 20 pcs			

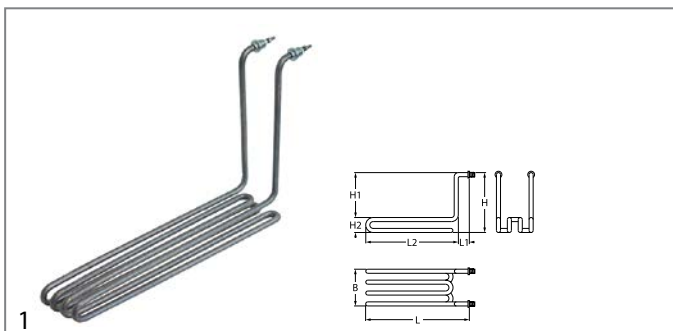

<b>GEV No.</b>	415924	<b>Ref. No.</b>	1130002
<b>description</b>	heating element 3000W 230V heating circuits 1 L 297mm W 86mm H 243mm L1 22mm L2 275mm H1 207mm H2 36mm thread 1/4" mounting distance 34mm tube $\varnothing$ 8.5mm 2 hole fixing connection M4 fryer heaters windings 4		
<b>accessories for</b> 415924			
	GEV No.	361182	Ref. No. —
nut thread 1/4" H 5mm nickel-plated brass WS 17 Qty 1 pcs			
	GEV No.	510417	Ref. No. —
flat gasket fibre ED $\varnothing$ 20mm ID $\varnothing$ 14mm thickness 2mm Qty 1 pcs			
	GEV No.	520228	Ref. No. —
tooth lock washer ID $\varnothing$ 15.3mm ED $\varnothing$ 24mm steel Qty 1 pcs for thread M14			
	GEV No.	521103	Ref. No. —
nut thread M4 H 3mm WS 7 brass Qty 20 pcs			
	GEV No.	521104	Ref. No. —
washer ID $\varnothing$ 4.3mm ED $\varnothing$ 8mm thickness 0.5mm brass Qty 20 pcs for thread M4			
	GEV No.	550262	Ref. No. —
flat gasket copper ED $\varnothing$ 20mm ID $\varnothing$ 14mm thickness 2mm			
	GEV No.	560111	Ref. No. —
plain washer ID $\varnothing$ 4.3mm ED $\varnothing$ 9mm thickness 0.8mm SS Qty 20 pcs DIN 125A for thread M4			
	GEV No.	560131	Ref. No. —
hexagonal nut thread M4 H 3.2mm WS 7 SS DIN/ISO DIN 934 / ISO 4032/8673 Qty 20 pcs			



<b>GEV No.</b>	416782	<b>Ref. No.</b>	9000007
<b>description</b>	heating element 3333W 230V heating circuits 1 L 395mm W 85mm H 245mm L1 23mm L2 375mm H1 210mm H2 35mm thread 1/4" mounting distance 76mm tube $\varnothing$ 8.5mm 2 hole fixing connection M4 connection length 37mm fryer heaters windings 4		
<b>accessories for</b> 416782			
	GEV No.	521103	Ref. No. —
nut thread M4 H 3mm WS 7 brass Qty 20 pcs			
	GEV No.	521104	Ref. No. —
washer ID $\varnothing$ 4.3mm ED $\varnothing$ 8mm thickness 0.5mm brass Qty 20 pcs for thread M4			
	GEV No.	560111	Ref. No. —
plain washer ID $\varnothing$ 4.3mm ED $\varnothing$ 9mm thickness 0.8mm SS Qty 20 pcs DIN 125A for thread M4			
	GEV No.	560131	Ref. No. —
hexagonal nut thread M4 H 3.2mm WS 7 SS DIN/ISO DIN 934 / ISO 4032/8673 Qty 20 pcs			

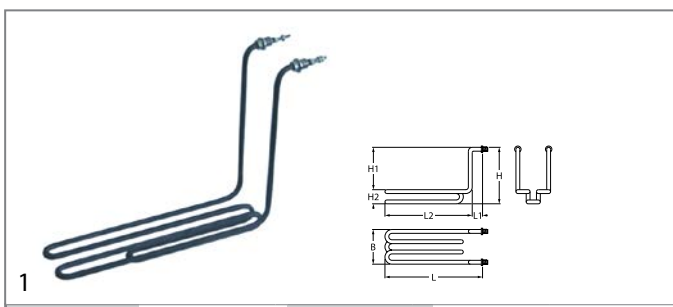









<b>GEV No.</b>	415923	<b>Ref. No.</b>	8800027
<b>description</b>	heating element 2000W 230V heating circuits 1 L 315mm W 74mm H 250mm L1 20mm L2 295mm H1 214mm H2 36mm thread 1/4" mounting distance 66mm tube $\varnothing$ 8.5mm 2 hole fixing connection M4 fryer heaters windings 2 fryer		
<b>spare parts for</b> 415923			
	GEV No.	510417	Ref. No. —
flat gasket fibre ED $\varnothing$ 20mm ID $\varnothing$ 14mm thickness 2mm Qty 1 pcs			
<b>accessories for</b> 415923			
	GEV No.	361182	Ref. No. —
nut thread 1/4" H 5mm nickel-plated brass WS 17 Qty 1 pcs			
	GEV No.	520228	Ref. No. —
tooth lock washer ID $\varnothing$ 15.3mm ED $\varnothing$ 24mm steel Qty 1 pcs for thread M14			
	GEV No.	521103	Ref. No. —
nut thread M4 H 3mm WS 7 brass Qty 20 pcs			
	GEV No.	521104	Ref. No. —
washer ID $\varnothing$ 4.3mm ED $\varnothing$ 8mm thickness 0.5mm brass Qty 20 pcs for thread M4			

Table continues overleaf



accessories for		415923	
	GEV No.	550262	Ref. No. —
flat gasket copper ED ø 20mm ID ø 14mm thickness 2mm			
	GEV No.	560111	Ref. No. —
plain washer ID ø 4.3mm ED ø 9mm thickness 0.8mm SS Qty 20 pcs DIN 125A for thread M4			
	GEV No.	560131	Ref. No. —
hexagonal nut thread M4 H 3.2mm WS 7 SS DIN/ISO DIN 934 / ISO 4032/8673 Qty 20 pcs			

heating elements for heated cabinets



GEV No.	419065	Ref. No.	1510002
description	heating element 1400W 230V heating circuits 1 L 375mm W 140mm connection length 30mm connection male faston 6.3mm tube ø 6.3mm 2 hole fixing thread M10x1 dry heating element L1 45mm L2 75mm L3 255mm W1 45mm W2 50mm mounting distance 44mm		

6 hole fixing



GEV No.	420209	Ref. No.	16500005
description	heating element 9000W 230V heating circuits 3 L 310mm W 180mm H 235mm L1 10mm L2 300mm thread 1/4" mounting distance 34.5mm tube ø 8.5mm 6 hole fixing connection male faston 6.3mm immersion heater fryer		

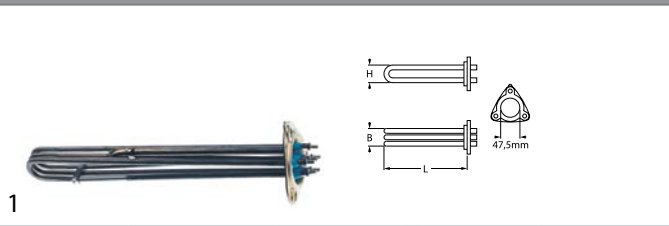

immersion heating elements

3 hole flange ø47.5mm



GEV No.	418136	Ref. No.	1250007
description	heating element 4360W 240V mounting ø 47.5mm heating circuits 3 L 310mm W 31mm H 35mm number of thermostat sleeves 1 thermostat sleeves ø 7mm length thermostat sleeves 200mm thermostat sleeve clinging tube ø 6.3mm hole distance 62mm hole ø 8mm connection M4 3 hole flange immersion heater		

spare parts for		418136	
	GEV No.	510408	Ref. No. —
O-ring EPDM thickness 5.34mm ID ø 47mm Qty 1 pcs			

accessories for		418136	
	GEV No.	510408	Ref. No. —
O-ring EPDM thickness 5.34mm ID ø 47mm Qty 1 pcs			
	GEV No.	510562	Ref. No. —
O-ring silicone thickness 5.34mm ID ø 47mm Qty 1 pcs			

heating elements for griddles



GEV No.	420218	Ref. No.	016053 32100002
description	heating element 1000W 230V heating circuits 1 L 345mm W 56mm H 55mm tube ø 10x10mm screw connection M4 connection distance 46mm dry heating element		

heating elements for contact grills



GEV No.	420217	Ref. No.	32400014
description	heating element 1300W 230V heating circuits 1 L 300mm W 130mm H 55mm connection distance 120mm tube ø 10mm dry heating element connection screw		

with expansion flange 70 x 18mm



GEV No.	418137	Ref. No.	42000003
description	heating element 3000W 230V heating circuits 1 flange 70x18mm L 220mm W 65mm Hmm connection male faston 6.3mm tube ø 8.5mm immersion heater expansion flange connection length 34mm		



## heating elements for convection



1

<b>GEV No.</b>	418102	<b>Ref. No.</b>	91600001
<b>description</b>	heating element 16400W 230V heating circuits 3 ID $\varnothing$ 441mm ED $\varnothing$ 458mm L 492mm H 143mm L1 34mm W1 104mm H1 128mm H2 115mm flange length 142mm flange width 25mm hole distance 63mm connection M6x1 tube $\varnothing$ 8.5mm convection heating element hole $\varnothing$ 6mm rectangular flange		
<b>accessories for</b>	418102		
	<b>GEV No.</b>	699165	<b>Ref. No.</b> —
	gasket L 142mm W 25mm D1 $\varnothing$ 6.5mm D2 $\varnothing$ 12mm hole distance 17mm 9 holes graphite thickness 2mm		



1

<b>GEV No.</b>	418134	<b>Ref. No.</b>	1230005
<b>description</b>	heating element 3300W 240V heating circuits 1 ID $\varnothing$ 185mm ED $\varnothing$ 200mm L 215mm H 30mm W1 60mm H1 5mm H2 25mm flange length 100mm flange width 22mm hole distance 85mm connection male faston 6.3mm connection length 22mm tube $\varnothing$ 6.5mm convection heating element hole $\varnothing$ 5mm rectangular flange		



1

<b>GEV No.</b>	418132	<b>Ref. No.</b>	1250016
<b>description</b>	heating element 7350W 230V heating circuits 3 ID $\varnothing$ 250mm ED $\varnothing$ 265mm L 277mm H 75mm L1 17mm W1 102mm H1 12mm H2 67mm flange length 143mm flange width 25mm hole distance 7mm connection M4 tube $\varnothing$ 6.5mm convection heating element hole $\varnothing$ 63mm rectangular flange		

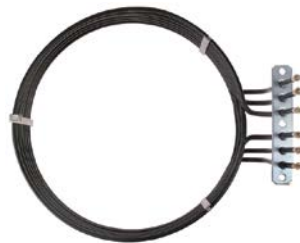





1

<b>GEV No.</b>	418753	<b>Ref. No.</b>	45200001
<b>description</b>	heating element 8000W 230V heating circuits 3 ID $\varnothing$ 287mm ED $\varnothing$ 300mm L 345mm H 90mm L1 39mm H1 20mm H2 67mm flange length 142mm flange width 25mm hole distance 12.7mm connection M4 connection length 67mm tube $\varnothing$ 6.5mm convection heating element hole $\varnothing$ 7mm rectangular flange		



1

<b>GEV No.</b>	418135	<b>Ref. No.</b>	1230006
<b>description</b>	heating element 920W 230V heating circuits 1 ID $\varnothing$ 200mm ED $\varnothing$ 215mm L 255mm H 40mm thread 1/4" connection male faston 6.3mm 2 hole fixing mounting distance 24mm tube $\varnothing$ 8.5mm convection heating element		
<b>accessories for</b>	418135		
	<b>GEV No.</b>	361182	<b>Ref. No.</b> —
	nut thread 1/4" H 5mm nickel-plated brass WS 17 Qty 1 pcs		
	<b>GEV No.</b>	510417	<b>Ref. No.</b> —
	flat gasket fibre ED $\varnothing$ 20mm ID $\varnothing$ 14mm thickness 2mm Qty 1 pcs		
	<b>GEV No.</b>	520228	<b>Ref. No.</b> —
	tooth lock washer ID $\varnothing$ 15.3mm ED $\varnothing$ 24mm steel Qty 1 pcs for thread M14		
	<b>GEV No.</b>	550262	<b>Ref. No.</b> —
	flat gasket copper ED $\varnothing$ 20mm ID $\varnothing$ 14mm thickness 2mm		





1

<b>GEV No.</b>	419261	<b>Ref. No.</b>	92000041
<b>description</b>	heating element 9500/10400W 230/240V heating circuits 3 ID $\varnothing$ 320mm ED $\varnothing$ 337mm L 380mm H 148mm L1 40mm W1 105mm H1 20mm H2 120mm flange length 142mm flange width 25mm hole distance 18mm connection M6x1 connection length 85mm tube $\varnothing$ 8.5mm convection heating element flange combi-steamer		



			
1			
<b>GEV No.</b>	419222	<b>Ref. No.</b>	92800004
<b>description</b>	heating element 27000/29000W 400/415V L 590mm W 545mm H 140mm heating circuits 3 cable lengthmm		

			
1			
<b>GEV No.</b>	418139	<b>Ref. No.</b>	1240014
<b>description</b>	heating element 3500W 240V heating circuits 1 L 620mm W 120mm L1 33mm L2 587mm W2 90mm flange length 70mm flange width 22mm hole distance 56mm connection length 100mm connection M4 tube ø 8.5mm hole ø 6mm W1 30mm rectangular flange convection heating element windings 2		

accessories			
hexagonal nuts			
			
1			
<b>GEV No.</b>	520230	<b>Ref. No.</b>	00112127 010106
<b>description</b>	nut thread M14x1.5 H 5mm WS 19 zinc-coated steel Qty 1 pcs		

energy regulators			
EGO			
1-circuit			
			
1			
<b>GEV No.</b>	380019	<b>Ref. No.</b>	1230018
<b>description</b>	energy regulator 240V 13A single-circuit turn direction right shaft ø 6x4.6mm shaft L 23mm mounting thread M4 power release 6-100% no. 50.57071.010		

thermostats			
control and safety thermostats			
EGO			
control thermostats			
55.10/19_ series			
			
1			
<b>GEV No.</b>	390779	<b>Ref. No.</b>	64100014
<b>description</b>	thermostat t.max. 190°C temperature range 105-190°C 1-pole 1NO 0.5A probe ø 4mm probe L 235mm capillary pipe 1470mm capillary pipe isolated 1250mm gland nut M10x1 shaft ø 6x4.6mm shaft L 23mm shaft position lower rotation 270°		

			
1			
<b>GEV No.</b>	390731	<b>Ref. No.</b>	8500014
<b>description</b>	thermostat t.max. 195°C temperature range 65-195°C 1-pole 1NO 16A probe ø 4mm probe L 106mm capillary pipe 1470mm capillary pipe isolatedmm gland nut shaft ø 6x4.6mm shaft L 23mm shaft position° shaft position upper rotation 270°		

			
1			
<b>GEV No.</b>	390068	<b>Ref. No.</b>	1230017
<b>description</b>	thermostat t.max. 269°C temperature range 55-269°C 1-pole 1CO 16A probe ø 3.1mm probe L 219mm capillary pipe 1280mm capillary pipe isolated 1270mm gland nut shaft ø 6x4.6mm shaft L 23mm shaft position upper° rotation 318°		



<b>GEV No.</b>	375002	<b>Ref. No.</b>	1270013
<b>description</b>	thermostat t.max. 320°C temperature range 55-320°C 1-pole 1NO 16A probe ø 3.1mm probe L 226mm capillary pipe 870mm capillary pipe isolated 850mm gland nut shaft L 23mm shaft position upper rotation 270°		

55.13\_series



<b>GEV No.</b>	375505	<b>Ref. No.</b>	32403007
<b>description</b>	thermostat t.max. 320°C temperature range 50-320°C 1-pole 1NO 16A probe ø 3mm probe L 160mm capillary pipe 870mm capillary pipe isolatedmm gland nut shaft ø 6x4.6mm shaft L 23mm shaft position upper rotation 270°		

55.34\_series

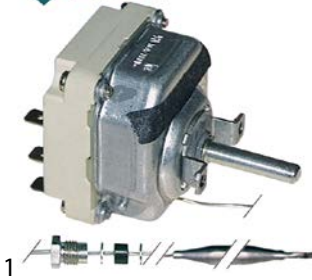

<b>GEV No.</b>	375021	<b>Ref. No.</b>	22405003
<b>description</b>	thermostat t.max. 110°C temperature range 32-110°C 3-pole 3CO 16A probe ø 6mm probe L 138mm capillary pipe 2980mm capillary pipe isolated 2200mm gland nut M9x1 shaft ø 6x4.6mm shaft L 23mm shaft position upper rotation 270°		

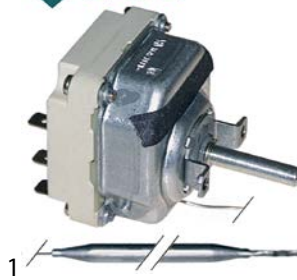

<b>GEV No.</b>	375038	<b>Ref. No.</b>	32104009
<b>description</b>	thermostat t.max. 300°C temperature range 50-300°C 3-pole 3NO 16A probe ø 6mm probe L 79mm capillary pipe 1740mm capillary pipe isolated 800mm gland nut shaft ø 6x4.6mm shaft L 23mm shaft position upper rotation 270°		

<b>accessories for</b>	375038			
	<b>GEV No.</b>	110123	<b>Ref. No.</b>	—
	knob thermostat t.max. 300°C ø 50mm shaft ø 6x4.6mm shaft flat upper black temperature range 50-300°C rotation 270°			

56.\_series



<b>GEV No.</b>	376076	<b>Ref. No.</b>	57103017
<b>description</b>	thermostat t.max. 200°C temperature range 60-200°C 16A probe ø 6mm probe L 78mm capillary pipe 870mm		

safety thermostats

55.10/19\_series

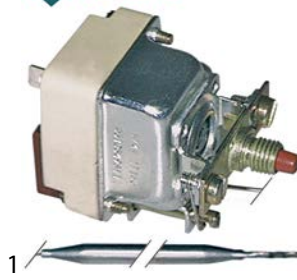

<b>GEV No.</b>	375250	<b>Ref. No.</b>	1440003
<b>description</b>	safety thermostat capillary pipe 870mm probe ø 6mm 1-pole probe L 129mm 16A capillary pipe isolatedmm gland nut switch-off temp. 130°C probe SS		

<b>spare parts for</b>	375250			
	<b>GEV No.</b>	551083	<b>Ref. No.</b>	—
	cap for safety thermostat thread M8x1			





**E·G·O**



1

<b>GEV No.</b>	390730	<b>Ref. No.</b>	09500064
<b>description</b>	safety thermostat switch-off temp. 230°C 1-pole 0.5A probe ø 4mm probe L 125mm capillary pipe 1550mm capillary pipe isolated 1410mm gland nut probe		

55.13\_ series

**E·G·O**



1

<b>GEV No.</b>	390804	<b>Ref. No.</b>	010677 20400023 73313025
<b>description</b>	safety thermostat switch-off temp. 340°C 1-pole 1NC 16A probe ø 3mm probe L 160mm capillary pipe 870mm capillary pipe isolated 600mm gland nut probe connection male faston 6.3mm		

55.31\_ series

**E·G·O**



1

<b>GEV No.</b>	390091	<b>Ref. No.</b>	8700021
<b>description</b>	safety thermostat switch-off temp. 230°C 3-pole 20A probe ø 6mm probe L 239mm capillary pipe 830mm capillary pipe isolated 960mm gland nut probe SS 380V		

55.32\_ series

**E·G·O**



1

<b>GEV No.</b>	375649	<b>Ref. No.</b>	1250025
<b>description</b>	safety thermostat switch-off temp. 160°C 3-pole 20A probe ø 6mm probe L 87mm capillary pipe 890mm capillary pipe isolated 880mm gland nut probe SS		

56\_ series

**E·G·O**



1

<b>GEV No.</b>	390714	<b>Ref. No.</b>	8500016
<b>description</b>	safety thermostat switch-off temp. 230°C 1-pole 1NC 16A probe ø 6mm probe L 75mm capillary pipe 740mm capillary pipe isolated 200mm gland nut probe SS		

IMIT / TEMPOMATIC / ARTHERMO

control thermostats

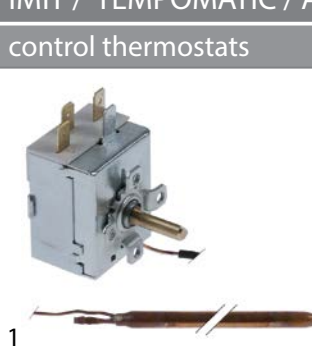

1

<b>GEV No.</b>	390683	<b>Ref. No.</b>	25304008
<b>description</b>	thermostat t.max. 86°C temperature range 0-86°C 1-pole 1CO 16A probe ø 6.5mm probe L 98mm capillary pipe 1000mm capillary pipe isolated 960mm gland nut shaft ø 6x4.6mm shaft L 20mm shaft position +135° rotation 270° probe material copper		
<b>accessories for</b>	390683		
		<b>GEV No.</b>	110100
		<b>Ref. No.</b>	—
	knob thermostat t.max. 90°C 0-90°C ø 42mm shaft ø 6x4.6mm shaft flat -135° black		

<b>GEV No.</b>	375847	<b>Ref. No.</b>	25304008
<b>description</b>	thermostat t.max. 90°C temperature range 0-90°C 1-pole 1CO 15A probe ø 6.5mm probe L 100mm capillary pipe 1500mm capillary pipe isolatedmm gland nut shaft ø 6x4.6mm shaft L 18mm shaft position +135° rotation 270° 250V		

### safety thermostats



<b>GEV No.</b>	375941	<b>Ref. No.</b>	57103016
<b>description</b>	safety thermostat switch-off temp. 238°C 1-pole 1NC 16A probe ø 5mm probe L 100mm capillary pipe 1050mm capillary pipe isolatedmm gland nut 250V		

### CAEM

#### control thermostats

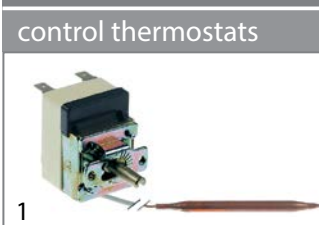

<b>GEV No.</b>	375645	<b>Ref. No.</b>	43000006
<b>description</b>	thermostat t.max. 120°C temperature range 30-120°C 1-pole 1CO 16A probe ø 6mm probe L 110mm capillary pipe 1600mm capillary pipe isolated 1550mm gland nut shaft ø 6x4.6mm shaft L 22mm shaft position upper rotation 270° probe material copper 250V		

### accessories

#### miscellaneous



<b>GEV No.</b>	550268	<b>Ref. No.</b>	8700008
<b>description</b>	cover cap for push-button		

## switches and momentary switches

### microswitches

#### pin-plunger actuated

M10



<b>GEV No.</b>	347216	<b>Ref. No.</b>	1230024
<b>description</b>	microswitch with plunger thread M10x0.75 thread L 14mm 250V 10A 1CO connection male faston 6.3mm stroke 7.5mm mounting distance 22mm L 28mm ambient temperature max. 125°C type NR6K5 actuating force: 260g		

### system switches (ROLD)



<b>GEV No.</b>	345537	<b>Ref. No.</b>	44700004
<b>description</b>	element holder mounting measurements 20.6x16.4mm grey arched for push buttons 13x17mm		



<b>GEV No.</b>	345131	<b>Ref. No.</b>	1510009
<b>description</b>	element holder mounting measurements 28.5x28.5mm grey single element holder		





<b>GEV No.</b>	345606	<b>Ref. No.</b>	43000005
<b>description</b>	momentary switch unit 2CO 250V 16A connection male faston 6.3mm		



<b>GEV No.</b>	346211	<b>Ref. No.</b>	1510008
<b>description</b>	push button ø 23mm grey with lens		



			
1			
<b>GEV No.</b>	345539	<b>Ref. No.</b>	44700003
<b>description</b>	push button size 17x13mm grey		

			
1			
<b>GEV No.</b>	345605	<b>Ref. No.</b>	1250039
<b>description</b>	switch 2CO 250V 16A connection male faston 6.3mm		

cam switches

4 operating positions

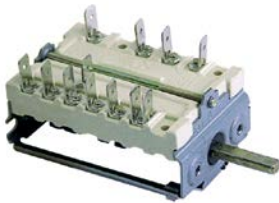
			
1			
<b>GEV No.</b>	300010	<b>Ref. No.</b>	1230016
<b>description</b>	cam switch 4 operating positions 2NO/2CO sequence 0-1-2-3 16A shaft ø 6x4.6mm shaft L 23mm connection male faston 6.3mm ceramic		

operation switches

			
1			
<b>GEV No.</b>	300153	<b>Ref. No.</b>	1270012
<b>description</b>	cam switch 3 operating positions operation switch 16A sequence 0-1-2 shaft ø 6x4.6mm shaft L 23mm connection male faston 6.3mm plastic ambient temperature max. 240°C		

rotary switches

TECNOMATIC



			
1			
<b>GEV No.</b>	345016	<b>Ref. No.</b>	8700027
<b>description</b>	rotary switch 2 0-1 sets of contacts 1 type HD1201R000 600V 12A shaft ø 5x5mm shaft L 23mm shaft square connection screw		

TELERGON

			
1			
<b>GEV No.</b>	347693	<b>Ref. No.</b>	015963 27800010
<b>description</b>	rotary switch 2 0-1 sets of contacts 1 type T-0002000011E1N1 300V 20A shaft ø 5x5mm shaft L 15mm shaft square with knob connection screw clamp		

magnetic switches

37x16mm

			
1			
<b>GEV No.</b>	345600	<b>Ref. No.</b>	92000018
<b>description</b>	magnetic switch L 37mm W 16mm 1NO 250V 0.2A P max. 50W connection cable cable length 960mm		
<b>accessories for</b>	345600		
	<b>GEV No.</b>	519049	<b>Ref. No.</b>
			—

accessories

magnets

			
1			
<b>GEV No.</b>	691178	<b>Ref. No.</b>	92000021
<b>description</b>	magnet ø 22mm Lmm H 7mm Wmm ED ø 22mm M5		

encoders and potentiometers

			
1			
<b>GEV No.</b>	402322	<b>Ref. No.</b>	90200019
<b>description</b>	encoder		



			
1			
<b>GEV No.</b>	300272	<b>Ref. No.</b>	90100015
<b>description</b>	encoder shaft $\varnothing$ 6x4.6mm for combi-steamer		

			
1			
<b>GEV No.</b>	401592	<b>Ref. No.</b>	020042 44100002
<b>description</b>	potentiometer 10KOhm		

## lamps

### indicator lights

#### indicator lights (complete)

$\varnothing$ 10mm

with screw socket

			
1			
<b>GEV No.</b>	359528	<b>Ref. No.</b>	57103020
<b>description</b>	indicator light $\varnothing$ 10mm 400V red connection male faston 6.3mm socket male faston 6.3mm		

with plug-in socket

			
1			
<b>GEV No.</b>	359139	<b>Ref. No.</b>	1250050
<b>description</b>	indicator light $\varnothing$ 10mm green 230V connection male faston 6.3mm Qty 1 pcs		

			
1			
<b>GEV No.</b>	359138	<b>Ref. No.</b>	1260025
<b>description</b>	indicator light $\varnothing$ 10mm red 230V connection male faston 6.3mm Qty 1 pcs		

			
1			
<b>GEV No.</b>	359140	<b>Ref. No.</b>	1230023
<b>description</b>	indicator light $\varnothing$ 10mm yellow 230V connection male faston 6.3mm Qty 1 pcs		

$\varnothing$ 13mm

with screw socket

			
1			
<b>GEV No.</b>	357125	<b>Ref. No.</b>	32100012
<b>description</b>	indicator light $\varnothing$ 13mm red 400V connection screw clamp		

33x10mm

			
1			
<b>GEV No.</b>	359452	<b>Ref. No.</b>	8500007
<b>description</b>	indicator light mounting measurements 33.1x10.3mm 400V green connection male faston 6.3mm		

			
1			
<b>GEV No.</b>	359451	<b>Ref. No.</b>	8500005
<b>description</b>	indicator light mounting measurements 33.1x10.3mm 400V yellow connection male faston 6.3mm		

#### miscellaneous

			
1			
<b>GEV No.</b>	357124	<b>Ref. No.</b>	012865 25303013
<b>description</b>	indicator light green/red 230V connection screw		

			
1			
<b>GEV No.</b>	357123	<b>Ref. No.</b>	16300009
<b>description</b>	indicator light red 230V connection cable $\varnothing$ 8mm		

### screw-on/push-on fit

#### light bulbs

for ovens



			
1			
<b>GEV No.</b>	359610	<b>Ref. No.</b>	1230009
<b>description</b>	light bulb t.max. 300°C socket E14 15W 230V $\varnothing$ 22mm L 47mm lens L 20mm for oven lamp type Philips		





			
1			
<b>GEV No.</b>	357153	<b>Ref. No.</b>	1250021
<b>description</b>	light bulb t.max. 300°C socket E14 25W 230V ø 25mm L 55mm lens L 30mm for oven type		

<b>halogen lamp</b>			
for socket G4 / G6.35 / G9			
			
1 <b>500°C</b>			
<b>GEV No.</b>	359599	<b>Ref. No.</b>	42200007
<b>description</b>	halogen lamp socket G4 12V 20W temp.-resist. 500°C		

<b>oven lamps</b>			
<b>universal oven lamps</b>			
mounting diameter 35.5mm			
			
1			
<b>GEV No.</b>	359701	<b>Ref. No.</b>	1230010
<b>description</b>	lamp socket socket E14 220-230V mounting ø 35.5mm connection male faston 6.3mm 15W		
<b>accessories for</b>	359701		
	<b>GEV No.</b>	359705	<b>Ref. No.</b> —
oven lamp glass thr.ø 33.5mm ø 52mm hard glas temp.-resist. 350°C			
	<b>GEV No.</b>	359709	<b>Ref. No.</b> —
oven lamp glass thr.ø 33.5mm ø 42mm hard glas temp.-resist. 350°C			
	<b>GEV No.</b>	359721	<b>Ref. No.</b> 1230008
gasket silicone ED ø 48mm ID ø 39.5mm thickness 5mm Qty 1 pcs			
	<b>GEV No.</b>	359942	<b>Ref. No.</b> —
oven lamp glass thr.ø 33.5mm ø 41mm hard glas temp.-resist. 350°C			

			
1			
<b>GEV No.</b>	359661	<b>Ref. No.</b>	1230007
<b>description</b>	oven lamp glass thread 32.1 ø 58mm hard glas temp.-resist. 350°C		
<b>accessories for</b>	359661		
	<b>GEV No.</b>	359700	<b>Ref. No.</b> —
gasket for pizza oven fibre glass ID ø 32.5mm ED ø 55mm thickness 5mm			

			
1			
<b>GEV No.</b>	359721	<b>Ref. No.</b>	1230008
<b>description</b>	gasket silicone ED ø 48mm ID ø 39.5mm thickness 5mm Qty 1 pcs		

<b>55x70mm</b>			
			
1			
<b>GEV No.</b>	359297	<b>Ref. No.</b>	44100006
<b>description</b>	frame L 95mm W 81mm mounting distance 68/83mm thickness 6mm		
<b>accessories for</b>	359297		
	<b>GEV No.</b>	359299	<b>Ref. No.</b> 44100005
gasket L 91mm W 77mm hole ø 3mm for oven lamp			

			
1			
<b>GEV No.</b>	359299	<b>Ref. No.</b>	44100005
<b>description</b>	gasket L 91mm W 77mm hole ø 3mm for oven lamp		

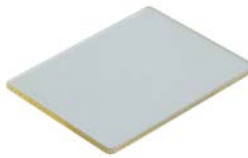
			
1			
<b>GEV No.</b>	359296	<b>Ref. No.</b>	44100004
<b>description</b>	lamp glass L 74mm W 58mm thickness 3mm		











<b>55x100mm</b>			
			
1			
<b>GEV No.</b>	359698	<b>Ref. No.</b>	1250065
<b>description</b>	lamp socket L 100mm W 55mm socket E14 connection male faston 6.3mm		
<b>spare parts for</b>	359698		
	<b>GEV No.</b>	358119	<b>Ref. No.</b> —
frame L 118mm W 72mm mounting distance 143mm for bulb socket			
	<b>GEV No.</b>	358122	<b>Ref. No.</b> —
gasket L 112mm W 68mm silicone thickness 3mm for bulb socket			
	<b>GEV No.</b>	358123	<b>Ref. No.</b> —
lamp glass L 112mm W 68mm			

Table continues overleaf













<b>spare parts for</b> 359698				
	GEV No.	359612	Ref. No.	—
light bulb t.max. 300°C socket E14 25W 230V ø 25mm L 56mm lens L 30mm for oven lamp type Philips				
	GEV No.	359714	Ref. No.	1250020
gasket for bulb socket				
	GEV No.	359715	Ref. No.	1250019
lamp glass L 110mm W 65mm thickness 5mm				
	GEV No.	359716	Ref. No.	1250018
frame for bulb socket				
<b>accessories for</b> 359698				
	GEV No.	359612	Ref. No.	—
light bulb t.max. 300°C socket E14 25W 230V ø 25mm L 56mm lens L 30mm for oven lamp type Philips				
	GEV No.	359938	Ref. No.	—
borosilicate glass L 115mm W 69mm				

				
1				
<b>GEV No.</b>	359716	<b>Ref. No.</b>	1250018	
<b>description</b>	frame for bulb socket			

				
1				
<b>GEV No.</b>	359714	<b>Ref. No.</b>	1250020	
<b>description</b>	gasket for bulb socket			

				
1				
<b>GEV No.</b>	359715	<b>Ref. No.</b>	1250019	
<b>description</b>	lamp glass L 110mm W 65mm thickness 5mm			

				
1				
<b>GEV No.</b>	359698	<b>Ref. No.</b>	1250065	
<b>description</b>	lamp socket L 100mm W 55mm socket E14 connection male faston 6.3mm			
<b>spare parts for</b> 359698				
	GEV No.	358119	Ref. No.	—
frame L 118mm W 72mm mounting distance 143mm for bulb socket				

<b>spare parts for</b> 359698				
	GEV No.	358122	Ref. No.	—
gasket L 112mm W 68mm silicone thickness 3mm for bulb socket				
	GEV No.	358123	Ref. No.	—
lamp glass L 112mm W 68mm				
	GEV No.	359612	Ref. No.	—
light bulb t.max. 300°C socket E14 25W 230V ø 25mm L 56mm lens L 30mm for oven lamp type Philips				
	GEV No.	359714	Ref. No.	1250020
gasket for bulb socket				
	GEV No.	359715	Ref. No.	1250019
lamp glass L 110mm W 65mm thickness 5mm				
	GEV No.	359716	Ref. No.	1250018
frame for bulb socket				
<b>accessories for</b> 359698				
	GEV No.	359612	Ref. No.	—
light bulb t.max. 300°C socket E14 25W 230V ø 25mm L 56mm lens L 30mm for oven lamp type Philips				
	GEV No.	359938	Ref. No.	—
borosilicate glass L 115mm W 69mm				

**lamps**



**light bulbs**

				
1				
<b>GEV No.</b>	359610	<b>Ref. No.</b>	1230009	
<b>description</b>	light bulb t.max. 300°C socket E14 15W 230V ø 22mm L 47mm lens L 20mm for oven lamp type Philips			

				
1				
<b>GEV No.</b>	357153	<b>Ref. No.</b>	1250021	
<b>description</b>	light bulb t.max. 300°C socket E14 25W 230V ø 25mm L 55mm lens L 30mm for oven type			

**halogen lamps**

**for socket G4 / G6.35 / G9**

				
1 				
<b>GEV No.</b>	359599	<b>Ref. No.</b>	42200007	
<b>description</b>	halogen lamp socket G4 12V 20W temp.-resist. 500°C			



sockets

G4 / G5,3 / G6,35



1

<b>GEV No.</b>	359646	<b>Ref. No.</b>	42200008
<b>description</b>	lamp socket socket G4/G5.3/G6.35 24V ø 17mm H 15mm connection cable 130mm mounting distance 26mm for halogen lamp holder length 31mm cable length 130mm		

timers

programme timers



1

<b>GEV No.</b>	360645	<b>Ref. No.</b>	92000036
<b>description</b>	timer CDC 11901F engines 1 chambers 1 operation time 20S 230V 50/60Hz shaft ø 6x4mm shaft L 25mm manuf. no. 11901F1CEE000.0000		

mechanical timers



1

<b>GEV No.</b>	350008	<b>Ref. No.</b>	1250037
<b>description</b>	timer M2 with bell 2-pole operation time 120min impulse mechanical 2NO at 250V 16A permanent position yes shaft ø 6x4.6mm shaft 6x4.6mm shaft L 24mm mounting distance 28mm connection lateral		

alarm devices

buzzers



1

<b>GEV No.</b>	350050	<b>Ref. No.</b>	1230015
<b>description</b>	buzzer 230VAC connection male faston 6.3mm screw mounting thread M4 60dB		

contactors

LOVATO

power contactors



1

<b>GEV No.</b>	380704	<b>Ref. No.</b>	92000046
<b>description</b>	power contactor resistive load 20A 230VAC (AC3/400V) 9A/4kW main contacts 3NO auxiliary contacts 1NC connection screw connection type 11BG0901A230		



1

<b>GEV No.</b>	380083	<b>Ref. No.</b>	16300011 92000044
<b>description</b>	power contactor resistive load 25A 230VAC (AC3/400V) 9A/4.2kW main contacts 3NO auxiliary contacts 1NC connection screw connection type BF0901A230		



1

<b>GEV No.</b>	380717	<b>Ref. No.</b>	16500007
<b>description</b>	power contactor resistive load 32A 230VAC (AC3/400V) 18A/7.5kW main contacts 3NO auxiliary contacts 1NC connection screw connection type BF1801A230		

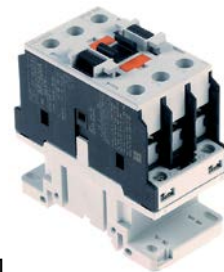

1

<b>GEV No.</b>	380722	<b>Ref. No.</b>	92200003
<b>description</b>	power contactor resistive load 56A 230VAC (AC3/400V) 32A/16kW main contacts 3NO auxiliary contacts connection screw connection type BF3200A230		



SIEMENS

power contactors



1	<b>GEV No.</b>	380645	<b>Ref. No.</b>	1260010
<b>description</b> power contactor 230VAC with auxiliary contacts				



1	<b>GEV No.</b>	380389	<b>Ref. No.</b>	1430006
<b>description</b> power contactor resistive load 22A 230VAC (AC3/400V) 9A/4kW main contacts 3NO auxiliary contacts 1NO connection screw connection type 3RT10-16-1AP01				

overload switches



1	<b>GEV No.</b>	381002	<b>Ref. No.</b>	1420005
<b>description</b> overload switch setting range 1.8-2.5A				

TELEMECANIQUE (Schneider Electric)

power contactors



1	<b>GEV No.</b>	380820	<b>Ref. No.</b>	1130014
<b>description</b> power contactor resistive load 25A 230VAC (AC3/400V) 9A/4kW main contacts 3NO auxiliary contacts 1NO/1NC connection screw connection type LC1D0900M7				

relays

power relays

with male contacts

female contact 2.0mm

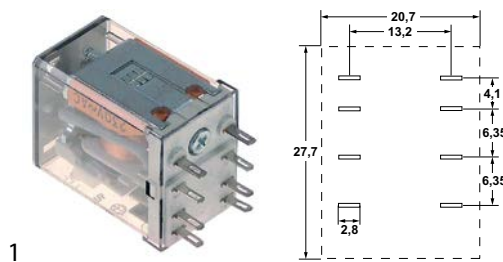

1	<b>GEV No.</b>	380129	<b>Ref. No.</b>	41200002
---	----------------	--------	-----------------	----------

**description** power relays 24VAC 12A 2CO connection F2 plug-in connection 94.92.3 250V connection 2mm

**accessories for** 380129

	<b>GEV No.</b>	380341	<b>Ref. No.</b>	—
relay socket 4-pole contacts 12 300V voltage AC 6A Italiana Relè manuf. no. ZMD4				

	<b>GEV No.</b>	380378	<b>Ref. No.</b>	—
relay socket 2-pole 55/85 dimensions 70.5x30x27mm 250V voltage AC 10A FINDER manuf. no. 94.72				

	<b>GEV No.</b>	380384	<b>Ref. No.</b>	—
relay socket 2-pole contacts male faston 2.8mm 250V voltage AC 10A W 23mm for				

	<b>GEV No.</b>	380399	<b>Ref. No.</b>	—
relay socket 4-pole dimensions 76.2x27x86.1mm 250V voltage AC 1A FINDER manuf. no. 94.94.3				





level relays

GICAR



1



<b>GEV No.</b>	401224	<b>Ref. No.</b>	43700002
<b>description</b>	level relay 230V connection F6.3 type RL30/3ES/F/G		

time relays

time relays



1

<b>GEV No.</b>	380329	<b>Ref. No.</b>	43000002
<b>description</b>	time relay FIBER 85.02.8.240 time range 0.05s - 100h 230-240VAC 10A mounting measurements 20.6x27.7mm 2CO connection 2.0		
<b>accessories for</b>	380329		
	<b>GEV No.</b>	380378	<b>Ref. No.</b> —
	relay socket 2-pole 55/85 dimensions 70.5x30x27mm 250V voltage AC 10A FINDER manuf. no. 94.72		
	<b>GEV No.</b>	380803	<b>Ref. No.</b> —
	relay socket 2-pole dimensions 76.2x27x86.1mm 250V voltage AC 10A FINDER manuf. no. 94.92.3		



1

<b>GEV No.</b>	380639	<b>Ref. No.</b>	41100005
<b>description</b>	time relay TECNOLOGIC RTR12DS06S time range 6s 230VAC 5A mounting measurements 34x34mm 1CO connection plug-in connection round 8-pole		
<b>accessories for</b>	380639		
	<b>GEV No.</b>	380638	<b>Ref. No.</b> —
	relay socket 8-pole dimensions 51x41x23mm 250V 10A FINDER manuf. no. 90.26		



1

<b>GEV No.</b>	380640	<b>Ref. No.</b>	41100006
<b>description</b>	time relay TECNOLOGIC RTR12DS60S time range 60s 230VAC 5A 1CO connection plug-in connection round 8-pole		
<b>accessories for</b>	380640		
	<b>GEV No.</b>	380638	<b>Ref. No.</b> —
	relay socket 8-pole dimensions 51x41x23mm 250V 10A FINDER manuf. no. 90.26		

transformers

open transformers

with clamp terminal



1

<b>GEV No.</b>	403905	<b>Ref. No.</b>	92000016
<b>description</b>	transformer primary 230V/50-60Hz secondary 12V 50VA connection screw connection type T1ULF		

with plug connection



1

<b>GEV No.</b>	400956	<b>Ref. No.</b>	92000045
<b>description</b>	transformer primary 230VAC secondary 12VAC 20VA connection male faston 6.3mm 50/60Hz type T602012/E temperature restriction 150°C ambient temperature max. 80°C		



# electronic controllers

## EVCO - EVERY CONTROL

### universal controllers

#### built-in version



<b>1</b>	<b>GEV No.</b>	378131	<b>Ref. No.</b>	1230020
<b>description</b>	electronic controller EVERY CONTROL EVK411M mounting measurements 71x29mm 12V voltage AC/DC NTC/PTC/Pt100/Pt1000 relay outputs 1 CO-16A(8) NTC/PTC/Pt100/Pt1000/TC(J,K)/mV/mA yes protection IP65 dependent on probe°C display 3½ digits			
<b>accessories for</b>	378131			
	<b>GEV No.</b>	379050	<b>Ref. No.</b>	—
<b>description</b>	temperature probe Pt100 cable Vetrotex probe -200 up to +600°C cable -50 up to +350°C probe ø6x100mm cable length 2.7m without screw connection 3-wire			
	<b>GEV No.</b>	379160	<b>Ref. No.</b>	—
<b>description</b>	temperature probe NTC 10kOhm cable thermoplastic probe -40 up to +110°C cable -40 up to +110°C probe ø6x14mm cable length 1.5m without screw connection 2-wire			
	<b>GEV No.</b>	379781	<b>Ref. No.</b>	—
<b>description</b>	temperature probe PTC 1kOhm cable thermoplastic probe -50 up to +150°C cable -40 up to +110°C probe ø6x14mm cable length 1.5m without screw connection 2-wire			
	<b>GEV No.</b>	379944	<b>Ref. No.</b>	—
<b>description</b>	temperature probe Pt1000 cable Vetrotex probe -70 up to +500°C cable -50 up to +350°C connection 2-wire thread probe ø6x180mm cable length 1.7m			

<b>1</b>	<b>GEV No.</b>	379331	<b>Ref. No.</b>	9200004
<b>description</b>	temperature probe Pt1000 cable PTFE probe -70 up to +500°C cable -40 up to +250°C connection 2-wire thread M10x1 probe ø3x60mm cable length 0.7m			

### core probes

<b>1</b>	<b>GEV No.</b>	379945	<b>Ref. No.</b>	4270004
<b>description</b>	core temperature probe Pt100 cable PTFE probe -40 up to +250°C cable -40 up to +250°C connection plug probe ø3.5x100mm thread cable length 0.5m handle ø 10mm handle length 80mm			

<b>1</b>	<b>GEV No.</b>	379946	<b>Ref. No.</b>	011915 4270001
<b>description</b>	core temperature probe Pt100 cable PTFE probe -40 up to +250°C cable -40 up to +250°C connection plug probe ø3.5x100mm thread cable length 0.7m handle ø 10mm handle length 80mm			

<b>1</b>	<b>GEV No.</b>	379350 <sup>1</sup>	<b>Ref. No.</b>	44300003
<b>description</b>	core temperature probe PTC 1kOhm cable silicone probe -40 up to +120°C cable -50 up to +180°C connection plug probe ø4x100mm thread cable length 1.7m handle ø 8mm handle length 120/35mm L1 120mm L2 130mm			

<sup>1</sup>multipoint probe

# probes

## universal probes

### temperature probes

<b>1</b>	<b>GEV No.</b>	379052	<b>Ref. No.</b>	44300002
<b>description</b>	temperature probe PTC 1kOhm cable silicone probe -50 up to +150°C cable -50 up to +180°C probe ø6x40mm cable length 1.5m without screw connection 2-wire			

## producer-specific probes

### probes

<b>1</b>	<b>GEV No.</b>	402154	<b>Ref. No.</b>	1460011
<b>description</b>	temperature probe Pt100 cable silicone probe -100 up to 450°C cable -50 up to +180°C connection 3-wire thread 1/8" probe ø6x35mm cable length 1.5m			



1

<b>GEV No.</b>	379662 <sup>1</sup>	<b>Ref. No.</b>	44200002
<b>description</b>	core temperature probe PTC 1kOhm cable silicone probe -40 up to +120°C cable -50 up to +180°C connection plug probe ø4x70mm thread cable length 1.3m handle ø 16mm handle length 120mm L1 120mm L2 130mm		

<sup>1</sup>multipoint probe



1

<b>GEV No.</b>	401566	<b>Ref. No.</b>	42200006	
<b>description</b>	power PCB without EPROM type CQB 324(02)			
<b>accessories for</b>	401566			
	<b>GEV No.</b>	403062	<b>Ref. No.</b>	—
	EPROM type FOCABO P5			
	<b>GEV No.</b>	403201	<b>Ref. No.</b>	—
	EPROM type FOCABO 59			

## electronics

### PCBs



1

<b>GEV No.</b>	401245	<b>Ref. No.</b>	1270005
<b>description</b>	keypad PCB		



1

<b>GEV No.</b>	403473	<b>Ref. No.</b>	005883 49200017
<b>description</b>	PCB combi-steamer LCM06/M100 L 95mm W 79mm H 43mm Fan Reversal Card		



1

<b>GEV No.</b>	404028	<b>Ref. No.</b>	92100004
<b>description</b>	PCB for combi-steamer ANGELO PO L 140mm W 100mm		

## solenoïd valves

### solenoïd valves (water)

#### ELBI

#### straight



1

<b>GEV No.</b>	373017	<b>Ref. No.</b>	1230013	
<b>description</b>	solenoid valve single straight 230VAC inlet 3/4" outlet 11.5mm DN10 ELBI			
<b>spare parts for</b>	373017			
	<b>GEV No.</b>	370467	<b>Ref. No.</b>	—
	solenoid valve filter suitable for ELBI			

#### RPE

#### reducers

#### outlet side



1

<b>GEV No.</b>	371269	<b>Ref. No.</b>	009006 1250022
<b>description</b>	reducer flow rate 0.07-0.14l/min brown		



1

<b>GEV No.</b>	371266	<b>Ref. No.</b>	008887 1250009
<b>description</b>	reducer flow rate 0.2l/min red		



solenoid valves with reducers

4-fold



<b>GEV No.</b>	374026	<b>Ref. No.</b>	1450003
<b>description</b>	solenoid valve 4-fold straight 230VAC inlet 3/4" outlet 11.5mm duty cycle 100% RPE plastic pressure range 0.2-10bar		
<b>spare parts for</b>	374026		
	<b>GEV No.</b>	371015	<b>Ref. No.</b> —
	solenoid coil RPE 230VAC 8.4VA 50/60Hz seat ø 9mm connection male faston 6.3mm		

TP

solenoid valves with reducers



<b>GEV No.</b>	370648	<b>Ref. No.</b>	92000030 92000031
<b>description</b>	solenoid valve double straight 220-240VAC inlet 3/4" input 10l/min DN10 TP outlet 11.5mm output A 3.4l/min flow regulating valve outlet A green		



<b>GEV No.</b>	370628	<b>Ref. No.</b>	1240007
<b>description</b>	solenoid valve double straight 230VAC inlet 3/4" input 16l/min DN10 TP plastic outlet 11.5mm		

ball valves electric



<b>GEV No.</b>	401233	<b>Ref. No.</b>	43000004
<b>description</b>	ball valve inlet 1/2" IT outlet 1/2" IT 230V 50/60Hz mode of operation electric W 60mm H 99mm cable 4-pole 2.5W 4-pole duty cycle 50%		

pressure switches

for combi-steamers



<b>GEV No.</b>	541806	<b>Ref. No.</b>	92000033
<b>description</b>	pressure control ø 38mm pressure range 0.2-3.0bar connection 1/8" 250V 10A GP600 pressure connection 1/8"		
<b>accessories for</b>	541806		
	<b>GEV No.</b>	541814	<b>Ref. No.</b> —
	protection cap for pressure switch EPDM XP600		

electrodes



<b>GEV No.</b>	401161	<b>Ref. No.</b>	43000007
<b>description</b>	level electrode 1/4" total length 210mm probe L 184mm insulated probe length 26mm connection male faston 6.3mm stainless steel ø 2.5mm		



<b>GEV No.</b>	401225	<b>Ref. No.</b>	1250012
<b>description</b>	level electrode M12 ET - 1/8" ET total length 124/127/139mm probe L 91/95/104mm insulated probe length 42mm set 3-piece connection male faston 6.3mm ø 2.5mm		



<b>GEV No.</b>	401226	<b>Ref. No.</b>	1260005
<b>description</b>	level electrode M12x1 total length 150/160/171mm probe L 117/127/138mm insulated probe length 20mm set 3-piece connection male faston 6.3mm ø 2.5mm		



fans

axial fans

import



1			
<b>GEV No.</b>	601080 <sup>1</sup>	<b>Ref. No.</b>	42300006
<b>description</b>	axial fan L 119mm W 119mm H 38mm 230VAC 50/60Hz 23/20W bearing ball bearing connection male faston 2.8mm metal ADDA fan wheel ø 110mm temp.-resist. 70°C		
<b>accessories for</b>	601080		
	<b>GEV No.</b>	550898	<b>Ref. No.</b> —
	connecting cable cable length 2000mm connection F 2.8 connection distance 7.9mm for axial flow fan		
	<b>GEV No.</b>	692519	<b>Ref. No.</b> —
	guard L 120mm W 120mm plastic		

<sup>1</sup>with ball bearings



1			
<b>GEV No.</b>	601130 <sup>1</sup>	<b>Ref. No.</b>	41100009
<b>description</b>	axial fan L 80mm W 80mm H 25mm 230VAC 50/60Hz 13/14W bearing ball bearing connection male faston 2.8mm metal ADDA fan wheel ø 75mm temp.-resist. 70°C airflow 30.6m <sup>3</sup> /h		
<b>accessories for</b>	601130		
	<b>GEV No.</b>	550898	<b>Ref. No.</b> —
	connecting cable cable length 2000mm connection F 2.8 connection distance 7.9mm for axial flow fan		

<sup>1</sup>with ball bearings

hot air motors



1			
<b>GEV No.</b>	550757	<b>Ref. No.</b>	002080 43000044
<b>description</b>	counterflange for fan motor ED ø 48mm int. ø 1 24mm int. ø 2 15mm thickness 5mm brass		



1			
<b>GEV No.</b>	550859	<b>Ref. No.</b>	002115 43000047
<b>description</b>	counterflange for fan motor ED ø 60mm int. ø 1 34mm int. ø 2 25mm thickness 6mm brass		

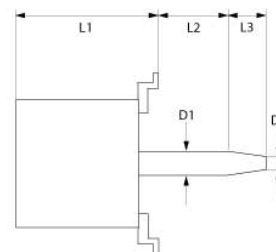

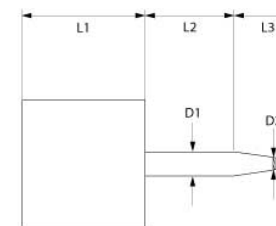

1			
<b>GEV No.</b>	601046	<b>Ref. No.</b>	1240004
<b>description</b>	fan motor 220/380V 3 phase 50/60Hz 0.75kW 1350/1650rpm speeds 1 L1 185mm L2 42mm L3 47mm D1 ø 24mm D2 ø 20mm M12L IT 1.9/3.3A Cos(φ) 0.83 at 50Hz 200-240/346-415V at 60Hz 200-277/346-480V at 50Hz 1350rpm at 60Hz 1650rpm type ST80/4 no. 661512		

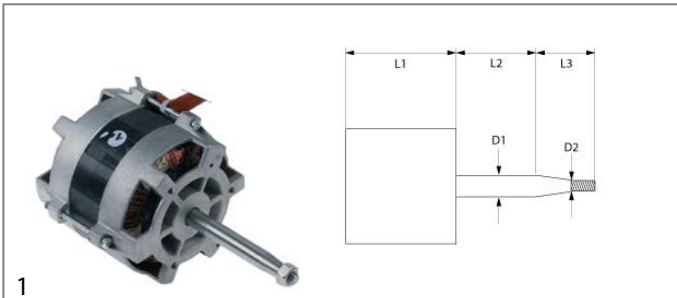

1			
<b>GEV No.</b>	601043	<b>Ref. No.</b>	008939 1250015
<b>description</b>	fan motor 220-240V 1 phase 50Hz 0.37/0.07kW 0.1/0.5HP 1400/2700rpm speeds 2 L1 123mm L2 107mm L3 15mm D1 ø 15mm D2 ø 12mm M10L ET 2/0.7A suitable capacitor 20µF/250V at 50Hz 1400/2700rpm type 1057		
<b>accessories for</b>	601043		
	<b>GEV No.</b>	365019	<b>Ref. No.</b> —
	operating capacitor capacity 20µF 400V tolerance 5% 50/60Hz ambient temperature max. -25 to +85°C ø 39.5mm L 70mm M8 plastic connection male faston 6.3mm 16.10.25. protection		



1

<b>GEV No.</b>	601166	<b>Ref. No.</b>	44700005
<b>description</b>	fan motor 220-240V 1 phase 50Hz 0.37kW 2700rpm speeds 1 L1 123mm L2 77mm L3 30mm D1 ø 15mm D2 ø 12mm M10L ET 2A suitable capacitor 12.5µF/450V at 50Hz 2700rpm type 1057.2157		
<b>spare parts for</b>	601166		
	<b>GEV No.</b>	<b>Ref. No.</b>	—
	365014		
<b>accessories for</b>	601166		
	<b>GEV No.</b>	<b>Ref. No.</b>	—
	601165		
<b>description</b>	fan wheel D1 ø 160mm H1 60mm blades 15 D2 ø 16mm D3 ø 16mm H2 29mm		



1

<b>GEV No.</b>	602175	<b>Ref. No.</b>	92000040
<b>description</b>	fan motor 230/400V 3 phase 50/60Hz 0.7kW 1400/1700rpm L1 150mm L2 80mm L3 32mm D1 ø 18mm D2 ø 15mm M8 suitable capacitor 3µF400V type 3042P4050		

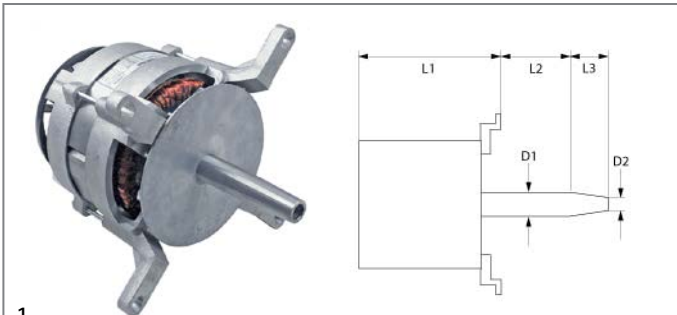

1

<b>GEV No.</b>	499185	<b>Ref. No.</b>	009961 1260008
<b>description</b>	fan motor 380-415V 3 phase 50/60Hz 0.13/0.55kW 700/1350rpm speeds 2 L1 170mm L2 49mm L3 45mm D1 ø 24mm D2 ø 20mm M12x1.75 4P/8P type FB100L		

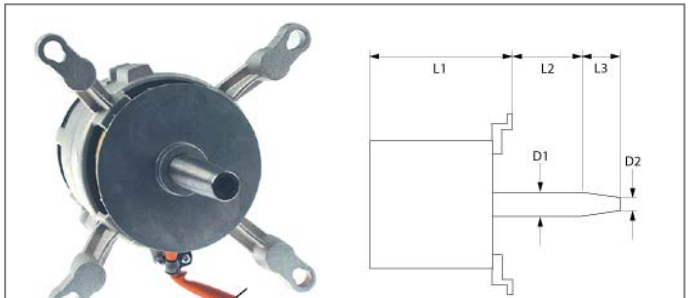

1

<b>GEV No.</b>	500652	<b>Ref. No.</b>	009961 1260008
<b>description</b>	fan motor 380-415V 3 phase 50Hz 0.13/0.55kW 700/1350rpm speeds 2 L1 188mm L2 44mm L3 48mm D1 ø 24mm D2 ø 20mm M12L ITA Cos(φ) 0.13/0.55 at 50Hz 700/1350rpm 4P/8P type FB80 4/8 no. 390133		



1

<b>GEV No.</b>	601067	<b>Ref. No.</b>	41100010
<b>description</b>	fan wheel D1 ø 150mm H1 38mm blades 36 D2 ø 6mm D3 ø 6mm H2 14mm		

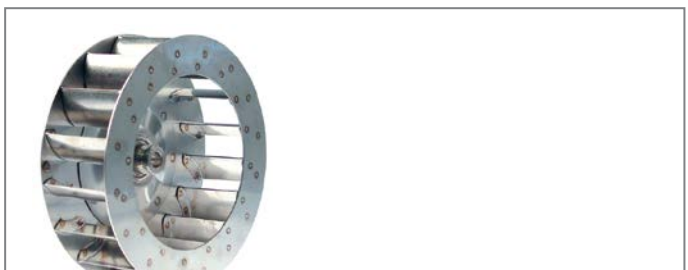

1

<b>GEV No.</b>	601060	<b>Ref. No.</b>	1250014
<b>description</b>	fan wheel D1 ø 180mm H1 60mm blades 16 D2 ø 11mm D3 ø 16mm H2 30mm		



1

<b>GEV No.</b>	601064	<b>Ref. No.</b>	44700002
<b>description</b>	fan wheel D1 ø 220mm H1 78mm blades 20 D2 ø 11.5mm D3 ø 16.5mm H2 30mm		





			
1			
<b>GEV No.</b>	601224	<b>Ref. No.</b>	1260007
<b>description</b>	fan wheel D1 ø 300mm H1 100mm blades 24 D2 ø 19.5mm D3 ø 23mm H2 46mm		

			
1			
<b>GEV No.</b>	601063	<b>Ref. No.</b>	1410004
<b>description</b>	fan wheel D1 ø 350mm H1 100mm blades 24 D2 ø 19.5mm D3 ø 23mm H2 46mm		

			
1			
<b>GEV No.</b>	691810	<b>Ref. No.</b>	002067 43000043
<b>description</b>	flange for fan motor ED ø 48mm int. ø 1 19.5mm int. ø 2 15mm thickness 3.5mm brass		

			
1			
<b>GEV No.</b>	550858	<b>Ref. No.</b>	002101 43000046
<b>description</b>	flange for fan motor ED ø 60mm int. ø 1 28.5mm int. ø 2 25mm thickness 4mm brass		



			
1			
<b>GEV No.</b>	550686	<b>Ref. No.</b>	90200030
<b>description</b>	gasket for fan motor ID ø 12mm ED ø 58mm thickness 1mm with 3 screw holes		

			
1			
<b>GEV No.</b>	511171	<b>Ref. No.</b>	43000042
<b>description</b>	shaft seal ID ø 14.5mm ED ø 20mm thickness 3mm		

			
1			
<b>GEV No.</b>	511172	<b>Ref. No.</b>	43000045
<b>description</b>	shaft sealing ID ø 24mm ED ø 29mm thickness 3mm		

hot air fans

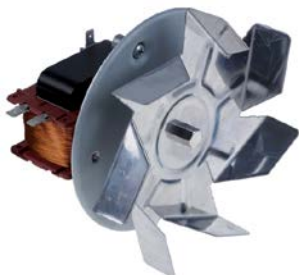
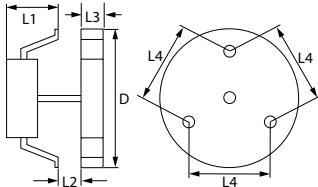
miscellaneous

				
1				
				
<b>GEV No.</b>	601011	<b>Ref. No.</b>	1510006	
<b>description</b>	hot air fan 220-240V 40W 50/60Hz L1 65mm L2 15mm L3 25mm L4 87mm fan wheel ø 150mm FIME type C25R8023CLH			
<b>accessories for</b>	601011			
	<b>GEV No.</b>	550879	<b>Ref. No.</b>	—
	 insulation ø 130mm thickness 3mm hole ø 20mm for hot air fan			
	<b>GEV No.</b>	601260	<b>Ref. No.</b>	—
	 nut thread M6L IT for hot air fan			

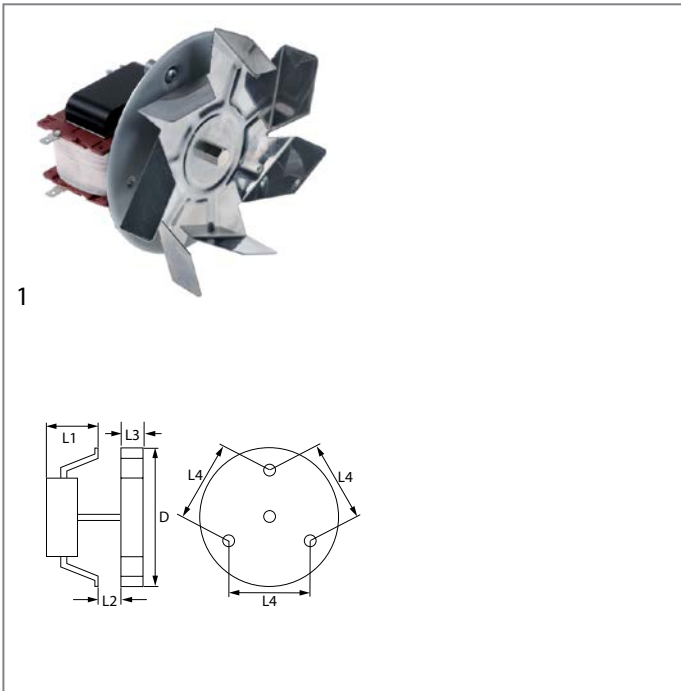

<b>GEV No.</b>	601125	<b>Ref. No.</b>	1270016
<b>description</b>	hot air fan 220-240V 45W 50/60Hz L1 70mm L2 11mm L3 25mm L4 87mm fan wheel ø 150mm FIME type C30R0479CLF		
<b>accessories for</b>	601125		
	<b>GEV No.</b>	550879	<b>Ref. No.</b> —
	insulation ø 130mm thickness 3mm hole ø 20mm for hot air fan		

## pumps

### drain pumps

#### ASKOLL



<b>GEV No.</b>	500565	<b>Ref. No.</b>	1250030
<b>description</b>	drain pump 30W		

## condensators & interference suppression filters

### operating capacitors

#### plastic

	<b>GEV No.</b>	365022	<b>Ref. No.</b>	90400011
<b>description</b>	operating capacitor capacity 40µF 400V tolerance 5%Hz ambient temperature max. -25 to +85°C ø 45mm L 95mm M8 plastic connection male faston 6.3mm protection			

## electric accessories

### cables

#### earthing cables

	<b>GEV No.</b>	104684	<b>Ref. No.</b>	90200015
<b>description</b>	earthing cable connection F2.8mm / lug M5 cable length 350mm 1.5mm <sup>2</sup>			

	<b>GEV No.</b>	104527	<b>Ref. No.</b>	00128157 019715
<b>description</b>	earthing cable connection F2.8mm/lug M6 cable length 270mm Qty 1 ED ø 3mm			

#### miscellaneous

	<b>GEV No.</b>	403098	<b>Ref. No.</b>	003368 00400011
<b>description</b>	cable for piezoelectric igniter L 1250m connection female bullet ø2mm/lug M5			

	<b>GEV No.</b>	403097	<b>Ref. No.</b>	008022 08100027
<b>description</b>	cable L 500m connection female bullet ø2/4mm			

### terminals

#### porcelain clamps

	<b>GEV No.</b>	550112	<b>Ref. No.</b>	32100015
<b>description</b>	porcelain terminal block 2-pole 2.5mm <sup>2</sup> max. 10A max 250V t.max. 200°C L 22mm W 17mm H 15mm mounting distancemm Qty 1 pcs			





gas taps

COPRECI

CAL-3200



1

<b>GEV No.</b>	109109	<b>Ref. No.</b>	00119075 006120
<b>description</b>	gas tap COPRECI type CAL-3200 gas inlet M18x1.5 (tube ø 12mm) bypass nozzle ø 0.75mm gas outlet M18x1.5 (tube ø 12mm) thermocouple connection M8x1 pilot connection 1/8" shaft ø 10x8mm shaft flat right shaft L 28/12mm		

CAL-5200



1

<b>GEV No.</b>	107766	<b>Ref. No.</b>	006385 24609015
<b>description</b>	gas tap COPRECI type CAL-5200 gas inlet pipe flange ø21mm bypass nozzle ø 0.6mm gas outlet M16x1.25 (tube ø 6mm) thermocouple connection M8x1 pilot connection shaft ø 10x8mm shaft L 32/12mm		



1

<b>GEV No.</b>	106294	<b>Ref. No.</b>	24609015 (old version)
<b>description</b>	gas tap COPRECI type CAL-5200 gas inlet pipe flange ø21mm bypass nozzle ø 0.6mm gas outlet M16x1.25 (tube ø 6mm) thermocouple connection M8x1 pilot connection shaft ø 8x6.5mm shaft L 32/12mm shaft flat right with pipe outlet		
<b>spare parts for</b>	106294		
	<b>GEV No.</b>	101060	<b>Ref. No.</b> 24600044
	magnet unit standard L 39mm D1 ø 15.4mm D2 ø 11mm suitable for PEL20-21/JUNKERS/EGA		

GAI



1

<b>GEV No.</b>	106566	<b>Ref. No.</b>	N/A
<b>description</b>	gas tap GAI gas inlet 1/2" (tube ø 13mm) bypass nozzle ø 0mm gas outlet 1/2" (tube ø 10mm) thermocouple connection M9x1 pilot connection M10x1 shaft ø 10x8mm shaft L 38/15mm shaft flat right		



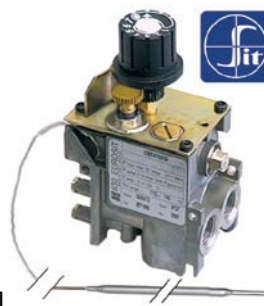

gas thermostats

SIT

630 Eurosit series



1

<b>GEV No.</b>	101188	<b>Ref. No.</b>	40900005
<b>description</b>	gas thermostat type 630 Eurosit series t.max. 190°C 110-190°C gas inlet 3/8" gas outlet 3/8" thermocouple connection M9x1 pilot connection M10x1 probe ø 4mm probe L 202mm capillary pipe 1050mm SIT		
<b>accessories for</b>	101188		
	<b>GEV No.</b>	100904	<b>Ref. No.</b> —
	locking screw M10x1 for pipe ø 4mm Qty 1 pcs		
	<b>GEV No.</b>	100905	<b>Ref. No.</b> 00131131 43000018
	locking screw M10x1 for pipe ø 6mm Qty 1 pcs		
	<b>GEV No.</b>	101273	<b>Ref. No.</b> —
	olive for pipe ø 12mm L 9.5mm brass Qty 1 pcs suitable for universal		
	<b>GEV No.</b>	101276	<b>Ref. No.</b> —
	union screw thread 3/8" tube ø 12mm Qty 1 pcs		
	<b>GEV No.</b>	101333	<b>Ref. No.</b> —
	plug thread 3/8" with O-ring		



710 Minisit series

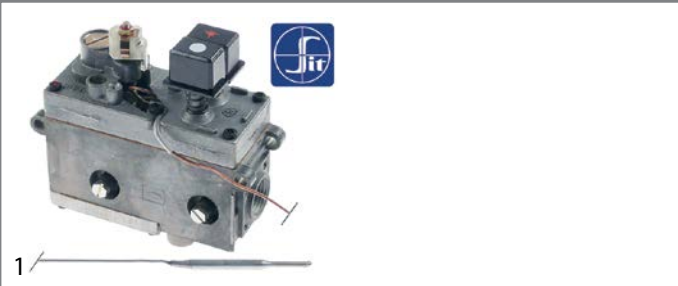

<b>GEV No.</b>	101132	<b>Ref. No.</b>	00131000
<b>description</b>	gas thermostat SIT type MINISIT 710 t.max. 340°C 100-340°C gas inlet 1/2" gas outlet 3/8" thermocouple connection M9x1 pilot connection M10x1 probe ø 5mm probe L 68mm capillary pipe 1050mm probe type type B1 pressure controller no pressure regulator mbar gland nut ignition gas no		

<b>spare parts for</b>	101132			
	<b>GEV No.</b>	101053	<b>Ref. No.</b>	—
	magnet unit T1: M9x1 T2: M24x1 L 45mm ø 17mm suitable for Minisit			
	<b>GEV No.</b>	102102	<b>Ref. No.</b>	—
	probe 100-340°C probe ø 5mm probe L 68mm capillary pipe 1750mm t.max. 340°C oven/grill probe type type B1 suitable for MINISIT 710			

<b>accessories for</b>	101132			
	<b>GEV No.</b>	100809	<b>Ref. No.</b>	—
	O-ring EPDM thickness 2mm ID ø 21mm Qty 1 pcs			
	<b>GEV No.</b>	100904	<b>Ref. No.</b>	—
	locking screw M10x1 for pipe ø 4mm Qty 1 pcs			
	<b>GEV No.</b>	100905	<b>Ref. No.</b>	00131131 43000018
	locking screw M10x1 for pipe ø 6mm Qty 1 pcs			
	<b>GEV No.</b>	101054	<b>Ref. No.</b>	—
	magnet unit T1: M10x1 T2: M24x1 L 45mm ø 17mm suitable for Minisit			
	<b>GEV No.</b>	101136	<b>Ref. No.</b>	—
	piezoelectric igniter suitable for Minisit with cover cap ømm connection F6.3x0.8			
	<b>GEV No.</b>	101137	<b>Ref. No.</b>	—
	cover cap without piezoelectric igniter			
	<b>GEV No.</b>	101267	<b>Ref. No.</b>	—
	reducer IT 3/8" ET 1/2" L 21mm			
	<b>GEV No.</b>	101268	<b>Ref. No.</b>	—
	gas connection thread 3/8" angled with O-ring MINISIT 710			
	<b>GEV No.</b>	101269	<b>Ref. No.</b>	—
	gas connection thread 1/2" angled with O-ring MINISIT 710			
	<b>GEV No.</b>	101270	<b>Ref. No.</b>	—
	screw connection IT 3/8" ET 3/8" L 28mm			
	<b>GEV No.</b>	101272	<b>Ref. No.</b>	—
	screw connection IT 1/2" ET 3/8" L 57mm			
	<b>GEV No.</b>	101273	<b>Ref. No.</b>	—
	olive for pipe ø 12mm L 9.5mm brass Qty 1 pcs suitable for universal			

<b>accessories for</b>	101132			
	<b>GEV No.</b>	101274	<b>Ref. No.</b>	—
	olive for pipe ø 16mm Qty 1 pcs			
	<b>GEV No.</b>	101275	<b>Ref. No.</b>	—
	union screw thread 1/2" for pipe ø 16mm Qty 1 pcs			
	<b>GEV No.</b>	101276	<b>Ref. No.</b>	—
	union screw thread 3/8" tube ø 12mm Qty 1 pcs			
	<b>GEV No.</b>	110068	<b>Ref. No.</b>	—
	knob suitable for Minisit ø 37mm			



<b>GEV No.</b>	101434	<b>Ref. No.</b>	9400008
<b>description</b>	gas thermostat without accessories SIT type MINISIT 710 t.max. 190°C 110-190°C gas inlet 1/2" gas outlet 3/8" thermocouple connection M9x1 pilot connection M10x1 probe ø 5mm probe L 102mm capillary pipe 1200mm probe type type G1 pressure controller no pressure regulator mbar gland nut		

<b>spare parts for</b>	101434			
	<b>GEV No.</b>	101053	<b>Ref. No.</b>	—
	magnet unit T1: M9x1 T2: M24x1 L 45mm ø 17mm suitable for Minisit			
	<b>GEV No.</b>	102105	<b>Ref. No.</b>	—
	probe 110-200°C probe ø 6mm probe L 102mm capillary pipe 1050mm t.max. 200°C fryer probe type type G1 suitable for MINISIT 710			

<b>accessories for</b>	101434			
	<b>GEV No.</b>	100809	<b>Ref. No.</b>	—
	O-ring EPDM thickness 2mm ID ø 21mm Qty 1 pcs			
	<b>GEV No.</b>	100904	<b>Ref. No.</b>	—
	locking screw M10x1 for pipe ø 4mm Qty 1 pcs			
	<b>GEV No.</b>	100905	<b>Ref. No.</b>	00131131 43000018
	locking screw M10x1 for pipe ø 6mm Qty 1 pcs			
	<b>GEV No.</b>	101054	<b>Ref. No.</b>	—
	magnet unit T1: M10x1 T2: M24x1 L 45mm ø 17mm suitable for Minisit			
	<b>GEV No.</b>	101136	<b>Ref. No.</b>	—
	piezoelectric igniter suitable for Minisit with cover cap ømm connection F6.3x0.8			
	<b>GEV No.</b>	101137	<b>Ref. No.</b>	—
	cover cap without piezoelectric igniter			
	<b>GEV No.</b>	101267	<b>Ref. No.</b>	—
	reducer IT 3/8" ET 1/2" L 21mm			

Table continues overleaf



accessories for		101434	
	GEV No.	101268	Ref. No. —
gas connection thread 3/8" angled with O-ring MINISIT 710			
	GEV No.	101269	Ref. No. —
gas connection thread 1/2" angled with O-ring MINISIT 710			
	GEV No.	101270	Ref. No. —
screw connection IT 3/8" ET 3/8" L 28mm			
	GEV No.	101272	Ref. No. —
screw connection IT 1/2" ET 3/8" L 57mm			
	GEV No.	101273	Ref. No. —
olive for pipe ø 12mm L 9.5mm brass Qty 1 pcs suitable for universal			
	GEV No.	101274	Ref. No. —
olive for pipe ø 16mm Qty 1 pcs			
	GEV No.	101275	Ref. No. —
union screw thread 1/2" for pipe ø 16mm Qty 1 pcs			
	GEV No.	101276	Ref. No. —
union screw thread 3/8" tube ø 12mm Qty 1 pcs			
	GEV No.	110068	Ref. No. —
knob suitable for Minisit ø 37mm			

accessories

probes

	1		
GEV No.	102101	Ref. No.	00100144
description	probe 100-340°C probe ø 5mm probe L 70mm capillary pipe 1000mm t.max. 340°C suitable for MINISIT 710		







gas valves and ignition boxes

gas control valves

SIT

NOVASIT



1	GEV No.	101187	Ref. No.	64100011
description	gas valve SIT series Novasit 820 0.17VHz gas inlet 1/2" gas outlet 1/2" thermocouple connection M9x1 pilot connection M10x1 ignition pressurebar pressure range 5-50mbar pressure regulator connection blind equiv. no. 0.820.301 supply Operator millivolt			
spare parts for	101187			
	GEV No.	101065	Ref. No.	—
magnet unit with cable L 44mm D1 ø 30mm D2 ø 20mm suitable for NOVASIT				
accessories for	101187			
	GEV No.	100110	Ref. No.	—
pilot burner SIT type 190 series 3 flames nozzle ømm gas connectionmm				
	GEV No.	101305	Ref. No.	—
gas connection straight 1/2" flange 45x45mm ELETTRISIT/V4400/4600/4605 suitable for SIT/HONEYWELL hole distance 36x36mm				
	GEV No.	101306	Ref. No.	—
gas connection angled flange 45x45mm hole distance 36x36mm 1/2" ELETTRISIT/V4400/4600/4605 screw with O-ring suitable for SIT/HONEYWELL				
	GEV No.	101307	Ref. No.	—
gas connection straight flange 45x45mm hole distance 36x36mm 3/4" ELETTRISIT/V4400/4600/4605 screw with O-ring suitable for SIT/HONEYWELL				
	GEV No.	101308	Ref. No.	—
gas connection angled flange 45x45mm hole distance 36x36mm 3/4" ELETTRISIT/V4400/4600/4605 screw with O-ring suitable for SIT/HONEYWELL				
	GEV No.	102116	Ref. No.	64100008
thermopile ROBERTSHAW L 900mm probe ø 9mm probe L 57mm 250-750mV screw connection 7/16"				

accessories

	1			
GEV No.	100905	Ref. No.	00131131 43000018	
description	locking screw M10x1 for pipe ø 6mm Qty 1 pcs			





SIGMA



1			
<b>GEV No.</b>	107894	<b>Ref. No.</b>	92100003
<b>description</b>	gas valve type 0848083 230V 50Hz gas inlet 3/4" gas outlet 3/4" pressure range 0.5-12mbar incl reducer 1/2" - 3/4"		



1			
<b>GEV No.</b>	107498	<b>Ref. No.</b>	43000009
<b>description</b>	gas valve type Sigma 230V 50Hz gas inlet 1/2" gas outlet 1/2" pressure range 2-50mbar		
<b>spare parts for</b>	107498		
	<b>GEV No.</b>	106214	<b>Ref. No.</b> 90200020
	solenoid coil 230V 50Hz Sigma		
<b>accessories for</b>	107498		
	<b>GEV No.</b>	107222	<b>Ref. No.</b> —
	plug for solenoid valve 3-pole cable length 1070mm		

ignition boxes

HONEYWELL



1			
<b>GEV No.</b>	101165	<b>Ref. No.</b>	1440006
<b>description</b>	ignition box HONEYWELL type S4560A 1008 equiv. no. S4560A 1008 electrodes 1 waiting time 0s safety time 10s 220-240V 10VA 50Hz		
<b>spare parts for</b>	101165		
	<b>GEV No.</b>	358696	<b>Ref. No.</b> —
	fine fuse size ø5x20mm 4A medium lag rated 250V Qty 10 pcs		



1			
<b>GEV No.</b>	102367	<b>Ref. No.</b>	43000031
<b>description</b>	ignition box HONEYWELL type S4565A 2092 1 electrodes 3 waiting times safety time 10s 220-240V 4VA 50/60Hz		

SIT

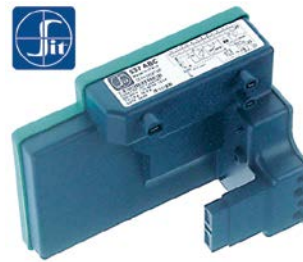

1			
<b>GEV No.</b>	102309	<b>Ref. No.</b>	43000008
<b>description</b>	ignition box SIT type 537ABC electrodes 3 waiting time 1.5s safety time 10s 230V 10VA 50-60Hz protection IP44		

ignition parts

pilot burners

SIT

100 series



















1			
<b>GEV No.</b>	106906	<b>Ref. No.</b>	00106039
<b>description</b>	pilot burner SIT type 100 series 3 flames nozzle ø 0.2mm gas connection 6mm		
<b>spare parts for</b>	106906		
	<b>GEV No.</b>	100245	<b>Ref. No.</b> —
	pilot burner nozzle LPG code 20 bore ø 0.2mm Qty 1 pcs thread M8x0.75		
	<b>GEV No.</b>	100855	<b>Ref. No.</b> —
	pilot burner bracket triple		
	<b>GEV No.</b>	100885	<b>Ref. No.</b> —
	air mixing sleeve for pilot burner Qty 1 pcs		
	<b>GEV No.</b>	100916	<b>Ref. No.</b> —
	compression spring for pilot burner Qty 1 pcs		
	<b>GEV No.</b>	100917	<b>Ref. No.</b> —
	gasket for pilot burner Qty 1 pcs aluminium		

Table continues overleaf



spare parts for		106906	
	GEV No.	100918	Ref. No. —
screw for pilot burner			
	GEV No.	107162	Ref. No. —
pilot burner cap SIT 3 flames Hmm Lmm Qty 1 pcs			
	GEV No.	107701	Ref. No. —
pilot burner bottom part SIT 100 series nozzle ø 0.2mm			
accessories for		106906	
	GEV No.	100245	Ref. No. —
pilot burner nozzle LPG code 20 bore ø 0.2mm Qty 1 pcs thread M8x0.75			
	GEV No.	100246	Ref. No. —
pilot burner nozzle natural gas bore ø 0.35mm Qty 1 pcs thread M8x0.75			
	GEV No.	100904	Ref. No. —
locking screw M10x1 for pipe ø 4mm Qty 1 pcs			
	GEV No.	100905	Ref. No. 00131131 43000018
locking screw M10x1 for pipe ø 6mm Qty 1 pcs			
	GEV No.	102110	Ref. No. —
pilot tube copper pipe ø 4mm thickness 1mm L 3000mm			
	GEV No.	102111	Ref. No. —
pilot tube copper pipe ø 6mm thickness 1mm L 3000mm			
	GEV No.	107171	Ref. No. —
pilot burner nozzle SIT natural/liquid gas bore ø 0.25mm Qty 1 pcs			
	GEV No.	107700	Ref. No. —
pilot burner bottom part SIT 100 series nozzle ø 0.25mm			
	GEV No.	107702	Ref. No. —
pilot burner bottom part SIT 100 series nozzle ø 0.35mm			

accessories

ignition electrodes

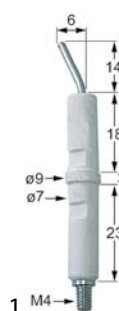

GEV No.	100706	Ref. No.	40100008
description	ignition electrode connection M4 Qty 1 pcs		

160 series





GEV No.	100055	Ref. No.	00150219
description	pilot burner SIT type 160 series 2 flames nozzle ø 0.41mm gas connection 6mm		
spare parts for		100055	
	GEV No.	100907	Ref. No. —
screw connection thread M10x1 Qty 1 pcs type SEF 1 ømm for thermocouple			
accessories for		100055	
	GEV No.	100202	Ref. No. —
pilot burner nozzle natural gas code 41 Qty 1 pcs nozzle ø 0.41mm			
	GEV No.	100203	Ref. No. 00150220
pilot burner nozzle LPG code 25 Qty 1 pcs nozzle ø 0.25mm			
	GEV No.	100701	Ref. No. 00142187
ignition electrode connection M4 Qty 1 pcs			
	GEV No.	100869	Ref. No. 00142186
pilot burner nozzle natural gas code 51 Qty 1 pcs suitable for 160 series nozzle ø 0.51mm			
	GEV No.	100906	Ref. No. —
screw connection thread M10x1 for ignition electrode brass Qty 1 pcs WS 10			
	GEV No.	100908	Ref. No. —
union screw thread M10x1 for pipe ø 4mm Qty 1 pcs			
	GEV No.	100909	Ref. No. —
union screw thread M10x1 for pipe ø 6mm Qty 1 pcs			
	GEV No.	101282	Ref. No. —
olive for pipe ø 4mm L 7.4mm Qty 1 pcs			
	GEV No.	101287	Ref. No. 00142188
olive for pipe ø 6mm Qty 1 pcs			
	GEV No.	102110	Ref. No. —
pilot tube copper pipe ø 4mm thickness 1mm L 3000mm			
	GEV No.	102111	Ref. No. —
pilot tube copper pipe ø 6mm thickness 1mm L 3000mm			
	GEV No.	107650	Ref. No. —
pilot burner nozzle SIT LPG code 30 Qty 1 pcs			



			
<b>GEV No.</b>	100056	<b>Ref. No.</b>	00142184
<b>description</b>	pilot burner SIT type 160 series 3 flames nozzle ømm gas connectionmm		
<b>spare parts for</b>	100056		
	<b>GEV No.</b>	100907	<b>Ref. No.</b> —
	screw connection thread M10x1 Qty 1 pcs type SEF 1 ømm for thermocouple		
<b>accessories for</b>	100056		
	<b>GEV No.</b>	100202	<b>Ref. No.</b> —
	pilot burner nozzle natural gas code 41 Qty 1 pcs nozzle ø 0.41mm		
	<b>GEV No.</b>	100203	<b>Ref. No.</b> 00150220
	pilot burner nozzle LPG code 25 Qty 1 pcs nozzle ø 0.25mm		
	<b>GEV No.</b>	100701	<b>Ref. No.</b> 00142187
	ignition electrode connection M4 Qty 1 pcs		
	<b>GEV No.</b>	100801	<b>Ref. No.</b> —
	gasket for pilot burner Qty 1 pcs		
	<b>GEV No.</b>	100869	<b>Ref. No.</b> 00142186
	pilot burner nozzle natural gas code 51 Qty 1 pcs suitable for 160 series nozzle ø 0.51mm		
	<b>GEV No.</b>	100870	<b>Ref. No.</b> —
	olive for pipe ø 4mm Qty 1 pcs suitable for 160 series for pilot burner		
	<b>GEV No.</b>	100906	<b>Ref. No.</b> —
	screw connection thread M10x1 for ignition electrode brass Qty 1 pcs WS 10		
	<b>GEV No.</b>	100908	<b>Ref. No.</b> —
	union screw thread M10x1 for pipe ø 4mm Qty 1 pcs		
	<b>GEV No.</b>	100909	<b>Ref. No.</b> —
	union screw thread M10x1 for pipe ø 6mm Qty 1 pcs		
	<b>GEV No.</b>	101287	<b>Ref. No.</b> 00142188
	olive for pipe ø 6mm Qty 1 pcs		
	<b>GEV No.</b>	102110	<b>Ref. No.</b> —
	pilot tube copper pipe ø 4mm thickness 1mm L 3000mm		
	<b>GEV No.</b>	102111	<b>Ref. No.</b> —
	pilot tube copper pipe ø 6mm thickness 1mm L 3000mm		
	<b>GEV No.</b>	107650	<b>Ref. No.</b> —
	pilot burner nozzle SIT LPG code 30 Qty 1 pcs		

<b>190 series</b>			
			
<b>GEV No.</b>	106722	<b>Ref. No.</b>	64100007
<b>description</b>	pilot burner SIT type 190 series 3 flames natural/liquid gas nozzle 35/51 nozzle ø 0.35/0.51mm gas connection 6mm complete with nozzle		

<b>POLIDORO</b>			
<b>pilot burners</b>			
			
<b>GEV No.</b>	104485	<b>Ref. No.</b>	40900004
<b>description</b>	pilot burner POLIDORO 2 flames natural gas code 29.2 gas connection 6mm		

<b>producer-specific pilot burners</b>			
<b>REPAGAS</b>			
			
<b>GEV No.</b>	104524	<b>Ref. No.</b>	002676 24204028
<b>description</b>	pilot burner KROMSCHRÖDER 1 natural/liquid gas nozzle ø 0.18/0.22mm		







			
<b>GEV No.</b>	107189	<b>Ref. No.</b>	50116000
<b>description</b>	pilot burner SIT 1 flame nozzle ø 0.2mm gas connectionmm		
<b>spare parts for</b>	107189		
	<b>GEV No.</b>	100245	<b>Ref. No.</b> —
	pilot burner nozzle LPG code 20 bore ø 0.2mm Qty 1 pcs thread M8x0.75		

Table continues overleaf





<b>spare parts for</b> 107189	
	GEV No. 100832 Ref. No. — pilot burner cap 1 flame suitable for 100 series Hmm Lmm Qty 1 pcs
	GEV No. 100854 Ref. No. — pilot burner bracket double
	GEV No. 100885 Ref. No. — air mixing sleeve for pilot burner Qty 1 pcs
	GEV No. 100916 Ref. No. — compression spring for pilot burner Qty 1 pcs
	GEV No. 100917 Ref. No. — gasket for pilot burner Qty 1 pcs aluminium
	GEV No. 100918 Ref. No. — screw for pilot burner
	GEV No. 107701 Ref. No. — pilot burner bottom part SIT 100 series nozzle $\varnothing$ 0.2mm

miscellaneous

	
1	
<b>GEV No.</b> 106966	<b>Ref. No.</b> 40200022
<b>description</b> pilot burner 2 flames natural/liquid gas nozzle $\varnothing$ 0.45mm gas connection 6mm	
<b>spare parts for</b> 106966	
	GEV No. 100855 Ref. No. — pilot burner bracket triple
	GEV No. 100885 Ref. No. — air mixing sleeve for pilot burner Qty 1 pcs
	GEV No. 102742 Ref. No. — pilot burner nozzle LPG code 25 bore $\varnothing$ 0.25mm Qty 1 pcs
	GEV No. 102973 Ref. No. — pilot burner nozzle natural gas bore $\varnothing$ 0.45mm Qty 1 pcs

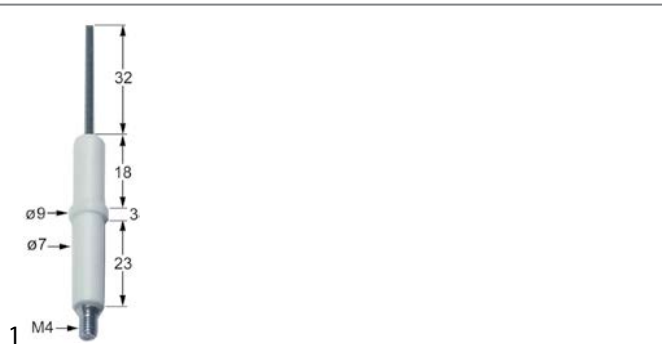
electrodes



<b>GEV No.</b> 100701	<b>Ref. No.</b> 00142187
<b>description</b> ignition electrode connection M4 Qty 1 pcs	
<b>accessories for</b> 100701	
	GEV No. 100906 Ref. No. — screw connection thread M10x1 for ignition electrode brass Qty 1 pcs WS 10

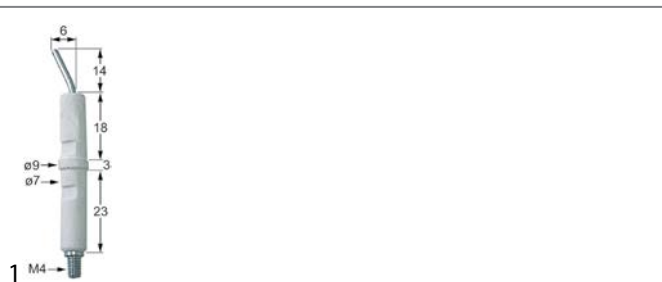

<b>GEV No.</b> 100706	<b>Ref. No.</b> 40100008
<b>description</b> ignition electrode connection M4 Qty 1 pcs	



<b>GEV No.</b> 102871	<b>Ref. No.</b> 64100005
<b>description</b> ignition electrode D1 $\varnothing$ 7mm D2 $\varnothing$ 9mm connection M4 L1 8mm BL1 18mm BL2 3mm BL3 23mm to clip	

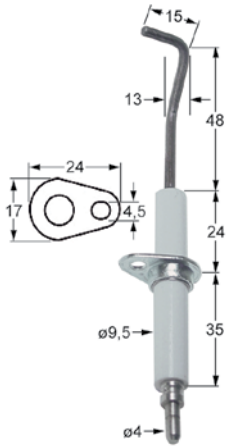

<b>GEV No.</b>	102342	<b>Ref. No.</b>	43000026
<b>description</b>	ignition electrode flange length 24mm flange width 17mm D1 ø 9.5mm L1 48mm L2 13mm L3 15mm BL1 24mm BL2 35mm fixing dimensions ø4.5mm with flange connection ø 4mm		



<b>GEV No.</b>	104799	<b>Ref. No.</b>	92900003
<b>description</b>	ignition electrode flange length 56mm flange width 22mm D1 ø 9x62mm D2 ø 9x62mm L1 130mm L2 140mm		



<b>GEV No.</b>	103287	<b>Ref. No.</b>	92100002
<b>description</b>	ignition electrode kit flange length 56mm flange width 22mm D1 ø 3mm D2 ø 9.5mm mounting distance 47mm		

## ignition cables

### pre-assembled cables

<b>GEV No.</b>	102180	<b>Ref. No.</b>	00106042
<b>description</b>	ignition cable cable length 1200mm connection ø2.4mm / ø2.4mm		

<b>GEV No.</b>	102187	<b>Ref. No.</b>	90200014
<b>description</b>	ignition cable cable length 300mm connection ø4mm / F2.8mm		

<b>GEV No.</b>	102162	<b>Ref. No.</b>	91100002
<b>description</b>	ignition cable cable length 400mm connection F2.8mm / F6.3mm		

<b>GEV No.</b>	100025	<b>Ref. No.</b>	40100009
<b>description</b>	ignition cable cable length 600mm connection ø4mm / F6.3mm		

## piezoelectric igniters

### mounting diameter 22mm

<b>GEV No.</b>	100013	<b>Ref. No.</b>	00128101
<b>description</b>	piezoelectric igniter body plastic blowing mounting ø 22mm connection ø2.4mm cable lengthmm		

<b>accessories for</b>	100013			
	<b>GEV No.</b>	100023	<b>Ref. No.</b>	—
	female bullet size 2.3mm 0.5-1.5mm <sup>2</sup> CuZn t.max. 125°C Qty 20 pcs			

## ignition units

<b>GEV No.</b>	103334	<b>Ref. No.</b>	90200013
<b>description</b>	ignition unit outputs 2 220-240VAC dimensions 83x42x32mm mounting distance 34mm inlet F2.8 outlet F2.8 type TSM 17VA 50/60Hz		





			
1			
<b>GEV No.</b>	101002	<b>Ref. No.</b>	1430008
<b>description</b>	ignition unit outputs 2 230VAC dimensions 88x23x34mm mounting distance 73mm inlet F6.3x0.8 outlet F2.8x0.8 0.6VA 50/60Hz		

thermocouples

plug-in thermocouples

plug-in thermocouples standard

with barrel socket ø6(6.5)mm

thermocouples SIT

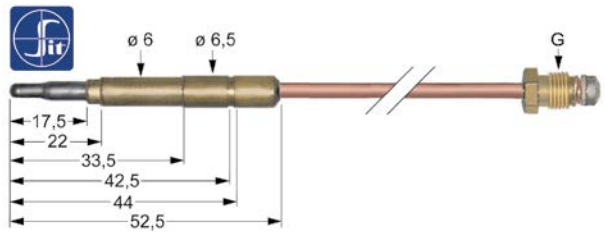
			
<b>GEV No.</b>	107615	<b>Ref. No.</b>	24204026
<b>description</b>	thermocouple SIT M10x1 L 320mm plug connection ø6.0(6.5)mm		

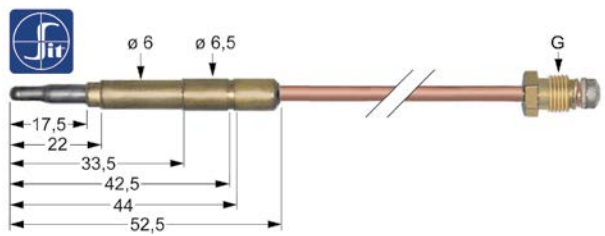
			
<b>GEV No.</b>	107600	<b>Ref. No.</b>	00100095
<b>description</b>	thermocouple SIT M8x1 L 320mm plug connection ø6.0(6.5)mm		

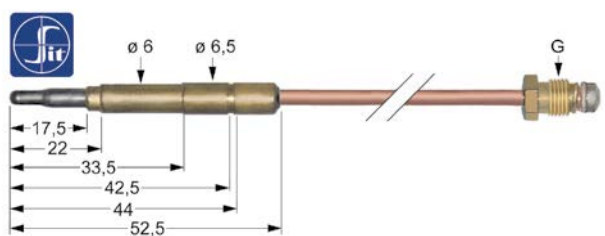
			
<b>GEV No.</b>	107178	<b>Ref. No.</b>	00100079
<b>description</b>	thermocouple SIT M8x1 L 750mm plug connection ø6.0(6.5)mm		

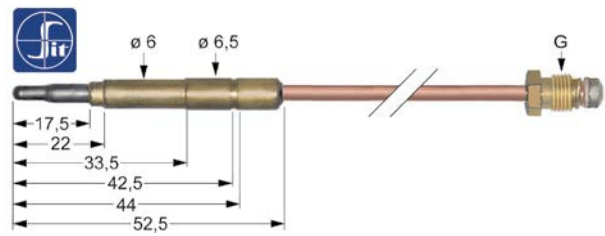
			
<b>GEV No.</b>	107612	<b>Ref. No.</b>	00106040
<b>description</b>	thermocouple SIT M9x1 L 1000mm plug connection ø6.0(6.5)mm		

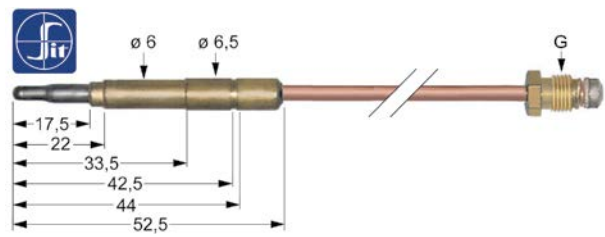
			
<b>GEV No.</b>	107613	<b>Ref. No.</b>	25100058
<b>description</b>	thermocouple SIT M9x1 L 1200mm plug connection ø6.0(6.5)mm		

thermocouples with aluminised tip

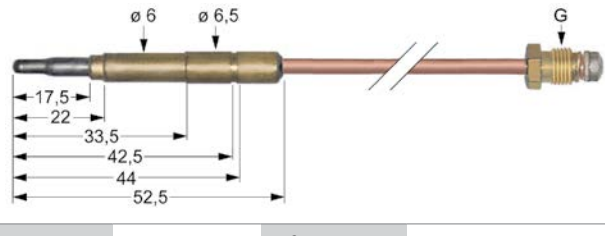
			
<b>GEV No.</b>	102037	<b>Ref. No.</b>	50100032
<b>description</b>	thermocouple M8x1 L 1200mm plug connection ø6.0(6.5)mm		

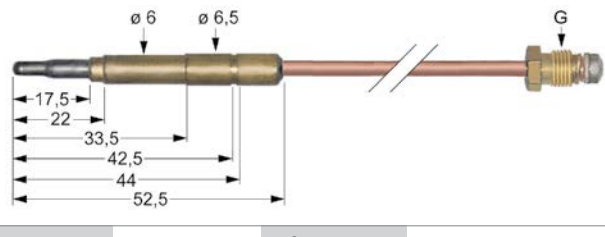
			
<b>GEV No.</b>	102038	<b>Ref. No.</b>	51600020
<b>description</b>	thermocouple M8x1 L 1500mm plug connection ø6.0(6.5)mm		

plug-in thermocouples with interrupter

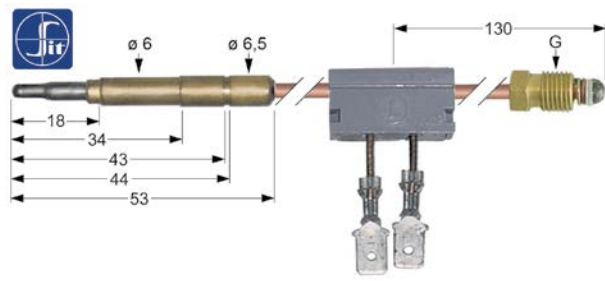
			
<b>GEV No.</b>	107177	<b>Ref. No.</b>	9400051
<b>description</b>	thermocouple SIT with interrupter M9x1 L 600mm plug connection ø6.0mm F 6.3mm		



## gas burners

### hob burners

#### producer-specific hob burners

#### REPAGAS

#### until 2005



<b>GEV No.</b>	104497	<b>Ref. No.</b>	00100107
<b>description</b>	burner cap ø 110mm		



<b>GEV No.</b>	104495	<b>Ref. No.</b>	00100172
<b>description</b>	burner cap ø 115mm		



<b>GEV No.</b>	104498	<b>Ref. No.</b>	001382 50132064
<b>description</b>	burner cap ø 115mm		



<b>GEV No.</b>	104496	<b>Ref. No.</b>	005648 02100030
<b>description</b>	burner cap ø 95mm		



<b>GEV No.</b>	104488	<b>Ref. No.</b>	00100171 00100171+0670018+1083-P 013119+016550
<b>description</b>	burner head ø 115mm for burner cap ø 105mm		
<b>accessories for</b>	104488		



<b>GEV No.</b>	104655	<b>Ref. No.</b>	017956 06700018
<b>description</b>	air mixing tube L 74mm ED ø 22mm ID ø 20mm		



<b>GEV No.</b>	560555	<b>Ref. No.</b>	1083-P
<b>description</b>	hexagonal screw thread M6 thread L 15mm SS WS 10 Qty 1 pcs DIN 933 / ISO 4017		

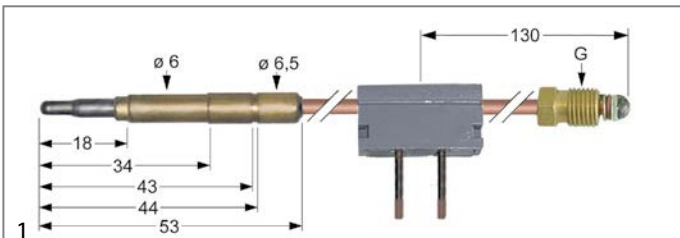

<b>GEV No.</b>	102069	<b>Ref. No.</b>	09500065
<b>description</b>	thermocouple with interrupter M9x1 L 600mm plug connection ø6.0mm soldering connection		

### threaded thermocouples

#### threaded thermocouples standard

with socket with thread M8x1

type Junkers with aluminised tip

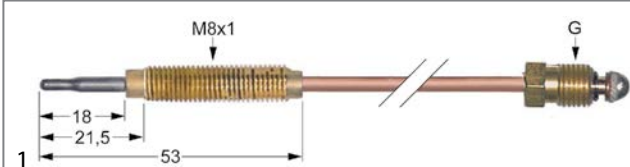

<b>GEV No.</b>	102058	<b>Ref. No.</b>	04700019
<b>description</b>	thermocouple M8x1 L 1000mm M8x1		

**accessories for** 102058

	<b>GEV No.</b>	102067	<b>Ref. No.</b>	—
	nut thread M8x1 H 3mm brass Qty 1 pcs type SEF 1			

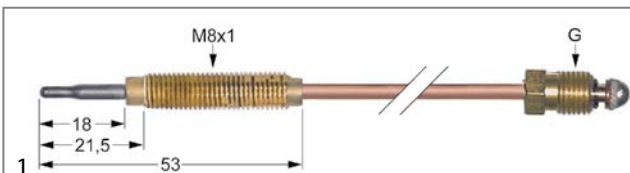

<b>GEV No.</b>	102057	<b>Ref. No.</b>	04700018
<b>description</b>	thermocouple M8x1 L 850mm M8x1		

**accessories for** 102057

	<b>GEV No.</b>	102067	<b>Ref. No.</b>	—
	nut thread M8x1 H 3mm brass Qty 1 pcs type SEF 1			

### thermopiles

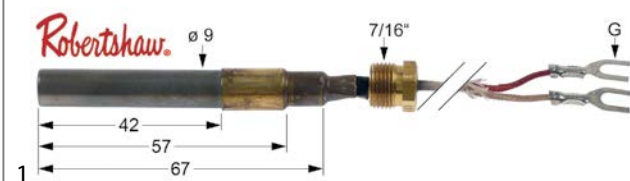

<b>GEV No.</b>	102116	<b>Ref. No.</b>	64100008
<b>description</b>	thermopile ROBERTSHAW L 900mm probe ø 9mm probe L 57mm 250-750mV screw connection 7/16"		





 <p>1</p>			
<b>GEV No.</b>	104514	<b>Ref. No.</b>	010720 31300021
<b>description</b>	burner holder ø 37mm seat ø 22mm		

 <p>1</p>			
<b>GEV No.</b>	104509	<b>Ref. No.</b>	00121077 001694
<b>description</b>	burner holder ø 44mm seat ø 34mm thread M18x1.5		

since 2005			
 <p>1</p>			
<b>GEV No.</b>	104493	<b>Ref. No.</b>	015430 50141088
<b>description</b>	burner cap ø 120mm		



 <p>1</p>			
<b>GEV No.</b>	104494	<b>Ref. No.</b>	002910 50142090
<b>description</b>	burner cap ø 140mm		

 <p>1</p>			
<b>GEV No.</b>	104492	<b>Ref. No.</b>	007139 50140086
<b>description</b>	burner cap ø 95mm		

pan supports			
 <p>1</p>			
<b>GEV No.</b>	210040	<b>Ref. No.</b>	00100110 012605
<b>description</b>	pan support W 365mm L 395mm H 65mm		

reducers for pan supports			
 <p>1</p>			
<b>GEV No.</b>	104499	<b>Ref. No.</b>	00100132 012790
<b>description</b>	reducer for pan support L 175mm W 114mm		

accessories			
reducers for pan supports			
 <p>1</p>			
<b>GEV No.</b>	104499	<b>Ref. No.</b>	00100132 012790
<b>description</b>	reducer for pan support L 175mm W 114mm		

air mixers			
 <p>1</p>			
<b>GEV No.</b>	104655	<b>Ref. No.</b>	017956 06700018
<b>description</b>	air mixing tube L 74mm ED ø 22mm ID ø 20mm		
<b>accessories for</b>	104655		
	<b>GEV No.</b>	104488	<b>Ref. No.</b> 00100171
	burner head ø 115mm for burner cap ø 105mm		

bar burners			
bar burners			
 <p>1</p>			
<b>GEV No.</b>	105788	<b>Ref. No.</b>	1440002
<b>description</b>	bar burner 1-row ø 50mm Wmm Hmm L 483mm flange width 71mm convection oven flange ø 75mm		

 <p>1</p>			
<b>GEV No.</b>	104483	<b>Ref. No.</b>	40900007
<b>description</b>	bar burner ø 40mm Wmm Hmm L 340mm flange width 50mm flange length 62mm fryer		





			
1			
<b>GEV No.</b>	105787	<b>Ref. No.</b>	1430003
<b>description</b>	bar burner ø 40mm Wmm Hmm L 415mm flange width 43mm flange length 43mm convection oven		

			
1			
<b>GEV No.</b>	105790	<b>Ref. No.</b>	008017 1430002
<b>description</b>	bar burner ø 50mm Wmm Hmm L 325mm flange width 57mm flange length 57mm convection oven		

			
1			
<b>GEV No.</b>	105789	<b>Ref. No.</b>	1450001
<b>description</b>	bar burner ø 50mm Wmm Hmm L 618mm flange width 71mm convection oven flange ø 75mm		

			
1			
<b>GEV No.</b>	107345	<b>Ref. No.</b>	30100013
<b>description</b>	gas injector thread M9x1 WS 10 bore ø 0.9mm		

			
1			
<b>GEV No.</b>	100504	<b>Ref. No.</b>	00120151
<b>description</b>	gas injector thread M9x1 WS 10 bore ø 1.15mm		

			
1			
<b>GEV No.</b>	100503	<b>Ref. No.</b>	20111020
<b>description</b>	gas injector thread M9x1 WS 10 bore ø 1.1mm		

			
1			
<b>GEV No.</b>	100505	<b>Ref. No.</b>	02107015
<b>description</b>	gas injector thread M9x1 WS 10 bore ø 1.2mm		

			
1			
<b>GEV No.</b>	100507	<b>Ref. No.</b>	30100039
<b>description</b>	gas injector thread M9x1 WS 10 bore ø 1.35mm		

			
1			
<b>GEV No.</b>	100956	<b>Ref. No.</b>	00112037
<b>description</b>	gas injector thread M9x1 WS 10 bore ø 1.3mm		

			
1			
<b>GEV No.</b>	107346	<b>Ref. No.</b>	07600009
<b>description</b>	gas injector thread M9x1 WS 10 bore ø 1.4mm		

## gas nozzles

### main nozzles

#### gas nozzles M8x1

			
1			
<b>GEV No.</b>	104737	<b>Ref. No.</b>	90200025
<b>description</b>	gas injector thread M8x1 WS 10 bore ø 0.5mm		

#### gas nozzles M9x1

			
1			
<b>GEV No.</b>	100501	<b>Ref. No.</b>	04704017
<b>description</b>	gas injector thread M9x1 WS 10 bore ø 0.95mm		





			
1			
<b>GEV No.</b>	100509	<b>Ref. No.</b>	09511127
<b>description</b>	gas injector thread M9x1 WS 10 bore ø 1.55mm		

			
1			
<b>GEV No.</b>	100510	<b>Ref. No.</b>	00100139
<b>description</b>	gas injector thread M9x1 WS 10 bore ø 1.8mm		

			
1			
<b>GEV No.</b>	100511	<b>Ref. No.</b>	50100013
<b>description</b>	gas injector thread M9x1 WS 10 bore ø 1.9mm		

			
1			
<b>GEV No.</b>	100502	<b>Ref. No.</b>	21107011
<b>description</b>	gas injector thread M9x1 WS 10 bore ø 1mm		

			
1			
<b>GEV No.</b>	106881	<b>Ref. No.</b>	07600010
<b>description</b>	gas injector thread M9x1 WS 10 bore ø 2.1mm		

			
1			
<b>GEV No.</b>	107347	<b>Ref. No.</b>	50100069
<b>description</b>	gas injector thread M9x1 WS 10 bore ø 2.4mm		

gas nozzles M10x1			
			
1			
<b>GEV No.</b>	107343	<b>Ref. No.</b>	40200025
<b>description</b>	gas injector thread M10x1 WS 12 bore ø 1.2mm LPG gas pressure 30mbar		

			
1			
<b>GEV No.</b>	106290	<b>Ref. No.</b>	40200015 40200018
<b>description</b>	gas injector thread M10x1 WS 12 bore ø 1.85mm inner peaked		

gas nozzles M13x1			
			
1			
<b>GEV No.</b>	103270	<b>Ref. No.</b>	012419 40100029
<b>description</b>	gas injector thread M13x1 bore ø 2.4mm WS 13		

### pilot burner nozzles

pilot burner nozzle AB			
			
1			
<b>GEV No.</b>	100203	<b>Ref. No.</b>	00150220
<b>description</b>	pilot burner nozzle LPG code 25 Qty 1 pcs nozzle ø 0.25mm		

			
1			
<b>GEV No.</b>	100869	<b>Ref. No.</b>	00142186
<b>description</b>	pilot burner nozzle natural gas code 51 Qty 1 pcs suitable for 160 series nozzle ø 0.51mm		

			
1			
<b>GEV No.</b>	100201	<b>Ref. No.</b>	00142185
<b>description</b>	pilot burner nozzle PRO-GAS LPG code 30 Qty 1 pcs nozzle ø 0.3mm		

pilot burner nozzles POLIDORO			
			
1			
<b>GEV No.</b>	100000	<b>Ref. No.</b>	40900003
<b>description</b>	pilot burner nozzle POLIDORO LPG code 22 bore ø 0.22mm Qty 1 pcs		

			
1			
<b>GEV No.</b>	104486	<b>Ref. No.</b>	40900006
<b>description</b>	pilot burner nozzle POLIDORO natural gas code 29.2 bore ø 2x0.29mm Qty 1 pcs		

<b>angle pieces</b>			
			
1			
<b>GEV No.</b>	104484	<b>Ref. No.</b>	40600008
<b>description</b>	angle piece T1: 1/2" ET T2: 1/2" ET		

auxiliary gas parts

screw connections

olives

			
1			
<b>GEV No.</b>	104526	<b>Ref. No.</b>	00100152 012941
<b>description</b>	olive L 6mm Qty 1 pcs ID ø 4.4/6mm ED ø 8mm		

			
1			
<b>GEV No.</b>	104490	<b>Ref. No.</b>	008322 27306000
<b>description</b>	angle piece T1: 1/2" IT T2: 1/2" ET grommet ø 13.5mm grommet length 22mm WS 24 brass		

union screws

			
1			
<b>GEV No.</b>	100905	<b>Ref. No.</b>	00131131 43000018
<b>description</b>	locking screw M10x1 for pipe ø 6mm Qty 1 pcs		

			
1			
<b>GEV No.</b>	104489	<b>Ref. No.</b>	00135000 011894
<b>description</b>	angle piece T1: 3/4" IT T2: 1/2" ET grommet ø 13.5mm grommet length 22mm WS 24 brass		

			
1			
<b>GEV No.</b>	104487	<b>Ref. No.</b>	00100153 012949
<b>description</b>	union screw thread 1/8" for pipe ø 6mm L 13mm brass Qty 1 pcs WS 11		

equipment-specific units

for deep fryers

<b>miscellaneous</b>			
			
1			
<b>GEV No.</b>	550268	<b>Ref. No.</b>	8700008
<b>description</b>	cover cap for push-button		

			
1			
<b>GEV No.</b>	104491	<b>Ref. No.</b>	00131225 004497
<b>description</b>	union screw thread M10x1 for pipe ø 6mm L 16mm Qty 1 pcs WS 11		





for convection ovens/combi-steamers

<b>drain valves</b>			
			
1			
<b>GEV No.</b>	696788	<b>Ref. No.</b>	91200011
<b>description</b>	drain pipe thread 1 1/2" IT T-piece plastic ID ø 37mm ED ø 40mm for combi-steamer		



door mechanics

locking mechanism

			
1			
<b>GEV No.</b>	698503	<b>Ref. No.</b>	92800011
<b>description</b>	espagnolette lock complete		
<b>accessories for</b>	698503		
	<b>GEV No.</b>	690041	<b>Ref. No.</b> —
	cam L 148mm mounting distance 32mm		
	<b>GEV No.</b>	694409	<b>Ref. No.</b> —
	mounting set for espagnolette lock 694382		
	<b>GEV No.</b>	700604	<b>Ref. No.</b> 1260017
	latch gear opening to the right shaft intake ø 8x8mm L 170mm W 40mm H 40mm		



for ovens

miscellaneous

			
1			
<b>GEV No.</b>	698478	<b>Ref. No.</b>	92800013
<b>description</b>	coupling for oven for door L 80mm W 26mm intake 7.8 x 7.8		





knobs

universal knobs

			
1			
<b>GEV No.</b>	110119	<b>Ref. No.</b>	22405005
<b>description</b>	knob thermostat t.max. 110°C ø 50mm shaft ø 6x4.6mm shaft flat upper black temperature range 30-110°C rotation 270°		
<b>accessories for</b>	110119		
	<b>GEV No.</b>	110135	<b>Ref. No.</b> —
	rosette knob up to ø 52mm		

producer-specific knobs

REPAGAS

			
1			
<b>GEV No.</b>	111474	<b>Ref. No.</b>	001624 30100053
<b>description</b>	knob gas tap ø 63mm shaft ø 8x6mm shaft flat right		
			
1			
<b>GEV No.</b>	111472	<b>Ref. No.</b>	00300078 013839
<b>description</b>	knob gas tap with ignition flame ø 63mm shaft ø 10x8mm shaft flat right		
			
1			
<b>GEV No.</b>	111473	<b>Ref. No.</b>	012948 60100059
<b>description</b>	knob gas tap with ignition flame ø 63mm shaft ø 8x6mm shaft flat right		
			
1			
<b>GEV No.</b>	111471	<b>Ref. No.</b>	002217 50100083
<b>description</b>	knob gas tap with ignition flame ø 76mm shaft ø 10x8mm shaft flat right		
			
1			
<b>GEV No.</b>	112769	<b>Ref. No.</b>	017181 30800043
<b>description</b>	knob gas tap without ignition flame ø 76mm shaft ø 10x8mm shaft flat right		

## locks

### edgmount latches

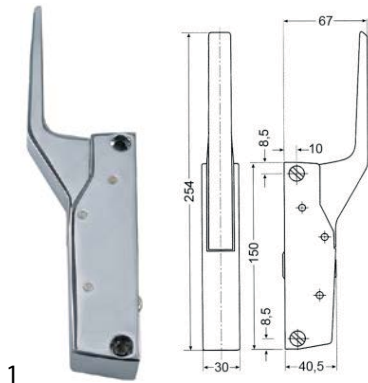

#### handle latches

##### CAFF/FERMOD



<b>GEV No.</b>	700060	<b>Ref. No.</b>	1250056
<b>description</b>	handle latch L 150mm mounting distance 133mm non lockable heated units G 791		

##### accessories for

	<b>GEV No.</b>	700061	<b>Ref. No.</b>	1250046
	<b>description</b>	door catch L 58mm W 20mm H 35mm mounting distance 42mm chrome-plated brass for headed units		
	<b>GEV No.</b>	700062	<b>Ref. No.</b>	—
	<b>description</b>	handle protection heated units		

#### door catches



<b>GEV No.</b>	700061	<b>Ref. No.</b>	1250046
<b>description</b>	door catch L 58mm W 20mm H 35mm mounting distance 42mm chrome-plated brass for headed units		

##### accessories for

	<b>GEV No.</b>	690414	<b>Ref. No.</b>	—
	<b>description</b>	handle latch L 150mm mounting distance 133mm non lockable refrigeration units G 791		

## snap locks

#### universal



<b>GEV No.</b>	690903	<b>Ref. No.</b>	1270034
<b>description</b>	snap lock L 69mm W 13mm H 20mm mounting distance 57mm complete with door catch nickel-plated brass		



<b>GEV No.</b>	692609	<b>Ref. No.</b>	1270034
<b>description</b>	snap lock L 70mm W 13mm H 21mm mounting distance 60/30mm complete with door catch zamak		

## espagnolette locks

#### universal



<b>GEV No.</b>	700604	<b>Ref. No.</b>	1260017
<b>description</b>	latch gear opening to the right shaft intake ø 8x8mm L 170mm W 40mm H 40mm		

## hinges

#### oven hinges



<b>GEV No.</b>	701137	<b>Ref. No.</b>	00107027 003626
<b>description</b>	cover mounting distance 95mm L 112mm W 26mm thickness 1mm cut-out 9x66mm for oven hinge		



<b>GEV No.</b>	701135	<b>Ref. No.</b>	00111000
<b>description</b>	opposite support mounting distance 94mm L 110mm W 19mm for oven hinge		







 <p>1</p>			
<b>GEV No.</b>	701136	<b>Ref. No.</b>	00148000 005488
<b>description</b>	opposite support mounting distance 94mm L 110mm W 21mm cut-out 8x59mm for oven hinge		

 <p>1</p>			
<b>GEV No.</b>	701134	<b>Ref. No.</b>	000620 00144000
<b>description</b>	oven hinge mounting distance 173mm mounting distance 2mm lug mounting 14mm lever length 123mm groove distance 10mm spring thickness 3.5mm mounting ear position left/right spring length 112mm L 207mm W 25mm		

door bearing

 <p>1</p>			
<b>GEV No.</b>	514310	<b>Ref. No.</b>	009400 1250066
<b>description</b>	hinge bearing mounting pos. bottom left without bolt		



 <p>1</p>			
<b>GEV No.</b>	514309	<b>Ref. No.</b>	009413 1250067
<b>description</b>	hinge bearing mounting pos. upper left without bolt		

 <p>1</p>			
<b>GEV No.</b>	514312	<b>Ref. No.</b>	001988 43000034
<b>description</b>	hinge bearing mounting pos. upper left without bolt		

fittings for catering equipment

outlet taps

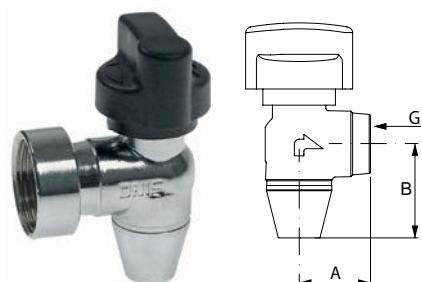
universal

 <p>1</p>			
<b>GEV No.</b>	541609	<b>Ref. No.</b>	8500001
<b>description</b>	outlet tap chrome-plated brass W 46mm H 40mm thread 1" IT		
<b>spare parts for</b>	541609		
	<b>GEV No.</b>	540747	<b>Ref. No.</b> —
	outlet tap chrome-plated brass angled W 30mm H 40mm thread 1/2" IT		

equipment feet and end caps

equipment feet

with fixing plate

 <p>1</p>			
<b>GEV No.</b>	701132	<b>Ref. No.</b>	00102005 007971
<b>description</b>	equipment foot tube ø 64mm plate size 70x90mm hole distance 35x76mm H 115-155mm SS size 2 1/2" Qty 1 pcs		

## screw-in feet



1

<b>GEV No.</b>	701133	<b>Ref. No.</b>	018148+008243 24600030 34101010 34101010+078-p
<b>description</b>	equipment foot thread M10 thread L 34mm ø 40mm H 25mm WS 17 Qty 1 pcs		

## baskets

## fryer baskets

## REPAGAS



1

<b>GEV No.</b>	970778	<b>Ref. No.</b>	001414 57200022
<b>description</b>	fryer basket W1 210mm L1 240mm H1 115mm chrome-plated steel		

## shelves and shelf rails

## grates

## universal

## without upstand



1

<b>GEV No.</b>	970120	<b>Ref. No.</b>	4100029
<b>description</b>	grate W 325mm D 530mm GN 1/1 chrome-plated steel wire gauge frame 7mm lengthwise wires gauge 4mm crossing wires 1		
<b>accessories for</b>	970120		
	<b>GEV No.</b>	<b>Ref. No.</b>	—
	690330		
	rack L 1000mm W 22mm H 4mm aperture 3x8mm hole distance 12.5mm stainless steel		
	<b>GEV No.</b>	<b>Ref. No.</b>	—
	694700		
	shelf support L 31/28mm W 22mm H 18mm SS Qty 12 pcs		
	<b>GEV No.</b>	<b>Ref. No.</b>	—
	694701		
	shelf support L 31/28mm W 22mm H 17mm SS with hook Qty 12 pcs		

## with upstand



1

<b>GEV No.</b>	970527	<b>Ref. No.</b>	00100115
<b>description</b>	grate W 530mm D 650mm GN 2/1 chrome-plated steel with hinge camp crossing wires 2 suitable for refrigerator		
<b>accessories for</b>	970527		
	<b>GEV No.</b>	<b>Ref. No.</b>	—
	690330		
	rack L 1000mm W 22mm H 4mm aperture 3x8mm hole distance 12.5mm stainless steel		
	<b>GEV No.</b>	<b>Ref. No.</b>	—
	694700		
	shelf support L 31/28mm W 22mm H 18mm SS Qty 12 pcs		
	<b>GEV No.</b>	<b>Ref. No.</b>	—
	694701		
	shelf support L 31/28mm W 22mm H 17mm SS with hook Qty 12 pcs		

## gaskets

## gaskets for heated units

## window seals

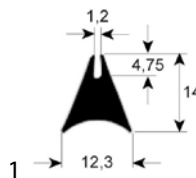

1

<b>GEV No.</b>	900058	<b>Ref. No.</b>	009293 1240011 1250054
<b>description</b>	window gasket profile 1620 Qty supplied by meter		

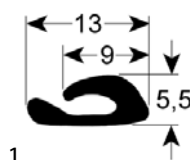

1

<b>GEV No.</b>	900470	<b>Ref. No.</b>	007609 42300002
<b>description</b>	window gasket profile 1880 L 520mm Qty 1		
<b>accessories for</b>	900470		
	<b>GEV No.</b>	<b>Ref. No.</b>	—
	900471		
	window gasket profile 1880 L 680mm Qty 1		

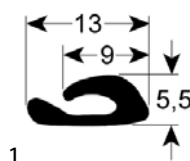

1

<b>GEV No.</b>	900882	<b>Ref. No.</b>	007620 42300003
<b>description</b>	window gasket profile 1880 Qty supplied by meter		



door seals

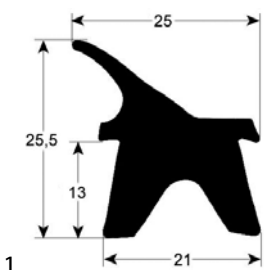

<b>GEV No.</b>	900348	<b>Ref. No.</b>	1240012
<b>description</b>	door seal profile 2402 Qty supplied by meter		

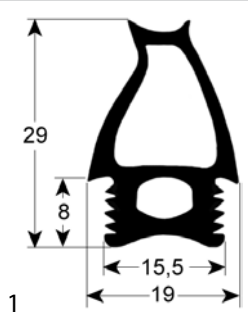

<b>GEV No.</b>	901627	<b>Ref. No.</b>	92800001
<b>description</b>	door seal profile 2781 W 688mm L 1410mm external size suitable for ANGELO PO		

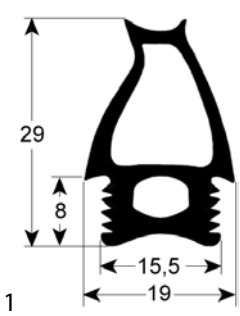

<b>GEV No.</b>	901624	<b>Ref. No.</b>	92600002
<b>description</b>	door seal profile 2781 W 475mm L 1410mm external size suitable for ANGELO PO		

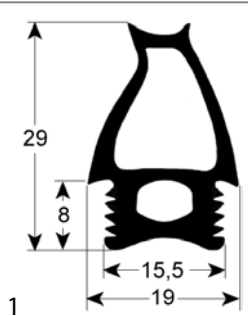

<b>GEV No.</b>	901626	<b>Ref. No.</b>	92800010
<b>description</b>	door seal profile 2781 W 688mm L 886mm external size suitable for ANGELO PO		

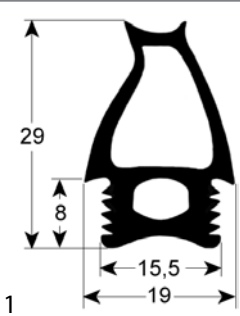

<b>GEV No.</b>	901622	<b>Ref. No.</b>	92000022
<b>description</b>	door seal profile 2781 W 475mm L 475mm external size suitable for ANGELO PO		

**gaskets for tray rack trolleys**

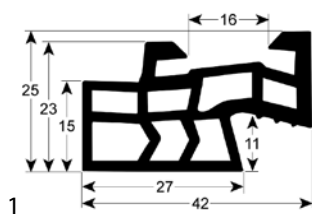

<b>GEV No.</b>	902520	<b>Ref. No.</b>	92600004
<b>description</b>	tray rack trolley gasket profile 4140 L 515mm Qty 1		

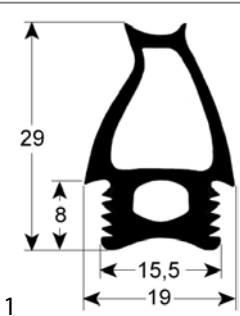

<b>GEV No.</b>	901623	<b>Ref. No.</b>	92200002
<b>description</b>	door seal profile 2781 W 475mm L 725mm external size suitable for ANGELO PO		

**sealing washers**

**graphite gaskets**



<b>GEV No.</b>	501423	<b>Ref. No.</b>	006621 04708015
<b>description</b>	flat gasket graphite ED ø 20mm ID ø 8mm thickness 1mm eccentric Qty 1 pcs		



<b>GEV No.</b>	501422	<b>Ref. No.</b>	005438 07108015
<b>description</b>	flat gasket graphite ED ø 46mm ID ø 35mm thickness 1mm Qty 1 pcs		

rubber gaskets



1

<b>GEV No.</b>	511926	<b>Ref. No.</b>	009037 04708016
<b>description</b>	flat gasket rubber ED ø 11.3mm ID ø 7.5mm thickness 2.7mm Qty 1 pcs		

silicone gaskets



1

<b>GEV No.</b>	359721	<b>Ref. No.</b>	1230008
<b>description</b>	gasket silicone ED ø 48mm ID ø 39.5mm thickness 5mm Qty 1 pcs		

shaft gaskets

shaft gaskets



1

<b>GEV No.</b>	511171	<b>Ref. No.</b>	43000042
<b>description</b>	shaft seal ID ø 14.5mm ED ø 20mm thickness 3mm		



1

<b>GEV No.</b>	511172	<b>Ref. No.</b>	43000045
<b>description</b>	shaft sealing ID ø 24mm ED ø 29mm thickness 3mm		

manometers



1

<b>GEV No.</b>	541508	<b>Ref. No.</b>	90200028
<b>description</b>	manometer ø 40mm pressure range 0-4bar connection thread 1/8"		

hose reels and spray guns

spray guns



1

<b>GEV No.</b>	691048	<b>Ref. No.</b>	1270003R
<b>description</b>	spray gun for appliances 1/2" ET L 225mm type STAR		
<b>spare parts for</b>	691048		
	<b>GEV No.</b>	507309	<b>Ref. No.</b> —
	O-ring EPDM thickness 2.62mm ID ø 17.13mm Qty 1 pcs		
	<b>GEV No.</b>	510322	<b>Ref. No.</b> —
	O-ring EPDM thickness 1.78mm ID ø 17.17mm Qty 1 pcs		
	<b>GEV No.</b>	524055	<b>Ref. No.</b> —
	flat gasket rubber ED ø 18mm ID ø 12mm thickness 2mm Qty 1 pcs		
	<b>GEV No.</b>	528485	<b>Ref. No.</b> —
	O-ring EPDM thickness 1.78mm ID ø 6.07mm Qty 1 pcs		
	<b>GEV No.</b>	528494	<b>Ref. No.</b> —
	gasket rubber ED ø 13mm ID ø 4mm thickness 4mm Qty 1 pcs		

valves and tank inlets

ball valves

ball valves electric



1

<b>GEV No.</b>	401233	<b>Ref. No.</b>	43000004
<b>description</b>	ball valve inlet 1/2" IT outlet 1/2" IT 230V 50/60Hz mode of operation electric W 60mm H 99mm cable 4-pole 2.5W 4-pole duty cycle 50%		



## water cycle components

### pressure reduction valves

#### pressure reduction valves

##### universal



1	<b>GEV No.</b>	520967	<b>Ref. No.</b>	90200026
<b>description</b> pressure reduction valve series HP WR01 connection 1/2" default setting 3bar setting range 1-6bar p max 16bar t.max. 40°C chrome-plated brass IMPORT				

## measuring equipment

### thermometers

#### built-in thermometers

##### ø52mm



1	<b>GEV No.</b>	541252	<b>Ref. No.</b>	9400021
<b>description</b> thermometer mounting ø 52mm t.max. 250°C 0 up to +250°C probe ø 4mm probe L 74mm capillary pipe 1330mm				



1	<b>GEV No.</b>	541077	<b>Ref. No.</b>	1230022
<b>description</b> thermometer mounting ø 52mm t.max. 350°C +50 up to +350°C probe ø 6mm probe L 30mm capillary pipe 1000mm built-in depth 28mm				

## fastening material

### screws

#### hexagonal screws

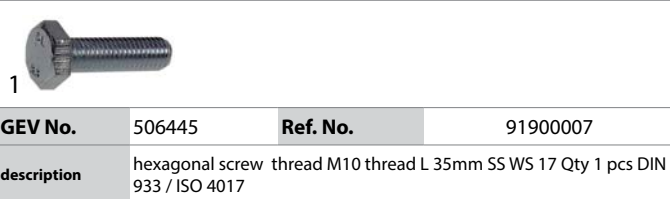

1	<b>GEV No.</b>	506445	<b>Ref. No.</b>	91900007
<b>description</b> hexagonal screw thread M10 thread L 35mm SS WS 17 Qty 1 pcs DIN 933 / ISO 4017				

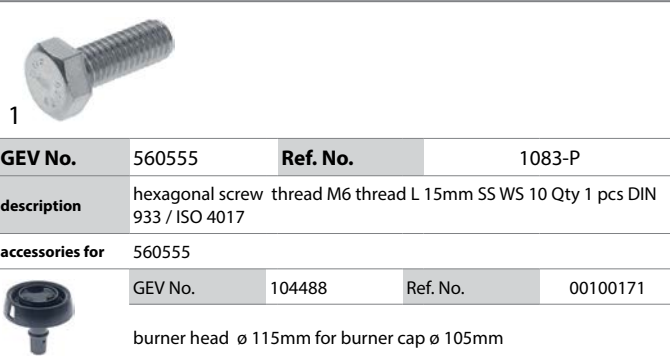

1	<b>GEV No.</b>	560555	<b>Ref. No.</b>	1083-P
<b>description</b> hexagonal screw thread M6 thread L 15mm SS WS 10 Qty 1 pcs DIN 933 / ISO 4017				

<b>accessories for</b> 560555				
	<b>GEV No.</b>	104488	<b>Ref. No.</b>	00100171
burner head ø 115mm for burner cap ø 105mm				

### nuts

#### hexagonal nuts

##### hexagonal nuts metric (without norm)

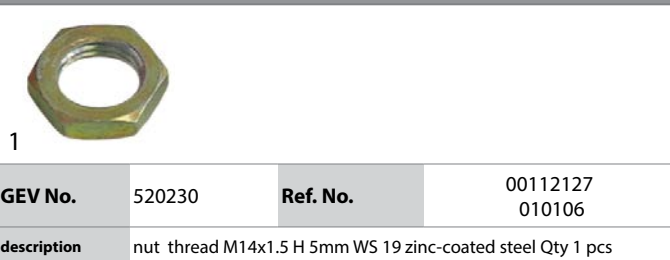

1	<b>GEV No.</b>	520230	<b>Ref. No.</b>	00112127 010106
<b>description</b> nut thread M14x1.5 H 5mm WS 19 zinc-coated steel Qty 1 pcs				

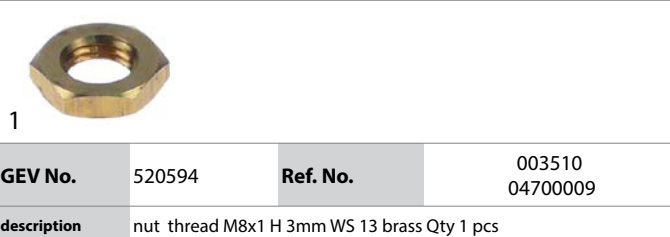

1	<b>GEV No.</b>	520594	<b>Ref. No.</b>	003510 04700009
<b>description</b> nut thread M8x1 H 3mm WS 13 brass Qty 1 pcs				

### washers

#### washers

##### miscellaneous

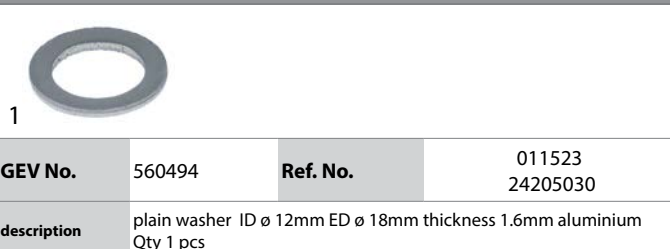

1	<b>GEV No.</b>	560494	<b>Ref. No.</b>	011523 24205030
<b>description</b> plain washer ID ø 12mm ED ø 18mm thickness 1.6mm aluminium Qty 1 pcs				



## fasteners

## roll pins



1

<b>GEV No.</b>	691637	<b>Ref. No.</b>	1260021
<b>description</b>	roll pin ø 3mm L 20mm		

<b>A</b>			
alarm devices	15	heating elements for fryers	3
axial fans	21	heating elements for griddles	5
<b>B</b>		heating elements for heated cabinets	5
ball valves	44	hexagonal nuts	45
ball valves electric	20, 44	hexagonal screws	45
bar burners	35	hob burners	34
<b>C</b>		hot air fans	23
cables	24	hot air motors	21
cam switches	11	<b>I</b>	
condensators & interference suppression filters	24	ignition boxes	28
contactors	15	ignition cables	32
control thermostats	7, 9	ignition units	32
<b>D</b>		immersion heating elements	5
door catches	40	indicator lights	12
door seals	43	indicator lights (complete)	12
drain pumps	24	<b>L</b>	
<b>E</b>		lamps	12
earthing cables	24	light bulbs	12
edgemount latches	40	<b>M</b>	
electric accessories	24	magnetic switches	11
electrodes	20	measuring equipment	45
electronic controllers	18	mechanical timers	15
energy regulators	7	microswitches	10
espagnolette locks	40	<b>N</b>	
<b>F</b>		nuts	45
fans	21	<b>O</b>	
fasteners	46	operating capacitors	24
fastening material	45	oven hinges	40
<b>G</b>		oven lamps	13
gas burners	34	<b>P</b>	
gas control valves	27	piezoelectric igniters	32
gas nozzles	36	pilot burners	28
gas taps	25	pressure reduction valves	45, 45
gas thermostats	25	pressure switches	20
gaskets for heated units	42	probes	18
gaskets for tray rack trolleys	43	programme timers	15
grates	42	pumps	24
<b>H</b>		<b>R</b>	
halogen lamp	13	relays	16
handle latches	40	roll pins	46
heating elements	3	rotary switches	11
heating elements for bain maries	3	<b>S</b>	
heating elements for contact grills	5	safety thermostats	8, 10
heating elements for convection	6	screws	45
		sealing washers	43

shaft gaskets	44
shelves and shelf rails	42
snap locks	40
solenoid valves	19
spray guns	44
spray guns with external thread	44
switches and momentary switches	10
system switches (ROLD)	10

**T**

temperature probes	18
terminals	24
thermocouples	33
thermostats	7
time relays	17
timers	15
transformers	17

**U**

universal probes	18
------------------	----

**V**

valves and tank inlets	44
------------------------	----

**W**

washers	45
water cycle components	45
window seals	42