



GAS COMPONENTS



ELECTRIC COMPONENTS



WATER TECHNOLOGY



MECHANICAL COMPONENTS



TOOLS

Spare parts suitable for

RM-GASTRO

Find the complete and up-to-date range of products in our GEV Webshop



Manufacturer catalogue

The most important spare parts and accessories arranged clearly for every manufacturer

- ✓ Complete product range and all appliance data always up to date in the GEV Webshop
- ✓ Alphabetical Index at the end of the catalogue

GEV Webshop

www.gev-online.co.uk

www.gev-online.com



- 🔍 Add to Favourites
- 🔍 Sign In with email address and usual password
- 🔍 Easy-order – place several items in your basket at the same time
- 🔍 Quick Item search – no login needed



heating elements

heating elements for bain maries

			
GEV No.	416195	Ref. No.	401023000
description	heating element 1500W 230V heating circuits 1 L 368mm L1 23mm W 268mm connection male faston 6.3mm connection distance 263mm tube ø 6.3mm dry heating element bain marie L2 345mm H 19mm		
For models:	BM1120, BMV1120, BMV2120		

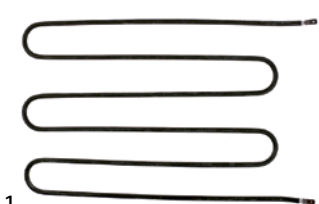





			
GEV No.	418668	Ref. No.	401021700 40121700
description	heating element 700W 230V heating circuits 1 L 370mm L1 35mm W 230mm connection 6.3 connection distance 224mm tube ø 6.3mm bain marie L2 335mm H 15mm		
For models:	BMPD2120, BMPD3120, BMPD4120, BMPK4120, BMSD2120, BMSD4120		

heating elements for chip scuttles

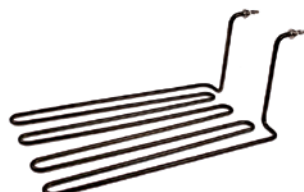
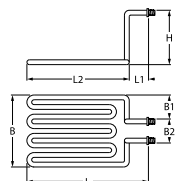
			
GEV No.	418659	Ref. No.	401021000
description	heating element 350W 230V heating circuits 1 L 175mm W 180mm connection 6.3 tube ø 6.5mm dry heating element hot dog machine L1 30mm L2 145mm H 17mm connection distance 174mm		

heating elements for fryers

2 hole fixing

 			
GEV No.	418665	Ref. No.	401003000
description	heating element 5000W 230V heating circuits 1 L 473mm W 250mm H 190mm connection M6 L1 23mm L2 450mm W1 53mm W2 145mm tube ø 8.5mm thread 1/4" windings 4 fryer		
For models:	FE60P		
accessories for	418665		
	GEV No.	361182	Ref. No. —
	nut thread 1/4" H 5mm nickel-plated brass WS 17 Qty 1 pcs		
	GEV No.	510417	Ref. No. —
	flat gasket fibre ED ø 20mm ID ø 14mm thickness 2mm Qty 1 pcs		
	GEV No.	520228	Ref. No. —
	tooth lock washer ID ø 15.3mm ED ø 24mm steel Qty 1 pcs for thread M14		
	GEV No.	550262	Ref. No. —
	flat gasket copper ED ø 20mm ID ø 14mm thickness 2mm		
	GEV No.	560113	Ref. No. —
	plain washer ID ø 6.4mm ED ø 12mm thickness 1.6mm SS Qty 20 pcs DIN 125A for thread M6		
	GEV No.	560133	Ref. No. —
	hexagonal nut thread M6 H 5mm WS 10 SS DIN/ISO DIN 934 / ISO 4032/8673 Qty 20 pcs		





 			
GEV No.	418654	Ref. No.	401001000
description	heating element 2100W 230V heating circuits 1 L 270mm W 120mm H 200mm L1 15mm L2 255mm H1 155mm H2 45mm thread 1/4" tube ø 8.5mm connection M4 fryer windings 4		
For models:	EF05, EF55, EF85, FE44, FE44E, FE74, FE74E		
accessories for	418654		
	GEV No.	521103	Ref. No. —
	nut thread M4 H 3mm WS 7 brass Qty 20 pcs		
	GEV No.	521104	Ref. No. —
	washer ID ø 4.3mm ED ø 8mm thickness 0.5mm brass Qty 20 pcs for thread M4		
	GEV No.	560111	Ref. No. —
	plain washer ID ø 4.3mm ED ø 9mm thickness 0.8mm SS Qty 20 pcs DIN 125A for thread M4		



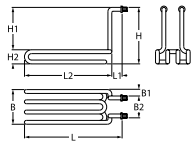

Table continues overleaf

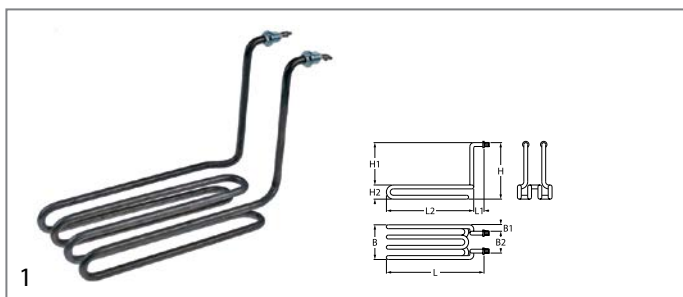

accessories for	418654			
	GEV No.	560131	Ref. No.	—
	hexagonal nut thread M4 H 3.2mm WS 7 SS DIN/ISO DIN 934 / ISO 4032/8673 Qty 20 pcs			







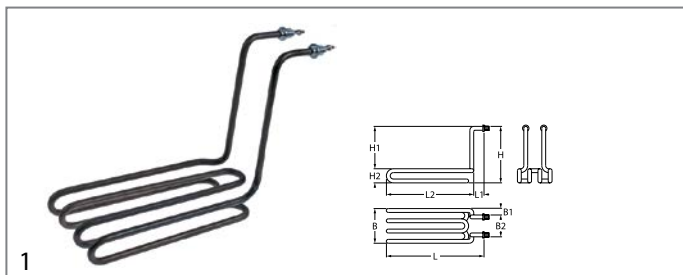

GEV No.	418669	Ref. No.	401002000
description	heating element 3000W 230V heating circuits 1 L 270mm W 110mm H 200mm L1 15mm L2 255mm H1 160mm H2 40mm thread 1/4" tube ø 8.5mm connection M4 fryer windings 4		
For models:	EF08, EF85, EF88, FE04S, FE07EV, FE07TE, FE44S, FE74E, FE77T		

accessories for	418669			
	GEV No.	521103	Ref. No.	—
	nut thread M4 H 3mm WS 7 brass Qty 20 pcs			
	GEV No.	521104	Ref. No.	—
	washer ID ø 4.3mm ED ø 8mm thickness 0.5mm brass Qty 20 pcs for thread M4			
	GEV No.	560111	Ref. No.	—
	plain washer ID ø 4.3mm ED ø 9mm thickness 0.8mm SS Qty 20 pcs DIN 125A for thread M4			
	GEV No.	560131	Ref. No.	—
	hexagonal nut thread M4 H 3.2mm WS 7 SS DIN/ISO DIN 934 / ISO 4032/8673 Qty 20 pcs			



GEV No.	418671	Ref. No.	401002520
description	heating element 3000W 230V heating circuits 1 L 300mm W 120mm H 215mm L1 50mm L2 250mm H1 180mm H2 35mm thread 1/4" tube ø 8.5mm connection M4 immersion heater fryer windings 4		

spare parts for	418671			
	GEV No.	510417	Ref. No.	—
	flat gasket fibre ED ø 20mm ID ø 14mm thickness 2mm Qty 1 pcs			
accessories for	418671			
	GEV No.	361182	Ref. No.	—
	nut thread 1/4" H 5mm nickel-plated brass WS 17 Qty 1 pcs			
	GEV No.	520228	Ref. No.	—
	tooth lock washer ID ø 15.3mm ED ø 24mm steel Qty 1 pcs for thread M14			
	GEV No.	521103	Ref. No.	—
	nut thread M4 H 3mm WS 7 brass Qty 20 pcs			
	GEV No.	521104	Ref. No.	—
	washer ID ø 4.3mm ED ø 8mm thickness 0.5mm brass Qty 20 pcs for thread M4			

accessories for	418671			
	GEV No.	550262	Ref. No.	—
	flat gasket copper ED ø 20mm ID ø 14mm thickness 2mm			
	GEV No.	560111	Ref. No.	—
	plain washer ID ø 4.3mm ED ø 9mm thickness 0.8mm SS Qty 20 pcs DIN 125A for thread M4			
	GEV No.	560131	Ref. No.	—
	hexagonal nut thread M4 H 3.2mm WS 7 SS DIN/ISO DIN 934 / ISO 4032/8673 Qty 20 pcs			

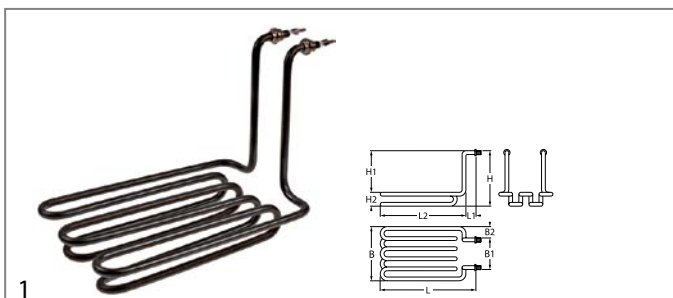

GEV No.	418655	Ref. No.	401002500
description	heating element 3000W 230V heating circuits 1 L 275mm W 175mm H 200mm L1 15mm L2 260mm H1 160mm H2 40mm thread 1/4" tube ø 8.5mm connection M4 windings 5 W1 50mm W2 75mm		
For models:	FE74, FE77, FE77V		

spare parts for	418655			
	GEV No.	510417	Ref. No.	—
	flat gasket fibre ED ø 20mm ID ø 14mm thickness 2mm Qty 1 pcs			
accessories for	418655			
	GEV No.	361182	Ref. No.	—
	nut thread 1/4" H 5mm nickel-plated brass WS 17 Qty 1 pcs			
	GEV No.	520228	Ref. No.	—
	tooth lock washer ID ø 15.3mm ED ø 24mm steel Qty 1 pcs for thread M14			
	GEV No.	521103	Ref. No.	—
	nut thread M4 H 3mm WS 7 brass Qty 20 pcs			
	GEV No.	521104	Ref. No.	—
	washer ID ø 4.3mm ED ø 8mm thickness 0.5mm brass Qty 20 pcs for thread M4			
	GEV No.	550262	Ref. No.	—
	flat gasket copper ED ø 20mm ID ø 14mm thickness 2mm			
	GEV No.	560111	Ref. No.	—
	plain washer ID ø 4.3mm ED ø 9mm thickness 0.8mm SS Qty 20 pcs DIN 125A for thread M4			
	GEV No.	560131	Ref. No.	—
	hexagonal nut thread M4 H 3.2mm WS 7 SS DIN/ISO DIN 934 / ISO 4032/8673 Qty 20 pcs			



GEV No.	418670	Ref. No.	401002510
description	heating element 3000W 230V heating circuits 1 L 310mm W 175mm H 220mm L1 50mm L2 260mm H1 180mm H2 40mm thread 1/4" tube ø 8.5mm connection M4 windings 5 W1 50mm W2 75mm		

heating elements for hot dog machines

GEV No.	418661	Ref. No.	401022500
description	heating element 1000W 230V L 180mm W 187mm H 18mm tube ø 6.2mm L1 30mm L2 150mm connection 6.3 connection distance 181mm heating circuits 1 hot dog machine		
For models:	HD3N, HD4N, HD4NK, HDN, WE11, WEV12		

heating elements for griddles

GEV No.	419009	Ref. No.	401025000
description	heating element 3000W 230V heating circuits 1 L 430mm W 270mm H 35mm tube ø 8.5mm W1 20mm W2 230mm connection male faston 6.3mm griddle connection distance 200mm dry heating element		
For models:	FTH30, FTH60, FTHR60, FTR30		

GEV No.	418656	Ref. No.	401020500
description	heating element 110W 230V L 131mm W 140mm H 6mm tube ø 6.5mm connection cable with thermal fuse cable length 160/300mm dry heating element heating circuits 1		
For models:	HD01, HD02, HD03, HD04, HD3N, HD4N, HD4NK		

heating elements for hot counters

GEV No.	415699	Ref. No.	401021200
description	heating element 400W 230V heating circuits 1 L 298mm W 138mm tube ø 6.3mm connection male faston 6.3mm dry heating element for vitrine 2 hole fixing thread M12x1.25 mounting distance 132mm		

heating elements for contact grills

GEV No.	418660	Ref. No.	401031200
description	heating element 1200W 230V L 177mm W 215mm H 20mm W1 35mm W2 145mm tube ø 6.3mm windings 4 connection M4		
For models:	PD2020L, PD2020R, PM2015R		





GEV No.	418666	Ref. No.	401021701	
description	heating element 700W 230V heating circuits 1 L 630mm W 160mm tube ø 6.3mm connection male faston 6.3mm for vitrine thread M12 mounting distance 154mm			
For models:	VEC810, VEC820			
spare parts for	418666			
	GEV No.	521110	Ref. No.	—
	flat gasket fibre ED ø 20mm ID ø 13mm thickness 2mm Qty 1 pcs			
accessories for	418666			
	GEV No.	520229	Ref. No.	—
	nut thread M12x1 H 4mm WS 16 zinc-coated steel Qty 1 pcs			
	GEV No.	521131	Ref. No.	—
	nut thread M12x1 H 3.5mm WS 17 SS Qty 1 pcs			
	GEV No.	528110	Ref. No.	—
	O-ring EPDM thickness 2.62mm ID ø 12.37mm Qty 1 pcs			

GEV No.	418664	Ref. No.	401031800
description	heating element 1800W 230V L 185mm W 205mm H 20mm W1 40mm W2 125mm tube ø 6.3mm windings 4 connection M4		
For models:	PD2020L, PD2020R, PM2015R		



heating elements for pasta cookers



GEV No.	418663	Ref. No.	401002600
description	heating element 3000W 230V L 245mm W 225mm H 27mm connection 6.3 thread M10x1 tube ø 6.3mm L1 120mm L2 125mm mounting distance 220mm		
spare parts for	418663		
	GEV No.	510893	Ref. No. —
	O-ring EPDM thickness 2.62mm ID ø 9.92mm Qty 1 pcs		
accessories for	418663		
	GEV No.	510416	Ref. No. —
	flat gasket fibre ED ø 19mm ID ø 10.5mm thickness 1.5mm for thread M10 Qty 1 pcs		
	GEV No.	520231	Ref. No. —
	nut thread M10x1 H 6mm WS 14 zinc-coated steel Qty 1 pcs		
	GEV No.	521129	Ref. No. —
	nut thread M10 H 6mm SS WS 17 Qty 1 pcs DIN/ISO DIN 439		

heating elements for pizza ovens

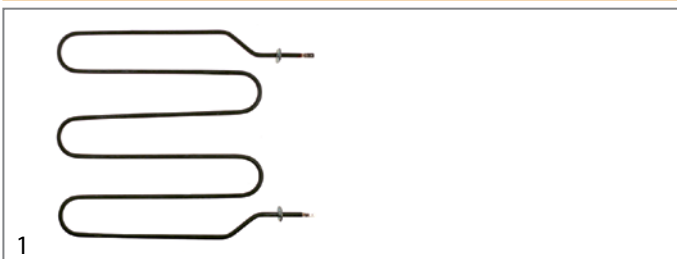

GEV No.	418672	Ref. No.	401031000
description	heating element 1000W 230V heating circuits 1 L 330mm W 300mm L1 30mm L2 60mm L3 240mm W1 35mm W2 230mm lug length 27mm lug width 22mm connection length 55mm connection male faston 6.3mm tube ø 6.3mm 2 hole fixing hole ø 3mm dry heating element pizza oven		
For models:	FP36, FP36S		

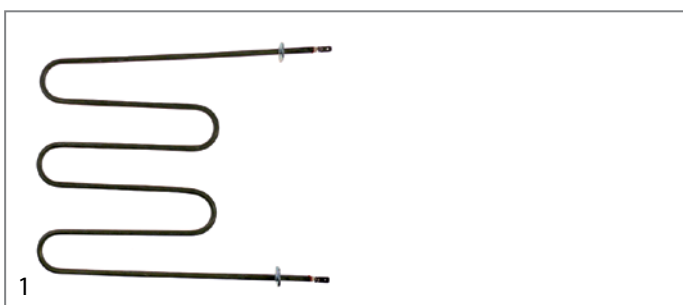

GEV No.	418667	Ref. No.	401021750
description	heating element 750W 230V heating circuits 1 L 310mm W 250mm lug length 30mm lug width 20.4mm connection male faston 6.3mm pizza oven		
For models:	FP36, FP36S		

heating elements for rolling grills



GEV No.	416189	Ref. No.	637108200
description	heating element 220W 240V heating circuits 1 L 359mm connection distance 359mm tube ø 8.5mm dry heating element roller grill		
For models:	CW8		

heating elements for salamanders/toast-

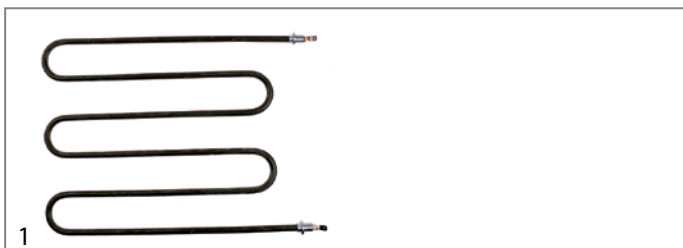

GEV No.	418653	Ref. No.	401024000
description	heating element 2200W 230V L 350mm W 260mm thread M12 mounting distance 245mm connection 6.3 air tube ø 8.5mm heating circuits 1 H 8.5mm		
spare parts for	418653		
	GEV No.	521110	Ref. No. —
	flat gasket fibre ED ø 20mm ID ø 13mm thickness 2mm Qty 1 pcs		
accessories for	418653		
	GEV No.	520229	Ref. No. —
	nut thread M12x1 H 4mm WS 16 zinc-coated steel Qty 1 pcs		
	GEV No.	521131	Ref. No. —
	nut thread M12x1 H 3.5mm WS 17 SS Qty 1 pcs		
	GEV No.	528110	Ref. No. —
	O-ring EPDM thickness 2.62mm ID ø 12.37mm Qty 1 pcs		



heating elements for heating bridges



1

GEV No.	418657	Ref. No.	401021500
description	heating element 500W 230V heating circuits 1 L 165mm W 125mm connection 6.3 tube ø 8.5mm dry heating element heated bridge L1 30mm L2 135mm H 16mm		

quartz heating elements



1

GEV No.	693058	Ref. No.	637000200
description	insulator female L 7mm hole ø 5.5mm ø 13mm		
For models:	CW8		



1

GEV No.	416187	Ref. No.	401023400
description	quartz heating element 400W 115V L 260mm ø 12mm connection male faston 6.3mm mounting distance 24.8mm		
For models:	TO920, TO940		



1

GEV No.	418625	Ref. No.	401023500
description	quartz heating element 500W 115V L 365mm ø 10mm connection male faston 6.3mm		
For models:	TO930, TO960		

heating elements for convection



1

GEV No.	418662	Ref. No.	401033000
description	heating element 3000W 230V heating circuits 1 ID ø 186mm ED ø 200mm L 217mm H 31mm L1 17mm W1 31mm H1 6mm H2 25mm flange length 70mm flange width 22mm hole distance 56mm connection male faston 6.3mm connection length 30mm tube ø 6.3mm convection heating element hole ø 5.5mm rectangular flange		
For models:	SPT60GLS, SPT90-5ELS, SPT90-5GLS, SPT90ELS, SPT90GL, SPT90GLS		
spare parts for	418662		
	GEV No.	510368	Ref. No. —
	gasket L 70mm W 23.5mm hole ø 5mm hole distance 56mm FIBER thickness 2mm for heating element		

accessories



1

GEV No.	693058	Ref. No.	637000200
description	insulator female L 7mm hole ø 5.5mm ø 13mm		
For models:	CW8		



1

GEV No.	693057	Ref. No.	637000100
description	insulator male L 10mm hole ø 8.4mm ø 13mm		
For models:	CW8		

hot plates

round

with radiused edge

for domestic kitchens



1

GEV No.	490006	Ref. No.	401051820
description	hot plate ø 180mm 2000W 230V with protector connection 4 screw clamps with 4mm spill ring		
For models:	SPT90-5ELS, SPT90ELS		



energy regulators

EGO

1-circuit



1

GEV No.	380015	Ref. No.	402520000 637060100
description	energy regulator 230V 13A single-circuit turn direction right shaft ø 6x4.6mm shaft L 23mm mounting thread M4 power release 6-100% no. 50.57021.010		
For models:	CW8		

thermostats

control and safety thermostats

EGO

safety thermostats

56._ series



1

GEV No.	390610	Ref. No.	402511000
description	safety thermostat switch-off temp. 235°C 1-pole 16A probe ø 3mm probe L 190mm capillary pipe 1000mm capillary pipe isolated 640mm gland nut probe SS		
For models:	EF05, EF08, EF55, EF85, EF88, FE04S, FE07EV, FE07TE, FE44, FE44E, FE44S, FE60P, FE74, FE74E, FE77, FE77T, FE77V		

CAEM

control thermostats



1

GEV No.	390082	Ref. No.	40250110
description	thermostat t.max. 100°C temperature range 30-90°C 1-pole 1CO 16A probe ø 6mm probe L 94mm capillary pipe 1600mm capillary pipe isolatedmm gland nut shaft ø 6x4.6mm shaft L 22mm shaft position upper rotation 270° probe material copper		

	1		
GEV No.	390604	Ref. No.	402501500
description	thermostat t.max. 110°C temperature range 30-110°C 1-pole 1NO 16A probe ø 5mm probe L 90mm capillary pipe 970mm capillary pipe isolated 28mm gland nut shaft ø 6x4.6mm shaft L 17mm rotation 270°		

	1		
GEV No.	390882	Ref. No.	402501501
description	thermostat t.max. 120°C temperature range 30-120°C 1-pole 1NO 16A probe ø 5mm probe L 80mm capillary pipe 980mm capillary pipe isolated 28mm gland nut shaft ø 6x4.6mm shaft L 17mm rotation 270° 250V		

	1		
GEV No.	390611	Ref. No.	402502000
description	thermostat t.max. 190°C temperature range 50-190°C 1-pole 1NO 16A probe ø 3mm probe L 185mm capillary pipe 980mm capillary pipe isolated 640mm gland nut shaft ø 6x4.6mm shaft L 23mm shaft position upper rotation 270° probe material SS		
For models:	EF05, EF08, EF55, EF85, EF88, FE04S, FE07EV, FE07TE, FE44, FE44E, FE44S, FE60P, FE74, FE74E, FE77, FE77T, FE77V, HD3N, HD4N, HD4NK, HDN		

	1		
GEV No.	390606	Ref. No.	402503150
description	thermostat t.max. 300°C temperature range 50-300°C 1-pole 1NO 16A probe ø 3mm probe L 175mm capillary pipe 1500mm capillary pipe isolated 650mm gland nut shaft ø 6x4.6mm shaft L 18mm rotation 270°		
For models:	SPT60GLS, SPT90-5ELS, SPT90-5GLS, SPT90ELS, SPT90GL, SPT90GLS		

GEV No.	390602	Ref. No.	402503000 402503002 402503500
description	thermostat t.max. 300°C temperature range 50-300°C 1-pole 1NO 16A probe ø 5mm probe L 70mm capillary pipe 900mm capillary pipe isolated 700mm gland nut shaft L 18mm rotation 270°		
For models:	FP36, FP36S, FTH30, FTH60, FTHR60, FTR30, PD2020L, PD2020R, PM2015R		

various

safety thermostats



GEV No.	390607	Ref. No.	402511200
description	safety thermostat switch-off temp. 360°C 1-pole 20A probe ø 3mm probe L 150mm capillary pipe 920mm capillary pipe isolated 240mm gland nut probe SS		
For models:	SPT60GLS, SPT90-5ELS, SPT90-5GLS, SPT90ELS, SPT90GL, SPT90GLS		

safety thermostats



GEV No.	390603	Ref. No.	402511130
description	safety thermostat switch-off temp. 130°C 1-pole 16A probe ø 5mm probe L 120mm capillary pipe 900mm capillary pipe isolatedmm gland nut probe SS		

accessories

connecting bows



GEV No.	550060	Ref. No.	402503201
description	connecting bow long for thermostat Qty 1 pcs		
For models:	SPT60GLS, SPT90-5ELS, SPT90ELS, SPT90GL, SPT90GLS		

TECASA

control thermostats



GEV No.	390980	Ref. No.	402501400
description	thermostat t.max. 90°C temperature range 30-90°C 1-pole 1NO 16A probe ø 6mm probe L 95mm capillary pipe 1550mm capillary pipe isolated 1500mm gland nut shaft ø 6x4.6mm shaft L 16mm shaft position° shaft position upper rotation 270° outer switch probe material SS probe thread disc ømm screw connection		

switches and momentary switches

rocker/momentary rocker switches

30x22mm



GEV No.	346896 ¹	Ref. No.	637086000
description	rocker switch mounting measurements 30x22mm black 2NO 250V 16A 0-I connection male faston 6.3mm ambient temperature max. 125/55°C protection IP65		
For models:	CW8		



¹non-illuminated



GEV No.	301003	Ref. No.	401500550	
description	rocker switch mounting measurements 30x22mm green 2NO 250V 16A illuminated 0-I connection male faston 6.3mm ambient temperature max. 125/55°C protection IP65			
For models:	BMPD2120, BMPD3120, BMPD4120, BMPK4120, BMSD2120, BMSD4120			
accessories for	301003			
	GEV No.	301036	Ref. No.	401509000
	protective cover internal size 30x22mm for rocker switch mounting measurementsmm			



			
1			
GEV No.	301036	Ref. No.	401509000
description	protective cover internal size 30x22mm for rocker switch mounting measurementsmm		
For models:	BM1120, BMPD2120, BMPD3120, BMPD4120, BMPK4120, BMSD2120, BMSD4120, BMV1120, BMV2120, FE07EV, FE07TE, FE44E, FE74E, FTH30, FTH60, FTHR60, FTR30, PD2020L, PD2020R, PM2015R		

			
1			
GEV No.	346377	Ref. No.	401500500
description	rocker switch mounting measurements 30x22mm black 2CO 230V 16A 0-I connection male faston 6.3mm ambient temperature max. 125/55°C protection IP40		
For models:	BM1120, BMV1120, BMV2120, FE07EV, FE07TE, FE44E, FE74E, FTH30, FTH60, FTHR60, FTR30, HD04, HD3N, HD4N, HD4NK, HDN, PD2020L, PD2020R, PM2015R, VEC810, VEC820, WE11, WEV12		
accessories for	346377		
		GEV No.	301036
		Ref. No.	401509000
	protective cover internal size 30x22mm for rocker switch mounting measurementsmm		

			
1			
GEV No.	346985	Ref. No.	401500600
description	rocker switch mounting measurements 30x22mm black 1NO/1CO 250V 16A 0-I/II connection male faston 6.3mm ambient temperature max. 85°C protection IP40		
For models:	HD01, HD02, HD03, HD3N, HD4N, HD4NK		

push/momentary push switches

30x22mm

			
1			
GEV No.	301086	Ref. No.	401500530
description	push switch mounting measurements 30x22mm black 2NO 250V 12A 0-1 connection male faston 6.3mm ambient temperature max. 85/55°C protection IP54 with protective collar		
For models:	FE04S, FE44, FE44S, FE60P, FE74, FE77, FE77T, FE77V		

			
1			
GEV No.	301036	Ref. No.	401509000
description	protective cover internal size 30x22mm for rocker switch mounting measurementsmm		
For models:	BM1120, BMPD2120, BMPD3120, BMPD4120, BMPK4120, BMSD2120, BMSD4120, BMV1120, BMV2120, FE07EV, FE07TE, FE44E, FE74E, FTH30, FTH60, FTHR60, FTR30, PD2020L, PD2020R, PM2015R		

microswitches

pin-plunger actuated

M10

			
1			
GEV No.	345032	Ref. No.	401520000
description	microswitch with plunger thread M10x1 thread L 12mm 250V 16A 1CO connection male faston 6.3mm stroke 7mm mounting distance 22mm L 28mm ambient temperature max. 125°C type SP9603 actuating force: 180g		
For models:	EF05, EF08, EF55, EF85, EF88, FE04S, FE07EV, FE07TE, FE44, FE44E, FE44S, FE60P, FE74, FE74E, FE77, FE77T, FE77V		

cam switches

2 operating positions

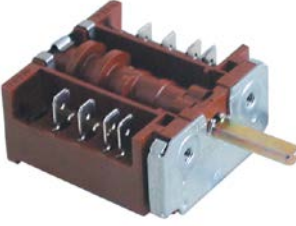
			
1			
GEV No.	301715	Ref. No.	401505000
description	cam switch 2 operating positions sequence 0-1 16A shaft ø 6x4.6mm shaft L 23mm connection male faston 6.3mm plastic		
For models:	TO920, TO930, TO940, TO960		

6 operating positions

			
1			
GEV No.	301714	Ref. No.	401505100
description	cam switch 6 operating positions 3-pole		
For models:	SPT90-5ELS, SPT90ELS		



operation switches



1			
GEV No.	300091	Ref. No.	401506000
description	operation switch EGO 2 operating positions 2NO 16A sequence 0-1 shaft ø 6x4.6mm shaft L 23mm connection screw ceramic		
For models:	SPT60GLS, SPT90-5ELS, SPT90-5GLS, SPT90ELS, SPT90GL, SPT90GLS		

lamps

indicator lights

indicator lights (complete)

ø10mm

with plug-in socket



1			
GEV No.	359139	Ref. No.	401515100 401515150
description	indicator light ø 10mm green 230V connection male faston 6.3mm Qty 1 pcs		
For models:	EF05, EF08, EF55, EF85, EF88, FP36, FP36S, HD01, HD02, HD03, HD04, HD3N, HD4N, HD4NK, HDN, SPT60GLS, SPT90-5ELS, SPT90-5GLS, SPT90ELS, SPT90GL, SPT90GLS, TO920, TO930, TO940, TO960		



1			
GEV No.	359140	Ref. No.	401515200 401515250
description	indicator light ø 10mm yellow 230V connection male faston 6.3mm Qty 1 pcs		
For models:	BMPD2120, BMPD3120, BMPD4120, BMPK4120, BMSD2120, BMSD4120, FP36, FP36S, SPT60GLS, SPT90-5ELS, SPT90-5GLS, SPT90ELS, SPT90GL, SPT90GLS, TO920, TO930, TO940, TO960		

30x22mm



1			
GEV No.	359164	Ref. No.	401510001 637082100
description	indicator light mounting measurements 30x22mm 230V green/white connection male faston 6.3mm temp.-resist. 125°C		
For models:	CW8		



1			
GEV No.	301138	Ref. No.	401510000
description	indicator light mounting measurements 30x22mm 230V red/green connection male faston 6.3mm temp.-resist. 125/55°C type RL2		
For models:	BM1120, BMV1120, BMV2120, FE04S, FE07EV, FE07TE, FE44, FE44E, FE44S, FE60P, FE74, FE74E, FE77, FE77T, FE77V, FTH30, FTH60, FTHR60, FTR30, PD2020L, PD2020R, PM2015R, VEC810, VEC820, WE11, WEV12		

timers

mechanical timers



1			
GEV No.	350181	Ref. No.	401550010
description	timer C20 with bell 2-pole operation time 15min impulse mechanical 2NO at 250V 16A permanent position yes shaft ø 6x4.6mm shaft 6x4.6mm shaft L 20mm mounting distance 28mm		
For models:	FP36, FP36S		



1			
GEV No.	360409	Ref. No.	401550000
description	timer MT49 2-pole operation time 15min impulse mechanical 2NO at 250V 16A permanent position no shaft 6x4.6mm shaft L 17mm mounting distance 28mm		
For models:	TO920, TO930, TO940, TO960		

audible timers



1			
GEV No.	350180	Ref. No.	401550025
description	audible timer operation time 120min ø 56mm shaft ø 6x4.6mm shaft L 24mm mounting distance 28mm		
For models:	SPT90-5ELS, SPT90-5GLS, SPT90ELS, SPT90GL, SPT90GLS		



contactors

TELEMECANIQUE (Schneider Electric)

power contactors



1			
GEV No.	380479	Ref. No.	401531090
description	power contactor resistive load 25A 230VAC (AC3/400V) 9A/4kW main contacts 3NO auxiliary contacts 1NO/1NC connection screw connection type LC1D09P7		
For models:	FP36S		



1			
GEV No.	380976	Ref. No.	401531000
description	power contactor resistive load 32A 230VAC (AC3/400V) 18A/7.5kW main contacts 3NO auxiliary contacts 1NO/1NC connection screw connection		
For models:	FE07TE, FE77T		



1			
GEV No.	380979	Ref. No.	401531050
description	power contactor resistive load 40A 230VAC (AC3/400V) 25A/11kW main contacts 3NO auxiliary contacts 1NO/1NC connection screw connection type LC1D25P7		
For models:	FE60P		

fans

hot air motors

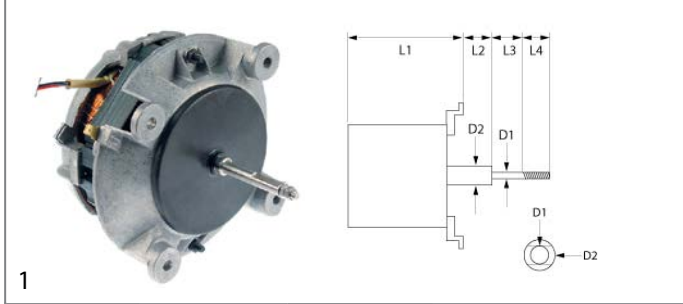

1			
GEV No.	500662	Ref. No.	403000200
description	fan motor 220-240V 1 phase 50/60Hz 0.12kW 2800/3200rpm speeds 1 L1 85mm L2 7mm L3 47mm L4 12mm D1 ø 8/6mm D2 ø 12mm M5R ET 1.6A power input 0.25W suitable capacitor 5µF/400V		
For models:	SPT60GLS, SPT90-5ELS, SPT90-5GLS, SPT90ELS, SPT90GL, SPT90GLS		



1			
GEV No.	601450	Ref. No.	403000250
description	fan wheel D1 ø 160mm H1 45mm blades 36 D2 ø 8mm D3 ø 8mm H2 24mm		
For models:	SPT60GLS, SPT90-5ELS, SPT90-5GLS, SPT90ELS, SPT90GL, SPT90GLS		

motors

gear motors

for grills

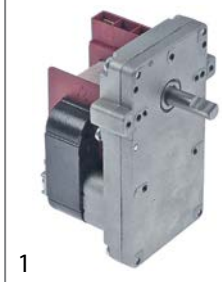

1			
GEV No.	499209	Ref. No.	637075100
description	gear motor KENTA type K9113069 23W 230V 50Hz 2.5rpm shaft ø 6x8mm L 108mm W 58mm H 66mm		
For models:	CW8		



condensators & interference suppression filters

operating capacitors

plastic



1

GEV No.	365009	Ref. No.	401590400
description	operating capacitor capacity 2.5µF 400V tolerance 5% 50Hz ambient temperature max. -25 to +85°C ø 36.5mm L 55mm M8 plastic connection male faston 6.3mm 1.27.65C3 protection		
For models:	SPT60GLS, SPT90-5ELS, SPT90-5GLS, SPT90ELS, SPT90GL, SPT90GLS		

electric accessories

plugs - couplings - power sockets

protective contact power sockets

producer-specific power sockets

miscellaneous



1

GEV No.	550975	Ref. No.	401590000
description	built-in socket max. 16A with earth pin countries B 240V mounting ø 43mm 1 phase L/N/PE		
For models:	BMPD2120, BMPD3120, BMPD4120, BMPK4120		

cables

spiral cables



1

GEV No.	550071	Ref. No.	402010100
description	spiral cable plug type CEE7/7 type E+F 1.5mm ² 3-pole with plug L 500mm expansion 5:1 countries A/D/I black		
For models:	BMPD2120, BMPD3120, BMPD4120, BMPK4120		

accessories

cable glands

threaded cable glands

screw connections



1

GEV No.	550971	Ref. No.	402086016
description	cable gland thread PG16 cable ø 14mm mounting ø 22.5mm Qty 1 pcs plastic WS 27		
For models:	FE07TE, FE60P, FE77T, FTH60, FTHR60, PD2020L, PD2020R, SPT90-5ELS, SPT90ELS		

terminals

connection terminals with screw/faston connections



1

GEV No.	550517	Ref. No.	402080100
description	power terminal block 5-pole max. 40A max 450V connection M6/ male faston 6.3mm temp.-resist. 150°C cross section 6mm ²		
For models:	FE07TE, FE60P, FE77T, FTH60, FTHR60, PD2020L, PD2020R, SPT90-5ELS, SPT90ELS		

connection terminals with strain relief



1







GEV No.	550976	Ref. No.	402085500
description	power terminal block 2-pole max 450V max. 16A cable ø 10.5mm cross section 1.5mm ² with strain relief		
For models:	BM1120, BMPD2120, BMPD3120, BMPD4120, BMPK4120, BMSD2120, BMSD4120, BMV1120, BMV2120, FE04S, FE07EV, FE44, FE44E, FE44S, FE74, FE74E, FE77, FE77V, FP36, FP36S, FTH30, FTR30, HD01, HD02, HD03, HD04, HD3N, HD4N, HD4NK, HDN, PM2015R, TO920, TO930, TO940, TO960, VEC810, VEC820, WE11, WEV12		

gas taps



PEL

20S series







GEV No.	104774	Ref. No.	404500100
description	gas tap PEL type 20S gas inlet M16x1.5 (tube ø 10mm) bypass nozzle ø 0mm gas outlet M16x1.5 (tube ø 10/8mm) thermocouple connection M8x1 pilot connection shaft ø 8x6.5mm shaft L 22/15mm shaft flat upper without ignition flame connection		
For models:	FTH30GL		
spare parts for	104774		
	GEV No.	101060	Ref. No. —
	magnet unit standard L 39mm D1 ø 15.4mm D2 ø 11mm suitable for PEL20-21/JUNKERS/EGA		
	GEV No.	101230	Ref. No. —
	thermocouple nut T1: M8x1 T2: M18x1 aluminium		
accessories for	104774		
	GEV No.	101278	Ref. No. —
	olive for pipe ø 10mm Qty 1 pcs		
	GEV No.	101300	Ref. No. —
	union nut thread M16x1.5 tube ø 10mm		
	GEV No.	101450	Ref. No. —
	olive for pipe ø 8mm L 12.7mm Qty 1 pcs ED ø 10mm		
	GEV No.	101451	Ref. No. —
	union nut thread M16x1.5 tube ø 8mm		

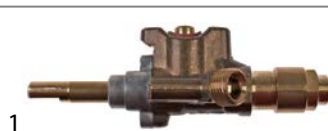

GEV No.	106806	Ref. No.	404500110
description	gas tap PEL type 20S gas inlet pipe flange ø21mm bypass nozzle ø 0mm gas outlet M16x1.5 (tube ø 10/8mm) thermocouple connection M8x1 pilot connection shaft ø 8x6.5mm shaft L 23/15mm shaft flat upper		
For models:	SPT60GLS, SPT90-5GLS, SPT90GLS		
spare parts for	106806		
	GEV No.	101060	Ref. No. —
	magnet unit standard L 39mm D1 ø 15.4mm D2 ø 11mm suitable for PEL20-21/JUNKERS/EGA		
	GEV No.	101230	Ref. No. —
	thermocouple nut T1: M8x1 T2: M18x1 aluminium		

SABAF



GEV No.	104775	Ref. No.	404000260
description	gas tap SABAF type 10 gas inlet pipe flange ø14mm bypass nozzle ø 0.56mm gas outlet 1/4" (tube ø 8mm) front fixing thermocouple connection M8x1 shaft ø 8x6.5mm shaft L 32/12.5mm shaft flat right		
For models:	SPT90GL		
spare parts for	104775		
	GEV No.	106724	Ref. No. —
	magnet unit L 30mm D1 ø 12.5mm D2 ø 8.5mm suitable for SABAF		
accessories for	104775		
	GEV No.	101277	Ref. No. 404000204 404000263
	olive ID ø 8mm Qty 1 pcs		
	GEV No.	520656	Ref. No. —
	union nut thread 1/4" tube ø 6/8mm		



GEV No.	106577	Ref. No.	404000261
description	gas tap SABAF type 10 gas inlet pipe flange ø23mm bypass nozzle ø 0.38mm gas outlet 1/4" (tube ø 8mm) front fixing thermocouple connection M8x1 shaft ø 8x6.5mm shaft L 32/12.5mm shaft flat right		
For models:	SPT90GL		
spare parts for	106577		
	GEV No.	106724	Ref. No. —
	magnet unit L 30mm D1 ø 12.5mm D2 ø 8.5mm suitable for SABAF		
accessories for	106577		
	GEV No.	101277	Ref. No. 404000204 404000263
	olive ID ø 8mm Qty 1 pcs		
	GEV No.	101376	Ref. No. —
	gasket ID ø 8mm ED ø 12mm H 3/5mm		
	GEV No.	101751	Ref. No. —
	bracket		
	GEV No.	520656	Ref. No. —
	union nut thread 1/4" tube ø 6/8mm		



ignition parts

electrodes

GEV No.	104772	Ref. No.	404000209 500401800
description	ignition electrode D1 ø 5mm cable length 550mm connection ø2.4mm D2 ø 6mm BL1 16mm BL2 2mm BL3 5mm BL4 8.5mm		
For models:	SPT90GL		

GEV No.	104785	Ref. No.	404530200
description	ignition electrode flange length 38mm flange width 17mm D1 ø 9.5mm L1 15mm BL1 30mm BL2 30mm connection M4 fixing dimensions ø4.5mm mounting distance 28mm		
For models:	FTH30GL		

ignition cables

pre-assembled cables

GEV No.	100186	Ref. No.	402008000
description	ignition cable cable length 600mm connection ø2.4mm / lug M4		
For models:	FTH30GL		

piezoelectric igniters

mounting diameter 18mm

GEV No.	100009	Ref. No.	401540000	
description	piezoelectric igniter body plastic blowing mounting ø 18mm connection ø2.4mm front measurements 26mm M18x1.5			
accessories for	100009			
	GEV No.	101339	Ref. No.	—
	cover cap for piezoelectric igniter			

accessories for	100009			
	GEV No.	106869	Ref. No.	—
	cover cap for piezoelectric igniter ID ø 22mm ED ø 35mm H 25mm			
	GEV No.	107931	Ref. No.	—
	cover cap for piezoelectric igniter ID ø 21mm ED ø 36mm			

thermocouples

threaded thermocouples

threaded thermocouples standard

with socket with thread M8x1

SIT

GEV No.	107630	Ref. No.	404050200	
description	thermocouple SIT M8x1 L 600mm M8x1			
For models:	FTH30GL, SPT60GLS, SPT90-5GLS, SPT90GL, SPT90GLS			
accessories for	107630			
	GEV No.	102067	Ref. No.	—
	nut thread M8x1 H 3mm brass Qty 1 pcs type SEF 1			

accessories

miscellaneous

GEV No.	104771	Ref. No.	450401057
description	fastening angle for thermocouple		

gas burners

hob burners

universal hob burners

SABAF

1 series



GEV No.	104288	Ref. No.	404000200
description	burner cap 3.6kW ø 120mm		
For models:	SPT90GL		
accessories for	104288		
	GEV No.	104289	Ref. No. 404000203
	burner lower part 3/3.6kW for burner cap ø 90/120mm		
	GEV No.	105086	Ref. No. 404000201
	burner ring 3.6kW for burner cap ø 120mm		
	GEV No.	105087	Ref. No. 404000202
	burner head 3.6kW for burner cap ø 120mm		



GEV No.	104286	Ref. No.	404000248
description	burner cap 3kW ø 90mm		
For models:	SPT90GL		
accessories for	104286		
	GEV No.	104289	Ref. No. 404000203
	burner lower part 3/3.6kW for burner cap ø 90/120mm		
	GEV No.	105089	Ref. No. 404000249
	burner ring 3kW for burner cap ø 90mm		
	GEV No.	105090	Ref. No. 404000250
	burner head 3kW for burner cap ø 90mm		



GEV No.	105087	Ref. No.	404000202
description	burner head 3.6kW for burner cap ø 120mm		
For models:	SPT90GL		
accessories for	105087		
	GEV No.	104288	Ref. No. 404000200
	burner cap 3.6kW ø 120mm		
	GEV No.	105085	Ref. No. —
	burner cap ø 120mm		
	GEV No.	105086	Ref. No. 404000201
	burner ring 3.6kW for burner cap ø 120mm		

accessories for	105087		
	GEV No.	105088	Ref. No. —
	burner cap A ø 110mm with central hole		
	GEV No.	105089	Ref. No. 404000249
	burner ring 3kW for burner cap ø 90mm		







GEV No.	105090	Ref. No.	404000250
description	burner head 3kW for burner cap ø 90mm		
For models:	SPT90GL		
accessories for	105090		
	GEV No.	104286	Ref. No. 404000248
	burner cap 3kW ø 90mm		
	GEV No.	104289	Ref. No. 404000203
	burner lower part 3/3.6kW for burner cap ø 90/120mm		
	GEV No.	105089	Ref. No. 404000249
	burner ring 3kW for burner cap ø 90mm		



GEV No.	104289	Ref. No.	404000203
description	burner lower part 3/3.6kW for burner cap ø 90/120mm		
For models:	SPT90GL		
accessories for	104289		
	GEV No.	104286	Ref. No. 404000248
	burner cap 3kW ø 90mm		
	GEV No.	104288	Ref. No. 404000200
	burner cap 3.6kW ø 120mm		
	GEV No.	105086	Ref. No. 404000201
	burner ring 3.6kW for burner cap ø 120mm		
	GEV No.	105087	Ref. No. 404000202
	burner head 3.6kW for burner cap ø 120mm		
	GEV No.	105089	Ref. No. 404000249
	burner ring 3kW for burner cap ø 90mm		
	GEV No.	105090	Ref. No. 404000250
	burner head 3kW for burner cap ø 90mm		
	GEV No.	106482	Ref. No. —
	gas injector thread M6x0.75 WS 7 bore ø 1.1mm		
	GEV No.	106485	Ref. No. —
	gas injector thread M6x0.75 WS 7 bore ø 1.6mm		





			
1			
GEV No.	105086	Ref. No.	404000201
description	burner ring 3.6kW for burner cap ø 120mm		
For models:	SPT90GL		
accessories for	105086		
	GEV No.	105085	Ref. No. —
	burner cap ø 120mm		
	GEV No.	105087	Ref. No. 404000202
	burner head 3.6kW for burner cap ø 120mm		
	GEV No.	105088	Ref. No. —
	burner cap A ø 110mm with central hole		
	GEV No.	105089	Ref. No. 404000249
	burner ring 3kW for burner cap ø 90mm		

			
1			
GEV No.	105089	Ref. No.	404000249
description	burner ring 3kW for burner cap ø 90mm		
For models:	SPT90GL		
accessories for	105089		
	GEV No.	104286	Ref. No. 404000248
	burner cap 3kW ø 90mm		
	GEV No.	104289	Ref. No. 404000203
	burner lower part 3/3.6kW for burner cap ø 90/120mm		
	GEV No.	105090	Ref. No. 404000250
	burner head 3kW for burner cap ø 90mm		

FLAM GAS

FGP series

			
1			
GEV No.	104776	Ref. No.	404000113
description	air mixing tube L 43.4mm ø 14mm		
For models:	SPT60GLS, SPT90-5GLS, SPT90GLS		

			
1			
GEV No.	104773	Ref. No.	404000111
description	burner cap ø 83mm 4.5kW		
For models:	SPT60GLS, SPT90-5GLS, SPT90GLS		

			
1			
GEV No.	104762	Ref. No.	404000112
description	burner head for burner cap ø 83mm 4.5kW		
For models:	SPT60GLS, SPT90-5GLS, SPT90GLS		

			
1			
GEV No.	104763	Ref. No.	404000114
description	burner lower part for burner cap ø 83mm 4.5kW		
For models:	SPT60GLS, SPT90-5GLS, SPT90GLS		

			
1			
GEV No.	104764	Ref. No.	404000105
description	burner unit 4.5kW complete		

			
1			
GEV No.	104784	Ref. No.	404520200
description	nozzle holder nozzle mounting M10x1 tube ø 10mm gas inlet M16x1.5 gas outlet M14x1		
For models:	FTH30GL		

producer-specific hob burners

RM GASTRO

600 (1) series







			
1			
GEV No.	104288	Ref. No.	404000200
description	burner cap 3.6kW ø 120mm		
For models:	SPT90GL		
accessories for	104288		
	GEV No.	104289	Ref. No. 404000203
	burner lower part 3/3.6kW for burner cap ø 90/120mm		
	GEV No.	105086	Ref. No. 404000201
	burner ring 3.6kW for burner cap ø 120mm		

Table continues overleaf





accessories for	104288		
	GEV No.	105087	Ref. No. 404000202
burner head 3.6kW for burner cap ø 120mm			

1			
GEV No.	104286	Ref. No.	404000248
description	burner cap 3kW ø 90mm		
For models:	SPT90GL		
accessories for	104286		
	GEV No.	104289	Ref. No. 404000203
burner lower part 3/3.6kW for burner cap ø 90/120mm			
	GEV No.	105089	Ref. No. 404000249
burner ring 3kW for burner cap ø 90mm			
	GEV No.	105090	Ref. No. 404000250
burner head 3kW for burner cap ø 90mm			

1			
GEV No.	105087	Ref. No.	404000202
description	burner head 3.6kW for burner cap ø 120mm		
For models:	SPT90GL		
accessories for	105087		
	GEV No.	104288	Ref. No. 404000200
burner cap 3.6kW ø 120mm			
	GEV No.	105085	Ref. No. —
burner cap ø 120mm			
	GEV No.	105086	Ref. No. 404000201
burner ring 3.6kW for burner cap ø 120mm			
	GEV No.	105088	Ref. No. —
burner cap A ø 110mm with central hole			
	GEV No.	105089	Ref. No. 404000249
burner ring 3kW for burner cap ø 90mm			



1			
GEV No.	105090	Ref. No.	404000250
description	burner head 3kW for burner cap ø 90mm		
For models:	SPT90GL		
accessories for	105090		
	GEV No.	104286	Ref. No. 404000248
burner cap 3kW ø 90mm			
	GEV No.	104289	Ref. No. 404000203
burner lower part 3/3.6kW for burner cap ø 90/120mm			

accessories for	105090		
	GEV No.	105089	Ref. No. 404000249
burner ring 3kW for burner cap ø 90mm			

1			
GEV No.	104289	Ref. No.	404000203
description	burner lower part 3/3.6kW for burner cap ø 90/120mm		
For models:	SPT90GL		
accessories for	104289		
	GEV No.	104286	Ref. No. 404000248
burner cap 3kW ø 90mm			
	GEV No.	104288	Ref. No. 404000200
burner cap 3.6kW ø 120mm			
	GEV No.	105086	Ref. No. 404000201
burner ring 3.6kW for burner cap ø 120mm			
	GEV No.	105087	Ref. No. 404000202
burner head 3.6kW for burner cap ø 120mm			
	GEV No.	105089	Ref. No. 404000249
burner ring 3kW for burner cap ø 90mm			
	GEV No.	105090	Ref. No. 404000250
burner head 3kW for burner cap ø 90mm			
	GEV No.	106482	Ref. No. —
gas injector thread M6x0.75 WS 7 bore ø 1.1mm			
	GEV No.	106485	Ref. No. —
gas injector thread M6x0.75 WS 7 bore ø 1.6mm			

1			
GEV No.	105086	Ref. No.	404000201
description	burner ring 3.6kW for burner cap ø 120mm		
For models:	SPT90GL		
accessories for	105086		
	GEV No.	105085	Ref. No. —
burner cap ø 120mm			
	GEV No.	105087	Ref. No. 404000202
burner head 3.6kW for burner cap ø 120mm			
	GEV No.	105088	Ref. No. —
burner cap A ø 110mm with central hole			
	GEV No.	105089	Ref. No. 404000249
burner ring 3kW for burner cap ø 90mm			



 <p>1</p>			
GEV No.	105089	Ref. No.	404000249
description	burner ring 3kW for burner cap ø 90mm		
For models:	SPT90GL		
accessories for	105089		
 <p>GEV No. 104286 Ref. No. 404000248</p> <p>burner cap 3kW ø 90mm</p>			
 <p>GEV No. 104289 Ref. No. 404000203</p> <p>burner lower part 3/3.6kW for burner cap ø 90/120mm</p>			
 <p>GEV No. 105090 Ref. No. 404000250</p> <p>burner head 3kW for burner cap ø 90mm</p>			

 <p>1</p>			
GEV No.	104764	Ref. No.	404000105
description	burner unit 4.5kW complete		

 <p>1</p>			
GEV No.	104784	Ref. No.	404520200
description	nozzle holder nozzle mounting M10x1 tube ø 10mm gas inlet M16x1.5 gas outlet M14x1		
For models:	FTH30GL		

600 (2) series			
 <p>1</p>			
GEV No.	104776	Ref. No.	404000113
description	air mixing tube L 43.4mm ø 14mm		
For models:	SPT60GLS, SPT90-5GLS, SPT90GLS		

pan supports			
 <p>1</p>			
GEV No.	211055	Ref. No.	408014035 SPG 07313
description	pan support W 315mm L 515mm H 43mm stainless steel		
For models:	SPT90GL		

 <p>1</p>			
GEV No.	104773	Ref. No.	404000111
description	burner cap ø 83mm 4.5kW		
For models:	SPT60GLS, SPT90-5GLS, SPT90GLS		

 <p>1</p>			
GEV No.	211092	Ref. No.	408014065
description	pan support W 320mm L 520mm H 45mm		
For models:	SPT60GLS, SPT90-5GLS, SPT90GLS		

 <p>1</p>			
GEV No.	104762	Ref. No.	404000112
description	burner head for burner cap ø 83mm 4.5kW		
For models:	SPT60GLS, SPT90-5GLS, SPT90GLS		

 <p>1</p>			
GEV No.	104763	Ref. No.	404000114
description	burner lower part for burner cap ø 83mm 4.5kW		
For models:	SPT60GLS, SPT90-5GLS, SPT90GLS		

accessories

pan supports



1

GEV No.	211055	Ref. No.	408014035 SPG 07313
description	pan support W 315mm L 515mm H 43mm stainless steel		
For models:	SPT90GL		



1

GEV No.	211092	Ref. No.	408014065
description	pan support W 320mm L 520mm H 45mm		
For models:	SPT60GLS, SPT90-5GLS, SPT90GLS		

bar burners

bar burners



1

GEV No.	104761	Ref. No.	404000100
description	bar burner ø 40mm Wmm Hmm L 385mm flange width 43mm flange length 43mm griddle		
For models:	FTH30GL		



1

GEV No.	211091	Ref. No.	503000268
description	chargrill grid L 485mm W 310mm		



1

GEV No.	211090	Ref. No.	503000285
description	chargrill grid L 485mm W 310mm fish		



1

GEV No.	210256	Ref. No.	503000305 503000310
description	lava rock grid L 420mm W 240mm H 35mm		



1

GEV No.	211089	Ref. No.	503000355 503000360
description	lava rock grid L 570mm W 420mm H 35mm		

chargrill grids



1

GEV No.	211091	Ref. No.	503000268
description	chargrill grid L 485mm W 310mm		



1

GEV No.	211090	Ref. No.	503000285
description	chargrill grid L 485mm W 310mm fish		

lava rock grids



1

GEV No.	210256	Ref. No.	503000305 503000310
description	lava rock grid L 420mm W 240mm H 35mm		



1

GEV No.	211089	Ref. No.	503000355 503000360
description	lava rock grid L 570mm W 420mm H 35mm		



accessories

nozzle holders



1

GEV No.	104784	Ref. No.	404520200
description	nozzle holder nozzle mounting M10x1 tube ø 10mm gas inlet M16x1.5 gas outlet M14x1		
For models:	FTH30GL		

miscellaneous



1

GEV No.	104786	Ref. No.	404000109
description	connecting fitting L 27.5mm		
For models:	SPT60GLS, SPT90-5GLS, SPT90GLS		

gas nozzles

main nozzles

gas nozzles M6x0.75



1

GEV No.	104766	Ref. No.	404000252
description	gas injector thread M6x0.75 WS 7 bore ø 0.85mm		
For models:	SPT90GL		



1

GEV No.	104767	Ref. No.	404000207
description	gas injector thread M6x0.75 WS 7 bore ø 0.96mm		
For models:	SPT90GL		



1

GEV No.	104782	Ref. No.	404000251
description	gas injector thread M6x0.75 WS 7 bore ø 0.75mm		
For models:	SPT90GL		



1

GEV No.	104765	Ref. No.	404000206
description	gas injector thread M6x0.75 WS 7 bore ø 0.8mm		
For models:	SPT90GL		



1

GEV No.	104781	Ref. No.	404000253
description	gas injector thread M6x0.75 WS 7 bore ø 1.3mm		
For models:	SPT90GL		



1

GEV No.	104778	Ref. No.	404000208
description	gas injector thread M6x0.75 WS 7 bore ø 1.45mm		
For models:	SPT90GL		



1

GEV No.	104787	Ref. No.	404000254
description	gas injector thread M6x0.75 WS 7 bore ø 1.4mm		
For models:	SPT90GL		



1

GEV No.	104788	Ref. No.	404000211
description	gas injector thread M6x0.75 WS 7 bore ø 1.58mm		
For models:	SPT90GL		

gas nozzles M10x1



1

GEV No.	100633	Ref. No.	404547077
description	gas injector thread M10x1 WS 11 bore ø 0.75mm inner peaked		





1

GEV No.	100636	Ref. No.	404547093
description	gas injector thread M10x1 WS 11 bore ø 0.9mm inner peaked		
For models:	FTH30GL		

			
1			
GEV No.	100637	Ref. No.	404547110
description	gas injector thread M10x1 WS 11 bore ø 1.1mm inner peaked		

			
1			
GEV No.	100641	Ref. No.	404547135
description	gas injector thread M10x1 WS 11 bore ø 1.35mm inner peaked		
For models:	FTH30GL		

			
1			
GEV No.	104780	Ref. No.	404547105
description	gas injector thread M10x1 WS 11 bore ø 1.05mm		
For models:	SPT90GLS		

			
1			
GEV No.	104779	Ref. No.	404547160
description	gas injector thread M10x1 WS 11 bore ø 1.6mm		
For models:	SPT90GLS		

			
1			
GEV No.	104777	Ref. No.	404547090
description	gas injector thread M10x1 WS 11 bore ø 1.7mm		
For models:	SPT90GLS		

			
1			
GEV No.	104768	Ref. No.	404547170
description	gas injector thread M10x1 WS 13 bore ø 1.7mm		
For models:	SPT90GLS		

auxiliary gas parts

screw connections

union screws

			
1			
GEV No.	104783	Ref. No.	404000205
description	union screw for pipe ø 8mm Qty 1 pcs WS 13		
For models:	SPT90GL		

consumables

lava rocks / ceramic briquetts

			
1			
GEV No.	211008	Ref. No.	153000150
description	lava rocks size ca.20-70mm Qty 5kg		

equipment-specific units

for bain marie

spare parts and accessories

			
1			
GEV No.	691318	Ref. No.	500400365
description	fixing plate mounting pos. right		
For models:	FTH30GL, SPT60GLS, SPT90-5ELS, SPT90-5GLS, SPT90ELS, SPT90GL, SPT90GLS		

housing and bezels

			
1			
GEV No.	691357	Ref. No.	450134000
description	fastening angle		

for deep fryers

housing and bezels

			
1			
GEV No.	691357	Ref. No.	450134000
description	fastening angle		

miscellaneous

			
1			
GEV No.	514402	Ref. No.	452510015 502520710
description	drain filter ø 37.5mm		

			
1			
GEV No.	541922	Ref. No.	408712120
description	drain pipe L 120mm thread 3/4"		

			
1			
GEV No.	541923	Ref. No.	408712060
description	drain pipe L 60mm thread 3/4"		

for griddles

spare parts and accessories

			
1			
GEV No.	691318	Ref. No.	500400365
description	fixing plate mounting pos. right		
For models:	FTH30GL, SPT60GLS, SPT90-5ELS, SPT90-5GLS, SPT90ELS, SPT90GL, SPT90GLS		

for hot dog machines

lids

			
1			
GEV No.	691299	Ref. No.	502000400
description	lid ø 200mm		
For models:	HD3N, HD4N, HD4NK, HDN		

glass cylinders

			
1			
GEV No.	691325	Ref. No.	407860003
description	glass cylinder ø 193.5mm H 240mm		
For models:	HD3N, HD4N, HD4NK, HDN		

miscellaneous

			
1			
GEV No.	691301	Ref. No.	502000350
description	bottom plate for hot dog machine perforated ø 190mm		
For models:	HD3N, HD4N, HD4NK, HDN		

			
1			
GEV No.	691302	Ref. No.	502000600
description	connection plate for hot dog machine aluminium HD-01		
For models:	HD01		

			
1			
GEV No.	691305	Ref. No.	502000601
description	connection plate for hot dog machine aluminium HD-02		
For models:	HD02		



1

GEV No.	691303	Ref. No.	502000602
description	connection plate for hot dog machine aluminium HD-03		
For models:	HD03, HD3N		



1

GEV No.	691306	Ref. No.	502000700
description	connection plate for hot dog machine aluminium HD-04		
For models:	HD04, HD4N, HD4NK		



1

GEV No.	691304	Ref. No.	502000500
description	connection plate for hot dog machine L 195mm W 195mm thickness 7.5mm aluminium HD-xN		
For models:	HD3N, HD4N, HD4NK, HDN		



1

GEV No.	691359	Ref. No.	630011300
description	mounting angle		
For models:	CW8		



1

GEV No.	691358	Ref. No.	630011200 6440073
description	mounting angle L 207mm		
For models:	CW8		



1

GEV No.	691300	Ref. No.	452005400
description	separating plate for hot dog machine perforated L 230mm W 178mm		
For models:	HD3N, HD4N, HD4NK, HDN		

skewers



1

GEV No.	691316	Ref. No.	408706100
description	bun spikes ø 24.8mm hot dog grill aluminium		
For models:	HD01, HD02, HD03, HD04, HD3N, HD4N, HD4NK		

water containers



1

GEV No.	691307	Ref. No.	408735100 408735101
description	water container for hot dog machine ø 197mm		
For models:	HD3N, HD4N, HD4NK, HDN		

gear wheels



1

GEV No.	693062	Ref. No.	633100300
description	gear wheel teeth 11 shaft intake ø 8mm ø 31mm hub ø 18mm stainless steel		
For models:	CW8		

for ovens

spare parts and accessories



1

GEV No.	691318	Ref. No.	500400365
description	fixing plate mounting pos. right		
For models:	FTH30GL, SPT60GLS, SPT90-SELS, SPT90-5GLS, SPT90ELS, SPT90GL, SPT90GLS		



doors



1

GEV No.	691375	Ref. No.	507009030
description	oven door H 435mm W 650mm complete		
For models:	SPT60GLS, SPT90-SELS, SPT90-5GLS, SPT90ELS, SPT90GL, SPT90GLS		

for pizza ovens

spare parts and accessories



1

GEV No.	691317	Ref. No.	454500360
description	fastening angle for handle		
For models:	FP36S		

for rolling grills

pipes

bushes



1

GEV No.	693060	Ref. No.	633080100
description	bushing PTFE		
For models:	CW8		

pipes



1

GEV No.	693713	Ref. No.	634210100
description	pipe with gear wheel L 370mm for roller grill		

gear wheels



1

GEV No.	693062	Ref. No.	633100300
description	gear wheel teeth 11 shaft intake ø 8mm ø 31mm hub ø 18mm stainless steel		
For models:	CW8		

for dishwashers

washing and rinsing systems



1

GEV No.	510011	Ref. No.	429008
description	screw connection plastic		

for toasters

pliers

pliers



1

GEV No.	690010	Ref. No.	408012003
description	plier for toaster H 180mm total length 100mm		
For models:	TO920, TO930, TO940, TO960		

knobs

producer-specific knobs

RM GASTRO



1

GEV No.	112926	Ref. No.	402590500
description	knob energy regulator 1-3 t.max.°C temperature range° C ø 42mm shaft ø 6x4.6mm shaft flat upper black		



1

GEV No.	112927	Ref. No.	402593200
description	knob gas tap without ignition flame t.max.°C temperature range° C ø 42mm shaft ø 6x4.6mm shaft flat right		
For models:	SPT60GLS, SPT90-5GLS, SPT90GL, SPT90GLS		



1

GEV No.	112928	Ref. No.	402593100
description	knob gas tap without ignition flame t.max.°C temperature range° C ø 42mm shaft ø 6x4.6mm shaft flat upper		
For models:	FTH30GL		



1

GEV No.	112925	Ref. No.	402593300
description	knob switch 7-position t.max.°C temperature range° C ø 42mm shaft ø 6x4.6mm shaft flat upper black		
For models:	SPT90-5ELS, SPT90ELS		



1

GEV No.	112918	Ref. No.	402592130
description	knob thermostat t.max. 110°C temperature range 30-110°C ø 42mm shaft ø 6x4.6mm shaft flat upper rotation 270° black		



1

GEV No.	112921	Ref. No.	402592005
description	knob thermostat t.max. 190°C temperature range 50-190°C ø 42mm shaft ø 6x4.6mm shaft flat lower rotation 270° black		



1

GEV No.	112922	Ref. No.	402592000
description	knob thermostat t.max. 190°C temperature range 50-190°C ø 42mm shaft ø 6x4.6mm shaft flat upper rotation 270° black		
For models:	EF05, EF08, EF55, EF85, EF88, FE04S, FE07EV, FE07TE, FE44, FE44E, FE44S, FE60P, FE74, FE74E, FE77, FE77T, FE77V		



1

GEV No.	112938	Ref. No.	402593000
description	knob thermostat t.max. 300°C temperature range 50-300°C ø 42mm shaft ø 6x4.6mm shaft flat upper rotation 270° black		
For models:	FP36, FP36S, FTH30, FTH60, FTHR60, FTR30, PD2020L, PD2020R, PM2015R, SPT60GLS, SPT90-5ELS, SPT90-5GLS, SPT90ELS, SPT90GL, SPT90GLS		



1

GEV No.	112919	Ref. No.	402591100
description	knob thermostat t.max. 90°C temperature range 30-90°C ø 42mm shaft ø 6x4.6mm shaft flat right rotation 270° black		
For models:	BMPK4120, VEC810, VEC820		



1			
GEV No.	112920	Ref. No.	402591000
description	knob thermostat t.max. 90°C temperature range 30-90°C ø 42mm shaft ø 6x4.6mm shaft flat upper rotation 270° black		
For models:	BM1120, BMPD2120, BMPD3120, BMPD4120, BMSD2120, BMSD4120, BMV1120, BMV2120, HD3N, HD4N, HD4NK, HDN, WE11, WEV12		

1			
GEV No.	112930	Ref. No.	402590900
description	knob toaster t.max.°C temperature range°C ø 42mm shaft ø 6x4.6mm shaft flat right		
For models:	TO940, TO960		

1			
GEV No.	112923	Ref. No.	402590820
description	knob time 120min t.max.°C temperature range°C ø 42mm shaft ø 6x4.6mm shaft flat upper black		
For models:	SPT90-5ELS, SPT90-5GLS, SPT90ELS, SPT90GL, SPT90GLS		

accessories

rosettes

1			
GEV No.	110105	Ref. No.	402595001
description	rosette knob ø 42mm ø 56mm zero mark		
For models:	FP36S		

1			
GEV No.	112937	Ref. No.	402590750
description	knob time 15min + permanent ON t.max.°C temperature range°C ø 42mm shaft ø 6x4.6mm shaft flat left		
For models:	TO920, TO930, TO940, TO960		

1			
GEV No.	110310	Ref. No.	402595000
description	rosette knob up to ø 45mm		
For models:	BM1120, BMPD2120, BMPD3120, BMPD4120, BMPK4120, BMSD2120, BMSD4120, BMV1120, BMV2120, EF05, EF08, EF55, EF85, EF88, FE04S, FE07EV, FE07TE, FE44, FE44E, FE44S, FE60P, FE74, FE74E, FE77, FE77T, FE77V, FTH30, FTH30GL, FTH60, FTHR60, FTR30, HD3N, HD4N, HD4NK, HDN, PD2020L, PD2020R, PM2015R, SPT60GLS, SPT90-5ELS, SPT90-5GLS, SPT90ELS, SPT90GL, SPT90GLS, TO920, TO930, TO940, TO960, VEC810, VEC820...(Other models you can see in the webshop)		

1			
GEV No.	112924	Ref. No.	402590770
description	knob time 15min + permanent ON t.max.°C temperature range°C ø 42mm shaft ø 6x4.6mm shaft flat left black		
For models:	FP36, FP36S		

handles and hand wheels

cylindrical handles

fixed

1			
GEV No.	691314	Ref. No.	407803000
description	cylindrical handle thread M8 ø 28mm L 86mm		

1			
GEV No.	112929	Ref. No.	402590700
description	knob toaster t.max.°C temperature range°C ø 42mm shaft ø 6x4.6mm shaft flat right		
For models:	TO920, TO930		

cone handles

1			
GEV No.	110704	Ref. No.	407803190
description	cone handle thread M6 ø 16mm L 25mm plastic black		
For models:	FE07EV, FE77V		

mushroom cap handles

			
1			
GEV No.	112936	Ref. No.	407803050
description	mushroom cap handle thread M5 handle ø 25mm L 17mm plastic black		
For models:	FP36, FP36S, PD2020L, PD2020R, PM2015R		

			
1			
GEV No.	112935	Ref. No.	407802001
description	mushroom cap handle thread M5 handle ø 30mm L 19mm plastic black		
For models:	EF05, EF08, EF55, EF85, EF88, HD3N, HD4N, HD4NK, HDN, WE11, WEV12		

ball handles

			
1			
GEV No.	691311	Ref. No.	407803200
description	ball handle thread M6 ø 20mm		
For models:	PD2020L, PD2020R, PM2015R		

handle bars

handle bars

			
1			
GEV No.	691373	Ref. No.	500504080
description	handle rod tube ø 30.5mm thickness 1.5mm L 460mm SS		
For models:	BMPK4120		

			
1			
GEV No.	691372	Ref. No.	500504280
description	handle rod tube ø 30.5mm thickness 1.5mm L 660mm SS		
For models:	BMPD2120		

HANDLES AND HAND WHEELS RM-GASTRO

consoles

			
1			
GEV No.	690115	Ref. No.	407803100
description	console pair GN 667 tube ø 30mm H 59mm A 78mm B 37mm C 56mm plastic		
For models:	BMPD2120, BMPD3120, BMPD4120, BMPK4120		
accessories for	690115		
	GEV No.	690439	Ref. No.
			—
	handle rod tube ø 30mm thickness 1.5mm L 300mm SS		
	GEV No.	690440	Ref. No.
			—
	handle rod tube ø 30mm thickness 1.5mm L 500mm SS		
	GEV No.	690441	Ref. No.
			—
	handle rod tube ø 30mm thickness 1.5mm L 700mm SS		

bracket handles

			
1			
GEV No.	700736	Ref. No.	407801500
description	pull handle		
For models:	FE04S, FE07EV, FE07TE, FE44, FE44E, FE44S, FE74, FE74E, FE77, FE77T, FE77V		

			
1			
GEV No.	700737	Ref. No.	407802100
description	pull handle L 120mm H 32mm mounting distance 110mm thread M4 W 17mm		
For models:	FE60P		

			
1			
GEV No.	691315	Ref. No.	408015110
description	pull handle L 190mm H 48mm mounting distance 173mm handle M6		
For models:	SPT90-5ELS, SPT90-5GLS, SPT90ELS, SPT90GL, SPT90GLS		



			
1			
GEV No.	691374	Ref. No.	408015100
description	pull handle L 515mm H 50mm mounting distance 497mm handle M6		
For models:	SPT60GLS, SPT90-5ELS, SPT90-5GLS, SPT90ELS, SPT90GL, SPT90GLS		

			
1			
GEV No.	691312	Ref. No.	407801100
description	pull handle L 91mm H 26mm mounting distance 73mm handle M4		
For models:	FE60P		

folding grill handles

			
1			
GEV No.	691340	Ref. No.	408015020
description	handle tube ø 26mm thickness 6mm L 220mm plastic for contact grill		
For models:	PD2020L, PD2020R		

			
1			
GEV No.	691341	Ref. No.	408015010
description	handle tube ø 26mm thickness 6mm L 325mm plastic for contact grill black		
For models:	PM2015R		

miscellaneous

			
1			
GEV No.	691313	Ref. No.	407803035
description	handle		
For models:	FP36, FP36S		

			
1			
GEV No.	691308	Ref. No.	407800100
description	handle L 140mm W 22mm hole distance 120mm Qty 1 pcs		
For models:	FE04S, FE44, FE44S, FE60P, FE74, FE77, FE77T, FE77V		

accessories



extensions

			
1			
GEV No.	691348	Ref. No.	408701500
description	threaded part L 26mm thread M6		
For models:	PD2020L, PD2020R, PM2015R		

hinges

oven hinges

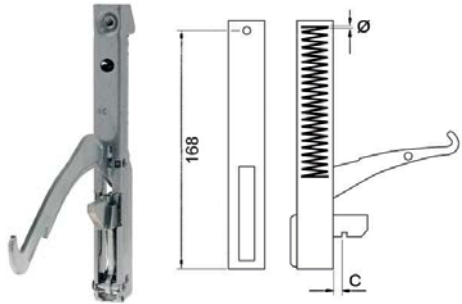
			
1			
GEV No.	700739	Ref. No.	408790310
description	opposite support mounting distance 91mm L 115mm W 10mm		
For models:	SPT60GLS, SPT90-5ELS, SPT90-5GLS, SPT90ELS, SPT90GL, SPT90GLS		

				
1				
GEV No.	700738	Ref. No.	408790300 408790305	
description	oven hinge mounting distance 168mm lever length 158mm groove distance 15mm spring thickness 3.8mm spring length 65mm L 178mm			
For models:	SPT60GLS, SPT90-5ELS, SPT90-5GLS, SPT90ELS, SPT90GL, SPT90GLS			
accessories for	700738			
	GEV No.	700739	Ref. No.	408790310
	opposite support mounting distance 91mm L 115mm W 10mm			

equipment feet and end caps

equipment feet

with screw mounting



1

GEV No.	701203	Ref. No.	407812300
description	equipment foot tube ø 58mm thread M10 thread L 20mm H 110-170mm plastic size 2 1/3" Qty 1 pcs		
For models:	SPT60GLS, SPT90-SELS, SPT90-5GLS, SPT90ELS, SPT90GL, SPT90GLS		



1

GEV No.	701202	Ref. No.	407812200
description	equipment foot tube ø 67mm thread M10 thread L 21mm H 115/175mm SS size 2 1/2" Qty 1 pcs		
For models:	FE60P		

bullet feet

plastic



1

GEV No.	700117	Ref. No.	407810810
description	equipment foot pipe type 30x30 thickness 1.2-1.5mm H 23-55mm plastic Qty 1 pcs load capacity 90kg		
For models:	BMSD2120, BMSD4120		

screw-in feet



1

GEV No.	691344	Ref. No.	407810500 636002100
description	equipment foot thread M8 thread L 20mm ø 23mm H 12mm Qty 1 pcs		
For models:	BM1120, BMV1120, BMV2120, CW8, FTH30, FTH30GL, FTH60, FTHR60, FTR30, PD2020L, PD2020R, PM2015R, VEC810, VEC820		



1

GEV No.	696496	Ref. No.	409083050
description	equipment foot thread M8 thread L 20mm ø 23mm H 12mm Qty 4 pcs		

bolting feet



1

GEV No.	691345	Ref. No.	407810000
description	equipment foot ø 28mm H 21mm bore ø 5mm Qty 1 pcs hole ø 10mm		
For models:	FP36, FP36S		

end caps and plugs

housing plugs



1

GEV No.	691343	Ref. No.	407810100
description	plug mounting ø 6mm ø 11mm H 10mm plastic Qty 1 pcs		
For models:	EF05, EF08, EF55, EF85, EF88, FE04S, FE07EV, FE07TE, FE44, FE44E, FE44S, FE74, FE74E, FE77, FE77T, FE77V, HD01, HD02, HD03, HD04, HD3N, HD4N, HD4NK, HDN, TO920, TO930, TO940, TO960, VEN510, VEN520, VEN810, VEN820, WE11, WEV12		

for square pipes



1

GEV No.	691342	Ref. No.	407825000
description	end cap L 30mm W 20mm Qty 1 pcs for square pipes		



DERBY RUOTE

with bolt hole

chrome-plated steel



1

GEV No.	700733	Ref. No.	408791210
description	swivel castor ø 125mm bolt hole bolt hole ø 12mm housing chrome-plated sheet steel capacity 100kg bearing ball bearing wheel body polypropylene tread TPE tyres H 159mm wheel width 30mm Qty 1 pcs		
For models:	BMPD2120, BMPD3120, BMPD4120, BMPK4120		



1

GEV No.	700732	Ref. No.	408792100
description	swivel castor with swivel brake ø 125mm bolt hole bolt hole ø 12mm housing chrome-plated sheet steel capacity 100kg bearing ball bearing wheel body polypropylene tread TPE tyres H 159mm wheel width 30mm Qty 1 pcs		
For models:	BMPD2120, BMPD3120, BMPD4120, BMPK4120		

bumper angles



1

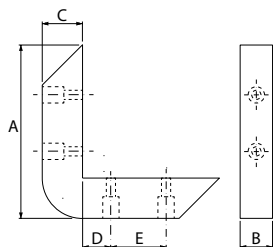

GEV No.	690938	Ref. No.	407830000
description	bumper angle outer length 126mm inner length 99mm W 27mm H 29mm mounting distance 30mm hole distance 35mm hole ø 5mm rubber black		
For models:	BMPD2120, BMPD3120, BMPD4120, BMPK4120		

baskets

fryer baskets

RM GASTRO



1

GEV No.	970616	Ref. No.	408000102 408000106
description	fryer basket L1 235mm W1 130mm H1 105mm H3 200mm fastening behind		
For models:	EF05, EF55, EF85		



1

GEV No.	970618	Ref. No.	408000101 408000104
description	fryer basket L1 235mm W1 130mm H1 105mm H3 200mm fastening in front		
For models:	FE04S, FE44, FE44E, FE44S, FE74, FE74E		



1

GEV No.	970612	Ref. No.	408000501 408001501
description	fryer basket L1 235mm W1 210mm H1 105mm L2 390mm H2 170mm H3 210mm fastening in front		
For models:	FE07EV, FE07TE, FE74, FE74E, FE77, FE77T, FE77V		



1

GEV No.	970617	Ref. No.	408001000
description	fryer basket L1 245mm W1 300mm H1 120mm H3 210mm fastening in front		



1

GEV No.	970619	Ref. No.	408001030
description	fryer basket L1 455mm W1 245mm H1 90mm		



1

GEV No.	970620	Ref. No.	408001060
description	fryer basket L1 575mm W1 440mm H1 80mm		
For models:	FE60P		



1

GEV No.	970773	Ref. No.	408000502 408001502
description	fryer basket W1 210mm L1 235mm H1 105mm L2 390mm H2 170mm H3 210mm fastening behind		
For models:	EF08, EF85, EF88		

pasta baskets

RM GASTRO



1

GEV No.	970846	Ref. No.	408001110
description	pasta basket H1 135mm W1 100mm L1 135mm L2 210mm H2 210mm H3 300mm stainless steel		



1

GEV No.	970621	Ref. No.	408001100
description	pasta basket L1 135mm W1 100mm H1 135mm stainless steel		

wire baskets for hot dog machines



1

GEV No.	691360	Ref. No.	408009000
description	grid basket for hot dog grill ø 175mm H 215mm		
For models:	HD3N, HD4N, HD4NK, HDN		

shelves and shelf rails

grates

producer-specific



1

GEV No.	691370	Ref. No.	408011500
description	chargrill grid W 300mm D 645mm chrome-plated steel with handle for salamander grill		

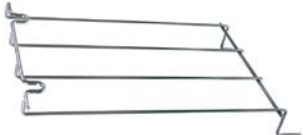

grid attachments

 <p>1</p>			
GEV No.	691371	Ref. No.	408013100
description	rack support		
For models:	SPT60GLS, SPT90-5ELS, SPT90-5GLS, SPT90ELS, SPT90GL, SPT90GLS		

shelf rails and supports

producer-specific

 <p>1</p>			
GEV No.	692758	Ref. No.	453500160
description	shelf support L 40mm W 30mm		

gaskets

gaskets for heated units

door seals

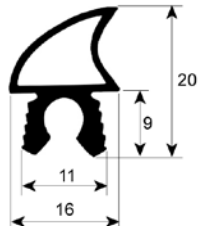
 <p>1</p>			
GEV No.	900792	Ref. No.	409081000 507009120
description	door seal profile 2748 L 1750mm		
For models:	SPT60GLS, SPT90-5ELS, SPT90-5GLS, SPT90ELS, SPT90GL, SPT90GLS		

transmission technology and ball bearings

chains

roller chains 05B-1 single

 <p>1</p>			
GEV No.	693063	Ref. No.	633110000
description	chain DIN/ISO 05 B-1 splitting 8mm links 35 internal width 3mm rollerø 5mm single closed		
For models:	CW8		

 <p>1</p>			
GEV No.	693064	Ref. No.	633110100
description	chain DIN/ISO 05 B-1 splitting 8mm links 52 internal width 3mm rollerø 5mm single		
For models:	CW8		

springs

torsion springs

 <p>1</p>			
GEV No.	700723	Ref. No.	408702505
description	torsion spring ø 20.5mm L1 40mm L2 120mm L3 40mm wire gauge ø 3.6mm		
For models:	PM2015R		

 <p>1</p>			
GEV No.	700084	Ref. No.	408702500
description	torsion spring ø 22mm L1 119mm L2 64mm L3 64mm wire gauge ø 3.5mm		
For models:	PD2020L, PD2020R		

fittings, hose and pipe connectors

fittings

reducers

 <p>1</p>			
GEV No.	520182	Ref. No.	409017100
description	reducer thread 3/4" ET - 1/2" IT nickel-plated brass total length 17.5mm WS 30		
For models:	FE07EV, FE60P, FE77V		

sleeves

 <p>1</p>			
GEV No.	520176	Ref. No.	409021134
description	sleeve thread 3/4" - 3/4" nickel-plated brass WS 32 total length 32mm		



angle pieces



1

GEV No.	541924	Ref. No.	409011100
description	angle piece thread 1/2" IT - 1/2" IT brass		
For models:	BMV1120, BMV2120, WEV12		



1

GEV No.	520950	Ref. No.	402 525 203
description	elbow thread 1/2" IT stainless steel 90°		

miscellaneous



1

GEV No.	541928	Ref. No.	409006250
description	angle piece thread 3/4"		

extensions



1

GEV No.	541925	Ref. No.	409031140
description	extension fitting thread 1/2" IT - 1/2" ET brass L 40mm		
For models:	BMV1120, BMV2120		



1

GEV No.	541926	Ref. No.	409032330
description	extension fitting thread 3/4" IT - 3/4" ET brass L 30mm		



1

GEV No.	541927	Ref. No.	409032340
description	extension fitting thread 3/4" IT - 3/4" ET chrome-plated brass L 40mm		
For models:	FE60P		

valves and tank inlets

ball valves

universal

mini ball valves



1

GEV No.	514403	Ref. No.	409000200
description	ball valve angled connection 3/8" ET - 1/2" ET DN8 total length 56mm		
For models:	BMV1120, BMV2120, WEV12		

ball valves with lever handle



1

GEV No.	541921	Ref. No.	409001100
description	ball valve connection 1/2" IT - 1/2" IT DN15 total length 61mm		
For models:	BMPD2120, BMPD3120, BMPD4120, BMPK4120, BMSD2120, BMSD4120		



1

GEV No.	520836	Ref. No.	409001200
description	ball valve connection 3/4" IT - 3/4" IT total length 54mm handle length 87mm		
For models:	FE60P		

measuring equipment

thermometers

built-in thermometers



1

GEV No.	541929	Ref. No.	6111959
description	thermometer mounting measurements 58x25.5mm -40 up to +40°C capillary pipe 700mm probe ø 6mm probe L 85mm		



fastening material

fasteners			
retaining rings			
DIN 471			
			
1			
GEV No.	693061	Ref. No.	633050500
description	retaining ring shaft ø 25mm thickness 1.2mm steel DIN 471		
For models:	CW8		

consumables

lava rocks / ceramic briquetts			
			
1			
GEV No.	211008	Ref. No.	153000150
description	lava rocks size ca.20-70mm Qty 5kg		

A		
audible timers	11	
B		
ball valves	34	
bar burners	20	
C		
cable glands	13	
cables	13	
cam switches	10	
castors and bumper angles	31	
condensators & interference suppression filters	13	
consumables	35	
contactors	12	
D		
door seals	33	
E		
electric accessories	13	
end caps and plugs	30	
energy regulators	8	
F		
fans	12	
fasteners	35	
fastening material	35	
fittings	33	
G		
gas burners	16	
gas nozzles	21	
gas taps	14	
gaskets for heated units	33	
grates	32	
H		
heating elements	3	
heating elements for bain maries	3	
heating elements for chip scuttles	3	
heating elements for contact grills	5	
heating elements for convection	7	
heating elements for fryers	3	
heating elements for griddles	5	
heating elements for heating bridges	7	
heating elements for pasta cookers	6	
heating elements for pizza ovens	6	
heating elements for salamanders/toasters	6	
hob burners	16	
hot air motors	12	
hot plates	7	
I		
ignition cables	15	
indicator lights	11	
indicator lights (complete)	11	
L		
lamps	11	
lava rocks / ceramic briquettes	22, 35	
M		
measuring equipment	34	
mechanical timers	11	
microswitches	10	
motors	12	
O		
operating capacitors	13	
oven hinges	29	
P		
piezoelectric igniters	15	
plugs - couplings - power sockets	13	
protective contact power sockets	13	
push/momentary push switches	10	
Q		
quartz heating elements	7	
R		
reducers	33	
retaining rings	35	
rocker/momentary rocker switches	9	
S		
safety thermostats	8	
shelves and shelf rails	32	
sleeves	33	
spiral cables	13	
switches and momentary switches	9	
T		
terminals	13	
thermocouples	15	
thermostats	8	
threaded cable glands	13	
timers	11	
V		
valves and tank inlets	34	