



GAS COMPONENTS



ELECTRIC COMPONENTS



WATER TECHNOLOGY



MECHANICAL COMPONENTS



TOOLS

Spare parts suitable for

QUALITYESPRESSO-FUTURMAT

Find the complete and up-to-date range of products in our GEV Webshop



Manufacturer catalogue

The most important spare parts and accessories arranged clearly for every manufacturer

- ✓ Complete product range and all appliance data always up to date in the GEV Webshop
- ✓ Alphabetical Index at the end of the catalogue

GEV Webshop

www.gev-online.co.uk

www.gev-online.com







- 🔍 Add to Favourites
- 🔍 Sign In with email address and usual password
- 🔍 Easy-order – place several items in your basket at the same time
- 🔍 Quick Item search – no login needed





heating elements

heating elements for coffee machine

			
GEV No.	417001	Ref. No.	02212439
description	heating element 2600W 230V heating circuits 2 mounting \varnothing 42mm hole distance 74mm L 330mm W 30mm H 60mm L1 23mm L2 65mm L3 202mm H1 30mm H2 30mm hole \varnothing 12mm tube \varnothing 8.5mm thermostat sleeves \varnothing 7mm length thermostat sleeves 195mm thermostat sleeve eccentric, non clinging number of thermostat sleeves 1 connection M6 immersion heater 2 hole flange		
accessories for	417001		
	GEV No.	528002	Ref. No. —
	flat gasket PTFE ED \varnothing 57mm ID \varnothing 42mm thickness 3mm Qty 1 pcs equiv. no. 12001/W10470 suitable for		
	GEV No.	528488	Ref. No. —
	flat gasket fibre ED \varnothing 57mm ID \varnothing 42mm thickness 3mm Qty 1 pcs		

			
GEV No.	417290	Ref. No.	08024804
description	heating element 3000W 230V heating circuits 2 mounting \varnothing 42mm hole distance 74mm L 250mm W 28mm H 65mm L1 20mm L2 40mm L3 190mm H1 30mm H2 35mm hole \varnothing 10mm tube \varnothing 8.5mm thermostat sleeves \varnothing 7mm length thermostat sleeves 210mm number of thermostat sleeves 1 connection M4 immersion heater 2 hole flange		

			
GEV No.	417108	Ref. No.	08148002
description	heating element 3500W 230V heating circuits 2 mounting \varnothing 42mm hole distance 74mm L 380mm W 30mm H 50mm L1 25mm L2 70mm L3 275mm H1 25mm H2 25mm hole \varnothing 10mm tube \varnothing 8.5mm thermostat sleeves \varnothing 7mm length thermostat sleeves 190mm thermostat sleeve not clinging number of thermostat sleeves 1 connection M4 immersion heater 2 hole flange		

			
GEV No.	417105	Ref. No.	02212538
description	heating element 3700W 230V heating circuits 2 mounting \varnothing 42mm hole distance 74mm L 530mm W 28mm H 50mm L1 30mm L2 75mm L3 400mm H1 25mm H2 25mm hole \varnothing 9mm tube \varnothing 8.4mm thermostat sleeves \varnothing 7.5mm length thermostat sleeves 185mm thermostat sleeve eccentric, non clinging number of thermostat sleeves 1 connection M6 immersion heater 2 hole flange suitable for FAEMA		

			
GEV No.	417289	Ref. No.	08335100
description	heating element 4600W 230V heating circuits 2 mounting \varnothing 42mm hole distance 74mm L 565mm W 34mm H 70mm L1 20mm L2 40mm L3 505mm H1 30mm H2 40mm hole \varnothing 10mm tube \varnothing 8.3mm thermostat sleeves \varnothing 7mm length thermostat sleeves 210mm thermostat sleeve centre number of thermostat sleeves 1 connection M4 immersion heater 2 hole flange		

accessories

hexagonal nuts

			
GEV No.	361184	Ref. No.	05060680
description	nut thread 1/2" H 6mm nickel-plated brass WS 24 Qty 1 pcs		

sealing washers

O-rings

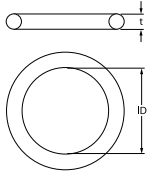
 			
GEV No.	510893	Ref. No.	07763204
description	O-ring EPDM thickness 2.62mm ID \varnothing 9.92mm Qty 1 pcs		

thermostats

bi-metal thermostats

bi-metal thermostats

			
GEV No.	390319	Ref. No.	08368400
description	bi-metal thermostat hole distance 23.8mm switch-off temp. 80°C 1NC 1-pole 16A connection F6.3 2 hole fixing		

control and safety thermostats

EGO

safety thermostats

55.32_ series

			
GEV No.	390324	Ref. No.	07476906
description	safety thermostat switch-off temp. 169°C 3-pole 3NC 20A probe \varnothing 4mm probe L 128mm capillary pipe 890mm capillary pipe isolated 210/210mm gland nut probe SS		



various

safety thermostats



GEV No.	375501	Ref. No.	08324600
description	safety thermostat switch-off temp. 172°C 1-pole 16A probe ø 3mm probe L 135mm capillary pipe 88mm capillary pipe isolated 80mm gland nut probe SS		

switches and momentary switches

rocker/momentary rocker switches

30x22mm



GEV No.	301002	Ref. No.	07967010 07967020
description	rocker switch mounting measurements 30x22mm orange 2NO 250V 16A illuminated 0-I connection male faston 6.3mm ambient temperature max. 85/125°C protection IP65		
accessories for	301002		
	GEV No.	301036	Ref. No. —
	protective cover internal size 30x22mm for rocker switch mounting measurementsmm		



GEV No.	301001	Ref. No.	07967000
description	rocker switch mounting measurements 30x22mm red 2NO 250V 16A illuminated 0-I connection male faston 6.3mm ambient temperature max. 125/55°C protection IP65		
accessories for	301001		
	GEV No.	301036	Ref. No. —
	protective cover internal size 30x22mm for rocker switch mounting measurementsmm		

labelled



GEV No.	300125	Ref. No.	04001140 09000209
description	rocker switch mounting measurements 30x22mm green 2NO 230V 16A 0-I connection male faston 6.3mm ambient temperature max. 125/55°C protection IP65 with cover cap		
accessories for	300125		
	GEV No.	301036	Ref. No. —
	protective cover internal size 30x22mm for rocker switch mounting measurementsmm		

microswitches

roller-lever actuated

microswitches



GEV No.	345250	Ref. No.	04001130 09000208
description	microswitch with handle with a switch 250V 16A 1CO connection male faston 6.3mm L 27mm L1 36mm ambient temperature max. 125°C mounting distance 22mm type RL6-1-FGE-P12-5-L actuating force: 90g		

pin-plunger actuated



GEV No.	527736	Ref. No.	10975704
description	microswitch 250V 16A 1CO connection male faston 4.8mm ambient temperature max. 125°C mounting distance 22mm with plunger blue/black		



GEV No.	345105	Ref. No.	010957504
description	microswitch with plunger 250V 16A 1CO connection male faston 6.3mm L 28mm ambient temperature max. 125°C mounting distance 22mm type SM-51 actuating force: 280g black		

roller actuated

roller 90°



GEV No.	345104	Ref. No.	07421605
description	microswitch with roller plunger 250V 16A 1CO connection male faston 6.3mm L 24mm ambient temperature max. 125°C thread L 12mm thread M10x0.75 mounting distance 22mm actuating force: 280g type EF83161.1		



rotary switches

GOTTAK



1

GEV No.	345148	Ref. No.	07847908
description	rotary switch 3 0-1-2 sets of contacts 6 type 4RH 400V 10A shaft ø 4.8x6mm shaft L 21mm shaft oval connection male faston 6.3mm		

accessories

symbol labels



1

GEV No.	347266	Ref. No.	08283301
description	symbol label 0-1 ø 60mm bore ø 7mm mounting distance 28mm		



1

GEV No.	347265	Ref. No.	08283202 08336200
description	symbol label 0-1-heating off ø 53mm bore ø 7mm mounting distance 28mm		

lamps

indicator lights

indicator lights (complete)

ø 9mm



1

GEV No.	359491	Ref. No.	08456900
description	indicator light ø 9mm clear connection plug cable length 33mm		

ø 10mm

with screw socket



1

GEV No.	346881	Ref. No.	08329800
description	indicator light ø 10mm 230V red connection male faston 6.3mm		

with plug-in socket



1

GEV No.	359486	Ref. No.	08478100
description	indicator light ø 10mm 250V red connection male faston 6.3mm cable length 400mm		

ø 12mm

with plug-in socket



1

GEV No.	359043	Ref. No.	0847800
description	indicator light ø 12mm red 230V connection male faston 6.3mm temp.-resist. 120°C Qty 1 pcs		

ø 13mm

with plug-in socket



1

GEV No.	359143	Ref. No.	0847820
description	indicator light ø 13mm yellow 230V connection male faston 6.3mm temp.-resist. 120°C Qty 1 pcs		

miscellaneous



1

GEV No.	359490	Ref. No.	08428600
description	indicator lamp clear 230V connection male faston 6.3mm cable length 80mm ø 7mm		



1

GEV No.	359489	Ref. No.	08428500
description	indicator light lens red ø 10.5mm		

LED

indicator lamps

miscellaneous



1

GEV No.	359487	Ref. No.	08477800
description	indicator light LED mounting ø 10mm 250 red connection with plug 1W		



contactors

LOVATO

power contactors



1

GEV No.	380964	Ref. No.	0651/060119
description	power contactor resistive load 20A 230VAC (AC3/400V) 9A/4kW main contacts 4NO auxiliary contacts connection screw connection type 11BG09T4A230		

solid state relays

miscellaneous



1

GEV No.	403941	Ref. No.	08371300
description	solid state relay CARLO GAVAZZI 2 phase 40A 24-280V 5-15VDC L 58mm W 44mm male faston 6.3mm type RA2A23D40C		

relays

level relays

miscellaneous



1

GEV No.	403445	Ref. No.	08386800
description	level controller 230V type		

transformers

open transformers

with plug connection



1

GEV No.	402441	Ref. No.	04300660 09000222
description	transformer primary 230V secondary 8/18V 48VA secondary 0.6/2.4A connection male faston 6.3mm 50/60Hz		

toroidal core transformers



1

GEV No.	402381	Ref. No.	08414800
description	transformer primary 220V secondary 30V 80VA connection male faston 6.3mm 50/60Hz		

probes

producer-specific probes

probes



1

GEV No.	379464	Ref. No.	08370500
description	temperature probe NTC cable silicone probe -40 up to +110°C cable -50 up to +180°C connection coded plug thread 3/8" probe ø12x8mm cable length 0.5m		



1

GEV No.	379461	Ref. No.	08370510
description	temperature probe NTC cable silicone probe -40 up to +110°C cable -50 up to +180°C connection plug thread 3/8" probe ø10x8mm cable length 0.5m		



sensors

1



GEV No.	379467	Ref. No.	08417900
description	temperature probe set PTC probe L 26mm probe ø 5mm 2-group		

1



GEV No.	379465	Ref. No.	08418000
description	temperature probe set PTC probe L 26mm probe ø 5mm 3-group		

electronics

EPROMS

1



GEV No.	402432	Ref. No.	09001278 43524660
description	EPROM type CP-A for coffee grinder CODE 09001278		

PCBs

1



GEV No.	402783	Ref. No.	08331610 08372000
description	display espresso machine QUALITY ESPRESSO model new		

1



GEV No.	402369	Ref. No.	08372010
description	display L 106mm W 48mm with keypad		

1



GEV No.	402385	Ref. No.	08264301
description	display L 131mm W 47mm with keypad		

1



GEV No.	402443	Ref. No.	08506200 09001263 43310420
description	PCB for coffee grinder suitable for QUALITY ESPRESSO		

1



GEV No.	402363	Ref. No.	08406400
description	probe L 128mm W 106mm with keypad		

central units

1



GEV No.	402357	Ref. No.	08363800 08363800/6
description	central unit 230V		



			
1			
GEV No.	402361	Ref. No.	08363900 08363900/09
description	central unit 230V		

			
1			
GEV No.	402356	Ref. No.	08220303 08220303/06
description	central unit 2-group 230V		

			
1			
GEV No.	402358	Ref. No.	08351500 08351500/6
description	central unit 3-4-group 230V		

			
1			
GEV No.	402359	Ref. No.	08371740
description	central unit 3-group 230V		

			
1			
GEV No.	402362	Ref. No.	08371720
description	central unit 3-group 230V		

			
1			
GEV No.	402360	Ref. No.	08455700
description	central unit 4-group 230V		

			
1			
GEV No.	402368	Ref. No.	08414500
description	central unit temperature 24V		

			
1			
GEV No.	400445	Ref. No.	08280307 08280307/09 08280307/6
description	control box 4-group for coffee machine		

keypads

front foils

			
1			
GEV No.	526689	Ref. No.	08456700
description	front foil for indicator light L 50mm W 16mm		

			
1			
GEV No.	402389	Ref. No.	08264509
description	front foil with keypad L 112mm W 36mm		

			
1			
GEV No.	401434	Ref. No.	08109600
description	keypad foil coffee machine Arienne/Arieta 1-2-3-4 gr. L 92mm W 26mm buttons 5		

			
1			
GEV No.	401433	Ref. No.	08274607
description	keypad foil coffee machine Ottima/Genova/Compac L 80mm W 44mm buttons 5		

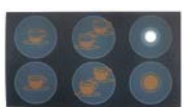
			
1			
GEV No.	402386	Ref. No.	08272106
description	keypad foil grey L 80mm W 44mm buttons 5		



			
1			
GEV No.	400442	Ref. No.	08274201
description	keypad foil L 80mm W 44mm buttons 5		

			
1			
GEV No.	401432	Ref. No.	08274409
description	keypad foil L 80mm W 44mm buttons 5		

			
1			
GEV No.	402387	Ref. No.	08221608
description	keypad foil silver L 80mm W 44mm buttons 5		

			
1			
GEV No.	402388	Ref. No.	08323900
description	keypad foil suitable for GENOVA L 80mm W 44mm buttons 5		

membrane keypads

			
1			
GEV No.	525549	Ref. No.	09001137 42923151
description	keypad foil for coffee grinder suitable for QUALITY ESPRESSO L 85mm W 62mm		

			
1			
GEV No.	400447	Ref. No.	N/A
description	membrane keypad		

keypad units

			
Image not available			
1			
GEV No.	400440	Ref. No.	08272205 + 08274409
description	keypad unit		

			
1			
GEV No.	402375	Ref. No.	08337000
description	keypad unit buttons 1 L 106mm W 50mm		

			
1			
GEV No.	402382	Ref. No.	08332600
description	keypad unit buttons 1 L 50mm W 46mm		

			
1			
GEV No.	402383	Ref. No.	08331900 08331910
description	keypad unit buttons 1 L 50mm W 46mm		

			
1			
GEV No.	402384	Ref. No.	08373100
description	keypad unit buttons 1 L 50mm W 46mm Spezial		



1

GEV No.	402366	Ref. No.	08405700
description	keypad unit buttons 1 red L 106mm W 76mm		



1

GEV No.	402374	Ref. No.	08474500
description	keypad unit buttons 5 L 106mm W 50mm		



1

GEV No.	402372	Ref. No.	08336900 08336910
description	keypad unit buttons 2 L 106mm W 50mm		



1

GEV No.	402376	Ref. No.	08332200
description	keypad unit buttons 5 L 106mm W 50mm		



1

GEV No.	402371	Ref. No.	08405800
description	keypad unit buttons 2 red L 106mm W 76mm		



1

GEV No.	402377	Ref. No.	08330700
description	keypad unit buttons 5 L 106mm W 50mm		



1

GEV No.	402378	Ref. No.	08234213
description	keypad unit buttons 5 black with LED suitable for ARIANNA, COMPAC L 142mm W 62mm with bush		



1

GEV No.	402373	Ref. No.	08378400
description	keypad unit buttons 5 L 125mm W 50mm		



1

GEV No.	402379	Ref. No.	08234205
description	keypad unit buttons 5 grey with LED suitable for ARIANNA, COMPAC L 142mm W 62mm with bush		



1

GEV No.	402364	Ref. No.	08427600
description	keypad unit buttons 5 L 185mm W 70mm		

1

GEV No.	402365	Ref. No.	08427610
description	keypad unit buttons 5 L 185mm W 70mm ECONOMY		



1

GEV No.	400441	Ref. No.	08272205
description	keypad unit buttons 5 L 91mm W 51mm		



1

GEV No.	402367	Ref. No.	08405620
description	keypad unit buttons 5 white L 106mm W 76mm		



1

GEV No.	402380	Ref. No.	08109400 08211906
description	keypad unit coffee machine Arienne/Arieta 1-2-3-4 gr. buttons 5 L 110mm W 39mm		

solenoid valves

solenoid valves (water)

metal

PARKER

2-way

E-146 series



1

GEV No.	370067	Ref. No.	N/A
description	solenoid valve 2-ways 230VAC connection 1/4" L 40mm DN 3mm slide-on receptacle DIN -20° up to 130°C PARKER type series VE-146 coil type ZB09 membranes FKM (water) p max 7bar		
spare parts for	370067		
	GEV No.	371029	Ref. No.
			—

accessories for 370067

	GEV No.	371090	Ref. No.	—
				power socket plug type DIN 43650A screw

compressors

CUBIGEL

accessories



1

GEV No.	380913	Ref. No.	07985500
description	start relay MTRP3920 743 250V 8A		

motors

motors

for coffee grinders

complete



1



GEV No.	525529	Ref. No.	09001132 09112400 42922200
description	motor with belt pulley 24V 1 phase shaft ø 2mm type WRS-365SH-14134 ø 28mm L 32mm		
accessories for	525529		
	GEV No.	525531	Ref. No.
			09000302 09710320
			round belt for coffee grinder thickness 2.68mm ø 50.47mm



1

GEV No.	525530	Ref. No.	09001133 09112500 42922210
description	motor with belt pulley ø 28mm L 32mm cable length 150mm cable colours red/orange		
accessories for	525530		
	GEV No.	525531	Ref. No.
			09000302 09710320
			round belt for coffee grinder thickness 2.68mm ø 50.47mm



			
1			
GEV No.	525528	Ref. No.	09001131 42922180
description	motor with belt pulley ø 28mm L 32mm cable length 250mm cable colours blue/yellow		
accessories for	525528		
	GEV No.	525531	Ref. No. 09000302 09710320
round belt for coffee grinder thickness 2.68mm ø 50.47mm			

condensators & interference suppression filters

starting capacitors

starting capacitors

			
1			
GEV No.	365129	Ref. No.	07273006
description	starting capacitor 88-106µF 220V 50-60Hz duty cycle 3s with discharge resistor 12.80.2360 ø 46mm L 85mm plastic connection male faston 6.3mm		

operating capacitors

plastic

			
1			
GEV No.	365127	Ref. No.	03203950 09000125
description	operating capacitor capacity 70µF 250V tolerance 5% 50Hz ambient temperature max. -25 to +85°C ø 45mm L 120mm M8 plastic connection male faston 6.3mm 16.18.39 protection		

metal

			
1			
GEV No.	365128	Ref. No.	03203120 09000117
description	operating capacitor capacity 16µF 450V tolerance 5% 50-60Hz ambient temperature max. -25 to +85°C ø 40mm L 100mm M8 aluminium connection male faston 6.3mm 16.26.16 protection		

equipmentspecific units

filter holders

filter holders standard

filter holders (complete)

			
1			
GEV No.	531173	Ref. No.	08485800
description	filter holder 1-way suitable for FUTURMAT complete number of wedges 2		





			
1			
GEV No.	531174	Ref. No.	08485900
description	filter holder 2-way suitable for FUTURMAT complete number of wedges 2		

			
1			
GEV No.	526729	Ref. No.	08480080 08486700
description	filter holder without filter suitable for QUALITY ESPRESSO mounting ø 83mm ID ø 61.5mm wedge height 10.4mm wedge position horizontal number of wedges 2		
accessories for	526729		
	GEV No.	526699	Ref. No. 08366650
filter holder spout thread 3/8" 1-way curved outlet distance 55mm			
	GEV No.	526719	Ref. No. 08366750
filter holder spout thread 3/8" 2-way curved outlet distance 55mm			





filter holders short			
			
1			
GEV No.	529041	Ref. No.	08486680
description	filter holder mounting ø 82.5mm outlet 3/8" ID ø 62mm handle M12x1.75 wedge hight 10.5mm wedge position horizontal number of wedges 2 lever straight chrome-plated brass		

			
1			
GEV No.	531185	Ref. No.	08480050
description	filter holder mounting ø 83mm hole ø 17mm ID ø 62mm handle M12x1.75 wedge hight 10.5mm wedge position horizontal number of wedges 2 lever inclined chrome-plated brass		
accessories for	531185		
			
GEV No.	526699	Ref. No.	08366650
description	filter holder spout thread 3/8" 1-way curved outlet distancemm		
			
GEV No.	526719	Ref. No.	08366750
description	filter holder spout thread 3/8" 2-way curved outlet distance 55mm		
			
GEV No.	526733	Ref. No.	08480100
description	screw connection thread 3/8" for outlet ø 25mm H 14mm chrome-plated brass		

			
1			
GEV No.	526785	Ref. No.	08486650 08486680
description	filter holder mounting ø 83mm hole ø 17mm ID ø 62mm handle M12x1.75 wedge hight 10.5mm wedge position horizontal number of wedges 2 lever straight chrome-plated brass		
accessories for	526785		
			
GEV No.	526699	Ref. No.	08366650
description	filter holder spout thread 3/8" 1-way curved outlet distancemm		
			
GEV No.	526719	Ref. No.	08366750
description	filter holder spout thread 3/8" 2-way curved outlet distance 55mm		
			
GEV No.	526733	Ref. No.	08480100
description	screw connection thread 3/8" for outlet ø 25mm H 14mm chrome-plated brass		

handles			
with bore			
			
1			
GEV No.	526745	Ref. No.	08412010
description	handle ø 32mm L 123mm black L1 50mm		

			
1			
GEV No.	526746	Ref. No.	08412000
description	handle ø 33mm L 125mm grey L1 56mm		

			
1			
GEV No.	526751	Ref. No.	08335700
description	handle ø 35mm L 123mm black L1 44mm		

			
1			
GEV No.	529049	Ref. No.	08103600
description	handle ø 36mm aperture 13x13mm ID ø 9mm IT L 127mm black		

end caps			
			
1			
GEV No.	526688	Ref. No.	08412300
description	end cap ø 25mm silver		

			
1			
GEV No.	526748	Ref. No.	08336000
description	end cap ø 32mm black		

			
1			
GEV No.	526744	Ref. No.	08412210
description	ring for handle ø 33mm black		

			
1			
GEV No.	526747	Ref. No.	08412200
description	ring ø 33mm grey		

sleeves			
			
1			
GEV No.	526675	Ref. No.	08412110
description	sleeve ø 34mm L 50mm black		

			
1			
GEV No.	526749	Ref. No.	08412100
description	sleeve ø 35mm L 51mm grey		

			
1			
GEV No.	526750	Ref. No.	08335900
description	sleeve ø 36mm L 40mm black		

screws			
			
1			
GEV No.	529123	Ref. No.	05193800
description	cylinder head bolt thread M8 L 80mm thread L 30mm WS 6 SS Qty 1 pcs DIN 912/ISO 4762		

			
1			
GEV No.	526793	Ref. No.	08335800
description	handle holder thread M12 L 76mm thread L 100mm zinc-coated steel		

spouts			
with thread 3/8"			
			
1			
GEV No.	526699	Ref. No.	08366650
description	filter holder spout thread 3/8" 1-way curved outlet distance 55mm		

			
1			
GEV No.	526719	Ref. No.	08366750
description	filter holder spout thread 3/8" 2-way curved outlet distance 55mm		

accessories			
			
1			
GEV No.	526733	Ref. No.	08480100
description	screw connection thread 3/8" for outlet ø 25mm H 14mm chrome-plated brass		

brewing units			
shower screens			
with upstand			
			
1			
GEV No.	526788	Ref. No.	02610004
description	shower screen ø 58mm H 17.5mm		

filter holder gaskets			
flat			
standard			
			
1			
GEV No.	528030	Ref. No.	01652809
description	filter holder gasket D1 ø 72.7mm D2 ø 57.2mm H 8mm Qty 1 pcs		





brewing units with solenoid valve			
filters			
filters			
			
1			
GEV No.	526738	Ref. No.	NT0029
description	filter set for brewing unit		

brewing units manual			
components			
drain units			
drain pipes			
			
1			
GEV No.	526786	Ref. No.	02010809
description	drain pipe thread M30x1.5 T1: 1/2" L 72mm chrome-plated brass WS 36		

			
1			
GEV No.	528534	Ref. No.	02010809
description	drain pipe thread M30x1.5 T1: 1/2" L 73mm WS 36 L1 21.5mm L2 36.5mm		

			
1			
GEV No.	528538	Ref. No.	02121002
description	end piece thread 1/2" int. ø 1 12mm int. ø 2 15mm L 36mm chrome-plated brass WS 26		

tap aerators			
			
1			
GEV No.	526791	Ref. No.	02121101
description	tap aerator D1 ø 8mm D2 ø 14.5mm ID ø 6mm H 14.2mm 4 holes brass		

shafts			
			
1			
GEV No.	528532	Ref. No.	02326106
description	shaft thread M4 square L 34mm W 6mm brass		

bushes			
			
1			
GEV No.	528920	Ref. No.	01860402
description	bush D1 ø 15mm D2 ø 10.8mm ID ø 8mm H 30mm brass		

			
1			
GEV No.	526790	Ref. No.	02446300
description	filter support D1 ø 13mm ID ø 5mm int. ø 1 11mm H 9mm brass		

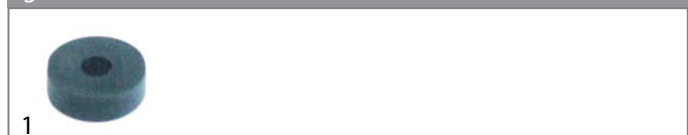
gaskets			
			
1			
GEV No.	528494	Ref. No.	01954502
description	gasket rubber ED ø 13mm ID ø 4mm thickness 4mm Qty 1 pcs		

gasket supports			
			
1			
GEV No.	528528	Ref. No.	01955103 02021608
description	gasket support ED ø 16mm ID ø 13mm H 13mm for gasket thread M3 brass L 13mm int. ø 1 13mm		

miscellaneous



1

GEV No.	528530	Ref. No.	02211100
description	bolt square brass thread M3 L 11mm W 6mm H 6mm thread L 10mm		



1

GEV No.	528531	Ref. No.	02211001
description	bolt square brass thread M3 L 12mm W 6mm H 6mm thread L 10mm		



1

GEV No.	526792	Ref. No.	02326007
description	nut triangle brass thread M3 L 6.2mm W 6.2mm H 6.2mm		



1

GEV No.	528529	Ref. No.	04732202
description	plain washer ID ϕ 3.5mm ED ϕ 6.6mm thickness 0.5mm brass Qty 1 pcs		

nozzle holders



1

GEV No.	528523	Ref. No.	02102309
description	nozzle holder thread M30x1.5 IT M16x1.5 IT 1 M6 ϕ 25.5mm int. ϕ 1 15.3mm int. ϕ 2 17.8mm L 66.5mm total length 82mm WS 36 chrome-plated brass		

accessories for

GEV No.	525318	Ref. No.	—
----------------	--------	-----------------	---



shaft bearing suitable for FAEMA E61



1

GEV No.	526783	Ref. No.	02102300 02102309
description	nozzle holder thread M30x1.5 IT M16x1.5 IT 1 M8 ϕ 26mm int. ϕ 1 15mm int. ϕ 2 17.5mm L 66.5mm total length 82mm WS 36 chrome-plated brass		



1

GEV No.	526782	Ref. No.	08299100
description	nozzle holder thread M8 int. ϕ 1 4mm int. ϕ 2 7mm L 12mm total length 18.5mm WS 8 brass		



1

GEV No.	526781	Ref. No.	08299000
description	nozzle holder thread M8 int. ϕ 1 4mm int. ϕ 2 7mm L 42mm total length 48mm WS 8 brass		

springs



1

GEV No.	528526	Ref. No.	02318400
description	compression spring ϕ 12.9mm L 41mm wire gauge ϕ 1.2mm		

filters



1

GEV No.	526737	Ref. No.	NT0028
description	filter set for brewing unit E61		

camshafts



1

GEV No.	528539	Ref. No.	01769702
description	camshaft shaft ϕ 8mm shaft intake ϕ 10mm L 79mm W 20.5mm H 17mm thread M6 brass		





1

GEV No.	528527	Ref. No.	02102200
description	spindle shaft ϕ 4mm L 40mm thread M4 brass for cam shaft		



valves			
			
1			
GEV No.	526736	Ref. No.	02022804
description	valve for outlet L 19.3mm ED ø 16mm brass		

			
1			
GEV No.	526734	Ref. No.	02023000
description	valve L 58.2mm ED ø 16mm brass		

			
1			
GEV No.	526735	Ref. No.	02022903
description	valve L 59.4mm triangle ED ø 16mm brass		

screw connections			
			
1			
GEV No.	527802	Ref. No.	01878909
description	screw connection thread 1/2" int. ø 1 11mm int. ø 2 15mm L 9mm WS 24 chrome-plated brass		

			
1			
GEV No.	526730	Ref. No.	02026300
description	screw connection thread M30x1.5 IT 1/2" ø 36mm int. ø 1 8mm int. ø 2 15mm L 26mm total length 38mm WS 26 chrome-plated brass		

			
1			
GEV No.	526726	Ref. No.	01770601
description	stop bolt thread M6 ø 6.5mm total length 13mm SS		

components			
nozzles			
with thread			
			
1			
GEV No.	528486	Ref. No.	02446706
description	nozzle bore ø 0.7mm thread M6x0.75 L 9mm WS 7		

without thread			
			
1			
GEV No.	526732	Ref. No.	08298800
description	nozzle bore ø 0.65mm ø 7mm L 21mm		

screws			
			
1			
GEV No.	560373	Ref. No.	05194402
description	cylinder head bolt thread M4 thread L 12mm WS 3 SS Qty 1 pcs intake internal hexagon DIN 912/ISO 4762		

screw connections			
			
1			
GEV No.	528661	Ref. No.	02736403
description	end cap thread M12x1.5 L 18mm chrome-plated brass WS 16		

			
1			
GEV No.	526724	Ref. No.	07557200
description	end cap thread M16x1.5 ID ø 10mm L 22mm chrome-plated brass WS 22		

			
1			
GEV No.	527270	Ref. No.	02446201
description	end cap thread M16x1.5 ID ø 8.9mm L 21mm chrome-plated WS 22		

water dispersions

water dispersions

group 2



1

GEV No.	526787	Ref. No.	02012904
description	water distributor \varnothing 30mm hole \varnothing 1.5mm H 15mm ET M10x1 grooves 6 1.5mm brass 2 holes perforation \varnothing 1mm		

expansion valves



1

GEV No.	529317	Ref. No.	N/A
description	expansion valve T1: 1/4" ET T2: 1/4" IT L 58mm		

gaskets



1

GEV No.	526694	Ref. No.	07412109
description	gasket copper ED \varnothing 30mm ID \varnothing 21mm thickness 1.5mm		



1

GEV No.	526692	Ref. No.	01853704
description	gasket ED \varnothing 15mm seat \varnothing 6mm H 4mm overall height 9mm		

gasket supports



1

GEV No.	528769	Ref. No.	01853803
description	gasket support D1 \varnothing 10.5mm D2 \varnothing 17mm ID \varnothing 6mm int. \varnothing 1 15mm L 9mm brass		

compression springs



1

GEV No.	526690	Ref. No.	00109108
description	compression spring \varnothing 15mm L 27mm wire gauge \varnothing 2.2mm		

with non-return valve



1

GEV No.	529323	Ref. No.	07843808
description	expansion valve connection 3/8" with non-return valve		

drain pans

drain pans



1

GEV No.	526697	Ref. No.	0271/050106 08478700
description	drain pan L 106mm W 76mm H 32mm hose \varnothing 18mm		

aerators and air bleeders



1

GEV No.	526780	Ref. No.	08178808
description	aerator and air bleeder screw connection 1/4"		

boilers

pipes



1

GEV No.	526722	Ref. No.	07695604
description	aspiration tube tube \varnothing 10mm pipe length 145mm T1: 1/4" T2: 1/4"		





			
1			
GEV No.	526721	Ref. No.	08489000
description	aspiration tube tube ø 8mm pipe length 130mm T1: 1/4"		

heat exchangers

injector tubes

			
1			
GEV No.	526739	Ref. No.	08489500
description	injector T1: 1/4"		



			
1			
GEV No.	526740	Ref. No.	08355000
description	injector T1: 1/4" T2: 1/4"		





			
1			
GEV No.	526720	Ref. No.	08362100
description	injector pipe tube ø 6mm pipe length 125mm T1: 1/4" T2: 1/4"		

steam/water taps

steam/water taps

steam/water taps

			
1			
GEV No.	528427	Ref. No.	08204802
description	steam/water tap inlet 1/4" outlet 3/8" brass		
accessories for	528427		
	GEV No.	510893	Ref. No. 07763204
	O-ring EPDM thickness 2.62mm ID ø 9.92mm Qty 1 pcs		
	GEV No.	528184	Ref. No. 08165300
	compression spring ø 10.8mm L 25mm wire gauge ø 1.8mm		
	GEV No.	528401	Ref. No. —
	flat gasket fibre ED ø 22mm ID ø 16mm thickness 2mm Qty 1 pcs		
	GEV No.	528653	Ref. No. 08165508
	plain washer D1 ø 7mm D2 ø 14.5mm thickness 2mm brass		

accessories for	528427		
	GEV No.	528654	Ref. No. 08165201
	bush D1 ø 15mm D2 ø 11mm H 7.7mm nylon ID ø 7mm		
	GEV No.	529587	Ref. No.
	steam pipe		
	GEV No.	529588	Ref. No. —
	steam pipe SS		
	GEV No.	529589	Ref. No. —
	water pipe		

steam taps

steam taps (complete)

			
1			
GEV No.	526775	Ref. No.	08493200
description	steam tap inlet 1/4" pipe length 150mm tube ø 8mm shaft 6mm		

			
1			
GEV No.	526774	Ref. No.	08448400 08448440
description	steam tap inlet 1/4" pipe length 160mm tube ø 10mm shaft M6		

			
1			
GEV No.	526725	Ref. No.	08165904
description	steam tap inlet 3/8" pipe length 150mm tube ø 8mm shaft 6mm		



1

GEV No.	526777	Ref. No.	08388700
description	steam tap mounting pos. left inlet 3/8" pipe length 150mm tube ø 10mm shaft M6		



1

GEV No.	526776	Ref. No.	08388600
description	steam tap mounting pos. right inlet 3/8" pipe length 150mm tube ø 10mm shaft M6		

components

shafts



1

GEV No.	526773	Ref. No.	11156530
description	shaft ø 14mm D2 ø 6mm L 85.5mm SS		



1

GEV No.	526772	Ref. No.	08389200
description	shaft ø 14mm D2 ø 7.6mm L 86mm thread M6 SS		

bushes



1

GEV No.	526010	Ref. No.	03001500	
description	bush steam/water tap D1 ø 10.5mm D2 ø 9mm ID ø 6.3mm H 4.6mm brass			
accessories for	526010			
	GEV No.	526005	Ref. No.	—
	shaft steam tap ø 14.8mm L 92.5mm thread M6 brass			

gaskets



1

GEV No.	528648	Ref. No.	11181302
description	gasket D1 ø 12.2mm thickness 6mm		

springs



1

GEV No.	526789	Ref. No.	08389900
description	compression spring ø 11.3mm L 31mm wire gauge ø 1.5mm		

tap bodies



1

GEV No.	526762	Ref. No.	08165003
description	tap body T1: M16x1 T2: 3/8" T3: 1/4" L 49mm		



1

GEV No.	526763	Ref. No.	08493100
description	tap body T1: M16x1 T2: 3/8" T3: M12x1 L 49mm		

union nuts



1

GEV No.	526727	Ref. No.	08389800
description	nut thread M6 L 7.5mm WS 10		

washers



1

GEV No.	526695	Ref. No.	07413107
description	plain washer D1 ø 29mm D2 ø 22.6mm thickness 1.5mm brass		





			
1			
GEV No.	528653	Ref. No.	08165508
description	plain washer D1 ø 7mm D2 ø 14.5mm thickness 2mm brass		

screw connections			
			
1			
GEV No.	526761	Ref. No.	07358609
description	screw connection T1: M16x1 L 66mm ID ø 12mm WS 26 brass		

water taps			
			
1			
GEV No.	526691	Ref. No.	08493300
description	water tap inlet 1/4" pipe length 60mm tube ø 10mm shaft 6mm		

			
1			
GEV No.	526693	Ref. No.	08205908
description	water tap inlet 3/8" pipe length 60mm tube ø 10mm shaft 6mm		

			
1			
GEV No.	526760	Ref. No.	08340400
description	water tap with water pipe inlet 1/4" pipe length 84mm tube ø 10mm		

steam/water pipes			
steam pipes			
			
1			
GEV No.	529587	Ref. No.	08165722+08165110+08207400
description	steam pipe		

			
1			
GEV No.	526769	Ref. No.	08341400
description	steam pipe H 100mm W 80mm tube ø 8mm SS		

			
1			
GEV No.	526779	Ref. No.	08448540
description	steam pipe thread 1/2" H 180mm 1-2 group tube ø 10mm cable length 1000mm		

			
1			
GEV No.	526778	Ref. No.	08448550
description	steam pipe thread 1/2" H 180mm 3-4 group tube ø 10mm with probe cable length 1400mm		

			
1			
GEV No.	526768	Ref. No.	08340300
description	steam pipe thread M10x1 L 170mm W 105mm tube ø 10mm SS		

			
1			
GEV No.	526767	Ref. No.	08165722
description	steam pipe thread M8x1 L 140mm W 80mm tube ø 8mm SS		

nozzles for steam pipes			
			
1			
GEV No.	526765	Ref. No.	08391900
description	nozzle thread M10x1 ø 15mm L 22mm 4 holes bore ø 1.25mm SS		

			
1			
GEV No.	526764	Ref. No.	08207400
description	nozzle thread M8x1 ø 13mm L 22mm 4 holes bore ø 1.25mm SS		

nozzles for water pipes			
tap aerators			
			
1			
GEV No.	529608	Ref. No.	09000325
description	tap aerator D1 ø 23mm H 15mm thread M22x1		

accessories			
bushes			
			
1			
GEV No.	526797	Ref. No.	08397800
description	bush D1 ø 14.5mm D2 ø 10.8mm H 7.7mm PTFE ID ø 7mm		

			
1			
GEV No.	528654	Ref. No.	08165201
description	bush D1 ø 15mm D2 ø 11mm H 7.7mm nylon ID ø 7mm		

gaskets			
			
1			
GEV No.	510893	Ref. No.	07763204
description	O-ring EPDM thickness 2.62mm ID ø 9.92mm Qty 1 pcs		

springs			
			
1			
GEV No.	528184	Ref. No.	08165300
description	compression spring ø 10.8mm L 25mm wire gauge ø 1.8mm		

tube handles			
			
1			
GEV No.	526743	Ref. No.	09000586
description	tube handle for pipe ø 10mm ø 15mm L 28mm silicone		

			
1			
GEV No.	526742	Ref. No.	08339100 08339100P
description	tube handle for pipe ø 10mm ø 15mm L 50mm rubber		

			
1			
GEV No.	526741	Ref. No.	08339000
description	tube handle for pipe ø 8mm ø 12.5mm L 50mm rubber		

union nuts			
			
1			
GEV No.	526766	Ref. No.	08165110 08165130+0847990
description	union nut thread 3/8" L 34mm hole ø 12mm		

fine filters			
			
1			
GEV No.	528326	Ref. No.	N/A
description	fine filter flat ø 11.2mm		

			
1			
GEV No.	529911	Ref. No.	02435808
description	fine filter flat ø 11mm H 0.25mm		



			
1			
GEV No.	526731	Ref. No.	08298700
description	fine filter ø 8.5mm H 15mm for brewing unit stainless steel		

intake valves

			
1			
GEV No.	529524	Ref. No.	07466006
description	intake valve water inlet 1/4" outlet 1/4" 3/8"		

accessories

gaskets

			
1			
GEV No.	528596	Ref. No.	02932200
description	gasket ED ø 12mm ID ø 4mm overall height 4mm conical		

gasket supports

			
1			
GEV No.	526771	Ref. No.	03059003
description	gasket support D1 ø 6mm D2 ø 16mm int. ø 1 3mm H 6.8mm plastic		

valves

			
1			
GEV No.	526770	Ref. No.	07665409
description	valve L 66mm ED ø 17mm		

level glasses

level glasses

gaskets

			
1			
GEV No.	526696	Ref. No.	08367000
description	gasket D1 ø 11mm D2 ø 8mm H 10mm		

level glasses (complete)

			
1			
GEV No.	526698	Ref. No.	08181505 08181604
description	water level tube L 180mm W 72mm ø 11mm thread 1/2"		

level glass pipes

			
1			
GEV No.	529367	Ref. No.	08181703
description	water level tube ø 11mm H 108mm		

non-return valves

compression springs

			
1			
GEV No.	526723	Ref. No.	01720606
description	compression spring ø 7.8mm L 34mm wire gauge ø 0.4mm		

grinding burrs

grinding burrs straight

standard

			
1			
GEV No.	527224	Ref. No.	00896209
description	grinding burrs pair turn direction left D1 ø 54mm ID ø 31mm H 8mm tooth spacing 3.5mm hole ø 4.5mm bore ø 6.5mm mounting ø 45 straight suitable for FAEMA (FP)		

			
1			
GEV No.	525533	Ref. No.	09000298 (Standard)
description	grinding burrs pair turn direction left D1 ø 64mm ID ø 37mm H 9mm tooth spacing 3mm hole ø 5.6mm bore ø 8.5mm mounting ø 50		

TITAN

			
1			
GEV No.	523039	Ref. No.	09000298 09710020
description	grinding burrs pair titanium turn direction left D1 ø 64mm ID ø 37mm H 8.5mm tooth spacing 3mm hole ø 5.6mm bore ø 8.5mm mounting ø 50		

screws

			
1			
GEV No.	525562	Ref. No.	04148219
description	screw thread M4 thread L 8mm head ø 5.5mm head thickness 3mm		

			
1			
GEV No.	525561	Ref. No.	04148110
description	screw thread M5 thread L 8mm head ø 7mm head thickness 3.5mm		

spillage trays

			
1			
GEV No.	525548	Ref. No.	09000546 11025311
description	drain tray L 240mm W 170mm for coffee grinder		

miscellaneous

			
1			
GEV No.	525543	Ref. No.	09000548 11025331
description	bezel L 142mm plastic		

			
1			
GEV No.	525558	Ref. No.	2600/010133
description	equipment foot ø 29mm L 12mm rubber for coffee grinder		

			
1			
GEV No.	525546	Ref. No.	09103400
description	flap left plastic		

			
1			
GEV No.	525545	Ref. No.	09103300
description	flap right plastic		

			
1			
GEV No.	111286	Ref. No.	09000299 09710030
description	knob spring L 20.3mm W 9.5mm H 12.5mm		

			
1			
GEV No.	525539	Ref. No.	09000421 10012690
description	pin for stop ø 4mm L 15mm		

			
1			
GEV No.	525541	Ref. No.	09000547 11025321
description	protector L 58mm plastic		

			
1			
GEV No.	800014	Ref. No.	08290900
description	puller for knob ø 59mm H 21.5mm ID ø 35mm plastic		

			
1			
GEV No.	525542	Ref. No.	09000739 19019650
description	retainer clip L 42mm		

			
1			
GEV No.	525531	Ref. No.	09000302 09710320
description	round belt for coffee grinder thickness 2.68mm ø 50.47mm		







 <p>Image not available</p>			
1			
GEV No.	525552	Ref. No.	09000682 12001840
description	spring for stop ø 4mm L 15mm		

dosing containers			
dosing container lids			
			
1			
GEV No.	525557	Ref. No.	00882506
description	lid for dosing container mounting ø 114mm ø 124mm plastic		

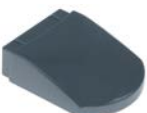
springs			
group 1			
			
1			
GEV No.	525560	Ref. No.	00883603
description	tension spring for lever L1 12mm L2 17mm L3 12mm ø 14mm wire gauge ø 1.3mm		

levers			
levers			
			
1			
GEV No.	525559	Ref. No.	07147804
description	lever for dosing container hole ø 20mm L 130mm metal		

coffee presses				
components				
holders				
				
1				
GEV No.	525534	Ref. No.	09000562 09000564 11025461 11025464	
description	bracket for coffee press aluminium L 80mm			
accessories for	525534			
	GEV No.	525535	Ref. No.	09000948 41105851
coffee press ø 57mm H 16mm thread M4 plastic				
	GEV No.	525536	Ref. No.	09000053
screw for coffee press thread M4 L 20mm				

accessories for	525534			
	GEV No.	525537	Ref. No.	09001136 42923051
coffee press ø 52mm H 19mm thread M4 plastic				

pressers				
				
1				
GEV No.	525537	Ref. No.	09001136 42923051	
description	coffee press ø 52mm H 19mm thread M4 plastic			

				
1				
GEV No.	525535	Ref. No.	09000948 41105851	
description	coffee press ø 57mm H 16mm thread M4 plastic			

screws				
				
1				
GEV No.	525536	Ref. No.	09000053	
description	screw for coffee press thread M4 L 20mm			

adjustment mechanism				
setting rings				
				
1				
GEV No.	525540	Ref. No.	09000543 11025280	
description	setting ring for coffee grinder ø 85mm ID ø 54mm H 17mm plastic			

				
1				
GEV No.	525554	Ref. No.	01314608	
description	setting ring mounting ø 88mm ø 125mm ID ø 52mm H 54mm			

coffee beans containers

container lids



1

GEV No.	525547	Ref. No.	09000549
----------------	--------	-----------------	----------

description	lid for coffee beans container L 280mm W 190mm		
--------------------	--	--	--

coffee beans containers



1

GEV No.	525527	Ref. No.	09001108 09102700
----------------	--------	-----------------	----------------------

description	coffee beans container with lid L 280mm W 190mm H 180mm seat ø 51mm		
--------------------	---	--	--

spare parts for	525527		
------------------------	--------	--	--



GEV No.	525547	Ref. No.	09000549
----------------	--------	-----------------	----------

lid for coffee beans container L 280mm W 190mm

support for filter holder



1

GEV No.	525550	Ref. No.	09000789 31095450
----------------	--------	-----------------	----------------------

description	filter holder support large SS		
--------------------	--------------------------------	--	--



1

GEV No.	525551	Ref. No.	09001130 42922151
----------------	--------	-----------------	----------------------

description	filter holder support standard plastic		
--------------------	--	--	--



1

GEV No.	530888	Ref. No.	09111200
----------------	--------	-----------------	----------

description	filter holder support standard steel		
--------------------	--------------------------------------	--	--

manifolds



1

GEV No.	525544	Ref. No.	09001201
----------------	--------	-----------------	----------

description	manifold 2-way L 230mm plastic for coffee grinder		
--------------------	---	--	--

spare parts for	525544		
------------------------	--------	--	--



GEV No.	525542	Ref. No.	09000739 19019650
----------------	--------	-----------------	----------------------

retainer clip L 42mm

knobs

steam/water taps

steam/water taps



1

GEV No.	111305	Ref. No.	08183311
----------------	--------	-----------------	----------

description	knob ø 42mm shaft ø 6x5mm shaft flat on both sides black		
--------------------	--	--	--



1

GEV No.	111307	Ref. No.	08099700
----------------	--------	-----------------	----------

description	knob ø 42mm shaft ø 6x5mm shaft flat on both sides black		
--------------------	--	--	--





1

GEV No.	111098	Ref. No.	08183303
----------------	--------	-----------------	----------

description	knob ø 42mm shaft ø 6x5mm shaft flat on both sides grey		
--------------------	---	--	--





			
1			
GEV No.	111063	Ref. No.	08185911
description	knob ø 50mm black		

			
1			
GEV No.	111020	Ref. No.	07678709 08225401
description	knob zero mark white ø 38mm shaft ø 6x5mm shaft flat on both sides black		

			
1			
GEV No.	530623	Ref. No.	PZ901788
description	turning handle ø 48mm L 43mm shaft ø 23mm black		

			
1			
GEV No.	526757	Ref. No.	08411410
description	turning handle ø 50mm shaft ø 23.5mm black		

			
1			
GEV No.	526756	Ref. No.	08411400
description	turning handle ø 50mm shaft ø 23.5mm grey		

			
1			
GEV No.	526755	Ref. No.	08335400
description	turning handle ø 51mm shaft ø 24mm black		

knob dial plates

			
1			
GEV No.	526752	Ref. No.	08389500
description	cam disc ø 17.5mm L 10mm fixed		

			
1			
GEV No.	526753	Ref. No.	08389600
description	cam disc ø 24mm L 15mm mobile		

			
1			
GEV No.	526754	Ref. No.	08389710
description	coupling ø 45mm L 35mm		

			
1			
GEV No.	526758	Ref. No.	08389700
description	coupling ø 45mm L 35mm		

			
1			
GEV No.	528760	Ref. No.	08185804
description	knob adapter ø 45mm L 43mm		

			
1			
GEV No.	111113	Ref. No.	08147804
description	knob dial plate steam ø 15mm		

			
1			
GEV No.	111114	Ref. No.	08147903
description	knob dial plate water ø 15mm		

			
1			
GEV No.	111103	Ref. No.	08100000
description	knob dial plate water t.max. 12°C		

			
1			
GEV No.	526759	Ref. No.	08411500
description	sign for handle ø 47mm L 4mm		

accessories

			
1			
GEV No.	111273	Ref. No.	09000277
description	cotter pin ø 1.3mm L 25mm		

miscellaneous



1

GEV No.	111303	Ref. No.	08411610
----------------	--------	-----------------	----------

description	knob ø 42mm W 25mm black
--------------------	--------------------------



1

GEV No.	111302	Ref. No.	08411600
----------------	--------	-----------------	----------

description	knob ø 42mm W 25mm grey
--------------------	-------------------------

accessories for	111302
------------------------	--------



GEV No.	111301	Ref. No.	08411700
----------------	--------	-----------------	----------

description	sign ø 38mm
--------------------	-------------



1

GEV No.	525538	Ref. No.	09000537 11025211
----------------	--------	-----------------	----------------------

description	knob shaft ø 8x7 black plastic
--------------------	--------------------------------



1

GEV No.	111304	Ref. No.	08336100
----------------	--------	-----------------	----------

description	knob zero mark ø 42mm L 24mm black
--------------------	------------------------------------

accessories

button springs



1

GEV No.	111286	Ref. No.	09000299 09710030
----------------	--------	-----------------	----------------------

description	knob spring L 20.3mm W 9.5mm H 12.5mm
--------------------	---------------------------------------

covers



1

GEV No.	111301	Ref. No.	08411700
----------------	--------	-----------------	----------

description	sign ø 38mm
--------------------	-------------

rosettes



1

GEV No.	111306	Ref. No.	08099500
----------------	--------	-----------------	----------

description	rosette for filling valve knob ø 42mm ø 55mm black
--------------------	--



1

GEV No.	111069	Ref. No.	08099518
----------------	--------	-----------------	----------

description	rosette for filling valve knob ø 42mm ø 55mm grey
--------------------	---

handles and hand wheels

lever handles



1

GEV No.	528658	Ref. No.	08111200
----------------	--------	-----------------	----------

description	lever handle plastic black shaft 6.5x6.5mm
--------------------	--

equipment feet and end caps

equipment feet with stem



1

GEV No.	525558	Ref. No.	2600/010133
----------------	--------	-----------------	-------------

description	equipment foot ø 29mm L 12mm rubber for coffee grinder
--------------------	--



gaskets

O-rings

EPDM

ø2.62mm

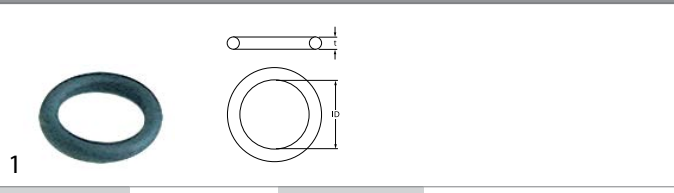

GEV No.	529412	Ref. No.	08291007
description	O-ring EPDM thickness 2.62mm ID ø 10.78mm Qty 1 pcs		

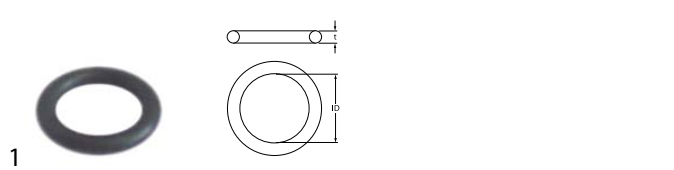

GEV No.	528487	Ref. No.	07763204
description	O-ring EPDM thickness 2.62mm ID ø 9.19mm Qty 1 pcs		

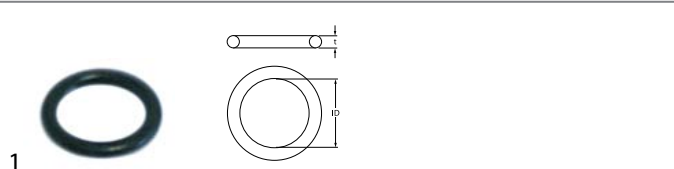

GEV No.	510893	Ref. No.	07763204
description	O-ring EPDM thickness 2.62mm ID ø 9.92mm Qty 1 pcs		

silicone

ø2.00mm

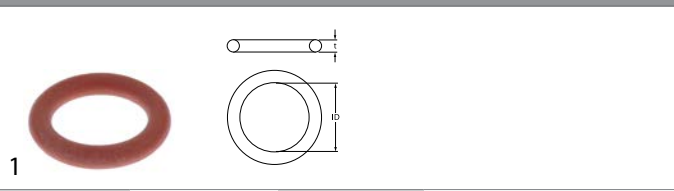

GEV No.	532716	Ref. No.	NM01.057
description	O-ring silicone thickness 2mm ID ø 5mm Qty 10 pcs		

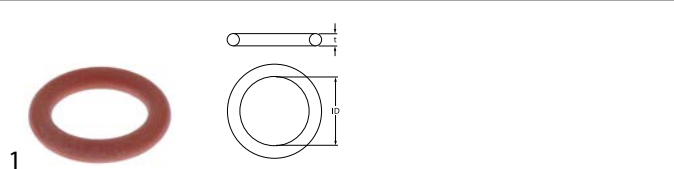

GEV No.	532715	Ref. No.	140320459
description	O-ring silicone thickness 2mm ID ø 8mm Qty 10 pcs		

Viton

ø1.50mm

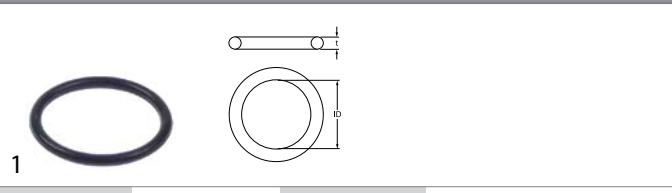

GEV No.	525532	Ref. No.	08494700
description	O-ring Viton thickness 1.5mm ID ø 14mm Qty 1 pcs		

ø1.78mm

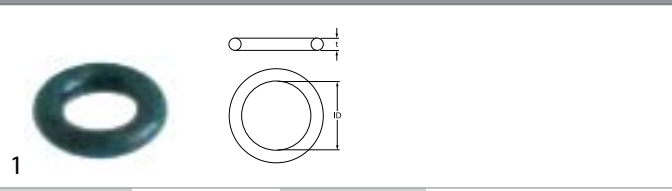

GEV No.	528687	Ref. No.	0371/040103
description	O-ring Viton thickness 1.78mm ID ø 3.69mm Qty 1 pcs		

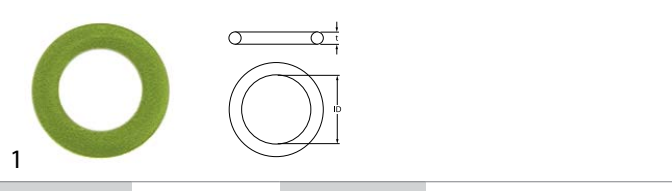

GEV No.	101526	Ref. No.	03070802
description	O-ring Viton thickness 1.78mm ID ø 4.48mm Qty 1 pcs		

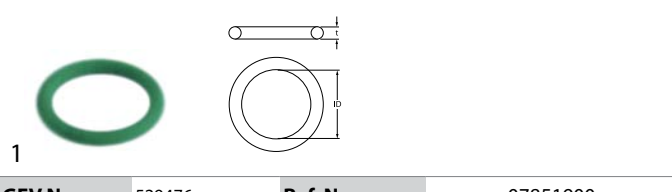

GEV No.	529476	Ref. No.	07851900
description	O-ring Viton thickness 1.78mm ID ø 9.25mm Qty 1 pcs		

ø2.00mm

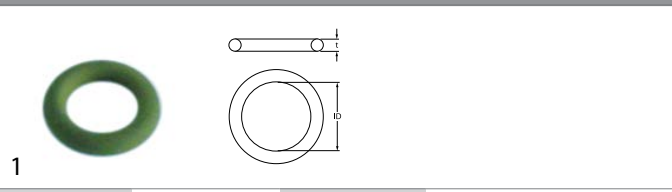

GEV No.	528649	Ref. No.	02476703
description	O-ring Viton thickness 2mm ID ø 6mm Qty 1 pcs		

ø3.53mm

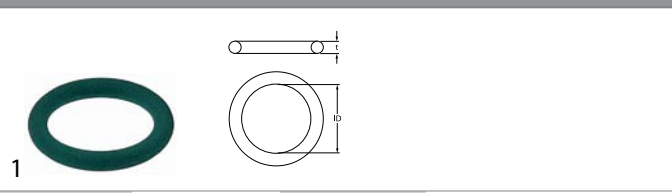

GEV No.	528525	Ref. No.	02019701
description	O-ring Viton thickness 3.53mm ID ø 18.64mm Qty 1 pcs		

sealing washers

rubber gaskets



1	GEV No.	528494	Ref. No.	01954502
description gasket rubber ED ø 13mm ID ø 4mm thickness 4mm Qty 1 pcs				



1	GEV No.	528495	Ref. No.	10257608
description gasket rubber ED ø 16mm ID ø 8mm thickness 4mm Qty 1 pcs				

copper gaskets

DIN-7603-A



1	GEV No.	528197	Ref. No.	07411705
description flat gasket copper ED ø 10mm ID ø 6mm thickness 1mm Qty 1 pcs				



1	GEV No.	528662	Ref. No.	07411507
description flat gasket copper ED ø 16mm ID ø 12mm thickness 1.5mm				



1	GEV No.	529361	Ref. No.	01626804
description flat gasket copper ED ø 18mm ID ø 13.5mm thickness 1.5mm for thread 1/4"				



1	GEV No.	528660	Ref. No.	07412208
description flat gasket copper ED ø 21mm ID ø 17mm thickness 1.5mm suitable for 3/8"				



1	GEV No.	526694	Ref. No.	07412109
description gasket copper ED ø 30mm ID ø 21mm thickness 1.5mm				

DIN-7603-C



1	GEV No.	528520	Ref. No.	02455103
description gasket copper ED ø 22mm ID ø 16mm thickness 2mm				



1	GEV No.	529360	Ref. No.	02455202
description gasket copper ED ø 26.1mm ID ø 21mm thickness 2.1mm for thread 1/2"				

PTFE gaskets



1	GEV No.	528945	Ref. No.	05132808
description flat gasket PTFE ED ø 22mm ID ø 16mm thickness 1.5mm Qty 1 pcs equiv. no. W10309 suitable for ESPRESSA, WEGA				



1	GEV No.	526795	Ref. No.	05132900
description flat gasket PTFE ED ø 36mm ID ø 30.2mm thickness 1.5mm Qty 1 pcs				

special gaskets

group gaskets



1	GEV No.	526794	Ref. No.	08150203
description group gasket L 78mm W 72mm thickness 1mm aperture 65x24mm hole distance 58mm				



springs

compression springs

1 

GEV No.	528184	Ref. No.	08165300
description	compression spring ø 10.8mm L 25mm wire gauge ø 1.8mm		

1 

GEV No.	526789	Ref. No.	08389900
description	compression spring ø 11.3mm L 31mm wire gauge ø 1.5mm		

1 

GEV No.	528526	Ref. No.	02318400
description	compression spring ø 12.9mm L 41mm wire gauge ø 1.2mm		

1 

GEV No.	528533	Ref. No.	02054609
description	compression spring ø 14.6mm L 43mm wire gauge ø 1.4mm		

1 

GEV No.	528475	Ref. No.	01784909
description	compression spring ø 14.7mm L 33mm wire gauge ø 2mm		

1 

GEV No.	528542	Ref. No.	01854306
description	compression spring ø 15mm L 27mm wire gauge ø 1.8mm windings 5		

1 

GEV No.	526690	Ref. No.	00109108
description	compression spring ø 15mm L 27mm wire gauge ø 2.2mm		

1 

GEV No.	528758	Ref. No.	08018707
description	compression spring ø 29.6mm L 28mm wire gauge ø 1.5mm		

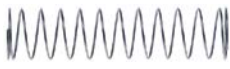
1 

GEV No.	526723	Ref. No.	01720606
description	compression spring ø 7.8mm L 34mm wire gauge ø 0.4mm		

1 

GEV No.	528521	Ref. No.	02446409
description	compression spring ø 8.3mm L 19mm wire gauge ø 0.9mm windings 5		

tension springs

1 

GEV No.	525560	Ref. No.	00883603
description	tension spring for lever L1 12mm L2 17mm L3 12mm ø 14mm wire gauge ø 1.3mm		

manometers

1 

GEV No.	541709	Ref. No.	08385000
description	manometer double scale ø 60mm pressure range 0-2.5 / 0-16bar connection on the backside thread 1/8"		

1 

GEV No.	541710	Ref. No.	08339500
description	manometer double scale ø 60mm pressure range 0-2.5 / 0-16bar connection on the backside thread 1/8"		

1

GEV No.	541711	Ref. No.	08405500
description	manometer double scale ø 60mm pressure range 0-2.5 / 0-16bar connection on the backside thread 1/8"		



1

GEV No.	541713	Ref. No.	08130600
description	manometer double scale ø 60mm pressure range 0-2.5 / 0-16bar connection on the backside thread 1/8"		



1

GEV No.	541712	Ref. No.	08323500
description	manometer pressure range 0-2.5bar ø 60mm connection 1/8" marking 0.7-1		

dosing pumps

accessories

hose couplings

metal



1

GEV No.	361184	Ref. No.	05060680
description	nut thread 1/2" H 6mm nickel-plated brass WS 24 Qty 1 pcs		

hoses

industrial hoses

PTFE hoses

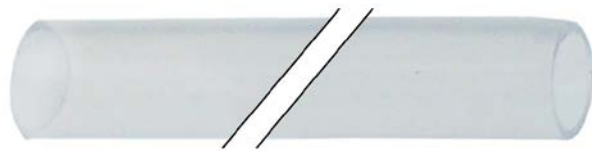

1

GEV No.	520479	Ref. No.	67615610080
description	PTFE hose ED ø 10mm ID ø 8mm thickness 1mm L 1000mm		

tools

cleaning tools

brushes

pipe brushes

nylon



1

GEV No.	802400	Ref. No.	09000410 09716130
description	brush nylon ø 30mm total length 480mm brush length 110mm		

fastening material

screws

cylinder head bolts

DIN 912/ISO 4762



1

GEV No.	560373	Ref. No.	05194402
description	cylinder head bolt thread M4 thread L 12mm WS 3 SS Qty 1 pcs intake internal hexagon DIN 912/ISO 4762		



1

GEV No.	560031	Ref. No.	05194006
description	cylinder head bolt thread M6 thread L 10mm WS 5 SS Qty 20 pcs DIN 912/ISO 4762		



1

GEV No.	529123	Ref. No.	05193800
description	cylinder head bolt thread M8 L 80mm thread L 30mm WS 6 SS Qty 1 pcs DIN 912/ISO 4762		

nuts

cap nuts



1

GEV No.	560137	Ref. No.	08115600
description	cap nuts thread M6 WS 10 SS Qty 20 pcs DIN/ISO DIN 1587		



hexagonal nuts

hexagonal nuts inch thread

			
1			
GEV No.	361184	Ref. No.	05060680
description	nut thread 1/2" H 6mm nickel-plated brass WS 24 Qty 1 pcs		

			
1			
GEV No.	511472	Ref. No.	04531505
description	nut thread 3/8" H 4mm brass WS 21 Qty 1 pcs		

washers

washers

DIN 9021

			
1			
GEV No.	560398	Ref. No.	07414501
description	plain washer ID ø 6.5mm ED ø 22mm thickness 1.5mm SS Qty 1 pcs		

miscellaneous

			
1			
GEV No.	560399	Ref. No.	07412509
description	plain washer ID ø 21.5mm ED ø 32mm thickness 0.5mm SS Qty 1 pcs		

			
1			
GEV No.	528529	Ref. No.	04732202
description	plain washer ID ø 3.5mm ED ø 6.6mm thickness 0.5mm brass Qty 1 pcs		

			
1			
GEV No.	526728	Ref. No.	04711701
description	plain washer ID ø 6.5mm ED ø 14.5mm thickness 1mm brass Qty 1 pcs		

			
1			
GEV No.	528522	Ref. No.	04715801
description	plain washer ID ø 6.7mm ED ø 10.8mm thickness 1mm brass Qty 1 pcs		

			
1			
GEV No.	525884	Ref. No.	07414300
description	plain washer ID ø 8mm ED ø 16mm thickness 1.5mm brass Qty 1 pcs		

tooth lock washers

DIN 6798A

			
1			
GEV No.	560127	Ref. No.	09000067 7568603
description	tooth lock washer ID ø 6.2mm ED ø 11mm SS DIN/ISO DIN 6798A Qty 20 pcs for thread M6		

			
1			
GEV No.	560128	Ref. No.	07568702
description	tooth lock washer ID ø 8.3mm ED ø 15mm SS DIN/ISO DIN 6798A Qty 20 pcs for thread M8		

fasteners

cotter pins

			
1			
GEV No.	111273	Ref. No.	09000277
description	cotter pin ø 1.3mm L 25mm		

			
1			
GEV No.	695209	Ref. No.	05160007
description	cotter pin ø 2mm L 20mm SS		

B		R	
bi-metal thermostats	3, 3	relays	6
brushes	32	rocker/momentary rocker switches	4
C		rotary switches	5
cap nuts	32	S	
cleaning tools	32	safety thermostats	3
compressors	11	screws	32
condensators & interference suppression filters	12	sealing washers	30
contactors	6	solenoid valves	11
cotter pins	33	solid state relays	6
cylinder head bolts	32	starting capacitors	12
D		switches and momentary switches	4
dosing pumps	32	T	
F		thermostats	3
fasteners	33	tools	32
fastening material	32	tooth lock washers	33
H		transformers	6
heating elements	3	W	
heating elements for coffee machine	3	washers	33
hexagonal nuts	33		
hose couplings	32		
hoses	32		
I			
indicator lights	5		
indicator lights (complete)	5		
industrial hoses	32		
L			
lamps	5		
LED	5		
M			
microswitches	4		
motors	11		
N			
nuts	32		
O			
operating capacitors	12		
O-rings	29		
P			
pipe brushes	32		
probes	6		
PTFE hoses	32		