



GAS COMPONENTS



ELECTRIC COMPONENTS



WATER TECHNOLOGY



MECHANICAL COMPONENTS



TOOLS

Spare parts suitable for

POTIS

Find the complete and up-to-date range of products in our GEV Webshop



Manufacturer catalogue

The most important spare parts and accessories arranged clearly for every manufacturer

- ✓ Complete product range and all appliance data always up to date in the GEV Webshop
- ✓ Alphabetical Index at the end of the catalogue

GEV Webshop

www.gev-online.co.uk

www.gev-online.com



- 🔍 Add to Favourites
- 🔍 Sign In with email address and usual password
- 🔍 Easy-order – place several items in your basket at the same time
- 🔍 Quick Item search – no login needed









heating elements

heating elements for gyros grills







1

GEV No.	415562	Ref. No.	PT0094
description	heating element 1300W 230V L 270mm W 92mm H 80mm connection M4 thread M14x1.5 tube ø 8.5mm connection length 13mm 2 hole fixing dry heating element mounting distance 85mm		
For models:	E1, E2, E3		
spare parts for	415562		
	GEV No.	510417	Ref. No. —
	flat gasket fibre ED ø 20mm ID ø 14mm thickness 2mm Qty 1 pcs		
accessories for	415562		
	GEV No.	520228	Ref. No. —
	tooth lock washer ID ø 15.3mm ED ø 24mm steel Qty 1 pcs for thread M14		
	GEV No.	520230	Ref. No. —
	nut thread M14x1.5 H 5mm WS 19 zinc-coated steel Qty 1 pcs		
	GEV No.	521101	Ref. No. —
	nut thread M14x1.5 H 5mm WS 19 SS Qty 1 pcs		
	GEV No.	550262	Ref. No. —
	flat gasket copper ED ø 20mm ID ø 14mm thickness 2mm		



1



GEV No.	415563	Ref. No.	PT0095
description	heating element 1500W 230V L 265mm W 93mm H 80mm connection M4 thread M14x1.5 tube ø 8.5mm 2 hole fixing dry heating element mounting distance 84mm		
spare parts for	415563		
	GEV No.	510417	Ref. No. —
	flat gasket fibre ED ø 20mm ID ø 14mm thickness 2mm Qty 1 pcs		
accessories for	415563		
	GEV No.	520228	Ref. No. —
	tooth lock washer ID ø 15.3mm ED ø 24mm steel Qty 1 pcs for thread M14		
	GEV No.	520230	Ref. No. —
	nut thread M14x1.5 H 5mm WS 19 zinc-coated steel Qty 1 pcs		
	GEV No.	521101	Ref. No. —
	nut thread M14x1.5 H 5mm WS 19 SS Qty 1 pcs		
	GEV No.	550262	Ref. No. —
	flat gasket copper ED ø 20mm ID ø 14mm thickness 2mm		

ceramic heaters

245x60mm



1

GEV No.	415104	Ref. No.	PT0212
description	ceramic emitter 1000W 230V cable beaded cord L 245mm W 60mm H 35mm		
For models:	EH		
spare parts for	415104		
	GEV No.	415109	Ref. No. —
	spring clip		
accessories for	415104		
	GEV No.	415110	Ref. No. —
	reflector L 245mm W 95mm H 31mm thickness 0.75mm hole ø 15x40mm		

accessories



1

GEV No.	850030	Ref. No.	PT0106
description	ceramic plate curved		
For models:	E1, E2, E3, EH		

switches and momentary switches

rocker/momentary rocker switches

30x11mm



1

GEV No.	345575	Ref. No.	PT0176
description	rocker switch mounting measurements 30x11mm black 1CO 250V 16A I O II connection male faston 6.3mm ambient temperature max. 90°C protection IP40 with neutral position		
For models:	E1, E2, E3, EH, G1, G2, G3, GD1, GD2, GD3, GD4, GD5		



cam switches

7-position





1

GEV No.	300004	Ref. No.	PT0178
description	cam switch 7 operating positions 1NO/2CO sequence 0-1-2-3-4-5-6 16A shaft ø 6x4.6mm shaft L 23mm connection male faston 6.3mm 7-position ceramic		
For models:	E1, E2, E3, EH		



1

GEV No.	300025	Ref. No.	PT0177	
description	cam switch 7 operating positions 1NO/2CO sequence 0-1-2-3-4-5-6 16A shaft ø 6x4.6mm shaft L 23mm connection screw 7-position ceramic			
For models:	E1, E2, E3, EH			
accessories for	300025			
	GEV No.	112172	Ref. No.	—
	knob universal ø 70mm black without adaptor/dial plate			
	GEV No.	112213	Ref. No.	—
	knob dial plate silver switch 7-position t.max.°C°C ED ø 63mm ID ø 45.5mm			
	GEV No.	112311	Ref. No.	—
	knob adapter shaft ø 6x4.6mm L 0mm with spring			

lamps

indicator lights

indicator lights 2-piece (lens and indicator lamp)

indicator lamps for socket type SRZ / SDK / SDY / SFK



1

GEV No.	359430	Ref. No.	PT0118	
description	indicator lamp 230V clear connection cable 400mm			
For models:	E1, E2, E3, EH			
accessories for	359430			
	GEV No.	359260	Ref. No.	—
	indicator light housings mounting measurements ø12mm yellow round Qty 1 pcs			

indicator lights (complete)

ø12mm

with plug-in socket



1

GEV No.	359900	Ref. No.	PT0117
description	indicator light ø 12mm 230V red with cable		

motors

gear motors

for gyros grills

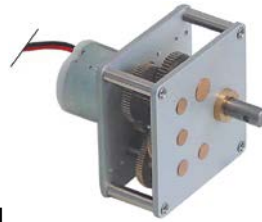

1

GEV No.	500503	Ref. No.	PT0162
description	gear motor 12V 1rpm		



1

GEV No.	500070	Ref. No.	PT0153
description	gear motor POTIS 230V 50Hz 1rpm shaft ø 8mm L 64mm W 64mm H 80mm		
For models:	E1, E2, E3, EH, G1, G2, G3, GD1, GD2, GD3, GD4, GD5		



1

GEV No.	500502	Ref. No.	PT0156
description	gear motor POTIS type 427 220-240V 50Hz 2rpm shaft ø 8mm L 64mm W 64mm H 56mm capacitor 0.12µF		
For models:	E1, E2, E3, EH, G1, G2, G3, GD1, GD2, GD3, GD4, GD5		





1

GEV No.	500785	Ref. No.	PT0161
description	gear motor POTIS 0.96W 12V voltage DC 1rpm shaft ø 18mm L 180mm W 95mm H 115mm		



1

GEV No.	500797	Ref. No.	PT0152	
description	gear motor POTIS type PT0152 3.5W 230V voltage AC 50Hz 1rpm shaft ø 18mm L 160mm W 115mm H 95mm with housing			
For models:	E1, E2, E3, EH, G1, G2, G3, GD1, GD2, GD3, GD4, GD5			
spare parts for	500797			
	GEV No.	345575	Ref. No.	PT0176
	rocker switch mounting measurements 30x11mm black 1CO 250V 16A I O II connection male faston 6.3mm ambient temperature max. 90°C protection IP40 with neutral position			

fuses

fine fuses



1

GEV No.	358603	Ref. No.	PT0195
description	fine fuse size ø5x20mm 2A slow-acting rated 250V Qty 10 pcs		
For models:	E1, E2, E3, EH		

electric accessories

plugs - couplings - power sockets

protective contact plugs



1

GEV No.	550241 ¹	Ref. No.	PT0207
description	plug CEE7/7 type E+F angled 3-pole contacts P+N+E max. 16A max 250V with switch thermoplastic countries D/F/B/I		
For models:	E1, E2, E3, EH, G1, G2, G3, GD1, GD2, GD3, GD4, GD5		

¹incl. rocker switch

protective contact power sockets

producer-specific power sockets

miscellaneous



1

GEV No.	550054	Ref. No.	PT0206
description	power socket CEE7/4 type F built-in version contacts P+N+E max. 16A max 230V protection IP44 with fine fuse countries DE H 62mm mounting ø 45mm W 50mm		
For models:	E1, E2, E3, EH		

gas taps

MADEC (MP)

with pipe outlet





1

GEV No.	103203 ¹	Ref. No.	PT0085 PT0085 Flüssiggas
description	gas tap MADEC type LPG with pipe outlet with thermocouple and knob gas inlet M12x1 (tube ø 8mm) bypass nozzle ø 1mm gas outlet M12x1 (tube ø 8mm) thermocouple connection M8x1 front fixing M12x1 shaft ø 6x4.6mm shaft L 29.5/21mm shaft flat right		
For models:	G1, G2, G3, GD1, GD2, GD3, GD4, GD5		

¹incl. thermocouple and knob





1

GEV No.	103205 ¹	Ref. No.	PT0086 PT0086 Flüssiggas	
description	gas tap MADEC type LPG with thermocouple and knob gas inlet pipe flange ø16mm bypass nozzle ø 1mm gas outlet M12x1 (tube ø 8mm) thermocouple connection M8x1 front fixing M12x1 shaft ø 6x4.6mm shaft L 27/20mm shaft flat lower			
accessories for	103205			
	GEV No.	102054	Ref. No.	—
	thermocouple M8x1 L 320mm M8x1			
	GEV No.	110149	Ref. No.	PT0114
	knob gas tap without ignition flame t.max.°C temperature range°C ø 50mm shaft ø 6x4.6mm shaft flat right black			

¹incl. thermocouple and knob





1

GEV No.	103202 ¹	Ref. No.	PT0085 PT0085 Erdgas
description	gas tap MADEC type natural gas with pipe outlet with thermocouple and knob gas inlet M12x1 (tube ø 8mm) bypass nozzle ø 0.65mm gas outlet M12x1 (tube ø 8mm) thermocouple connection M8x1 front fixing M12x1 shaft ø 6x4.6mm shaft L 29.5/21mm shaft flat right		
accessories for	103202		
	GEV No.	102054	Ref. No. —
	thermocouple M8x1 L 320mm M8x1		
	GEV No.	110149	Ref. No. PT0114
	knob gas tap without ignition flame t.max.°C temperature range°C ø 50mm shaft ø 6x4.6mm shaft flat right black		

¹incl. thermocouple and knob



1

GEV No.	103204 ¹	Ref. No.	PT0086 PT0086 Erdgas
description	gas tap MADEC type natural gas with thermocouple and knob gas inlet pipe flange ø16mm bypass nozzle ø 0.65mm gas outlet M12x1 (tube ø 8mm) thermocouple connection M8x1 front fixing M12x1 shaft ø 6x4.6mm shaft L 27/20mm shaft flat lower		
accessories for	103204		
	GEV No.	102054	Ref. No. —
	thermocouple M8x1 L 320mm M8x1		
	GEV No.	110149	Ref. No. PT0114
	knob gas tap without ignition flame t.max.°C temperature range°C ø 50mm shaft ø 6x4.6mm shaft flat right black		

¹incl. thermocouple and knob



1

GEV No.	101638	Ref. No.	N/A
description	gas tap MADEC with pipe outlet gas inlet M12x1 (tube ø 8mm) bypass nozzle ø 1mm gas outlet M12x1 (tube ø 8mm) thermocouple connection M8x1 front fixing M12x1 shaft ø 6x4.6mm shaft L 29.5/21mm shaft flat right		
spare parts for	101638		
	GEV No.	100454	Ref. No. —
	bypass nozzle MADEC bore ø 1mm thread M4.5x0.6		

spare parts for	101638		
	GEV No.	101051	Ref. No. PT0150
	magnet unit L 27mm D1 ø 12.5mm D2 ø 8.5mm suitable for JUNKERS/EGA/MADEC/SABAF standard		
	GEV No.	101234	Ref. No. —
	union nut T1: M8x1 T2: M15		
accessories for	101638		
	GEV No.	100360	Ref. No. N/A
	bypass nozzle MADEC bore ø 0.35mm thread M4.5x0.6 total length 13mm		
	GEV No.	101277	Ref. No. PT0010
	olive ID ø 8mm Qty 1 pcs		
	GEV No.	101296	Ref. No. PT0244
	union nut thread M12x1 for pipe ø 8mm		
	GEV No.	101299	Ref. No. Mutter M12x1
	nut thread M12x1		
	GEV No.	110149	Ref. No. PT0114
	knob gas tap without ignition flame t.max.°C temperature range°C ø 50mm shaft ø 6x4.6mm shaft flat right black		

ignition parts

thermocouples

plug-in thermocouples

plug-in thermocouples standard

threaded thermocouples (miscellaneous)

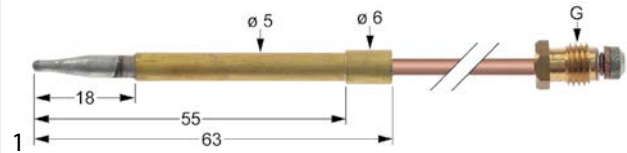



GEV No.	106989	Ref. No.	PT0243
description	thermocouple M8x1 L 330mm plug connection ø5.0mm		
For models:	G1, G2, G3, GD1, GD2, GD3, GD4, GD5		

threaded thermocouples

threaded thermocouples flexible

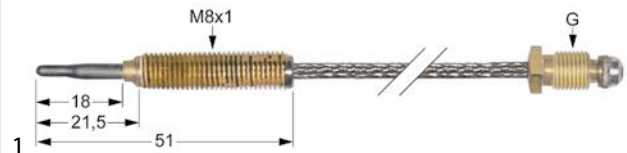
with socket with thread M8x1









GEV No.	102128	Ref. No.	PT0241
description	thermocouple M8x1 L 320mm M8x1		
accessories for	102128		
	GEV No.	102067	Ref. No. —
	nut thread M8x1 H 3mm brass Qty 1 pcs type SEF 1		



gas burners





ceramic burners

 <p>1</p>			
GEV No.	104280	Ref. No.	PT0005
description	ceramic burner L 160mm W 121mm firing range 130x90mm 1.75kW		
For models:	G1, G2, G3		
spare parts for	104280		
	GEV No.	104282	Ref. No. PT0007 PT0007+PT0008
ceramic plate L 132mm W 92mm H 12mm			
accessories for	104280		
	GEV No.	100611	Ref. No. PT0012
gas injector bore \varnothing 0.59mm LPG			
	GEV No.	100612	Ref. No. PT0013
gas injector bore \varnothing 1.05mm natural gas			

 <p>1</p>			
GEV No.	104281	Ref. No.	PT0006 PT0006 Erdgas
description	ceramic burner L 216mm W 160mm firing range 177x125mm pipe connection \varnothing 8mm nozzle \varnothing 1.45mm		
For models:	GD1, GD2, GD3, GD4, GD5		
spare parts for	104281		
	GEV No.	104282	Ref. No. PT0007 PT0007+PT0008
ceramic plate L 132mm W 92mm H 12mm			
accessories for	104281		
	GEV No.	100613	Ref. No. PT0014
gas injector bore \varnothing 0.81mm LPG			
	GEV No.	100614	Ref. No. PT0015
gas injector bore \varnothing 1.45mm natural gas			
	GEV No.	850029	Ref. No. PT0291
burner grid L 230mm W 150mm new edition			
	GEV No.	850031	Ref. No. PT0265
burner grid L 170mm W 165mm			

accessories

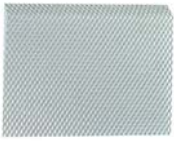
burner grids

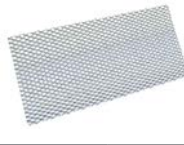
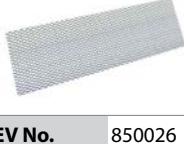
 <p>1</p>			
GEV No.	850031	Ref. No.	PT0265
description	burner grid L 170mm W 165mm		
For models:	GD1		
 <p>1</p>			
GEV No.	850028	Ref. No.	PT0290
description	burner grid L 180mm W 113mm suitable for G1, G2, G3		
For models:	G1, G2, G3		
 <p>1</p>			
GEV No.	850032	Ref. No.	PT0266
description	burner grid L 205mm W 160mm		
For models:	GD2		
 <p>1</p>			
GEV No.	850029	Ref. No.	PT0291
description	burner grid L 230mm W 150mm new edition		
For models:	GD3, GD4, GD5		
 <p>1</p>			
GEV No.	850025	Ref. No.	PT0270
description	burner grid L 350mm W 160mm		
 <p>1</p>			
GEV No.	850026	Ref. No.	PT0271
description	burner grid L 480mm W 160mm		

			
1			
GEV No.	850027	Ref. No.	PT0272
description	burner grid L 590mm W 160mm		

ceramic plates			
			
1			
GEV No.	104282	Ref. No.	PT0007 PT0007+PT0008
description	ceramic plate L 132mm W 92mm H 12mm		

			
1			
GEV No.	100614	Ref. No.	PT0015
description	gas injector bore ø 1.45mm natural gas		
For models:	GD1, GD2, GD3, GD4, GD5		

bypass nozzles

bypass nozzles MADEC			
			
1			
GEV No.	100360	Ref. No.	N/A
description	bypass nozzle MADEC bore ø 0.35mm thread M4.5x0.6 total length 13mm		

gas nozzles

main nozzles

gas nozzles (other)

			
1			
GEV No.	100611	Ref. No.	PT0012
description	gas injector bore ø 0.59mm LPG		
For models:	G1, G2, G3		

			
1			
GEV No.	107778	Ref. No.	N/A
description	gas injector bore ø 0.75mm LPG		



			
1			
GEV No.	100613	Ref. No.	PT0014
description	gas injector bore ø 0.81mm LPG		
For models:	GD1, GD2, GD3, GD4, GD5		

			
1			
GEV No.	100612	Ref. No.	PT0013
description	gas injector bore ø 1.05mm natural gas		
For models:	G1, G2, G3		

auxiliary gas parts

screw connections

union nuts

			
1			
GEV No.	101296	Ref. No.	PT0244
description	union nut thread M12x1 for pipe ø 8mm		
For models:	G1, G2, G3, GD1, GD2, GD3, GD4, GD5		
accessories for	101296		
		GEV No.	101277
		Ref. No.	PT0010
	olive ID ø 8mm Qty 1 pcs		

equipment-specific units

for gyros grills

skewers

			
1			
GEV No.	694311	Ref. No.	PT0200
description	skewer for gyro grill size 20x20mm L 895mm		



knobs

universal knobs

			
1			
GEV No.	110234	Ref. No.	PT0113
description	knob switch 7-position t.max.°C ø 50mm shaft ø 6x4.6mm shaft flat upper black		
For models:	E1, E2, E3, EH		

			
1			
GEV No.	110234	Ref. No.	PT0113
description	knob switch 7-position t.max.°C ø 50mm shaft ø 6x4.6mm shaft flat upper black		
For models:	E1, E2, E3, EH		

producer-specific knobs

POTIS

			
1			
GEV No.	110149	Ref. No.	PT0114
description	knob gas tap without ignition flame t.max.°C temperature range°C ø 50mm shaft ø 6x4.6mm shaft flat right black		
For models:	G1, G2, G3, GD1, GD2, GD3, GD4, GD5		

consumables

fuses

fine fuses

			
1			
GEV No.	358603	Ref. No.	PT0195
description	fine fuse size ø5x20mm 2A slow-acting rated 250V Qty 10 pcs		
For models:	E1, E2, E3, EH		

C

cam switches	4
ceramic burners	7
ceramic heaters	3
consumables	9

E

electric accessories	5
----------------------	---

F

fine fuses	9
fuses	5,9

G

gas burners	7
gas nozzles	8
gas taps	5

H

heating elements	3
heating elements for gyros grills	3

I

indicator lights	4
indicator lights (complete)	4

L

lamps	4
-------	---

M

motors	4
--------	---

P

plugs - couplings - power sockets	5
protective contact plugs	5
protective contact power sockets	5

R

rocker/momentary rocker switches	3
----------------------------------	---

S

switches and momentary switches	3
---------------------------------	---

T

thermocouples	6
---------------	---