



GAS COMPONENTS



ELECTRIC COMPONENTS



WATER TECHNOLOGY



MECHANICAL COMPONENTS



TOOLS

Spare parts suitable for

POLARIS

Find the complete and up-to-date range of products in our GEV Webshop



Manufacturer catalogue

The most important spare parts and accessories arranged clearly for every manufacturer

- ✓ Complete product range and all appliance data always up to date in the GEV Webshop
- ✓ Alphabetical Index at the end of the catalogue

GEV Webshop

www.gev-online.co.uk

www.gev-online.com



- 🔍 Add to Favourites
- 🔍 Sign In with email address and usual password
- 🔍 Easy-order – place several items in your basket at the same time
- 🔍 Quick Item search – no login needed





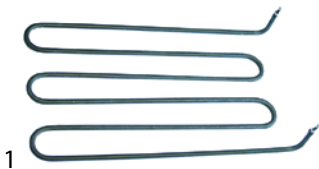

heating elements

heating elements for bain maries

| | | | |
|---|---|-----------------|---------|
|  | | | |
| GEV No. | 416797 | Ref. No. | A037050 |
| description | heating element 2000W 230V heating circuits 1 L 480mm W 275mm connection male faston 6.3mm connection length 21mm tube ø 8.5mm dry heating element H 60mm | | |

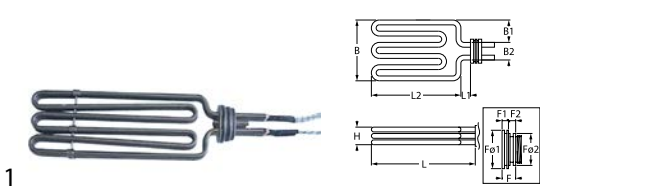
heating elements for fryers

center connection

| | | | |
|---|--|-----------------|---|
|  | | | |
| GEV No. | 415297 | Ref. No. | 4185326002136 BN4185326002136 SI0108058 SIR0108058 |
| description | heating element 6800W 230/400V heating circuits 3 L 299mm W 107mm H 35mm flange length 19.5mm flange length 1 9.5mm flange length 2 9.8mm flange ø1 62mm flange ø2 57mm thermostat sleeves ø 8.5mm sensor screw connection 2x M10x1 thermostat sleeve upper/lower L1 16mm L2 283mm W1 30mm W2 77mm thread M54x1.5 tube ø 8.5mm cable length 450mm rotation flange immersion heater | | |
| accessories for | 415297 | | |
| | GEV No. | Ref. No. | — |
|  | 510243 | | |
| | O-ring Viton thickness 3.53mm ID ø 55.56mm Qty 1 pcs | | |
|  | 510245 | | |
| | O-ring Viton thickness 3.53mm ID ø 50.8mm Qty 1 pcs | | |
|  | 550447 | | |
| | ring nut thread M54x1.5 | | |

heating elements for refrigeration

heating elements for defrosting

| | | | |
|---|--|-----------------|----------------------|
|  | | | |
| GEV No. | 419208 | Ref. No. | 1666250 BN1666250 |
| description | heating element 250W 230V L 420mm W 50mm Hmm cable length 360mm tube ø 6mm refrigerator connection F6.3 | | |
| For models: | KTAP00, KTAP00-BASE-20220501062N, KTAP01, KTAP01-205202, KTAP01-205204, KTAP01-BASE-20220901044U, KTAP02, KTAP02-600-20221205CN, KTAP02-BASE-20221301048K, KTAP03, KTAP03-BASE-2022180109UA, KTAP04, KTAP04-BASE-2022230109RY, KTAP84EN-20228403, KTAPBT02, KTAPBT03, KTAR01, KTAR02, KTAR03, KTAR04, KTARS24, KTARS35 | | |

| | | | |
|---|---|-----------------|---|
|  | | | |
| GEV No. | 420528 | Ref. No. | 16668401 936706 997317 BN1666004 BN16668401 FR936706 FR997317 |
| description | heating element 260W 230V L 390mm cable length 2010mm with thermal fuse | | |

| | | | |
|--|---|-----------------|----------------------|
|  | | | |
| GEV No. | 419209 | Ref. No. | 1666400 BN1666400 |
| description | heating element 270W 230V L 380mm W 120mm L1 15mm L2 365mm W1 80mm W2 50mm cable length 300mm tube ø 6mm refrigerator | | |
| For models: | BT70G, KCTN3030-20090710, KPC30-30-20100720, KPC3030-20100720, KSABT70G-204537, KSABT70G-2045370CC4, KTN40-21090640, KTN40-210906400BAI, M70TN, TARS27-2124130027 | | |

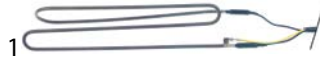
| | | | |
|--|---|-----------------|----------------------|
|  | | | |
| GEV No. | 416376 | Ref. No. | 1666320 BN1666320 |
| description | heating element 300W 230V L 430mm W 85mm connection male faston 6.3mm cable length 400mm tube ø 6.3mm defrosting H 70mm | | |
| For models: | KTAP00, KTAP00-BASE-20220501062N, KTAP00BT-BASE-2022550105KR, KTAP01, KTAP01-BASE-20220901044U, KTAP01BT-BASE-2022590105KU, KTAP02, KTAP02-20221301P0201, KTAP02-BASE-20221301048K, KTAP02BT-BASE-2022630105KW, KTAP02-ESP45300-20221301P0202, KTAP03, KTAP03-BASE-2022180109UA, KTAP03BT-BASE-2022680109UW, KTAP04, KTAP04-BASE-2022230109RY, KTAPBT00, KTAPBT01, KTAPBT02, KTAPBT03, KTAR01, KTAR01-BASE-20201001, KTAR01N, KTAR01N-BASE-20201005043V, KTAR02, KTAR02N, KTAR02N-BASE-20201305043Y, KTAR03, KTAR03-BASE-2020180105, KTAR03N, KTAR03N-BASE-202018050441, KTAR04, KTAR04N, KTAR04N-BASE-2020230508V7, KTAR902BT-ESP66300BT-202509P0201, KTARBT02, KTARBT02-205101, KTARBT02-205102, KTARBT02-205103, KTARBT02-BASE-2025130104FU, KTARBT03, KTARBT03-BASE-2025180104FW, KTARBT04, KTARBT04-BASE-2025230104FZ, KTARBT902, KTARBT9-02-BASE-20250904MU, KTARS24-202413010480, KTARS35-2024180104HC, TSP00, TSP00-BASE-202606010BRU...(Other models you can see in the webshop) | | |

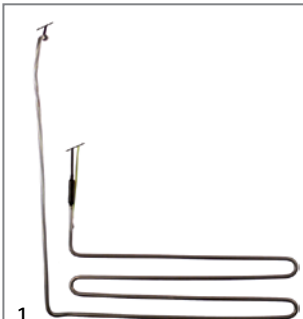

| | | | |
|--------------------|---|-----------------|--|
| GEV No. | 418752 | Ref. No. | 1666355 BN1666353 BN1666355 FR6621230 |
| description | heating element 350W 230V L 395mm W 450mm L1 45mm L2 360mm W1 360mm W2 95mm cable length 1000mm tube ø 6mm defrosting connection with cable | | |
| For models: | AFB-70-20171707G, AFN-70-20170707G, ARCO-BT140-20172404, ARCO-BT140-20172405, ARCO-BT140-BASE-20172408, ARCO-BT140-PLUS-20172409, ARCO-BT70-20171704, ARCO-BT70430-20171705, ARCO-BT70-BASE-20171708, ARCO-BT70GN2-1-2017817304, ARCO-BT70-PLUS-20171709, ARCO-TN140-BASE-20171408, ARCO-TN140-PLUS-20171409, ARCO-TN140-20171404, ARCO-TN140430-20171405, ARCO-TN70-20170704, ARCO-TN70430-20170705, ARCO-TN7070-20177040GL70, ARCO-TN70-BASE-20170708, ARCO-TN70-PLUS-20170709, ARCO-TNN70-20170706, NFB0070F, NFB0070N, NFB0070P, NFB0072F, NFB0072N, NFB0072P, NFB0140F, NFB0140N, NFB0140P, NFB0144F, NFB0144N, NFB0144P, NORD-700BT-2017817305, NORD-700BT-2017817305P, NORD-700TNN-2017807305, NORD-700TNN-2017807305P | | |

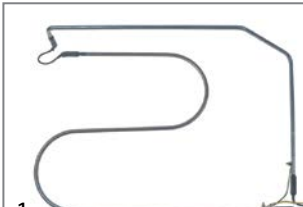

| | | | |
|--------------------|--|-----------------|----------------------|
| GEV No. | 419207 | Ref. No. | 1666352 BN1666352 |
| description | heating element 350W 230V L 510mm W 340mm connection F 2.8 cable length 1000mm tube ø 8.5mm refrigerator | | |

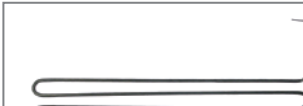

| | | | |
|--------------------|---|-----------------|--|
| GEV No. | 418576 | Ref. No. | 6621081 935614 FR6621081 FR935614 |
| description | heating element 500W 230V L 100mm W 520mm L1 30mm L2 70mm W1 35mm W2 495mm cable length 1700mm defrosting | | |

heating elements for condensate evaporation







| | | | |
|--------------------|---|-----------------|----------------------|
| GEV No. | 420170 | Ref. No. | 1666096 BN1666096 |
| description | heating element 95W 230V L 400mm W 60mm cable length 4000mm tube ø 6.2mm condensate evaporation | | |
| For models: | TARS22EP-2124091023, TARS22ES-2124091022 | | |

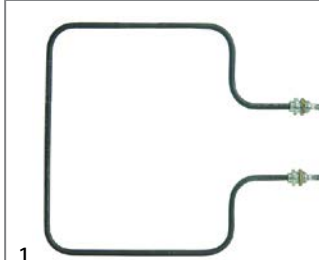

| | | | |
|--------------------|--|-----------------|----------------------|
| GEV No. | 420095 | Ref. No. | 1666095 BN1666095 |
| description | heating element 95W 230V L 445mm W 60mm H 25mm cable length 4000mm tube ø 6.2mm | | |
| For models: | KB120-20180710, KB240-20181410, KBT140-20021410, KBT142-20021420, KBT144-20021430, KBT70-20020710, KBT72-20020720, KBTG140-20021470, KBTG70-20020770, KBTV140-20021440, KBTV70-20020730, KC105-35-20051440, KC10535-20051440, KC2545-20050710, KC3513-20050715, KC3535-20050720, KC4512-20050725, KC70-70-20051410, KC7070-20051410, KCTN10535-20031440, KCTN2545-20030725, KCTN3513-20030730, KCTN3535-20030735, KCTN45-12-20030745, KCTN4512-20030745, KCTN7070-20031410, KPBT105-35-20061420, KPBT70-70-20061410, KPTN10535-20041440, KPTN70-70-20041410, KTN140-20011400WZ, KTN140-20011410, KTN140-BASE-20011400WZ, KTN140-BASE-20011400X0, KTN140-BASE-20011400X1, KTN140-BASE-20011400X2, KTN142-20011400X0, KTN142-20011420, KTN144-20011400X1, KTN144-20011430, KTN3513-200107, KTN3513-20010735, KTN4512-200107, KTN4512-20010745, KTN70-200107003W, KTN70-20010700VF, KTN70-20010710, KTN70-210107, KTN70-BASE-20010700VX, KTN72-200107...(Other models you can see in the webshop) | | |

heating elements for heated cabinets



| | | | | |
|---|---|-----------------|-----------------|---|
| GEV No. | 416787 | Ref. No. | A036800 | |
| description | heating element 420W 230V heating circuits 1 L 265mm W 245mm connection male faston 6.3mm tube ø 6.3mm 2 hole fixing thread 1/4" dry heating element heated cabinet L1 60mm L2 185mm W1 82mm W2 70mm mounting distance 64mm | | | |
| accessories for | 416787 | | | |
|  | GEV No. | 361182 | Ref. No. | — |
| | nut thread 1/4" H 5mm nickel-plated brass WS 17 Qty 1 pcs | | | |
|  | GEV No. | 510417 | Ref. No. | — |
| | flat gasket fibre ED ø 20mm ID ø 14mm thickness 2mm Qty 1 pcs | | | |
|  | GEV No. | 520228 | Ref. No. | — |
| | tooth lock washer ID ø 15.3mm ED ø 24mm steel Qty 1 pcs for thread M14 | | | |
|  | GEV No. | 550262 | Ref. No. | — |
| | flat gasket copper ED ø 20mm ID ø 14mm thickness 2mm | | | |



heating cables

drain heating cables

| | | | |
|---|--|-----------------|-----------------------------------|
|  | | | |
| 1 | | | |
| GEV No. | 418570 | Ref. No. | 1666009 BN1666009 FR6620031 |
| description | drain heating cable 12W 230V ø 4mm L 3190mm L1 (unheated) 1650mm L2 (heated) 1540mm defrost drain metal connection male faston | | |
| For models: | MTTF4xN, MTTF4xP | | |

connection on both sides (metal braided)

| | | | |
|---|--|-----------------|----------------------|
|  | | | |
| 1 | | | |
| GEV No. | 416747 | Ref. No. | 1666046 BN1666046 |
| description | heating cable 46W 230V L1 (unheated) 870mm L2 (heated) 4560mm ø 4mm L 6300mm connection male faston | | |
| For models: | KB100-20180720, KB120-20180710, KB200-20181420, KB240-20181410, KBT120-20081410, KBT120-200814O218, KBT120-BASE-200814O218, KBT120-BASE-200814O2BT, KBT120-BASE-200814O2XU, KBT120-P0120081410, KBT122-200814O2XU, KBT122-20081420, KBT122-200814O2XU, KBT124-200814O431, KBT140-200214O11K, KBT140-20021410, KBT140-BASE-200214O11K, KBT140-BASE-200214O11L, KBT140-BASE-200214O11N, KBT142-200214O11L, KBT142-20021420, KBT144-200214O11M, KBT60-2008070124, KBT60-20080710, KBT60-BASE-2008070124, KBT60-BASE-2008070126, KBT70, KBT70-20020700YN, KBT70-20020710, KBT70-BASE-20020700YL, KBT70G-200220, KBT70G-BASE-20022001TZ, KBT72-20020720, KBTG140-20021470, KBTG70-20020770, KBTV120, KBTV120-200814O2BT, KBTV120-20081440, KBTV140-200214O11N, KBTV140-20021440, KBTV60, KBTV60-2008070126, KBTV60-20080730, KBTV60-P0120080730, KBTV70-200207, KBTV70-20020730, KBTV70-BASE-20020700YN, KC105-35-20051440, KC10535-20051440, KC6060-20091430...(Other models you can see in the webshop) | | |

heating cartridges

| | | | |
|---|--|-----------------|---------------------------------|
|  | | | |
| 1 | | | |
| GEV No. | 417227 | Ref. No. | 1666090 1666150 BN1666090 |
| description | heating cartridge 90W 230V ø 12mm L 124mm thread 3/8" cable length 4000mm Hmm Wmm condensate evaporation | | |
| For models: | KB100-20180720, KB200-20181420, KBT120-20081410, KBT120-200814O218, KBT120-BASE-200814O218, KBT120-BASE-200814O2BT, KBT120-BASE-200814O2XU, KBT120-BASE-200814O431, KBT120-P0120081410, KBT122-200814O2XU, KBT122-20081420, KBT122-200814O2XU, KBT124-200814O431, KBT124-20081430, KBT124-P0120081430, KBT140-200214O11K, KBT140-200214O11M, KBT140-20021410, KBT140-BASE-200214O11K, KBT140-BASE-200214O11L, KBT140-BASE-200214O11N, KBT142-200214O11L, KBT142-20021420, KBT144-200214O11M, KBT144-20021430, KBT40-21091640, KBT40-21091640BAJ, KBT60-2008070124, KBT60-20080710, KBT60-BASE-2008070124, KBT60-BASE-2008070126, KBT60-BASE-20080705H5, KBT62-20080705H5, KBT62-20080720, KBT62-20080705H5, KBT70, KBT70-20020700YN, KBT70-200207061E, KBT70-20020710, KBT70-BASE-20020700YL, KBT70G-200220, KBT70G-BASE-20022001TZ, KBT72-200207061E, KBT72-20020720, KBT72-210207, KBT72-BASE-200207061E, KBTG70-20020770, KBTV120, KBTV120-200814O2BT, KBTV120-20081440...(Other models you can see in the webshop) | | |

foil heating elements

| | | | |
|--|---|-----------------|----------------------|
|  | | | |
| 1 | | | |
| GEV No. | 417701 | Ref. No. | 1666273 BN1666273 |
| description | heater mat L 430mm W 120mm 30W 230V cable length 1200mm connection male faston 6.3mm | | |
| For models: | P105-35TNN-2047640100, P105-35TNN-BT-2047660100, P140BT-2047220101, P140BTV-2047260101, P144BT-2047360100, P70-70TNN-BT-2047560100, P70BT-2047020101, P70BTV-2046060101, P70TN-2041000101, P70TNV-2047040101, P72BT-2047120101, S140BT-2048220101, S70BT-2048020101, T105-35TNN-2046640100, T105-35TNN-BT-2046660100, T140BT-2046220100, T140BTV-2046260100, T144BT-2046xxxxx, T70-70TNN-BT-2046560100, T70TNV-2046040100 | | |

thermostats

control and safety thermostats

| | | | |
|---|--|-----------------|---------|
| <p>EGO</p> <p>control thermostats</p> <p>55.10/19_ series</p>  | | | |
| 1 | | | |
| GEV No. | 375381 | Ref. No. | A046050 |
| description | thermostat t.max. 90°C temperature range 30-90°C 1-pole 1NO 16A probe ø 6mm probe L 130mm capillary pipe 2000mm capillary pipe isolated 2000mm gland nut shaft ø 6x4.6mm shaft L 23mm shaft position upper rotation 270° | | |

| | | | |
|---|--|-----------------|---------|
| <p>55.34_ series</p>  | | | |
| 1 | | | |
| GEV No. | 375384 | Ref. No. | A044601 |
| description | thermostat t.max. 275°C temperature range 50-275°C 3-pole 3NO 16A probe ø 3mm probe L 219mm capillary pipe 900mm capillary pipe isolated 900mm gland nut shaft ø 6x4.6mm shaft L 23mm shaft position lower rotation 318° probe material SS | | |



| | | | |
|--------------------|--|-----------------|---------|
| GEV No. | 375411 | Ref. No. | A046250 |
| description | thermostat t.max. 93°C temperature range 30-93°C 3-pole 3NO 16A probe ø 6mm probe L 129mm capillary pipe 1480mm capillary pipe isolated 1100mm gland nut M10x1 shaft ø 6x4.6mm shaft L 23mm shaft position upper rotation 270° | | |

safety thermostats

55.10/19_ series

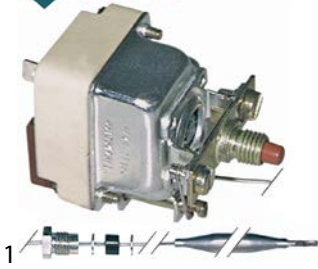

| | | | |
|--------------------|--|-----------------|---------|
| GEV No. | 390061 | Ref. No. | A049401 |
| description | safety thermostat switch-off temp. 220°C 1-pole 0.5A probe ø 6mm probe L 140mm capillary pipe 900mm capillary pipe isolatedmm gland nut probe M9x1 | | |

55.32_ series



| | | | |
|--------------------|---|-----------------|---------|
| GEV No. | 375228 | Ref. No. | A046150 |
| description | safety thermostat switch-off temp. 350°C 3-pole 20A probe ø 3mm probe L 188mm capillary pipe 900mm capillary pipe isolated 900mm gland nut probe SS | | |

refrigeration thermostats

universal without housing



| | | | | |
|---|--|-----------------|-----------------|---|
| GEV No. | 390534 | Ref. No. | 16810035 | |
| description | thermostat temperature range -35 up to +35°C probe ø6x110mm capillary pipe 1800mm PRODIGY | | | |
| For models: | ARBT70 | | | |
| accessories for | 390534 | | | |
|  | GEV No. | 110305 | Ref. No. | — |
| | knob thermostat t.max. 35°C temperature range -35 up to +35°C ø 45mm shaft ø 6x4.6mm shaft flat inclined rotation 270° white | | | |

universal with housing



| | | | |
|--------------------|--|-----------------|----------|
| GEV No. | 390538 | Ref. No. | 16810036 |
| description | thermostat temperature range -35 up to +35°C probe ø6x110mm capillary pipemm PRODIGY | | |

accessories

gland nut accessories

washers with slot





| | | | |
|--------------------|---|-----------------|---------|
| GEV No. | 510241 | Ref. No. | A038803 |
| description | washer with slot ED ø 7.8mm slit width 1.3mm Qty 10 | | |

gaskets



| | | | |
|--------------------|---|-----------------|---------|
| GEV No. | 550982 | Ref. No. | A038804 |
| description | gasket graphite ø 7.5mm L 7mm Qty 1 pcs for gland nut | | |



| bolts with slot | | | |
|---|---|-----------------|---------|
|  | | | |
| 1 | | | |
| GEV No. | 520243 | Ref. No. | A038801 |
| description | bolt with slot thread M9x1 Qty 10 pcs nickel-plated brass | | |
| accessories for | 520243 | | |
|  | | | |
| GEV No. | 510591 | Ref. No. | — |
| description | washer with slot ED ø 8.8mm slit width 1.2mm Qty 10 | | |
|  | | | |
| GEV No. | 510592 | Ref. No. | — |
| description | gasket ø 8x8.7mm Qty 10 pcs slotted silicone | | |

| connecting bows | | | |
|---|--|-----------------|---------|
|  | | | |
| 1 | | | |
| GEV No. | 550060 | Ref. No. | A045900 |
| description | connecting bow long for thermostat Qty 1 pcs | | |

| | | | |
|--|---|-----------------|---------|
|  | | | |
| 1 | | | |
| GEV No. | 550059 | Ref. No. | A045000 |
| description | connecting bow short for switch Qty 1 pcs | | |

switches and momentary switches

rocker/momentary rocker switches

| 27.8x25mm | | | |
|---|--|-----------------|----------------------|
|  | | | |
| 1 | | | |
| GEV No. | 348221 | Ref. No. | 1635110 BN1635110 |
| description | rocker switch mounting measurements 27.8x25mm black/green 1NO/indicator light 250V 16A ON-OFF connection F6.3x0.8 ambient temperature max. 100/55°C protection IP40 | | |
| For models: | 140, 70, AFN-70ESx-20173707GXPS, AP-140-221314XG, AP-70TN-221307XG, B100, B120, B200, B240, BT140, BT60, BT70, BT72, BTV70, EN02TN-VCR-20208204, KBF050GB-20350103, KBF050GS-20350203, KST6-03TN-2055030CC9, KST6-04TN-2055040CCA, KTAP00, KTAP00-BASE-20220501062N, KTAP00BT-BASE-2022550105KR, KTAP01, KTAP01-205202, KTAP01-205204, KTAP01-BASE-20220901044U, KTAP01BT-BASE-2022590105KU, KTAP02, KTAP02-600-20221205CN, KTAP02-BASE-20221301048K, KTAP02BT-205301, KTAP02BT-205302, KTAP02BT-205303, KTAP02BT-BASE-2022630105KW, KTAP03, KTAP03-600-20221705CM, KTAP03-BASE-2022180109UA, KTAP03BT-BASE-2022680109UW, KTAP04, KTAP04-BASE-2022230109RY, KTAP84EN-20228403, KTAP902, KTAPBT00, KTAPBT01, KTAPBT02, KTAPBT03, KTAPBT902, KTAR00, KTAR01, KTAR01-BASE-20201001... (Other models you can see in the webshop) | | |

| 30x22mm | | | |
|---|--|-----------------|----------------------|
|  | | | |
| 1 | | | |
| GEV No. | 301314 | Ref. No. | 1635103 BN1635103 |
| description | rocker switch mounting measurements 30x22mm white 2NO 250V 16A ON-OFF connection male faston 6.3mm ambient temperature max. 100/55°C protection IP40 | | |
| For models: | ARBT70, ARTN120, ARTN70, KB100-20180720, KB120-20180710, KB200-20181420, KB240-20181410, KBT120-2008140218, KBT120-BASE-2008140218, KBT120-BASE-20081402BT, KBT120-BASE-20081402XU, KBT120-BASE-2008140431, KBT120-P0120081410, KBT124-20081402XU, KBT122-20081402XU, KBT124-2008140431, KBT140-P0120081430, KBT140-200214011K, KBT140-200214011M, KBT140-20021410, KBT140-BASE-200214011K, KBT140-BASE-200214011L, KBT140-BASE-200214011N, KBT142-200214011L, KBT142-20021420, KBT144-200214011M, KBT144-20021430, KBT40-21091640, KBT40-210916400BAJ, KBT60-2008070124, KBT60-BASE-2008070124, KBT60-BASE-2008070126, KBT60-BASE-20080705H5, KBT62-20080705H5, KBT62-20080705H5, KBT70, KBT70-20020700YN, KBT70-200207061E, KBT70-20020710, KBT70-BASE-20020700YL, KBT70G-200220, KBT70G-BASE-20022001TZ, KBT72-200207061E, KBT72-20020720, KBT72-210207, KBT72-BASE-200207061E, KBTG70-20020770, KBTV120, KBTV120-20081402BT, KBTV140-200214011N... (Other models you can see in the webshop) | | |

microswitches

| lever actuated | | | |
|---|--|-----------------|--------|
|  | | | |
| 1 | | | |
| GEV No. | 345044 | Ref. No. | 164602 |
| description | microswitch with lever 250V 16A 1CO connection male faston 6.3mm ambient temperature max. 85°C mounting distance 25mm type C99ZP3 actuating force: 25g lever length 71mm | | |
| For models: | ARBT70, ARTN120, ARTN70, KBT40-21091640, KBT40-210916400BAJ, KTN40-21090640, KTN40-210906400BAI, M70BT, M70TN | | |



with push button

switches with snap-fit



1

| | | | |
|--------------------|---|-----------------|--|
| GEV No. | 347057 | Ref. No. | 164606 164608 935823 936091 BN164606 BN164608 FR935823 FR936091 |
| description | microswitch with push button 250V 2.5A 1CO connection male faston 4.8mm L 27x21mm ambient temperature max. 85°C type built-in version actuating force: 300g | | |
| For models: | 140, 70, AFB-140-20172407G, AFB-70-20171707G, AFB-70Sx-20171707GXPS, AFN-140E-20173407G, AFN-70-20170707G, AFN-70E-20173707G, AFN-70ESx-20173707GXPS, AP-140-221314XG, AP-70TN-221307XG, ARCO-BT140-20172404, ARCO-BT140-20172405, ARCO-BT140-BASE-20172408, ARCO-BT140GN2-1-2017824301, ARCO-BT140-PLUS-20172409, ARCO-BT70-20171704, ARCO-BT70430-20171705, ARCO-BT70-BASE-20171708, ARCO-BT70GN2-1-2017817304, ARCO-BT70-PLUS-20171709, ARCO-TN140.-BASE-20171408, ARCO-TN140.-PLUS-20171409, ARCO-TN140-20171404, ARCO-TN140-2017814301, ARCO-TN140430-20171405, ARCO-TN70-20170704, ARCO-TN70-2017807304, ARCO-TN70430-20170705, ARCO-TN7070-201777040GL70, ARCO-TN70-BASE-20170708, ARCO-TN70-PLUS-20170709, ARCO-TNN70-20170706, B100, B120, B200, B240, BT140, BT60, BT70, BT72, BTV70, KBF050GB-20350103, KBF050GS-20350203, KSA105-35-2045260CC0, KSA140BT-2045240C10, KSA140TN-2045140CAC, KSA70BT-2045170C0Z, KSA70TN-2045070CA9, KSABT70G-2045370CC4...(Other models you can see in the webshop) | | |

operation switches



1

| | | | |
|--------------------|---|-----------------|---------|
| GEV No. | 300002 | Ref. No. | A046001 |
| description | cam switch 2 operating positions 4NO 16A sequence 0-1 shaft ø 6x4.6mm shaft L 23mm connection male faston 6.3mm ceramic | | |



1

| | | | |
|--------------------|--|-----------------|---------|
| GEV No. | 300200 | Ref. No. | A046000 |
| description | operation switch 2 operating positions 2NO 16A sequence 0-1 shaft ø 6x4.6mm shaft L 23mm connection male faston 6.3mm operation switch ceramic | | |

cam switches

4 operating positions

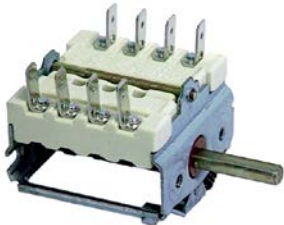

1

| | | | |
|--------------------|---|-----------------|---------|
| GEV No. | 300184 | Ref. No. | A046750 |
| description | cam switch 4 operating positions sequence 0-3-2-1 shaft ø 6x4.6mm connection male faston 4-pole | | |



magnetic switches

36x13mm

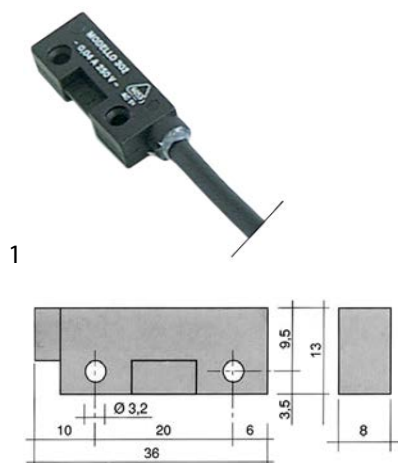

| | | | |
|------------------------|---|-----------------|--------------------|
| GEV No. | 345335 | Ref. No. | 995405 FR995405 |
| description | magnetic switch L 36mm W 13mm 1NO 250V 0.04A P max. 10W connection cable cable length 960mm | | |
| For models: | 120, 122, 201, 202, KBC051-20354051, KBC101-20354101, KBC151-20354151, KBC201-20355201, KBC201-PASS-THROUGH-20355221, KBC202-20355202, KBC202-PASS-THROUGH-20355222, KBF051-20364051, KBF051T-20363050, KBF101-20364101, KBF151-20364151, KBF201-20365201, KBF201-PASS-THROUGH-20365221, KBF202-20365202, KBF202-PASS-THROUGH-20365222, KRC201-20358201, KRC202-20358202, KRF201-20368201, KRF202-20368202, PBC051DF-ASX-203505AS, PBC081AF-ASX-203528AS, PBC121DF-ASX-203512AS, PBC122DF-ASX-223512AS, PBC161DF-ASX-203516AS, PBC201DP-20355203, PBC202DP-20355204, PBC401DCFDX-20356403, PBC402DCFDX-20356404, PBF031AF-ASX-203623AS, PBF051-AFST-AB-5GN11-BF-PDX-203626AD, PRC120AF-ASX-203530AS | | |
| accessories for | 345335 | | |
| | GEV No. | 519049 | Ref. No. — |
| | magnet ømm L 63mm H 10.7mm W 18.8mm hole distance 52mm M2 hole ø 2mm | | |

65x20mm

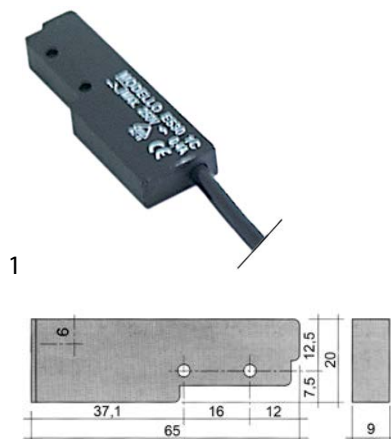

| | | | |
|------------------------|---|-----------------|--------------------|
| GEV No. | 345116 | Ref. No. | 161801 BN161801 |
| description | magnetic switch L 65mm W 20mm 1NO 250V 0.4A P max. 100W connection cable cable length 3000mm | | |
| For models: | KB100-20180720, KB120-20180710, KB200-20181420, KB240-20181410, KBC10, KBC10-BASE-20351002PM, KBC5, KBC5-BA-SE-20350502PK, KBC6, KBC6-BASE-20350602PL, KBCF10, KBCF10-BASE-20361002PV, KBCF5, KBCF5-BASE-20360502PN, KBCF6, KBCF6-BASE-20360602PT, KBT120-20081410, KBT120-2008140218, KBT120-BASE-2008140218, KBT120-BASE-20081402BT, KBT120-BASE-20081402XU, KBT120-BASE-2008140431, KBT120-P0120081410, KBT122-20081402XU, KBT122-20081420, KBT122-20081402XU, KBT124-2008140431, KBT124-20081430, KBT124-P0120081430, KBT140-200214011K, KBT140-200214011M, KBT140-20021410, KBT140-BASE-200214011K, KBT140-BASE-200214011L, KBT140-BASE-200214011N, KBT142-200214011L, KBT142-20021420, KBT144-200214011M, KBT144-20021430, KBT60-2008070124, KBT60-20080710, KBT60-BASE-2008070124, KBT60-BASE-2008070126, KBT60-BASE-20080705H5, KBT62-20080705H5, KBT62-20080720, KBT62-20080705H5, KBT70, KBT70-20020700YN, KBT70-200207061E...(Other models you can see in the webshop) | | |
| accessories for | 345116 | | |
| | GEV No. | 345399 | Ref. No. — |
| | magnet ø 3.3mm L 40mm H 8mm W 13mm hole distance 30mm M3 | | |

lamps

indicator lights

indicator lights 2-piece (lens and indicator lamp)

indicator lamps for socket type SRZ / SDK / SDY / SFK



| | | | |
|--------------------|--|-----------------|---------|
| GEV No. | 359131 | Ref. No. | A038506 |
| description | indicator lamp 400V clear connection male faston 6.3mm | | |

indicator lights (complete)

ø12mm

with screw socket



| | | | |
|--------------------|--|-----------------|---------|
| GEV No. | 359994 | Ref. No. | A039207 |
| description | indicator light ø 12mm 400V clear connection male faston 6.3mm | | |

30x22mm



| | | | |
|--------------------|---|-----------------|-----------|
| GEV No. | 359154 | Ref. No. | 168110001 |
| description | indicator light mounting measurements 30x22mm 230V white connection male faston 6.3mm temp.-resist. 125/55°C type RL2 | | |

fridge lamps



| | | | |
|--------------------|--|-----------------|----------------------|
| GEV No. | 359595 | Ref. No. | 1640403 BN1640403 |
| description | light bulb socket E14 15W 230-240V ø 25mm L 56mm lens L 30mm Qty 1 pcs | | |

For models: AFB-140-20172407G, AFB-70-20171707G, AFB-70Sx-20171707GX-PS, AFN-140E-20173407G, AFN-70-20170707G, AFN-70E-20173707G, AFN-70ESx-20173707GXPS, ARCO-BT140-20172404, ARCO-BT140-20172405, ARCO-BT140-BASE-20172408, ARCO-BT140GN2-1-2017824301, ARCO-BT140-PLUS-20172409, ARCO-BT70-20171704, ARCO-BT70430-20171705, ARCO-BT70-BASE-20171708, ARCO-BT70GN2-1-2017817304, ARCO-BT70-PLUS-20171709, ARCO-TN140.-BASE-20171408, ARCO-TN140.-PLUS-20171409, ARCO-TN140.-20171404, ARCO-TN140-2017814301, ARCO-TN140430-20171405, ARCO-TN70-20170704, ARCO-TN70-2017807304, ARCO-TN70430-20170705, ARCO-TN70-BASE-20170708, ARCO-TN70-PLUS-20170709, ARCO-TNN70-20170706, BT140, BT60, BT70, BT70G, BT72, KSA105-35-204515, KSA105-35-2045150C0R, KSA105-35-2045260CCO, KSA140BT-204524, KSA140BT-2045240BYF, KSA140BT-2045240C10, KSA140BT-2045240CAD, KSA140P-204534, KSA140P-2045340C0X, KSA140TN-204514, KSA140TN-2045140B8X, KSA140TN-2045140CAB, KSA140TN-2045140CAC, KSA35-35-204535, KSA35-35-2045350BYG, KSA70-70-204577, KSA70-70-2045770BYH...(Other models you can see in the webshop)

producer-specific fridge lamps

POLARIS



| | | | |
|--------------------|------------------------|-----------------|--------------------|
| GEV No. | 550070 | Ref. No. | 165705 BN165705 |
| description | lamp socket socket E14 | | |

For models: AFB-140-20172407G, AFB-70-20171707G, AFB-70Sx-20171707GX-PS, AFN-140E-20173407G, AFN-70-20170707G, AFN-70E-20173707G, AFN-70ESx-20173707GXPS, ARCO-BT140-20172404, ARCO-BT140-20172405, ARCO-BT140-BASE-20172408, ARCO-BT140GN2-1-2017824301, ARCO-BT140-PLUS-20172409, ARCO-BT70-20171704, ARCO-BT70430-20171705, ARCO-BT70-BASE-20171708, ARCO-BT70GN2-1-2017817304, ARCO-BT70-PLUS-20171709, ARCO-TN140.-BASE-20171408, ARCO-TN140.-PLUS-20171409, ARCO-TN140-20171404, ARCO-TN140-2017814301, ARCO-TN140430-20171405, ARCO-TN70-20170704, ARCO-TN70-2017807304, ARCO-TN70430-20170705, ARCO-TN70-BASE-20170708, ARCO-TN70-PLUS-20170709, ARCO-TNN70-20170706, B100, B120, B200, B240, BT140, BT60, BT70, BT70G, BT72, KSA105-35-204515, KSA105-35-2045150C0R, KSA105-35-2045260CCO, KSA140BT-204524, KSA140BT-2045240BYF, KSA140BT-2045240C10, KSA140BT-2045240CAD, KSA140P-204534, KSA140P-2045340C0X, KSA140TN-204514, KSA140TN-2045140B8X, KSA140TN-2045140CAB, KSA140TN-2045140CAC...(Other models you can see in the webshop)

timers

programme timers



| | | | |
|--------------------|--|-----------------|--------------------|
| GEV No. | 360388 | Ref. No. | 995393 FR995393 |
| description | timer FIBER P25 engines 1 chambers 2 operation time 7.2h 230V shaft ø 6x4.6mm shaft L 14mm manuf. no. P255J02R0V2 motor type M51BJ0L6400 for blast chiller operation time 7.2h | | |

| | | | |
|---|--|--------|-----------------|
| spare parts for | 360388 | | |
| | GEV No. | 360674 | Ref. No. |
|  | motor kit pinion ø 6.8mm teeth 15 230V voltage AC 50/60Hz turn direction counterclockwise motor ø 48mm H 18.5mm motor type UDS40NE1RNZ165 cable length 150mm with holder | | |



defrost timers

BIGATTI



1

| | | | |
|--------------------|--|-----------------|---------|
| GEV No. | 360055 | Ref. No. | 1680381 |
| description | defrost timer type SB3.81 defrosting interval 1-12x in 24h defrosting time 2-54min fan delaymin 230V | | |



1

| | | | |
|--------------------|--|-----------------|---------|
| GEV No. | 360058 | Ref. No. | 1680382 |
| description | defrost timer type SB3.82 defrosting interval 1-12x in 24h defrosting time 2-54min fan delay 0-15min 230V defr. funct. 1-12x per 24h | | |
| For models: | ARBT70, ARTN120, ARTN70 | | |

relays

power relays

with DIN rail mounting

upper

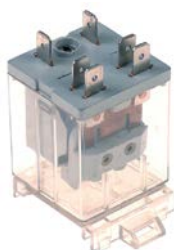

1

| | | | |
|--------------------|--|-----------------|--------------------------|
| GEV No. | 380314 | Ref. No. | 166550971 BN166550971 |
| description | power relays Italiana Relè 230VAC 20A 1NC/1NO connection male faston 6.3mm DIN rail manuf. no. A1B-230AC-AD | | |
| For models: | KB100-20180720, KB120-20180710, KB200-20181420, KB240-20181410, KBT120-20081410, KBT120-2008140218, KBT120-BASE-2008140218, KBT120-BASE-20081402BT, KBT120-BASE-20081402XU, KBT120-BASE-2008140431, KBT120-P0120081410, KBT122-20081402XU, KBT122-20081420, KBT122-20081402XU, KBT124-2008140431, KBT124-20081430, KBT124-P0120081430, KBT140-200214011K, KBT140-200214011M, KBT140-20021410, KBT140-BASE-200214011K, KBT140-BASE-200214011L, KBT140-BASE-200214011N, KBT142-200214011L, KBT142-20021420, KBT144-200214011M, KBT144-20021430, KBT40-21091640, KBT40-210916400BAJ, KBT60-2008070124, KBT60-20080710, KBT60-BASE-2008070124, KBT60-BASE-2008070126, KBT60-BASE-20080705H5, KBT62-20080705H5, KBT62-20080720, KBT62-20080705H5, KBT70, KBT70-20020700YN, KBT70-200207061E, KBT70-20020710, KBT70-BASE-20020700YL, KBT70G-200220, KBT70G-BASE-20022001TZ, KBT72-200207061E, KBT72-20020720, KBT72-210207, KBT72-BASE-200207061E, KBTG140-20021470, KBTG70-20020770...(Other models you can see in the webshop) | | |

lateral



1

| | | | |
|--------------------|--|-----------------|--------------------------|
| GEV No. | 380313 | Ref. No. | 166550972 BN166550972 |
| description | power relays FINDER 230VAC 16A 3CO connection male faston DIN rail manuf. no. 62.83.8.230.0008 | | |
| For models: | ARBT70 | | |

with bracket mounting



1

| | | | |
|--------------------|---|-----------------|--------------------|
| GEV No. | 380185 | Ref. No. | 166560 BN166560 |
| description | power relays Italiana Relè 230VAC 30A 1NO connection F6.3 bracket mounting dimensions 36.5x32.2x51.8mm manuf. no. A1O-230AC-FA | | |
| For models: | KBF050GB-20350103, KBF050GS-20350203, KBT40-210916400BAJ, KTAR902BT-ESP66300BT-202509P0201, KTARB02-BASE-2025130104FU, KTARB09-02-BASE-20250904MU, MTTFF4xN, MTTFF4xP, SABT140-DOUBLE-DOOR-20197400KG, SABT144-BASE-201974402C2, SABT70-2017170208EB, SATNN140-2017140208DW, SATNN144-BASE-2017140208RY, SATNN70-2017070208EA, SATNN72-BASE-2017070208RX, SPA70-70TN-BT-201778030BYA, SPA70-70TN-TN-201777030BY8, SPABT140-201724030C54, SPABTV70-201717030C1C, TFT01BT-BASE-2095011070N, TFT02BT-BASE-2095021070R, TFT03BT-BASE-2095031070U, TFTP00BT-BASE-2096011070W, TFTP01BT-BASE-2096021070Z, TFTP02BT-BASE-20960310712 | | |



transformers

encapsulated transformers

PMA



| | | | |
|--------------------|--|-----------------|--------------------|
| 1 | | | |
| GEV No. | 379054 | Ref. No. | 168305 BN168305 |
| description | transformer primary 230VAC secondary 12VAC 3VA secondary 0.25A H 40mm L 45mm W 50mm connection screw 50/60Hz type 153/M | | |
| For models: | KBT120-200814O218, KBT122-200814O2XU, KBT124-200814O431, KBT140-200214011K, KBT140-20021410, KBT142-200214011L, KBT142-20021420, KBT144-200214011M, KBT144-20021430, KBT40-21091640, KBT40-210916400BAJ, KBT60-2008070124, KBT62-20080705H5, KBT70, KBT70-20020710, KBT70-BASE-20020700YL, KBT70G-200220, KBT72-200207061E, KBT72-20020720, KBT72-210207, KBTV120, KBTV140-200214011N, KBTV140-20021440, KBTV60, KBTV70-200207, KC10535-20051440, KC2545-20050710, KC3513-20050715, KC3535-20050720, KC4512-20050725, KC6060-20091430, KC70-70-20051410, KC7070-20051410, KC9030-20091420, KCTN10535-20031440, KCTN2545-20030725, KCTN3030-20090710, KCTN3513-20030730, KCTN3535-20030735, KCTN4512-20030745, KCTN6060-20091410, KCTN7070-20031410, KP140-20041405, KP60-20100710, KP70-20040710, KPBT105-35-20061420, KPBT10535-20061420, KPBT2545-20060710, KPBT3513-20060720, KPBT3535-20060730...(Other models you can see in the webshop) | | |

| | | | |
|------------------------|--|--------|--|
| accessories for | 378228 | | |
| | GEV No. | 379052 | Ref. No. |
| | | | 167201 BN167201 |
| | temperature probe PTC 1kOhm cable silicone probe -50 up to +150°C cable -50 up to +180°C probe ø6x40mm cable length 1.5m without screw connection 2-wire | | |
| | GEV No. | 379053 | Ref. No. |
| | | | — |
| | temperature probe PTC 1kOhm cable PVC probe -50 up to +150°C cable -10 up to 100°C probe ø6x30mm cable length 3m without screw connection 2-wire | | |
| | GEV No. | 379057 | Ref. No. |
| | | | — |
| | temperature probe NTC 10kOhm cable PVC probe -20 up to +80°C cable -10 up to 100°C probe ø6x25mm cable length 3m 2-wire | | |
| | GEV No. | 379064 | Ref. No. |
| | | | 167207 167208 167210 BN167207 FR995562 |
| | temperature probe PTC 1kOhm cable silicone probe -50 up to +150°C cable -50 up to +180°C probe ø6x40mm cable length 3m without screw connection 2-wire | | |
| | GEV No. | 379160 | Ref. No. |
| | | | 167212 BN167212 |
| | temperature probe NTC 10kOhm cable thermoplastic probe -40 up to +110°C cable -40 up to +110°C probe ø6x14mm cable length 1.5m without screw connection 2-wire | | |
| | GEV No. | 379161 | Ref. No. |
| | | | 167211 BN167211 |
| | temperature probe NTC 10kOhm cable thermoplastic probe -40 up to +110°C cable -40 up to +110°C probe ø6x14mm cable length 3m without screw connection 2-wire | | |
| | GEV No. | 379162 | Ref. No. |
| | | | — |
| | temperature probe NTC 10kOhm cable thermoplastic probe -40 up to +110°C cable -40 up to +110°C probe ø6x14mm cable length 6m 2-wire | | |
| | GEV No. | 379343 | Ref. No. |
| | | | — |
| | temperature probe NTC 10kOhm cable silicone probe -40 up to +110°C cable -50 up to +180°C probe ø6x40mm cable length 3m 2-wire | | |
| | GEV No. | 379458 | Ref. No. |
| | | | — |
| | temperature probe NTC 10kOhm cable silicone probe -40 up to +110°C cable -50 up to +180°C probe ø6x40mm cable length 1.5m without screw connection 2-wire | | |
| | GEV No. | 402818 | Ref. No. |
| | | | — |
| | programming key 4K for electronic controller DIXELL | | |

electronic controllers

DIXELL

refrigeration controllers

built-in version



| | | | |
|------------------------|---|-----------------|------------------------|
| 1 | | | |
| GEV No. | 378228 | Ref. No. | 16815108 BN16815108 |
| description | electronic controller DIXELL XW20L-5NOC1 mounting measurements 150x30mm built-in depth 65.5mm 230V voltage AC NTC/PTC relay outputs 2 NO-20A(8) CO-8A(3) NTC/PTC DI -50 up to +150°C display 3½ digits | | |
| For models: | ARCO-TN140.-BASE-20171408, ARCO-TN140.-PLUS-20171409, ARCO-TN140-20171404, ARCO-TN140-2017814301, ARCO-TN140430-20171405, ARCO-TN70-20170704, ARCO-TN70-2017807304, ARCO-TN70430-20170705, ARCO-TN70-BASE-20170708, ARCO-TN70-PLUS-20170709, NFB0070P, NFB0072P, NFB0140P, NFB0144P | | |
| accessories for | 378228 | | |
| | GEV No. | 378194 | Ref. No. |
| | | | — |
| | temperature probe NTC 10kOhm cable PVC probe -20 up to +80°C cable -10 up to 100°C probe ø7x24.5mm cable length 1.5m without screw connection 2-wire | | |



| | | | | |
|------------------------|---|--|--|--------------------|
| 1 | | | | |
| GEV No. | 402011 | Ref. No. | 16815100 16815107 996659 996768 BN16815100 BN16815107 FR996659 FR996768 | |
| description | electronic controller DIXELL XW60L-5N0C1 mounting measurements 150x30mm built-in depth 50mm 230V voltage AC NTC relay outputs 4 NO-20A(8) CO-8A(3) NO-8A(3) NO-8A(3) NTC/PTC NTC/PTC DI protection IP65 -50 up to +150°C display 3½ digits | | | |
| For models: | AFB-140-20172407G, AFB-70-20171707G, AFB-70Sx-20171707GXPS, AFN-70-20170707G, ARCO-BT140-20172404, ARCO-BT140-20172405, ARCO-BT140-BASE-20172408, ARCO-BT140GN2-1-2017824301, ARCO-BT140-PLUS-20172409, ARCO-BT70-20171704, ARCO-BT70430-20171705, ARCO-BT70-BASE-20171708, ARCO-BT70GN2-1-2017817304, ARCO-BT70-PLUS-20171709, ARCO-TN7070-201777040GL70, ARCO-TNN70-20170706, KST01BT-205111, KST01BT-VCR-205701, KST01BT-VCR-205711, KST01TN-205001, KST01TN-205011, KST01TN-VCR-205601, KST01TN-VCR-205611, KST02BT-205112, KST02BT-VCR-205702, KST02BT-VCR-205712, KST02TN-205002, KST02TN-205012, KST02TNH760-205802, KST02TN-VCR-205602, KST02TN-VCR-205612, KST03BT-205113, KST03BT-VCR-205703, KST03BT-VCR-205713, KST03TN-205003, KST03TN-205013, KST03TN-VCR-205603, KST03TN-VCR-205613, KST04BT-205114, KST04BT-VCR-205714, KST04TN-205004, KST04TN-205014, KST04TN-VCR-205604, KST04TN-VCR-205614, KST-BT01, KST-BT04, KST-BT-VCR01, KST-BT-VCR02, KST-BT-VCR03, KSTP01BT-205311...(Other models you can see in the webshop) | | | |
| accessories for | 402011 | | | |
| | GEV No. | 378194 | Ref. No. | — |
| | | temperature probe NTC 10kOhm cable PVC probe -20 up to +80°C cable -10 up to 100°C probe ø7x24.5mm cable length 1.5m without screw connection 2-wire | | |
| | GEV No. | 379057 | Ref. No. | — |
| | | temperature probe NTC 10kOhm cable PVC probe -20 up to +80°C cable -10 up to 100°C probe ø6x25mm cable length 3m 2-wire | | |
| | GEV No. | 379160 | Ref. No. | 167212 BN167212 |
| | | temperature probe NTC 10kOhm cable thermoplastic probe -40 up to +110°C cable -40 up to +110°C probe ø6x14mm cable length 1.5m without screw connection 2-wire | | |
| | GEV No. | 379161 | Ref. No. | 167211 BN167211 |
| | | temperature probe NTC 10kOhm cable thermoplastic probe -40 up to +110°C cable -40 up to +110°C probe ø6x14mm cable length 3m without screw connection 2-wire | | |
| | GEV No. | 379162 | Ref. No. | — |
| | | temperature probe NTC 10kOhm cable thermoplastic probe -40 up to +110°C cable -40 up to +110°C probe ø6x14mm cable length 6m 2-wire | | |
| | GEV No. | 379343 | Ref. No. | — |
| | | temperature probe NTC 10kOhm cable silicone probe -40 up to +110°C cable -50 up to +180°C probe ø6x40mm cable length 3m 2-wire | | |
| | GEV No. | 379458 | Ref. No. | — |
| | | temperature probe NTC 10kOhm cable silicone probe -40 up to +110°C cable -50 up to +180°C probe ø6x40mm cable length 1.5m without screw connection 2-wire | | |

ELIWELL
refrigeration controllers
built-in version



| | | | | |
|--------------------|--|-----------------|----------------------|--|
| 1 | | | | |
| GEV No. | 379102 | Ref. No. | 1681109 BN1681109 | |
| description | electronic controller ELIWELL type EWPC970 mounting measurements 71x29mm 12V relay outputs 8A | | | |
| For models: | KC3513-20050715, KC4512-20050725, KCTN2545-20030725, KCTN3513-20030730, KCTN3535-20030735, KCTN4512-20030745, KPBT3513-20060720, KPBT4512-20060740, KPTN2545-20040720, KPTN3513-20040725, KPTN3535-20040730, KTAR602, KTAR612, KTAR614, KUC3513-20150715, KUC4512-20150725, KUCTN2545-20130710, KUCTN35-13-20130715, KUCTN3513-20130715, KUCTN45-12-20130730, KUCTN4512-20130730, KUPBT3513-20160720, KUPBT4512-20160740, KUPTN2545-20140710, KUPTN35-13-20140720, KUPTN3513-20140720, KUPTN45-12-20140740, TPV16, TPV16-2128150002, TPV21, TPV21-2128210003, TPV21C, TPV21C-2128210003, TPV26C, TPV26C-2128260004 | | | |



| | | | | |
|------------------------|---|--|------------------------|--|
| 1 | | | | |
| GEV No. | 379570 | Ref. No. | 16811201 BN16811201 | |
| description | electronic controller ELIWELL type ID961 mounting measurements 71x29mm 12V voltage AC/DC NTC/PTC relay outputs 1 relay -50 up to +150°C display 3½ digits RoomTempIN yes compressor relay 8A | | | |
| For models: | SABT70-BASE-2017170108EB, SABTV70-BASE-2017170108ER, SATN140-BASE-20196400KF, SATN140-BASE-201964013Z, SATN144-BASE-201964402BZ, SATN70-BASE-20195700F9, SATN70-BASE-2019570117, SATN72-BASE-201957202BM, SATNBT3535-BASE-20193603CV, SATNBT7070-BASE-201967803CU, SATNTN3535-BASE-20193503CP, SATNTN7070-BASE-201967703CT, STN140A, STN140-BASE-20191400KF, STN144A, STN70A, STN70-BASE-20190700F9, STN72A, STNV140A, STNV70A, TARS22-2124922, TARS22-212492208L6, TARS22-212492208VT, TARS22-21249220AO2, TARS22-21249220AO3, TARS22-21249220AO4, TARS22-21249220AO6, TARS22-KIT1, TARS22-Kit1-212492201, TARS22-KIT2, TARS22-Kit2-212492202, TARS22-KIT3, TARS22-Kit3-212492203, TARS22-KIT4, TARS22-Kit4-212492204, TARS22-KIT5, TARS22-Kit5-212492205, TARS22-KIT6, TARS22-Kit6-212492206, TARS22-KIT6-21249220AO5, TARS22-KIT7, TARS22-Kit7-212492207, TP122-TARS22-KIT5-212492208VR, VP3014N, VP3014Q, VP3018N, VP3018Q, VP3114N, VP3114Q, VP3118N...(Other models you can see in the webshop) | | | |
| accessories for | 379570 | | | |
| | GEV No. | 379053 | Ref. No. | — |
| | | temperature probe PTC 1kOhm cable PVC probe -50 up to +150°C cable -10 up to 100°C probe ø6x30mm cable length 3m without screw connection 2-wire | | |
| | GEV No. | 379064 | Ref. No. | 167207 167208 167210 BN167207 FR995562 |
| | | temperature probe PTC 1kOhm cable silicone probe -50 up to +150°C cable -50 up to +180°C probe ø6x40mm cable length 3m without screw connection 2-wire | | |

Table continues overleaf

| | | | |
|--|--------|----------|--------------------|
| accessories for 379570 | | | |
| GEV No. | 379161 | Ref. No. | 167211 BN167211 |
| temperature probe NTC 10kOhm cable thermoplastic probe -40 up to +110°C cable -40 up to +110°C probe ø6x14mm cable length 3m without screw connection 2-wire | | | |
| GEV No. | 379782 | Ref. No. | — |
| temperature probe PTC 1kOhm cable thermoplastic probe -50 up to +150°C cable -40 up to +110°C probe ø6x14mm cable length 3m 2-wire resistor 1kOhm | | | |



| | | | |
|----------------|--------|-----------------|----------------------|
| GEV No. | 379577 | Ref. No. | 1681108 BN1681108 |
|----------------|--------|-----------------|----------------------|

description electronic controller ELIWELL type ID974 mounting measurements 71x29mm 230V voltage AC NTC/PTC relay outputs 3 relays -50 up to +150°C display 3½ digits RoomTempIN yes DEF Probe yes DEF Relay 8A fan relay 5A compressor relay 8A

For models: KBT120-2008140218, KBT120-P0120081410, KBT122-20081402XU, KBT124-2008140431, KBT124-P0120081430, KBT140-200214011K, KBT142-200214011L, KBT144-200214011M, KBT60-2008070124, KBT62-20080705H5, KBT70, KBT70-20020710, KBT70-BASE-20020700YL, KBT72-200207061E, KBT72-20020720, KBT72-210207, KBTV120, KBTV140-200214011N, KBTV60, KBTV60-P0120080730, KBTV70-200207, KC10535-20051440, KC3535-20050720, KC6060-20091430, KC70-70-20051410, KC7070-20051410, KC9030-20091420, KPBT10535-20061420, KPBT3535-20060730, KPBT7070-20061410, KTAP00BT-BASE-2022550105KR, KTAP01BT-BASE-2022590105KU, KTAP02BT-205301, KTAP02BT-205302, KTAP02BT-205303, KTAP02BT-BASE-2022630105KW, KTAP03BT-BASE-2022680109UW, KTAPBT00, KTAPBT01, KTARBT02, KUBT140-20121410, KUBT142-20121420, KUBT144-20121430, KUBT70-20120712, KUBT72-20120720, KUBTV140-20121440, KUBTV70-20120730, KUC10535-20151440, KUC3535-20150720, KUC7070-20151410...(Other models you can see in the webshop)



| | | | |
|----------------|--------|-----------------|------------------------|
| GEV No. | 379025 | Ref. No. | 16814001 BN16814001 |
|----------------|--------|-----------------|------------------------|

description electronic controller ELIWELL type ID961LX mounting measurements 71x29mm 230V voltage AC NTC/PTC relay outputs 1 front measurements 76.2x35mm protection IP65 -55 up to +150°C display 3½ digits

For models: KTAP02-600-20221205CN, KTAP03-600-20221705CM, KTAR02-600-BASE-20201205CU, KTAR03-600-BASE-20201705DD, KTAR9-02-202009040Y, KTARI140-BASE-20210140, KTARI140-BA-SE-20210141, KTARS21-2124100021, KTN40-210906400BAI, STN1400GN2-1TH.60-201781420BU9, STN700GN2-1TH.60-201780720BU7, STNV1400GN2-1TH.60-201781420BUA, STNV700GN2-1TH.60-201780720BU8, TARS21-2124100022, TARS21-2124100023, TARS22-2124922, TARS22-212492208L6, TARS22-212492208VT, TARS22-21249220AO2, TARS22-21249220AO3, TARS22-21249220AO4, TARS22-21249220AO6, TARS22-KIT1, TARS22-Kit1-212492201, TARS22-KIT2, TARS22-Kit2-212492202, TARS22-KIT3, TARS22-Kit3-212492203, TARS22-KIT4, TARS22-Kit4-212492204, TARS22-KIT5, TARS22-Kit5-212492205, TARS22-KIT6, TARS22-Kit6-212492206, TARS22-KIT6-21249220AO5, TARS22-KIT7, TARS22-Kit7-212492207, TP122-TARS22-KIT5-212492208VR

| | | | |
|-------------------------------|--------|----------|---|
| accessories for 379577 | | | |
| GEV No. | 379053 | Ref. No. | — |

temperature probe PTC 1kOhm cable PVC probe -50 up to +150°C cable -10 up to 100°C probe ø6x30mm cable length 3m without screw connection 2-wire

| | | | |
|---------|--------|----------|--|
| GEV No. | 379064 | Ref. No. | 167207 167208 167210 BN167207 FR995562 |
|---------|--------|----------|--|

temperature probe PTC 1kOhm cable silicone probe -50 up to +150°C cable -50 up to +180°C probe ø6x40mm cable length 3m without screw connection 2-wire

| | | | |
|---------|--------|----------|--------------------|
| GEV No. | 379161 | Ref. No. | 167211 BN167211 |
|---------|--------|----------|--------------------|

temperature probe NTC 10kOhm cable thermoplastic probe -40 up to +110°C cable -40 up to +110°C probe ø6x14mm cable length 3m without screw connection 2-wire

| | | | |
|---------|--------|----------|---|
| GEV No. | 379782 | Ref. No. | — |
|---------|--------|----------|---|

temperature probe PTC 1kOhm cable thermoplastic probe -50 up to +150°C cable -40 up to +110°C probe ø6x14mm cable length 3m 2-wire resistor 1kOhm



| | | | |
|----------------|--------|-----------------|-----------|
| GEV No. | 378416 | Ref. No. | FR6634510 |
|----------------|--------|-----------------|-----------|

description electronic controller ELIWELL type ID974LX mounting measurements 71x29mm NTC(PTC) no probe -50 to +140°C display 3½ digits



| | | | |
|---|---|-----------------|----------------------|
|  | | | |
| 1 | | | |
| GEV No. | 378294 | Ref. No. | 1681405 BN1681405 |
| description | electronic controller ELIWELL type IWC720 mounting measurements 150x30mm 230V voltage AC NTC relay outputs 2 relays -50 up to +110°C display 3½ digits RoomTempIN yes DigiIN1 yes DEF Relay 8A compressor relay 24A | | |

| | | | |
|---|--|-----------------|----------------------|
|  | | | |
| 1 | | | |
| GEV No. | 378269 | Ref. No. | 1681406 BN1681406 |
| description | electronic controller ELIWELL type IWC750 mounting measurements 150x30mm 230V voltage AC NTC relay outputs 5 -50 up to +110°C display 3¾ digits RoomTempIN NTC DigiIN1 yes DEF Relay 8A fan relay 8(3)A 5A 8(3)A evaporator probe NTC compressor relay 8(3)A | | |

EVCO - EVERY CONTROL

refrigeration controllers

built-in version

| | | | |
|---|---|-----------------|------------------------|
|  | | | |
| 1 | | | |
| GEV No. | 378506 | Ref. No. | 32140974 BN32140974 |
| description | electronic controller EVCO type EVKB23N7PXXSX01 mounting measurements 71x29mm 230V PTC/NTC -40 up to +105°C preprogrammed | | |

| | | | |
|--|---|-----------------|----------------------|
|  | | | |
| 1 | | | |
| GEV No. | 379820 | Ref. No. | 1681114 BN1681114 |
| description | electronic controller EVERY CONTROL type EVC20S35N7ALX30 mounting measurements 165x45mm 230V voltage AC NTC relay outputs 3 NO-16A(5) NO-8A(4) CO-8A(4) NTC NTC DI for fridge front measurementsmm built-in depth 56mm protection IP00 yes yes yes -40° up to 105°C display 4 digits | | |
| For models: | P105-35TNN-2047640100, P105-35TNN-BT-2047660100, P140BT-2047220101, P140TN-2047200101, P140T-NN-2047210101, P144BT-2047360100, P144TNN-2047350100, P35-35TNN-2047440100, P35-35TNN-BT-2047460100, P70-70TNN-2047540100, P70-70TNN-BT-2047560100, P70BT-2047020101, P70TN-2041000101, P70TNN-2047010101, P72BT-2047120101, P72TNN-2047110101, S120BT-2088420100, S120TN-2088400100, S120TNN-2088410100, S140BT-2048220101, S140TN-2048200101, S60BT-2088120100, S60TN-2088100100, S60TNN-2088110100, S70BT-2048020101, S70TN-2048000101, S70TNN-2048010101 | | |

| | | | |
|--|---|-----------------|---------------------------------|
|  | | | |
| 1 | | | |
| GEV No. | 379850 | Ref. No. | 936092 BN1681118 FR936092 |
| description | electronic controller EVERY CONTROL type EVC20S35N7ALX40 mounting measurements 165x45mm 230V voltage AC NTC relay outputs 4 NO-16A(5) NO-8A(4) CO-8A(4) NO-8A(4) NTC NTC DI DI for fridge front measurementsmm built-in depth 56mm protection IP00 yes yes yes -40 up to +99°C display 4 digits | | |

| | | | |
|--|--|-----------------|--|
|  | | | |
| 1 | | | |
| GEV No. | 378154 | Ref. No. | 1681160 |
| description | electronic controller EVERY CONTROL type EVK203N7VXBS mounting measurements 71x29mm 230V voltage AC NTC/PTC relay outputs 3 NO-16A(5) CO-8A(4) NO-8A(4) NTC/PTC NTC/PTC DI front measurementsmm built-in depth 59mm protection IP65 yes -50 up to +150°C display 3½ digits | | |
| For models: | M70BT, M70TN | | |
| accessories for | 378154 | | |
| | GEV No. | Ref. No. | — |
| | temperature probe PTC 1kOhm cable PVC probe -50 up to +150°C cable -10 up to 100°C probe ø6x30mm cable length 3m without screw connection 2-wire | | |
| | GEV No. | Ref. No. | 167207 167208 167210 BN167207 FR995562 |
| | temperature probe PTC 1kOhm cable silicone probe -50 up to +150°C cable -50 up to +180°C probe ø6x40mm cable length 3m without screw connection 2-wire | | |



Table continues overleaf



| | | | |
|--|--------|----------|--------------------|
| accessories for 378154 | | | |
| GEV No. | 379161 | Ref. No. | 167211 BN167211 |
| temperature probe NTC 10kOhm cable thermoplastic probe -40 up to +110°C cable -40 up to +110°C probe ø6x14mm cable length 3m without screw connection 2-wire | | | |
| GEV No. | 379782 | Ref. No. | — |
| temperature probe PTC 1kOhm cable thermoplastic probe -50 up to +150°C cable -40 up to +110°C probe ø6x14mm cable length 3m 2-wire resistor 1kOhm | | | |



1

| | | | | |
|---|---------|----------|--|---|
| GEV No. | 379738 | Ref. No. | 1681455 BN1681455 FR996193 | |
| description electronic controller EVERY CONTROL type EVKB21N7PCXSX01 mounting measurements 71x29mm 230V voltage AC NTC relay outputs 1 front measurementsmm built-in depth 59mm protection IP65 preprogrammed -40 up to +105°C display 3½ digits 2 RoomTempIN NTC DEF Probe TempIN3 DEF Relay fan relay DigiIN 1 compressor relay CO-16A(5) | | | | |
| accessories for 379738 | | | | |
| GEV No. | 379053 | Ref. No. | — | |
| temperature probe PTC 1kOhm cable PVC probe -50 up to +150°C cable -10 up to 100°C probe ø6x30mm cable length 3m without screw connection 2-wire | | | | |
| GEV No. | 379064 | Ref. No. | 167207 167208 167210 BN167207 FR995562 | |
| temperature probe PTC 1kOhm cable silicone probe -50 up to +150°C cable -50 up to +180°C probe ø6x40mm cable length 3m without screw connection 2-wire | | | | |
| GEV No. | 379161 | Ref. No. | 167211 BN167211 | |
| temperature probe NTC 10kOhm cable thermoplastic probe -40 up to +110°C cable -40 up to +110°C probe ø6x14mm cable length 3m without screw connection 2-wire | | | | |
| GEV No. | 379782 | Ref. No. | — | |
| temperature probe PTC 1kOhm cable thermoplastic probe -50 up to +150°C cable -40 up to +110°C probe ø6x14mm cable length 3m 2-wire resistor 1kOhm | | | | |
|  | GEV No. | 550801 | Ref. No. | — |
| PCB terminal block 3-pole raster size 5mm | | | | |
|  | GEV No. | 550803 | Ref. No. | — |
| PCB terminal block 5-pole raster size 5mm | | | | |

for blast chiller



1

| | | | |
|---|--------|----------|-----------------------|
| GEV No. | 378484 | Ref. No. | FR6635860 FR995036 |
| description electronic controller EVCO type EVK802P7 mounting measurements 71x29mm 230V voltage AC NTC/PTC relay outputs 2 NO-8A(4) CO-8A(4) NTC/PTC DI for blast freezer built-in depth 59mm protection IP65 -40 up to +105°C display 3½ digits with additional input for core temperature probe | | | |

SHANGFANG

accessories



1

| | | | |
|--|--------|----------|--------------------|
| GEV No. | 379054 | Ref. No. | 168305 BN168305 |
| description transformer primary 230VAC secondary 12VAC 3VA secondary 0.25A H 40mm L 45mm W 50mm connection screw 50/60Hz type 153/M | | | |
| For models: KBT120-2008140218, KBT122-20081402XU, KBT124-2008140431, KBT140-200214011K, KBT140-20021410, KBT142-200214011L, KBT142-20021420, KBT144-200214011M, KBT144-20021430, KBT40-21091640, KBT40-210916400BAJ, KBT60-2008070124, KBT62-20080705H5, KBT70, KBT70-20020710, KBT70-BASE-20020700YL, KBT70G-200220, KBT72-200207061E, KBT72-20020720, KBT72-210207, KBTV120, KBTV140-200214011N, KBTV140-20021440, KBTV60, KBTV70-200207, KC10535-20051440, KC2545-20050710, KC3513-20050715, KC3535-20050720, KC4512-20050725, KC6060-20091430, KC70-70-20051410, KC7070-20051410, KC9030-20091420, KCTN10535-20031440, KCTN2545-20030725, KCTN3030-20090710, KCTN3513-20030730, KCTN3535-20030735, KCTN4512-20030745, KCTN6060-20091410, KCTN7070-20031410, KP140-20041405, KP60-20100710, KP70-20040710, KPBT105-35-20061420, KPBT10535-20061420, KPBT2545-20060710, KPBT3513-20060720, KPBT3535-20060730...(Other models you can see in the webshop) | | | |

miscellaneous

refrigeration controllers



1

| | | | |
|---|--------|----------|--------------------|
| GEV No. | 378411 | Ref. No. | 996380 FR996595 |
| description power PCB EVCO type EVC80P16P7FRL01 mounting measurements 170x120mm | | | |
| For models: 120, 122, 201, 202, PBC051DF-ASX-203505AS, PBC081AF-ASX-203528AS, PBC121DF-ASX-203512AS, PBC122DF-ASX-223512AS, PBC161DF-ASX-203516AS, PBC201DP-20355203, PBC202DP-20355204, PBC401DCFDX-20356403, PBC402DCFDX-20356404, PBF031AF-ASX-203623AS, PBF051-AFST-AB-5GN11-BF-PDX-203626AD, PRC120AF-ASX-203530AS | | | |





probes

universal probes

temperature probes

| | | | |
|---|---|-----------------|--------------------|
|  | | | |
| GEV No. | 379160 | Ref. No. | 167212 BN167212 |
| description | temperature probe NTC 10kOhm cable thermoplastic probe -40 up to +110°C cable -40 up to +110°C probe ø6x14mm cable length 1.5m without screw connection 2-wire | | |
| For models: | AFB-140-20172407G, AFN-70ESx-20173707GXPS, ARCO-BT140-20172404, ARCO-BT140-20172405, ARCO-BT140-BA-SE-20172408, ARCO-BT140-PLUS-20172409, ARCO-BT70-20171704, ARCO-BT70430-20171705, ARCO-BT70-BASE-20171708, ARCO-BT-70GN2-1-2017817304, ARCO-BT70-PLUS-20171709, ARCO-TN140-BA-SE-20171408, ARCO-TN140-PLUS-20171409, ARCO-TN140-20171404, ARCO-TN140430-20171405, ARCO-TN70-20170704, ARCO-TN70430-20170705, ARCO-TN70-BASE-20170708, ARCO-TN70-PLUS-20170709, ARCO-TNN70-20170706, B100, B120, B200, B240, BT140, BT60, BT70, BT70G, BT72, BTV70, KB100-20180720, KB120-20180710, KB200-20181420, KB240-20181410, KBT120-200814, KBT120-20081410, KBT120-BASE-2008140218, KBT120-BASE-200814022T, KBT120-BASE-20081402XU, KBT120-BASE-2008140431, KBT122-20081402XU, KBT122-20081420, KBT124-2008140431, KBT124-20081430, KBT140-200214011M, KBT140-20021410, KBT140-BASE-200214011K, KBT140-BASE-200214011L, KBT140-BASE-200214011N, KBT142-20021420...(Other models you can see in the webshop) | | |

| | | | |
|---|--|-----------------|--------------------|
|  | | | |
| GEV No. | 379161 | Ref. No. | 167211 BN167211 |
| description | temperature probe NTC 10kOhm cable thermoplastic probe -40 up to +110°C cable -40 up to +110°C probe ø6x14mm cable length 3m without screw connection 2-wire | | |
| For models: | 140, 70, AFB-140-20172407G, AFB-70-20171707G, AFB-70Sx-20171707GXPS, AFN-140E-20173407G, AFN-70-20170707G, AFN-70E-20173707G, AFN-70ESx-20173707GXPS, AP-140-221314XG, AP-70TN-221307XG, ARCO-BT140-20172404, ARCO-BT140-20172405, ARCO-BT140-BASE-20172408, ARCO-BT140-PLUS-20172409, ARCO-BT70-20171704, ARCO-BT70430-20171705, ARCO-BT70-BASE-20171708, ARCO-BT70GN2-1-2017817304, ARCO-BT70-PLUS-20171709, ARCO-TNN70-20170706, B100, B120, B200, B240, BT140, BT60, BT70, BT70G, BT72, BTV70, KC3513-20050715, KC3535-20050720, KCTN2545-20030725, KCTN3030-20090710, KCTN3513-20030730, KCTN3535-20030735, KCTN45-12-20030745, KPBT3513-20060720, KPBT3535c-20060730, KPC30-30-20100720, KPTN3513-20040725, KPTN3535-20040730, KSA140BT-204524, KSA140BT-2045240BYF, KSA140BT-2045240C10, KSA140BT-2045240CAD, KSA140P-204534, KSA140P-2045340C0X, KSA140TN-204514...(Other models you can see in the webshop) | | |

| | | | |
|---|--|-----------------|--------------------|
|  | | | |
| GEV No. | 379142 | Ref. No. | 167202 BN167202 |
| description | temperature probe PTC 1kOhm cable PVC probe -50 up to +150°C cable -10 up to 100°C probe ø6x30mm cable length 1.5m without screw connection 2-wire | | |
| For models: | KBC10, KBC10-BASE-20351002PM, KBC5, KBC6, KBC6-BASE-20350602PL, KBCF10, KBCF10-BASE-20361002PV, KBCF5, KBCF5-BA-SE-20360502PN, KBCF6, KBCF6-BASE-20360602PT, KC2545-20050710, KPBT2545-20060710, KPTN2545-20040720, TRANSF90001MOTBT, TRANSF90001MOTTN, TRANSF90002MOTBT, TRANSF90002MOTTN, TRANSF90003MOTBT, TRANSF90003MOTTN, TRANSF90004MOTTN | | |

| | | | |
|--|---|-----------------|--------------------|
|  | | | |
| GEV No. | 379052 | Ref. No. | 167201 BN167201 |
| description | temperature probe PTC 1kOhm cable silicone probe -50 up to +150°C cable -50 up to +180°C probe ø6x40mm cable length 1.5m without screw connection 2-wire | | |
| For models: | KBF050-20350503, KBF050-203505030CBO, KBF050GB-20350103, KBF050GS-20350203, KBF050GS-20350203F, KBT120-2008140218, KBT120-P0120081410, KBT122-20081402XU, KBT124-2008140431, KBT124-P0120081430, KBT140-200214011K, KBT142-200214011L, KBT144-200214011M, KBT40-21091640, KBT40-210916400BAJ, KBT60-2008070124, KBT62-20080705H5, KBT70, KBT70-20020710, KBT70-BASE-20020700YL, KBT70G-200220, KBT72-200207061E, KBT72-20020720, KBT72-210207, KBTV120, KBTV140-200214011N, KBTV60, KBTV60-P0120080730, KBTV70-200207, KC10535-20051440, KC2545-20050710, KC3513-20050715, KC3535-20050720, KC4512-20050725, KC6060-20091430, KC70-70-20051410, KC7070-20051410, KC9030-20091420, KCTN10535-20031440, KCTN2545-20030725, KCTN3030-20090710, KCTN3513-20030730, KCTN3535-20030735, KCTN4512-20030745, KCTN6060-20091410, KCTN7070-20031410, KP140-20041405, KP60-20100710, KP70-20040710, KPBT10535-20061420...(Other models you can see in the webshop) | | |

| | | | |
|--|--|-----------------|--|
|  | | | |
| GEV No. | 379064 | Ref. No. | 167207 167208 167210 BN167207 FR995562 |
| description | temperature probe PTC 1kOhm cable silicone probe -50 up to +150°C cable -50 up to +180°C probe ø6x40mm cable length 3m without screw connection 2-wire | | |

producer-specific probes

core probes

| | | | |
|--|---|-----------------|---------------------------------|
|  | | | |
| GEV No. | 378679 | Ref. No. | 965295 FR6638220 FR965295 |
| description | core temperature probe Pt1000 connection 8-wire probe ø4x100mm cable length 5m handle ø 16mm handle length 110mm | | |
| For models: | 201, 202, PBC051DF-ASX-203505AS, PBC081AF-ASX-203528AS, PBC121DF-ASX-203512AS, PBC161DF-ASX-203516AS, PBC201DP-20355203, PBC202DP-20355204, PBC401DCFDX-20356403, PBC402DCFDX-20356404, PBF031AF-ASX-203623AS, PBF051-AFST-AB-5GN11-BF-PDX-203626AD | | |

1 electric components



accessories

| | | | |
|---|---|-----------------|------------------------|
|  | | | |
| GEV No. | 401777 | Ref. No. | 16671299 BN16671299 |
| description | buttons strip 8 buttons L 200mm W 37mm | | |
| For models: | BT140, BT70G, KSA105-35-2045260CC0, KSA140BT-204524, KSA140BT-2045240BYF, KSA140BT-2045240C10, KSA140BT-2045240CAD, KSA140P-204534, KSA140P-2045340C0X, KSA140TN-204514, KSA140TN-2045140B8X, KSA140TN-2045140CAB, KSA140TN-2045140CAC, KSA70BT-204517, KSA70BT-2045170BYL, KSA70BT-2045170C0Z, KSA70BT-2045170CAA, KSA70P-204527, KSA70P-2045270C0W, KSA70TN-204507, KSA70TN-2045070B5E, KSA70TN-2045070C6A, KSA70TN-2045070CA9, KSABT70G-204537, KSABT70G-2045370CC4, KSAP105-35-2045250CC1, KSAP35-35-2045450CBT, KSAPC35-35-2045460CBU, P140, P70, TN70 | | |

solenoid valves

solenoid valves (refrigeration)

CASTEL

valve bodies

STANDARD series

suitable for refrigerants R22, R134a, R404A, R407C, R410A, R507

| | | | |
|---|---|-----------------|--------------------------|
|  | | | |
| GEV No. | 370382 | Ref. No. | 14970245 |
| description | solenoid valve body NC type 1028/M10S p max 45bar connection 10mm soldering connection DN 3mm -35 up to +105°C L 125mm refrigeration straight CASTEL | | |
| For models: | KBC5, KBCF5, KBCF5-BASE-20360502PN, KBT40-21091640, KBT40-210916400BAJ, KBT70G-BASE-20022001TZ, KBTG140-20021470, KBTG70-20020770, KSABT70G-2045370CC4, M70BT | | |
| accessories for | 370382 | | |
|  | GEV No. | 371084 | Ref. No. — |
| | solenoid coil CASTEL 230VAC 8VA 50/60Hz connection cable 1000mm type CM2 | | |
|  | GEV No. | 371090 | Ref. No. 14970511 |
| | power socket plug type DIN 43650A screw | | |
|  | GEV No. | 371301 | Ref. No. — |
| | solenoid coil CASTEL 110VAC 8VA 50/60Hz seat ø 11.5mm connection DIN 43650A type HF2 | | |
|  | GEV No. | 371314 | Ref. No. — |
| | solenoid coil CASTEL 240VAC 8VA 50/60Hz seat ø 11.5mm | | |
|  | GEV No. | 371321 | Ref. No. — |
| | solenoid coil CASTEL 12/24VAC 50/60Hz seat ø 11.5mm connection DIN 43650A type HF2 | | |

spare parts and accessories

| | | | |
|---|--|-----------------|--------------------------|
|  | | | |
| GEV No. | 371041 | Ref. No. | 14970502 |
| description | solenoid coil CASTEL 240VAC 8VA 50/60Hz seat ø 11.5mm connection DIN 43650A type HM2 | | |
| For models: | KBC10, KBC10-BASE-20351002PM, KBC5, KBC6, KBC6-BA-SE-20350602PL, KBCF10, KBCF10-BASE-20361002PV, KBCF5, KBCF5-BASE-20360502PN, KBCF6, KBCF6-BASE-20360602PT, KBT70G-BASE-20022001TZ, KBTG140-20021470, KBTG70-20020770, KSABT70G-2045370CC4, KTAR82-202082020AWO, KTAR83-202083020AWP, KTAR84-202084020AWQ, KTARS27-20282700, TPV16, TPV16-2128150002, TPV21, TPV21-2128210003, TPV21C, TPV21C-2128211003, TPV26C, TPV26C-2128260004, TSR01, TSR01-BA-SE-202108010BPA, TSR02, TSR02-202113010BGO, TSR03, TSR03-BASE-202117010BGK, TSR04, TSR04-BASE-202122010BE8 | | |
| accessories for | 371041 | | |
|  | GEV No. | 371090 | Ref. No. 14970511 |
| | power socket plug type DIN 43650A screw | | |
|  | GEV No. | 371092 | Ref. No. — |
| | power socket plug type DIN large cable length 1000mm | | |

| | | | |
|--|--|-----------------|----------|
|  | | | |
| GEV No. | 371090 | Ref. No. | 14970511 |
| description | power socket plug type DIN 43650A screw | | |
| For models: | KBC10, KBC10-BASE-20351002PM, KBC5, KBC6, KBC6-BA-SE-20350602PL, KBCF10, KBCF10-BASE-20361002PV, KBCF5, KBCF5-BASE-20360502PN, KBCF6, KBCF6-BASE-20360602PT, KBT70G-BASE-20022001TZ, KBTG140-20021470, KBTG70-20020770, KSABT70G-2045370CC4, KTAR82-202082020AWO, KTAR83-202083020AWP, KTAR84-202084020AWQ, KTARS27-20282700, TPV16, TPV16-2128150002, TPV21, TPV21-2128210003, TPV21C, TPV21C-2128211003, TPV26C, TPV26C-2128260004, TSR01, TSR01-BA-SE-202108010BPA, TSR02, TSR02-202113010BGO, TSR03, TSR03-BASE-202117010BGK, TSR04, TSR04-BASE-202122010BE8 | | |

SANHUA

valves

| | | | |
|--|--|-----------------|--------------------|
|  | | | |
| GEV No. | 370757 | Ref. No. | 995508 FR995508 |
| description | solenoid valve type MDF-A03-6H001 230VAC p max 45bar pressure range 2 up to 31bar connection 10mm soldering connection -30 up to +105°C SANHUA refrigeration tube ø 10mm L 111mm | | |
| For models: | 122, PBC081AF-ASX-203528AS, PBC121DF-ASX-203512AS, PBC122DF-ASX-223512AS, PBC161DF-ASX-203516AS | | |



compressors

ACC/ZEL

R134A

HMBP monophase

High/Medium evaporation temperature above -20/-15 °C



1

| | | | |
|--------------------|--|-----------------|--------------------------------|
| GEV No. | 605012 | Ref. No. | 141565100025 BN141565100025 |
| description | compressor coolant R134a type GL45TB 220-240V 50Hz HMBP fully hermetic 8.4kg 1/6HP power input 342W cylinder capacity 4.5cm ³ CSIR H 175.5mmW 76W 101W 134W 175W 223W 278W 342W 413W test method ASHRAE ambient temperature max. 43°C | | |
| For models: | SATNBT3535-BASE-20193603CV, SATNTN3535-BASE-20193503CP | | |



1

| | | | |
|--------------------|--|-----------------|--|
| GEV No. | 605007 | Ref. No. | 141514200595 141565100035 BN141565100035 |
| description | compressor coolant R134a type GL60TB 220-240V 50Hz HMBP fully hermetic 9.5kg 1/5HP power input 437W cylinder capacity 5.7cm ³ CSIR H 175.5mm 95W 128W 170W 222W 284W 355W 437W 528W test method ASHRAE ambient temperature max. 43°C | | |
| For models: | KTAR01, KTAR01-BASE-20201001, KTAR01N, KTAR01N-BASE-20201005043V, KTAR02, KTAR02N, KTAR02N-BASE-20201305043Y, KTAR03, KTAR03-BASE-2020180105, KTAR03N, KTAR03N-BASE-202018050441, KTAR04, KTAR04N, KTAR04N-BASE-2020230508V7, KTAR82-202082020AWO, KTAR902, KTAR9-02-202009040Y, KTARBTO2-205101, KTARBTO2-205102, KTARBTO2-205103, KTARBTO2-BASE-2025130104FU, KTARBTO3-BASE-2025180104FW, KTARBTO4-BASE-2025230104FZ, KTN40-21090640, KTN40-210906400BAI, TARS22E-2124091022, TARS22EP-2124091023, TARS22ES-2124091022, TARS22R-21240913, TARS22RP-21240914, TARS22RS-21240913, TFT01, TFT01-BASE-209001106V7, TFT02, TFT02-BASE-209002106XF, TFT03, TFT03-BASE-209003106XY, TFT04, TFT04-BASE-209004106YC, TP0200Q-20283200, TP0220Q-20283220, TP0224Q-20283224, TP0227Q-20283227, TP0240Q-20283240, TP0247Q-20283247, TP0270Q-20283270, TPR02-2028020007Z4, TRANSF90001MOTTN, TSP00, TSP00-BASE-202606010BRU...(Other models you can see in the webshop) | | |



1

| | | | |
|--------------------|--|-----------------|--------------------------------|
| GEV No. | 605008 | Ref. No. | 141565100030 BN141565100030 |
| description | compressor coolant R134a type GL80TB 220-240V 50Hz HMBP fully hermetic 9.5kg 1/5HP power input 554W cylinder capacity 7.6cm ³ CSIR H 175.5mm 165W 215W 290W 390W 500W 615W 727W 840W test method ASHRAE ambient temperature max. 43°C | | |
| For models: | AFN-70-20170707G, AFN-70E-20173707G, AFN-70ESx-20173707GX-PS, ARCO-TN70-20170704, ARCO-TN70430-20170705, ARCO-TN7070-201777040GL70, ARCO-TN70-BASE-20170708, ARCO-TN70-PLUS-20170709, ARCO-TNN70-20170706, KC6060-20091430, KC9030-20091420, KCTN60-60-20091410, KPC90-30-20101410, KTAR01, KTAR01-BASE-20201001, KTAR01N, KTAR01N-BASE-20201005043V, KTAR02, KTAR02-600-BASE-20201205CU, KTAR02N, KTAR02N-BASE-20201305043Y, KTAR03, KTAR03-600-BASE-20201705DD, KTAR03-BASE-2020180105, KTAR03N, KTAR03N-BASE-202018050441, KTAR04, KTAR04N, KTAR04N-BASE-2020230508V7, KTAR6-03-202316010AMQ, KTAR6-03-202316010AMR, KTAR6-03-202316010AMS, KTARBTO2-205101, KTARBTO2-205102, KTARBTO2-205103, KTARBTO2-BASE-2025130104FU, KTARBTO3-BASE-2025180104FW, KTARBTO4-BASE-2025230104FZ, KTARS21-2124100021, KTARS24-202413010480, KTARS35-2024180104HC, KTN60-20070710, KTN60-BASE-20070700XE, KTN60-BASE-20070700XF, KTN62-20070700XF, KTN62-20070720, NFB0070N, NFB0070P, NFB0072N, NFB0072P...(Other models you can see in the webshop) | | |



1

| | | | |
|--------------------|---|-----------------|--------------------------------|
| GEV No. | 605010 | Ref. No. | 141565100050 BN141565100050 |
| description | compressor coolant R134a type GP12TB 220-240V 50Hz HMBP fully hermetic 11.2kg 3/8HP power input 661W cylinder capacity 12cm ³ CSIR H 203.6mmW 143W 194W 259W 339W 432W 539W 661W 796W test method ASHRAE ambient temperature max. 43°C | | |
| For models: | AFN-140E-20173407G, ARCO-TN140.-BASE-20171408, ARCO-TN140.-PLUS-20171409, ARCO-TN140-20171404, ARCO-TN140430-20171405, KTAR01, KTAR01-BASE-20201001, KTAR01N, KTAR01N-BASE-20201005043V, KTAR02, KTAR02N, KTAR02N-BASE-20201305043Y, KTAR03, KTAR03-BASE-2020180105, KTAR03N, KTAR03N-BASE-202018050441, KTAR04, KTAR04N, KTAR04N-BASE-2020230508V7, KTAR84-202084020AWQ, KTARBT02-205101, KTARBT02-205102, KTARBT02-205103, KTARBT02-BASE-2025130104FU, KTARBT03-BASE-2025180104FW, KTARBT04-BASE-2025230104FZ, KTARS27-20282700, KTN60-BASE-20070700XH, KTNV60-20070700XH, KTNV60-20070730, NFB0140N, NFB0140P, NFB0144N, NFB0144P, S120TN-2088400100, S120TNN-2088410100, SATN140-201714020998, SATN144-BASE-20171402099A, SATNN140-2017140208DW, SATNN144-BASE-2017140208RY, SATNV140-BASE-201714020999, STN140A, STN144A, STNN140A, STNN144A, STNV140A, TFT01, TFT01-BASE-209001106V7, TFT02, TFT02-BASE-209002106XF...(Other models you can see in the webshop) | | |

R404a/R507

LBP monophase

Lower evaporation temperature below -20°C



1

| | | | |
|--------------------|--|-----------------|--------------------------------|
| GEV No. | 605073 | Ref. No. | 141565100180 BN141565100180 |
| description | compressor coolant R404a/R507 type MP14FB 220-240V 50Hz LBP fully hermetic 13.9kg 1/2HP cylinder capacity 14cm ³ CSIR H 203.6mm 439W 584W 746W 926W 1124W test method ASHRAE | | |
| For models: | AFB-70-20171707G, AFB-70Sx-20171707GXPS, ARCO-BT70-20171704, ARCO-BT70430-20171705, ARCO-BT70-BASE-20171708, ARCO-BT70-PLUS-20171709, KTRE4-202117120G1J, NFB0070F, NFB0072F, NORD-700BT-2017817305, NORD-700BT-2017817305P, TPECO03-20261512, TPECO03-202615120G5V, TPECO04-20262012, TPECO04-202620120G5W, TRECO03-20211712, TRECO04, TRECO04-20212212, TRECO04-202122120FLN, TSR03, TSR03-BASE-202117010BGK, TSR04, TSR04-BASE-202122010BE8 | | |

HMBP monophase

High/Medium evaporation temperature above -20/-15 °C



1

| | | | |
|--------------------|--|-----------------|--------------------------------|
| GEV No. | 605014 | Ref. No. | 141565100027 BN141565100027 |
| description | compressor coolant R404a/R507 type ML80TB 220-240V 50Hz HMBP fully hermetic 11.4kg 3/8HP cylinder capacity 7.57cm ³ CSIR H 175.5mmW 261W 346W 446W 561W 691W 835W 993W 1167W test method ASHRAE ambient temperature max. 43°C | | |



1

| | | | |
|--------------------|--|-----------------|--------------------------------|
| GEV No. | 605028 | Ref. No. | 141565100040 BN141565100040 |
| description | compressor coolant R404a/R507 type ML90TB 220-240V 50Hz HMBP fully hermetic 11.6kg 3/8HP cylinder capacity 8.85cm ³ CSIR H 175.5mmW 323W 418W 532W 666W 819W 990W 1181W 1391W test method ASHRAE ambient temperature max. 43°C | | |
| For models: | KTAR83-202083020AWP, MBM8.5CC-21661500, TFT01, TFT01-BASE-209001106V7, TFT02, TFT02-BASE-209002106XF, TFT03, TFT03-BASE-209003106XY, TFT04, TFT04-BASE-209004106YC, TP0300Q-20283300, TP0320Q-20283320, TP0370Q-20283340, TP0370Q-20283370, TPR03-2028030007Z5, TRANSF90002MOTTN, TRANSF90003MOTTN | | |



CUBIGEL

R404a/R507

LBP monophase

Lower evaporation temperature below -20°C



| | | | |
|--------------------|---|-----------------|-------------|
| GEV No. | 605207 | Ref. No. | 14156510020 |
| description | compressor coolant R404a/R507 type ML80FB 220-240V 50Hz LBP 10.9kg 1/4HP cylinder capacity 8.1cm ³ CSIR H 185mm 276W 314W 356W 401W 450WWWWWW test method ASHRAE ambient temperature max. 43°C | | |



| | | | |
|--------------------|--|-----------------|--------------------------------|
| GEV No. | 605176 | Ref. No. | 141565100021 BN141565100021 |
| description | compressor coolant R404a/R507 type ML90FB 220-240V 50Hz LBP 11kg 1/3HP cylinder capacity 8.85cm ³ CSIR H 198mm 305W 394W 495W 606W 729WWWWWW test method ASHRAE | | |
| For models: | KTARI140-BASE-20210140, KTARI140-BASE-20210141, TPE-CO02-20261112, TPECO02-202611120G5U, TRECO02-20211312, TRECO02-202113120FLM, TRECO02-20221312, TRECO02-21750101, TSR02, TSR02-202113010BG0 | | |



| | | | |
|--------------------|--|-----------------|--------------|
| GEV No. | 605138 | Ref. No. | 141565100170 |
| description | compressor coolant R404a/R507 type MP12FB 220-240V 50Hz LBP 12kg 3/8HP cylinder capacity 12cm ³ CSIR H 215mm 381W 510W 657W 819W 999WWWWWW test method ASHRAE | | |
| For models: | 140, AP-140-221314XG, KC105-35-20051440, KC3513-20050715, KC3535-20050720, KC9030-20091420, KPBT3513-20060720, KPBT3535c-20060730, KUC105-35-20151440, KUC25-45-20150710, KUC3513-20150715, KUC35-35-20150720, KUC4512-20150725, KUPBT2545-20160710, KUPBT3513-20160720, KUPBT3535-20160730, KUPBT4512-20160740, LLP140TN, LLP140TNGN2-1-221314, SAT-NBT3535-BASE-20193603CV | | |



| | | | |
|--------------------|---|-----------------|--------------------------------|
| GEV No. | 605075 | Ref. No. | 141565100195 BN141565100195 |
| description | compressor coolant R404a/R507a type MX21FB_A 220-240V 50Hz LBP 16.5kg 3/4HP cylinder capacity 20.72cm ³ CSR H 220mm 575W 655W 742W 836W 938WWWWWW test method ASHRAE | | |
| For models: | S120BT-2088420100, T140BT-2046220100 | | |



EMBRACO / ASPERA

R290A

LBP monophase

Lower evaporation temperature below -20°C

R290



1

| | | | |
|--------------------|---|-----------------|---------------|
| GEV No. | 605204 | Ref. No. | BN14156511060 |
| description | compressor coolant R290 type NEK2160U 220-240V 50Hz LBP 11.9kg 3/4HP cylinder capacity 16.8cm ³ CSR H 206mm 508W 646W 808W 995W 1206WWWWW test method ASHRAE | | |

R290



1

| | | | |
|--------------------|--|-----------------|---------------|
| GEV No. | 605202 | Ref. No. | BN14156511065 |
| description | compressor coolant R290 type NT2170U 220-240V 50Hz LBP 17kg 3/4HP cylinder capacity 20.44cm ³ CSR H 220mm 544W 698W 883W 1097W 1340WWWWW test method ASHRAE | | |

MBP monophase

Medium evaporation temperature above -20°C

R290



1

| | | | |
|--------------------|---|-----------------|---------------|
| GEV No. | 605200 | Ref. No. | BN14156511070 |
| description | compressor coolant R290 type EMT6144U 220-240V 50Hz MBP 7.8kg 1/6HP cylinder capacity 4.5cm ³ CSIR H 166mmWW 228W 280W 342W 416W 502W 598W 705W test method EN 12900 | | |

R404a/R507

LBP monophase

Lower evaporation temperature below -20°C



1

| | | | |
|--------------------|---|-----------------|---------------------------------|
| GEV No. | 605144 | Ref. No. | 995745 FR6683120 FR995745 |
| description | compressor coolant R404a/R507 type NEK2168GK 220-240V 50Hz LBP 22.9kg 3/4HP cylinder capacity 14.28cm ³ CSR H 200mm 345W 454W 587W 742W 921W 1123WWWWW | | |
| For models: | PBF031AF-ASX-203623AS | | |



1

| | | | |
|--------------------|--|-----------------|---|
| GEV No. | 605174 | Ref. No. | 141565100200 BN141565100200 FR6681010 FR995767 |
| description | compressor coolant R404a/R507 type NJ2192GK 220-240V 50Hz LBP 20.4kg 1 1/4HP cylinder capacity 26.2cm ³ CSR H 265mm 685W 989W 1342W 1745W 2196W 2196WWWWW | | |
| For models: | KBT120-P0120081410, KBT124-P0120081430, KBT140-200214011M, KBT140-20021410, KBT140-BASE-200214011K, KBT140-BASE-200214011L, KBT142-20021420, KBT144-20021430, KBTV140-20021440 | | |



1

| | | | |
|--------------------|--|-----------------|--------------|
| GEV No. | 605078 | Ref. No. | 141514202580 |
| description | compressor coolant R404a/R507 type NT2180GK 220-240V 50Hz LBP fully hermetic 17.3kg 1HP cylinder capacity 20.44cm ³ CSIR H 221mm 515W 598W 682W 769W 859W 956WWWWW test method ASHRAE | | |
| For models: | ROLL-IN-1P, ROLL-IN-1P-2110081205Z6, ROLL-IN-1PP, ROLL-IN-1PPM, ROLL-IN-1PPV, ROLL-IN-1PV, ROLL-IN-1PV-2110081206F1, ROLL-IN-2PPM-TN, ROLL-IN-2PPM-TN-2110162206X4, ROLL-IN-2PP-TN, ROLL-IN-2PP-TN-2110162205Z9, ROLL-IN-2PPV-TN, ROLL-IN-2PPV-TN-2110162206FC, ROLL-IN-2P-TN, ROLL-IN-2P-TN-2110161205Z8, ROLL-IN-2PV-TN, ROLL-IN-2PV-TN-2110161206F9, ROLL-INP-1P-2110082205Z7, ROLL-INP-1P-2110082206F6, ROLL-INP-1P-2110082206X3 | | |



electric components

L'UNITE HERMETIQUE / TECUMSEH

R404A

HMBP monophase

High/Medium evaporation temperature above -20/-15 °C



| | | | |
|--------------------|--|-----------------|--------------|
| GEV No. | 605021 | Ref. No. | 141565100028 |
| description | compressor coolant R404A type AEZ4425Z 220-240V 50Hz HMBP fully hermetic 9.8kg 1/5HP cylinder capacity 4.5cm ³ CSIR H 186mmWW 198W 263W 341W 432W 537W 629W test method EN 12900 723W | | |

SECOP DANFOSS

R134A

MBP monophase

Medium evaporation temperature above -20°C



| | | | |
|------------------------|--|-----------------|--------------------------------|
| GEV No. | 605060 | Ref. No. | 141552211000 BN141552211000 |
| description | compressor coolant R134a type NL10MF 220-240V 50/60Hz MBP fully hermetic 10.5kg 1/3HP cylinder capacity 10.1cm ³ RSIR/CSIR H 203mmWW 293W 382W 487W 611W 758W 930W 1129W test method ASHRAE (50Hz) | | |
| For models: | KST04TN-205004, KST04TN-205014, KST04TN-VCR-205604, KST04TN-VCR-205614, KSTP04TN-205214, KSTP05TN-205205, KSTP05TN-205215, KSTS24-205424, KSTS24-2054240IDP, KSTS24-2054240JGN, KST-TN04, KST-TN-VCR04, NFS0143NG, NFS0144NG, NFS0144P | | |
| spare parts for | 605060 | | |
| | GEV No. | 381530 | Ref. No. — |
| | start relay DANFOSS 117U6022 HST | | |

HMBP monophase

High/Medium evaporation temperature above -20/-15 °C



| | | | |
|------------------------|--|-----------------|--------------------------------|
| GEV No. | 605089 | Ref. No. | 141514208850 BN141514208850 |
| description | compressor coolant R134a type NL8.4MF 220-240V 50Hz HMBP fully hermetic 10.5kg 1/4HP cylinder capacity 8.35cm ³ RSIR/CSIR H 197mmWW 235W 305W 390W 491W 610W 749W 912W test method ASHRAE | | |
| For models: | KC105-35-20051440, KC10535-20051440, KC70-70-20051410, KC7070-20051410, KCTN10535-20031440, KCTN7070-20031410, KPTN10535-20041440, KPTN70-70-20041410, KTAR04, KTN3513-200107, KTN3513-20010735, KTN4512-200107, KTN4512-20010745, KTN70-200107003W, KTN70-20010700VF, KTN70-20010710, KTN70-210107, KTN70-BASE-20010700VX, KTN72-200107, KTN72-20010720, KTN72-BASE-20010700VF, KTNV60-20070700XH, KTNV70-200107003W, KTNV70-20010730, KTNV70-210107, KUC105-35-20151440, KUC10535-20151440, KUC70-70-20151410, KUC7070-20151410, KUCTN10535-20131440, KUCTN7070-20131410, KUPTN105-35-20141440, KUPTN10535-20141440, KUPTN70-70-20141410, KUPTN7070-20141410, KUTN3513-20110735, KUTN4512-20110770, KUTN70-20110710, KUTN72-20110720, KUTNV70-20110730, ROLL-IN-1P, ROLL-IN-1P-2110081205Z6, ROLL-IN-1PP, ROLL-IN-1PPM, ROLL-IN-1PPV, ROLL-IN-1PV, ROLL-IN-1PV-2110081206F1, ROLL-IN-2PPM-TN, ROLL-IN-2PPM-TN-2110162206X4, ROLL-IN-2PP-TN...(Other models you can see in the webshop) | | |
| spare parts for | 605089 | | |
| | GEV No. | 381528 | Ref. No. — |
| | start relay DANFOSS 117U6016 HST | | |



| | | | |
|------------------------|--|-----------------|---------------------------------------|
| GEV No. | 605077 | Ref. No. | 141555100030 FR6681520 FR995983 |
| description | compressor coolant R134a type SC15G 220-240V 50Hz HMBP fully hermetic 13.1kg 3/8HP cylinder capacity 15.3cm ³ CSIR H 203mmWW 203W 358W 523W 703W 901W 1124W 1377W 1665W test method ASHRAEW 1993W | | |
| For models: | SATN140-BASE-20196400KF, SATN140-BASE-201964013Z, SATN144-BASE-201964402BZ, STN140, STN140A-201964, STN140A-20196400KF, STN140-BASE-20191400KF, STN144A-201964, STNV140, STNV140A-201964 | | |
| spare parts for | 605077 | | |
| | GEV No. | 365062 | Ref. No. — |
| | starting capacitor 80µF 220/300V 50/60Hz duty cycle 3min/1min ø 38mm L 98mm plastic connection cable 100mm | | |

Table continues overleaf



| | | | |
|---|---------|--------|------------|
| spare parts for 605077 | | | |
|  | GEV No. | 380078 | Ref. No. — |
| start relay DANFOSS 117U6005 HST | | | |

R404a/R507

LBP monophase

Lower evaporation temperature below -20°C

| | | | |
|---|---|----------|--------------------------------|
|  | | | |
| 1 | | | |
| GEV No. | 605058 | Ref. No. | 141555100055 BN141555100055 |
| description | compressor coolant R404a/R507 type SC15CL 220-240V 50Hz LBP fully hermetic 13.8kg 1/2HP cylinder capacity 15.28cm ³ CSIR H 219mm 486W 637W 813W 1017W 1251W 1699W test method ASHRAE 175W 358W | | |
| For models: | BT60, BT70, BT72, BTV70, KSA105-35-2045260CCO, KSA70-70PBT-2045800C0U, KSA70-70PBT-2045800CJ8, KSA70BT-204517, KSA70BT-2045170BYL, KSA70BT-2045170C0Z, KSA70BT-2045170CAA, KSAC105-35-2045160C0S, KSAC70-70-2045780BRL, KSAC70-70-2045780CJ6, KST02BT-205112, KST02BT-VCR-205702, KST02BT-VCR-205712, KST-BT-VCR02, KSTP02BT-205312, NFB0140NF, NFB0143FN, NFB0143NF, NFB0143PF, NFS140IF, NFS140NF, NFS143FN, NFS143IF, P140BT-2047220101, P140BT-2047260101, P144BT-2047360100, P70-70TNN-BT-2047560100, P70BT-2047020101, P70BT-2046060101, P70TNN-2047040101, S140BT-2048220101, S70BT-2048020101, SPA70-70TN-BT-201778030BYA, SPABT60-20171603, SPABT60-201716030C19, SPABT60-201716030C1A, SPABT60-201716030C1B, SPABT70-20171703, SPABT70-201717030BY7, SPABT72-201717030C14, SPABTV70-201717030C1C, T140BT-2046260100, T144BT-2046xxxxx, T70-70TNN-BT-2046560100, T70BT-2046020100, T70BT-2046060x00... (Other models you can see in the webshop) | | |
| spare parts for 605058 | | | |
|  | GEV No. | 380058 | Ref. No. — |
| start relay DANFOSS 117U6019/F278 HST | | | |

evaporation and condensing trays

condensing trays heated

universal

heating cartridges

| | | | |
|--|---|----------|---------------------------------|
|  | | | |
| 1 | | | |
| GEV No. | 417227 | Ref. No. | 1666090 1666150 BN1666090 |
| description | heating cartridge 90W 230V ø 12mm L 124mm thread 3/8" cable length 4000mm Hmm Wmm condensate evaporation | | |
| For models: | KB100-20180720, KB200-20181420, KBT120-20081410, KBT120-2008140218, KBT120-BASE-2008140218, KBT120-BASE-20081402BT, KBT120-BASE-20081402XU, KBT120-BASE-2008140431, KBT120-P0120081410, KBT122-20081402XU, KBT122-20081420, KBT122-20081402XU, KBT124-2008140431, KBT124-20081430, KBT124-P0120081430, KBT140-200214011K, KBT140-200214011M, KBT140-20021410, KBT140-BASE-200214011K, KBT140-BASE-200214011L, KBT140-BASE-200214011N, KBT142-200214011L, KBT142-20021420, KBT144-200214011M, KBT144-20021430, KBT40-21091640, KBT40-210916400BAJ, KBT60-2008070124, KBT60-20080710, KBT60-BASE-2008070124, KBT60-BASE-2008070126, KBT60-BASE-20080705H5, KBT62-20080705H5, KBT62-20080720, KBT62-20080705H5, KBT70, KBT70-20020700YN, KBT70-200207061E, KBT70-20020710, KBT70-BASE-20020700YL, KBT70G-200220, KBT70G-BASE-20022001TZ, KBT72-200207061E, KBT72-20020720, KBT72-210207, KBT72-BASE-200207061E, KBTG70-20020770, KBTV120, KBTV120-20081402BT, KBTV120-20081440...(Other models you can see in the webshop) | | |

→ electric components



fans

axial fans

import



| | | | |
|------------------------|--|-----------------|--------------------------|
| GEV No. | 601080 ¹ | Ref. No. | 1648110107 MACM303000 |
| description | axial fan L 119mm W 119mm H 38mm 230VAC 50/60Hz 23/20W bearing ball bearing connection male faston 2.8mm metal ADDA fan wheel ø 110mm temp.-resist. 70°C | | |
| For models: | KBT40-21091640, KBT40-210916400BAJ, KTAP00BT-BASE-2022550105KR, KTAP01BT-BASE-2022590105KU, KTAP02BT-205301, KTAP02BT-205302, KTAP02BT-205303, KTAP02BT-BASE-2022630105KW, KTAP03BT-BASE-2022680109UW, KTAPBT00, KTAPBT01, KTAPBT02, KTAPBT03, KTARBT02, KTARBT03, KTARBT04, KTN40-21090640, KTN40-210906400BAI, M70TN, PIZZA160, ROLL-IN-1P, ROLL-IN-1P-2110081205Z6, ROLL-IN-1P-BT, ROLL-IN-1P-BT-2110091206GZ, ROLL-IN-1PP, ROLL-IN1PP-BT, ROLL-IN-1PPM, ROLL-IN-1PPV, ROLL-IN-1PV, ROLL-IN-1PV-2110081206F1, ROLL-IN-2PPM-TN, ROLL-IN-2PPM-TN-2110162206X4, ROLL-IN-2PP-TN, ROLL-IN-2PP-TN-2110162205Z9, ROLL-IN-2PPV-TN, ROLL-IN-2PPV-TN-2110162206FC, ROLL-IN-2P-TN, ROLL-IN-2P-TN-2110161205Z8, ROLL-IN-2PV-TN, ROLL-IN-2PV-TN-2110161206F9, ROLL-INP-1P-2110082205Z7, ROLL-INP-1P-2110082206F6, ROLL-INP-1P-2110082206X3, ROLL-INP-1P-BT-2110092206KU, TARS21, TARS21-2124100021, TARS22E-2124091022, TARS22EP-2124091023, TARS22ES-2124091022 | | |
| accessories for | 601080 | | |
| | GEV No. | 550898 | Ref. No. — |
| | connecting cable cable length 2000mm connection F 2.8 connection distance 7.9mm for axial flow fan | | |
| | GEV No. | 692519 | Ref. No. — |
| | guard L 120mm W 120mm plastic | | |

¹with ball bearings



| | | | |
|------------------------|---|-----------------|--|
| GEV No. | 601055 ¹ | Ref. No. | 1648110086 1648110150 BN1648110150 |
| description | axial fan L 92mm W 92mm H 25mm 230VAC 50/60Hz 14.5/14W bearing ball bearing connection male faston 2.8mm metal ADDA fan wheel ø 85mm temp.-resist. 70°C | | |
| For models: | KST01BT-VCR-205711, KST01TN-205001, KST01TN-205011, KST-01TN-VCR-205611, KST02TN-205002, KST02TN-205012, KST02TN-NH760-205802, KST02TN-VCR-205602, KST02TN-VCR-205612, KST03TN-205003, KST03TN-205013, KST03TN-VCR-205603, KST03TN-VCR-205613, KST04TN-205004, KST04TN-205014, KST04TN-VCR-205604, KST04TN-VCR-205614, KSTP01TN-205211, KSTP02TN-205212, KSTP03TN-205213, KSTP04TN-205214, KSTP05TN-205205, KSTP05TN-205215, KSTS24-205424, KSTS24-2054240IDP, KSTS24-2054240JGN, KST-TN01, KST-TN02, KST-TN03, KST-TN04, KST-TN-VCR01, KST-TN-VCR02, KST-TN-VCR03, KST-TN-VCR04, KTAR6-02-BASE-20231207MZ, KTAR6-02-BASE-20231207N0, KTAR6-02-BASE-20231207N1, KTAR6-03-202316010AMQ, KTAR6-03-202316010AMR, KTAR6-03-202316010AMS, KTAR902, KTAR9-02-202009040Y, KTARBT902, KTARI140-BASE-20210140, KTARI140-BASE-20210141, KTRE4-202117120G1J, TARS22-2124922, TARS22-212492208L6, TARS22-212492208VT, TARS22-21249220AO2... (Other models you can see in the webshop) | | |
| accessories for | 601055 | | |
| | GEV No. | 550898 | Ref. No. — |
| | connecting cable cable length 2000mm connection F 2.8 connection distance 7.9mm for axial flow fan | | |
| | GEV No. | 691103 | Ref. No. — |
| | guard ø 90mm mounting distance 83mm for axial fan 92mm | | |

¹with ball bearings



refrigeration fans

refrigeration motors universal

ELCO

N series - multi fit



1

| | | | |
|---|---|-----------------|-------------------|
| GEV No. | 601430 | Ref. No. | 1648000510 |
| description | fan motor ELCO 5W 230V 50/60Hz bearing slide bearing L1 48mm L2 52mm L3 79.5mm W 83mm connection cable 500mm 1300/1550rpm 5 mounting options VNT5-13/027 | | |
| For models: | KC25-45-20050710, KC45-12-20050725, KPBT25-45-20060710, KPBT4512-20060740, TARS22-2124922, TARS22-212492208L6, TARS22-212492208VT, TARS22-21249220AO2, TARS22-21249220AO3, TARS22-21249220AO4, TARS22-21249220AO6, TARS22-KIT1, TARS22-Kit1-212492201, TARS22-KIT2, TARS22-Kit2-212492202, TARS22-KIT3, TARS22-Kit3-212492203, TARS22-KIT4, TARS22-Kit4-212492204, TARS22-KIT5, TARS22-Kit5-212492205, TARS22-KIT6, TARS22-Kit6-212492206, TARS22-KIT6-21249220AO5, TARS22-KIT7, TARS22-Kit7-212492207, TP122-TARS22-KIT5-212492208VR | | |
| spare parts for | 601430 | | |
|  | GEV No. | 560140 | Ref. No. — |
| | hexagonal nut thread M4 H 4.8mm SS WS 7 Qty 20 pcs DIN/ISO DIN 985 self-locking | | |
|  | GEV No. | 560332 | Ref. No. — |
| | plain washer ID ø 4.3mm ED ø 9mm thickness 0.8mm SS Qty 1 pcs | | |
|  | GEV No. | 560340 | Ref. No. — |
| | hexagonal nut thread M4 H 3.2mm WS 7 SS DIN/ISO DIN 934 / ISO 4032/8673 Qty 1 pcs | | |

N series - standard



1

| | | | |
|--------------------|---|-----------------|---|
| GEV No. | 601442 | Ref. No. | 1648001017 BN1648001017 FR6671010 |
| description | fan motor ELCO 10W 230V 50-60Hz bearing slide bearing L1 45mm L3 83mm W 83mm cable length 1800mm 1300/1550rpm 3 mounting options VN10-20/507 triple | | |
| For models: | 140, 70, AFB-70-20171707G, AFB-70Sx-20171707GXPS, AFN-70-20170707G, AFN-70E-20173707G, AFN-70ESx-20173707GXPS, AP-140-221314XG, AP-70TN-221307XG, ARCO-BT70-20171704, ARCO-BT70430-20171705, ARCO-BT70-BASE-20171708, ARCO-BT70GN2-1-2017817304, ARCO-BT70-PLUS-20171709, ARCO-TN140-2017814301, ARCO-TN70-20170704, ARCO-TN70-2017807304, ARCO-TN70430-20170705, ARCO-TN7070-20177704, ARCO-TN7070-201777040GL70, ARCO-TN70-BASE-20170708, ARCO-TN70-PLUS-20170709, ARCO-TNBT7070-20177804, ARCO-TNN70-20170706, KSA105-35-2045150C0R, KSA105-35-2045260C0C, KSA140TN-2045140B8X, KSA140TN-2045140CAB, KSA140TN-2045140CAC, KSA70-70-2045770BYH, KSA70-70-2045770CJ5, KSA70-70PBT-2045800C0U, KSA70-70PBT-2045800CJ8, KSA70-70PTN-2045790C0T, KSA70-70PTN-2045790CJ7, KSA70BT-2045170BYL, KSA70BT-2045170C0Z, KSA70BT-2045170CAA, KSA70P-2045270C0W, KSA70TN-2045070B5E, KSA70TN-2045070C6A, KSA70TN-2045070CA9, KSAC105-35-2045160C0S, KSAC70-70-2045780BRL, KSAC70-70-2045780CJ6, KSACTN70-70-2045770EVM0, KSAP105-35-2045250CC1, KSAP35-35-2045450CBT, KSAPC35-35-2045460CBU, K TAR6-03-202316010AMQ... | | |
| | (Other models you can see in the webshop) | | |



IMPORT

multi fit fan motors



1

| | | | |
|--------------------|---|-----------------|--|
| GEV No. | 601022 | Ref. No. | 1648001010 1648001015 BN1648001015 |
| description | fan motor 10W 230V 50-60Hz L1 44mm L2 54mm L3 85mm W 84mm cable length 500mm 1300rpm YZF10-20-18/26 5 mounting options bearing slide bearing | | |
| For models: | AFN-70ESx-20173707GXPS, B100, B120, BT140, BT60, BT70G, KB100-20180720, KB120-20180710, KB200-20181420, KB240-20181410, KBC5, KBC5-BASE-20350502PK, KBCF5, KBCF5-BASE-20360502PN, KBT120-BASE-2008140218, KBT120-BASE-20081402BT, KBT120-BASE-20081402XU, KBT120-BASE-2008140431, KBT122-20081402XU, KBT124-2008140431, KBT40-21091640, KBT40-210916400BAJ, KBT60-2008070124, KBT60-20080710, KBT60-BASE-2008070124, KBT60-BA-SE-2008070126, KBT60-BASE-20080705H5, KBT62-20080705H5, KBT62-20080720, KBT62-20080705H5, KBT70-20020700YN, KBT70-200207061E, KBT70-20020710, KBT70-BASE-20020700YL, KBT70G-BASE-20022001TZ, KBT72-20020720, KBT72-BASE-200207061E, KBTG140-20021470, KBTV120-20081402BT, KBTV60-2008070126, KBTV60-20080730, KBTV60-P0120080730, KBTV70-20020730, KBTV70-BASE-20020700YN, KC105-35-20051440, KC10535-20051440, KC25-45-20050710, KC2545-20050710, KC3513-20050715, KC3535-20050720...(Other models you can see in the webshop) | | |

accessories

fan wheels

aluminium

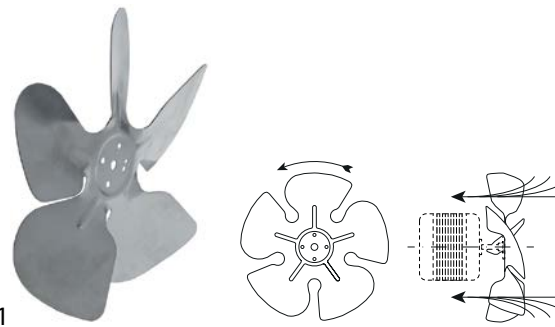

1

| | | | |
|--------------------|---|-----------------|------------------------|
| GEV No. | 601070 | Ref. No. | 1495200028 FR925648 |
| description | fan wheel sucking ø 200mm fan wheel mounting 25.4mm blade angle 28° W 38mm aluminium | | |
| For models: | KBT40-21091640, KBT40-210916400BAJ, KC25-45-20050710, KC2545-20050710, KC3513-20050715, KC3535-20050720, KC45-12-20050725, KC4512-20050725, KCTN10535-20031440, KCTN2545-20030725, KCTN3030-20090710, KCTN3513-20030730, KCTN3535-20030735, KCTN45-12-20030745, KCTN4512-20030745, KPBT105-35-20061420, KPBT10535-20061420, KPBT25-45-20060710, KPBT2545-20060710, KPBT3513-20060720, KPBT3535-20060730, KPBT3535c-20060730, KPBT4512-20060740, KPC30-30-20100720, KPC3030-20100720, KPC90-30-20101410, KPC9030-20101410, KPTN10535-20041440, KPTN25-45-20040720, KPTN2545-20040720, KPTN3513-20040725, KPTN3535-20040730, KTAP902, KTAP902, KTAR902, KTAR9-02-202009040Y, KTAR902BT-ESP66300BT-202509P0201, KTARB902, KTARB9-02-BASE-20250904MU, KTARS21-2124100021, KTN40-21090640, KTN40-210906400BAI, KUC25-45-20150710, KUC2545-20150710, KUC3513-20150715, KUC35-35-20150720, KUC3535-20150720, KUC4512-20150725, KUCTN10535-20131440, KUCTN2545-20130710...(Other models you can see in the webshop) | | |



2

| | | | |
|--------------------|---|-----------------|--|
| GEV No. | 601023 | Ref. No. | 1648000514 1648001600 BN1648000514 BN1648001600 MA25314399 |
| description | fan motor 16W 230V 50-60Hz L1 45mm L2 61mm L3 92mm W 84mm cable length 500mm 1300rpm YZF16-25-18/26 5 mounting options bearing slide bearing | | |
| For models: | BT70G, KBF050-20350503, KBF050-20350503OCBO, KB-F050GB-20350103, KBF050GS-20350203, KBF050GS-20350203F, KBT120-2008140218, KBT120-BASE-2008140218, KBT120-BASE-20081402BT, KBT120-BASE-20081402XU, KBT120-BASE-2008140431, KBT122-20081402XU, KBT122-20081402XU, KBT124-2008140431, KBT140-200214011K, KBT142-200214011L, KBT144-200214011M, KBT60-BASE-2008070126, KBT70, KBT70-20020700YN, KBT70-200207061E, KBT70-20020710, KBT70-BASE-20020700YL, KBT70G-200220, KBT70G-BASE-20022001TZ, KBT72-200207061E, KBT72-20020720, KBT72-210207, KBT72-BASE-200207061E, KBTG140-20021470, KBTG70-20020770, KBTV120, KBTV120-20081402BT, KBTV140-200214011N, KBTV60, KBTV60-2008070126, KBTV70-200207, KBTV70-20020730, KBTV70-BASE-20020700YN, KC70-70-20051410, KC7070-20051410, KPBT105-35-20061420, KPBT10535-20061420, KPBT70-70-20061410, KPBT7070-20061410, KSABT70G-204537, KSABT70G-2045370CC4, KTARB03, KTARB03-BASE-2025180104FW, KTARB04...(Other models you can see in the webshop) | | |

1

| | | | |
|--------------------|--|-----------------|----------------------------|
| GEV No. | 601282 | Ref. No. | 1495200034 BN1495200034 |
| description | fan wheel sucking ø 200mm fan wheel mounting 25.4mm blade angle 34° W 44mm aluminium | | |
| For models: | AFN-140E-20173407G, AFN-70-20170707G, AFN-70E-20173707G, AFN-70ESx-20173707GXPS, AP-70TN-221307XG, ARCO-TN140-BASE-20171408, ARCO-TN140-PLUS-20171409, ARCO-TN140-20171404, ARCO-TN140430-20171405, ARCO-TN70-20170704, ARCO-TN70430-20170705, ARCO-TN7070-20177040GL70, ARCO-TN70-BASE-20170708, ARCO-TN70-PLUS-20170709, ARCO-TNN70-20170706, BT140, KSA105-35-2045150C0R, KSA105-35-2045260C0C, KSA140BT-204524, KSA140BT-2045240BYF, KSA140BT-2045240C10, KSA140BT-2045240CAD, KSA140P-204534, KSA140P-2045340C0X, KSA140TN-204514, KSA140TN-2045140B8X, KSA140TN-2045140CAB, KSA140TN-2045140CAC, KSA70-70-2045770BYH, KSA70-70-2045770CJ5, KSA70-70PBT-2045800COU, KSA70-70PBT-2045800CJ8, KSA70-70PTN-2045790C0T, KSA70-70PTN-2045790CJ7, KSA70BT-204517, KSA70BT-2045170BYL, KSA70BT-2045170C0Z, KSA70BT-2045170CAA, KSA70P-204527, KSA70P-2045270C0W, KSA70TN-204507, KSA70TN-2045070B5E, KSA70TN-2045070C6A, KSA70TN-2045070CA9, KSAC105-35-2045160C0S, KSAC70-70-2045780BRL, KSAC70-70-2045780CJ6, KSAP105-35-2045250CC1, KSAP35-35-2045450CBT, KSAPC35-35-2045460CBU...(Other models you can see in the webshop) | | |

2

| | | | |
|--------------------|--|-----------------|----------------------------|
| GEV No. | 601172 | Ref. No. | 1495230034 BN1495230034 |
| description | fan wheel sucking ø 230mm fan wheel mounting 25.4mm blade angle 34° W 50mm aluminium | | |
| For models: | 140, 70, AFB-70-20171707G, AFB-70Sx-20171707GXPS, AP-140-221314XG, ARCO-BT70-20171704, ARCO-BT70430-20171705, ARCO-BT70-BASE-20171708, ARCO-BT70GN2-1-2017817304, ARCO-BT70-PLUS-20171709, ARCO-TN140-2017814301, ARCO-TN70-2017807304, ARTN120, ARTN70, BT140, BT70G, KB100-20180720, KB120-20180710, KB200-20181420, KB240-20181410, KBT120-20081410, KBT120-BASE-2008140218, KBT120-BASE-20081402BT, KBT120-BASE-20081402XU, KBT120-BASE-2008140431, KBT120-P0120081410, KBT122-20081402XU, KBT122-20081420, KBT124-2008140431, KBT124-20081430, KBT124-P0120081430, KBT140-200214011M, KBT140-20021410, KBT140-BASE-200214011K, KBT140-BASE-200214011L, KBT140-BASE-200214011N, KBT142-20021420, KBT144-20021430, KBT60-2008070124, KBT60-20080710, KBT60-BASE-2008070124, KBT60-BASE-2008070126, KBT60-BASE-20080705H5, KBT62-20080705H5, KBT62-20080720, KBT62-20080705H5, KBT70-20020700YN, KBT70-200207061E, KBT70-20020710, KBT70-BASE-20020700YL...(Other models you can see in the webshop) | | |

1

| | | | |
|--------------------|--|-----------------|----------------------------|
| GEV No. | 601387 | Ref. No. | 1495254028 BN1495254028 |
| description | fan wheel sucking ø 254mm fan wheel mounting 25.4mm blade angle 34° W 50mm aluminium | | |
| For models: | BT70G, KBF050-20350503, KBF050-203505030CBO, KBF050GB-20350103, KBF050GS-20350203, KBF050GS-20350203F, KBT120-2008140218, KBT120-BASE-2008140218, KBT120-BASE-20081402BT, KBT120-BASE-20081402XU, KBT120-BASE-2008140431, KBT122-20081402XU, KBT122-20081402XU, KBT124-2008140431, KBT140-200214011K, KBT142-200214011L, KBT144-200214011M, KBT60-BASE-2008070126, KBT70, KBT70-20020700YN, KBT70-200207061E, KBT70-20020710, KBT70-BASE-20020700YL, KBT70G-200220, KBT70G-BASE-20022001TZ, KBT72-200207061E, KBT72-20020720, KBT72-210207, KBT72-BASE-200207061E, KBTG140-20021470, KBTG70-20020770, KBTV120, KBTV120-20081402BT, KBTV140-200214011N, KBTV60-2008070126, KBTV70-200207, KBTV70-20020730, KBTV70-BASE-20020700YN, KC6060-20091430, KC70-70-20051410, KC7070-20051410, KPBT105-35-20061420, KPBT10535-20061420, KPBT70-70-20061410, KPBT7070-20061410, KSABT70G-204537, KSABT70G-2045370CC4, KTARBTO3, KTARBTO3-BASE-2025180104FW, KTARBTO4...(Other models you can see in the webshop) | | |

cooling motors (various)

accessories for cooling fan

1

| | | | |
|--------------------|---|-----------------|----------------------------|
| GEV No. | 601814 | Ref. No. | 1433116050 BN1433116050 |
| description | guard ø 250mm H 23mm mounting distance 234mm | | |
| For models: | S120BT-2088420100, S120TN-2088400100, S120TNN-2088410100, S60BT-2088120100, S60TN-2088100100, S60TNN-2088110100 | | |



cold air circulating fans (complete)

ebm-papst

A2E series

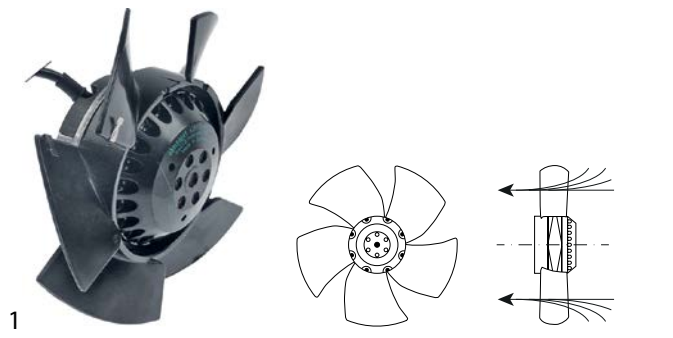

| | | | |
|---|--|-----------------|----------------------------|
| GEV No. | 601963 | Ref. No. | 1648112000 BN1648112000 |
| description | fan A2E170AF23-01 fan wheel ø 170mm blades 6 230V 50Hz 50/46W 2500rpm cable length 400mm ebm-papst sucking suitable capacitor 1.5µF | | |
| For models: | KBC5, KBC5-BASE-20350502PK, KBCF5, KBCF5-BASE-20360502PN | | |
| spare parts for | 601963 | | |
|  | GEV No. | 365171 | Ref. No. — |
| | capacitor capacity 1.5µF 400V tolerance 5% 50/60Hz ambient temperature max. -40 up to +85°C ø 25mm L 50mm M8 plastic connection cable 250mm MLR25PRL | | |

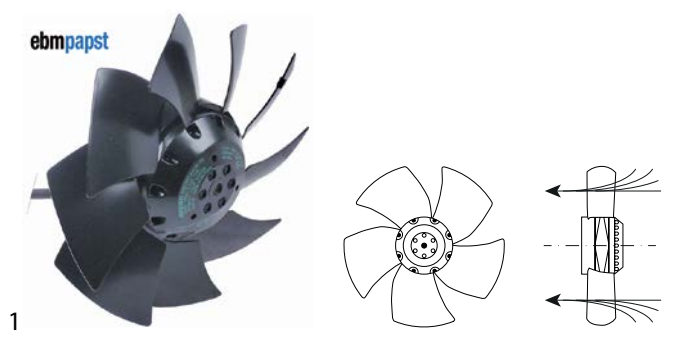

| | | | |
|---|--|-----------------|----------------------------|
| GEV No. | 601535 | Ref. No. | 1648112005 BN1648112005 |
| description | fan A2E200-AH38-01 fan wheel ø 200mm blades 9 230V 60Hz 78W 2600rpm cable length 450mm ebm-papst sucking suitable capacitor 1.5µF | | |
| For models: | KBC10, KBC10-BASE-20351002PM, KBC6, KBC6-BASE-20350602PL, KBCF10, KBCF10-BASE-20361002PV, KBCF6, KBCF6-BASE-20360602PT | | |
| spare parts for | 601535 | | |
|  | GEV No. | 365008 | Ref. No. — |
| | operating capacitor capacity 1.5µF 400V tolerance 5% 50/60Hz ambient temperature max. -25 to +85°C ø 25mm L 75mm M8 aluminium connection cable 300mm MKP protection IP65 | | |

S6E series

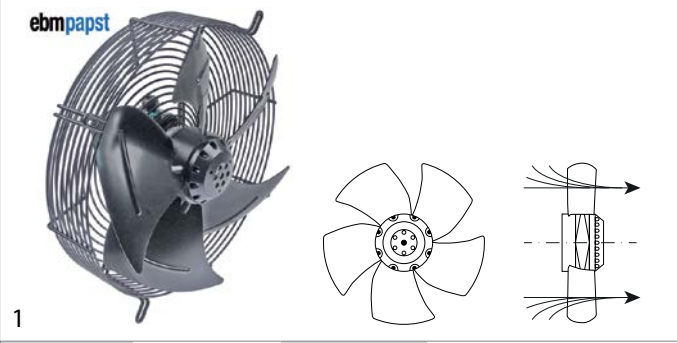

| | | | |
|--------------------|--|-----------------|----------------------------|
| GEV No. | 601624 | Ref. No. | 1648112008 BN1648112008 |
| description | fan S6E330-AP02-34 fan wheel ø 330mm blades 5 230V 50Hz 65W 940rpm cable length 420mm ebm-papst blowing suitable capacitor 2µF | | |
| For models: | KBC10, KBC10-BASE-20351002PM, KBC6, KBC6-BASE-20350602PL, KBCF10, KBCF10-BASE-20361002PV, KBCF6, KBCF6-BASE-20360602PT | | |

HIDRIA

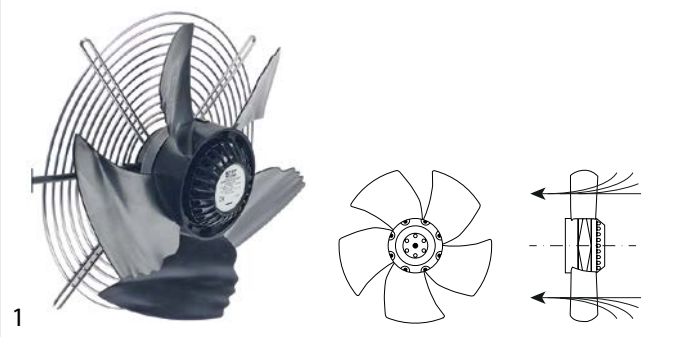

| | | | |
|--------------------|--|-----------------|-----------|
| GEV No. | 602029 | Ref. No. | FR6678370 |
| description | fan type R09R-30SPB-4M-3509 fan wheel ø 300mm 230V 50/60Hz 80W ø 105mm suitable capacitor 2.5µF HIDRIA suitable for blast chiller 1370rpm H 90mm cable length 1800mm mounting distance 255mm | | |

miscellaneous



| | | | |
|---|--|-----------------|---------------------------------|
| GEV No. | 601858 | Ref. No. | 996074 FR6671580 FR996074 |
| description | fan 52W REH190X62-1CN fan wheel ø 190mm blades 16 230V 50/60Hz input current 0.39/0.49A H 70mm 2600/2900rpm connection 4-wire cable length 450mm rotation direction right XFAN with capacitor suitable capacitor 2.5µF | | |
| For models: | 030, KBF030-20362030, PBF030-AFG-20362231 | | |
| spare parts for | 601858 | | |
|  | GEV No. | 365170 | Ref. No. — |
| | capacitor capacity 2µF 425V tolerance 5% 50/60Hz ambient temperature max. -25 to +85°C ø 25mm L 49mm M8 plastic connection cable 250mm 416.17.74 protection | | |



cross flow fans

ebm-papst



1

| | | | |
|--------------------|--|-----------------|----------------------------|
| GEV No. | 601000 | Ref. No. | 1648106045 BN1648106045 |
| description | cross flow fan ebm-papst QLK45/0006-2513 roller ø 45mm roller length 60mm laminated core thickness 13mm motor position left 230V/50Hz 15W refrigeration bearing rubber connection male faston 6.3mm airflow 36m ³ /h 0 up to +60°C | | |
| For models: | KTAP00, KTAP00-BASE-20220501062N, KTAP01, KTAP01-205202, KTAP01-205204, KTAP01-BASE-20220901044U, KTAP02, KTAP02-600-20221205CN, KTAP02-BASE-20221301048K, KTAP03, KTAP03-BASE-2022180109UA, KTAP04, KTAP04-BASE-2022230109RY, KTAP84EN-20228403, KTAR01, KTAR02, KTAR03, KTAR03-BA-SE-2020180105, KTAR04, KTAR602, KTAR612, KTAR614, KTARS24, KTARS35 | | |

EMMEVI - FERGAS

with moulded coils



1

| | | | |
|--------------------|---|-----------------|----------------------------|
| GEV No. | 601110 | Ref. No. | 1648106018 BN1648106018 |
| description | cross flow fan TGO 60/1-180/20 roller ø 60mm roller length 180mm laminated core thickness 20mm motor position left 230V/50Hz 28W refrigeration bearing rubber connection male faston 6.3mm -30 up to +100°C 230V cable length 1800mm | | |
| For models: | KC105-35-20051440, KC10535-20051440, KC3535-20050720, KC6060-20091430, KC70-70-20051410, KC7070-20051410, KC9030-20091420, KCTN10535-20031440, KCTN2545-20030725, KCTN3030-20090710, KCTN3513-20030730, KCTN3535-20030735, KCTN45-12-20030745, KCTN60-60-20091410, KCTN6060-20091410, KCTN7070-20031410, KP140-20041405, KP60-20100710, KP70-20040710, KPBT105-35-20061420, KPBT25-45-20060710, KPBT3513-20060720, KPBT3535c-20060730, KPBT70-70-20061410, KPBT7070-20061410, KPC30-30-20100720, KPC90-30-20101410, KPC9030-20101410, KPTN10535-20041440, KPTN25-45-20040720, KPTN3513-20040725, KPTN3535-20040730, KPTN70-70-20041410, KPTN7070-20041410, KTAP02-600-20221205CN, KTAP03-600-20221705CM, KTAP82, KTAP82-202282020AWR, KTAP83, KTAP83-202283020AWS, KTAP84, KTAP84-202284020AWT, KTAR01, KTAR01-BASE-20201001, KTAR01N, KTAR01N-BASE-20201005043V, KTAR02, KTAR02-600-BA-SE-20201205CU, KTAR02N, KTAR02N-BASE-20201305043Y...(Other models you can see in the webshop) | | |

COPREL

with moulded coils



1

| | | | |
|--------------------|--|-----------------|----------------------|
| GEV No. | 601399 | Ref. No. | 6670250 FR6670250 |
| description | cross flow fan COPREL TFL roller ø 60mm roller length 270mm laminated core thickness 35mm motor position left 230V/50Hz 49W refrigeration bearing rubber connection cable 2700mm coil type impregnated -10 up to +60°C | | |
| For models: | P35-35TNN-2047440100, P35-35TNN-BT-2047460100, T35-35TNN-2046440100, T35-35TNN-BT-2046460100 | | |

electric accessories

terminals

connection terminals with screw/faston connections



1

| | | | |
|--------------------|--|-----------------|---------|
| GEV No. | 550349 | Ref. No. | A036204 |
| description | power terminal block 4-pole max. 40A max 400V connection ø6mm ² / F6.3 temp.-resist. 150°C cross section 6mm ² | | |



1

| | | | |
|--------------------|--|-----------------|---------|
| GEV No. | 550977 ¹ | Ref. No. | A036206 |
| description | power terminal block 6-pole max. 40A max 450V connection ø6mm ² / F6.3 temp.-resist. 150°C cross section 6mm ² with ground lug | | |

¹with ground lug







gas taps

PEL

21S series



1

| GEV No. | 101095 | Ref. No. | A011490 | |
|---|---|----------|----------|--------------------|
| description | gas tap PEL type 21S gas inlet M16x1.5 (tube ø 10mm) bypass nozzle ø 0.35mm gas outlet M16x1.5 (tube ø 10/8mm) thermocouple connection M8x1 pilot connection M10x1 shaft ø 8x6.5mm shaft L 22/15mm shaft flat lower | | | |
| spare parts for | 101095 | | | |
|  | GEV No. | 100408 | Ref. No. | — |
| | bypass nozzle type PEL20/21 bore ø 0.35mm thread M5x0.5 | | | |
|  | GEV No. | 101060 | Ref. No. | — |
| | magnet unit standard L 39mm D1 ø 15.4mm D2 ø 11mm suitable for PEL20-21/JUNKERS/EGA | | | |
|  | GEV No. | 101206 | Ref. No. | — |
| | gas tap front part shaft ø 8x6.5mm shaft L 22/15mm shaft flat upper/lower suitable for PEL21 | | | |
|  | GEV No. | 101230 | Ref. No. | — |
| | thermocouple nut T1: M8x1 T2: M18x1 aluminium | | | |
| accessories for | 101095 | | | |
|  | GEV No. | 100908 | Ref. No. | A016110 A017000 |
| | union screw thread M10x1 for pipe ø 4mm Qty 1 pcs | | | |
|  | GEV No. | 100909 | Ref. No. | — |
| | union screw thread M10x1 for pipe ø 6mm Qty 1 pcs | | | |
|  | GEV No. | 101246 | Ref. No. | A016120 |
| | olive for pipe ø 4mm Qty 1 pcs | | | |
|  | GEV No. | 101278 | Ref. No. | A011480 |
| | olive for pipe ø 10mm Qty 1 pcs | | | |
|  | GEV No. | 101286 | Ref. No. | — |
| | olive ID ø 6mm Qty 1 pcs | | | |
|  | GEV No. | 101300 | Ref. No. | A011485 |
| | union nut thread M16x1.5 tube ø 10mm | | | |
|  | GEV No. | 101450 | Ref. No. | — |
| | olive for pipe ø 8mm L 12.7mm Qty 1 pcs ED ø 10mm | | | |
|  | GEV No. | 101451 | Ref. No. | — |
| | union nut thread M16x1.5 tube ø 8mm | | | |
|  | GEV No. | 110081 | Ref. No. | — |
| | knob ø 70mm shaft ø 8x6.5mm shaft flat universal | | | |
|  | GEV No. | 112206 | Ref. No. | — |
| | knob dial plate silver gas tap PEL21/22/23 t.max.°C ED ø 63mm ID ø 45.5mm | | | |

gas thermostats

SIT

630 Eurosit series

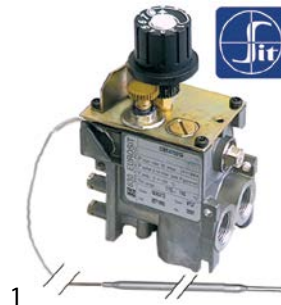

1

| GEV No. | 101188 | Ref. No. | 8219900 | |
|---|--|----------|----------|---------|
| description | gas thermostat type 630 Eurosit series t.max. 190°C 110-190°C gas inlet 3/8" gas outlet 3/8" thermocouple connection M9x1 pilot connection M10x1 probe ø 4mm probe L 202mm capillary pipe 1050mm SIT | | | |
| accessories for | 101188 | | | |
|  | GEV No. | 100904 | Ref. No. | A011608 |
| | locking screw M10x1 for pipe ø 4mm Qty 1 pcs | | | |
|  | GEV No. | 100905 | Ref. No. | — |
| | locking screw M10x1 for pipe ø 6mm Qty 1 pcs | | | |
|  | GEV No. | 101273 | Ref. No. | A011625 |
| | olive for pipe ø 12mm L 9.5mm brass Qty 1 pcs suitable for universal | | | |
|  | GEV No. | 101276 | Ref. No. | A011620 |
| | union screw thread 3/8" tube ø 12mm Qty 1 pcs | | | |
|  | GEV No. | 101333 | Ref. No. | — |
| | plug thread 3/8" with O-ring | | | |



1

















| GEV No. | 101125 | Ref. No. | 8219950 | |
|---|---|----------|----------|---------|
| description | gas thermostat type 630 Eurosit series t.max. 340°C 100-340°C gas inlet 3/8" gas outlet 3/8" thermocouple connection M9x1 pilot connection M10x1 probe ø 4mm probe L 72mm capillary pipe 1050mm SIT | | | |
| accessories for | 101125 | | | |
|  | GEV No. | 100825 | Ref. No. | — |
| | gas tap spindle shaft ø 8x6.5mm shaft L 22/14mm suitable for EUROSIT | | | |
|  | GEV No. | 100904 | Ref. No. | A011608 |
| | locking screw M10x1 for pipe ø 4mm Qty 1 pcs | | | |
|  | GEV No. | 100905 | Ref. No. | — |
| | locking screw M10x1 for pipe ø 6mm Qty 1 pcs | | | |

Table continues overleaf



| accessories for | | 101125 | | |
|---|---------|--------|----------|---------|
|  | GEV No. | 100949 | Ref. No. | — |
| gasket suitable for 630 Eurosit series | | | | |
|  | GEV No. | 101273 | Ref. No. | A011625 |
| olive for pipe ø 12mm L 9.5mm brass Qty 1 pcs suitable for universal | | | | |
|  | GEV No. | 101276 | Ref. No. | A011620 |
| union screw thread 3/8" tube ø 12mm Qty 1 pcs | | | | |
|  | GEV No. | 101333 | Ref. No. | — |
| plug thread 3/8" with O-ring | | | | |
|  | GEV No. | 101390 | Ref. No. | — |
| gas tap spindle shaft ø 6x4.6mm shaft L 32/15mm gas tap with ignition flame suitable for ZANUSSI, MARENO for gas thermostat EUROSIT | | | | |
|  | GEV No. | 101392 | Ref. No. | — |
| adapter suitable for 630 Eurosit series | | | | |
|  | GEV No. | 110357 | Ref. No. | — |
| gas tap spindle shaft ø 8x6.5mm shaft L 36/12mm suitable for 630 Eurosit series | | | | |
|  | GEV No. | 110358 | Ref. No. | — |
| adapter shaft ø 10x8mm shaft L 29/18mm suitable for 630 Eurosit series | | | | |

| accessories for | | 107701 | | |
|---|---------|--------|----------|---------|
|  | GEV No. | 100904 | Ref. No. | A011608 |
| locking screw M10x1 for pipe ø 4mm Qty 1 pcs | | | | |
|  | GEV No. | 100905 | Ref. No. | — |
| locking screw M10x1 for pipe ø 6mm Qty 1 pcs | | | | |
|  | GEV No. | 102110 | Ref. No. | — |
| pilot tube copper pipe ø 4mm thickness 1mm L 3000mm | | | | |
|  | GEV No. | 102111 | Ref. No. | — |
| pilot tube copper pipe ø 6mm thickness 1mm L 3000mm | | | | |
|  | GEV No. | 102742 | Ref. No. | — |
| pilot burner nozzle LPG code 25 bore ø 0.25mm Qty 1 pcs | | | | |

ignition parts

pilot burners

SIT

100 series

accessories

pilot burner bottom parts

| | | | | |
|---|---------|----------|----------|---|
|  | 1 | | | |
| GEV No. | 107701 | Ref. No. | 2510359 | |
| description pilot burner bottom part SIT 100 series nozzle ø 0.2mm | | | | |
| spare parts for | | 107701 | | |
|  | GEV No. | 100245 | Ref. No. | — |
| pilot burner nozzle LPG code 20 bore ø 0.2mm Qty 1 pcs thread M8x0.75 | | | | |
|  | GEV No. | 100916 | Ref. No. | — |
| compression spring for pilot burner Qty 1 pcs | | | | |
|  | GEV No. | 100917 | Ref. No. | — |
| gasket for pilot burner Qty 1 pcs aluminium | | | | |
|  | GEV No. | 100918 | Ref. No. | — |
| screw for pilot burner | | | | |
| accessories for | | 107701 | | |
|  | GEV No. | 100246 | Ref. No. | — |
| pilot burner nozzle natural gas bore ø 0.35mm Qty 1 pcs thread M8x0.75 | | | | |

ignition electrodes



| | | | |
|--|--------|----------|---------|
| GEV No. | 100707 | Ref. No. | A013302 |
| description ignition electrode D1 ø 7mm D2 ø 9mm connection ø 2.4mm L1 14mm L2 6mm BL1 18mm BL2 3mm BL3 23mm to clip Qty 1 pcs | | | |

POLIDORO

pilot burners





| | | | | |
|--|---------|----------|----------|---|
|  | 1 | | | |
| GEV No. | 100076 | Ref. No. | A013220 | |
| description pilot burner POLIDORO 3 flames natural gas code 29.2 gas connection 6mm | | | | |
| spare parts for | | 100076 | | |
|  | GEV No. | 100907 | Ref. No. | — |
| screw connection thread M10x1 Qty 1 pcs type SEF 1 ømm for thermocouple | | | | |
| accessories for | | 100076 | | |
|  | GEV No. | 100000 | Ref. No. | — |
| pilot burner nozzle POLIDORO LPG code 22 bore ø 0.22mm Qty 1 pcs | | | | |
|  | GEV No. | 100208 | Ref. No. | — |
| pilot burner nozzle POLIDORO LPG code 20 bore ø 0.2mm Qty 1 pcs | | | | |
|  | GEV No. | 100209 | Ref. No. | — |
| pilot burner nozzle POLIDORO natural gas code 40 bore ø 0.4mm Qty 1 pcs | | | | |

Table continues overleaf

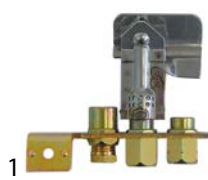

| accessories for | | 100076 | | |
|-----------------|--|--------|----------|--------------------|
| | GEV No. | 100701 | Ref. No. | — |
| | ignition electrode connection M4 Qty 1 pcs | | | |
| | GEV No. | 100906 | Ref. No. | — |
| | screw connection thread M10x1 for ignition electrode brass Qty 1 pcs WS 10 | | | |
| | GEV No. | 100907 | Ref. No. | — |
| | screw connection thread M10x1 Qty 1 pcs type SEF 1 0mm for thermocouple | | | |
| | GEV No. | 100908 | Ref. No. | A016110 A017000 |
| | union screw thread M10x1 for pipe 4mm Qty 1 pcs | | | |
| | GEV No. | 100909 | Ref. No. | — |
| | union screw thread M10x1 for pipe 6mm Qty 1 pcs | | | |
| | GEV No. | 102110 | Ref. No. | — |
| | pilot tube copper pipe 4mm thickness 1mm L 3000mm | | | |
| | GEV No. | 102111 | Ref. No. | — |
| | pilot tube copper pipe 6mm thickness 1mm L 3000mm | | | |
| | GEV No. | 102508 | Ref. No. | — |
| | union screw thread M10x1 for pipe 4mm Qty 5 pcs | | | |
| | GEV No. | 102509 | Ref. No. | — |
| | union screw thread M10x1 for pipe 6mm Qty 5 pcs | | | |
| | GEV No. | 102699 | Ref. No. | — |
| | pilot burner nozzle POLIDORO natural gas code 25.2 bore 2x0.25mm Qty 1 pcs 2 bores | | | |
| | GEV No. | 102795 | Ref. No. | — |
| | olive for pipe 4mm Qty 1 pcs | | | |
| | GEV No. | 102797 | Ref. No. | — |
| | olive for pipe 6mm Qty 1 pcs | | | |
| | GEV No. | 106703 | Ref. No. | A013230 |
| | pilot burner nozzle POLIDORO natural gas code 27.2 bore 2x0.27mm Qty 1 pcs | | | |
| | GEV No. | 106704 | Ref. No. | A013240 |
| | pilot burner nozzle POLIDORO LPG code 16.2 bore 2x0.16mm Qty 1 pcs | | | |
| | GEV No. | 106763 | Ref. No. | — |
| | pilot burner nozzle POLIDORO natural gas code 27.2A bore 2x0.27mm Qty 1 pcs | | | |
| | GEV No. | 106859 | Ref. No. | — |
| | pilot burner nozzle POLIDORO LPG code 24 bore 0.24mm Qty 1 pcs | | | |

electrodes

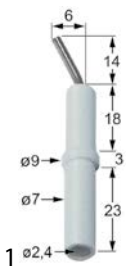

| GEV No. | 100707 | Ref. No. | A013302 |
|-------------|--|----------|---------|
| description | ignition electrode D1 7mm D2 9mm connection 2.4mm L1 14mm L2 6mm BL1 18mm BL2 3mm BL3 23mm to clip Qty 1 pcs | | |

ignition cables

pre-assembled cables



| GEV No. | 102181 | Ref. No. | A041410 |
|-------------|---|----------|---------|
| description | ignition cable cable length 1500mm connection 2.4mm / 2.4mm | | |



| GEV No. | 100016 | Ref. No. | 2510698 |
|-------------|--|----------|---------|
| description | ignition cable cable length 900mm connection 2.4mm / 2.4mm | | |

piezoelectric igniters

mounting diameter 18mm



| GEV No. | 100009 | Ref. No. | A041105 | |
|-----------------|---|----------|----------|---|
| description | piezoelectric igniter body plastic blowing mounting 18mm connection 2.4mm front measurements 26mm M18x1.5 | | | |
| accessories for | 100009 | | | |
| | GEV No. | 101339 | Ref. No. | — |
| | cover cap for piezoelectric igniter | | | |
| | GEV No. | 106869 | Ref. No. | — |
| | cover cap for piezoelectric igniter ID 22mm ED 35mm H 25mm | | | |
| | GEV No. | 107931 | Ref. No. | — |
| | cover cap for piezoelectric igniter ID 21mm ED 36mm | | | |



thermocouples

plug-in thermocouples

plug-in thermocouples standard

with barrel socket $\varnothing 6(6.5)$ mm

thermocouples SIT

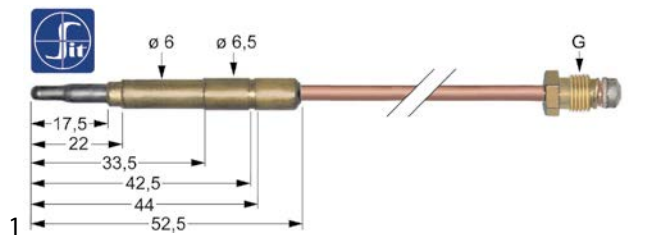

| | | | |
|--------------------|---|-----------------|---------|
| GEV No. | 107608 | Ref. No. | A011912 |
| description | thermocouple SIT M9x1 L 500mm plug connection $\varnothing 6.0(6.5)$ mm | | |

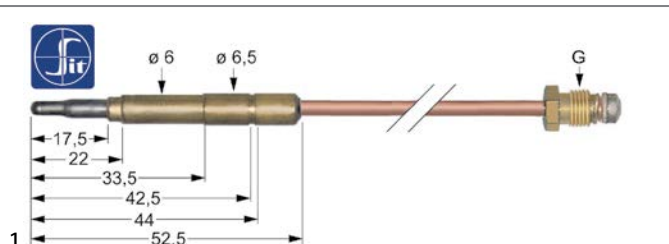

| | | | |
|--------------------|---|-----------------|---------|
| GEV No. | 107609 | Ref. No. | A011909 |
| description | thermocouple SIT M9x1 L 600mm plug connection $\varnothing 6.0(6.5)$ mm | | |

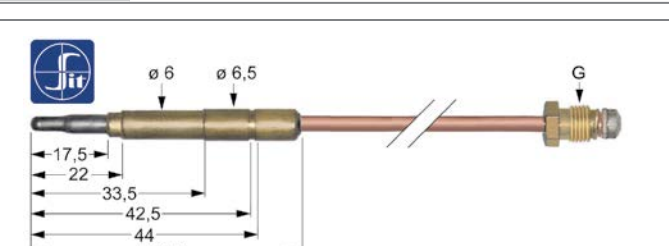

| | | | |
|--------------------|---|-----------------|---------|
| GEV No. | 107611 | Ref. No. | A011904 |
| description | thermocouple SIT M9x1 L 850mm plug connection $\varnothing 6.0(6.5)$ mm | | |

thermocouples with aluminised tip

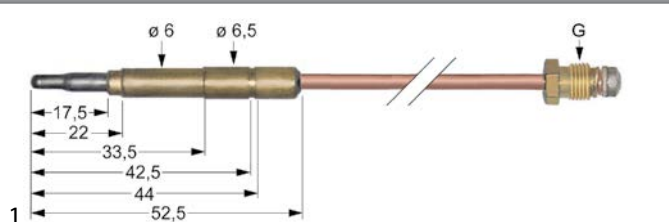

| | | | |
|--------------------|--|-----------------|---------|
| GEV No. | 102045 | Ref. No. | A011800 |
| description | thermocouple M9x1 L 1500mm plug connection $\varnothing 6.0(6.5)$ mm | | |

gas burners

bar burners

bar burners



| | | | |
|--------------------|---|-----------------|---------|
| GEV No. | 103154 | Ref. No. | 2519430 |
| description | bar burner $\varnothing 40$ mm Wmm Hmm L 420mm flange width 43mm flange length 43mm fryer | | |



| | | | |
|--------------------|---|-----------------|---------|
| GEV No. | 105436 | Ref. No. | 2510697 |
| description | bar burner $\varnothing 50$ mm Wmm Hmm L 608mm flange width 71mm gas range flange $\varnothing 75$ mm | | |

accessories



nozzle holders



| | | | |
|------------------------|-------------------------------------|-----------------|---------|
| GEV No. | 105290 | Ref. No. | A014708 |
| description | nozzle holder nozzle mounting M11x1 | | |
| accessories for | 105290 | | |

| | | | | |
|--|--------------------|--|-----------------|---------|
| | GEV No. | 105280 | Ref. No. | 2510351 |
| | description | burner head C for burner cap $\varnothing 80$ mm 3.5kW | | |
| | GEV No. | 105281 | Ref. No. | 2510352 |
| | description | burner cap C $\varnothing 80$ mm 3.5kW with central hole ID $\varnothing 32$ mm | | |
| | GEV No. | 105283 | Ref. No. | 2510354 |
| | description | burner head D for burner cap $\varnothing 105$ mm 5.6kW | | |
| | GEV No. | 105284 | Ref. No. | 2510355 |
| | description | burner cap ID $\varnothing 54$ mm D $\varnothing 105$ mm 5.6kW with central hole | | |
| | GEV No. | 105285 | Ref. No. | 2510353 |
| | description | venturi D for burner cap $\varnothing 105$ mm 5.6kW | | |
| | GEV No. | 105286 | Ref. No. | — |
| | description | burner head E for burner cap $\varnothing 125$ mm 7kW | | |
| | GEV No. | 105287 | Ref. No. | — |
| | description | burner cap E $\varnothing 125$ mm 7kW with central hole | | |

Table continues overleaf

| | | | |
|---|--|--------|------------------|
| accessories for | 105290 | | |
|  | GEV No. | 105288 | Ref. No. — |
| | venturi E for burner cap ø 125mm 7kW | | |
|  | GEV No. | 105289 | Ref. No. 2519002 |
| | air mixing sleeve L 50mm ED ø 45mm ID ø 42mm aluminium | | |

gas nozzles

main nozzles

gas nozzles M11x1

| | | | |
|---|---|-----------------|---------|
|  | 1 | | |
| GEV No. | 106642 | Ref. No. | 2510368 |
| description | gas injector thread M11x1 WS 13 bore ø 1.05mm | | |

| | | | |
|---|---|-----------------|---------|
|  | 1 | | |
| GEV No. | 100682 | Ref. No. | 2510370 |
| description | gas injector thread M11x1 WS 13 bore ø 1.15mm | | |

| | | | |
|---|--|-----------------|---------|
|  | 1 | | |
| GEV No. | 100686 | Ref. No. | 2510367 |
| description | gas injector thread M11x1 WS 13 bore ø 1.7mm | | |

| | | | |
|---|---|-----------------|---------|
|  | 1 | | |
| GEV No. | 100689 | Ref. No. | 2510369 |
| description | gas injector thread M11x1 WS 13 bore ø 1.85mm | | |

pilot burner nozzles

pilot burner nozzles POLIDORO

| | | | |
|---|--|-----------------|---------|
|  | 1 | | |
| GEV No. | 106704 | Ref. No. | A013240 |
| description | pilot burner nozzle POLIDORO LPG code 16.2 bore ø 2x0.16mm Qty 1 pcs | | |

| | | | |
|---|--|-----------------|---------|
|  | 1 | | |
| GEV No. | 106703 | Ref. No. | A013230 |
| description | pilot burner nozzle POLIDORO natural gas code 27.2 bore ø 2x0.27mm Qty 1 pcs | | |

pilot burner nozzles SIT



100 series





| | | | |
|---|---|-----------------|---------|
|  | 1 | | |
| GEV No. | 107170 | Ref. No. | A013103 |
| description | pilot burner nozzle SIT natural gas bore ø 0.35mm Qty 1 pcs | | |

auxiliary gas parts

screw connections



olives

| | | | |
|---|--|-----------------|------------------|
|  | 1 | | |
| GEV No. | 101249 | Ref. No. | A011470 |
| description | olive for pipe ø 10mm Qty 1 pcs | | |
| accessories for | 101249 | | |
|  | GEV No. | 101250 | Ref. No. A011475 |
| | union nut thread M20x1.5 for pipe ø 10mm | | |



| | | | |
|--|---------------------------------------|-----------------|------------------|
|  | 1 | | |
| GEV No. | 101278 | Ref. No. | A011480 |
| description | olive for pipe ø 10mm Qty 1 pcs | | |
| accessories for | 101278 | | |
|  | GEV No. | 100943 | Ref. No. — |
| | union nut thread M17x1 tube ø 10mm | | |
|  | GEV No. | 101300 | Ref. No. A011485 |
| | union nut thread M16x1.5 tube ø 10mm | | |
|  | GEV No. | 101478 | Ref. No. — |
| | union nut thread 3/8" for pipe ø 10mm | | |







| | | | |
|---|--|-----------------|---------|
|  | | | |
| 1 | | | |
| GEV No. | 106638 | Ref. No. | A016300 |
| description | olive for pipe ø 12mm L 10mm Qty 1 pcs | | |



| | | | |
|---|--|-----------------|-------------------------|
|  | | | |
| 1 | | | |
| GEV No. | 101273 | Ref. No. | A011625 |
| description | olive for pipe ø 12mm L 9.5mm brass Qty 1 pcs suitable for universal | | |
| accessories for | 101273 | | |
|  | GEV No. | 100944 | Ref. No. — |
| union nut thread M18x1.5 for pipe ø 12mm | | | |
|  | GEV No. | 101276 | Ref. No. A011620 |
| union screw thread 3/8" tube ø 12mm Qty 1 pcs | | | |

| | | | |
|---|--------------------------------------|-----------------|---------|
|  | | | |
| 1 | | | |
| GEV No. | 106637 | Ref. No. | A016900 |
| description | olive for pipe ø 4mm L 7mm Qty 1 pcs | | |

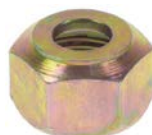
| | | | |
|---|--------------------------------|-----------------|------------------------------------|
|  | | | |
| 1 | | | |
| GEV No. | 101246 | Ref. No. | A016120 |
| description | olive for pipe ø 4mm Qty 1 pcs | | |
| accessories for | 101246 | | |
|  | GEV No. | 100908 | Ref. No. A016110 A017000 |
| union screw thread M10x1 for pipe ø 4mm Qty 1 pcs | | | |

| union nuts | | | |
|---|--------------------------------------|-----------------|-------------------------|
|  | | | |
| 1 | | | |
| GEV No. | 101300 | Ref. No. | A011485 |
| description | union nut thread M16x1.5 tube ø 10mm | | |
| accessories for | 101300 | | |
|  | GEV No. | 101278 | Ref. No. A011480 |
| olive for pipe ø 10mm Qty 1 pcs | | | |

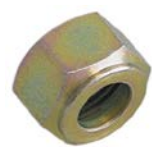
| | | | |
|---|--|-----------------|-------------------------|
|  | | | |
| 1 | | | |
| GEV No. | 101250 | Ref. No. | A011475 |
| description | union nut thread M20x1.5 for pipe ø 10mm | | |
| accessories for | 101250 | | |
|  | GEV No. | 101249 | Ref. No. A011470 |
| olive for pipe ø 10mm Qty 1 pcs | | | |

| | | | |
|---|--|-----------------|-------------------|
|  | | | |
| 1 | | | |
| GEV No. | 101251 | Ref. No. | A016200 |
| description | union nut thread M20x1.5 for pipe ø 12mm | | |
| accessories for | 101251 | | |
|  | GEV No. | 101248 | Ref. No. — |
| olive for pipe ø 12mm Qty 1 pcs suitable for PEL | | | |

| union screws | | | |
|--|--|-----------------|---------|
|  | | | |
| 1 | | | |
| GEV No. | 100904 | Ref. No. | A011608 |
| description | locking screw M10x1 for pipe ø 4mm Qty 1 pcs | | |

| | | | |
|---|---|-----------------|-------------------------|
|  | | | |
| 1 | | | |
| GEV No. | 100908 | Ref. No. | A016110 A017000 |
| description | union screw thread M10x1 for pipe ø 4mm Qty 1 pcs | | |
| accessories for | 100908 | | |
|  | GEV No. | 100897 | Ref. No. — |
| olive for pipe ø 4mm Qty 1 pcs for pilot burner | | | |
|  | GEV No. | 101246 | Ref. No. A016120 |
| olive for pipe ø 4mm Qty 1 pcs | | | |
|  | GEV No. | 101280 | Ref. No. — |
| olive for pipe ø 4mm Qty 1 pcs | | | |
|  | GEV No. | 101282 | Ref. No. — |
| olive for pipe ø 4mm L 7.4mm Qty 1 pcs | | | |

equipment-specific units

for fridges

housing and bezels

miscellaneous



1

| | | | |
|--------------------|---|-----------------|------------------------|
| GEV No. | 691590 | Ref. No. | 33277017 BN33277017 |
| description | protective plate L 580mm H 125mm | | |
| For models: | ARCO-BT140-20172404, ARCO-BT140-20172405, ARCO-BT140-BA-SE-20172408, ARCO-BT140-PLUS-20172409, ARCO-BT70-20171704, ARCO-BT70430-20171705, ARCO-BT70-BASE-20171708, ARCO-BT70-PLUS-20171709, ARCO-TN140.-BASE-20171408, ARCO-TN140.-PLUS-20171409, ARCO-TN140-20171404, ARCO-TN140430-20171405, ARCO-TN70-20170704, ARCO-TN70430-20170705, ARCO-TN70-BASE-20170708, ARCO-TN70-PLUS-20170709, ARCO-TNN70-20170706, NFB0070F, NFB0070N, NFB0070P, NFB0072F, NFB0072N, NFB0072P, NFB0140F, NFB0140N, NFB0140P, NFB0144F, NFB0144N, NFB0144P, NORD-700BT-2017817305, NORD-700BT-2017817305P, NORD-700TNN-2017807305, NORD-700TNN-2017807305P | | |

for cold storage cells

pressure compensation valves



1

| | | | |
|---|---|-----------------|-------------------------------------|
| GEV No. | 750332 | Ref. No. | 14970302 BN14970302 FR4750450 |
| description | pressure compensation valve mounting ø 61mm MiniElebar T.N. unheated for walk-in fridge +1 up to +10°C built-in depth 60mm mounting pos. horizontal | | |
| For models: | ARBT70, KBT120-20081410, KBT120-2008140218, KBT120-BA-SE-2008140218, KBT120-BASE-20081402BT, KBT120-BASE-20081402XU, KBT120-BASE-2008140431, KBT120-P0120081410, KBT122-20081402XU, KBT122-20081420, KBT122-20081402XU, KBT124-2008140431, KBT124-20081430, KBT124-P0120081430, KBT140-200214011K, KBT140-200214011M, KBT140-20021410, KBT140-BASE-200214011K, KBT140-BASE-200214011L, KBT140-BA-SE-200214011N, KBT142-200214011L, KBT142-20021420, KBT144-200214011M, KBT144-20021430, KBT60-2008070124, KBT60-20080710, KBT60-BASE-2008070124, KBT60-BASE-2008070126, KBT60-BASE-20080705H5, KBT62-20080705H5, KBT62-20080720, KBT62-20080705H5, KBT70, KBT70-20020700YN, KBT70-200207061E, KBT70-20020710, KBT70-BASE-20020700YL, KBT70G-200220, KBT70G-BASE-20022001TZ, KBT72-200207061E, KBT72-20020720, KBT72-210207, KBT72-BASE-200207061E, KBTG140-20021470, KBTG70-20020770, KBTV120, KBTV120-20081402BT, KBTV120-20081440, KBTV140-200214011N, KBTV140-20021440...(Other models you can see in the webshop) | | |
| spare parts for | 750332 | | |
|  | GEV No. | 750335 | Ref. No. — |
| | ventilation grille suitable for MiniElebar ø 86mm mounting distance 69.5mm H 14.5mm | | |

knobs

accessories

gaskets



1

| | | | |
|--------------------|--|-----------------|---------|
| GEV No. | 112529 | Ref. No. | 2519490 |
| description | gasket for knob rubber D1 ø 36mm D2 ø 46mm thickness 9mm | | |

handles and hand wheels

cylindrical handles

fixed



1

| | | | |
|--------------------|--|-----------------|---------|
| GEV No. | 540235 | Ref. No. | A019302 |
| description | cylindrical handle thread M6 ø 17mm L 40mm | | |

bracket handles



1

| | | | |
|--------------------|--|-----------------|---------|
| GEV No. | 691327 | Ref. No. | 8222510 |
| description | pull handle L 119mm H 37mm mounting distance 105mm handle M6 | | |

hinges

spring assisted hinges

universal

CAFF/FERMOD

group 2

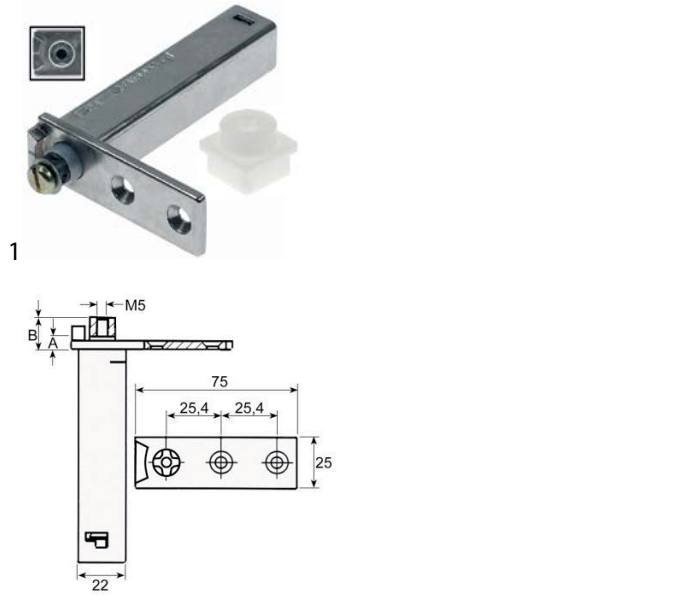

| | | | |
|--------------------|--|-----------------|----------------------|
| GEV No. | 690494 | Ref. No. | 1412001 BN1412001 |
| description | spring assisted hinge series 175 mounting pos. left/right torx L 75mm W 25.6mm H 100mm A 4mm B 11mm mounting measurements 22x22mm intake torx refrigeration units mounting distance 25mm | | |
| For models: | ARBT144, ARBT70, ARBT72, ARTN120, ARTN140, ARTN210, ARTN60, ARTN70, ARTN72, KBC10, KBC10-BASE-20351002PM, KBC5, KBC5-BASE-20350502PK, KBC6, KBC6-BASE-20350602PL, KBCF10, KBCF10-BASE-20361002PV, KBCF5, KBCF5-BASE-20360502PN, KBCF6, KBCF6-BASE-20360602PT, KBT120-20081410, KBT120-2008140218, KBT120-BASE-2008140218, KBT120-BASE-20081402XU, KBT120-BASE-2008140431, KBT120-P0120081410, KBT122-20081402XU, KBT122-20081420, KBT122-20081402XU, KBT124-2008140431, KBT124-20081430, KBT124-P0120081430, KBT140-200214011K, KBT140-200214011M, KBT140-20021410, KBT140-BASE-200214011K, KBT140-BASE-200214011L, KBT142-200214011L, KBT142-20021420, KBT144-200214011M, KBT144-20021430, KBT40-21091640, KBT40-210916400BAJ, KBT60-2008070124, KBT60-20080710, KBT60-BASE-2008070124, KBT60-BASE-20080705H5, KBT62-20080705H5, KBT62-20080720...(Other models you can see in the webshop) | | |

INTERKLIMAT

hinges

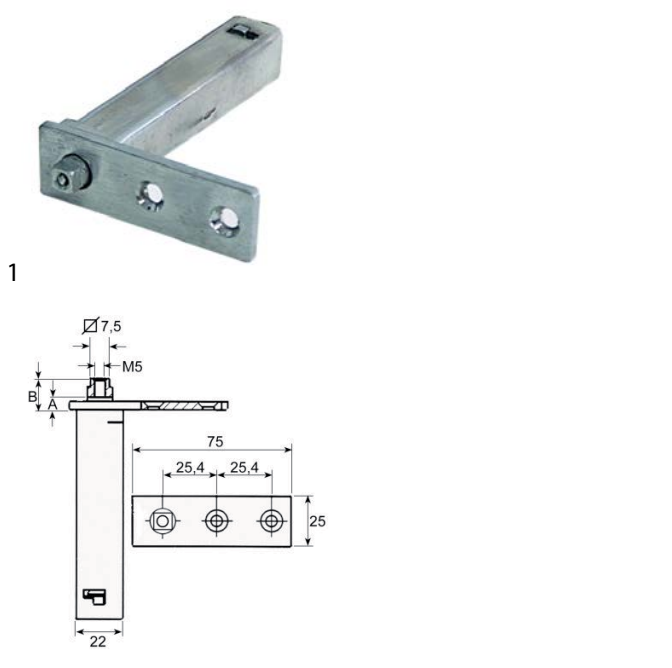

| | | | |
|--------------------|--|-----------------|--|
| GEV No. | 690714 | Ref. No. | 1412050 2476700 BN1412050 MA2476700 |
| description | spring assisted hinge series 28XC mounting pos. left/right L 75mm W 25mm H 103mm A 8mm B 11mm intake 7.5x7.5 refrigeration units mounting distance 25mm | | |
| For models: | KBF050-20350503, KBF050-20350503CBO, KBF050GB-20350103, KBF050GS-20350203, KBF050GS-20350203F, SABT140-BASE-2017240108EL, SABT140-DOUBLE-DOOR-20197400KG, SABT144-BASE-201974402C2, SABT70-2017170208EB, SABT70-BASE-2017170108EB, SABT70-SINGLE-DOOR-20196700HC, SABT72-BASE-201967202BW, SABTV70-BASE-2017170108ER, SATN140-201714020998, SATN140-BASE-20196400KF, SATN144-BASE-20171402099A, SATN144-BASE-201964402BZ, SATN70-201707020994, SATN70-BASE-20195700F9, SATN72-BASE-201707020997, SATN72-BASE-201957202BM, SATNBT3535-BASE-20193603CV, SATNBT7070-BASE-201967803CU, SATNN140-2017140208DW, SATNN144-BASE-2017140208RY, SATNN70-2017070208EA, SATNN72-BASE-2017070208RX, SATNTN3535-BASE-20193503CP, SATNTN7070-BASE-201967703CT, SBE140-BASE-20178242, SBT140A, SBT140A-201974, SBT144A, SBT144A-201974, SBT700GN2-1TH.60-201781720BUB, SBT70A, SBT70A-201967, SBT70A-20196700HC, SBT70AT-201967T, SBT72A, SBT72A-201967, SBTV140A, SBTV70A, SC3535A-201936, SC7070A-2019678, SCTN3535A-201935, SCTN3535A-20193503CP, SCTN7070A-2019677, STN140, STN1400GN2-1TH.60-201781420BU9...(Other models you can see in the webshop) | | |

oven hinges

| | | | |
|--------------------|--|-----------------|---------|
| GEV No. | 700001 | Ref. No. | A035930 |
| description | opposite support L 118mm W 17mm mounting distance 94mm | | |

| | | | |
|------------------------|---|-----------------|---------|
| GEV No. | 700006 | Ref. No. | A035910 |
| description | oven hinge mounting distance 173mm mounting distance 2 105mm lug mounting 14mm lever length 120mm groove distance 11mm spring thickness 3.5mm mounting ear position left spring length 112mm W 25mm | | |
| accessories for | 700006 | | |

| | | | | |
|--|--|--------|-----------------|---------|
| | GEV No. | 700001 | Ref. No. | A035930 |
| | opposite support L 118mm W 17mm mounting distance 94mm | | | |
| | GEV No. | 700007 | Ref. No. | A035920 |
| | oven hinge mounting distance 173mm mounting distance 2 105mm lug mounting 14mm lever length 120mm groove distance 11mm spring thickness 3.5mm mounting ear position right spring length 112mm W 25mm | | | |

| | | | |
|------------------------|--|-----------------|---------|
| GEV No. | 700007 | Ref. No. | A035920 |
| description | oven hinge mounting distance 173mm mounting distance 2 105mm lug mounting 14mm lever length 120mm groove distance 11mm spring thickness 3.5mm mounting ear position right spring length 112mm W 25mm | | |
| accessories for | 700007 | | |

| | | | | |
|--|--|--------|-----------------|---------|
| | GEV No. | 700001 | Ref. No. | A035930 |
| | opposite support L 118mm W 17mm mounting distance 94mm | | | |

door bearing

| | | | |
|--------------------|---|-----------------|----------------------|
| GEV No. | 701437 | Ref. No. | 1412262 BN1412262 |
| description | door hinge L 45mm W 35mm mounting pos. upper bolt 14.5mm bolt ø 6mm refrigerator | | |
| For models: | KST01BT-205111, KST01BT-VCR-205711, KST01TN-205001, KST01TN-205011, KST01TN-VCR-205611, KST02BT-205112, KST02BT-VCR-205702, KST02BT-VCR-205712, KST02TN-205002, KST02TN-205012, KST02TNH760-205802, KST02TN-VCR-205602, KST02TN-VCR-205612, KST03BT-205113, KST03BT-VCR-205713, KST03TN-205003, KST03TN-205013, KST03TN-VCR-205603, KST03TN-VCR-205613, KST04BT-205114, KST04TN-205004, KST04TN-205014, KST04TN-VCR-205604, KST04TN-VCR-205614, KST-BT01, KST-BT04, KST-BT-VCR01, KST-BT-VCR02, KST-BT-VCR03, KSTP01BT-205311, KSTP01TN-205211, KSTP02BT-205312, KSTP02TN-205212, KSTP03-205203, KSTP03BT-205313, KSTP03TN-205213, KSTP04TN-205214, KSTP05TN-205205, KSTP05TN-205215, KSTS24-205424, KSTS24-2054240IDP, KSTS24-2054240JGN, KST-TN01, KST-TN02, KST-TN03, KST-TN04, KST-TN-VCR01, KST-TN-VCR02, KST-TN-VCR03, KST-TN-VCR04...(Other models you can see in the webshop) | | |

| | | | |
|--------------------|--|-----------------|------------------------|
| GEV No. | 701436 | Ref. No. | 14850012 BN14850012 |
| description | door hinge L 60mm W 30mm mounting pos. upper bolt 14mm bolt ø 15mm suitable for refrigerator | | |
| For models: | P105-35TNN-2047640100, P105-35TNN-BT-2047660100, P140BT-2047220101, P140TN-2047200101, P140TNN-2047210101, P144BT-2047360100, P144TNN-2047350100, P35-35TNN-2047440100, P35-35TNN-BT-2047460100, P70-70TNN-2047540100, P70-70TNN-BT-2047560100, P70BT-2047020101, P70TN-2041000101, P70TNN-2047010101, P72BT-2047120101, P72TNN-2047110101, S120BT-2088420100, S120TN-2088400100, S120TNN-2088410100, S140BT-2048220101, S140TN-2048200101, S60BT-2088120100, S60TN-2088100100, S60TNN-2088110100, S70BT-2048020101, S70TN-2048000101, S70TNN-2048010101, T105-35TNN-2046640100, T105-35TNN-BT-2046660100, T140BT-2046220100, T140ITT-2046230100, T140TNN-2046210100, T144BT-2046xxxxxx, T144TNN-2046350100, T35-35TNN-2046440100, T35-35TNN-BT-2046460100, T70-70TNN-2046540100, T70-70TNN-BT-2046560100, T70BT-2046020100, T70ITT-2046030100, T70TNN-2046010100, T72BT-2046120x00, T72TNN-2046110100 | | |



1

| | | | |
|--------------------|---|-----------------|------------------------|
| GEV No. | 699245 | Ref. No. | 32213056 BN32213056 |
| description | hinge L 58.5mm W 35mm H 109mm mounting pos. lower bolt 94mm bolt ø 8mm with accessories | | |
| For models: | KST01BT-205111, KST01BT-VCR-205711, KST01TN-205001, KST01TN-205011, KST01TN-VCR-205611, KST02BT-205112, KST02BT-VCR-205702, KST02BT-VCR-205712, KST02TN-205002, KST02TN-205012, KST02TNH760-205802, KST02TN-VCR-205602, KST02TN-VCR-205612, KST03BT-205113, KST03BT-VCR-205713, KST03TN-205003, KST03TN-205013, KST03TN-VCR-205603, KST03TN-VCR-205613, KST04BT-205114, KST04TN-205004, KST04TN-205014, KST04TN-VCR-205604, KST04TN-VCR-205614, KST-BT01, KST-BT04, KST-BT-VCR01, KST-BT-VCR02, KST-BT-VCR03, KSTP01BT-205311, KSTP01TN-205211, KSTP02BT-205312, KSTP02TN-205212, KSTP03-205203, KSTP03BT-205313, KSTP03TN-205213, KSTP04TN-205214, KSTP05TN-205205, KSTP05TN-205215, KSTS24-205424, KSTS24-2054240IDP, KSTS24-2054240JGN, KST-TN01, KST-TN02, KST-TN03, KST-TN04, KST-TN-VCR01, KST-TN-VCR02, KST-TN-VCR03, KST-TN-VCR04...(Other models you can see in the webshop) | | |



1

| | | | |
|--------------------|---|-----------------|------------------------|
| GEV No. | 692174 | Ref. No. | 14850003 BN14850003 |
| description | hinge mounting pos. upper left with bolt | | |
| For models: | ARCO-BT140-20172404, ARCO-BT140-20172405, ARCO-BT140-BASE-20172408, ARCO-BT140GN2-1-2017824301, ARCO-BT140-PLUS-20172409, ARCO-BT70-20171704, ARCO-BT70430-20171705, ARCO-BT70-BASE-20171708, ARCO-BT70-PLUS-20171709, ARCO-TN140.-BASE-20171408, ARCO-TN140.-PLUS-20171409, ARCO-TN140-20171404, ARCO-TN140-2017814301, ARCO-TN140430-20171405, ARCO-TN70-20170704, ARCO-TN70430-20170705, ARCO-TN7070-20177040GL70, ARCO-TN70-BASE-20170708, ARCO-TN70-PLUS-20170709, ARCO-TNN70-20170706, NFB0070F, NFB0070N, NFB0070P, NFB0072F, NFB0072N, NFB0072P, NFB0140F, NFB0140N, NFB0140P, NFB0144F, NFB0144N, NFB0144P, NORD-700BT-2017817305, NORD-700BT-2017817305P, NORD-700TNN-2017807305, NORD-700TNN-2017807305P | | |



2

| | | | |
|--------------------|---|-----------------|------------------------|
| GEV No. | 690538 | Ref. No. | 32140098 BN32140098 |
| description | hinge mounting pos. bottom left with bolt | | |
| For models: | ARCO-BT140-20172404, ARCO-BT140-20172405, ARCO-BT140-BASE-20172408, ARCO-BT140-PLUS-20172409, ARCO-TN140.-BASE-20171408, ARCO-TN140.-PLUS-20171409, ARCO-TN140-20171404, ARCO-TN140430-20171405, NFB0140F, NFB0140N, NFB0140P, NFB0144F, NFB0144N, NFB0144P | | |



1

| | | | |
|--------------------|--|-----------------|------------------------|
| GEV No. | 690539 | Ref. No. | 14850002 BN14850002 |
| description | hinge mounting pos. upper right with bolt | | |
| For models: | ARCO-BT140-20172404, ARCO-BT140-20172405, ARCO-BT140-BASE-20172408, ARCO-BT140GN2-1-2017824301, ARCO-BT140-PLUS-20172409, ARCO-BT70-20171704, ARCO-BT70430-20171705, ARCO-BT70-BASE-20171708, ARCO-BT70GN2-1-2017817304, ARCO-BT70-PLUS-20171709, ARCO-TN140.-BASE-20171408, ARCO-TN140.-PLUS-20171409, ARCO-TN140-20171404, ARCO-TN140-2017814301, ARCO-TN140430-20171405, ARCO-TN70-20170704, ARCO-TN70-2017807304, ARCO-TN70430-20170705, ARCO-TN7070-20177040GL70, ARCO-TN70-BASE-20170708, ARCO-TN70-PLUS-20170709, ARCO-TNN70-20170706, NFB0070F, NFB0070N, NFB0070P, NFB0072F, NFB0072N, NFB0072P, NFB0140F, NFB0140N, NFB0140P, NFB0144F, NFB0144N, NFB0144P, NORD-700BT-2017817305, NORD-700BT-2017817305P, NORD-700TNN-2017807305, NORD-700TNN-2017807305P | | |



1

| | | | |
|--------------------|--|-----------------|------------------------|
| GEV No. | 690537 | Ref. No. | 32140097 BN32140097 |
| description | hinge mounting pos. bottom right with bolt | | |
| For models: | ARCO-BT140-20172404, ARCO-BT140-20172405, ARCO-BT140-BASE-20172408, ARCO-BT140-PLUS-20172409, ARCO-BT70-20171704, ARCO-BT70430-20171705, ARCO-BT70-BASE-20171708, ARCO-BT70-PLUS-20171709, ARCO-TN140.-BASE-20171408, ARCO-TN140.-PLUS-20171409, ARCO-TN140-20171404, ARCO-TN140430-20171405, ARCO-TN70-20170704, ARCO-TN70430-20170705, ARCO-TN70-BASE-20170708, ARCO-TN70-PLUS-20170709, ARCO-TNN70-20170706, NFB0070N, NFB0070P, NFB0072F, NFB0072N, NFB0072P, NFB0140F, NFB0140N, NFB0140P, NFB0144F, NFB0144N, NFB0144P | | |



1

| | | | |
|--------------------|---|-----------------|------------------------|
| GEV No. | 692428 | Ref. No. | 14850010 BN14850010 |
| description | hinge mounting pos. upper right with bolt | | |



pullouts

drawer slides

universal

compeX

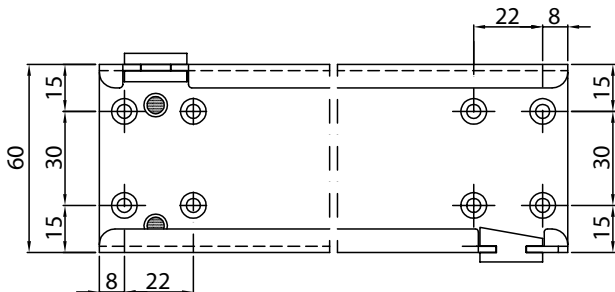

| | | | |
|------------------------|---|-----------------|-------------------|
| GEV No. | 690753 ¹ | Ref. No. | BN144906+1449081 |
| description | telescopic slide pair L 550mm pull-out length 610mm total length 1160mm Qty 1 pair capacity 50kg H 60mm SS telescopic | | |
| spare parts for | 690753 | | |
| | GEV No. | 690750 | Ref. No. — |
| | stop fortelescopic rail L 20mm plastic H 12mm D 9mm | | |
| | GEV No. | 696333 | Ref. No. — |
| | stop fortelescopic rail L 20mm plastic H 15mm D 8mm | | |

¹multiple slide (60mm more than nominal length)

equipment feet and end caps

equipment feet

with screw mounting

components



| | | | |
|--------------------|---|-----------------|---------|
| GEV No. | 700103 | Ref. No. | 1467001 |
| description | equipment foot tube ø 56mm plate sizemm hole distancemm H 130mm SS size 2" Qty 1 pcs | | |
| For models: | ARBT144, ARBT70, ARBT72, ARTN120, ARTN140, ARTN210, ARTN60, ARTN70, ARTN72, KBT120-P0120081410, KBT124-P0120081430, KC25-45-20050710, KC45-12-20050725, KPBT25-45-20060710, KPBT4512-20060740, KTN70-20010710, KTN72-20010720, KTNV140-2001440, KTNV70-20010730, M70BT, M70TN, TAR02S, TAR132, TAR82, TAR83 | | |

with fixing plate



| | | | |
|--------------------|--|-----------------|---------|
| GEV No. | 701204 | Ref. No. | 2519500 |
| description | equipment foot tube ø 52mm plate size 67x67mm hole distance 51x51mm H 120-190mm SS size 2" Qty 1 pcs | | |



| | | | |
|--------------------|--|-----------------|----------------------|
| GEV No. | 700220 | Ref. No. | 1467516 BN1467516 |
| description | equipment foot tube ø 64mm plate size 76/90mm hole distance 60x80mm H 115-170mm SS size 2 1/2" Qty 1 pcs | | |

For models:
 AFB-140-20172407G, AFB-70-20171707G, AFB-70Sx-20171707GX-PS, AFN-140E-20173407G, AFN-70-20170707G, AFN-70E-20173707G, AFN-70ESx-20173707GXPS, ARCO-BT140-20172404, ARCO-BT140-20172405, ARCO-BT140-BASE-20172408, ARCO-BT140GN2-1-2017824301, ARCO-BT140-PLUS-20172409, ARCO-BT70-20171704, ARCO-BT70430-20171705, ARCO-BT70-BASE-20171708, ARCO-BT70GN2-1-2017817304, ARCO-BT70-PLUS-20171709, ARCO-TN140-BASE-20171408, ARCO-TN140-PLUS-20171409, ARCO-TN140-20171404, ARCO-TN140-2017814301, ARCO-TN140430-20171405, ARCO-TN70-20170704, ARCO-TN70-2017807304, ARCO-TN70430-20170705, ARCO-TN7070-201777040GL70, ARCO-TN70-BASE-20170708, ARCO-TN70-PLUS-20170709, ARCO-TNN70-20170706, KSA105-35-2045150COR, KSA105-35-2045260CC0, KSA140BT-2045240BYF, KSA140BT-2045240C10, KSA140BT-2045240CAD, KSA140P-2045340COX, KSA140TN-2045140B8X, KSA140TN-2045140CAB, KSA140TN-2045140CAC, KSA35-35-2045350BYG, KSA70-70-2045770BYH, KSA70-70-2045770CJ5, KSA70-70PBT-2045800C0U, KSA70-70PBT-2045800CJ8, KSA70-70PTN-2045790C0T, KSA70-70PTN-2045790CJ7, KSA70BT-2045170BYL, KSA70BT-2045170C0Z, KSA70BT-2045170CAA, KSA70P-2045270C0W, KSA70TN-2045070B5E...(Other models you can see in the webshop)

components



| | | | |
|--------------------|---|-----------------|---------|
| GEV No. | 700103 | Ref. No. | 1467001 |
| description | equipment foot tube ø 56mm plate sizemm hole distancemm H 130mm SS size 2" Qty 1 pcs | | |
| For models: | ARBT144, ARBT70, ARBT72, ARTN120, ARTN140, ARTN210, ARTN60, ARTN70, ARTN72, KBT120-P0120081410, KBT124-P0120081430, KC25-45-20050710, KC45-12-20050725, KPBT25-45-20060710, KPBT4512-20060740, KTN70-20010710, KTN72-20010720, KTNV140-2001440, KTNV70-20010730, M70BT, M70TN, TAR02S, TAR132, TAR82, TAR83 | | |

DERBY RUOTE

with fixing plate

chrome-plated steel



| | | | |
|--------------------|---|-----------------|--------------------|
| GEV No. | 700851 | Ref. No. | 147802 BN147802 |
| description | swivel castor with brake ø 80mm with flange plate bearing slide bearing | | |
| For models: | KBC10, KBC10-BASE-20351002PM, KBC5, KBC6, KBC6-BASE-20350602PL, KBCF10, KBCF10-BASE-20361002PV, KBCF5, KBCF5-BASE-20360502PN, KBCF6, KBCF6-BASE-20360602PT, KTAP00, KTAP00-BASE-20220501062N, KTAP00BT-BASE-2022550105KR, KTAP01, KTAP01-205202, KTAP01-205204, KTAP01-BASE-20220901044U, KTAP01BT-BASE-2022590105KU, KTAP02, KTAP02-600-20221205CN, KTAP02-BASE-20221301048K, KTAP02BT-205301, KTAP02BT-205302, KTAP02BT-205303, KTAP02BT-BASE-2022630105KW, KTAP03, KTAP03-BASE-2022180109UA, KTAP03BT-BASE-2022680109UW, KTAP04, KTAP04-BASE-2022230109RY, KTAP84EN-20228403, KTAPBT00, KTAPBT01, KTAPBT02, KTAPBT03, KTAR01, KTAR01-BASE-20201001, KTAR01N, KTAR01N-BASE-20201005043V, KTAR02, KTAR02N, KTAR02N-BASE-20201305043Y, KTAR03, KTAR03-BASE-2020180105, KTAR03N, KTAR03N-BASE-202018050441, KTAR04, KTAR04N, KTAR04N-BASE-2020230508V7...(Other models you can see in the webshop) | | |

TENTE

with fixing plate

chrome-plated steel



| | | | |
|--------------------|---|-----------------|--------------------|
| GEV No. | 700214 | Ref. No. | 147805 BN147805 |
| description | swivel castor ø 100mm plate fixing housing zinc-plated sheet steel plate size 105x85mm hole distance 60x78mm capacity 80kg bearing slide bearing wheel body polypropylene tread TPE tyres H 128mm wheel width 32mm | | |
| For models: | 140, 70, ARCO-BT140-20172404, ARCO-BT140-20172405, ARCO-BT140-BASE-20172408, ARCO-BT140-PLUS-20172409, ARCO-BT70-20171704, ARCO-BT70430-20171705, ARCO-BT70-BASE-20171708, ARCO-BT70-PLUS-20171709, ARCO-TN140-BASE-20171408, ARCO-TN140-PLUS-20171409, ARCO-TN140-20171404, ARCO-TN140430-20171405, ARCO-TN70-20170704, ARCO-TN70430-20170705, ARCO-TN70-BASE-20170708, ARCO-TN70-PLUS-20170709, ARCO-TNN70-20170706, KBC10, KBC10-BASE-20351002PM, KBC5, KBC6, KBC6-BASE-20350602PL, KBCF10, KBCF10-BASE-20361002PV, KBCF5, KBCF5-BASE-20360502PN, KBCF6, KBCF6-BASE-20360602PT, KST6-02TN-2055020CYA, KTAP00, KTAP00-BASE-20220501062N, KTAP00BT-BASE-2022550105KR, KTAP01, KTAP01-205202, KTAP01-205204, KTAP01-BASE-20220901044U, KTAP01BT-BASE-2022590105KU, KTAP02, KTAP02-600-20221205CN, KTAP02-BASE-20221301048K, KTAP02BT-205301, KTAP02BT-205302, KTAP02BT-205303, KTAP02BT-BASE-2022630105KW, KTAP03, KTAP03-BASE-2022180109UA, KTAP03BT-BASE-2022680109UW, KTAP04...(Other models you can see in the webshop) | | |



| | | | |
|--------------------|---|-----------------|--------------------|
| GEV No. | 700852 | Ref. No. | 147801 BN147801 |
| description | swivel castor without brake ø 80mm with flange plate | | |
| For models: | KBC10, KBC10-BASE-20351002PM, KBC5, KBC6, KBC6-BASE-20350602PL, KBCF10, KBCF10-BASE-20361002PV, KBCF5, KBCF5-BASE-20360502PN, KBCF6, KBCF6-BASE-20360602PT, KTAP00, KTAP00-BASE-20220501062N, KTAP00BT-BASE-2022550105KR, KTAP01, KTAP01-205202, KTAP01-205204, KTAP01-BASE-20220901044U, KTAP01BT-BASE-2022590105KU, KTAP02, KTAP02-600-20221205CN, KTAP02-BASE-20221301048K, KTAP02BT-205301, KTAP02BT-205302, KTAP02BT-205303, KTAP02BT-BASE-2022630105KW, KTAP03, KTAP03-BASE-2022180109UA, KTAP03BT-BASE-2022680109UW, KTAP04, KTAP04-BASE-2022230109RY, KTAP84EN-20228403, KTAPBT00, KTAPBT01, KTAPBT02, KTAPBT03, KTAR01, KTAR01-BASE-20201001, KTAR01N, KTAR01N-BASE-20201005043V, KTAR02, KTAR02N, KTAR02N-BASE-20201305043Y, KTAR03, KTAR03-BASE-2020180105, KTAR03N, KTAR03N-BASE-202018050441, KTAR04, KTAR04N, KTAR04N-BASE-2020230508V7...(Other models you can see in the webshop) | | |



| | | | |
|--------------------|---|-----------------|--------------------|
| GEV No. | 700213 ¹ | Ref. No. | 147806 BN147806 |
| description | swivel castor with swivel brake ø 100mm plate fixing housing zinc-plated sheet steel plate size 105x85mm hole distance 60x78mm capacity 80kg bearing slide bearing wheel body polypropylene tread TPE tyres H 128mm wheel width 32mm Qty 1 pcs | | |
| For models: | 140, 70, ARCO-BT140-20172404, ARCO-BT140-20172405, ARCO-BT140-BASE-20172408, ARCO-BT140-PLUS-20172409, ARCO-BT70-20171704, ARCO-BT70430-20171705, ARCO-BT70-BASE-20171708, ARCO-BT70-PLUS-20171709, ARCO-TN140-BASE-20171408, ARCO-TN140-PLUS-20171409, ARCO-TN140-20171404, ARCO-TN140430-20171405, ARCO-TN70-20170704, ARCO-TN70430-20170705, ARCO-TN70-BASE-20170708, ARCO-TN70-PLUS-20170709, ARCO-TNN70-20170706, KBC10, KBC10-BASE-20351002PM, KBC5, KBC6, KBC6-BASE-20350602PL, KBCF10, KBCF10-BASE-20361002PV, KBCF5, KBCF5-BASE-20360502PN, KBCF6, KBCF6-BASE-20360602PT, KST6-02TN-2055020CYA, KTAP00, KTAP00-BASE-20220501062N, KTAP00BT-BASE-2022550105KR, KTAP01, KTAP01-205202, KTAP01-205204, KTAP01-BASE-20220901044U, KTAP01BT-BASE-2022590105KU, KTAP02, KTAP02-600-20221205CN, KTAP02-BASE-20221301048K, KTAP02BT-205301, KTAP02BT-205302, KTAP02BT-205303, KTAP02BT-BASE-2022630105KW, KTAP03, KTAP03-BASE-2022180109UA, KTAP03BT-BASE-2022680109UW, KTAP04...(Other models you can see in the webshop) | | |

¹with swivel brake



shelves and shelf rails

grates

universal

without upstand



| | | | |
|------------------------|--|-----------------|----------------------------|
| GEV No. | 970126 | Ref. No. | 1440165530 BN1440165530 |
| description | grate W 530mm D 650mm GN 2/1 plastic-coated steel wire gauge frame 8mm lengthwise wires gauge 5mm crossing wires 2 white suitable for refrigerator | | |
| For models: | SPEBTG70, SPEBTG70-204538 | | |
| accessories for | 970126 | | |
| | GEV No. | 690330 | Ref. No. — |
| | rack L 1000mm W 22mm H 4mm aperture 3x8mm hole distance 12.5mm stainless steel | | |
| | GEV No. | 694700 | Ref. No. — |
| | shelf support L 31/28mm W 22mm H 18mm SS Qty 12 pcs | | |
| | GEV No. | 694701 | Ref. No. — |
| | shelf support L 31/28mm W 22mm H 17mm SS with hook Qty 12 pcs | | |

with upstand



| | | | |
|--------------------|---|-----------------|----------------------------|
| GEV No. | 970807 | Ref. No. | 1440050530 BN1440050530 |
| description | grate W 530mm D 500mm H 40mm plastic-coated steel wire gauge frame 8.8mm lengthwise wires gauge 4.8mm crossing wires 1 grey | | |
| For models: | KBT120-2008140218, KBT122-20081402XU, KBT124-2008140431, KBT60-2008070124, KBT62-20080705H5, KBTV120, KBTV60, KC6060-20091430, KC9030-20091420, KCTN3030-20090710, KCTN6060-20091410, KPC3030-20100720, KPC9030-20101410, KTN120, KTN122-200714011U, KTN124-20071400XM, KTN60-20070700XE, KTN60-BASE-20070700XE, KTNV120, KTNV60-20070700XH | | |

| | | | |
|--------------------|--|-----------------|----------------------------|
| GEV No. | 970626 | Ref. No. | 1440065530 BN1440065530 |
| description | grate W 650mm D 530mm GN 2/1 plastic-coated steel with hinge camp crossing wires 2 grey suitable for refrigerator | | |
| For models: | 140, 70, AP-140-221314XG, AP-70TN-221307XG, ARCO-BT140-20172404, ARCO-BT140-20172405, ARCO-BT140-BASE-20172408, ARCO-BT140-PLUS-20172409, ARCO-BT70-20171704, ARCO-BT70430-20171705, ARCO-BT70-BASE-20171708, ARCO-BT70-PLUS-20171709, ARCO-TN140.-BASE-20171408, ARCO-TN140.-PLUS-20171409, ARCO-TN140-20171404, ARCO-TN140430-20171405, ARCO-TN70-20170704, ARCO-TN70430-20170705, ARCO-TN70-BASE-20170708, ARCO-TN70-PLUS-20170709, ARCO-TNN70-20170706, BT140, BT144, BT70, BT72, KTN70-20010710, KTN72-20010720, KTNV140-2001440, KTNV70-20010730, LLP140TN, LLP140T-NGN2-1-221314, LLP70TN, LLP70TNGN2-1-221307, M70BT, M70TN, NFB0070F, NFB0070N, NFB0070P, NFB0072F, NFB0072FN, NFB0072N, NFB0072NI, NFB0072NN, NFB0072P, NFB0072PF, NFB0072PN, NFB0072PP, NFB0140F, NFB0140N, NFB0140NF...(Other models you can see in the webshop) | | |

producer-specific



| | | | |
|--------------------|---|-----------------|--|
| GEV No. | 970662 | Ref. No. | 1440055530 1440055535 BN1440055530 BN1440055535 |
| description | grate W 530mm D 550mm with layer RILSAN | | |
| For models: | ARTN120, ARTN60 | | |

grid attachments



| | | | |
|--------------------|---|-----------------|------------------------|
| GEV No. | 970661 | Ref. No. | 33510070 BN33510070 |
| description | bearing rail L 600mm H 34.2mm W 17mm | | |
| For models: | KBT140-200214011K, KBT142-200214011L, KBT144-200214011M, KBT70, KBT70-20020710, KBT70-BASE-20020700YL, KBT72-200207061E, KBT72-20020720, KBT72-210207, KBTV140-200214011N, KBTV70-200207, KC10535-20051440, KC2545-20050710, KC3513-20050715, KC3535-20050720, KC4512-20050725, KC70-70-20051410, KC7070-20051410, KCTN10535-20031440, KCTN2545-20030725, KCTN3535-20030735, KCTN7070-20031410, KP70-20040710, KPBT10535-20061420, KPBT2545-20060710, KPBT3513-20060720, KPBT3535-20060730, KPBT4512-20060740, KPBT7070-20061410, KPTN10535-20041440, KPTN2545-20040720, KPTN3535-20040730, KPTN7070-20041410, KTN122-200714011U, KTN140-20011400WZ, KTN140-BASE-20011400WZ, KTN142-20011400X0, KTN144-20011400X1, KTN3513-200107, KTN4512-200107, KTN70-200107003W, KTN70-20010710, KTN70-210107, KTN70-BASE-20010700VX, KTN72-200107, KTN72-20010720, KTNV140-20011400X2, KTNV140-2001440, KTNV70-200107003W, KTNV70-20010730...(Other models you can see in the webshop) | | |

shelf rails and supports

producer-specific

| | | | |
|---|---|-----------------|----------------------|
|  | | | |
| GEV No. | 690258 | Ref. No. | 1231190 FR1231190 |
| description | guide U-shape L 615mm W 13mm H 20mm mounting pos. left/right | | |
| For models: | P105-35TNN-2047640100, P105-35TNN-BT-2047660100, P140BT-2047220101, P140BTV-2047260101, P140TN-2047200101, P140TNN-2047210101, P140TNV-2047240101, P144BT-2047360100, P144TNN-2047350100, P35-35TNN-2047440100, P35-35TNN- BT-2047460100, P70-70TNN-2047540100, P70-70TNN- BT-2047560100, P70BT-2047020101, P70BTV-2046060101, P70TN-2041000101, P70TNN-2047010101, P70TNV-2047040101, P72BT-2047120101, P72TNN-2047110101, S140BT-2048220101, S140TN-2048200101, S70BT-2048020101, S70TN-2048000101, S70TNN-2048010101, T105-35TNN-2046640100, T105-35TNN- BT-2046660100, T140BT-2046220100, T140BTV-2046260100, T140ITT-2046230100, T140TNN-2046210100, T140TNV-2046240100, T144BT-2046xxxxxx, T144TNN-2046350100, T35-35TNN-2046440100, T35-35TNN-BT-2046460100, T70-70TNN-2046540100, T70- 70TNN-BT-2046560100, T70BT-2046020100, T70BTV-2046060x00, T70ITT-2046030100, T70TNN-2046010100, T70TNV-2046040100, T72BT-2046120x00, T72TNN-2046110100 | | |

| | | | |
|---|---------------------|-----------------|----------------------------|
|  | | | |
| GEV No. | 700847 | Ref. No. | 3351100000 BN3351100000 |
| description | pair of setting bar | | |
| For models: | ARTN120, ARTN60 | | |

| | | | |
|---|--|-----------------|------------------------|
|  | | | |
| GEV No. | 690745 | Ref. No. | 33510060 BN33510060 |
| description | pair of setting bar U-shape L 470mm W 15mm inner height 21mm | | |
| For models: | KBT120-2008140218, KBT122-20081402XU, KBT124-2008140431, KBT60-2008070124, KBT62-20080705H5, KBTV120, KBTV60, KC6060-20091430, KC9030-20091420, KCTN3030-20090710, KCTN6060-20091410, KP60-20100710, KPC3030-20100720, KPC9030- 20101410, KTN120, KTN120-20071410, KTN122-20071420, KTN124- 20071400XM, KTN60-20070710, KTN60-200707OOXE, KTN60-BASE- 20070700XE, KTN62-200707OOXF, KTNV120, KTNV60-200707OOXH | | |

| | | | |
|--|--|-----------------|----------------------------|
|  <p>Image not available</p> | | | |
| GEV No. | 700846 | Ref. No. | 3351300030 BN3351300030 |
| description | pair of setting bar U-shape L 540mm W 30mm | | |
| For models: | TAR02S, TAR132, TARS27-2124130027 | | |

| | | | |
|--|--|-----------------|------------------------|
|  | | | |
| GEV No. | 690566 | Ref. No. | 33510071 BN33510071 |
| description | pair of setting bar U-shape L 615mm W 26mm inner height 18mm mounting pos. left/right | | |
| For models: | ARCO-BT140-20172404, ARCO-BT140-20172405, ARCO-BT140-BA- SE-20172408, ARCO-BT140-PLUS-20172409, ARCO-BT70-20171704, ARCO-BT70430-20171705, ARCO-BT70-BASE-20171708, ARCO- BT70-PLUS-20171709, ARCO-TN140-BASE-20171408, ARCO-TN140- PLUS-20171409, ARCO-TN140-20171404, ARCO-TN140430-20171405, ARCO-TN70-20170704, ARCO-TN70430-20170705, ARCO-TN70-BA- SE-20170708, ARCO-TN70-PLUS-20170709, ARCO-TNN70-20170706, NFB0070F, NFB0070N, NFB0070P, NFB0072F, NFB0072FN, NFB0072N, NFB0072NI, NFB0072NN, NFB0072P, NFB0072PF, NFB0072PN, NFB- 0072PP, NFB0140F, NFB0140N, NFB0140NF, NFB0140NI, NFB0140P, NFB0143FN, NFB0143NF, NFB0143NN, NFB0143PF, NFB0143PN, NFB0143PP, NFB0144F, NFB0144N, NFB0144P, NFB0144PF, NFB0144PN, NFS0072FG, NFS0072NG, NFS0143FG, NFS0143I, NFS0143NG, NFS0144FG...(Other models you can see in the webshop) | | |

| | | | |
|---|---|-----------------|------------------------|
|  | | | |
| GEV No. | 700327 | Ref. No. | 33580092 BN33580092 |
| description | rack L 1260mm W 35mm mounting pos. left | | |
| For models: | ARCO-BT140-20172404, ARCO-BT140-20172405, ARCO-BT140-BA- SE-20172408, ARCO-BT140-PLUS-20172409, ARCO-BT70-20171704, ARCO-BT70430-20171705, ARCO-BT70-BASE-20171708, ARCO- BT70-PLUS-20171709, ARCO-TN140-BASE-20171408, ARCO-TN140- PLUS-20171409, ARCO-TN140-20171404, ARCO-TN140430-20171405, ARCO-TN70-20170704, ARCO-TN70430-20170705, ARCO-TN70-BA- SE-20170708, ARCO-TN70-PLUS-20170709, ARCO-TNN70-20170706, NFB0070F, NFB0070N, NFB0070P, NFB0072F, NFB0072N, NFB0072P, NFB0140F, NFB0140N, NFB0140P, NFB0144F, NFB0144N, NFB0144P, NORD-700BT-2017817305, NORD-700BT-2017817305P, NORD- 700TNN-2017807305, NORD-700TNN-2017807305P | | |



| | | | |
|--------------------|--|-----------------|------------------------|
| GEV No. | 700326 | Ref. No. | 33580091 BN33580091 |
| description | rack L 1260mm W 35mm mounting pos. right | | |
| For models: | ARCO-BT140-20172404, ARCO-BT140-20172405, ARCO-BT140-BASE-20172408, ARCO-BT140-PLUS-20172409, ARCO-BT70-20171704, ARCO-BT70430-20171705, ARCO-BT70-BASE-20171708, ARCO-BT70-PLUS-20171709, ARCO-TN140.-BASE-20171408, ARCO-TN140.-PLUS-20171409, ARCO-TN140-20171404, ARCO-TN140430-20171405, ARCO-TN70-20170704, ARCO-TN70430-20170705, ARCO-TN70-BASE-20170708, ARCO-TN70-PLUS-20170709, ARCO-TNN70-20170706, NFB0070F, NFB0070N, NFB0070P, NFB0072F, NFB0072N, NFB0072P, NFB0140F, NFB0140N, NFB0140P, NFB0144F, NFB0144N, NFB0144P, NORD-700BT-2017817305, NORD-700BT-2017817305P, NORD-700TNN-2017807305, NORD-700TNN-2017807305P | | |

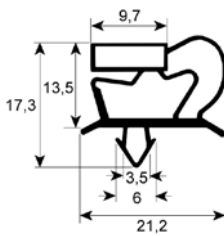

| | | | |
|--------------------|--|-----------------|------------------------------|
| GEV No. | 900347 | Ref. No. | 14414300200 BN14414300200 |
| description | refrigeration gasket profile 9048 W 178mm L 396mm plug size | | |
| For models: | KTAP00, KTAP00-BASE-20220501062N, KTAP01, KTAP01-205202, KTAP01-205204, KTAP01-BASE-20220901044U, KTAP02, KTAP02-600-20221205CN, KTAP02-BASE-20221301048K, KTAP03, KTAP03-BASE-2022180109UA, KTAP04, KTAP04-BASE-2022230109RY, KTAP84EN-20228403, KTAPBT00, KTAPBT01, KTAPBT02, KTAPBT03, KTAR00, KTAR01, KTAR01-BASE-20201001, KTAR01N, KTAR01N-BASE-20201005043V, KTAR02, KTAR02N, KTAR02N-BASE-20201305043Y, KTAR03, KTAR03-BASE-2020180105, KTAR03N, KTAR03N-BASE-202018050441, KTAR04, KTAR04N, KTAR04N-BASE-2020230508V7, KTAR602, KTAR6-02-BASE-20231207N0, KTAR6-02-BASE-20231207N1, KTAR6-03-202316010AMR, KTAR6-03-202316010AMS, KTAR612, KTAR614, KTARBT02, KTARBT02-205101, KTARBT02-205102, KTARBT02-205103, KTARBT02-BASE-2025130104FU, KTARBT03, KTARBT03-BASE-2025180104FW, KTARBT04, KTARBT04-BASE-2025230104FZ, KTARS24-202413010480...(Other models you can see in the webshop) | | |

gaskets

refrigeration gaskets

plug-in gaskets

profile 9048

We offer custom-made gaskets for this profile

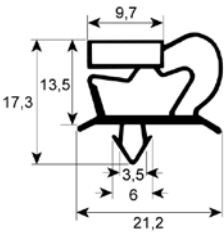

| | | | |
|--------------------|---|-----------------|------------------------------|
| GEV No. | 901021 | Ref. No. | 14414300150 BN14414300150 |
| description | refrigeration gasket profile 9048 W 142mm L 396mm plug size | | |
| For models: | KTAP00, KTAP00-BASE-20220501062N, KTAP01, KTAP01-205202, KTAP01-205204, KTAP01-BASE-20220901044U, KTAP02, KTAP02-600-20221205CN, KTAP02-BASE-20221301048K, KTAP03, KTAP03-BASE-2022180109UA, KTAP04, KTAP04-BASE-2022230109RY, KTAP84EN-20228403, KTAPBT00, KTAPBT01, KTAPBT02, KTAPBT03, KTAR00, KTAR01, KTAR01-BASE-20201001, KTAR01N, KTAR01N-BASE-20201005043V, KTAR02, KTAR02N, KTAR02N-BASE-20201305043Y, KTAR03, KTAR03-BASE-2020180105, KTAR03N, KTAR03N-BASE-202018050441, KTAR04, KTAR04N, KTAR04N-BASE-2020230508V7, KTARBT02, KTARBT02-205101, KTARBT02-205102, KTARBT02-205103, KTARBT02-BASE-2025130104FU, KTARBT03, KTARBT03-BASE-2025180104FW, KTARBT04, KTARBT04-BASE-2025230104FZ, TSP00, TSP00-BASE-202606010BRU, TSP01, TSP01-BASE-202611010BRY, TSP02, TSP02-BASE-202615010BS8, TSP03, TSP03-BASE-202620010BSK...(Other models you can see in the webshop) | | |

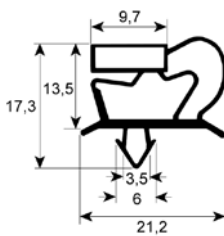

| | | | |
|--------------------|--|-----------------|------------------------------|
| GEV No. | 900360 | Ref. No. | 14411990418 BN14411990418 |
| description | refrigeration gasket profile 9048 W 186mm L 405mm plug size size 1/3 | | |
| For models: | TAR132 | | |

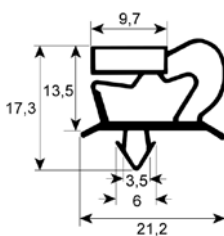

| | | | |
|--------------------|--|-----------------|------------------------------|
| GEV No. | 900846 | Ref. No. | 14416800214 BN14416800214 |
| description | refrigeration gasket profile 9048 W 218mm L 684mm plug size drawer | | |
| For models: | KC3513-20050715, KC4512-20050725, KCTN3513-20030730, KCTN4512-20030745, KCTN4512-20030745, KPBT3513-20060720, KPBT4512-20060740, KPTN3513-20040725, KTN3513-200107, KTN3513-20010735, KTN4512-200107, KTN4512-20010745, KUC3513-20150715, KUC4512-20150725, KUCTN3513-13-20130715, KUCTN3513-20130715, KUCTN4512-20130730, KU-CTN4512-20130730, KUPBT3513-20160720, KUPBT4512-20160740, KUPTN3513-20140720, KUPTN3513-20140720, KUPTN4512-20140740, KUTN3513-20110735, KUTN4512-20110770 | | |

| | | | |
|--------------------|--|-----------------|------------------------------|
| GEV No. | 900918 | Ref. No. | 14415396253 BN14415396253 |
| description | refrigeration gasket profile 9048 W 260mm L 390mm plug size plug-in gasket | | |

| | | | |
|--------------------|---|-----------------|------------------------------|
| GEV No. | 900548 | Ref. No. | 14414300290 BN14414300290 |
| description | refrigeration gasket profile 9048 W 267mm L 394mm plug size | | |
| For models: | KTAP00, KTAP00-BASE-20220501062N, KTAP01, KTAP01-205202, KTAP01-205204, KTAP01-BASE-20220901044U, KTAP02, KTAP02-600-20221205CN, KTAP02-BASE-20221301048K, KTAP03, KTAP03-BASE-2022180109UA, KTAP04, KTAP04-BASE-2022230109RY, KTAP84EN-20228403, KTAPBT00, KTAPBT01, KTAPBT02, KTAPBT03, KTAR00, KTAR01, KTAR01-BASE-20201001, KTAR01N, KTAR01N-BASE-20201005043V, KTAR02, KTAR02N, KTAR02N-BASE-20201305043Y, KTAR03, KTAR03-BASE-2020180105, KTAR03N, KTAR03N-BASE-202018050441, KTAR04, KTAR04N, KTAR04N-BASE-2020230508V7, KTARBT02, KTARBT02-205101, KTARBT02-205102, KTARBT02-205103, KTARBT02-BASE-2025130104FU, KTARBT03, KTARBT03-BASE-2025180104FW, KTARBT04, KTARBT04-BASE-2025230104FZ, TSP00, TSP00-BASE-202606010BRU, TSP01, TSP01-BASE-202611010BRV, TSP02, TSP02-BASE-202615010BS8, TSP03, TSP03-BASE-202620010BSK...(Other models you can see in the webshop) | | |

| | | | |
|--------------------|--|-----------------|------------------------------|
| GEV No. | 900849 | Ref. No. | 14415396291 BN14415396291 |
| description | refrigeration gasket profile 9048 W 278mm L 396mm plug size drawer | | |
| For models: | TFT01, TFT01-BASE-209001106V7, TFT02, TFT02-BASE-209002106XF, TFT03, TFT03-BASE-209003106XY, TFT04, TFT04-BASE-209004106YC, TFTP00, TFTP00-BASE-209101106YW, TFTP01, TFTP01-BASE-209102106Z7, TFTP02, TFTP02-BASE-209103106ZN, TFTP03, TFTP03-BASE-20910410705, TRANSF90001MOTTN, TRANSF90002MOTTN, TRANSF90003MOTTN, TRANSF90004MOTTN | | |

| | | | |
|--------------------|---|-----------------|------------------------------|
| GEV No. | 900845 | Ref. No. | 14414240286 BN14414240286 |
| description | refrigeration gasket profile 9048 W 289mm L 426mm plug size drawer | | |
| For models: | KTARS21-2124100021, TARS21, TARS21-2124100021, TARS21-2124100022, TARS21-2124100023 | | |

| | | | |
|--------------------|---|-----------------|------------------------------|
| GEV No. | 900836 | Ref. No. | 14413090501 BN14413090501 |
| description | refrigeration gasket profile 9048 W 295mm L 485mm plug size | | |

| | | | |
|--------------------|---|-----------------|------------------------------|
| GEV No. | 900359 | Ref. No. | 14413090418 BN14413090418 |
| description | refrigeration gasket profile 9048 W 296mm L 405mm plug size drawer size 1/2 | | |
| For models: | TAR02S, TARS27-2124130027 | | |

| | | | |
|--------------------|---|-----------------|------------------------------|
| GEV No. | 901018 | Ref. No. | 14416070295 BN14416070295 |
| description | refrigeration gasket profile 9048 W 296mm L 607mm plug size | | |



| | | | |
|--------------------|---|-----------------|------------------------------|
| GEV No. | 901778 | Ref. No. | 14412950408 BN14412950408 |
| description | refrigeration gasket profile 9048 W 300mm L 410mm plug size | | |

| | | | |
|--------------------|---|-----------------|------------------------------|
| GEV No. | 900831 | Ref. No. | 14414300390 BN14414300390 |
| description | refrigeration gasket profile 9048 W 354mm L 396mm plug size drawer size 2/3 | | |

For models: KTAP00, KTAP00-BASE-20220501062N, KTAP01, KTAP01-205202, KTAP01-205204, KTAP01-BASE-20220901044U, KTAP02, KTAP02-600-20221205CN, KTAP02-BASE-20221301048K, KTAP03, KTAP03-BASE-2022180109UA, KTAP04, KTAP04-BASE-2022230109RY, KTAP84EN-20228403, KTAPBT00, KTAPBT01, KTAPBT02, KTAPBT03, KTAR00, KTAR01, KTAR01-BASE-20201001, KTAR01N, KTAR01N-BASE-20201005043V, KTAR02, KTAR02N, KTAR02N-BASE-20201305043Y, KTAR03, KTAR03-BASE-2020180105, KTAR03N, KTAR03N-BASE-202018050441, KTAR04, KTAR04N, KTAR04N-BASE-2020230508V7, KTARBT02, KTARBT02-205101, KTARBT02-205102, KTARBT02-205103, KTARBT02-BASE-2025130104FU, KTARBT03, KTARBT03-BASE-2025180104FW, KTARBT04, KTARBT04-BASE-2025230104FZ, TSP00, TSP00-BASE-202606010BRU, TSP01, TSP01-BASE-202611010BRV, TSP02, TSP02-BASE-202615010BS8, TSP03, TSP03-BASE-202620010BSK...(Other models you can see in the webshop)

| | | | |
|--------------------|--|-----------------|--|
| GEV No. | 900842 | Ref. No. | 14413690499 925633 BN14413690499 FR925633 |
| description | refrigeration gasket profile 9048 W 370mm L 500mm plug size | | |
| For models: | TARS22-2124922, TARS22-212492208L6, TARS22-212492208VT, TARS22-21249220AO2, TARS22-21249220AO3, TARS22-21249220AO4, TARS22-21249220AO6, TARS22-KIT1, TARS22-Kit1-212492201, TARS22-KIT2, TARS22-Kit2-212492202, TARS22-KIT3, TARS22-Kit3-212492203, TARS22-KIT4, TARS22-Kit4-212492204, TARS22-KIT5, TARS22-Kit5-212492205, TARS22-KIT6, TARS22-Kit6-212492206, TARS22-KIT6-21249220AO5, TARS22-KIT7, TARS22-Kit7-212492207, TP122-TARS22-KIT5-212492208VR | | |

| | | | |
|--------------------|---|-----------------|------------------------------|
| GEV No. | 901172 | Ref. No. | 14414300254 BN14414300254 |
| description | refrigeration gasket profile 9048 W 383mm L 254mm plug size | | |

For models: KST01BT-205111, KST01BT-VCR-205701, KST01BT-VCR-205711, KST01TN-205001, KST01TN-205011, KST01TN-VCR-205601, KST01TN-VCR-205611, KST02BT-205112, KST02BT-VCR-205702, KST02BT-VCR-205712, KST02TN-205002, KST02TN-205012, KST02TNH760-205802, KST02TN-VCR-205602, KST02TN-VCR-205612, KST03BT-205113, KST03BT-VCR-205703, KST03BT-VCR-205713, KST03TN-205003, KST03TN-205013, KST03TN-VCR-205603, KST03TN-VCR-205613, KST04BT-205114, KST04BT-VCR-205714, KST04TN-205004, KST04TN-205014, KST04TN-VCR-205604, KST04TN-VCR-205614, KST-BT01, KST-BT04, KST-BT-VCR01, KST-BT-VCR02, KST-BT-VCR03, KSTP01BT-205311, KSTP01TN-205211, KSTP02BT-205312, KSTP02TN-205212, KSTP03-205203, KSTP03BT-205313, KSTP03TN-205213, KSTP04TN-205214, KSTP05TN-205205, KSTP05TN-205215, KSTS24-205424, KSTS24-2054240IDP, KSTS24-2054240JGN, KST-TN01, KST-TN02, KST-TN03, KST-TN04...(Other models you can see in the webshop)

| | | | |
|--------------------|---|-----------------|--|
| GEV No. | 901173 | Ref. No. | 14414300569 926058 BN14414300569 FR926058 |
| description | refrigeration gasket profile 9048 W 383mm L 569mm plug size | | |

For models: KST01BT-205111, KST01BT-VCR-205711, KST01TN-205001, KST01TN-205011, KST01TN-VCR-205611, KST02BT-205112, KST02BT-VCR-205702, KST02BT-VCR-205712, KST02TN-205002, KST02TN-205012, KST02TNH760-205802, KST02TN-VCR-205602, KST02TN-VCR-205612, KST03BT-205113, KST03BT-VCR-205713, KST03TN-205003, KST03TN-205013, KST03TN-VCR-205603, KST03TN-VCR-205613, KST04BT-205114, KST04TN-205004, KST04TN-205014, KST04TN-VCR-205604, KST04TN-VCR-205614, KST-BT01, KST-BT04, KST-BT-VCR01, KST-BT-VCR02, KST-BT-VCR03, KSTP01BT-205311, KSTP01TN-205211, KSTP02BT-205312, KSTP02TN-205212, KSTP03-205203, KSTP03BT-205313, KSTP03TN-205213, KSTP04TN-205214, KSTP05TN-205205, KSTP05TN-205215, KSTS24-205424, KSTS24-2054240IDP, KSTS24-2054240JGN, KST-TN01, KST-TN02, KST-TN03, KST-TN04, KST-TN-VCR01, KST-TN-VCR02, KST-TN-VCR03, KST-TN-VCR04...(Other models you can see in the webshop)

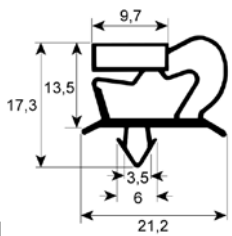

| | | | |
|--------------------|---|-----------------|------------------------------|
| GEV No. | 901234 | Ref. No. | 14416600390 BN14416600390 |
| description | refrigeration gasket profile 9048 W 390mm L 660mm plug size for blast chiller | | |
| For models: | KBC5, KBC5-BASE-20350502PK, KBCF5, KBCF5-BASE-20360502PN | | |

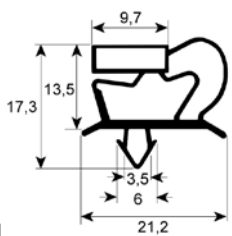

| | | | |
|--------------------|---|-----------------|------------------------------|
| GEV No. | 900734 | Ref. No. | 14415396458 BN14415396458 |
| description | refrigeration gasket profile 9048 W 396mm L 458mm plug size | | |
| For models: | KTAP902, KTAPBT902, KTAR902, KTAR9-02-202009040Y, KTAR902BT-ESP66300BT-202509P0201, KTARBT902, KTARBT9-02-BASE-20250904MU | | |

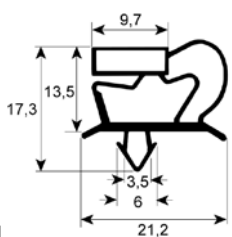

| | | | |
|--------------------|--|-----------------|--|
| GEV No. | 900731 | Ref. No. | 14414300620 926005 BN14414300620 FR926005 |
| description | refrigeration gasket profile 9048 W 396mm L 566mm plug size | | |
| For models: | KST6-02TN-2055020CYA, KST6-03TN-2055030CC9, KST6-04TN-2055040CCA, KTAP00, KTAP00-BASE-20220501062N, KTAP00BT-BASE-2022550105KR, KTAP01, KTAP01-205202, KTAP01-205204, KTAP01-BASE-20220901044U, KTAP01BT-BASE-2022590105KU, KTAP02, KTAP02-20221301P0201, KTAP02-600-20221205CN, KTAP02-BASE-20221301048K, KTAP02BT-205301, KTAP02BT-205302, KTAP02BT-205303, KTAP02BT-BASE-2022630105KW, KTAP02-ESP45300-20221301P0202, KTAP03, KTAP03-600-20221705CM, KTAP03-BASE-2022180109UA, KTAP03BT-BASE-2022680109UW, KTAP04, KTAP04-BASE-2022230109RY, KTAP84EN-20228403, KTAPBT00, KTAPBT01, KTAPBT02, KTAPBT03, KTAR01, KTAR01N, KTAR01N-BASE-20201005043V, KTAR02, KTAR02-600-BASE-20201205CU, KTAR02N, KTAR02N-BASE-20201305043Y, KTAR03, KTAR03-600-BASE-20201705DD, KTAR03N, KTAR03N-BA-SE-202018050441, KTAR04, KTAR04N, KTAR04N-BASE-2020230508V7, KTARBT02, KTARBT02-BASE-2025130104FU, KTARBT03, KTARBT03-BASE-2025180104FW, KTARBT04...(Other models you can see in the webshop) | | |

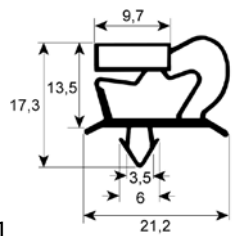

| | | | |
|--------------------|---|-----------------|------------------------------|
| GEV No. | 901020 | Ref. No. | 14414020516 BN14414020516 |
| description | refrigeration gasket profile 9048 W 402mm L 516mm plug size | | |

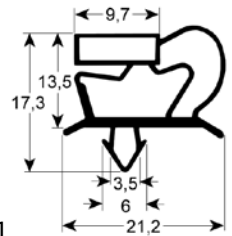

| | | | |
|--------------------|---|-----------------|------------------------------|
| GEV No. | 902145 | Ref. No. | 14416070406 BN14416070406 |
| description | refrigeration gasket profile 9048 W 403mm L 607mm plug size | | |

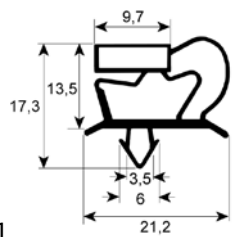

| | | | |
|--------------------|---|-----------------|------------------------------|
| GEV No. | 900358 | Ref. No. | 14414180418 BN14414180418 |
| description | refrigeration gasket profile 9048 W 405mm L 405mm plug size drawer size 2/3 | | |
| For models: | TAR132 | | |

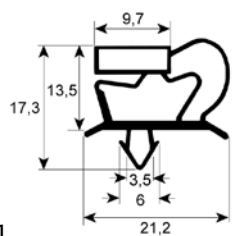

| | | | |
|--------------------|--|-----------------|------------------------------|
| GEV No. | 900830 | Ref. No. | 14414080540 BN14414080540 |
| description | refrigeration gasket profile 9048 W 405mm L 535mm plug size door | | |
| For models: | PIZZA160, TARS22E-2124091022, TARS22EP-2124091023, TARS22ES-2124091022, TARS22R-21240913, TARS22RP-21240914, TARS22RS-21240913 | | |

| | | | |
|--------------------|--|-----------------|------------------------------|
| GEV No. | 900357 | Ref. No. | 14414180640 BN14414180640 |
| description | refrigeration gasket profile 9048 W 405mm L 627mm plug size door for refrigerated counter size 1/1 | | |
| For models: | TAR02S, TAR13Z, TARS27-2124130027 | | |

| | | | |
|--------------------|--|-----------------|------------------------------|
| GEV No. | 900832 | Ref. No. | 14415396405 BN14415396405 |
| description | refrigeration gasket profile 9048 W 471mm L 626mm plug size door | | |
| For models: | KTAP82-202282020AWR, KTAP83-202283020AWS, KTAP84-202284020AWT, KTAR82-202082020AWO, KTAR83-202083020AWP, KTAR84-202084020AWQ, KTARS27-20282700, TP0200Q-20283200, TP0220Q-20283220, TP0224Q-20283224, TP0227Q-20283227, TP0240Q-20283240, TP0247Q-20283247, TP0270Q-20283270, TP0300Q-20283300, TP0320Q-20283320, TP0370Q-20283340, TP0370Q-20283370, TPP02-2028220007Z7, TPP03-2028230007Z8, TPP04-2028240009UZ, TPR02-2028020007Z4, TPR03-2028030007Z5, TPR04-2028040009V0 | | |

| | | | |
|--------------------|---|-----------------|------------------------------|
| GEV No. | 900844 | Ref. No. | 14414240610 BN14414240610 |
| description | refrigeration gasket profile 9048 W 426mm L 612mm plug size door | | |
| For models: | KTARS21-2124100021, TARS21, TARS21-2124100021, TARS21-2124100022, TARS21-2124100023 | | |

| | | | |
|--------------------|---|-----------------|------------------------------|
| GEV No. | 901014 | Ref. No. | 14416800487 BN14416800487 |
| description | refrigeration gasket profile 9048 W 494mm L 684mm plug size | | |
| For models: | KC2545-20050710, KCTN2545-20030725, KPBT2545-20060710, KPTN25-45-20040720, KPTN2545-20040720, KUC25-45-20150710, KUC2545-20150710, KUCTN2545-20130710, KUPBT2545-20160710, KUPTN2545-20140710 | | |

| | | | |
|--------------------|---|-----------------|------------------------------|
| GEV No. | 901019 | Ref. No. | 14414600640 BN14414600640 |
| description | refrigeration gasket profile 9048 W 450mm L 626mm plug size | | |

| | | | |
|--------------------|---|-----------------|------------------------------|
| GEV No. | 901016 | Ref. No. | 14414990738 BN14414990738 |
| description | refrigeration gasket profile 9048 W 499mm L 738mm plug size | | |

| | | | |
|--------------------|---|-----------------|------------------------------|
| GEV No. | 901061 | Ref. No. | 14415465626 BN14415465626 |
| description | refrigeration gasket profile 9048 W 468mm L 636mm plug size | | |
| For models: | KTAP82, KTAP82-202282020AWR, KTAP83, KTAP83-202283020AWS, KTAP84, KTAP84-202284020AWT | | |

| | | | |
|--------------------|---|-----------------|------------------------------|
| GEV No. | 901233 | Ref. No. | 14417000520 BN14417000520 |
| description | refrigeration gasket profile 9048 W 520mm L 700mm plug size for blast chiller | | |
| For models: | KBC6, KBC6-BASE-20350602PL, KBCF6, KBCF6-BASE-20360602PT | | |

| | | | |
|--------------------|--|-----------------|------------------------------|
| GEV No. | 901015 | Ref. No. | 14415601460 BN14415601460 |
| description | refrigeration gasket profile 9048 W 560mm L 1460mm plug size | | |
| For models: | KBT40-21091640, KBT40-210916400BAJ, KTN40-21090640, KTN40-210906400BAI | | |

| | | | |
|--------------------|--|-----------------|------------------------------|
| GEV No. | 900838 | Ref. No. | 14416451606 BN14416451606 |
| description | refrigeration gasket profile 9048 W 606mm L 1566mm plug size | | |
| For models: | SABT140-DOUBLE-DOOR-20197400KG, SABT70-SINGLE-DOOR-20196700HC, SATN140-BASE-20196400KF, SATN70-BASE-20195700F9, SATNBT7070-BASE-201967803CU, SATNTN7070-BASE-201967703CT, SBT140A-201974, SBT70A-201967, SBT70A-20196700HC, SB-T70AT-201967T, SC7070A-2019678, SCTN7070A-2019677, STN140, STN140A-201964, STN140A-20196400KF, STN140-BASE-20191400KF, STN70, STN70A-201957, STN70A-20195700F9, STN70-BASE-20190700F9 | | |

| | | | |
|--------------------|---|-----------------|--|
| GEV No. | 900839 | Ref. No. | 14415990738 14416451604 BN14415990738 BN14416451604 |
| description | refrigeration gasket profile 9048 W 606mm L 744mm plug size door | | |
| For models: | BT72, NFB0072F, NFB0072N, NFB0072P, NFB0144F, NFB0144N, NFB0144P, SABT144-BASE-201974402C2, SABT72-BASE-201967202BW, SATN144-BASE-20171402099A, SATN144-BASE-201964402BZ, SATN72-BASE-201707020997, SATN72-BASE-201957202BM, SATNBT3535-BASE-20193603CV, SATNN144-BASE-2017140208RY, SATNN72-BASE-2017070208RX, SATNTN3535-BASE-20193503CP, SBT144A, SBT144A-201974, SBT72A, SBT72A-201967, SC3535A-201936, SCTN3535A-201935, SCTN3535A-20193503CP, SPA120TN-201712030C18, SPA60TN-201706030C16, SPABT120-201722030C1F, SPABT140-201724030C15, SPABT60-201716030C1A, SPABT72-201717030C14, SPAC35-35-201736030BYB, SPATN120-RPPC-201742030CML, SPATN140-201714030C13, SPATN140-201734030CMM, SPATN60-RPPC-201746030CMJ, SPATN70-201737030CMK, SPATNN72-201707030BW5, SPATN-TN35-35-201735030BY2, STN144A, STN144A-201964, STN72A, STN72A-201957, STNN140A, STNN144A, STNN72A, TNN72 | | |

| | | | |
|--------------------|---|-----------------|------------------------------|
| GEV No. | 901017 | Ref. No. | 14416070626 BN14416070626 |
| description | refrigeration gasket profile 9048 W 607mm L 626mm plug size | | |

| | | | |
|--------------------|---|-----------------|------------------------------|
| GEV No. | 900833 | Ref. No. | 14416191489 BN14416191489 |
| description | refrigeration gasket profile 9048 W 619mm L 1489mm plug size door | | |
| For models: | BT140, BT70G, KSA105-35-2045150C0R, KSA105-35-2045260CC0, KSA140BT-204524, KSA140BT-2045240BYF, KSA140BT-2045240C10, KSA140BT-2045240CAD, KSA140P-204534, KSA140P-2045340C0X, KSA140TN-204514, KSA140TN-2045140B8X, KSA140TN-2045140CAB, KSA140TN-2045140CAC, KSA70-70-2045770BYH, KSA70-70-2045770CJ5, KSA70-70PBT-2045800C0U, KSA70-70PBT-2045800CJ8, KSA70-70PTN-2045790C0T, KSA70-70PTN-2045790CJ7, KSA70BT-204517, KSA70BT-2045170BYL, KSA70BT-2045170C0Z, KSA70BT-2045170CAA, KSA70P-204527, KSA70P-2045270C0W, KSA70TN-204507, KSA70TN-2045070B5E, KSA70TN-2045070C6A, KSA70TN-2045070CA9, KSABT70G-204537, KSABT70G-2045370CC4, KSAC105-35-2045160C05, KSAC70-70-2045780BRL, KSAC70-70-2045780CJ6, KSAP105-35-2045250CC1, NFB0072FN, NFB0072NI, NFB0072NN, NFB0072PF, NFB0072PN, NFB0072PP, NFB0140NF, NFB0140NI, NFB0143FN, NFB0143NF, NFB0143NN, NFB0143PF, NFB0143PN, NFB0143PP..(Other models you can see in the webshop) | | |

| | | | |
|--------------------|---|-----------------|------------------------------|
| GEV No. | 900795 | Ref. No. | 14416451605 BN14416451605 |
| description | refrigeration gasket profile 9048 W 645mm L 1605mm plug size door | | |

| | | | |
|--------------------|---|-----------------|------------------------------|
| GEV No. | 900356 | Ref. No. | 14416761594 BN14416761594 |
| description | refrigeration gasket profile 9048 W 660mm L 1580mm plug size | | |
| For models: | ARBT70, ARTN120, ARTN140, ARTN210, ARTN60, ARTN70, M70BT, M70TN | | |

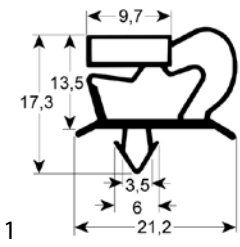
| | | | |
|--------------------|---|-----------------|------------------------------|
| GEV No. | 900355 | Ref. No. | 14416760784 BN14416760784 |
| description | refrigeration gasket profile 9048 W 663mm L 767mm plug size | | |
| For models: | ARBT144, ARBT72, ARTN72 | | |

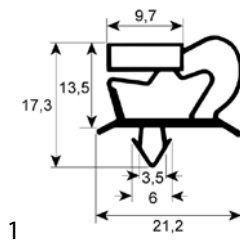

| | | | |
|--------------------|--|-----------------|------------------------------|
| GEV No. | 900733 | Ref. No. | 14416800759 BN14416800759 |
| description | refrigeration gasket profile 9048 W 684mm L 762mm plug size | | |
| For models: | KBT120-BASE-20081402XU, KBT120-BASE-2008140431, KBT122-20081402XU, KBT122-20081420, KBT122-20081402XU, KBT124-2008140431, KBT124-20081430, KBT124-P0120081430, KBT140-200214011M, KBT140-BASE-200214011L, KBT142-200214011L, KBT142-20021420, KBT144-200214011M, KBT144-20021430, KBT60-BASE-20080705H5, KBT62-20080705H5, KBT62-20080720, KBT62-20080705H5, KBT70-200207061E, KBT72-200207061E, KBT72-20020720, KBT72-210207, KBT72-BASE-200207061E, KC105-35-20051440, KC10535-20051440, KC3513-20050715, KC3535-20050720, KC9030-20091420, KCTN10535-20031440, KCTN3030-20090710, KCTN3513-20030730, KCTN3535-20030735, KPBT105-35-20061420, KPBT10535-20061420, KPBT3513-20060720, KPBT3535-20060730, KPBT3535c-20060730, KPC30-30-20100720, KPC3030-20100720, KPC90-30-20101410, KPC9030-20101410, KPTN10535-20041440, KPTN3513-20040725, KPTN3535-20040730, KTN120-BASE-20071400XM, KTN120-BASE-200714011U, KTN122-200714011U, KTN122-20071420, KTN124-20071400XM, KTN124-20071430...(Other models you can see in the webshop) | | |

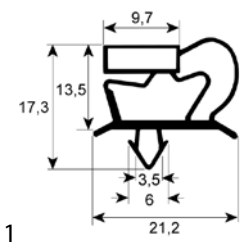

| | | | |
|--------------------|--|-----------------|------------------------------|
| GEV No. | 901013 | Ref. No. | 14416801032 BN14416801032 |
| description | refrigeration gasket profile 9048 W 684mm L 1031mm plug size | | |
| For models: | KC2545-20050710, KC4512-20050725, KCTN2545-20030725, KCTN45-12-20030745, KCTN4512-20030745, KPBT2545-20060710, KPBT4512-20060740, KPTN25-45-20040720, KPTN2545-20040720, KTN3513-200107, KTN4512-20010745, KUC25-45-20150710, KUC2545-20150710, KUC4512-20150725, KU-CTN2545-20130710, KUCTN45-12-20130730, KUCTN4512-20130730, KUPBT2545-20160710, KUPBT4512-20160740, KUPTN2545-20140710, KUPTN45-12-20140740, KUTN4512-20110770 | | |

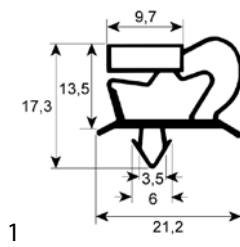

| | | | |
|--------------------|---|-----------------|------------------------------|
| GEV No. | 900841 | Ref. No. | 14417000780 BN14417000780 |
| description | refrigeration gasket profile 9048 W 700mm L 780mm plug size | | |
| For models: | KBC10, KBC10-BASE-20351002PM, KBCF10, KBCF10-BA-SE-20361002PV | | |

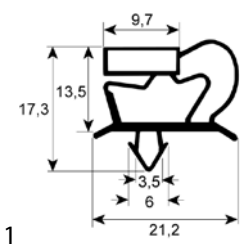

| | | | |
|--------------------|---|-----------------|------------------------------|
| GEV No. | 900732 | Ref. No. | 14416801580 BN14416801580 |
| description | refrigeration gasket profile 9048 W 684mm L 1584mm plug size | | |
| For models: | KBT120-20081410, KBT120-2008140218, KBT120-BASE-2008140218, KBT120-BASE-20081402XU, KBT120-P0120081410, KBT122-20081402XU, KBT122-20081420, KBT122-20081402XU, KBT140-200214011K, KBT140-20021410, KBT140-BASE-200214011K, KBT140-BASE-200214011L, KBT142-200214011L, KBT142-20021420, KBT60-2008070124, KBT60-20080710, KBT60-BASE-2008070124, KBT70, KBT70-20020710, KBT70-BASE-20020700YL, KBT70G-200220, KBT70G-BASE-20022001TZ, KBT72-20020720, KBTG140-20021470, KBTG70-20020770, KC105-35-20051440, KC10535-20051440, KC6060-20091430, KC70-70-20051410, KC7070-20051410, KC9030-20091420, KCTN10535-20031440, KCTN60-60-20091410, KCTN6060-20091410, KCTN7070-20031410, KP140-20041405, KP60-20100710, KP70-20040710, KPBT105-35-20061420, KPBT10535-20061420, KPBT70-70-20061410, KPBT7070-20061410, KPC90-30-20101410, KPC9030-20101410, KPTN10535-20041440, KPTN70-70-20041410, KPTN7070-20041410, KTN120, KTN120-20071410, KTN120-BASE-20071400XK...(Other models you can see in the webshop) | | |

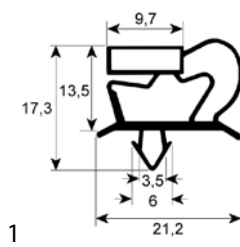

| | | | |
|--------------------|--|-----------------|------------------------------|
| GEV No. | 900837 | Ref. No. | 14417321850 BN14417321850 |
| description | refrigeration gasket profile 9048 W 732mm L 1848mm plug size | | |

| | | | |
|--------------------|---|-----------------|------------------------------|
| GEV No. | 900847 | Ref. No. | 14417511862 BN14417511862 |
| description | refrigeration gasket profile 9048 W 751mm L 1862mm plug size door | | |
| For models: | ROLL-IN-1P, ROLL-IN-1P-2110081205Z6, ROLL-IN-1P-BT, ROLL-IN-1P-BT-2110091206GZ, ROLL-IN-1PP, ROLL-IN1PP-BT, ROLL-IN-1PPM, ROLL-IN-1PPV, ROLL-IN-1PV, ROLL-IN-1PV-2110081206F1, ROLL-IN-2PPM-TN, ROLL-IN-2PPM-TN-2110162206X4, ROLL-IN-2PP-TN, ROLL-IN-2PP-TN-2110162205Z9, ROLL-IN-2PPV-TN, ROLL-IN-2PPV-TN-2110162206FC, ROLL-IN-2P-TN, ROLL-IN-2P-TN-2110161205Z8, ROLL-IN-2PV-TN, ROLL-IN-2PV-TN-2110161206F9, ROLL-INP-1P-2110082205Z7, ROLL-INP-1P-2110082206F6, ROLL-INP-1P-2110082206X3, ROLL-INP-1P-BT-2110092206KU | | |

| | | | |
|--------------------|--|-----------------|-----|
| GEV No. | 902258 | Ref. No. | N/A |
| description | refrigeration gasket profile 9048 Wmm L 2500mm | | |

profile 9703

We offer custom-made gaskets for this profile

| | | | |
|--------------------|--|-----------------|------------------------------|
| GEV No. | 901022 | Ref. No. | 14426761594 BN14426761594 |
| description | refrigeration gasket profile 9703 W 676mm L 1594mm plug size | | |
| For models: | KTNV140-2001440, KTNV70-20010730 | | |

| | | | |
|--------------------|---|-----------------|------------------------------|
| GEV No. | 900843 | Ref. No. | 14426761595 BN14426761595 |
| description | refrigeration gasket profile 9703 W 712mm L 1610mm plug size door | | |
| For models: | KBTV120, KBTV140-200214011N, KBTV60, KBTV70-200207, KTNV70-200107003W, KTNV120, KTNV140-20011400X2, KTNV60-20070700XH, KTNV70-200107003W, KTNV70-210107, KUBTV140-20121440, KUBTV70-20120730, KUTNV140-20111440, KUTNV70-20110730 | | |

profile 9704

We offer custom-made gaskets for this profile

| | | | |
|--------------------|--|-----------------|-----|
| GEV No. | 902299 | Ref. No. | N/A |
| description | refrigeration gasket profile 9704 Wmm L 2500mm | | |

profile 9794

We offer custom-made gaskets for this profile

| | | | |
|--------------------|---|-----------------|--|
| GEV No. | 901525 | Ref. No. | 14415991560 936087 BN14415991560 FR936087 |
| description | gasket profile 9794 W 570mm L 1500mm plug size | | |
| For models: | P105-35TNN-2047640100, P105-35TNN-BT-2047660100, P140BT-2047220101, P140BT-2047260101, P140TN-2047200101, P140TNN-2047210101, P140TNV-2047240101, P70-70TNN-2047540100, P70BT-2047020101, P70BT-2046060101, P70TN-2041000101, P70TNN-2047010101, P70TNV-2047040101, S120BT-2088420100, S120TN-2088400100, S120TNN-2088410100, S140BT-2048220101, S140TN-2048200101, S60BT-2088120100, S60TN-2088100100, S60TNN-2088110100, S70BT-2048020101, S70TN-2048000101, S70TNN-2048010101, T105-35TNN-2046640100, T105-35TNN-BT-2046660100, T140BT-2046220100, T140BT-2046260100, T140ITT-2046230100, T140TNN-2046210100, T140TNV-2046240100, T70-70TNN-2046540100, T70-70TNN-BT-2046560100, T70BT-2046020100, T70BT-2046060x00, T70ITT-2046030100, T70TNN-2046010100, T70TNV-2046040100 | | |



| | | | |
|--------------------|---|-----------------|------------------------------|
| GEV No. | 902391 | Ref. No. | 14414300149 BN14414300149 |
| description | refrigeration gasket profile 9794 W 150mm L 380mm | | |
| For models: | KST01BT-205111, KST01BT-VCR-205711, KST01TN-205001, KST01TN-205011, KST01TN-VCR-205611, KST02BT-205112, KST02BT-VCR-205702, KST02BT-VCR-205712, KST02TN-205002, KST02TN-205012, KST02TNH760-205802, KST02TN-VCR-205602, KST02TN-VCR-205612, KST03BT-205113, KST03BT-VCR-205713, KST03TN-205003, KST03TN-205013, KST03TN-VCR-205603, KST03TN-VCR-205613, KST04BT-205114, KST04TN-205004, KST04TN-205014, KST04TN-VCR-205604, KST04TN-VCR-205614, KST-BT01, KST-BT04, KST-BT-VCR01, KST-BT-VCR02, KST-BT-VCR03, KSTP01BT-205311, KSTP01TN-205211, KSTP02BT-205312, KSTP02TN-205212, KSTP03-205203, KSTP03BT-205313, KSTP03TN-205213, KSTP04TN-205214, KSTP05TN-205205, KSTP05TN-205215, KSTS24-205424, KSTS24-2054240IDP, KSTS24-2054240JGN, KST-TN01, KST-TN02, KST-TN03, KST-TN04, KST-TN-VCR01, KST-TN-VCR02, KST-TN-VCR03, KST-TN-VCR04...(Other models you can see in the webshop) | | |

| | | | |
|--------------------|---|-----------------|------------------------------|
| GEV No. | 901413 | Ref. No. | 14415010640 BN14415010640 |
| description | refrigeration gasket profile 9794 W 480mm L 625mm plug size | | |
| For models: | TAR83, TPV16, TPV16-2128150002, TPV21, TPV21-2128210003, TPV21C, TPV21C-2128211003, TPV26C, TPV26C-2128260004 | | |

| | | | |
|--------------------|---|-----------------|--|
| GEV No. | 901838 | Ref. No. | 1441571718 935204 BN1441571718 FR935204 |
| description | refrigeration gasket profile 9794 W 571mm L 718mm | | |
| For models: | P105-35TNN-2047640100, P105-35TNN-BT-2047660100, P144BT-2047360100, P144TNN-2047350100, P35-35TNN-2047440100, P35-35TNN-BT-2047460100, P70-70TNN-BT-2047560100, P72BT-2047120101, P72TNN-2047110101, T105-35TNN-2046640100, T105-35TNN-BT-2046660100, T144BT-2046xxxxxx, T144TNN-2046350100, T35-35TNN-2046440100, T35-35TNN-BT-2046460100, T72BT-2046120x00, T72TNN-2046110100 | | |

| | | | |
|--------------------|--|-----------------|------------------------------|
| GEV No. | 901367 | Ref. No. | 14416690388 BN14416690388 |
| description | refrigeration gasket profile 9794 W 385mm L 665mm plug size | | |
| For models: | KBF050-20350503, KBF050-203505030CBO, KBF050GB-20350103, KBF050GS-20350203, KBF050GS-20350203F | | |

| | | | |
|--------------------|---|-----------------|---|
| GEV No. | 900344 | Ref. No. | 14415991559 5700033 935168 BN14415991559 FR935168 |
| description | refrigeration gasket profile 9794 W 595mm L 1565mm plug size | | |
| For models: | 140, 70, AFB-140-20172407G, AFB-70-20171707G, AFB-70Sx-20171707GXPS, AFN-140E-20173407G, AFN-70-20170707G, AFN-70E-20173707G, AFN-70ESx-20173707GXPS, AP-140-221314XG, AP-70TN-221307XG, ARCO-BT140-20172404, ARCO-BT140-20172405, ARCO-BT140-BASE-20172408, ARCO-BT140GN2-1-2017824301, ARCO-BT140-PLUS-20172409, ARCO-BT70-20171704, ARCO-BT70430-20171705, ARCO-BT70-BASE-20171708, ARCO-BT70GN2-1-2017817304, ARCO-BT70-PLUS-20171709, ARCO-TN140-BASE-20171408, ARCO-TN140-PLUS-20171409, ARCO-TN140-20171404, ARCO-TN140-2017814301, ARCO-TN140430-20171405, ARCO-TN70-20170704, ARCO-TN70-2017807304, ARCO-TN70430-20170705, ARCO-TN7070-201777040GL70, ARCO-TN70-BASE-20170708, ARCO-TN70-PLUS-20170709, ARCO-TNN70-20170706, BT140, BT60, BT70, BTV70, LLP140TN, LLP140TNGN2-1-221314, LLP140TNR290-221334, LLP70TN, LLP70T-NGN2-1-221307, LLP70TNR290-221327, NFB0070F, NFB0070N, NFB0070P, NFB0140F, NFB0140N, NFB0140P, NORD-700BT-2017817305...(Other models you can see in the webshop) | | |

| | | | |
|--------------------|---|-----------------|---|
| GEV No. | 900684 | Ref. No. | 077925281 077FR925281 4500661 BN077FR925281 FR4500661 |
| description | refrigeration gasket profile 9794 W 390mm L 580mm plug size | | |

| | | | |
|--------------------|---|-----------------|--|
| GEV No. | 902523 | Ref. No. | 14414580620 915259 BN14414580620 FR915259 |
| description | refrigeration gasket profile 9794 W 450mm L 613mm plug size | | |

| | | | |
|--------------------|---|-----------------|--|
| GEV No. | 902523 | Ref. No. | 14414580620 915259 BN14414580620 FR915259 |
| description | refrigeration gasket profile 9794 W 450mm L 613mm plug size | | |

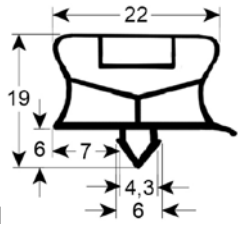

| | | | |
|--------------------|--|-----------------|--|
| GEV No. | 900612 | Ref. No. | 4500651 975004 FR4500651 FR975004 |
| description | refrigeration gasket profile 9794 W 755mm L 1820mm plug size | | |

profile 9794Z (blast freezer)

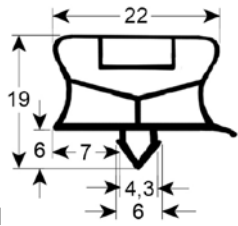

| | | | |
|--------------------|---|-----------------|--|
| GEV No. | 901800 ¹ | Ref. No. | 4501512 996457 FR4501512 FR996457 |
| description | blast freezer gasket profile 9794Z W 847mm L 685mm for blast chiller suitable for FRIULINOX | | |
| For models: | 120, 122, PBC121DF-ASX-203512AS, PBC122DF-ASX-223512AS, PRC120AF-ASX-203530AS | | |

¹for blast freezer

profile 9195

We offer custom-made gaskets for this profile

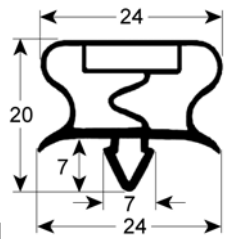

| | | | |
|--------------------|---|-----------------|--------------------|
| GEV No. | 902435 | Ref. No. | 996453 FR996453 |
| description | refrigeration gasket profile 9195 W 400mm L 690mm | | |
| For models: | PBC051DF-ASX-203505AS, PBF051-AFST-AB-5GN11-BF-PDX-203626AD | | |

gaskets for heated units

door seals

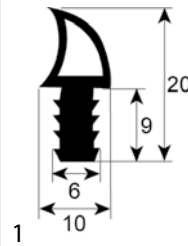

| | | | |
|--------------------|--|-----------------|----------------------|
| GEV No. | 900829 | Ref. No. | 2510674 BN2510674 |
| description | door seal profile 2741 Qty supplied by meter | | |

O-rings

EPDM

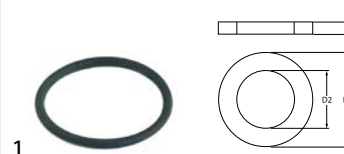

| | | | |
|--------------------|---|-----------------|---------|
| GEV No. | 504561 | Ref. No. | 8217550 |
| description | O-ring EPDM thickness 2.62mm ID ø 29.82mm Qty 1 pcs | | |

sealing cords

round



| | | | |
|--------------------|--|-----------------|---------|
| GEV No. | 691631 | Ref. No. | A098400 |
| description | sealing cord round ø 16mm braided L 1m Qty 1 | | |

evaporators

for fridges

producer-specific



| | | | |
|--------------------|------------|-----------------|------------------------------|
| GEV No. | 750267 | Ref. No. | 14330309240 BN14330309240 |
| description | evaporator | | |



1

| | | | |
|--------------------|--|-----------------|----------------------------|
| GEV No. | 750271 | Ref. No. | 1433070702 BN1433070702 |
| description | evaporator | | |
| For models: | SABT70-2017170208EB, SATN70-201707020994, SATN72-BA-SE-201707020997, SATNN70-2017070208EA, SATNN72-BA-SE-2017070208RX, SATNV70-BASE-201707020995, SBT70A, SBT72A, SBTV70A, STN70A, STN72A, STNN70A, STNN70A-2017070208EA, STNN72A, STNV70A | | |



1

| | | | |
|--------------------|--|-----------------|------------------------------|
| GEV No. | 750386 | Ref. No. | 14330210187 BN14330210187 |
| description | evaporator L 350mm W 90mm H 375mm Dmm overall width 395mm connection 3/8"mm mounting distance 1 350mm | | |
| For models: | KTAP00, KTAP00-BASE-20220501062N, KTAP00BT-BASE-2022550105KR, KTAP01, KTAP01-BASE-20220901044U, KTAP01BT-BASE-2022590105KU, KTAP02, KTAP02-20221301P0201, KTAP02-BASE-20221301048K, KTAP02BT-BASE-2022630105KW, KTAP02-ESP45300-20221301P0202, KTAP03, KTAP03-BASE-2022180109UA, KTAP03BT-BASE-2022680109UW, KTAP04, KTAP04-BASE-2022230109RY, KTAP902, KTAPBT00, KTAPBT01, KTAPBT02, KTAPBT03, KTAPBT902, KTAR01N, KTAR02N, KTAR03, KTAR03-BA-SE-2020180105, KTAR03N, KTAR03N-BASE-202018050441, KTAR04, KTAR04N, KTAR04N-BASE-2020230508V7, KTARS35-2024180104HC | | |



1

| | | | |
|--------------------|--|-----------------|---|
| GEV No. | 750305 | Ref. No. | 14330070134 935879 BN14330070134 BN14330070334 FR935879 |
| description | evaporator L 300mm W 195mm H 235mm | | |
| For models: | KSA105-35-2045150C0R, KSA105-35-2045260CC0, KSA70-70-2045770BYH, KSA70-70-2045770CJ5, KSA70-70PBT-2045800C0U, KSA70-70PBT-2045800CJ8, KSA70-70PTN-2045790C0T, KSA70-70PTN-2045790CJ7, KSA70BT-204517, KSA70BT-2045170BYL, KSA70BT-2045170C0Z, KSA70BT-2045170CAA, KSA70P-204527, KSA70P-2045270C0W, KSA70TN-204507, KSA70TN-2045070B5E, KSA70TN-2045070C6A, KSA70TN-2045070CA9, KSAC105-35-2045160C0S, KSAC70-70-2045780BRL, KSAC70-70-2045780CJ6, KSAP105-35-2045250CC1, KSAP35-35-2045450CBT, KSAPC35-35-2045460CBU, NFB0072FN, NFB0072NI, NFB0072NN, NFB0072PF, NFB0072PN, NFB0072PP, NFB0140NF, NFB0140NI, NFB0143FN, NFB0143NF, NFB0143NN, NFB0143PF, NFB0143PN, NFS0072FG, NFS140IF, NFS140IN, NFS140NF, NFS140NP, NFS140PN, NFS143FN, NFS143IF, NFS143IN, NFS143PN, NFS72FI, NFS72FN, NFS72NI...(Other models you can see in the webshop) | | |



1

| | | | |
|--------------------|---|-----------------|---|
| GEV No. | 750269 | Ref. No. | 14330210171 14330210179 14330210186 BN14330210179 BN14330210186 |
| description | evaporator L 350mm W 90mm H 375mm overall width 400mm connection 3/8"mm mounting distance 1 350mm with boiler | | |
| For models: | KTAP00, KTAP01, KTAP02, KTAP03, KTAP04, KTAR00, KTAR01, KTAR01-BASE-20201001, KTAR01N, KTAR01N-BASE-20201005043V, KTAR02, KTAR02N, KTAR02N-BASE-20201305043Y, KTAR03, KTAR03-BASE-2020180105, KTAR03N, KTAR03N-BASE-202018050441, KTAR04, KTAR04N, KTAR04N-BASE-2020230508V7, KTAR902, KTARBT02, KTARBT02-205101, KTARBT02-205102, KTARBT02-205103, KTARBT02-BASE-2025130104FU, KTARBT03, KTARBT03-BASE-2025180104FW, KTARBT04, KTARBT04-BASE-2025230104FZ, KTARBT902, KTARS24, KTARS24-202413010480, KTARS35, KTARS35-2024180104HC, TSP00, TSP00-BASE-202606010BRU, TSP01, TSP01-BASE-202611010BRY, TSP02, TSP02-BASE-202615010BS8, TSP03, TSP03-BASE-202620010BSK, TSR01, TSR01-BASE-20210801, TSR01-BASE-202108010BPA, TSR02, TSR02-202113010BGO, TSR03, TSR03-BASE-202117010BGK...(Other models you can see in the webshop) | | |



1

| | | | |
|--------------------|---|-----------------|------------------------------|
| GEV No. | 750306 | Ref. No. | 14330210175 BN14330210175 |
| description | evaporator L 380mm W 75mm H 270mm | | |
| For models: | KTAR01, KTARS21-2124100021, TARS21, TARS21-2124100021, TARS21-2124100022, TARS21-2124100023, TARS22E-2124091022, TARS22EP-2124091023, TARS22ES-2124091022 | | |



1

| | | | |
|--------------------|--|-----------------|--|
| GEV No. | 750292 | Ref. No. | 14330210167 14330210168 14330210169 BN14330210167 BN14330210168 BN14330210169 |
| description | evaporator L 400mm W 70mm H 390mm | | |
| For models: | KTAP02-600-20221205CN, KTAP03-600-20221705CM, KTAR03-600-BASE-20201705DD | | |



1

| | | | |
|--------------------|---|-----------------|--|
| GEV No. | 750104 | Ref. No. | 14330570134 935869 BN14330570134 FR935869 |
| description | evaporator L 410mm W 120mm H 490mm complete with fan | | |
| For models: | AFB-70-20171707G, AFB-70Sx-20171707GXPS, AFN-70-20170707G, AFN-70ESx-20173707GXPS, ARCO-BT70-20171704, ARCO-BT70430-20171705, ARCO-BT70-BASE-20171708, ARCO-BT70GN2-1-2017817304, ARCO-BT70-PLUS-20171709, ARCO-TN70-2017807304, ARCO-TN7070-20177704, ARCO-TNBT7070-20177804, ARCO-TNN70-20170706, B100, B120, BT60, BT70, BT72, BTV70, NFB0070F, NFB0070N, NFB0072F, NFB0072N, NORD-700BT-2017817305, NORD-700BT-2017817305P, NORD-700TNN-2017807305, NORD-700TNN-2017807305P, SPA60TN-201706030C16, SPA60TNV-201706030CC2, SPA70-70TN-BT-201778030BYA, SPA70-70TN-TN-201777030BY8, SPA70TN-20170703, SPAB100-201706030CBR, SPAB120-201707030CBS, SPABT120-20172203, SPABT120-201722030C1E, SPABT120-201722030C1F, SPABT120-201722030C1G, SPABT60-20171603, SPABT60-201716030C19, SPABT60-201716030C1A, SPABT60-201716030C1B, SPABT70-20171703, SPABT70-201717030BY7, SPABT70-20171707, SPABT72-201717030C14, SPABTV70-201717030C1C, SPATN60-20170603, SPATN60-RPPC-20174603, SPATN60-RPPC-201746030CMF...(Other models you can see in the webshop) | | |



1

| | | | |
|--------------------|---|-----------------|------------------------------|
| GEV No. | 750103 | Ref. No. | 14330570135 BN14330570135 |
| description | evaporator L 410mm W 120mm H 490mm IN 53W / OUT 10W complete with fan | | |
| For models: | AFN-70E-20173707G, AFN-70ESx-20173707GXPS, ARCO-TN70-20170704, ARCO-TN70430-20170705, ARCO-TN7070-201777040GL70, ARCO-TN70-BASE-20170708, ARCO-TN70-PLUS-20170709, NFB0070P, NFB0072P | | |



1

| | | | |
|--------------------|---|-----------------|------------------------------|
| GEV No. | 750366 | Ref. No. | 14330540140 BN14330540140 |
| description | evaporator L 430mm W 140mm H 230mm | | |
| For models: | P140TN-2047200101, P140TNV-2047240101, S140TN-2048200101, T140BT-2046220100, T140TNV-2046240100 | | |



1

| | | | |
|--------------------|--|-----------------|----------------------------|
| GEV No. | 750362 | Ref. No. | 1433110401 BN1433110401 |
| description | evaporator L 435mm W 405mm H 120mm complete with fan | | |
| For models: | KC25-45-20050710, KC2545-20050710, KCTN2545-20030725, KCTN3535-20030735, KPTN25-45-20040720, KPTN2545-20040720, KPTN3535-20040730, KUC25-45-20150710, KUC2545-20150710, KU-CTN2545-20130710, KUCTN3535-20130720, KUPTN2545-20140710, KUPTN35-35-20140730, KUPTN3535-20140730, TN70, TN72 | | |



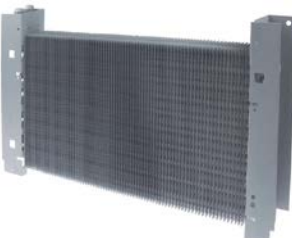

1

| | | | |
|--------------------|--|-----------------|------------------------------|
| GEV No. | 750268 | Ref. No. | 14330312410 BN14330312410 |
| description | evaporator L 500mm W 70mm H 160mm | | |
| For models: | SABT70-BASE-20196701ZW, SABT70-SINGLE-DOOR-20196700HC, SABT72-BASE-201967202BW, SATN140-BASE-20196400KF, SATN140-BASE-201964013Z, SATN144-BASE-201964402BZ, SATN70-BASE-20195700F9, SATN70-BASE-2019570117, SATN72-BASE-201957202BM, SATNBT3535-BASE-20193603CV, SATNBT7070-BASE-201967803CU, SATNTN3535-BASE-20193503CP, SATNTN7070-BASE-201967703CT, SBT70A-201967, SBT70A-20196700HC, SBT70AT-201967T, SBT72A-201967, SBTV70A-201967, SC7070A-2019678, SCTN7070A-2019677, STN140, STN140A-201964, STN140A-20196400KF, STN140-BASE-20191400KF, STN144A-201964, STN70, STN70A-201957, STN70A-20195700F9, STN70-BASE-20190700F9, STN72A-201957, STNV140, STNV140A-201964, STNV70, STNV70A-201957 | | |

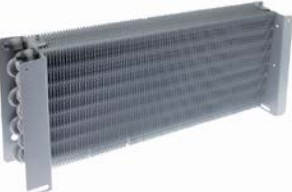

1

| | | | |
|--------------------|-----------------------------------|-----------------|------------------------------|
| GEV No. | 750363 | Ref. No. | 14330210292 BN14330210292 |
| description | evaporator L 520mm W 60mm H 300mm | | |



1

| | | | |
|--------------------|-----------------------------------|-----------------|---------------------------------|
| GEV No. | 750239 | Ref. No. | 935613 FR6524980 FR935613 |
| description | evaporator L 535mm W 95mm H 210mm | | |



1

| | | | |
|--------------------|--|-----------------|------------------------------|
| GEV No. | 750547 | Ref. No. | 14330540134 BN14330540134 |
| description | evaporator L 550mm W 400mm H 115mm suitable for POLARIS | | |
| For models: | AFB-140-20172407G, AFN-140E-20173407G, ARCO-BT140-20172404, ARCO-BT140-20172405, ARCO-BT140-BASE-20172408, ARCO-BT140GN2-1-2017824301, ARCO-BT140-PLUS-20172409, ARCO-TN140-BASE-20171408, ARCO-TN140-PLUS-20171409, ARCO-TN140-20171404, ARCO-TN140-2017814301, ARCO-TN140430-20171405, ARCO-TNN140-20171406, B200, B240, BT140, NFB0140F, NFB0140N, NFB0140P, NFB0144F, NFB0144N, NFB0144P, SPA120TN-201712030C17, SPA120TN-201712030C18, SPA120TNV-201712030CC3, SPAB200-201712030CBP, SPAB240-201714030CBQ, SPABT120-201722030C1E, SPABT120-201722030C1F, SPABT120-201722030C1G, SPABT140-20172403, SPABT140-201724030BW2, SPABT140-201724030C15, SPABT140-201724030C54, SPABT140-20172407, SPATN120-20171203, SPATN120-RPPC-20174203, SPATN120-RPPC-201742030CMG, SPATN120-RPPC-201742030CML, SPATN140-201714030C13, SPATN140-201714030CA8, SPATN140-20171407, SPATN140-20173403, SPATN140-201734030CMH, SPATN140-201734030CMM, SPATN140-RPPC-20173407, SPATNN140-201714030C12, TN120, TN140, TNN140... (Other models you can see in the webshop) | | |

evaporation and condensing trays

evaporation trays



1

| | | | |
|--------------------|--|-----------------|------------------------|
| GEV No. | 694334 | Ref. No. | 32107060 BN32107060 |
| description | evaporation tray L 450mm W 595mm for fridge | | |
| For models: | KC6060-20091430, KC9030-20091420, KCTN6060-20091410, KP60-20100710, KPC9030-20101410, KTN120, KTN120-20071410, KTN122-200714011U, KTN122-20071420, KTN60-20070710, KTN60-20070700XE, KTN60-BASE-20070700XE, KTN62-20070700XF, KTNV120, KTNV60-20070700XH | | |





1



| | | | |
|--------------------|---|-----------------|--|
| GEV No. | 750225 | Ref. No. | 1405020090 995605 BN1405020090 FR995605 |
| description | evaporation tray L 520mm W 68mm H 28mm | | |
| For models: | EN02TN-VCR-20208204, KST01TN-205001, KST01TN-VCR-205601, KST02TN-205002, KST02TN-VCR-205602, KST03TN-205003, KST03TN-VCR-205603, KST04TN-205004, KST04TN-VCR-205604, KSTP03-205203, KSTP05TN-205205, KTAP01-205201, KTAP01-205202, KTAP01-205204, KTAP84EN-20228403, KTAR82EN-20208203, KTAR84EN-20208403 | | |

| | | | |
|---|---|-----------------|--|
|  | | | |
| GEV No. | 694346 | Ref. No. | 144501 32107070 BN144501 BN32107070 |
| description | evaporation tray L 600mm W 599mm for evaporator | | |
| For models: | KC105-35-20051440, KC10535-20051440, KC70-70-20051410, KC7070-20051410, KC9030-20091420, KCTN10535-20031440, KCTN7070-20031410, KP140-20041405, KP70-20040710, KPBT70-70-20061410, KPBT7070-20061410, KPC90-30-20101410, KPTN10535-20041440, KPTN70-70-20041410, KPTN7070-20041410, KTN140-20011400WZ, KTN140-20011410, KTN140-BASE-20011400WZ, KTN140-BASE-20011400X0, KTN140-BASE-20011400X1, KTN140-BASE-20011400X2, KTN142-20011400X0, KTN142-20011420, KTN144-20011400X1, KTN144-20011430, KTN3513-200107, KTN3513-20010735, KTN4512-200107, KTN4512-20010745, KTN70-200107003W, KTN70-20010700VF, KTN70-20010710, KTN70-210107, KTN70-BASE-20010700VX, KTN72-200107, KTN72-20010720, KTN72-BASE-20010700VF, KTNV140-20011400X2, KTNV140-20011440, KTNV140-2001440, KTNV70-200107003W, KTNV70-20010730, KTNV70-210107, KUC105-35-20151440, KUC10535-20151440, KUC70-70-20151410, KUC7070-20151410, KUCTN10535-20131440, KUCTN7070-20131410, KUP70-20140750...(Other models you can see in the webshop) | | |

springs

torsion springs

| | | | |
|--|---|-----------------|---|
|  | | | |
| GEV No. | 690272 | Ref. No. | 1412084 BN1412084 |
| description | torsion spring ø 15mm L2 80mm wire gauge ø 2.5mm mounting pos. left L1 27mm L3 16mm | | |
| For models: | 140, 70, AFB-140-20172407G, AFB-70Sx-20171707GXPS, AFN-140E-20173407G, AFN-70ESx-20173707GXPS, AP-140-221314XG, AP-70TN-221307XG, ARCO-BT140-20172404, ARCO-BT140-20172405, ARCO-BT140-BASE-20172408, ARCO-BT140GN2-1-2017824301, ARCO-BT140-PLUS-20172409, ARCO-BT70-20171704, ARCO-BT70430-20171705, ARCO-BT70-BASE-20171708, ARCO-BT70-PLUS-20171709, ARCO-TN140-BASE-20171408, ARCO-TN140-PLUS-20171409, ARCO-TN140-20171404, ARCO-TN140-2017814301, ARCO-TN140430-20171405, ARCO-TN70-20170704, ARCO-TN70430-20170705, ARCO-TN7070-20177040GL70, ARCO-TN70-BASE-20170708, ARCO-TN70-PLUS-20170709, ARCO-TNN70-20170706, BT140, BT60, BT70, BT70G, BT72, KSA105-35-2045150C0R, KSA105-35-2045260C0C, KSA140BT-204524, KSA140BT-2045240BYF, KSA140BT-2045240C10, KSA140BT-2045240CAD, KSA140P-204534, KSA140P-2045340C0X, KSA140TN-204514, KSA140TN-2045140B8X, KSA140TN-2045140CAB, KSA140TN-2045140CAC, KSA70-70-2045770BYH, KSA70-70-2045770CJ5, KSA70-70PBT-2045800C0U, KSA70-70PBT-2045800CJ8, KSA70-70PTN-2045790C0T...(Other models you can see in the webshop) | | |
| accessories for | 690272 | | |
|  | GEV No. | 690271 | Ref. No. 1412083 935696 BN1412083 FR935696 |
| torsion spring ø 15mm L2 80mm wire gauge ø 2.5mm mounting pos. right L1 27mm L3 16mm | | | |

| | | | |
|---|---|-----------------|--|
|  | | | |
| GEV No. | 690271 | Ref. No. | 1412083 935696 BN1412083 FR935696 |
| description | torsion spring ø 15mm L2 80mm wire gauge ø 2.5mm mounting pos. right L1 27mm L3 16mm | | |
| For models: | 120, 122, 140, 70, AFB-140-20172407G, AFB-70-20171707G, AFN-140E-20173407G, AFN-70-20170707G, AFN-70E-20173707G, AFN-70ESx-20173707GXPS, AP-140-221314XG, AP-70TN-221307XG, ARCO-BT140-20172404, ARCO-BT140-20172405, ARCO-BT140-BASE-20172408, ARCO-BT140GN2-1-2017824301, ARCO-BT140-PLUS-20172409, ARCO-BT70-20171704, ARCO-BT70430-20171705, ARCO-BT70-BASE-20171708, ARCO-BT70GN2-1-2017817304, ARCO-BT70-PLUS-20171709, ARCO-TN140-BASE-20171408, ARCO-TN140-PLUS-20171409, ARCO-TN140-20171404, ARCO-TN140-2017814301, ARCO-TN140430-20171405, ARCO-TN70-20170704, ARCO-TN70-2017807304, ARCO-TN70430-20170705, ARCO-TN7070-20177040GL70, ARCO-TN70-BASE-20170708, ARCO-TN70-PLUS-20170709, ARCO-TNN70-20170706, BT140, BT60, BT70, BT70G, BT72, KSA105-35-2045150C0R, KSA105-35-2045260C0C, KSA140BT-204524, KSA140BT-2045240BYF, KSA140BT-2045240C10, KSA140BT-2045240CAD, KSA140P-204534, KSA140P-2045340C0X, KSA140TN-204514, KSA140TN-2045140B8X, KSA140TN-2045140CAB...(Other models you can see in the webshop) | | |
| accessories for | 690271 | | |
|  | GEV No. | 690272 | Ref. No. 1412084 BN1412084 |
| torsion spring ø 15mm L2 80mm wire gauge ø 2.5mm mounting pos. left L1 27mm L3 16mm | | | |

valves and tank inlets

shut-off valves

universal

| | | | |
|---|---|-----------------|---------|
|  | | | |
| GEV No. | 540415 | Ref. No. | A022453 |
| description | star handle connection cold total lengthmm mounting pos. shaft diameter 7x7mm ø 55mm 35 built-in depth 22mm | | |

inlet taps

| | | | |
|--|--|-----------------|---------|
|  | | | |
| GEV No. | 514408 | Ref. No. | A022910 |
| description | inlet spout connection 3/8" ET tube ø 12mm projection 58mm overall height 76mm spout height 30mm rotation° | | |



fastening material

nuts

hexagonal nuts

hexagonal nuts metric (without norm)



1

| | | | |
|--------------------|--|-----------------|---------|
| GEV No. | 101345 | Ref. No. | A010820 |
| description | nut thread M15x1 H 3mm WS 19 brass Qty 1 pcs | | |

| | | | |
|---|----|----------------------------------|----|
| A | | | |
| axial fans | 26 | indicator lights | 9 |
| B | | indicator lights (complete) | 10 |
| bar burners | 35 | inlet spouts | 60 |
| C | | inlet taps | 60 |
| cam switches | 8 | L | |
| castors and bumper angles | 44 | lamps | 9 |
| cold air circulating fans (complete) | 30 | M | |
| compressors | 20 | magnetic switches | 9 |
| condensing trays heated | 25 | microswitches | 7 |
| control thermostats | 5 | N | |
| cross flow fans | 31 | nuts | 61 |
| D | | O | |
| defrost timers | 11 | O-rings | 56 |
| door seals | 56 | oven hinges | 41 |
| E | | P | |
| electric accessories | 31 | piezoelectric igniters | 34 |
| electronic controllers | 12 | pilot burners | 33 |
| evaporators | 56 | plug-in gaskets | 47 |
| F | | probes | 17 |
| fans | 26 | programme timers | 10 |
| fastening material | 61 | R | |
| foil heating elements | 5 | refrigeration fans | 27 |
| fridge lamps | 10 | refrigeration gaskets | 47 |
| G | | refrigeration motors universal | 27 |
| gas burners | 35 | refrigeration thermostats | 6 |
| gas nozzles | 36 | relays | 11 |
| gas taps | 32 | rocker/momentary rocker switches | 7 |
| gas thermostats | 32 | S | |
| gaskets for heated units | 56 | safety thermostats | 6 |
| grates | 45 | sealing cords | 56 |
| H | | shelves and shelf rails | 45 |
| heating cables | 5 | shut-off valves | 60 |
| heating cartridges | 5 | solenoid valves | 19 |
| heating elements | 3 | spring assisted hinges | 40 |
| heating elements for bain maries | 3 | switches and momentary switches | 7 |
| heating elements for condensate evaporation | 4 | T | |
| heating elements for defrosting | 3 | temperature probes | 17 |
| heating elements for fryers | 3 | terminals | 31 |
| heating elements for heated cabinets | 4 | thermocouples | 35 |
| heating elements for refrigeration | 3 | thermostats | 5 |
| hexagonal nuts | 61 | timers | 10 |
| I | | transformers | 12 |
| ignition cables | 34 | U | |
| | | universal probes | 17 |

V

valves and tank inlets

60