



**GAS COMPONENTS**



**ELECTRIC COMPONENTS**



**WATER TECHNOLOGY**



**MECHANICAL COMPONENTS**



**TOOLS**

Spare parts suitable for

**PALUX**

Find the complete and up-to-date range of products in our GEV Webshop



# Manufacturer catalogue

The most important spare parts and accessories arranged clearly for every manufacturer

- ✓ Complete product range and all appliance data always up to date in the GEV Webshop
- ✓ Alphabetical Index at the end of the catalogue

## GEV Webshop

[www.gev-online.co.uk](http://www.gev-online.co.uk)

[www.gev-online.com](http://www.gev-online.com)



- 🔍 Add to Favourites
- 🔍 Sign In with email address and usual password
- 🔍 Easy-order – place several items in your basket at the same time
- 🔍 Quick Item search – no login needed

# heating elements

## heating elements for ovens

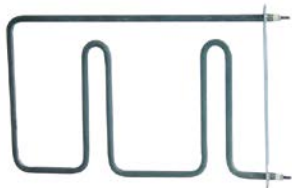

1

<b>GEV No.</b>	416448	<b>Ref. No.</b>	637742
<b>description</b>	heating element 1275W 230V L 325mm W 202mm flange length 225mm flange width 20mm hole distance 219mm tube ø 8.5mm heating circuits 1 hole ø 5.5mm connection M4 mounting pos. lower rectangular flange dry heating element oven		
<b>For models:</b>	541869, 638625		

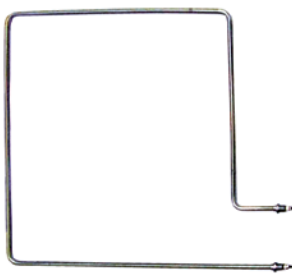

1

<b>GEV No.</b>	415787	<b>Ref. No.</b>	290718
<b>description</b>	heating element 1450W 400V heating circuits 1 L 502mm W 455mm L1 75mm L2 427mm W1 357mm W2 98mm mounting distance 90mm thread M14x1.5 tube ø 8.5mm connection M4 mounting pos. lower-outer 2 hole fixing		
<b>For models:</b>	Maxima-Elektro-Backofen-700-850, Maxima-Elektro-Backofen-850		





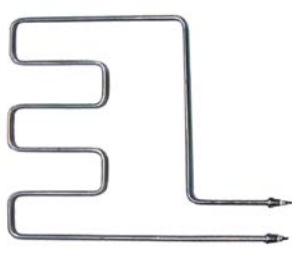

1

<b>GEV No.</b>	415570	<b>Ref. No.</b>	731811
<b>description</b>	heating element 1500W 230V L 470mm W 200mm flange length 225mm flange width 20mm hole distance 214mm tube ø 8.3mm heating circuits 1 hole ø 6mm connection M4 mounting pos. lower rectangular flange dry heating element oven		
<b>For models:</b>	730416		





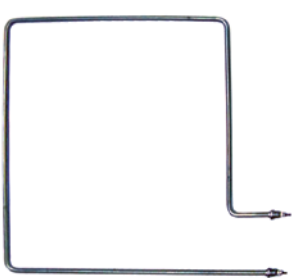

1

<b>GEV No.</b>	415786	<b>Ref. No.</b>	290696	
<b>description</b>	heating element 1500W 380V heating circuits 1 L 432mm W 392mm L1 135mm L2 302mm W1 322mm W2 70mm mounting distance 61mm thread M14x1.5 tube ø 8.6mm connection M4 mounting pos. upper inner dry heating element oven 2 hole fixing			
<b>For models:</b>	Maxima-Elektro-Backofen-700-850, Maxima-Elektro-Backofen-850			
<b>accessories for</b>	415786			
	<b>GEV No.</b>	510417	<b>Ref. No.</b>	—
	flat gasket fibre ED ø 20mm ID ø 14mm thickness 2mm Qty 1 pcs			

<b>accessories for</b>	415786			
	<b>GEV No.</b>	520228	<b>Ref. No.</b>	—
	tooth lock washer ID ø 15.3mm ED ø 24mm steel Qty 1 pcs for thread M14			
	<b>GEV No.</b>	520230	<b>Ref. No.</b>	—
	nut thread M14x1.5 H 5mm WS 19 zinc-coated steel Qty 1 pcs			
	<b>GEV No.</b>	521101	<b>Ref. No.</b>	—
	nut thread M14x1.5 H 5mm WS 19 SS Qty 1 pcs			
	<b>GEV No.</b>	550262	<b>Ref. No.</b>	—
	flat gasket copper ED ø 20mm ID ø 14mm thickness 2mm			



1

<b>GEV No.</b>	415785	<b>Ref. No.</b>	290688	
<b>description</b>	heating element 1500W 380V heating circuits 1 L 505mm W 463mm L1 75mm L2 430mm W1 357mm W2 98mm mounting distance 90mm thread M14x1.5 tube ø 8.5mm connection M4 mounting pos. upper outer dry heating element 2 hole fixing			
<b>For models:</b>	Maxima-Elektro-Backofen-700-850, Maxima-Elektro-Backofen-850			
<b>spare parts for</b>	415785			
	<b>GEV No.</b>	510417	<b>Ref. No.</b>	—
	flat gasket fibre ED ø 20mm ID ø 14mm thickness 2mm Qty 1 pcs			
<b>accessories for</b>	415785			
	<b>GEV No.</b>	520228	<b>Ref. No.</b>	—
	tooth lock washer ID ø 15.3mm ED ø 24mm steel Qty 1 pcs for thread M14			
	<b>GEV No.</b>	520230	<b>Ref. No.</b>	—
	nut thread M14x1.5 H 5mm WS 19 zinc-coated steel Qty 1 pcs			
	<b>GEV No.</b>	521101	<b>Ref. No.</b>	—
	nut thread M14x1.5 H 5mm WS 19 SS Qty 1 pcs			
	<b>GEV No.</b>	550262	<b>Ref. No.</b>	—
	flat gasket copper ED ø 20mm ID ø 14mm thickness 2mm			

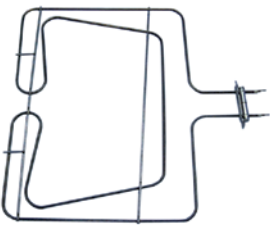





<b>GEV No.</b>	415995	<b>Ref. No.</b>	150673
<b>description</b>	heating element 1500W 400V heating circuits 1 L 460mm W 484mm L1 107mm L2 360mm W1 211mm W2 62mm flange length 104mm flange width 32mm hole distance 96/39mm hole ø 4mm tube ø 6.4mm connection male faston 6.3mm connection length 51mm tilt flange dry heating element		
<b>For models:</b>	00068x, 00099x, 00121x, 00149x, 00183x, 001864, 002046, 002682, 003131, 00314x, 750026, 750034, 750042, 750050, 750069, 750077, 750085, 750093, 750107, 750115		

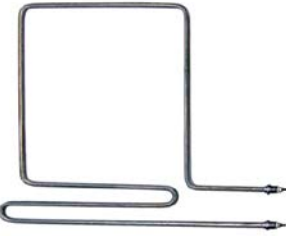







<b>GEV No.</b>	415810	<b>Ref. No.</b>	290750
<b>description</b>	heating element 1500W 400V heating circuits 1 L 495mm W 635mm L1 75mm L2 420mm W1 515mm W2 120mm mounting distance 100mm thread M14x1.5 tube ø 8.5mm connection M4 mounting pos. upper outer 2 hole fixing		
<b>For models:</b>	Maxima-Elektro-Backofen-700-850, Maxima-Elektro-Backofen-850		



<b>GEV No.</b>	415788	<b>Ref. No.</b>	290726
<b>description</b>	heating element 1700W 380V heating circuits 1 L 475mm W 386mm L1 140mm L2 295mm L3 40mm W1 320mm W2 66mm mounting distance 58mm thread M14x1.5 tube ø 8.5mm connection M4 mounting pos. lower-inner dry heating element 2 hole fixing		
<b>For models:</b>	Maxima-Elektro-Backofen-700-850, Maxima-Elektro-Backofen-850		
<b>accessories for</b>	415788		
	<b>GEV No.</b>	510417	<b>Ref. No.</b> —
	flat gasket fibre ED ø 20mm ID ø 14mm thickness 2mm Qty 1 pcs		
	<b>GEV No.</b>	520228	<b>Ref. No.</b> —
	tooth lock washer ID ø 15.3mm ED ø 24mm steel Qty 1 pcs for thread M14		
	<b>GEV No.</b>	520230	<b>Ref. No.</b> —
	nut thread M14x1.5 H 5mm WS 19 zinc-coated steel Qty 1 pcs		
	<b>GEV No.</b>	521101	<b>Ref. No.</b> —
	nut thread M14x1.5 H 5mm WS 19 SS Qty 1 pcs		

<b>accessories for</b>	415788		
	<b>GEV No.</b>	550262	<b>Ref. No.</b> —
	flat gasket copper ED ø 20mm ID ø 14mm thickness 2mm		



<b>GEV No.</b>	415812	<b>Ref. No.</b>	290777
<b>description</b>	heating element 1700W 400V heating circuits 1 L 495mm W 635mm L1 75mm L2 420mm W1 515mm W2 120mm mounting distance 110mm thread M14x1.5 tube ø 8.5mm connection M4 mounting pos. lower-outer dry heating element 2 hole fixing		
<b>For models:</b>	Maxima-Elektro-Backofen-700-850, Maxima-Elektro-Backofen-850		
<b>accessories for</b>	415812		
	<b>GEV No.</b>	510417	<b>Ref. No.</b> —
	flat gasket fibre ED ø 20mm ID ø 14mm thickness 2mm Qty 1 pcs		
	<b>GEV No.</b>	520228	<b>Ref. No.</b> —
	tooth lock washer ID ø 15.3mm ED ø 24mm steel Qty 1 pcs for thread M14		
	<b>GEV No.</b>	520230	<b>Ref. No.</b> —
	nut thread M14x1.5 H 5mm WS 19 zinc-coated steel Qty 1 pcs		
	<b>GEV No.</b>	521101	<b>Ref. No.</b> —
	nut thread M14x1.5 H 5mm WS 19 SS Qty 1 pcs		
	<b>GEV No.</b>	550262	<b>Ref. No.</b> —
	flat gasket copper ED ø 20mm ID ø 14mm thickness 2mm		

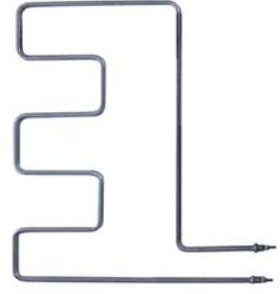









<b>GEV No.</b>	415811	<b>Ref. No.</b>	290769
<b>description</b>	heating element 1700W 400V L 447mm W 540mm L1 137mm L2 310mm W1 474mm W2 66mm mounting distance 58mm thread M14x1.5 tube ø 8.5mm connection M4 mounting pos. upper inner 2 hole fixing		
<b>For models:</b>	Maxima-Elektro-Backofen-700-850, Maxima-Elektro-Backofen-850		
<b>accessories for</b>	415811		
	<b>GEV No.</b>	510417	<b>Ref. No.</b> —
	flat gasket fibre ED ø 20mm ID ø 14mm thickness 2mm Qty 1 pcs		
	<b>GEV No.</b>	520228	<b>Ref. No.</b> —
	tooth lock washer ID ø 15.3mm ED ø 24mm steel Qty 1 pcs for thread M14		

Table continues overleaf





<b>accessories for</b>	415811		
	GEV No.	520230	Ref. No. —
	nut thread M14x1.5 H 5mm WS 19 zinc-coated steel Qty 1 pcs		
	GEV No.	521101	Ref. No. —
	nut thread M14x1.5 H 5mm WS 19 SS Qty 1 pcs		
	GEV No.	550262	Ref. No. —
	flat gasket copper ED ø 20mm ID ø 14mm thickness 2mm		

<b>accessories for</b>	416447		
	GEV No.	520228	Ref. No. —
	tooth lock washer ID ø 15.3mm ED ø 24mm steel Qty 1 pcs for thread M14		
	GEV No.	521101	Ref. No. —
	nut thread M14x1.5 H 5mm WS 19 SS Qty 1 pcs		
	GEV No.	550262	Ref. No. —
	flat gasket copper ED ø 20mm ID ø 14mm thickness 2mm		

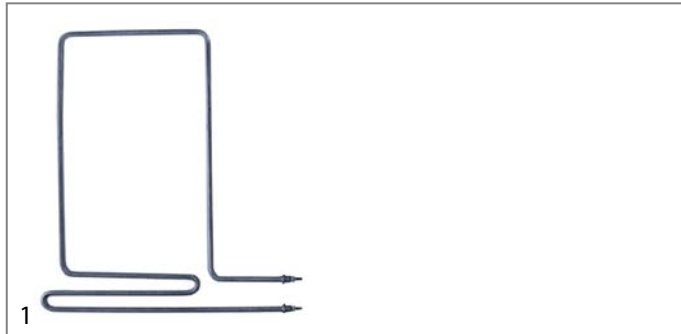

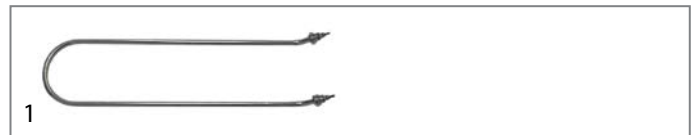

<b>GEV No.</b>	415813	<b>Ref. No.</b>	290785
<b>description</b>	heating element 1950W 400V heating circuits 1 L 467mm W 520mm L1 140mm L2 290mm L3 37mm W1 465mm W2 55mm mounting distance 45mm thread M14x1.5 tube ø 8.5mm connection M4 mounting pos. lower-inner dry heating element 2 hole fixing		
<b>For models:</b>	Maxima-Elektro-Backofen-700-850, Maxima-Elektro-Backofen-850		
<b>accessories for</b>	415813		
	GEV No.	510417	Ref. No. —
	flat gasket fibre ED ø 20mm ID ø 14mm thickness 2mm Qty 1 pcs		
	GEV No.	520228	Ref. No. —
	tooth lock washer ID ø 15.3mm ED ø 24mm steel Qty 1 pcs for thread M14		
	GEV No.	521101	Ref. No. —
	nut thread M14x1.5 H 5mm WS 19 SS Qty 1 pcs		
	GEV No.	550262	Ref. No. —
	flat gasket copper ED ø 20mm ID ø 14mm thickness 2mm		

heating elements for bain maries

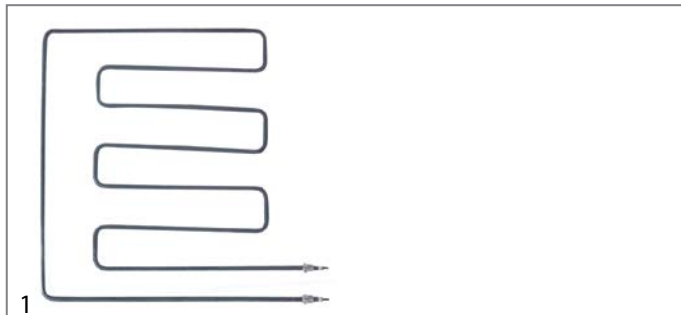

<b>GEV No.</b>	415420	<b>Ref. No.</b>	290653
<b>description</b>	heating element 1500W 220V heating circuits 1 L 443mm W 114mm connection M4 tube ø 8.5mm 2 hole fixing thread M14x1.5 H 22mm mounting distance 105mm		
<b>For models:</b>	Maxima-Elektro-Bain-Marie-700-850, Maxima-Elektro-Bain-Marie-850		
<b>accessories for</b>	415420		
	GEV No.	510417	Ref. No. —
	flat gasket fibre ED ø 20mm ID ø 14mm thickness 2mm Qty 1 pcs		
	GEV No.	520228	Ref. No. —
	tooth lock washer ID ø 15.3mm ED ø 24mm steel Qty 1 pcs for thread M14		
	GEV No.	520230	Ref. No. —
	nut thread M14x1.5 H 5mm WS 19 zinc-coated steel Qty 1 pcs		
	GEV No.	521101	Ref. No. —
	nut thread M14x1.5 H 5mm WS 19 SS Qty 1 pcs		
	GEV No.	550262	Ref. No. —
	flat gasket copper ED ø 20mm ID ø 14mm thickness 2mm		



<b>GEV No.</b>	416447	<b>Ref. No.</b>	637734
<b>description</b>	heating element 2450W 230V heating circuits 1 L 495mm W 510mm L1 65mm L2 430mm W1 440mm W2 70mm mounting distance 62mm thread M14x1.5 tube ø 8.5mm connection M4 mounting pos. upper dry heating element 2 hole fixing		
<b>For models:</b>	541869, 638625		
<b>accessories for</b>	416447		
	GEV No.	510417	Ref. No. —
	flat gasket fibre ED ø 20mm ID ø 14mm thickness 2mm Qty 1 pcs		

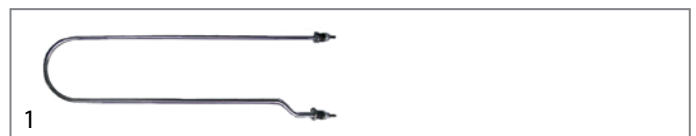









<b>GEV No.</b>	415421	<b>Ref. No.</b>	290661
<b>description</b>	heating element 1500W 220V heating circuits 1 L 445mm W 135mm connection M4 tube ø 8.5mm 2 hole fixing thread M14x1.5 immersion heater L1 20mm L2 50mm L3 380mm W1 20mm W2 117mm mounting distance 129mm		
<b>For models:</b>	Maxima-Elektro-Bain-Marie-700-850, Maxima-Elektro-Bain-Marie-850		
<b>spare parts for</b>	415421		
	GEV No.	510407	Ref. No. —
	flat gasket fibre ED ø 78mm ID ø 60mm thickness 2mm for heating element for thread 2" Qty 1 pcs		
<b>accessories for</b>	415421		
	GEV No.	510417	Ref. No. —
	flat gasket fibre ED ø 20mm ID ø 14mm thickness 2mm Qty 1 pcs		
	GEV No.	520228	Ref. No. —
	tooth lock washer ID ø 15.3mm ED ø 24mm steel Qty 1 pcs for thread M14		

Table continues overleaf





<b>accessories for</b>	415421		
	GEV No.	520230	Ref. No. —
	nut thread M14x1.5 H 5mm WS 19 zinc-coated steel Qty 1 pcs		
	GEV No.	521101	Ref. No. —
	nut thread M14x1.5 H 5mm WS 19 SS Qty 1 pcs		
	GEV No.	521103	Ref. No. —
	nut thread M4 H 3mm WS 7 brass Qty 20 pcs		
	GEV No.	521104	Ref. No. —
	washer ID ø 4.3mm ED ø 8mm thickness 0.5mm brass Qty 20 pcs for thread M4		
	GEV No.	550262	Ref. No. —
	flat gasket copper ED ø 20mm ID ø 14mm thickness 2mm		
	GEV No.	560111	Ref. No. —
	plain washer ID ø 4.3mm ED ø 9mm thickness 0.8mm SS Qty 20 pcs DIN 125A for thread M4		
	GEV No.	560131	Ref. No. —
	hexagonal nut thread M4 H 3.2mm WS 7 SS DIN/ISO DIN 934 / ISO 4032/8673 Qty 20 pcs		

	1		
<b>GEV No.</b>	415434	<b>Ref. No.</b>	056928
<b>description</b>	heating element 1500W 230V heating circuits 1 L 342mm W 79mm connection length 14mm connection male faston 6.3mm tube ø 8.5mm 2 hole fixing thread M14x1.5 immersion heater H 29mm mounting distance 72mm		
<b>For models:</b>	614009, 614106, 614404, 624004, 624101, 627100, Bain-Marie-614, Bain-Marie-624, Bain-Marie-626		
<b>accessories for</b>	415434		
	GEV No.	510417	Ref. No. —
	flat gasket fibre ED ø 20mm ID ø 14mm thickness 2mm Qty 1 pcs		
	GEV No.	520228	Ref. No. —
	tooth lock washer ID ø 15.3mm ED ø 24mm steel Qty 1 pcs for thread M14		
	GEV No.	520230	Ref. No. —
	nut thread M14x1.5 H 5mm WS 19 zinc-coated steel Qty 1 pcs		
	GEV No.	521101	Ref. No. —
	nut thread M14x1.5 H 5mm WS 19 SS Qty 1 pcs		
	GEV No.	550262	Ref. No. —
	flat gasket copper ED ø 20mm ID ø 14mm thickness 2mm		

## heating elements for frying pans

	1		
<b>GEV No.</b>	416898	<b>Ref. No.</b>	501808
<b>description</b>	heating element 1600W 230V L 435mm W 110mm connection male faston 6.3mm tube ø 6.3mm H 93mm connection distance 104mm		
<b>For models:</b>	502650, 688290, Vario-Braeter-400		

	1		
<b>GEV No.</b>	417650	<b>Ref. No.</b>	501816
<b>description</b>	heating element 3500W 230V heating circuits 1 L 430mm W 245mm connection male faston 6.3mm tube ø 6.3mm 2. generation		
<b>For models:</b>	502707, 686328, Vario-Braeter-600		

	1		
<b>GEV No.</b>	416899	<b>Ref. No.</b>	501816 old
<b>description</b>	heating element 3500W 230V heating circuits 1 L 430mm W 245mm connection male faston 6.3mm tube ø 8.5mm 1. generation		

	1		
<b>GEV No.</b>	416902	<b>Ref. No.</b>	516392
<b>description</b>	heating element 4500W 230V		
<b>For models:</b>	516678, 639087, 699063, Vario-Braeter-plus		





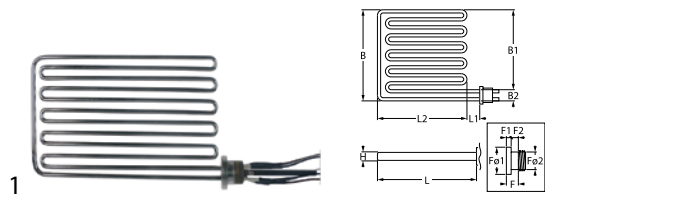

**heating elements for fryers**

**side connection**





**with thread**



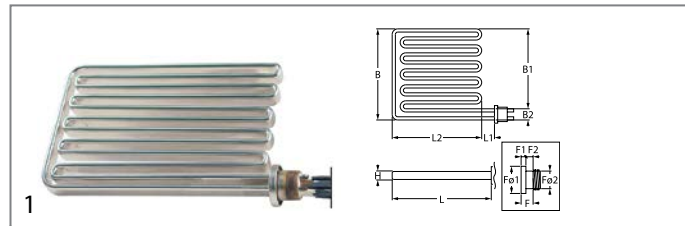



<b>GEV No.</b>	416909	<b>Ref. No.</b>	100056 257001
<b>description</b>	heating element 6000W 230/400V heating circuits 3 L 300mm W 185mm H 22mm flange length 20mm flange length 1 9mm flange length 2 11mm flange ø1 51mm flange ø2 36mm thermostat sleeves ø 4mm length thermostat sleeves 280/300mm number of thermostat sleeves 2 L1 15mm L2 285mm W1 162mm W2 23mm thread M36x1.5 windings 5 cable length 650mm rotation flange immersion heater for fryer/pasta cooker		
<b>For models:</b>	502200, 502308, 601004, 601209, 601403, 602000, 602205, 602280, 603201, 649554, 649562, 650943, 650951, 686336, 688339, 688347, 688355, 721468, 722588, Fritteuse-365, Topline-Friteuse		
<b>accessories for</b>	416909		
	<b>GEV No.</b>	521004	<b>Ref. No.</b> 264849
	hexagonal nut thread M36x1.5 WS 46 H 14mm brass		
	<b>GEV No.</b>	550673	<b>Ref. No.</b> 262153
	flat gasket PTFE D1 ø 46mm D2 ø 36/38.2mm thickness 5mm Qty 1 pcs mounting pos. outer		
	<b>GEV No.</b>	550674	<b>Ref. No.</b> 261033
	flat gasket PTFE ED ø 46mm ID ø 36mm thickness 4mm Qty 1 pcs mounting pos. inner		
	<b>GEV No.</b>	692060	<b>Ref. No.</b> 262161
	retaining ring brass H 10mm ID ø 36mm ED ø 50mm		

<b>accessories for</b>	416906		
	<b>GEV No.</b>	692060	<b>Ref. No.</b> 262161
	retaining ring brass H 10mm ID ø 36mm ED ø 50mm		

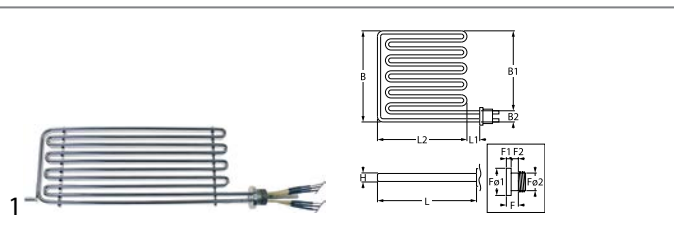

<b>GEV No.</b>	416910	<b>Ref. No.</b>	602051
<b>description</b>	heating element 8000W 230/400V heating circuits 3 L 300mm W 185mm H 22mm flange length 20mm flange length 1 9mm flange length 2 11mm flange ø1 51mm flange ø2 36mm thermostat sleeves ø 4mm length thermostat sleeves 280/300mm number of thermostat sleeves 2 L1 15mm L2 285mm W1 162mm W2 23mm thread M36x1.5 windings 5 cable length 650mm rotation flange immersion heater pasta cooker		
<b>For models:</b>	502200, 502308, 601004, 601209, 601403, 602000, 602205, 602280, 649554, 649562, 650943, 650951, 686336, 688339, 688347, 688355, 699047, 699055, 750255, Fritteuse-365, Topline-Friteuse		
<b>accessories for</b>	416910		
	<b>GEV No.</b>	521004	<b>Ref. No.</b> 264849
	hexagonal nut thread M36x1.5 WS 46 H 14mm brass		
	<b>GEV No.</b>	550673	<b>Ref. No.</b> 262153
	flat gasket PTFE D1 ø 46mm D2 ø 36/38.2mm thickness 5mm Qty 1 pcs mounting pos. outer		
	<b>GEV No.</b>	550674	<b>Ref. No.</b> 261033
	flat gasket PTFE ED ø 46mm ID ø 36mm thickness 4mm Qty 1 pcs mounting pos. inner		
	<b>GEV No.</b>	692060	<b>Ref. No.</b> 262161
	retaining ring brass H 10mm ID ø 36mm ED ø 50mm		



<b>GEV No.</b>	416906	<b>Ref. No.</b>	542326 618411 852716
<b>description</b>	heating element 7000W 230/400V heating circuits 3 mounting pos. left L 458mm W 178mm H 22mm flange length 20mm flange length 1 9.8mm flange length 2 9.7mm flange ø1 51mm flange ø2 36mm thermostat sleeves ø 5.5mm length thermostat sleeves 180/270mm number of thermostat sleeves 2 L1 43mm L2 415mm W1 155mm W2 23mm thread M36x1.5 windings 4 cable length 650mm rotation flange immersion heater for fryer/pasta cooker connection length 75mm		
<b>For models:</b>	503010, 503150, 517887, 637564, 657735, 686298, 688428, 700673, 702560		
<b>accessories for</b>	416906		
	<b>GEV No.</b>	521004	<b>Ref. No.</b> 264849
	hexagonal nut thread M36x1.5 WS 46 H 14mm brass		
	<b>GEV No.</b>	550673	<b>Ref. No.</b> 262153
	flat gasket PTFE D1 ø 46mm D2 ø 36/38.2mm thickness 5mm Qty 1 pcs mounting pos. outer		
	<b>GEV No.</b>	550674	<b>Ref. No.</b> 261033
	flat gasket PTFE ED ø 46mm ID ø 36mm thickness 4mm Qty 1 pcs mounting pos. inner		

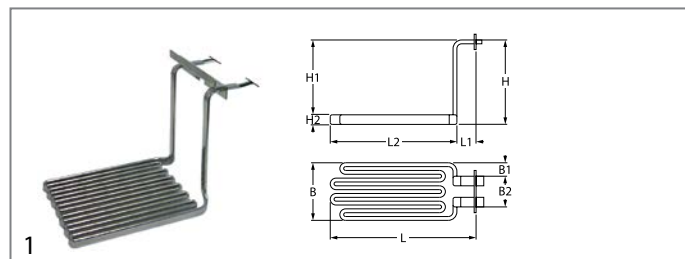



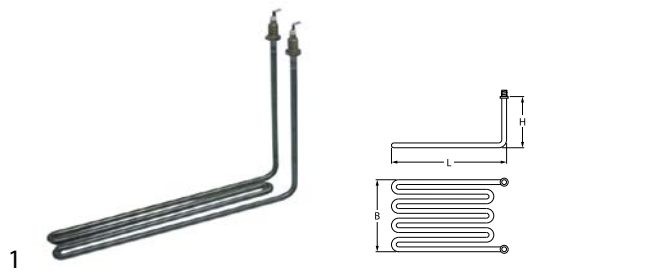

<b>GEV No.</b>	415444	<b>Ref. No.</b>	008591
<b>description</b>	heating element 6000W 230/400V L 272mm W 206mm H 220mm rectangular flange connection cable heating circuits 3 immersion heater L1 20mm L2 252mm hole distance 54mm hole ø 4.5mm flange length 168mm flange width 24mm		
<b>For models:</b>	600008, 600067, 601004, 601209, 601403, 602000, 602205, 602280, 603007, 603023, 603201, Fritteuse-600, Fritteuse-601, Fritteuse-602, Fritteuse-603		

2 hole fixing





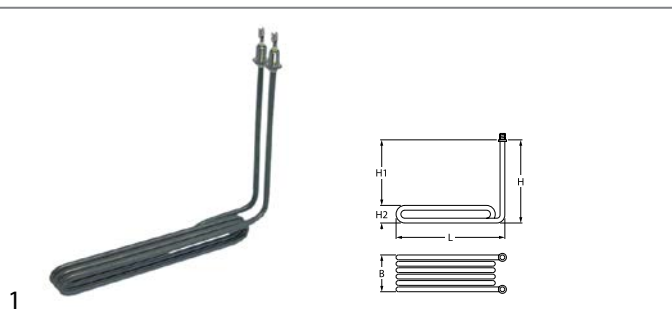

<b>GEV No.</b>	415443	<b>Ref. No.</b>	N/A
<b>description</b>	heating element 2000W 230V heating circuits 1 L 324mm W 62mm H 200mm thread M14x1.5 tube ø 8.5mm windings 2 mounting distance 58mm connection male faston 6.3mm 2 hole fixing fryer heaters		

<b>accessories for</b>	415443			
	<b>GEV No.</b>	510417	<b>Ref. No.</b>	—
	flat gasket fibre ED ø 20mm ID ø 14mm thickness 2mm Qty 1 pcs			
	<b>GEV No.</b>	520228	<b>Ref. No.</b>	—
	tooth lock washer ID ø 15.3mm ED ø 24mm steel Qty 1 pcs for thread M14			
	<b>GEV No.</b>	520230	<b>Ref. No.</b>	—
	nut thread M14x1.5 H 5mm WS 19 zinc-coated steel Qty 1 pcs			
	<b>GEV No.</b>	521101	<b>Ref. No.</b>	—
	nut thread M14x1.5 H 5mm WS 19 SS Qty 1 pcs			
	<b>GEV No.</b>	550262	<b>Ref. No.</b>	—
	flat gasket copper ED ø 20mm ID ø 14mm thickness 2mm			



<b>GEV No.</b>	415591	<b>Ref. No.</b>	150711
<b>description</b>	heating element 2000W 230V heating circuits 1 L 285mm W 40mm H 240mm H1 200mm H2 40mm mounting pos. 20 thread M14x1.5 tube ø 8.5mm mounting distance 20mm windings 3 2 hole fixing connection male faston 6.3mm immersion heater		

<b>For models:</b>	750255, 750263, 750271, 750298			
<b>spare parts for</b>	415591			
	<b>GEV No.</b>	510417	<b>Ref. No.</b>	—
	flat gasket fibre ED ø 20mm ID ø 14mm thickness 2mm Qty 1 pcs			
<b>accessories for</b>	415591			
	<b>GEV No.</b>	520228	<b>Ref. No.</b>	—
	tooth lock washer ID ø 15.3mm ED ø 24mm steel Qty 1 pcs for thread M14			
	<b>GEV No.</b>	520230	<b>Ref. No.</b>	—
	nut thread M14x1.5 H 5mm WS 19 zinc-coated steel Qty 1 pcs			
	<b>GEV No.</b>	521101	<b>Ref. No.</b>	—
	nut thread M14x1.5 H 5mm WS 19 SS Qty 1 pcs			

<b>accessories for</b>	415591			
	<b>GEV No.</b>	550262	<b>Ref. No.</b>	—
	flat gasket copper ED ø 20mm ID ø 14mm thickness 2mm			

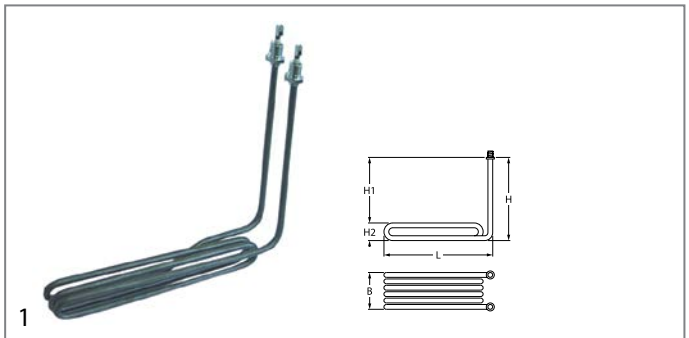

<b>GEV No.</b>	415978	<b>Ref. No.</b>	155268
<b>description</b>	heating element 3000W 230V heating circuits 1 L 288mm W 48mm H 243mm H1 205mm H2 38mm thread M14x1.5 tube ø 8.5mm windings 3 2 hole fixing connection male faston 6.3mm		
<b>For models:</b>	750255, 750263, 750271, 750298		

<b>spare parts for</b>	415978			
	<b>GEV No.</b>	510417	<b>Ref. No.</b>	—
	flat gasket fibre ED ø 20mm ID ø 14mm thickness 2mm Qty 1 pcs			
<b>accessories for</b>	415978			
	<b>GEV No.</b>	510417	<b>Ref. No.</b>	—
	flat gasket fibre ED ø 20mm ID ø 14mm thickness 2mm Qty 1 pcs			
	<b>GEV No.</b>	520228	<b>Ref. No.</b>	—
	tooth lock washer ID ø 15.3mm ED ø 24mm steel Qty 1 pcs for thread M14			
	<b>GEV No.</b>	520230	<b>Ref. No.</b>	—
	nut thread M14x1.5 H 5mm WS 19 zinc-coated steel Qty 1 pcs			
	<b>GEV No.</b>	521101	<b>Ref. No.</b>	—
	nut thread M14x1.5 H 5mm WS 19 SS Qty 1 pcs			
	<b>GEV No.</b>	550262	<b>Ref. No.</b>	—
	flat gasket copper ED ø 20mm ID ø 14mm thickness 2mm			

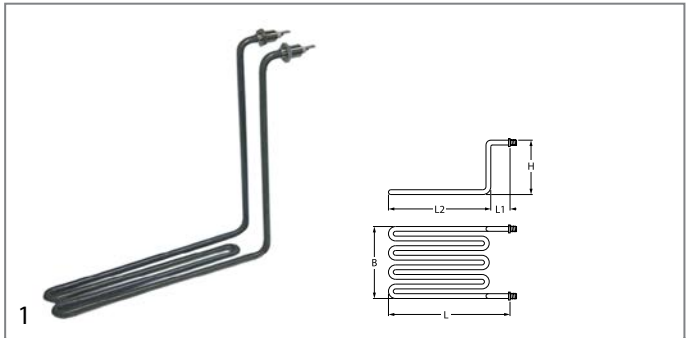

<b>GEV No.</b>	415474	<b>Ref. No.</b>	N/A
<b>description</b>	heating element 1660W 230V heating circuits 1 L 288mm W 66mm H 242mm L1 25mm L2 263mm thread M14x1.5 mounting distance 55mm tube ø 8.5mm windings 2 2 hole fixing connection male faston 6.3mm connection length 18mm immersion heater		







<b>accessories for</b>	415474			
	<b>GEV No.</b>	510417	<b>Ref. No.</b>	—
	flat gasket fibre ED ø 20mm ID ø 14mm thickness 2mm Qty 1 pcs			

Table continues overleaf



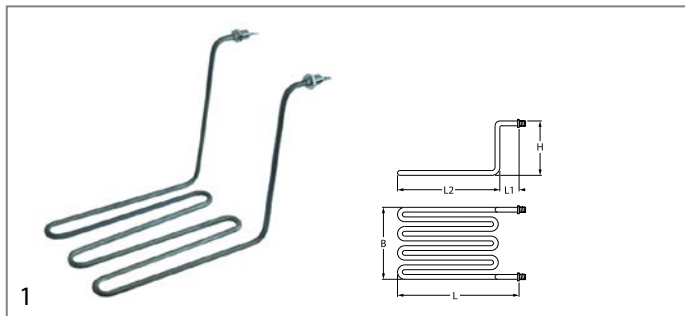



<b>accessories for</b>	415474		
	GEV No.	520228	Ref. No. —
	tooth lock washer ID ø 15.3mm ED ø 24mm steel Qty 1 pcs for thread M14		
	GEV No.	550262	Ref. No. —
	flat gasket copper ED ø 20mm ID ø 14mm thickness 2mm		



<b>GEV No.</b>	415441	<b>Ref. No.</b>	N/A
<b>description</b>	heating element 3000W 230V heating circuits 1 L 294mm W 150mm H 242mm L1 29mm L2 265mm thread M14x1.5 mounting distance 142mm tube ø 8.5mm windings 3 2 hole fixing connection male faston 6.3mm fryer heaters		
<b>accessories for</b>	415441		
	GEV No.	510417	Ref. No. —
	flat gasket fibre ED ø 20mm ID ø 14mm thickness 2mm Qty 1 pcs		
	GEV No.	520228	Ref. No. —
	tooth lock washer ID ø 15.3mm ED ø 24mm steel Qty 1 pcs for thread M14		
	GEV No.	520230	Ref. No. —
	nut thread M14x1.5 H 5mm WS 19 zinc-coated steel Qty 1 pcs		
	GEV No.	521101	Ref. No. —
	nut thread M14x1.5 H 5mm WS 19 SS Qty 1 pcs		
	GEV No.	550262	Ref. No. —
	flat gasket copper ED ø 20mm ID ø 14mm thickness 2mm		

heating elements for griddles



<b>GEV No.</b>	415435	<b>Ref. No.</b>	083577
<b>description</b>	heating element 1500W 220V heating circuits 1 L 425mm W 100mm H 28mm tube ø 9mm 2 hole fixing connection M4 thread M14x1.5 mounting distance 91mm grill dry heating element		
<b>For models:</b>	610003, 610038, 610402, 611018, 611050, 612006, 612057, 613002, 613088, 615005, 615013, 615056, 620009, 621005, 621056, 622001, 622052, 62510, 62520, 62530, Brater-611, Brater-621, Elektro-Waermeschrank, Frittenwanne-615, Griddle-Platte-612, Griddleplatte-622, OEWs1245-einseitig-400x1200mm, OEWs1246-einseitig-mit-Rueckwandverkleidung, sudpfanne-613, UDWE1225L, UDWE1225L-doppelseitig-Eck-640x1200mm, UDWE1225R, UDWE1225R-doppelseitig-Eck-640x1200mm, UDWF0825, UDWF0825D-doppelseitig-640x800mm, UDWs1225, UDWs1225-doppelseitig-640x1200mm, UEFWF0825, UEFWF0825D-einseitig-640x800mm, UEWs06-schubladenblock-640x600mm, UEWs1225, UEWs1225-doppelseitig-640x1200mm, UEWs1225-einseitig-640x1200mm, UGWf0835, UGWf0835D-Fluegeltuer-710x800mm, UGWs1235, UGWs1235-schiebetuer-710x1200mm, Wurstgrill-610, Wurstgrill-620		
<b>spare parts for</b>	415435		
	GEV No.	510417	Ref. No. —
	flat gasket fibre ED ø 20mm ID ø 14mm thickness 2mm Qty 1 pcs		
<b>accessories for</b>	415435		
	GEV No.	520228	Ref. No. —
	tooth lock washer ID ø 15.3mm ED ø 24mm steel Qty 1 pcs for thread M14		
	GEV No.	520230	Ref. No. —
	nut thread M14x1.5 H 5mm WS 19 zinc-coated steel Qty 1 pcs		
	GEV No.	521101	Ref. No. —
	nut thread M14x1.5 H 5mm WS 19 SS Qty 1 pcs		
	GEV No.	550262	Ref. No. —
	flat gasket copper ED ø 20mm ID ø 14mm thickness 2mm		









<b>GEV No.</b>	415434	<b>Ref. No.</b>	056928
<b>description</b>	heating element 1500W 230V heating circuits 1 L 342mm W 79mm connection length 14mm connection male faston 6.3mm tube ø 8.5mm 2 hole fixing thread M14x1.5 immersion heater H 29mm mounting distance 72mm		
<b>For models:</b>	614009, 614106, 614404, 624004, 624101, 627100, Bain-Marie-614, Bain-Marie-624, Bain-Marie-626		
<b>accessories for</b>	415434		
	GEV No.	510417	Ref. No. —
	flat gasket fibre ED ø 20mm ID ø 14mm thickness 2mm Qty 1 pcs		
	GEV No.	520228	Ref. No. —
	tooth lock washer ID ø 15.3mm ED ø 24mm steel Qty 1 pcs for thread M14		
	GEV No.	520230	Ref. No. —
	nut thread M14x1.5 H 5mm WS 19 zinc-coated steel Qty 1 pcs		

Table continues overleaf



<b>accessories for</b>	415434		
	GEV No.	521101	Ref. No. —
	nut thread M14x1.5 H 5mm WS 19 SS Qty 1 pcs		
	GEV No.	550262	Ref. No. —
	flat gasket copper ED ø 20mm ID ø 14mm thickness 2mm		

	1		
<b>GEV No.</b>	415442	<b>Ref. No.</b>	N/A
<b>description</b>	heating element 1500W 230V heating circuits 1 L 400mm W 50mm H 54mm tube ø 8.5mm connection male faston 6.3mm connection length 15mm grill connection distance 42mm dry heating element		

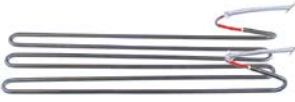
	1		
<b>GEV No.</b>	418218	<b>Ref. No.</b>	148040
<b>description</b>	heating element 1600W 230V L 433mm W 108mm H 56mm tube ø 6.3mm L1 75mm W1 15mm W2 74mm cable length 1100mm connection distance 68mm dry heating element		
<b>For models:</b>	626104, 626112, 626201, 626228, 626309, 626317		

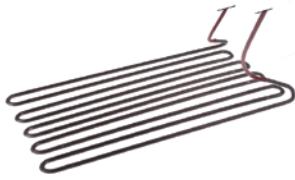
	1		
<b>GEV No.</b>	416896	<b>Ref. No.</b>	147990
<b>description</b>	heating element 3500W 230V heating circuits 1 L 435mm W 240mm H 45mm tube ø 6.3mm L1 50mm W1 33mm W2 175mm dry heating element		
<b>For models:</b>	626104, 626112, 626201, 626228, 626309, 626317, 721476, 721484, 722596, 722618		

### heating elements for large hobs

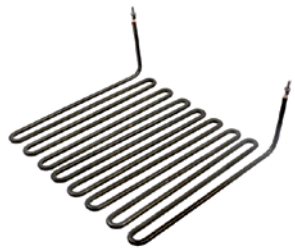
	1		
<b>GEV No.</b>	416894	<b>Ref. No.</b>	602523
<b>description</b>	heating element 3500W 230V heating circuits 1 L 265mm W 260mm H 98mm tube ø 6.25mm mounting pos. connection length 25mm connection M4 connection distance 254mm windings 8 dry heating element		
<b>For models:</b>	505900, 505935, 687200, 690600, Vario-Herd		

### heating elements for chicken rotisseries

	1		
<b>GEV No.</b>	415532	<b>Ref. No.</b>	103691
<b>description</b>	heating element 1000W 230V L 700mm W 64mm Hmm heating circuits 1 connection male faston 6.3mm dry heating element tube ø 6.3mm connection distance 59mm		
<b>For models:</b>	574961, Grill-680		

	1		
<b>GEV No.</b>	415531	<b>Ref. No.</b>	103640
<b>description</b>	heating element 1000W 230V L 725mm W 50mm Hmm heating circuits 1 connection male faston 6.3mm dry heating element tube ø 6.3mm connection distance 46mm		
<b>For models:</b>	Grill-681		

	1		
<b>GEV No.</b>	415533	<b>Ref. No.</b>	101575
<b>description</b>	heating element 1100W 230V L 727mm W 50mm Hmm heating circuits 1 connection M4 dry heating element tube ø 8.6mm connection length 19mm		
<b>For models:</b>	Grill-682, Grill-683		

### heating elements for hot counters

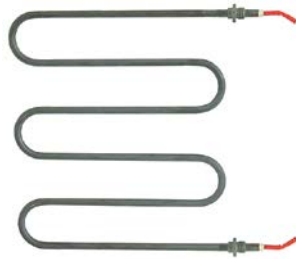
	1		
<b>GEV No.</b>	416510	<b>Ref. No.</b>	371955
<b>description</b>	heating element 1200W 230V heating circuits 1 L 260mm W 284mm connection length 46mm tube ø 8.5mm cable length 480mm dry heating element hot bar 2 hole fixing thread M14x1.5 mounting distance 275mm		
<b>For models:</b>	Heisse-Theke-HT-50-85-und-120-3		

<b>spare parts for</b>	416510		
	GEV No.	550262	Ref. No. —
	flat gasket copper ED ø 20mm ID ø 14mm thickness 2mm		

<b>accessories for</b>	416510		
------------------------	--------	--	--

	GEV No.	510417	Ref. No. —
	flat gasket fibre ED ø 20mm ID ø 14mm thickness 2mm Qty 1 pcs		

	GEV No.	520228	Ref. No. —
	tooth lock washer ID ø 15.3mm ED ø 24mm steel Qty 1 pcs for thread M14		

	GEV No.	520230	Ref. No. —
	nut thread M14x1.5 H 5mm WS 19 zinc-coated steel Qty 1 pcs		

	GEV No.	521101	Ref. No. —
	nut thread M14x1.5 H 5mm WS 19 SS Qty 1 pcs		

<b>GEV No.</b>	416429	<b>Ref. No.</b>	647918
<b>description</b>	heating element 1600W 230V heating circuits 1 L 300mm W 205mm W1 5mm W2 195mm tube ø 8.5mm connection male faston 6.3mm dry heating element hot bar L1 50mm L2 20mm L3 230mm 2 hole fixing thread M14x1.5 mounting distance 202mm		
<b>For models:</b>	361429, HTP1		

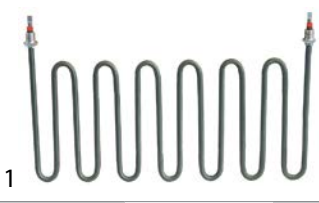

<b>GEV No.</b>	416430	<b>Ref. No.</b>	647926
<b>description</b>	heating element 2000W 230V L 215mm W 415mm tube ø 8.5mm connection male faston 6.3mm dry heating element hot bar 2 hole fixing thread M14x1.5 mounting distance 409mm		
<b>For models:</b>	361437, HTP2		



<b>GEV No.</b>	416512	<b>Ref. No.</b>	371939	
<b>description</b>	heating element 2700W 230V heating circuits 1 L 822mm W 300mm connection length 55mm tube ø 8.6mm cable length 440mm dry heating element hot bar 2 hole fixing thread M14x1.5 mounting distance 291mm			
<b>For models:</b>	Heisse-Theke-HT-50-85-und-120-3			
<b>accessories for</b>	416512			
	<b>GEV No.</b>	510417	<b>Ref. No.</b>	—
	flat gasket fibre ED ø 20mm ID ø 14mm thickness 2mm Qty 1 pcs			
	<b>GEV No.</b>	520228	<b>Ref. No.</b>	—
	tooth lock washer ID ø 15.3mm ED ø 24mm steel Qty 1 pcs for thread M14			
	<b>GEV No.</b>	520230	<b>Ref. No.</b>	—
	nut thread M14x1.5 H 5mm WS 19 zinc-coated steel Qty 1 pcs			
	<b>GEV No.</b>	521101	<b>Ref. No.</b>	—
	nut thread M14x1.5 H 5mm WS 19 SS Qty 1 pcs			
	<b>GEV No.</b>	550262	<b>Ref. No.</b>	—
	flat gasket copper ED ø 20mm ID ø 14mm thickness 2mm			

heating elements for coffee machine



<b>GEV No.</b>	415436	<b>Ref. No.</b>	381268	
<b>description</b>	heating element 1600W 220V L 240mm W 33mm H 30mm L1 65mm L2 175mm mounting distance 25mm thread M12x1 stainless steel connection M4 tube ø 8.5mm 2 hole fixing immersion heater			
<b>For models:</b>	810002, 813303			
<b>accessories for</b>	415436			
	<b>GEV No.</b>	510413	<b>Ref. No.</b>	—
	flat gasket L 43mm W 19mm hole ø 12mm hole distance 24mm copper thickness 2.3mm for heating element			
	<b>GEV No.</b>	510901	<b>Ref. No.</b>	—
	O-ring EPDM thickness 2mm ID ø 13mm Qty 1 pcs			
	<b>GEV No.</b>	520229	<b>Ref. No.</b>	—
	nut thread M12x1 H 4mm WS 16 zinc-coated steel Qty 1 pcs			
	<b>GEV No.</b>	521103	<b>Ref. No.</b>	—
	nut thread M4 H 3mm WS 7 brass Qty 20 pcs			
	<b>GEV No.</b>	521104	<b>Ref. No.</b>	—
	washer ID ø 4.3mm ED ø 8mm thickness 0.5mm brass Qty 20 pcs for thread M4			
	<b>GEV No.</b>	521110	<b>Ref. No.</b>	—
	flat gasket fibre ED ø 20mm ID ø 13mm thickness 2mm Qty 1 pcs			
	<b>GEV No.</b>	521131	<b>Ref. No.</b>	—
	nut thread M12x1 H 3.5mm WS 17 SS Qty 1 pcs			
	<b>GEV No.</b>	560111	<b>Ref. No.</b>	—
	plain washer ID ø 4.3mm ED ø 9mm thickness 0.8mm SS Qty 20 pcs DIN 125A for thread M4			
	<b>GEV No.</b>	560131	<b>Ref. No.</b>	—
	hexagonal nut thread M4 H 3.2mm WS 7 SS DIN/ISO DIN 934 / ISO 4032/8673 Qty 20 pcs			























<b>GEV No.</b>	415439	<b>Ref. No.</b>	378577	
<b>description</b>	heating element 2000W 230V heating circuits 1 L 342mm W 33mm H 26mm mounting distance 25mm thread M12x1 connection M4 tube ø 8.5mm 2 hole fixing immersion heater			
<b>For models:</b>	340022, 340030, 340049, 340057, 340073, 340xxx, 354392, 361763, 378933, 440078, 440086, 440094, 440140, 440655, 450111, 810002, 813303, 890529, 890561, 890588, Geschirrspuelautomat-700, GsP-350, Heissluftdaempfer-10x1-1, Heissluftdaempfer-20x1-1, Heissluft-daempfer-5x1-1			
<b>spare parts for</b>	415439			
	<b>GEV No.</b>	532009	<b>Ref. No.</b>	—
	O-ring EPDM thickness 1.78mm ID ø 14mm Qty 10 pcs			
<b>accessories for</b>	415439			
	<b>GEV No.</b>	520228	<b>Ref. No.</b>	—
	tooth lock washer ID ø 15.3mm ED ø 24mm steel Qty 1 pcs for thread M14			
	<b>GEV No.</b>	520229	<b>Ref. No.</b>	—
	nut thread M12x1 H 4mm WS 16 zinc-coated steel Qty 1 pcs			

Table continues overleaf



<b>accessories for</b> 415439			
	GEV No.	521103	Ref. No. —
nut thread M4 H 3mm WS 7 brass Qty 20 pcs			
	GEV No.	521104	Ref. No. —
washer ID ø 4.3mm ED ø 8mm thickness 0.5mm brass Qty 20 pcs for thread M4			
	GEV No.	560111	Ref. No. —
plain washer ID ø 4.3mm ED ø 9mm thickness 0.8mm SS Qty 20 pcs DIN 125A for thread M4			
	GEV No.	560131	Ref. No. —
hexagonal nut thread M4 H 3.2mm WS 7 SS DIN/ISO DIN 934 / ISO 4032/8673 Qty 20 pcs			

			
1			
GEV No.	415437	Ref. No.	017299 378585
description	heating element 3000W 220V heating circuits 1 L 350mm W 33mm H 32mm L1 10mm L2 30mm mounting distance 25mm thread M12x1 connection M4 tube ø 8.6mm 2 hole fixing immersion heater L3 303mm connection length 20mm		
For models:	353167, 354457, 810002, 813303, 890529, 890561, 890588		
<b>accessories for</b> 415437			
	GEV No.	510413	Ref. No. —
flat gasket L 43mm W 19mm hole ø 12mm hole distance 24mm copper thickness 2.3mm for heating element			
	GEV No.	510901	Ref. No. —
O-ring EPDM thickness 2mm ID ø 13mm Qty 1 pcs			
	GEV No.	520229	Ref. No. —
nut thread M12x1 H 4mm WS 16 zinc-coated steel Qty 1 pcs			
	GEV No.	521103	Ref. No. —
nut thread M4 H 3mm WS 7 brass Qty 20 pcs			
	GEV No.	521104	Ref. No. —
washer ID ø 4.3mm ED ø 8mm thickness 0.5mm brass Qty 20 pcs for thread M4			
	GEV No.	521110	Ref. No. —
flat gasket fibre ED ø 20mm ID ø 13mm thickness 2mm Qty 1 pcs			
	GEV No.	521131	Ref. No. —
nut thread M12x1 H 3.5mm WS 17 SS Qty 1 pcs			
	GEV No.	560111	Ref. No. —
plain washer ID ø 4.3mm ED ø 9mm thickness 0.8mm SS Qty 20 pcs DIN 125A for thread M4			
	GEV No.	560131	Ref. No. —
hexagonal nut thread M4 H 3.2mm WS 7 SS DIN/ISO DIN 934 / ISO 4032/8673 Qty 20 pcs			

			
1			
GEV No.	415440	Ref. No.	372749
description	heating element 3300W 220V heating circuits 1 L 255mm W 67mm H 20mm L1 20mm L2 25mm L3 210mm W1 16mm W2 33mm mounting distance 25mm thread M12x1 stainless steel connection cable tube ø 8.5mm 2 hole fixing immersion heater cable length 365mm		
For models:	805149, 805300, 805408, 805459, 805556, 805xxx, Aromacarina, Aromacarina-Dampf, Aromacarina-EsA, Aromacarina-ETA, Aromacarina-ETA-EsA		
<b>accessories for</b> 415440			
	GEV No.	520229	Ref. No. —
nut thread M12x1 H 4mm WS 16 zinc-coated steel Qty 1 pcs			
	GEV No.	521110	Ref. No. —
flat gasket fibre ED ø 20mm ID ø 13mm thickness 2mm Qty 1 pcs			
	GEV No.	521131	Ref. No. —
nut thread M12x1 H 3.5mm WS 17 SS Qty 1 pcs			
	GEV No.	528110	Ref. No. —
O-ring EPDM thickness 2.62mm ID ø 12.37mm Qty 1 pcs			

			
1			
GEV No.	415438	Ref. No.	187003 381233
description	heating element 4000W 220V L 430mm W 30mm H 37mm mounting distance 22mm thread M12x1 connection M4 tube ø 8.5mm 2 hole fixing immersion heater		
For models:	674524, 674532, 674605, 810002, 813303, 890529, 890561, 890588, Heissluftdaempfer-10x1-1, Heissluftdaempfer-20x1-1		
<b>accessories for</b> 415438			
	GEV No.	510413	Ref. No. —
flat gasket L 43mm W 19mm hole ø 12mm hole distance 24mm copper thickness 2.3mm for heating element			
	GEV No.	520229	Ref. No. —
nut thread M12x1 H 4mm WS 16 zinc-coated steel Qty 1 pcs			
	GEV No.	521103	Ref. No. —
nut thread M4 H 3mm WS 7 brass Qty 20 pcs			
	GEV No.	521104	Ref. No. —
washer ID ø 4.3mm ED ø 8mm thickness 0.5mm brass Qty 20 pcs for thread M4			
	GEV No.	521110	Ref. No. —
flat gasket fibre ED ø 20mm ID ø 13mm thickness 2mm Qty 1 pcs			
	GEV No.	521131	Ref. No. —
nut thread M12x1 H 3.5mm WS 17 SS Qty 1 pcs			
	GEV No.	528110	Ref. No. —
O-ring EPDM thickness 2.62mm ID ø 12.37mm Qty 1 pcs			
	GEV No.	560111	Ref. No. —
plain washer ID ø 4.3mm ED ø 9mm thickness 0.8mm SS Qty 20 pcs DIN 125A for thread M4			
	GEV No.	560131	Ref. No. —
hexagonal nut thread M4 H 3.2mm WS 7 SS DIN/ISO DIN 934 / ISO 4032/8673 Qty 20 pcs			



heating elements for tilting bratt pan



<b>GEV No.</b>	415475	<b>Ref. No.</b>	290734
<b>description</b>	heating element 1670W 230V L 110mm W 430mm H 45mm connection M4 dry heating element heating circuits 1 tube ø 8.5mm W1 200mm W2 30mm mounting pos. inner connection distance 22mm		
<b>For models:</b>	Maxima-Elektro-Kippbratpfanne-700-850		







<b>GEV No.</b>	415476	<b>Ref. No.</b>	290742
<b>description</b>	heating element 1670W 230V L 650mm W 470mm H 35mm connection M4 dry heating element heating circuits 1 tube ø 8.5mm W2 45mm mounting pos. outer connection distance 37mm		
<b>For models:</b>	Maxima-Elektro-Kippbratpfanne-700-850		







<b>GEV No.</b>	415477	<b>Ref. No.</b>	194700
<b>description</b>	heating element 1670W 230V L 95mm W 465mm H 45mm connection M4 dry heating element heating circuits 1 tube ø 8.5mm W1 220mm W2 25mm connection distance 16mm		
<b>For models:</b>	Maxima-Elektro-Kippbratpfanne-700-850		

heating elements for pasta cookers

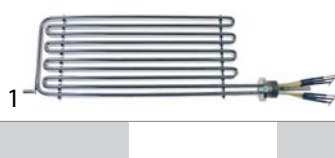





<b>GEV No.</b>	416909	<b>Ref. No.</b>	100056 257001
<b>description</b>	heating element 6000W 230/400V heating circuits 3 L 300mm W 185mm H 22mm flange length 20mm flange length 1 9mm flange length 2 11mm flange ø1 51mm flange ø2 36mm thermostat sleeves ø 4mm length thermostat sleeves 280/300mm number of thermostat sleeves 2 L1 15mm L2 285mm W1 162mm W2 23mm thread M36x1.5 windings 5 cable length 650mm rotation flange immersion heater for fryer/pasta cooker		
<b>For models:</b>	502200, 502308, 601004, 601209, 601403, 602000, 602205, 602280, 603201, 649554, 649562, 650943, 650951, 686336, 688339, 688347, 688355, 721468, 722588, Fritteuse-365, Topline-Fritteuse		
<b>accessories for</b>	416909		
	<b>GEV No.</b>	<b>Ref. No.</b>	264849
	hexagonal nut thread M36x1.5 WS 46 H 14mm brass		
	<b>GEV No.</b>	<b>Ref. No.</b>	262153
	flat gasket PTFE D1 ø 46mm D2 ø 36/38.2mm thickness 5mm Qty 1 pcs mounting pos. outer		
	<b>GEV No.</b>	<b>Ref. No.</b>	261033
	flat gasket PTFE ED ø 46mm ID ø 36mm thickness 4mm Qty 1 pcs mounting pos. inner		
	<b>GEV No.</b>	<b>Ref. No.</b>	262161
	retaining ring brass H 10mm ID ø 36mm ED ø 50mm		



<b>GEV No.</b>	416906	<b>Ref. No.</b>	542326 618411 852716
<b>description</b>	heating element 7000W 230/400V heating circuits 3 mounting pos. left L 458mm W 178mm H 22mm flange length 20mm flange length 1 9.8mm flange length 2 9.7mm flange ø1 51mm flange ø2 36mm thermostat sleeves ø 5.5mm length thermostat sleeves 180/270mm number of thermostat sleeves 2 L1 43mm L2 415mm W1 155mm W2 23mm thread M36x1.5 windings 4 cable length 650mm rotation flange immersion heater for fryer/pasta cooker connection length 75mm		
<b>For models:</b>	503010, 503150, 517887, 637564, 657735, 686298, 688428, 700673, 702560		
<b>accessories for</b>	416906		
	<b>GEV No.</b>	<b>Ref. No.</b>	264849
	hexagonal nut thread M36x1.5 WS 46 H 14mm brass		
	<b>GEV No.</b>	<b>Ref. No.</b>	262153
	flat gasket PTFE D1 ø 46mm D2 ø 36/38.2mm thickness 5mm Qty 1 pcs mounting pos. outer		
	<b>GEV No.</b>	<b>Ref. No.</b>	261033
	flat gasket PTFE ED ø 46mm ID ø 36mm thickness 4mm Qty 1 pcs mounting pos. inner		
	<b>GEV No.</b>	<b>Ref. No.</b>	262161
	retaining ring brass H 10mm ID ø 36mm ED ø 50mm		





			
1			
<b>GEV No.</b>	416910	<b>Ref. No.</b>	602051
<b>description</b>	heating element 8000W 230/400V heating circuits 3 L 300mm W 185mm H 22mm flange length 20mm flange length 1 9mm flange length 2 11mm flange ø1 51mm flange ø2 36mm thermostat sleeves ø 4mm length thermostat sleeves 280/300mm number of thermostat sleeves 2 L1 15mm L2 285mm W1 162mm W2 23mm thread M36x1.5 windings 5 cable length 650mm rotation flange immersion heater pasta cooker		
<b>For models:</b>	502200, 502308, 601004, 601209, 601403, 602000, 602205, 602280, 649554, 649562, 650943, 650951, 686336, 688339, 688347, 688355, 699047, 699055, 750255, Fritteuse-365, Topline-Friteuse		
<b>accessories for</b>	416910		
	<b>GEV No.</b>	521004	<b>Ref. No.</b> 264849
	hexagonal nut thread M36x1.5 WS 46 H 14mm brass		
	<b>GEV No.</b>	550673	<b>Ref. No.</b> 262153
	flat gasket PTFE D1 ø 46mm D2 ø 36/38.2mm thickness 5mm Qty 1 pcs mounting pos. outer		
	<b>GEV No.</b>	550674	<b>Ref. No.</b> 261033
	flat gasket PTFE ED ø 46mm ID ø 36mm thickness 4mm Qty 1 pcs mounting pos. inner		
	<b>GEV No.</b>	692060	<b>Ref. No.</b> 262161
	retaining ring brass H 10mm ID ø 36mm ED ø 50mm		





## heating elements for pizza ovens

			
1			
<b>GEV No.</b>	415524	<b>Ref. No.</b>	126551
<b>description</b>	heating element 1100W 230V L 720mm W 200mm thread M14x1.5 mounting distance 210mm connection length 40mm tube ø 8.5mm cable length 1000mm heating circuits 1 dry heating element 2 hole fixing		
<b>For models:</b>	Pizza-Ofen-ELP, Pizza-Ofen-P500, Pizza-Ofen-P501, Pizza-Ofen-P502		
<b>accessories for</b>	415524		
	<b>GEV No.</b>	361182	<b>Ref. No.</b> —
	nut thread 1/4" H 5mm nickel-plated brass WS 17 Qty 1 pcs		
	<b>GEV No.</b>	510417	<b>Ref. No.</b> —
	flat gasket fibre ED ø 20mm ID ø 14mm thickness 2mm Qty 1 pcs		
	<b>GEV No.</b>	520228	<b>Ref. No.</b> —
	tooth lock washer ID ø 15.3mm ED ø 24mm steel Qty 1 pcs for thread M14		
	<b>GEV No.</b>	550262	<b>Ref. No.</b> —
	flat gasket copper ED ø 20mm ID ø 14mm thickness 2mm		

			
1			
<b>GEV No.</b>	415525	<b>Ref. No.</b>	368512
<b>description</b>	heating element 1100W 380V L 716mm W 205mm thread M15x1 mounting distance 197mm connection length 40mm tube ø 8mm cable length 980mm heating circuits 1 dry heating element 2 hole fixing		
<b>For models:</b>	Pizza-Ofen-P501		

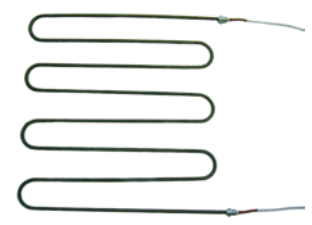
			
1			
<b>GEV No.</b>	415527	<b>Ref. No.</b>	368539
<b>description</b>	heating element 1500W 220V L 720mm W 260mm thread M14x1.5 mounting distance 252mm tube ø 8.5mm cable length 1000mm heating circuits 1 dry heating element 2 hole fixing		
<b>For models:</b>	Pizza-Ofen-P500, Pizza-Ofen-P501, Pizza-Ofen-P502		

			
1			
<b>GEV No.</b>	415526	<b>Ref. No.</b>	368520
<b>description</b>	heating element 1500W 380V L 720mm W 260mm thread M14x1.5 mounting distance 290mm connection cable tube ø 8.5mm cable length 1000mm heating circuits 1 dry heating element 2 hole fixing		
<b>For models:</b>	Pizza-Ofen-P502		

			
1			
<b>GEV No.</b>	415528	<b>Ref. No.</b>	126578
<b>description</b>	heating element 2000W 230V L 465mm W 450mm thread M14x1.5 mounting distance 441mm connection length 36mm tube ø 8.5mm cable length 430mm heating circuits 1 dry heating element 2 hole fixing		
<b>For models:</b>	Pizza-Ofen-ELP		
<b>spare parts for</b>	415528		
	<b>GEV No.</b>	510417	<b>Ref. No.</b> —
	flat gasket fibre ED ø 20mm ID ø 14mm thickness 2mm Qty 1 pcs		
<b>accessories for</b>	415528		
	<b>GEV No.</b>	361182	<b>Ref. No.</b> —
	nut thread 1/4" H 5mm nickel-plated brass WS 17 Qty 1 pcs		
	<b>GEV No.</b>	520228	<b>Ref. No.</b> —
	tooth lock washer ID ø 15.3mm ED ø 24mm steel Qty 1 pcs for thread M14		
	<b>GEV No.</b>	550262	<b>Ref. No.</b> —
	flat gasket copper ED ø 20mm ID ø 14mm thickness 2mm		







heating elements for chargrills



<b>GEV No.</b>	415398	<b>Ref. No.</b>	244600
<b>description</b>	heating element 1280W 230V heating circuits 1 L 440mm W 112mm H 28mm windings 4 tube ømm cable length 1200/1600mm dry heating element bracket mounting connection length 45mm		
<b>For models:</b>	620408		



<b>GEV No.</b>	418771	<b>Ref. No.</b>	649473
<b>description</b>	heating element 1280W 230V heating circuits 1 L 441mm W 110mm windings 4 cable length 900mm dry heating element bracket mounting		
<b>For models:</b>	620424		



<b>GEV No.</b>	415399	<b>Ref. No.</b>	244619 649481
<b>description</b>	heating element 1600W 230V heating circuits 1 L 440mm W 145mm H 28mm windings 5 tube ømm cable length 900mm dry heating element bracket mounting		
<b>For models:</b>	610402, 610429		

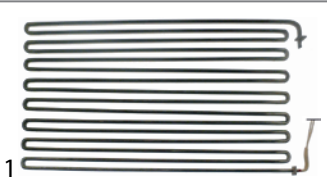

<b>GEV No.</b>	417649	<b>Ref. No.</b>	868507
<b>description</b>	heating element 2500W 230V heating circuits 1 L 450mm W 240mm H 14mm cable length 860mm mounting pos. left		

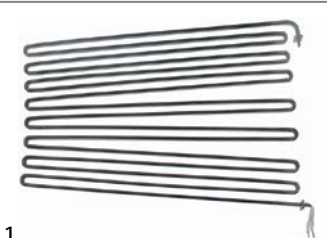



<b>GEV No.</b>	417648	<b>Ref. No.</b>	868523
<b>description</b>	heating element 2500W 230V heating circuits 1 L 450mm W 240mm H 14mm cable length 860mm mounting pos. right		



<b>GEV No.</b>	415358	<b>Ref. No.</b>	N/A	
<b>description</b>	heating element 2250W 230V L 485mm W 135mm L1 35mm L2 60mm L3 390mm W1 20mm W2 115mm 2 hole fixing thread M14x1.5 mounting distance 170mm connection M3 dry heating element tube ø 8.5mm windings 3 heating circuits 1 H 8.5mm			
<b>accessories for</b>	415358			
	<b>GEV No.</b>	560110	<b>Ref. No.</b>	—
	plain washer ID ø 3.2mm ED ø 7mm thickness 0.5mm SS Qty 20 pcs DIN 125A for thread M3			



<b>GEV No.</b>	415359	<b>Ref. No.</b>	N/A	
<b>description</b>	heating element 3000W 230V L 473mm W 170mm L1 15mm L2 50mm L3 410mm W1 15mm W2 160mm 2 hole fixing thread M14x1.5 mounting distance 140mm connection M3 dry heating element tube ø 8.5mm windings 4 heating circuits 1 connection length 19mm H 8.5mm			
<b>accessories for</b>	415359			
	<b>GEV No.</b>	361182	<b>Ref. No.</b>	—
	nut thread 1/4" H 5mm nickel-plated brass WS 17 Qty 1 pcs			
	<b>GEV No.</b>	510417	<b>Ref. No.</b>	—
	flat gasket fibre ED ø 20mm ID ø 14mm thickness 2mm Qty 1 pcs			
	<b>GEV No.</b>	520228	<b>Ref. No.</b>	—
	tooth lock washer ID ø 15.3mm ED ø 24mm steel Qty 1 pcs for thread M14			
	<b>GEV No.</b>	527169	<b>Ref. No.</b>	—
	hexagonal nut thread M3 H 2.8mm WS 5.5 brass Qty 1 pcs			
	<b>GEV No.</b>	550262	<b>Ref. No.</b>	—
	flat gasket copper ED ø 20mm ID ø 14mm thickness 2mm			
	<b>GEV No.</b>	560110	<b>Ref. No.</b>	—
	plain washer ID ø 3.2mm ED ø 7mm thickness 0.5mm SS Qty 20 pcs DIN 125A for thread M3			
	<b>GEV No.</b>	560130	<b>Ref. No.</b>	—
	hexagonal nut thread M3 H 2.4mm WS 5.5 SS DIN/ISO DIN 934 / ISO 4032/8673 Qty 20 pcs			



## heating elements for salamanders/toast-

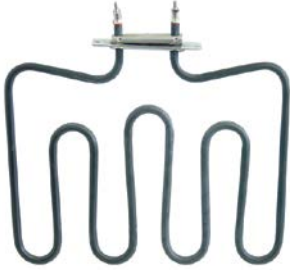



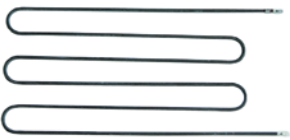

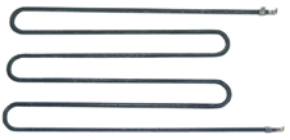
			
1			
<b>GEV No.</b>	416653	<b>Ref. No.</b>	371718
<b>description</b>	heating element 2000W 230V L 225mm W 283mm L1 15mm L2 210mm W1 110mm W2 63mm hole distance 96mm connection M4 tube ø 8.5mm flange length 106mm flange width 32mm heating circuits 1 hole ø 5mm tilt flange dry heating element H 8.5mm		
<b>For models:</b>	686026, 686034		

			
1			
<b>GEV No.</b>	416654	<b>Ref. No.</b>	371726
<b>description</b>	heating element 2000W 230V L 230mm W 230mm L1 22mm L2 208mm W1 83mm W2 63mm hole distance 96mm tube ø 8.5mm flange length 106mm flange width 32mm heating circuits 1 hole ø 5mm tilt flange dry heating element H 8.5mm		
<b>For models:</b>	686026, 686034		

			
1			
<b>GEV No.</b>	415539	<b>Ref. No.</b>	127132
<b>description</b>	heating element 2100W 220V heating circuits 1 L 470mm W 207mm connection male faston 6.3mm connection distance 201mm tube ø 6.3mm dry heating element H 6.3mm		
<b>For models:</b>	686018		

			
1			
<b>GEV No.</b>	415538	<b>Ref. No.</b>	102644
<b>description</b>	heating element 2200W 230V heating circuits 1 L 365mm W 178mm connection male faston 6.3mm connection distance 172mm tube ø 6.3mm dry heating element H 6.3mm		
<b>For models:</b>	574961, 685003		

## heating elements for heated cabinets

			
1			
<b>GEV No.</b>	415435	<b>Ref. No.</b>	083577
<b>description</b>	heating element 1500W 220V heating circuits 1 L 425mm W 100mm H 28mm tube ø 9mm 2 hole fixing connection M4 thread M14x1.5 mounting distance 91mm grill dry heating element		
<b>For models:</b>	610003, 610038, 610402, 611018, 611050, 612006, 612057, 613002, 613088, 615005, 615013, 615056, 620009, 621005, 621056, 622001, 622052, 62510, 62520, 62530, Brater-611, Brater-621, Elektro-Waermeschrank, Frittenwanne-615, Griddle-Platte-612, Griddleplatte-622, OEWs1245-einseitig-400x1200mm, OEWs1246-einseitig-mit-Rueckwandverkleidung, sudpfanne-613, UDWE1225L, UDWE1225L-doppelseitig-Eck-640x1200mm, UDWE1225R, UDWE1225R-doppelseitig-Eck-640x1200mm, UDWF0825, UDWF0825D-doppelseitig-640x800mm, UDWs1225, UDWs1225-doppelseitig-640x1200mm, UEFW0825, UEFW0825D-einseitig-640x800mm, UEWs06-schubladenblock-640x600mm, UEWs1225, UEWs1225-doppelseitig-640x1200mm, UEWs1225-einseitig-640x1200mm, UGWF0835, UGWF0835D-Fluegeltuer-710x800mm, UGWs1235, UGWs1235-schiebetuer-710x1200mm, Wurstgrill-610, Wurstgrill-620		
<b>spare parts for</b>	415435		
	<b>GEV No.</b>	510417	<b>Ref. No.</b> —
flat gasket fibre ED ø 20mm ID ø 14mm thickness 2mm Qty 1 pcs			
<b>accessories for</b>	415435		
	<b>GEV No.</b>	520228	<b>Ref. No.</b> —
tooth lock washer ID ø 15.3mm ED ø 24mm steel Qty 1 pcs for thread M14			
	<b>GEV No.</b>	520230	<b>Ref. No.</b> —
nut thread M14x1.5 H 5mm WS 19 zinc-coated steel Qty 1 pcs			
	<b>GEV No.</b>	521101	<b>Ref. No.</b> —
nut thread M14x1.5 H 5mm WS 19 SS Qty 1 pcs			
	<b>GEV No.</b>	550262	<b>Ref. No.</b> —
flat gasket copper ED ø 20mm ID ø 14mm thickness 2mm			

## pilot heating elements









			
1			
<b>GEV No.</b>	415607	<b>Ref. No.</b>	702188
<b>description</b>	heating element 500W 230V heating circuits 1 thread 3/4" L 295mm W 20mm H 19mm length thermostat sleeves 235mm thermostat sleeves ø 6mm number of thermostat sleeves 1 thermostat sleeve clanging tube ø 6.5mm immersion heater flange with thread connection length 50mm pilot heating element		
<b>For models:</b>	00443x, 00457x, 136581, 690570		
<b>spare parts for</b>	415607		
	<b>GEV No.</b>	510403	<b>Ref. No.</b> —
flat gasket fibre ED ø 36.5mm ID ø 27mm thickness 2mm Qty 1 pcs			
<b>accessories for</b>	415607		
	<b>GEV No.</b>	510421	<b>Ref. No.</b> —
gasket copper ED ø 31.8mm ID ø 26.4mm thickness 2.2mm for thread 3/4"			

Table continues overleaf

<b>accessories for</b>	415607		
	<b>GEV No.</b>	520234	<b>Ref. No.</b> —
	nut thread 3/4" H 5mm brass WS 30 Qty 1 pcs		

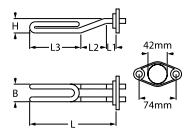

**immersion heating elements**



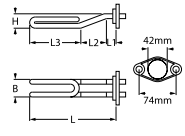

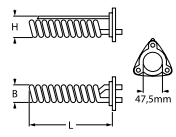

**2 hole flange 74mm**

			
<b>1</b>			
<b>GEV No.</b>	415191	<b>Ref. No.</b>	208639
<b>description</b>	heating element 2300W 220V heating circuits 1 mounting $\phi$ 42mm L 240mm W 29mm H 27mm L1 35mm L2 35mm L3 170mm tube $\phi$ 8.5mm hole distance 74mm hole $\phi$ 8mm connection M4 immersion heater 2 hole flange H1 8mm H2 23mm flange length 94mm flange width 58mm		
<b>For models:</b>	Glaeserspuelautomat-310, Glaeserspuelautomat-311, Glaeserspuelautomat-320, Glaeserspuelautomat-321		
<b>accessories for</b>	415191		
	<b>GEV No.</b>	521103	<b>Ref. No.</b> —
	nut thread M4 H 3mm WS 7 brass Qty 20 pcs		
	<b>GEV No.</b>	521104	<b>Ref. No.</b> —
	washer ID $\phi$ 4.3mm ED $\phi$ 8mm thickness 0.5mm brass Qty 20 pcs for thread M4		
	<b>GEV No.</b>	560111	<b>Ref. No.</b> —
	plain washer ID $\phi$ 4.3mm ED $\phi$ 9mm thickness 0.8mm SS Qty 20 pcs DIN 125A for thread M4		
	<b>GEV No.</b>	560131	<b>Ref. No.</b> —
	hexagonal nut thread M4 H 3.2mm WS 7 SS DIN/ISO DIN 934 / ISO 4032/8673 Qty 20 pcs		

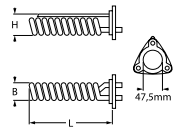
			
<b>1</b>			
<b>GEV No.</b>	415192	<b>Ref. No.</b>	090050
<b>description</b>	heating element 3000W 220V heating circuits 1 mounting $\phi$ 42mm L 225mm W 29mm H 39mm L1 20mm L2 35mm L3 170mm hole distance 74mm hole $\phi$ 9mm connection male faston 6.3mm immersion heater 2 hole flange		
<b>For models:</b>	Glaeserspuelautomat-310, Glaeserspuelautomat-311, Glaeserspuelautomat-320, Glaeserspuelautomat-321		

**3 hole flange  $\phi$ 47.5mm**

			
<b>1</b>			
<b>GEV No.</b>	415668	<b>Ref. No.</b>	349801
<b>description</b>	heating element 2625W 230V mounting $\phi$ 47.5mm heating circuits 1 L 190mm W 41mm H 54mm number of thermostat sleeves 1 thermostat sleeves $\phi$ 7mm length thermostat sleeves 170mm thermostat sleeve eccentric, non clinging tube $\phi$ 6.3mm hole distance 62mm hole $\phi$ 8mm connection M4 3 hole flange immersion heater		
<b>For models:</b>	665843, 665851, Glaeserspuelautomat-325		
<b>accessories for</b>	415668		
	<b>GEV No.</b>	510562	<b>Ref. No.</b> —
	O-ring silicone thickness 5.34mm ID $\phi$ 47mm Qty 1 pcs		

				
<b>1</b>				
<b>GEV No.</b>	415002	<b>Ref. No.</b>	386839	
<b>description</b>	heating element 3000W 230V mounting $\phi$ 47.5mm heating circuits 1 L 198mm W 35mm H 44mm number of thermostat sleeves 1 thermostat sleeves $\phi$ 7mm length thermostat sleeves 175mm thermostat sleeve not clinging tube $\phi$ 6.3mm hole distance 64mm hole $\phi$ 8mm connection M4 3 hole flange immersion heater			
<b>For models:</b>	Glaeserspuelautomat-328			
<b>accessories for</b>	415002			
	<b>GEV No.</b>	510408	<b>Ref. No.</b>	349232
	O-ring EPDM thickness 5.34mm ID $\phi$ 47mm Qty 1 pcs			
	<b>GEV No.</b>	510562	<b>Ref. No.</b>	—
	O-ring silicone thickness 5.34mm ID $\phi$ 47mm Qty 1 pcs			
	<b>GEV No.</b>	521103	<b>Ref. No.</b>	—
	nut thread M4 H 3mm WS 7 brass Qty 20 pcs			
	<b>GEV No.</b>	521104	<b>Ref. No.</b>	—
	washer ID $\phi$ 4.3mm ED $\phi$ 8mm thickness 0.5mm brass Qty 20 pcs for thread M4			
	<b>GEV No.</b>	560111	<b>Ref. No.</b>	—
	plain washer ID $\phi$ 4.3mm ED $\phi$ 9mm thickness 0.8mm SS Qty 20 pcs DIN 125A for thread M4			
	<b>GEV No.</b>	560131	<b>Ref. No.</b>	—
	hexagonal nut thread M4 H 3.2mm WS 7 SS DIN/ISO DIN 934 / ISO 4032/8673 Qty 20 pcs			

with compression flange 50 x 26mm

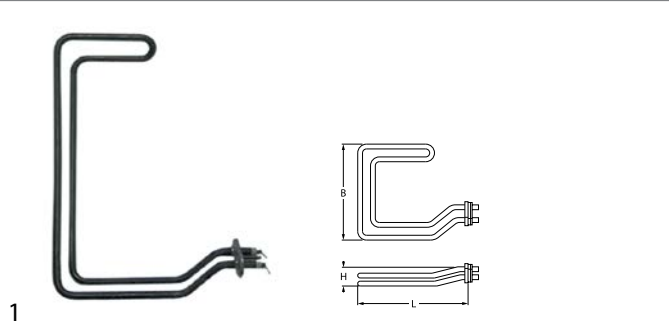

<b>GEV No.</b>	415396	<b>Ref. No.</b>	172847
<b>description</b>	heating element 2500W 230V heating circuits 1 flange 50x26mm L 190mm W 290mm H 47mm compression flange connection male faston 6.3mm tube ø 8.5mm immersion heater		
<b>For models:</b>	271500, 337xxx, Geschirrspuelautomat-335, Geschirrspuelautomat-336, GsP-500, GsP-600		
<b>accessories for</b>	415396		
	<b>GEV No.</b>	510387	<b>Ref. No.</b> —
	gasket L 46mm W 22mm ømm EPDM for heating element for flange 50x26mm		
	<b>GEV No.</b>	510388	<b>Ref. No.</b> —
	counterflange ømm hole distancemm perforation ømm L 43mm W 21mm SS for heating element for flange 50x26mm		

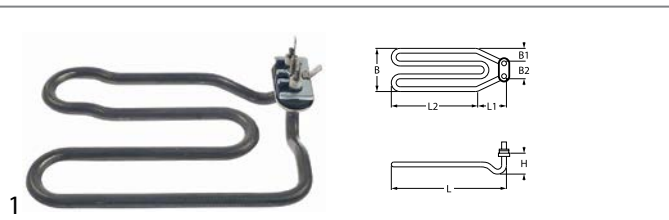

<b>GEV No.</b>	420464	<b>Ref. No.</b>	73069
<b>description</b>	heating element 2500W 230V heating circuits 1 screw flange 50x26mm L 170mm W 120mm H 30mm L1 50mm L2 120mm tube ø 8.5mm warewashing		
<b>spare parts for</b>	420464		
	<b>GEV No.</b>	510387	<b>Ref. No.</b> —
	gasket L 46mm W 22mm ømm EPDM for heating element for flange 50x26mm		
	<b>GEV No.</b>	510388	<b>Ref. No.</b> —
	counterflange ømm hole distancemm perforation ømm L 43mm W 21mm SS for heating element for flange 50x26mm		

with expansion flange 70 x 18mm



<b>GEV No.</b>	415225	<b>Ref. No.</b>	350184
<b>description</b>	heating element 2000W 230V heating circuits 1 flange 70x18mm L 395mm W 57mm connection male faston 6.3mm tube ø 8.5mm immersion heater expansion flange		
<b>For models:</b>	361763, 378933, 440078, 440086, 440094, 440140, 440655, 450111, Geschirrspuelautomat-335, Geschirrspuelautomat-336, GsP-350		
<b>accessories for</b>	415225		
	<b>GEV No.</b>	510415	<b>Ref. No.</b> —
	gasket L 75mm W 23mm hole distance 50mm 4 holes for heating element type DB 70 code L with thermostat sensor hole		
	<b>GEV No.</b>	520238	<b>Ref. No.</b> —
	flange L 80mm W 28mm hole distance 13mm 5 holes type DB 70 code L		



<b>GEV No.</b>	415431	<b>Ref. No.</b>	350214
<b>description</b>	heating element 2500W 230V heating circuits 1 flange 70x18mm L 368mm W 60mm connection male faston 6.3mm tube ø 8.5mm immersion heater expansion flange connection length 13mm TD ø 6mm		
<b>For models:</b>	353167, 354392, 354457, 361763, 378933, 440078, 440086, 440094, 440140, 440655, 450111, Geschirrspuelautomat-335, Geschirrspuelautomat-336, GsP-350		
<b>accessories for</b>	415431		
	<b>GEV No.</b>	510415	<b>Ref. No.</b> —
	gasket L 75mm W 23mm hole distance 50mm 4 holes for heating element type DB 70 code L with thermostat sensor hole		
	<b>GEV No.</b>	520238	<b>Ref. No.</b> —
	flange L 80mm W 28mm hole distance 13mm 5 holes type DB 70 code L		

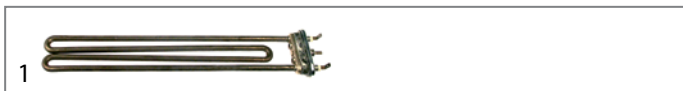









<b>GEV No.</b>	415432	<b>Ref. No.</b>	350206
<b>description</b>	heating element 3000W 230V heating circuits 1 flange 70x18mm L 370mm W 58mm connection male faston 6.3mm tube ø 8.5mm immersion heater expansion flange connection length 17mm TD ø 6mm		
<b>For models:</b>	271500, 337xxx, 353167, 354392, 354457, GsP-500, GsP-600		
<b>accessories for</b>	415432		
	<b>GEV No.</b>	510415	<b>Ref. No.</b> —
	gasket L 75mm W 23mm hole distance 50mm 4 holes for heating element type DB 70 code L with thermostat sensor hole		
	<b>GEV No.</b>	520238	<b>Ref. No.</b> —
	flange L 80mm W 28mm hole distance 13mm 5 holes type DB 70 code L		













<b>GEV No.</b>	415429	<b>Ref. No.</b>	350176
<b>description</b>	heating element 4000W 230V heating circuits 2 flange 70x18mm L 370mm W 60mm H 55mm L1 20mm L2 60mm L3 290mm H1 55mm connection male faston 6.3mm immersion heater expansion flange 70x18		
<b>For models:</b>	353167, 354392, 354457, 361763, 378933, 440078, 440086, 440094, 440140, 440655, 450111, Geschirrspuelautomat-335, Geschirrspuelautomat-336, GsP-350		
<b>accessories for</b>	415429		
	<b>GEV No.</b>	510412	<b>Ref. No.</b> —
	gasket L 77mm W 24mm hole distance 50mm 5 holes for heating element type DB 70		
	<b>GEV No.</b>	520238	<b>Ref. No.</b> —
	flange L 80mm W 28mm hole distance 13mm 5 holes type DB 70 code L		





			
1			
<b>GEV No.</b>	415433	<b>Ref. No.</b>	350192
<b>description</b>	heating element 6000W 230V heating circuits 2 flange 70x18mm L 372mm W 58mm H 54mm L1 28mm L2 70mm L3 274mm connection male faston 6.3mm immersion heater connection length 24mm expansion flange		
<b>For models:</b>	271500, 337xxx, 353167, 354392, 354457, GsP-500, GsP-600		
<b>accessories for</b>	415433		
		GEV No. 510412	Ref. No. —
	gasket L 77mm W 24mm hole distance 50mm 5 holes for heating element type DB 70		
		GEV No. 520238	Ref. No. —
	flange L 80mm W 28mm hole distance 13mm 5 holes type DB 70 code L		

<b>accessories for</b>	415405		
		GEV No. 520235	Ref. No. —
	3 hole flange hole distance 70.5mm perforation ø 6.5mm ID ø 53.5mm		
		GEV No. 520236	Ref. No. —
	flange for heating element ID ø 50mm ED ø 90mm hole ø 6.5mm 3 holes		
		GEV No. 521012	Ref. No. —
	gasket graphite ED ø 15mm ID ø 5mm thickness 1.2mm Qty 1 pcs		
		GEV No. 550002	Ref. No. —
	tension strap H 10mm L 21mm W 10mm hole ø 6.5mm for heating element		
		GEV No. 550362	Ref. No. —
	blind flange ø 64mm mounting ø 47.5mm		

with round flange ø47.5mm			
			
1			
<b>GEV No.</b>	415604	<b>Ref. No.</b>	702196
<b>description</b>	heating element 3000W 230/400V heating circuits 3 L 160mm W 36mm H 25mm connection male faston 6.3mm immersion heater round flange mounting ø 47.5mm		
<b>For models:</b>	690570		
<b>accessories for</b>	415604		
		GEV No. 510408	Ref. No. 349232
	O-ring EPDM thickness 5.34mm ID ø 47mm Qty 1 pcs		
		GEV No. 510562	Ref. No. —
	O-ring silicone thickness 5.34mm ID ø 47mm Qty 1 pcs		
		GEV No. 520235	Ref. No. —
	3 hole flange hole distance 70.5mm perforation ø 6.5mm ID ø 53.5mm		
		GEV No. 520236	Ref. No. —
	flange for heating element ID ø 50mm ED ø 90mm hole ø 6.5mm 3 holes		
		GEV No. 550002	Ref. No. —
	tension strap H 10mm L 21mm W 10mm hole ø 6.5mm for heating element		
		GEV No. 550362	Ref. No. —
	blind flange ø 64mm mounting ø 47.5mm		

1"			
			
1			
<b>GEV No.</b>	415195	<b>Ref. No.</b>	209538
<b>description</b>	heating element 2500W 230V heating circuits 1 thread 1" L 200mm W 20mm H 20mm tube ø 8.5mm connection male faston 6.3mm immersion heater flange with thread		
<b>For models:</b>	Glaeserspuelautomat-310, Glaeserspuelautomat-311, Glaeserspuelautomat-320, Glaeserspuelautomat-321		
<b>accessories for</b>	415195		
		GEV No. 510404	Ref. No. —
	flat gasket fibre ED ø 44mm ID ø 34mm thickness 2mm Qty 1 pcs		
		GEV No. 510422	Ref. No. —
	gasket copper ED ø 37.7mm ID ø 32.5mm thickness 2.7mm for thread 1"		
		GEV No. 520233	Ref. No. —
	nut thread 1" H 6mm brass WS 47 Qty 1 pcs		



			
1			
<b>GEV No.</b>	415405	<b>Ref. No.</b>	826677
<b>description</b>	heating element 6000W 230V heating circuits 3 L 465mm W 38mm H 24mm tube ø 6.3mm connection male faston 6.3mm immersion heater round flange mounting ø 47.5mm		
<b>For models:</b>	00443x, 00457x, 136581		
<b>spare parts for</b>	415405		
		GEV No. 504148	Ref. No. —
	boiler		

1½"			
			
1			
<b>GEV No.</b>	415402	<b>Ref. No.</b>	103268 290645
<b>description</b>	heating element 6000W 400/230V heating circuits 3 thread 1½" L 425mm W 35mm H 35mm thermostat sleeves ø 7mm length thermostat sleeves 330mm thermostat sleeve centre not clinging tube ø 8.5mm connection M4 immersion heater flange with thread WS 60 no original spare part number of thermostat sleeves 1		
<b>For models:</b>	Maxima-Elektro-Kochkessel-100, Maxima-Elektro-Kochkessel-700-850, Maxima-Elektro-Kochkessel-80		
<b>spare parts for</b>	415402		
		GEV No. 510406	Ref. No. —
	flat gasket fibre ED ø 60mm ID ø 48mm thickness 3mm for thread 1½" Qty 1 pcs		
<b>accessories for</b>	415402		
		GEV No. 510424	Ref. No. —
	gasket copper ED ø 55mm ID ø 48mm thickness 2.2mm Centellen for thread 1½"		
		GEV No. 520211	Ref. No. —
	reducer thread 2" ET - 1½" IT brass		

Table continues overleaf









<b>accessories for</b>	415402		
	GEV No.	520212	Ref. No. —
	hexagonal nut thread 1½" brass WS 60 H 8mm		
	GEV No.	550361	Ref. No. —
	blind flange ø 58mm thread 1½"		









<b>GEV No.</b>	415010	<b>Ref. No.</b>	349577
<b>description</b>	heating element 2000W 230V heating circuits 1 L 260mm W 125mm H 20mm L1 110mm L2 150mm W1 42mm W2 83mm thread M10x1 mounting distance 70mm tube ø 6.5mm connection M4 immersion heater 2 hole fixing		
<b>For models:</b>	665843, 665851, Glaeserspielautomat-325, Glaeserspielautomat-328		
<b>spare parts for</b>	415010		
	GEV No.	510416	Ref. No. —
	flat gasket fibre ED ø 19mm ID ø 10.5mm thickness 1.5mm for thread M10 Qty 1 pcs		
<b>accessories for</b>	415010		
	GEV No.	504306	Ref. No. —
	gasket fibre ED ø 16mm ID ø 10mm thickness 2mm Qty 1 pcs		
	GEV No.	510893	Ref. No. —
	O-ring EPDM thickness 2.62mm ID ø 9.92mm Qty 1 pcs		
	GEV No.	520231	Ref. No. —
	nut thread M10x1 H 6mm WS 14 zinc-coated steel Qty 1 pcs		
	GEV No.	521103	Ref. No. —
	nut thread M4 H 3mm WS 7 brass Qty 20 pcs		
	GEV No.	521104	Ref. No. —
	washer ID ø 4.3mm ED ø 8mm thickness 0.5mm brass Qty 20 pcs for thread M4		
	GEV No.	521129	Ref. No. —
	nut thread M10 H 6mm SS WS 17 Qty 1 pcs DIN/ISO DIN 439		
	GEV No.	560111	Ref. No. —
	plain washer ID ø 4.3mm ED ø 9mm thickness 0.8mm SS Qty 20 pcs DIN 125A for thread M4		
	GEV No.	560131	Ref. No. —
	hexagonal nut thread M4 H 3.2mm WS 7 SS DIN/ISO DIN 934 / ISO 4032/8673 Qty 20 pcs		



<b>GEV No.</b>	415397	<b>Ref. No.</b>	233978
<b>description</b>	heating element 2500W 230V heating circuits 1 L 273mm W 85mm thread M14x1.5 mounting distance 77mm tube ø 8.5mm connection length 15mm 2 hole fixing immersion heater connection male faston 6.3mm		
<b>For models:</b>	353167, 354392, 354457, 361763, 378933, 440078, 440086, 440094, 440140, 440655, 450111, Geschirrspielautomat-330, GsP-350		
<b>spare parts for</b>	415397		
	GEV No.	510417	Ref. No. —
	flat gasket fibre ED ø 20mm ID ø 14mm thickness 2mm Qty 1 pcs		

<b>accessories for</b>	415397		
	GEV No.	361182	Ref. No. —
	nut thread 1/4" H 5mm nickel-plated brass WS 17 Qty 1 pcs		
	GEV No.	520228	Ref. No. —
	tooth lock washer ID ø 15.3mm ED ø 24mm steel Qty 1 pcs for thread M14		
	GEV No.	550262	Ref. No. —
	flat gasket copper ED ø 20mm ID ø 14mm thickness 2mm		



<b>GEV No.</b>	415438	<b>Ref. No.</b>	187003 381233
<b>description</b>	heating element 4000W 220V L 430mm W 30mm H 37mm mounting distance 22mm thread M12x1 connection M4 tube ø 8.5mm 2 hole fixing immersion heater		
<b>For models:</b>	674524, 674532, 674605, 810002, 813303, 890529, 890561, 890588, Heissluftdaempfer-10x1-1, Heissluftdaempfer-20x1-1		
<b>accessories for</b>	415438		
	GEV No.	510413	Ref. No. —
	flat gasket L 43mm W 19mm hole ø 12mm hole distance 24mm copper thickness 2.3mm for heating element		
	GEV No.	520229	Ref. No. —
	nut thread M12x1 H 4mm WS 16 zinc-coated steel Qty 1 pcs		
	GEV No.	521103	Ref. No. —
	nut thread M4 H 3mm WS 7 brass Qty 20 pcs		
	GEV No.	521104	Ref. No. —
	washer ID ø 4.3mm ED ø 8mm thickness 0.5mm brass Qty 20 pcs for thread M4		
	GEV No.	521110	Ref. No. —
	flat gasket fibre ED ø 20mm ID ø 13mm thickness 2mm Qty 1 pcs		
	GEV No.	521131	Ref. No. —
	nut thread M12x1 H 3.5mm WS 17 SS Qty 1 pcs		
	GEV No.	528110	Ref. No. —
	O-ring EPDM thickness 2.62mm ID ø 12.37mm Qty 1 pcs		
	GEV No.	560111	Ref. No. —
	plain washer ID ø 4.3mm ED ø 9mm thickness 0.8mm SS Qty 20 pcs DIN 125A for thread M4		
	GEV No.	560131	Ref. No. —
	hexagonal nut thread M4 H 3.2mm WS 7 SS DIN/ISO DIN 934 / ISO 4032/8673 Qty 20 pcs		



heating elements for convection







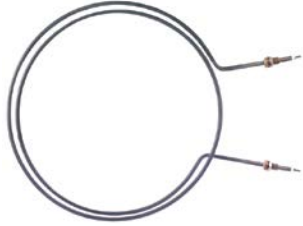

1

<b>GEV No.</b>	418739	<b>Ref. No.</b>	742414
<b>description</b>	heating element 10500W 230V heating circuits 3 ID ø 411mm ED ø 428mm L 480mm H 110mm L1 52mm W1 99mm H1 18mm H2 92mm flange length 130mm flange width 54mm hole distance 55mm connection M5 connection length 96mm tube ø 8.5mm convection heating element mounting thread M6 rectangular flange with thread bolt		
<b>For models:</b>	754595, 754609, 754676, 754681, 754692, 754706, 754749, 757365, 757373, 757381, 757403, 758736, 759201, 759678, 759686, 759694		
<b>accessories for</b>	418739		
	<b>GEV No.</b>	551240	<b>Ref. No.</b> —
	gasket L 129mm W 87mm D1 ø 12mm D2 ø 7mm 12 holes graphite thickness 1mm		



1

<b>GEV No.</b>	418766	<b>Ref. No.</b>	101125
<b>description</b>	heating element 4500W 230V heating circuits 1 ID ø 380mm ED ø 405mm L 530mm L1 100mm H 17mm thread M14x1.5 connection M4 tube ø 8.5mm		
<b>For models:</b>	674524, 674532, 674559, 674605, 674680, 674699, 674710, Heissluft-daempfer-10x1-1, Heissluftdaempfer-5x1-1, Heissluftdaempfer-6x1-1, Heissluftdaempfer-Varioplus-20x1-1, Heissluftgeraet-10x1-1, Heissluftgeraet-5x1-1		
<b>spare parts for</b>	418766		
	<b>GEV No.</b>	510417	<b>Ref. No.</b> —
	flat gasket fibre ED ø 20mm ID ø 14mm thickness 2mm Qty 1 pcs		
<b>accessories for</b>	418766		
	<b>GEV No.</b>	520228	<b>Ref. No.</b> —
	tooth lock washer ID ø 15.3mm ED ø 24mm steel Qty 1 pcs for thread M14		
	<b>GEV No.</b>	520230	<b>Ref. No.</b> —
	nut thread M14x1.5 H 5mm WS 19 zinc-coated steel Qty 1 pcs		
	<b>GEV No.</b>	521101	<b>Ref. No.</b> —
	nut thread M14x1.5 H 5mm WS 19 SS Qty 1 pcs		
	<b>GEV No.</b>	550262	<b>Ref. No.</b> —
	flat gasket copper ED ø 20mm ID ø 14mm thickness 2mm		





1

<b>GEV No.</b>	415805	<b>Ref. No.</b>	693383
<b>description</b>	heating element 5700W 230V heating circuits 3 ID ø 206mm ED ø 245mm L 290mm H 42mm L1 45mm W1 97mm H1 2mm H2 40mm flange length 110mm flange width 20mm hole distance 35mm connection male faston 6.3mm connection length 58mm tube ø 6.3mm convection heating element hole ø 6.5mm rectangular flange		
<b>For models:</b>	671568, 671576, 671584, 671592, 671606, 671614, 671622, 671630, 758752, 758760, 758981, 759007, 759015, 759023, 759031, 759058, 759066, 759074, 759171, 759198		



1

<b>GEV No.</b>	415133	<b>Ref. No.</b>	399329
<b>description</b>	heating element 1430W 230V heating circuits 1 L 85mm W 395mm connection male faston 6.3mm tube ø 6.3mm thread M10x1 2 hole fixing dry heating element mounting distance 389mm		
<b>For models:</b>	390003, 397776, 397784, 397792, 397806, 397814, 397822, 397830, 397849, 397857, 397865, 397873, 399019, 399027, 399035, 399043, 399051, 399078, 399086, 399094, 399108, 399116, 609544, 609552, 609560, 645893, 645907, 645915, 645923, 645931, 645958, 645966, 645974, 645982, 645990, 646024, 646032, 674710, 674788, 674818, HLD-2011		
<b>accessories for</b>	415133		
	<b>GEV No.</b>	520231	<b>Ref. No.</b> —
	nut thread M10x1 H 6mm WS 14 zinc-coated steel Qty 1 pcs		
	<b>GEV No.</b>	521129	<b>Ref. No.</b> —
	nut thread M10 H 6mm SS WS 17 Qty 1 pcs DIN/ISO DIN 439		
	<b>GEV No.</b>	528433	<b>Ref. No.</b> 097071
	flat gasket copper ED ø 14mm ID ø 10mm thickness 1mm		

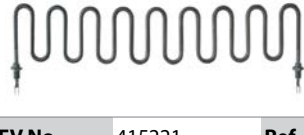

1







<b>GEV No.</b>	415221	<b>Ref. No.</b>	332429
<b>description</b>	heating element 1430W 230V heating circuits 1 L 90mm W 390mm connection male faston 6.3mm tube ø 6.3mm thread M10x1 2 hole fixing dry heating element mounting distance 376mm		
<b>For models:</b>	674664, 674672, Heissluftdaempfer-10x1-1, Heissluftdaempfer-6x1-1		
<b>spare parts for</b>	415221		
	<b>GEV No.</b>	510416	<b>Ref. No.</b> —
	flat gasket fibre ED ø 19mm ID ø 10.5mm thickness 1.5mm for thread M10 Qty 1 pcs		
<b>accessories for</b>	415221		
	<b>GEV No.</b>	510893	<b>Ref. No.</b> —
	O-ring EPDM thickness 2.62mm ID ø 9.92mm Qty 1 pcs		



Table continues overleaf

<b>accessories for</b> 415221			
	GEV No.	520231	Ref. No. —
nut thread M10x1 H 6mm WS 14 zinc-coated steel Qty 1 pcs			
	GEV No.	521129	Ref. No. —
nut thread M10 H 6mm SS WS 17 Qty 1 pcs DIN/ISO DIN 439			
	GEV No.	528433	Ref. No. 097071
flat gasket copper ED ø 14mm ID ø 10mm thickness 1mm			

			
1			
<b>GEV No.</b>	418970	<b>Ref. No.</b>	585726
<b>description</b>	heating element 1450W 230V heating circuits 1 L 90mm W 315mm		
<b>For models:</b>	390003, 397229, 397237, 397245, 397253, 397261, 397288, 397296, 397318, 397326, 397334, 397342, 397350, 397776, 397784, 397792, 397806, 397814, 397822, 397830, 397849, 397857, 397865, 397873, 606316, 606324, 606332, 606340, 606359, 606367, 645893, 645907, 645915, 645923, 645931, 645958, 645966, 645974, 645982, 645990, 646024, 646032, 646040, 646059, 646067, 646768, 646776, 646784, 646792, 646806...(Other models you can see in the webshop)		

## radiation heaters

### square

			
1			
<b>GEV No.</b>	490159	<b>Ref. No.</b>	830127
<b>description</b>	radiation heater L 300mm W 300mm 3500W 230V connections 3 square without pan detection EGO		
<b>spare parts for</b>	490159		
	GEV No.	499157	Ref. No. —
protection pipe for temperature probe ceramic L 297mm ED ø 7mm ID ø 5mm			

			
1			
<b>GEV No.</b>	416911	<b>Ref. No.</b>	826715
<b>description</b>	radiation heater rectangular 3200W 400V L 420mm W 278mm		
<b>For models:</b>	004081, 105872		

			
1			
<b>GEV No.</b>	416907	<b>Ref. No.</b>	171646
<b>description</b>	radiation heater rectangular 3500W 400V L 415mm W 275mm H 46mm heating circuits 2 connections 2		
<b>For models:</b>	750204, 750212, 750220, 750239		

			
1			
<b>GEV No.</b>	416897	<b>Ref. No.</b>	186406
<b>description</b>	radiation heater rectangular 3500W 400V L 415mm W 275mm H 46mm heating circuits 2 connections 2x 2		
<b>For models:</b>	750336, 750352, 750360		

			
1			
<b>GEV No.</b>	416895	<b>Ref. No.</b>	159832
<b>description</b>	radiation heater rectangular 5200W 230V L 530mm W 300mm heating circuits 2		
<b>For models:</b>	750077, 750085, 750093, 750107, 750115		

### 1-circuit

			
1			
<b>GEV No.</b>	490131	<b>Ref. No.</b>	689181
<b>description</b>	radiation heater ø 250mm 2500W 400V heating circuits 1 energy regulation with temperature signalization with ribbon heater connections 2+2 connection type male faston 6.3mm EGO		
<b>For models:</b>	672300, 706272		



2-circuit



1

<b>GEV No.</b>	490028	<b>Ref. No.</b>	155276
<b>description</b>	radiation heater ø 230mm 2100W 230V heating circuits 2 energy regulation with temperature signalization partial power 650W with heating coil connections 3+2 connection type male faston 6.3mm EGO		
<b>For models:</b>	750077, 750085, 750093, 750107, 750115		



1

<b>GEV No.</b>	490068 <sup>1</sup>	<b>Ref. No.</b>	290610
<b>description</b>	hot plate dimensions 220x220mm 2600W 400V with spill ring connection 4 screw clamps protector yes square		
<b>For models:</b>	Maxima-Elektro-Herd-700-850, Maxima-Elektro-Herd-850		

<sup>1</sup>incl. protector

## hot plates

### square & rectangular

#### with radiused edge



1

<b>GEV No.</b>	490067	<b>Ref. No.</b>	290599
<b>description</b>	hot plate dimensions 220x220mm 2000W 400V with spill ring connection 4 screw clamps protector no square		
<b>For models:</b>	Maxima-Elektro-Herd-700-850, Maxima-Elektro-Herd-850		
<b>accessories for</b>	490067		
	<b>GEV No.</b>	<b>Ref. No.</b>	—
	693464		
	sealing cord ø 10mm Qty supplied by meter		



1

<b>GEV No.</b>	490128 <sup>1</sup>	<b>Ref. No.</b>	290629
<b>description</b>	hot plate dimensions 300x300mm 2500W 400V with spill ring connection 4 screw clamps protector yes square		
<b>For models:</b>	Maxima-Elektro-Herd-700-850, Maxima-Elektro-Herd-850		

<sup>1</sup>incl. protector



1

<b>GEV No.</b>	490074 <sup>1</sup>	<b>Ref. No.</b>	290637
<b>description</b>	hot plate dimensions 300x300mm 4000W 400V with spill ring connection 4 screw clamps protector yes square		
<b>For models:</b>	Maxima-Elektro-Herd-700-850, Maxima-Elektro-Herd-850		

<sup>1</sup>incl. protector



1

<b>GEV No.</b>	490066 <sup>1</sup>	<b>Ref. No.</b>	081922
<b>description</b>	hot plate dimensions 220x220mm 2600W 230V with spill ring connection 4 screw clamps protector yes square		
<b>For models:</b>	616001, 616109, 623008, 623105, Elektroherd-4-Platten-623, Elektroherd-616		

<sup>1</sup>incl. protector

### round

#### with radiused edge

#### for domestic and commercial kitchens



1

<b>GEV No.</b>	490015	<b>Ref. No.</b>	290572
<b>description</b>	hot plate ø 180mm 1500W 400V connection 4 screw clamps with 8mm spill ring		
<b>For models:</b>	Maxima-Elektro-Herd-700-850, Maxima-Elektro-Herd-850		



1

<b>GEV No.</b>	490017	<b>Ref. No.</b>	290602
<b>description</b>	hot plate ø 180mm 2000W 400V connection 4 screw clamps with 8mm spill ring		
<b>For models:</b>	Maxima-Elektro-Herd-700-850, Maxima-Elektro-Herd-850		



1

<b>GEV No.</b>	490019	<b>Ref. No.</b>	290580
<b>description</b>	hot plate ø 220mm 2000W 400V connection 4 screw clamps with 8mm spill ring		
<b>For models:</b>	Maxima-Elektro-Herd-700-850, Maxima-Elektro-Herd-850		

## energy regulators

### EGO

#### 1-circuit



1

<b>GEV No.</b>	380016	<b>Ref. No.</b>	201006
<b>description</b>	energy regulator 230V 12A dual circuit turn direction right with operation switch 1-pole		
<b>For models:</b>	750077, 750085, 750093, 750107, 750115		



1

<b>GEV No.</b>	380015	<b>Ref. No.</b>	314544
<b>description</b>	energy regulator 230V 13A single-circuit turn direction right shaft ø 6x4.6mm shaft L 23mm mounting thread M4 power release 6-100% no. 50.57021.010		
<b>For models:</b>	503010, 503150, 517887, 574961, 610038, 61030x, 610402, 610429, 620203, 620300, 620408, 620424, 637564, 657735, 659002, 685003, 686018, 686026, 686034, 686298, 688428, 700673, 702560, 706000, FOEM-Kippbratpfanne-Elektro, ODWB-1040-Waermebruecken, ODWB-1240-Waermebruecken, ODWB-1440-Waermebruecken, ODWB-1640-Waermebruecken, ODWB-1840-Waermebruecken, ODWB-2040-Waermebruecken, OEWB-1040-Wand-Waermeborde, OEWB-1240-Wand-Waermeborde, OEWB-1440-Wand-Waermeborde, OEWB-1640-Wand-Waermeborde, OEWB-1840-Wand-Waermeborde, OEWB-2040-Wand-Waermeborde, steakgrill-61030, steakgrill-62030		



1

<b>GEV No.</b>	380013	<b>Ref. No.</b>	689394
<b>description</b>	energy regulator 400V 7A single-circuit turn direction right shaft ø 6x4.6mm mounting thread M4 no. 50.57031.010		
<b>For models:</b>	672300, 706272		

## accessories

### knobs



1

<b>GEV No.</b>	110235	<b>Ref. No.</b>	341894
<b>description</b>	knob energy regulator 1-3 t.max.°C ø 50mm shaft ø 6x4.6mm shaft flat upper black		
<b>For models:</b>	610038, 610429, 620203, 620424		

## thermostats

### bi-metal thermostats

#### bi-metal thermostats



1

<b>GEV No.</b>	390123	<b>Ref. No.</b>	679194
<b>description</b>	bi-metal thermostat hole distance 23.8mm switch-off temp. 50°C 1NC 1-pole 16A 250V connection F6.3 2 hole fixing		



1

<b>GEV No.</b>	390319	<b>Ref. No.</b>	676551
<b>description</b>	bi-metal thermostat hole distance 23.8mm switch-off temp. 80°C 1NC 1-pole 16A connection F6.3 2 hole fixing		
<b>For models:</b>	505900, 505935, 663263, 663395, 670618, 670626, 686409, 687200, 688096, 688118, 688363, 690600, 703095, 703109, 703117, 703125, 709816, 709824, 709832, 709840, 733105, 733113, 736422, 736430		





control and safety thermostats

EGO

control thermostats

55.10/19\_ series



<b>GEV No.</b>	375070	<b>Ref. No.</b>	091634
<b>description</b>	thermostat t.max. 250°C temperature range 55-250°C 1-pole 1CO 16A probe ø 3.1mm probe L 226mm capillary pipe 1170mm capillary pipe isolated 1100mm gland nut M9x1 shaft L 23mm shaft position upper rotation 270°		
<b>For models:</b>	140902, 367788, 382191, 385018, 385026, 385034, 385042, 385050, 385514, 389595, 389609, 390003, 397210, 397229, 397237, 397245, 397253, 397261, 397288, 397296, 397318, 397326, 397334, 397342, 397350, 397431, 397776, 397784, 397792, 397806, 397814, 397822, 397830, 397849, 397857, 397865, 397873, 398047, 398055, 398063, 398071, 398098, 398101, 398128, 398136, 398144, 398152, 398950, 398969, 398977...(Other models you can see in the webshop)		



<b>GEV No.</b>	390307	<b>Ref. No.</b>	376035
<b>description</b>	thermostat t.max. 86°C temperature range 30-82°C 1-pole 1CO 16A probe ø 3mm probe L 156mm capillary pipe 600mm capillary pipe isolated 600mm gland nut shaft ø 6x4.6mm shaft L 8.5mm shaft position left rotation 180° outer switch eccentric 1/2"-3/4" contacts 1CO		
<b>For models:</b>	Glaeserspielautomat-328		



<b>GEV No.</b>	375135	<b>Ref. No.</b>	337609
<b>description</b>	thermostat t.max. 91°C temperature range 25-90°C 1-pole 1CO 16A probe ø 6mm probe L 174mm capillary pipe 900mm capillary pipe isolated 900mm gland nut shaft ø 6x4.6mm shaft L 23mm shaft position upper rotation 270° probe material SS		
<b>For models:</b>	271500, 337xxx, 340022, 340030, 340049, 340057, 340073, 340xxx, 353167, 354392, 354457, 361763, 378933, 440078, 440086, 440094, 440140, 440655, 450111, 614106, 615080, 624101, Bain-Marie-626, Frittenwanne-615, Geschirrspuelautomat-330, Geschirrspuelautomat-335, Geschirrspuelautomat-336, Geschirrspuelautomat-700, GsP-350, GsP-500, GsP-600		

55.13\_ series



<b>GEV No.</b>	375179	<b>Ref. No.</b>	371017
<b>description</b>	thermostat t.max. 131°C temperature range 80-131°C 1-pole 1NO 16A probe ø 6mm probe L 98mm capillary pipe 1730mm capillary pipe isolatedmm gland nut shaft ø 6x4.6mm shaft L 23mm shaft position upper rotation 270°		
<b>For models:</b>	361429, 361437, Heisse-Theke-HT-50-85-und-120-3, HTP1, HTP2		



<b>GEV No.</b>	375193	<b>Ref. No.</b>	637718
<b>description</b>	thermostat t.max. 300°C temperature range 50-300°C 1-pole 1NO 16A probe ø 4mm probe L 91mm capillary pipe 1130mm capillary pipe isolated 1100mm gland nut shaft L 23mm shaft position upper rotation 270°		
<b>For models:</b>	541869, 638625		





<b>GEV No.</b>	375505	<b>Ref. No.</b>	202029
<b>description</b>	thermostat t.max. 320°C temperature range 50-320°C 1-pole 1NO 16A probe ø 3mm probe L 160mm capillary pipe 870mm capillary pipe isolatedmm gland nut shaft ø 6x4.6mm shaft L 23mm shaft position upper rotation 270°		
<b>For models:</b>	750204, 750212, 750220, 750239, 750336, 750352, 750360		



<b>GEV No.</b>	375006	<b>Ref. No.</b>	349313
<b>description</b>	thermostat t.max. 85°C temperature range 30-85°C 1-pole 1CO 16A probe ø 6mm probe L 92mm capillary pipe 3150mm capillary pipe isolated 300mm gland nut shaft L 23mm shaft position upper rotation 270° probe material SS		
<b>For models:</b>	Glaeserspuelautomat-325		

55.14\_series



<b>GEV No.</b>	390001	<b>Ref. No.</b>	349305
<b>description</b>	thermostat t.max. 58°C temperature range fixed 58°C 1-pole 1NC 16A probe ø 11 mm probe L 35mm capillary pipe 580mm capillary pipe isolated 580mm gland nut shaft Lmm shaft position° shaft position screw-in probe probe thread M14x1		
<b>For models:</b>	Glaeserspuelautomat-325, Glaeserspuelautomat-328		
<b>accessories for</b>	390001		
	<b>GEV No.</b>	510417	<b>Ref. No.</b> —
	flat gasket fibre ED ø 20mm ID ø 14mm thickness 2mm Qty 1 pcs		
	<b>GEV No.</b>	550261	<b>Ref. No.</b> —
	nut thread M14x1 H 4mm WS 19 SS Qty 1 pcs		

55.34\_series



<b>GEV No.</b>	375021	<b>Ref. No.</b>	291706
<b>description</b>	thermostat t.max. 110°C temperature range 32-110°C 3-pole 3CO 16A probe ø 6mm probe L 138mm capillary pipe 2980mm capillary pipe isolated 2200mm gland nut M9x1 shaft ø 6x4.6mm shaft L 23mm shaft position upper rotation 270°		
<b>For models:</b>	Maxima-Elektro-Kochkessel-100, Maxima-Elektro-Kochkessel-700-850, Maxima-Elektro-Kochkessel-80		



<b>GEV No.</b>	375143	<b>Ref. No.</b>	290319
<b>description</b>	thermostat t.max. 110°C temperature range 32-110°C 3-pole 3NO 16A probe ø 6mm probe L 138mm capillary pipe 1480mm capillary pipe isolated 1100mm gland nut M9x1 shaft ø 6x4.6mm shaft L 23mm shaft position upper rotation 270°		
<b>For models:</b>	140902, 667412, 684848, 688436, 689335, 689343, 689351, 689378, 718793, Maxima-Elektro-Bain-Marie-700-850, Maxima-Elektro-Bain-Marie-850		



<b>GEV No.</b>	375697	<b>Ref. No.</b>	136840
<b>description</b>	thermostat t.max. 120°C temperature range fixed 120°C 2-pole 2CO 16A probe ø 3.1mm probe L 305mm capillary pipe 720mm capillary pipe isolated 600mm gland nut shaft Lmm		
<b>For models:</b>	502200, 502308, 601004, 601209, 601403, 602000, 602205, 602280, 603201, 649554, 649562, 650943, 650951, 686336, 688339, 688347, 688355, 699047, 699055, 721468, 722588, 750255, Fritteuse-365, Topline-Fritteuse		
<b>accessories for</b>	375697		
	<b>GEV No.</b>	550039	<b>Ref. No.</b> —
	probe clip for pipe ø 8.5mm for probe ø 3.1mm Qty 1 pcs		



<b>GEV No.</b>	375058	<b>Ref. No.</b>	178144
<b>description</b>	thermostat t.max. 185°C temperature range 95-185°C 3-pole 3NO 16A probe ø 6mm probe L 117mm capillary pipe 1480mm capillary pipe isolated 800mm gland nut shaft ø 6x4.6mm shaft L 23mm shaft position upper rotation 270°		
<b>For models:</b>	600008, 600067, 601004, 601209, 601403, 602000, 602205, 602280, 603007, 603023, 603201, Fritteuse-600, Fritteuse-601, Fritteuse-602, Fritteuse-603		
<b>accessories for</b>	375058		
	<b>GEV No.</b>	550148	<b>Ref. No.</b> —
	gland duct ET M12x0.75 IT M9x1 probe ø max. 6.5mm WS 17 silicone		

Table continues overleaf



accessories for	375058			
	GEV No.	550982	Ref. No.	—
	gasket graphite ø 7.5mm L 7mm Qty 1 pcs for gland nut			

 			
GEV No.	375390	Ref. No.	723231
description	thermostat t.max. 300°C temperature range 50-300°C 3-pole 3NO 16A probe ø 4mm probe L 292mm capillary pipe 880mm capillary pipe isolated 800mm gland nut shaft ø 6x4.6mm shaft L 23mm shaft position upper		
For models:	541869, 638625, 730416		

 			
GEV No.	375057	Ref. No.	224081
description	thermostat t.max. 300°C temperature range 60-300°C 3-pole 3NO 16A probe ø 4mm probe L 128mm capillary pipe 880mm capillary pipe isolated 800mm gland nut shaft L 23mm shaft position upper rotation 270°		
For models:	502650, 502707, 610003, 610038, 610402, 611018, 611050, 611220, 612006, 612057, 620009, 621005, 621056, 621110, 622001, 622052, 629006, 629022, 686328, 688290, Backofen-629, Brater-611, Brater-621, Griddle-Platte-612, Griddleplatte-622, Vario-Braeter-400, Vario-Braeter-600, Wurstgrill-610, Wurstgrill-620		

 			
GEV No.	390282	Ref. No.	283878
description	thermostat t.max. 300°C temperature range 95-300°C 3-pole 3CO 16A probe ø 6mm probe L 177mm capillary pipe 880mm capillary pipe isolated 800mm gland nut shaft ø 6x4.6mm shaft L 23mm shaft position upper rotation 270°		
For models:	62510, 62520, 62530, 626104, 626112, 626201, 626228, 626309, 626317, 721476, 721484, 722596, 722618		

 			
GEV No.	375026	Ref. No.	290300 291730
description	thermostat t.max. 350°C temperature range 100-350°C 3-pole 3NO 16A probe ø 6mm probe L 77mm capillary pipe 2430mm capillary pipe isolated 1100mm gland nut shaft ø 6x4.6mm shaft L 23mm shaft position upper rotation 270°		
For models:	Maxima-Elektro-Backofen-700-850, Maxima-Elektro-Backofen-850, Maxima-Elektro-Kippbratpfanne-700-850		

 			
GEV No.	375101	Ref. No.	126543
description	thermostat t.max. 360°C temperature range 140-360°C 3-pole 3NO 16A probe ø 4mm probe L 292mm capillary pipe 990mm capillary pipe isolated 500mm gland nut shaft L 23mm shaft position upper rotation 318°		
For models:	Pizza-Ofen-ELP		

 			
GEV No.	375018	Ref. No.	277096
description	thermostat t.max. 90°C temperature range fixed 55/90°C 2-pole 2CO 16A probe ø 6mm probe L 175mm capillary pipe 360mm capillary pipe isolated 210mm gland nut shaft Lmm probe material copper		
For models:	361763, 378933, 440078, 440086, 440094, 440140, 440655, 450111, Geschirrspuelautomat-330, GsP-350		



<b>GEV No.</b>	375174	<b>Ref. No.</b>	006955
<b>description</b>	thermostat t.max. 93°C temperature range 30-93°C 3-pole 3CO 16A probe ø 6mm probe L 235mm capillary pipe 880mm capillary pipe isolated 700mm gland nut M9x1 shaft ø 6x4.6mm shaft L 23mm shaft position upper rotation 270°		
<b>For models:</b>	340022, 340030, 340049, 340057, 340073, 614009, 614404, 615005, 615013, 615056, 615080, 624004, 627100, Bain-Marie-614, Bain-Marie-624, Elektro-Waermeschrank, OEWs1245-einseitig-400x1200mm, OEWs1246-einseitig-mit-Rueckwandverkleidung, UDWE1225L, UDWE1225L-doppelseitig-Eck-640x1200mm, UDWE1225R, UDWE1225R-doppelseitig-Eck-640x1200mm, UDWF0825, UDWF0825D-doppelseitig-640x800mm, UDWs1225, UDWs1225-doppelseitig-640x1200mm, UEWf0825, UEWf0825D-einseitig-640x800mm, UEWs06-schubladenblock-640x600mm, UEWs1225, UEWs1225-doppelseitig-640x1200mm, UEWs1225-einseitig-640x1200mm, UGWF0835, UGWF0835D-Fluegeltuer-710x800mm, UGWs1235, UGWs1235-schiebetuer-710x1200mm		

55.40\_ series



<b>GEV No.</b>	375658	<b>Ref. No.</b>	634980
<b>description</b>	thermostat t.max. 300°C temperature range 60-204°C/135-300°C 4-pole 2NO/2NO 16A probe ø 4mm probe L 128mm capillary pipe 880mm capillary pipe isolated 800mm gland nut shaft ø 6x4.6mm shaft L 23mm shaft position upper rotation 310°		
<b>For models:</b>	503010, 503150, 517887, 637564, 657735, 686298, 688428, 700673, 702560, 705993		

safety thermostats

55.11\_ series



<b>GEV No.</b>	375093	<b>Ref. No.</b>	242746
<b>description</b>	safety thermostat switch-off temp. 318°C 1-pole 12A probe ø 4mm probe L 111mm capillary pipe 530mm capillary pipe isolated 450mm gland nut M9x1 probe SS		

55.31\_ series



<b>GEV No.</b>	375175	<b>Ref. No.</b>	294020
<b>description</b>	safety thermostat switch-off temp. 115°C 3-pole 20A probe ø 6mm probe L 173mm capillary pipe 830mm capillary pipe isolated 770mm gland nut probe SS		
<b>For models:</b>	340022, 340030, 340049, 340057, 340073, 340xxx, 353167, 354392, 354457, 361763, 378933, 440078, 440086, 440094, 440140, 440655, 450111, Elektro-Waermeschrank, Geschirrspuelautomat-700, OEWs1245-einseitig-400x1200mm, OEWs1246-einseitig-mit-Rueckwandverkleidung, UDWE1225L, UDWE1225L-doppelseitig-Eck-640x1200mm, UDWE1225R, UDWE1225R-doppelseitig-Eck-640x1200mm, UDWF0825, UDWF0825D-doppelseitig-640x800mm, UDWs1225, UDWs1225-doppelseitig-640x1200mm, UEWf0825, UEWf0825D-einseitig-640x800mm, UEWs06-schubladenblock-640x600mm, UEWs1225, UEWs1225-doppelseitig-640x1200mm, UEWs1225-einseitig-640x1200mm, UGWF0835, UGWF0835D-Fluegeltuer-710x800mm, UGWs1235, UGWs1235-schiebetuer-710x1200mm		

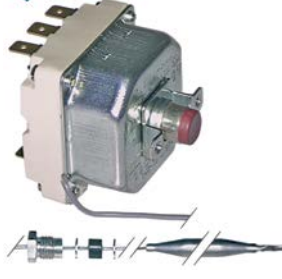

<b>GEV No.</b>	375524	<b>Ref. No.</b>	291749
<b>description</b>	safety thermostat switch-off temp. 135°C 3-pole 20A probe ø 6mm probe L 173mm capillary pipe 1430mm capillary pipe isolated 800mm gland nut M9x1 probe SS		
<b>For models:</b>	Maxima-Elektro-Kochkessel-100, Maxima-Elektro-Kochkessel-700-850, Maxima-Elektro-Kochkessel-80		





<b>GEV No.</b>	375072	<b>Ref. No.</b>	041254
<b>description</b>	safety thermostat switch-off temp. 170°C 3-pole 20A probe ø 3.1mm probe L 524mm capillary pipe 350mm capillary pipe isolated 350mm gland nut probe SS		
<b>For models:</b>	674524, 674532, 674605, 805149, 805300, 805408, 805459, 805556, 805xxx, 810002, 813303, 890529, 890561, 890588, Aromacarina, Aromacarina-Dampf, Aromacarina-EsA, Aromacarina-ETA, Aromacarina-ETA-EsA, Heissluftdaempfer-10x1-1, Heissluftdaempfer-20x1-1, Heissluftdaempfer-5x1-1, Heissluftdaempfer-5x2-3, standkaffeemaschine-solomatic-2, standkaffeemaschine-solomatic-4		



<b>GEV No.</b>	375059	<b>Ref. No.</b>	027332
<b>description</b>	safety thermostat switch-off temp. 255°C 3-pole 20A probe ø 3.1mm probe L 307mm capillary pipe 730mm capillary pipe isolated 700mm gland nut probe SS		
<b>For models:</b>	601004, 601209, 601403, 602000, 602205, 602280, 603201, 721468, 722588, Fritteuse-365, Topline-Friteuse		



<b>GEV No.</b>	390066	<b>Ref. No.</b>	088552 088562
<b>description</b>	safety thermostat switch-off temp. 220°C 3-pole 20A probe ø 14mm probe L 105mm capillary pipe 820mm capillary pipe isolated 660mm gland nut probe with half round bulb		
<b>For models:</b>	600008, 600067, 601004, 601209, 601403, 602000, 602205, 602280, 603007, 603023, 603201, Fritteuse-600, Fritteuse-601, Fritteuse-602, Fritteuse-603		



<b>GEV No.</b>	375680	<b>Ref. No.</b>	502537
<b>description</b>	safety thermostat switch-off temp. 365°C 3-pole 20A probe ø 4mm probe L 100mm capillary pipe 1190mm capillary pipe isolated 400mm gland nut probe SS		
<b>For models:</b>	144819, 502650, 502707, 516678, 626104, 626112, 626201, 626228, 626309, 626317, 639087, 686328, 688290, 699063, 716626, 725315, 730718, 811084, Vario-Braeter-400, Vario-Braeter-600, Vario-Braeter-plus		

55.32\_series



<b>GEV No.</b>	375258	<b>Ref. No.</b>	961809
<b>description</b>	safety thermostat switch-off temp. 232°C 3-pole 20A probe ø 6mm probe L 94mm capillary pipe 900mm capillary pipe isolated 670mm gland nut M10x1 probe SS		



<b>GEV No.</b>	375627	<b>Ref. No.</b>	603589
<b>description</b>	safety thermostat switch-off temp. 480°C 3-pole 20A probe ø 4mm probe L 230mm capillary pipe 890mm capillary pipe isolated gland nut probe probe material SS		
<b>For models:</b>	503010, 503150, 515892, 515906, 517887, 637564, 657735, 686298, 688428, 689696, 700673, 702560, 705993, Vario-Griller		



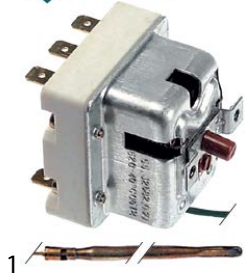

<b>GEV No.</b>	375681	<b>Ref. No.</b>	619221
<b>description</b>	safety thermostat switch-off temp. 520°C 3-pole 20A probe ø 3.9mm probe L 228mm capillary pipe 890mm capillary pipe isolated 400mm gland nut		
<b>For models:</b>	505900, 505935, 611220, 621110, 687200, 690600, Vario-Herd		

55.33\_ series



<b>GEV No.</b>	375698	<b>Ref. No.</b>	686832
<b>description</b>	safety thermostat switch-off temp. 250°C 3-pole 20A probe ø 3.1mm probe L 307mm capillary pipe 710mm capillary pipe isolated 700mm gland nut probe SS		
<b>For models:</b>	502200, 502308, 601004, 601209, 601403, 602000, 602205, 602280, 603201, 649554, 649562, 650943, 650951, 686336, 688339, 688347, 688355, 699047, 699055, 750255, Fritteuse-365		

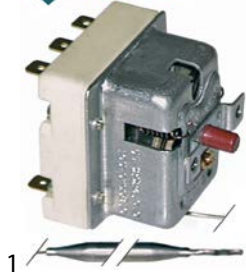

<b>GEV No.</b>	375516	<b>Ref. No.</b>	637726
<b>description</b>	safety thermostat switch-off temp. 250°C 3-pole 20A probe ø 6mm probe L 107mm capillary pipe 1470mm capillary pipe isolated 1100mm gland nut M9x1 probe SS		
<b>For models:</b>	541869, 638625, 730416		



<b>GEV No.</b>	375118	<b>Ref. No.</b>	580457
<b>description</b>	safety thermostat switch-off temp. 360°C 3-pole 20A probe ø 15mm probe L 8mm capillary pipe 1150mm capillary pipe isolated 1100mm gland nut probe with knob		
<b>For models:</b>	671568, 671576, 671584, 671592, 671606, 671614, 671622, 671630, 671649, 671657, 671665, 671673, 671681, 671711, 671746, 671754, 671762, 671770, 671789, 671797, 671800, 671819, 671827, 671835, 671843, 671851, 671878, 671886, 671894, 671908, 671916, 671975, 671983, 671991, 680583, 680591		

56.\_ series

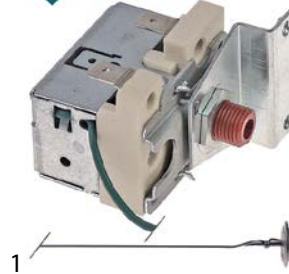

<b>GEV No.</b>	375889	<b>Ref. No.</b>	504602
<b>description</b>	safety thermostat switch-off temp. 360°C 1-pole 16A probe ø 15mm probe L 6.5mm capillary pipe 1140mm capillary pipe isolated 1100mm gland nut probe		
<b>For models:</b>	671568, 671576, 671584, 671592, 671606, 671614, 671622, 671630, 754595, 754609, 754617, 754668, 754676, 754681, 754692, 754706, 754714, 754722, 754730, 754749, 754757, 754773, 754781, 757292, 757314, 757365, 757373, 757381, 757403, 757411, 757438, 757446, 757454, 757462, 757470, 758736, 758752, 758760, 758833, 758981, 759007, 759015, 759023, 759031, 759058, 759066, 759074, 759171, 759198, 759201...(Other models you can see in the webshop)		

<b>accessories for</b>	375889			
	<b>GEV No.</b>	518669	<b>Ref. No.</b>	—
	gasket PTFE ED ø 21mm ID ø 15mm thickness 3.5mm			

control thermostats with operation switch

55.13\_series

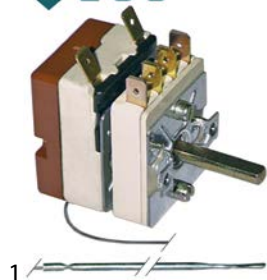

<b>GEV No.</b>	375073	<b>Ref. No.</b>	201928
<b>description</b>	thermostat t.max. 320°C temperature range 50-320°C 1-pole capillary pipe isolatedmm gland nut		
<b>For models:</b>	00068x, 00099x, 00121x, 00149x, 00183x, 001864, 002046, 002682, 00300x, 003131, 00314x, 00376x, 004081, 105716, 105759, 105872, 750026, 750034, 750042, 750050, 750069, 750077, 750085, 750093, 750107, 750115, 750336, 750352, 750360		

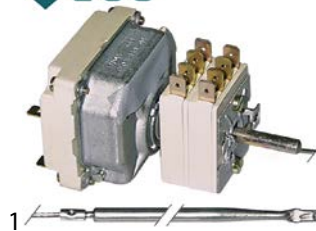

<b>GEV No.</b>	390266	<b>Ref. No.</b>	631981
<b>description</b>	thermostat t.max. 255°C temperature range 70-255°C 3-pole 3NO 16A probe ø 4mm probe L 128mm capillary pipe 880mm capillary pipe isolated 880mm gland nut shaft ø 6x4.6mm shaft L 23mm shaft position upper° rotation 270° outer switch 2NO/2NO		
<b>For models:</b>	502650, 502707, 626104, 626112, 626201, 626228, 626309, 626317, 686328, 688290, 716626, 725315, 730718, 811084		

55.34\_series

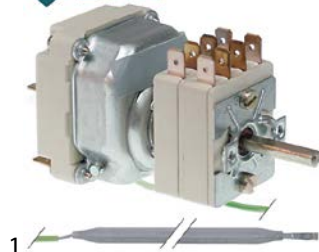

<b>GEV No.</b>	375592	<b>Ref. No.</b>	700509
<b>description</b>	thermostat t.max. 110°C temperature range 32-110°C 3-pole 3NO 16A probe ø 6mm probe L 138mm capillary pipe 1180mm capillary pipe isolated 1100mm gland nut shaft ø 6x4.6mm shaft L 23mm shaft position upper rotation 270° outer switch 2NO/2NO		
<b>For models:</b>	140902, 667412, 684848, 688436, 689335, 689343, 689351, 689378, 699020, 699039, 707503, 718793		

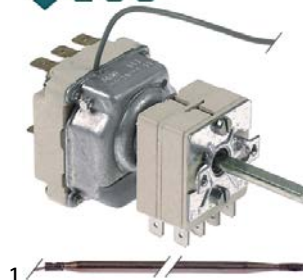

<b>GEV No.</b>	390530	<b>Ref. No.</b>	606227
<b>description</b>	thermostat t.max. 300°C temperature range 77-300°C 3-pole 3NO 16A probe ø 4mm probe L 128mm capillary pipe 880mm capillary pipe isolated 800mm gland nut shaft ø 6x4.6mm shaft L 33mm shaft position upper° rotation 270° outer switch 2NO/2NO		
<b>For models:</b>	503010, 503150, 517887, 637564, 657735, 686298, 688428, 700673, 702560		

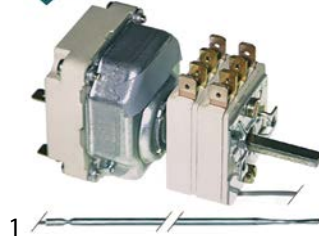

<b>GEV No.</b>	375023	<b>Ref. No.</b>	026611
<b>description</b>	thermostat t.max. 180°C temperature range 103-175/108-180°C 3-pole 2NO/2NO 16A probe ø 3.1mm probe L 305mm capillary pipe 720mm capillary pipe isolated 700mm gland nut shaft ø 6x4.6mm shaft L 23mm shaft position upper rotation 270° outer switch 2NO/2NO		
<b>For models:</b>	502200, 502308, 601004, 601209, 601403, 602000, 602205, 602280, 603201, 649554, 649562, 650943, 650951, 686336, 688339, 688347, 688355, 699047, 699055, 721468, 722588, 750255, Fritteuse-365, Topline-Friteuse		

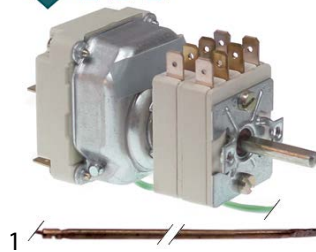

<b>GEV No.</b>	375691	<b>Ref. No.</b>	619248
<b>description</b>	thermostat t.max. 390°C temperature range 60-390°C 3-pole 3NO 16A probe ø 3.9mm probe L 228mm capillary pipe 1110mm capillary pipe isolated 600/700mm gland nut shaft ø 6x4.6mm shaft L 23mm shaft position upper rotation 270° outer switch 2NO/2NO		
<b>For models:</b>	505900, 505935, 515892, 515906, 686409, 687200, 688363, 689696, 690600, 703095, 703109, 709816, 709824, Vario-Griller, Vario-Herd		

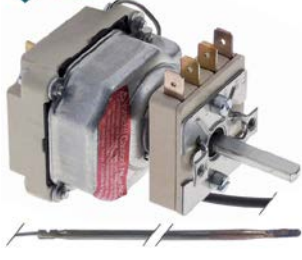

<b>GEV No.</b>	375140	<b>Ref. No.</b>	661635
<b>description</b>	thermostat t.max. 650°C temperature range 50°C/50-600°C/70-650°C 3-pole 3NO 16A probe ø 4mm probe L 228mm capillary pipe 1200mm capillary pipe isolated 1200mm gland nut shaft ø 6x4.6mm shaft L 23mm shaft position left rotation 318° outer switch 2NO		
<b>For models:</b>	663263, 663395, 670618, 670626, 688096, 688118, 703117, 703125, 709832, 709840, 733105, 733113, 736422, 736430		



**IMIT / TEMPOMATIC / ARTERMO**  
control thermostats



<b>GEV No.</b>	390186	<b>Ref. No.</b>	208442
<b>description</b>	thermostat t.max. 52°C temperature range fixed 52°C 1-pole 1CO 16A probe ø 6.5mm probe L 95mm capillary pipe 1000mm capillary pipe isolated 1000mm gland nut shaft Lmm contacts 1CO		
<b>For models:</b>	Glaeserspuelautomat-310, Glaeserspuelautomat-311, Glaeserspuelautomat-320, Glaeserspuelautomat-321		



<b>GEV No.</b>	390006	<b>Ref. No.</b>	208418
<b>description</b>	thermostat t.max. 86°C temperature range 0-86°C 1-pole 1CO 16A probe ø 6.5mm probe L 95mm capillary pipe 1500mm capillary pipe isolatedmm gland nut shaft ø 6x4.6mm shaft L 19mm rotation 270°		
<b>For models:</b>	Glaeserspuelautomat-310, Glaeserspuelautomat-311, Glaeserspuelautomat-320, Glaeserspuelautomat-321		

<b>accessories for</b>	390006			
	<b>GEV No.</b>	110100	<b>Ref. No.</b>	—
	<b>description</b>	knob thermostat t.max. 90°C 0-90°C ø 42mm shaft ø 6x4.6mm shaft flat -135° black		
	<b>GEV No.</b>	110105	<b>Ref. No.</b>	—
	<b>description</b>	rosette knob ø 42mm ø 56mm zero mark		

control thermostats with actual value



<b>GEV No.</b>	379034	<b>Ref. No.</b>	368814
<b>description</b>	thermostat t.max. 450°C temperature range 50-450°C 1-pole 1CO 5A probe ø 6mm probe L 30mm capillary pipe 1150mm capillary pipe isolatedmm gland nut mounting ø 80mm mounting measurements 96x96mm		
<b>For models:</b>	Pizza-Ofen-P501, Pizza-Ofen-P502		

accessories

protective pipes for capillary pipes



<b>GEV No.</b>	550146	<b>Ref. No.</b>	088404
<b>description</b>	protective pipe for capillaries thread M10x1 H1 210mm H2mm L1 25mm L2 30mm		
<b>For models:</b>	600008, 600067, 601004, 601209, 601403, 602000, 602205, 602280, 603007, 603023, 603201, Fritteuse-600, Fritteuse-601, Fritteuse-602, Fritteuse-603		

connecting bows



<b>GEV No.</b>	550059	<b>Ref. No.</b>	086223
<b>description</b>	connecting bow short for switch Qty 1 pcs		

miscellaneous



<b>GEV No.</b>	551115	<b>Ref. No.</b>	502987
<b>description</b>	protective plate for probe hole ø 4.4mm L 300mm W 9mm thickness 0.8mm		
<b>For models:</b>	502650, 502707, 686328, 688290, 716626, 811084, Vario-Braeter-400, Vario-Braeter-600		



## switches and momentary switches

### rocker/momentary rocker switches

30x22mm



1

<b>GEV No.</b>	301003	<b>Ref. No.</b>	053295
<b>description</b>	rocker switch mounting measurements 30x22mm green 2NO 250V 16A illuminated 0-I connection male faston 6.3mm ambient temperature max. 125/55°C protection IP65		
<b>For models:</b>	271500, 643807, 707007, 805556, 825263, Geschirrspuelautomat-330, GsP-350, GsP-500, schokomat-C		
<b>accessories for</b>	301003		
	<b>GEV No.</b>	301036	<b>Ref. No.</b> —
	protective cover internal size 30x22mm for rocker switch mounting measurementsmm		

### push/momentary push switches

30x22mm



1

<b>GEV No.</b>	345863	<b>Ref. No.</b>	336912
<b>description</b>	momentary push switch mounting measurements 30x22mm clear 1NO/1NC 250V 16A illuminated connection male faston 4.8mm/6.3mm ambient temperature max. 85°C protection IP40		
<b>For models:</b>	361763, 367788, 378933, 382191, 385018, 385026, 385034, 385042, 385050, 385514, 397210, 397431, 440078, 440086, 440094, 440140, 440655, 450111, 606294		



1

<b>GEV No.</b>	301044	<b>Ref. No.</b>	308064
<b>description</b>	momentary push switch mounting measurements 30x22mm green 2NO 250V 16A illuminated		
<b>For models:</b>	680583, 680591, Glaeserspielautomat-325		



1

<b>GEV No.</b>	345865	<b>Ref. No.</b>	336939
<b>description</b>	momentary push switch mounting measurements 30x22mm yellow 1NO 250V 16A illuminated, indicator light 24V connection F4.8/F2.8 (lamp) ambient temperature max. 85°C protection IP40 1-pole		
<b>For models:</b>	361763, 378933, 440078, 440086, 440094, 440140, 440655, 450111, GsP-350		



1

<b>GEV No.</b>	301043 <sup>1</sup>	<b>Ref. No.</b>	308161
<b>description</b>	momentary push switch mounting measurements 30x22mm yellow 2NO 250V 16A illuminated connection male faston 6.3mm ambient temperature max. 85°C protection IP40		
<b>For models:</b>	Glaeserspielautomat-325, Glaeserspielautomat-328		

<sup>1</sup>illuminated



1

<b>GEV No.</b>	301040 <sup>1</sup>	<b>Ref. No.</b>	266108 336904
<b>description</b>	push switch mounting measurements 30x22mm green 2NO 250V 16A illuminated connection male faston 6.3mm ambient temperature max. 85°C protection IP40		
<b>For models:</b>	340022, 340030, 340049, 340057, 340073, 353167, 354392, 354457, 361763, 378933, 440078, 440086, 440094, 440140, 440655, 450111, 643807, 668001, 669008, 707007, 825263, Glaeserspielautomat-325, Glaeserspielautomat-328, ODWB-1040-Waermebruecken, ODWB-1240-Waermebruecken, ODWB-1440-Waermebruecken, ODWB-1640-Waermebruecken, ODWB-1840-Waermebruecken, ODWB-2040-Waermebruecken, OEWB-1040-Wand-Waermeborde, OEWB-1240-Wand-Waermeborde, OEWB-1440-Wand-Waermeborde, OEWB-1640-Wand-Waermeborde, OEWB-1840-Wand-Waermeborde, OEWB-2040-Wand-Waermeborde, OEWs1245-einseitig-400x1200mm, OEWs1246-einseitig-mit-Rueckwandverkleidung, UDWE1225L, UDWE1225L-doppelseitig-Eck-640x1200mm, UDWE1225R, UDWE1225R-doppelseitig-Eck-640x1200mm, UDWF0825, UDWF0825D-doppelseitig-640x800mm, UDWs1225, UDWs1225-doppelseitig-640x1200mm, UEWF0825, UEWF0825D-einseitig-640x800mm, UEWs06-schubladenblock-640x600mm, UEWs1225, UEWs1225-doppelseitig-640x1200mm...(Other models you can see in the webshop)		

<sup>1</sup>illuminated



1

<b>GEV No.</b>	301041 <sup>1</sup>	<b>Ref. No.</b>	308072
<b>description</b>	push switch mounting measurements 30x22mm yellow 2NO 250V 16A illuminated connection male faston 6.3mm ambient temperature max. 85°C protection IP40		
<b>For models:</b>	Glaeserspielautomat-325		

<sup>1</sup>illuminated



1

<b>GEV No.</b>	345864 <sup>1</sup>	<b>Ref. No.</b>	336947
<b>description</b>	push switch mounting measurements 30x22mm yellow 2NO 250V 16A illuminated, indicator light 24V connection male faston 6.3mm ambient temperature max. 85°C protection IP40		
<b>For models:</b>	340022, 340030, 340049, 340057, 340073, 353167, 354392, 354457, 361763, 378933, 440078, 440086, 440094, 440140, 440655, 450111		

<sup>1</sup>indicator light 24V



ø12mm			
			
1			
<b>GEV No.</b>	346594	<b>Ref. No.</b>	835358
<b>description</b>	momentary push switch mounting ø 12mm black 1NO 250V 4A connection male faston 6.3mm ambient temperature max. 85°C protection IP40		
<b>For models:</b>	824321, 824348		

microswitches

lever actuated

			
1			
<b>GEV No.</b>	345773	<b>Ref. No.</b>	144894 680907
<b>description</b>	microswitch with lever 250V 16A 1CO connection male faston 6.3mm L 60mm ambient temperature max. 125°C mounting distance 22mm actuating force: 65g lever length 51mm		
<b>For models:</b>	144819, 502200, 502308, 503010, 503150, 515892, 515906, 516678, 517887, 601004, 601209, 601403, 602000, 602205, 602280, 603007, 603023, 603201, 637564, 639087, 649554, 649562, 650943, 650951, 657735, 686298, 686336, 688339, 688347, 688355, 688428, 689696, 699047, 699055, 699063, 700673, 702560, 721468, 722588, 750255, Fritteuse-365, Fritteuse-600, Fritteuse-601, Fritteuse-602, Fritteuse-603, schokomat-C, Topline-Friteuse, Vario-Braeter-plus, Vario-Griller		

roller-lever actuated

heavy duty version

			
1			
<b>GEV No.</b>	345045	<b>Ref. No.</b>	163236 271551
<b>description</b>	microswitch with handle with a switch 250V 16A 1CO connection soldering connection L 49mm L1 55mm ambient temperature max. 85°C mounting distance 24mm type C36ZP actuating force: 95g lever length 66mm		
<b>For models:</b>	271500, Geschirrspuelautomat-335, Geschirrspuelautomat-336, GsP-500		

pin-plunger actuated

			
1			
<b>GEV No.</b>	345060	<b>Ref. No.</b>	242039
<b>description</b>	microswitch with plunger 250V 16A 1NO connection male faston 6.3mm ambient temperature max. 85°C mounting distance 22mm type BS1010 actuating force: 350g red stroke 9mm		
<b>For models:</b>	750255, 750263, 750271, 750298		

			
1			
<b>GEV No.</b>	345247	<b>Ref. No.</b>	218.002
<b>description</b>	microswitch with plunger 250V 6A 2NO connection male faston 6.3mm ambient temperature max. 85°C mounting distance 22mm type 3SE4305 actuating force: 350g black		

M10

			
1			
<b>GEV No.</b>	345032	<b>Ref. No.</b>	208477
<b>description</b>	microswitch with plunger thread M10x1 thread L 12mm 250V 16A 1CO connection male faston 6.3mm stroke 7mm mounting distance 22mm L 28mm ambient temperature max. 125°C type SP9603 actuating force: 180g		
<b>For models:</b>	Glaeserspuelautomat-310, Glaeserspuelautomat-311, Glaeserspuelautomat-320, Glaeserspuelautomat-321		

M16

			
1			
<b>GEV No.</b>	345046	<b>Ref. No.</b>	092444
<b>description</b>	microswitch with plunger thread M16x1 thread L 25mm 250V 5A 1NC/1NO connection male faston 6.3mm stroke 6mm ambient temperature max. 85°C actuating force: 400g		
<b>For models:</b>	389595, 389609, 398950, 398969, 398977, 609188, 609196, 637599, 674524, 674532, 674605, 674648, 674656, 674664, 674672, 674680, 674699, 674885, Heissluftdaempfer-10x1-1, Heissluftdaempfer-5x1-1, Heissluftdaempfer-5x2-3, Heissluftdaempfer-6x1-1, Heissluftgeraet-5x1-1, Heissluftgeraet-5x2-3		

accessories

			
1			
<b>GEV No.</b>	347013	<b>Ref. No.</b>	587141
<b>description</b>	lever for microswitch		
<b>For models:</b>	671568, 671576, 671584, 671592, 671606, 671614, 671622, 671630, 758752, 758760, 758981, 759007, 759015, 759023, 759031, 759058, 759066, 759074, 759171, 759198		





cam switches

on/off

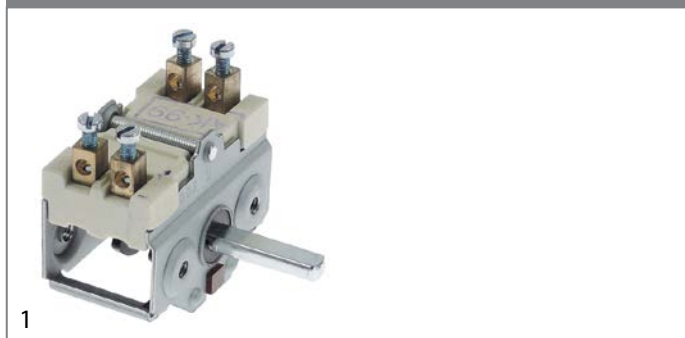

1			
<b>GEV No.</b>	300020	<b>Ref. No.</b>	291757
<b>description</b>	cam switch 4 operating positions 2NO sequence 0-1-0-1 16A shaft ø 6x4.6mm shaft L 23mm connection screw ceramic		
<b>For models:</b>	Maxima-Elektro-Kippbratpfanne-700-850, Maxima-Gas-Kippbratpfanne-neue-Ausführung-700-850		
<b>accessories for</b>	300020		
	<b>GEV No.</b>	110135	<b>Ref. No.</b> —
	rosette knob up to ø 52mm		
	<b>GEV No.</b>	110231	<b>Ref. No.</b> —
	knob switch 0-1-0-1 t.max.°C°C ø 50mm shaft ø 6x4.6mm shaft flat upper black		



1			
<b>GEV No.</b>	300021	<b>Ref. No.</b>	290343
<b>description</b>	cam switch 4 operating positions 4NO sequence 0-1-0-1 16A shaft ø 6x4.6mm shaft L 23mm connection screw ceramic		
<b>For models:</b>	541869, 574961, 638625, 663263, 663395, 670618, 670626, 688096, 688118, 703117, 703125, 709832, 709840, 733105, 733113, 736422, 736430, Maxima-Elektro-Kochkessel-100, Maxima-Elektro-Kochkessel-700-850, Maxima-Elektro-Kochkessel-80		



1			
<b>GEV No.</b>	300102	<b>Ref. No.</b>	291722
<b>description</b>	cam switch 4 operating positions 4NO sequence 0-1-0-1 32A shaft ø 6x4.6mm shaft L 23mm connection screw ceramic		
<b>For models:</b>	144819, 516678, 639087, 699063, Maxima-Elektro-Backofen-700-850, Maxima-Elektro-Backofen-850, Maxima-Elektro-Bain-Marie-700-850, Maxima-Elektro-Bain-Marie-850, Vario-Braeter-plus		

4-position

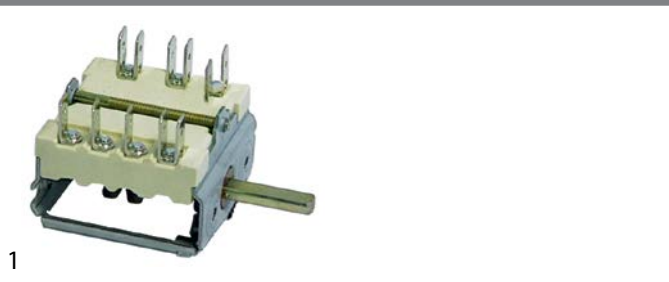

1			
<b>GEV No.</b>	300016	<b>Ref. No.</b>	104248
<b>description</b>	cam switch 4 operating positions 1NO/2CO sequence 0-1-2-3 16A shaft ø 6x4.6mm shaft L 23mm connection male faston 6.3mm ceramic		
<b>For models:</b>	685003, Grill-681		



1			
<b>GEV No.</b>	300103	<b>Ref. No.</b>	226491
<b>description</b>	cam switch 4 operating positions 1NO/2CO sequence 0-1-2-3 32A shaft ø 6x4.6mm shaft L 23mm connection screw ceramic		
<b>For models:</b>	541869, 638625, 730416, FOEM-Elektro-Kochplatten		

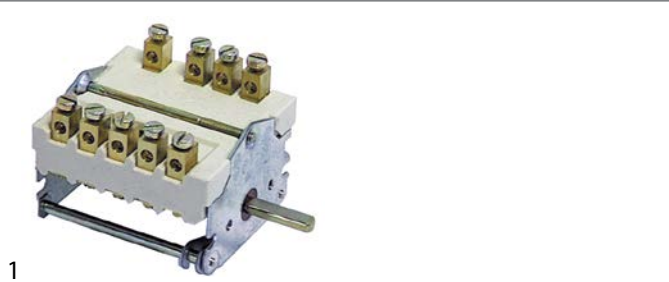

1			
<b>GEV No.</b>	300104	<b>Ref. No.</b>	126608
<b>description</b>	cam switch 4 operating positions 3NO/1CO sequence 0-1-2-3 32A shaft ø 6x4.6mm shaft L 23mm connection screw ceramic		
<b>For models:</b>	Grill-682, Grill-683		

5-position

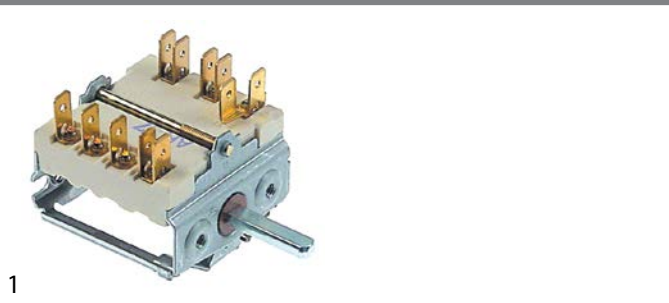

1			
<b>GEV No.</b>	300172	<b>Ref. No.</b>	193224
<b>description</b>	cam switch 5 operating positions 1NO/2CO sequence 0-1-2-3-4 16A shaft ø 6x4.6mm shaft L 23mm connection male faston 6.3mm 5-position		
<b>For models:</b>	750026, 750034, 750042, 750050, 750069, 750077, 750085, 750093, 750107, 750115, AEH618		



7-position



<b>GEV No.</b>	300004	<b>Ref. No.</b>	010170 201820
<b>description</b>	cam switch 7 operating positions 1NO/2CO sequence 0-1-2-3-4-5-6 16A shaft ø 6x4.6mm shaft L 23mm connection male faston 6.3mm 7-position ceramic		
<b>For models:</b>	616001, 616109, 623008, 623105, 750077, 750085, 750093, 750107, 750115, Elektroherd-4-Platten-623, Elektroherd-616		



<b>GEV No.</b>	300025	<b>Ref. No.</b>	290335
<b>description</b>	cam switch 7 operating positions 1NO/2CO sequence 0-1-2-3-4-5-6 16A shaft ø 6x4.6mm shaft L 23mm connection screw 7-position ceramic		
<b>For models:</b>	Maxima-Elektro-Herd-700-850, Maxima-Elektro-Herd-850		

**accessories for** 300025

	<b>GEV No.</b>	112172	<b>Ref. No.</b>	—
	knob universal ø 70mm black without adaptor/dial plate			
	<b>GEV No.</b>	112213	<b>Ref. No.</b>	—
	knob dial plate silver switch 7-position t.max.°C ED ø 63mm ID ø 45.5mm			
	<b>GEV No.</b>	112311	<b>Ref. No.</b>	—
	knob adapter shaft ø 6x4.6mm L 0mm with spring			

4 operating positions

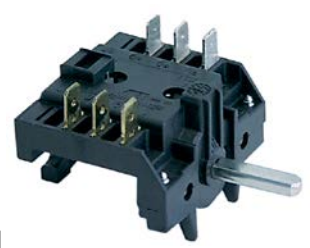

<b>GEV No.</b>	300033	<b>Ref. No.</b>	103680 370983
<b>description</b>	cam switch 4 operating positions 4NO sequence 0-1-2-3 16A shaft ø 6x4.6mm shaft L 23mm connection male faston 6.3mm plastic		
<b>For models:</b>	Heisse-Theke-HT-50-85-und-120-3		

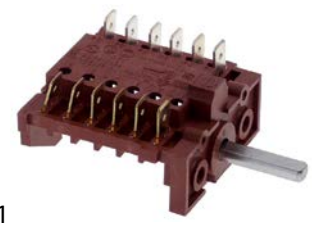

<b>GEV No.</b>	300057	<b>Ref. No.</b>	292664
<b>description</b>	cam switch 4 operating positions 6NO sequence 0-1-2-3 16A shaft ø 6x4.6mm shaft L 23mm connection male faston 6.3mm 6CH/141 plastic		
<b>For models:</b>	Heissluftdaempfer-10x1-1, Heissluftdaempfer-5x1-1, Heissluftdaempfer-5x2-3		



<b>GEV No.</b>	300034	<b>Ref. No.</b>	103772
<b>description</b>	cam switch 4 operating positions selector switch sequence 0-1-2-3 16A shaft ø 6x4.6mm connection male faston 6.3mm 4-pole		
<b>For models:</b>	Grill-680		

5 operating positions

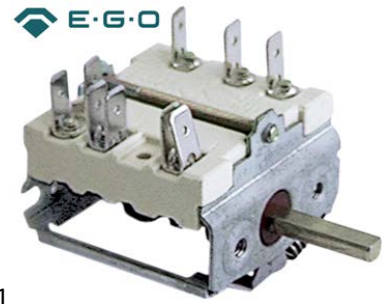

<b>GEV No.</b>	345199	<b>Ref. No.</b>	720534
<b>description</b>	cam switch 5 operating positions 2NO/1CO sequence 0-1-2-3-4 16A shaft ø 6x4.6mm shaft L 23mm connection male faston 6.3mm		
<b>For models:</b>	354716, 354724		



operation switches

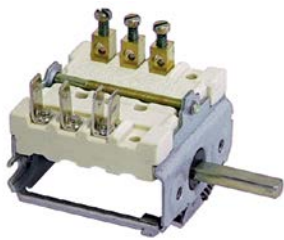

1			
<b>GEV No.</b>	300027	<b>Ref. No.</b>	086312
<b>description</b>	cam switch 2 operating positions 3NO 16A sequence 0-1 shaft $\varnothing$ 6x4.6mm shaft L 23mm connection screw/F6.3 operation switch ceramic		
<b>For models:</b>	140902, 502650, 502707, 601004, 601209, 601403, 602000, 602205, 602280, 603007, 603023, 603201, 610003, 610038, 61030x, 610402, 611018, 611050, 612006, 612057, 613002, 613088, 614009, 614106, 614404, 615005, 615013, 615056, 615080, 620009, 620300, 621005, 621056, 622001, 622052, 624004, 624101, 62510, 62520, 62530, 626104, 626112, 626201, 626228, 626309, 626317, 627100, 629006, 629022, 667412...(Other models you can see in the webshop)		

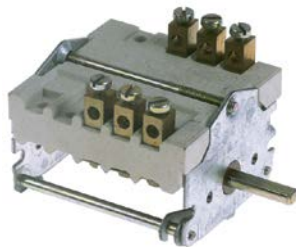

2			
<b>GEV No.</b>	300215	<b>Ref. No.</b>	010162
<b>description</b>	cam switch 2 operating positions sequence 0-1 3-pole ambient temperature max. 318°C		
<b>For models:</b>	600008, 600067, Fritteuse-600		

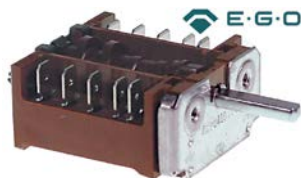

1			
<b>GEV No.</b>	300173	<b>Ref. No.</b>	634999 685380
<b>description</b>	cam switch 3 operating positions 4NO 16A sequence 0-1-2 shaft $\varnothing$ 6x4.6mm shaft L 232mm connection male faston 6.3mm plastic 4-pole		
<b>For models:</b>	503010, 503150, 517887, 637564, 657735, 686298, 688428, 700673, 702560		

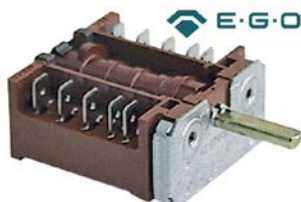

1			
<b>GEV No.</b>	300067	<b>Ref. No.</b>	N/A
<b>description</b>	cam switch 3 operating positions 4NO 16A sequence 0-1-2 shaft $\varnothing$ 6x4.6mm shaft L 23mm connection male faston 6.3mm plastic		



1			
<b>GEV No.</b>	345321	<b>Ref. No.</b>	647967
<b>description</b>	operation switch 4 operating positions 5NO 16A sequence 0-1-2-3 shaft $\varnothing$ 6x4.6mm shaft L 23mm connection male faston 6.3mm plastic 3-pole ambient temperature max. 300°C		

magnetic switches

36x13mm

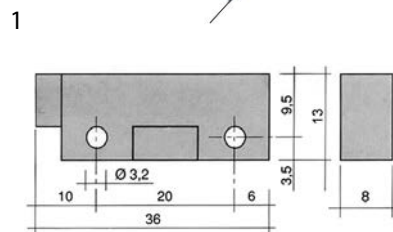

1			
<b>GEV No.</b>	345118 <sup>1</sup>	<b>Ref. No.</b>	376094
<b>description</b>	magnetic switch L 36mm W 13mm 1NO 250V 1A P max. 50W connection cable length 980mm		
<b>For models:</b>	665843, 665851, Glaeserspielautomat-328		
<b>accessories for</b>	345118		
	<b>GEV No.</b>	345399	<b>Ref. No.</b> —
	magnet $\varnothing$ 3.3mm L 40mm H 8mm W 13mm hole distance 30mm M3		

<sup>1</sup>with coded connector

control equipment

SCHLEGEL

push buttons



1			
<b>GEV No.</b>	359183	<b>Ref. No.</b>	323527
<b>description</b>	momentary switch unit mounting measurements $\varnothing$ 16/24x24mm type momentary anthracite/transparent square		
<b>For models:</b>	Heissluftdaempfer-10x1-1, Heissluftdaempfer-20x1-1, Heissluftdaempfer-5x1-1, Heissluftdaempfer-5x2-3, Heissluftgeraet-672, Heissluftgeraet-673		



1

<b>GEV No.</b>	346188	<b>Ref. No.</b>	580341
<b>description</b>	momentary switch unit mounting measurements ø16/24x24mm type momentary black/white square		
<b>For models:</b>	671568, 671576, 671584, 671592, 671606, 671614, 671622, 671630, 671649, 671657, 671665, 671673, 671681, 671711, 671746, 671754, 671789, 671797, 671800, 671819, 671827, 671835, 671843, 671851		

switch blocks



1

<b>GEV No.</b>	359756	<b>Ref. No.</b>	580384
<b>description</b>	contact block latching 1NO/1NC connection male faston 2.8mm illuminable socket T5.5K type BFL5		
<b>For models:</b>	671568, 671576, 671584, 671592, 671606, 671614, 671622, 671630, 671649, 671657, 671665, 671673, 671681, 671711, 671746, 671754, 671789, 671797, 671800, 671819, 671827, 671835, 671843, 671851		
<b>accessories for</b>	359756		
		<b>GEV No.</b>	359593
		<b>Ref. No.</b>	323519
	light bulb socket T5.5K 60V 0.02A		



1

<b>GEV No.</b>	359187	<b>Ref. No.</b>	323543
<b>description</b>	contact block latching 2NO/2NC connection male faston 2.8mm illuminable socket T5.5K type AFL2		
<b>For models:</b>	Heissluftdaempfer-10x1-1, Heissluftdaempfer-20x1-1, Heissluftdaempfer-5x1-1, Heissluftdaempfer-5x2-3, Heissluftgeraet-672, Heissluftgeraet-673		



1

<b>GEV No.</b>	359184	<b>Ref. No.</b>	323535
<b>description</b>	contact block momentary 1NC/1NO connection male faston 2.8mm socket type AT		
<b>For models:</b>	389595, 389609, 398950, 398969, 398977, 609188, 609196, 637599, 674648, 674656, 674664, 674680, 674885, Heissluftdaempfer-10x1-1, Heissluftdaempfer-20x1-1, Heissluftdaempfer-5x1-1, Heissluftdaempfer-5x2-3, Heissluftdaempfer-6x1-1, Heissluftdaempfer-Varioplus-20x1-1, Heissluftdaempfer-Varioplus-20x2-1, Heissluftgeraet-672, Heissluftgeraet-673		

lamps



1

<b>GEV No.</b>	359593	<b>Ref. No.</b>	323519
<b>description</b>	light bulb socket T5.5K 60V 0.02A		
<b>For models:</b>	Heissluftdaempfer-10x1-1, Heissluftdaempfer-20x1-1, Heissluftdaempfer-5x1-1, Heissluftdaempfer-5x2-3, Heissluftgeraet-672, Heissluftgeraet-673		

encoders and potentiometers



1

<b>GEV No.</b>	402979	<b>Ref. No.</b>	689416
<b>description</b>	potentiometer rotation 360° shaft ø 6x4.6mm shaft L 23mm		
<b>For models:</b>	672319, 672327, 672335, 706280, 706299, 706515, 829811, 829838, 829846, 829862, 829870, 829897		

lamps

indicator lights

indicator lights 3-piece (housing, lens and bulb)

ø16.2mm



1

<b>GEV No.</b>	359060	<b>Ref. No.</b>	101818
<b>description</b>	lamp socket mounting measurements ø16.2mm socket E10 connection screw		
<b>For models:</b>	685003, 686018, Grill-680, Grill-681, Grill-682, Grill-683, Heissluftgeraet-10x1-1, Heissluftgeraet-5x1-1, Heissluftgeraet-5x2-3, Heissluftgeraet-672, Heissluftgeraet-673, Heissluftgeraet-67310		

lamps









light bulbs





1

<b>GEV No.</b>	359593	<b>Ref. No.</b>	323519
<b>description</b>	light bulb socket T5.5K 60V 0.02A		
<b>For models:</b>	Heissluftdaempfer-10x1-1, Heissluftdaempfer-20x1-1, Heissluftdaempfer-5x1-1, Heissluftdaempfer-5x2-3, Heissluftgeraet-672, Heissluftgeraet-673		







neon light bulbs			
			
1			
<b>GEV No.</b>	359600	<b>Ref. No.</b>	035378
<b>description</b>	neon light bulb socket E10 220V 0.35W clear ø 10mm L 28mm		
<b>For models:</b>	685003, 686018, Grill-680, Grill-681, Grill-682, Grill-683, Heissluftgeraet-10x1-1, Heissluftgeraet-5x1-1, Heissluftgeraet-5x2-3, Heissluftgeraet-672, Heissluftgeraet-673, Heissluftgeraet-67310, Wandkaffeemaschine-001		
<b>accessories for</b>	359600		
	<b>GEV No.</b>	359060	<b>Ref. No.</b> 101818
	lamp socket mounting measurements ø16.2mm socket E10 connection screw		
	<b>GEV No.</b>	359063	<b>Ref. No.</b> —
	lamp socket mounting measurements ø19.2mm socket E14 connection screw		
	<b>GEV No.</b>	359064	<b>Ref. No.</b> —
	lamp socket mounting measurements ø22.3mm socket E14 connection screw 250/380V ambient temperature at 1W 100°C ambient temperature at 2W 85°C		
	<b>GEV No.</b>	359685	<b>Ref. No.</b> —
	lamp socket mounting measurements ø16.2mm socket E10		
	<b>GEV No.</b>	359832	<b>Ref. No.</b> —
	lamp socket mounting measurements ø16.2mm socket Ba9s connection male faston 6.3mm		
	<b>GEV No.</b>	359853	<b>Ref. No.</b> —
	lamp socket mounting measurements ø18.2mm socket Ba9s connection male faston 6.3mm		
	<b>GEV No.</b>	359988	<b>Ref. No.</b> —
	lamp socket mounting measurements ø30.5mm 250V connection F6.3 temp.-resist. 55°C E14		

			
1			
<b>GEV No.</b>	359602	<b>Ref. No.</b>	006718
<b>description</b>	neon light bulb socket E14 230V clear ø 14mm L 30mm		
<b>For models:</b>	721468, 721476, 721484, 722588, 722596, 722618, Maxima-Elektro-Backofen-700-850, Maxima-Elektro-Backofen-850, Maxima-Elektro-Bain-Marie-700-850, Maxima-Elektro-Bain-Marie-850, Maxima-Elektro-Herd-700-850, Maxima-Elektro-Herd-850, Maxima-Elektro-Kippbratpfanne-700-850		

indicator lights (complete)			
ø10mm			
with plug-in socket			
			
1			
<b>GEV No.</b>	359230	<b>Ref. No.</b>	370991
<b>description</b>	indicator light ø 10mm green 230V connection male faston 2.8mm Qty 1 pcs		
<b>For models:</b>	Heisse-Theke-HT-50-85-und-120-3		

			
1			
<b>GEV No.</b>	359140	<b>Ref. No.</b>	091642
<b>description</b>	indicator light ø 10mm yellow 230V connection male faston 6.3mm Qty 1 pcs		

ø16mm			
with screw socket			
			
1			
<b>GEV No.</b>	359835	<b>Ref. No.</b>	694339
<b>description</b>	indicator light ø 16mm 230V green connection male faston 6.3mm		
<b>For models:</b>	00068x, 00099x, 00121x, 00149x, 00183x, 001864, 002046, 002682, 00300x, 003131, 00314x, 00376x, 004081, 00443x, 00457x, 105716, 105759, 105872, 136581, 140902, 667412, 684848, 688436, 689335, 689343, 689351, 689378, 699020, 699039, 699047, 699055, 705993, 706000, 707503, 718793, 750026, 750034, 750042, 750050, 750069, 750077, 750085, 750093, 750107, 750115, 750204, 750212, 750220, 750239, 750247...(Other models you can see in the webshop)		
<b>accessories for</b>	359835		
	<b>GEV No.</b>	550559	<b>Ref. No.</b> —
	nut thread M16x1 H 5.5mm WS 19		

			
1			
<b>GEV No.</b>	359834	<b>Ref. No.</b>	N/A
<b>description</b>	indicator light ø 16mm 230V yellow connection male faston 6.3mm temp.-resist. 120°C		
<b>accessories for</b>	359834		
	<b>GEV No.</b>	550559	<b>Ref. No.</b> —
	nut thread M16x1 H 5.5mm WS 19		

with plug-in socket			
			
1			
<b>GEV No.</b>	359828	<b>Ref. No.</b>	688991
<b>description</b>	indicator light ø 16mm 400V green cable length 200mm cable material silicone wire		
<b>For models:</b>	672122, 672157, 672300, 706221, 706248, 706272		

			
1			
<b>GEV No.</b>	359167	<b>Ref. No.</b>	699012
<b>description</b>	indicator light ø 16mm 230V yellow		
<b>For models:</b>	699020, 699039, 699047, 699055, 705993, 706000, 707503, 750255		







			
1			
<b>GEV No.</b>	359169	<b>Ref. No.</b>	249955 694320
<b>description</b>	indicator light ø 16mm 400V yellow		
<b>For models:</b>	00068x, 00099x, 00121x, 00149x, 00183x, 001864, 002046, 002682, 00300x, 003131, 00314x, 00376x, 004081, 00443x, 00457x, 105716, 105759, 105872, 136581, 140902, 667412, 684848, 688436, 689335, 689343, 689351, 689378, 699020, 699039, 699047, 699055, 707503, 718793, 750026, 750034, 750042, 750050, 750069, 750077, 750085, 750093, 750107, 750115, 750204, 750212, 750220, 750239, 750247, 750255, 750263...(Other models you can see in the webshop)		









ø22mm			
			
1			
<b>GEV No.</b>	359208	<b>Ref. No.</b>	340820
<b>description</b>	indicator light ø 22mm 400V clear connection screw		
<b>For models:</b>	721468, 721476, 721484, 722588, 722596, 722618		

22x10mm			
			
1			
<b>GEV No.</b>	359215	<b>Ref. No.</b>	080837 325708
<b>description</b>	indicator light mounting measurements 22x10mm 230V clear connection male faston 6.3mm		
<b>For models:</b>	600008, 600067, 601004, 601209, 601403, 602000, 602205, 602280, 603007, 603023, 603201, 610003, 610038, 61030x, 610402, 610429, 611018, 611050, 611220, 612006, 612057, 613002, 613088, 614009, 614106, 614404, 615005, 615013, 615056, 615080, 616001, 616109, 620009, 620203, 620300, 620408, 620424, 621005, 621056, 621110, 622001, 622052, 623008, 623105, 624004, 624101, 62510, 62520, 62530, 626104...(Other models you can see in the webshop)		

30x22mm			
			
1			
<b>GEV No.</b>	359156	<b>Ref. No.</b>	053317
<b>description</b>	indicator light mounting measurements 30x22mm 230V yellow connection male faston 6.3mm temp.-resist. 125/55°C type RL2		
<b>For models:</b>	271500, 805556, Geschirrspuelautomat-330, GsP-350, GsP-500		

miscellaneous			
			
1			
<b>GEV No.</b>	359429	<b>Ref. No.</b>	395056
<b>description</b>	indicator light 230V connection male faston 6.3mm mounting ø 18mm		
<b>For models:</b>	140902, 354643, 354651, 354678, 354686, 354694, 354708, 502200, 502308, 502650, 502707, 503010, 503150, 505900, 505935, 515892, 515906, 517887, 541869, 627984, 628018, 628026, 637564, 638625, 649554, 649562, 650129, 650137, 650145, 650153, 650943, 650951, 657735, 659002, 663263, 663395, 667412, 670618, 670626, 684848, 686247, 686298, 686328, 686336, 686409, 687200, 687960, 688096, 688118, 688290...(Other models you can see in the webshop)		

## screw-on/push-on fit

neon light bulbs			
			
1			
<b>GEV No.</b>	359600	<b>Ref. No.</b>	035378
<b>description</b>	neon light bulb socket E10 220V 0.35W clear ø 10mm L 28mm		
<b>For models:</b>	685003, 686018, Grill-680, Grill-681, Grill-682, Grill-683, Heissluftgeraet-10x1-1, Heissluftgeraet-5x1-1, Heissluftgeraet-5x2-3, Heissluftgeraet-672, Heissluftgeraet-673, Heissluftgeraet-67310, Wandkaffeemaschine-001		
<b>accessories for</b>	359600		
	<b>GEV No.</b>	359060	<b>Ref. No.</b> 101818
	lamp socket mounting measurements ø16.2mm socket E10 connection screw		
	<b>GEV No.</b>	359063	<b>Ref. No.</b> —
	lamp socket mounting measurements ø19.2mm socket E14 connection screw		
	<b>GEV No.</b>	359064	<b>Ref. No.</b> —
	lamp socket mounting measurements ø22.3mm socket E14 connection screw 250/380V ambient temperature at 1W 100°C ambient temperature at 2W 85°C		
	<b>GEV No.</b>	359685	<b>Ref. No.</b> —
	lamp socket mounting measurements ø16.2mm socket E10		
	<b>GEV No.</b>	359832	<b>Ref. No.</b> —
	lamp socket mounting measurements ø16.2mm socket Ba9s connection male faston 6.3mm		
	<b>GEV No.</b>	359853	<b>Ref. No.</b> —
	lamp socket mounting measurements ø18.2mm socket Ba9s connection male faston 6.3mm		
	<b>GEV No.</b>	359988	<b>Ref. No.</b> —
	lamp socket mounting measurements ø30.5mm 250V connection F6.3 temp.-resist. 55°C E14		

			
1			
<b>GEV No.</b>	359602	<b>Ref. No.</b>	006718
<b>description</b>	neon light bulb socket E14 230V clear ø 14mm L 30mm		
<b>For models:</b>	721468, 721476, 721484, 722588, 722596, 722618, Maxima-Elektro-Backofen-700-850, Maxima-Elektro-Backofen-850, Maxima-Elektro-Bain-Marie-700-850, Maxima-Elektro-Bain-Marie-850, Maxima-Elektro-Herd-700-850, Maxima-Elektro-Herd-850, Maxima-Elektro-Kippbratpfanne-700-850		

light bulbs  
for ovens

			
1			
<b>GEV No.</b>	359610	<b>Ref. No.</b>	047635
<b>description</b>	light bulb t.max. 300°C socket E14 15W 230V ø 22mm L 47mm lens L 20mm for oven lamp type Philips		
<b>For models:</b>	685003, 805xxx, 890502, 890510, 890529, 890553, 890561, 890588, 890596, 890618, 890626, Aromacarina, Aromacarina-Dampf, Aromacarina-EsA, Aromacarina-ETA, Aromacarina-ETA-EsA, Heissluftdaempfer-10x1-1, Heissluftdaempfer-20x1-1, Heissluftdaempfer-5x1-1, Heissluftdaempfer-5x2-3, Heissluftgeraet-10x1-1, Heissluftgeraet-5x1-1, Heissluftgeraet-5x2-3, Heissluftgeraet-672, Heissluftgeraet-673, Heissluftgeraet-67310		

			
1			
<b>GEV No.</b>	359612	<b>Ref. No.</b>	354252
<b>description</b>	light bulb t.max. 300°C socket E14 25W 230V ø 25mm L 56mm lens L 30mm for oven lamp type Philips		
<b>For models:</b>	367788, 382191, 385018, 385026, 385034, 385042, 385050, 385514, 389595, 389609, 390003, 397210, 397229, 397237, 397245, 397253, 397261, 397288, 397296, 397318, 397326, 397334, 397342, 397350, 397431, 397776, 397784, 397792, 397806, 397814, 397822, 397830, 397849, 397857, 397865, 397873, 398047, 398055, 398063, 398071, 398098, 398101, 398128, 398136, 398144, 398152, 398950, 398969, 398977, 399019...(Other models you can see in the webshop)		

for indicator lights

			
1			
<b>GEV No.</b>	359593	<b>Ref. No.</b>	323519
<b>description</b>	light bulb socket T5.5K 60V 0.02A		
<b>For models:</b>	Heissluftdaempfer-10x1-1, Heissluftdaempfer-20x1-1, Heissluftdaempfer-5x1-1, Heissluftdaempfer-5x2-3, Heissluftgeraet-672, Heissluftgeraet-673		

<b>miscellaneous</b>			
			
1			
<b>GEV No.</b>	362023	<b>Ref. No.</b>	581488
<b>description</b>	light bulb socket T5.5K 48V 1.2W 0.025A		
<b>For models:</b>	671568, 671576, 671584, 671592, 671606, 671614, 671622, 671630, 671649, 671657, 671665, 671673, 671681, 671711, 671746, 671754, 671789, 671797, 671800, 671819, 671827, 671835, 671843, 671851, 671894, 671908, 671916, 671975, 671983, 671991, 754595, 754617, 754676, 754714, 758736, 758752, 758760, 758833, 759015, 759023, 759031, 759058, 759201, 759651		

linear lamps

<b>infrared lamps</b>			
<b>with base type R7s</b>			
			
1			
<b>GEV No.</b>	359628	<b>Ref. No.</b>	164941
<b>description</b>	infrared lamp socket R7s L 117.6mm 240V 300W IMPORT unjacketed		
<b>For models:</b>	Heisse-Theke-HT-50-85-und-120-3		

			
1			
<b>GEV No.</b>	359627	<b>Ref. No.</b>	971464
<b>description</b>	infrared lamp socket R7s L 220mm 230V 500W IMPORT		

with base type X lug

			
1			
<b>GEV No.</b>	359617	<b>Ref. No.</b>	104566
<b>description</b>	infrared lamp 1000W 220V L 365mm lens L 340mm total length 480mm with mounting strap		
<b>For models:</b>	Grill-681, Grill-682, Grill-683		

sockets for linear lamps

<b>R7s</b>			
			
1			
<b>GEV No.</b>	359717	<b>Ref. No.</b>	153982
<b>description</b>	lamp socket socket R7s 250V ø 18mm Lmm H 31mm connection cable 320mm mounting distance 28mm holder length 37mm cable material PTFE		
<b>For models:</b>	Heisse-Theke-HT-50-85-und-120-3		

X lug



<b>GEV No.</b>	359710	<b>Ref. No.</b>	104574
<b>description</b>	lamp socket L 70mm W 70mm H 49mm mounting distance 50mm bracket mounting		
<b>For models:</b>	Grill-681, Grill-682, Grill-683		

fluorescent lamps

accessories

sockets





<b>GEV No.</b>	381156	<b>Ref. No.</b>	314015
<b>description</b>	lamp socket socket 2G11 hole distance 24mm t.max. 140°C for fluorescent lamps		

oven lamps

universal oven lamps





mounting diameter 35.5mm



<b>GEV No.</b>	359701	<b>Ref. No.</b>	100838
<b>description</b>	lamp socket socket E14 220-230V mounting ø 35.5mm connection male faston 6.3mm 15W		
<b>For models:</b>	398047, 398055, 398063, 398071, 398098, 398101, 398128, 398136, 398144, 398152, 609501, 609528, 609536, 674559, 674648, 674656, 674664, 674672, 674680, 674699, 674834, 674893, 685003, Heissluftdaempfer-10x1-1, Heissluftdaempfer-20x1-1, Heissluftdaempfer-5x1-1, Heissluftdaempfer-5x2-3, Heissluftdaempfer-6x1-1, Heissluftgeraet-10x1-1, Heissluftgeraet-5x1-1, Heissluftgeraet-5x2-3, Heissluftgeraet-672, Heissluftgeraet-673, Heissluftgeraet-67310		
<b>accessories for</b>	359701		
	<b>GEV No.</b>	359705	<b>Ref. No.</b> 092339
	oven lamp glass thr.ø 33.5mm ø 52mm hard glas temp.-resist. 350°C		
	<b>GEV No.</b>	359709	<b>Ref. No.</b> —
	oven lamp glass thr.ø 33.5mm ø 42mm hard glas temp.-resist. 350°C		
	<b>GEV No.</b>	359721	<b>Ref. No.</b> 316296
	gasket silicone ED ø 48mm ID ø 39.5mm thickness 5mm Qty 1 pcs		

<b>accessories for</b>	359701		
	<b>GEV No.</b>	359942	<b>Ref. No.</b> —
	oven lamp glass thr.ø 33.5mm ø 41mm hard glas temp.-resist. 350°C		

	<b>GEV No.</b>	359705	<b>Ref. No.</b> 092339
<b>description</b>	oven lamp glass thr.ø 33.5mm ø 52mm hard glas temp.-resist. 350°C		
<b>For models:</b>	671568, 671576, 671584, 671592, 671606, 671614, 671622, 671630, 758752, 758760, 758981, 759007, 759015, 759023, 759031, 759058, 759066, 759074, 759171, 759198, Heissluftdaempfer-10x1-1, Heissluftdaempfer-20x1-1, Heissluftdaempfer-5x1-1, Heissluftdaempfer-5x2-3		

<b>accessories for</b>	359705		
	<b>GEV No.</b>	359610	<b>Ref. No.</b> 047635
	light bulb t.max. 300°C socket E14 15W 230V ø 22mm L 47mm lens L 20mm for oven lamp type Philips		
	<b>GEV No.</b>	359700	<b>Ref. No.</b> —
	gasket for pizza oven fibre glass ID ø 32.5mm ED ø 55mm thickness 5mm		
	<b>GEV No.</b>	359721	<b>Ref. No.</b> 316296
	gasket silicone ED ø 48mm ID ø 39.5mm thickness 5mm Qty 1 pcs		
	<b>GEV No.</b>	359837	<b>Ref. No.</b> —
	gasket ID ø 33mm ED ø 46mm thickness 1mm graphite		
	<b>GEV No.</b>	359838	<b>Ref. No.</b> —
	gasket ID ø 33mm ED ø 45mm		

	<b>GEV No.</b>	359721	<b>Ref. No.</b> 316296
<b>description</b>	gasket silicone ED ø 48mm ID ø 39.5mm thickness 5mm Qty 1 pcs		
<b>For models:</b>	Heissluftdaempfer-10x1-1, Heissluftdaempfer-5x1-1, Heissluftdaempfer-5x2-3		

producer-specific oven lamps

<b>PALUX</b>			
	<b>GEV No.</b>	359068	<b>Ref. No.</b> 314019
<b>description</b>	lamp socket with 2 hole fixing socket E14 ø 25mm		

**lamps**

**light bulbs**

			
1			
<b>GEV No.</b>	359610	<b>Ref. No.</b>	047635
<b>description</b>	light bulb t.max. 300°C socket E14 15W 230V ø 22mm L 47mm lens L 20mm for oven lamp type Philips		
<b>For models:</b>	685003, 805xxx, 890502, 890510, 890529, 890553, 890561, 890588, 890596, 890618, 890626, Aromacarina, Aromacarina-Dampf, Aromacarina-EsA, Aromacarina-ETA, Aromacarina-ETA-EsA, Heissluftdaempfer-10x1-1, Heissluftdaempfer-20x1-1, Heissluftdaempfer-5x1-1, Heissluftdaempfer-5x2-3, Heissluftgeraet-10x1-1, Heissluftgeraet-5x1-1, Heissluftgeraet-5x2-3, Heissluftgeraet-672, Heissluftgeraet-673, Heissluftgeraet-67310		

			
1			
<b>GEV No.</b>	359612	<b>Ref. No.</b>	354252
<b>description</b>	light bulb t.max. 300°C socket E14 25W 230V ø 25mm L 56mm lens L 30mm for oven lamp type Philips		
<b>For models:</b>	367788, 382191, 385018, 385026, 385034, 385042, 385050, 385514, 389595, 389609, 390003, 397210, 397229, 397237, 397245, 397253, 397261, 397288, 397296, 397318, 397326, 397334, 397342, 397350, 397431, 397776, 397784, 397792, 397806, 397814, 397822, 397830, 397849, 397857, 397865, 397873, 398047, 398055, 398063, 398071, 398098, 398101, 398128, 398136, 398144, 398152, 398950, 398969, 398977, 399019...(Other models you can see in the webshop)		

**sockets**

**G4 / G5,3 / G6,35**

			
1			
<b>GEV No.</b>	359646	<b>Ref. No.</b>	577294
<b>description</b>	lamp socket socket G4/G5.3/G6.35 24V ø 17mm H 15mm connection cable 130mm mounting distance 26mm for halogen lamp holder length 31mm cable length 130mm		
<b>For models:</b>	671568, 671576, 671584, 671592, 671606, 671614, 671622, 671630, 671649, 671657, 671665, 671673, 671681, 671711, 671746, 671754, 671762, 671770, 671789, 671797, 671800, 671819, 671827, 671835, 671843, 671851, 671878, 671886, 671894, 671908, 671916, 671975, 671983, 671991, 680583, 680591, 758752, 758760, 758981, 759007, 759015, 759023, 759031, 759058, 759066, 759074, 759171, 759198		



**residual heat indicators**



			
1			
<b>GEV No.</b>	359429	<b>Ref. No.</b>	395056
<b>description</b>	indicator light 230V connection male faston 6.3mm mounting ø 18mm		
<b>For models:</b>	140902, 354643, 354651, 354678, 354686, 354694, 354708, 502200, 502308, 502650, 502707, 503010, 503150, 505900, 505935, 515892, 515906, 517887, 541869, 627984, 628018, 628026, 637564, 638625, 649554, 649562, 650129, 650137, 650145, 650153, 650943, 650951, 657735, 659002, 663263, 663395, 667412, 670618, 670626, 684848, 686247, 686298, 686328, 686336, 686409, 687200, 687960, 688096, 688118, 688290...(Other models you can see in the webshop)		

**timers**

**programme timers**

			
1			
<b>GEV No.</b>	360005	<b>Ref. No.</b>	359300
<b>description</b>	timer BIGATTI D94 engines 1 chambers 1 operation time 20min 230V shaft ømm shaft Lmm manuf. no. WE006 motor type 82354021L		
<b>For models:</b>	Glaeserspielautomat-325		

			
1			
<b>GEV No.</b>	360349	<b>Ref. No.</b>	359297
<b>description</b>	timer CDC 11803 engines 1 chambers 3 operation time 150s 230V shaft ømm shaft Lmm manuf. no. 11803F1BEE000.0010 motor type M48R ATS type 11803F1 / 238046		
<b>For models:</b>	Glaeserspielautomat-325		
<b>spare parts for</b>	360349		
	<b>GEV No.</b>	<b>Ref. No.</b>	—
	360673		
	motor kit pinion ø 6.8mm teeth 15 230V voltage AC 50/60Hz turn direction clockwise motor ø 48mm H 18.5mm motor type UDS-40NE1RNZ165 cable length 150mm with holder		

			
1			
<b>GEV No.</b>	360040	<b>Ref. No.</b>	256617
<b>description</b>	timer CDC 9003F engines 1 chambers 3 operation time 6min 230V shaft ø 6x4.6mm shaft L 21mm manuf. no. 9003F3 / PRCIH5 motor type M48R ATS		
<b>For models:</b>	Glaeserspielautomat-320, Glaeserspielautomat-321		
<b>spare parts for</b>	360040		
	<b>GEV No.</b>	<b>Ref. No.</b>	—
	360118		
	motor CDC pinion ø 4.9mm teeth 10 230V voltage AC 50/60Hz turn direction right motor ø 47mm H 19.3mm motor type M48R ATS for timer cable length 260mm 1.9/2.5W		
<b>accessories for</b>	360040		
	<b>GEV No.</b>	<b>Ref. No.</b>	—
	110197		
	knob switch zero mark ø 42mm shaft ø 6x4.6mm shaft flat adjustable black		



### electric timers



<b>GEV No.</b>	350001	<b>Ref. No.</b>	157988
<b>description</b>	timer 2CO at 250V 16A permanent position yes impulse electric shaft ø 6x4.6mm shaft L 22mm mounting distance 28mm connection rear 2-pole operation time 120min		
<b>For models:</b>	389595, 389609, 398950, 398969, 398977, 609188, 609196, 637599, 674524, 674532, 674605, 674648, 674656, 674664, 674680, 674885, Heissluftdaempfer-10x1-1, Heissluftdaempfer-20x1-1, Heissluftdaempfer-5x1-1, Heissluftdaempfer-5x2-3, Heissluftdaempfer-6x1-1, Heissluftdaempfer-Varioplus-20x1-1, Heissluftdaempfer-Varioplus-20x2-1, Heissluftgeraet-10x1-1, Heissluftgeraet-5x1-1, Heissluftgeraet-5x2-3		

### audible timers



<b>GEV No.</b>	350014	<b>Ref. No.</b>	018511 720585 836117
<b>description</b>	audible timer operation time 15min ø 56mm shaft ø 6x4.6mm shaft L 24mm mounting distance 28mm		
<b>For models:</b>	354716, 354724, 502200, 502308, 600008, 600067, 601004, 601209, 601403, 602000, 602205, 602280, 603007, 603023, 603201, 649554, 649562, 650943, 650951, 686336, 688339, 688347, 688355, Fritteuse-365, Fritteuse-600, Fritteuse-601, Fritteuse-602, Fritteuse-603, Topline-Fritteuse		

### alarm devices

#### buzzers



<b>GEV No.</b>	350051	<b>Ref. No.</b>	091472
<b>description</b>	buzzer 230VAC connection male faston 6.3mm screw thread M4 buzzer 62dB		
<b>For models:</b>	367788, 382191, 385018, 385026, 385034, 385042, 385050, 385514, 389595, 389609, 397210, 397431, 398950, 398969, 398977, 505900, 505935, 606294, 606308, 609188, 609196, 637599, 663263, 663395, 670618, 670626, 674648, 674656, 674664, 674680, 674885, 680583, 680591, 686409, 687200, 688096, 688118, 688363, 690570, 690600, 703095, 703109, 703117, 703125, 709816, 709824, 709832, 709840, 733105, 733113...(Other models you can see in the webshop)		

### contactors

#### ABB

##### power contactors



<b>GEV No.</b>	380104	<b>Ref. No.</b>	324001 523909
<b>description</b>	power contactor resistive load 25A 230VAC (AC3/400V) 9A/4kW main contacts 3NO auxiliary contacts 1NO connection screw connection type A9-30-10		
<b>For models:</b>	754730, 754749, 757292, 758752, 758760, 758981, 759007, 759015, 759023, 759031, 759058, 759066, 759074, 759171, 759198, 759678, 759686, 759694, 759708, 759716		



<b>GEV No.</b>	380112	<b>Ref. No.</b>	523895
<b>description</b>	power contactor resistive load 45A 230VAC (AC3/400V) 26A/11kW main contacts 3NO auxiliary contacts 1NO connection screw connection type A26-30-10		
<b>For models:</b>	754595, 754609, 754617, 754668, 754676, 754681, 754692, 754706, 754714, 754722, 754730, 754749, 754757, 754773, 754781, 757292, 757314, 757365, 757373, 757381, 757403, 757411, 757438, 757446, 757454, 757462, 757470, 758736, 758833, 759201, 759651, 759678, 759686, 759694, 759708, 759716		

<b>accessories for</b>	380112		
<b>GEV No.</b>	381031	<b>Ref. No.</b>	—
<b>description</b>	auxiliary contact contacts 1NO/1NC AC1 16A AC15 3A connection screw connection for contactors B6/B7/VB7		

#### GENERAL ELECTRIC (AEG)

##### power contactors



<b>GEV No.</b>	380231	<b>Ref. No.</b>	307491
<b>description</b>	power contactor resistive load 16A 230VAC (AC3/400V) 6A/3kW main contacts 3NO auxiliary contacts 1NC connection screw connection type AEG LS0701A		





ISKRA (FANAL)

power contactors



1

<b>GEV No.</b>	380423	<b>Ref. No.</b>	181498
<b>description</b>	power contactor resistive load 35A 230VAC (AC3/400V) 25A/11kW main contacts 3NO auxiliary contacts connection screw connection type Fanal DSL22 type ISKRA KNL22		
<b>For models:</b>	340022, 340030, 340049, 340057, 340073, 340xxx, 353167, 354392, 354457, 690570, 810002, 813303, 890502, 890510, 890529, 890553, 890561, 890588, 890596, 890618, 890626, Geschirrspuelautomat-700, Heissluftdaempfer-10x1-1, Heissluftdaempfer-5x1-1		

solid state relays

CRYDOM



1

<b>GEV No.</b>	402052	<b>Ref. No.</b>	752665
<b>description</b>	solid state relay CRYDOM 1 phase 90A 600V 4-32VDC L 58.6mm W 45mm screw type H12WD4890PG		

relays

power relays

with flange mounting



1

<b>GEV No.</b>	380131	<b>Ref. No.</b>	359289
<b>description</b>	power relays Italiana Relè 230VAC 16A 3CO connection male faston 6.3mm screw mounting manuf. no. B2-3-230AC		
<b>For models:</b>	Glaeserspielautomat-325		



1

<b>GEV No.</b>	380130	<b>Ref. No.</b>	376078
<b>description</b>	power relays Italiana Relè 230VAC 16A 3NO connection male faston 6.3mm screw mounting manuf. no. B1-3-230AC		
<b>For models:</b>	665843, 665851, Glaeserspielautomat-328		

with bracket mounting



1

<b>GEV No.</b>	380687	<b>Ref. No.</b>	849618
<b>description</b>	power relays FINDER 230VAC 30A 2NO connection F6.3 bracket mounting manuf. no. 66.82.8.230.0300		

level relays

miscellaneous



1

<b>GEV No.</b>	380346	<b>Ref. No.</b>	210153
<b>description</b>	level relay 1CO 230V voltage AC		
<b>For models:</b>	750204, 750212, 750220, 750239		

time relays

time relays



1

<b>GEV No.</b>	380288	<b>Ref. No.</b>	332615
<b>description</b>	time relay ELEKTRON VZE 806 time range 60s 24-250 AC/DC 5A connection cable mounting measurements DIN railmm		
<b>For models:</b>	389595, 389609, 398950, 398969, 398977, 609188, 609196, 637599, 674648, 674656, 674664, 674885, 680583, 680591, Heissluftdaempfer-10x1-1, Heissluftdaempfer-5x2-3, Heissluftdaempfer-6x1-1		



electric components

## transformers

### encapsulated transformers

#### multiple connections



1			
<b>GEV No.</b>	402051	<b>Ref. No.</b>	742775
<b>description</b>	transformer primary 230VAC secondary 16.5VAC 2x15VA connection male faston 50/60Hz		
<b>For models:</b>	754595, 754609, 754617, 754668, 754676, 754681, 754692, 754706, 754714, 754722, 754730, 754749, 754757, 754773, 754781, 757292, 757314, 757365, 757373, 757381, 757403, 757411, 757438, 757446, 757454, 757462, 757470, 758736, 758833, 759201, 759651, 759678, 759686, 759694, 759708, 759716		

#### PMA



1			
<b>GEV No.</b>	379054	<b>Ref. No.</b>	368849
<b>description</b>	transformer primary 230VAC secondary 12VAC 3VA secondary 0.25A H 40mm L 45mm W 50mm connection screw 50/60Hz type 153/M		
<b>For models:</b>	Pizza-Ofen-P501, Pizza-Ofen-P502		

## electronic controllers

### SHANGFANG

#### accessories



1			
<b>GEV No.</b>	379054	<b>Ref. No.</b>	368849
<b>description</b>	transformer primary 230VAC secondary 12VAC 3VA secondary 0.25A H 40mm L 45mm W 50mm connection screw 50/60Hz type 153/M		
<b>For models:</b>	Pizza-Ofen-P501, Pizza-Ofen-P502		

## TECNOLOGIC

### electronic thermometers

#### built-in version



1			
<b>GEV No.</b>	379203	<b>Ref. No.</b>	368830
<b>description</b>	thermometer TECNOLOGIC K38VFC-----E---- mounting measurements 70x28mm built-in depth 64mm 12V voltage AC/DC Pt100/TC (J,K) -200 up to +1760°C display 3½ digits 1 RoomTempIN Pt100/TC (J,K) defr. funct. no front measurements 35x78.5mm		
<b>For models:</b>	Pizza-Ofen-P500, Pizza-Ofen-P501, Pizza-Ofen-P502		
<b>accessories for</b>	379203		
	<b>GEV No.</b>	379050	<b>Ref. No.</b>
			—
	temperature probe Pt100 cable Vetrotex probe -200 up to +600°C cable -50 up to +350°C probe ø6x100mm cable length 2.7m without screw connection 3-wire		
	<b>GEV No.</b>	379054	<b>Ref. No.</b>
			368849
	transformer primary 230VAC secondary 12VAC 3VA secondary 0.25A H 40mm L 45mm W 50mm connection screw 50/60Hz type 153/M		

### miscellaneous

#### universal controllers



1			
<b>GEV No.</b>	400206	<b>Ref. No.</b>	332143
<b>description</b>	electronic controller 230V TempIn1 thermocouple K (NiCr-Ni) temperature controller		
<b>For models:</b>	389595, 389609, 398950, 398969, 398977, 609188, 609196, 637599, 674648, 674656, 674664, 674680, 674885, Heissluftdaempfer-10x1-1, Heissluftdaempfer-5x2-3, Heissluftdaempfer-6x1-1, Heissluftdaempfer-Varioplus-20x1-1, Heissluftdaempfer-Varioplus-20x2-1		



1			
<b>GEV No.</b>	400114	<b>Ref. No.</b>	702110
<b>description</b>	electronic controller type Pt100		
<b>For models:</b>	690570		
<b>accessories for</b>	400114		
	<b>GEV No.</b>	400119	<b>Ref. No.</b>
			—
	keypad foil tilting bratt pan NEP203/303/603 NER080/150/250/300		



## probes

### producer-specific probes

#### probes

1			
<b>GEV No.</b>	379399	<b>Ref. No.</b>	702285
<b>description</b>	temperature probe Pt100 cable PVC probe -50 up to +200°C cable -10 up to 100°C connection 2-wire thread M10x1 probe ø10x10mm cable length 1.55m		
<b>For models:</b>	690570		

#### core probes

1			
<b>GEV No.</b>	379592 <sup>1</sup>	<b>Ref. No.</b>	752363
<b>description</b>	core temperature probe 3 point probe cable PTFE probe -40 up to +250°C cable -40 up to +250°C connection 5-wire probe ø4x100mm thread cable length 4.5m handle ø 12mm handle length 85mm		
<b>For models:</b>	754595, 754609, 754617, 754668, 754676, 754681, 754692, 754706, 754714, 754722, 754730, 754749, 754757, 754773, 754781, 757292, 757314, 757365, 757373, 757381, 757403, 757411, 757438, 757446, 757454, 757462, 757470, 758736, 758833, 759201, 759651, 759678, 759686, 759694, 759708, 759716		

<sup>1</sup> multipoint probe

1			
<b>GEV No.</b>	379116	<b>Ref. No.</b>	32664
<b>description</b>	core temperature probe Pt100 cable PTFE probe -40 up to +250°C cable -40 up to +250°C connection 2-wire probe ø4x82mm thread 1/4" cable length 3m handle ø 12mm handle length 90mm		

## electronics

### PCBs

1			
<b>GEV No.</b>	400013	<b>Ref. No.</b>	214582
<b>description</b>	PCB combi-steamer 6x1/1 5x2/3 level control		
<b>For models:</b>	674524, 674532, 674605, 805556, Heissluftdaempfer-10x1-1, Heissluftdaempfer-20x1-1, Heissluftdaempfer-5x1-1, Heissluftdaempfer-5x2-3		

1			
<b>GEV No.</b>	361366	<b>Ref. No.</b>	376116 651079
<b>description</b>	PCB dishwasher 11F suitable for DB2 type DB2/EV1/EKP-M		
<b>For models:</b>	Glaeserspuelautomat-328		

1			
<b>GEV No.</b>	400027	<b>Ref. No.</b>	317225
<b>description</b>	relay PCB vario cooker 516678 with relay output		
<b>For models:</b>	516678, 610038, 610402, 610429, 620203, 620408, 620424, 639087, 699063, Vario-Braeter-plus		

## solenoid valves







### solenoid valves (water)











#### MÜLLER

medium temperature: 90°C  
duty cycle: 100%

1				
<b>GEV No.</b>	370004	<b>Ref. No.</b>	173266 297313	
<b>description</b>	solenoid valve double straight 230VAC inlet 3/4" outlet 14.5mm DN10 t.max. 90°C duty cycle 100% MÜLLER			
<b>For models:</b>	144819, 271500, 337xxx, 340022, 340030, 340049, 340057, 340073, 340xxx, 353167, 354392, 354457, 361763, 378933, 440078, 440086, 440094, 440140, 440655, 450111, 516678, 639087, 699063, Geschirrspuelautomat-330, Geschirrspuelautomat-335, Geschirrspuelautomat-336, Geschirrspuelautomat-700, GsP-350, GsP-500, GsP-600, Vario-Braeter-plus			
<b>spare parts for</b>	370004			
	<b>GEV No.</b>	370129	<b>Ref. No.</b>	—
	solenoid valve body double straight inlet 3/4" outlet 14.5mm DN10 t.max. 90°C duty cycle 100% MÜLLER 230V			
	<b>GEV No.</b>	371002	<b>Ref. No.</b>	—
	solenoid valve holder MÜLLER flange support			
	<b>GEV No.</b>	371009	<b>Ref. No.</b>	—
	compression spring for solenoid coil			
	<b>GEV No.</b>	371011	<b>Ref. No.</b>	—
	spare parts kit membrane with long star star hight 8mm MÜLLER			

Table continues overleaf

<b>spare parts for</b> 370004				
	GEV No.	371017	Ref. No.	—
solenoid coil MÜLLER 230VAC connection male faston 6.3mm				
	GEV No.	371122	Ref. No.	—
solenoid valve filter ø 19mm H 10mm suitable for MÜLLER				
	GEV No.	501161	Ref. No.	—
tap head for solenoid valve holder for solenoid coils				
<b>accessories for</b> 370004				
	GEV No.	371010	Ref. No.	—
solenoid coil 230VAC connection with cable cable length 2000mm				
	GEV No.	371037	Ref. No.	—
solenoid coil 24VAC 50/60Hz connection male faston 6.3mm				
	GEV No.	371038	Ref. No.	—
solenoid coil 230VAC connection appliance plug				

				
1				
GEV No.	370002	Ref. No.	334944	
<b>description</b> solenoid valve single straight 230VAC inlet 3/4" outlet 14.5mm DN10 t.max. 90°C duty cycle 100% MÜLLER				
<b>For models:</b> 144819, 340022, 340030, 340049, 340057, 340073, 353167, 354392, 354457, 361763, 378933, 440078, 440086, 440094, 440140, 440655, 450111				
<b>spare parts for</b> 370002				
	GEV No.	370127	Ref. No.	—
solenoid valve body single straight inlet 3/4" outlet 14.5mm DN10 t.max. 90°C duty cycle 100% MÜLLER 230V				
	GEV No.	371002	Ref. No.	—
solenoid valve holder MÜLLER flange support				
	GEV No.	371009	Ref. No.	—
compression spring for solenoid coil				
	GEV No.	371011	Ref. No.	—
spare parts kit membrane with long star star height 8mm MÜLLER				
	GEV No.	371017	Ref. No.	—
solenoid coil MÜLLER 230VAC connection male faston 6.3mm				
	GEV No.	371122	Ref. No.	—
solenoid valve filter ø 19mm H 10mm suitable for MÜLLER				
	GEV No.	501161	Ref. No.	—
tap head for solenoid valve holder for solenoid coils				
<b>accessories for</b> 370002				
	GEV No.	371010	Ref. No.	—
solenoid coil 230VAC connection with cable cable length 2000mm				
	GEV No.	371037	Ref. No.	—
solenoid coil 24VAC 50/60Hz connection male faston 6.3mm				

<b>accessories for</b> 370002				
	GEV No.	371038	Ref. No.	—
solenoid coil 230VAC connection appliance plug				





















<b>TP</b>				
				
1				
GEV No.	370017	Ref. No.	987017	
<b>description</b> solenoid valve single straight 230VAC inlet 3/4" outlet 11.5mm DN10 TP p max 10bar				
<b>spare parts for</b> 370017				
	GEV No.	371013	Ref. No.	—
solenoid coil TP 230VAC 50/60Hz				
<b>accessories for</b> 370017				
	GEV No.	371220	Ref. No.	—
reducer TP flow rate 3l/min red tolerance ±15%				
	GEV No.	371221	Ref. No.	—
reducer TP flow rate 5.5l/min yellow tolerance ±15%				
	GEV No.	371222	Ref. No.	—
reducer TP flow rate 6l/min grey tolerance ±15%				
	GEV No.	371223	Ref. No.	—
reducer TP flow rate 10l/min white tolerance ±15%				
	GEV No.	371224	Ref. No.	—
reducer TP flow rate 12l/min bronze tolerance ±15%				
	GEV No.	371225	Ref. No.	—
reducer TP flow rate 16l/min light brown tolerance ±15%				
	GEV No.	371226	Ref. No.	—
reducer TP flow rate 20l/min red tolerance ±15%				
	GEV No.	371230	Ref. No.	—
reducer TP flow rate 0.25l/min red tolerance ±25%				
	GEV No.	371231	Ref. No.	—
reducer TP flow rate 0.35l/min violet tolerance ±25%				
	GEV No.	371232	Ref. No.	—
reducer TP flow rate 0.5l/min orange tolerance ±25%				
	GEV No.	371233	Ref. No.	—
reducer TP flow rate 0.8l/min white tolerance ±25%				
	GEV No.	371234	Ref. No.	—
reducer TP flow rate 1l/min light blue tolerance ±25%				
	GEV No.	371235	Ref. No.	—
reducer TP flow rate 1.2l/min brown tolerance ±25%				

Table continues overleaf



accessories for		370017		
GEV No.	371236	Ref. No.	—	
	reducer TP flow rate 1.5l/min light brown tolerance ±25%			
GEV No.	371237	Ref. No.	—	
	reducer TP flow rate 2.5l/min yellow tolerance ±25%			
GEV No.	371238	Ref. No.	—	
	reducer TP flow rate 3.4l/min dark green tolerance ±25%			
GEV No.	371239	Ref. No.	—	
	reducer TP flow rate 5l/min black tolerance ±25%			
GEV No.	371240	Ref. No.	—	
	reducer TP flow rate 8l/min blue tolerance ±20%			

metal			
MÜLLER			
2-way			
	1		
GEV No.	370069 <sup>1</sup>	Ref. No.	374806 586935
description	solenoid valve 2-ways 230VAC inlet 1/8" IT outlet 1/8" IT L 30mm water MÜLLER DN10		
For models:	367788, 382191, 385018, 385026, 385034, 385042, 385050, 385514, 389595, 389609, 390003, 397210, 397229, 397237, 397245, 397253, 397261, 397288, 397296, 397318, 397326, 397334, 397342, 397350, 397431, 397776, 397784, 397792, 397806, 397814, 397822, 397830, 397849, 397857, 397865, 397873, 398047, 398055, 398063, 398071, 398098, 398101, 398128, 398136, 398144, 398152, 398950, 398969, 398977, 399019...(Other models you can see in the webshop)		

<sup>1</sup>with adjusting screw

	1		
GEV No.	370037 <sup>1</sup>	Ref. No.	079561
description	solenoid valve 2-ways 230VAC inlet 1/8" IT outlet M16x1 outer steam MÜLLER		
For models:	805149, 805300, 805408, 805459, 805xxx, 890502, 890510, 890529, 890553, 890561, 890588, 890596, 890618, 890626, Aromacarina, Aromacarina-Dampf, Aromacarina-EsA, Aromacarina-ETA, Aromacarina-ETA-EsA, Heissluftdaempfer-5x2-3		

<sup>1</sup>with adjusting screw

## pressure switches

for warewashing

ø 45mm with male faston 6.3mm

with connection horizontal

	1		
GEV No.	541014	Ref. No.	234125
description	pressure control pressure range 55/35mbar connection 6mm ø 45mm pressure connection horizontal warewashing pressure connection ø 6mm		
For models:	Geschirrspuelautomat-330		

ø 58mm with male faston 6.3mm

with connection horizontal

	1		
GEV No.	541003	Ref. No.	349399
description	pressure control pressure range 55/35mbar connection 6mm ø 58mm pressure connection horizontal warewashing pressure connection ø 6mm		
For models:	665843, 665851, Glaeserspuelautomat-325, Glaeserspuelautomat-328		

for coffee machines

ø 45mm

	1		
GEV No.	541015	Ref. No.	030422 301523
description	pressure control ø 45mm pressure range 400/360mbar pressure range 0.4/0.36bar p max 1.02bar pressure connection vertical coffee machine parts connection 1/4" 1CO suitable for Palux, Bremer pressure connection 1/4"		
For models:	674524, 674532, 674605, 805149, 805300, 805408, 805459, 805556, 805xxx, 810002, 813303, 890502, 890510, 890529, 890553, 890561, 890588, 890596, 890618, 890626, Aromacarina, Aromacarina-Dampf, Aromacarina-EsA, Aromacarina-ETA, Aromacarina-ETA-EsA, Heissluftdaempfer-10x1-1, Heissluftdaempfer-20x1-1, Heissluftdaempfer-5x1-1, Heissluftdaempfer-5x2-3, standkaffeemaschine-solomatic-2, standkaffeemaschine-solomatic-4, Wandkaffeemaschine-800		





for steam control



			
1			
<b>GEV No.</b>	541015	<b>Ref. No.</b>	030422 301523
<b>description</b>	pressure control ø 45mm pressure range 400/360mbar pressure range 0.4/0.36bar p max 1.02bar pressure connection vertical coffee machine parts connection 1/4" 1CO suitable for Palux, Bremer pressure connection 1/4"		
<b>For models:</b>	674524, 674532, 674605, 805149, 805300, 805408, 805459, 805556, 805xxx, 810002, 813303, 890502, 890510, 890529, 890553, 890561, 890588, 890596, 890618, 890626, Aromacarina, Aromacarina-Dampf, Aromacarina-EsA, Aromacarina-ETA, Aromacarina-ETA-EsA, Heissluftdaempfer-10x1-1, Heissluftdaempfer-20x1-1, Heissluftdaempfer-5x1-1, Heissluftdaempfer-5x2-3, standkaffeemaschine-solomatic-2, standkaffeemaschine-solomatic-4, Wandkaffeemaschine-800		

			
1			
<b>GEV No.</b>	541016	<b>Ref. No.</b>	702129
<b>description</b>	pressure control ø 45mm pressure range 480/430mbar pressure connection vertical steam control pressure range 0.48/0.43bar connection 1/4" pressure connection 1/4"		
<b>For models:</b>	00443x, 00457x, 136581, 690570		

			
1			
<b>GEV No.</b>	541342	<b>Ref. No.</b>	702153
<b>description</b>	pressure control ø 45mm reset pressure reclosing lockbar pressure connection vertical steam control pressure range 0.6/0.54bar connection 1/4" pressure connection 1/4"		
<b>For models:</b>	690570		

			
1			
<b>GEV No.</b>	541022	<b>Ref. No.</b>	127515
<b>description</b>	pressure control steam control pressure connection vertical pressure range adjustable 0.25-4.5bar connection 1/4" pressure connection 1/4" IT		
<b>For models:</b>	Maxima-Elektro-Kochkessel-100, Maxima-Elektro-Kochkessel-700-850, Maxima-Elektro-Kochkessel-80		

electrodes

			
1			
<b>GEV No.</b>	400697	<b>Ref. No.</b>	203858
<b>description</b>	level electrode PG16 total length 26mm probe L 20mm insulated probe length 5mm connection M5 ø 29mm		
<b>For models:</b>	750204, 750212, 750220, 750239		
<b>spare parts for</b>	400697		
	<b>GEV No.</b>	550577	<b>Ref. No.</b> —
	nut thread PG16 H 3mm WS 26 nickel-plated brass Qty 1 pcs mounting ømm cable ømm		

flow meters and flow sensors

flow meters

<b>GICAR</b>			
			
1			
<b>GEV No.</b>	400642	<b>Ref. No.</b>	027790
<b>description</b>	flow meter thread 1/4" plastic plug-in connection approval NSF		
<b>For models:</b>	805149, 805408, 805459, 805xxx, 890502, 890510, 890529, 890553, 890561, 890588, 890596, 890618, 890626, Aromacarina-EsA, Aromacarina-ETA-EsA		

## fans

### axial fans

#### import



<b>GEV No.</b>	601080 <sup>1</sup>	<b>Ref. No.</b>	693456
<b>description</b>	axial fan L 119mm W 119mm H 38mm 230VAC 50/60Hz 23/20W bearing ball bearing connection male faston 2.8mm metal ADDA fan wheel ø 110mm temp.-resist. 70°C		
<b>For models:</b>	671568, 671576, 671584, 671592, 671606, 671614, 671622, 671630, 758752, 758760, 758981, 759007, 759015, 759023, 759031, 759058, 759066, 759074, 759171, 759198		
<b>accessories for</b>	601080		
	<b>GEV No.</b>	550898	<b>Ref. No.</b> —
	connecting cable cable length 2000mm connection F 2.8 connection distance 7.9mm for axial flow fan		
	<b>GEV No.</b>	692519	<b>Ref. No.</b> —
	guard L 120mm W 120mm plastic		

<sup>1</sup>with ball bearings

### cross flow fans

#### ebm-papst



<b>GEV No.</b>	601505	<b>Ref. No.</b>	679178
<b>description</b>	cross flow fan QLN65/2400A17-3030L roller ø 65mm roller length 240mm laminated core thickness 29mm motor position right 230V/50Hz 22W refrigeration bearing silicone connection F 6.3 0 up to +60°C 230V throughput 200m <sup>3</sup> /h 50Hz		
<b>For models:</b>	354643, 354651, 354678, 354686, 354694, 354708, 505900, 505935, 650129, 650137, 650145, 650153, 663263, 663395, 670618, 670626, 686409, 687200, 688096, 688118, 688363, 690600, 696498, 703095, 703109, 703117, 703125, 709816, 709824, 709832, 709840, 716294, 716847, 733105, 733113, 733121, 733148, 733156, 733164, 736422, 736430, 736449, 736457, 736465, 736473		

## COPREL

### with moulded coils



<b>GEV No.</b>	601456	<b>Ref. No.</b>	202428
<b>description</b>	cross flow fan roller ø 45mm roller length 180mm laminated core thickness 15mm motor position right 230V/50Hz 26W universal bearing silicone connection male faston 6.3mm -30 up to +100°C 230V 50/60Hz		
<b>For models:</b>	750026, 750034, 750042, 750050, 750069		

### hot air motors

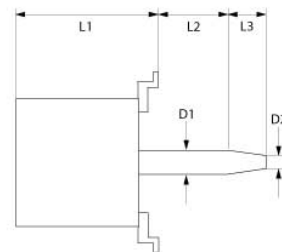

<b>GEV No.</b>	500102	<b>Ref. No.</b>	332410
<b>description</b>	fan motor 230-240V 1 phase 50Hz 0.09kW 1390rpm speeds 1 L1 150mm L2 32mm L3 27mm ø 125mm M10R IT 1.1A suitable capacitor 4µF/400V power input 200W at 50Hz 1390rpm type L7yzw4B-207 no. X5 D1 ø 17mm D2 ø 14mm		
<b>For models:</b>	385018, 385026, 385034, 385042, 385050, 385514, 390003, 397229, 397237, 397245, 397253, 397261, 397288, 397296, 397318, 397326, 397334, 397342, 397350, 397776, 397784, 397792, 397806, 397814, 397822, 397830, 397849, 397857, 397865, 397873, 399019, 399027, 399035, 399043, 399051, 399078, 399086, 399094, 399108, 399116, 606294, 606316, 606324, 606332, 606340, 606359, 606367, 609544, 609552, 609560...(Other models you can see in the webshop)		

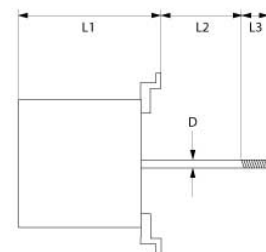

<b>GEV No.</b>	601474	<b>Ref. No.</b>	693286
<b>description</b>	fan motor 230V 1 phase 50/60Hz 0.03kW 3600rpm speeds 1 L1 115mm L2 20mm L3 32mm ø 12mm shaft flat length 23mm 7.5/8 0.35/0.56A suitable capacitor 3µF400V power input 75/125W at 50Hz 3600rpm type L5ow2B-317 no. W9		
<b>For models:</b>	671568, 671576, 671584, 671592, 671606, 671614, 671622, 671630, 758752, 758760, 758981, 759007, 759015, 759023, 759031, 759058, 759066, 759074, 759171, 759198		
<b>accessories for</b>	601474		
	<b>GEV No.</b>	602166	<b>Ref. No.</b> —
	fan wheel blades 9 D1 ø 175mm D2 ø 8mm D3 ø 8mm H1 30mm H2 28mm ED 6-23		



1

<b>GEV No.</b>	601871	<b>Ref. No.</b>	302821
<b>description</b>	fan motor 230V 1 phase 50Hz 85kW 2400rpm speeds 1 L1 85mm L2 40mm L3 33mm L4 133.5mm fan wheel ø 180mm at 50Hz 230V at 60Hz 230V at 50Hz 2600rpm at 60Hz 2850rpm type R2E180-AU01-09		
<b>For models:</b>	389595, 389609, 398950, 398969, 398977, 609188, 609196, 637599, 674648, 674656, 674885, Heissluftdaempfer-5x2-3, Heissluftgeraet-5x2-3		

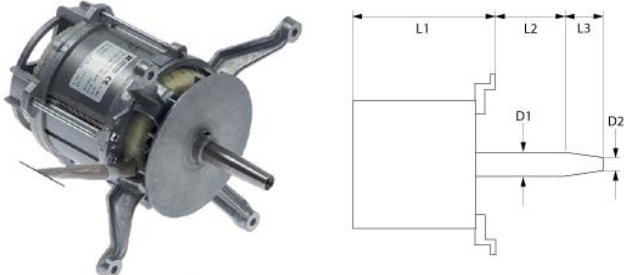

1

<b>GEV No.</b>	500170	<b>Ref. No.</b>	580287
<b>description</b>	fan motor 3 phase		
<b>For models:</b>	671649, 671657, 671665, 671673, 671681, 671711, 671746, 671754, 671762, 671770, 671789, 671797, 671800, 671819, 671827, 671835, 671843, 671851, 671878, 671886, 671894, 671908, 671916, 671975, 671983, 671991, 680583, 680591		

hot air fans

ebm-papst

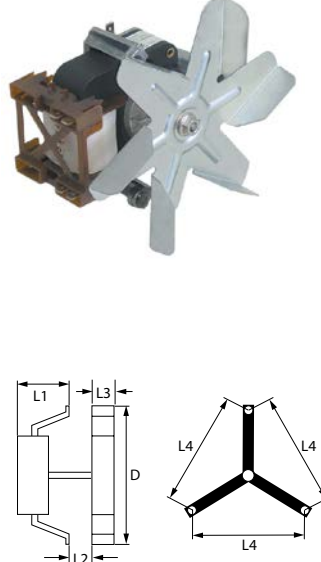

1

<b>GEV No.</b>	601059	<b>Ref. No.</b>	647896
<b>description</b>	hot air fan 220-230V 36W 0.26A L1 60mm L2 10mm L3 20mm L4 87mm fan wheel ø 150mm type R2K150-AN27-17 ebm-papst		
<b>For models:</b>	361429, 361437, HTP1, HTP2		

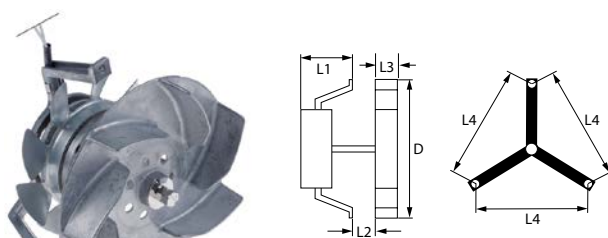

1

<b>GEV No.</b>	601013	<b>Ref. No.</b>	232572
<b>description</b>	hot air fan 230V 43W 0.25A L1 60mm L2 20mm L3 25mm L4 155mm fan wheel ø 150mm type R2S150-AA08-29 ebm-papst 2200rpm		
<b>For models:</b>	Elektro-Waermeschrank, OEWs1245-einseitig-400x1200mm, OEWs1246-einseitig-mit-Rueckwandverkleidung, UDWE1225L, UDWE1225L-doppelseitig-Eck-640x1200mm, UDWE1225R, UDWE1225R-doppelseitig-Eck-640x1200mm, UDWF0825, UDWF0825D-doppelseitig-640x800mm, UDWs1225, UDWs1225-doppelseitig-640x1200mm, UEWf0825, UEWf0825D-einseitig-640x800mm, UEWs06-schubladenblock-640x600mm, UEWs1225, UEWs1225-doppelseitig-640x1200mm, UEWs1225-einseitig-640x1200mm, UGWf0835, UGWf0835D-Fluegeltuer-710x800mm, UGWs1235, UGWs1235-schiebetuer-710x1200mm		

radial fans

miscellaneous



1

<b>GEV No.</b>	601475	<b>Ref. No.</b>	752525
<b>description</b>	radial fan 230V voltage AC 50/60Hz 20W H1 180mm L1 180mm D1 ø 86mm W1 40mm W2 34mm H2 122mm W3 40mm H3 172mm		
<b>For models:</b>	754668, 757314, 757462, 757470		

pumps

wash and rinse pumps

FIR

pumps



1

<b>GEV No.</b>	500560	<b>Ref. No.</b>	299200 645486
<b>description</b>	pump inlet ø 50mm outlet ø 37mm type B250.1500 230V 50Hz 1 phase 0.9kW 1.2HP L 265mm rotation direction left capacitor 12.5µF FIR		
<b>For models:</b>	271500, 337xxx, 353167, 354392, 354457, 361763, 378933, 440078, 440086, 440094, 440140, 440655, 450111, Geschirrspuelautomat-330, Geschirrspuelautomat-335, Geschirrspuelautomat-336, GsP-350, GsP-500, GsP-600		
<b>spare parts for</b>	500560		
	<b>GEV No.</b>	365014	<b>Ref. No.</b> —
	operating capacitor capacity 12.5µF 450V tolerance 5%Hz ambient temperature max. -25 to +85°C ø 35mm L 70mm M8 plastic connection male faston 6.3mm 45S.C3DS.12.5 protection		
	<b>GEV No.</b>	510693	<b>Ref. No.</b> 359416 441002
	mechanical shaft seal for shaft ø 12mm slide ring ext. ø 24mm slide ring H 15.5mm slide ring int. ø 11mm counter ring mounting ø 24mm height counter ring 8mm counter ring int. ø 13.5mm		
	<b>GEV No.</b>	521273	<b>Ref. No.</b> 728853
	impellor ø 103mm H 27mm rotation direction left thread M7R shaft ø 12mm shaft length 10mm blades 6		
	<b>GEV No.</b>	521567	<b>Ref. No.</b> 679623
	pump cover FIR inlet ø 50mm outlet ø 37mm ø 150mm ID ø 118mm inner height 25mm		
	<b>GEV No.</b>	521702	<b>Ref. No.</b> —
	pump cover gasket thickness 3.5x4.5mm Qty 1 pcs		

LGB



1

<b>GEV No.</b>	501486	<b>Ref. No.</b>	73048
<b>description</b>	pump inlet ø 42mm outlet ø 37mm type LA50 AP 230V 50Hz 1 phase 0.7kW L 220mm rotation direction right capacitor 14µF auxiliary pressure connection 8mm LGB		
<b>spare parts for</b>	501486		
	<b>GEV No.</b>	365020	<b>Ref. No.</b> —
	operating capacitor capacity 14µF 400V tolerance 5%Hz ambient temperature max. -25 to +85°C ø 35mm L 70mm M8 plastic connection male faston 6.3mm protection		
	<b>GEV No.</b>	510702	<b>Ref. No.</b> —
	mechanical shaft seal height counter ring 5.5mm ID ø 12mm		
	<b>GEV No.</b>	521024	<b>Ref. No.</b> —
	impellor ø 88mm H 30mm rotation direction right thread M7L shaft ø 12mm blades 6		
	<b>GEV No.</b>	698767	<b>Ref. No.</b> —
	fan blade ø 110mm H 18mm shaft intake ø 12mm plastic blades 6		
	<b>GEV No.</b>	698768	<b>Ref. No.</b> —
	pump cover LGB inlet ø 42mm pump type LA50 AP ø 115mm ID ø 36mm		
	<b>GEV No.</b>	698793	<b>Ref. No.</b> —
	pump cover outlet ø 24/36mm pump type LGB		
	<b>GEV No.</b>	698810	<b>Ref. No.</b> —
	O-ring EPDM thickness 3.56mm ID ø 112mm Qty 1 pcs		
	<b>GEV No.</b>	698827	<b>Ref. No.</b> —
	threaded ring LGB pump type LA50 ø 120mm ID ø 70mm		







electric components

OLYMPIA

pumps







1			
<b>GEV No.</b>	500003	<b>Ref. No.</b>	359270
<b>description</b>	pump inlet ø 45mm outlet ø 32mm type T30 230V 50Hz 1 phase 0.29kW 0.39HP L 190mm rotation direction right capacitor 8µF OLYMPIA		
<b>For models:</b>	665843, 665851, Glaeserspuelautomat-325, Glaeserspuelautomat-328		
<b>spare parts for</b>	500003		
	<b>GEV No.</b>	365013	<b>Ref. No.</b> —
	operating capacitor capacity 8µF 400V tolerance 5%Hz ambient temperature max. -25 to +85°C ø 31.5mm L 55mm M8 plastic connection male faston 6.3mm protection		
	<b>GEV No.</b>	510512	<b>Ref. No.</b> —
	pump cover OLYMPIA inlet ø 45mm outlet ø 31mm outlet 2 ø 24 turn direction right ø 130mm ID ø 124mm inner height 20mm		
	<b>GEV No.</b>	510554	<b>Ref. No.</b> —
	O-ring EPDM thickness 2mm ID ø 120mm Qty 1 pcs		
	<b>GEV No.</b>	510615	<b>Ref. No.</b> —
	impeller ø 90mm H 22mm rotation direction right thread M10L blades 4		
	<b>GEV No.</b>	510693	<b>Ref. No.</b> 359416 441002
	mechanical shaft seal for shaft ø 12mm slide ring ext. ø 24mm slide ring H 15.5mm slide ring int. ø 11mm counter ring mounting ø 24mm height counter ring 8mm counter ring int. ø 13.5mm		

booster pumps I



1			
<b>GEV No.</b>	500193	<b>Ref. No.</b>	958719
<b>description</b>	pump inlet ø 3/8" IT outlet ø 3/8" IT type C.1510 230V 50Hz 0.43kW ø 100mm L 170mm rotation direction left capacitor 10µF ALBA PUMPS (C&A)		
<b>spare parts for</b>	500193		
	<b>GEV No.</b>	550331	<b>Ref. No.</b> —
	protective covering 1-pole size 6.3mm straight nylon t.max. 120°C Qty 20 pcs		

<b>accessories for</b>	500193		
	<b>GEV No.</b>	365015	<b>Ref. No.</b> —
	operating capacitor capacity 10µF 400V tolerance 5%Hz ambient temperature max. -25 to +85°C ø 35.5mm L 59mm M8 plastic connection male faston 6.3mm protection		
	<b>GEV No.</b>	511279	<b>Ref. No.</b> —
	hose connector brass straight thread 3/8" hose ø 12mm Qty 1 pcs		
	<b>GEV No.</b>	520202	<b>Ref. No.</b> —
	hose connector nickel-plated brass straight thread 3/8" hose ø 12mm Qty 1 pcs		
	<b>GEV No.</b>	520204	<b>Ref. No.</b> —
	hose connector nickel-plated brass straight thread 3/8" hose ø 17mm Qty 1 pcs		

electric accessories

terminals

porcelain clamps

1			
<b>GEV No.</b>	550125	<b>Ref. No.</b>	151491
<b>description</b>	rail-mounted porcelain terminal 1-pole 10mm <sup>2</sup> max. 57A max 400V L 25mm W 15mm H 25mm mounting distance mm Qty 1 pcs		
<b>For models:</b>	600008, 600067, 601004, 601209, 601403, 602000, 602205, 602280, 610003, 610038, 61030x, 610402, 611018, 611050, 612006, 612057, 616001, 620009, 620300, 621005, 621056, 622001, 622052, 623008, 624004, 627100, 629006, 629022, Backofen-629, Bain-Marie-624, Bain-Marie-626, Brater-611, Brater-621, Elektroherd-4-Platten-623, Elektroherd-616, Fritteuse-600, Fritteuse-601, Fritteuse-602, Geschirrspuelautomat-335, Geschirrspuelautomat-336, Griddle-Platte-612, Griddleplatte-622, steakgrill-61030, steakgrill-62030, Wurstgrill-610, Wurstgrill-620		

connection terminals with screw/faston connections

1			
<b>GEV No.</b>	550762	<b>Ref. No.</b>	070858
<b>description</b>	connection terminal 2-pole max. 16A max 400V connection ø 2.5mm <sup>2</sup> / F6.3 temp.-resist. 150°C		
<b>For models:</b>	140902, 144819, 361763, 378933, 440078, 440086, 440094, 440140, 440655, 450111, 502200, 502308, 502650, 502707, 503010, 503150, 505900, 505935, 515892, 515906, 516678, 517887, 541869, 626104, 626112, 626201, 626228, 626309, 626317, 637564, 638625, 639087, 649554, 649562, 650943, 650951, 657735, 663263, 663395, 667412, 670618, 670626, 684848, 686298, 686328, 686336, 686409, 687200, 688096, 688118...(Other models you can see in the webshop)		











			
1			
<b>GEV No.</b>	550110	<b>Ref. No.</b>	002186
<b>description</b>	power terminal block 5-pole max. 40A max 250V connection M6/ male faston 6.3mm temp.-resist. 130°C		
<b>For models:</b>	140902, 144819, 353167, 354392, 354457, 354643, 354651, 354678, 354686, 354694, 354708, 361763, 378933, 440078, 440086, 440094, 440140, 440655, 450111, 502200, 502308, 502650, 502707, 503010, 503150, 505900, 505935, 515892, 515906, 516678, 517887, 541869, 601004, 601209, 601403, 602000, 602205, 602280, 603201, 610038, 610429, 611220, 614106, 615080, 616109, 620203, 620424, 621110, 623105, 624101...(Other models you can see in the webshop)		

## gas taps

### PEL





#### 21S series

			
1			
<b>GEV No.</b>	101671	<b>Ref. No.</b>	252859 259934 697451
<b>description</b>	gas tap PEL type 21S gas inlet pipe flange ø21mm bypass nozzle ø 0.35mm gas outlet M17x1 (tube ø 10mm) thermocouple connection M8x1 pilot connection M10x1 shaft ø 6x4.6mm shaft L 30/23mm shaft flat upper		
<b>For models:</b>	399701, 399728, 541419, 541427, 750123, 750131, 750158, 750166, 750174, 750182, 750190, 800163, 800171, 800198, 800201, 800228, 800236, 800244, 800252, 800260, 800279, 800287, 800295		
<b>spare parts for</b>	101671		
	<b>GEV No.</b>	100408	<b>Ref. No.</b> 834076
	bypass nozzle type PEL20/21 bore ø 0.35mm thread M5x0.5		
	<b>GEV No.</b>	100908	<b>Ref. No.</b> —
	union screw thread M10x1 for pipe ø 4mm Qty 1 pcs		
	<b>GEV No.</b>	101060	<b>Ref. No.</b> 296864
	magnet unit standard L 39mm D1 ø 15.4mm D2 ø 11mm suitable for PEL20-21/JUNKERS/EGA		
	<b>GEV No.</b>	101230	<b>Ref. No.</b> —
	thermocouple nut T1: M8x1 T2: M18x1 aluminium		
	<b>GEV No.</b>	101246	<b>Ref. No.</b> —
	olive for pipe ø 4mm Qty 1 pcs		
	<b>GEV No.</b>	101803	<b>Ref. No.</b> —
	gas tap front part shaft ø 6x4.6mm shaft L 30/23mm shaft flat upper/lower suitable for PEL21		
<b>accessories for</b>	101671		
	<b>GEV No.</b>	100909	<b>Ref. No.</b> —
	union screw thread M10x1 for pipe ø 6mm Qty 1 pcs		

<b>accessories for</b>	101671		
	<b>GEV No.</b>	101278	<b>Ref. No.</b> —
	olive for pipe ø 10mm Qty 1 pcs		
	<b>GEV No.</b>	101286	<b>Ref. No.</b> —
	olive ID ø 6mm Qty 1 pcs		
	<b>GEV No.</b>	101300	<b>Ref. No.</b> —
	union nut thread M16x1.5 tube ø 10mm		
	<b>GEV No.</b>	101450	<b>Ref. No.</b> —
	olive for pipe ø 8mm L 12.7mm Qty 1 pcs ED ø 10mm		
	<b>GEV No.</b>	101451	<b>Ref. No.</b> —
	union nut thread M16x1.5 tube ø 8mm		
	<b>GEV No.</b>	110078	<b>Ref. No.</b> —
	knob without symbol ø 70mm shaft ø 6x4.6mm shaft flat universal		
	<b>GEV No.</b>	112206	<b>Ref. No.</b> —
	knob dial plate silver gas tap PEL21/22/23 t.max.°C ED ø 63mm ID ø 45.5mm		

			
1			
<b>GEV No.</b>	101611	<b>Ref. No.</b>	831611
<b>description</b>	gas tap PEL type 21S/V gas inlet pipe flange ø21mm bypass nozzle ø 0.35mm gas outlet M16x1.5 (tube ø 10/8mm) thermocouple connection M8x1 pilot connection M10x1 shaft ø 6x4.6mm shaft L 30/17.5mm shaft flat upper		
<b>spare parts for</b>	101611		
	<b>GEV No.</b>	100408	<b>Ref. No.</b> 834076
	bypass nozzle type PEL20/21 bore ø 0.35mm thread M5x0.5		
	<b>GEV No.</b>	101060	<b>Ref. No.</b> 296864
	magnet unit standard L 39mm D1 ø 15.4mm D2 ø 11mm suitable for PEL20-21/JUNKERS/EGA		
	<b>GEV No.</b>	101230	<b>Ref. No.</b> —
	thermocouple nut T1: M8x1 T2: M18x1 aluminium		
	<b>GEV No.</b>	101804	<b>Ref. No.</b> —
	gas tap front part shaft ø 6x4.6mm shaft L 30/12.5mm shaft flat upper/lower suitable for PEL21		
<b>accessories for</b>	101611		
	<b>GEV No.</b>	100908	<b>Ref. No.</b> —
	union screw thread M10x1 for pipe ø 4mm Qty 1 pcs		
	<b>GEV No.</b>	100909	<b>Ref. No.</b> —
	union screw thread M10x1 for pipe ø 6mm Qty 1 pcs		
	<b>GEV No.</b>	101246	<b>Ref. No.</b> —
	olive for pipe ø 4mm Qty 1 pcs		
	<b>GEV No.</b>	101278	<b>Ref. No.</b> —
	olive for pipe ø 10mm Qty 1 pcs		

Table continues overleaf

accessories for 101611				
	GEV No.	101286	Ref. No.	—
olive ID ø 6mm Qty 1 pcs				
	GEV No.	101300	Ref. No.	—
union nut thread M16x1.5 tube ø 10mm				
	GEV No.	101450	Ref. No.	—
olive for pipe ø 8mm L 12.7mm Qty 1 pcs ED ø 10mm				
	GEV No.	101451	Ref. No.	—
union nut thread M16x1.5 tube ø 8mm				

22S/V series

 <p>1</p>				
GEV No.	101087	Ref. No.	321397	
description	gas tap PEL type 22S/V gas inlet M20x1.5 (tube ø 12mm) bypass nozzle ø 0.35mm gas outlet M20x1.5 (tube ø 12/10mm) thermocouple connection M9x1 pilot connection M10x1 shaft ø 10x8mm shaft L 25/17mm shaft flat upper			
For models:	910007, 910015, 910023, 910058, 910066, 910449, 910457, 910465			
spare parts for 101087				
	GEV No.	100259	Ref. No.	—
bypass nozzle type PEL22 bore ø 0.35mm thread M6x0.5				
	GEV No.	101058	Ref. No.	296872
magnet unit L 39mm D1 ø 15.4mm D2 ø 13.5mm suitable for PEL22/EGA24197 standard				
	GEV No.	101201	Ref. No.	—
gas tap front part shaft ø 10x8mm shaft L 25/17mm shaft flat upper/lower suitable for PEL22				
	GEV No.	101231	Ref. No.	—
thermocouple nut T1: M9x1 T2: M18x1				
	GEV No.	101241	Ref. No.	—
gas connection thread M20x1.5 tube ø 12/10mm for PEL gas taps vertical				
	GEV No.	101460	Ref. No.	—
O-ring ø 12.37mm D1 ø 2.62mm suitable for PEL22				
	GEV No.	101461	Ref. No.	—
screw kit suitable for PEL22 Qty 4 pcs				
accessories for 101087				
	GEV No.	100908	Ref. No.	—
union screw thread M10x1 for pipe ø 4mm Qty 1 pcs				
	GEV No.	100909	Ref. No.	—
union screw thread M10x1 for pipe ø 6mm Qty 1 pcs				
	GEV No.	101240	Ref. No.	—
gas connection thread M20x1.5 tube ø 12/10mm for PEL gas taps with gasket and screws horizontal				

accessories for 101087				
	GEV No.	101246	Ref. No.	—
olive for pipe ø 4mm Qty 1 pcs				
	GEV No.	101248	Ref. No.	—
olive for pipe ø 12mm Qty 1 pcs suitable for PEL				
	GEV No.	101249	Ref. No.	—
olive for pipe ø 10mm Qty 1 pcs				
	GEV No.	101250	Ref. No.	—
union nut thread M20x1.5 for pipe ø 10mm				
	GEV No.	101251	Ref. No.	—
union nut thread M20x1.5 for pipe ø 12mm				
	GEV No.	101286	Ref. No.	—
olive ID ø 6mm Qty 1 pcs				
	GEV No.	110080	Ref. No.	—
knob ø 70mm shaft ø 10x8mm shaft flat universal				
	GEV No.	112206	Ref. No.	—
knob dial plate silver gas tap PEL21/22/23 t.max.°C ED ø 63mm ID ø 45.5mm				

23S/V series











 <p>1</p>				
GEV No.	101630	Ref. No.	092415	
description	gas tap PEL type 23S/V gas inlet 1/2" IT bypass nozzle ø 0.35mm gas outlet 1/2" MT (tube ø 14mm) thermocouple connection M10x1 pilot connection M10x1 shaft ø 10mm shaft L 25mm shaft flat			
spare parts for 101630				
	GEV No.	100455	Ref. No.	—
bypass nozzle type PEL23/24 bore ø 0.35mm thread M8x0.5				
	GEV No.	101059	Ref. No.	—
magnet unit T1: M10x1 T2: M22x1 L 46mm ø 18mm suitable for PEL23S M10x1				
	GEV No.	102767	Ref. No.	—
gas tap front part shaft ø 10mm shaft L 26.5mm shaft flat suitable for PEL23S				
accessories for 101630				
	GEV No.	100908	Ref. No.	—
union screw thread M10x1 for pipe ø 4mm Qty 1 pcs				
	GEV No.	100909	Ref. No.	—
union screw thread M10x1 for pipe ø 6mm Qty 1 pcs				
	GEV No.	100945	Ref. No.	—
roll pin ø 3.2mm L 10mm				

Table continues overleaf



accessories for		101630		
	GEV No.	101218	Ref. No.	—
shaft extension JUNKERS				
	GEV No.	101219	Ref. No.	—
shaft extension L 25mm JUNKERS				
	GEV No.	101246	Ref. No.	—
olive for pipe ø 4mm Qty 1 pcs				
	GEV No.	101286	Ref. No.	—
olive ID ø 6mm Qty 1 pcs				
	GEV No.	110064	Ref. No.	—
knob				
	GEV No.	110066	Ref. No.	—
knob screw				
	GEV No.	550396	Ref. No.	—
shaft extension L 25mm JUNKERS				

accessories for		101603		
	GEV No.	100943	Ref. No.	—
union nut thread M17x1 tube ø 10mm				
	GEV No.	101278	Ref. No.	—
olive for pipe ø 10mm Qty 1 pcs				
	GEV No.	110078	Ref. No.	—
knob without symbol ø 70mm shaft ø 6x4.6mm shaft flat universal				
	GEV No.	110083	Ref. No.	—
knob dial plate gas tap without ignition flame silver				

alternatives to EGA

GPEL20 series

with pipe outlet

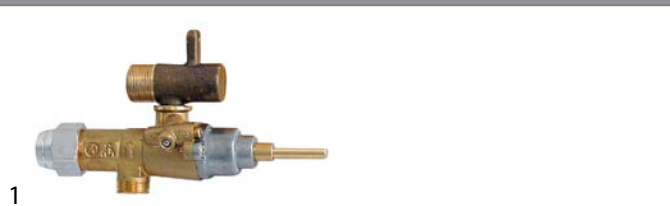

GEV No.	101603	Ref. No.	001163	
<b>description</b>	gas tap alternatives to EGA type GPEL20R with pipe outlet without ignition flame connection gas inlet M15x1 (tube ø 10mm) bypass nozzle ø 0.35mm gas outlet M17x1 (tube ø 10mm) thermocouple connection M8x1 shaft ø 6x4.6mm shaft L 31/23mm shaft flat upper			
<b>For models:</b>	645005, GasherD-645, GasherD-64502, GasherD-646			
<b>spare parts for</b>	101603			
	GEV No.	100408	Ref. No.	834076
bypass nozzle type PEL20/21 bore ø 0.35mm thread M5x0.5				
	GEV No.	101060	Ref. No.	296864
magnet unit standard L 39mm D1 ø 15.4mm D2 ø 11mm suitable for PEL20-21/JUNKERS/EGA				
	GEV No.	101230	Ref. No.	—
thermocouple nut T1: M8x1 T2: M18x1 aluminium				
	GEV No.	101801	Ref. No.	—
gas tap front part shaft ø 6x4.6mm shaft L 31/23mm shaft flat upper/lower suitable for PEL20				
<b>accessories for</b>	101603			
	GEV No.	100926	Ref. No.	—
centring piece thread M17x1				
	GEV No.	100942	Ref. No.	—
union nut thread M15x1 for pipe ø 10mm				

GPEL21 series

with pipe outlet



GEV No.	101612	Ref. No.	831743	
Alternative für 540889 Alternative für 540897				
<b>description</b>	gas tap alternatives to EGA type GPEL21R with pipe outlet gas inlet M15x1 (tube ø 10mm) bypass nozzle ø 0.35mm gas outlet M17x1 (tube ø 10mm) thermocouple connection M8x1 pilot connection M10x1 shaft ø 6x4.6mm shaft L 22/15mm shaft flat lower			
<b>For models:</b>	399604, 399612, 399701, 399728, 541419, 541427, 800163, 800171, 800198, 800201, 800228, 800236, 800244, 800252, 800260, 800279, 800287, 800295			
<b>spare parts for</b>	101612			
	GEV No.	100408	Ref. No.	834076
bypass nozzle type PEL20/21 bore ø 0.35mm thread M5x0.5				
	GEV No.	101060	Ref. No.	296864
magnet unit standard L 39mm D1 ø 15.4mm D2 ø 11mm suitable for PEL20-21/JUNKERS/EGA				
	GEV No.	101230	Ref. No.	—
thermocouple nut T1: M8x1 T2: M18x1 aluminium				
	GEV No.	101805	Ref. No.	—
gas tap front part shaft ø 6x4.6mm shaft L 38/15mm shaft flat upper/lower suitable for PEL21				
<b>accessories for</b>	101612			
	GEV No.	100908	Ref. No.	—
union screw thread M10x1 for pipe ø 4mm Qty 1 pcs				
	GEV No.	100909	Ref. No.	—
union screw thread M10x1 for pipe ø 6mm Qty 1 pcs				
	GEV No.	100926	Ref. No.	—
centring piece thread M17x1				
	GEV No.	100942	Ref. No.	—
union nut thread M15x1 for pipe ø 10mm				
	GEV No.	100943	Ref. No.	—
union nut thread M17x1 tube ø 10mm				

Table continues overleaf



accessories for		101612		
GEV No.	101246	Ref. No.	—	
	olive for pipe ø 4mm Qty 1 pcs			
	olive for pipe ø 10mm Qty 1 pcs			
	olive ID ø 6mm Qty 1 pcs			
	knob without symbol ø 70mm shaft ø 6x4.6mm shaft flat universal			
	knob dial plate silver gas tap PEL21/22/23 t.max.°C ED ø 63mm ID ø 45.5mm			

1				
GEV No.	101605	Ref. No.	N/A	
description	gas tap alternatives to EGA type GPEL21R with pipe outlet gas inlet M15x1 (tube ø 10mm) bypass nozzle ø 0.35mm gas outlet M17x1 (tube ø 10mm) thermocouple connection M8x1 pilot connection M10x1 shaft ø 6x4.6mm shaft L 30/23mm shaft flat upper			
spare parts for	101605			
	GEV No.	100408	Ref. No.	834076
	bypass nozzle type PEL20/21 bore ø 0.35mm thread M5x0.5			
	GEV No.	101060	Ref. No.	296864
	magnet unit standard L 39mm D1 ø 15.4mm D2 ø 11mm suitable for PEL20-21/JUNKERS/EGA			
	GEV No.	101230	Ref. No.	—
	thermocouple nut T1: M8x1 T2: M18x1 aluminium			
	GEV No.	101803	Ref. No.	—
	gas tap front part shaft ø 6x4.6mm shaft L 30/23mm shaft flat upper/lower suitable for PEL21			
accessories for	101605			
	GEV No.	100908	Ref. No.	—
	union screw thread M10x1 for pipe ø 4mm Qty 1 pcs			
	GEV No.	100909	Ref. No.	—
	union screw thread M10x1 for pipe ø 6mm Qty 1 pcs			
	GEV No.	100926	Ref. No.	—
	centring piece thread M17x1			
	GEV No.	100942	Ref. No.	—
	union nut thread M15x1 for pipe ø 10mm			
	GEV No.	100943	Ref. No.	—
	union nut thread M17x1 tube ø 10mm			
	GEV No.	101246	Ref. No.	—
	olive for pipe ø 4mm Qty 1 pcs			

accessories for		101605		
GEV No.	101278	Ref. No.	—	
	olive for pipe ø 10mm Qty 1 pcs			
	olive ID ø 6mm Qty 1 pcs			
	knob without symbol ø 70mm shaft ø 6x4.6mm shaft flat universal			
	knob dial plate silver gas tap PEL21/22/23 t.max.°C ED ø 63mm ID ø 45.5mm			

## GPEL22 series

with nozzle outlet





1				
GEV No.	101622	Ref. No.	290866	
description	gas tap alternatives to EGA type PEL22S with nozzle outlet (without nozzle) gas inlet M18x1.5 (tube ø 12mm) external nozzle ømm internal nozzle ømm bypass nozzle ø 0.35mm mixing pipe connection M22x1 thermocouple connection M8x1 pilot connection M10x1 shaft ø 6x4.6mm shaft L 35/21mm shaft flat upper			
For models:	Maxima-Gasherd-700, Maxima-Gasherd-850			
spare parts for	101622			
	GEV No.	100259	Ref. No.	—
	bypass nozzle type PEL22 bore ø 0.35mm thread M6x0.5			
	GEV No.	100927	Ref. No.	—
	torsion spring L 2.8-8.0mm for internal nozzle ø 3mm bore ømm			
	GEV No.	101058	Ref. No.	296872
	magnet unit L 39mm D1 ø 15.4mm D2 ø 13.5mm suitable for PEL22/EGA24197 standard			
	GEV No.	101230	Ref. No.	—
	thermocouple nut T1: M8x1 T2: M18x1 aluminium			
	GEV No.	101460	Ref. No.	—
	O-ring ø 12.37mm D1 ø 2.62mm suitable for PEL22			
	GEV No.	101527	Ref. No.	—
	O-ring Viton thickness 1.78mm ID ø 6.75mm Qty 1 pcs			
	GEV No.	101594	Ref. No.	—
	adjusting screw for internal nozzle thread M10x0.75			
	GEV No.	101823	Ref. No.	—
	gas tap front part shaft ø 6x4.6mm shaft L 35/21mm shaft flat upper/lower suitable for PEL22			
accessories for	101622			
	GEV No.	100908	Ref. No.	—
	union screw thread M10x1 for pipe ø 4mm Qty 1 pcs			

Table continues overleaf





accessories for		101622		
	GEV No.	100909	Ref. No.	—
union screw thread M10x1 for pipe ø 6mm Qty 1 pcs				
	GEV No.	100944	Ref. No.	—
union nut thread M18x1.5 for pipe ø 12mm				
	GEV No.	101246	Ref. No.	—
olive for pipe ø 4mm Qty 1 pcs				
	GEV No.	101273	Ref. No.	959715
olive for pipe ø 12mm L 9.5mm brass Qty 1 pcs suitable for universal				
	GEV No.	101286	Ref. No.	—
olive ID ø 6mm Qty 1 pcs				
	GEV No.	110078	Ref. No.	—
knob without symbol ø 70mm shaft ø 6x4.6mm shaft flat universal				
	GEV No.	112206	Ref. No.	—
knob dial plate silver gas tap PEL21/22/23 t.max.°C ED ø 63mm ID ø 45.5mm				

accessories for		101630		
	GEV No.	101246	Ref. No.	—
olive for pipe ø 4mm Qty 1 pcs				
	GEV No.	101286	Ref. No.	—
olive ID ø 6mm Qty 1 pcs				
	GEV No.	110064	Ref. No.	—
knob				
	GEV No.	110066	Ref. No.	—
knob screw				
	GEV No.	550396	Ref. No.	—
shaft extension L 25mm JUNKERS				







alternatives to JUNKERS

				
1				
GEV No.	101630	Ref. No.	092415	
description	gas tap PEL type 23S/V gas inlet 1/2" IT bypass nozzle ø 0.35mm gas outlet 1/2" MT (tube ø 14mm) thermocouple connection M10x1 pilot connection M10x1 shaft ø 10mm shaft L 25mm shaft flat			
spare parts for	101630			
	GEV No.	100455	Ref. No.	—
bypass nozzle type PEL23/24 bore ø 0.35mm thread M8x0.5				
	GEV No.	101059	Ref. No.	—
magnet unit T1: M10x1 T2: M22x1 L 46mm ø 18mm suitable for PEL23S M10x1				
	GEV No.	102767	Ref. No.	—
gas tap front part shaft ø 10mm shaft L 26.5mm shaft flat suitable for PEL23S				
accessories for	101630			
	GEV No.	100908	Ref. No.	—
union screw thread M10x1 for pipe ø 4mm Qty 1 pcs				
	GEV No.	100909	Ref. No.	—
union screw thread M10x1 for pipe ø 6mm Qty 1 pcs				
	GEV No.	100945	Ref. No.	—
roll pin ø 3.2mm L 10mm				
	GEV No.	101218	Ref. No.	—
shaft extension JUNKERS				
	GEV No.	101219	Ref. No.	—
shaft extension L 25mm JUNKERS				

EGA

24197 series

gas taps

				
1				
GEV No.	101149	Ref. No.	290874	
description	gas tap EGA type 24197 series			
For models:	Maxima-Gasherd-700, Maxima-Gasherd-850			
spare parts for	101149			
	GEV No.	101058	Ref. No.	296872
magnet unit L 39mm D1 ø 15.4mm D2 ø 13.5mm suitable for PEL22/ EGA24197 standard				
	GEV No.	101230	Ref. No.	—
thermocouple nut T1: M8x1 T2: M18x1 aluminium				
accessories for	101149			
	GEV No.	100944	Ref. No.	—
union nut thread M18x1.5 for pipe ø 12mm				
	GEV No.	101273	Ref. No.	959715
olive for pipe ø 12mm L 9.5mm brass Qty 1 pcs suitable for universal				
	GEV No.	101284	Ref. No.	—
olive for pipe ø 4mm Qty 1 pcs				
	GEV No.	101285	Ref. No.	—
union screw thread M8x1 for pipe ø 4mm Qty 1 pcs JUNKERS				



**26400 series**

**gas taps**

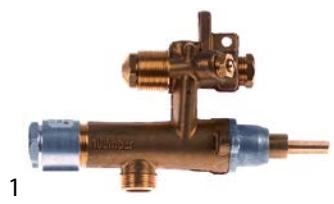



<b>GEV No.</b>	106319	<b>Ref. No.</b>	169498
<b>description</b>	gas tap EGA type 26400 series gas inlet 8mm pipe thermocouple connection M8 shaft ø 6x4.6mm external nozzle ø 270mm internal nozzle ø 130mm bypass nozzle ø 65mm shaft L 25mm shaft length knob 17mm shaft flat upper		
<b>For models:</b>	640018, 642053, Gas-Brater-641, Gas-Griddleplatte-642, Gas-sudpfanne-643, Gas-Wurstgrill-640		
<b>spare parts for</b>	106319		
	GEV No.	100295	Ref. No. 169595
	gas injector thread M12x1 WS 14 bore ø 2.70mm		
	GEV No.	100361	Ref. No. —
	bypass nozzle EGA type 31248 series bore ø 0.65mm		
	GEV No.	101060	Ref. No. 296864
	magnet unit standard L 39mm D1 ø 15.4mm D2 ø 11mm suitable for PEL20-21/JUNKERS/EGA		
	GEV No.	101230	Ref. No. —
	thermocouple nut T1: M8x1 T2: M18x1 aluminium		
	GEV No.	106510	Ref. No. —
	internal nozzle bore ø 1.30mm suitable for EGA26400/26440		
<b>accessories for</b>	106319		
	GEV No.	100941	Ref. No. —
	union nut thread M15x1 for pipe ø 8mm		
	GEV No.	101277	Ref. No. —
	olive ID ø 8mm Qty 1 pcs		

**26440 series**

**gas taps**



<b>GEV No.</b>	101142	<b>Ref. No.</b>	081167 081426
<b>description</b>	gas tap EGA type 26440 series		
<b>For models:</b>	Maxima-Gasherd-700-850, Maxima-Gasherd-mit-Gasbackofen, Maxima-Gasherd-neue-Ausfuehrung-700-850		
<b>spare parts for</b>	101142		
	GEV No.	101060	Ref. No. 296864
	magnet unit standard L 39mm D1 ø 15.4mm D2 ø 11mm suitable for PEL20-21/JUNKERS/EGA		
	GEV No.	101230	Ref. No. —
	thermocouple nut T1: M8x1 T2: M18x1 aluminium		

<b>accessories for</b>	101142		
	GEV No.	100926	Ref. No. —
	centring piece thread M17x1		
	GEV No.	100942	Ref. No. —
	union nut thread M15x1 for pipe ø 10mm		
	GEV No.	101278	Ref. No. —
	olive for pipe ø 10mm Qty 1 pcs		
	GEV No.	101284	Ref. No. —
	olive for pipe ø 4mm Qty 1 pcs		
	GEV No.	101285	Ref. No. —
	union screw thread M8x1 for pipe ø 4mm Qty 1 pcs JUNKERS		
	GEV No.	101394	Ref. No. —
	nut thread M17x1 H 3mm WS 19 brass Qty 1 pcs		

<b>GEV No.</b>	101145	<b>Ref. No.</b>	540889 540897
<b>description</b>	gas tap EGA type 26440 series		
<b>spare parts for</b>	101145		
	GEV No.	101060	Ref. No. 296864
	magnet unit standard L 39mm D1 ø 15.4mm D2 ø 11mm suitable for PEL20-21/JUNKERS/EGA		
	GEV No.	101233	Ref. No. —
	union nut thread M10x1 JUNKERS		
<b>accessories for</b>	101145		
	GEV No.	100926	Ref. No. —
	centring piece thread M17x1		
	GEV No.	100942	Ref. No. —
	union nut thread M15x1 for pipe ø 10mm		
	GEV No.	101278	Ref. No. —
	olive for pipe ø 10mm Qty 1 pcs		
	GEV No.	101284	Ref. No. —
	olive for pipe ø 4mm Qty 1 pcs		
	GEV No.	101285	Ref. No. —
	union screw thread M8x1 for pipe ø 4mm Qty 1 pcs JUNKERS		
	GEV No.	101394	Ref. No. —
	nut thread M17x1 H 3mm WS 19 brass Qty 1 pcs		



# ignition parts











## pilot burners

### SIT

#### 100 series

















1

<b>GEV No.</b>	107137	<b>Ref. No.</b>	321354
<b>description</b>	pilot burner SIT type 100 series 1 flame LPG nozzle $\varnothing$ 0.18mm gas connectionmm		
<b>spare parts for</b>	107137		
	<b>GEV No.</b>	100246	<b>Ref. No.</b> —
	pilot burner nozzle natural gas bore $\varnothing$ 0.35mm Qty 1 pcs thread M8x0.75		
	<b>GEV No.</b>	100916	<b>Ref. No.</b> —
	compression spring for pilot burner Qty 1 pcs		
	<b>GEV No.</b>	100917	<b>Ref. No.</b> —
	gasket for pilot burner Qty 1 pcs aluminium		
	<b>GEV No.</b>	100918	<b>Ref. No.</b> —
	screw for pilot burner		
<b>accessories for</b>	107137		
	<b>GEV No.</b>	100246	<b>Ref. No.</b> —
	pilot burner nozzle natural gas bore $\varnothing$ 0.35mm Qty 1 pcs thread M8x0.75		
	<b>GEV No.</b>	100904	<b>Ref. No.</b> —
	locking screw M10x1 for pipe $\varnothing$ 4mm Qty 1 pcs		
	<b>GEV No.</b>	100905	<b>Ref. No.</b> —
	locking screw M10x1 for pipe $\varnothing$ 6mm Qty 1 pcs		
	<b>GEV No.</b>	102110	<b>Ref. No.</b> —
	pilot tube copper pipe $\varnothing$ 4mm thickness 1mm L 3000mm		
	<b>GEV No.</b>	102111	<b>Ref. No.</b> —
	pilot tube copper pipe $\varnothing$ 6mm thickness 1mm L 3000mm		
	<b>GEV No.</b>	107171	<b>Ref. No.</b> —
	pilot burner nozzle SIT natural/liquid gas bore $\varnothing$ 0.25mm Qty 1 pcs		



1

<b>GEV No.</b>	106907	<b>Ref. No.</b>	321400 321699
<b>description</b>	pilot burner SIT type 100 series 3 flames nozzle $\varnothing$ 0.35mm gas connection 6mm		
<b>For models:</b>	710024, 710040, 710059, 710067, 910023, 910047, 910058, 910066, 910082, 910090, 910104, 910112, 910139, 910147, 910155, 910163, 910457, 910473, FOEM-Gas-Backofen		
<b>spare parts for</b>	106907		
	<b>GEV No.</b>	100246	<b>Ref. No.</b> —
	pilot burner nozzle natural gas bore $\varnothing$ 0.35mm Qty 1 pcs thread M8x0.75		
	<b>GEV No.</b>	100855	<b>Ref. No.</b> —
	pilot burner bracket triple		
	<b>GEV No.</b>	100885	<b>Ref. No.</b> —
	air mixing sleeve for pilot burner Qty 1 pcs		
	<b>GEV No.</b>	100916	<b>Ref. No.</b> —
	compression spring for pilot burner Qty 1 pcs		
	<b>GEV No.</b>	100917	<b>Ref. No.</b> —
	gasket for pilot burner Qty 1 pcs aluminium		
	<b>GEV No.</b>	100918	<b>Ref. No.</b> —
	screw for pilot burner		
	<b>GEV No.</b>	107162	<b>Ref. No.</b> —
	pilot burner cap SIT 3 flames Hmm Lmm Qty 1 pcs		
<b>accessories for</b>	106907		
	<b>GEV No.</b>	100245	<b>Ref. No.</b> —
	pilot burner nozzle LPG code 20 bore $\varnothing$ 0.2mm Qty 1 pcs thread M8x0.75		
	<b>GEV No.</b>	100904	<b>Ref. No.</b> —
	locking screw M10x1 for pipe $\varnothing$ 4mm Qty 1 pcs		
	<b>GEV No.</b>	100905	<b>Ref. No.</b> —
	locking screw M10x1 for pipe $\varnothing$ 6mm Qty 1 pcs		
	<b>GEV No.</b>	102110	<b>Ref. No.</b> —
	pilot tube copper pipe $\varnothing$ 4mm thickness 1mm L 3000mm		
	<b>GEV No.</b>	102111	<b>Ref. No.</b> —
	pilot tube copper pipe $\varnothing$ 6mm thickness 1mm L 3000mm		
	<b>GEV No.</b>	107171	<b>Ref. No.</b> —
	pilot burner nozzle SIT natural/liquid gas bore $\varnothing$ 0.25mm Qty 1 pcs		
	<b>GEV No.</b>	107700	<b>Ref. No.</b> —
	pilot burner bottom part SIT 100 series nozzle $\varnothing$ 0.25mm		
	<b>GEV No.</b>	107701	<b>Ref. No.</b> —
	pilot burner bottom part SIT 100 series nozzle $\varnothing$ 0.2mm		

1 gas components



accessories			
ignition electrodes			
<b>GEV No.</b>	100706	<b>Ref. No.</b>	321419
<b>description</b>	ignition electrode connection M4 Qty 1 pcs		
<b>For models:</b>	710059, 710067, 710083, 910023, 910047, 910058, 910066, 910082, 910090, 910104, 910112, 910139, 910147, 910155, 910163, 910457, 910473		

JUNKERS			
CB 502 series			
pilot burners			
<b>GEV No.</b>	100125	<b>Ref. No.</b>	374520 606197
<b>description</b>	pilot burner JUNKERS type CB502024		
<b>For models:</b>	399604, 399612, 750301, 750328, 750379, 750387		
<b>spare parts for</b>	100125		
	<b>GEV No.</b>	100228	<b>Ref. No.</b> —
	pilot burner nozzle town gas gas pressure 8mbar code 4 Qty 1 pcs suitable for JUNKERS CB50203_		
	<b>GEV No.</b>	100719	<b>Ref. No.</b> 097292
	ignition electrode D1 ø 7mm D2 ø 9mm connection M4 L1 12mm L2 17mm BL1 18mm BL2 3mm BL3 23mm		
	<b>GEV No.</b>	100906	<b>Ref. No.</b> 835803
	screw connection thread M10x1 for ignition electrode brass Qty 1 pcs WS 10		
	<b>GEV No.</b>	100907	<b>Ref. No.</b> —
	screw connection thread M10x1 Qty 1 pcs type SEF 1 ømm for thermocouple		
	<b>GEV No.</b>	101281	<b>Ref. No.</b> —
	olive for pipe ø 4mm L 8.7mm Qty 1 pcs suitable for CB 502/503		
	<b>GEV No.</b>	101283	<b>Ref. No.</b> —
	union screw thread M10x1 for pipe ø 4mm Qty 1 pcs		
<b>accessories for</b>	100125		
	<b>GEV No.</b>	100220	<b>Ref. No.</b> —
	pilot burner nozzle LPG gas pressure 50mbar code 2 Qty 1 pcs suitable for JUNKERS CB503_		
	<b>GEV No.</b>	100221	<b>Ref. No.</b> —
	pilot burner nozzle LPG gas pressure 30mbar code 29 Qty 1 pcs suitable for JUNKERS CB50203_		
	<b>GEV No.</b>	100222	<b>Ref. No.</b> —
	pilot burner nozzle LPG gas pressure 50mbar code 5 Qty 1 pcs suitable for JUNKERS CB50203_		

<b>accessories for</b>	100125		
	<b>GEV No.</b>	100222	<b>Ref. No.</b> —
	pilot burner nozzle LPG gas pressure 50mbar code 5 Qty 1 pcs suitable for JUNKERS CB50203_		
	<b>GEV No.</b>	100223	<b>Ref. No.</b> —
	pilot burner nozzle natural gas gas pressure 20mbar code 3 Qty 1 pcs suitable for JUNKERS CB503_		
	<b>GEV No.</b>	100224	<b>Ref. No.</b> —
	pilot burner nozzle natural gas gas pressure 25mbar code 26 Qty 1 pcs suitable for JUNKERS CB503_		
	<b>GEV No.</b>	100225	<b>Ref. No.</b> —
	pilot burner nozzle LPG gas pressure 30mbar code 39 Qty 1 pcs suitable for JUNKERS CB503_		
	<b>GEV No.</b>	100226	<b>Ref. No.</b> —
	pilot burner nozzle LPG gas pressure 50mbar code 15 suitable for JUNKERS		
	<b>GEV No.</b>	100227	<b>Ref. No.</b> —
	pilot burner nozzle natural gas gas pressure 25mbar code 6 Qty 1 pcs suitable for JUNKERS CB50203_		
	<b>GEV No.</b>	100909	<b>Ref. No.</b> —
	union screw thread M10x1 for pipe ø 6mm Qty 1 pcs		
	<b>GEV No.</b>	101287	<b>Ref. No.</b> —
	olive for pipe ø 6mm Qty 1 pcs		

CB 503 series			
pilot burners			
<b>GEV No.</b>	100101	<b>Ref. No.</b>	225894
<b>description</b>	pilot burner JUNKERS type CB503003 LPG nozzle no.2 gas connection 4mm with primary air		
<b>For models:</b>	FOEM-Offenen-Brennstellen, Maxima-Gasherdd-700, Maxima-Gasherdd-850		
<b>spare parts for</b>	100101		
	<b>GEV No.</b>	100224	<b>Ref. No.</b> —
	pilot burner nozzle natural gas gas pressure 25mbar code 26 Qty 1 pcs suitable for JUNKERS CB503_		
	<b>GEV No.</b>	101281	<b>Ref. No.</b> —
	olive for pipe ø 4mm L 8.7mm Qty 1 pcs suitable for CB 502/503		
	<b>GEV No.</b>	101283	<b>Ref. No.</b> —
	union screw thread M10x1 for pipe ø 4mm Qty 1 pcs		
<b>accessories for</b>	100101		
	<b>GEV No.</b>	100220	<b>Ref. No.</b> —
	pilot burner nozzle LPG gas pressure 50mbar code 2 Qty 1 pcs suitable for JUNKERS CB503_		
	<b>GEV No.</b>	100221	<b>Ref. No.</b> —
	pilot burner nozzle LPG gas pressure 30mbar code 29 Qty 1 pcs suitable for JUNKERS CB50203_		
	<b>GEV No.</b>	100222	<b>Ref. No.</b> —
	pilot burner nozzle LPG gas pressure 50mbar code 5 Qty 1 pcs suitable for JUNKERS CB50203_		

Table continues overleaf











accessories for		100101	
	GEV No.	100223	Ref. No. —
pilot burner nozzle natural gas gas pressure 20mbar code 3 Qty 1 pcs suitable for JUNKERS CB503_			
	GEV No.	100226	Ref. No. —
pilot burner nozzle LPG gas pressure 50mbar code 15 suitable for JUNKERS			
	GEV No.	100227	Ref. No. —
pilot burner nozzle natural gas gas pressure 25mbar code 6 Qty 1 pcs suitable for JUNKERS CB50203_			
	GEV No.	100228	Ref. No. —
pilot burner nozzle town gas gas pressure 8mbar code 4 Qty 1 pcs suitable for JUNKERS CB50203_			
	GEV No.	100909	Ref. No. —
union screw thread M10x1 for pipe ø 6mm Qty 1 pcs			
	GEV No.	101287	Ref. No. —
olive for pipe ø 6mm Qty 1 pcs			
	GEV No.	102110	Ref. No. —
pilot tube copper pipe ø 4mm thickness 1mm L 3000mm			
	GEV No.	102111	Ref. No. —
pilot tube copper pipe ø 6mm thickness 1mm L 3000mm			

accessories for		100079	
	GEV No.	102110	Ref. No. —
pilot tube copper pipe ø 4mm thickness 1mm L 3000mm			
	GEV No.	102111	Ref. No. —
pilot tube copper pipe ø 6mm thickness 1mm L 3000mm			
	GEV No.	102699	Ref. No. 835765
pilot burner nozzle POLIDORO natural gas code 25.2 bore ø 2x0.25mm Qty 1 pcs 2 bores			
	GEV No.	102795	Ref. No. —
olive for pipe ø 4mm Qty 1 pcs			
	GEV No.	102797	Ref. No. —
olive for pipe ø 6mm Qty 1 pcs			
	GEV No.	106703	Ref. No. —
pilot burner nozzle POLIDORO natural gas code 27.2 bore ø 2x0.27mm Qty 1 pcs			
	GEV No.	106704	Ref. No. —
pilot burner nozzle POLIDORO LPG code 16.2 bore ø 2x0.16mm Qty 1 pcs			
	GEV No.	106763	Ref. No. —
pilot burner nozzle POLIDORO natural gas code 27.2A bore ø 2x0.27mm Qty 1 pcs			
	GEV No.	106859	Ref. No. —
pilot burner nozzle POLIDORO LPG code 24 bore ø 0.24mm Qty 1 pcs			

**POLIDORO**

**pilot burners**



GEV No.	100079	Ref. No.	834610 835838
<b>description</b>	pilot burner POLIDORO 3 flames code gas connectionmm		
<b>accessories for</b>	100079		
	GEV No.	100000	Ref. No. —
pilot burner nozzle POLIDORO LPG code 22 bore ø 0.22mm Qty 1 pcs			
	GEV No.	100208	Ref. No. —
pilot burner nozzle POLIDORO LPG code 20 bore ø 0.2mm Qty 1 pcs			
	GEV No.	100209	Ref. No. —
pilot burner nozzle POLIDORO natural gas code 40 bore ø 0.4mm Qty 1 pcs			
	GEV No.	100701	Ref. No. —
ignition electrode connection M4 Qty 1 pcs			
	GEV No.	100906	Ref. No. 835803
screw connection thread M10x1 for ignition electrode brass Qty 1 pcs WS 10			
	GEV No.	100907	Ref. No. —
screw connection thread M10x1 Qty 1 pcs type SEF 1 ømm for thermocouple			
	GEV No.	100908	Ref. No. —
union screw thread M10x1 for pipe ø 4mm Qty 1 pcs			
	GEV No.	100909	Ref. No. —
union screw thread M10x1 for pipe ø 6mm Qty 1 pcs			

**producer-specific pilot burners**

**PALUX**

**Compact series**

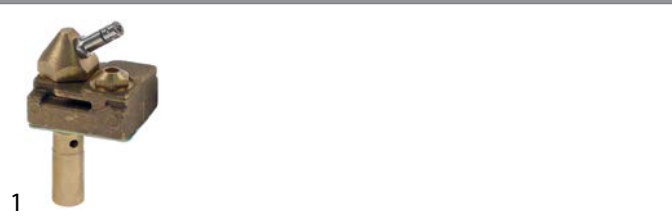

GEV No.	102956	Ref. No.	N/A
<b>description</b>	pilot burner type C without nozzle		



GEV No.	102957	Ref. No.	N/A
<b>description</b>	pilot burner type D without nozzle		











			
<b>GEV No.</b>	102958	<b>Ref. No.</b>	N/A
<b>description</b>	pilot burner type E without nozzle		

## Practica series

			
<b>GEV No.</b>	107137	<b>Ref. No.</b>	321354
<b>description</b>	pilot burner SIT type 100 series 1 flame LPG nozzle $\phi$ 0.18mm gas connectionmm		
<b>spare parts for</b>	107137		
	<b>GEV No.</b>	100246	<b>Ref. No.</b> —
pilot burner nozzle natural gas bore $\phi$ 0.35mm Qty 1 pcs thread M8x0.75			
	<b>GEV No.</b>	100916	<b>Ref. No.</b> —
compression spring for pilot burner Qty 1 pcs			
	<b>GEV No.</b>	100917	<b>Ref. No.</b> —
gasket for pilot burner Qty 1 pcs aluminium			
	<b>GEV No.</b>	100918	<b>Ref. No.</b> —
screw for pilot burner			
<b>accessories for</b>	107137		
	<b>GEV No.</b>	100246	<b>Ref. No.</b> —
pilot burner nozzle natural gas bore $\phi$ 0.35mm Qty 1 pcs thread M8x0.75			
	<b>GEV No.</b>	100904	<b>Ref. No.</b> —
locking screw M10x1 for pipe $\phi$ 4mm Qty 1 pcs			
	<b>GEV No.</b>	100905	<b>Ref. No.</b> —
locking screw M10x1 for pipe $\phi$ 6mm Qty 1 pcs			
<b>GEV No.</b>	102110	<b>Ref. No.</b>	—
 pilot tube copper pipe $\phi$ 4mm thickness 1mm L 3000mm			
<b>GEV No.</b>	102111	<b>Ref. No.</b>	—
 pilot tube copper pipe $\phi$ 6mm thickness 1mm L 3000mm			
<b>GEV No.</b>	107171	<b>Ref. No.</b>	—
 pilot burner nozzle SIT natural/liquid gas bore $\phi$ 0.25mm Qty 1 pcs			

## Topline series (version 1)

			
<b>GEV No.</b>	100088	<b>Ref. No.</b>	541346
<b>description</b>	pilot burner EGA type B		
<b>For models:</b>	399701, 399728, 541419, 541427, 800163, 800171, 800198, 800201, 800228, 800236, 800244, 800252, 800260, 800279, 800287, 800295		
<b>spare parts for</b>	100088		
	<b>GEV No.</b>	100961	<b>Ref. No.</b> 081515 360139
pilot burner head thread M7x0.75mm thread L 5mm ED $\phi$ 6mm ID $\phi$ 4.4mm total length 30mm L 20mm WS 8			
	<b>GEV No.</b>	101345	<b>Ref. No.</b> —
nut thread M15x1 H 3mm WS 19 brass Qty 1 pcs			
<b>accessories for</b>	100088		
	<b>GEV No.</b>	100270	<b>Ref. No.</b> 086339
pilot burner nozzle LPG bore $\phi$ 0.2mm thread M8x0.75 T1: M8x1			
	<b>GEV No.</b>	100271	<b>Ref. No.</b> —
pilot burner nozzle natural gas bore $\phi$ 0.3mm			
	<b>GEV No.</b>	100960	<b>Ref. No.</b> 082759
cover for pilot burner			
	<b>GEV No.</b>	101228	<b>Ref. No.</b> —
knurled nut thread M8x0.75 $\phi$ 14mm H 4mm mounting pos. outer brass			
	<b>GEV No.</b>	101259	<b>Ref. No.</b> —
union nut thread M8x1 for pipe $\phi$ 4mm			
	<b>GEV No.</b>	101284	<b>Ref. No.</b> —
olive for pipe $\phi$ 4mm Qty 1 pcs			

## electrodes

			
<b>GEV No.</b>	100706	<b>Ref. No.</b>	321419
<b>description</b>	ignition electrode connection M4 Qty 1 pcs		
<b>For models:</b>	710059, 710067, 710083, 910023, 910047, 910058, 910066, 910082, 910090, 910104, 910112, 910139, 910147, 910155, 910163, 910457, 910473		



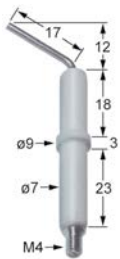

<b>GEV No.</b>	100719	<b>Ref. No.</b>	097292
<b>description</b>	ignition electrode D1 ø 7mm D2 ø 9mm connection M4 L1 12mm L2 17mm BL1 18mm BL2 3mm BL3 23mm		
<b>For models:</b>	640018, 642053, Gas-Brater-641, Gas-Griddleplatte-642, Gas-sudpfanne-643, Gas-Wurstgrill-640		



<b>GEV No.</b>	100741	<b>Ref. No.</b>	090069
<b>description</b>	ignition electrode D1 ø 9mm L1 8mm connection M4 PG9		
<b>For models:</b>	Maxima-Gas-Kippbratpfanne-neue-Ausfuehrung-700-850		



<b>GEV No.</b>	100906	<b>Ref. No.</b>	835803
<b>description</b>	screw connection thread M10x1 for ignition electrode brass Qty 1 pcs WS 10		



<b>GEV No.</b>	100005	<b>Ref. No.</b>	858528
<b>description</b>	piezoelectric igniter body plastic blowing mounting ø 22mm connection ø2.4mm cable lengthmm SIT		

**miscellaneous**



<b>GEV No.</b>	nla <sup>1</sup>	<b>Ref. No.</b>	089354 311723
<b>description</b>	piezoelectric igniter body metal connection F6.3x0.8 2 hole fixing ø 22mm		
<b>For models:</b>	640018, 642053, 645005, 710059, 710067, 710083, 750301, 750328, 750379, 750387, Gas-Brater-641, Gas-Griddleplatte-642, Gasherd-645, Gasherd-646, Gas-sudpfanne-643, Gas-Wurstgrill-640, Maxima-Gas-Bain-Marie-700-850, Maxima-Gas-Bain-Marie-850, Maxima-Gas-Kippbratpfanne-neue-Ausfuehrung-700-850		

<sup>1</sup>no longer available





<b>GEV No.</b>	nla <sup>1</sup>	<b>Ref. No.</b>	833291
<b>description</b>	piezoelectric igniter suitable for Minisit connection F6.3x0.8 ømm		

<sup>1</sup>no longer available

piezoelectric igniters

mounting diameter 22mm



<b>GEV No.</b>	100039	<b>Ref. No.</b>	269174
<b>description</b>	piezoelectric igniter body plastic blowing mounting ø 22mm connection F6.3x0.8 cable lengthmm		
<b>For models:</b>	Gas-Bain-Marie-644, Maxima-Gasherd-mit-Gasbackofen		
<b>accessories for</b>	100039		
	<b>GEV No.</b>	100115	<b>Ref. No.</b> —
	union nut ID ø M22x1mm		

thermocouples

plug-in thermocouples

plug-in thermocouples standard

with barrel socket ø5mm - type Junkers with aluminised tip

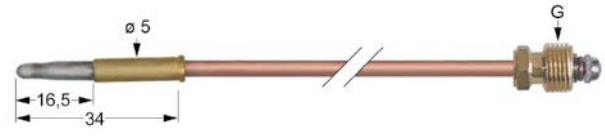

<b>GEV No.</b>	102205	<b>Ref. No.</b>	697443
<b>description</b>	thermocouple M8x1 L 750mm plug connection ø5.0mm		
<b>For models:</b>	399701, 399728, 541419, 541427, 800163, 800171, 800198, 800201, 800228, 800236, 800244, 800252, 800260, 800279, 800287, 800295		
<b>accessories for</b>	102205		
	<b>GEV No.</b>	101260	<b>Ref. No.</b> —
	thermocouple fitting thread M8x1 Qty 1 pcs		

with barrel socket  $\varnothing 6\text{mm}$

type Junkers with aluminised tip

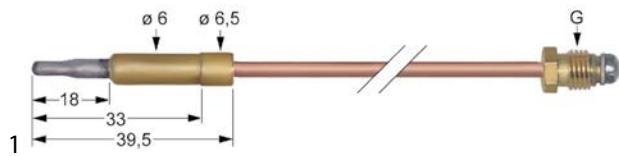

<b>GEV No.</b>	102218	<b>Ref. No.</b>	384267
<b>description</b>	thermocouple M8x1 L 320mm plug connection $\varnothing 6.0\text{mm}$		
<b>For models:</b>	750123, 750131, 750158, 750166, 750174, 750182, 750190, 750379, 750387		

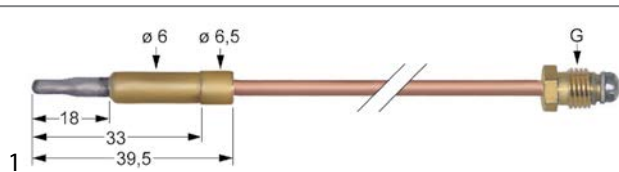

<b>GEV No.</b>	102220	<b>Ref. No.</b>	384275
<b>description</b>	thermocouple M8x1 L 600mm plug connection $\varnothing 6.0\text{mm}$		
<b>For models:</b>	750123, 750131, 750158, 750166, 750174, 750182, 750190		

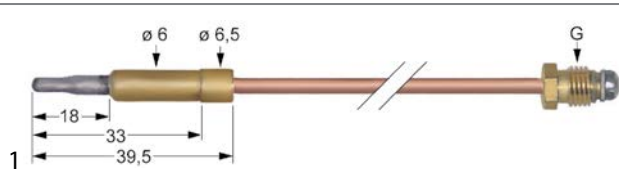

<b>GEV No.</b>	102221	<b>Ref. No.</b>	225908
<b>description</b>	thermocouple M8x1 L 750mm plug connection $\varnothing 6.0\text{mm}$		
<b>For models:</b>	FOEM-Offenen-Brennstellen		

with barrel socket  $\varnothing 6(6.5)\text{mm}$

thermocouples SIT

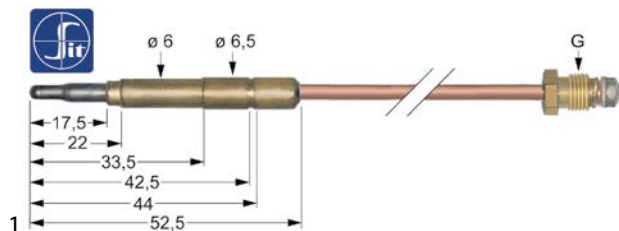

<b>GEV No.</b>	107609	<b>Ref. No.</b>	321702
<b>description</b>	thermocouple SIT M9x1 L 600mm plug connection $\varnothing 6.0(6.5)\text{mm}$		
<b>For models:</b>	710059, 710067, 910104, 910112, 910139		

plug-in thermocouples with cable link



<b>GEV No.</b>	102131	<b>Ref. No.</b>	384968
<b>description</b>	thermocouple with two-conductors L 1000mm plug connection $\varnothing 5.0\text{mm}$ M8x1		
<b>For models:</b>	750301, 750328		

threaded thermocouples

threaded thermocouples standard

with socket with thread M8x1

SIT

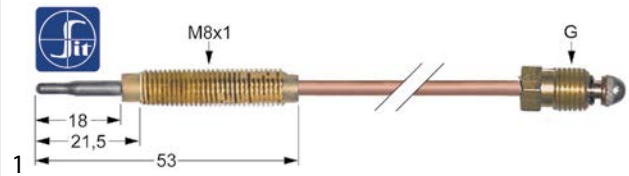

<b>GEV No.</b>	107645	<b>Ref. No.</b>	086363
<b>description</b>	thermocouple SIT M10x1 L 1500mm M8x1		
<b>For models:</b>	Maxima-Gasherd-mit-Gasbackofen		
<b>accessories for</b>	107645		
	<b>GEV No.</b>	102067	<b>Ref. No.</b> 054240
nut thread M8x1 H 3mm brass Qty 1 pcs type SEF 1			

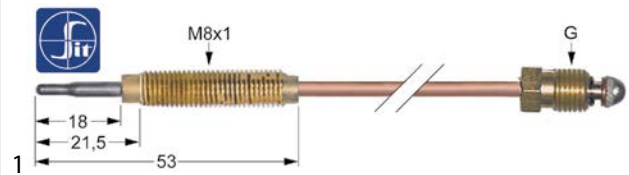

<b>GEV No.</b>	107632	<b>Ref. No.</b>	001198
<b>description</b>	thermocouple SIT M8x1 L 1000mm M8x1		
<b>For models:</b>	Gasherd-64502		
<b>accessories for</b>	107632		
	<b>GEV No.</b>	102067	<b>Ref. No.</b> 054240
nut thread M8x1 H 3mm brass Qty 1 pcs type SEF 1			

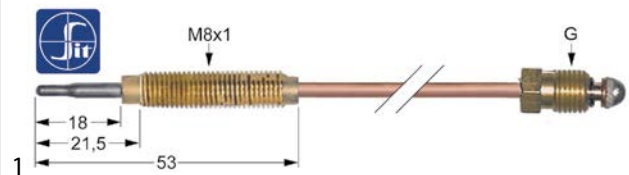

<b>GEV No.</b>	107633	<b>Ref. No.</b>	229644
<b>description</b>	thermocouple SIT M8x1 L 1200mm M8x1		
<b>For models:</b>	Gasherd-64502, Maxima-Gasherd-700, Maxima-Gasherd-850		
<b>accessories for</b>	107633		
	<b>GEV No.</b>	102067	<b>Ref. No.</b> 054240
nut thread M8x1 H 3mm brass Qty 1 pcs type SEF 1			

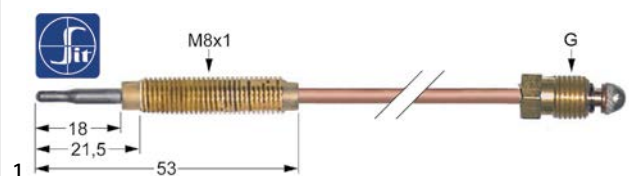

<b>GEV No.</b>	107629	<b>Ref. No.</b>	00118*
<b>description</b>	thermocouple SIT M8x1 L 450mm M8x1		
<b>accessories for</b>	107629		
	<b>GEV No.</b>	102067	<b>Ref. No.</b> 054240
nut thread M8x1 H 3mm brass Qty 1 pcs type SEF 1			



type Junkers with aluminised tip

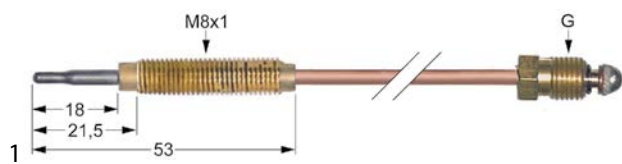

<b>GEV No.</b>	102233	<b>Ref. No.</b>	001201
<b>description</b>	thermocouple M8x1 L 750mm M8x1		
<b>For models:</b>	399701, 399728, 541419, 541427, 640018, 642053, 645005, 800163, 800171, 800198, 800201, 800228, 800236, 800244, 800252, 800260, 800279, 800287, 800295, Gas-Brater-641, Gas-Griddleplatte-642, Gasherhd-645, Gasherhd-646, Gas-Wurstgrill-640, Maxima-Gas-Bain-Marie-700-850, Maxima-Gas-Bain-Marie-850, Maxima-Gasherhd-700, Maxima-Gasherhd-700-850, Maxima-Gasherhd-850, Maxima-Gasherhd-neue-Ausfuehrung-700-850		
<b>accessories for</b>	102233		
	<b>GEV No.</b>	102067	<b>Ref. No.</b> 054240
	nut thread M8x1 H 3mm brass Qty 1 pcs type SEF 1		

accessories

nuts

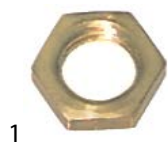

<b>GEV No.</b>	102067	<b>Ref. No.</b>	054240
<b>description</b>	nut thread M8x1 H 3mm brass Qty 1 pcs type SEF 1		
<b>For models:</b>	399701, 399728, 541419, 541427, 640018, 642053, 645005, 800163, 800171, 800198, 800201, 800228, 800236, 800244, 800252, 800260, 800279, 800287, 800295, Gas-Brater-641, Gas-Griddleplatte-642, Gasherhd-645, Gasherhd-64502, Gasherhd-646, Gas-sudpfanne-643, Gas-Wurstgrill-640, Maxima-Gasherhd-700-850, Maxima-Gasherhd-neue-Ausfuehrung-700-850		



<b>GEV No.</b>	100965	<b>Ref. No.</b>	054520 082953
<b>description</b>	thermocouple nut thread M8x1 H 15mm WS 11 brass Qty 1 pcs		
<b>For models:</b>	399701, 399728, 541419, 541427, 800163, 800171, 800198, 800201, 800228, 800236, 800244, 800252, 800260, 800279, 800287, 800295, Maxima-Gasherhd-700-850, Maxima-Gasherhd-neue-Ausfuehrung-700-850		

gas burners

hob burners

producer-specific hob burners

PALUX

Topline series (version 1)



<b>GEV No.</b>	104214	<b>Ref. No.</b>	540730
<b>description</b>	air mixing tube ID ø 12mm C		
<b>For models:</b>	399701, 399728, 541419, 541427, 800163, 800171, 800198, 800201, 800228, 800236, 800244, 800252, 800260, 800279, 800287, 800295		



<b>GEV No.</b>	104215	<b>Ref. No.</b>	540749
<b>description</b>	air mixing tube ID ø 14mm D		
<b>For models:</b>	399701, 399728, 541419, 541427, 800163, 800171, 800198, 800201, 800228, 800236, 800244, 800252, 800260, 800279, 800287, 800295		



<b>GEV No.</b>	103090	<b>Ref. No.</b>	290971
<b>description</b>	burner cap C ø 78mm		
<b>For models:</b>	399701, 399728, 541419, 541427, 800163, 800171, 800198, 800201, 800228, 800236, 800244, 800252, 800260, 800279, 800287, 800295, Maxima-Gasherhd-700, Maxima-Gasherhd-700-850, Maxima-Gasherhd-850, Maxima-Gasherhd-neue-Ausfuehrung-700-850		



<b>GEV No.</b>	103092	<b>Ref. No.</b>	540684
<b>description</b>	burner cap D ø 87mm		
<b>For models:</b>	399701, 399728, 541419, 541427, 800163, 800171, 800198, 800201, 800228, 800236, 800244, 800252, 800260, 800279, 800287, 800295, Maxima-Gasherhd-700-850, Maxima-Gasherhd-neue-Ausfuehrung-700-850		



<b>GEV No.</b>	103091	<b>Ref. No.</b>	290998
<b>description</b>	burner cap D ø 94mm with central hole		
<b>For models:</b>	Maxima-Gasherhd-700, Maxima-Gasherhd-850		



1

<b>GEV No.</b>	104207	<b>Ref. No.</b>	081574
<b>description</b>	burner head C for burner cap ø 78mm H 34mm		
<b>For models:</b>	399701, 399728, 541419, 541427, 800163, 800171, 800198, 800201, 800228, 800236, 800244, 800252, 800260, 800279, 800287, 800295		



1

<b>GEV No.</b>	104208	<b>Ref. No.</b>	540668
<b>description</b>	burner head D for burner cap ø 87mm H 34mm		
<b>For models:</b>	399701, 399728, 541419, 541427, 800163, 800171, 800198, 800201, 800228, 800236, 800244, 800252, 800260, 800279, 800287, 800295		
<b>accessories for</b>	104208		
	<b>GEV No.</b>	103092	<b>Ref. No.</b> 540684
burner cap D ø 87mm			



1

<b>GEV No.</b>	104098	<b>Ref. No.</b>	081639
<b>description</b>	burner lower part		
<b>For models:</b>	399701, 399728, 541419, 541427, 800163, 800171, 800198, 800201, 800228, 800236, 800244, 800252, 800260, 800279, 800287, 800295, Maxima-Gas-herd-700, Maxima-Gas-herd-700-850, Maxima-Gas-herd-850, Maxima-Gas-herd-neue-Aus-fuehrung-700-850		



1

<b>GEV No.</b>	104205	<b>Ref. No.</b>	084899
<b>description</b>	gasket C for burner head		



1

<b>GEV No.</b>	104206	<b>Ref. No.</b>	081582
<b>description</b>	gasket D for burner head		
<b>For models:</b>	Maxima-Gas-herd-700-850, Maxima-Gas-herd-neue-Aus-fuehrung-700-850		



1

<b>GEV No.</b>	104212	<b>Ref. No.</b>	081612
<b>description</b>	O-ring Viton thickness 3mm ID ø 32.5mm Qty 1 pcs		
<b>For models:</b>	399701, 399728, 541419, 541427, 800163, 800171, 800198, 800201, 800228, 800236, 800244, 800252, 800260, 800279, 800287, 800295, Maxima-Gas-herd-700-850, Maxima-Gas-herd-neue-Aus-fuehrung-700-850		



1

<b>GEV No.</b>	104213	<b>Ref. No.</b>	540722
<b>description</b>	venturi C/D		
<b>For models:</b>	399701, 399728, 541419, 541427, 800163, 800171, 800198, 800201, 800228, 800236, 800244, 800252, 800260, 800279, 800287, 800295		

## Topline series (version 2)



1

<b>GEV No.</b>	104520	<b>Ref. No.</b>	N/A
<b>description</b>	air mixing tube C ø 16mm		



1

<b>GEV No.</b>	105596	<b>Ref. No.</b>	000892
<b>description</b>	burner cap		
<b>For models:</b>	645005, Gas-herd-645, Gas-herd-646		



1

<b>GEV No.</b>	104501	<b>Ref. No.</b>	370312
<b>description</b>	burner cap C/2.3mm ø 83mm		
<b>For models:</b>	750123, 750131, 750158, 750166, 750174, 750182, 750190		





1

<b>GEV No.</b>	104530	<b>Ref. No.</b>	838373
<b>description</b>	burner cap C/2.6mm ø 83mm		





			
1			
<b>GEV No.</b>	104506	<b>Ref. No.</b>	697397
<b>description</b>	burner cap D ø 95mm with central hole		
<b>For models:</b>	399701, 399728, 541419, 541427, 800163, 800171, 800198, 800201, 800228, 800236, 800244, 800252, 800260, 800279, 800287, 800295		

			
1			
<b>GEV No.</b>	104508	<b>Ref. No.</b>	697400
<b>description</b>	burner cap E ø 115mm with central hole		
<b>For models:</b>	399701, 399728, 541419, 541427, 800163, 800171, 800198, 800201, 800228, 800236, 800244, 800252, 800260, 800279, 800287, 800295		

			
Image not available			
1			
<b>GEV No.</b>	105597	<b>Ref. No.</b>	001511
<b>description</b>	burner head		
<b>For models:</b>	645005, GasherD-645, GasherD-646		

			
1			
<b>GEV No.</b>	104500	<b>Ref. No.</b>	370320
<b>description</b>	burner head C for burner cap ø 85mm		

			
1			
<b>GEV No.</b>	104505	<b>Ref. No.</b>	370614
<b>description</b>	burner head D for burner cap ø 95mm		
<b>For models:</b>	399701, 399728, 541419, 541427, 750123, 750131, 750158, 750166, 750174, 750182, 750190, 800163, 800171, 800198, 800201, 800228, 800236, 800244, 800252, 800260, 800279, 800287, 800295		

			
1			
<b>GEV No.</b>	104507	<b>Ref. No.</b>	728721 N/A
<b>description</b>	burner head E for burner cap ø 115mm		
<b>For models:</b>	399701, 399728, 541419, 541427, 800163, 800171, 800198, 800201, 800228, 800236, 800244, 800252, 800260, 800279, 800287, 800295		

			
Image not available			
1			
<b>GEV No.</b>	105595	<b>Ref. No.</b>	00152*
<b>description</b>	burner lower part		

			
1			
<b>GEV No.</b>	104550	<b>Ref. No.</b>	N/A
<b>description</b>	burner lower part D ID ø 16.5mm		

			
1			
<b>GEV No.</b>	104711	<b>Ref. No.</b>	728748 N/A
<b>description</b>	burner lower part D ID ø 16.5mm for burner cap ø 95mm		
<b>For models:</b>	399701, 399728, 541419, 541427, 800163, 800171, 800198, 800201, 800228, 800236, 800244, 800252, 800260, 800279, 800287, 800295		

			
1			
<b>GEV No.</b>	104551	<b>Ref. No.</b>	N/A
<b>description</b>	burner lower part E ID ø 18mm		

			
1			
<b>GEV No.</b>	104511	<b>Ref. No.</b>	371076
<b>description</b>	gasket ø 72mm ID ø 45mm for burner head H 1.2mm perforation ø 5mm		
<b>For models:</b>	399701, 399728, 541419, 541427, 750123, 750131, 750158, 750166, 750174, 750182, 750190, 750379, 750387, 800163, 800171, 800198, 800201, 800228, 800236, 800244, 800252, 800260, 800279, 800287, 800295		

			
1			
<b>GEV No.</b>	104503	<b>Ref. No.</b>	380148
<b>description</b>	nozzle holder ID ø 8mm		
<b>For models:</b>	399701, 399728, 541419, 541427, 750123, 750131, 750158, 750166, 750174, 750182, 750190, 800163, 800171, 800198, 800201, 800228, 800236, 800244, 800252, 800260, 800279, 800287, 800295		





## reducers for pan supports



<b>GEV No.</b>	210015	<b>Ref. No.</b>	248215
<b>description</b>	reducer for pan support L 250mm W 250mm chrome-plated steel suitable for MKN		
<b>For models:</b>	Maxima-Gasherd-700, Maxima-Gasherd-850		

## accessories

## reducers for pan supports

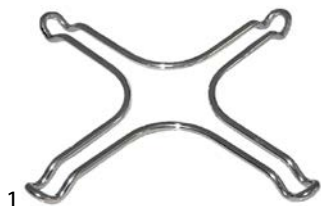

<b>GEV No.</b>	210015	<b>Ref. No.</b>	248215
<b>description</b>	reducer for pan support L 250mm W 250mm chrome-plated steel suitable for MKN		
<b>For models:</b>	Maxima-Gasherd-700, Maxima-Gasherd-850		

## air mixers



<b>GEV No.</b>	104214	<b>Ref. No.</b>	540730
<b>description</b>	air mixing tube ID ø 12mm C		
<b>For models:</b>	399701, 399728, 541419, 541427, 800163, 800171, 800198, 800201, 800228, 800236, 800244, 800252, 800260, 800279, 800287, 800295		



<b>GEV No.</b>	104215	<b>Ref. No.</b>	540749
<b>description</b>	air mixing tube ID ø 14mm D		
<b>For models:</b>	399701, 399728, 541419, 541427, 800163, 800171, 800198, 800201, 800228, 800236, 800244, 800252, 800260, 800279, 800287, 800295		

## bar burners

## bar burners



<b>GEV No.</b>	105603	<b>Ref. No.</b>	092819
<b>description</b>	bar burner 6 row tilting bratt pan		
<b>For models:</b>	Maxima-Gas-Kippbratpfanne-neue-Ausfuehrung-700-850		

## accessories

## nozzle holders



<b>GEV No.</b>	104522	<b>Ref. No.</b>	N/A
<b>description</b>	nozzle holder ID ø 10mm ET M17x1		



<b>GEV No.</b>	104503	<b>Ref. No.</b>	380148
<b>description</b>	nozzle holder ID ø 8mm		
<b>For models:</b>	399701, 399728, 541419, 541427, 750123, 750131, 750158, 750166, 750174, 750182, 750190, 800163, 800171, 800198, 800201, 800228, 800236, 800244, 800252, 800260, 800279, 800287, 800295		



<b>GEV No.</b>	101152	<b>Ref. No.</b>	169668
<b>description</b>	nozzle holder without internal nozzle, without external nozzle		
<b>For models:</b>	399701, 399728, 541419, 541427, 800163, 800171, 800198, 800201, 800228, 800236, 800244, 800252, 800260, 800279, 800287, 800295, Gas-Bain-Marie-644, Gasherd-646		

## gas nozzles

## main nozzles

## gas nozzles M12x1





<b>GEV No.</b>	100608	<b>Ref. No.</b>	Bohrung nach Maß
<b>description</b>	gas injector thread M12x1 bore custom-made		





			
1			
<b>GEV No.</b>	100974	<b>Ref. No.</b>	869899
<b>description</b>	gas injector thread M12x1 WS 14 bore ø 0.80mm		

			
1			
<b>GEV No.</b>	100282	<b>Ref. No.</b>	697842
<b>description</b>	gas injector thread M12x1 WS 14 bore ø 0.95mm		
<b>For models:</b>	399701, 399728, 541419, 541427, 750123, 750131, 750158, 750166, 750174, 750182, 750190, 800163, 800171, 800198, 800201, 800228, 800236, 800244, 800252, 800260, 800279, 800287, 800295		

			
1			
<b>GEV No.</b>	100285	<b>Ref. No.</b>	697834
<b>description</b>	gas injector thread M12x1 WS 14 bore ø 1.10mm		
<b>For models:</b>	399701, 399728, 541419, 541427, 800163, 800171, 800198, 800201, 800228, 800236, 800244, 800252, 800260, 800279, 800287, 800295		

			
1			
<b>GEV No.</b>	100243	<b>Ref. No.</b>	854409
<b>description</b>	gas injector thread M12x1 WS 14 bore ø 1.12mm		

			
1			
<b>GEV No.</b>	100663	<b>Ref. No.</b>	697877
<b>description</b>	gas injector thread M12x1 WS 14 bore ø 1.15mm		
<b>For models:</b>	399701, 399728, 541419, 541427, 800163, 800171, 800198, 800201, 800228, 800236, 800244, 800252, 800260, 800279, 800287, 800295		

			
1			
<b>GEV No.</b>	100286	<b>Ref. No.</b>	854395
<b>description</b>	gas injector thread M12x1 WS 14 bore ø 1.30mm		

			
1			
<b>GEV No.</b>	100300	<b>Ref. No.</b>	697869
<b>description</b>	gas injector thread M12x1 WS 14 bore ø 1.35mm		
<b>For models:</b>	399701, 399728, 541419, 541427, 800163, 800171, 800198, 800201, 800228, 800236, 800244, 800252, 800260, 800279, 800287, 800295		

			
1			
<b>GEV No.</b>	100700	<b>Ref. No.</b>	869880
<b>description</b>	gas injector thread M12x1 WS 14 bore ø 1.50mm		

			
1			
<b>GEV No.</b>	100301	<b>Ref. No.</b>	540765
<b>description</b>	gas injector thread M12x1 WS 14 bore ø 1.55mm		
<b>For models:</b>	399701, 399728, 541419, 541427, 800163, 800171, 800198, 800201, 800228, 800236, 800244, 800252, 800260, 800279, 800287, 800295		

			
1			
<b>GEV No.</b>	100239	<b>Ref. No.</b>	697826
<b>description</b>	gas injector thread M12x1 WS 14 bore ø 1.65mm		
<b>For models:</b>	399701, 399728, 541419, 541427, 750123, 750131, 750158, 750166, 750174, 750182, 750190, 800163, 800171, 800198, 800201, 800228, 800236, 800244, 800252, 800260, 800279, 800287, 800295		

			
1			
<b>GEV No.</b>	100289	<b>Ref. No.</b>	698997
<b>description</b>	gas injector thread M12x1 WS 14 bore ø 1.80mm		
<b>For models:</b>	399701, 399728, 541419, 541427, 800163, 800171, 800198, 800201, 800228, 800236, 800244, 800252, 800260, 800279, 800287, 800295		

			
1			
<b>GEV No.</b>	100302	<b>Ref. No.</b>	854387
<b>description</b>	gas injector thread M12x1 WS 14 bore ø 1.85mm		



1

<b>GEV No.</b>	100291	<b>Ref. No.</b>	697850
<b>description</b>	gas injector thread M12x1 WS 14 bore ø 2.00mm		
<b>For models:</b>	399701, 399728, 541419, 541427, 800163, 800171, 800198, 800201, 800228, 800236, 800244, 800252, 800260, 800279, 800287, 800295		



1

<b>GEV No.</b>	100303	<b>Ref. No.</b>	542857
<b>description</b>	gas injector thread M12x1 WS 14 bore ø 2.05mm		
<b>For models:</b>	399701, 399728, 541419, 541427, 800163, 800171, 800198, 800201, 800228, 800236, 800244, 800252, 800260, 800279, 800287, 800295		



1

<b>GEV No.</b>	100293	<b>Ref. No.</b>	699004
<b>description</b>	gas injector thread M12x1 WS 14 bore ø 2.20mm		
<b>For models:</b>	399701, 399728, 541419, 541427, 800163, 800171, 800198, 800201, 800228, 800236, 800244, 800252, 800260, 800279, 800287, 800295		



1

<b>GEV No.</b>	100295	<b>Ref. No.</b>	169595
<b>description</b>	gas injector thread M12x1 WS 14 bore ø 2.70mm		
<b>For models:</b>	640018, 642053, Gas-Brater-641, Gas-Griddleplatte-642, Gas-Wurstgrill-640		

## gas nozzles M13x1



1

<b>GEV No.</b>	103276	<b>Ref. No.</b>	881792
<b>description</b>	gas injector bore ø 2.5mm WS 13		



1

<b>GEV No.</b>	102787	<b>Ref. No.</b>	881825
<b>description</b>	gas injector thread M13x1 bore ø 1.05mm WS 13		



1

<b>GEV No.</b>	102780	<b>Ref. No.</b>	884360
<b>description</b>	gas injector thread M13x1 bore ø 1.15mm WS 13		



1

<b>GEV No.</b>	107338	<b>Ref. No.</b>	880826
<b>description</b>	gas injector thread M13x1 bore ø 1.25mm WS 13		



1

<b>GEV No.</b>	102786	<b>Ref. No.</b>	881826
<b>description</b>	gas injector thread M13x1 bore ø 1.2mm WS 13		



1

<b>GEV No.</b>	102823	<b>Ref. No.</b>	881170
<b>description</b>	gas injector thread M13x1 bore ø 1.35mm WS 13		



1

<b>GEV No.</b>	102782	<b>Ref. No.</b>	881711
<b>description</b>	gas injector thread M13x1 bore ø 1.45mm WS 13		



1

<b>GEV No.</b>	102784	<b>Ref. No.</b>	881828
<b>description</b>	gas injector thread M13x1 bore ø 1.55mm WS 13		





1

<b>GEV No.</b>	107462	<b>Ref. No.</b>	881976
<b>description</b>	gas injector thread M13x1 bore ø 1.5mm WS 13		





			
1			
<b>GEV No.</b>	102825	<b>Ref. No.</b>	881788
<b>description</b>	gas injector thread M13x1 bore ø 1.65mm WS 13		

			
1			
<b>GEV No.</b>	107339	<b>Ref. No.</b>	881712
<b>description</b>	gas injector thread M13x1 bore ø 2.05mm WS 13		

			
1			
<b>GEV No.</b>	100108	<b>Ref. No.</b>	881829
<b>description</b>	gas injector thread M13x1 bore ø 1.6mm WS 13		

			
1			
<b>GEV No.</b>	100417	<b>Ref. No.</b>	880827
<b>description</b>	gas injector thread M13x1 bore ø 2.15mm WS 13		

			
1			
<b>GEV No.</b>	102788	<b>Ref. No.</b>	881787
<b>description</b>	gas injector thread M13x1 bore ø 1.75mm WS 13		

			
1			
<b>GEV No.</b>	107476	<b>Ref. No.</b>	881838
<b>description</b>	gas injector thread M13x1 bore ø 2.25mm WS 13 code 225		

			
1			
<b>GEV No.</b>	107684	<b>Ref. No.</b>	881830
<b>description</b>	gas injector thread M13x1 bore ø 1.7mm WS 13 code 170		

			
1			
<b>GEV No.</b>	109108	<b>Ref. No.</b>	881714
<b>description</b>	gas injector thread M13x1 bore ø 2.2mm WS 13		

			
1			
<b>GEV No.</b>	107475	<b>Ref. No.</b>	881834
<b>description</b>	gas injector thread M13x1 bore ø 1.85mm WS 13 code 185		

			
1			
<b>GEV No.</b>	102471	<b>Ref. No.</b>	881715
<b>description</b>	gas injector thread M13x1 bore ø 2.3mm WS 13		

			
1			
<b>GEV No.</b>	102783	<b>Ref. No.</b>	881831
<b>description</b>	gas injector thread M13x1 bore ø 1.8mm WS 13		

			
1			
<b>GEV No.</b>	103270	<b>Ref. No.</b>	881713
<b>description</b>	gas injector thread M13x1 bore ø 2.4mm WS 13		

			
1			
<b>GEV No.</b>	100389	<b>Ref. No.</b>	881835
<b>description</b>	gas injector thread M13x1 bore ø 1.9mm WS 13		

			
1			
<b>GEV No.</b>	102790	<b>Ref. No.</b>	881839
<b>description</b>	gas injector thread M13x1 bore ø 2.55mm WS 13		



1

<b>GEV No.</b>	107463	<b>Ref. No.</b>	881795
<b>description</b>	gas injector thread M13x1 bore ø 2.6mm WS 13		



1

<b>GEV No.</b>	107477	<b>Ref. No.</b>	881796
<b>description</b>	gas injector thread M13x1 bore ø 2.7mm WS 13 code 270		



1

<b>GEV No.</b>	100710	<b>Ref. No.</b>	881841
<b>description</b>	gas injector thread M13x1 bore ø 2.85mm WS 13		



1

<b>GEV No.</b>	100722	<b>Ref. No.</b>	881843
<b>description</b>	gas injector thread M13x1 bore ø 2.95mm WS 13		



1

<b>GEV No.</b>	102470	<b>Ref. No.</b>	881836
<b>description</b>	gas injector thread M13x1 bore ø 2mm WS 13		



1

<b>GEV No.</b>	107478	<b>Ref. No.</b>	881846
<b>description</b>	gas injector thread M13x1 bore ø 3.25mm WS 13 code 325		



1

<b>GEV No.</b>	107570	<b>Ref. No.</b>	882797
<b>description</b>	gas injector thread M13x1 bore ø 3.2mm WS 13		



1

<b>GEV No.</b>	103200	<b>Ref. No.</b>	882798
<b>description</b>	gas injector thread M13x1 bore ø 3.3mm WS 13		



1

<b>GEV No.</b>	100923	<b>Ref. No.</b>	881847
<b>description</b>	gas injector thread M13x1 bore ø 3.4mm WS 13		



1

<b>GEV No.</b>	106272	<b>Ref. No.</b>	883143
<b>description</b>	gas injector thread M13x1 bore ø 3.55mm WS 13		



1

<b>GEV No.</b>	106274	<b>Ref. No.</b>	883144
<b>description</b>	gas injector thread M13x1 bore ø 3.75mm WS 13		



1

<b>GEV No.</b>	106273	<b>Ref. No.</b>	881851
<b>description</b>	gas injector thread M13x1 bore ø 3.7mm WS 13		



1

<b>GEV No.</b>	106275	<b>Ref. No.</b>	881852
<b>description</b>	gas injector thread M13x1 bore ø 3.8mm WS 13		



1

<b>GEV No.</b>	107569	<b>Ref. No.</b>	882796
<b>description</b>	gas injector thread M13x1 bore ø 3mm WS 13		





pilot burner nozzles

pilot burner nozzles EGA



<b>GEV No.</b>	101589	<b>Ref. No.</b>	697893
<b>description</b>	pilot burner nozzle LPG bore ø 0.18mm code 18 gas pressure 50mbar thread M5x0.8 WS 5.5		
<b>For models:</b>	399701, 399728, 541419, 541427, 750123, 750131, 750158, 750166, 750174, 750182, 750190, 800163, 800171, 800198, 800201, 800228, 800236, 800244, 800252, 800260, 800279, 800287, 800295		



<b>GEV No.</b>	101588	<b>Ref. No.</b>	737038
<b>description</b>	pilot burner nozzle natural gas bore ø 0.32mm code 32 gas pressure 20mbar thread M5x0.8		
<b>For models:</b>	800163, 800171, 800198, 800201, 800228, 800236, 800244, 800252, 800260, 800279, 800287, 800295		

pilot burner nozzles POLIDORO



<b>GEV No.</b>	102699	<b>Ref. No.</b>	835765
<b>description</b>	pilot burner nozzle POLIDORO natural gas code 25.2 bore ø 2x0.25mm Qty 1 pcs 2 bores		

pilot burner nozzles (other)

MKN



<b>GEV No.</b>	100270	<b>Ref. No.</b>	086339
<b>description</b>	pilot burner nozzle LPG bore ø 0.2mm thread M8x0.75 T1: M8x1		
<b>For models:</b>	399701, 399728, 541419, 541427, 800163, 800171, 800198, 800201, 800228, 800236, 800244, 800252, 800260, 800279, 800287, 800295, Maxima-Gasherd-700-850, Maxima-Gasherd-neue-Ausfuehrung-700-850		



<b>GEV No.</b>	100272	<b>Ref. No.</b>	086053
<b>description</b>	pilot burner nozzle natural gas bore ø 0.35mm		
<b>For models:</b>	399701, 399728, 541419, 541427, 800163, 800171, 800198, 800201, 800228, 800236, 800244, 800252, 800260, 800279, 800287, 800295, Maxima-Gasherd-700-850, Maxima-Gasherd-neue-Ausfuehrung-700-850		

bypass nozzles

bypass nozzles PEL20/21



<b>GEV No.</b>	100408	<b>Ref. No.</b>	834076
<b>description</b>	bypass nozzle type PEL20/21 bore ø 0.35mm thread M5x0.5		
<b>For models:</b>	399604, 399612, 399701, 399728, 541419, 541427		



<b>GEV No.</b>	100554	<b>Ref. No.</b>	833037
<b>description</b>	bypass nozzle type PEL20/21 bore ø 0.45mm thread M5x0.5		
<b>For models:</b>	800163, 800171, 800198, 800201, 800228, 800236, 800244, 800252, 800260, 800279, 800287, 800295		



<b>GEV No.</b>	100553	<b>Ref. No.</b>	869910
<b>description</b>	bypass nozzle type PEL20/21 bore ø 0.4mm thread M5x0.5		



<b>GEV No.</b>	100550	<b>Ref. No.</b>	833045
<b>description</b>	bypass nozzle type PEL20/21 bore ø 0.55mm thread M5x0.5		
<b>For models:</b>	800163, 800171, 800198, 800201, 800228, 800236, 800244, 800252, 800260, 800279, 800287, 800295		



<b>GEV No.</b>	100526	<b>Ref. No.</b>	834084
<b>description</b>	bypass nozzle type PEL20/21 bore ø 0.5mm thread M5x0.5		
<b>For models:</b>	399604, 399612, 399701, 399728, 541419, 541427		



<b>GEV No.</b>	100548	<b>Ref. No.</b>	833061
<b>description</b>	bypass nozzle type PEL20/21 bore ø 0.65mm thread M5x0.5		
<b>For models:</b>	800163, 800171, 800198, 800201, 800228, 800236, 800244, 800252, 800260, 800279, 800287, 800295		





<b>GEV No.</b>	100551	<b>Ref. No.</b>	833053
<b>description</b>	bypass nozzle type PEL20/21 bore ø 0.6mm thread M5x0.5		
<b>For models:</b>	800163, 800171, 800198, 800201, 800228, 800236, 800244, 800252, 800260, 800279, 800287, 800295		





<b>GEV No.</b>	100278	<b>Ref. No.</b>	869902
<b>description</b>	bypass nozzle type PEL20/21 bore ø 0.75mm thread M5x0.5		

			
<b>1</b>			
<b>GEV No.</b>	100527	<b>Ref. No.</b>	833088
<b>description</b>	bypass nozzle type PEL20/21 bore ø 0.85mm thread M5x0.5		
<b>For models:</b>	800163, 800171, 800198, 800201, 800228, 800236, 800244, 800252, 800260, 800279, 800287, 800295		

			
<b>1</b>			
<b>GEV No.</b>	100557	<b>Ref. No.</b>	833096
<b>description</b>	bypass nozzle type PEL20/21 bore ø 1.05mm thread M5x0.5		
<b>For models:</b>	800163, 800171, 800198, 800201, 800228, 800236, 800244, 800252, 800260, 800279, 800287, 800295		

			
<b>1</b>			
<b>GEV No.</b>	100532	<b>Ref. No.</b>	881857
<b>description</b>	bypass nozzle type PEL20/21 bore ø 1.2mm thread M5x0.5		

			
<b>1</b>			
<b>GEV No.</b>	100533	<b>Ref. No.</b>	937711
<b>description</b>	bypass nozzle type PEL20/21 bore ø 1.3mm thread M5x0.5		

			
<b>1</b>			
<b>GEV No.</b>	100529	<b>Ref. No.</b>	881486
<b>description</b>	bypass nozzle type PEL20/21 bore ø 1mm thread M5x0.5		

			
<b>1</b>			
<b>GEV No.</b>	106871	<b>Ref. No.</b>	881487
<b>description</b>	bypass nozzle type PEL20/21 bore ø 2.2mm thread M5x0.5		

			
<b>1</b>			
<b>GEV No.</b>	107524	<b>Ref. No.</b>	881859
<b>description</b>	bypass nozzle type PEL20/21 bore ø 2.5mm thread M5x0.5		

**internal nozzles**

**internal nozzles for EGA gas taps/nozzle holders**  
EGA 26400/26440/23268

			
<b>1</b>			
<b>GEV No.</b>	100311	<b>Ref. No.</b>	085529
<b>description</b>	internal nozzle bore ø 0.80mm suitable for EGA26400/26440		
<b>For models:</b>	399701, 399728, 541419, 541427, 800163, 800171, 800198, 800201, 800228, 800236, 800244, 800252, 800260, 800279, 800287, 800295, Maxima-Gasherd-700-850, Maxima-Gasherd-neue-Ausfuehrung-700-850		



			
<b>1</b>			
<b>GEV No.</b>	100238	<b>Ref. No.</b>	085499
<b>description</b>	internal nozzle bore ø 1.35mm suitable for EGA 23268,26400,26440		
<b>For models:</b>	399701, 399728, 541419, 541427, 800163, 800171, 800198, 800201, 800228, 800236, 800244, 800252, 800260, 800279, 800287, 800295, Maxima-Gasherd-700-850, Maxima-Gasherd-neue-Ausfuehrung-700-850		

			
<b>1</b>			
<b>GEV No.</b>	100244	<b>Ref. No.</b>	085707
<b>description</b>	internal nozzle bore ø 1.85mm suitable for EGA 23268,26400,26440		
<b>For models:</b>	399701, 399728, 541419, 541427, 800163, 800171, 800198, 800201, 800228, 800236, 800244, 800252, 800260, 800279, 800287, 800295, Maxima-Gasherd-700-850, Maxima-Gasherd-neue-Ausfuehrung-700-850		

**auxiliary gas parts**

**screw connections**

**olives**

			
<b>1</b>			
<b>GEV No.</b>	101273	<b>Ref. No.</b>	959715
<b>description</b>	olive for pipe ø 12mm L 9.5mm brass Qty 1 pcs suitable for universal		
<b>accessories for</b>	101273		
	<b>GEV No.</b>	100944	<b>Ref. No.</b>
			—
	union nut thread M18x1.5 for pipe ø 12mm		
	<b>GEV No.</b>	101276	<b>Ref. No.</b>
			—
	union screw thread 3/8" tube ø 12mm Qty 1 pcs		

**union screws**

			
<b>1</b>			
<b>GEV No.</b>	100906	<b>Ref. No.</b>	835803
<b>description</b>	screw connection thread M10x1 for ignition electrode brass Qty 1 pcs WS 10		



## equipment-specific units

### for bain marie

#### spare parts and accessories



1

<b>GEV No.</b>	514155	<b>Ref. No.</b>	085618
<b>description</b>	gasket L 52mm W 52mm H 24mm silicone		
<b>For models:</b>	600008, 600067, 601004, 601209, 601403, 602000, 602205, 602280, 603007, 603023, 603201, 614009, 614404, 624004, 627100, Bain-Marie-614, Bain-Marie-624, Bain-Marie-626, Fritteuse-600, Fritteuse-601, Fritteuse-602, Fritteuse-603, Fritteuse-604, Gas-Bain-Marie-644		



1

<b>GEV No.</b>	514157	<b>Ref. No.</b>	083186
<b>description</b>	lid W 50mm H 65mm SS for outlet		
<b>For models:</b>	600008, 600067, 601004, 601209, 601403, 602000, 602205, 602280, 603007, 603023, 603201, 614009, 614404, 624004, 627100, Bain-Marie-614, Bain-Marie-624, Bain-Marie-626, Fritteuse-600, Fritteuse-601, Fritteuse-602, Fritteuse-603, Fritteuse-604, Gas-Bain-Marie-644		

#### housing and bezels



1

<b>GEV No.</b>	514156	<b>Ref. No.</b>	081493
<b>description</b>	bezel L 72mm W 55mm H 55mm plastic		
<b>For models:</b>	600008, 600067, 601004, 601209, 601403, 602000, 602205, 602280, 603007, 603023, 603201, 614009, 614404, 624004, 627100, Bain-Marie-614, Bain-Marie-624, Bain-Marie-626, Fritteuse-600, Fritteuse-601, Fritteuse-602, Fritteuse-603, Fritteuse-604, Gas-Bain-Marie-644		

### for deep fryers

#### spare parts and accessories



1

<b>GEV No.</b>	514155	<b>Ref. No.</b>	085618
<b>description</b>	gasket L 52mm W 52mm H 24mm silicone		
<b>For models:</b>	600008, 600067, 601004, 601209, 601403, 602000, 602205, 602280, 603007, 603023, 603201, 614009, 614404, 624004, 627100, Bain-Marie-614, Bain-Marie-624, Bain-Marie-626, Fritteuse-600, Fritteuse-601, Fritteuse-602, Fritteuse-603, Fritteuse-604, Gas-Bain-Marie-644		



1

<b>GEV No.</b>	514157	<b>Ref. No.</b>	083186
<b>description</b>	lid W 50mm H 65mm SS for outlet		
<b>For models:</b>	600008, 600067, 601004, 601209, 601403, 602000, 602205, 602280, 603007, 603023, 603201, 614009, 614404, 624004, 627100, Bain-Marie-614, Bain-Marie-624, Bain-Marie-626, Fritteuse-600, Fritteuse-601, Fritteuse-602, Fritteuse-603, Fritteuse-604, Gas-Bain-Marie-644		

#### housing and bezels



1

<b>GEV No.</b>	514156	<b>Ref. No.</b>	081493
<b>description</b>	bezel L 72mm W 55mm H 55mm plastic		
<b>For models:</b>	600008, 600067, 601004, 601209, 601403, 602000, 602205, 602280, 603007, 603023, 603201, 614009, 614404, 624004, 627100, Bain-Marie-614, Bain-Marie-624, Bain-Marie-626, Fritteuse-600, Fritteuse-601, Fritteuse-602, Fritteuse-603, Fritteuse-604, Gas-Bain-Marie-644		

### for convection ovens/combi-steamers

#### miscellaneous



1

<b>GEV No.</b>	692306	<b>Ref. No.</b>	213519
<b>description</b>	pipe long D1 ø 10mm D2 ø 6mm L 134mm WS 19 thread 3/8"		
<b>For models:</b>	389595, 389609, 390003, 397229, 397237, 397245, 397253, 397261, 397288, 397296, 397318, 397326, 397334, 397342, 397350, 397776, 397784, 397792, 397806, 397814, 397822, 397830, 397849, 397857, 397865, 397873, 398047, 398055, 398063, 398071, 398098, 398101, 398128, 398136, 398144, 398152, 398950, 398969, 398977, 399019, 399027, 399035, 399043, 399051, 399078, 399086, 399094, 399108, 399116, 606316...(Other models you can see in the webshop)		

1



for pizza ovens

firebricks



<b>GEV No.</b>	850022	<b>Ref. No.</b>	368938
<b>description</b>	bottom plate L 495mm W 495mm H 16mm pizza oven for ELP500		
<b>For models:</b>	Pizza-Ofen-ELP, Pizza-Ofen-P501		

for dishwashers

air traps

air traps



<b>GEV No.</b>	510103	<b>Ref. No.</b>	382078
<b>description</b>	air trap L 85mm W 20mm H 80mm hose ø 6mm plastic		
<b>For models:</b>	665843, 665851, Glaeserspielautomat-328		

**spare parts for** 510103



<b>GEV No.</b>	505045	<b>Ref. No.</b>	—
<b>description</b>	O-ring EPDM thickness 1.78mm ID ø 5.28mm Qty 1 pcs		



<b>GEV No.</b>	505094	<b>Ref. No.</b>	—
<b>description</b>	air trap		



<b>GEV No.</b>	510016	<b>Ref. No.</b>	—
<b>description</b>	eye bolt for rinse aid container connection		



<b>GEV No.</b>	510105	<b>Ref. No.</b>	—
<b>description</b>	hose connector for air trap		

backflow preventers

backflow preventers



<b>GEV No.</b>	698704	<b>Ref. No.</b>	144993
<b>description</b>	air valve for drain hose D1 ø 21mm D2 ø 10.5mm		

washing and rinsing systems



<b>GEV No.</b>	510682	<b>Ref. No.</b>	173304
<b>description</b>	rinse jet ø 13mm H 11.5mm		
<b>For models:</b>	271500, 337xxx, 353167, 354392, 354457, 361763, 378933, 440078, 440086, 440094, 440655, 450111, Geschirrspuelautomat-335, GsP-500, GsP-600		



<b>GEV No.</b>	518079	<b>Ref. No.</b>	858196
<b>description</b>	wash arm bearing with nut		
<b>spare parts for</b>	518079		



<b>GEV No.</b>	510634	<b>Ref. No.</b>	—
<b>description</b>	wash arm bearing ø 22mm H 39mm		



<b>GEV No.</b>	510637	<b>Ref. No.</b>	—
<b>description</b>	nut for wash arm support		



<b>GEV No.</b>	698718	<b>Ref. No.</b>	69017
<b>description</b>	wash pipe mounting pos. upper ø 72x120mm L 310mm plastic thread M6		

knobs

universal knobs



<b>GEV No.</b>	110235	<b>Ref. No.</b>	341894
<b>description</b>	knob energy regulator 1-3 t.max.°C ø 50mm shaft ø 6x4.6mm shaft flat upper black		
<b>For models:</b>	610038, 610429, 620203, 620424		



1

<b>GEV No.</b>	110250	<b>Ref. No.</b>	093823
<b>description</b>	knob gas tap without ignition flame t.max. °C ø 50mm shaft ø 6x4.6mm shaft flat upper black		
<b>For models:</b>	640018, 642053, 645005, Gas-Brater-641, Gas-Griddleplatte-642, Gasherdd-645, Gasherdd-64502, Gasherdd-646, Gas-sudpfanne-643, Gas-Wurstgrill-640		



1

<b>GEV No.</b>	110232	<b>Ref. No.</b>	086517
<b>description</b>	knob switch 4-position t.max. °C ø 50mm shaft ø 6x4.6mm shaft flat upper black		



1

<b>GEV No.</b>	110241	<b>Ref. No.</b>	086533
<b>description</b>	knob thermostat t.max. 110°C ø 50mm shaft ø 6x4.6mm shaft flat upper black temperature range 30-110°C		
<b>For models:</b>	340xxx, 353167, 354392, 354457, 361763, 378933, 440078, 440086, 440094, 440140, 440655, 450111, 613002, 613088, 614009, 614106, 614404, 615005, 615013, 615056, 615080, 624004, 624101, 627100, Bain-Marie-614, Bain-Marie-624, Bain-Marie-626, Frittenwanne-615, Geschirrspuelautomat-700, sudpfanne-613		



1

<b>GEV No.</b>	110242	<b>Ref. No.</b>	088013
<b>description</b>	knob thermostat t.max. 180°C ø 50mm shaft ø 6x4.6mm shaft flat upper black temperature range 100-180°C		
<b>For models:</b>	600008, 600067, 601004, 601209, 601403, 602000, 602205, 602280, 603007, 603023, 603201, Fritteuse-600, Fritteuse-601, Fritteuse-602, Fritteuse-603		



1

<b>GEV No.</b>	110244	<b>Ref. No.</b>	649058
<b>description</b>	knob thermostat t.max. 250°C ø 50mm shaft ø 6x4.6mm shaft flat upper/lower black temperature range 30-250°C rotation 270°		
<b>For models:</b>	626104, 626112, 626201, 626228, 626309, 626317		



1

<b>GEV No.</b>	110245	<b>Ref. No.</b>	087432 279862
<b>description</b>	knob thermostat t.max. 300°C ø 50mm shaft ø 6x4.6mm shaft flat upper black temperature range 50-300°C		
<b>For models:</b>	610003, 610038, 610402, 611018, 611050, 611220, 612006, 612057, 620009, 621005, 621056, 621110, 622001, 622052, 62510, 62520, 62530, 626104, 626112, 626201, 626228, 626309, 626317, 629006, 629022, Backofen-629, Brater-611, Brater-621, Griddle-Platte-612, Griddleplatte-622, Grill-680, Grill-681, Grill-682, Grill-683, Heissluftgeraet-672, Heissluftgeraet-673, Heissluftgeraet-67310, Wurstgrill-610, Wurstgrill-620		

producer-specific knobs

PALUX



1

<b>GEV No.</b>	110235	<b>Ref. No.</b>	341894
<b>description</b>	knob energy regulator 1-3 t.max. °C ø 50mm shaft ø 6x4.6mm shaft flat upper black		
<b>For models:</b>	610038, 610429, 620203, 620424		



1

<b>GEV No.</b>	110250	<b>Ref. No.</b>	093823
<b>description</b>	knob gas tap without ignition flame t.max. °C ø 50mm shaft ø 6x4.6mm shaft flat upper black		
<b>For models:</b>	640018, 642053, 645005, Gas-Brater-641, Gas-Griddleplatte-642, Gasherdd-645, Gasherdd-64502, Gasherdd-646, Gas-sudpfanne-643, Gas-Wurstgrill-640		





1

<b>GEV No.</b>	110232	<b>Ref. No.</b>	086517
<b>description</b>	knob switch 4-position t.max. °C ø 50mm shaft ø 6x4.6mm shaft flat upper black		



1

<b>GEV No.</b>	111554	<b>Ref. No.</b>	393819
<b>description</b>	knob t.max. °C		
<b>For models:</b>	399604, 399612, 399701, 399728, 505900, 505935, 515892, 515906, 541419, 541427, 541869, 638625, 663263, 663395, 670618, 670626, 686409, 687200, 688096, 688118, 688363, 689696, 690570, 690600, 703095, 703109, 703117, 703125, 709816, 709824, 709832, 709840, 730416, 733105, 733113, 736422, 736430, Vario-Griller, Vario-Herd		



1

<b>GEV No.</b>	110241	<b>Ref. No.</b>	086533
<b>description</b>	knob thermostat t.max. 110°C ø 50mm shaft ø 6x4.6mm shaft flat upper black temperature range 30-110°C		
<b>For models:</b>	340xxx, 353167, 354392, 354457, 361763, 378933, 440078, 440086, 440094, 440140, 440655, 450111, 613002, 613088, 614009, 614106, 614404, 615005, 615013, 615056, 615080, 624004, 624101, 627100, Bain-Marie-614, Bain-Marie-624, Bain-Marie-626, Frittenwanne-615, Geschirrspuelautomat-700, sudpfanne-613		



1

<b>GEV No.</b>	110242	<b>Ref. No.</b>	088013
<b>description</b>	knob thermostat t.max. 180°C ø 50mm shaft ø 6x4.6mm shaft flat upper black temperature range 100-180°C		
<b>For models:</b>	600008, 600067, 601004, 601209, 601403, 602000, 602205, 602280, 603007, 603023, 603201, Fritteuse-600, Fritteuse-601, Fritteuse-602, Fritteuse-603		



1

<b>GEV No.</b>	110244	<b>Ref. No.</b>	649058
<b>description</b>	knob thermostat t.max. 250°C ø 50mm shaft ø 6x4.6mm shaft flat upper/lower black temperature range 30-250°C rotation 270°		
<b>For models:</b>	626104, 626112, 626201, 626228, 626309, 626317		



1

<b>GEV No.</b>	110245	<b>Ref. No.</b>	087432 279862
<b>description</b>	knob thermostat t.max. 300°C ø 50mm shaft ø 6x4.6mm shaft flat upper black temperature range 50-300°C		
<b>For models:</b>	610003, 610038, 610402, 611018, 611050, 611220, 612006, 612057, 620009, 621005, 621056, 621110, 622001, 622052, 62510, 62520, 62530, 626104, 626112, 626201, 626228, 626309, 626317, 629006, 629022, Backofen-629, Brater-611, Brater-621, Griddle-Platte-612, Griddleplatte-622, Grill-680, Grill-681, Grill-682, Grill-683, Heissluftgeraet-672, Heissluftgeraet-673, Heissluftgeraet-67310, Wurstgrill-610, Wurstgrill-620		

miscellaneous



1

<b>GEV No.</b>	110205	<b>Ref. No.</b>	301086
<b>description</b>	knob ø 27mm shaft ø 5x5mm		
<b>For models:</b>	340022, 340030, 340049, 340057, 340073, 340xxx, 640018, 642053, 645005, 649007, 650005, 685003, Gas-Brater-641, Gas-Gluehstein-grill-649, Gas-Griddleplatte-642, Gasherd-645, Gasherd-64502, Gasherd-646, Gas-sudpfanne-643, Gas-Wurstgrill-640, Geschirrspuelautomat-700, Glaeserspuelautomat-310, Glaeserspuelautomat-311, Glaeserspuelautomat-320, Glaeserspuelautomat-321, Heissluftdaempfer-10x1-1, Heissluftdaempfer-5x1-1, Heissluftdaempfer-5x2-3, Heissluftgeraet-10x1-1, Heissluftgeraet-5x1-1, Heissluftgeraet-672, Heissluftgeraet-673, Heissluftgeraet-67310, Pizza-Ofen-P500, Pizza-Ofen-P501, Pizza-Ofen-P502		



accessories

covers



<b>GEV No.</b>	111510	<b>Ref. No.</b>	748781
<b>description</b>	lid t.max.°C ø 37mm shaft ømm shaft flat silver for knob ELOMA		
<b>For models:</b>	754595, 754609, 754617, 754668, 754676, 754681, 754692, 754706, 754714, 754722, 754730, 754749, 754757, 754773, 754781, 757292, 757314, 757365, 757373, 757381, 757403, 757411, 757438, 757446, 757454, 757462, 757470, 758736, 758833, 759201, 759651, 759678, 759686, 759694, 759708, 759716		
<b>accessories for</b>	111510		
	<b>GEV No.</b>	111498	<b>Ref. No.</b> —
	knob t.max.°C ø 48mm shaft ø 6.5mm shaft flat blue		

handles and hand wheels

cone handles



<b>GEV No.</b>	540795	<b>Ref. No.</b>	034665
<b>description</b>	cylindrical handle thread M8x1.25 ø 25mm plastic L 105mm black thread L 12mm		
<b>For models:</b>	057436, 600008, 600067, 601004, 601209, 601403, 602000, 602205, 602280, 603007, 603023, 603201, 614009, 614404, 624004, 627100, Bain-Marie-614, Bain-Marie-624, Bain-Marie-626, Fritteuse-600, Fritteuse-601, Fritteuse-602, Fritteuse-603, Fritteuse-604, Gas-Bain-Marie-644, Wandkaffeemaschine-001, Wandkaffeemaschine-010, Wandkaffeemaschine-013		

locks

handle latches

producer-specific

PALUX



<b>GEV No.</b>	692744	<b>Ref. No.</b>	758388
<b>description</b>	door handle hinged at left blue		
<b>For models:</b>	754595, 754609, 754617, 754676, 754681, 754692, 754706, 754714, 754722, 754730, 754749, 754757, 754773, 754781, 757292, 757365, 757373, 757381, 757403, 757411, 757438, 757446, 757454, 758736, 758833, 759201, 759651, 759678, 759686, 759694, 759708, 759716		



<b>GEV No.</b>	691990	<b>Ref. No.</b>	748765
<b>description</b>	door handle hinged at right L 155mm W 60mm H 58mm spring length 53mm blue mounting distance 40mm mounting thread M4		
<b>For models:</b>	754595, 754609, 754617, 754668, 754676, 754681, 754692, 754706, 754714, 754722, 754730, 754749, 754757, 754773, 754781, 757292, 757314, 757365, 757373, 757381, 757403, 757411, 757438, 757446, 757454, 757462, 757470, 758736, 758833, 759201, 759651, 759678, 759686, 759694, 759708, 759716		
<b>spare parts for</b>	691990		
	<b>GEV No.</b>	514450	<b>Ref. No.</b> —
	spring for door handle ø 6mm L 61mm W 27.5mm		
<b>accessories for</b>	691990		
	<b>GEV No.</b>	111510	<b>Ref. No.</b> 748781
	lid t.max.°C ø 37mm shaft ømm shaft flat silver for knob ELOMA		



<b>GEV No.</b>	691988	<b>Ref. No.</b>	749532
<b>description</b>	door handle L 155mm W 60mm H 58mm spring length 53mm blue mounting distance 40mm spring thickness 3mm		
<b>accessories for</b>	691988		
	<b>GEV No.</b>	111510	<b>Ref. No.</b> 748781
	lid t.max.°C ø 37mm shaft ømm shaft flat silver for knob ELOMA		

## pullouts

## rollers

## rollers

## accessories



1

<b>GEV No.</b>	560133	<b>Ref. No.</b>	251887
<b>description</b>	hexagonal nut thread M6 H 5mm WS 10 SS DIN/ISO DIN 934 / ISO 4032/8673 Qty 20 pcs		
<b>For models:</b>	140902, 144819, 271500, 337xxx, 340022, 340030, 340049, 340057, 340073, 340xxx, 353167, 354392, 354457, 354643, 354651, 354678, 354686, 354694, 354708, 361429, 361437, 361763, 367788, 378933, 382191, 385018, 385026, 385034, 385042, 385050, 385514, 389595, 389609, 390003, 397210, 397229, 397237, 397245, 397253, 397261, 397288, 397296, 397318, 397326, 397334, 397342, 397350, 397431, 397776, 397784...(Other models you can see in the webshop)		

## fittings for catering equipment

## outlet taps

## universal

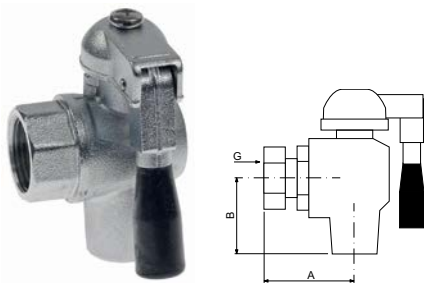

1

<b>GEV No.</b>	541540	<b>Ref. No.</b>	688916
<b>description</b>	outlet tap stainless steel W 38mm H 40mm thread 3/4" IT		
<b>For models:</b>	672343, 672351, 672378, 672386, 706523, 706531, 706558, 706566, 829854, 829900		
<b>spare parts for</b>	541540		
	<b>GEV No.</b>	697834	<b>Ref. No.</b>
			—
	cone handle thread M6x1 ø 13mm plastic L 53mm black thread L 6mm		

## equipment feet and end caps

## bolting feet



1

<b>GEV No.</b>	697868	<b>Ref. No.</b>	080500
<b>description</b>	equipment foot ømm L 72mm W 28mm H 23mm bore ø 4.4mm mounting distance 48mm Qty 1 pcs		
<b>For models:</b>	600008, 600067, 601004, 601209, 601403, 602000, 602205, 602280, 603007, 603023, 603201, 610003, 610038, 61030x, 610402, 610429, 611018, 611050, 612006, 612057, 613002, 613088, 614009, 614404, 615005, 615013, 615056, 615080, 616001, 616109, 620009, 620203, 620300, 620408, 620424, 621005, 621056, 622001, 622052, 623105, 624004, 62510, 62520, 62530, 626104, 626112, 626201, 626228, 626309, 626317...(Other models you can see in the webshop)		

## baskets

## fryer baskets

## PALUX



1

<b>GEV No.</b>	970153	<b>Ref. No.</b>	271586
<b>description</b>	fryer basket L1 295mm W1 200mm H1 120mm L2 440mm H2 225mm		
<b>For models:</b>	502200, 502308, 601004, 601209, 601403, 602000, 602205, 602280, 603201, 649554, 649562, 650943, 650951, 686336, 688339, 688347, 688355, 699047, 699055, 721468, 722588, 750255, Fritteuse-365		



1

<b>GEV No.</b>	970155	<b>Ref. No.</b>	146080
<b>description</b>	fryer basket L1 300mm W1 200mm H1 120mm		
<b>For models:</b>	601004, 601209, 601403, 602000, 602205, 602280, 603007, 603023, 603201, Fritteuse-601, Fritteuse-602, Fritteuse-603		



1

<b>GEV No.</b>	970154	<b>Ref. No.</b>	006483
<b>description</b>	fryer basket L1 315mm W1 185mm H1 115mm		

## gaskets

## gaskets for heated units

## door seals



1

<b>GEV No.</b>	900392	<b>Ref. No.</b>	724025
<b>description</b>	door seal		
<b>For models:</b>	541869, 638625, 730416		

<b>GEV No.</b>	900101	<b>Ref. No.</b>	382310
<b>description</b>	door seal profile 2070 W 645mm L 700mm external size Qty 1 10 x 1/1		
<b>For models:</b>	367788, 382191, 385018, 385026, 385034, 385042, 385050, 385514, 397210, 397229, 397237, 397245, 397253, 397261, 397288, 397296, 397318, 397326, 397334, 397342, 397350, 397431, 606294, 606308, 646768, 646776, 646784, 646792, 646806, 646814, 646822, 646830, 646849, 646857, 646865, 646873, 671789, 671797, 671800, 671819, 671827, 671835, 671843, 671851, 671878, 671886, 680583, 680591		

<b>GEV No.</b>	900865	<b>Ref. No.</b>	742368
<b>description</b>	door seal profile 2449 W 490mm L 520mm Qty 1		
<b>For models:</b>	754595, 754609, 754676, 754681, 754692, 754706, 754749, 757365, 757373, 757381, 757403, 758736, 759201, 759678, 759686, 759694		

<b>GEV No.</b>	900497	<b>Ref. No.</b>	742376
<b>description</b>	door seal profile 2449 W 520mm L 775mm Qty 1		
<b>For models:</b>	754617, 754714, 754722, 754730, 754757, 754773, 754781, 757292, 757411, 757438, 757446, 757454, 758833, 759651, 759708, 759716		

door seals with fixing hook

<b>GEV No.</b>	900390	<b>Ref. No.</b>	202223
<b>description</b>	door seal L 380mm Wmm with 5 mounting clips		
<b>For models:</b>	00068x, 00099x, 00121x, 00149x, 00183x, 001864, 002046, 002682, 003131, 00314x, 750026, 750034, 750042, 750050, 750069, 750077, 750085, 750093, 750107, 750115, 750166, 750190		

<b>GEV No.</b>	900391	<b>Ref. No.</b>	202290
<b>description</b>	door seal L 585mm Wmm with 9 mounting clips		
<b>For models:</b>	00068x, 00099x, 00121x, 00149x, 00183x, 001864, 002046, 002682, 003131, 00314x, 750026, 750034, 750042, 750050, 750069, 750077, 750085, 750093, 750107, 750115, 750166, 750190		

### O-rings

#### EPDM

<b>GEV No.</b>	504512	<b>Ref. No.</b>	378674
<b>description</b>	O-ring EPDM thickness 1.78mm ID ø 14mm Qty 1 pcs		
<b>For models:</b>	340022, 340030, 340049, 340057, 340073, 340xxx, 353167, 354392, 354457, 361763, 378933, 440078, 440086, 440094, 440140, 440655, 450111, 671894, 671908, 671916, 671975, 671983, 671991, 674524, 674532, 674605, 805149, 805300, 805408, 805459, 805556, 805xxx, 810002, 813303, 890529, 890561, 890588, Aromacarina, Aromacarina-Dampf, Aromacarina-EsA, Aromacarina-ETA, Aromacarina-ETA-EsA, Geschirrspuelautomat-700, GsP-350, Heissluftdaempfer-10x1-1, Heissluftdaempfer-20x1-1, Heissluftdaempfer-5x1-1, Heissluftdaempfer-5x2-3, schokomat-C, Wandkaffeemaschine-800		

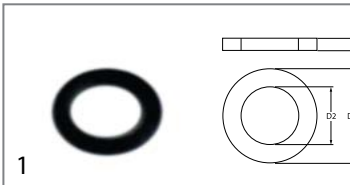

<b>GEV No.</b>	528485	<b>Ref. No.</b>	255823
<b>description</b>	O-ring EPDM thickness 1.78mm ID $\phi$ 6.07mm Qty 1 pcs		
<b>For models:</b>	271500, 337xxx, 340022, 340030, 340049, 340057, 340073, 340xxx, 353167, 354392, 354457, 361763, 378933, 440078, 440086, 440094, 440140, 440655, 450111, Geschirrspuelautomat-330, Geschirrspuelautomat-335, Geschirrspuelautomat-336, Geschirrspuelautomat-700, GsP-350, GsP-500, GsP-600		

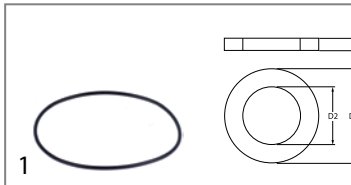

<b>GEV No.</b>	501000	<b>Ref. No.</b>	166952
<b>description</b>	O-ring EPDM thickness 4mm ID $\phi$ 145mm Qty 1 pcs		
<b>For models:</b>	271500, 337xxx, 340022, 340030, 340049, 340057, 340073, 340xxx, 353167, 354392, 354457, 361763, 378933, 440078, 440086, 440094, 440140, 440655, 450111, Geschirrspuelautomat-330, Geschirrspuelautomat-335, Geschirrspuelautomat-336, Geschirrspuelautomat-700, GsP-350, GsP-500, GsP-600		

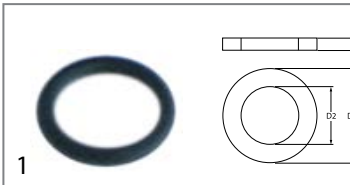

<b>GEV No.</b>	510177	<b>Ref. No.</b>	131946
<b>description</b>	O-ring EPDM thickness 1.78mm ID $\phi$ 7.66mm Qty 1 pcs		
<b>For models:</b>	337xxx, 340xxx, 665843, 665851, Geschirrspuelautomat-700, Glaeserspuelautomat-325, Glaeserspuelautomat-328, GsP-350, GsP-600		

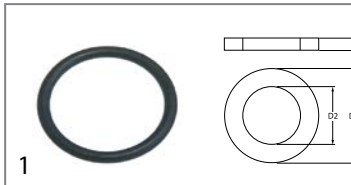

<b>GEV No.</b>	510408	<b>Ref. No.</b>	349232
<b>description</b>	O-ring EPDM thickness 5.34mm ID $\phi$ 47mm Qty 1 pcs		
<b>For models:</b>	665843, 665851, Glaeserspuelautomat-325, Glaeserspuelautomat-328		

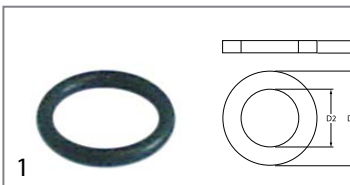

<b>GEV No.</b>	504574	<b>Ref. No.</b>	013471
<b>description</b>	O-ring EPDM thickness 1.78mm ID $\phi$ 9.25mm Qty 1 pcs		
<b>For models:</b>	140902, 367788, 382191, 385018, 385026, 385034, 385042, 385050, 385514, 389595, 389609, 390003, 397210, 397229, 397237, 397245, 397253, 397261, 397288, 397296, 397318, 397326, 397334, 397342, 397350, 397431, 397776, 397784, 397792, 397806, 397814, 397822, 397830, 397849, 397857, 397865, 397873, 398047, 398055, 398063, 398071, 398098, 398101, 398128, 398136, 398144, 398152, 398950, 398969, 398977...(Other models you can see in the webshop)		

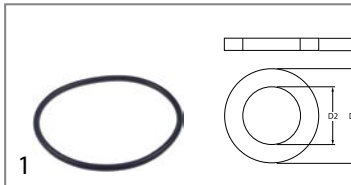

<b>GEV No.</b>	532601	<b>Ref. No.</b>	335770
<b>description</b>	O-ring EPDM thickness 7mm ID $\phi$ 135.89mm Qty 1 pcs		

Viton

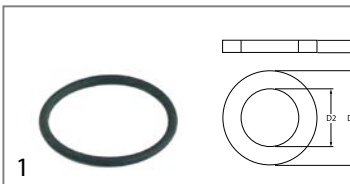

<b>GEV No.</b>	504561	<b>Ref. No.</b>	399434
<b>description</b>	O-ring EPDM thickness 2.62mm ID $\phi$ 29.82mm Qty 1 pcs		
<b>For models:</b>	144819, 385018, 385026, 385034, 385042, 385050, 385514, 389595, 389609, 390003, 397229, 397237, 397245, 397253, 397261, 397288, 397296, 397318, 397326, 397334, 397342, 397350, 397776, 397784, 397792, 397806, 397814, 397822, 397830, 397849, 397857, 397865, 397873, 398047, 398055, 398063, 398071, 398098, 398101, 398128, 398136, 398144, 398152, 398950, 398969, 398977, 399019, 399027, 399035, 399043...(Other models you can see in the webshop)		

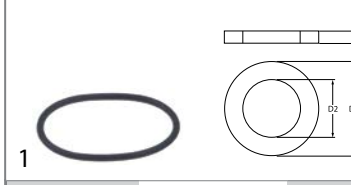

<b>GEV No.</b>	532624	<b>Ref. No.</b>	272825
<b>description</b>	O-ring Viton thickness 1.78mm ID $\phi$ 28.3mm Qty 1 pcs		

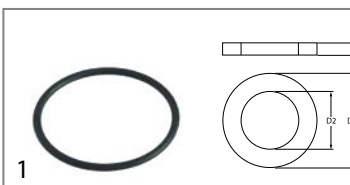

<b>GEV No.</b>	532067	<b>Ref. No.</b>	297259
<b>description</b>	O-ring EPDM thickness 2.62mm ID $\phi$ 37.77mm Qty 10 pcs		
<b>For models:</b>	271500, 337xxx, 340022, 340030, 340049, 340057, 340073, 340xxx, 353167, 354392, 354457, 361763, 378933, 440078, 440086, 440094, 440140, 440655, 450111, Geschirrspuelautomat-335, Geschirrspuelautomat-336, Geschirrspuelautomat-700, GsP-500, GsP-600		

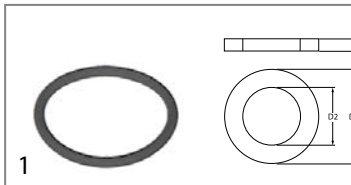

<b>GEV No.</b>	104212	<b>Ref. No.</b>	081612
<b>description</b>	O-ring Viton thickness 3mm ID $\phi$ 32.5mm Qty 1 pcs		
<b>For models:</b>	399701, 399728, 541419, 541427, 800163, 800171, 800198, 800201, 800228, 800236, 800244, 800252, 800260, 800279, 800287, 800295, Maxima-Gasherd-700-850, Maxima-Gasherd-neue-Ausfuehrung-700-850		





sealing washers

copper gaskets

DIN-7603-A



<b>GEV No.</b>	528433	<b>Ref. No.</b>	097071
<b>description</b>	flat gasket copper ED ø 14mm ID ø 10mm thickness 1mm		
<b>For models:</b>	390003, 397229, 397237, 397245, 397253, 397261, 397288, 397296, 397318, 397326, 397334, 397342, 397350, 397776, 397784, 397792, 397806, 397814, 397822, 397830, 397849, 397857, 397865, 397873, 398047, 398055, 398063, 398071, 398098, 398101, 398128, 398136, 398144, 398152, 399019, 399027, 399035, 399043, 399051, 399078, 399086, 399094, 399108, 399116, 606316, 606324, 606332, 606340, 606359, 606367...(Other models you can see in the webshop)		

PTFE gaskets



<b>GEV No.</b>	550674	<b>Ref. No.</b>	261033
<b>description</b>	flat gasket PTFE ED ø 46mm ID ø 36mm thickness 4mm Qty 1 pcs mounting pos. inner		
<b>For models:</b>	502200, 502308, 503010, 503150, 515892, 515906, 517887, 601004, 601209, 601403, 602000, 602205, 602280, 603201, 637564, 649554, 649562, 650943, 650951, 657735, 686298, 686336, 688339, 688347, 688355, 688428, 689696, 699047, 699055, 700673, 702560, 705993, 721468, 722588, 750255, Fritteuse-365, Topline-Fritteuse, Vario-Griller		

silicone gaskets



<b>GEV No.</b>	359721	<b>Ref. No.</b>	316296
<b>description</b>	gasket silicone ED ø 48mm ID ø 39.5mm thickness 5mm Qty 1 pcs		
<b>For models:</b>	Heissluftdaempfer-10x1-1, Heissluftdaempfer-5x1-1, Heissluftdaempfer-5x2-3		

springs

torsion springs

<p>Image not available</p>			
<b>GEV No.</b>	700188	<b>Ref. No.</b>	290564
<b>description</b>	torsion spring		
<b>For models:</b>	541869, 638625, 730416, Maxima-Elektro-Backofen-700-850, Maxima-Elektro-Backofen-850, Maxima-Gasherd-mit-Gasbackofen		

miscellaneous

<b>GEV No.</b>	700187	<b>Ref. No.</b>	202347
<b>description</b>	spring for door		
<b>For models:</b>	00068x, 00099x, 00121x, 00149x, 00183x, 001864, 002046, 002682, 003131, 00314x, 750026, 750034, 750042, 750050, 750069, 750077, 750085, 750093, 750107, 750115, 750166, 750190		

tension springs

<b>GEV No.</b>	517395	<b>Ref. No.</b>	019267
<b>description</b>	tension spring kit ø 33mm wire gauge ø 4.5mm L1 230mm		
<b>For models:</b>	271500, 337xxx, 353167, 354392, 354457, GsP-500, GsP-600		

<b>GEV No.</b>	700030	<b>Ref. No.</b>	G0195
<b>description</b>	tension spring ø 12.9mm total length 187mm wire gauge ø 2.1mm		

<b>GEV No.</b>	700031	<b>Ref. No.</b>	G0197
<b>description</b>	tension spring ø 15mm total length 290mm wire gauge ø 2.3mm		



<b>GEV No.</b>	700032	<b>Ref. No.</b>	G0199
<b>description</b>	tension spring ø 24.8mm total length 220mm wire gauge ø 3.2mm		

<b>GEV No.</b>	700033	<b>Ref. No.</b>	G0201
<b>description</b>	tension spring ø 30mm total length 300mm wire gauge ø 4.1mm		



## hose reels and spray guns

### spray guns

			
1			
<b>GEV No.</b>	540301	<b>Ref. No.</b>	587583
<b>description</b>	spray gun for appliances 1/2" ET L 128mm		
<b>For models:</b>	671568, 671576, 671584, 671592, 671606, 671614, 671622, 671630, 671649, 671657, 671665, 671673, 671681, 671711, 671746, 671754, 671762, 671770, 671789, 671797, 671800, 671819, 671827, 671835, 671843, 671851, 671878, 671886, 671894, 671908, 671916, 671975, 671983, 671991, 680583, 680591, 754595, 754609, 754617, 754668, 754676, 754681, 754692, 754706, 754714, 754722, 754730, 754749, 754757, 754773...(Other models you can see in the webshop)		
<b>accessories for</b>	540301		
	<b>GEV No.</b>	530922	<b>Ref. No.</b> —
shower hose connections 1/2" L 800mm SS for combi-steamer			





## dosing pumps

### peristaltic dosing pumps

#### ASF/THOMAS

#### built-in version



#### without control

			
1			
<b>GEV No.</b>	361272	<b>Ref. No.</b>	384615
<b>description</b>	dosing pump ASF/THOMAS without control 12l/h 230VAC detergent hose ø 4x7mm hose silicone type SR25 dimensions 63x124x101mm		
<b>For models:</b>	337xxx, 340022, 340030, 340049, 340057, 340073, 340xxx, 353167, 354392, 354457, 361763, 378933, 440078, 440086, 440094, 440140, 440655, 450111, Geschirrspuelautomat-700, GsP-350, GsP-600		
<b>spare parts for</b>	361272		
	<b>GEV No.</b>	361333	<b>Ref. No.</b> —
pump hose SR25 detergent hose ø 4x1.5mm hose type silicone			
	<b>GEV No.</b>	361335	<b>Ref. No.</b> —
hose guide SR25 for detergent hose type hose ø 6mm plastic 1-way/h			
	<b>GEV No.</b>	361336	<b>Ref. No.</b> —
closing clamp type SR25			
	<b>GEV No.</b>	361470	<b>Ref. No.</b> —
roller assembly type SR25 12l/h			



#### SEKO

#### built-in version

#### without control



			
1			
<b>GEV No.</b>	361867	<b>Ref. No.</b>	849537
<b>description</b>	dosing pump SEKO without control 0.4l/h 230VAC rinse aid hose ø 4x6mm hose type D hose Sekobril suction level 1.5m type NPG 0.4 8W cable length 45mm built-in version counter pressure 1bar		
<b>spare parts for</b>	361867		
	<b>GEV No.</b>	361135	<b>Ref. No.</b> 850942
pump hose SEKO rinse aid hose ø 3x8mm hose ø 4x6mm hose type D hose Sekobril			

#### spare parts

			
1			
<b>GEV No.</b>	361135	<b>Ref. No.</b>	850942
<b>description</b>	pump hose SEKO rinse aid hose ø 3x8mm hose ø 4x6mm hose type D hose Sekobril		
<b>spare parts for</b>	361135		
	<b>GEV No.</b>	361866	<b>Ref. No.</b> —
union nut for hose connector ø 17mm			

## piston pumps

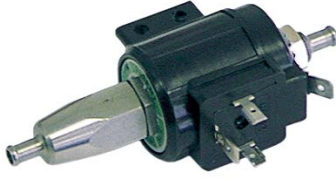
### with solenoid coil

			
1			
<b>GEV No.</b>	361026	<b>Ref. No.</b>	376108
<b>description</b>	dosing pump inlet 5mm outlet 5mm 230V detergent duty cycle 30% type EV1		
<b>For models:</b>	Glaeserspuelautomat-328		
<b>spare parts for</b>	361026		
	<b>GEV No.</b>	361365	<b>Ref. No.</b> 607185
solenoid coil 230VAC for type EV1			
	<b>GEV No.</b>	510298	<b>Ref. No.</b> 376167
lip valve dosing pump suitable for DB2/DS5			



spare parts



<b>GEV No.</b>	361113	<b>Ref. No.</b>	359386
<b>description</b>	solenoid coil 230VAC for type DB2		
<b>For models:</b>	665843, 665851, Glaeserspielautomat-325, Glaeserspielautomat-328		



<b>GEV No.</b>	361365	<b>Ref. No.</b>	607185
<b>description</b>	solenoid coil 230VAC for type EV1		
<b>For models:</b>	Glaeserspielautomat-328		



<b>GEV No.</b>	510298	<b>Ref. No.</b>	376167
<b>description</b>	lip valve dosing pump suitable for DB2/DS5		
<b>For models:</b>	Glaeserspielautomat-328		



<b>GEV No.</b>	361366	<b>Ref. No.</b>	376116 651079
<b>description</b>	PCB dishwasher 11F suitable for DB2 type DB2/EV1/EKP-M		
<b>For models:</b>	Glaeserspielautomat-328		

membrane dosing pumps

self-priming

various

spare parts



<b>GEV No.</b>	510298	<b>Ref. No.</b>	376167
<b>description</b>	lip valve dosing pump suitable for DB2/DS5		
<b>For models:</b>	Glaeserspielautomat-328		

self-priming with supporting pressure

ELETTROBAR



<b>GEV No.</b>	510298	<b>Ref. No.</b>	376167
<b>description</b>	lip valve dosing pump suitable for DB2/DS5		
<b>For models:</b>	Glaeserspielautomat-328		

GERMAC

spare parts





<b>GEV No.</b>	510298	<b>Ref. No.</b>	376167
<b>description</b>	lip valve dosing pump suitable for DB2/DS5		
<b>For models:</b>	Glaeserspielautomat-328		

LANG

dosing pumps



<b>GEV No.</b>	361012	<b>Ref. No.</b>	312320
<b>description</b>	dosing pump type N83 detergent pressure connection ø 8mm suction connection ø 8mm auxiliary pressure connection 8mm LANG		
<b>For models:</b>	271500, 337xxx, 340xxx, Geschirrspuelautomat-330, Geschirrspuelautomat-335, Geschirrspuelautomat-336, Geschirrspuelautomat-700, GsP-350, GsP-500, GsP-600		

<b>spare parts for</b>	361012			
	<b>GEV No.</b>	361137	<b>Ref. No.</b>	—
	membrane			
	<b>GEV No.</b>	361139	<b>Ref. No.</b>	194549
	hose connector complete suction connection type N83			

spare parts



<b>GEV No.</b>	361139	<b>Ref. No.</b>	194549
<b>description</b>	hose connector complete suction connection type N83		
<b>For models:</b>	271500, 337xxx, 340xxx, Geschirrspuelautomat-330, Geschirrspuelautomat-335, Geschirrspuelautomat-336, Geschirrspuelautomat-700, GsP-350, GsP-500, GsP-600		

## fittings, hose and pipe connectors

### fittings

#### reducers



1			
<b>GEV No.</b>	520963	<b>Ref. No.</b>	249696
<b>description</b>	reducer thread 3/4" ET - 3/8" IT nickel-plated brass total length 26.5mm WS 27 Qty 1 pcs		
<b>For models:</b>	367788, 382191, 385018, 385026, 385034, 385042, 385050, 385514, 389595, 389609, 390003, 397210, 397229, 397237, 397245, 397253, 397261, 397288, 397296, 397318, 397326, 397334, 397342, 397350, 397431, 397776, 397784, 397792, 397806, 397814, 397822, 397830, 397849, 397857, 397865, 397873, 398047, 398055, 398063, 398071, 398098, 398101, 398128, 398136, 398144, 398152, 398950, 398969, 398977, 399019...(Other models you can see in the webshop)		

### hose connectors

#### brass



1			
<b>GEV No.</b>	513253	<b>Ref. No.</b>	607169
<b>description</b>	hose connector brass angled thread 1/4" hose ø 12mm Qty 1 pcs		
<b>For models:</b>	665843, 665851, Glaeserspuelautomat-328		

## water cycle components

### pressure reduction valves

#### pressure reduction valves

##### producer-specific



1			
<b>GEV No.</b>	520502	<b>Ref. No.</b>	384437 577316
<b>description</b>	pressure reduction valve Norgren series R91 connection 1/8" default settingbar setting range 0.1-3bar p max 10bar t.max. 50°C brass		
<b>For models:</b>	367788, 382191, 385018, 385026, 385034, 385042, 385050, 385514, 389595, 389609, 390003, 397210, 397229, 397237, 397245, 397253, 397261, 397288, 397296, 397318, 397326, 397334, 397342, 397350, 397431, 397776, 397784, 397792, 397806, 397814, 397822, 397830, 397849, 397857, 397865, 397873, 398047, 398055, 398063, 398071, 398098, 398101, 398128, 398136, 398144, 398152, 398950, 398969, 398977, 399019...(Other models you can see in the webshop)		

## ancillary products

### clamps

#### security hose clamps

##### SS/brass



1			
<b>GEV No.</b>	520071	<b>Ref. No.</b>	276642
<b>description</b>	hose clamp SS/brass ø 17-22mm width 11mm Qty 5 pcs		
<b>For models:</b>	340022, 340030, 340049, 340057, 340073, 353167, 354392, 354457, 361763, 378933, 398047, 398055, 398063, 398071, 398098, 398101, 398128, 398136, 398144, 398152, 440078, 440086, 440094, 440140, 440655, 450111, 609501, 609528, 609536, 671649, 671657, 671665, 671673, 671681, 671711, 671746, 671754, 671762, 671770, 671789, 671797, 671800, 671819, 671827, 671835, 671843, 671851, 671878, 671886, 671894...(Other models you can see in the webshop)		

## tools

### cleaning tools

#### scrapers



1			
<b>GEV No.</b>	705000	<b>Ref. No.</b>	051144
<b>description</b>	scraper for 415398		
<b>For models:</b>	61030x, 620300, steakgrill-61030, steakgrill-62030		

## fastening material

### screws

#### sheet metal screws



1			
<b>GEV No.</b>	560096	<b>Ref. No.</b>	011754
<b>description</b>	sheet metal screws ø 2.9mm L 13mm SS Qty 20 pcs DIN 7981/ISO 7049 head ø 5.6mm oval head		





1

<b>GEV No.</b>	560100	<b>Ref. No.</b>	186465
<b>description</b>	sheet metal screws ø 3.5mm L 19mm SS Qty 20 pcs DIN 7981/ISO 7049 head ø 6.9mm oval head		
<b>For models:</b>	600008, 600067, 601004, 601209, 601403, 602000, 602205, 602280, 603007, 603023, 603201, Fritteuse-365, Fritteuse-600, Fritteuse-601, Fritteuse-602, Fritteuse-603, Fritteuse-604		

**grub screws**

DIN 916/ISO 4029



1

<b>GEV No.</b>	560173	<b>Ref. No.</b>	588512
<b>description</b>	grub screw thread M4 L 10mm SS DIN 916/ISO 4029 intake internal hexagon WS 2 Qty 20 pcs		
<b>For models:</b>	671568, 671576, 671584, 671592, 671606, 671614, 671622, 671630, 758752, 758760, 758981, 759007, 759015, 759023, 759031, 759058, 759066, 759074, 759171, 759198		

**nuts**

hexagonal nuts

DIN 934 / ISO 4032/8673



1

<b>GEV No.</b>	560133	<b>Ref. No.</b>	251887
<b>description</b>	hexagonal nut thread M6 H 5mm WS 10 SS DIN/ISO DIN 934 / ISO 4032/8673 Qty 20 pcs		
<b>For models:</b>	140902, 144819, 271500, 337xxx, 340022, 340030, 340049, 340057, 340073, 340xxx, 353167, 354392, 354457, 354643, 354651, 354678, 354686, 354694, 354708, 361429, 361437, 361763, 367788, 378933, 382191, 385018, 385026, 385034, 385042, 385050, 385514, 389595, 389609, 390003, 397210, 397229, 397237, 397245, 397253, 397261, 397288, 397296, 397318, 397326, 397334, 397342, 397350, 397431, 397776, 397784, 397792, 397806, 397814, 397822, 397830, 397849, 397857, 397865...(Other models you can see in the webshop)		

hexagonal nuts metric (without norm)



1

<b>GEV No.</b>	102067	<b>Ref. No.</b>	054240
<b>description</b>	nut thread M8x1 H 3mm brass Qty 1 pcs type SEF 1		
<b>For models:</b>	399701, 399728, 541419, 541427, 640018, 642053, 645005, 800163, 800171, 800198, 800201, 800228, 800236, 800244, 800252, 800260, 800279, 800287, 800295, Gas-Brater-641, Gas-Griddleplatte-642, Gasherd-645, Gasherd-64502, Gasherd-646, Gas-sudpfanne-643, Gas-Wurstgrill-640, Maxima-Gasherd-700-850, Maxima-Gasherd-neue-Ausfuehrung-700-850		

**washers**

washers

DIN 9021



1

<b>GEV No.</b>	560117	<b>Ref. No.</b>	000582
<b>description</b>	plain washer ID ø 6.4mm ED ø 18mm thickness 1.5mm SS Qty 20 pcs DIN 9021 for thread M6		
<b>For models:</b>	271500, 337xxx, 340022, 340030, 340049, 340057, 340073, 340xxx, 353167, 354392, 354457, 361763, 367788, 378933, 382191, 385018, 385026, 385034, 385042, 385050, 385514, 390003, 397210, 397229, 397237, 397245, 397253, 397261, 397288, 397296, 397318, 397326, 397334, 397342, 397350, 397431, 397776, 397784, 397792, 397806, 397814, 397822, 397830, 397849, 397857, 397865, 397873, 398047, 398055, 398063...(Other models you can see in the webshop)		

**tooth lock washers**

DIN 6798A



1

<b>GEV No.</b>	560127	<b>Ref. No.</b>	006777
<b>description</b>	tooth lock washer ID ø 6.2mm ED ø 11mm SS DIN/ISO DIN 6798A Qty 20 pcs for thread M6		
<b>For models:</b>	140902, 144819, 271500, 337xxx, 340022, 340030, 340049, 340057, 340073, 340xxx, 353167, 354392, 354457, 361763, 367788, 378933, 382191, 385018, 385026, 385034, 385042, 385050, 385514, 389595, 389609, 390003, 397210, 397229, 397237, 397245, 397253, 397261, 397288, 397296, 397318, 397326, 397334, 397342, 397350, 397431, 397776, 397784, 397792, 397806, 397814, 397822, 397830, 397849, 397857, 397865...(Other models you can see in the webshop)		

**fasteners**

clamps

security hose clamps

SS/brass



1

<b>GEV No.</b>	520071	<b>Ref. No.</b>	276642
<b>description</b>	hose clamp SS/brass ø 17-22mm width 11mm Qty 5 pcs		
<b>For models:</b>	340022, 340030, 340049, 340057, 340073, 353167, 354392, 354457, 361763, 378933, 398047, 398055, 398063, 398071, 398098, 398101, 398128, 398136, 398144, 398152, 440078, 440086, 440094, 440140, 440655, 450111, 609501, 609528, 609536, 671649, 671657, 671665, 671673, 671681, 671711, 671746, 671754, 671762, 671770, 671789, 671797, 671800, 671819, 671827, 671835, 671843, 671851, 671878, 671886, 671894...(Other models you can see in the webshop)		





<b>A</b>			
alarm devices	44	heating elements for fryers	7
audible timers	44	heating elements for frying pans	6
axial fans	51	heating elements for griddles	9
<b>B</b>		heating elements for heated cabinets	16
bar burners	70	heating elements for large hobs	10
bi-metal thermostats	24, 24	heating elements for ovens	3
booster pumps I	54	heating elements for pasta cookers	13
<b>C</b>		heating elements for pizza ovens	14
cam switches	35	heating elements for salamanders/toasters	16
clamps	88, 89	heating elements for tilting bratt pan	13
cleaning tools	88	hexagonal nuts	89
contactors	44	hob burners	67
control equipment	37	hose connectors	88
control thermostats	25, 32	hot air fans	52
cross flow fans	51	hot air motors	51
<b>D</b>		hot plates	23
door seals	82	<b>I</b>	
door seals with fixing hook	83	immersion heating elements	17
dosing pumps	86	indicator lights	38
<b>E</b>		indicator lights (complete)	39
electric accessories	54	infrared lamps	41
electric timers	44	<b>L</b>	
electrodes	50	lamps	38
electronic controllers	46	light bulbs	41
energy regulators	24	linear lamps	41
<b>F</b>		<b>M</b>	
fans	51	magnetic switches	37
fasteners	89	microswitches	34
fastening material	88	<b>N</b>	
fittings	88	neon light bulbs	39, 40
flow meters	50	nuts	89
fluorescent lamps	42	<b>O</b>	
<b>G</b>		O-rings	83
gas burners	67	oven lamps	42
gas nozzles	70	<b>P</b>	
gas taps	55	piezoelectric igniters	65
gaskets for heated units	82	pilot burners	61
grub screws	89	pilot heating elements	16
<b>H</b>		pressure reduction valves	88, 88
heating elements	3	pressure switches	49
heating elements for bain maries	5	probes	47
heating elements for charrills	15	programme timers	43
heating elements for coffee machine	11	protective pipes for capillary pipes	32
heating elements for convection	21	pumps	53
		push/momentary push switches	33

**R**

radial fans	52
radiation heaters	22
reducers	88
relays	45
residual heat indicators	43
rocker/momentary rocker switches	33

**S**

safety thermostats	28
screws	88
sealing washers	85
security hose clamps	88, 89
sheet metal screws	88
solenoid valves	47
solid state relays	45
spray guns	86
spray guns with external thread	86
switches and momentary switches	33

**T**

terminals	54
thermocouples	65
thermostats	24
time relays	45
timers	43
tools	88
tooth lock washers	89
transformers	46

**W**

wash and rinse pumps	53
washers	89
water cycle components	88