



GAS COMPONENTS



ELECTRIC COMPONENTS



WATER TECHNOLOGY



MECHANICAL COMPONENTS



TOOLS

Spare parts suitable for

OLIS

Find the complete and up-to-date range of products in our GEV Webshop



Manufacturer catalogue

The most important spare parts and accessories arranged clearly for every manufacturer

- ✓ Complete product range and all appliance data always up to date in the GEV Webshop
- ✓ Alphabetical Index at the end of the catalogue

GEV Webshop

www.gev-online.co.uk

www.gev-online.com



- 🔍 Add to Favourites
- 🔍 Sign In with email address and usual password
- 🔍 Easy-order – place several items in your basket at the same time
- 🔍 Quick Item search – no login needed



heating elements

heating elements for ovens

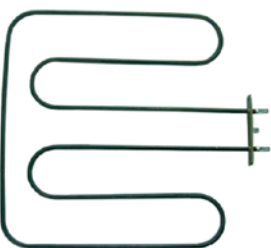

1

GEV No.	415968	Ref. No.	1037302400
description	heating element 1200W 230V heating circuits 1 L 346mm W 342mm L1 36mm L2 310mm W1 141mm W2 60mm flange length 100mm flange width 22mm hole distance 86mm hole ø 5mm tube ø 6.5mm connection male faston 6.3mm mounting pos. lower rectangular flange dry heating element		
For models:	FOE60M, OFOE60M, OFOE-60M-12601001		

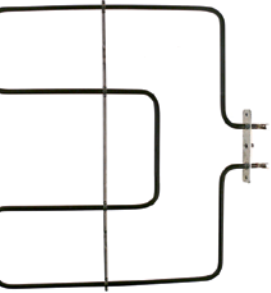

1

GEV No.	418696	Ref. No.	CR0410150
description	heating element 1300W 230V heating circuits 1 L 350mm W 380mm L1 35mm L2 315mm W1 160mm W2 60mm flange length 100mm flange width 22mm hole distance 86mm bridge length 400mm hole ø 3.2mm tube ø 6mm connection male faston 6.3mm connection length 10mm windings 2		
For models:	CFE60, CFE60P, OCFE60, OCFE-60-12601005, OCFE-60-12601005MN, OCFGE61		

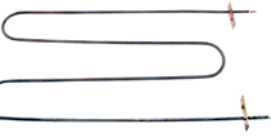

1

GEV No.	418025	Ref. No.	826620041 BN826620041
description	heating element 1500W 230V L 525mm W 240mm lug length 70mm lug width 22mm hole distance 56mm hole ø 5mm tube ø 6.3mm connection male faston 6.3mm heating circuits 1 dry heating element rectangular flange oven		
For models:	110-135CGE, 110-135CGE2P, 110-135CGEE, 110-135CGEE2P, 110-135CGEEP, 110-135CGEP, 110-90CGE, 110-90CGE1P, 110-90CGEP, 110-90CTEE, 110-90CTGE, 110-90FTFE, 110-90FTTGE, 7FTTF-GE800, 7FTTF-GE805, 7FTTF-GE820, 7FTTF-GE825, 7NPCF-VCE800, 7PCF-E120, 7PCF-E800, 7PCF-GE120, 7PCF-GE121, 7PCF-GE160, 7PCF-GE161, 7PCF-GE411, 7PCF-GE800, 7TP2F-G160, 7TP2F-GE160, 7TPF-EE800, 7TPF-G120, 7TPF-G800, 7TPF-GE120, 7TPF-GE800, 7TPMF-G120, 7TPMF-G800SX, 7TPMF-GE120, 7TPMF-GE800SX, 94-04CEE, 94-04CEE-12901210, 94-04CEE-12901210BN, 94-04CGE, 94-04CGE-12900011, 94-04CGE-12900011TA, 94-04CGE1P, 94-04CGE1P-12900031, 94-04CGEP, 94-04CGEP-12900061, 94-04CGEP-12900061TA, 94-04CGG1P-12900031TA, 94-04CTEE-12901180...(Other models you can see in the webshop)		

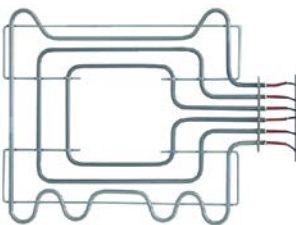

1

GEV No.	416785	Ref. No.	6A037300 BN6A037300
description	heating element 1800W 230/400V heating circuits 3 L 515mm W 452mm L1 57mm L2 458mm W1 162mm W2 128mm flange length 160mm flange width 22mm hole distance 144mm hole ø M5mm tube ø 8.5mm rectangular flange dry heating element oven cable length 570mm		
For models:	714CT-GVFE-1000180, 714CTGVFE-1000180, 714CT-GVFE-1000180R, 741CE-1000405, 741CE-1000405R, 749CGVFE-1950059, 749CGVFE-1950059R, 74CE-000400, 74CE-1000400, 74CE-1000400R, 761CE-1000455, 761CEAC-1000505, 761CEAC-1000505R, 761CEAN-1000455, 761CEAN-1000455R, 769CGVFE-1950089, 769CGVFE-1950089R, 769CGVFE-1950099, 769CGVFE-1950099R, 769CGVFEAC-1950099, 76CE-1000450, 76CEAC-000500, 76CEAC-1000500, 76CEAC-1000500R, 76CEAN-1000450, 76CEAN-1000450R		

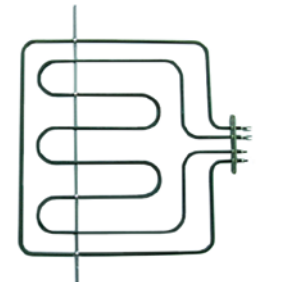

1

GEV No.	415967	Ref. No.	1037302300
description	heating element 2600W 230/400V heating circuits 2 L 355mm W 360mm L1 40mm L2 315mm W1 140mm W2 60mm flange length 100mm flange width 22mm hole distance 76mm bridge length 485mm hole ø 5mm tube ø 6.3mm connection male faston 6.3mm mounting pos. upper rectangular flange dry heating element		
For models:	FOE60M, OFOE60M, OFOE-60M-12601001		

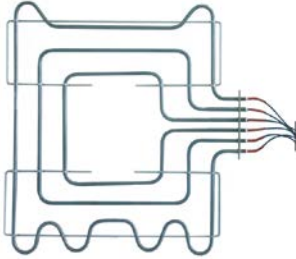

1

GEV No.	416786	Ref. No.	6A037400 BN6A037400
description	heating element 2750W 230/400V heating circuits 3 L 515mm W 580mm L1 55mm L2 460mm W1 130mm W2 225mm flange length 160mm flange width 22mm hole distance 139mm hole ø 4mm tube ø 8.5mm connection cable rectangular flange dry heating element oven cable length 590mm		
For models:	9141PCEE-1104394, 914PCGE-1103224, 914PCTGE-1103721, 914PFTGE-1103423, 914PFTGEC-1103425, 916PCGEE-1103246, 918PCGE-1103228, 92FE-1192220, 93FE-1192230, 941CEE-1292224, 941FTGE-1291422, 941FTGE1-2R-1291522, 941FTGE1-2R-1291622, 941FTGEC1-2-1291425, 941FTGEC-1291424, 941FTGER-1291522, 94CEE-1192224, 94CGE-1191224, 94CTGE-1191720, 961CEEE-1292246, 96CGEAC-1191246, 96CGEAN-1191226, 96CGEE-1191246, 98CGE-1191228, C-E904-1050350, C-E906AC-1050360, C-GV-904FE-1050135		



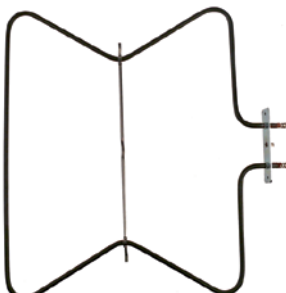

electric components





GEV No.	418695	Ref. No.	CR0410140
description	heating element 900W 230V heating circuits 1 L 350mm W 390mm L1 40mm L2 310mm W1 165mm W2 60mm flange length 100mm flange width 22mm hole distance 86mm bridge length 300mm hole ø 3.2mm tube ø 6mm connection male faston 6.3mm connection length 10mm windings 4 oven		
For models:	CFE60, CFE60P, OCFE60, OCFE-60-12601005, OCFE-60-12601005MN, OCFGE61		

heating elements for bain maries



GEV No.	415091	Ref. No.	1037039513
description	heating element 1000W 230V heating circuits 1 L 295mm W 85mm connection length 20mm connection M3 tube ø 6.5mm 2 hole fixing thread M14x1 immersion heater/dry heating element bain marie/ chip scuttle L1 145mm L2 150mm H 18mm mounting distance 79mm		
For models:	BSEI40M, OBSEI40M, OBSEI-40M-12601700		
spare parts for	415091		
	GEV No.	510417	Ref. No. —
	flat gasket fibre ED ø 20mm ID ø 14mm thickness 2mm Qty 1 pcs		
accessories for	415091		
	GEV No.	520228	Ref. No. —
	tooth lock washer ID ø 15.3mm ED ø 24mm steel Qty 1 pcs for thread M14		
	GEV No.	521133	Ref. No. 1325313
	nut thread M14x1.5 H 6mm WS 19 zinc-coated steel Qty 1 pcs		
	GEV No.	527169	Ref. No. —
	hexagonal nut thread M3 H 2.8mm WS 5.5 brass Qty 1 pcs		
	GEV No.	550261	Ref. No. —
	nut thread M14x1 H 4mm WS 19 SS Qty 1 pcs		
	GEV No.	550262	Ref. No. —
	flat gasket copper ED ø 20mm ID ø 14mm thickness 2mm		
	GEV No.	560110	Ref. No. —
	plain washer ID ø 3.2mm ED ø 7mm thickness 0.5mm SS Qty 20 pcs DIN 125A for thread M3		
	GEV No.	560130	Ref. No. —
	hexagonal nut thread M3 H 2.4mm WS 5.5 SS DIN/ISO DIN 934 / ISO 4032/8673 Qty 20 pcs		



GEV No.	416796	Ref. No.	6A045700 BN6A045700
description	heating element 1500W 240V heating circuits 1 L 325mm W 180mm connection male faston 6.3mm tube ø 6.3mm 2 hole fixing thread 1/4" dry heating element bain marie L1 155mm L2 170mm H 34mm mounting distance 174mm		
For models:	40SEBM, 40SEBM-1826100, 40SEBM2S-1826100, 60SEBM, 60SEBM-1826110, 60SEBM2S-1826110		
accessories for	416796		
	GEV No.	361182	Ref. No. —
	nut thread 1/4" H 5mm nickel-plated brass WS 17 Qty 1 pcs		
	GEV No.	510417	Ref. No. —
	flat gasket fibre ED ø 20mm ID ø 14mm thickness 2mm Qty 1 pcs		
	GEV No.	520228	Ref. No. —
	tooth lock washer ID ø 15.3mm ED ø 24mm steel Qty 1 pcs for thread M14		
	GEV No.	550262	Ref. No. —
	flat gasket copper ED ø 20mm ID ø 14mm thickness 2mm		



GEV No.	416798	Ref. No.	6A037420 BN6A037420
description	heating element 2000W 220V heating circuits 1 L 565mm L1 35mm W 200mm connection cable connection distance 192mm connection length 35mm tube ø 8.5mm cable length 450mm dry heating element bain marie L2 530mm H 20mm		
For models:	912PCCPE-1104856, 912PTCBE-1104391, 92CBE-1192301, 92TCBE-1192391		

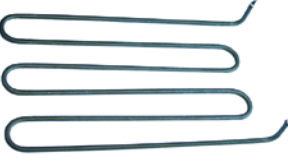

GEV No.	416797	Ref. No.	6A037050 BN6A037050
description	heating element 2000W 230V heating circuits 1 L 480mm W 275mm connection male faston 6.3mm connection length 21mm tube ø 8.5mm dry heating element H 60mm		
For models:	72-02CBE, 72-02CBE-12701150, 72-02TCBE, 72-02TCBE-12731150, 74-02TCBE, 74CBE-000550, 74CB-E-1000550, 74CBE-1000550, 74CB-E-1000550R, 7-BME		











			
GEV No.	418694	Ref. No.	CR0502320
description	heating element 750W 230V heating circuits 1 L 410mm W 63mm flange length 100mm flange width 22mm hole distance 86mm connection length 27mm connection male faston 6.3mm tube ø 8.5mm rectangular flange hole ø 5.5mm dry heating element		
For models:	OBME41M, OBME61M		

heating elements for frying pans

			
GEV No.	416794	Ref. No.	8217800 BN8217800
description	heating element 1750W 230V L 464mm W 82mm connection male faston 6.3mm tube ø 8.5mm 2 hole fixing thread M14x1.5 dry heating element for frying pan/boiling kettle H 45mm mounting distance 74mm		
For models:	40SEKB-1825200, 40SKE, 40SKE-1825200		





heating elements for chip scuttles

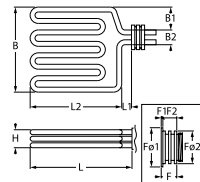

			
GEV No.	415091	Ref. No.	1037039513
description	heating element 1000W 230V heating circuits 1 L 295mm W 85mm connection length 20mm connection M3 tube ø 6.5mm 2 hole fixing thread M14x1 immersion heater/dry heating element bain marie/ chip scuttle L1 145mm L2 150mm H 18mm mounting distance 79mm		
For models:	BSEI40M, OBSEI40M, OBSEI-40M-12601700		
spare parts for	415091		
	GEV No.	510417	Ref. No. —
	flat gasket fibre ED ø 20mm ID ø 14mm thickness 2mm Qty 1 pcs		
accessories for	415091		
	GEV No.	520228	Ref. No. —
	tooth lock washer ID ø 15.3mm ED ø 24mm steel Qty 1 pcs for thread M14		
	GEV No.	521133	Ref. No. 1325313
	nut thread M14x1.5 H 6mm WS 19 zinc-coated steel Qty 1 pcs		
	GEV No.	527169	Ref. No. —
	hexagonal nut thread M3 H 2.8mm WS 5.5 brass Qty 1 pcs		
	GEV No.	550261	Ref. No. —
	nut thread M14x1 H 4mm WS 19 SS Qty 1 pcs		
	GEV No.	550262	Ref. No. —
	flat gasket copper ED ø 20mm ID ø 14mm thickness 2mm		
	GEV No.	560110	Ref. No. —
	plain washer ID ø 3.2mm ED ø 7mm thickness 0.5mm SS Qty 20 pcs DIN 125A for thread M3		
	GEV No.	560130	Ref. No. —
	hexagonal nut thread M3 H 2.4mm WS 5.5 SS DIN/ISO DIN 934 / ISO 4032/8673 Qty 20 pcs		

heating elements for fryers

off-center connection

with thread

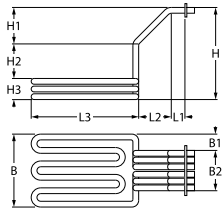
 			
GEV No.	420113	Ref. No.	CR0583860 CR0583860R
description	heating element 12000W 230V heating circuits 3 L 385mm W 205mm H 32mm flange length 21mm flange length 1 2mm flange length 2 19mm flange ø1 63mm flange ø2 54mm sensor screw connection 2x M10x1 thermostat sleeve upper/lower L1 20mm L2 365mm W1 45mm W2 32mm thread M54x1.5 tube ø 8.5mm cable length 300mm rotation flange immersion heater with probe intake ø 4mm for fryer		
accessories for	420113		
	GEV No.	532681	Ref. No. —
	O-ring Viton thickness 3.53mm ID ø 66.27mm Qty 1 pcs		
	GEV No.	550496	Ref. No. —
	O-ring Viton thickness 3.53mm ID ø 50.39mm Qty 1 pcs		
	GEV No.	550662	Ref. No. —
	ring nut thread M54x1.5 H 7mm		

 			
GEV No.	420063	Ref. No.	9000481 BN9000481
description	heating element 13000W 230/400V heating circuits 3 L 385mm W 200mm H 245mm L1 40mm L2 30mm L3 315mm W1 53mm W2 94mm H1 40mm H2 170mm H3 35mm rectangular flange hole distance 122mm hole ø 6mm flange length 132mm immersion heater flange width 38mm tube ø 8.5mm		
For models:	72-02FRE, 72-02FRE-12701500, 72-02FREM, 72-02FREM-12701530, 74-02FRE, 74-02FRE-12701600, 74-02FREM, 74-02FREM-12701630		
accessories for	420063		
	GEV No.	551114	Ref. No. —
	gasket L 131mm W 42mm silicone thickness 1mm for heating element		

GEV No.	418710	Ref. No.	9000483 BN9000483
description	heating element 13000W 230/400V heating circuits 3 L 385mm W 200mm H 270mm L1 40mm L2 30mm L3 315mm W1 54mm W2 92mm H1 30mm H2 200mm H3 35mm hole distance 122mm hole ø 6mm flange length 132mm flange width 38mm tube ø 8.5mm		
For models:	7FRI-E415, 7FRI-E415M, 7FRI-E815, 92-04FRE15L, 92-04FRE15L-12901510, 9FRI-E415, 9FRI-E420, 9FRI-E610, 9FRI-E815		

GEV No.	419019	Ref. No.	9000519 BN9000519
description	heating element 18000W 230V heating circuits 3 L 455mm W 243mm H 264mm L1 56mm L2 30mm L3 367mm W1 74.5mm W2 93.5mm H1 40mm H2 190mm H3 31.5mm		
For models:	92-04FRE20L, 92-04FRE20L-12901500, 92-04FRE20L-12901500BN, 94-04FRE-12901600, 94-04FRE20L, 9FRI-E415, 9FRI-E420, 9FRI-E610, 9FRI-E820		

GEV No.	418713	Ref. No.	9000482 BN9000482
description	heating element 9000W 230/400V heating circuits 3 L 395mm W 135mm H 267mm L1 35mm L2 40mm L3 320mm W1 22mm W2 90mm H1 40mm H2 195mm H3 32mm hole distance 121mm hole ø 6mm flange length 132mm flange width 38mm tube ø 8.5mm connection length 18mm		
For models:	7FRI-E610, 93-04FRE10L, 93-04FRE-12901550, 9FRI-E415, 9FRI-E420, 9FRI-E610		

GEV No.	420526	Ref. No.	9000480 BN9000480
description	heating element 9000W 230V heating circuits 3 L 390mm W 135mm H 230mm L1 50mm L2 40mm L3 315mm W1 20mm W2 94mm H1 105mm H2 170mm H3 35mm threaded hole distance 122mm		
For models:	73-02FRE, 73-02FRE-12701550, 73-02FRE, 73-02FRE-12701580		

2 hole fixing

GEV No.	417447	Ref. No.	9000475 BN9000475
description	heating element 3300W 230V heating circuits 1 L 220mm W 90mm H 287mm H1 237mm H2 50mm thread 1/4" tube ø 8.5mm windings 6 2 hole fixing connection M5 immersion heater		
For models:	7201FR-E-1077850R, 7221FR-E-1078050R		

accessories for	417447		
	GEV No.	361182	Ref. No. —
	nut thread 1/4" H 5mm nickel-plated brass WS 17 Qty 1 pcs		
	GEV No.	510417	Ref. No. —
	flat gasket fibre ED ø 20mm ID ø 14mm thickness 2mm Qty 1 pcs		
	GEV No.	520228	Ref. No. —
	tooth lock washer ID ø 15.3mm ED ø 24mm steel Qty 1 pcs for thread M14		
	GEV No.	550262	Ref. No. —
	flat gasket copper ED ø 20mm ID ø 14mm thickness 2mm		
	GEV No.	560112	Ref. No. —
	plain washer ID ø 5.3mm ED ø 10mm thickness 1mm SS Qty 20 pcs DIN 125A for thread M5		
	GEV No.	560132	Ref. No. —
	hexagonal nut thread M5 H 4mm WS 8 SS DIN/ISO DIN 934 / ISO 4032/8673 Qty 20 pcs		

GEV No.	416803	Ref. No.	9000510 BN9000510
description	heating element 5500W 230V heating circuits 1 L 320mm W 78mm H 282mm H1 232mm H2 52mm thread 1/4" tube ø 8.5mm mounting distance 69mm windings 7 2 hole fixing connection M5 connection length 23mm fryer		
For models:	9121PFRE-1204925, 9141PFRE-1204950, 921FRE, 921FRE-1292925, 921RFRE-1392925, 941FRE-1292950, 941RFRE-1392950		

accessories for	416803		
	GEV No.	560112	Ref. No. —
	plain washer ID ø 5.3mm ED ø 10mm thickness 1mm SS Qty 20 pcs DIN 125A for thread M5		
	GEV No.	560132	Ref. No. —
	hexagonal nut thread M5 H 4mm WS 8 SS DIN/ISO DIN 934 / ISO 4032/8673 Qty 20 pcs		



GEV No.	416800	Ref. No.	8208200 BN8208200
description	heating element 2300W 230V heating circuits 1 L 340mm W 42mm H 210mm L1 24mm L2 316mm H1 46mm H2 130mm H3 34mm mounting distance 32mm thread M14x1.5 tube ø 8.5mm connection length 20mm connection M5 2 hole fixing fryer		
For models:	41SEFR, 41SEFR-1826120, 41SEFR2S-1826120, 61SEFR, 61SEFR-1826130, 61SEFR2S-1826130		
spare parts for	416800		
	GEV No.	521101	Ref. No. —
	nut thread M14x1.5 H 5mm WS 19 SS Qty 1 pcs		
accessories for	416800		
	GEV No.	560112	Ref. No. —
	plain washer ID ø 5.3mm ED ø 10mm thickness 1mm SS Qty 20 pcs DIN 125A for thread M5		
	GEV No.	560132	Ref. No. —
	hexagonal nut thread M5 H 4mm WS 8 SS DIN/ISO DIN 934 / ISO 4032/8673 Qty 20 pcs		

GEV No.	416804	Ref. No.	9000509 BN9000509
description	heating element 3300W 230V heating circuits 1 L 331mm W 41mm H 260mm L1 14mm L2 331mm H1 54mm H2 170mm H3 36mm mounting distance 28mm thread 1/4" tube ø 8.5mm connection length 18mm connection M5 2 hole fixing fryer		
For models:	9122PFRE-1104930, 922FRE-1192930, 922RFRE-1392930		
accessories for	416804		
	GEV No.	361182	Ref. No. —
	nut thread 1/4" H 5mm nickel-plated brass WS 17 Qty 1 pcs		
	GEV No.	510417	Ref. No. —
	flat gasket fibre ED ø 20mm ID ø 14mm thickness 2mm Qty 1 pcs		
	GEV No.	520228	Ref. No. —
	tooth lock washer ID ø 15.3mm ED ø 24mm steel Qty 1 pcs for thread M14		
	GEV No.	550262	Ref. No. —
	flat gasket copper ED ø 20mm ID ø 14mm thickness 2mm		
	GEV No.	560112	Ref. No. —
	plain washer ID ø 5.3mm ED ø 10mm thickness 1mm SS Qty 20 pcs DIN 125A for thread M5		

accessories for	416804		
	GEV No.	560132	Ref. No. —
	hexagonal nut thread M5 H 4mm WS 8 SS DIN/ISO DIN 934 / ISO 4032/8673 Qty 20 pcs		

GEV No.	416802	Ref. No.	9000498 BN9000498
description	heating element 3300W 230V heating circuits 1 L 295mm W 75mm H 340mm L1 15mm L2 280mm H1 295mm H2 55mm thread 1/4" mounting distance 67mm tube ø 8.5mm 2 hole fixing connection clamp fryer windings 6		
For models:	720FRE-1077800, 722FRE-1078000		
spare parts for	416802		
	GEV No.	510417	Ref. No. —
	flat gasket fibre ED ø 20mm ID ø 14mm thickness 2mm Qty 1 pcs		
accessories for	416802		
	GEV No.	361182	Ref. No. —
	nut thread 1/4" H 5mm nickel-plated brass WS 17 Qty 1 pcs		
	GEV No.	520228	Ref. No. —
	tooth lock washer ID ø 15.3mm ED ø 24mm steel Qty 1 pcs for thread M14		
	GEV No.	550262	Ref. No. —
	flat gasket copper ED ø 20mm ID ø 14mm thickness 2mm		

6 hole fixing

GEV No.	416799	Ref. No.	8217600 BN8217600
description	heating element 5500W 230V heating circuits 3 L 297mm W 168mm H 31mm 6 hole fixing connection male faston 6.3mm L1 47mm L2 250mm W1 35mm W2 90mm immersion heater thread M12x1.5 tube ø 8.5mm		
For models:	40SEFR, 40SEFR-1826140, 40SEFR2S-1826140, 60SEFR, 60SEFR-1826150, 60SEFR2S-1826150, 914PF RTE-1204940		

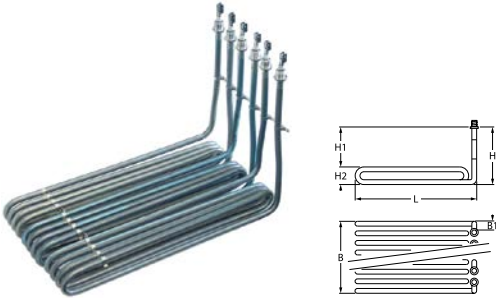



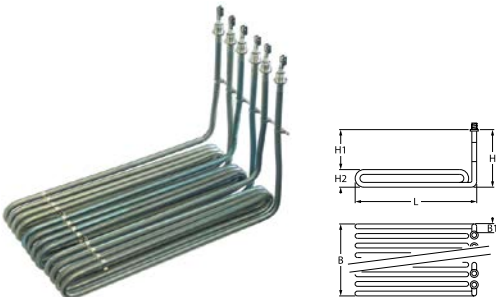

1

GEV No.	416810	Ref. No.	1037317100
description	heating element 6000W 230/400V heating circuits 3 L 320mm W 175mm H 205mm W1 5mm H1 165mm H2 40mm thread M12x1 tube ø 8.5mm connection male faston 6.3mm immersion heater 6 hole fixing		
For models:	FQE41L, FQE61L, OFQE41L, OFQE61L		



1

GEV No.	416811	Ref. No.	1037317200
description	heating element 9000W 230V heating circuits 3 L 320mm W 175mm H 205mm W1 5mm H1 165mm H2 40mm thread M12x1 tube ø 8.5mm connection male faston 6.3mm immersion heater 6 hole fixing		
For models:	FQE41, FQE61, OFQE41, OFQE-41-12601510, OFQE-41-12601510MN, OFQE61, OFQE-61-12601610, OFQE-61-12601610MN		

spare parts for	416811		
	GEV No.	521110	Ref. No. —
	flat gasket fibre ED ø 20mm ID ø 13mm thickness 2mm Qty 1 pcs		
accessories for	416811		
	GEV No.	520229	Ref. No. —
	nut thread M12x1 H 4mm WS 16 zinc-coated steel Qty 1 pcs		
	GEV No.	521131	Ref. No. —
	nut thread M12x1 H 3.5mm WS 17 SS Qty 1 pcs		
	GEV No.	528110	Ref. No. —
	O-ring EPDM thickness 2.62mm ID ø 12.37mm Qty 1 pcs		

heating elements for griddles



1

GEV No.	416789	Ref. No.	8217700 BN8217700
description	heating element 1300W 230V heating circuits 1 L 475mm W 83mm H 66mm tube ø 8.5mm connection M5 griddle dry heating element		
For models:	40SEFT, 40SEFT-1825040, 40SEFT-1825045, 40SEFTC, 40SEFTC-1825045, 40SEFTR, 40SEFTR-1825041, 60SEFT, 60SEFT1-2R-1825051, 60SEFT1-3RIG-1825050, 60SEFT-1825050, 60SEFTC, 60SEFTC-1825050, 60SEFTC-1825055, 60SEFTR-1825052, 60SEFTRIG-1825050, 80SEFTC-1825058		



1

GEV No.	416791	Ref. No.	6A044706 BN6A044706
description	heating element 1700W 230V heating circuits 1 L 440mm W 90mm H 64mm tube ø 8.5mm connection M5 dry heating element		
For models:	72-02FTE, 72-02FTE-12701130, 72-02FTEC, 72-02FTEC-12701135, 72-02FTECR, 72-02FTECR-12701132, 72-02TFTE, 72-02TFTE-12731130, 72-02TFTEC, 72-02TFTEC-12731135, 72-02TFTER, 72-02TFTER-12731132, 74-02FTE, 74-02FTE-12701140, 74-02FTE1-2R, 74-02FTE1-2R-12701141, 74-02FTEC-224745740, 74-02FTECR, 74-02FTECR-12701142, 74-02TFTE, 74-02TFTE-12731140, 74-02TFTE-12731140MN, 74-02TFTE1-2R, 74-02TFTE1-2R-12731141, 74-02TFTER, 74-02TFTER-12731142, 74FT-EC-1000805, 74FTEC-1000805, 74FT-EC-1000805R, 74TFTEC-1009805, 74TFTEC-1009805R		



1

GEV No.	416792	Ref. No.	6A037450 BN6A037450
description	heating element 2660W 230V heating circuits 1 L 578mm W 88mm H 63mm tube ø 8.5mm connection screw connection length 18mm connection distance 75mm dry heating element		
For models:	914PF RTE-1204940, 921FTE-1292401, 921FTEC-1292403, 921FTECR-1292501, 921TFTE-1292491, 921TFTEC-1292493, 921TFTER-1292591, 941FTE-1292402, 941FTE1-2R-1292502, 941FTE1-2R-1292602, 941FTE1-2RAC-1292562, 941FTE1-2RAC-1292662, 941FTEAC-1292462, 941FTEACC-1292464, 941FTEACC1-2R-1292465, 941FTEC-1292404, 941FTEC1-2R-1292405, 941FTEC1-2R-1292495, 941FTECR-1292502, 941FTECRAC-1292562, 941TFTE-1292492, 941TFTE1-2R-1292592, 941TFTE1-2R-1292692, 941TFTEC-1292494, 941TFTECR-1292592		



1

GEV No.	418444	Ref. No.	826620061 BN826620061
description	heating element 2666W 230V heating circuits 1 L 555mm W 100mm H 23mm tube ø 8.5mm bracket mounting connection male faston 6.3mm hole distance 92mm griddle dry heating element lug length 30mm lug width 18mm		
For models:	92-04FTE, 92-04FTE-12901130, 92-04FTEC, 92-04FTEC-12901135, 92-04FTECR, 92-04FTECR-12901137, 92-04FTECR-12901132, 92-04FTECR-12901137, 92-04TFTE, 92-04TFTE-12931130, 92-04TFTEC, 92-04TFTEC-12931135, 92-04TFTECR, 92-04TFTECR-12931137, 92-04TFTER, 92-04TFTER-12931132, 94-04FTE, 94-04FTE-12901140, 94-04FTE1-2R, 94-04FTE1-2R-12901141, 94-04FTE1-2R-12901141BN, 94-04FTEC, 94-04FTEC-12901145, 94-04FTEC1-2R, 94-04FTEC1-2R-12901146, 94-04FTECR, 94-04FTECR-12901147, 94-04FTECR, 94-04FTECR-12901142, 94-04TFTE, 94-04TFTE-12931140, 94-04TFTE1-2R, 94-04TFTE1-2R-12931141, 94-04TFTEC, 94-04TFTEC-12931145, 94-04TFTEC1-2R, 94-04TFTEC1-2R-12931146, 94-04TFTECR, 94-04TFTECR-12931147, 94-04TFTER, 94-04TFTER-12931142, 941FTEC-2295017830, 9FT-E400, 9FT-E405, 9FT-E410, 9FT-E415, 9FT-E800, 9FT-E805, 9FT-E810, 9FT-E815...(Other models you can see in the webshop)		

GEV No.	416790	Ref. No.	6A037250 BN6A037250
description	heating element 900W 220V heating circuits 1 L 435mm W 42.5mm H 50mm tube ø 8.5mm 2 hole fixing connection M5 thread 1/4" mounting distance 34mm griddle dry heating element		
For models:	74FTE-000800, 74FT-E-1000800, 74FTE-1000800, 74FT-E-1000800R, 74FTER-1000801, 74FT-ER1-1-1000801, 74FT-ER1-1-1000801R, 74TFTE-1009800, 74TFTE-1009800R, 74TFTE1-1R-1009801, 74TFTE1-1R-1009801R, 78FTE-000900, 78FT-E-1000900, 78FTE-1000900, 78FT-ER.1-1-1000902, 78FT-ER.1-2-1000901, 78FT-ER.1-2-1000901R, 78TFTE-1009900, 78TFTE-1009900R, 78TFTE1-1R-1009902, 78TFTE1-1R-1009902R, 78TFTE1-2R-1009901, 78TFTE1-2R-1009901R		

heating elements for refrigeration

heating elements for defrosting



GEV No.	419208	Ref. No.	1666250
description	heating element 250W 230V L 420mm W 50mm H cable length 360mm tube ø 6mm refrigerator connection F6.3		
For models:	KTAP01-BASE-20220901044U, KTAP02-BASE-20221301048K, KTAP03-BASE-2022180109UA, KTAP04-2022230109X0, KTAP04-BASE-2022230109RY, KTRP00522-2022130107K4, KTRP200022-202209010500, KTRP200022A-2022090104EB, KTRP200042-2022090107HY, KTRP200042A-20220901077B, KTRP200044-2022090105CF, KTRP200044A-2022090107HZ, KTRP200052-2022090107HW, KTRP200052A-2022090107HX, KTRP200055-2022090107K1, KTRP200055A-2022090107K0, KTRP300222-2022130105HP, KTRP300222A-2022130104EC, KTRP300422-2022130106TB, KTRP300422A-2022130105XL, KTRP300442-2022130107K6, KTRP300442A-2022130107K7, KTRP300522-2022130107K2, KTRP300522A-2022130107K3, KTRP300552A-2022130107K5, KTRP402222A-2022180109WR, KTRP404222-2022180109WV, KTRP404222A-2022180109WU, KTRP404422-2022180104VV, KTRP404422A-2022180107KE, KTRP405222-2022180109WT, KTRP405222A-2022180109WS, KTRP405522-2022180107KB, KTRP405522A-2022180107KC, KTRP522222-2022230109WW, KTRP522222A-2022230109WX, KTRP542222A-2022230109X1, KTRP544222-2022230107KR, KTRP544222A-2022230107KP, KTRP552222-2022230109WZ, KTRP552222A-2022230109WY, KTRP555222-2022230107KM, KTRP555222A-2022230107KN		



GEV No.	419209	Ref. No.	1666400
description	heating element 270W 230V L 380mm W 120mm L1 15mm L2 365mm W1 80mm W2 50mm cable length 300mm tube ø 6mm refrigerator		
For models:	KR41-210906400BFA, KTN40-21090640		



GEV No.	416376	Ref. No.	1666320
description	heating element 300W 230V L 430mm W 85mm connection male faston 6.3mm cable length 400mm tube ø 6.3mm defrosting H 70mm		
For models:	KTAP04-2022230109X0, KTAR01, KTAR01N, KTAR02, KTAR02N, KTAR03, KTAR03N, KTAR04, KTAR04N, KTRE21-202108010BL5, KTRE2-202108010BFC, KTRE2A-202108010BGP, KTRE3-202113010BHF, KTRE32A-202113010BLQ, KTRE34-202113010BLW, KTRE3A-202113010BFW, KTRE4-202117010BLG, KTRE42-202117010BMO, KTRE42A-202117010BMM6, KTRE44-202117010BMB, KTRE4A-202117010BFF, KTRE5-202122010BG2, KTRE52-202122010BNK, KTRE54-202122010BGC, KTRE54A-202122010BNP, KTRE5A-202122010BL3, KTREP3-202611010C2F, KTREP34-20261101096L, KTREP34A-20261101096K, KTREP3A-202611010C1L, KTREP4-202615010BNN, KTREP4A-202615010BNNR, KTRE-P52A-202620010B05, KTRN200012-202010050495, KTRN200012A-2020100507UK, KTRN200013-2020100507UV, KTRN200013A-2020100507UU, KTRN200014-2020100507UM, KTRN200014A-2020100507UL, KTRN200015-2020100507UR, KTRN200015A-2020100507UT, KTRN300122-202013050479, KTRN300122A-2020130504DY, KTRN300142-2020130506BG, KTRN300142A-2020130507GY, KTRN300144-2020130505UU, KTRN300144A-20201305079X, KTRN300152-2020130507GW, KTRN300152A-2020130507GX, KTRN300155-2020130507HC... (Other models you can see in the webshop)		



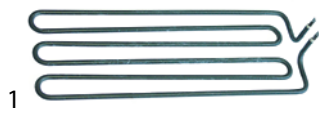

heating elements for tilting bratt pan



GEV No.	416806	Ref. No.	6A050190 BN6A050190
description	heating element 3490W 230V L 480mm W 185mm H 65mm dry heating element tube ø 8.5mm W1 78mm W2 30mm connection distance 22mm		
For models:	94KBE, 94KBE-1192870, 94KBEM-1192880, 94RKBE-1392870, 94RK-BEM-1392880		







GEV No.	417164	Ref. No.	826620120 BN826620120
description	heating element for tilting bratt pan 2000W 230V L 290mm W 143mm H 26mm connection male faston 6.3mm dry heating element tube ø 8.5mm 2 hole fixing thread 1/4" mounting distance 132mm connection length 83mm		
For models:	94-04KBE, 94-04KBE-12901115, 94-04KBE-12901115BN, 94-04KBE-12901118, 94-04KBEM, 94-04KBEM-12901125, 94-04KBEM-12901125BN, 94-04KBEM-12901128, 94-04NKBE-12901215, 94-04NKBE-12901215BN, 9BR-E100, 9BR-E105, 9BR-E80, 9BR-E81, 9BR-EM80, 9BRS-E100, 9BRS-E105		
accessories for	417164		
	GEV No.	550163	Ref. No. —
	ring terminal size M4 ø4.3mm 1.5-2.5mm ² Qty 100 pcs insulation PVC Cu gal Sn blue t.max. 75°C		

			
GEV No.	416805	Ref. No.	6A050210 BN6A050210
description	heating element for tilting bratt pan 2350W 230V L 400mm W 160mm H 55mm connection M5 dry heating element tube ø 8.5mm L1 210mm L2 190mm 2 hole fixing thread 1/4" mounting distance 152mm		
For models:	725KB-E-1000200, 725KBE-1000200, 725KB-E-1000200R, 725KB-EB-1000201, 725KBEB-1000201, 725KB-EB-1000201R, 725KBEM-000200, 725KBEM-1000210, 725KB-EM-1000210R, 725KB-EMB-1000211, 725KBEMB-1000211, 74-02KBEB, 74-02KBEB-12701110, 74-02KBEBI, 74-02KBEBI-12701115, 74-02KBEMB, 74-02KBEMB-12701120, 74-02KBEMBI, 74-02KBEMBI-12701125, 74-02KBEMBI-12701125HB		
spare parts for	416805		
		GEV No. 550262	Ref. No. —
	flat gasket copper ED ø 20mm ID ø 14mm thickness 2mm		
accessories for	416805		
		GEV No. 361182	Ref. No. —
	nut thread 1/4" H 5mm nickel-plated brass WS 17 Qty 1 pcs		
		GEV No. 510417	Ref. No. —
	flat gasket fibre ED ø 20mm ID ø 14mm thickness 2mm Qty 1 pcs		
		GEV No. 520228	Ref. No. —
	tooth lock washer ID ø 15.3mm ED ø 24mm steel Qty 1 pcs for thread M14		

heating elements for pasta cookers

			
GEV No.	418033	Ref. No.	4185326002064 BN4185326002064
description	heating element 3000W 240V L 447mm W 70mm 2 hole fixing connection M4 tube ø 8.5mm mounting distance 62mm pasta cooker immersion heater		

			
GEV No.	416795	Ref. No.	8218100 BN8218100
description	heating element 7500W 230V heating circuits 3 L 300mm W 237mm Hmm 6 hole fixing connection M5 thread M14x1 tube ø 8.9mm complete auxiliary equipment		
For models:	40SECP, 40SECP-1825080, 40SECP-1825080E, 55-45CPE, 55-90CPE, 72-02CPE, 72-02CPE-12701900, 74-02CPE, 74-02CPE-12701905, 7CP-E400, 7CP-E800		
spare parts for	416795		
		GEV No. 507309	Ref. No. —
	O-ring EPDM thickness 2.62mm ID ø 17.13mm Qty 1 pcs		

spare parts for	416795		
		GEV No. 550261	Ref. No. —
	nut thread M14x1 H 4mm WS 19 SS Qty 1 pcs		
accessories for	416795		
		GEV No. 510417	Ref. No. —
	flat gasket fibre ED ø 20mm ID ø 14mm thickness 2mm Qty 1 pcs		
		GEV No. 520228	Ref. No. —
	tooth lock washer ID ø 15.3mm ED ø 24mm steel Qty 1 pcs for thread M14		
		GEV No. 521133	Ref. No. 1325313
	nut thread M14x1.5 H 6mm WS 19 zinc-coated steel Qty 1 pcs		
		GEV No. 550262	Ref. No. —
	flat gasket copper ED ø 20mm ID ø 14mm thickness 2mm		















			
GEV No.	415971	Ref. No.	1870100 1870100R MA1870100R
description	heating element 9000W 230/415V heating circuits 3 L 245mm W 320mm H 25mm rotation flange tube ø 6.3mm thermostat sleeves ø 7mm length thermostat sleeves 210mm L1 55mm L2 190mm W1 28mm W2 292mm cable length 600mm number of thermostat sleeves 1 connection length 35mm flange length 1 9mm flange length 2 15.5mm flange length 24.5mm flange ø1 43.8mm flange ø2 39.7mm mounting pos. left suitable for 600 series thermostat sleeve centred, adjacent pasta cooker sensor screw connection M10x1		
For models:	CPE60, CPE60DB, OCPE60, OCPE-60-12601900, OCPE-60-12601900MN		
accessories for	415971		
		GEV No. 514016	Ref. No. 1814500
	flat gasket PTFE ED ø 45mm ID ø 40mm thickness 4mm Qty 1 pcs equiv. no. 1036500400/1814500 suitable for MARENO		
		GEV No. 514017	Ref. No. 1814400
	O-ring silicone thickness 3.53mm ID ø 32.93mm Qty 1 pcs		
		GEV No. 514018	Ref. No. 18146-00
	bush		
		GEV No. 514019	Ref. No. —
	threaded rod thread M8 L 45mm brass		
		GEV No. 514020	Ref. No. 1815014
	bush		
		GEV No. 514021	Ref. No. 1814700
	O-ring silicone thickness 3.53mm ID ø 49.21mm Qty 1 pcs		
		GEV No. 514022	Ref. No. 14044599
	nut thread 1½" H 12mm SS WS 59 Qty 1 pcs		





Table continues overleaf







accessories for 415971			
	GEV No.	540435	Ref. No. 1869600
threaded rod thread M10 hollow			
	GEV No.	540436	Ref. No. 1033514900
hexagonal nut thread M10x1.25 H 4mm WS 13 brass Qty 1 pcs			
	GEV No.	540438	Ref. No. 1868700
long nut thread M10 L 25mm WS 13 brass Qty 1 pcs			
	GEV No.	540439	Ref. No. 1869500
distance washer			

			
GEV No.	419078	Ref. No.	6A037205 6A037220 BN6A037220
description	heating element 9000W 230V heating circuits 3 L 480mm W 34mm H 52mm tube ø 8.5mm thermostat sleeves ø 7.5mm length thermostat sleeves 215mm H1 17mm H2 35mm mounting ø 47.5mm number of thermostat sleeves 1 thermostat sleeve eccentric, clinging immersion heater		
For models:	92-04CPE, 92-04CPE-12901900, 92CCPE-1192856, 92CCPE-1192856V, 92RCCPE-1392856, 94-04CPE, 94-04CPE-12901905, 94CCPE-1192861, 94RCCPE-1392861, 9CP-E400, 9CP-E800		
accessories for	419078		
	GEV No.	510408	Ref. No. 13005
O-ring EPDM thickness 5.34mm ID ø 47mm Qty 1 pcs			

heating elements for chargrills

			
GEV No.	415965	Ref. No.	1037311315 MA1037311315
description	heating element 1800W 230V L 486mm W 83mm H 30mm 2 hole fixing mounting distance 72mm connection M4 L1 38mm L2 448mm heating circuits 1 tube ø 6.3mm dry heating element thread M12x1 for sausage warmer		
accessories for	415965		
	GEV No.	520229	Ref. No. —
nut thread M12x1 H 4mm WS 16 zinc-coated steel Qty 1 pcs			
	GEV No.	521110	Ref. No. —
flat gasket fibre ED ø 20mm ID ø 13mm thickness 2mm Qty 1 pcs			
	GEV No.	521131	Ref. No. —
nut thread M12x1 H 3.5mm WS 17 SS Qty 1 pcs			
	GEV No.	528110	Ref. No. —
O-ring EPDM thickness 2.62mm ID ø 12.37mm Qty 1 pcs			

			
GEV No.	416793	Ref. No.	6A045800 BN6A045800
description	heating element 750W 230V L 473mm W 31mm H 101mm 2 hole fixing connection cable cable length 260mm L1 33mm L2 440mm tube ø 8.5mm dry heating element thread 1/4"		
For models:	40SEW, 40SEW-1825190		
spare parts for	416793		
	GEV No.	510417	Ref. No. —
flat gasket fibre ED ø 20mm ID ø 14mm thickness 2mm Qty 1 pcs			
accessories for	416793		
	GEV No.	361182	Ref. No. —
nut thread 1/4" H 5mm nickel-plated brass WS 17 Qty 1 pcs			
	GEV No.	520228	Ref. No. —
tooth lock washer ID ø 15.3mm ED ø 24mm steel Qty 1 pcs for thread M14			
	GEV No.	550262	Ref. No. —
flat gasket copper ED ø 20mm ID ø 14mm thickness 2mm			

heating elements for heated cabinets







			
GEV No.	416787	Ref. No.	6A036800 BN6A036800
description	heating element 420W 230V heating circuits 1 L 265mm W 245mm connection male faston 6.3mm tube ø 6.3mm 2 hole fixing thread 1/4" dry heating element heated cabinet L1 60mm L2 185mm W1 82mm W2 70mm mounting distance 64mm		
For models:	76-02CEEEACPO, 76-02CEEEACPT, 76-02CEEEPQ-12701216, 76-02CEEEPT-12701016, 76-02CGEE, 76-02CGEE-12700018, 76-02CGEE-12700018TA, 76-02CGGE, 76-02CGGE-12700016, 76-02CGGE-12700016TA, 76-02CTGGE, 76-02CTGGE-12700196, 76-02CTGGE-12700196TA, 761CEAC-1000505, 761CEAC-1000505R, 769CGVAC-1950079, 769CGVAC-1950079R, 769CGVFE-1950099, 769CGVFE-1950099R, 769CGVFEAC-1950099, 76CEAC-000500, 76CEAC-1000500, 76CEAC-1000500R, 78CB-EAC-1000565, 78CB-EAC-1000565R, 78CB-EAC-1000565R, 78CB-GAC-1000165, 78CBGAC-1000165, 916PCGEE-1103246, 916PCGEE-1103236, 961CEEE-1292246, 96CEEE-192246, 96CGEAC-1191246, 96CGEE-1191246, 96CGGAC-1191236, 96CGGE-1191236, 96CTGGAC-1191732, C-E906AC-1050360		
accessories for	416787		
	GEV No.	361182	Ref. No. —
nut thread 1/4" H 5mm nickel-plated brass WS 17 Qty 1 pcs			
	GEV No.	510417	Ref. No. —
flat gasket fibre ED ø 20mm ID ø 14mm thickness 2mm Qty 1 pcs			
	GEV No.	520228	Ref. No. —
tooth lock washer ID ø 15.3mm ED ø 24mm steel Qty 1 pcs for thread M14			

Table continues overleaf

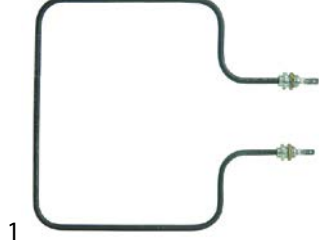



accessories for	416787			
	GEV No.	550262	Ref. No.	—
	flat gasket copper ED ø 20mm ID ø 14mm thickness 2mm			

heating cartridges

			
GEV No.	417227	Ref. No.	1666090 1666150
description	heating cartridge 90W 230V ø 12mm L 124mm thread 3/8" cable length 4000mm Hmm Wmm condensate evaporation		
For models:	KBT40-21091640, KC41-210916400BDC, KR41-210906400BFA, KSABT70G-2045370CJD, KTAP01-BASE-20220901044U, KTAP02-BASE-20221301048K, KTAP02BT-BASE-2022630105KW, KTAP03-BASE-2022180109UA, KTAP04-2022230109X0, KTAP04-BASE-2022230109RY, KTAP82-202282020AY0, KTAP82-202282020AY1, KTAP83-202283020AY3, KTAP84-202284020AY4, KTAP84-202284020AY5, KTN40-21090640, KTRP00522-2022130107K4, KTRP200022-202209010500, KTRP200022A-2022090104EB, KTRP200042-2022090107HY, KTRP200042A-20220901077B, KTRP200044-2022090105CF, KTRP200044A-2022090107HZ, KTRP200052-2022090107HW, KTRP200052A-2022090107HX, KTRP200055-2022090107K1, KTRP200055A-2022090107K0, KTRP300222-2022130105HP, KTRP300222A-2022130104EC, KTRP300422-2022130106TB, KTRP300422A-2022130105XL, KTRP300442-2022130107K6, KTRP300442A-2022130107K7, KTRP300522-2022130107K2, KTRP300522A-2022130107K3, KTRP300552A-2022130107K5, KTRP402222A-2022180109WR, KTRP404222-2022180109WV, KTRP404222A-2022180109WU, KTRP404422-2022180104VV, KTRP404422A-2022180107KE, KTRP405222-2022180109WT, KTRP405222A-2022180109WS, KTRP405522-2022180107KB, KTRP405522A-2022180107KC, KTRP522222-2022230109WW, KTRP522222A-2022230109WX, KTRP542222A-2022230109X1, KTRP544222-2022230107KR, KTRP544222A-2022230107KP...(Other models you can see in the webshop)		

ceramic heaters

245x60mm



				
GEV No.	415104	Ref. No.	8218000	
description	ceramic emitter 1000W 230V cable beaded cord L 245mm W 60mm H 35mm			
For models:	40SECC, 40SECC-1826260, 72-02SPE-12701700			
spare parts for	415104			
	GEV No.	415109	Ref. No.	—
	spring clip			
accessories for	415104			
	GEV No.	415110	Ref. No.	—
	reflector L 245mm W 95mm H 31mm thickness 0.75mm hole ø 15x40mm			

coil heating elements

			
GEV No.	419039	Ref. No.	2000359
description	heating element 2000/2180W 230/240V L 395mm W 93mm thread 3/8" connection M6 connection length 45mm dishwasher dry heating element heating circuits 1 2 hole fixing		
For models:	OLAX151, OLAX151EDX-1080725, OLAX151ELEFT-1080727, OLAX151-highspeed, OLAX160, OLAX160E-1080750, OLAX160E-1080751, OLAX160V-1080755, OLAX160V-1080756, OLAX160V-1081031, OLAX160V-1081032, OLAX210, OLAX210E-1081029, OLAX210E-1081030, OLAX220, OLAX220E-1080787, OLAX220E-1080788, OLAX220V-1080789, OLAX220V-1080790, OLAX230, OLAX230E-1080791, OLAX230E-1080792, OLAX230V-1080793, OLAX230V-1080794, OLAX240, OLAX240E-1080795, OLAX240E-1080796, OLAX240V-1080797, OLAX240V-1080798, OLAX250, OLAX250E-1080760, OLAX250E-1080761, OLAX250V-1080765, OLAX250V-1080766, OLAX300, OLAX300E-1080770, OLAX300E-1080771, OLAX300E-1081033, OLAX300E-1081035, OLAX300E-1081036, OLAX300LC, OLAX300LCE-1081034, OLAX300V-1080775, OLAX300V-1080776, OLAX310, OLAX310E-1081110, OLAX310E-1081111, OLAX310LC, OLAX310LCE-1081114, OLAX310LCE-1081115...(Other models you can see in the webshop)		

immersion heating elements

3 hole flange ø38.5mm

				
GEV No.	415261	Ref. No.	18206	
description	heating element 2400W 230V mounting ø 38.5mm heating circuits 1 L 242mm W 31mm H 22mm number of thermostat sleeves 1 thermostat sleeves ø 7.5mm length thermostat sleeves 180mm thermostat sleeve eccentric, non clinging tube ø 6.3mm hole distance 57mm hole ø 10mm cable length 130mm 3 hole flange connection male faston 6.3mm immersion heater			
For models:	OLDS35, OLDS35-1081061, OLDS35D-1081062, OLDS35-Neutra, OLDS37-1081006, OLDS37D-1081007, OLDS37LS-1081008, OLDS37LSD-1081009, OLG35-1080702, OLG37, OLG37-1080700, OLG37D-1080707, OLG37LS-1081001, OLG37LSD-1081002, OLG37-Neutra, OLG540, OLStar			
spare parts for	415261			
	GEV No.	521120	Ref. No.	13010
	O-ring EPDM thickness 5.34mm ID ø 37.47mm Qty 1 pcs			
accessories for	415261			
	GEV No.	532577	Ref. No.	—
	O-ring EPDM thickness 5.34mm ID ø 40.65mm Qty 1 pcs			

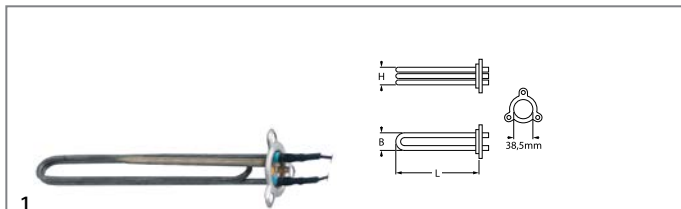

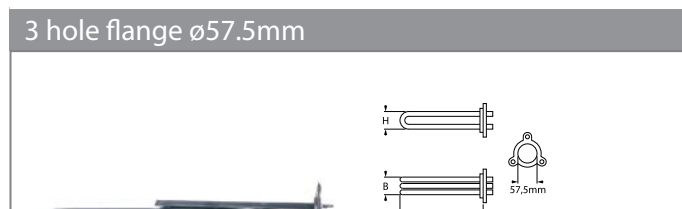

GEV No.	416277	Ref. No.	18206/D
description	heating element 2800W 230V mounting \varnothing 38.5mm heating circuits 1 L 302mm W 37mm H 28mm number of thermostat sleeves 1 thermostat sleeves \varnothing 7mm length thermostat sleeves 199mm thermostat sleeve not clinging tube \varnothing 6.4mm hole distance 57mm hole \varnothing 10mm cable length 114mm 3 hole flange connection 26 immersion heater		
For models:	OLDS35, OLDS35-1081061, OLDS35D-1081062, OLDS35-Neutra, OLDS37, OLDS37-1081063, OLDS37D-1081064, OLDS37-Neutra, OLDS40, OLDS40-1081065, OLDS40D-1081066, OLDS40E-1081067, OLDS40ED-1081068, OLDS40-Neutra, OLElectron400, OLG35-1080702, OLG37, OLG37-1080700, OLG37D-1080707, OLG37LS-1081001, OLG37LSD-1081002, OLG37-Neutra, OLG540, OLG540, OLG540-1080701, OLG540D-1080708, OLG540D-1081003, OLG540-Neutra, OLG540LSD-1081004		
accessories for	416277		
	GEV No.	532577	Ref. No.
			—
	O-ring EPDM thickness 5.34mm ID \varnothing 40.65mm Qty 1 pcs		

3 hole flange \varnothing 57.5mm

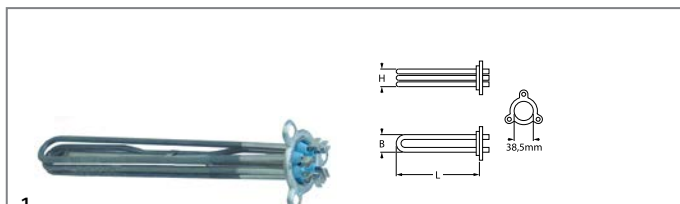

GEV No.	418714	Ref. No.	6A037190 BN6A037190
description	heating element 6000W 230V heating circuits 3 L 385mm W 37mm H 60mm tube \varnothing 8.5mm thermostat sleeves \varnothing 7.5mm length thermostat sleeves 210mm number of thermostat sleeves 1 thermostat sleeve eccentric, clinging connection male faston 6.3mm immersion heater 3 hole flange hole distance 75mm mounting \varnothing 57.5mm hole \varnothing 8x10mm		
For models:	74-02NPEI, 74-02NPEI-12701755, 7PN-EI50		
spare parts for	418714		
	GEV No.	510409	Ref. No.
			13015 R70045010
	O-ring EPDM thickness 5.34mm ID \varnothing 56.52mm Qty 1 pcs		



GEV No.	416398	Ref. No.	18215
description	heating element 4000W 230V mounting \varnothing 38.5mm heating circuits 3 L 287mm W 26mm H 34mm number of thermostat sleeves 1 thermostat sleeves \varnothing 7mm length thermostat sleeves 255mm thermostat sleeve centred, adjacent tube \varnothing 6.3mm hole distance 57mm hole \varnothing 10mm 3 hole flange connection male faston 6.3mm immersion heater		
For models:	OLDS40, OLDS40-1081065, OLDS40D-1081066, OLDS40E-1081067, OLDS40ED-1081068, OLDS40-Neutra, OLElectron400, OLG540, OLG540, OLG540-1080701, OLG540D-1080708, OLG540D-1081003, OLG540-Neutra, OLG540LSD-1081004		
accessories for	416398		
	GEV No.	521120	Ref. No.
			13010
	O-ring EPDM thickness 5.34mm ID \varnothing 37.47mm Qty 1 pcs		

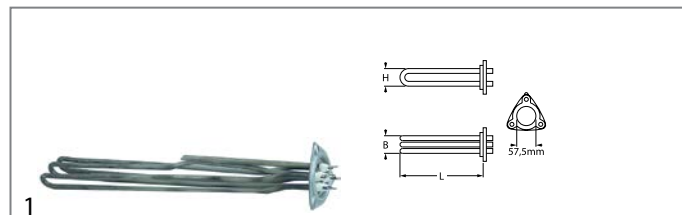

GEV No.	416807	Ref. No.	6A037202 BN6A037202
description	heating element 7500W 230V mounting \varnothing 57.5mm heating circuits 3 L 510mm W 40mm H 49mm number of thermostat sleeves 1 thermostat sleeves \varnothing 7.5mm length thermostat sleeves 215mm thermostat sleeve clinging tube \varnothing 8.5mm hole distance 83mm hole \varnothing 8.3mm connection length 26mm connection male faston 6.3mm 3 hole flange immersion heater		
For models:	911PEB-1192805, 911RPEB-1392890, 915PEB-1192800		
spare parts for	416807		
	GEV No.	510409	Ref. No.
			13015 R70045010
	O-ring EPDM thickness 5.34mm ID \varnothing 56.52mm Qty 1 pcs		

3 hole flange \varnothing 47.5mm

group 6

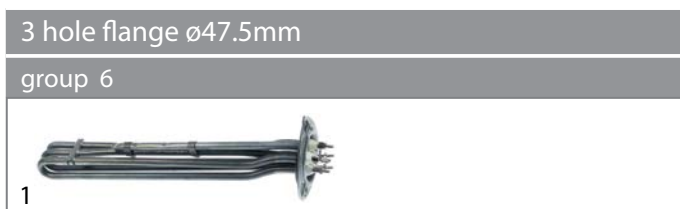

GEV No.	419060	Ref. No.	6A001421 BN6A001421
description	heating element 8000W 230V heating circuits 3 L 320mm W 34mm H 39mm tube \varnothing 8.5mm thermostat sleeves \varnothing 7.5mm length thermostat sleeves 210mm number of thermostat sleeves 1 thermostat sleeve eccentric, clinging connection M4 connection length 22mm immersion heater 3 hole flange L1 60mm L3 255mm H1 35mm H2 5mm mounting \varnothing 47.5mm		
For models:	94-04PEI100L, 94-04PEI100L-12901765, 94-04PEI110L-12901765BN, 9PN-EI100		

with compression flange 62 x 26mm

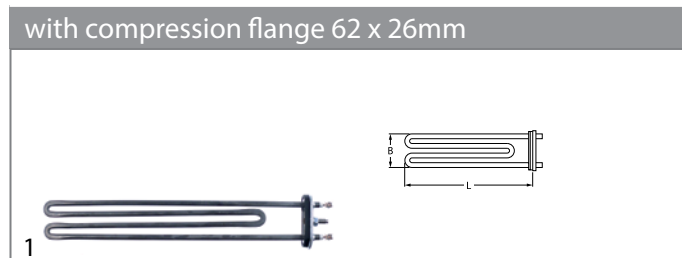

GEV No.	415266	Ref. No.	10714
description	heating element 2000W 230V heating circuits 1 compression flange 62x26mm L 300mm W 41mm Hmm connection male faston 6.3mm tube \varnothing 6.3mm immersion heater		
For models:	OLDerby, OLDS35-1081005, OLG35, OLG35D-1081000, OLG35-Neutra		

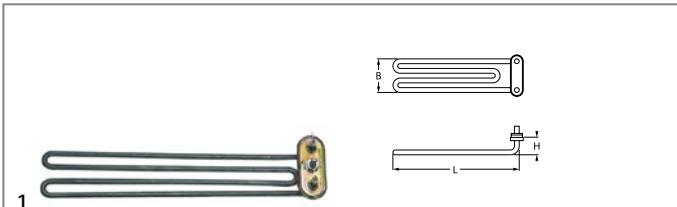

1

GEV No.	415268	Ref. No.	16035/A
description	heating element 1850-2020W 230-240V heating circuits 1 expansion flange flange 62x26mm L 245mm W 40mm H 25mm tube \varnothing 6.5mm connection male faston 6.3mm immersion heater		
For models:	OLDS35, OLDS35-1081061, OLDS35D-1081062, OLDS35-Neutra, OLDS37, OLDS37-1081063, OLDS37D-1081064, OLDS37-Neutra, OLDS40, OLDS40-1081010, OLDS40-1081065, OLDS40D-1081011, OLDS40D-1081066, OLDS40E-1081067, OLDS40ED-1081068, OLDS40LS-1081012, OLDS40LSD-1081013, OLDS40-Neutra, OLDS45, OLDS50, OLDS50-1081088, OLDS50D-1081089, OLDS50E-1081090, OLDS50ED-1081091, OLDS50-Neutra, OLG35-1080702, OLGastro450, OLG537, OLG537-1080700, OLG537D-1080707, OLG537LS-1081001, OLG537LSD-1081002, OLG537-Neutra, OLG540, OLG540, OLG540-1080701, OLG540D-1080708, OLG540D-1081003, OLG540-Neutra, OLG540LSD-1081004, OLG550, OLG550-1080705, OLG550D-1080706, OLG550E-1080730, OLG550ECO-1081014, OLG550ECOD-1081015, OLG550ED-1080731, OLG550-Neutra, OLLinear		

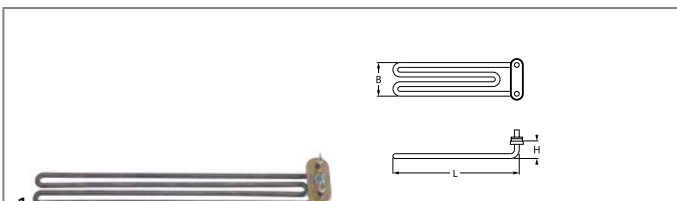

1

GEV No.	415270	Ref. No.	011DWM150047 BN011DWM150047
description	heating element 2700W 230V heating circuits 1 compression flange flange 62x26mm L 335mm W 43mm H 25mm tube \varnothing 6.3mm connection male faston 6.3mm immersion heater		
For models:	OLDS45, OLDS50, OLDS50-1081088, OLDS50D-1081089, OLDS50E-1081090, OLDS50ED-1081091, OLDS50-Neutra, OLDS50P-1081018, OLDS50PD-1081019, OLDS50H, OLElectron1000, OLElectron500, OLELELECTRON1000-1081084, OLELELECTRON1000D-1081085, OLGastro500Plus, OLGastro500S, OLGastro750Plus, OLGastro750S, OLG545, OLG550, OLG550-1080705, OLG550D-1080706, OLG550E-1080730, OLG550ECO-1081014, OLG550ECOD-1081015, OLG550ED-1080731, OLG550-Neutra, OLG585, OLG585-1081016, OLG585D-1081017, OLG585-Neutra, OLHT11-1081071, OLHT11D-1081072, OLHT11ECO-1081070, OLHT11S, OLHT11S-Neutra, OLLP155-1081087		

with expansion flange 40 x 14mm







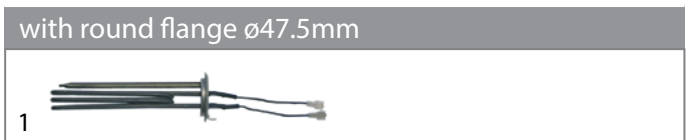

1

GEV No.	416276	Ref. No.	540401
description	heating element 1100W 230V flange 40x14mm L 203mm W 40mm H 27mm heating circuits 1 connection male faston 6.3mm immersion heater		
For models:	OLElectron400		

with round flange \varnothing 47.5mm



1

GEV No.	415260	Ref. No.	16036/A
description	heating element 2180/2370W 230/240V heating circuits 1 mounting \varnothing 47.5mm L 185mm W 40mm H 36mm round flange cable length 130mm immersion heater tube \varnothing 6.3mm thermostat sleeves \varnothing 7mm number of thermostat sleeves 1 length thermostat sleeves 165mm		
For models:	OLDS40-1081010, OLDS40D-1081011, OLDS40LS-1081012, OLDS40LSD-1081013, OLDS50, OLDS50-1081088, OLDS50D-1081089, OLDS50E-1081090, OLDS50ED-1081091, OLDS50-Neutra, OLLinear		
accessories for	415260		
	GEV No.	510408	Ref. No. 13005
	O-ring EPDM thickness 5.34mm ID \varnothing 47mm Qty 1 pcs		
	GEV No.	520235	Ref. No. 30001024
	3 hole flange hole distance 70.5mm perforation \varnothing 6.5mm ID \varnothing 53.5mm		
	GEV No.	520236	Ref. No. —
	flange for heating element ID \varnothing 50mm ED \varnothing 90mm hole \varnothing 6.5mm 3 holes		
	GEV No.	521012	Ref. No. —
	gasket graphite ED \varnothing 15mm ID \varnothing 5mm thickness 1.2mm Qty 1 pcs		
	GEV No.	550002	Ref. No. 16045
	tension strap H 10mm L 21mm W 10mm hole \varnothing 6.5mm for heating element		
	GEV No.	550362	Ref. No. —
	blind flange \varnothing 64mm mounting \varnothing 47.5mm		



1















GEV No.	415269	Ref. No.	15047/A
description	heating element 2700W 230V heating circuits 3 mounting \varnothing 47.5mm L 257mm W 28mm H 45mm round flange connection male faston 6.3mm immersion heater tube \varnothing 6.3mm H1 11mm H2 34mm connection length 28mm		
For models:	OLG600, OLH600, OLH600Electronic, OLHT-11-Neutra, OLHT12-1081075, OLHT12EL-1081080, OLHT12EL-1081083, OLHT12ELD-1081081, OLHT12ELPLUS-1081086, OLHT12S, OLHT12SElectronic, OLHT12S-Neutra, OLLP1-800, OLLP1-800-1080721, OLLP1-800EL, OLLP1-800-Neutra, OLLP-ZERO, OLLPZERO-1081057		
accessories for	415269		
	GEV No.	510408	Ref. No. 13005
	O-ring EPDM thickness 5.34mm ID \varnothing 47mm Qty 1 pcs		
	GEV No.	510562	Ref. No. —
	O-ring silicone thickness 5.34mm ID \varnothing 47mm Qty 1 pcs		
	GEV No.	520235	Ref. No. 30001024
	3 hole flange hole distance 70.5mm perforation \varnothing 6.5mm ID \varnothing 53.5mm		
	GEV No.	520236	Ref. No. —
	flange for heating element ID \varnothing 50mm ED \varnothing 90mm hole \varnothing 6.5mm 3 holes		
	GEV No.	550002	Ref. No. 16045
	tension strap H 10mm L 21mm W 10mm hole \varnothing 6.5mm for heating element		







Table continues overleaf



accessories for 415269			
	GEV No.	550362	Ref. No. —
blind flange ø 64mm mounting ø 47.5mm			

1 			
GEV No.	420056	Ref. No.	15089/D
description	heating element 2800W 230V heating circuits 1 L 380mm W 34mm H 33mm tube ø 6mm thermostat sleeves ø 8.5mm number of thermostat sleeves 1 length thermostat sleeves 230mm		
For models:	OLDS45, OLG545, OLG550, OLG550-1080705, OLG550D-1080706, OLG550E-1080730, OLG550ECO-1081014, OLG550ECOD-1081015, OLG550ED-1080731, OLG550-Neutra		
accessories for 420056			
	GEV No.	510408	Ref. No. 13005
O-ring EPDM thickness 5.34mm ID ø 47mm Qty 1 pcs			

1 			
GEV No.	415262	Ref. No.	15046
description	heating element 3000W 230V heating circuits 3 mounting ø 47.5mm L 260mm W 40mm H 36mm round flange connection male faston 6.3mm immersion heater tube ø 6.3mm thermostat sleeves ø 7mm number of thermostat sleeves 1 length thermostat sleeves 250mm thermostat sleeve upper centre not clinging		
For models:	OLDS40-1081010, OLDS40D-1081011, OLDS40LS-1081012, OLDS40SD-1081013, OLDS45, OLDS50P-1081018, OLDS50PD-1081019, OLG600, OLGastro450, OLGastro500Plus, OLG545, OLG585-Neutra, OLLinear, OLLP1-S8, OLLP1-S8EL		
accessories for 415262			
	GEV No.	510408	Ref. No. 13005
O-ring EPDM thickness 5.34mm ID ø 47mm Qty 1 pcs			
	GEV No.	510562	Ref. No. —
O-ring silicone thickness 5.34mm ID ø 47mm Qty 1 pcs			
	GEV No.	520235	Ref. No. 30001024
3 hole flange hole distance 70.5mm perforation ø 6.5mm ID ø 53.5mm			
	GEV No.	520236	Ref. No. —
flange for heating element ID ø 50mm ED ø 90mm hole ø 6.5mm 3 holes			
	GEV No.	550002	Ref. No. 16045
tension strap H 10mm L 21mm W 10mm hole ø 6.5mm for heating element			
	GEV No.	550362	Ref. No. —
blind flange ø 64mm mounting ø 47.5mm			

1 			
GEV No.	415263	Ref. No.	15089
description	heating element 4500W 230V heating circuits 3 mounting ø 47.5mm L 375mm W 38mm H 46mm round flange connection male faston 6.3mm immersion heater tube ø 6.3mm thermostat sleeves ø 7mm number of thermostat sleeves 1 length thermostat sleeves 240mm thermostat sleeve not clinging		
For models:	G125, OLDS45, OLDS50, OLDS50-1081088, OLDS50D-1081089, OLDS50E-1081090, OLDS50ED-1081091, OLDS50-Neutra, OLDW020H, OLElectron1000, OLElectron500, OLELELECTRON1000-1081084, OLELELECTRON1000D-1081085, OLG600, OLGastro500Plus, OLGastro500S, OLG545, OLG550, OLG550-1080705, OLG550D-1080706, OLG550E-1080730, OLG550ECO-1081014, OLG550ECOD-1081015, OLG550ED-1080731, OLG550-Neutra, OLG585, OLG585-1081016, OLG585D-1081017, OLG585-Neutra, OLLP155-1081087, OLLP1-S8, OLLP1-S8EL		
accessories for 415263			
	GEV No.	510408	Ref. No. 13005
O-ring EPDM thickness 5.34mm ID ø 47mm Qty 1 pcs			
	GEV No.	520235	Ref. No. 30001024
3 hole flange hole distance 70.5mm perforation ø 6.5mm ID ø 53.5mm			
	GEV No.	520236	Ref. No. —
flange for heating element ID ø 50mm ED ø 90mm hole ø 6.5mm 3 holes			
	GEV No.	521012	Ref. No. —
gasket graphite ED ø 15mm ID ø 5mm thickness 1.2mm Qty 1 pcs			
	GEV No.	550002	Ref. No. 16045
tension strap H 10mm L 21mm W 10mm hole ø 6.5mm for heating element			
	GEV No.	550362	Ref. No. —
blind flange ø 64mm mounting ø 47.5mm			

1 			
GEV No.	419040	Ref. No.	15089/E
description	heating element 6000/6530W 230/240V heating circuits 3 mounting ø 47.5mm L 375mm W 38mm H 39mm round flange connection male faston 6.3mm immersion heater tube ø 6.3mm thermostat sleeves ø 7mm number of thermostat sleeves 1 length thermostat sleeves 240mm thermostat sleeve eccentric, non clinging		
For models:	OLDS50, OLDS50-1081088, OLDS50D-1081089, OLDS50E-1081090, OLDS50ED-1081091, OLDS50-Neutra, OLElectron1000, OLElectron500, OLELELECTRON1000-1081084, OLELELECTRON1000D-1081085, OLGastro500Plus, OLGastro500S, OLGastro750Plus, OLGastro750S, OLG545, OLG550, OLG550-1080705, OLG550D-1080706, OLG550E-1080730, OLG550ECO-1081014, OLG550ECOD-1081015, OLG550ED-1080731, OLG550-Neutra, OLG585, OLG585-1081016, OLG585D-1081017, OLG585-Neutra		



with round flange ø57.5mm



GEV No.	416279	Ref. No.	30001011/A
description	heating element 12000W 230V heating circuits 3 mounting ø 57.5mm L 470mm W 48mm H 34mm round flange connection M5 immersion heater tube ø 8.5mm connection length 30mm thermostat sleeves ø 7mm number of thermostat sleeves 1 length thermostat sleeves 295mm thermostat sleeve eccentric, non clinging		
For models:	OLAX151, OLAX151EDX-1080725, OLAX151ELEFT-1080727, OLAX151-highspeed, OLAX160, OLAX160E-1080750, OLAX160E-1080751, OLAX160V-1080755, OLAX160V-1080756, OLAX160V-1081031, OLAX160V-1081032, OLAX210, OLAX210E-1081029, OLAX210E-1081030, OLAX220, OLAX220E-1080787, OLAX220E-1080788, OLAX220V-1080789, OLAX220V-1080790, OLAX230, OLAX230E-1080791, OLAX230E-1080792, OLAX230V-1080793, OLAX230V-1080794, OLAX240, OLAX240E-1080795, OLAX240E-1080796, OLAX240V-1080797, OLAX240V-1080798, OLAX250, OLAX250E-1080760, OLAX250E-1080761, OLAX250V-1080765, OLAX250V-1080766, OLAX300, OLAX300E-1080770, OLAX300E-1080771, OLAX300E-1081033, OLAX300E-1081035, OLAX300E-1081036, OLAX300LC, OLAX300LCE-1081034, OLAX300V-1080775, OLAX300V-1080776, OLAX310, OLAX310E-1081110, OLAX310E-1081111, OLAX310LC, OLAX310LCE-1081114, OLAX310LCE-1081115...(Other models you can see in the webshop)		
accessories for	416279		
	GEV No.	550002	Ref. No. 16045
	tension strap H 10mm L 21mm W 10mm hole ø 6.5mm for heating element		



GEV No.	420055	Ref. No.	30001011/B
description	heating element 14000W 230V heating circuits 3 L 480mm W 36mm H 44mm connection M5 tube ø 8.5mm thermostat sleeves ø 7.7mm number of thermostat sleeves 1 length thermostat sleeves 280mm		
For models:	OLAX151, OLAX151EDX-1080725, OLAX151ELEFT-1080727, OLAX151-highspeed, OLAX160, OLAX160E-1080750, OLAX160E-1080751, OLAX160V-1080755, OLAX160V-1080756, OLAX160V-1081031, OLAX160V-1081032, OLAX210, OLAX210E-1081029, OLAX210E-1081030, OLAX220, OLAX220E-1080787, OLAX220E-1080788, OLAX220V-1080789, OLAX220V-1080790, OLAX230, OLAX230E-1080791, OLAX230E-1080792, OLAX230V-1080793, OLAX230V-1080794, OLAX240, OLAX240E-1080795, OLAX240E-1080796, OLAX240V-1080797, OLAX240V-1080798, OLAX250, OLAX250E-1080760, OLAX250E-1080761, OLAX250V-1080765, OLAX250V-1080766, OLAX300, OLAX300E-1080770, OLAX300E-1080771, OLAX300E-1081033, OLAX300E-1081035, OLAX300E-1081036, OLAX300LC, OLAX300LCE-1081034, OLAX300V-1080775, OLAX300V-1080776, OLAX310, OLAX310E-1081110, OLAX310E-1081111, OLAX310LC, OLAX310LCE-1081114, OLAX310LCE-1081115...(Other models you can see in the webshop)		



GEV No.	415849	Ref. No.	R65020420 R65020421
description	heating element 15000W 230V heating circuits 3 mounting ø 57.5mm L 530mm W 45mm H 30mm round flange connection M4 immersion heater tube ø 8.5mm connection length 15mm thermostat sleeves ø 7mm number of thermostat sleeves 1 length thermostat sleeves 272mm thermostat sleeve eccentric, clinging		
For models:	CKEP20B, CKEP21B, CKEP40B, CKET20B, CKET21B, CKET40B		
accessories for	415849		
	GEV No.	550002	Ref. No. 16045
	tension strap H 10mm L 21mm W 10mm hole ø 6.5mm for heating element		







GEV No.	415264	Ref. No.	30001010
description	heating element 6000W 230V heating circuits 3 mounting ø 57.5mm L 480mm W 33mm H 42mm round flange connection M5 immersion heater tube ø 8.5mm connection length 19mm thermostat sleeves ø 7.5mm number of thermostat sleeves 1 length thermostat sleeves 268mm thermostat sleeve not clinging		
For models:	OLAX250, OLAX250E-1080760, OLAX250E-1080761, OLAX250V-1080765, OLAX250V-1080766, OLAX300, OLAX300E-1080770, OLAX300E-1080771, OLAX300E-1081033, OLAX300E-1081035, OLAX300E-1081036, OLAX300LC, OLAX300LCE-1081034, OLAX300V-1080775, OLAX300V-1080776, OLAX310, OLAX310E-1081110, OLAX310E-1081111, OLAX310LC, OLAX310LCE-1081114, OLAX310LCE-1081115, OLAX310LCV-1081116, OLAX310LCV-1081117, OLAX310V-1081112, OLAX310V-1081113, OLAX320, OLAX320E-1081118, OLAX320E-1081119, OLAX320V-1081120, OLAX320V-1081121, OLAX320V-1081125, OLAX330, OLAX330E-1081122, OLAX330E-1081123, OLAX330V-1081124, OLAX380, OLAX380E-1080780, OLAX380E-1080781, OLAX380E-1081037, OLAX380E-1081038, OLAX380E-1081039, OLAX380E-1081040, OLAX380E-1081043, OLAX380E-1081044, OLAX380E-1081046, OLAX380E-1081047, OLAX380E-1081048, OLAX380E-1081051, OLAX380E-1081052, OLAX380E-1081053...(Other models you can see in the webshop)		
spare parts for	415264		
	GEV No.	510409	Ref. No. 13015 R70045010
	O-ring EPDM thickness 5.34mm ID ø 56.52mm Qty 1 pcs		
accessories for	415264		
	GEV No.	550002	Ref. No. 16045
	tension strap H 10mm L 21mm W 10mm hole ø 6.5mm for heating element		





GEV No.	415848	Ref. No.	R65020350
description	heating element 7500W 230V heating circuits 3 mounting ø 57.5mm L 365mm W 36mm H 50mm round flange connection M4 immersion heater tube ø 8.5mm thermostat sleeves ø 7.5mm number of thermostat sleeves 1 length thermostat sleeves 270mm thermostat sleeve eccentric, clinging		
For models:	CKEP06B, CKEP10B, CKET06B, CKET10B		
spare parts for	415848		
	GEV No.	510409	Ref. No. 13015 R70045010
	O-ring EPDM thickness 5.34mm ID ø 56.52mm Qty 1 pcs		
accessories for	415848		
	GEV No.	550002	Ref. No. 16045
	tension strap H 10mm L 21mm W 10mm hole ø 6.5mm for heating element		



			
GEV No.	415265	Ref. No.	30001011
description	heating element 9000W 230V heating circuits 3 mounting ø 57.5mm L 470mm W 35mm H 41mm round flange connection M5 immersion heater tube ø 8.5mm connection length upper centre not clinging-mm thermostat sleeves ø 7.5mm number of thermostat sleeves 1 length thermostat sleeves 295mm		
For models:	G12S, OLAX151, OLAX151EDX-1080725, OLAX151ELEFT-1080727, OLAX151-highspeed, OLAX160, OLAX160E-1080750, OLAX160E-1080751, OLAX160V-1080755, OLAX160V-1080756, OLAX160V-1081031, OLAX160V-1081032, OLAX210, OLAX210E-1081029, OLAX210E-1081030, OLAX220, OLAX220E-1080787, OLAX220E-1080788, OLAX220V-1080789, OLAX220V-1080790, OLAX230, OLAX230E-1080791, OLAX230E-1080792, OLAX230V-1080793, OLAX230V-1080794, OLAX240, OLAX240E-1080795, OLAX240E-1080796, OLAX240V-1080797, OLAX240V-1080798, OLAX250, OLAX250E-1080760, OLAX250E-1080761, OLAX250V-1080765, OLAX250V-1080766, OLAX300, OLAX300E-1080770, OLAX300E-1080771, OLAX300E-1081033, OLAX300E-1081035, OLAX300E-1081036, OLAX300LC, OLAX300LCE-1081034, OLAX300V-1080775, OLAX300V-1080776, OLAX310, OLAX310E-1081110, OLAX310E-1081111, OLAX310LC, OLAX310LCE-1081114...(Other models you can see in the webshop)		
accessories for	415265		
	GEV No.	550002	Ref. No.
			16045
	tension strap H 10mm L 21mm W 10mm hole ø 6.5mm for heating element		



			
GEV No.	418112	Ref. No.	6A037484 BN6A037484
description	heating element 15000W 220V heating circuits 6 L 310mm W 230mm H 130mm thermostat sleeves ø 6/4mm length thermostat sleeves 137/125mm number of thermostat sleeves 2 thermostat sleeve clinging / not clinging connection male faston 6.3mm immersion heater		
For models:	CVP10E, CVP10E-1320700, CVP10E-2, CVP10E2-1320740, CVP10E2S-1320790, CVP10E-S, CVP10ES-1320750, CVP10E-S2, CVP10G, CVP10G-1310700, CVP10G-1310750, CVP10G-2, CVP10G2-1310740, CVP10GP-1310700, CVP10G-S, CVP10G-S2, CVP10GS2-1310790, CVP20E, CVP20E-1320800, CVP20E-2, CVP20E2-1320840, CVP20E-S, CVP20ES-1320850, CVP20E-S2, CVP20ES2-1320890, CVP20G, CVP20G-1310800, CVP20G-1310850, CVP20G-2, CVP20G-S, CVP20GS-1310840, CVP20G-S2, CVP20GS2-1310890, CVP21E, CVP21E-1322700, CVP21E-2, CVP21E-S, CVP21ES-1322750, CVP21E-S2, CVP21ES2-1322790, CVP21G, CVP21G-1312700, CVP21G-2, CVP21G2-1312740, CVP21G-S, CVP21GS-1312750, CVP21G-S2, CVP21GS2-1312790, ECV10ES2, ECV10ES2-1324290...(Other models you can see in the webshop)		
spare parts for	418112		
	GEV No.	375638	Ref. No.
			6A046186 A046186 BN6A046186
	bi-metal thermostat hole distance 23.5mm 1NC 1-pole connection F6.3 2 hole fixing		
accessories for	418112		
	GEV No.	550692	Ref. No.
			6A037485 A037485 BN6A037485
	gasket silicone thickness 7mm ID ø 193.7mm Qty 1 pcs for heating element suitable for BARON equiv. no. A037485		

			
GEV No.	418111	Ref. No.	6A037483 BN6A037483
description	heating element 7500W 220V heating circuits 6 L 310mm W 145mm H 130mm thermostat sleeves ø 6x4mm length thermostat sleeves 137/125mm number of thermostat sleeves 2 thermostat sleeve clinging / not clinging connection male faston 6.3mm immersion heater special fixing		
For models:	CVP6E, CVP6E-1320600, CVP6E-2, CVP6E2-1320640, CVP6E-S, CVP6ES-1320650, CVP6E-S2, CVP6ES2-1320690, CVP6G, CVP6G-1310600, CVP6G-2, CVP6G2-1310640, CVP6G-S, CVP6GS-1310650, CVP6G-S2, CVP6GS2-1310690, ECV6ES2, ECV6ES2-1324190, ECV6ES2-1326100, ECV6ES2-1326100H, ECV6GS2, ECV6GS2-1314190, ECV6GS2-1316100, ECV6ES2, ECV6ES2-1324590, ECV6ES2-1326180, ECV6GS2, ECV6GS2-1314590, ECV6GS2-1316180, FCV6E, FCV6E-2, FCV6E-2-418035420640, FCV6E-2S, FCV6E-2S-418035420650, FCV6E-418035420600, FCV6E-S, FCV6E-S-418035410690, FCV6G-2-418035410640, FCV6G-2S-418035410690, FCV6G-418035410600, FCV6G-S-418035410650, NECVM6ES2, NECVM6ES2-1327190, NECVM6ES2-1328100, NECVM6GS2, NECVM6GS2-1317190, NECVM6GS2-1318100, NECVP6ES2, NECVP6ES2-1327590, NECVP6ES2-1328180...(Other models you can see in the webshop)		
accessories for	418111		
	GEV No.	550692	Ref. No.
			6A037485 A037485 BN6A037485
	gasket silicone thickness 7mm ID ø 193.7mm Qty 1 pcs for heating element suitable for BARON equiv. no. A037485		





heating elements for convection

			
1			
GEV No.	418110	Ref. No.	6A037470 BN6A037470
description	heating element 10500W 230V heating circuits 3 ID ø 370mm ED ø 384mm L 405mm H 141mm L1 20mm W1 105mm H1 41mm H2 100mm flange length 142mm flange width 25mm hole distance 63mm connection M5 tube ø 6.5mm convection heating element hole ø 6mm rectangular flange		
For models:	CV20E, CV20E-1320200, CV20E-2, CV20E2-1320240, CV20EB-1321200, CV20E-S, CV20ES-1320250, CV20E-S2, CV20ES2-1320290, CVM20E, CVM20E-1320500, CVM20E-2, CVM20E2-1320540, CVM20E-S, CVM20ES-1320550, CVM20E-S2, CVM20ES2-1320590, CVP20E, CVP20E-1320800, CVP20E-2, CVP20E2-1320840, CVP20EB-1321200, CVP20E-S, CVP20ES-1320850, CVP20E-S2, CVP20ES2-1320890, ECV20ES2, ECV20ES2-1324390, ECV20ES2-1326140, ECV20ES2, ECV20ES2-1324790, ECV20ES2-1326220, FC20E, FC20E-2, FC20E-2-418035420240, FC20E-2S, FC20E-2S-418035420290, FC20E-418035420200, FC20E-S, FC20E-S-418035420250, FC-M20E, FCM20E-2, FCM20E-2-418035420540, FCM20E-2S, FCM20E-2S-418035420590, FCM20E-418035420500, FCM20E-S, FCM20E-S-418035420550, FCV20E, FCV20E-2...(Other models you can see in the webshop)		



			
2			
GEV No.	416784	Ref. No.	6A037650 BN6A037650
description	heating element 1300W 230V heating circuits 1 ID ø 178mm ED ø 194mm L 245mm H 25mm L1 51mm W1 30mm H1 6mm H2 19mm flange length 70mm flange width 22mm hole distance 56mm connection male faston 6.3mm tube ø 6.3mm convection heating element hole ø 5mm rectangular flange		
For models:	61FE-1826050, 61SCGFE3S-1826055, 61SCGFE4S-1827055, 61SECFE-1826075		
spare parts for	416784		
	GEV No.	510368	Ref. No. —
	gasket L 70mm W 23.5mm hole ø 5mm hole distance 56mm FIBER thickness 2mm for heating element		

			
1			
GEV No.	415828	Ref. No.	R65011310
description	heating element 15000W 230V heating circuits 3 ID ø 388mm ED ø 408mm L 428mm H 132mm L1 20mm W1 105mm H1 114mm H2 18mm flange length 140mm flange width 25mm hole distance 126mm connection M4 connection length 65mm tube ø 8.5mm convection heating element hole ø 6.3mm rectangular flange		
For models:	CCE101M, CKEP10, CKEP10B, CKEP20, CKEP20B, CKEP21, CKEP21B, CKEP40, CKEP40B, CKET10, CKET10B, CKET20, CKET20B, CKET21, CKET21B, CKET40, CKET40B		

			
1			
GEV No.	418197	Ref. No.	R65011250
description	heating element 15000W 230V heating circuits 3 ID ø 512mm ED ø 530mm L 545mm H 130mm L1 15mm W1 105mm H1 25mm H2 105mm flange length 142mm flange width 25mm hole distance 126mm connection M4 connection length 68mm tube ø 8.5mm convection heating element hole ø 6mm rectangular flange		
For models:	CKEP20, CKEP20B, CKEP40, CKEP40B, CKET20, CKET20B, CKET40, CKET40B		



			
1			
GEV No.	416788	Ref. No.	6A037600 BN6A037600
description	heating element 2400W 230V heating circuits 1 ID ø 175mm ED ø 193mm L 245mm H 35mm L1 45mm W1 31mm H1 33mm H2 33mm flange length 70mm flange width 22mm hole distance 56mm connection male faston 6.3mm connection length 20mm tube ø 6.3mm convection heating element hole ø 5mm rectangular flange		
For models:	941CEAC-1292164, 941FTE1-2RAC-1292562, 941FTE1-2RAC-1292662, 941FTEAC-1292462, 941FTEACC-1292464, 941FTEACC1-2R-1292465, 941FTEAC-1292562, 94CBEAC-1192362, 94CBGAC-1191362, 94CGAC-1191164, 94CTGAC-1191760, 98CGAC-1191168, TAC100-1022005, TAC101-1022006, TAC102-1022007, TAC130-1022105, TAC131-1022106, TAC132-1022107, TAC170-1022205, TAC171-1022206, TAC172-1022207, TAC210-1019505, TAC211-1019506, TAC212-1019507, TAC6100-1622005, TAC6130-1622105, TAC6131-1622106, TAC6170-1622205		
accessories for	416788		
	GEV No.	510368	Ref. No. —
	gasket L 70mm W 23.5mm hole ø 5mm hole distance 56mm FIBER thickness 2mm for heating element		



			
1			
GEV No.	415966	Ref. No.	1037300200
description	heating element 2500W 230V heating circuits 1 ID ø 176mm ED ø 188mm L 210mm H 28mm L1 22mm W1 30mm H1 3mm H2 25mm flange length 70mm flange width 22mm hole distance 56mm connection male faston 6.3mm tube ø 6.3mm convection heating element hole ø 5mm rectangular flange		
For models:	FOE60M, OFOE60M, OFOE-60M-12601001		
spare parts for	415966		
	GEV No.	510368	Ref. No. —
	gasket L 70mm W 23.5mm hole ø 5mm hole distance 56mm FIBER thickness 2mm for heating element		
accessories for	415966		
	GEV No.	510368	Ref. No. —
	gasket L 70mm W 23.5mm hole ø 5mm hole distance 56mm FIBER thickness 2mm for heating element		

			
1			
GEV No.	415845	Ref. No.	R65010320
description	heating element 3150W 230V heating circuits 3 ID ø 201mm ED ø 215mm L 272mm H 35mm L1 57mm W1 60mm H1 8mm H2 27mm flange length 95mm flange width 22mm hole distance 77mm connection male faston 6.3mm connection length 20mm tube ø 6.5mm convection heating element hole ø 6mm rectangular flange		
For models:	CCE042M		

			
1			
GEV No.	418196	Ref. No.	R65011530
description	heating element 6000W 230V heating circuits 3 ID ø 215mm ED ø 228mm L 266mm H 78mm L1 38mm W1 102mm H1 10mm H2 68mm flange length 142mm flange width 25mm hole distance 57mm connection M4 connection length 66mm tube ø 6.3mm convection heating element hole ø 6mm rectangular flange		
For models:	CCE051M		

			
1			
GEV No.	415829	Ref. No.	R65011540
description	heating element 7500W 230V heating circuits 3 ID ø 248mm ED ø 260mm L 287mm H 88mm L1 20mm W1 105mm H1 23mm H2 65mm flange length 142mm flange width 25mm hole distance 64mm connection M4 connection length 78mm convection heating element hole ø 5mm rectangular flange		
For models:	CCE071M, CKEP06, CKEP06B, CKET06, CKET06B		
accessories for	415829		
	GEV No.	531270	Ref. No. —
	gasket L 141mm W 22mm D1 ø 10mm D2 ø 9mm 9 holes graphite thickness 1mm suitable for UNOX		

			
1			
GEV No.	418107	Ref. No.	6A037460 BN6A037460
description	heating element 7500W 230V heating circuits 3 ID ø 368mm ED ø 385mm L 405mm H 135mm L1 24mm W1 105mm H1 35mm H2 100mm flange length 142mm flange width 24mm hole distance 64mm connection M5 connection length 92mm tube ø 8.5mm convection heating element hole ø 5.5mm rectangular flange		
For models:	CMV6ES2-1320392, CV10E, CV10E-1320100, CV10E-1320110, CV10E-2, CV10E2-1320140, CV10EB-1321100, CV10E-S, CV10ES-1320150, CV10E-S2, CV10ES2-1320190, CV21E, CV21E-1322100, CV21E-2, CV21E2-1322140, CV21E-S, CV21ES-1322150, CV21E-S2, CV21ES2-1322190, CV6E, CV6E-1320000, CV6E-1320010, CV6E-1320050, CV6E-2, CV6E2-1320040, CV6EB-1321000, CV6E-S, CV6E-S2, CV6ES2-1320090, CVM10E, CVM10E-1320400, CVM10E-1320410, CVM10E-2, CVM10E2-1320440, CVM10E-S, CVM10ES-1320450, CVM10E-S2, CVM10ES2-1320490, CVM21E, CVM21E-1322400, CVM21E-2, CVM21E2-1322440, CVM21E-S, CVM21ES-1322450, CVM21E-S2, CVM21ES2-1322490, CVM6E, CVM6E-1320300, CVM6E-1320340, CVM6E-1320390...(Other models you can see in the webshop)		



GEV No.	418108	Ref. No.	6A037480 BN6A037480
description	heating element 7500W 230V heating circuits 3 ID ø 475mm ED ø 495mm L 515mm H 143mm L1 15mm W1 105mm H1 43mm H2 100mm flange length 142mm flange width 25mm hole distance 64mm connection M4 tube ø 8.5mm convection heating element hole ø 6mm rectangular flange		
For models:	CV10E, CV10E-1320100, CV10E-1320110, CV10E-2, CV10E2-1320140, CV10EB-1321100, CV10E-S, CV10ES-1320150, CV10E-S2, CV10ES2-1320190, CV21E, CV21E-1322100, CV21E-2, CV21E2-1322140, CV21E-S, CV21ES-1322150, CV21E-S2, CV21ES2-1322190, CVM10E, CVM10E-1320400, CVM10E-1320410, CVM10E-2, CVM10E2-1320440, CVM10E-S, CVM10ES-1320450, CVM10E-S2, CVM10ES2-1320490, CVM21E, CVM21E-1322400, CVM21E-2, CVM21E2-1322440, CVM21E-S, CVM21ES-1322450, CVM21E-S2, CVM21ES2-1322490, CVP10E, CVP10E-1320700, CVP10E-1320710, CVP10E-2, CVP10E2-1320740, CVP10E2S-1320790, CVP10E-S, CVP10ES-1320750, CVP10ES-1320760, CVP10E-S2, CVP21E, CVP21E-1322700, CVP21E-2, CVP21E-S, CVP21ES-1322750...(Other models you can see in the webshop)		





GEV No.	419110	Ref. No.	R65011900
description	heating element 9000W 230V heating circuits 3 ID ø 250mm ED ø 266mm L 290mm H 93mm L1 24mm W1 105mm H1 11mm H2 82mm flange length 142mm flange width 25mm hole distance 63mm connection M4 tube ø 8.5mm hole ø 6.1mm		
For models:	CKEP06, CKEP06B, CKET06, CKET06B		

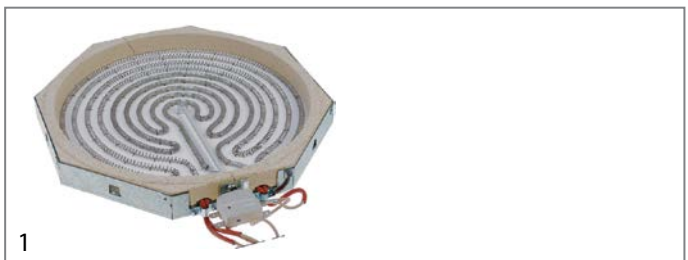

GEV No.	418109	Ref. No.	6A037475 BN6A037475
description	heating element 9000W 230V heating circuits 3 ID ø 470mm ED ø 485mm L 520mm H 155mm L1 18mm W1 104mm H1 50mm H2 105mm flange length 142mm flange width 25mm hole distance 63mm connection M5 tube ø 6.5mm convection heating element hole ø 6.3mm rectangular flange		
For models:	CV20E, CV20E-1320200, CV20E-2, CV20E2-1320240, CV20EB-1321200, CV20E-S, CV20ES-1320250, CV20E-S2, CV20ES2-1320290, CVM20E, CVM20E-1320500, CVM20E-2, CVM20E2-1320540, CVM20E-S, CVM20ES-1320550, CVM20E-S2, CVM20ES2-1320590, CVP20E, CVP20E-1320800, CVP20E-2, CVP20E2-1320840, CVP20EB-1321200, CVP20E-S, CVP20ES-1320850, CVP20E-S2, CVP20ES2-1320890, ECVM20ES2, ECVM20ES2-1324390, ECVM20ES2-1326140, ECVP20ES2, ECVP20ES2-1324790, ECVP20ES2-1326220, FC20E, FC20E-2, FC20E-2-418035420240, FC20E-2S, FC20E-2S-418035420290, FC20E-418035420200, FC20E-S, FC20E-S-418035420250, FC-M20E, FCM20E-2, FCM20E-2-418035420540, FCM20E-2S, FCM20E-2S-418035420590, FCM20E-418035420500, FCM20E-S, FCM20E-S-418035420550, FCV20E, FCV20E-2...(Other models you can see in the webshop)		

radiation heaters



GEV No.	490079	Ref. No.	6A001405MAG BN6A001405MAG
description	radiation heater octagonal 3400W 230V L 300mm W 300mm heating circuits 2 H 30mm with heating coil energy regulation with temperature signalization connections 4+2 connection type cable AD		
spare parts for	490079		
	GEV No.	390931	Ref. No. —
safety thermostat for radiation heater			



square



1

GEV No.	490202	Ref. No.	826620230 BN826620230 CR0735680
description	radiation heater L 300mm W 300mm 4000W 400V H 40mm connection type screw with pan detection		
For models:	110-90CTE, 110-90CTEE, 110-90TCTE, 94-04CTE-12901170, 94-04CTEE-12901180, 94-04CTEE-12901180BN, 94-04CTEES, 94-04CTEES-12901185, 94-04CTEES-12901185BN, 94-04CTES, 94-04CTES-12901175, 94-04TCTES, 94-04TCTES-12931175, 9TPF-E800, 9TPV-E800		



1

GEV No.	490172	Ref. No.	826620241 BN826620241
description	radiation heater rectangular 4500W 400V L 280mm W 400mm heating circuits 2 connections 2x 2 connection type cable cable length 800mm IRCA		
For models:	72-02KBEF, 72-02KBEF-12701127, 74-02KBEF, 74-02KBEF-12701128, 7BRF-E405, 7BRF-E805		

1-circuit



1

GEV No.	490150	Ref. No.	6A036750 CR0791310
description	radiation heater ø 250mm 2500W 230V heating circuits 1 energy regulation with temperature signalization with heating coil connections 2+2 connection type male faston 6.3mm EGO		
For models:	74-02CTE, 74-02CTE-12701170, 74-02CTEE, 74-02CTEE-12701180, 74-02TCTE, 74-02TCTE-12731170, 7TP-E800, 7TPF-EE800, 7TPV-E800, 7TPVP-E800		

2-circuit



1

GEV No.	490139	Ref. No.	6A001401 BN6A001401 CR0511560
description	radiation heater ø 250mm 2500W 230V heating circuits 2 energy regulation with temperature signalization partial power 1000W with ribbon heater connections 3+2 connection type male faston 6.3mm EGO		
For models:	72-02TVTC, 72-02TVTCV, 72-02TVTCV-12731005, 72-02VTC, 72-02VTCV, 72-02VTG-12701005, 74-02TVTC, 74-02TVTCV, 74-02TVTCV-12731006, 74-02VTC, 74-02VTCV, 74-02VTCEV, 74-02VTCEV-12701020, 74-02VTCV, 74-02VTCV-12701006, 7NPCF-VCE800, 7NPC-VCE400, 7NPC-VCE800, 7NPCVP-VCE400, 7NPCVP-VCE800, 7NPCV-VCE400, 7NPCV-VCE800		

accessories

hexagonal nuts



1

GEV No.	540436	Ref. No.	1033514900
description	hexagonal nut thread M10x1.25 H 4mm WS 13 brass Qty 1 pcs		
For models:	CFGE61, CFGE61D, CFGE61L, CFGE61P, CPE60, CPE60DB, OCFGE61, OCPE60, OCPE-60-12601900, OCPE-60-12601900MN, OPCG41, OPCG61		



1

GEV No.	514022	Ref. No.	14044599
description	nut thread 1½" H 12mm SS WS 59 Qty 1 pcs		
For models:	CPE60, CPE60DB, OCPE60, OCPE-60-12601900, OCPE-60-12601900MN		



1

GEV No.	521133	Ref. No.	1325313
description	nut thread M14x1.5 H 6mm WS 19 zinc-coated steel Qty 1 pcs		
For models:	CFG101, CFG120, CFG70, OCFG101, OCFG-101-12600025, OCFG120, OCFG70, OCFG-70-12600000, OPCG-41-12600010		

sealing washers

fibre gaskets

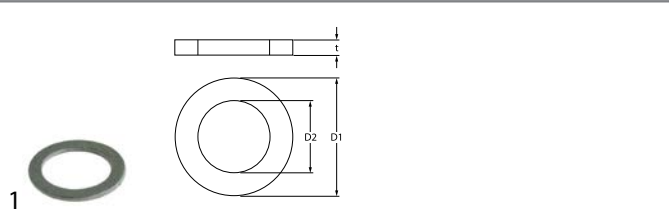

GEV No.	510404	Ref. No.	6A022280 BN6A022280
description	flat gasket fibre ED ø 44mm ID ø 34mm thickness 2mm Qty 1 pcs		
For models:	74-02NPEI, 74-02NPEI-12701755, 74-02NPGD, 74-02NPGD-12700750, 74-02NPGI, 74-02NPGI-12700755, 7NP-G50, 7NP-GI50, 7PN-EI50		

PTFE gaskets

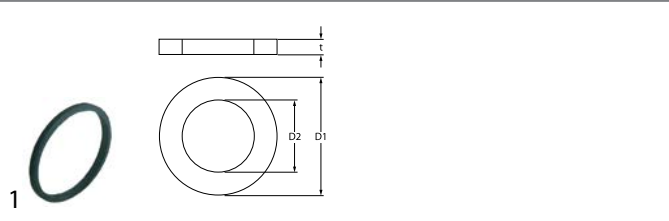

GEV No.	514016	Ref. No.	1814500
description	flat gasket PTFE ED ø 45mm ID ø 40mm thickness 4mm Qty 1 pcs equiv. no. 1036500400/1814500 suitable for MARENO		
For models:	CPE60, CPE60DB, OCPE60, OCPE-60-12601900, OCPE-60-12601900MN		

O-rings

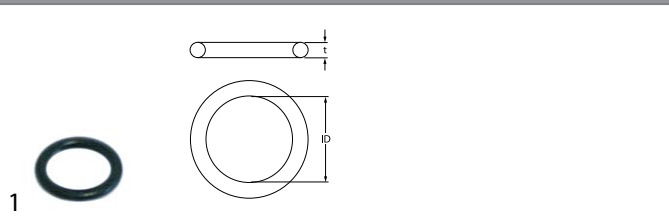

GEV No.	510893	Ref. No.	13003
description	O-ring EPDM thickness 2.62mm ID ø 9.92mm Qty 1 pcs		
For models:	G12S, OLDerby, OLDS35, OLDS35-1081005, OLDS35-1081061, OLDS35D-1081062, OLDS35-Neutra, OLDS37, OLDS37-1081006, OLDS37-1081063, OLDS37D-1081007, OLDS37D-1081064, OLDS37LS-1081008, OLDS37LSD-1081009, OLDS37-Neutra, OLDS40, OLDS40-1081010, OLDS40-1081065, OLDS40D-1081011, OLDS40D-1081066, OLDS40E-1081067, OLDS40ED-1081068, OLDS40LS-1081012, OLDS40LSD-1081013, OLDS40-Neutra, OLG35, OLG35-1080702, OLG35D-1081000, OLG35-Neutra, OLG600, OLGastro450, OLG537, OLG537-1080700, OLG537D-1080707, OLG537LS-1081001, OLG537LSD-1081002, OLG537-Neutra, OLG540, OLG540, OLG540-1080701, OLG540D-1080708, OLG540D-1081003, OLG540-Neutra, OLG540LSD-1081004, OLG540-Neutra, OLG540LSD-1081004, OLG540-Neutra, OLG540LSD-1081004, OLH600, OLH600Electronic, OLHT11-1081071, OLHT11D-1081072, OLHT11ECO-1081070, OLHT-11-Neutra...(Other models you can see in the webshop)		

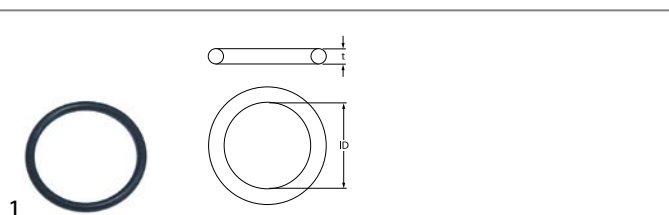

GEV No.	510899	Ref. No.	13022
description	O-ring EPDM thickness 3.53mm ID ø 37.69mm Qty 1 pcs		
For models:	OLHT-11-Neutra, OLLP1-800, OLLP1-800-1080721, OLLP1-800EL, OLLP1-800-Neutra, OLLP-ZERO, OLLPZERO-1081057		

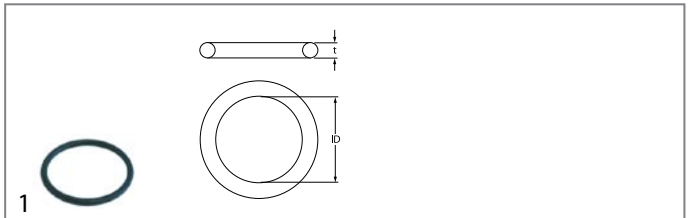

GEV No.	521120	Ref. No.	13010
description	O-ring EPDM thickness 5.34mm ID ø 37.47mm Qty 1 pcs		
For models:	OLDS35, OLDS35-1081061, OLDS35D-1081062, OLDS35-Neutra, OLDS37, OLDS37-1081006, OLDS37-1081063, OLDS37D-1081007, OLDS37D-1081064, OLDS37LS-1081008, OLDS37LSD-1081009, OLDS37-Neutra, OLDS40, OLDS40-1081065, OLDS40D-1081066, OLDS40E-1081067, OLDS40ED-1081068, OLDS40-Neutra, OLElectron400, OLG35-1080702, OLG537, OLG537-1080700, OLG537D-1080707, OLG537LS-1081001, OLG537LSD-1081002, OLG537-Neutra, OLG540, OLG540, OLG540-1080701, OLG540D-1080708, OLG540D-1081003, OLG540-Neutra, OLG540LSD-1081004, OLStar		

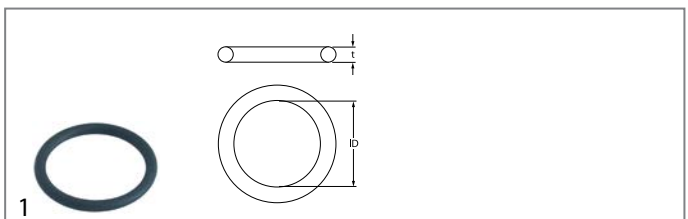

GEV No.	505092	Ref. No.	BN0119472130
description	O-ring EPDM thickness 5.34mm ID ø 43.82mm Qty 1 pcs		

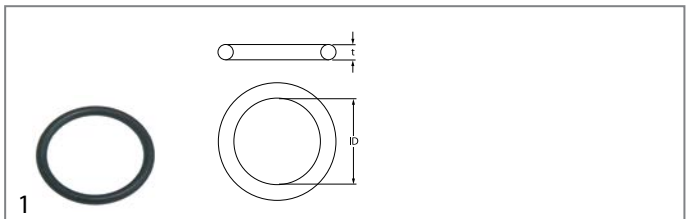

GEV No.	510408	Ref. No.	13005
description	O-ring EPDM thickness 5.34mm ID ø 47mm Qty 1 pcs		
For models:	OLDS40-1081010, OLDS40D-1081011, OLDS40LS-1081012, OLDS40LSD-1081013, OLDS45, OLDS50, OLDS50-1081088, OLDS50D-1081089, OLDS50E-1081090, OLDS50ED-1081091, OLDS50-Neutra, OLDS50P-1081018, OLDS50PD-1081019, OLElectron500, OLG600, OLGastro450, OLGastro500Plus, OLGastro500S, OLGastro750Plus, OLGastro750S, OLG545, OLG550, OLG550-1080705, OLG550D-1080706, OLG550E-1080730, OLG550ECO-1081014, OLG550ECOD-1081015, OLG550ED-1080731, OLG550-Neutra, OLG585, OLG585-1081016, OLG585D-1081017, OLG585-Neutra, OLLinear, OLLP-ZERO, OLLPZERO-1081057		



1			
GEV No.	510409	Ref. No.	13015 R70045010
description	O-ring EPDM thickness 5.34mm ID ø 56.52mm Qty 1 pcs		
For models:	CKEP06B, CKEP10B, CKEP20B, CKEP21, CKEP21B, CKET06B, CKET10B, CKET20B, CKET21, CKET21B, CKGP21, CKGP21B, CKGT21, CKGT21B, G12S, OLAX151, OLAX151EDX-1080725, OLAX151ELEFT-1080727, OLAX151-highspeed, OLAX160, OLAX160E-1080750, OLAX160E-1080751, OLAX160V-1080755, OLAX160V-1080756, OLAX160V-1081031, OLAX160V-1081032, OLAX210, OLAX210E-1081029, OLAX210E-1081030, OLAX220, OLAX220E-1080787, OLAX220E-1080788, OLAX220V-1080789, OLAX220V-1080790, OLAX230, OLAX230E-1080791, OLAX230E-1080792, OLAX230V-1080793, OLAX230V-1080794, OLAX240, OLAX240E-1080795, OLAX240E-1080796, OLAX240V-1080797, OLAX240V-1080798, OLAX250, OLAX250E-1080760, OLAX250E-1080761, OLAX250V-1080765, OLAX250V-1080766, OLAX300...(Other models you can see in the webshop)		

2			
GEV No.	514017	Ref. No.	1814400
description	O-ring silicone thickness 3.53mm ID ø 32.93mm Qty 1 pcs		
For models:	CPE60, CPE60DB, OCPE60, OCPE-60-12601900, OCPE-60-12601900MN		

1			
GEV No.	514021	Ref. No.	1814700
description	O-ring silicone thickness 3.53mm ID ø 49.21mm Qty 1 pcs		
For models:	CPE60, CPE60DB, OCPE60, OCPE-60-12601900, OCPE-60-12601900MN		

miscellaneous			
1			
GEV No.	550692	Ref. No.	6A037485 BN6A037485
description	gasket silicone thickness 7mm ID ø 193.7mm Qty 1 pcs for heating element suitable for BARON equiv. no. A037485		
For models:	CVP10E, CVP10E-1320700, CVP10E-2, CVP10E2-1320740, CVP10E2S-1320790, CVP10E-S, CVP10ES-1320750, CVP10E-S2, CVP10G, CVP10G-1310700, CVP10G-1310750, CVP10G-2, CVP10G2-1310740, CVP10GP-1310700, CVP10G-S, CVP10G-S2, CVP10GS2-1310790, CVP20E, CVP20E-1320800, CVP20E-2, CVP20E2-1320840, CVP20E-S, CVP20ES-1320850, CVP20E-S2, CVP20ES2-1320890, CVP20G, CVP20G-1310800, CVP20G-1310850, CVP20G-2, CVP20G-S, CVP20GS-1310840, CVP20G-S2, CVP20GS2-1310890, CVP21E, CVP21E-1322700, CVP21E-2, CVP21E-S, CVP21ES-1322750, CVP21E-S2, CVP21ES2-1322790, CVP21G, CVP21G-1312700, CVP21G-2, CVP21G2-1312740, CVP21G-S, CVP21GS-1312750, CVP21G-S2, CVP21GS2-1312790, CVP6E, CVP6E-1320600...(Other models you can see in the webshop)		

flange gaskets			
counterflanges			
1			
GEV No.	520235	Ref. No.	30001024
description	3 hole flange hole distance 70.5mm perforation ø 6.5mm ID ø 53.5mm		
For models:	G12S		

1			
GEV No.	550002	Ref. No.	16045
description	tension strap H 10mm L 21mm W 10mm hole ø 6.5mm for heating element		
For models:	OLAX151, OLAX151EDX-1080725, OLAX151ELEFT-1080727, OLAX151-highspeed, OLAX160, OLAX160E-1080750, OLAX160E-1080751, OLAX160V-1080755, OLAX160V-1080756, OLAX160V-1081031, OLAX160V-1081032, OLAX210, OLAX210E-1081029, OLAX210E-1081030, OLAX220, OLAX220E-1080787, OLAX220E-1080788, OLAX220V-1080789, OLAX220V-1080790, OLAX230, OLAX230E-1080791, OLAX230E-1080792, OLAX230V-1080793, OLAX230V-1080794, OLAX240, OLAX240E-1080795, OLAX240E-1080796, OLAX240V-1080797, OLAX240V-1080798, OLAX250, OLAX250E-1080760, OLAX250E-1080761, OLAX250V-1080765, OLAX250V-1080766, OLAX300, OLAX300E-1080770, OLAX300E-1080771, OLAX300E-1081033, OLAX300E-1081035, OLAX300E-1081036, OLAX300LC, OLAX300LCE-1081034, OLAX300V-1080775, OLAX300V-1080776, OLAX310, OLAX310E-1081110, OLAX310E-1081111, OLAX310LC, OLAX310LCE-1081114, OLAX310LCE-1081115...(Other models you can see in the webshop)		





			
1			
GEV No.	550002	Ref. No.	16045
description	tension strap H 10mm L 21mm W 10mm hole ø 6.5mm for heating element		
For models:	OLAX151, OLAX151EDX-1080725, OLAX151ELEFT-1080727, OLAX151-highspeed, OLAX160, OLAX160E-1080750, OLAX160E-1080751, OLAX160V-1080755, OLAX160V-1080756, OLAX160V-1081031, OLAX160V-1081032, OLAX210, OLAX210E-1081029, OLAX210E-1081030, OLAX220, OLAX220E-1080787, OLAX220E-1080788, OLAX220V-1080789, OLAX220V-1080790, OLAX230, OLAX230E-1080791, OLAX230E-1080792, OLAX230V-1080793, OLAX230V-1080794, OLAX240, OLAX240E-1080795, OLAX240E-1080796, OLAX240V-1080797, OLAX240V-1080798, OLAX250, OLAX250E-1080760, OLAX250E-1080761, OLAX250V-1080765, OLAX250V-1080766, OLAX300, OLAX300E-1080770, OLAX300E-1080771, OLAX300E-1081033, OLAX300E-1081035, OLAX300E-1081036, OLAX300LC, OLAX300LCE-1081034, OLAX300V-1080775, OLAX300V-1080776, OLAX310, OLAX310E-1081110, OLAX310E-1081111, OLAX310LC, OLAX310LCE-1081114, OLAX310LCE-1081115...(Other models you can see in the webshop)		

capillary tube clips			
			
1			
GEV No.	550970	Ref. No.	1033709500
description	capillary tube clip for pipe ø 8.5mm		
For models:	FQE41, FQE41L, FQE41L2, FQE61, FQE61L, FQE61L2, OFQE41, OFQE41-12601510, OFQE41-12601510MN, OFQE41L, OFQE61, OFQE61-12601610, OFQE61-12601610MN, OFQE61L		

			
1			
GEV No.	550980	Ref. No.	8208270 BN8208270
description	capillary tube clip for pipe ø 8.5mm Qty 1 pcs		
For models:	41SEFR2S-1826120, 41SEFR-1826125, 55-45FRE, 55-90FRE, 61SEFR2S-1826130, 621SEFR-1826135, 7101FR-E-1077750R, 7121FR-E-1077950R, 7201FR-E-1077850R, 72-02FRE, 72-02FRE-12701500, 72-02FRE, 72-02FRE-12701530, 7221FR-E-1078050R, 73-02FRE, 73-02FRE-12701550, 73-02FRE, 73-02FRE-12701580, 74-02FRE, 74-02FRE-12701600, 74-02FRE, 74-02FRE-12701630, 7FRI-E415, 7FRI-E415M, 7FRI-E610, 7FRI-E815, 9122PFRE-1104930, 9141PFRE-1204950, 92-04FRE15L-12901510, 92-04FRE20L-12901500, 92-04FRE20L-12901500BN, 921FRE-1292925, 921RFRE-1392925, 922RFRE-1392930, 93-04FRE-12901550, 94-04FRE-12901600, 941FRE-1292950, 941RFRE-1392950, 9FRI-E415, 9FRI-E420, 9FRI-E610, 9FRI-E815, 9FRI-E820		

spring clips			
			
1			
GEV No.	550041	Ref. No.	8208250 BN8208250
description	probe clip for pipe ø 7mm for probe ø 6mm		
For models:	40SEFR2S-1826140, 41SEFR2S-1826120, 421SEFR-1826125, 55-45FRE, 55-90FRE, 60SEFR2S-1826150, 61SEFR2S-1826130, 621SEFR-1826135, 7101FR-E-1077750R, 7121FR-E-1077950R, 7201FR-E-1077850R, 72-02FRE, 72-02FRE-12701500, 7221FR-E-1078050R, 73-02FRE, 73-02FRE-12701550, 74-02FRE, 74-02FRE-12701600, 7FRI-E415, 7FRI-E415M, 7FRI-E610, 7FRI-E815, 9122PFRE-1104930, 9141PFRE-1204950, 914PFRE-1204940, 92-04FRE15L-12901510, 92-04FRE20L-12901500, 92-04FRE20L-12901500BN, 921FRE-1292925, 921RFRE-1392925, 922RFRE-1392930, 92CCPE-1192856, 92CCPE-1192856V, 92RCCPE-1392856, 93-04FRE-12901550, 94-04FRE-12901600, 941FRE-1292950, 941RFRE-1392950, 94RCCPE-1392861, 9FRI-E415, 9FRI-E420, 9FRI-E610, 9FRI-E815, 9FRI-E820		

			
1			
GEV No.	550417	Ref. No.	1033515200
description	probe clip for pipe ø 2x8.5mm for probe ø 6mm for heating elements spacing 15-19mm Qty 1 pcs		
For models:	FQE41, FQE41L, FQE41L2, FQE61, FQE61L, FQE61L2, OFQE41, OFQE41-12601510, OFQE41-12601510MN, OFQE41L, OFQE61, OFQE61-12601610, OFQE61-12601610MN, OFQE61L		

			
1			
GEV No.	550981	Ref. No.	8208260 BN8208260
description	probe clip for pipe ø 8.5mm for probe ø 6mm for heating elements spacing 0.4mm Qty 1 pcs		
For models:	40SEFR2S-1826140, 41SEFR2S-1826120, 421SEFR-1826125, 55-45FRE, 55-90FRE, 60SEFR2S-1826150, 61SEFR2S-1826130, 621SEFR-1826135, 7101FR-E-1077750R, 7121FR-E-1077950R, 7201FR-E-1077850R, 72-02FRE, 72-02FRE-12701500, 72-02FRE, 72-02FRE-12701530, 7221FR-E-1078050R, 73-02FRE, 73-02FRE-12701550, 73-02FRE, 73-02FRE-12701580, 74-02FRE, 74-02FRE-12701600, 74-02FRE, 74-02FRE-12701630, 7FRI-E415, 7FRI-E415M, 7FRI-E610, 7FRI-E815, 9122PFRE-1104930, 9141PFRE-1204950, 92-04FRE15L-12901510, 92-04FRE20L-12901500, 92-04FRE20L-12901500BN, 921FRE-1292925, 921RFRE-1392925, 922RFRE-1392930, 93-04FRE-12901550, 94-04FRE-12901600, 941FRE-1292950, 941RFRE-1392950, 9FRI-E415, 9FRI-E420, 9FRI-E610, 9FRI-E815, 9FRI-E820		

			
1			
GEV No.	514018	Ref. No.	18146-00
description	bush		
For models:	CPE60, CPE60DB, OCPE60, OCPE-60-12601900, OCPE-60-12601900MN		



			
1			
GEV No.	514020	Ref. No.	1815014
description	bush		
For models:	CPE60, CPE60DB, OCPE60, OCPE-60-12601900, OCPE-60-12601900MN		

			
1			
GEV No.	691335	Ref. No.	1033715314
description	lever for tilting element		
For models:	FQE41, FQE41L, FQE41L2, FQE61, FQE61L, FQE61L2, OFQE41, OFQE-41-12601510, OFQE-41-12601510MN, OFQE41L, OFQE61, OFQE-61-12601610, OFQE-61-12601610MN, OFQE61L		

			
1			
GEV No.	691354	Ref. No.	1041304334
description	lever for tilting element		
For models:	FQE41, FQE41L, FQE41L2, FQE61, FQE61L, FQE61L2, OFQE41, OFQE-41-12601510, OFQE-41-12601510MN, OFQE41L, OFQE61, OFQE-61-12601610, OFQE-61-12601610MN, OFQE61L		

hot plates

square & rectangular

with radiused edge

			
1			
GEV No.	490066 ¹	Ref. No.	6A036720 BN6A036720 CR1078117R MA1712913
description	hot plate dimensions 220x220mm 2600W 230V with spill ring connection 4 screw clamps protector yes square		
For models:	72-02CEPQ, 72-02CEPQ-12701201, 72-02TCEPQ, 72-02TCEPQ-12731201, 74-02CEEPO, 74-02CEEPO-12701210, 74-02CEPQ, 74-02CEPQ-12701202, 74-02TCEPQ, 74-02TCEPQ-12731202, 76-02CEEANPQ, 76-02CEEACPO, 76-02CEEPO-12701216, 76-02CEE-PO-12701215, 76-02CEPQ, 76-02CEPQ-12701203, 76-02TCEPQ, 76-02TCEPQ-12731203, EHB-78, EHU-78		

¹incl. protector

			
1			
GEV No.	490068 ¹	Ref. No.	6A036730 BN6A036730
description	hot plate dimensions 220x220mm 2600W 400V with spill ring connection 4 screw clamps protector yes square		
For models:	721CAE-1000255, 721CAE-1000255R, 721TCE-1009255, 721TCE-1009255R, 741CAE-1000305, 741CAE-1000305R, 741CE-1000405, 741CE-1000405R, 741TCE-1009305, 741TCE-1009305R, 761CAE-1000355, 761CAE-1000355R, 761CE-1000455, 761CEAC-1000505, 761CEAC-1000505R, 761CEAN-1000455, 761CEAN-1000455R, 761TCE-1009355		

¹incl. protector

			
1			
GEV No.	490176 ¹	Ref. No.	BN6A036735 SIR0109190
description	hot plate dimensions 220x220mm 2600W 440V with spill ring connection 4 screw clamps protector yes		

¹incl. protector

			
1			
GEV No.	490056 ¹	Ref. No.	1036520 6A036530 BN6A036530
description	hot plate dimensions 300x300mm 3000W 230V with spill ring connection 4 screw clamps protector yes square		
For models:	92-04CE, 92-04CEPQ-12901201, 92-04TCE, 92-04TCE-12931201, 94-04CE, 94-04CE-12901202, 94-04CEE, 94-04CEE-12901210, 94-04CEE-12901210BN, 94-04TCE, 94-04TCE-12931202, 9PC-E400, 9PC-E800, 9PCF-E800, 9PCV-E400, 9PCV-E800		

¹incl. protector



GEV No.	490057 ¹	Ref. No.	6A036510 BN6A036510
description	hot plate dimensions 300x300mm 3000W 400V with spill ring connection 4 screw clamps protector yes square		
For models:	9121PTCE-1104292, 9141PCEE-1104394, 9141PTCE-1104294, 9161PTCE-1104296, 921CE-1292102, 921TCE-1292092, 92ICE-1292102, 941CE-1292104, 941CEAC-1292164, 941CEE-1292224, 941TCE-1292094, 961CE-1292106, 961CEEE-1292246, 961TCE-1292096, CA-E92-1050310, C-E904-1050350, C-E906AC-1050360		

¹incl. protector



GEV No.	490177	Ref. No.	BN6A036540
description	hot plate dimensions 300x300mm 3000W 440V with spill ring connection 4 screw clamps protector no		

round

with radiused edge

for domestic and commercial kitchens



GEV No.	490129	Ref. No.	1839813
description	hot plate ø 180mm 1500W 230V connection 4 screw clamps with 8mm spill ring		
For models:	CFE60, CFE60P, OCFE60, OCFE-60-12601005, OCFE-60-12601005MN, OPCE60, OPCE-60-12601015, OPCE-60-12601015MN, PCE60, PCE60D, PCE60DB		



GEV No.	490016	Ref. No.	6A048901 BN6A048901
description	hot plate ø 180mm 2000W 230V connection 4 screw clamps with 8mm spill ring		
For models:	72-02CEPT, 72-02CEPT-12701001, 72-02CEPT-2212701001, 72-02TCEPT, 72-02TCEPT-12731001, 72CAE-000250, 7-2FXE, 74-02CEPT, 74-02CEPT-12701010, 74-02CEPT, 74-02CEPT-12701002, 74-02TCEPT, 74-02TCEPT-12731002, 74CAE-000300, 74CE-000400, 76-02CEANPT, 76-02CEEEACT, 76-02CEEEPT-12701016, 76-02CEPT-12701015, 76-02CEPT, 76-02CEPT-12701003, 76-02TCEPT, 76-02TCEPT-12731003, 76CAE-272106, 76CEAC-000500, FO-E32C-1008325, FO-E32L-1008335		



GEV No.	490017	Ref. No.	6A048910 BN6A048910
description	hot plate ø 180mm 2000W 400V connection 4 screw clamps with 8mm spill ring		
For models:	72CA-E-1000250, 72CA-E-1000250R, 72TCE-1009250, 72TCE-1009250R, 74CA-E-1000300, 74CA-E-1000300R, 74CE-1000400, 74CE-1000400R, 74TCE-1009300, 74TCE-1009300R, 76CA-E-1000350, 76CA-E-1000350R, 76CE-1000450, 76CEAC-1000500, 76CE-AC-1000500R, 76CEAN-1000450, 76CEAN-1000450R, 76TCE-1009350, FO-E32C-1008320, FO-E32L-1008330		



GEV No.	490018	Ref. No.	BN6A045301
description	hot plate ø 220mm 2000W 230V connection 4 screw clamps with 8mm spill ring		



GEV No.	490130	Ref. No.	1647013
description	hot plate ø 220mm 2000W 230V connection 4 screw clamps with 8mm spill ring		
For models:	CFE60, CFE60P, OCFE60, OCFE-60-12601005, OCFE-60-12601005MN		



GEV No.	490020	Ref. No.	1832313 6A045601 BN6A045601
description	hot plate ø 220mm 2600W 230V connection 4 screw clamps with 8mm spill ring		
For models:	40SEC, 40SEC-1825060, 60SEC, 60SEC-1825070, 61SECFE-1826075, 72-02CEPT, 72-02CEPT-12701001, 72-02CEPT-2212701001, 72-02TCEPT, 72-02TCEPT-12731001, 72CAE-000250, 7-2FXE, 74-02CEPT, 74-02CEPT-12701010, 74-02CEPT, 74-02CEPT-12701002, 74-02TCEPT, 74-02TCEPT-12731002, 74CAE-000300, 74CE-000400, 76-02CEANPT, 76-02CEEEACT, 76-02CEEEPT-12701016, 76-02CEPT-12701015, 76-02CEPT, 76-02CEPT-12701003, 76-02TCEPT, 76-02TCEPT-12731003, 76CAE-272106, 76CEAC-000500, CFE60, CFE60P, FO-E32C-1008325, FO-E32L-1008335, OCFE60, OCFE-60-12601005MN, OPCE40, OPCE-40-12601010, OPCE-40-12601010MN, OPCE60, OPCE-60-12601015, OPCE-60-12601015MN, PCE40, PCE40D, PCE40DB, PCE60, PCE60D, PCE60DB		

accessories for	490020			
	GEV No.	550796	Ref. No.	—
	fixing plate for hot plate ø220mm			





			
1			
GEV No.	490021	Ref. No.	6A045600 BN41826620010
description	hot plate ø 220mm 2600W 400V connection 4 screw clamps with 8mm spill ring		
For models:	72CA-E-1000250, 72CA-E-1000250R, 72TCE-1009250, 72TCE-1009250R, 74CA-E-1000300, 74CA-E-1000300R, 74CE-1000400, 74CE-1000400R, 74TCE-1009300, 74TCE-1009300R, 76CA-E-1000350, 76CA-E-1000350R, 76CE-1000450, 76CE-1000450R, 76CE-AC-1000500R, 76CEAN-1000450, 76CEAN-1000450R, 76TCE-1009350, FO-E32C-1008320, FO-E32L-1008330		

			
1			
GEV No.	490175	Ref. No.	BN6A045602
description	hot plate ø 220mm 2600W 440V connection 4 screw clamps with 8mm spill ring		

energy regulators

EGO

1-circuit			
			
1			
GEV No.	380015	Ref. No.	0111641820 6A049320 BN0111641820
description	energy regulator 230V 13A single-circuit turn direction right shaft ø 6x4.6mm shaft L 23mm mounting thread M4 power release 6-100% no. 50.57021.010		
For models:	40SEW, 40SEW-1825190, 74-02CTE, 74-02CTE-12701170, 74-02CTEE, 74-02CTEE-12701180, 74-02NPEI, 74-02NPEI-12701755, 74-02TCTE, 74-02TCTE-12731170, 7PN-EI50, 7TP-E800, 7TPF-EE800, 7TPV-E800, 7TPVP-E800, 911PEB-1192805, 911RPEB-1392890, 915PEB-1192800, 96-04KBEC-12901105, 9BR-E100, 9BR-E105, 9BRS-E100, 9BRS-E105, CV10E, CV10E-1320100, CV10E-2, CV10E2-1320140, CV10EB-1321100, CV10E-S, CV10ES-1320150, CV10E-S2, CV10ES2-1320190, CV10G, CV10G-1310100, CV10G-2, CV10G2-1310140, CV10GB-1311100, CV10G-S, CV10GS-1310150, CV10G-S2, CV10GS2-1310190, CV20E, CV20E-1320200, CV20E-2, CV20E2-1320240, CV20EB-1321200, CV20E-S, CV20ES-1320250, CV20E-S2, CV20ES2-1320290...(Other models you can see in the webshop)		

2-circuit			
			
1			
GEV No.	380027	Ref. No.	6A001402 CM293900 MACM293900
description	energy regulator EGO 230V 13A dual circuit turn direction right shaft ø 6x4.6mm shaft L 23mm mounting thread M4 power release 6-70% no. 50.55021.100		
For models:	72-02TVTC, 72-02TVTCV, 72-02TVTCV-12731005, 72-02VTC, 72-02VTCV, 72-02VTG-12701005, 74-02TVTC, 74-02TVTCV, 74-02TVTCV-12731006, 74-02VTC, 74-02VTCV, 74-02VTCV-12701006, 7NPCF-VCE800, 7NPC-VCE400, 7NPC-VCE800, 7NPCVP-VCE400, 7NPCVP-VCE800, 7NPCV-VCE400, 7NPCV-VCE800, 92-04TVTC, 92-04TVTC-12931005, 92-04TVTCV-12931055, 92-04VTC, 92-04VTCV-12901055, 94-04TVTC, 94-04TVTC-12931006, 94-04TVTCV-12931056, 94-04VTC, 94-04VTCV, 94-04VTCEV-12901050, 94-04VTCV-12901056, 9NPCF-VCE800, 9NPC-VCE400, 9NPC-VCE800, 9NPCVP-VCE400, 9NPCVP-VCE800, 9NPCV-VCE400, 9NPCV-VCE800, CPE60, CPE60DB, OCPE60, OCPE-60-12601900, OCPE-60-12601900MN		

thermostats

bi-metal thermostats

safety bi-metal thermostats

			
1			
GEV No.	390480	Ref. No.	15550
description	bi-metal safety thermostat hole distance 23.8mm switch-off temp. 105°C 1NC 1-pole 16A connection F6.3 2 hole fixing		
For models:	OLDerby, OLDS35, OLDS35-1081005, OLDS35-1081061, OLDS35D-1081062, OLDS35-Neutra, OLDS37, OLDS37-1081006, OLDS37-1081063, OLDS37D-1081007, OLDS37D-1081064, OLDS37LS-1081008, OLDS37LSD-1081009, OLDS37-Neutra, OLDS40, OLDS40-1081010, OLDS40-1081065, OLDS40D-1081011, OLDS40D-1081066, OLDS40E-1081067, OLDS40ED-1081068, OLDS40LS-1081012, OLDS40LSD-1081013, OLDS40-Neutra, OLDS45, OLDS50, OLDS50-1081088, OLDS50D-1081089, OLDS50E-1081090, OLDS50ED-1081091, OLDS50-Neutra, OLDS50P-1081018, OLDS50PD-1081019, OLElectron400, OLElectron500, OLG35-1080702, OLG600, OLGastro450, OLGastro500Plus, OLGastro500S, OLGastro750Plus, OLGastro750S, OLGs37, OLGs37-1080700, OLGs37D-1080707, OLGs37LS-1081001, OLGs37LSD-1081002, OLGs37-Neutra, OLGs40, OLGs40...(Other models you can see in the webshop)		



bi-metal thermostats



GEV No.	375638	Ref. No.	6A046186 BN6A046186
description	bi-metal thermostat hole distance 23.5mm 1NC 1-pole connection F6.3 2 hole fixing		
For models:	CVP10E, CVP10E-1320700, CVP10E-2, CVP10E2-1320740, CVP10E2S-1320790, CVP10E-S, CVP10ES-1320750, CVP10E-S2, CVP10G, CVP10G-1310700, CVP10G-1310750, CVP10G-2, CVP10G2-1310740, CVP10GP-1310700, CVP10G-S, CVP10G-S2, CVP10GS2-1310790, CVP20E, CVP20E-1320800, CVP20E-2, CVP20E2-1320840, CVP20E-S, CVP20ES-1320850, CVP20E-S2, CVP20E2S-1320890, CVP20G, CVP20G-1310800, CVP20G-1310850, CVP20G-2, CVP20G-S, CVP20GS-1310840, CVP20G-S2, CVP20GS2-1310890, CVP21E, CVP21E-1322700, CVP21E-2, CVP21E-S, CVP21ES-1322750, CVP21E-S2, CVP21ES2-1322790, CVP21G, CVP21G-1312700, CVP21G-2, CVP21G2-1312740, CVP21G-S, CVP21GS-1312750, CVP21G-S2, CVP21GS2-1312790, CVP6E, CV-P6E-1320600...(Other models you can see in the webshop)		



GEV No.	390613	Ref. No.	6A035210 BN6A035210
description	bi-metal thermostat hole distance 23.5mm switch-off temp. 150°C 1NCA connection F6.3		
For models:	72-02TVTCV, 72-02TVTCV-12731005, 72-02VTC, 72-02VTCV, 72-02VTG-12701005, 74-02TVTCV, 74-02TVTCV-12731006, 74-02VTCEV, 74-02VTCEV-12701020, 74-02VTCV, 74-02VTCV-12701006, 7NPCF-VCE800, 7NPC-VCE400, 7NPC-VCE800, 7NPCVP-VCE400, 7NPCVP-VCE800, 7NPCV-VCE400, 7NPCV-VCE800, 92-04TVTC, 92-04TVTC-12931005, 92-04TVTCV-12931055, 92-04VTC, 92-04VTCV-12901055, 94-04TVTC, 94-04TVTC-12931006, 94-04TVTCV-12931056, 94-04VTC, 94-04VTC, 94-04VTCV-12901050, 94-04VTCV-12901056, 9NPCF-VCE800, 9NPC-VCE400, 9NPC-VCE800, 9NPCVP-VCE400, 9NPCVP-VCE800, 9NPCV-VCE400, 9NPCV-VCE800		



GEV No.	390612	Ref. No.	6A035200 BN6A035200
description	bi-metal thermostat hole distance 24mm switch-off temp. 110°C		
For models:	72-02TVTCV, 72-02TVTCV-12731005, 72-02VTC, 72-02VTCV, 72-02VTG-12701005, 74-02TVTCV, 74-02TVTCV-12731006, 74-02VTCEV, 74-02VTCEV-12701020, 74-02VTCV, 74-02VTCV-12701006, 7NPCF-VCE800, 7NPC-VCE400, 7NPC-VCE800, 7NPCVP-VCE400, 7NPCVP-VCE800, 7NPCV-VCE400, 7NPCV-VCE800, 92-04TVTC, 92-04TVTC-12931005, 92-04TVTCV-12931055, 92-04VTC, 92-04VTCV-12901055, 94-04TVTC, 94-04TVTC-12931006, 94-04TVTCV-12931056, 94-04VTC, 94-04VTC, 94-04VTCV-12901050, 94-04VTCV-12901056, 9NPCF-VCE800, 9NPC-VCE400, 9NPC-VCE800, 9NPCVP-VCE400, 9NPCVP-VCE800, 9NPCV-VCE400, 9NPCV-VCE800		



GEV No.	390231	Ref. No.	15551
description	bi-metal thermostat hole distance 40mm switch-off temp. 55°C 1CO 1-pole 16A connection F6.3 2 hole fixing		
For models:	OLElectron400		

control and safety thermostats

EGO

control thermostats

55.10/19_ series



GEV No.	375386	Ref. No.	6A046105 BN6A046105
description	thermostat t.max. 110°C temperature range 30-110°C 1-pole 1NO 16A probe ø 6mm probe L 130mm capillary pipe 2000mm capillary pipe isolated 2000mm gland nut shaft ø 6x4.6mm shaft L 23mm shaft position upper rotation 318°		
For models:	761CEAC-1000505, 761CEAC-1000505R, 769CGVAC-1950079, 769CGVAC-1950079R, 769CGVFE-1950099, 769CGVFE-1950099R, 769CGVFEAC-1950099, 76CEAC-1000500, 76CEAC-1000500R, C-E906AC-1050360		



GEV No.	375647	Ref. No.	6A046100 BN6A046100
description	thermostat t.max. 110°C temperature range 31-110°C 1-pole 1NO 16A probe ø 6mm probe L 133mm capillary pipe 870mm capillary pipe isolatedmm gland nut shaft ø 6x4.6mm shaft L 23mm shaft position upper rotation 318°		
For models:	TAC100-1022005, TAC101-1022006, TAC102-1022007, TAC130-1022105, TAC131-1022106, TAC132-1022107, TAC170-1022205, TAC171-1022206, TAC172-1022207, TAC6100-1622005, TAC6130-1622105, TAC6131-1622106, TAC6170-1622205		



GEV No.	375363	Ref. No.	6A001414 BN6A001414
description	thermostat t.max. 161°C temperature range 73-161°C 1-pole 1NO 16A probe ø 3mm probe L 144mm capillary pipe 1600mm capillary pipe isolated 1600mm gland nut shaft ø 6x4.6mm shaft L 23mm shaft position upper rotation 270°		
For models:	94-04PEI100L, 94-04PEI100L-12901765, 94-04PEI110L-12901765BN, 94-04PEI150L, 94-04PEI150L-12901767, 94-04PEI150L-12901767BN, 9PN-EI100, 9PN-EI150		



GEV No.	375382	Ref. No.	6A049200 BN6A049200
description	thermostat t.max. 295°C temperature range 45-295°C 1-pole 1NO 16A probe ø 3mm probe L 219mm capillary pipe 1300mm capillary pipe isolated 350mm gland nut shaft ø 6x4.6mm shaft L 23mm rotation 270°		
For models:	61FE-1826050, 61SCGF3S-1826055, 61SCGF4S-1827055, 61SECFE-1826075, 725KB-E-1000200, 725KBE-1000200, 725KB-E-1000200R, 725KB-EB-1000201, 725KBEB-1000201, 725KB-EB-1000201R, 725KBEM-000200, 725KBEM-1000210, 725KB-EM-1000210R, 725KB-EMB-1000211, 725KBEMB-1000211, 725KB-G-1000110, 725KBG-1000110, 725KB-G-1000110R, 725KB-GB-1000111, 725KB-GB-1000111R, 725KBGM-000120, 725KB-GM-1000120, 725KB-GM-1000120R, 725KB-GMB-1000121, 725KB-GMB-1000121R, 74-02KBEB, 74-02KBEB-12701110, 74-02KBEBI, 74-02KBEBI-12701115, 74-02KBEMB, 74-02KBEMB-12701120, 74-02KBEMBI, 74-02KBEMBI-12701125, 74-02KBEMBI-12701125HB, 74-02KBGB, 74-02KBGB-12700110, 74-02KBGBI, 74-02KBGBI-12700115, 74-02KBGMB, 74-02KBGMB-12700120, 74-02KBGMBI, 74-02KBGMBI-12700125, 94-04KBG, 94-04KBG-12900115, 94-04KBG-12900115TA, 94-04KBG-12900118, 94-04KBG-12900118TA, 94-04KBGM, 94-04KBGM-12900125, 94-04KBGM-12900125TA...(Other models you can see in the webshop)		

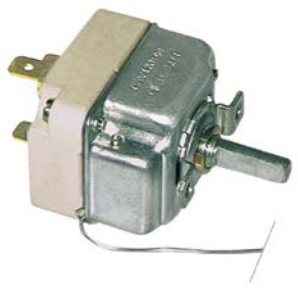

GEV No.	375387	Ref. No.	9000216 BN9000216
description	thermostat t.max. 170°C temperature range 85-170°C 1-pole 1NO 16A probe ø 4mm probe L 231mm capillary pipe 900mm capillary pipe isolated 850mm gland nut M9x1 shaft L 23mm shaft position upper rotation 270° probe material SS		
For models:	912PFRG-1103925, 914PFRG-1103950, 922FRE-1192930, 92FRE-192925, 92FRG, 92FRG-1191925, 92RFRG-1391925, 94FRE-192950, 94FRG, 94FRG-1191950, 94FRG-191950, 94RFRG-1391950		



GEV No.	375270	Ref. No.	40100042 SI0101377 SIR0101377
description	thermostat t.max. 295°C temperature range 45-295°C 1-pole 1NO 16A probe ø 4mm probe L 100mm capillary pipe 900mm capillary pipe isolated 350mm gland nut shaft L 23mm shaft position upper rotation 270°		



GEV No.	375639	Ref. No.	6A049100 BN6A049100
description	thermostat t.max. 192°C temperature range 100-192°C 1-pole 1NO 16A probe ø 4mm probe L 235mm capillary pipe 870mm capillary pipe isolatedmm gland nut shaft ø 6x4.6mm shaft L 21mm shaft position upper rotation 270°		
For models:	710FRE-1077700, 712FRE-1077900, 720FRE-1077800, 722FRE-1078000, 92-04FRG20L, 92-04FRG20L-12900500, 92-04FRG20L-12900500TA, 94-04FRG-12900600, 94-04FRG20L, 94-04FRG20L-12900600TA, 94-04FRG23L-12900605, FR-E925N-1050730, FR-E950N-1050732		



GEV No.	375184	Ref. No.	1037102300
description	thermostat t.max. 298°C temperature range 55-294°C 1-pole 1NO 16A probe ø 3.1mm probe L 226mm capillary pipe 870mm capillary pipe isolated 350mm gland nut shaft L 23mm shaft position upper probe material SS		
For models:	CFE60, CFE60P, FOE60M, OCFE60, OCFE-60-12601005, OCFE-60-12601005MN, OCFGE61, OFOE60M, OFOE-60M-12601001		

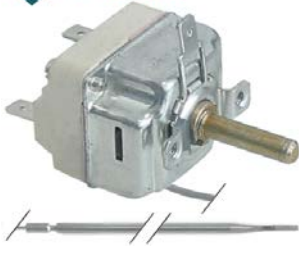

GEV No.	375667	Ref. No.	R65070360
description	thermostat t.max. 300°C temperature range 68-300°C 1-pole 1NO 16A probe ø 3.1mm probe L 226mm capillary pipe 980mm capillary pipe isolated 980mm gland nut shaft ø 6x4.6mm shaft L 23mm shaft position upper rotation 318°		
For models:	CCE042M, CCE051M, CCE071M, CCE101M, CCE102M, CCG051M, CCG071M, CCG101M, CCG102M		



GEV No.	375002	Ref. No.	9010
description	thermostat t.max. 320°C temperature range 55-320°C 1-pole 1NO 16A probe ø 3.1mm probe L 226mm capillary pipe 870mm capillary pipe isolated 850mm gland nut shaft L 23mm shaft position upper rotation 270°		
For models:	OLCX, OLFX, OLFX250E-1081151, OLFX250V-1081152, OLFX250V-1081153, OLFX380E-1081154, OLFX380E-1081155, OLFX380V-1081156, OLFX380V-1081157, OLFX420E-1081158, OLFX420E-1081159, OLFX420V-1081160, OLFX420V-1081161, OLFX540E-1081162, OLFX540E-1081163, OLFX540V-1081164, OLFX540V-1081165, OLFX600E-1081166, OLFX600E-1081167, OLFX600V-1081168, OLFX600V-1081169, OLFX680E-1081170, OLFX680E-1081171, OLFX680V-1081172, OLFX680V-1081173, OLFX780E-1081174, OLFX780E-1081175, OLFX780V-1081176, OLFX780V-1081177, OLFX900E-1081178, OLFX900E-1081179, OLFX900V-1081180, OLFX900V-1081181, WASHER-1081150		



GEV No.	375604	Ref. No.	826630191 BN826630191
description	thermostat t.max. 320°C temperature range 64-320°C 1-pole 1NO 0.5A probe ø 4mm probe L 124mm capillary pipe 1470mm capillary pipe isolatedmm gland nut shaft ø 6x4.6mm shaft L 23mm shaft position upper rotation 270°		
For models:	72-02KBEF, 72-02KBEF-12701127, 74-02KBEF, 74-02KBEF-12701128, 7BR-E100, 7BR-E105, 7BRF-E805, 7BR-G100, 7BR-G105, 7BRS-E100, 7BRS-E105, 7BRS-G100, 7BRS-G105, 94-04KBE, 94-04KBE-12901115, 94-04KBE-12901115BN, 94-04KBE-12901118, 94-04KBEM, 94-04KBEM-12901125, 94-04KBEM-12901125BN, 94-04KBEM-12901128, 94-04NKBE-12901215, 94-04NKBE-12901215BN, 96-04KBEC, 96-04KBEC-12901105, 96-04KBGC, 96-04KBGC-12900105, 96-04KBGC-12900105TA, 9BR-E100, 9BR-E105, 9BR-E125, 9BR-G100, 9BR-G105, 9BRS-E100, 9BRS-E105		



GEV No.	375636	Ref. No.	6A046195 BN6A046195
description	thermostat t.max. 60°C temperature range fixed 60°C 1-pole 1CO 16A probe ø 11mm probe L 29mm capillary pipe 1470mm capillary pipe isolated 1450mm gland nut screw-in probe probe thread M14x1		
For models:	CMV6E52-1320392, CVM10E, CVM10E-1320400, CVM10E-1320410, CVM10E-2, CVM10E2-1320440, CVM10E-S, CVM10E-S-1320450, CVM10E-S2, CVM10ES2-1320490, CVM10ES2-1320495, CVM10G, CVM10G-1310400, CVM10G-1310410, CVM10G-1310430, CVM10G-1310450, CVM10G-2, CVM10G2-1310440, CVM10GP-1310400, CVM10G-S, CVM10GS-1310460, CVM10G-S2, CVM10GS2-1310490, CVM10GS2-1310495, CVM20E, CVM20E-1320500, CVM20E-2, CVM20E2-1320540, CVM20E-S, CVM20ES-1320550, CVM20E-S2, CVM20ES2-1320590, CVM20G, CVM20G-1310500, CVM20G-2, CVM20G2-1310540, CVM20G-S, CVM20GS-1310550, CVM20G-S2, CVM20GS2-1310590, CVM21E, CVM21E-1322400, CVM21E-2, CVM21E2-1322440, CVM21E-S, CVM21ES-1322450, CVM21E-S2, CVM21ES2-1322490, CVM21ES2-1322495, CVM21G...(Other models you can see in the webshop)		





GEV No.	390040	Ref. No.	6A046260 BN6A046260 MA7800300
description	thermostat t.max. 90°C temperature range 30-90°C 1-pole 1CO 16A probe ø 6mm probe L 130mm capillary pipe 2040mm capillary pipe isolated 1940mm gland nut shaft ø 6x4.6mm shaft L 23mm shaft position upper rotation 270° probe material SS		
For models:	40SEBM, 40SEBM-1826100, 40SEBM25-1826100, 40SECP, 60SEBM, 60SEBM-1826110, 60SEBM25-1826110, 912PCCPE-1104856, 912PTCBE-1104391, 92CBE-1192301, 92TCBE-1192391, 941CEAC-1292164, 941FTE1-2RAC-1292562, 941FTE1-2RAC-1292662, 941FTEAC-1292462, 941FTEACC-1292464, 941FTEACC1-2R-1292465, 941FTERAC-1292562, 94CBEAC-1192362, 94CBGAC-1191362, 94CGAC-1191164, 94CTGAC-1191760, 98CGAC-1191168, TAC210-1019505, TAC211-1019506, TAC212-1019507		



GEV No.	375381	Ref. No.	6A046050 BN6A046050
description	thermostat t.max. 90°C temperature range 30-90°C 1-pole 1NO 16A probe ø 6mm probe L 130mm capillary pipe 2000mm capillary pipe isolated 2000mm gland nut shaft ø 6x4.6mm shaft L 23mm shaft position upper rotation 270°		
For models:	72-02CBE-12701150, 72-02TCBE-12731150, 74CBE-000550, 74CB-E-1000550, 74CBE-1000550, 74CB-E-1000550R, 76-02CEEEACPO, 76-02CEEEACPT, 76-02CEEEPQ-12701216, 76-02CEEEPT-12701016, 76-02CGEE, 76-02CGEE-12700018, 76-02CGEE-12700018TA, 76-02CGGE, 76-02CGGE-12700016, 76-02CGGE-12700016TA, 76-02CTGGE, 76-02CTGGE-12700196, 76-02CTGGE-12700196TA, 76CEAC-000500, 78CB-EAC-1000565, 78CB-EAC-1000565, 78CB-EAC-1000565R, 78CB-EAC-1000165, 78CBGAC-1000165, 916PCGEE-1103246, 916PCGEE-1103236, 961CEEE-1292246, 96CEEE-192246, 96CGEAC-1191246, 96CGEE-1191246, 96CGGAC-1191236, 96CGGE-1191236, 96CTGGAC-1191732		

55.14_series



GEV No.	375874	Ref. No.	1037117700
description	thermostat t.max. 90°C temperature range 30-90°C 1-pole 1NO 16A probe ø 6mm probe L 74mm capillary pipe 900mm capillary pipe isolated 800mm gland nut M10x1 shaft ø 6x4.6mm shaft L 23mm shaft position 180° shaft position rotation 270°		
For models:	BSEI40M, OBME41M, OBME61M, OBSEI40M, OBSEI-40M-12601700		

55.18_series



GEV No.	375110	Ref. No.	6A010502
description	thermostat t.max. 190°C temperature range 121-190°C 1-pole 1NC 16A probe ø 6mm probe L 117mm capillary pipe 390mm capillary pipe isolated 390mm gland nut shaft ø 6x4.6mm shaft L 15mm shaft position left rotation 270° probe material SS		

55.34_series



GEV No.	375640	Ref. No.	6A046240 BN6A046240
description	thermostat t.max. 110°C temperature range 1x20-90/2x40-110°C 3-pole 2NO/1NO 16A probe ø 6mm probe L 130mm capillary pipe 900mm capillary pipe isolated 900mm gland nut shaft ø 6x4.6mm shaft L 23mm shaft position upper rotation 270°		
For models:	40SECP, 40SECP-1825080, 40SECP-1825080E		



GEV No.	375887	Ref. No.	6A044650 BN6A044650
description	thermostat t.max. 125°C temperature range 65-125°C 3-pole 3NO 16A probe ø 6mm probe L 77mm capillary pipe 880mm capillary pipe isolated 880mm gland nut shaft L 23mm shaft position upper*		
For models:	55-45CPE, 55-90CPE, 72-02CPE, 72-02CPE-12701900, 74-02CPE, 74-02CPE-12701905, 7CP-E400, 7CP-E800, 92-04CPE, 92-04CPE-12901900, 92CCPE-1192856, 92CCPE-1192856V, 92RCCPE-1392856, 94-04CPE, 94-04CPE-12901905, 94CCPE-1192861, 94RCCPE-1392861, 9CP-E400, 9CP-E800		



GEV No.	375385	Ref. No.	8219601 BN8219601
description	thermostat t.max. 180°C temperature range 100-180°C 3-pole 3NO 16A probe ø 6mm probe L 131mm capillary pipe 2000mm capillary pipe isolated 1800mm gland nut shaft ø 6x4.6mm shaft L 23mm shaft position upper rotation 270°		
For models:	40SEFR, 40SEFR-1826140, 40SEFR2S-1826140, 41SEFR, 41SEFR-1826120, 41SEFR2S-1826120, 421SEFR-1826125, 55-45FRE, 55-90FRE, 60SEFR, 60SEFR-1826150, 60SEFR2S-1826150, 61SEFR, 61SEFR-1826130, 61SEFR2S-1826130, 621SEFR-1826135, 7101FR-E-1077750R, 7121FR-E-1077950R, 7201FR-E-1077850R, 72-02FRE, 72-02FRE-12701500, 7221FR-E-1078050R, 73-02FRE, 73-02FRE-12701550, 74-02FRE, 74-02FRE-12701600, 7FRI-E415, 7FRI-E415M, 7FRI-E610, 7FRI-E815, 9121PFRE-1204925, 9122PFRE-1104930, 9141PFRE-1204950, 914PFRE-1204940, 92-04FRE15L, 92-04FRE15L-12901510, 92-04FRE20L, 92-04FRE20L-12901500, 92-04FRE20L-12901500BN, 921FRE, 921FRE-1292925, 921RFRE-1392925, 922FRE-1192930, 922RFRE-1392930, 93-04FRE10L, 93-04FRE-12901550, 94-04FRE-12901600, 94-04FRE20L, 941FRE-1292950, 941RFRE-1392950...(Other models you can see in the webshop)		

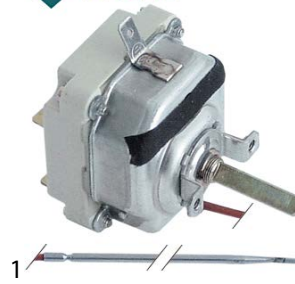

GEV No.	375384	Ref. No.	6A044601 BN6A044601
description	thermostat t.max. 275°C temperature range 50-275°C 3-pole 3NO 16A probe ø 3mm probe L 219mm capillary pipe 900mm capillary pipe isolated 900mm gland nut shaft ø 6x4.6mm shaft L 23mm shaft position lower rotation 318° probe material SS		
For models:	110-135CGE, 110-135CGE2P, 110-135CGEE, 110-135CGEE2P, 110-135CGEEP, 110-135CGEP, 110-90CGE, 110-90CGE1P, 110-90CGEP, 110-90CTEE, 110-90CTGE, 110-90FTTE, 110-90FTTGE, 40SEFTC-1825045, 60SEFTC-1825055, 72-02FTEC, 72-02FTEC-12701135, 72-02TFTEC, 72-02TFTEC-12731135, 74-02CEEPO, 74-02CEEPO-12701210, 74-02CEEPT, 74-02CEEPT-12701010, 74-02CGE, 74-02CGE-12700011, 74-02CGE-12700011TA, 74-02CTEE, 74-02CTEE-12701180, 74-02CTGE, 74-02CTGE-12700190, 74-02CTGE-12700190TA, 74-02VTCE, 74-02VTCEV, 74-02VTCEV-12701020, 74FT-EC-1000805, 74FTEC-1000805, 74FT-EC-1000805R, 74TFTEC-1009805, 74TFTEC-1009805R, 76-02CEEANPQ, 76-02CEEANPT, 76-02CEEPEQ-12701216, 76-02CEEPT-12701016, 76-02CEEPO-12701215, 76-02CEEPT-12701015, 76-02CGE, 76-02CGE-12700017, 76-02CGE-12700017TA, 76-02CGEE, 76-02CGEE-12700018...(Other models you can see in the webshop)		

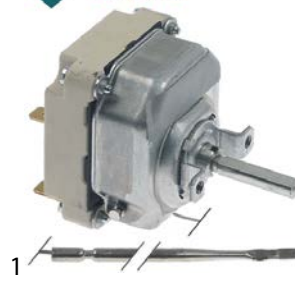

GEV No.	375192	Ref. No.	1309115
description	thermostat t.max. 300°C temperature range 50-300°C 3-pole 3NO 16A probe ø 3mm probe L 219mm capillary pipe 900mm capillary pipe isolatedmm gland nut shaft ø 6x4.6mm shaft L 23mm shaft position upper rotation 270°		
For models:	BRE40, BRE40D, BRE40DB, BRE40DG, BRE40DGB, BRE40G, FTE100B, FTE100BR, FTE100CRL, FTE40B, FTE40BR, FTE40C, FTE40D, FTE40DC, FTE60B, FTE60BR, FTE60C, FTE60D, FTE60DC, FTE60DR, FTE60DRCL, OBRE40, OBRE-40-12601110, OBRE-40-12601110MN, OFTE-100C-12601136, OFTE-100C-12601136MN, OFTE100CRL, OFTE-100CRL-12601138, OFTE40B, OFTE-40B-12601130, OFTE-40B-12601130MN, OFTE40BR, OFTE-40BR-12601132, OFTE-40BR-12601132MN, OFTE40C, OFTE-40C-12601135, OFTE-40C-12601135MN, OFTE60B, OFTE-60B-12601140, OFTE-60B-12601140MN, OFTE60BR, OFTE-60BR-12601141, OFTE-60BR-12601141MN, OFTE60BRR, OFTE-60BRR-12601142, OFTE-60BRR-12601142MN, OFTE60C, OFTE-60C-12601145, OFTE-60C-12601145MN		

GEV No.	375412	Ref. No.	6A044600 BN6A044600
description	thermostat t.max. 320°C temperature range 50-320°C 3-pole 3NO 16A probe ø 3.1mm probe L 226mm capillary pipe 1480mm capillary pipe isolated 1400mm gland nut shaft ø 6x4.6mm shaft L 23mm shaft position upper rotation 318°		
For models:	40SEFT, 40SEFT-1825040, 40SEFT-1825045, 40SEFTC, 40SEFTC-1825045, 40SEFTR, 40SEFTR-1825041, 60SEFT, 60SEFT1-2R-1825051, 60SEFT1-3RIG-1825050, 60SEFT-1825050, 60SEFTC, 60SEFTC-1825050, 60SEFTR-1825052, 60SEFTRIG-1825050, 714CT-GVFE-1000180, 714CTGVFE-1000180, 714CT-GVFE-1000180R, 72-02FTE, 72-02FTE-12701130, 72-02FTE, 72-02FTE-12701132, 72-02TFTE, 72-02TFTE-12731130, 72-02TFTE, 72-02TFTE-12731132, 74-02FTE, 74-02FTE-12701140, 74-02FTE1-2R, 74-02FTE1-2R-12701141, 74-02FTE, 74-02FTE-12701142, 74-02TFTE, 74-02TFTE-12731140, 74-02TFTE-12731140MN, 74-02TFTE1-2R, 74-02TFTE1-2R-12731141, 74-02TFTE, 74-02TFTE-12731142, 741CE-1000405, 741CE-1000405R, 749CGVFE-1950059, 749CGVFE-1950059R, 74CE-000400, 74CE-1000400, 74CE-1000400R, 74FTE-000800, 74FT-E-1000800, 74FTE-1000800, 74FT-E-1000800R...(Other models you can see in the webshop)		



GEV No.	375411	Ref. No.	6A046250 BN6A046250
description	thermostat t.max. 93°C temperature range 30-93°C 3-pole 3NO 16A probe ø 6mm probe L 129mm capillary pipe 1480mm capillary pipe isolated 1100mm gland nut M10x1 shaft ø 6x4.6mm shaft L 23mm shaft position upper rotation 270°		
For models:	72-02CBE, 72-02CBE-12701150, 72-02TCBE, 72-02TCBE-12731150, 74-02CBE, 74-02CBE-12701155, 74-02TCBE, 74-02TCBE-12731155, 78CBE-000560, 78CB-E-1000560, 78CBE-1000560, 78CB-E-1000560R, 78CB-EAC-1000565, 78CBEAC-1000565, 78CB-EAC-1000565R, 7-BME, 94CBE-1192302, 94CBEAC-1192362, 94TCBE-1192392		

safety thermostats

55.10/19_ series



GEV No.	375383	Ref. No.	6A044900
description	thermostat t.max. 350°C temperature range 100-350°C 3-pole 3NO 16A probe ø 6mm probe L 75mm capillary pipe 870mm capillary pipe isolatedmm gland nut shaft ø 6x4.6mm shaft L 23mm shaft position upper rotation 270°		
For models:	40SEKB-1825200, 40SKE, 40SKE-1825200, FT-E940-1050510, FT-E940-1050511, FT-E980-1050520, FT-E980-1050521, FT-E980R1-2-1050522		



GEV No.	375379	Ref. No.	9000217 BN9000217
description	safety thermostat switch-off temp. 200°C 1-pole 0.5A probe ø 6mm probe L 130mm capillary pipe 900mm capillary pipe isolated 900mm gland nut probe		
For models:	912PFRG-1103925, 914PFRG-1103950, 922FRE-1192930, 92FRG, 92FRG-1191925, 92RFRG-1391925, 94FRG, 94FRG-1191950, 94FRG-191950, 94RFRG-1391950		



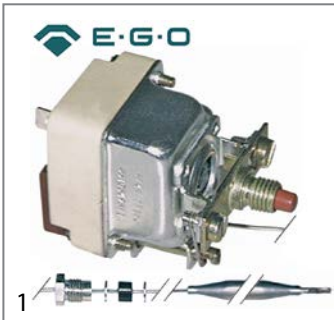

GEV No.	375917	Ref. No.	6A046130 BN6A046130
description	thermostat t.max. 550°C temperature range 85-500/85-550°C 3-pole 2NO/1NO 16A probe ø 3.9mm probe L 228mm capillary pipe 1110mm capillary pipe isolated 600mm gland nut shaft ø 6x4.6mm shaft L 23mm rotation 318° outer switch 2NO/2NO		
For models:	110-90CTE, 110-90CTEE, 110-90TCTE, 94-04CTEES, 94-04CTEES-12901185, 94-04CTEES-12901185BN, 94-04CTES-12901175, 94-04TCTES-12931175, 9TPF-EE800		



GEV No.	390061	Ref. No.	6A049401 BN6A049401
description	safety thermostat switch-off temp. 220°C 1-pole 0.5A probe ø 6mm probe L 140mm capillary pipe 900mm capillary pipe isolatedmm gland nut probe M9x1		
For models:	40SGFR, 40SGFR-1826160, 40SGFR2S-1826160, 55-45FRG, 55-90FRG, 60SGFR, 60SGFR-1826170, 60SGFR2S-1826170, 710FRG-1077300, 710FR-G-1077350, 710FR-G-1077350R, 712FR-G-1077550, 712FRG-1077550, 712FR-G-1077550R, 72-02FRG, 72-02FRG-12700500, 72-02FRG17-12700505, 72-02FRGM, 72-02FRGM-12700530, 72-02FRGM-12700530TA, 720FRG-1077400, 720FR-G-1077450, 720FRG-1077450, 720FR-G-1077450R, 720FR-G-1077650, 722FRG-1077600, 722FR-G-1077650R, 73-02FRG, 73-02FRG-12700550, 73-02FRGM, 73-02FRGM-12700580, 73-02FRGM-12700580TA, 74-02FRG, 74-02FRG-12700600, 74-02FRG17-12700605, 74-02FRGM, 74-02FRGM-12700630, 7FRI-G415, 7FRI-G610, 7FRI-G815, 9122PPFG-1103930, 92-04FRG15L, 92-04FRG15L-12900510, 92-04FRG17L-12900515, 92-04FRG20L, 92-04FRG20L-12900500, 92-04FRG20L-12900500TA, 922FRG-1191930, 922RFRG-1391930, 93-04FRG...(Other models you can see in the webshop)		



GEV No.	375378	Ref. No.	6A046170 BN6A046170
description	safety thermostat switch-off temp. 350°C 1-pole 16A probe ø 6mm probe L 74mm capillary pipe 900mm capillary pipe isolatedmm gland nut probe SS		
For models:	61FE-1826050, 61SCGFE3S-1826055, 61SCGFE4S-1827055, 61SECFE-1826075		
accessories for	375378		
	GEV No.	102067	Ref. No. 939300
	nut thread M8x1 H 3mm brass Qty 1 pcs type SEF 1		
	GEV No.	102500	Ref. No. —
	nut thread M8x1 Qty 10 pcs		

55.13_ series



GEV No.	391031	Ref. No.	BN9000515
description	safety thermostat switch-off temp. 235°C 1-pole 1CO 16A probe ø 6mm probe L 133mm capillary pipe 870mm shaft ømm probe SS		



GEV No.	375936	Ref. No.	6A046140 BN6A046140
description	safety thermostat switch-off temp. 658°C 3-pole 3NC probe ø 4mm probe L 160mm capillary pipe 1210mm capillary pipe isolated 790mm gland nut probe		
For models:	110-90CTE, 110-90CTEE, 110-90TCTE, 94-04CTEES, 94-04CTEES-12901185, 94-04CTEES-12901185BN, 94-04CTES-12901175, 94-04TCTES-12931175, 9TPF-EE800		



GEV No.	375285	Ref. No.	6A049500 BN6A049500
description	safety thermostat switch-off temp. 327°C 1-pole 1NC 16A probe ø 6mm probe L 77mm capillary pipe 870mm capillary pipe isolatedmm gland nut probe SS		
For models:	KB-E970-1050410, KB-E970A-1050411, KB-G970-1050450, KB-G970A-1050451		



55.31_ series



GEV No.	390091	Ref. No.	6A046900 BN6A046900
description	safety thermostat switch-off temp. 230°C 3-pole 20A probe ø 6mm probe L 239mm capillary pipe 830mm capillary pipe isolated gland nut probe SS 380V		
For models:	710FRE-077700, 710FRE-1077700, 712FRE-077900, 712FRE-1077900, 720FRE-077800, 720FRE-1077800, 722FRE-078000, 722FRE-1078000, 92FRE-192925		



GEV No.	375888	Ref. No.	6A049407 BN6A049407
description	safety thermostat switch-off temp. 132°C 3-pole 3NC 20A probe ø 6mm probe L 87mm capillary pipe 890mm capillary pipe isolated 850mm gland nut starting temperature 118°C probe SS probe material SS		
For models:	55-45CPE, 55-90CPE, 72-02CPE, 72-02CPE-12701900, 74-02CPE, 74-02CPE-12701905, 7CP-E400, 7CP-E800, 92-04CPE, 92-04CPE-12901900, 92CCPE-1192856, 92CCPE-1192856V, 92RCCPE-1392856, 94-04CPE, 94-04CPE-12901905, 94CCPE-1192861, 94RCCPE-1392861, 9CP-E400, 9CP-E800		

55.32_ series



GEV No.	390907	Ref. No.	15553
description	safety thermostat switch-off temp. 110°C 3-pole 3NC 20A probe ø 6mm probe L 95mm capillary pipe 1500mm capillary pipe isolated 1400mm gland nut probe		
For models:	OLDS50, OLDS50-1081088, OLDS50D-1081089, OLDS50E-1081090, OLDS50ED-1081091, OLDS50-Neutra, OLElectron500, OLG550, OLG550-1080705, OLG550D-1080706, OLG550E-1080730, OLG550E-CO-1081014, OLG550ED-1080731, OLG550-Neutra		

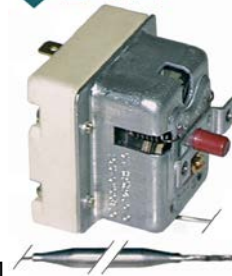

GEV No.	390159	Ref. No.	R65070081
description	safety thermostat switch-off temp. 150°C 1-pole 20A probe ø 6mm probe L 89mm capillary pipe 900mm capillary pipe isolated 800mm gland nut probe		
For models:	CKEP06B, CKEP10B, CKEP20B, CKEP21B, CKEP40B, CKET06B, CKET10B, CKET20B, CKET21B, CKET40B, CKGP06B, CKGP10B, CKGP20B, CKGP21B, CKGP40B, CKGT06B, CKGT10B, CKGT20B, CKGT21B, CKGT40B		



GEV No.	375199	Ref. No.	1878900
description	safety thermostat switch-off temp. 132°C 3-pole 2x20/1x0.5A probe ø 6mm probe L 77mm capillary pipe 890mm capillary pipe isolated gland nut M10x1 probe SS		
For models:	CPE60, CPE60DB, OCPE60, OCPE-60-12601900, OCPE-60-12601900MN		



GEV No.	375380	Ref. No.	6A049405 BN6A049405
description	safety thermostat switch-off temp. 160°C 3-pole 20A probe ø 6mm probe L 89mm capillary pipe 900mm capillary pipe isolated 900mm gland nut probe SS		
For models:	40SECP, 40SECP-1825080, 40SECP-1825080E, 74-02NPEI, 74-02NPEI-12701755, 74-02NPGI, 7NP-GI50, 7PN-EI50, 911PEB-1192805, 911RPEB-1392890, 915PEB-1192800		

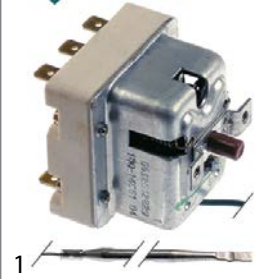

GEV No.	375364	Ref. No.	6A001415 BN6A001415
description	safety thermostat switch-off temp. 190°C 3-pole 20A probe ø 4mm probe L 120mm capillary pipe 3000mm capillary pipe isolated 3000mm gland nut probe		
For models:	94-04PEI100L, 94-04PEI100L-12901765, 94-04PEI110L-12901765BN, 94-04PEI150L, 94-04PEI150L-12901767, 94-04PEI150L-12901767BN, 94-04PGD100L, 94-04PGD110L-12900760, 94-04PGD150L, 94-04PGD-150LGAS-12900762, 94-04PGI100L, 94-04PGI110L-12900765, 94-04PGI150L, 94-04PGI150L-12900767, 9PF-G100, 9PF-G150, 9PF-GI100, 9PF-GI150, 9PN-EI100, 9PN-EI150		

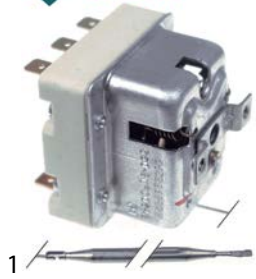

GEV No.	375873	Ref. No.	1878600
description	safety thermostat switch-off temp. 236°C 3-pole 20A probe ø 6mm probe L 77mm capillary pipe 1190mm capillary pipe isolated 990mm gland nut starting temperature 218°C probe		
For models:	FQE41, FQE41L, FQE41L2, FQE61, FQE61L, FQE61L2, OFQE41, OFQE-41-12601510, OFQE-41-12601510MN, OFQE41L, OFQE61, OFQE-61-12601610, OFQE-61-12601610MN, OFQE61L		
accessories for	375873		
	GEV No.	550148	Ref. No.
			—
	gland duct ET M12x0.75 IT M9x1 probe ø max. 6.5mm WS 17 silicone		



GEV No.	375358	Ref. No.	1871100
description	safety thermostat switch-off temp. 230°C 2-pole 1x20/1x0.5A probe ø 6mm probe L 74mm capillary pipe 880mm capillary pipe isolated-mm gland nut M9x1 probe SS automatic		
For models:	FQG40, FQG60		

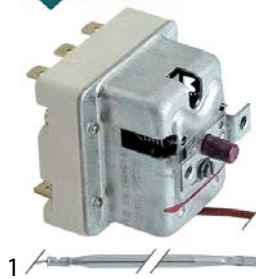

GEV No.	375312	Ref. No.	8219602 BN8219602
description	safety thermostat switch-off temp. 245°C 3-pole 3NC 20A probe ø 4mm probe L 120mm capillary pipe 1800mm capillary pipe isolated 1800mm gland nut probe SS		
For models:	40SEFR, 40SEFR-1826140, 40SEFR2S-1826140, 41SEFR, 41SEFR-1826120, 41SEFR2S-1826120, 421SEFR-1826125, 55-45FRE, 55-90FRE, 60SEFR, 60SEFR-1826150, 60SEFR2S-1826150, 61SEFR, 61SEFR-1826130, 61SEFR2S-1826130, 621SEFR-1826135, 7101FR-E-1077750R, 7121FR-E-1077950R, 7201FR-E-1077850R, 72-02FRE, 72-02FRE-12701500, 72-02FREM, 72-02FREM-12701530, 7221FR-E-1078050R, 73-02FRE, 73-02FRE-12701550, 73-02FREM, 73-02FREM-12701580, 74-02FRE, 74-02FRE-12701600, 74-02FREM, 74-02FREM-12701630, 7FRI-E415, 7FRI-E415M, 7FRI-E610, 7FRI-E815, 9121PFRE-1204925, 9122PFRE-1104930, 9141PFRE-1204950, 914PFRE-1204940, 92-04FRE15L, 92-04FRE15L-12901510, 92-04FRE20L, 92-04FRE20L-12901500, 92-04FRE20L-12901500BN, 921FRE, 921FRE-1292925, 921RFRE-1392925, 922FRE-1192930, 922RFRE-1392930... (Other models you can see in the webshop)		
accessories for	375312		
	GEV No.	550981	Ref. No.
			8208260 BN8208260
	probe clip for pipe ø 8.5mm for probe ø 6mm for heating elements spacing 0.4mm Qty 1 pcs		

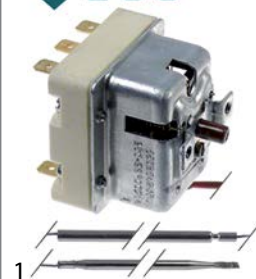

GEV No.	375445	Ref. No.	MACM097701
description	safety thermostat switch-off temp. 230°C 3-pole 2x20/1x0.5A probe ø 4mm probe L 120mm capillary pipe 900mm capillary pipe isolated 700mm gland nut probe		



1

GEV No.	375635	Ref. No.	6A046190 BN6A046190
description	safety thermostat switch-off temp. 300°C 1-pole 20A probe ø 11mm probe L 16mm capillary pipe 900mm capillary pipe isolated 900mm gland nut screw-in probe probe thread M14x1		
For models:	CV10E, CV10E-1320100, CV10E-2, CV10E2-1320140, CV10EB-1321100, CV10E-S, CV10ES-1320150, CV10E-S2, CV10ES2-1320190, CV10G, CV10G-1310100, CV10G-2, CV10G2-1310140, CV10GB-1311100, CV10G-S, CV10GS-1310150, CV10G-S2, CV10GS2-1310190, CV20E, CV20E-1320200, CV20E-2, CV20E2-1320240, CV20EB-1321200, CV20E-S, CV20ES-1320250, CV20E-S2, CV20ES2-1320290, CV20G, CV20G-1310200, CV20G-2, CV20G2-1310240, CV20GB-1311200, CV20G-S, CV20GS-1310250, CV20G-S2, CV20GS2-1310290, CV21E, CV21E-1322100, CV21E-2, CV21E2-1322140, CV21E-S, CV21ES-1322150, CV21E-S2, CV21ES2-1322190, CV21G, CV21G-1312100, CV21G-2, CV21G2-1312140, CV21G-S, CV21GS-1312150...(Other models you can see in the webshop)		



1

GEV No.	375228	Ref. No.	6A046150 BN6A046150
description	safety thermostat switch-off temp. 350°C 3-pole 20A probe ø 3mm probe L 188mm capillary pipe 900mm capillary pipe isolated 900mm gland nut probe SS		
For models:	40SEFTC-1825045, 60SEFTC-1825055, 72-02CEPQ, 72-02CEPQ-12701201, 72-02CEPT, 72-02CEPT-12701001, 72-02CEPT-2212701001, 72-02FTEC, 72-02FTEC-12701135, 72-02TCEPQ, 72-02TCEPQ-12731201, 72-02TCEPT, 72-02TCEPT-12731001, 72-02TFTEC, 72-02TFTEC-12731135, 7-2FXE, 74-02CEEPQ, 74-02CEEPQ-12701210, 74-02CEEPT, 74-02CEEPT-12701010, 74-02CEPQ, 74-02CEPQ-12701202, 74-02CEPT, 74-02CEPT-12701002, 74-02CGE, 74-02CGE-12700011, 74-02CGE-12700011TA, 74-02CTEE, 74-02CTEE-12701180, 74-02CTGE, 74-02CTGE-12700190, 74-02CTGE-12700190TA, 74-02TCEPQ, 74-02TCEPQ-12731202, 74-02TCEPT, 74-02TCEPT-12731002, 74-02VTCE, 74-02VTCEV, 74-02VTCEV-12701020, 74CE-000400, 74FT-EC-1000805, 74FT-EC-1000805R, 74TFTEC-1009805, 74TFTEC-1009805R, 76-02CEEANPQ, 76-02CEEANPT, 76-02CEEEACPO, 76-02CEEEACPT, 76-02CEEE-PQ-12701216, 76-02CEEEPT-12701016...(Other models you can see in the webshop)		



1

GEV No.	375357	Ref. No.	1942900
description	safety thermostat switch-off temp. 325°C 1-pole 0.5A probe ø 3mm probe L 188mm capillary pipe 900mm capillary pipe isolatedmm gland nut probe		
For models:	FTG40BLC, FTG60BLC, OFTG40BLC, OFTG60BLC		



1

GEV No.	375684	Ref. No.	R65070350
description	safety thermostat switch-off temp. 360°C 1-pole 20A probe ø 11mm probe L 16mm capillary pipe 900mm capillary pipe isolated 900mm gland nut probe screw-in probe probe thread M14x1		
For models:	CCE042M, CCE051M, CCE071M, CCE101M, CCE102M, CCG051M, CCG071M, CCG101M, CCG102M, CKEP06, CKEP06B, CKEP10, CKEP10B, CKEP20, CKEP20B, CKEP21, CKEP21B, CKEP40, CKEP40B, CKET06, CKET06B, CKET10, CKET10B, CKET20, CKET20B, CKET21, CKET21B, CKET40, CKET40B, CKGP06, CKGP06B, CKGP10, CKGP10B, CKGP20, CKGP20B, CKGP21, CKGP21B, CKGP40, CKGP40B, CKGT06, CKGT06B, CKGT10B, CKGT20, CKGT20B, CKGT21, CKGT21B, CKGT40, CKGT40B		



GEV No.	375187	Ref. No.	1878500
description	safety thermostat switch-off temp. 360°C 3-pole 3NC 2x20/1x0.5A probe ø 6mm probe L 79mm capillary pipe 890mm capillary pipe isolated gland nut probe SS		
For models:	CFE60, CFE60P, FOE60M, FTE100B, FTE100BR, FTE100CRL, FTE40B, FTE40BR, FTE40C, FTE40D, FTE40DC, FTE60B, FTE60BR, FTE60C, FTE60D, FTE60DC, FTE60DR, FTE60DRCL, OCFE60, OCFE60-12601005, OCFE60-12601005MN, OCFGE61, OFOE60M, OFOE60M-12601001, OFTE-100C-12601136, OFTE-100C-12601136MN, OFTE100CRL, OFTE-100CRL-12601138, OFTE40B, OFTE-40B-12601130, OFTE-40B-12601130MN, OFTE40BR, OFTE-40BR-12601132, OFTE-40BR-12601132MN, OFTE40C, OFTE-40C-12601135, OFTE-40C-12601135MN, OFTE60B, OFTE-60B-12601140, OFTE-60B-12601140MN, OFTE60BR, OFTE-60BR-12601141, OFTE-60BR-12601141MN, OFTE60BRR, OFTE-60BRR-12601142, OFTE-60BRR-12601142MN, OFTE60C, OFTE-60C-12601145, OFTE-60C-12601145MN, OFTG40BLC...(Other models you can see in the webshop)		

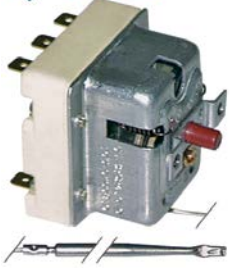

GEV No.	390181	Ref. No.	6A046180 BN6A046180
description	safety thermostat switch-off temp. 420°C 3-pole 20A probe ø 3.9mm probe L 306mm capillary pipe 870mm capillary pipe isolated 850mm gland nut probe SS		
For models:	40SEFT, 40SEFT-1825040, 40SEFT-1825045, 40SEFTC, 40SEFTC-1825045, 40SEFTR, 40SEFTR-1825041, 60SEFT, 60SEFT1-2R-1825051, 60SEFT1-3RIG-1825050, 60SEFT-1825050, 60SEFTC, 60SEFTC-1825050, 60SEFTR-1825052, 60SEFTRIG-1825050, 72-02FTE, 72-02FTE-12701130, 72-02FTE, 72-02FTE-12701132, 72-02TFTE, 72-02TFTE-12731130, 72-02TFTE, 72-02TFTE-12731132, 74-02FTE, 74-02FTE-12701140, 74-02FTE1-2R, 74-02FTE1-2R-12701141, 74-02FTE, 74-02FTE-12701142, 74-02TFTE, 74-02TFTE-12731140, 74-02TFTE-12731140MN, 74-02TFTE1-2R, 74-02TFTE1-2R-12731141, 74-02TFTE, 74-02TFTE-12731142, 9141PCEE-1104394, 914PCGE-1103224, 914PCTGE-1103721, 914PFTGE-1103423, 914PFTGEC-1103425, 916PCGEE-1103246, 918PCGE-1103228, 921FTE-1292401, 921FTE-1292501, 921TFTE-1292491, 921TFTE-1292591, 92FE-1192220, 93FE-1192230, 941CEE-1292224...(Other models you can see in the webshop)		

control thermostats with operation switch

55.10/19_series

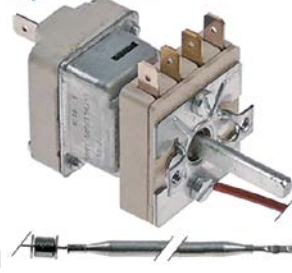

GEV No.	375875	Ref. No.	1037317300
description	thermostat t.max. 180°C temperature range 53-180°C 1-pole 1NO 16A probe ø 6mm probe L 133mm capillary pipe 1170mm capillary pipe isolated 1000mm gland nut shaft ø 6x4.6mm shaft L 23mm rotation 270° outer switch 2NO		
For models:	FQE41, FQE41L, FQE41L2, FQE61, FQE61L, FQE61L2, OFQE41, OFQE-41-12601510, OFQE-41-12601510MN, OFQE41L, OFQE61, OFQE-61-12601610, OFQE-61-12601610MN, OFQE61L		

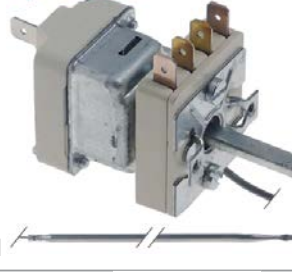

GEV No.	375180	Ref. No.	CR0589660
description	thermostat t.max. 185°C temperature range 99-185°C 1-pole 1NO 0.5A probe ø 4mm probe L 235mm capillary pipe 870mm capillary pipe isolated 700mm gland nut shaft ø 6x4.6mm shaft L 23mm shaft position rotation 270° outer switch 2NO		

IMIT / TEMPOMATIC / ARATHERMO

control thermostats

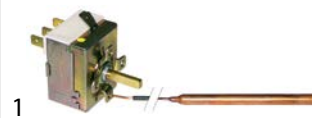

GEV No.	390192	Ref. No.	10707/2
description	thermostat t.max. 90°C temperature range 0-90°C 1-pole 1CO 16A probe ø 6.5mm probe L 95mm capillary pipe 2000mm capillary pipe isolated 2000mm gland nut shaft ø 6x4.6mm shaft L 19mm shaft position upper rotation 270° probe material copper		
For models:	OLAX151, OLAX160, OLAX160V-1081031, OLAX160V-1081032, OLAX210, OLAX210E-1081029, OLAX210E-1081030, OLAX220, OLAX220E-1080787, OLAX220E-1080788, OLAX220V-1080789, OLAX220V-1080790, OLAX230, OLAX230E-1080791, OLAX230E-1080792, OLAX230V-1080793, OLAX230V-1080794, OLAX240, OLAX240E-1080795, OLAX240E-1080796, OLAX240V-1080797, OLAX240V-1080798, OLAX250, OLAX380, OLAX380LC, OLAX400, OLAX440, OLAX440LC, OLAX510, OLAX510LC, OLAX540, OLAX540LC		



GEV No.	390460	Ref. No.	10707/1
description	thermostat t.max. 90°C temperature range 30-90°C 1-pole 1CO 16A probe ø 6.5mm probe L 95mm capillary pipe 2000mm capillary pipe isolated 1950mm gland nut shaft ømm shaft Lmm shaft position rotation 270° probe material copper		
For models:	G12S, OLAX151, OLAX151EDX-1080725, OLAX151ELEFT-1080727, OLAX151-highspeed, OLAX160, OLAX160E-1080750, OLAX160E-1080751, OLAX160V-1080755, OLAX160V-1080756, OLAX160V-1081031, OLAX160V-1081032, OLAX210, OLAX210E-1081029, OLAX210E-1081030, OLAX220, OLAX220E-1080787, OLAX220E-1080788, OLAX220V-1080789, OLAX220V-1080790, OLAX230, OLAX230E-1080791, OLAX230E-1080792, OLAX230V-1080793, OLAX230V-1080794, OLAX240, OLAX240E-1080795, OLAX240E-1080796, OLAX240V-1080797, OLAX240V-1080798, OLAX250, OLAX250E-1080760, OLAX250E-1080761, OLAX250V-1080765, OLAX250V-1080766, OLAX300, OLAX300E-1080770, OLAX300E-1080771, OLAX300E-1081033, OLAX300E-1081035, OLAX300E-1081036, OLAX300LC, OLAX300LCE-1081034, OLAX300V-1080775, OLAX300V-1080776, OLAX310, OLAX310E-1081110, OLAX310E-1081111, OLAX310LC, OLAX310LCE-1081114...(Other models you can see in the webshop)		

CAMPINI

control thermostats



GEV No.	375934	Ref. No.	10707/3
description	thermostat t.max. 280°C temperature range 50-280°C 1-pole 1NO 16A probe ø 3mm probe L 185mm capillary pipe 960mm capillary pipe isolated 700mm gland nut shaft ø 6x4.6mm shaft L 23mm shaft position upper rotation 270° probe material SS 250V		
For models:	OLAX151, OLAX151EDX-1080725, OLAX151ELEFT-1080727, OLAX151-highspeed, OLAX160, OLAX160E-1080750, OLAX160E-1080751, OLAX160V-1080755, OLAX160V-1080756, OLAX250, OLAX250E-1080760, OLAX250E-1080761, OLAX250V-1080765, OLAX250V-1080766, OLAX300, OLAX300E-1080770, OLAX300E-1080771, OLAX300E-1081033, OLAX300E-1081035, OLAX300E-1081036, OLAX300LC, OLAX300LCE-1081034, OLAX300V-1080775, OLAX300V-1080776, OLAX310, OLAX310E-1081110, OLAX310E-1081111, OLAX310LC, OLAX310LCE-1081114, OLAX310LCE-1081115, OLAX310LCV-1081116, OLAX310LCV-1081117, OLAX310V-1081112, OLAX310V-1081113, OLAX320, OLAX320E-1081118, OLAX320E-1081119, OLAX320V-1081120, OLAX320V-1081121, OLAX320V-1081125, OLAX330, OLAX330E-1081122, OLAX330E-1081123, OLAX330V-1081124, OLAX380, OLAX380E-1080780, OLAX380E-1080781, OLAX380E-1081037, OLAX380E-1081038, OLAX380E-1081039...(Other models you can see in the webshop)		

various

safety thermostats



GEV No.	375637	Ref. No.	6A046185 BN6A046185
description	safety thermostat switch-off temp. 135°C temperature range°C 1-pole 1NC 16A probe ø 6mm probe L 75mm capillary pipe 600mm capillary pipe isolatedmm gland nut shaft ømm probe copper 250V		
For models:	CVP10E, CVP10E-1320700, CVP10E-2, CVP10E2-1320740, CVP10E2S-1320790, CVP10E-S, CVP10ES-1320750, CVP10E-S2, CVP10G, CVP10G-1310700, CVP10G-1310750, CVP10G-2, CVP10G2-1310740, CVP10GP-1310700, CVP10G-S, CVP10G-S2, CVP10GS2-1310790, CVP20E, CVP20E-1320800, CVP20E-2, CVP20E2-1320840, CVP20E-S, CVP20ES-1320850, CVP20E-S2, CVP20ES2-1320890, CVP20G, CVP20G-1310800, CVP20G-1310850, CVP20G-2, CVP20G-S, CVP20GS-1310840, CVP20G-S2, CVP20GS2-1310890, CVP21G, CVP21G-1312700, CVP21G-2, CVP21G2-1312740, CVP21G-S, CVP21GS-1312750, CVP21G-S2, CVP21GS2-1312790, CVP6E, CVP6E-1320600, CVP6E-2, CVP6E2-1320640, CVP6E-S, CVP6ES-1320650, CVP6E-S2, CVP6ES2-1320690, CVP6G...(Other models you can see in the webshop)		



GEV No.	390194	Ref. No.	2000430 BN011DW2000430
description	safety thermostat switch-off temp. 90-110°C 1-pole 16A probe ø 6.5mm probe L 87mm capillary pipe 1500mm capillary pipe isolated 1497mm connection male faston 6.3mm adjustable		
For models:	G12S, OLAX151, OLAX151EDX-1080725, OLAX151ELEFT-1080727, OLAX151-highspeed, OLAX160, OLAX160E-1080750, OLAX160E-1080751, OLAX160V-1080755, OLAX160V-1080756, OLAX160V-1081031, OLAX160V-1081032, OLAX210, OLAX210E-1081029, OLAX210E-1081030, OLAX220, OLAX220E-1080787, OLAX220E-1080788, OLAX220V-1080789, OLAX220V-1080790, OLAX230, OLAX230E-1080791, OLAX230E-1080792, OLAX230V-1080793, OLAX230V-1080794, OLAX240, OLAX240E-1080795, OLAX240E-1080796, OLAX240V-1080797, OLAX240V-1080798, OLAX250, OLAX250E-1080760, OLAX250E-1080761, OLAX250V-1080765, OLAX250V-1080766, OLAX300, OLAX300E-1080770, OLAX300E-1080771, OLAX300E-1081033, OLAX300E-1081035, OLAX300E-1081036, OLAX300LC, OLAX300LCE-1081034, OLAX300V-1080775, OLAX300V-1080776, OLAX310, OLAX310E-1081110, OLAX310E-1081111, OLAX310LC, OLAX310LCE-1081114, OLAX310LCE-1081115, OLAX310LCV-1081116, OLAX310LCV-1081117, OLAX310V-1081112, OLAX310V-1081113, OLAX320, OLAX320E-1081118, OLAX320E-1081119, OLAX320V-1081120, OLAX320V-1081121, OLAX320V-1081125, OLAX330, OLAX330E-1081122, OLAX330E-1081123, OLAX330V-1081124, OLAX380, OLAX380E-1080780, OLAX380E-1080781, OLAX380E-1081037, OLAX380E-1081038, OLAX380E-1081039...(Other models you can see in the webshop)		

accessories

probe clips

spring clips

for thermostat



GEV No.	550041	Ref. No.	8208250 BN8208250
description	probe clip for pipe \varnothing 7mm for probe \varnothing 6mm		
For models:	40SEFR2S-1826140, 41SEFR2S-1826120, 421SEFR-1826125, 55-45FRE, 55-90FRE, 60SEFR2S-1826150, 61SEFR2S-1826130, 621SEFR-1826135, 7101FR-E-1077750R, 7121FR-E-1077950R, 7201FR-E-1077850R, 72-02FRE, 72-02FRE-12701500, 7221FR-E-1078050R, 73-02FRE, 73-02FRE-12701550, 74-02FRE, 74-02FRE-12701600, 7FRI-E415, 7FRI-E415M, 7FRI-E610, 7FRI-E815, 9122PFRE-1104930, 9141PFRE-1204950, 914PFRE-1204940, 92-04FRE15L-12901510, 92-04FRE20L-12901500, 92-04FRE20L-12901500BN, 921FRE-1292925, 921RFRE-1392925, 922RFRE-1392930, 92CCPE-1192856, 92CCPE-1192856V, 92RCCPE-1392856, 93-04FRE-12901550, 94-04FRE-12901600, 941FRE-1292950, 941RFRE-1392950, 94RCCPE-1392861, 9FRI-E415, 9FRI-E420, 9FRI-E610, 9FRI-E815, 9FRI-E820		

for safety thermostat



GEV No.	550417	Ref. No.	1033515200
description	probe clip for pipe \varnothing 2x8.5mm for probe \varnothing 6mm for heating elements spacing 15-19mm Qty 1 pcs		
For models:	FQE41, FQE41L, FQE41L2, FQE61, FQE61L, FQE61L2, OFQE41, OFQE-41-12601510, OFQE-41-12601510MN, OFQE41L, OFQE61, OFQE61-12601610, OFQE-61-12601610MN, OFQE61L		



GEV No.	550981	Ref. No.	8208260 BN8208260
description	probe clip for pipe \varnothing 8.5mm for probe \varnothing 6mm for heating elements spacing 0.4mm Qty 1 pcs		
For models:	40SEFR2S-1826140, 41SEFR2S-1826120, 421SEFR-1826125, 55-45FRE, 55-90FRE, 60SEFR2S-1826150, 61SEFR2S-1826130, 621SEFR-1826135, 7101FR-E-1077750R, 7121FR-E-1077950R, 7201FR-E-1077850R, 72-02FRE, 72-02FRE-12701500, 72-02FREM, 72-02FREM-12701530, 7221FR-E-1078050R, 73-02FRE, 73-02FRE-12701550, 73-02FREM, 73-02FREM-12701580, 74-02FRE, 74-02FRE-12701600, 74-02FREM, 74-02FREM-12701630, 7FRI-E415, 7FRI-E415M, 7FRI-E610, 7FRI-E815, 9122PFRE-1104930, 9141PFRE-1204950, 914PFRE-1204940, 92-04FRE15L-12901510, 92-04FRE20L-12901500, 92-04FRE20L-12901500BN, 921FRE-1292925, 921RFRE-1392925, 922RFRE-1392930, 93-04FRE-12901550, 94-04FRE-12901600, 941FRE-1292950, 941RFRE-1392950, 9FRI-E415, 9FRI-E420, 9FRI-E610, 9FRI-E815, 9FRI-E820		

capillary tube clips



GEV No.	550970	Ref. No.	1033709500
description	capillary tube clip for pipe \varnothing 8.5mm		
For models:	FQE41, FQE41L, FQE41L2, FQE61, FQE61L, FQE61L2, OFQE41, OFQE-41-12601510, OFQE-41-12601510MN, OFQE41L, OFQE61, OFQE61-12601610, OFQE-61-12601610MN, OFQE61L		



GEV No.	550980	Ref. No.	8208270 BN8208270
description	capillary tube clip for pipe \varnothing 8.5mm Qty 1 pcs		
For models:	41SEFR2S-1826120, 421SEFR-1826125, 55-45FRE, 55-90FRE, 61SEFR2S-1826130, 621SEFR-1826135, 7101FR-E-1077750R, 7121FR-E-1077950R, 7201FR-E-1077850R, 72-02FRE, 72-02FRE-12701500, 72-02FREM, 72-02FREM-12701530, 7221FR-E-1078050R, 73-02FRE, 73-02FRE-12701550, 73-02FREM, 73-02FREM-12701580, 74-02FRE, 74-02FRE-12701600, 74-02FREM, 74-02FREM-12701630, 7FRI-E415, 7FRI-E415M, 7FRI-E610, 7FRI-E815, 9122PFRE-1104930, 9141PFRE-1204950, 92-04FRE15L-12901510, 92-04FRE20L-12901500, 92-04FRE20L-12901500BN, 921FRE-1292925, 921RFRE-1392925, 922RFRE-1392930, 93-04FRE-12901550, 94-04FRE-12901600, 941FRE-1292950, 941RFRE-1392950, 9FRI-E415, 9FRI-E420, 9FRI-E610, 9FRI-E815, 9FRI-E820		

gland nut accessories

washers with slot





GEV No.	510241	Ref. No.	6A038803 BN6A038803
description	washer with slot ED \varnothing 7.8mm slit width 1.3mm Qty 10		
For models:	40SEFR2S-1826140, 40SGFR-1826160, 40SGFR2S-1826160, 55-45FRG, 55-90FRG, 60SEFR2S-1826150, 60SGFR-1826170, 60SGFR2S-1826170, 72-02FRG, 72-02FRG-12700500, 72-02FRG17-12700505, 72-02FRGM-12700530, 72-02FRGM-12700530TA, 73-02FRG, 73-02FRG-12700550, 73-02FRGM-12700580, 73-02FRGM-12700580TA, 74-02FRG, 74-02FRG-12700600, 74-02FRG17-12700605, 74-02FRGM-12700630, 7FRI-G415, 7FRI-G610, 7FRI-G815, 9122PFRG-1103930, 914PFRE-1204940, 92-04FRG15L, 92-04FRG15L-12900510, 92-04FRG17L-12900515, 92-04FRG20L, 92-04FRG20L-12900500, 92-04FRG20L-12900500TA, 922FRG-1191930, 922RFRG-1391930, 93-04FRG, 93-04FRG-12900550, 93-04FRG-12900550H, 94-04FRG-12900600, 94-04FRG20L, 94-04FRG20L-12900600TA, 94-04FRG23L-12900605, 9FRI-G415, 9FRI-G610, 9FRI-G815		

gaskets			
 <p>1</p>			
GEV No.	550982	Ref. No.	6A038804 BN6A038804
description	gasket graphite ø 7.5mm L 7mm Qty 1 pcs for gland nut		
For models:	40SEFR2S-1826140, 40SGFR-1826160, 40SGFR2S-1826160, 55-45FRG, 55-90FRG, 60SEFR2S-1826150, 60SGFR-1826170, 60SGFR2S-1826170, 72-02FRG, 72-02FRG-12700500, 72-02FRG17-12700505, 73-02FRG, 73-02FRG-12700550, 74-02FRG, 74-02FRG-12700600, 74-02FRG17-12700605, 7FRI-G415, 7FRI-G610, 7FRI-G815, 9122PFRG-1103930, 914PFRTE-1204940, 92-04FRG15L, 92-04FRG15L-12900510, 92-04FRG17L-12900515, 92-04FRG20L, 92-04FRG20L-12900500, 92-04FRG20L-12900500TA, 922FRG-1191930, 922RFRG-1391930, 93-04FRG, 93-04FRG-12900550, 93-04FRG-12900550H, 94-04FRG-12900600, 94-04FRG20L, 94-04FRG20L-12900600TA, 94-04FRG23L-12900605, 9FRI-G415, 9FRI-G610, 9FRI-G815, FR-E925N-1050730, FR-E950N-1050732, FR-G925N-1050731, FR-G950N-1050733		

bolts with slot			
 <p>1</p>			
GEV No.	520243	Ref. No.	6A038801 BN6A038801
description	bolt with slot thread M9x1 Qty 10 pcs nickel-plated brass		
For models:	40SEFR2S-1826140, 40SGFR-1826160, 40SGFR2S-1826160, 55-45FRG, 55-90FRG, 60SEFR2S-1826150, 60SGFR-1826170, 60SGFR2S-1826170, 72-02FRG, 72-02FRG-12700500, 72-02FRG17-12700505, 73-02FRG, 73-02FRG-12700550, 74-02FRG, 74-02FRG-12700600, 74-02FRG17-12700605, 7FRI-G415, 7FRI-G610, 7FRI-G815, 9122PFRG-1103930, 914PFRTE-1204940, 92-04FRG15L, 92-04FRG15L-12900510, 92-04FRG17L-12900515, 92-04FRG20L, 92-04FRG20L-12900500, 92-04FRG20L-12900500TA, 922FRG-1191930, 922RFRG-1391930, 93-04FRG, 93-04FRG-12900550, 93-04FRG-12900550H, 94-04FRG-12900600, 94-04FRG20L, 94-04FRG20L-12900600TA, 94-04FRG23L-12900605, 9FRI-G415, 9FRI-G610, 9FRI-G815, FR-E925N-1050730, FR-E950N-1050732, FR-G925N-1050731, FR-G950N-1050733		
accessories for	520243		
 <p>GEV No. 510591 Ref. No. —</p> <p>washer with slot ED ø 8.8mm slit width 1.2mm Qty 10</p>			
 <p>GEV No. 510592 Ref. No. —</p> <p>gasket ø 8x8.7mm Qty 10 pcs slotted silicone</p>			

locking screws			
 <p>1</p>			
GEV No.	106605	Ref. No.	CM012401
description	union screw thread M10x1 probe ø max. 4.5mm		
For models:	FQG41, FQG61, OFQG41, OFQG-41-12600500, OFQG61, OFQG-61-12600600		

plunger sockets			
 <p>1</p>			
GEV No.	517292	Ref. No.	12510
description	thermowell thread M10x1 ID ø 7.7mm L 108mm SS single ø 10mm		
For models:	OLDS40-1081010, OLDS40D-1081011, OLDS40LS-1081012, OLDS40LSD-1081013, OLG600, OLGastro450, OLLinear		

connecting bows			
 <p>1</p>			
GEV No.	550060	Ref. No.	1988500 6A045900 921200 BN6A045900
description	connecting bow long for thermostat Qty 1 pcs		
For models:	40SEC, 40SEC-1825060, 60SEC, 60SEC-1825070, 61FE-1826050, 61SCGFE3S-1826055, 61SCGFE4S-1827055, 61SECFE-1826075, 72-02CBE-12701150, 72-02CG, 72-02CG-12700001, 72-02CG-12700001TA, 72-02FRE, 72-02FRE-12701500, 72-02TCBE-12731150, 72-02TCG-12730001, 72-02TCG-12730001TA, 72-02TGC, 725KB-E-1000200, 725KB-E-1000200R, 725KB-EB-1000201, 725KB-EB-1000201R, 725KB-EM-1000210R, 725KB-EMB-1000211, 74-02CG, 74-02CG-12700002, 74-02CG-12700002TA, 74-02CGE, 74-02CGE-12700011, 74-02CGE-12700011TA, 74-02CGG, 74-02CGG-12700010, 74-02CGG-12700010TA, 74-02FRE, 74-02FRE-12701600, 74-02KBEB-12701110, 74-02KBEBI-12701115, 74-02KBEMB-12701120, 74-02KBEMBI-12701125, 74-02KBGB, 74-02KBGB-12700110, 74-02KBGBI, 74-02KBGBI-12700115, 74-02KBGMB, 74-02KBGMB-12700120, 74-02KBGMBI, 74-02KBGMBI-12700125, 74-02TCG-12730002, 74-02TCG-12730002TA, 74-02TGC...(Other models you can see in the webshop)		

 <p>1</p>			
GEV No.	550059	Ref. No.	6A045000
description	connecting bow short for switch Qty 1 pcs		
For models:	40SEBM2S-1826100, 40SEC-1825060, 40SECP-1825080, 40SECP-1825080E, 40SEFR, 40SEFR-1826140, 40SEFR2S-1826140, 40SEFT-1825040, 40SEFTC-1825045, 40SEFTR-1825041, 40SEKB-1825200, 41SEFR-1826120, 41SEFR2S-1826120, 421SEFR-1826125, 60SEBM-1826110, 60SEBM2S-1826110, 60SEC-1825070, 60SEFR, 60SEFR-1826150, 60SEFR2S-1826150, 60SEFT1-2R-1825051, 60SEFT-1825050, 60SEFTC-1825055, 60SEFTR-1825052, 61SEFR-1826130, 61SEFR2S-1826130, 621SEFR-1826135, 7101FR-E-1077750R, 7121FR-E-1077950R, 714CT-GVFE-1000180, 714CT-GVFE-1000180R, 7201FR-E-1077850R, 72-02CBE, 72-02CBE-12701150, 72-02CPE, 72-02CPE-12701900, 72-02FTE, 72-02FTE-12701130, 72-02FTEC, 72-02FTEC-12701135, 72-02FTER, 72-02FTER-12701132, 72-02TCBE, 72-02TCBE-12731150, 72-02TFTE, 72-02TFTE-12731130, 72-02TFTEC, 72-02TFTEC-12731135, 72-02TFTER, 72-02TFTER-12731132...(Other models you can see in the webshop)		



switches and momentary switches

rocker/momentary rocker switches

27.8x25mm



GEV No.	348221	Ref. No.	1635110
description	rocker switch mounting measurements 27.8x25mm black/green 1NO/indicator light 250V 16A ON-OFF connection F6.3x0.8 ambient temperature max. 100/55°C protection IP40		
For models:	KTAP01-BASE-20220901044U, KTAP02-BASE-20221301048K, KTAP02BT-BASE-2022630105KW, KTAP03-BASE-2022180109UA, KTAP04-2022230109X0, KTAP04-BASE-2022230109RY, KTAR01, KTAR01N, KTAR02, KTAR02N, KTAR03, KTAR03N, KTAR04, KTAR04N, KTRE21-202108010BL5, KTRE2-202108010BFC, KTRE2A-202108010BGP, KTRE3-202113010BHF, KTRE32A-202113010BLQ, KTRE34-202113010BLW, KTRE3A-202113010BFW, KTRE4-202117010BLG, KTRE42-202117010BMO, KTRE42A-202117010BM6, KTRE44-202117010BMB, KTRE4A-202117010BFF, KTRE5-202122010BG2, KTRE52-202122010BNK, KTRE54-202122010BGC, KTRE54A-202122010BNP, KTRE5A-202122010BL3, KTREP3-202611010C2F, KTREP34-20261101096L, KTREP34A-20261101096K, KTREP3A-202611010C1L, KTREP4-202615010BNQ, KTREP4A-202615010BNR, KTRE-P52A-202620010BO5, KTRN200012-202010050495, KTRN200012A-2020100507UK, KTRN200013-2020100507UV, KTRN200013A-2020100507UU, KTRN200014-2020100507UM, KTRN200014A-2020100507UL, KTRN200015-2020100507UR, KTRN200015A-2020100507UT, KTRN300122-202013050479, KTRN300122A-2020130504DY, KTRN300142-2020130506BG, KTRN300142A-2020130507GY...(Other models you can see in the webshop)		

30x22mm



GEV No.	301314	Ref. No.	1635103
description	rocker switch mounting measurements 30x22mm white 2NO 250V 16A ON-OFF connection male faston 6.3mm ambient temperature max. 100/55°C protection IP40		
For models:	KBT40-21091640, KC41-210916400BDC, KR41-210906400BFA, KTN40-21090640		

blank



GEV No.	345983	Ref. No.	15049	
description	momentary rocker switch mounting measurements 30x22mm green 2NO 250V 16A illuminated 0-I connection male faston 6.3mm ambient temperature max. 85°C protection IP65 with cover cap			
For models:	G125			
accessories for	345983			
	GEV No.	301036	Ref. No.	—
	protective cover internal size 30x22mm for rocker switch mounting measurementsmm			

push/momentary push switches

28.5x28.5mm



GEV No.	345975	Ref. No.	15849 15861
description	push switch mounting measurements 28.5x28.5mm green/red 2NO 250V 16A main switch connection male faston 6.3mm ambient temperature max. 150°C protection IP40 with indicator green/red		
For models:	OLAX151, OLAX151EDX-1080725, OLAX151ELEF-1080727, OLAX151-highspeed, OLAX160, OLAX160E-1080750, OLAX160E-1080751, OLAX160V-1080755, OLAX160V-1080756, OLAX160V-1081031, OLAX160V-1081032, OLAX210, OLAX210E-1081029, OLAX210E-1081030, OLAX220, OLAX220E-1080787, OLAX220E-1080788, OLAX220V-1080789, OLAX220V-1080790, OLAX230, OLAX230E-1080791, OLAX230E-1080792, OLAX230V-1080793, OLAX230V-1080794, OLAX240, OLAX240E-1080795, OLAX240E-1080796, OLAX240V-1080797, OLAX240V-1080798, OLAX250, OLAX250E-1080760, OLAX250E-1080761, OLAX250V-1080765, OLAX250V-1080766, OLAX300, OLAX300E-1080770, OLAX300E-1080771, OLAX300E-1081033, OLAX300E-1081035, OLAX300E-1081036, OLAX300LC, OLAX300LCE-1081034, OLAX300V-1080775, OLAX300V-1080776, OLAX310, OLAX310E-1081110, OLAX310E-1081111, OLAX310LC, OLAX310LCE-1081114, OLAX310LCE-1081115...(Other models you can see in the webshop)		

30x22mm



GEV No.	301086	Ref. No.	6A038550 BN6A038550
description	push switch mounting measurements 30x22mm black 2NO 250V 12A 0-1 connection male faston 6.3mm ambient temperature max. 85/55°C protection IP54 with protective collar		
For models:	ECVM10ES2, ECVM10ES2-1324290, ECVM10ES2-1324290MN, ECVM10ES2-1326120, ECVM10GS2, ECVM10GS2-1314290, ECVM10GS2-1316120, ECVM20ES2, ECVM20ES2-1324390, ECVM20ES2-1326140, ECVM20GS2, ECVM20GS2-1314390, ECVM20GS2-1316140, ECVM21ES2, ECVM21ES2-1324490, ECVM21ES2-1326160, ECVM21GS2-1314490, ECVM21GS2-1316160, ECVM6ES2, ECVM6ES2-1324190, ECVM6ES2-1326100, ECVM6ES2-1326100H, ECVM6GS2, ECVM6GS2-1314190, ECVM6GS2-1316100, ECVP10ES2, ECVP10ES2-1324690, ECVP10ES2-1326200, ECVP10GS2, ECVP10GS2-1314690, ECVP10GS2-1316200, ECVP20ES2, ECVP20ES2-1324790, ECVP20ES2-1326220, ECVP20GS2, ECVP20GS2-1314790, ECVP20GS2-1316220, ECVP21ES2, ECVP21ES2-1324890, ECVP21ES2-1326240, ECVP21GS2, ECVP21GS2-1314890, ECVP21GS2-1316240, ECVP6ES2, ECVP6ES2-1324590, ECVP6ES2-1326180, ECVP6GS2, ECVP6GS2-1314590, ECVP6GS2-1316180		



ø16mm





GEV No.	301172	Ref. No.	R65260610
description	momentary push switch mounting ø 16mm black 1NO 250V 16A connection male faston 6.3mm protection IP40 ambient temperature max. 150°C		
For models:	CCE042M, CCE051M, CCE071M, CCE101M, CCE102M, CCG051M, CCG071M, CCG101M, CCG102M		



 <p>1</p>			
GEV No.	301227	Ref. No.	R65260600
description	push switch mounting ø 16mm black 1NO 250V 16A connection male faston 6.3mm protection IP40 ambient temperature max. 150°C		
For models:	CCE042M, CCE051M, CCE071M, CCE101M, CCE102M, CCG051M, CCG071M, CCG101M, CCG102M		

<p>ø25mm</p>  <p>1</p>			
GEV No.	345743	Ref. No.	2510607 BN2510607
description	momentary push switch mounting ø 25mm red 1NO 250V 16A with cover cap ignition connection male faston 6.3mm ambient temperature max. 85°C protection IP65		
For models:	2FX+PCF, 4FX, 716CTG-000195, 716CTGV-000195, 72+2CTGG-12700013, 72-02FRGM-12700530, 72-02FRGM-12700530TA, 72CAGV-000010, 73-02FRGM-12700580, 73-02FRGM-12700580TA, 74+2CTGGAN-12700025, 74-02FRGM-12700630, 74CAGV-000020, 74CGV-000040, 76CAGV-000030, 76CGV-000050, 76CGVFL-000070, 796CG-000270, CG796-000270		
accessories for	345743		
	GEV No.	345039	Ref. No. 41826630420
	 <p>protective cover round ED ø 33mm external size 23mm internal size 21mm H 12mm clear mounting ø 25mm</p>		

 <p>1</p>			
GEV No.	345039	Ref. No.	41826630420
description	protective cover round ED ø 33mm external size 23mm internal size 21mm H 12mm clear mounting ø 25mm		
For models:	7CP-G400, 7CP-G800, 7PCF-G120, 7PCF-G121, 7PCF-G160, 7PCF-G161, 7PCF-G800, 7PCF-G811, 9BR-G125, 9CP-G400, 9CP-G800, 9FRI-G415, 9FRI-G610, 9FRI-G815, 9GL-G400, 9GL-G800, 9TGL-G400, 9TGL-G800		
accessories for	345039		
	GEV No.	345001	Ref. No. —
	 <p>momentary push switch mounting ø 25mm yellow 1NO/indicator light 250V 16A cover connection male faston 6.3mm ambient temperature max. 85°C protection IP65</p>		

<p>2 hole fixing</p>  <p>1</p>			
GEV No.	346359	Ref. No.	3108870 BN3108870
description	momentary push switch connection cable ambient temperature max. 85°C protection IP40 door contact switch		
For models:	CV10E, CV10E-1320100, CV10E-2, CV10E2-1320140, CV10E-S, CV10ES-1320150, CV10E-S2, CV10ES2-1320190, CV10G, CV10G-1310100, CV10G-2, CV10G2-1310140, CV10G-S, CV10GS-1310150, CV10G-S2, CV10GS2-1310190, CV20E, CV20E-1320200, CV20E-2, CV20E2-1320240, CV20E-S, CV20ES-1320250, CV20E-S2, CV20ES2-1320290, CV20G, CV20G-1310200, CV20G-2, CV20G2-1310240, CV20G-S, CV20GS-1310250, CV20G-S2, CV20GS2-1310290, CV21E, CV21E-1322100, CV21E-2, CV21E2-1322140, CV21E-S, CV21ES-1322150, CV21E-S2, CV21ES2-1322190, CV21G, CV21G-1312100, CV21G-2, CV21G2-1312140, CV21G-S, CV21GS-1312150, CV21G-S2, CV21GS2-1312190, CV6E, CV6E-1320000...(Other models you can see in the webshop)		

accessories

<p>blank elements</p>  <p>1</p>			
GEV No.	346353	Ref. No.	3102870 BN3102870
description	dummy element		
For models:	CV10E, CV10E-1320100, CV10E-1320110, CV10E-2, CV10E2-1320140, CV10EB-1321100, CV10E-S, CV10ES-1320150, CV10E-S2, CV10ES2-1320190, CV10G, CV10G-1310100, CV10G-2, CV10G2-1310140, CV10GB-1311100, CV10G-S, CV10GS-1310150, CV10G-S2, CV10GS2-1310190, CV20E, CV20E-1320200, CV20E-2, CV20E2-1320240, CV20EB-1321200, CV20E-S, CV20ES-1320250, CV20E-S2, CV20ES2-1320290, CV20G, CV20G-1310200, CV20G-2, CV20G2-1310240, CV20GB-1311200, CV20G-S, CV20GS-1310250, CV20G-S2, CV20GS2-1310290, CV21E-1322100, CV21E2-1322140, CV21G-1312100, CV21G2-1312140, CV6E, CV6E-1320000, CV6E-1320010, CV6E-1320050, CV6E-2, CV6E2-1320040, CV6EB-1321000, CV6E-S, CV6E-S2...(Other models you can see in the webshop)		

microswitches

<p>lever actuated</p>  <p>1</p>			
GEV No.	345257	Ref. No.	10704
description	microswitch with lever 250V 16A 1CO connection male faston 6.3mm L 29mm L1 33mm ambient temperature max. 120°C mounting distance 22mm actuating force: 130g lever length 31.5mm		
For models:	OLDerby, OLDS35-1081005, OLDS37-1081006, OLDS37D-1081007, OLDS37LS-1081008, OLDS37LSD-1081009, OLDS40-1081010, OLDS40D-1081011, OLDS40LS-1081012, OLDS40LSD-1081013, OLDS50P-1081018, OLDS50PD-1081019, OLDW020H, OLElectron1000, OLElectron400, OLElectron500, OLELELECTRON1000-1081084, OLELELECTRON1000D-1081085, OLG600, OLGastro450, OLGastro500Plus, OLGastro500S, OLGastro750Plus, OLGastro750S, OLLinear, OLLP155-1081087, OLStar		



1

GEV No.	345044	Ref. No.	164602
description	microswitch with lever 250V 16A 1CO connection male faston 6.3mm ambient temperature max. 85°C mounting distance 25mm type C99ZP3 actuating force: 25g lever length 71mm		
For models:	KBT40-21091640, KC41-210916400BDC, KR41-210906400BFA, KTN40-21090640		

pin-plunger actuated



1

GEV No.	345326	Ref. No.	1037312900
description	microswitch with plunger 250V 16A 1NO connection male faston 6.3mm ambient temperature max. 85°C mounting distance 22mm type XP52Z11 actuating force: 350g red stroke 15mm		
For models:	FQE41, FQE41L, FQE41L2, FQE61, FQE61L, FQE61L2, OFQE41, OFQE-41-12601510, OFQE-41-12601510MN, OFQE41L, OFQE61, OFQE-61-12601610, OFQE-61-12601610MN, OFQE61L		

M10



1

GEV No.	345032	Ref. No.	6A039800 BN6A039800 R65260540
description	microswitch with plunger thread M10x1 thread L 12mm 250V 16A 1CO connection male faston 6.3mm stroke 7mm mounting distance 22mm L 28mm ambient temperature max. 125°C type SP9603 actuating force: 180g		
For models:	41SEFR, 41SEFR-1826120, 41SEFR2S-1826120, 421SEFR-1826125, 55-45FRE, 55-90FRE, 61SEFR, 61SEFR-1826130, 61SEFR2S-1826130, 621SEFR-1826135, 7101FR-E-1077750R, 710FRE-1077700, 7121FR-E-1077950R, 712FRE-1077900, 7201FR-E-1077850R, 72-02FRE, 72-02FRE-12701500, 72-02FREM, 72-02FREM-12701530, 720FRE-1077800, 7221FR-E-1078050R, 722FRE-1078000, 725KBEM-000200, 725KBEM-1000210, 725KB-EM-1000210R, 725KB-EMB-1000211, 725KBEMB-1000211, 73-02FRE, 73-02FRE-12701550, 73-02FREM, 73-02FREM-12701580, 74-02FRE, 74-02FRE-12701600, 74-02FREM, 74-02FREM-12701630, 74-02KBEB, 74-02KBEB-12701110, 74-02KBEBI, 74-02KBEBI-12701115, 74-02KBEMB, 74-02KBEMB-12701120, 74-02KBEMBI, 74-02KBEMBI-12701125, 74-02KBEMBI-12701125HB, 74-02KBGB, 74-02KBGB-12700110, 74-02KBGBI, 74-02KBGBI-12700115, 74-02KBGMB, 74-02KBGMB-12700120...(Other models you can see in the webshop)		

with push button

switches with snap-fit



1

GEV No.	347057	Ref. No.	164606 164608
description	microswitch with push button 250V 2.5A 1CO connection male faston 4.8mm L 27x21mm ambient temperature max. 85°C type built-in version actuating force: 300g		
For models:	KSABT70G-2045370CJD, OLKSABTV140-2045240CIY, OLKSABTV70-2045170CIR, OLKSATNV140-2045140CIX, OLKSATNV70-2045070CIQ, OLSPAB100-201706030CLP, OLSPAB120-201707030CLN, OLSPAB200-201712030CLO, OLSPAB240-201714030CLO, OLSPABT120-201722030CI, OLSPABT124-201722030CIM, OLSPABT140-201724030CI2, OLSPABT144-201724030CI6, OLSPABT60-201716030CIC, OLSPABT70-201717030CHW, OLSPABT72-201717030CIO, OLSPABTV120-201722030CIK, OLSPABTV140-201724030CI4, OLSPABTV70-201717030CHY, OLSPATNN120-201712030CIH, OLSPATNN124-201712030CIL, OLSPATNN140-201714030CI1, OLSPATNN144-201714030CI5, OLSPATNN60-201706030CIB, OLSPATNN62-201706030CIF, OLSPATNN70-201707030CEM, OLSPATNN72-201707030CHZ, OLSPATNV120-201712030CIJ, OLSPATNV140-201714030CI3, OLSPATNV60-201706030CID, OLSPATNV70-201707030CHX, TN140, TN144, TN70, TN72, TNV140, TNV144, TNV70, TNV72		

roller actuated

roller 90°



1

GEV No.	347096	Ref. No.	70305
description	microswitch with roller plunger 250V 20A 1CO connection screw L1 49mm ambient temperature max. 125°C thread L 14.5mm thread M12x1 mounting distance 25mm actuating force: 370g type Z15G1318		
For models:	G12S, OLSH600, OLSH600Electronic, OLHT11-1081071, OLHT11D-1081072, OLHT11ECO-1081070, OLHT-11-Neutra, OLHT11S, OLHT11S-Neutra, OLHT12-1081075, OLHT12EL-1081080, OLHT12EL-1081083, OLHT12ELD-1081081, OLHT12ELPLUS-1081086, OLHT12S, OLHT12SElectronic, OLHT12S-Neutra		

system switches (ROLD)





1

GEV No.	346229	Ref. No.	15880
description	blank size 23x23mm grey		
For models:	OLDS35-Neutra, OLDS37-Neutra, OLDS40-Neutra, OLDS50-Neutra, OLG35-Neutra, OLG537-Neutra, OLG540, OLG540-Neutra, OLG550E-COD-1081015, OLG550-Neutra, OLG585-Neutra, OLHT-11-Neutra, OLHT11S-Neutra, OLHT12S-Neutra, OLLP1-800-Neutra		



			
1			
GEV No.	345721	Ref. No.	15844
description	blank cap holder		
For models:	OLDerby, OLDS35-1081005, OLDS35-Neutra, OLDS37-1081006, OLDS37D-1081007, OLDS37LS-1081008, OLDS37LSD-1081009, OLDS37-Neutra, OLDS40-1081010, OLDS40D-1081011, OLDS40LS-1081012, OLDS40LSD-1081013, OLDS40-Neutra, OLDS50-Neutra, OLG35-Neutra, OLG600, OLGastro450, OLG537-Neutra, OLG540, OLG540-Neutra, OLG550ECOD-1081015, OLG550-Neutra, OLG585-Neutra, OLH600, OLHT11-1081071, OLHT11D-1081072, OLHT11ECO-1081070, OLHT-11-Neutra, OLHT11S, OLHT11S-Neutra, OLHT12-1081075, OLHT12EL-1081080, OLHT12EL-1081083, OLHT12ELD-1081081, OLHT12ELPLUS-1081086, OLHT12S, OLHT12S-Neutra, OLLinear, OLLP1-800, OLLP1-800-1080721, OLLP1-800EL, OLLP1-800-Neutra, OLLP1-S8, OLLP1-S8EL, OLLP-ZERO, OLLPZERO-1081057, OLStar		

			
1			
GEV No.	347592	Ref. No.	15815
description	element holder single mounting measurements 28.5x28.5mm grey for push buttons 23x23mm		
For models:	OLAX151, OLAX151EDX-1080725, OLAX151LEFT-1080727, OLAX151-highspeed, OLAX160, OLAX160E-1080750, OLAX160E-1080751, OLAX160V-1080755, OLAX160V-1080756, OLAX160V-1081031, OLAX160V-1081032, OLAX210, OLAX210E-1081029, OLAX210E-1081030, OLAX220, OLAX220E-1080787, OLAX220E-1080788, OLAX220V-1080789, OLAX220V-1080790, OLAX230, OLAX230E-1080791, OLAX230E-1080792, OLAX230V-1080793, OLAX230V-1080794, OLAX240, OLAX240E-1080795, OLAX240E-1080796, OLAX240V-1080797, OLAX240V-1080798, OLAX250, OLAX250E-1080760, OLAX250E-1080761, OLAX250V-1080765, OLAX250V-1080766, OLAX300, OLAX300E-1080770, OLAX300E-1080771, OLAX300E-1081033, OLAX300E-1081035, OLAX300E-1081036, OLAX300LC, OLAX300LCE-1081034, OLAX300V-1080775, OLAX300V-1080776, OLAX310, OLAX310E-1081110, OLAX310E-1081111, OLAX310LC, OLAX310LCE-1081114, OLAX310LCE-1081115...(Other models you can see in the webshop)		

			
1			
GEV No.	345603	Ref. No.	15843
description	element holder triple mounting measurements 28.5x77.5mm black for push buttons 23x23mm		
For models:	OLDS35-Neutra, OLDS37-Neutra, OLDS40-Neutra, OLDS50-Neutra, OLG35-Neutra, OLG537-Neutra, OLG540, OLG540-Neutra, OLG550ECOD-1081015, OLG550-Neutra, OLG585-Neutra		

			
1			
GEV No.	347620	Ref. No.	15836
description	element holder triple mounting measurements 28.5x77.5mm grey for push buttons 23x23mm		
For models:	OLDS35-Neutra, OLDS37-Neutra, OLDS40-Neutra, OLDS50-Neutra, OLG35-Neutra, OLG537-Neutra, OLG540, OLG540-Neutra, OLG550ECOD-1081015, OLG550-Neutra, OLG585-Neutra		

			
1			
GEV No.	345601	Ref. No.	15827
description	indicator lamp holder V ø 11mm		
For models:	OLDS35-Neutra, OLDS37-Neutra, OLDS40-Neutra, OLDS50-Neutra, OLG35-Neutra, OLG537-Neutra, OLG540, OLG540-Neutra, OLG550ECOD-1081015, OLG550-Neutra, OLG585-Neutra, OLHT-11-Neutra, OLHT11S-Neutra, OLHT12S-Neutra, OLLP1-800-Neutra		

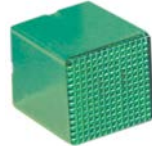
			
1			
GEV No.	346245	Ref. No.	15825
description	indicator light lens size 23x23mm green		
For models:	OLDS35-Neutra, OLDS37-Neutra, OLDS40-Neutra, OLDS50-Neutra, OLG35-Neutra, OLG537-Neutra, OLG540, OLG540-Neutra, OLG550ECOD-1081015, OLG550-Neutra, OLG585-Neutra, OLHT-11-Neutra, OLHT11S-Neutra, OLHT12S-Neutra, OLLP1-800-Neutra		

			
1			
GEV No.	346249	Ref. No.	15876
description	indicator light lens size 23x23mm green temperature		
For models:	OLDS35-Neutra, OLDS37-Neutra, OLDS40-Neutra, OLDS50-Neutra, OLG35-Neutra, OLG537-Neutra, OLG540, OLG540-Neutra, OLG550ECOD-1081015, OLG550-Neutra, OLG585-Neutra, OLHT12S-Neutra		

			
1			
GEV No.	346250	Ref. No.	15875
description	indicator light lens size 23x23mm green washing cycle		
For models:	OLDS35-Neutra, OLDS37-Neutra, OLDS40-Neutra, OLDS50-Neutra, OLG35-Neutra, OLG537-Neutra, OLG540, OLG540-Neutra, OLG550ECOD-1081015, OLG550-Neutra, OLG585-Neutra, OLHT-11-Neutra, OLHT12S-Neutra		





			
GEV No.	347193	Ref. No.	15813
description	momentary switch unit 1NO 250V 16A connection male faston 6.3mm		
For models:	OLDerby, OLDS35, OLDS35-1081005, OLDS35-1081061, OLDS35D-1081062, OLDS35-Neutra, OLDS37, OLDS37-1081006, OLDS37-1081063, OLDS37D-1081007, OLDS37D-1081064, OLDS37LS-1081008, OLDS37LSD-1081009, OLDS37-Neutra, OLDS40, OLDS40-1081010, OLDS40-1081065, OLDS40D-1081011, OLDS40D-1081066, OLDS40E-1081067, OLDS40ED-1081068, OLDS40LS-1081012, OLDS40LSD-1081013, OLDS40-Neutra, OLDS45, OLDS50, OLDS50-1081088, OLDS50D-1081089, OLDS50E-1081090, OLDS50ED-1081091, OLDS50-Neutra, OLDS50P-1081018, OLDS50PD-1081019, OLG35, OLG35-1080702, OLG35D-1081000, OLG35-Neutra, OLG600, OLGastro450, OLGastro500Plus, OLGastro500S, OLGastro750Plus, OLGastro750S, OLG537, OLG537-1080700, OLG537D-1080707, OLG537LS-1081001, OLG537LSD-1081002, OLG537-Neutra, OLG540...(Other models you can see in the webshop)		

			
GEV No.	345606	Ref. No.	15811/A
description	momentary switch unit 2CO 250V 16A connection male faston 6.3mm		
For models:	OLDS40, OLDS40-1081010, OLDS40-1081065, OLDS40D-1081011, OLDS40D-1081066, OLDS40E-1081067, OLDS40ED-1081068, OLDS40LS-1081012, OLDS40LSD-1081013, OLDS50-Neutra, OLDS50P-1081018, OLDS50PD-1081019, OLGastro500Plus, OLGastro500S, OLGastro750Plus, OLGastro750S, OLG540, OLG540, OLG540-1080701, OLG540D-1080708, OLG540D-1081003, OLG545, OLG545LSD-1081004, OLG550, OLG550-1080705, OLG550D-1080706, OLG550E-1080730, OLG550ECO-1081014, OLG550ECOD-1081015, OLG550ED-1080731, OLG550-Neutra, OLG585, OLG585-1081016, OLG585D-1081017, OLHT11-1081071, OLHT11D-1081072, OLHT11ECO-1081070, OLHT11-Neutra, OLHT11S, OLHT11S-Neutra, OLHT12S-Neutra, OLLinear, OLLP1-800, OLLP1-800-1080721, OLLP1-800EL, OLLP1-800-Neutra, OLLP1-S8, OLLP1-S8EL, OLLP-ZERO, OLLPZERO-1081057		

			
GEV No.	345980	Ref. No.	15800
description	momentary switch unit 2NO 250V 16A connection male faston 6.3mm		
For models:	OLDS35, OLDS35-1081061, OLDS35D-1081062, OLDS35-Neutra, OLDS37, OLDS37-1081063, OLDS37D-1081064, OLDS37-Neutra, OLDS40, OLDS40-1081010, OLDS40-1081065, OLDS40D-1081011, OLDS40D-1081066, OLDS40E-1081067, OLDS40ED-1081068, OLDS40LS-1081012, OLDS40LSD-1081013, OLDS40-Neutra, OLDS45, OLDS50, OLDS50-1081088, OLDS50D-1081089, OLDS50E-1081090, OLDS50ED-1081091, OLDS50-Neutra, OLDS50P-1081018, OLDS50PD-1081019, OLG35, OLG35-1080702, OLG35D-1081000, OLG35-Neutra, OLGastro500Plus, OLGastro500S, OLGastro750Plus, OLGastro750S, OLG537, OLG537-1080700, OLG537D-1080707, OLG537LS-1081001, OLG537LSD-1081002, OLG537-Neutra, OLG540, OLG540, OLG540-1080701, OLG540D-1080708, OLG540D-1081003, OLG540-Neutra, OLG545, OLG545LSD-1081004, OLG550...(Other models you can see in the webshop)		

			
GEV No.	345539	Ref. No.	84001
description	push button size 17x13mm grey		
For models:	OLDS35-Neutra, OLDS37-Neutra, OLDS40-Neutra, OLDS50-Neutra, OLG35-Neutra, OLG537-Neutra, OLG540-Neutra, OLG550E-COD-1081015, OLG550-Neutra, OLHT11S-Neutra, OLHT12S-Neutra		

			
GEV No.	347895	Ref. No.	15817
description	push button size 23x23mm blue		
For models:	OLDS35-Neutra, OLDS37-Neutra, OLDS40-Neutra, OLDS50-Neutra, OLG35-Neutra, OLG537-Neutra, OLG540, OLG540-Neutra, OLG550E-COD-1081015, OLG550-Neutra, OLG585-Neutra, OLHT11-Neutra, OLHT11S-Neutra, OLLP1-800-Neutra		

			
GEV No.	347892	Ref. No.	15990
description	push button size 23x23mm blue drain pump		
For models:	OLDS35-Neutra, OLDS37-Neutra, OLDS40-Neutra, OLDS50-Neutra, OLG35-Neutra, OLG537-Neutra, OLG540, OLG540-Neutra, OLG550E-COD-1081015, OLG550-Neutra, OLG585-Neutra, OLHT11-Neutra, OLHT11S-Neutra, OLHT12S-Neutra, OLLP1-800-Neutra		

			
GEV No.	347893	Ref. No.	15988
description	push button size 23x23mm blue ON-OFF with lens		
For models:	OLDS35-Neutra, OLDS37-Neutra, OLDS40-Neutra, OLDS50-Neutra, OLG35-Neutra, OLG537-Neutra, OLG540, OLG540-Neutra, OLG550E-COD-1081015, OLG550-Neutra, OLG585-Neutra, OLHT11-Neutra, OLHT11S-Neutra, OLHT12S-Neutra, OLLP1-800-Neutra		

			
GEV No.	347701	Ref. No.	15877
description	push button size 23x23mm blue programme		
For models:	OLHT11-Neutra, OLHT11S-Neutra, OLLP1-800-Neutra		





			
1			
GEV No.	347891	Ref. No.	15993
description	push button size 23x23mm blue regeneration		
For models:	OLDS35-Neutra, OLDS37-Neutra, OLDS40-Neutra, OLDS50-Neutra, OLG35-Neutra, OLG537-Neutra, OLG540, OLG540-Neutra, OLG550E-COD-1081015, OLG550-Neutra, OLG585-Neutra, OLHT-11-Neutra, OLHT11S-Neutra		

			
1			
GEV No.	347894	Ref. No.	15986
description	push button size 23x23mm blue START		
For models:	OLDS35-Neutra, OLDS37-Neutra, OLDS40-Neutra, OLDS50-Neutra, OLG35-Neutra, OLG537-Neutra, OLG540, OLG540-Neutra, OLG550E-COD-1081015, OLG550-Neutra, OLG585-Neutra, OLHT-11-Neutra, OLHT11S-Neutra, OLHT12S-Neutra, OLLP1-800-Neutra		

			
1			
GEV No.	347896	Ref. No.	15872
description	push button size 23x23mm green cold rinsing		
For models:	OLDS35-Neutra, OLDS37-Neutra, OLDS40-Neutra, OLDS50-Neutra, OLG35-Neutra, OLG537-Neutra, OLG540, OLG540-Neutra, OLG550E-COD-1081015, OLG550-Neutra, OLG585-Neutra		

			
1			
GEV No.	347590	Ref. No.	15854
description	push button size 23x23mm green drain pump		
For models:	OLDS35-Neutra, OLDS37-Neutra, OLDS40-Neutra, OLDS50-Neutra, OLG35-Neutra, OLG537-Neutra, OLG540, OLG540-Neutra, OLG550E-COD-1081015, OLG550-Neutra, OLG585-Neutra, OLHT-11-Neutra, OLHT11S-Neutra, OLHT12S-Neutra, OLLP1-800-Neutra		

			
1			
GEV No.	346221	Ref. No.	15874
description	push button size 23x23mm green ON-OFF with lens		
For models:	OLAX151, OLAX151EDX-1080725, OLAX151ELEFF-1080727, OLAX151-highspeed, OLAX160, OLAX160E-1080750, OLAX160E-1080751, OLAX160V-1080755, OLAX160V-1080756, OLAX160V-1081031, OLAX160V-1081032, OLAX210, OLAX210E-1081029, OLAX210E-1081030, OLAX220, OLAX220E-1080787, OLAX220E-1080788, OLAX220V-1080789, OLAX220V-1080790, OLAX230, OLAX230E-1080791, OLAX230E-1080792, OLAX230V-1080793, OLAX230V-1080794, OLAX240, OLAX240E-1080795, OLAX240E-1080796, OLAX240V-1080797, OLAX240V-1080798, OLAX250, OLAX250E-1080760, OLAX250E-1080761, OLAX250V-1080765, OLAX250V-1080766, OLAX300, OLAX300E-1080770, OLAX300E-1080771, OLAX300E-1081033, OLAX300E-1081035, OLAX300E-1081036, OLAX300LC, OLAX300LCE-1081034, OLAX300V-1080775, OLAX300V-1080776, OLAX310, OLAX310E-1081110, OLAX310E-1081111, OLAX310LC, OLAX310LCE-1081114, OLAX310LCE-1081115...(Other models you can see in the webshop)		

			
1			
GEV No.	346224	Ref. No.	15871
description	push button size 23x23mm green regeneration		
For models:	OLDS35-Neutra, OLDS37-Neutra, OLDS40-Neutra, OLDS50-Neutra, OLG35-Neutra, OLG537-Neutra, OLG540, OLG540-Neutra, OLG550E-COD-1081015, OLG550-Neutra, OLG585-Neutra, OLHT-11-Neutra, OLHT11S-Neutra		

			
1			
GEV No.	346222	Ref. No.	15873
description	push button size 23x23mm green START		
For models:	OLDS35-Neutra, OLDS37-Neutra, OLDS40-Neutra, OLDS50-Neutra, OLG35-Neutra, OLG537-Neutra, OLG540, OLG540-Neutra, OLG550E-COD-1081015, OLG550-Neutra, OLG585-Neutra, OLHT-11-Neutra, OLHT11S-Neutra, OLHT12S-Neutra, OLLP1-800-Neutra		

			
1			
GEV No.	346214	Ref. No.	15819
description	push button size 23x23mm yellow		
For models:	OLDS35-Neutra, OLDS37-Neutra, OLDS40-Neutra, OLDS50-Neutra, OLG35-Neutra, OLG537-Neutra, OLG540, OLG540-Neutra, OLG550E-COD-1081015, OLG550-Neutra, OLG585-Neutra, OLHT-11-Neutra, OLHT11S-Neutra, OLLP1-800-Neutra		

			
1			
GEV No.	347889	Ref. No.	15991
description	push button size 23x23mm yellow drain pump		
For models:	OLDS35-Neutra, OLDS37-Neutra, OLDS40-Neutra, OLDS50-Neutra, OLG35-Neutra, OLG37-Neutra, OLG540, OLG540-Neutra, OLG550E-COD-1081015, OLG550-Neutra, OLG585-Neutra, OLHT-11-Neutra, OLHT115-Neutra, OLHT125-Neutra, OLLP1-800-Neutra		

			
1			
GEV No.	347484	Ref. No.	15989
description	push button size 23x23mm yellow ON-OFF with lens		
For models:	OLDS35-Neutra, OLDS37-Neutra, OLDS40-Neutra, OLDS50-Neutra, OLG35-Neutra, OLG37-Neutra, OLG540, OLG540-Neutra, OLG550E-COD-1081015, OLG550-Neutra, OLG585-Neutra, OLHT-11-Neutra, OLHT115-Neutra, OLHT125-Neutra, OLLP1-800-Neutra		

			
1			
GEV No.	347890	Ref. No.	15858
description	push button size 23x23mm yellow regeneration		
For models:	OLDS35-Neutra, OLDS37-Neutra, OLDS40-Neutra, OLDS50-Neutra, OLG35-Neutra, OLG37-Neutra, OLG540, OLG540-Neutra, OLG550E-COD-1081015, OLG550-Neutra, OLG585-Neutra, OLHT-11-Neutra, OLHT115-Neutra		

			
1			
GEV No.	347888	Ref. No.	15987
description	push button size 23x23mm yellow START		
For models:	OLDS35-Neutra, OLDS37-Neutra, OLDS40-Neutra, OLDS50-Neutra, OLG35-Neutra, OLG37-Neutra, OLG540, OLG540-Neutra, OLG550E-COD-1081015, OLG550-Neutra, OLG585-Neutra, OLHT-11-Neutra, OLHT115-Neutra, OLHT125-Neutra, OLLP1-800-Neutra		

			
1			
GEV No.	346251	Ref. No.	15824 15824/A
description	rotary disc orange/green disc ø 20.6mm		
For models:	OLAX151, OLAX151EDX-1080725, OLAX151ELEFT-1080727, OLAX151-highspeed, OLAX160, OLAX160E-1080750, OLAX160E-1080751, OLAX160V-1080755, OLAX160V-1080756, OLAX160V-1081031, OLAX160V-1081032, OLAX210, OLAX210E-1081029, OLAX210E-1081030, OLAX220, OLAX220E-1080787, OLAX220E-1080788, OLAX220V-1080789, OLAX220V-1080790, OLAX230, OLAX230E-1080791, OLAX230E-1080792, OLAX230V-1080793, OLAX230V-1080794, OLAX240, OLAX240E-1080795, OLAX240E-1080796, OLAX240V-1080797, OLAX240V-1080798, OLAX250, OLAX250E-1080760, OLAX250E-1080761, OLAX250V-1080765, OLAX250V-1080766, OLAX300, OLAX300E-1080770, OLAX300E-1080771, OLAX300E-1081033, OLAX300E-1081035, OLAX300E-1081036, OLAX300LC, OLAX300LCE-1081034, OLAX300V-1080775, OLAX300V-1080776, OLAX310, OLAX310E-1081110, OLAX310E-1081111, OLAX310LC, OLAX310LCE-1081114, OLAX310LCE-1081115...(Other models you can see in the webshop)		

			
1			
GEV No.	345605	Ref. No.	15811
description	switch 2CO 250V 16A connection male faston 6.3mm		
For models:	OLDS35, OLDS35-1081061, OLDS35D-1081062, OLDS35-Neutra, OLDS37, OLDS37-1081006, OLDS37-1081063, OLDS37D-1081007, OLDS37D-1081064, OLDS37LS-1081008, OLDS37LSD-1081009, OLDS37-Neutra, OLDS40, OLDS40-1081010, OLDS40-1081065, OLDS40D-1081011, OLDS40D-1081066, OLDS40E-1081067, OLDS40ED-1081068, OLDS40LS-1081012, OLDS40LSD-1081013, OLDS50-Neutra, OLDS50P-1081018, OLDS50PD-1081019, OLG35, OLG35-1080702, OLG35D-1081000, OLG35-Neutra, OLGastro-500Plus, OLGastro500S, OLGastro750Plus, OLGastro750S, OLG357, OLG357-1080700, OLG357D-1080707, OLG357LS-1081001, OLG357LSD-1081002, OLG357-Neutra, OLG540, OLG540, OLG540-1080701, OLG540D-1080708, OLG540D-1081003, OLG545, OLG545LSD-1081004, OLG550, OLG550-1080705, OLG550D-1080706, OLG550E-1080730, OLG550ECO-1081014...(Other models you can see in the webshop)		

			
1			
GEV No.	345720	Ref. No.	15812
description	switch 2NO 250V 16A connection male faston 6.3mm		
For models:	OLAX151, OLAX151EDX-1080725, OLAX151ELEFT-1080727, OLAX151-highspeed, OLAX160, OLAX160E-1080750, OLAX160E-1080751, OLAX160V-1080755, OLAX160V-1080756, OLAX160V-1081031, OLAX160V-1081032, OLAX210, OLAX210E-1081029, OLAX210E-1081030, OLAX220, OLAX220E-1080787, OLAX220E-1080788, OLAX220V-1080789, OLAX220V-1080790, OLAX230, OLAX230E-1080791, OLAX230E-1080792, OLAX230V-1080793, OLAX230V-1080794, OLAX240, OLAX240E-1080795, OLAX240E-1080796, OLAX240V-1080797, OLAX240V-1080798, OLAX250, OLAX250E-1080760, OLAX250E-1080761, OLAX250V-1080765, OLAX250V-1080766, OLAX300, OLAX300E-1080770, OLAX300E-1080771, OLAX300E-1081033, OLAX300E-1081035, OLAX300E-1081036, OLAX300LC, OLAX300LCE-1081034, OLAX300V-1080775, OLAX300V-1080776, OLAX310, OLAX310E-1081110, OLAX310E-1081111, OLAX310LC, OLAX310LCE-1081114, OLAX310LCE-1081115...(Other models you can see in the webshop)		



float switches

			
1			
GEV No.	401986	Ref. No.	6A021950 BN6A021950
description	float switch thread 1/8" 1NO \varnothing 28mm L 116mm mounting \varnothing 10mm 220V 0.5A cable cable length 330mm		
For models:	74-02NPEI, 7PN-EI50		

cam switches

on/off

			
1			
GEV No.	300020	Ref. No.	6A049300 BN6A049300
description	cam switch 4 operating positions 2NO sequence 0-1-0-1 16A shaft \varnothing 6x4.6mm shaft L 23mm connection screw ceramic		
For models:	40SECC, 40SECC-1826260, 72-02FREM, 72-02FREM-12701530, 72-02KBEF, 72-02KBEF-12701127, 72-02SPE-12701700, 725KBEM-000200, 725KB-G-1000110, 725KBG-1000110, 725KB-G-1000110R, 725KB-GB-1000111, 725KB-GB-1000111R, 725KBGM-000120, 725KB-GM-1000120, 725KB-GM-1000120R, 725KB-GMB-1000121, 725KB-GMB-1000121R, 74-02FREM, 74-02FREM-12701630, 74-02KBEF, 74-02KBEF-12701128, FR-E925N-1050730, FR-E950N-1050732, KB-E970-1050410, KBE970-1050410, KB-E970A-1050411, KB-G970-1050450, KB-G970A-1050451		
accessories for	300020		
		GEV No.	110135 Ref. No. —
	rosette knob up to \varnothing 52mm		
		GEV No.	110231 Ref. No. —
	knob switch 0-1-0-1 t.max.°C°C \varnothing 50mm shaft \varnothing 6x4.6mm shaft flat upper black		

			
1			
GEV No.	300021	Ref. No.	1230100 6A046700 MA1230100
description	cam switch 4 operating positions 4NO sequence 0-1-0-1 16A shaft \varnothing 6x4.6mm shaft L 23mm connection screw ceramic		
For models:	72-02KBEF-12701127, 73-02FREM, 73-02FREM-12701580, 7BRF-E405, 7BRF-E805, 96-04CGFL, 96-04CGFL-12900019, 96-04CGFL2P, 96-04CG-FL2P-12900037, 96-04CGFLP, 96-04CGFLP-12900069, BSEI40M, C-GV906FL-1050200, OBSEI40M, OBSEI-40M-12601700		

4-position

			
1			
GEV No.	300104	Ref. No.	6A038300 BN6A038300
description	cam switch 4 operating positions 3NO/1CO sequence 0-1-2-3 32A shaft \varnothing 6x4.6mm shaft L 23mm connection screw ceramic		

7-position

			
1			
GEV No.	300025	Ref. No.	1616100 6A045500 MA1616100
description	cam switch 7 operating positions 1NO/2CO sequence 0-1-2-3-4-5-6 16A shaft \varnothing 6x4.6mm shaft L 23mm connection screw 7-position ceramic		
For models:	40SEC, 40SEC-1825060, 60SEC, 60SEC-1825070, 61SECFE-1826075, 72-02CEPQ, 72-02CEPQ-12701201, 72-02CEPT, 72-02CEPT-12701001, 72-02CEPT-2212701001, 72-02TCEPQ, 72-02TCEPQ-12731201, 72-02TCEPT, 72-02TCEPT-12731001, 721CAE-1000255, 721CAE-1000255R, 721TCE-1009255, 721TCE-1009255R, 72CA-E-1000250, 72CA-E-1000250R, 7-2FXE, 72TCE-1009250, 72TCE-1009250R, 74-02CEEPEQ, 74-02CEEPEQ-12701210, 74-02CEEPT, 74-02CEEPT-12701010, 74-02CEPQ, 74-02CEPQ-12701202, 74-02CEPT, 74-02CEPT-12701002, 74-02TCEPQ, 74-02TCEPQ-12731202, 74-02TCEPT, 74-02TCEPT-12731002, 741CAE-1000305, 741CAE-1000305R, 741CE-1000405, 741CE-1000405R, 741TCE-1009305, 741TCE-1009305R, 74CAE-000300, 74CA-E-1000300, 74CA-E-1000300R, 74CE-000400, 74CE-1000400, 74CE-1000400R, 74TCE-1009300, 74TCE-1009300R, 76-02CEEANPQ...(Other models you can see in the webshop)		
accessories for	300025		
		GEV No.	112172 Ref. No. —
	knob universal \varnothing 70mm black without adaptor/dial plate		
		GEV No.	112213 Ref. No. —
	knob dial plate silver switch 7-position t.max.°C°C ED \varnothing 63mm ID \varnothing 45.5mm		
		GEV No.	112311 Ref. No. —
	knob adapter shaft \varnothing 6x4.6mm L 0mm with spring		



3 operating positions

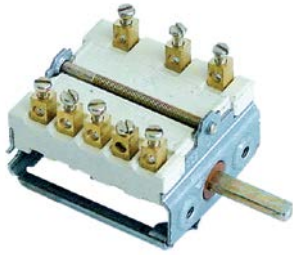

GEV No.	300167	Ref. No.	6A001412 BN6A001412
description	cam switch 3 operating positions 2NO/1CO sequence 0-1-2 16A shaft ø 6x4.6mm shaft L 23mm connection screw		
For models:	94-04PEI100L, 94-04PEI100L-12901765, 94-04PEI110L-12901765BN, 94-04PEI150L, 94-04PEI150L-12901767, 94-04PEI150L-12901767BN, 9PN-EI100, 9PN-EI150		

4 operating positions

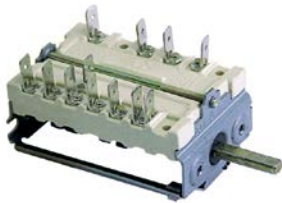

GEV No.	300010	Ref. No.	R65080010
description	cam switch 4 operating positions 2NO/2CO sequence 0-1-2-3 16A shaft ø 6x4.6mm shaft L 23mm connection male faston 6.3mm ceramic		
For models:	CCE042M, CCE051M, CCE071M, CCE101M, CCE102M, CCG051M, CCG071M, CCG101M, CCG102M		



GEV No.	300081	Ref. No.	MA1309000
description	cam switch 4 operating positions 3NO/2CO sequence 0-1-2-3 16A shaft ø 6x4.6mm shaft L 23mm connection screw		

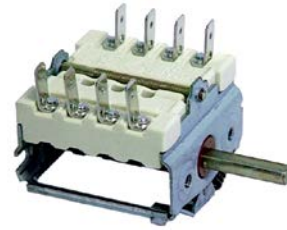

GEV No.	300184	Ref. No.	6A046750 BN6A046750
description	cam switch 4 operating positions sequence 0-3-2-1 shaft ø 6x4.6mm connection male faston 4-pole		
For models:	110-135CGE, 110-135CGE2P, 110-135CGEE, 110-135CGEE2P, 110-135CGEEP, 110-135CGEP, 110-90CGE, 110-90CGE1P, 110-90CGEP, 110-90CTEE, 110-90CTGE, 110-90FTEE, 110-90FTTGE, 74-02CEE-PQ, 74-02CEEPQ-12701210, 74-02CEEPT, 74-02CEEPT-12701010, 74-02CGE, 74-02CGE-12700011, 74-02CGE-12700011TA, 74-02CTEE, 74-02CTEE-12701180, 74-02CTGE, 74-02CTGE-12700190, 74-02CTGE-12700190TA, 74-02VTCE, 74-02VTCEV, 74-02VTCEV-12701020, 76-02CEEANPQ, 76-02CEEANPT, 76-02CEEACAPQ, 76-02CEEACAPT, 76-02CEEAPQ-12701216, 76-02CEEPT-12701016, 76-02CEE-PQ-12701215, 76-02CEEPT-12701015, 76-02CGE, 76-02CGE-12700017, 76-02CGE-12700017TA, 76-02CGEE, 76-02CGEE-12700018, 76-02CGEE-12700018TA, 7FTTF-GE800, 7FTTF-GE805, 7FTTF-GE820, 7FTTF-GE825, 7NPCF-VCE800, 7PCF-E120, 7PCF-E800, 7PCF-GE120... (Other models you can see in the webshop)		

5 operating positions

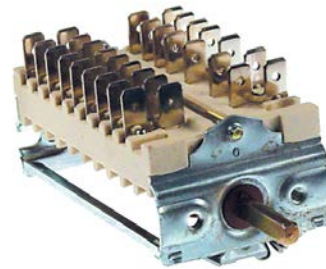

GEV No.	346352	Ref. No.	6A046015 BN6A046015
description	cam switch 5 operating positions 5NO/2CO sequence 1-0-2-3-4 16A shaft ø 6x4.6mm shaft L 23mm connection male faston 6.3mm ceramic		
For models:	CV10E, CV10E-1320100, CV10E-2, CV10E2-1320140, CV10EB-1321100, CV10E-S, CV10ES-1320150, CV10E-S2, CV10ES2-1320190, CV10G, CV10G-1310100, CV10G-2, CV10G2-1310140, CV10GB-1311100, CV10G-S, CV10GS-1310150, CV10G-S2, CV10GS2-1310190, CV20E, CV20E-1320200, CV20E-2, CV20E2-1320240, CV20EB-1321200, CV20E-S, CV20ES-1320250, CV20E-S2, CV20ES2-1320290, CV20G, CV20G-1310200, CV20G-2, CV20G2-1310240, CV20GB-1311200, CV20G-S, CV20GS-1310250, CV20G-S2, CV20GS2-1310290, CV21E, CV21E-1322100, CV21E-2, CV21E2-1322140, CV21E-S, CV21ES-1322150, CV21E-S2, CV21ES2-1322190, CV21G, CV21G-1312100, CV21G-2, CV21G2-1312140, CV21G-S, CV21GS-1312150... (Other models you can see in the webshop)		



10 operating positions



GEV No.	345666	Ref. No.	1037103800
description	cam switch 10 operating positions 6NO/1CO sequence 0-1-2-3-4-5-6-7-8-9 8A shaft ø 6x4.6mm shaft L 23mm connection male faston 6.3mm plastic		
For models:	FOE60M, OFOE60M, OFOE-60M-12601001		

operation switches



GEV No.	300002	Ref. No.	6A046001 BN6A046001
description	cam switch 2 operating positions 4NO 16A sequence 0-1 shaft ø 6x4.6mm shaft L 23mm connection male faston 6.3mm ceramic		
For models:	110-135CGE, 110-135CGE2P, 110-135CGEE, 110-135CGEE2P, 110-135CGEEP, 110-135CGEP, 110-90CGE, 110-90CGE1P, 110-90CGEP, 110-90CTEE, 110-90CTGE, 110-90FTFE, 110-90FTTGE, 40SEC-1825060, 40SECP, 40SECP-1825080, 40SECP-1825080E, 40SEFR, 40SEFR-1826140, 40SEFR2S-1826140, 40SEFT, 40SEFT-1825040, 40SEFT-1825045, 40SEFTC, 40SEFTC-1825045, 40SEFTR, 40SEFTR-1825041, 41SEFR, 41SEFR-1826120, 41SEFR2S-1826120, 421SEFR-1826125, 55-45CPE, 55-90CPE, 60SEC-1825070, 60SEFR, 60SEFR-1826150, 60SEFR2S-1826150, 60SEFT, 60SEFT1-2R-1825051, 60SEFT1-3RIG-1825050, 60SEFT-1825050, 60SEFTC, 60SEFTC-1825050, 60SEFTC-1825055, 60SEFTR-1825052, 60SEFTRIG-1825050, 61SECFE-1826075, 61SEFR, 61SEFR-1826130, 61SEFR2S-1826130...(Other models you can see in the webshop)		



GEV No.	300080	Ref. No.	6A044800 710300 MA710300	
description	cam switch 2 operating positions 4NO 16A sequence 0-1 shaft ø 6x4.6mm shaft L 23mm connection screw operation switch ceramic ambient temperature max. 150°C			
For models:	40SEBM, 40SEBM-1826100, 40SECP, 40SEKB-1825200, 40SKE, 40SKE-1825200, 60SEBM, 60SEBM-1826110, 72-02FRGM, 72-02FRGM-12700530, 72-02FRGM-12700530TA, 73-02FRGM, 73-02FRGM-12700580, 73-02FRGM-12700580TA, 74-02FRGM, 74-02FRGM-12700630, BRE40, BRE40D, BRE40DB, BRE40DG, BRE40DGB, BRE40G, CFE60, CFE60P, FTE100B, FTE100BR, FTE100CRL, FTE40B, FTE40BR, FTE40C, FTE40D, FTE40DC, FTE60B, FTE60BR, FTE60C, FTE60D, FTE60DC, FTE60DR, FTE60DRCL, OBRE40, OBRE-40-12601110, OBRE-40-12601110MN, OCFE60, OCFE-60-12601005, OCFE-60-12601005MN, OCFGE61, OFTE-100C-12601136, OFTE-100C-12601136MN, OFTE100CRL, OFTE-100CRL-12601138...(Other models you can see in the webshop)			
accessories for	300080			
	GEV No.	551456	Ref. No.	—
	gasket for switch ED ø 14mm ID ø 2.5mm thickness 3.5mm white			



GEV No.	300200	Ref. No.	1037313200 6A046000 MA1037313200
description	operation switch 2 operating positions 2NO 16A sequence 0-1 shaft ø 6x4.6mm shaft L 23mm connection male faston 6.3mm operation switch ceramic		
For models:	110-90FTE, 110-90FTE1-2R, 110-90FTEC, 110-90FTEC1-2R, 110-90FTECR, 110-90FTEE, 110-90FTEER, 110-90TFTE, 110-90TFTE1-2R, 110-90TFTEC, 110-90TFTEC1-2R, 110-90TFTECR, 110-90TFTEER, 40SEC, 40SEC-1825060, 40SEFT-1825040, 55-45FRE, 55-90FRE, 60SEC, 60SEC-1825070, 61FE-1826050, 61SCGFE3S-1826055, 61SCGFE4S-1827055, 61SECFE-1826075, 710FRE-1077700, 72-02CBE-12701150, 72-02FRE, 72-02FRE-12701500, 72-02TCBE-12731150, 720FRE-1077800, 722FRE-1078000, 725KB-E-1000200, 725KBE-1000200, 725KB-E-1000200R, 725KB-EB-1000201, 725KBEB-1000201, 725KB-EB-1000201R, 725KBEM-1000210, 725KB-EM-1000210R, 725KB-EMB-1000211, 725KBEMB-1000211, 74-02FRE, 74-02FRE-12701600, 74-02KBEB, 74-02KBEB-12701110, 74-02KBEB1, 74-02KBEB1-12701115, 74-02KBEMB, 74-02KBEMB-12701120, 74-02KBEMB1...(Other models you can see in the webshop)		

rotary switches

BREMAS

A1200 series



GEV No.	345912	Ref. No.	10300206
description	rotary switch		
For models:	G12S		



GEV No.	345913	Ref. No.	10300207 10300208
description	rotary switch sets of contacts 4 4 1-2-3-4 type CS012M014 400V 12A shaft ø 5x5mm shaft L 23mm shaft square with knob connection screw		
For models:	OLH600, OLHT11-1081071, OLHT11D-1081072, OLHT11E-CO-1081070, OLHT11S, OLHT11S-Neutra, OLHT12-1081075, OLHT12EL-1081080, OLHT12EL-1081083, OLHT12ELD-1081081, OLHT12ELPLUS-1081086, OLHT12S, OLHT12S-Neutra		

			
1			
GEV No.	347857	Ref. No.	3002031
description	rotary switch sets of contacts 6 4 0-1-2-3 type CA0127042 600V 12A shaft ø 5x5mm shaft L 25mm shaft square with knob connection screw		
For models:	OLAX151, OLAX151EDX-1080725, OLAX151ELEFT-1080727, OLAX151-highspeed, OLAX160, OLAX160E-1080750, OLAX160E-1080751, OLAX160V-1080755, OLAX160V-1080756, OLAX160V-1081031, OLAX160V-1081032, OLAX210, OLAX210E-1081029, OLAX210E-1081030, OLAX220, OLAX220E-1080787, OLAX220E-1080788, OLAX220V-1080789, OLAX220V-1080790, OLAX230, OLAX230E-1080791, OLAX230E-1080792, OLAX230V-1080793, OLAX230V-1080794, OLAX240, OLAX240E-1080795, OLAX240E-1080796, OLAX240V-1080797, OLAX240V-1080798, OLBX230, OLBX230Special, OLBX280, OLUX220		

			
1			
GEV No.	110731	Ref. No.	89321
description	knob switch zero mark ø 29mm black shaft special		
For models:	OLH600, OLHT11-1081071, OLHT11D-1081072, OLHT11E-CO-1081070, OLHT11S, OLHT12-1081075, OLHT12EL-1081080, OLHT12EL-1081083, OLHT12ELD-1081081, OLHT12ELPLUS-1081086, OLHT12S		

producer-specific rotary switches

DIHR / KROMO

			
1			
GEV No.	345911	Ref. No.	89349
description	element holder blue-grey format round 0-3		
For models:	OLH600, OLHT11-1081071, OLHT11D-1081072, OLHT11E-CO-1081070, OLHT11S, OLHT12-1081075, OLHT12EL-1081080, OLHT12EL-1081083, OLHT12ELD-1081081, OLHT12ELPLUS-1081086, OLHT12S		

			
1			
GEV No.	345896	Ref. No.	89332
description	O-ring EPDM thickness 1.5mm ID ø 37mm Qty 1 pcs		
For models:	OLDerby, OLDS35-1081005, OLDS37-1081006, OLDS37D-1081007, OLDS37LS-1081008, OLDS37LSD-1081009, OLDS40-1081010, OLDS40D-1081011, OLDS40LS-1081012, OLDS40LSD-1081013, OLG600, OLGastro450, OLH600, OLHT11-1081071, OLHT11D-1081072, OLHT11ECO-1081070, OLHT11S, OLHT12-1081075, OLHT12EL-1081080, OLHT12EL-1081083, OLHT12ELD-1081081, OLHT12ELPLUS-1081086, OLHT12S, OLLinear, OLLP1-800, OLLP1-800-1080721, OLLP1-800EL, OLLP1-S8, OLLP1-S8EL, OLLP-ZERO, OLLPZERO-1081057, OLStar		

			
1			
GEV No.	697909	Ref. No.	89322
description	fastening angle for rotary switch plastic L 76mm W 31mm		
For models:	OLH600, OLHT11-1081071, OLHT11D-1081072, OLHT11E-CO-1081070, OLHT11S, OLHT12-1081075, OLHT12EL-1081080, OLHT12EL-1081083, OLHT12ELD-1081081, OLHT12ELPLUS-1081086, OLHT12S		

			
1			
GEV No.	345913	Ref. No.	10300207 10300208
description	rotary switch sets of contacts 4 4 1-2-3-4 type CS012M014 400V 12A shaft ø 5x5mm shaft L 23mm shaft square with knob connection screw		
For models:	OLH600, OLHT11-1081071, OLHT11D-1081072, OLHT11E-CO-1081070, OLHT11S, OLHT11S-Neutra, OLHT12-1081075, OLHT12EL-1081080, OLHT12EL-1081083, OLHT12ELD-1081081, OLHT12ELPLUS-1081086, OLHT12S, OLHT12S-Neutra		

			
1			
GEV No.	697910	Ref. No.	89323
description	fixing plate for rotary switch L 80mm W 60mm thickness 1mm		
For models:	OLH600, OLHT11-1081071, OLHT11D-1081072, OLHT11E-CO-1081070, OLHT11S, OLHT12-1081075, OLHT12EL-1081080, OLHT12EL-1081083, OLHT12ELD-1081081, OLHT12ELPLUS-1081086, OLHT12S		

touch sensitive light switches

			
1			
GEV No.	346388	Ref. No.	R65260750
description	touch sensitive light switch 1NOVA for combi-steamer L 47mm W 20mm H 30mm		
For models:	CCE071M, CCE101M, CCE102M, CCG071M, CCG101M, CCG102M, CKEP06, CKEP06B, CKEP10, CKEP10B, CKEP20, CKEP20B, CKEP21, CKEP21B, CKEP40, CKEP40B, CKET06, CKET06B, CKET10, CKET10B, CKET20, CKET20B, CKET21, CKET21B, CKET40, CKET40B, CKGP06, CKGP06B, CKGP10, CKGP10B, CKGP20, CKGP20B, CKGP21, CKGP21B, CKGP40, CKGP40B, CKGT06, CKGT06B, CKGT10, CKGT10B, CKGT20, CKGT20B, CKGT21, CKGT21B, CKGT40, CKGT40B		





magnetic switches

36x13mm

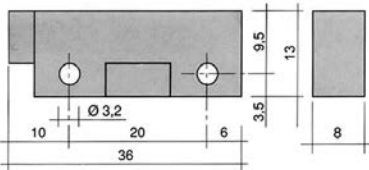

1



GEV No.	345335	Ref. No.	995405
description	magnetic switch L 36mm W 13mm 1NO 250V 0.04A P max. 10W connection cable cable length 960mm		
For models:	031, 051, 081, 121, 161, BBC051DF-ASX-4186V21A286220, BBF031AF-ASX-4186V204286210, KBC051-20354051, KBC151-20354151, KBC201-20355201, KBC201-PASS-THROUGH-20355221, KBC202-20355202, KBC202-PASS-THROUGH-20355222, KBF051T-20363050, KRC201-20358201, KRC202-20358202, OBC051DF-ASX-6V21A-286220OL, OBC081AF-ASX-6V221285220OL, OBC121DF-ASX-6V23A-285220OL, OBC161DF-ASX-6V24A485220OL, OBF031AF-ASX-6V204286210OL, OLBFO51-20364051OL, OLBFO51T-20363050OL, OLBF151-20364151OL, OLBFO21-20365201OL, OLBFO21-20365221OL, OLBFO22-20365202OL, OLBFO22-20365222OL, OLRFO21-20368201OL, OLRFO22-20368202OL		
accessories for	345335		
		GEV No.	519049
		Ref. No.	—
	magnet \varnothing mm L 63mm H 10.7mm W 18.8mm hole distance 52mm M2 hole \varnothing 2mm		

37x16mm

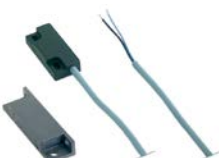

1

GEV No.	347790	Ref. No.	R65265100
description	magnetic switch L 37mm W 16mm 1NO 250V connection cable cable length 1960mm 10W with magnet nominal 0.04A		
For models:	CKEP06, CKEP06B, CKEP10, CKEP10B, CKEP20, CKEP20B, CKEP21, CKEP21B, CKEP40, CKEP40B, CKET06, CKET06B, CKET10, CKET10B, CKET20, CKET20B, CKET21, CKET21B, CKET40, CKET40B, CKGP06, CKGP06B, CKGP10, CKGP10B, CKGP20, CKGP20B, CKGP21, CKGP21B, CKGP40, CKGP40B, CKGT06, CKGT06B, CKGT10B, CKGT20, CKGT20B, CKGT21, CKGT21B, CKGT40, CKGT40B		

40x13mm



1

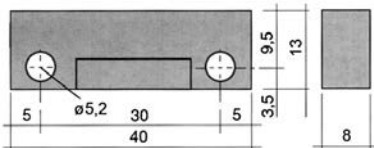

GEV No.	346351	Ref. No.	6A047085 BN6A047085
description	magnetic switch L 40mm W 13mm 1NO 250V 0.04A P max. 10W connection cable cable length 650mm		
For models:	CMV6ES2-1320392, CV10E, CV10E-1320100, CV10E-1320110, CV10E-2, CV10E2-1320140, CV10EB-1321100, CV10E-S, CV10ES-1320150, CV10E-S2, CV10ES2-1320190, CV10G, CV10G-1310100, CV10G-2, CV10G2-1310140, CV10GB-1311100, CV10G-S, CV10GS-1310150, CV10G-S2, CV10GS2-1310190, CV20E, CV20E-1320200, CV20E-2, CV20E2-1320240, CV20EB-1321200, CV20E-S, CV20ES-1320250, CV20E-S2, CV20ES2-1320290, CV20G, CV20G-1310200, CV20G-2, CV20G2-1310240, CV20GB-1311200, CV20G-S, CV20GS-1310250, CV20G-S2, CV20GS2-1310290, CV21E, CV21E-1322100, CV21E-2, CV21E2-1322140, CV21E-S, CV21ES-1322150, CV21E-S2, CV21ES2-1322190, CV21G, CV21G-1312100, CV21G-2, CV21G2-1312140...(Other models you can see in the webshop)		



1

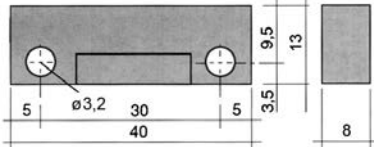

GEV No.	345990	Ref. No.	10778
description	magnetic switch L 40mm W 13mm 1NO 250V 0.04A P max. 10W connection male faston 6.3mm cable length 2000mm		
For models:	OLDS45, OLDS50, OLDS50-1081088, OLDS50D-1081089, OLDS50E-1081090, OLDS50ED-1081091, OLDS50-Neutra, OLG540, OLG545, OLG550, OLG550-1080705, OLG550D-1080706, OLG550E-1080730, OLG550ECO-1081014, OLG550ECOD-1081015, OLG550ED-1080731, OLG550-Neutra, OLG585, OLG585-1081016, OLG585D-1081017, OLG585-Neutra		



65x20mm

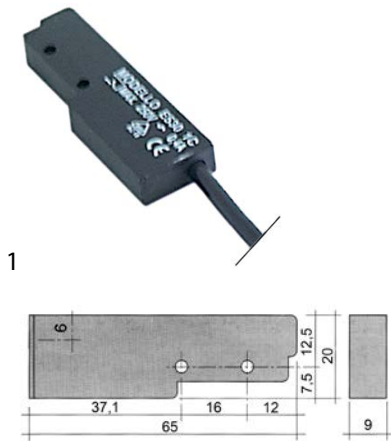

GEV No.	345116	Ref. No.	3003112
description	magnetic switch L 65mm W 20mm 1NO 250V 0.4A P max. 100W connection cable cable length 3000mm		
For models:	OLAX151, OLAX151EDX-1080725, OLAX151ELEFT-1080727, OLAX151-highspeed, OLAX160, OLAX160E-1080750, OLAX160E-1080751, OLAX160V-1080755, OLAX160V-1080756, OLAX160V-1081031, OLAX160V-1081032, OLAX210, OLAX210E-1081029, OLAX210E-1081030, OLAX220, OLAX220E-1080787, OLAX220E-1080788, OLAX220V-1080789, OLAX220V-1080790, OLAX230, OLAX230E-1080791, OLAX230E-1080792, OLAX230V-1080793, OLAX230V-1080794, OLAX240, OLAX240E-1080795, OLAX240E-1080796, OLAX240V-1080797, OLAX240V-1080798, OLAX250, OLAX250E-1080760, OLAX250E-1080761, OLAX250V-1080765, OLAX250V-1080766, OLAX300, OLAX300E-1080770, OLAX300E-1080771, OLAX300E-1081033, OLAX300E-1081035, OLAX300E-1081036, OLAX300LC, OLAX300LCE-1081034, OLAX300V-1080775, OLAX300V-1080776, OLAX310, OLAX310E-1081110, OLAX310E-1081111, OLAX310LC, OLAX310LCE-1081114, OLAX310LCE-1081115...(Other models you can see in the webshop)		
accessories for	345116		
	GEV No.	345399	Ref. No. —
	magnet ø 3.3mm L 40mm H 8mm W 13mm hole distance 30mm M3		

ø 9mm



GEV No.	345991	Ref. No.	2000309
description	magnetic switch 250V 0.04A P max. 10W probe L 30mm 1NO connection cable cable length 2000mm		
For models:	OLLP1-1081059, OLLP1-800, OLLP1-800-1080721, OLLP1-800EL, OLLP1-800-Neutra, OLLP2-1080722, OLLP2Electronic-Neutra, OLLP3-1080723, OLLP3Electronic-Neutra, OLLP4-800-1081058, OLLP4-800Electronic-Neutra, OLLP-ZERO, OLLPZERO-1081057		

miscellaneous



GEV No.	401961	Ref. No.	R66110300
description	magnetic switch door contact		
For models:	CCE071M, CCE101M, CCE102M, CCG071M, CCG101M, CCG102M, CKEP06, CKEP06B, CKEP10, CKEP10B, CKEP20, CKEP20B, CKEP21, CKEP21B, CKEP40, CKEP40B, CKET06, CKET06B, CKET10, CKET10B, CKET20, CKET20B, CKET21, CKET21B, CKET40, CKET40B, CKGP06, CKGP06B, CKGP10, CKGP10B, CKGP20, CKGP20B, CKGP21, CKGP21B, CKGP40, CKGP40B, CKGT06, CKGT06B, CKGT10, CKGT10B, CKGT20, CKGT21, CKGT21B, CKGT40, CKGT40B		

accessories

magnets



GEV No.	347702	Ref. No.	3003113
description	magnet H 10mm ED ø 12mm		
For models:	OLAX151, OLAX151EDX-1080725, OLAX151ELEFT-1080727, OLAX151-highspeed, OLAX160, OLAX160E-1080750, OLAX160E-1080751, OLAX160V-1080755, OLAX160V-1080756, OLAX160V-1081031, OLAX160V-1081032, OLAX210, OLAX210E-1081029, OLAX210E-1081030, OLAX220, OLAX220E-1080787, OLAX220E-1080788, OLAX220V-1080789, OLAX220V-1080790, OLAX230, OLAX230E-1080791, OLAX230E-1080792, OLAX230V-1080793, OLAX230V-1080794, OLAX240, OLAX240E-1080795, OLAX240E-1080796, OLAX240V-1080797, OLAX240V-1080798, OLAX250, OLAX250E-1080760, OLAX250E-1080761, OLAX250V-1080765, OLAX250V-1080766, OLAX300, OLAX300E-1080770, OLAX300E-1080771, OLAX300E-1081033, OLAX300E-1081035, OLAX300E-1081036, OLAX300LC, OLAX300LCE-1081034, OLAX300V-1080775, OLAX300V-1080776, OLAX310, OLAX310E-1081110, OLAX310E-1081111, OLAX310LC, OLAX310LCE-1081114, OLAX310LCE-1081115...(Other models you can see in the webshop)		

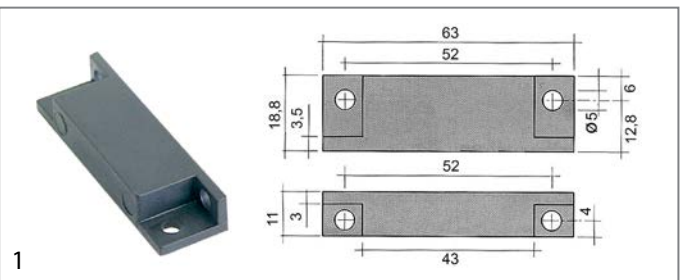

GEV No.	345336	Ref. No.	3108890 80232 BN3108890
description	magnet ø 4.8mm L 63mm H 11mm W 18.8mm hole distance 51mm M4		
For models:	CMV6ES2-1320392, CV10E, CV10E-1320100, CV10E-1320110, CV10E-2, CV10E2-1320140, CV10EB-1321100, CV10E-S, CV10ES-1320150, CV10E-S2, CV10ES2-1320190, CV10G, CV10G-1310100, CV10G-2, CV10G2-1310140, CV10GB-1311100, CV10G-S, CV10GS-1310150, CV10G-S2, CV10GS2-1310190, CV20E, CV20E-1320200, CV20E-2, CV20E2-1320240, CV20EB-1321200, CV20E-S, CV20ES-1320250, CV20E-S2, CV20ES2-1320290, CV20G, CV20G-1310200, CV20G-2, CV20G2-1310240, CV20GB-1311200, CV20G-S, CV20GS-1310250, CV20G-S2, CV20GS2-1310290, CV21E, CV21E-1322100, CV21E-2, CV21E2-1322140, CV21E-S, CV21ES-1322150, CV21E-S2, CV21ES2-1322190, CV21G, CV21G-1312100, CV21G-2, CV21G2-1312140...(Other models you can see in the webshop)		



magnetic holders



1			
GEV No.	524076	Ref. No.	3003058
description	magnet holder internal size 13mm H 60mm for dishwasher		
For models:	OLAX151, OLAX151EDX-1080725, OLAX151ELEFT-1080727, OLAX151-highspeed, OLAX160, OLAX160E-1080750, OLAX160E-1080751, OLAX160V-1080755, OLAX160V-1080756, OLAX160V-1081031, OLAX160V-1081032, OLAX210, OLAX210E-1081029, OLAX210E-1081030, OLAX220, OLAX220E-1080787, OLAX220E-1080788, OLAX220V-1080789, OLAX220V-1080790, OLAX230, OLAX230E-1080791, OLAX230E-1080792, OLAX230V-1080793, OLAX230V-1080794, OLAX240, OLAX240E-1080795, OLAX240E-1080796, OLAX240V-1080797, OLAX240V-1080798, OLAX250, OLAX250E-1080760, OLAX250E-1080761, OLAX250V-1080765, OLAX250V-1080766, OLAX300, OLAX300E-1080770, OLAX300E-1080771, OLAX300E-1081033, OLAX300E-1081035, OLAX300E-1081036, OLAX300LC, OLAX300LCE-1081034, OLAX300V-1080775, OLAX300V-1080776, OLAX310, OLAX310E-1081110, OLAX310E-1081111, OLAX310LC, OLAX310LCE-1081114, OLAX310LCE-1081115...(Other models you can see in the webshop)		
accessories for	524076		
	GEV No.	524655	Ref. No. —
	screw cap for magnet holder thread M16x1.25 SS WS 19		

miscellaneous



1			
GEV No.	346360	Ref. No.	3108879 BN3108879
description	switch mounting pos. door		
For models:	CMV6ES2-1320392, CV10E, CV10E-1320100, CV10E-1320110, CV10E-2, CV10E2-1320140, CV10E-S, CV10ES-1320150, CV10E-S2, CV10ES2-1320190, CV10G, CV10G-1310100, CV10G-2, CV10G2-1310140, CV10G-S, CV10GS-1310150, CV10G-S2, CV10GS2-1310190, CV20E, CV20E-1320200, CV20E-2, CV20E2-1320240, CV20E-S, CV20ES-1320250, CV20E-S2, CV20ES2-1320290, CV20G, CV20G-1310200, CV20G-2, CV20G2-1310240, CV20G-S, CV20GS-1310250, CV20G-S2, CV20GS2-1310290, CV21E, CV21E-1322100, CV21E-2, CV21E2-1322140, CV21E-S, CV21ES-1322150, CV21E-S2, CV21ES2-1322190, CV21G, CV21G-1312100, CV21G-2, CV21G2-1312140, CV21G-S, CV21GS-1312150, CV21G-S2, CV21GS2-1312190...(Other models you can see in the webshop)		

control equipment

MOELLER/EATON

switches (complete)

rotary switches



1			
GEV No.	346461	Ref. No.	R65080150
description	rotary switch mounting measurements ø22mm black latching 1NC/1NO sequence 0-1		
For models:	CKEP06, CKEP06B, CKEP10, CKEP10B, CKEP20, CKEP20B, CKEP21, CKEP21B, CKEP40, CKEP40B, CKGP06, CKGP06B, CKGP10, CKGP10B, CKGP20, CKGP20B, CKGP21, CKGP21B, CKGP40, CKGP40B		

ERSCE

push buttons



1			
GEV No.	346654	Ref. No.	2000284
description	push button mounting measurements ø22mm green illuminated		
For models:	OLAX250, OLAX250E-1080760, OLAX250E-1080761, OLAX250V-1080765, OLAX250V-1080766, OLAX300, OLAX300E-1080770, OLAX300E-1080771, OLAX300E-1081033, OLAX300E-1081035, OLAX300E-1081036, OLAX300LC, OLAX300LCE-1081034, OLAX300V-1080775, OLAX300V-1080776, OLAX310, OLAX310E-1081110, OLAX310E-1081111, OLAX310LC, OLAX310LCE-1081114, OLAX310LCE-1081115, OLAX310LCV-1081116, OLAX310LCV-1081117, OLAX310V-1081112, OLAX310V-1081113, OLAX320, OLAX320E-1081118, OLAX320E-1081119, OLAX320V-1081120, OLAX320V-1081121, OLAX320V-1081125, OLAX330, OLAX330E-1081122, OLAX330E-1081123, OLAX330V-1081124, OLAX380, OLAX380E-1080780, OLAX380E-1080781, OLAX380E-1081037, OLAX380E-1081038, OLAX380E-1081039, OLAX380E-1081040, OLAX380E-1081043, OLAX380E-1081044, OLAX380E-1081046, OLAX380E-1081047, OLAX380E-1081048, OLAX380E-1081051, OLAX380E-1081052, OLAX380E-1081053...(Other models you can see in the webshop)		

			
1			
GEV No.	346659	Ref. No.	3002052
description	contact block ERSCE C02 2NC max 400V 10(4)A red/red		
For models:	OLAX151, OLAX151EDX-1080725, OLAX151ELEFT-1080727, OLAX151-highspeed, OLAX160, OLAX160E-1080750, OLAX160E-1080751, OLAX160V-1080755, OLAX160V-1080756, OLAX160V-1081031, OLAX160V-1081032, OLAX210, OLAX210E-1081029, OLAX210E-1081030, OLAX220, OLAX220E-1080787, OLAX220E-1080788, OLAX220V-1080789, OLAX220V-1080790, OLAX230, OLAX230E-1080791, OLAX230E-1080792, OLAX230V-1080793, OLAX230V-1080794, OLAX240, OLAX240E-1080795, OLAX240E-1080796, OLAX240V-1080797, OLAX240V-1080798, OLAX250, OLAX250E-1080760, OLAX250E-1080761, OLAX250V-1080765, OLAX250V-1080766, OLAX300, OLAX300E-1080770, OLAX300E-1080771, OLAX300E-1081033, OLAX300E-1081035, OLAX300E-1081036, OLAX300LC, OLAX300LCE-1081034, OLAX300V-1080775, OLAX300V-1080776, OLAX310, OLAX310E-1081110, OLAX310E-1081111, OLAX310LC, OLAX310LCE-1081114, OLAX310LCE-1081115...(Other models you can see in the webshop)		

			
2			
GEV No.	346658	Ref. No.	3002051
description	contact block ERSCE C02 2NO max 400V 10(4)A green/green		
For models:	OLAX250, OLAX250E-1080760, OLAX250E-1080761, OLAX250V-1080765, OLAX250V-1080766, OLAX300, OLAX300E-1080770, OLAX300E-1080771, OLAX300E-1081033, OLAX300E-1081035, OLAX300E-1081036, OLAX300LC, OLAX300LCE-1081034, OLAX300V-1080775, OLAX300V-1080776, OLAX310, OLAX310E-1081110, OLAX310E-1081111, OLAX310LC, OLAX310LCE-1081114, OLAX310LCE-1081115, OLAX310LCV-1081116, OLAX310LCV-1081117, OLAX310V-1081112, OLAX310V-1081113, OLAX320, OLAX320E-1081118, OLAX320E-1081119, OLAX320V-1081120, OLAX320V-1081121, OLAX320V-1081125, OLAX330, OLAX330E-1081122, OLAX330E-1081123, OLAX330V-1081124, OLAX380, OLAX380E-1080780, OLAX380E-1080781, OLAX380E-1081037, OLAX380E-1081038, OLAX380E-1081039, OLAX380E-1081040, OLAX380E-1081043, OLAX380E-1081044, OLAX380E-1081046, OLAX380E-1081047, OLAX380E-1081048, OLAX380E-1081051, OLAX380E-1081052, OLAX380E-1081053...(Other models you can see in the webshop)		

SIEMENS			
3SB series ø16mm			
fascias			
			
1			
GEV No.	346357	Ref. No.	3102860 BN3102860
description	blank mounting measurements ø16mm black		
For models:	CMV6ES2-1320392, CV10E, CV10E-1320100, CV10E-1320110, CV10E-2, CV10E2-1320140, CV10EB-1321100, CV10E-S, CV10ES-1320150, CV10E-S2, CV10ES2-1320190, CV10G, CV10G-1310100, CV10G-2, CV10G2-1310140, CV10GB-1311100, CV10G-S, CV10GS-1310150, CV10G-S2, CV10GS2-1310190, CV20E, CV20E-1320200, CV20E-2, CV20E2-1320240, CV20E-S, CV20ES-1320250, CV20E-S2, CV20ES2-1320290, CV20G, CV20G-1310200, CV20G-2, CV20G2-1310240, CV20GB-1311200, CV20G-S, CV20GS-1310250, CV20G-S2, CV20GS2-1310290, CV21E, CV21E-1322100, CV21E-2, CV21E2-1322140, CV21E-S, CV21ES-1322150, CV21E-S2, CV21ES2-1322190, CV21G-1312100, CV21G2-1312140, CV21GS-1312150, CV21GS2-1312190, CV6E...(Other models you can see in the webshop)		

push buttons			
			
1			
GEV No.	346356	Ref. No.	3102801 BN3102801
description	push button mounting measurements ø16mm green		
For models:	CV10E, CV10E-1320100, CV10E-2, CV10E2-1320140, CV10EB-1321100, CV10E-S, CV10ES-1320150, CV10E-S2, CV10ES2-1320190, CV10G, CV10G-1310100, CV10G-2, CV10G2-1310140, CV10GB-1311100, CV10G-S, CV10GS-1310150, CV10G-S2, CV10GS2-1310190, CV20E, CV20E-1320200, CV20E-2, CV20E2-1320240, CV20EB-1321200, CV20E-S, CV20ES-1320250, CV20E-S2, CV20ES2-1320290, CV20G, CV20G-1310200, CV20G-2, CV20G2-1310240, CV20GB-1311200, CV20G-S, CV20GS-1310250, CV20G-S2, CV20GS2-1310290, CV21E, CV21E-1322100, CV21E-2, CV21E2-1322140, CV21E-S, CV21ES-1322150, CV21E-S2, CV21ES2-1322190, CV21G, CV21G-1312100, CV21G-2, CV21G2-1312140, CV21G-S, CV21GS-1312150...(Other models you can see in the webshop)		



3SB series ø22mm old

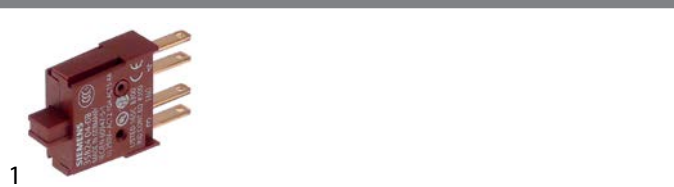

GEV No.	346354	Ref. No.	3102803 BN3102803
description	contact block SIEMENS 1NO 3SB2404-0B brown max 250V 10A		
For models:	CMV6ES2-1320392, CV10E, CV10E-1320100, CV10E-1320110, CV10E-2, CV10E2-1320140, CV10EB-1321100, CV10E-S, CV10ES-1320150, CV10E-S2, CV10ES2-1320190, CV10G, CV10G-1310100, CV10G-2, CV10G2-1310140, CV10GB-1311100, CV10G-S, CV10GS-1310150, CV10G-S2, CV10GS2-1310190, CV20E, CV20E-1320200, CV20E-2, CV20E2-1320240, CV20EB-1321200, CV20E-S, CV20ES-1320250, CV20E-S2, CV20ES2-1320290, CV20G, CV20G-1310200, CV20G-2, CV20G2-1310240, CV20GB-1311200, CV20G-S, CV20GS-1310250, CV20G-S2, CV20GS2-1310290, CV21E, CV21E-1322100, CV21E-2, CV21E2-1322140, CV21E-S, CV21ES-1322150, CV21E-S2, CV21ES2-1322190, CV21G, CV21G-1312100, CV21G-2, CV21G2-1312140...(Other models you can see in the webshop)		

signal element



GEV No.	347700	Ref. No.	2000232
description	signal element mounting measurements ø22mm green metal		
For models:	OLAX250, OLAX250E-1080760, OLAX250E-1080761, OLAX250V-1080765, OLAX250V-1080766, OLAX300, OLAX300E-1080770, OLAX300E-1080771, OLAX300E-1081033, OLAX300E-1081035, OLAX300E-1081036, OLAX300LC, OLAX300LCE-1081034, OLAX300V-1080775, OLAX300V-1080776, OLAX310, OLAX310E-1081110, OLAX310E-1081111, OLAX310LC, OLAX310LCE-1081114, OLAX310LCE-1081115, OLAX310LCV-1081116, OLAX310LCV-1081117, OLAX310V-1081112, OLAX310V-1081113, OLAX320, OLAX320E-1081118, OLAX320E-1081119, OLAX320V-1081120, OLAX320V-1081121, OLAX320V-1081125, OLAX330, OLAX330E-1081122, OLAX330E-1081123, OLAX330V-1081124, OLAX380, OLAX380E-1080780, OLAX380E-1080781, OLAX380E-1081037, OLAX380E-1081038, OLAX380E-1081039, OLAX380E-1081040, OLAX380E-1081043, OLAX380E-1081044, OLAX380E-1081046, OLAX380E-1081047, OLAX380E-1081048, OLAX380E-1081051, OLAX380E-1081052, OLAX380E-1081053...(Other models you can see in the webshop)		

TELEMECANIQUE (EFA)

XB4 series



GEV No.	347497	Ref. No.	3002056
description	contact block 2NC colour coding red		
For models:	OLAX151, OLAX151EDX-1080725, OLAX151ELEFT-1080727, OLAX151-highspeed, OLAX160, OLAX160E-1080750, OLAX160E-1080751, OLAX160V-1080755, OLAX160V-1080756, OLAX160V-1081031, OLAX160V-1081032, OLAX210, OLAX210E-1081029, OLAX210E-1081030, OLAX220, OLAX220E-1080787, OLAX220E-1080788, OLAX220V-1080789, OLAX220V-1080790, OLAX230, OLAX230E-1080791, OLAX230E-1080792, OLAX230V-1080793, OLAX230V-1080794, OLAX240, OLAX240E-1080795, OLAX240E-1080796, OLAX240V-1080797, OLAX240V-1080798, OLAX250, OLAX250E-1080760, OLAX250E-1080761, OLAX250V-1080765, OLAX250V-1080766, OLAX300, OLAX300E-1080770, OLAX300E-1080771, OLAX300E-1081033, OLAX300E-1081035, OLAX300E-1081036, OLAX300LC, OLAX300LCE-1081034, OLAX300V-1080775, OLAX300V-1080776, OLAX310, OLAX310E-1081110, OLAX310E-1081111, OLAX310LC, OLAX310LCE-1081114, OLAX310LCE-1081115...(Other models you can see in the webshop)		





GEV No.	347730	Ref. No.	2000234
description	signal element mounting measurements ø22mm metal		
For models:	OLAX250, OLAX250E-1080760, OLAX250E-1080761, OLAX250V-1080765, OLAX250V-1080766, OLAX300, OLAX300E-1080770, OLAX300E-1080771, OLAX300E-1081033, OLAX300E-1081035, OLAX300E-1081036, OLAX300LC, OLAX300LCE-1081034, OLAX300V-1080775, OLAX300V-1080776, OLAX310, OLAX310E-1081110, OLAX310E-1081111, OLAX310LC, OLAX310LCE-1081114, OLAX310LCE-1081115, OLAX310LCV-1081116, OLAX310LCV-1081117, OLAX310V-1081112, OLAX310V-1081113, OLAX320, OLAX320E-1081118, OLAX320E-1081119, OLAX320V-1081120, OLAX320V-1081121, OLAX320V-1081125, OLAX330, OLAX330E-1081122, OLAX330E-1081123, OLAX330V-1081124, OLAX380, OLAX380E-1080780, OLAX380E-1080781, OLAX380E-1081037, OLAX380E-1081038, OLAX380E-1081039, OLAX380E-1081040, OLAX380E-1081043, OLAX380E-1081044, OLAX380E-1081046, OLAX380E-1081047, OLAX380E-1081048, OLAX380E-1081051, OLAX380E-1081052, OLAX380E-1081053...(Other models you can see in the webshop)		



GEV No.	347496	Ref. No.	3002054
description	contact block 2NO colour coding green		
For models:	OLAX151, OLAX151EDX-1080725, OLAX151ELEFT-1080727, OLAX151-highspeed, OLAX160, OLAX160E-1080750, OLAX160E-1080751, OLAX160V-1080755, OLAX160V-1080756, OLAX160V-1081031, OLAX160V-1081032, OLAX210, OLAX210E-1081029, OLAX210E-1081030, OLAX220, OLAX220E-1080787, OLAX220E-1080788, OLAX220V-1080789, OLAX220V-1080790, OLAX230, OLAX230E-1080791, OLAX230E-1080792, OLAX230V-1080793, OLAX230V-1080794, OLAX240, OLAX240E-1080795, OLAX240E-1080796, OLAX240V-1080797, OLAX240V-1080798, OLAX250, OLAX250E-1080760, OLAX250E-1080761, OLAX250V-1080765, OLAX250V-1080766, OLAX300, OLAX300E-1080770, OLAX300E-1080771, OLAX300E-1081033, OLAX300E-1081035, OLAX300E-1081036, OLAX300LC, OLAX300LCE-1081034, OLAX300V-1080775, OLAX300V-1080776, OLAX310, OLAX310E-1081110, OLAX310E-1081111, OLAX310LC, OLAX310LCE-1081114, OLAX310LCE-1081115...(Other models you can see in the webshop)		

			
1			
GEV No.	347727	Ref. No.	2000231
description	signal element mounting measurements ø22mm red metal		
For models:	OLAX250, OLAX250E-1080760, OLAX250E-1080761, OLAX250V-1080765, OLAX250V-1080766, OLAX300, OLAX300E-1080770, OLAX300E-1080771, OLAX300E-1081033, OLAX300E-1081035, OLAX300E-1081036, OLAX300LC, OLAX300LCE-1081034, OLAX300V-1080775, OLAX300V-1080776, OLAX310, OLAX310E-1081110, OLAX310E-1081111, OLAX310LC, OLAX310LCE-1081114, OLAX310LCE-1081115, OLAX310LCV-1081116, OLAX310LCV-1081117, OLAX310V-1081112, OLAX310V-1081113, OLAX320, OLAX320E-1081118, OLAX320E-1081119, OLAX320V-1081120, OLAX320V-1081121, OLAX320V-1081125, OLAX330, OLAX330E-1081122, OLAX330E-1081123, OLAX330V-1081124, OLAX380, OLAX380E-1080780, OLAX380E-1080781, OLAX380E-1081037, OLAX380E-1081038, OLAX380E-1081039, OLAX380E-1081040, OLAX380E-1081043, OLAX380E-1081044, OLAX380E-1081046, OLAX380E-1081047, OLAX380E-1081048, OLAX380E-1081051, OLAX380E-1081052, OLAX380E-1081053...(Other models you can see in the webshop)		

			
1			
GEV No.	347485	Ref. No.	3002050
description	emergency switch mounting measurements ø22mm red		
For models:	OLAX151, OLAX151EDX-1080725, OLAX151ELEFT-1080727, OLAX151-highspeed, OLAX160, OLAX160E-1080750, OLAX160E-1080751, OLAX160V-1080755, OLAX160V-1080756, OLAX160V-1081031, OLAX160V-1081032, OLAX210, OLAX210E-1081029, OLAX210E-1081030, OLAX220, OLAX220E-1080787, OLAX220E-1080788, OLAX220V-1080789, OLAX220V-1080790, OLAX230, OLAX230E-1080791, OLAX230E-1080792, OLAX230V-1080793, OLAX230V-1080794, OLAX240, OLAX240E-1080795, OLAX240E-1080796, OLAX240V-1080797, OLAX240V-1080798, OLAX250, OLAX250E-1080760, OLAX250E-1080761, OLAX250V-1080765, OLAX250V-1080766, OLAX300, OLAX300E-1080770, OLAX300E-1080771, OLAX300E-1081033, OLAX300E-1081035, OLAX300E-1081036, OLAX300LC, OLAX300LCE-1081034, OLAX300V-1080775, OLAX300V-1080776, OLAX310, OLAX310E-1081110, OLAX310E-1081111, OLAX310LC, OLAX310LCE-1081114, OLAX310LCE-1081115...(Other models you can see in the webshop)		

			
2			
GEV No.	347728	Ref. No.	2000230
description	signal element mounting measurements ø22mm yellow metal		
For models:	OLAX250, OLAX250E-1080760, OLAX250E-1080761, OLAX250V-1080765, OLAX250V-1080766, OLAX300, OLAX300E-1080770, OLAX300E-1080771, OLAX300E-1081033, OLAX300E-1081035, OLAX300E-1081036, OLAX300LC, OLAX300LCE-1081034, OLAX300V-1080775, OLAX300V-1080776, OLAX310, OLAX310E-1081110, OLAX310E-1081111, OLAX310LC, OLAX310LCE-1081114, OLAX310LCE-1081115, OLAX310LCV-1081116, OLAX310LCV-1081117, OLAX310V-1081112, OLAX310V-1081113, OLAX320, OLAX320E-1081118, OLAX320E-1081119, OLAX320V-1081120, OLAX320V-1081121, OLAX320V-1081125, OLAX330, OLAX330E-1081122, OLAX330E-1081123, OLAX330V-1081124, OLAX380, OLAX380E-1080780, OLAX380E-1080781, OLAX380E-1081037, OLAX380E-1081038, OLAX380E-1081039, OLAX380E-1081040, OLAX380E-1081043, OLAX380E-1081044, OLAX380E-1081046, OLAX380E-1081047, OLAX380E-1081048, OLAX380E-1081051, OLAX380E-1081052, OLAX380E-1081053...(Other models you can see in the webshop)		

			
1			
GEV No.	347729	Ref. No.	2000311
description	rotary selector mounting measurements ø22mm black		
For models:	OLAX250, OLAX250E-1080760, OLAX250E-1080761, OLAX250V-1080765, OLAX250V-1080766, OLAX300, OLAX300E-1080770, OLAX300E-1080771, OLAX300E-1081033, OLAX300E-1081035, OLAX300E-1081036, OLAX300LC, OLAX300LCE-1081034, OLAX300V-1080775, OLAX300V-1080776, OLAX310, OLAX310E-1081110, OLAX310E-1081111, OLAX310LC, OLAX310LCE-1081114, OLAX310LCE-1081115, OLAX310LCV-1081116, OLAX310LCV-1081117, OLAX310V-1081112, OLAX310V-1081113, OLAX320, OLAX320E-1081118, OLAX320E-1081119, OLAX320V-1081120, OLAX320V-1081121, OLAX320V-1081125, OLAX330, OLAX330E-1081122, OLAX330E-1081123, OLAX330V-1081124, OLAX380, OLAX380E-1080780, OLAX380E-1080781, OLAX380E-1081037, OLAX380E-1081038, OLAX380E-1081039, OLAX380E-1081040, OLAX380E-1081043, OLAX380E-1081044, OLAX380E-1081046, OLAX380E-1081047, OLAX380E-1081048, OLAX380E-1081051, OLAX380E-1081052, OLAX380E-1081053...(Other models you can see in the webshop)		



miscellaneous

			
1			
GEV No.	347698	Ref. No.	3002055
description	push button mounting measurements ø22mm black metal		
For models:	OLAX151, OLAX151EDX-1080725, OLAX151ELEFT-1080727, OLAX151-highspeed, OLAX160, OLAX160E-1080750, OLAX160E-1080751, OLAX160V-1080755, OLAX160V-1080756, OLAX160V-1081031, OLAX160V-1081032, OLAX210, OLAX210E-1081029, OLAX210E-1081030, OLAX220, OLAX220E-1080787, OLAX220E-1080788, OLAX220V-1080789, OLAX220V-1080790, OLAX230, OLAX230E-1080791, OLAX230E-1080792, OLAX230V-1080793, OLAX230V-1080794, OLAX240, OLAX240E-1080795, OLAX240E-1080796, OLAX240V-1080797, OLAX240V-1080798, OLAX250, OLAX250E-1080760, OLAX250E-1080761, OLAX250V-1080765, OLAX250V-1080766, OLAX300, OLAX300E-1080770, OLAX300E-1080771, OLAX300E-1081033, OLAX300E-1081035, OLAX300E-1081036, OLAX300LC, OLAX300LCE-1081034, OLAX300V-1080775, OLAX300V-1080776, OLAX310, OLAX310E-1081110, OLAX310E-1081111, OLAX310LC, OLAX310LCE-1081114, OLAX310LCE-1081115...(Other models you can see in the webshop)		

			
2			
GEV No.	347699	Ref. No.	2000310
description	rotary selector mounting measurements ø22mm black metal		
For models:	OLAX250, OLAX250E-1080760, OLAX250E-1080761, OLAX250V-1080765, OLAX250V-1080766, OLAX300, OLAX300E-1080770, OLAX300E-1080771, OLAX300E-1081033, OLAX300E-1081035, OLAX300E-1081036, OLAX300LC, OLAX300LCE-1081034, OLAX300V-1080775, OLAX300V-1080776, OLAX310, OLAX310E-1081110, OLAX310E-1081111, OLAX310LC, OLAX310LCE-1081114, OLAX310LCE-1081115, OLAX310LCV-1081116, OLAX310LCV-1081117, OLAX310V-1081112, OLAX310V-1081113, OLAX320, OLAX320E-1081118, OLAX320E-1081119, OLAX320V-1081120, OLAX320V-1081121, OLAX320V-1081125, OLAX330, OLAX330E-1081122, OLAX330E-1081123, OLAX330V-1081124, OLAX380, OLAX380E-1080780, OLAX380E-1080781, OLAX380E-1081037, OLAX380E-1081038, OLAX380E-1081039, OLAX380E-1081040, OLAX380E-1081043, OLAX380E-1081044, OLAX380E-1081046, OLAX380E-1081047, OLAX380E-1081048, OLAX380E-1081051, OLAX380E-1081052, OLAX380E-1081053...(Other models you can see in the webshop)		

lamps

			
1			
GEV No.	359807	Ref. No.	3002068
description	light bulb socket Ba9s 24V 2W ø 10mm L 28mm clear		
For models:	OLAX250, OLAX250E-1080760, OLAX250E-1080761, OLAX250V-1080765, OLAX250V-1080766, OLAX300, OLAX300E-1080770, OLAX300E-1080771, OLAX300E-1081033, OLAX300E-1081035, OLAX300E-1081036, OLAX300LC, OLAX300LCE-1081034, OLAX300V-1080775, OLAX300V-1080776, OLAX310, OLAX310E-1081110, OLAX310E-1081111, OLAX310LC, OLAX310LCE-1081114, OLAX310LCE-1081115, OLAX310LCV-1081116, OLAX310LCV-1081117, OLAX310V-1081112, OLAX310V-1081113, OLAX320, OLAX320E-1081118, OLAX320E-1081119, OLAX320V-1081120, OLAX320V-1081121, OLAX320V-1081125, OLAX330, OLAX330E-1081122, OLAX330E-1081123, OLAX330V-1081124, OLAX380, OLAX380E-1080780, OLAX380E-1080781, OLAX380E-1081037, OLAX380E-1081038, OLAX380E-1081039, OLAX380E-1081040, OLAX380LC, OLAX380V-1080785, OLAX380V-1080786, OLAX400, OLAX400E-1081126, OLAX400E-1081127, OLAX400V-1081128, OLAX400V-1081129...(Other models you can see in the webshop)		

encoders and potentiometers

			
1			
GEV No.	401194	Ref. No.	3103267 BN3103267
description	encoder		
For models:	ECVM10ES2, ECVM10ES2-1324290, ECVM10ES2-1324290MN, ECVM10ES2-1326120, ECVM10GS2, ECVM10GS2-1314290, ECVM10GS2-1316120, ECVM20ES2, ECVM20ES2-1324390, ECVM20ES2-1326140, ECVM20GS2, ECVM20GS2-1314390, ECVM20GS2-1316140, ECVM21ES2, ECVM21ES2-1324490, ECVM21ES2-1326160, ECVM21GS2-1314490, ECVM21GS2-1316160, ECVM6ES2, ECVM6ES2-1324190, ECVM6ES2-1326100, ECVM6ES2-1326100H, ECVM6GS2, ECVM6GS2-1314190, ECVM6GS2-1316100, ECVP10ES2, ECVP10ES2-1324690, ECVP10ES2-1326200, ECVP10GS2, ECVP10GS2-1314690, ECVP10GS2-1316200, ECVP20ES2, ECVP20ES2-1324790, ECVP20ES2-1326220, ECVP20GS2, ECVP20GS2-1314790, ECVP20GS2-1316220, ECVP21ES2, ECVP21ES2-1324890, ECVP21ES2-1326240, ECVP21GS2, ECVP21GS2-1314890, ECVP21GS2-1316240, ECVP6ES2, ECVP6ES2-1324590, ECVP6ES2-1326180, ECVP6GS2, ECVP6GS2-1314590, ECVP6GS2-1316180, NECVM10ES2...(Other models you can see in the webshop)		

			
1			
GEV No.	401338	Ref. No.	R65301450
description	encoder		
For models:	CKEP06, CKEP06B, CKEP10, CKEP10B, CKEP20, CKEP20B, CKEP21, CKEP21B, CKEP40, CKEP40B, CKET06, CKET06B, CKET10, CKET10B, CKET20, CKET20B, CKET21, CKET21B, CKET40, CKET40B, CKGP06, CKGP06B, CKGP10, CKGP10B, CKGP20, CKGP20B, CKGP21, CKGP21B, CKGP40, CKGP40B, CKGT06, CKGT06B, CKGT10, CKGT10B, CKGT20, CKGT20B, CKGT21, CKGT21B, CKGT40, CKGT40B		



			
1			
GEV No.	300188	Ref. No.	3103260 BN3103260
description	potentiometer rotation 310° oven		
For models:	CMV6ES2-1320392, CV10E, CV10E-1320100, CV10E-1320110, CV10E-2, CV10E2-1320140, CV10EB-1321100, CV10E-S, CV10ES-1320150, CV10E-S2, CV10ES2-1320190, CV10G, CV10G-1310100, CV10G-2, CV10G2-1310140, CV10GB-1311100, CV10G-S, CV10GS-1310150, CV10G-S2, CV10GS2-1310190, CV20E, CV20E-1320200, CV20E-2, CV20E2-1320240, CV20EB-1321200, CV20E-S, CV20ES-1320250, CV20E-S2, CV20ES2-1320290, CV20G, CV20G-1310200, CV20G-2, CV20G2-1310240, CV20GB-1311200, CV20G-S, CV20GS-1310250, CV20G-S2, CV20GS2-1310290, CV21E-1322100, CV21E2-1322140, CV21ES-1322150, CV21ES2-1322190, CV21G, CV21G-1312100, CV21G-2, CV21G2-1312140, CV21G-S, CV21GS-1312150, CV21G-S2, CV21GS2-1312190...(Other models you can see in the webshop)		

lamps

indicator lights

indicator lights 2-piece (lens and indicator lamp)

indicator light lenses

ø10mm (type SRZ-3)

			
1			
GEV No.	359125	Ref. No.	6A038907 bis 2009 A038907BIS2009 BN6A038907 bis 2009
description	indicator light housings mounting measurements ø10mm red round Qty 1 pcs		

ø12mm (type SDY-3)

			
1			
GEV No.	359262	Ref. No.	6A001438 BN6A001438
description	indicator light housings mounting measurements ø12mm green round Qty 1 pcs		
For models:	94-04PEI100L, 94-04PEI100L-12901765, 94-04PEI110L-12901765BN, 94-04PEI150L, 94-04PEI150L-12901767, 94-04PEI150L-12901767BN, 9PN-EI100, 9PN-EI150		

			
1			
GEV No.	359261	Ref. No.	6A001436 BN6A001436
description	indicator light housings mounting measurements ø12mm red round Qty 1 pcs		
For models:	94-04PEI100L, 94-04PEI100L-12901765, 94-04PEI110L-12901765BN, 94-04PEI150L, 94-04PEI150L-12901767, 94-04PEI150L-12901767BN, 9PN-EI100, 9PN-EI150		

			
1			
GEV No.	359260	Ref. No.	6A001437 BN6A001437
description	indicator light housings mounting measurements ø12mm yellow round Qty 1 pcs		
For models:	94-04PEI100L, 94-04PEI100L-12901765, 94-04PEI110L-12901765BN, 94-04PEI150L, 94-04PEI150L-12901767, 94-04PEI150L-12901767BN, 9PN-EI100, 9PN-EI150		

indicator lamps for socket type SRZ / SDK / SDY / SFK

			
1			
GEV No.	359131	Ref. No.	6A038506
description	indicator lamp 400V clear connection male faston 6.3mm		
For models:	110-135CGE, 110-135CGE2P, 110-135CGEE, 110-135CGEE2P, 110-135CGEEP, 110-135CGEP, 110-135CGGE, 110-135CGGE2P, 110-135CGGEP, 110-45CBE, 110-45TCBE, 110-90CGE, 110-90CGE1P, 110-90CGEP, 110-90CTE, 110-90CTEE, 110-90CTGE, 110-90FTE, 110-90FTE1-2R, 110-90FTEC, 110-90FTEC1-2R, 110-90FTECR, 110-90FTEE, 110-90FTEFR, 110-90FTTGE, 110-90TCTE, 110-90TFTE, 110-90TFTE1-2R, 110-90TFTEC, 110-90TFTEC1-2R, 110-90TFTECR, 110-90TFTER, 40SEBM, 40SEBM-1826100, 40SEBM2S-1826100, 40SEC, 40SEC-1825060, 40SECC, 40SECC-1826260, 40SECP, 40SECP-1825080, 40SECP-1825080E, 40SEFR, 40SEFR-1826140, 40SEFR2S-1826140, 40SEFT, 40SEFT-1825040, 40SEFT-1825045, 40SEFTC, 40SEFTC-1825045...(Other models you can see in the webshop)		

			
1			
GEV No.	359133	Ref. No.	6A001435
description	indicator lamp 400V green connection male faston 6.3mm		
For models:	94-04PEI100L, 94-04PEI100L-12901765, 94-04PEI110L-12901765BN, 94-04PEI150L, 94-04PEI150L-12901767, 94-04PEI150L-12901767BN, 9PN-EI100, 9PN-EI150		

			
1			
GEV No.	359132	Ref. No.	15826
description	indicator lamp green 250V connection male faston 6.3mm protection IP54 ambient temperature max. 85°C		
For models:	OLDerby, OLDS35, OLDS35-1081005, OLDS35-1081061, OLDS35D-1081062, OLDS35-Neutra, OLDS37, OLDS37-1081006, OLDS37-1081063, OLDS37D-1081007, OLDS37D-1081064, OLDS37LS-1081008, OLDS37LSD-1081009, OLDS37-Neutra, OLDS40, OLDS40-1081010, OLDS40-1081065, OLDS40D-1081011, OLDS40D-1081066, OLDS40E-1081067, OLDS40ED-1081068, OLDS40LS-1081012, OLDS40LSD-1081013, OLDS40-Neutra, OLDS45, OLDS50, OLDS50-1081088, OLDS50D-1081089, OLDS50E-1081090, OLDS50ED-1081091, OLDS50-Neutra, OLDS50P-1081018, OLDS50PD-1081019, OLG35, OLG35-1080702, OLG35D-1081000, OLG35-Neutra, OLG600, OLGastro450, OLGastro500Plus, OLGastro500S, OLGastro750Plus, OLGastro750S, OLG537, OLG537-1080700, OLG537D-1080707, OLG537LS-1081001, OLG537LSD-1081002, OLG537-Neutra, OLG540...(Other models you can see in the webshop)		

indicator lights 3-piece (housing, lens and bulb)

lamps

light bulbs



1

GEV No.	359807	Ref. No.	3002068
description	light bulb socket Ba9s 24V 2W ø 10mm L 28mm clear		
For models:	OLAX250, OLAX250E-1080760, OLAX250E-1080761, OLAX250V-1080765, OLAX250V-1080766, OLAX300, OLAX300E-1080770, OLAX300E-1080771, OLAX300E-1081033, OLAX300E-1081035, OLAX300E-1081036, OLAX300LC, OLAX300LCE-1081034, OLAX300V-1080775, OLAX300V-1080776, OLAX310, OLAX310E-1081110, OLAX310E-1081111, OLAX310LC, OLAX310LCE-1081114, OLAX310LCE-1081115, OLAX310LCV-1081116, OLAX310LCV-1081117, OLAX310V-1081112, OLAX310V-1081113, OLAX320, OLAX320E-1081118, OLAX320E-1081119, OLAX320V-1081120, OLAX320V-1081121, OLAX320V-1081125, OLAX330, OLAX330E-1081122, OLAX330E-1081123, OLAX330V-1081124, OLAX380, OLAX380E-1080780, OLAX380E-1080781, OLAX380E-1081037, OLAX380E-1081038, OLAX380E-1081039, OLAX380E-1081040, OLAX380LC, OLAX380V-1080785, OLAX380V-1080786, OLAX400, OLAX400E-1081126, OLAX400E-1081127, OLAX400V-1081128, OLAX400V-1081129... (Other models you can see in the webshop)		



1

GEV No.	360148	Ref. No.	3002066
description	indicator light ø 10mm 24V green cable length 200mm socket screw base		
For models:	OLAX151, OLAX151EDX-1080725, OLAX151ELEFT-1080727, OLAX151-highspeed, OLAX160, OLAX160E-1080750, OLAX160E-1080751, OLAX160V-1080755, OLAX160V-1080756, OLAX160V-1081031, OLAX160V-1081032, OLAX210, OLAX210E-1081029, OLAX210E-1081030, OLAX220, OLAX220E-1080787, OLAX220E-1080788, OLAX220V-1080789, OLAX220V-1080790, OLAX230, OLAX230E-1080791, OLAX230E-1080792, OLAX230V-1080793, OLAX230V-1080794, OLAX240, OLAX240E-1080795, OLAX240E-1080796, OLAX240V-1080797, OLAX240V-1080798, OLBX230, OLBX230Special, OLBX280, OLUX220		



1

GEV No.	360111	Ref. No.	3002065
description	indicator light ø 10mm 24V red cable length 200mm socket screw base		
For models:	OLAX151, OLAX151EDX-1080725, OLAX151ELEFT-1080727, OLAX151-highspeed, OLAX160, OLAX160E-1080750, OLAX160E-1080751, OLAX160V-1080755, OLAX160V-1080756, OLAX160V-1081031, OLAX160V-1081032, OLAX210, OLAX210E-1081029, OLAX210E-1081030, OLAX220, OLAX220E-1080787, OLAX220E-1080788, OLAX220V-1080789, OLAX220V-1080790, OLAX230, OLAX230E-1080791, OLAX230E-1080792, OLAX230V-1080793, OLAX230V-1080794, OLAX240, OLAX240E-1080795, OLAX240E-1080796, OLAX240V-1080797, OLAX240V-1080798, OLBX230, OLBX230Special, OLBX280, OLUX220		

indicator lights (complete)

ø 6mm



1

GEV No.	359004	Ref. No.	10711
description	indicator light ø 6mm 230V green cable length 400mm temp.-resist. 106°C		
For models:	OLDS35-Neutra, OLDS37-Neutra, OLDS40-Neutra, OLDS50-Neutra, OLG35-Neutra, OLG37-Neutra, OLG40-Neutra, OLG50-COD-1081015, OLG50-Neutra, OLHT11S-Neutra, OLHT12S-Neutra		



1

GEV No.	360502	Ref. No.	3002067
description	indicator light ø 10mm 24V yellow cable length 200mm socket screw base		
For models:	OLAX151, OLAX151EDX-1080725, OLAX151ELEFT-1080727, OLAX151-highspeed, OLAX160, OLAX160E-1080750, OLAX160E-1080751, OLAX160V-1080755, OLAX160V-1080756, OLAX160V-1081031, OLAX160V-1081032, OLAX210, OLAX210E-1081029, OLAX210E-1081030, OLAX220, OLAX220E-1080787, OLAX220E-1080788, OLAX220V-1080789, OLAX220V-1080790, OLAX230, OLAX230E-1080791, OLAX230E-1080792, OLAX230V-1080793, OLAX230V-1080794, OLAX240, OLAX240E-1080795, OLAX240E-1080796, OLAX240V-1080797, OLAX240V-1080798, OLBX230, OLBX230Special, OLBX280, OLUX220		

ø10mm

with screw socket



1

GEV No.	359378	Ref. No.	1037300810
description	indicator light ø 10mm 230V green connection male faston 6.3mm socket screw base		
For models:	BRE40, BRE40D, BRE40DB, BRE40DG, BRE40DGB, BRE40G, BSEI40M, CFE60, CFE60P, FQE41, FQE41L, FQE41L2, FQE61, FQE61L, FQE61L2, FTE100B, FTE100BR, FTE100CRL, FTE40B, FTE40BR, FTE40C, FTE40D, FTE40DC, FTE60B, FTE60BR, FTE60C, FTE60D, FTE60DC, FTE60DR, FTE60DRCL, OBRE40, OBRE-40-12601110, OBRE-40-12601110MN, OBSEI40M, OBSEI-40M-12601700, OCFE60, OCFE-60-12601005, OCFE-60-12601005MN, OCFGE61, OFQE41, OFQE-41-12601510, OFQE-41-12601510MN, OFQE41L, OFQE61, OFQE-61-12601610, OFQE-61-12601610MN, OFQE61L, OFTE-100C-12601136, OFTE-100C-12601136MN, OFTE100CRL...(Other models you can see in the webshop)		

with plug-in socket



1

GEV No.	359139	Ref. No.	10711/B
description	indicator light ø 10mm green 230V connection male faston 6.3mm Qty 1 pcs		
For models:	OLDS35-Neutra, OLDS37-Neutra, OLDS40-Neutra, OLDS50-Neutra, OLG35-Neutra, OLG37-Neutra, OLG40, OLG40-Neutra, OLG50ECOD-1081015, OLG50-Neutra, OLH600, OLHT-11-Neutra, OLHT11S-Neutra, OLHT12-1081075, OLHT12EL-1081080, OLHT12EL-1081083, OLHT12ELD-1081081, OLHT12ELPLUS-1081086, OLHT12S, OLHT12S-Neutra, OLLP1-800-Neutra		





			
GEV No.	359140	Ref. No.	1037300900 1037300910
description	indicator light ø 10mm yellow 230V connection male faston 6.3mm Qty 1 pcs		
For models:	BRE40, BRE40D, BRE40DB, BRE40DG, BRE40DGB, BRE40G, BSEI40M, CFE60, CFE60P, FQE41, FQE41L, FQE41L2, FQE61, FQE61L, FQE61L2, FTE100B, FTE100BR, FTE100CRL, FTE40B, FTE40BR, FTE40C, FTE40D, FTE40DC, FTE60B, FTE60BR, FTE60C, FTE60D, FTE60DC, FTE60DR, FTE60DRCL, OBME41M, OBME61M, OBRE40, OBRE-40-12601110, OBRE-40-12601110MN, OBSEI40M, OBSEI-40M-12601700, OCFE60, OCFE-60-12601005, OCFE-60-12601005MN, OCFGE61, OFQE41, OFQE-41-12601510, OFQE-41-12601510MN, OFQE41L, OFQE61, OFQE-61-12601610, OFQE-61-12601610MN, OFQE61L, OFTE-100C-12601136...(Other models you can see in the webshop)		

<p>ø12mm</p> <p>with screw socket</p> 			
GEV No.	359994	Ref. No.	6A039207 BN6A039207
description	indicator light ø 12mm 400V clear connection male faston 6.3mm		
For models:	110-135CGE, 110-135CGE2P, 110-135CGEE, 110-135CGEE2P, 110-135CGEEP, 110-135CGEP, 110-135CGGE, 110-135CGGE2P, 110-135CGGEP, 110-45CBE, 110-45TCBE, 110-90CGE, 110-90CGE1P, 110-90CGEP, 110-90CTE, 110-90CTEE, 110-90CTGE, 110-90FTE, 110-90FTE1-2R, 110-90FTEC, 110-90FTEC1-2R, 110-90FTECR, 110-90FTEE, 110-90FTER, 110-90FTTGE, 110-90TCTE, 110-90TFTE, 110-90TFTE1-2R, 110-90TFTEC, 110-90TFTEC1-2R, 110-90TFTECR, 110-90TFTER, 40SEBM, 40SEBM-1826100, 40SEBM2S-1826100, 40SEC, 40SEC-1825060, 40SECC, 40SECC-1826260, 40SECP, 40SECP-1825080, 40SECP-1825080E, 40SEFR, 40SEFR-1826140, 40SEFR2S-1826140, 40SEFT, 40SEFT-1825040, 40SEFT-1825045, 40SEFTC, 40SEFTC-1825045...(Other models you can see in the webshop)		

			
GEV No.	359291	Ref. No.	6A038507 von 2010 A038507VON2010 BN6A038507 von 2010 SI0101169 SIR0101169
description	indicator light ø 12mm 400V green connection male faston 6.3mm		

			
GEV No.	359292	Ref. No.	6A038907 von 2010 A038907VON2010 BN6A038907 von 2010
description	indicator light ø 12mm 400V red connection male faston 6.3mm		

<p>ø13mm</p> <p>with plug-in socket</p> 			
GEV No.	359016	Ref. No.	6A038500+6A039200 A038500+A039200
description	indicator light ø 13mm clear 400V model OB/2		

			
GEV No.	359015	Ref. No.	6A038500+6A038900 A038500+A038900
description	indicator light ø 13mm red 400V model OB/1		

<p>ø16mm</p> <p>with plug-in socket</p> 			
GEV No.	359788	Ref. No.	R65270160
description	indicator light ø 16mm 230V green connection male faston 6.3mm		
For models:	CCE042M, CCE071M, CCE101M, CCE102M, CCG071M, CCG101M, CCG102M		

			
GEV No.	359789	Ref. No.	R65270150
description	indicator light ø 16mm 230V yellow connection male faston 6.3mm		
For models:	CCE042M, CCE071M, CCE101M, CCE102M, CCG071M, CCG101M, CCG102M		

<p>ø18mm</p> 			
GEV No.	346358	Ref. No.	3102850 BN3102850
description	lamp socket ø 18mm 230V without cap		
For models:	CV10E, CV10E-1320100, CV10E-2, CV10E2-1320140, CV10EB-1321100, CV10E-S, CV10ES-1320150, CV10E-S2, CV10ES2-1320190, CV10G, CV10G-1310100, CV10G-2, CV10G2-1310140, CV10GB-1311100, CV10G-S, CV10GS-1310150, CV10G-S2, CV10GS2-1310190, CV20E, CV20E-1320200, CV20E-2, CV20E2-1320240, CV20EB-1321200, CV20E-S, CV20ES-1320250, CV20E-S2, CV20ES2-1320290, CV20G, CV20G-1310200, CV20G-2, CV20G2-1310240, CV20GB-1311200, CV20G-S, CV20GS-1310250, CV20G-S2, CV20GS2-1310290, CV21E, CV21E-1322100, CV21E-2, CV21E2-1322140, CV21E-S, CV21ES-1322150, CV21E-S2, CV21ES2-1322190, CV21G, CV21G-1312100, CV21G-2, CV21G2-1312140, CV21G-S, CV21GS-1312150...(Other models you can see in the webshop)		

28.5x28.5mm

lamps (complete)



1

GEV No.	345978	Ref. No.	15862
description	indicator light mounting measurements 28.5x28.5mm 230V green		
For models:	G12S		

screw-on/push-on fit

light bulbs

for indicator lights



1

GEV No.	359807	Ref. No.	3002068
description	light bulb socket Ba9s 24V 2W ø 10mm L 28mm clear		
For models:	OLAX250, OLAX250E-1080760, OLAX250E-1080761, OLAX250V-1080765, OLAX250V-1080766, OLAX300, OLAX300E-1080770, OLAX300E-1080771, OLAX300E-1081033, OLAX300E-1081035, OLAX300E-1081036, OLAX300LC, OLAX300LCE-1081034, OLAX300V-1080775, OLAX300V-1080776, OLAX310, OLAX310E-1081110, OLAX310E-1081111, OLAX310LC, OLAX310LCE-1081114, OLAX310LCE-1081115, OLAX310LCV-1081116, OLAX310LCV-1081117, OLAX310V-1081112, OLAX310V-1081113, OLAX320, OLAX320E-1081118, OLAX320E-1081119, OLAX320V-1081120, OLAX320V-1081121, OLAX320V-1081125, OLAX330, OLAX330E-1081122, OLAX330E-1081123, OLAX330V-1081124, OLAX380, OLAX380E-1080780, OLAX380E-1080781, OLAX380E-1081037, OLAX380E-1081038, OLAX380E-1081039, OLAX380E-1081040, OLAX380LC, OLAX380V-1080785, OLAX380V-1080786, OLAX400, OLAX400E-1081126, OLAX400E-1081127, OLAX400V-1081128, OLAX400V-1081129... (Other models you can see in the webshop)		

halogen lamp

for socket G4 / G6.35 / G9



1

GEV No.	359599	Ref. No.	R65270020
description	halogen lamp socket G4 12V 20W temp.-resist. 500°C		
For models:	CCE071M, CCE101M, CCE102M, CCG071M, CCG101M, CCG102M, CKEP06, CKEP06B, CKEP10, CKEP10B, CKEP20, CKEP20B, CKEP21, CKEP21B, CKEP40, CKEP40B, CKET06, CKET06B, CKET10, CKET10B, CKET20, CKET20B, CKET21, CKET21B, CKET40, CKET40B, CKGP06, CKGP06B, CKGP10, CKGP10B, CKGP20, CKGP20B, CKGP21B, CKGP40, CKGP40B, CKGT06, CKGT06B, CKGT10, CKGT10B, CKGT20B, CKGT21, CKGT21B, CKGT40, CKGT40B		

fluorescent lamps

accessories

ballasts



1

GEV No.	401187	Ref. No.	6A047060 BN6A047060
description	electrical ballast 60W for fluorescent lamps		
For models:	CV10E, CV10E-1320100, CV10E-2, CV10E2-1320140, CV10E-S, CV10ES-1320150, CV10E-S2, CV10ES2-1320190, CV10G, CV10G-1310100, CV10G-2, CV10G2-1310140, CV10G-S, CV10GS-1310150, CV10G-S2, CV10GS2-1310190, CV20E, CV20E-1320200, CV20E-2, CV20E2-1320240, CV20E-S, CV20ES-1320250, CV20E-S2, CV20ES2-1320290, CV20G, CV20G-1310200, CV20G-2, CV20G2-1310240, CV20G-S, CV20GS-1310250, CV20G-S2, CV20GS2-1310290, CV6E, CV6E-1320000, CV6E-1320050, CV6E-2, CV6E2-1320040, CV6E-S, CV6E-S2, CV6ES2-1320090, CV6G, CV6G-1310000, CV6G-2, CV6G2-1310040, CV6G-S, CV6GS-1310050, CV6G-S2, CV6GS2-1310090, CVM10E, CVM10E-1320400...(Other models you can see in the webshop)		

fridge lamps



1

GEV No.	359595	Ref. No.	1640403
description	light bulb socket E14 15W 230-240V ø 25mm L 56mm lens L 30mm Qty 1 pcs		
For models:	KSABT70G-2045370CJD, OLKSABT140-2045240CIW, OLKSABT144-2045240CJO, OLKSABT70-2045170CIO, OLKSABT72-2045170CIT, OLKSABTV140-2045240CIY, OLKSABTV70-2045170CIR, OLKSAP70-2045270CIP, OLKSATN140-2045140CIV, OLKSATN144-2045140CIZ, OLKSATN70-2045070CIN, OLKSATN72-2045070CIS, OLKSATNV140-2045140CIX, OLKSATNV70-2045070CIQ, OLSPAB120-201707030CLN, OLSPAB200-201712030CLO, OLSPAB240-201714030CLO, OLSPABT120-201722030CII, OLSPABT124-201722030CIM, OLSPABT140-201724030CI2, OLSPABT144-201724030CI6, OLSPABT60-201716030CIC, OLSPABT70-201717030CHW, OLSPABT72-201717030CIO, OLSPABTV140-201724030CI4, OLSPABTV70-201717030CHY, OLSPATNN120-201712030CIH, OLSPATNN124-201712030CIL, OLSPATNN140-201714030CI1, OLSPATNN144-201714030CI5, OLSPATNN60-201706030CIB, OLSPATNN62-201706030CIF, OLSPATNN70-201707030CEM, OLSPATNN72-201707030CHZ, OLSPATNV120-201712030CIJ, OLSPATNV140-201714030CI3, OLSPATNV60-201706030CID, OLSPATNV70-201707030CHX, TN140, TN144, TN70, TN72		



producer-specific fridge lamps

POLARIS





GEV No.	550070	Ref. No.	165705
description	lamp socket socket E14		
For models:	KSABT70G-2045370CJD, OLKSABT140-2045240CIW, OLKSABT144-2045240CJ0, OLKSABT70-2045170CIO, OLKSABT72-2045170CIT, OLKSABTV140-2045240CIY, OLKSABTV70-2045170CIR, OLKSAP70-2045270CIP, OLKSATN140-2045140CIV, OLKSATN144-2045140CIZ, OLKSATN70-2045070CIN, OLKSATN72-2045070CIS, OLKSATNV140-2045140CIX, OLKSATNV70-2045070CIQ, OLSPAB100-201706030CLP, OLSPAB120-201707030CLN, OLSPAB200-201712030CLQ, OLSPAB240-201714030CLO, OLSPABT120-201722030CII, OLSPABT124-201722030CIM, OLSPABT140-201724030CII, OLSPABT144-201724030CI6, OLSPABT60-201716030CIC, OLSPABT70-201717030CHW, OLSPABT72-201717030CII, OLSPABTV140-201724030CI4, OLSPABTV70-201717030CHY, OLSPATNN120-201712030CIH, OLSPATNN124-201712030CIL, OLSPATNN140-201714030CI1, OLSPATNN144-201714030CI5, OLSPATNN60-201706030CIB, OLSPATNN62-201706030CIF, OLSPATNN70-201707030CEM, OLSPATNN72-201707030CHZ, OLSPATNV120-201712030CIJ, OLSPATNV140-201714030CI3, OLSPATNV60-201706030CID, OLSPATNV70-201707030CHX, TN140, TN144, TN70, TN72		

oven lamps

universal oven lamps

mounting diameter 35.5mm



GEV No.	359718	Ref. No.	1037300100
description	oven lamp mounting ø 35.5mm 230V 15W socket E14 temp.-resist. 300°C connection male faston 6.3mm hard glas		
For models:	FOE60M, OFOE60M, OFOE-60M-12601001		
spare parts for	359718		
	GEV No.	359701	Ref. No. —
	lamp socket socket E14 220-230V mounting ø 35.5mm connection male faston 6.3mm 15W		
	GEV No.	359740	Ref. No. —
	light bulb t.max. 300°C socket E14 15W 230V ø 22mm L 48mm lens L 20mm for oven lamp IMPORT		

55x70mm



GEV No.	359375	Ref. No.	R65270510
description	lamp socket complete without lamp socket E14 mounting measurements 55x70mm		
For models:	CCE042M, CCE051M, CCG051M		

lamps

halogen lamps

for socket G4 / G6.35 / G9



GEV No.	359599	Ref. No.	R65270020
description	halogen lamp socket G4 12V 20W temp.-resist. 500°C		
For models:	CCE071M, CCE101M, CCE102M, CCG071M, CCG101M, CCG102M, CKEP06, CKEP06B, CKEP10, CKEP10B, CKEP20, CKEP20B, CKEP21, CKEP21B, CKEP40, CKEP40B, CKET06, CKET06B, CKET10, CKET10B, CKET20, CKET20B, CKET21, CKET21B, CKET40, CKET40B, CKGP06, CKGP06B, CKGP10, CKGP10B, CKGP20, CKGP20B, CKGP21B, CKGP40, CKGP40B, CKGT06, CKGT06B, CKGT10, CKGT10B, CKGT20B, CKGT21, CKGT21B, CKGT40, CKGT40B		

sockets

G4 / G5,3 / G6,35



GEV No.	359836	Ref. No.	3108860 BN3108860
description	lamp socket socket G4 for halogen lamp		
For models:	CMV6E52-1320392, CV10E, CV10E-1320100, CV10E-1320110, CV10E-2, CV10E2-1320140, CV10E-S, CV10E5-1320150, CV10E-S2, CV10E52-1320190, CV10G, CV10G-1310100, CV10G-2, CV10G2-1310140, CV10G-S, CV10G5-1310150, CV10G-S2, CV10G52-1310190, CV20E, CV20E-1320200, CV20E-2, CV20E2-1320240, CV20E-S, CV20E5-1320250, CV20E-S2, CV20E52-1320290, CV20G, CV20G-1310200, CV20G-2, CV20G2-1310240, CV20G-S, CV20G5-1310250, CV20G-S2, CV20G52-1310290, CV21E, CV21E-1322100, CV21E-2, CV21E2-1322140, CV21E-S, CV21E5-1322150, CV21E-S2, CV21E52-1322190, CV21G, CV21G-1312100, CV21G-2, CV21G2-1312140, CV21G-S, CV21G5-1312150, CV21G-S2, CV21G52-1312190...(Other models you can see in the webshop)		

residual heat indicators



GEV No.	357003	Ref. No.	6A001404 BN6A001404
description	residual heat indicator single 250V connection male faston 6.3mm mounting ø 14mm temp.-resist. 180°C		
For models:	72-02TVTC, 72-02TVTCV, 72-02TVTCV-12731005, 72-02VTC, 72-02VTCV, 72-02VTG-12701005, 74-02TVTC, 74-02TVTCV, 74-02TVTCV-CV-12731006, 74-02VTC, 74-02VTCE, 74-02VTCEV, 74-02VTCEV-12701020, 74-02VTCV, 74-02VTCV-12701006, 7NPCF-VCE800, 7NPC-VCE400, 7NPC-VCE800, 7NPCVP-VCE400, 7NPCVP-VCE800, 7NPCV-VCE400, 7NPCV-VCE800, 92-04TVTC, 92-04TVTC-12931005, 92-04TVTCV-12931055, 92-04VTC, 92-04VTCV-12901055, 94-04TVTC, 94-04TVTC-12931006, 94-04TVTCV-12931056, 94-04VTC, 94-04VTCV, 94-04VTCV-12901050, 94-04VTCV-12901056, 9NPCF-VCE800, 9NPC-VCE400, 9NPC-VCE800, 9NPCVP-VCE400, 9NPCVP-VCE800, 9NPCV-VCE400, 9NPCV-VCE800		

timers

programme timers



1

GEV No.	403577	Ref. No.	R65095000
description	gear motor CDC 4901F1 engines 1 chambers 1 operation time 20s 230V 50Hz shaft ø 6x4.6mm shaft L 24mm		
For models:	CCG071M, CCG101M, CCG102M, CKEP06, CKEP06B, CKEP10, CKEP10B, CKEP20, CKEP20B, CKEP21, CKEP21B, CKEP40, CKEP40B, CKET06, CKET06B, CKET10, CKET10B, CKET20, CKET20B, CKET21, CKET21B, CKET40, CKET40B, CKGP06, CKGP06B, CKGP10, CKGP10B, CKGP20, CKGP20B, CKGP21, CKGP21B, CKGP40, CKGP40B, CKGT06, CKGT06B, CKGT10B, CKGT10B, CKGT20, CKGT20B, CKGT21, CKGT21B, CKGT40, CKGT40B		

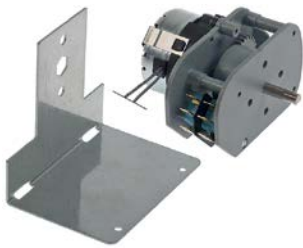

1

GEV No.	360633	Ref. No.	6A047080 BN6A047080
description	time switch kit 14000F3 operation time 120min impulse electric shaft ø 6x4.6mm shaft L 20mm CDC 230V engines 1 chambers 2		
For models:	CV10E, CV10E-1320100, CV10E-2, CV10E2-1320140, CV10EB-1321100, CV10E-S, CV10ES-1320150, CV10E-S2, CV10ES2-1320190, CV10G, CV10G-1310100, CV10G-2, CV10G2-1310140, CV10GB-1311100, CV10G-S, CV10GS-1310150, CV10G-S2, CV10GS2-1310190, CV20E, CV20E-1320200, CV20E-2, CV20E2-1320240, CV20EB-1321200, CV20E-S, CV20ES-1320250, CV20E-S2, CV20ES2-1320290, CV20G, CV20G-1310200, CV20G-2, CV20G2-1310240, CV20GB-1311200, CV20G-S, CV20GS-1310250, CV20G-S2, CV20GS2-1310290, CV21E, CV21E-1322100, CV21E-2, CV21E2-1322140, CV21E-S, CV21ES-1322150, CV21E-S2, CV21ES2-1322190, CV21G, CV21G-1312100, CV21G-2, CV21G2-1312140, CV21G-S, CV21GS-1312150...(Other models you can see in the webshop)		



1

GEV No.	360291	Ref. No.	10708/E
description	timer CDC 11803 engines 1 chambers 3 operation time 120s 115V shaft ømm shaft Lmm manif. no. 11803F1 / 10708E motor type M48R ATS /60Hz connection F4.8 supply at 60Hz 115V		
For models:	OLDerby, OLDS35-1081005, OLG550, OLG550-1080705, OLG550D-1080706, OLG550E-1080730, OLG550ECO-1081014, OLG550ECOD-1081015, OLG550ED-1080731, OLG550-Neutra		
spare parts for	360291		
		GEV No.	360118
		Ref. No.	—
	motor CDC pinion ø 4.9mm teeth 10 230V voltage AC 50/60Hz turn direction right motor ø 47mm H 19.3mm motor type M48R ATS for timer cable length 260mm 1.9/2.5W		



1

GEV No.	360273	Ref. No.	16064/A
description	timer CDC 11803 engines 1 chambers 3 operation time 18min 230V shaft ømm shaft Lmm manif. no. 11803F1 / 16064/A motor type M48R ATS		
For models:	OLDS37-1081006, OLDS37D-1081007, OLDS37LS-1081008, OLDS37LSD-1081009, OLDS40-1081010, OLDS40D-1081011, OLDS40LS-1081012, OLDS40LSD-1081013, OLDS50P-1081018, OLDS50PD-1081019, OLG35-1080702, OLG600, OLGastro450, OLGastro500Plus, OLGastro500S, OLGastro750Plus, OLGastro750S, OLG537, OLG537-1080700, OLG537D-1080707, OLG537LS-1081001, OLG537LSD-1081002, OLG537-Neutra, OLG540, OLG540, OLG540-1080701, OLG540D-1080708, OLG540D-1081003, OLG540-Neutra, OLG545, OLG545LSD-1081004, OLG585, OLG585-1081016, OLG585D-1081017, OLG585-Neutra, OLHT-11-Neutra, OLLinear, OLStar		
spare parts for	360273		
		GEV No.	360118
		Ref. No.	—
	motor CDC pinion ø 4.9mm teeth 10 230V voltage AC 50/60Hz turn direction right motor ø 47mm H 19.3mm motor type M48R ATS for timer cable length 260mm 1.9/2.5W		



1

GEV No.	360569	Ref. No.	10708/B
description	timer CDC 11804F engines 1 chambers 3 operation time 120s 230V 60Hz shaft ømm shaft Lmm manuf. no. 11804F1ADY000.0010 motor type M48R ATS voltage AC		
For models:	OLDerby, OLDS35, OLDS35-1081005, OLDS35-1081061, OLDS35D-1081062, OLDS35-Neutra, OLDS37, OLDS37-1081006, OLDS37-1081063, OLDS37D-1081007, OLDS37D-1081064, OLDS37LS-1081008, OLDS37LSD-1081009, OLDS37-Neutra, OLDS40, OLDS40-1081010, OLDS40-1081065, OLDS40D-1081011, OLDS40D-1081066, OLDS40E-1081067, OLDS40ED-1081068, OLDS40LS-1081012, OLDS40LSD-1081013, OLDS40-Neutra, OLG35, OLG35-1080702, OLG35D-1081000, OLG35-Neutra, OLG600, OLGastro450, OLG537, OLG537-1080700, OLG537D-1080707, OLG537LS-1081001, OLG537LSD-1081002, OLG537-Neutra, OLG540, OLG540, OLG540-1080701, OLG540D-1080708, OLG540D-1081003, OLG540-Neutra, OLG540LSD-1081004, OLG550, OLG550-1080705, OLG550D-1080706, OLG550E-1080730, OLG550ECO-1081014, OLG550ECOD-1081015, OLG550ED-1080731...(Other models you can see in the webshop)		



2

GEV No.	360290	Ref. No.	10708/T
description	timer CDC 11804F engines 1 chambers 4 operation time 120s 230V shaft ømm shaft Lmm manuf. no. 11804F1 / 10708T motor type M48R ATS connection F4.8		
For models:	OLDS35, OLDS35-1081061, OLDS35D-1081062, OLDS35-Neutra, OLDS37, OLDS37-1081063, OLDS37D-1081064, OLDS37-Neutra, OLDS40, OLDS40-1081010, OLDS40-1081065, OLDS40D-1081011, OLDS40D-1081066, OLDS40E-1081067, OLDS40ED-1081068, OLDS40LS-1081012, OLDS40LSD-1081013, OLDS40-Neutra, OLG35, OLG35-1080702, OLG35D-1081000, OLG35-Neutra, OLGastro450, OLG537, OLG537-1080700, OLG537D-1080707, OLG537LS-1081001, OLG537LSD-1081002, OLG537-Neutra, OLG540, OLG540, OLG540-1080701, OLG540D-1080708, OLG540D-1081003, OLG540-Neutra, OLG540LSD-1081004, OLG550, OLG550-1080705, OLG550D-1080706, OLG550E-1080730, OLG550ECO-1081014, OLG550ECOD-1081015, OLG550ED-1080731, OLG550-Neutra, OLHT-11-Neutra, OLLinear		
spare parts for	360290		
	GEV No.	360118	Ref. No. —
	motor CDC pinion ø 4.9mm teeth 10 230V voltage AC 50/60Hz turn direction right motor ø 47mm H 19.3mm motor type M48R ATS for timer cable length 260mm 1.9/2.5W		



1

GEV No.	360427	Ref. No.	10708/N
description	timer CDC 11804F engines 1 chambers 4 operation time 90s 230V shaft ømm shaft Lmm motor type M48R ATS		
For models:	OLG600, OLG585, OLG585-1081016, OLG585D-1081017, OLG585-Neutra, OLHT11-1081071, OLHT11D-1081072, OLHT11ECO-1081070, OLHT-11-Neutra, OLHT11S, OLHT11S-Neutra		



1

GEV No.	360709	Ref. No.	LA65090110 LAR65090110
description	timer CDC 14003F3 engines 1 chambers 3 operation time 120min shaft ø 6x4.6mm shaft L 22mm manuf. no. 14003F3120ME0.0010		





1

GEV No.	360752	Ref. No.	R65090190
description	timer CDC 4902F1 engines 1 chambers 2 operation time 8min 230V shaft ømm shaft Lmm		
For models:	CCE042M, CCE051M, CCE071M, CCE101M, CCE102M, CCG051M, CCG071M, CCG101M, CCG102M		



1

GEV No.	360389	Ref. No.	011DW10300122 BN011DW10300122
description	timer CDC 4904F engines 1 chambers 4 operation time 5min 230V shaft ømm shaft Lmm manuf. no. 4904F3 / 10300122 motor type M48L ATS		
For models:	OLH600, OLHT-11-Neutra, OLHT12-1081075, OLHT12EL-1081080, OLHT12EL-1081083, OLHT12ELD-1081081, OLHT12ELPLUS-1081086, OLHT12S, OLHT12S-Neutra		
spare parts for	360389		
	GEV No.	360083	Ref. No. —
	motor CDC pinion ø 4.9mm teeth 10 230V turn direction left motor ø 47mm H 19.3mm motor type M48L ATS for timer		





1

GEV No.	360464	Ref. No.	10300118
description	timer CDC 4904F engines 1 chambers 4 operation time 6min 230V 60Hz shaft ømm shaft Lmm voltage AC		
For models:	OLHT11-1081071, OLHT11D-1081072, OLHT11ECO-1081070, OLHT-11-Neutra, OLHT11S, OLHT11S-Neutra		





1

GEV No.	360297	Ref. No.	10300121
description	timer CDC 4904F engines 1 chambers 4 operation time 6min 230V 60Hz shaft ømm shaft Lmm voltage AC		
For models:	OLHT11-1081071, OLHT11D-1081072, OLHT11ECO-1081070, OLHT-11-Neutra, OLHT11S, OLHT11S-Neutra		
spare parts for	360297		
	GEV No.	360083	Ref. No. —
	motor CDC pinion ø 4.9mm teeth 10 230V turn direction left motor ø 47mm H 19.3mm motor type M48L ATS for timer		





1

GEV No.	360257	Ref. No.	10300117
description	timer CDC 4904F engines 1 chambers 4 operation time 6min 230V 60Hz shaft ømm shaft Lmm voltage AC		
For models:	G12S, OLHT-11-Neutra		
spare parts for	360257		
	GEV No.	360083	Ref. No. —
	motor CDC pinion ø 4.9mm teeth 10 230V turn direction left motor ø 47mm H 19.3mm motor type M48L ATS for timer		





1



GEV No.	360296	Ref. No.	10300123
description	timer CDC 7804DV engines 2 chambers 4 operation time 6s / 3min 230V shaft ømm shaft Lmm voltage AC		
For models:	OLGastro750Plus, OLGastro750S		
spare parts for	360296		
	GEV No.	360119	Ref. No. —
	motor CDC pinion ø 5.4mm teeth 12 230V turn direction right motor ø 37mm motor type M37RN for timer		
	GEV No.	360131	Ref. No. —
	motor CDC pinion ø 5.4mm teeth 12 230V turn direction left motor ø 37mm motor type M37LN for timer		





1

GEV No.	360293	Ref. No.	30001027
description	timer CDC 7804DV engines 2 chambers 4 operation time 6s / 3min 230V shaft ømm shaft Lmm voltage AC		
For models:	OLDS50, OLDS50-1081088, OLDS50D-1081089, OLDS50E-1081090, OLDS50ED-1081091, OLDS50-Neutra, OLDS50P-1081018, OLDS50PD-1081019, OLGastro500Plus, OLG550, OLG550-1080705, OLG550D-1080706, OLG550E-1080730, OLG550ECO-1081014, OLG550ECOD-1081015, OLG550ED-1080731, OLG550-Neutra		
spare parts for	360293		
	GEV No.	360119	Ref. No. —
	motor CDC pinion ø 5.4mm teeth 12 230V turn direction right motor ø 37mm motor type M37RN for timer		
	GEV No.	360131	Ref. No. —
	motor CDC pinion ø 5.4mm teeth 12 230V turn direction left motor ø 37mm motor type M37LN for timer		





1			
GEV No.	360295	Ref. No.	22011
description	timer CDC 7805DV engines 2 chambers 5 operation time 6s / 4min 230V shaft ømm shaft Lmm manuf. no. 7805DV / 22011 motor type M37RN/M37LN		
For models:	OLLP1-800, OLLP1-800-1080721, OLLP1-800EL, OLLP1-800-Neutra, OLLP1-S8, OLLP1-S8EL, OLLP-ZERO, OLLPZERO-1081057		
spare parts for	360295		
	GEV No.	360119	Ref. No. —
	motor CDC pinion ø 5.4mm teeth 12 230V turn direction right motor ø 37mm motor type M37RN for timer		
	GEV No.	360131	Ref. No. —
	motor CDC pinion ø 5.4mm teeth 12 230V turn direction left motor ø 37mm motor type M37LN for timer		

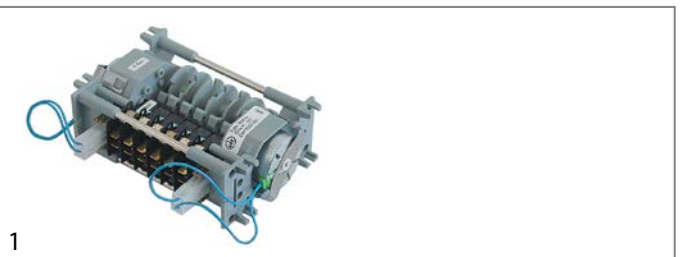

1			
GEV No.	360346	Ref. No.	30001032
description	timer CDC 7806DV engines 2 chambers 6 operation time 6s / 3min 230V shaft ømm shaft Lmm manuf. no. 7806DV / 30001032 motor type M37RN/M37LN		
For models:	OLDS50P-1081018, OLDS50PD-1081019, OLGastro500Plus, OLGastro500S, OLGastro750Plus, OLGastro750S		
spare parts for	360346		
	GEV No.	360119	Ref. No. —
	motor CDC pinion ø 5.4mm teeth 12 230V turn direction right motor ø 37mm motor type M37RN for timer		
	GEV No.	360131	Ref. No. —
	motor CDC pinion ø 5.4mm teeth 12 230V turn direction left motor ø 37mm motor type M37LN for timer		



1			
GEV No.	360294	Ref. No.	30001031
description	timer CDC 7806DV engines 2 chambers 6 operation time 6s / 3min 230V shaft ømm shaft Lmm manuf. no. 7806DV / 30001031 motor type M37RN/M37LN		
For models:	OLDS50, OLDS50-1081088, OLDS50D-1081089, OLDS50E-1081090, OLDS50ED-1081091, OLDS50-Neutra, OLDS50P-1081018, OLDS50PD-1081019, OLGastro500Plus, OLGastro500S, OLGastro750Plus, OLGastro750S, OLG50, OLG50-1080705, OLG50D-1080706, OLG50E-1080730, OLG50ECO-1081014, OLG50ECOD-1081015, OLG50ED-1080731, OLG50-Neutra		
spare parts for	360294		
	GEV No.	360119	Ref. No. —
	motor CDC pinion ø 5.4mm teeth 12 230V turn direction right motor ø 37mm motor type M37RN for timer		
	GEV No.	360131	Ref. No. —
	motor CDC pinion ø 5.4mm teeth 12 230V turn direction left motor ø 37mm motor type M37LN for timer		



1			
GEV No.	360289	Ref. No.	10708/L
description	timer CROUZET engines 1 chambers 2 operation time 120s 230V shaft ømm shaft Lmm manuf. no. 627/5309 motor type 600		
For models:	OLDerby, OLDS35, OLDS35-1081005, OLDS35-1081061, OLDS35D-1081062, OLDS35-Neutra, OLDS37, OLDS37-1081006, OLDS37-1081063, OLDS37D-1081007, OLDS37D-1081064, OLDS37LS-1081008, OLDS37LSD-1081009, OLDS37-Neutra, OLDS40, OLDS40-1081010, OLDS40-1081065, OLDS40D-1081011, OLDS40D-1081066, OLDS40E-1081067, OLDS40ED-1081068, OLDS40LS-1081012, OLDS40LSD-1081013, OLDS40-Neutra, OLDS50, OLDS50-1081088, OLDS50D-1081089, OLDS50E-1081090, OLDS50ED-1081091, OLDS50-Neutra, OLG35, OLG35-1080702, OLG35D-1081000, OLG35-Neutra, OLGastro450, OLG537, OLG537-1080700, OLG537D-1080707, OLG537LS-1081001, OLG537LSD-1081002, OLG537-Neutra, OLG540, OLG540, OLG540-1080701, OLG540D-1080708, OLG540D-1081003, OLG540-Neutra, OLG545, OLG545LSD-1081004, OLG550...(Other models you can see in the webshop)		



1

GEV No.	360336	Ref. No.	3102335 BN3102335
description	timer FIBER P25 engines 1 chambers 1 operation time 30s 230V shaft ø 6x4.6mm shaft L 18mm manuf. no. P255J01C6R7 motor type M51BJ0R6400		
For models:	ECVM10ES2, ECVM10ES2-1324290, ECVM10ES2-1324290MN, ECVM10ES2-1326120, ECVM10GS2, ECVM10GS2-1314290, ECVM10GS2-1316120, ECVM20ES2, ECVM20ES2-1324390, ECVM20ES2-1326140, ECVM20GS2, ECVM20GS2-1314390, ECVM20GS2-1316140, ECVM21ES2, ECVM21ES2-1324490, ECVM21ES2-1326160, ECVM21GS2, ECVM21GS2-1314490, ECVM21GS2-1316160, ECVM6ES2, ECVM6ES2-1324190, ECVM6ES2-1326100, ECVM6ES2-1326100H, ECVM6GS2, ECVM6GS2-1314190, ECVM6GS2-1316100, ECVP10ES2, ECVP10ES2-1324690, ECVP10ES2-1326200, ECVP10GS2, ECVP10GS2-1314690, ECVP10GS2-1316200, ECVP20ES2, ECVP20ES2-1324790, ECVP20ES2-1326220, ECVP20GS2, ECVP20GS2-1314790, ECVP20GS2-1316220, ECVP21ES2, ECVP21ES2-1324890, ECVP21ES2-1326240, ECVP21GS2, ECVP21GS2-1314890, ECVP21GS2-1316240, ECVP6ES2, ECVP6ES2-1324590, ECVP6ES2-1326180, ECVP6GS2, ECVP6GS2-1314590, ECVP6GS2-1316180...(Other models you can see in the webshop)		



1

GEV No.	360337	Ref. No.	3102320 BN3102320
description	timer FIBER P25 engines 1 chambers 2 operation time 8min 230V shaft ø 6x4.6mm shaft L 20mm manuf. no. P255J02J2E4 motor type M51B-J0R6400		
For models:	CV10E-1320100, CV10EB-1321100, CV10G-1310100, CV10GB-1311100, CV20E-1320200, CV20EB-1321200, CV20G-1310200, CV20GB-1311200, CV21E-1322100, CV21ES2-1322190, CV21G-1312100, CV21GS2-1312190, CV6E-1320000, CV6E2-1320040, CV6G-1310000, CVM10E-1320400, CVM10G-1310400, CVM10G-1310410, CVM10GP-1310400, CVM20E-1320500, CVM20G-1310500, CVM21E-1322400, CVM21ES2-1322490, CVM21G-1312400, CVM21GS2-1312490, CVM6E-1320300, CVM6G-1310300, CVM6G-1310310, CVP10E-1320700, CVP10G-1310700, CVP10GP-1310700, CVP20E-1320800, CVP20EB-1321200, CVP20G-1310800, CVP21E-1322700, CVP21ES2-1322790, CVP21GS-1312750, CVP21GS2-1312790, CVP6E-1320600, CVP6G-1310600		
spare parts for	360337		
	GEV No.	360673	Ref. No. —
	motor kit pinion ø 6.8mm teeth 15 230V voltage AC 50/60Hz turn direction clockwise motor ø 48mm H 18.5mm motor type UDS-40NE1RNZ165 cable length 150mm with holder		



1

GEV No.	360435	Ref. No.	011DWM10300121 BN011DWM10300121
description	timer FIBER P25 engines 1 chambers 4 operation time 6min 230V 50Hz shaft ø 6mm shaft Lmm motor type M51BJ0L6400		
spare parts for	360435		
	GEV No.	360674	Ref. No. —
	motor kit pinion ø 6.8mm teeth 15 230V voltage AC 50/60Hz turn direction counterclockwise motor ø 48mm H 18.5mm motor type UDS40NE1RNZ165 cable length 150mm with holder		

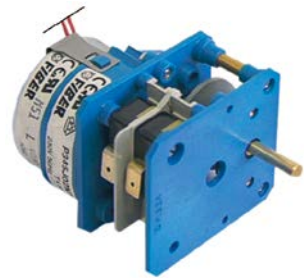

1

GEV No.	350038	Ref. No.	R65090020
description	timer FIBER P34 engines 1 chambers 2 operation time 144min 230V shaft ø 6x4.6mm shaft L 20mm manuf. no. P345J02N765 motor type M51BJ0L6400 impulse electric		
For models:	CCE042M, CCE051M, CCE071M, CCE101M, CCE102M, CCG051M, CCG071M, CCG101M, CCG102M		
spare parts for	350038		
	GEV No.	360674	Ref. No. —
	motor kit pinion ø 6.8mm teeth 15 230V voltage AC 50/60Hz turn direction counterclockwise motor ø 48mm H 18.5mm motor type UDS40NE1RNZ165 cable length 150mm with holder		

audible timers



1

GEV No.	350036	Ref. No.	1031006400
description	audible timer operation time 60min ø 55mm shaft ø 6x4.6mm shaft L 22mm mounting distance 28mm		
For models:	FOE60M, OFOE60M, OFOE-60M-12601001		





alarm devices

alarm units

			
1			
GEV No.	350114	Ref. No.	6A021955
description	buzzer 110-240VAC ø 22.5mm H 68mm built-in version mounting ø 22.5 80dB		
For models:	74-02NPEI, 7PN-EI50		

buzzers

			
1			
GEV No.	350086	Ref. No.	R65301440
description	buzzer 12VDC connection cable 200mm PCB buzzer 20dB		
For models:	CKEP06, CKEP06B, CKEP10, CKEP10B, CKEP20, CKEP20B, CKEP21, CKEP21B, CKEP40, CKEP40B, CKET06, CKET06B, CKET10, CKET10B, CKET20, CKET20B, CKET21, CKET21B, CKET40, CKET40B, CKGP06, CKGP06B, CKGP10, CKGP10B, CKGP20, CKGP20B, CKGP21, CKGP21B, CKGP40, CKGP40B, CKGT06, CKGT06B, CKGT10, CKGT10B, CKGT20, CKGT20B, CKGT21, CKGT21B, CKGT40, CKGT40B		

			
1			
GEV No.	350050	Ref. No.	R65330010
description	buzzer 230VAC connection male faston 6.3mm screw mounting thread M4 60dB		
For models:	CCE042M, CCE051M, CCE071M, CCE101M, CCE102M, CCG051M, CCG071M, CCG101M, CCG102M		

			
1			
GEV No.	350080	Ref. No.	3103266 BN3103266
description	buzzer buzzer		
For models:	ECVM10ES2, ECVM10ES2-1324290, ECVM10ES2-1324290MN, ECVM10ES2-1326120, ECVM10GS2, ECVM10GS2-1314290, ECVM10GS2-1316120, ECVM20ES2, ECVM20ES2-1324390, ECVM20ES2-1326140, ECVM20GS2, ECVM20GS2-1314390, ECVM20GS2-1316140, ECVM21ES2, ECVM21ES2-1324490, ECVM21ES2-1326160, ECVM21GS2-1314490, ECVM21GS2-1316160, ECVM6ES2, ECVM6ES2-1324190, ECVM6ES2-1326100, ECVM6ES2-1326100H, ECVM6GS2, ECVM6GS2-1314190, ECVM6GS2-1316100, ECVP10ES2, ECVP10ES2-1324690, ECVP10ES2-1326200, ECVP10GS2, ECVP10GS2-1314690, ECVP10GS2-1316200, ECVP20ES2, ECVP20ES2-1324790, ECVP20ES2-1326220, ECVP20GS2, ECVP20GS2-1314790, ECVP20GS2-1316220, ECVP21ES2, ECVP21ES2-1324890, ECVP21ES2-1326240, ECVP21GS2, ECVP21GS2-1314890, ECVP21GS2-1316240, ECVP6ES2, ECVP6ES2-1324590, ECVP6ES2-1326180, ECVP6GS2, ECVP6GS2-1314590, ECVP6GS2-1316180, NECVM10ES2...(Other models you can see in the webshop)		

contactors

ABB

power contactors

			
1			
GEV No.	380104	Ref. No.	6A001410
description	power contactor resistive load 25A 230VAC (AC3/400V) 9A/4kW main contacts 3NO auxiliary contacts 1NO connection screw connection type A9-30-10		
For models:	94-04PEI100L, 94-04PEI100L-12901765, 94-04PEI110L-12901765BN, 94-04PEI150L, 94-04PEI150L-12901767, 94-04PEI150L-12901767BN, 9PN-EI100, 9PN-EI150		

GENERAL ELECTRIC (AEG)

power contactors

			
1			
GEV No.	380239	Ref. No.	10300391 15086/B 6A047031 BN6A047031
description	power contactor resistive load 20A 230VAC (AC3/400V) 8.4A/4kW main contacts 3NO auxiliary contacts 1NC connection screw connection type LS05 01A type AEG LS05 01A type GE MC1A 301A		
For models:	110-135CGE, 110-135CGE2P, 110-135CGEE, 110-135CGEE2P, 110-135CGEEP, 110-135CGEP, 110-90CGE, 110-90CGE1P, 110-90CGEP, 110-90CTEE, 110-90CTGE, 110-90FTE, 110-90FTE1-2R, 110-90FTEC, 110-90FTEC1-2R, 110-90FTECR, 110-90FTEE, 110-90FTER, 110-90FT-TGE, 110-90FTTE, 110-90FTTE1-2R, 110-90FTTEC, 110-90FTTEC1-2R, 110-90FTTECR, 110-90FTTER, 55-45FRE, 55-90FRE, 73-02FRE, 73-02FRE-12701550, 73-02FREM, 73-02FREM-12701580, 7FRI-E610, 93-04FRE10L, 93-04FRE-12901550, 94-04CEE, 94-04CEE-12901210, 94-04CEE-12901210BN, 94-04CGE-12900011, 94-04CGE-12900011TA, 94-04CGE1P-12900031, 94-04CGEP-12900061, 94-04CGEP-12900061TA, 94-04CGG1P-12900031TA, 94-04CTEE-12901180, 94-04CTEE-12901180BN, 94-04CTEES, 94-04CTEES-12901185, 94-04CTEES-12901185BN, 94-04CTGE, 94-04CTGE-12900190...(Other models you can see in the webshop)		

1

GEV No.	380238	Ref. No.	10300392
description	power contactor resistive load 20A 230VAC (AC3/400V) 8.4A/4kW main contacts 3NO auxiliary contacts 1NO connection screw connection type LS0510A type AEG LS0510A type GE MC1A 310A		
For models:	OLH600, OLH600Electronic, OLHT11-1081071, OLHT11D-1081072, OLHT11ECO-1081070, OLHT-11-Neutra, OLHT11S, OLHT11S-Neutra, OLHT12-1081075, OLHT12EL-1081080, OLHT12EL-1081083, OLHT12ELD-1081081, OLHT12ELPLUS-1081086, OLHT12S, OLHT12SElectronic, OLHT12S-Neutra		



2

GEV No.	380337	Ref. No.	6A047037 BN6A047037
description	power contactor resistive load 20A 230VAC (AC3/400V) 8.4A/4kW main contacts 4NO auxiliary contacts connection screw connection type AEG LS05 400A type GE MC1A 400A		
For models:	421SEFR-1826125, 621SEFR-1826135, CV10E, CV10E-1320100, CV10E-2, CV10E2-1320140, CV10EB-1321100, CV10E-S, CV10ES-1320150, CV10E-S2, CV10ES2-1320190, CV10G, CV10G-1310100, CV10G-2, CV10G2-1310140, CV10GB-1311100, CV10G-S, CV10GS-1310150, CV10G-S2, CV10GS2-1310190, CV20E, CV20E-1320200, CV20E-2, CV20E2-1320240, CV20EB-1321200, CV20E-S, CV20ES-1320250, CV20E-S2, CV20ES2-1320290, CV20G, CV20G-1310200, CV20G-2, CV20G2-1310240, CV20GB-1311200, CV20G-S, CV20GS-1310250, CV20G-S2, CV20GS2-1310290, CV21E, CV21E-1322100, CV21E-2, CV21E2-1322140, CV21E-S, CV21ES-1322150, CV21E-S2, CV21ES2-1322190, CV21G, CV21G-1312100, CV21G-2, CV21G2-1312140...(Other models you can see in the webshop)		



1

GEV No.	380839	Ref. No.	2000370
description	power contactor resistive load 20A 24VAC (AC3/400V) 9A/4kW main contacts 3NO auxiliary contacts 1NO connection screw connection type LS0510A type AEG LS0510A type GE MC1A 310A		
For models:	OLAX151, OLAX151EDX-1080725, OLAX151ELEF-1080727, OLAX151-highspeed, OLAX160, OLAX160E-1080750, OLAX160E-1080751, OLAX160V-1080755, OLAX160V-1080756, OLAX160V-1081031, OLAX160V-1081032, OLAX210, OLAX210E-1081029, OLAX210E-1081030, OLAX220, OLAX220E-1080787, OLAX220E-1080788, OLAX220V-1080789, OLAX220V-1080790, OLAX230, OLAX230E-1080791, OLAX230E-1080792, OLAX230V-1080793, OLAX230V-1080794, OLAX240, OLAX240E-1080795, OLAX240E-1080796, OLAX240V-1080797, OLAX240V-1080798, OLAX250, OLAX250E-1080760, OLAX250E-1080761, OLAX250V-1080765, OLAX250V-1080766, OLAX300, OLAX300E-1080770, OLAX300E-1080771, OLAX300E-1081033, OLAX300E-1081035, OLAX300E-1081036, OLAX300LC, OLAX300LCE-1081034, OLAX300V-1080775, OLAX300V-1080776, OLAX310, OLAX310E-1081110, OLAX310E-1081111, OLAX310LC, OLAX310LCE-1081114, OLAX310LCE-1081115...(Other models you can see in the webshop)		



1

GEV No.	380245	Ref. No.	6A047034 BN6A047034
description	power contactor resistive load 25A 230VAC (AC3/400V) 9A/4kW main contacts 3NO auxiliary contacts 1NC connection screw connection type AEG LS4K 01A type GE CL00A 301 H 85mm		
For models:	40SEW-1825190, 41SEFR, 41SEFR-1826120, 41SEFR2S-1826120, 61SEFR, 61SEFR-1826130, 61SEFR2S-1826130, 7101FR-E-1077750R, 7121FR-E-1077950R, 7201FR-E-1077850R, 72-02FRE, 72-02FRE-12701500, 72-02FREM, 72-02FREM-12701530, 7221FR-E-1078050R, 725KB-E-1000200, 725KB-E-1000200R, 725KB-EB-1000201, 725KB-EB-1000201R, 725KB-EM-1000210R, 725KB-EMB-1000211, 73-02FRE, 73-02FRE-12701550, 74-02FRE, 74-02FRE-12701600, 74-02FREM, 74-02FREM-12701630, 74-02KBEB, 74-02KBEB-12701110, 74-02KBEBI, 74-02KBEBI-12701115, 74-02KBEBF, 74-02KBEBF-12701128, 74-02KBEMB, 74-02KBEMB-12701120, 74-02KBEMBI, 74-02KBEMBI-12701125, 74-02KBEMBI-12701125HB, 74-02NPEI, 74-02NPEI-12701755, 7FRI-E415, 7FRI-E415M, 7FRI-E815, 7PN-EI50, 9122PFRE-1104930, 9141PFRE-1204950, 92-04FRE15L, 92-04FRE15L-12901510, 921FRE-1292925, 921RFRE-1392925...(Other models you can see in the webshop)		





1

GEV No.	380244	Ref. No.	10300050
description	power contactor resistive load 25A 230VAC (AC3/400V) 9A/4kW main contacts 3NO auxiliary contacts 1NO connection screw connection type AEG LS4K 10A type GE CL00A 310		
For models:	G12S, OLGRANUL900, OLH600, OLH600Electronic, OLHT11-1081071, OLHT11D-1081072, OLHT11ECO-1081070, OLHT-11-Neutra, OLHT11S, OLHT11S-Neutra, OLHT12-1081075, OLHT12EL-1081080, OLHT12EL-1081083, OLHT12ELD-1081081, OLHT12ELPLUS-1081086, OLHT12S, OLHT12SElectronic, OLHT12S-Neutra, OLLP1-1081059, OLLP1-800, OLLP1-800-1080721, OLLP1-800EL, OLLP1-800-Neutra, OLLP1-S8, OLLP1-S8EL, OLLP2-1080722, OLLP2-1080742, OLLP2Electronic-Neutra, OLLP2PLUS, OLLP3-1080723, OLLP3-1080743, OLLP3Electronic-Neutra, OLLP3PLUS, OLLP4-1081258, OLLP4-800-1081058, OLLP4-800Electronic-Neutra, OLLP4PLUS, OLLP-ZERO, OLLPZERO-1081057		

			
1			
GEV No.	381136	Ref. No.	2000380
description	power contactor resistive load 25A 24VAC (AC3/400V) 12A/5.5kW main contacts 3NO auxiliary contacts 1NO connection screw connection type AEG type GE CL01A310T1		
For models:	OLAX151, OLAX151EDX-1080725, OLAX151ELEFT-1080727, OLAX151-highspeed, OLAX160, OLAX160E-1080750, OLAX160E-1080751, OLAX160V-1080755, OLAX160V-1080756, OLAX160V-1081031, OLAX160V-1081032, OLAX210, OLAX210E-1081029, OLAX210E-1081030, OLAX220, OLAX220E-1080787, OLAX220E-1080788, OLAX220V-1080789, OLAX220V-1080790, OLAX230, OLAX230E-1080791, OLAX230E-1080792, OLAX230V-1080793, OLAX230V-1080794, OLAX240, OLAX240E-1080795, OLAX240E-1080796, OLAX240V-1080797, OLAX240V-1080798, OLAX250, OLAX250E-1080760, OLAX250E-1080761, OLAX250V-1080765, OLAX250V-1080766, OLAX300, OLAX300E-1080770, OLAX300E-1080771, OLAX300E-1081033, OLAX300E-1081035, OLAX300E-1081036, OLAX300LC, OLAX300LCE-1081034, OLAX300V-1080775, OLAX300V-1080776, OLAX310, OLAX310E-1081110, OLAX310E-1081111, OLAX310LC, OLAX310LCE-1081114, OLAX310LCE-1081115...(Other models you can see in the webshop)		

			
2			
GEV No.	380262	Ref. No.	10300052 6A047036 BN6A047036
description	power contactor resistive load 32A 230VAC (AC3/400V) 17A/7.5kW main contacts 3NO auxiliary contacts 1NC connection screw connection type AEG LS7K01A type GE CL02A 301 H 85mm		
For models:	72-02TVTCV, 72-02TVTCV-12731005, 72-02VTC, 72-02VTCV, 72-02VTG-12701005, 74-02TVTCV, 74-02TVTCV-12731006, 74-02VTCEV, 74-02VTCEV-12701020, 74-02VTCV, 74-02VTCV-12701006, 7NPCF-VCE800, 92-04FRE20L, 92-04FRE20L-12901500, 92-04FRE20L-12901500BN, 92-04VTVC, 92-04TVTC-12931005, 92-04TVTCV-12931055, 92-04VTC, 92-04VTCV-12901055, 94-04FRE-12901600, 94-04FRE20L, 9FRI-E415, 9FRI-E420, 9FRI-E610, 9FRI-E820, 9NPC-VCE400, 9NPCV-VCE400, CV20E, CV20E-1320200, CV20E-2, CV20E2-1320240, CV20EB-1321200, CV20E-S, CV20ES-1320250, CV20E-S2, CV20ES2-1320290, CVM20E, CVM20E-1320500, CVM20E-2, CVM20E2-1320540, CVM20E-S, CVM20ES-1320550, CVM20E-S2, CVM20ES2-1320590, CVP20E, CVP20E-1320800, CVP20E-2, CVP20E2-1320840, CVP20EB-1321200...(Other models you can see in the webshop)		

			
1			
GEV No.	381154	Ref. No.	10300054
description	power contactor resistive load 32A 230VAC (AC3/400V) 17A/7.5kW main contacts 3NO auxiliary contacts 1NO connection screw connection type AEG type GE CL02A310R6		
For models:	OLH600, OLH600Electronic, OLHT11-1081071, OLHT11D-1081072, OLHT11ECO-1081070, OLHT-11-Neutra, OLHT11S, OLHT11S-Neutra, OLHT12-1081075, OLHT12EL-1081080, OLHT12EL-1081083, OLHT12ELD-1081081, OLHT12ELPLUS-1081086, OLHT12S, OLHT12SElectronic, OLHT12S-Neutra, OLLP1-1081059, OLLP2-1080722, OLLP2EIElectronic-Neutra, OLLP4-800-1081058, OLLP4-800Electronic-Neutra		

			
1			
GEV No.	380671	Ref. No.	2000385
description	power contactor resistive load 45A 24VAC (AC3/400V) 25A/11kW main contacts 3NO auxiliary contacts connection screw connection type AEG LS11K 00A type GE CL25A300T1		
For models:	OLAX151, OLAX151EDX-1080725, OLAX151ELEFT-1080727, OLAX151-highspeed, OLAX160, OLAX160E-1080750, OLAX160E-1080751, OLAX160V-1080755, OLAX160V-1080756, OLAX160V-1081031, OLAX160V-1081032, OLAX210, OLAX210E-1081029, OLAX210E-1081030, OLAX220, OLAX220E-1080787, OLAX220E-1080788, OLAX220V-1080789, OLAX220V-1080790, OLAX230, OLAX230E-1080791, OLAX230E-1080792, OLAX230V-1080793, OLAX230V-1080794, OLAX240, OLAX240E-1080795, OLAX240E-1080796, OLAX240V-1080797, OLAX240V-1080798, OLAX250, OLAX250E-1080760, OLAX250E-1080761, OLAX250V-1080765, OLAX250V-1080766, OLAX300, OLAX300E-1080770, OLAX300E-1080771, OLAX300E-1081033, OLAX300E-1081035, OLAX300E-1081036, OLAX300LC, OLAX300LCE-1081034, OLAX300V-1080775, OLAX300V-1080776, OLAX310, OLAX310E-1081110, OLAX310E-1081111, OLAX310LC, OLAX310LCE-1081114, OLAX310LCE-1081115...(Other models you can see in the webshop)		

 			
1			
GEV No.	380385	Ref. No.	6A047035 BN6A047035
description	power contactor resistive load 60A 230VAC (AC3/400V) 32A/16kW main contacts 3NO auxiliary contacts 1NC connection screw connection type AEG LS15K 01A type GE CL04A 310		
For models:	CV21E, CV21E-1322100, CV21E-2, CV21E2-1322140, CV21E-S, CV21ES-1322150, CV21E-S2, CV21ES2-1322190, CVM21E, CVM21E-1322400, CVM21E-2, CVM21E2-1322440, CVM21E-S, CVM21ES-1322450, CVM21E-S2, CVM21ES2-1322490, CVP21E, CVP21E-1322700, CVP21E-2, CVP21E-S, CVP21ES-1322750, CVP21E-S2, CVP21ES2-1322790, ECVM20ES2, ECVM20ES2-1324390, ECVM20ES2-1326140, ECVM21ES2, ECVP20ES2, ECVP20ES2-1324790, ECVP20ES2-1326220, ECVP21ES2, ECVP21ES2-1324890, ECVP21ES2-1326240, FC21E, FC21E-2, FC21E-2-418035422140, FC21E-2S, FC21E-2S-418035422190, FC21E-418035422100, FC21E-S, FC21E-S-418035422150, FCM21E, FCM21E-2, FCM21E-2-418035422440, FCM21E-2S, FCM21E-2S-418035422490, FCM21E-418035422400, FCM21E-S, FCM21E-S-418035422450, FCV21E... (Other models you can see in the webshop)		

			
1			
GEV No.	380243	Ref. No.	6A047039 BN6A047039
description	auxiliary contact contacts 2NO/2NC for contactors M+LS05 connection screw AC-12 10A type AEG HS05K 22HS type GE MARN 422		
For models:	CV10E-2, CV10E2-1320140, CV10E-S2, CV10ES2-1320190, CV10G-2, CV10G2-1310140, CV10G-S2, CV10GS2-1310190, CV20E-2, CV20E2-1320240, CV20E-S2, CV20ES2-1320290, CV20G-2, CV20G2-1310240, CV20G-S2, CV20GS2-1310290, CV21E-1322100, CV21E-2, CV21E2-1322140, CV21E-S2, CV21ES2-1322190, CV21G-2, CV21G2-1312140, CV21G-S2, CV21GS2-1312190, CV6E-2, CV6E2-1320040, CV6E-S2, CV6ES2-1320090, CV6G-2, CV6G2-1310040, CV6G-S2, CV6GS2-1310090, CVM10E-2, CVM10E2-1320440, CVM10E-S2, CVM10ES2-1320490, CVM10G-2, CVM10G2-1310440, CVM10G-S2, CVM10GS2-1310490, CVM20E-2, CVM20E2-1320540, CVM20E-S2, CVM20ES2-1320590, CVM20G-2, CVM20G2-1310540, CVM20G-S2, CVM20GS2-1310590, CVM21E-1322400...(Other models you can see in the webshop)		

auxiliary contacts			
			
1			
GEV No.	380242	Ref. No.	6A047038 BN6A047038
description	auxiliary contact contacts 1NO/1NC for contactors M+LS05 connection screw AC-12 10A type AEG HS05K 11HS type GE MARN 211		
For models:	CV10E, CV10E-1320100, CV10E-2, CV10E2-1320140, CV10EB-1321100, CV10E-S, CV10ES-1320150, CV10E-S2, CV10ES2-1320190, CV10G, CV10G-1310100, CV10G-2, CV10G2-1310140, CV10GB-1311100, CV10G-S, CV10GS-1310150, CV10G-S2, CV10GS2-1310190, CV20E, CV20E-1320200, CV20E-2, CV20E2-1320240, CV20EB-1321200, CV20E-S, CV20ES-1320250, CV20E-S2, CV20ES2-1320290, CV20G, CV20G-1310200, CV20G-2, CV20G2-1310240, CV20GB-1311200, CV20G-S, CV20GS-1310250, CV20G-S2, CV20GS2-1310290, CV21E-1322100, CV21E-2, CV21E2-1322140, CV21E-S2, CV21ES2-1322190, CV21G-2, CV21G2-1312140, CV21G-S2, CV21GS2-1312190, CV6E, CV6E-1320000, CV6E-1320050, CV6E-2, CV6E2-1320040...(Other models you can see in the webshop)		

			
1			
GEV No.	380387	Ref. No.	6A047040 BN6A047040
description	auxiliary contact contacts 3NO/1NC AC15 6A for contactors M+LS05 connection screw AC-12 10A		
For models:	CV21E, CV21E-1322100, CV21E-2, CV21E2-1322140, CV21E-S, CV21ES-1322150, CV21E-S2, CV21ES2-1322190, CV21G, CV21G-1312100, CV21G-2, CV21G2-1312140, CV21G-S, CV21GS-1312150, CV21G-S2, CV21GS2-1312190, CVM21E, CVM21E-1322400, CVM21E-2, CVM21E2-1322440, CVM21E-S, CVM21ES-1322450, CVM21E-S2, CVM21ES2-1322490, CVM21G, CVM21G-1312400, CVM21G-2, CVM21G2-1312440, CVM21G-S, CVM21GS-1312450, CVM21G-S2, CVM21GS2-1312490, CVP21E, CVP21E-1322700, CVP21E-2, CVP21E-S, CVP21ES-1322750, CVP21E-S2, CVP21ES2-1322790, CVP21G, CVP21G-1312700, CVP21G-2, CVP21G2-1312740, CVP21G-S, CVP21GS-1312750, CVP21G-S2, CVP21GS2-1312790, FC21E, FC21E-2, FC21E-2-418035422140...(Other models you can see in the webshop)		



motor protection circuit breakers



1

GEV No.	380940	Ref. No.	2000394
description	motor protection circuit breaker type GPS1BSAH setting range 2.5-4A DIN rail contacts screw clamp		
For models:	OLAX151, OLAX151EDX-1080725, OLAX151ELEFT-1080727, OLAX151-highspeed, OLAX160, OLAX160E-1080750, OLAX160E-1080751, OLAX160V-1080755, OLAX160V-1080756, OLAX160V-1081031, OLAX160V-1081032, OLAX210, OLAX210E-1081029, OLAX210E-1081030, OLAX220, OLAX220E-1080787, OLAX220E-1080788, OLAX220V-1080789, OLAX220V-1080790, OLAX230, OLAX230E-1080791, OLAX230E-1080792, OLAX230V-1080793, OLAX230V-1080794, OLAX240, OLAX240E-1080795, OLAX240E-1080796, OLAX240V-1080797, OLAX240V-1080798, OLAX250, OLAX250E-1080760, OLAX250E-1080761, OLAX250V-1080765, OLAX250V-1080766, OLAX300, OLAX300E-1080770, OLAX300E-1080771, OLAX300E-1081033, OLAX300E-1081035, OLAX300E-1081036, OLAX300LC, OLAX300LCE-1081034, OLAX300V-1080775, OLAX300V-1080776, OLAX310, OLAX310E-1081110, OLAX310E-1081111, OLAX310LC, OLAX310LCE-1081114, OLAX310LCE-1081115...(Other models you can see in the webshop)		



2

GEV No.	380939	Ref. No.	2000400
description	motor protection circuit breaker type GPS1BSAJ setting range 4-6.3A DIN rail connection screw		
For models:	OLAX151, OLAX151EDX-1080725, OLAX151ELEFT-1080727, OLAX151-highspeed, OLAX160, OLAX160E-1080750, OLAX160E-1080751, OLAX160V-1080755, OLAX160V-1080756, OLAX160V-1081031, OLAX160V-1081032, OLAX210, OLAX210E-1081029, OLAX210E-1081030, OLAX220, OLAX220E-1080787, OLAX220E-1080788, OLAX220V-1080789, OLAX220V-1080790, OLAX230, OLAX230E-1080791, OLAX230E-1080792, OLAX230V-1080793, OLAX230V-1080794, OLAX240, OLAX240E-1080795, OLAX240E-1080796, OLAX240V-1080797, OLAX240V-1080798, OLAX250, OLAX250E-1080760, OLAX250E-1080761, OLAX250V-1080765, OLAX250V-1080766, OLAX300, OLAX300E-1080770, OLAX300E-1080771, OLAX300E-1081033, OLAX300E-1081035, OLAX300E-1081036, OLAX300LC, OLAX300LCE-1081034, OLAX300V-1080775, OLAX300V-1080776, OLAX310, OLAX310E-1081110, OLAX310E-1081111, OLAX310LC, OLAX310LCE-1081114, OLAX310LCE-1081115...(Other models you can see in the webshop)		

ISKRA (FANAL)

power contactors



1

GEV No.	380213	Ref. No.	15086
description	power contactor resistive load 20A 230VAC (AC3/400V) 8.5A/5.5kW main contacts 3NO auxiliary contacts 1NO connection screw connection type Fanal DSL7 10 type ISKRA K07M 10		
For models:	G12S, OLDS40-1081010, OLDS40D-1081011, OLDS40LS-1081012, OLDS40LSD-1081013, OLDS45, OLDS50, OLDS50-1081088, OLDS50D-1081089, OLDS50E-1081090, OLDS50ED-1081091, OLDS50-Neutra, OLDS50P-1081018, OLDS50PD-1081019, OLDW020H, OLElectron1000, OLElectron400, OLElectron500, OLELELECTRON1000-1081084, OLELELECTRON1000D-1081085, OLG600, OLGastro450, OLGastro500Plus, OLGastro500S, OLGastro750Plus, OLGastro750S, OLGRANUL900, OLG540, OLG545, OLG550, OLG550-1080705, OLG550D-1080706, OLG550E-1080730, OLG550ECO-1081014, OLG550ECOD-1081015, OLG550ED-1080731, OLG550-Neutra, OLG585, OLG585-1081016, OLG585D-1081017, OLG585-Neutra, OLH600, OLH600Electronic, OLHT11-1081071, OLHT11D-1081072, OLHT11ECO-1081070, OLHT11-Neutra, OLHT11S, OLHT11S-Neutra, OLHT12-1081075...(Other models you can see in the webshop)		

LOVATO

power contactors



1





GEV No.	380855	Ref. No.	6A047200 826630300 BN826630300
description	power contactor resistive load 25A 230VAC (AC3/400V) 4.2kW main contacts 3NO auxiliary contacts 1NO		
For models:	40SEW, 40SEW-1825190, 41SEFR, 41SEFR-1826120, 61SEFR, 61SEFR-1826130, 710FRE-1077700, 712FRE-1077900, 720FRE-1077800, 722FRE-1078000, 725KB-E-1000200, 725KBE-1000200, 725KBEB-1000201, 725KBEM-1000210, 725KBEMB-1000211, 7BR-E100, 7BR-E105, 7BRF-E805, 7BRS-E100, 7BRS-E105, 9121PFRE-1204925, 9122PFRE-1104930, 9141PFRE-1204950, 921FRE, 921FRE-1292925, 921RFRE-1392925, 922FRE-1192930, 922RFRE-1392930, 941FRE-1292950, 941RFRE-1392950, 96-04KBEC, 96-04KBEC-12901105, 9BR-E100, 9BR-E105, 9BR-E125, 9BRS-E100, 9BRS-E105, CV6E-1320000, CV6E2-1320040, CV6EB-1321000		
accessories for	380855		
	GEV No.	380055	Ref. No. —
	RC circuit voltage AC/DC suitable for BF09-32 rated 240V		
	GEV No.	380118	Ref. No. —
	auxiliary contact contacts 1NO/1NC AC1 10A for contactors BF series connection screw type G480/11		



			
1			
GEV No.	380782	Ref. No.	6A047030 BN6A047030
description	power contactor resistive load 40A 230VAC (AC3/400V) 12.5kW main contacts 3NO connection screw connection		
For models:	911PEB-1192805, 911RPEB-1392890, 915PEB-1192800, 94KBE, 94KBE-1192870, 94KBEM-1192880, 94RKBE-1392870, 94RKBE-1392880		

			
1			
GEV No.	381005	Ref. No.	R65140710
description	power contactor resistive load 35A 230VAC (AC3/400V) 17A/7.5kW main contacts 3NO auxiliary contacts 1NC connection screw connection type DILM 17-01		
For models:	CCE101M, CCE102M, CKEP06B, CKEP10, CKEP10B, CKET10, CKET10B		

MOELLER/EATON
power contactors

			
1			
GEV No.	380550	Ref. No.	R65140550 R65140700
description	power contactor resistive load 20A 230VAC (AC3/400V) 9A/4kW main contacts 3NO auxiliary contacts 1NC connection screw connection type DILM9 01		
For models:	CCE042M, CCE051M, CCE071M, CCE101M, CCE102M, CCG071M, CCG101M, CCG102M, CKEP06, CKEP06B, CKEP10, CKEP10B, CKET06, CKET06B, CKET10B, CKGP06, CKGP06B, CKGP10, CKGP10B, CKGT06, CKGT06B, CKGT10B		
accessories for	380550		
	GEV No.	380555	Ref. No. —
	auxiliary contact contacts 2NO/2NC AC15 16A for contactors DILEM connection screw type DILA-XHI22		
	GEV No.	380556	Ref. No. —
	auxiliary contact contacts 4NO AC15 16A for contactors DILM 7-32 connection screw type DILA-XHI40		
	GEV No.	380557	Ref. No. —
	auxiliary contact contacts 4NC AC15 16A for contactors DILM 7-32 connection screw type DILA-XHI04		
	GEV No.	380558	Ref. No. —
	auxiliary contact contacts 3NO/1NC AC15 16A for contactors DILM 7-32 connection screw type DILA-XHI31		
	GEV No.	380559	Ref. No. —
	auxiliary contact contacts 1NO/3NC AC15 16A for contactors DILM 7-32 connection screw type DILA-XHI13		
	GEV No.	380568	Ref. No. —
	RC circuit suitable for DILM 9-12 rated 110-240V		

overload switches

			
1			
GEV No.	381006	Ref. No.	R65160760
description	overload switch connection screw setting range 1-1.6A type ZB12		
For models:	CCE101M, CCE102M, CKEP10, CKEP10B, CKGP10, CKGP10B		

auxiliary contacts

			
1			
GEV No.	381007	Ref. No.	R65140730
description	auxiliary contact contacts 1NO/1NC AC15 10A for contactors connection screw type DILA-XHI11		
For models:	CKEP06, CKEP06B, CKEP10B, CKET06, CKET06B, CKET10B		

			
1			
GEV No.	380565	Ref. No.	R65140740
description	auxiliary contact contacts 1NO/1NC AC15 10A for contactors DIL 17-32 connection screw type DILM 32-CHI11-S		
For models:	CKEP06, CKEP10, CKEP10B, CKET10		



SIEMENS

power contactors



1

GEV No.	380652	Ref. No.	R65140380
description	power contactor resistive load 22A 230VAC (AC3/400V) 9A/4kW main contacts 3NO auxiliary contacts 1NC connection screw connection type 3RT10-16-1AP02		
For models:	CKEP20, CKEP20B, CKEP21, CKEP21B, CKEP40, CKEP40B, CKGP20, CKGP20B, CKGP21, CKGP21B, CKGP40, CKGP40B, CKGT20, CKGT20B, CKGT21, CKGT21B, CKGT40, CKGT40B		



1

GEV No.	380389	Ref. No.	CM187300
description	power contactor resistive load 22A 230VAC (AC3/400V) 9A/4kW main contacts 3NO auxiliary contacts 1NO connection screw connection type 3RT10-16-1AP01		
For models:	CPE60, CPE60DB, FQE41, FQE41L, FQE41L2, FQE61, FQE61L, FQE61L2, OCPE60, OCPE-60-12601900, OCPE-60-12601900MN, OFQE41, OFQE-41-12601510, OFQE-41-12601510MN, OFQE41L, OFQE61, OFQE-61-12601610, OFQE-61-12601610MN, OFQE61L		



1

GEV No.	380646	Ref. No.	R65140400
description	power contactor resistive load 40A 230VAC (AC3/400V) 17A/7.5kW main contacts 3NO auxiliary contacts connection screw connection type 3RT10-25-1AL20		
For models:	CKEP20, CKEP20B, CKEP21, CKEP21B, CKEP40, CKEP40B, CKET20, CKET20B, CKET21, CKET21B, CKET40, CKET40B		

auxiliary contacts



1

GEV No.	380653	Ref. No.	R65140420
description	auxiliary contact contacts 1NO/1NC AC15 3A for contactors 3RT101 connection screw connection type 3RH1911-1FA11		
For models:	CKEP20		



1

GEV No.	380647	Ref. No.	R65140430
description	auxiliary contact contacts 1NO/1NC AC15 3A for contactors 3RT102 3 RT103 connection screw connection type 3RH1921-1EA11 resistive load 10A AC-12 10A		
For models:	CKEP20, CKEP20B, CKEP21, CKEP21B, CKEP40, CKEP40B, CKET20, CKET20B, CKET21, CKET21B, CKET40, CKET40B		

overload switches



1

GEV No.	380659	Ref. No.	R65160570
description	overload switch setting range 0.7-1A connection screw type 3RU1116-0JB0 (AC3/400V) 0.25kW		
For models:	CKEP20, CKEP20B, CKEP21, CKEP21B, CKEP40, CKEP40B		



1

GEV No.	380661	Ref. No.	R65160620
description	overload switch setting range 1.4-2.0A connection screw type 3RU1116-1BB0 (AC3/400V) 0.75kW		
For models:	CKEP20, CKEP21, CKEP21B, CKEP40, CKEP40B, CKGP20, CKGP20B, CKGP21, CKGP21B, CKGP40, CKGP40B		



motor protection circuit breakers



1

GEV No.	382000	Ref. No.	R65160590
description	motor protection circuit breaker type 3RU1116-1EBO setting range 2.8-4A (AC3/400V) 1.5kW		
For models:	CKEP20B, CKGP20, CKGP20B, CKGP21, CKGP21B, CKGP40, CKGP40B		

ABL SURSUM

motor protection circuit breakers



1

GEV No.	380300	Ref. No.	2000390
description	motor protection circuit breaker type Mbs25-016 setting range 1-1.6A (AC3/400V) 0.55kW		
For models:	OLAX151, OLAX151EDX-1080725, OLAX151ELEFT-1080727, OLAX151-highspeed, OLAX160, OLAX160E-1080750, OLAX160E-1080751, OLAX160V-1080755, OLAX160V-1080756, OLAX160V-1081031, OLAX160V-1081032, OLAX210, OLAX210E-1081029, OLAX210E-1081030, OLAX220, OLAX220E-1080787, OLAX220E-1080788, OLAX220V-1080789, OLAX220V-1080790, OLAX230, OLAX230E-1080791, OLAX230E-1080792, OLAX230V-1080793, OLAX230V-1080794, OLAX240, OLAX240E-1080795, OLAX240E-1080796, OLAX240V-1080797, OLAX240V-1080798, OLAX250, OLAX250E-1080760, OLAX250E-1080761, OLAX250V-1080765, OLAX250V-1080766, OLAX300, OLAX300E-1080770, OLAX300E-1080771, OLAX300E-1081033, OLAX300E-1081035, OLAX300E-1081036, OLAX300LC, OLAX300LCE-1081034, OLAX300V-1080775, OLAX300V-1080776, OLAX310, OLAX310E-1081110, OLAX310E-1081111, OLAX310LC, OLAX310LCE-1081114, OLAX310LCE-1081115...(Other models you can see in the webshop)		
accessories for	380300		
	GEV No.	380305	Ref. No. —
	auxiliary contact contacts 1NO/1NC HMS11		

relays

power relays

with DIN rail mounting

upper



1

GEV No.	380180	Ref. No.	560301
description	power relays FINDER 230VAC 16A 3CO connection male faston 6.3mm DIN rail manuf. no. 62.83.8.230.4007		
For models:	G12S, OLDS45, OLDS50, OLDS50-1081088, OLDS50D-1081089, OLDS50E-1081090, OLDS50ED-1081091, OLHT11-1081071, OLHT11D-1081072, OLHT11ECO-1081070, OLHT11S, OLHT11S-Neutra, OLHT12-1081075, OLHT12EL-1081080, OLHT12EL-1081083, OLHT12ELD-1081081, OLHT12ELPLUS-1081086, OLHT12S, OLHT12SElectronic, OLHT12S-Neutra		



1

GEV No.	380314	Ref. No.	166550971
description	power relays Italiana Relè 230VAC 20A 1NC/1NO connection male faston 6.3mm DIN rail manuf. no. A1B-230AC-AD		
For models:	KBT40-21091640, KC41-210916400BDC		

lateral



1



GEV No.	380336	Ref. No.	LA65170100 LAR65170100
description	power relays FINDER 230VAC 16A 2NO connection male faston 6.3mm DIN rail manuf. no. 62.82.8.230.0308		
For models:	CCG051M, CCG071M, CCG101M, CCG102M, CKGP06, CKGP06B, CKGP10, CKGP10B, CKGP20, CKGP20B, CKGP21, CKGP21B, CKGP40, CKGP40B		
accessories for	380336		
	GEV No.	380703	Ref. No. —
	adapter for flange mounting suitable for Finder relay 62 series.		
	GEV No.	380811	Ref. No. —
	adapter with bracket mounting suitable for Finder relay 62 series.		

Table continues overleaf



accessories for		380336	
GEV No.	380954	Ref. No.	—
adapter hole distance 54mm bracket mounting suitable for Finder relay 62 series. L 41mm W 39mm H 49mm			
GEV No.	381003	Ref. No.	—
adapter for DIN rail mounting suitable for Finder relay 62 series.			
GEV No.	381039	Ref. No.	—
adapter for DIN rail mounting suitable for Finder relay 62 series.			

with bracket mounting



GEV No.	380139	Ref. No.	15620
description	power relays FINDER 230VAC 16A 2CO connection F6.3 bracket mounting dimensions 68x38.2x35.8mm manuf. no. 62.82.8.230.0000		
For models:	OLDS35, OLDS35-1081061, OLDS35D-1081062, OLDS35-Neutra, OLDS37, OLDS37-1081006, OLDS37-1081063, OLDS37D-1081007, OLDS37D-1081064, OLDS37LS-1081008, OLDS37LSD-1081009, OLDS37-Neutra, OLDS40, OLDS40-1081010, OLDS40-1081065, OLDS40D-1081011, OLDS40D-1081066, OLDS40E-1081067, OLDS40ED-1081068, OLDS40LS-1081012, OLDS40LSD-1081013, OLDS40-Neutra, OLDS50-Neutra, OLG35, OLG35D-1081000, OLG35-Neutra, OLG600, OLGastro450, OLGastro500Plus, OLGastro500S, OLGastro750Plus, OLGastro750S, OLG40, OLG45, OLG50, OLG50-1080705, OLG50D-1080706, OLG50E-1080730, OLG50ECO-1081014, OLG50ECOD-1081015, OLG50ED-1080731, OLG50-Neutra, OLG585, OLG585-1081016, OLG585D-1081017, OLG585-Neutra, OLHT11-1081071, OLHT11D-1081072, OLHT11E-CO-1081070, OLHT-11-Neutra...(Other models you can see in the webshop)		



GEV No.	380403	Ref. No.	16047
description	power relays FINDER 230VAC 16A 3CO connection F6.3 bracket mounting manuf. no. 62.83.8.230.0500		
For models:	OLDS37-1081006, OLDS37D-1081007, OLDS37LS-1081008, OLDS37LSD-1081009, OLDS40-1081010, OLDS40D-1081011, OLDS40LS-1081012, OLDS40LSD-1081013, OLG35-1080702, OLG37, OLG37-1080700, OLG37D-1080707, OLG37LS-1081001, OLG37LSD-1081002, OLG37-Neutra, OLG40, OLG40-1080701, OLG40D-1080708, OLG40D-1081003, OLG40-Neutra, OLG45, OLG45LSD-1081004, OLG585, OLG585-1081016, OLG585D-1081017, OLG585-Neutra, OLLinear, OLStar		

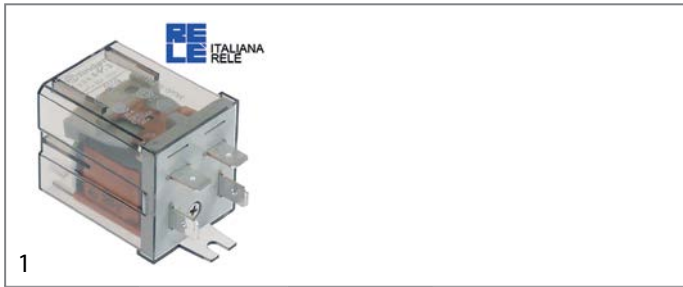

GEV No.	380185	Ref. No.	166560
description	power relays Italiana Relè 230VAC 30A 1NO connection F6.3 bracket mounting dimensions 36.5x32.2x51.8mm manuf. no. A10-230AC-FA		
For models:	KC41-210916400BDC, KTRNBT300122-2025130105DK, KTRNB-T300122A-20251301051G, OLSPABTV140-201724030CI4, OLSPABTV70-201717030CHY, ROLL-IN1P-211008120CJE, ROLL-IN1P-211008120CJG, ROLL-IN1PBT-211009120CJF, ROLL-IN2P-211016120CJL, ROLL-IN2P-211016120CJM, ROLL-IN2P-211016220CJN, ROLL-IN2P-211016220CJP, ROLL-IN2PMTN-211016220CJO, ROLL-INP1P-211008220CJH, ROLL-INP1P-211008220CJG, ROLL-INP1PBT-211009220CJI, ROLL-INP1PMTN-211008220CJJ		

with male contacts

female contact 2.0mm

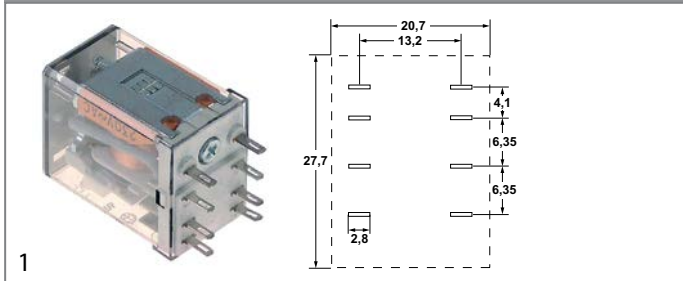

GEV No.	380377	Ref. No.	6A047070 BN6A047070 FR995940
description	power relays FINDER 220-240VAC 10A 2CO connection F2 plug-in connection manuf. no. 55.32.8.230.0000 94.92.3 250V		
For models:	74-02NPEI, 7PN-EI50, CV10E-1320100, CV10EB-1321100, CV10G, CV10G-1310100, CV10G-2, CV10G2-1310140, CV10GB-1311100, CV10G-S, CV10GS-1310150, CV10G-S2, CV10GS2-1310190, CV20E-1320200, CV20EB-1321200, CV20G, CV20G-1310200, CV20G-2, CV20G2-1310240, CV20GB-1311200, CV20G-S, CV20GS-1310250, CV20G-S2, CV20GS2-1310290, CV21E-1322100, CV21ES2-1322190, CV21G-1312100, CV21GS2-1312190, CV6E-1320000, CV6E2-1320040, CV6EB-1321000, CV6G, CV6G-1310000, CV6G-2, CV6G2-1310040, CV6GB-1311000, CV6G-S, CV6GS-1310050, CV6G-S2, CV6GS2-1310090, CVM10E-1320400, CVM10G-1310400, CVM10G-1310410, CVM10GP-1310400, CVM20E-1320500, CVM20G-1310500, CVM21E-1322400, CVM21ES2-1322490, CVM21G-1312400, CVM21GS2-1312490...(Other models you can see in the webshop)		

accessories for		380377	
GEV No.	380341	Ref. No.	—
relay socket 4-pole contacts 12 300V voltage AC 6A Italiana Relè manuf. no. ZMD4			
GEV No.	380378	Ref. No.	—
relay socket 2-pole 55/85 dimensions 70.5x30x27mm 250V voltage AC 10A FINDER manuf. no. 94.72			
GEV No.	380384	Ref. No.	6A047074 A047074 BN6A047074
relay socket 2-pole contacts male faston 2.8mm 250V voltage AC 10A W 23mm for			
GEV No.	380399	Ref. No.	—
relay socket 4-pole dimensions 76.2x27x86.1mm 250V voltage AC 1A FINDER manuf. no. 94.94.3			

plug-in/print relays



1

GEV No.	381151	Ref. No.	3006078	
description	print relay 24VAC 2CO 2-pole at 250V 8A connection pins raster size 5mm FINDER manuf. no. 40.52.8.024.0000 95.65/95.75			
For models:	OLAX151, OLAX151EDX-1080725, OLAX151ELEFT-1080727, OLAX151-highspeed, OLAX160, OLAX160E-1080750, OLAX160E-1080751, OLAX160V-1080755, OLAX160V-1080756, OLAX160V-1081031, OLAX160V-1081032, OLAX210, OLAX210E-1081029, OLAX210E-1081030, OLAX220, OLAX220E-1080787, OLAX220E-1080788, OLAX220V-1080789, OLAX220V-1080790, OLAX230, OLAX230E-1080791, OLAX230E-1080792, OLAX230V-1080793, OLAX230V-1080794, OLAX240, OLAX240E-1080795, OLAX240E-1080796, OLAX240V-1080797, OLAX240V-1080798, OLAX250, OLAX250E-1080760, OLAX250E-1080761, OLAX250V-1080765, OLAX250V-1080766, OLAX300, OLAX300E-1080770, OLAX300E-1080771, OLAX300E-1081033, OLAX300E-1081035, OLAX300E-1081036, OLAX300LC, OLAX300LCE-1081034, OLAX300V-1080775, OLAX300V-1080776, OLAX310, OLAX310E-1081110, OLAX310E-1081111, OLAX310LC, OLAX310LCE-1081114, OLAX310LCE-1081115...(Other models you can see in the webshop)			
accessories for	381181			
	GEV No.	381455	Ref. No.	—
	support bracket			



1

GEV No.	380384	Ref. No.	6A047074 BN6A047074	
description	relay socket 2-pole contacts male faston 2.8mm 250V voltage AC 10A W 23mm for			
For models:	74-02NPEI, 7PN-EI50, CV10G-1310100, CV20E-1320200, CV20G-1310200, CV20GB-1311200, CV21ES2-1322190, CV21GS2-1312190, CV6E-1320000, CV6G-1310000, CVM10E-1320400, CVM10G-1310400, CVM10GP-1310400, CVM20E-1320500, CVM21ES2-1322490, CVM21GS2-1312490, CVM6E-1320300, CVP10E-1320700, CVP10G-1310700, CVP10GP-1310700, CVP20E-1320800, CVP20G-1310800, CVP21ES2-1322790, CVP21GS2-1312790, CVP6E-1320600, CVP6G-1310600			
accessories for	380384			
	GEV No.	380804	Ref. No.	—
	support bracket			

relay sockets



1

GEV No.	381181	Ref. No.	3006079	
description	relay socket 2-pole 40.51/40.52/40.61 connection screw clamp dimensions 15.8x78.6mm 250V voltage AC 10A FINDER manuf. no. 95.75			
For models:	OLAX151, OLAX151EDX-1080725, OLAX151ELEFT-1080727, OLAX151-highspeed, OLAX160, OLAX160E-1080750, OLAX160E-1080751, OLAX160V-1080755, OLAX160V-1080756, OLAX160V-1081031, OLAX160V-1081032, OLAX210, OLAX210E-1081029, OLAX210E-1081030, OLAX220, OLAX220E-1080787, OLAX220E-1080788, OLAX220V-1080789, OLAX220V-1080790, OLAX230, OLAX230E-1080791, OLAX230E-1080792, OLAX230V-1080793, OLAX230V-1080794, OLAX240, OLAX240E-1080795, OLAX240E-1080796, OLAX240V-1080797, OLAX240V-1080798, OLAX250, OLAX250E-1080760, OLAX250E-1080761, OLAX250V-1080765, OLAX250V-1080766, OLAX300, OLAX300E-1080770, OLAX300E-1080771, OLAX300E-1081033, OLAX300E-1081035, OLAX300E-1081036, OLAX300LC, OLAX300LCE-1081034, OLAX300V-1080775, OLAX300V-1080776, OLAX310, OLAX310E-1081110, OLAX310E-1081111, OLAX310LC, OLAX310LCE-1081114, OLAX310LCE-1081115...(Other models you can see in the webshop)			
accessories for	381181			
	GEV No.	381455	Ref. No.	—
	support bracket			

level relays

GICAR



1

GEV No.	401224	Ref. No.	6A001423
description	level relay 230V connection F6.3 type RL30/3ES/F/G		
For models:	94-04PEI100L, 94-04PEI100L-12901765, 94-04PEI110L-12901765BN, 94-04PEI150L, 94-04PEI150L-12901767, 94-04PEI150L-12901767BN, 9PN-EI100, 9PN-EI150		

time relays

time relays



1

GEV No.	381421	Ref. No.	R65090450
description	time relay CROUZET EMAR7 88 829 117 time range 0.1s-20h 240VAC 5A NO connection grip connection		
For models:	CCG051M, CCG071M, CCG101M, CCG102M		



1

GEV No.	380386	Ref. No.	6A047065 BN6A047065
description	time relay CROUZET MUS2-88826004 time range 0.1s-100h 24-240VAC 0.7A 1NO connection grip connection		
For models:	CV10E-1320100, CV10G-1310100, CV20E-1320200, CV20G-1310200, CV21E-1322100, CV21ES2-1322190, CV21G-1312100, CV21GS2-1312190, CV6E-1320000, CV6E2-1320040, CV6G-1310000, CVM10E-1320400, CVM10G-1310400, CVM10G-1310410, CVM10GP-1310400, CVM20E-1320500, CVM20G-1310500, CVM21E-1322400, CVM21ES2-1322490, CVM21G-1312400, CVM21GS2-1312490, CVM6E-1320300, CVM6G-1310300, CVM6G-1310310, CVP10E-1320700, CVP10G-1310700, CVP10GP-1310700, CVP20E-1320800, CVP20G-1310800, CVP21E-1322700, CVP21ES2-1322790, CVP21GS-1312750, CVP21GS2-1312790, CVP6E-1320600, CVP6G-1310600		



1

GEV No.	380878	Ref. No.	3006225 3006226
description	time relay FINDER 80.11.0.240 time range 0.1s-20h 12-240V AC/DC 16A mounting measurements DIN railmm 1CO connection grip connection		
For models:	OLAX151, OLAX151EDX-1080725, OLAX151ELEFT-1080727, OLAX151-highspeed, OLAX160, OLAX160E-1080750, OLAX160E-1080751, OLAX160V-1080755, OLAX160V-1080756, OLAX160V-1081031, OLAX160V-1081032, OLAX210, OLAX210E-1081029, OLAX210E-1081030, OLAX220, OLAX220E-1080787, OLAX220E-1080788, OLAX220V-1080789, OLAX220V-1080790, OLAX230, OLAX230E-1080791, OLAX230E-1080792, OLAX230V-1080793, OLAX230V-1080794, OLAX240, OLAX240E-1080795, OLAX240E-1080796, OLAX240V-1080797, OLAX240V-1080798, OLAX250, OLAX250E-1080760, OLAX250E-1080761, OLAX250V-1080765, OLAX250V-1080766, OLAX300, OLAX300E-1080770, OLAX300E-1080771, OLAX300E-1081033, OLAX300E-1081035, OLAX300E-1081036, OLAX300LC, OLAX300LCE-1081034, OLAX300V-1080775, OLAX300V-1080776, OLAX310, OLAX310E-1081110, OLAX310E-1081111, OLAX310LC, OLAX310LCE-1081114, OLAX310LCE-1081115...(Other models you can see in the webshop)		

transformers

open transformers

with clamp terminal

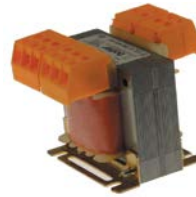

1

GEV No.	401189	Ref. No.	6A047047 BN6A047047
description	transformer 20VA		
For models:	ECVM10ES2, ECVM10ES2-1324290, ECVM10ES2-1326120, ECVM10GS2, ECVM10GS2-1314290, ECVM10GS2-1316120, ECVM20ES2, ECVM20ES2-1324390, ECVM20ES2-1326140, ECVM20GS2, ECVM20GS2-1314390, ECVM20GS2-1316140, ECVM21ES2, ECVM6ES2, ECVM6ES2-1324190, ECVM6ES2-1326100, ECVM6ES2-1326100H, ECVM6GS2, ECVM6GS2-1314190, ECVM6GS2-1316100, ECVP10ES2, ECVP10ES2-1324690, ECVP10ES2-1326200, ECVP10GS2, ECVP10GS2-1314690, ECVP10GS2-1316200, ECVP20ES2, ECVP20ES2-1324790, ECVP20ES2-1326220, ECVP20GS2, ECVP20GS2-1314790, ECVP20GS2-1316220, ECVP21ES2, ECVP21ES2-1324890, ECVP21ES2-1326240, ECVP21GS2, ECVP21GS2-1314890, ECVP21GS2-1316240, ECVP6ES2, ECVP6ES2-1324590, ECVP6ES2-1326180, ECVP6GS2, ECVP6GS2-1314590, ECVP6GS2-1316180, NECVM10ES2, NECVM10ES2-1327290, NECVM10ES2-1328120, NECVM10ES2-1328120H, NECVM10GS2, NECVM10GS2-1317290...(Other models you can see in the webshop)		

encapsulated transformers

with screw connection



1

GEV No.	400127	Ref. No.	R65180430
description	transformer primary 230VAC secondary 12VAC 40VA secondary 3.2A H 63mm L 75mm W 78mm connection 2-wire connection systems 50/60Hz moulded		
For models:	CKEP10, CKEP10B, CKEP20, CKEP20B, CKEP21, CKEP21B, CKEP40, CKEP40B, CKET10, CKET10B, CKET20, CKET20B, CKET21, CKET21B, CKET40, CKET40B, CKGP10, CKGP10B, CKGP20, CKGP20B, CKGP21, CKGP21B, CKGP40, CKGP40B, CKGT10B, CKGT20, CKGT20B, CKGT21, CKGT21B, CKGT40, CKGT40B		



PMA



1

GEV No.	400126	Ref. No.	R65180420
description	transformer primary 230VAC secondary 12VAC 20VA secondary 2.1A connection screw 50Hz		
For models:	CCE071M, CCE101M, CCE102M, CCG071M, CCG101M, CCG102M, CKEP06, CKEP06B, CKEP10, CKEP10B, CKEP20, CKEP20B, CKEP21, CKEP21B, CKEP40, CKEP40B, CKET06, CKET06B, CKET10, CKET10B, CKET20, CKET20B, CKET21, CKET21B, CKET40, CKET40B, CKGP06, CKGP06B, CKGP10, CKGP10B, CKGP20, CKGP20B, CKGP21, CKGP21B, CKGP40, CKGP40B, CKGT06, CKGT06B, CKGT10B, CKGT20, CKGT20B, CKGT21, CKGT21B, CKGT40, CKGT40B		



1

GEV No.	379054	Ref. No.	168305
description	transformer primary 230VAC secondary 12VAC 3VA secondary 0.25A H 40mm L 45mm W 50mm connection screw 50/60Hz type 153/M		
For models:	KBT40-21091640, KC41-21091640BDC, KR41-210906400BFA, KTAP01-BASE-20220901044U, KTAP02-BASE-20221301048K, KTAP02BT-BASE-2022630105KW, KTAP03-BASE-2022180109UA, KTAP04-2022230109X0, KTAP04-BASE-2022230109RY, KTAR01, KTAR01N, KTAR02, KTAR02N, KTAR03, KTAR03N, KTAR04, KTAR04N, KTN40-21090640, KTRE21-202108010BL5, KTRE2-202108010BFC, KTRE2A-202108010BGP, KTRE3-202113010BHF, KTRE32A-202113010BLQ, KTRE34-202113010BLW, KTRE3A-202113010BFW, KTRE4-202117010BLG, KTRE42-202117010BM0, KTRE42A-202117010BM6, KTRE44-202117010BMB, KTRE4A-202117010BFF, KTRE5-202122010BG2, KTRE52-202122010BNK, KTRE54-202122010BGC, KTRE54A-202122010BNP, KTRE5A-202122010BL3, KTREP3-202611010C2F, KTREP34-20261101096L, KTREP34A-20261101096K, KTREP3A-202611010C1L, KTREP4-202615010BNQ, KTREP4A-202615010BNR, KTRP52A-202620010BO5, KTRN200012-202010050495, KTRN200012A-2020100507UK, KTRN200013-2020100507UV, KTRN200013A-2020100507UU, KTRN200014-2020100507UM, KTRN200014A-2020100507UL, KTRN200015-2020100507UR, KTRN200015A-2020100507UT...(Other models you can see in the webshop)		

for lighting



1

GEV No.	401188	Ref. No.	6A047061 BN6A047061
description	transformer primary 240V secondary 11.5V 100VA		
For models:	CV21E, CV21E-1322100, CV21E-2, CV21E2-1322140, CV21E-S, CV21E5-1322150, CV21E-S2, CV21E52-1322190, CV21G, CV21G-1312100, CV21G-2, CV21G2-1312140, CV21G-S, CV21GS-1312150, CV21G-S2, CV21GS2-1312190, CVM21E, CVM21E-1322400, CVM21E-2, CVM21E2-1322440, CVM21E-S, CVM21E5-1322450, CVM21E-S2, CVM21E52-1322490, CVM21G, CVM21G-1312400, CVM21G-2, CVM21G2-1312440, CVM21G-S, CVM21GS-1312450, CVM21G-S2, CVM21GS2-1312490, CVP21E, CVP21E-1322700, CVP21E-2, CVP21E-S, CVP21E5-1322750, CVP21E-S2, CVP21E52-1322790, CVP21G, CVP21G-1312700, CVP21G-2, CVP21G2-1312740, CVP21G-S, CVP21GS-1312750, CVP21G-S2, CVP21GS2-1312790, ECVM21E52, ECVM21GS2, ECVM21GS2-1314490...(Other models you can see in the webshop)		

electronic controllers

DIXELL

refrigeration controllers

built-in version













1

GEV No.	378249	Ref. No.	3006120
description	electronic controller DIXELL XR20C-1P3C0 mounting measurements 71x29mm 24V voltage AC/DC NTC/PTC relay outputs 1 CO-8A(3) NTC/PTC DI protection IP54 -50 up to +150°C display 3½ digits		
For models:	OLAX250, OLAX250E-1080760, OLAX250E-1080761, OLAX250V-1080765, OLAX250V-1080766, OLAX300, OLAX300E-1080770, OLAX300E-1080771, OLAX300E-1081033, OLAX300E-1081035, OLAX300E-1081036, OLAX300LC, OLAX300LCE-1081034, OLAX300V-1080775, OLAX300V-1080776, OLAX310, OLAX310E-1081110, OLAX310E-1081111, OLAX310LC, OLAX310LCE-1081114, OLAX310LCE-1081115, OLAX310LCV-1081116, OLAX310LCV-1081117, OLAX310V-1081112, OLAX310V-1081113, OLAX320, OLAX320E-1081118, OLAX320E-1081119, OLAX320V-1081120, OLAX320V-1081121, OLAX320V-1081125, OLAX330, OLAX330E-1081122, OLAX330E-1081123, OLAX330V-1081124, OLAX380, OLAX380E-1080780, OLAX380E-1080781, OLAX380E-1081037, OLAX380E-1081038, OLAX380E-1081039, OLAX380E-1081040, OLAX380E-1081043, OLAX380E-1081044, OLAX380E-1081046, OLAX380E-1081047, OLAX380E-1081048, OLAX380E-1081051, OLAX380E-1081052, OLAX380E-1081053...(Other models you can see in the webshop)		



1

GEV No.	378228	Ref. No.	16815108 BN16815108
description	electronic controller DIXELL XW20L-5N0C1 mounting measurements 150x30mm built-in depth 65.5mm 230V voltage AC NTC/PTC relay outputs 2 NO-20A(8) CO-8A(3) NTC/PTC DI -50 up to +150°C display 3½ digits		
For models:	5520178		
accessories for	378228		
	GEV No.	Ref. No.	—
	temperature probe NTC 10kOhm cable PVC probe -20 up to +80°C cable -10 up to 100°C probe ø7x24.5mm cable length 1.5m without screw connection 2-wire		
	GEV No.	Ref. No.	167201
	temperature probe PTC 1kOhm cable silicone probe -50 up to +150°C cable -50 up to +180°C probe ø6x40mm cable length 1.5m without screw connection 2-wire		
	GEV No.	Ref. No.	—
	temperature probe PTC 1kOhm cable PVC probe -50 up to +150°C cable -10 up to 100°C probe ø6x30mm cable length 3m without screw connection 2-wire		
	GEV No.	Ref. No.	—
	temperature probe NTC 10kOhm cable PVC probe -20 up to +80°C cable -10 up to 100°C probe ø6x25mm cable length 3m 2-wire		
	GEV No.	Ref. No.	—
	temperature probe PTC 1kOhm cable silicone probe -50 up to +150°C cable -50 up to +180°C probe ø6x40mm cable length 3m without screw connection 2-wire		
	GEV No.	Ref. No.	167212
	temperature probe NTC 10kOhm cable thermoplastic probe -40 up to +110°C cable -40 up to +110°C probe ø6x14mm cable length 1.5m without screw connection 2-wire		
	GEV No.	Ref. No.	167211 2000401
	temperature probe NTC 10kOhm cable thermoplastic probe -40 up to +110°C cable -40 up to +110°C probe ø6x14mm cable length 3m without screw connection 2-wire		
	GEV No.	Ref. No.	—
	temperature probe NTC 10kOhm cable thermoplastic probe -40 up to +110°C cable -40 up to +110°C probe ø6x14mm cable length 6m 2-wire		
	GEV No.	Ref. No.	—
	temperature probe NTC 10kOhm cable silicone probe -40 up to +110°C cable -50 up to +180°C probe ø6x40mm cable length 3m 2-wire		
	GEV No.	Ref. No.	—
	temperature probe NTC 10kOhm cable silicone probe -40 up to +110°C cable -50 up to +180°C probe ø6x40mm cable length 1.5m without screw connection 2-wire		
	GEV No.	Ref. No.	—
	GEV No.	Ref. No.	—
	programming key 4K for electronic controller DIXELL		

electronic thermometers

built-in version

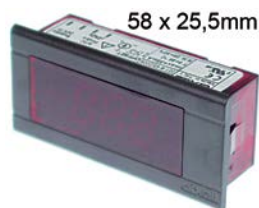

1

GEV No.	378046	Ref. No.	2000402
description	thermometer DIXELL XT11S mounting measurements 58x25.5mm 24V voltage AC/DC NTC 0 up to +60°C display 2½ digit 1 TempIn1 NTC DigilN1 defr. funct. front measurements 31x64mm		
For models:	OLAX151, OLAX151EDX-1080725, OLAX151ELEF-1080727, OLAX151-highspeed, OLAX160, OLAX160E-1080750, OLAX160E-1080751, OLAX160V-1080755, OLAX160V-1080756, OLAX160V-1081031, OLAX160V-1081032, OLAX210, OLAX210E-1081029, OLAX210E-1081030, OLAX220, OLAX220E-1080787, OLAX220E-1080788, OLAX220V-1080789, OLAX220V-1080790, OLAX230, OLAX230E-1080791, OLAX230E-1080792, OLAX230V-1080793, OLAX230V-1080794, OLAX240, OLAX240E-1080795, OLAX240E-1080796, OLAX240V-1080797, OLAX240V-1080798, OLBX230, OLBX280, OLUX220		





ELIWELL

refrigeration controllers

built-in version



1

GEV No.	379570	Ref. No.	16811201
description	electronic controller ELIWELL type ID961 mounting measurements 71x29mm 12V voltage AC/DC NTC/PTC relay outputs 1 relay -50 up to +150°C display 3½ digits RoomTempIn yes compressor relay 8A		
For models:	SAL22R-2124922093V		
accessories for	379570		
	GEV No.	Ref. No.	—
	temperature probe PTC 1kOhm cable PVC probe -50 up to +150°C cable -10 up to 100°C probe ø6x30mm cable length 3m without screw connection 2-wire		
	GEV No.	Ref. No.	—
	temperature probe PTC 1kOhm cable silicone probe -50 up to +150°C cable -50 up to +180°C probe ø6x40mm cable length 3m without screw connection 2-wire		
	GEV No.	Ref. No.	167211 2000401
	temperature probe NTC 10kOhm cable thermoplastic probe -40 up to +110°C cable -40 up to +110°C probe ø6x14mm cable length 3m without screw connection 2-wire		
	GEV No.	Ref. No.	—
	temperature probe PTC 1kOhm cable thermoplastic probe -50 up to +150°C cable -40 up to +110°C probe ø6x14mm cable length 3m 2-wire resistor 1kOhm		

1

GEV No.	379025	Ref. No.	16814001
description	electronic controller ELIWELL type ID961LX mounting measurements 71x29mm 230V voltage AC NTC/PTC relay outputs 1 front measurements 76.2x35mm protection IP65 -55 up to +150°C display 3½ digits		
For models:	KR41-210906400BFA, SAL22R-2124922093V		



1

GEV No.	379577	Ref. No.	1681108
description	electronic controller ELIWELL type ID974 mounting measurements 71x29mm 230V voltage AC NTC/PTC relay outputs 3 relays -50 up to +150°C display 3½ digits RoomTempIN yes DEF Probe yes DEF Relay 8A fan relay 5A compressor relay 8A		
For models:	KTAP02BT-BASE-2022630105KW, KTRPBT300222-2022630107KT, KTRPBT300222A-2022630107KU		
accessories for	379577		
	GEV No.	Ref. No.	—
	temperature probe PTC 1kOhm cable PVC probe -50 up to +150°C cable -10 up to 100°C probe ø6x30mm cable length 3m without screw connection 2-wire		
	GEV No.	Ref. No.	—
	temperature probe PTC 1kOhm cable silicone probe -50 up to +150°C cable -50 up to +180°C probe ø6x40mm cable length 3m without screw connection 2-wire		
	GEV No.	Ref. No.	167211 2000401
	temperature probe NTC 10kOhm cable thermoplastic probe -40 up to +110°C cable -40 up to +110°C probe ø6x14mm cable length 3m without screw connection 2-wire		
	GEV No.	Ref. No.	—
	temperature probe PTC 1kOhm cable thermoplastic probe -50 up to +150°C cable -40 up to +110°C probe ø6x14mm cable length 3m 2-wire resistor 1kOhm		

EVCO - EVERY CONTROL

refrigeration controllers

built-in version

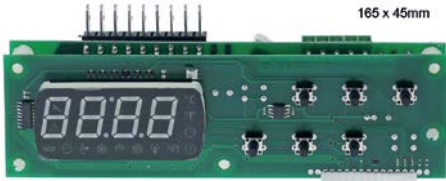

165 x 45mm

1

GEV No.	379820	Ref. No.	BN1681114
description	electronic controller EVERY CONTROL type EVC20S35N7ALX30 mounting measurements 165x45mm 230V voltage AC NTC relay outputs 3 NO-16A(5) NO-8A(4) CO-8A(4) NTC NTC DI for fridge front measurementsmm built-in depth 56mm protection IP00 yes yes yes -40° up to 105°C display 4 digits		



1

GEV No.	379850	Ref. No.	936092 BN1681118 FR936092
description	electronic controller EVERY CONTROL type EVC20S35N7ALX40 mounting measurements 165x45mm 230V voltage AC NTC relay outputs 4 NO-16A(5) NO-8A(4) CO-8A(4) NO-8A(4) NTC NTC DI DI for fridge front measurementsmm built-in depth 56mm protection IP00 yes yes yes -40 up to +99°C display 4 digits		

SHANGFANG

accessories



1

GEV No.	379054	Ref. No.	168305
description	transformer primary 230VAC secondary 12VAC 3VA secondary 0.25A H 40mm L 45mm W 50mm connection screw 50/60Hz type 153/M		
For models:	KBT40-21091640, KC41-210916400BDC, KR41-210906400BFA, KTAP01-BASE-20220901044U, KTAP02-BASE-20221301048K, KTAP02BT-BASE-2022630105KW, KTAP03-BASE-2022180109UA, KTAP04-2022230109X0, KTAP04-BASE-2022230109RY, KTAR01, KTAR01N, KTAR02, KTAR02N, KTAR03, KTAR03N, KTAR04, KTAR04N, KTN40-21090640, KTRE21-202108010BL5, KTRE2-202108010BFC, KTRE2A-202108010BGP, KTRE3-202113010BHF, KTRE32A-202113010BLQ, KTRE34-202113010BLW, KTRE3A-202113010BFW, KTRE4-202117010BLG, KTRE42-202117010BMO, KTRE42A-202117010BM6, KTRE44-202117010BMB, KTRE4A-202117010BFF, KTRE5-202122010BG2, KTRE52-202122010BNK, KTRE54-202122010BGC, KTRE54A-202122010BNP, KTRE5A-202122010BL3, KTREP3-202611010C2F, KTREP3A-20261101096L, KTREP34A-20261101096K, KTREP3A-202611010C1L, KTREP4-202615010BNQ, KTREP4A-202615010BNR, KTREP52A-202620010BO5, KTRN200012-202010050495, KTRN200012A-2020100507UK, KTRN200013-2020100507UV, KTRN200013A-2020100507UU, KTRN200014-2020100507UM, KTRN200014A-2020100507UL, KTRN200015-2020100507UR, KTRN200015A-2020100507UT...(Other models you can see in the webshop)		



miscellaneous

refrigeration controllers



GEV No.	378411	Ref. No.	996380
description	power PCB EVCO type EVC80P16P7FRL01 mounting measurements 170x120mm		
For models:	031, 051, 081, 121, 161, BBC051DF-ASX-4186V21A286220, BB-F031AF-ASX-4186V204286210, OBC051DF-ASX-6V21A286220OL, OBC081AF-ASX-6V221285220OL, OBC121DF-ASX-6V23A285220OL, OBC161DF-ASX-6V24A485220OL, OBF031AF-ASX-6V204286210OL		

probes

universal probes

temperature probes



GEV No.	379160	Ref. No.	167212
description	temperature probe NTC 10kOhm cable thermoplastic probe -40 up to +110°C cable -40 up to +110°C probe ø6x14mm cable length 1.5m without screw connection 2-wire		
For models:	KSABT70G-2045370CJD, OLKSABT140-2045240CIW, OLKSABT144-2045240CJ0, OLKSABT70-2045170CIO, OLKSABT72-2045170CIT, OLKSABTV140-2045240CIY, OLKSABTV70-2045170CIR, OLKSAP70-2045270CIP, OLKSATN140-2045140CIV, OLKSATN144-2045140CIZ, OLKSATN70-2045070CIN, OLKSATN72-2045070CIS, OLKSATNV140-2045140CIX, OLKSATNV70-2045070CIQ, OLSPAB100-201706030CLP, OLSPAB120-201707030CLN, OLSPAB200-201712030CLO, OLSPAB240-201714030CLO, OLSPABT120-201722030CII, OLSPABT124-201722030CIM, OLSPABT140-201724030CI2, OLSPABT144-201724030CI6, OLSPABT60-201716030CIC, OLSPABT70-201717030CHW, OLSPABT72-201717030CIO, OLSPABTV120-201722030CIK, OLSPABTV140-201724030CI4, OLSPABTV70-201717030CHY, OLSPATNN120-201712030CIH, OLSPATNN124-201712030CIL, OLSPATNN140-201714030CI1, OLSPATNN144-201714030CI5, OLSPATNN60-201706030CIB, OLSPATNN62-201706030CIF, OLSPATNN70-201707030CEM, OLSPATNN72-201707030CHZ, OLSPATNV120-201712030CIJ, OLSPATNV140-201714030CI3, OLSPATNV60-201706030CID, OLSPATNV70-201707030CHX, ROLL-IN1P-211008120CJE, ROLL-IN1P-211008120CJG, ROLL-IN1PBT-211009120CJF, ROLL-IN2P-211016120CJL, ROLL-IN2P-211016120CJM, ROLL-IN2P-211016220CJN, ROLL-IN2P-211016220CJP, ROLL-IN2PMTN-211016220CJO, ROLL-INP1P-211008220CJH, ROLL-INP1P-211008220CJK...(Other models you can see in the webshop)		

GEV No.	379161	Ref. No.	167211 2000401
description	temperature probe NTC 10kOhm cable thermoplastic probe -40 up to +110°C cable -40 up to +110°C probe ø6x14mm cable length 3m without screw connection 2-wire		
For models:	KSABT70G-2045370CJD, KTAP01-BASE-20220901044U, KTAP02-BASE-20221301048K, KTAP03-BASE-2022180109UA, KTAP04-2022230109X0, KTAP04-BASE-2022230109RY, KTRP00522-2022130107K4, KTRP200022-202209010500, KTRP200022A-2022090104EB, KTRP200042-2022090107HY, KTRP200042A-20220901077B, KTRP200044-2022090105CF, KTRP200044A-2022090107HZ, KTRP200052-2022090107HW, KTRP200052A-2022090107HX, KTRP200055-2022090107K1, KTRP200055A-2022090107K0, KTRP300222-2022130105HP, KTRP300222A-2022130104EC, KTRP300422-2022130106TB, KTRP300422A-2022130105XL, KTRP300442-2022130107K6, KTRP300442A-2022130107K7, KTRP300522-2022130107K2, KTRP300522A-2022130107K3, KTRP300552A-2022130107K5, KTRP402222A-2022180109WR, KTRP404222-2022180109WV, KTRP404222A-2022180109WU, KTRP404422-2022180104VV, KTRP404422A-2022180107KE, KTRP405222-2022180109WT, KTRP405222A-2022180109WS, KTRP405522-2022180107KB, KTRP405522A-2022180107KC, KTRP522222-2022230109WW, KTRP522222A-2022230109WX, KTRP542222A-2022230109X1, KTRP544222-2022230107KR, KTRP544222A-2022230107KP, KTRP552222-2022230109WZ, KTRP552222A-2022230109WY, KTRP555222-2022230107KN, KTRP555222A-2022230107KN, OLAX151, OLAX151EDX-1080725, OLAX151ELEF-1080727, OLAX151-highspeed, OLAX160, OLAX160E-1080750...(Other models you can see in the webshop)		

GEV No.	379130 ¹	Ref. No.	R65325000
description	temperature probe Pt100 cable Vetrotex probe -200 up to +600°C cable -50 up to +350°C probe ø6x100mm cable length 1.4m without screw connection 3-wire resistance at 0°C 100Ohm		
For models:	CKEP06, CKEP06B, CKEP10, CKEP10B, CKEP20, CKEP20B, CKEP21, CKEP21B, CKEP40, CKEP40B, CKET06, CKET06B, CKET10, CKET10B, CKET20, CKET20B, CKET21, CKET21B, CKET40, CKET40B, CKGP06, CKGP06B, CKGP10, CKGP10B, CKGP20, CKGP20B, CKGP21, CKGP21B, CKGP40, CKGP40B, CKGT06, CKGT06B, CKGT10B, CKGT20, CKGT20B, CKGT21, CKGT21B, CKGT40, CKGT40B		

¹3-wire

GEV No.	379050 ¹	Ref. No.	R65325010
description	temperature probe Pt100 cable Vetrotex probe -200 up to +600°C cable -50 up to +350°C probe ø6x100mm cable length 2.7m without screw connection 3-wire		
For models:	CKEP21, CKEP21B, CKEP40, CKEP40B, CKET21, CKET21B, CKET40, CKET40B, CKGP21, CKGP21B, CKGP40, CKGP40B, CKGT21, CKGT21B, CKGT40, CKGT40B		

¹3-wire



			
GEV No.	379199	Ref. No.	3006121
description	temperature probe PTC 1kOhm cable PVC probe -50 up to +150°C cable -10 up to 100°C probe ø6x30mm cable length 5m without screw connection 2-wire		
For models:	OLAX250, OLAX250E-1080760, OLAX250E-1080761, OLAX250V-1080765, OLAX250V-1080766, OLAX300, OLAX300E-1080770, OLAX300E-1080771, OLAX300E-1081033, OLAX300E-1081035, OLAX300E-1081036, OLAX300LC, OLAX300LCE-1081034, OLAX300V-1080775, OLAX300V-1080776, OLAX310, OLAX310E-1081110, OLAX310E-1081111, OLAX310LC, OLAX310LCE-1081114, OLAX310LCE-1081115, OLAX310LCV-1081116, OLAX310LCV-1081117, OLAX310V-1081112, OLAX310V-1081113, OLAX320, OLAX320E-1081118, OLAX320E-1081119, OLAX320V-1081120, OLAX320V-1081121, OLAX320V-1081125, OLAX330, OLAX330E-1081122, OLAX330E-1081123, OLAX330V-1081124, OLAX380, OLAX380E-1080780, OLAX380E-1080781, OLAX380E-1081037, OLAX380E-1081038, OLAX380E-1081039, OLAX380E-1081040, OLAX380E-1081043, OLAX380E-1081044, OLAX380E-1081046, OLAX380E-1081047, OLAX380E-1081048, OLAX380E-1081051, OLAX380E-1081052, OLAX380E-1081053...(Other models you can see in the webshop)		

			
GEV No.	379052	Ref. No.	167201
description	temperature probe PTC 1kOhm cable silicone probe -50 up to +150°C cable -50 up to +180°C probe ø6x40mm cable length 1.5m without screw connection 2-wire		
For models:	KBT40-21091640, KC41-210916400BDC, KR41-210906400BFA, KTN40-21090640		

core probes

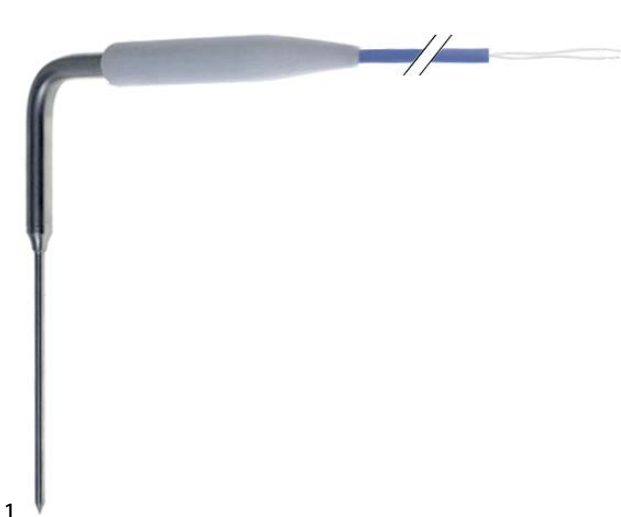
			
GEV No.	378392	Ref. No.	6638200 996424 FR6638200 FR996424
description	core temperature probe Pt1000 universal angled probe -40 up to +120°C cable -10 up to 100°C cable PVC probe ø4x100mm cable length 5m 2-wire resistance at 0°C 10000hm for blast chiller		

producer-specific probes

probes

			
GEV No.	378248	Ref. No.	50562
description	temperature probe NTC 10kOhm cable PVC probe -40 up to +110°C cable -10 up to 100°C connection coded plug thread probe ø6x14mm cable length 2m		
For models:	OLDS40, OLDS40-1081065, OLDS40D-1081066, OLDS40E-1081067, OLDS40ED-1081068, OLDS40-Neutra, OLDS50, OLDS50-1081088, OLDS50D-1081089, OLDS50E-1081090, OLDS50ED-1081091, OLDS50-Neutra, OLDW020H, OLElectron1000, OLElectron400, OLElectron500, OLELELECTRON1000-1081084, OLELELECTRON1000D-1081085, OLGRANUL900, OLG550, OLG550-1080705, OLG550D-1080706, OLG550E-1080730, OLG550ECO-1081014, OLG550ECOD-1081015, OLG550ED-1080731, OLG550-Neutra, OLH600E-Neutra, OLHT-11-Neutra, OLHT12-1081075, OLHT12EL-1081080, OLHT12EL-1081083, OLHT12ELD-1081081, OLHT12ELPLUS-1081086, OLHT12S, OLHT12SElectronic, OLHT12S-Neutra, OLLP1-800, OLLP1-800-1080721, OLLP1-800EL, OLLP155-1081087, OLLP1-S8, OLLP1-S8EL, OLLP2-1080742, OLLP2-PLUS, OLLP3-1080743, OLLP3-PLUS, OLLP4-1081258, OLLP4-PLUS		

			
GEV No.	378314	Ref. No.	3006165
description	temperature probe NTC 10kOhm cable silicone probe -40 up to +110°C cable -50 up to +180°C connection coded plug thread probe ø5x30mm cable length 0.35m		
For models:	OLAX250, OLAX250E-1080760, OLAX250E-1080761, OLAX250V-1080765, OLAX250V-1080766, OLAX300, OLAX300E-1080770, OLAX300E-1080771, OLAX300E-1081033, OLAX300E-1081035, OLAX300E-1081036, OLAX300LC, OLAX300LCE-1081034, OLAX300V-1080775, OLAX300V-1080776, OLAX310, OLAX310E-1081110, OLAX310E-1081111, OLAX310LC, OLAX310LCE-1081114, OLAX310LCE-1081115, OLAX310LCV-1081116, OLAX310LCV-1081117, OLAX310V-1081112, OLAX310V-1081113, OLAX320, OLAX320E-1081118, OLAX320E-1081119, OLAX320V-1081120, OLAX320V-1081121, OLAX320V-1081125, OLAX330, OLAX330E-1081122, OLAX330E-1081123, OLAX330V-1081124, OLAX380, OLAX380E-1080780, OLAX380E-1080781, OLAX380E-1081037, OLAX380E-1081038, OLAX380E-1081039, OLAX380E-1081040, OLAX380E-1081043, OLAX380E-1081044, OLAX380E-1081046, OLAX380E-1081047, OLAX380E-1081048, OLAX380E-1081051, OLAX380E-1081052, OLAX380E-1081053...(Other models you can see in the webshop)		

			
GEV No.	378268	Ref. No.	50563
description	temperature probe NTC cable silicone probe -40 up to +110°C cable -50 up to +180°C connection coded plug thread probe ø6x15mm cable length 1.1m		
For models:	OLLP1-1081059, OLLP2-1080722, OLLP2Electronic-Neutra, OLLP3-1080723, OLLP3Electronic-Neutra, OLLP4-800-1081058, OLLP4-800Electronic-Neutra		



1



GEV No.	379936	Ref. No.	3103275 BN3103275
description	temperature probe Pt100 cable Vetrotex probe -200 up to +600°C cable -50 up to +350°C connection 2-wire thread probe ø4-6x100mm cable length 1m		
For models:	CV20E-1320200, CV20E2-1320240, CV20EB-1321200, CV20ES-1320250, CV20ES2-1320290, CV20G, CV20G-1310200, CV20G-2, CV20G2-1310240, CV20GB-1311200, CV20G-S, CV20GS-1310250, CV20G-S2, CV20GS2-1310290, CV21E, CV21E-1322100, CV21E-2, CV21E2-1322140, CV21E-S, CV21ES-1322150, CV21E-S2, CV21ES2-1322190, CV21G, CV21G-1312100, CV21G-2, CV21G2-1312140, CV21G-S, CV21GS-1312150, CV21G-S2, CV21GS2-1312190, CVM20E, CVM20E-1320500, CVM20E-2, CVM20E2-1320540, CVM20E-S, CVM20ES-1320550, CVM20E-S2, CVM20ES2-1320590, CVM20G, CVM20G-1310500, CVM20G-2, CVM20G2-1310540, CVM20G-S, CVM20GS-1310550, CVM20G-S2, CVM20GS2-1310590, CVM21E, CVM21E-1322400, CVM21E-2, CVM21E2-1322440...(Other models you can see in the webshop)		

2



GEV No.	379935	Ref. No.	3103270 BN3103270
description	temperature probe Pt100 cable Vetrotex probe -200 up to +600°C cable -50 up to +350°C connection 2-wire thread probe ø6x100mm cable length 0.8m		
For models:	CMV6ES2-1320392, CV10E, CV10E-1320100, CV10E-1320110, CV10E-2, CV10E2-1320140, CV10EB-1321100, CV10E-S, CV10ES-1320150, CV10E-S2, CV10ES2-1320190, CV10G, CV10G-1310100, CV10G-2, CV10G2-1310140, CV10GB-1311100, CV10G-S, CV10GS-1310150, CV10G-S2, CV10GS2-1310190, CV20E, CV20E-1320200, CV20E-2, CV20E2-1320240, CV20E-S, CV20ES-1320250, CV20E-S2, CV20ES2-1320290, CV6E, CV6E-1320000, CV6E-1320010, CV6E-1320050, CV6E-2, CV6E2-1320040, CV6EB-1321000, CV6E-S, CV6E-S2, CV6ES2-1320090, CV6G, CV6G-1310000, CV6G-1310010, CV6G-2, CV6G2-1310040, CV6GB-1311000, CV6G-S, CV6GS-1310050, CV6G-S2, CV6GS2-1310090, CVM10E, CVM10E-1320400...(Other models you can see in the webshop)		

1



GEV No.	379937	Ref. No.	3103282 BN3103282
description	temperature probe thermocouple K (NiCr-Ni) cable PTFE probe -50 up to 1150°C cable -40 up to +250°C connection 2-wire thread probe ø4x120mm cable length 2.4m -40 up to +250°C		
For models:	ECVM10ES2, ECVM10ES2-1324290, ECVM10ES2-1324290MN, ECVM10ES2-1326120, ECVM10GS2, ECVM10GS2-1314290, ECVM10GS2-1316120, ECVM20ES2, ECVM20ES2-1324390, ECVM20ES2-1326140, ECVM20GS2, ECVM20GS2-1314390, ECVM20GS2-1316140, ECVM21ES2, ECVM21ES2-1324490, ECVM21ES2-1326160, ECVM21GS2, ECVM21GS2-1314490, ECVM21GS2-1316160, ECVM6ES2, ECVM6ES2-1324190, ECVM6ES2-1326100, ECVM6ES2-1326100H, ECVM6GS2, ECVM6GS2-1314190, ECVM6GS2-1316100, ECVP10ES2, ECVP10ES2-1324690, ECVP10ES2-1326200, ECVP10GS2, ECVP10GS2-1314690, ECVP10GS2-1316200, ECVP20ES2, ECVP20ES2-1324790, ECVP20ES2-1326220, ECVP20GS2, ECVP20GS2-1314790, ECVP20GS2-1316220, ECVP21ES2, ECVP21ES2-1324890, ECVP21ES2-1326240, ECVP21GS2, ECVP21GS2-1314890, ECVP21GS2-1316240, ECVP6ES2, ECVP6ES2-1324590, ECVP6ES2-1326180, ECVP6GS2, ECVP6GS2-1314590, ECVP6GS2-1316180...(Other models you can see in the webshop)		

core probes





1

GEV No.	379939	Ref. No.	3103280 BN3103280
description	core temperature probe Pt100 cable PTFE probe -40 up to +250°C cable -40 up to +250°C connection plug probe ø4x100mm thread cable length 1.25m handle ø 10mm handle length 90/100mm		
For models:	CMV6ES2-1320392, CV10E-1320100, CV10E-2, CV10EB-1321100, CV10E-S, CV10ES-1320150, CV10E-S2, CV10ES2-1320190, CV10G-1310100, CV10GB-1311100, CV10G-S, CV10GS-1310150, CV10G-S2, CV10GS2-1310190, CV20E-1320200, CV20E-2, CV20EB-1321200, CV20E-S, CV20ES-1320250, CV20E-S2, CV20ES2-1320290, CV20G-1310200, CV20GB-1311200, CV20G-S, CV20GS-1310250, CV20G-S2, CV20GS2-1310290, CV21E-1322100, CV21E-S, CV21ES-1322150, CV21E-S2, CV21ES2-1322190, CV21G-S, CV21GS-1312150, CV21G-S2, CV21GS2-1312190, CV6E-1320000, CV6E-1320050, CV6E-2, CV6E2-1320040, CV6EB-1321000, CV6E-S, CV6E-S2, CV6ES2-1320090, CV6G-1310000, CV6GB-1311000, CV6G-S, CV6GS-1310050, CV6G-S2, CV6GS2-1310090...(Other models you can see in the webshop)		
accessories for	379939		
	GEV No.	379938	Ref. No.
			3103285 BN3103285
	female connector 4-pole		

1

GEV No.	378679	Ref. No.	965295
description	core temperature probe Pt1000 connection 8-wire probe ø4x100mm cable length 5m handle ø 16mm handle length 110mm		
For models:	031, 051, 081, 121, 161, BBC051DF-ASX-4186V21A286220, BB-F031AF-ASX-4186V204286210, OBC051DF-ASX-6V21A286220OL, OBC081AF-ASX-6V221285220OL, OBC121DF-ASX-6V23A285220OL, OBC161DF-ASX-6V24A485220OL, OBF031AF-ASX-6V204286210OL		

			
1			
GEV No.	379510	Ref. No.	R65321100
description	core temperature probe thermocouple K (NiCr-Ni) cable PTFE probe -40 up to +250°C cable -40 up to +250°C connection 6-pin connector probe ø3.5x90mm thread cable length 1.1m handle ømm handle length 90mm		
For models:	CKET06, CKET06B, CKET10, CKET10B, CKET20, CKET20B, CKET21, CKET21B, CKET40, CKET40B, CKGT06, CKGT06B, CKGT10, CKGT10B, CKGT20, CKGT20B, CKGT21, CKGT21B, CKGT40, CKGT40B		

			
2			
GEV No.	379773 ¹	Ref. No.	R65321120
description	core temperature probe thermocouple K (NiCr-Ni) cable PTFE probe -40 up to +250°C cable -40 up to +250°C connection plug probe ø3.5x90mm thread cable length 1.1m handle ømm handle length 90mm		
For models:	CKEP06, CKEP06B, CKEP10, CKEP10B, CKEP20, CKEP20B, CKEP21, CKEP21B, CKEP40, CKEP40B, CKGP06, CKGP06B, CKGP10, CKGP10B, CKGP20, CKGP20B, CKGP21, CKGP21B, CKGP40, CKGP40B		

¹ multipoint probe

accessories

plugs/bushes

			
1			
GEV No.	378016	Ref. No.	R65320920
description	female connector 4-pole		
For models:	CKEP06, CKEP06B, CKEP10, CKEP10B, CKEP20, CKEP20B, CKEP21, CKEP21B, CKEP40, CKEP40B, CKGP06, CKGP06B, CKGP10, CKGP10B, CKGP20, CKGP20B, CKGP21, CKGP21B, CKGP40, CKGP40B		

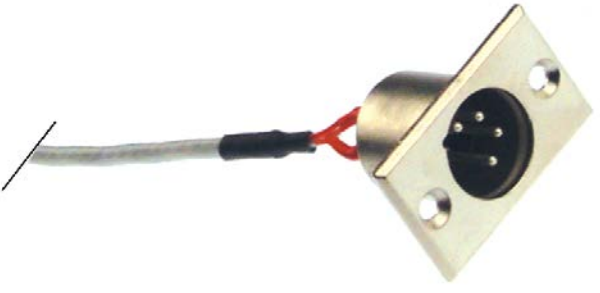
			
1			
GEV No.	379938	Ref. No.	3103285 BN3103285
description	female connector 4-pole		
For models:	CMV6ES2-1320392, CV10E-1320100, CV10E-2, CV10EB-1321100, CV10E-S, CV10ES-1320150, CV10E-S2, CV10ES2-1320190, CV10G-1310100, CV10GB-1311100, CV10G-S, CV10GS-1310150, CV10G-S2, CV10GS2-1310190, CV20E-1320200, CV20E-2, CV20EB-1321200, CV20E-S, CV20ES-1320250, CV20E-S2, CV20ES2-1320290, CV20G-1310200, CV20GB-1311200, CV20G-S, CV20GS-1310250, CV20G-S2, CV20GS2-1310290, CV21E-1322100, CV21E-S, CV21ES-1322150, CV21E-S2, CV21ES2-1322190, CV21G-S, CV21GS-1312150, CV21G-S2, CV21GS2-1312190, CV6E-1320000, CV6E-1320050, CV6E-2, CV6E2-1320040, CV6EB-1321000, CV6E-S, CV6E-S2, CV6ES2-1320090, CV6G-1310000, CV6GB-1311000, CV6G-S, CV6GS-1310050, CV6G-S2, CV6GS2-1310090...(Other models you can see in the webshop)		

			
1			
GEV No.	379940	Ref. No.	3103290 BN3103290
description	lid		
For models:	CMV6ES2-1320392, CV10E-1320100, CV10E-2, CV10EB-1321100, CV10E-S, CV10ES-1320150, CV10E-S2, CV10ES2-1320190, CV10G-1310100, CV10GB-1311100, CV10G-S, CV10GS-1310150, CV10G-S2, CV10GS2-1310190, CV20E-1320200, CV20E-2, CV20EB-1321200, CV20E-S, CV20ES-1320250, CV20E-S2, CV20ES2-1320290, CV20G-1310200, CV20GB-1311200, CV20G-S, CV20GS-1310250, CV20G-S2, CV20GS2-1310290, CV21E-1322100, CV21E-S, CV21ES-1322150, CV21E-S2, CV21ES2-1322190, CV21G-S, CV21GS-1312150, CV21G-S2, CV21GS2-1312190, CV6E-1320000, CV6E-1320050, CV6E-2, CV6E2-1320040, CV6EB-1321000, CV6E-S, CV6E-S2, CV6ES2-1320090, CV6G-1310000, CV6GB-1311000, CV6G-S, CV6GS-1310050, CV6G-S2, CV6GS2-1310090...(Other models you can see in the webshop)		

			
1			
GEV No.	378017	Ref. No.	R65321020
description	lid for plug contact		
For models:	CKEP06, CKEP06B, CKEP10, CKEP10B, CKEP20, CKEP20B, CKEP21, CKEP21B, CKEP40, CKEP40B, CKET06, CKET06B, CKET10, CKET10B, CKET20, CKET20B, CKET21, CKET21B, CKET40, CKET40B, CKGP06, CKGP06B, CKGP10, CKGP10B, CKGP20, CKGP20B, CKGP21, CKGP21B, CKGP40, CKGP40B, CKGT06, CKGT06B, CKGT10, CKGT10B, CKGT20, CKGT20B, CKGT21, CKGT21B, CKGT40, CKGT40B		

miscellaneous

			
1			
GEV No.	379856	Ref. No.	R86020420
description	bag for core temperature probe		
For models:	CKEP06, CKEP06B, CKEP10, CKEP10B, CKEP20, CKEP20B, CKEP21, CKEP21B, CKEP40, CKEP40B, CKET06, CKET06B, CKET10, CKET10B, CKET20, CKET20B, CKET21, CKET21B, CKET40, CKET40B, CKGP06, CKGP06B, CKGP10, CKGP10B, CKGP20, CKGP20B, CKGP21, CKGP21B, CKGP40, CKGP40B, CKGT06, CKGT06B, CKGT10, CKGT10B, CKGT20, CKGT20B, CKGT21, CKGT21B, CKGT40		



electronics

frequency converters

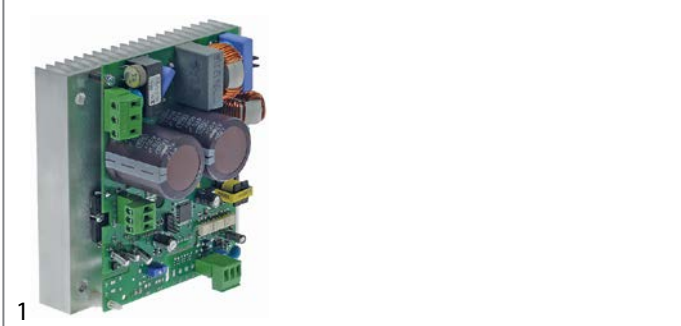

GEV No.	403841	Ref. No.	R65140830
description	frequency converter with heat sink for combi-steamer L 135mm W 135mm 800W ECS P0010205-0		
For models:	CKET10, CKET10B, CKET20, CKET20B, CKET21, CKET21B, CKET40, CKET40B, CKGT10B, CKGT20, CKGT20B, CKGT21, CKGT21B, CKGT40, CKGT40B		

PCBs



GEV No.	401191	Ref. No.	3103251 BN3103251
description	keypad PCB		
For models:	ECVM10ES2, ECVM10ES2-1324290, ECVM10ES2-1324290MN, ECVM10ES2-1326120, ECVM10GS2, ECVM10GS2-1314290, ECVM10GS2-1316120, ECVM20ES2, ECVM20ES2-1324390, ECVM20ES2-1326140, ECVM20GS2, ECVM20GS2-1314390, ECVM20GS2-1316140, ECVM21ES2, ECVM21ES2-1324490, ECVM21ES2-1326160, ECVM21GS2-1314490, ECVM21GS2-1316160, ECVM6ES2, ECVM6ES2-1324190, ECVM6ES2-1326100, ECVM6ES2-1326100H, ECVM6GS2, ECVM6GS2-1314190, ECVM6GS2-1316100, ECVP10ES2, ECVP10ES2-1324690, ECVP10ES2-1326200, ECVP10GS2, ECVP10GS2-1314690, ECVP10GS2-1316200, ECVP20ES2, ECVP20ES2-1324790, ECVP20ES2-1326220, ECVP20GS2, ECVP20GS2-1314790, ECVP20GS2-1316220, ECVP21ES2, ECVP21ES2-1324890, ECVP21ES2-1326240, ECVP21GS2, ECVP21GS2-1314890, ECVP21GS2-1316240, ECVP6ES2, ECVP6ES2-1324590, ECVP6ES2-1326180, ECVP6GS2, ECVP6GS2-1314590, ECVP6GS2-1316180		

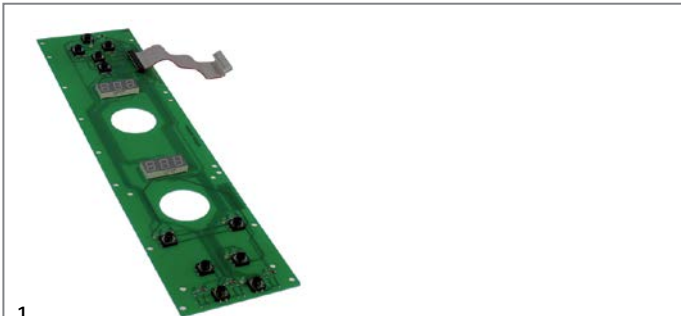

GEV No.	401957	Ref. No.	R65302180
description	keypad PCB		
For models:	CKEP06, CKEP06B, CKEP10, CKEP10B, CKEP20, CKEP20B, CKEP21, CKEP21B, CKEP40, CKEP40B, CKGP06, CKGP06B, CKGP10, CKGP10B, CKGP20, CKGP20B, CKGP21, CKGP21B, CKGP40, CKGP40B		

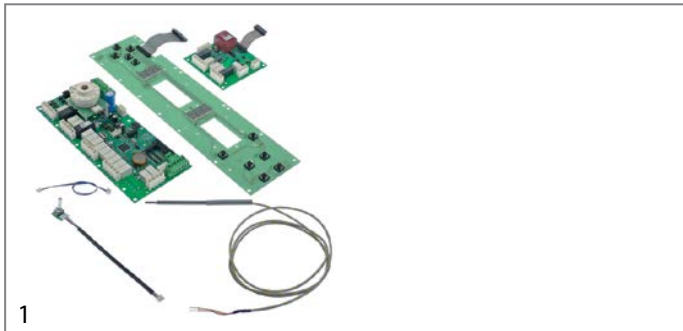

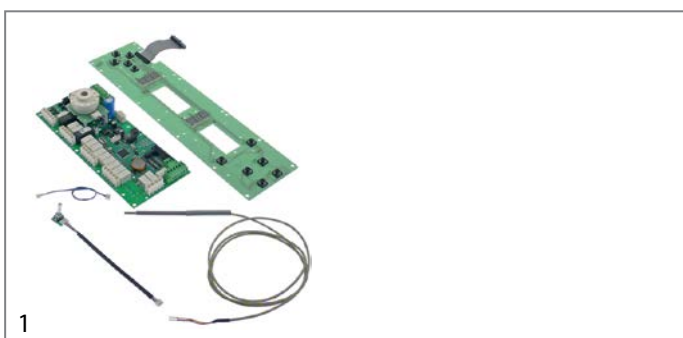

GEV No.	403498	Ref. No.	R65302160
description	keypad PCB combi-steamer with steam generator suitable for HME/HVE/HVG/HMG suitable for LAINOX 3 type K probes		
For models:	CKEP06B, CKEP10B, CKEP20B, CKEP21B, CKEP40B, CKGP06B, CKGP10B, CKGP20B, CKGP21B, CKGP40B		
spare parts for	403498		
	GEV No.	Ref. No.	R65325000
	temperature probe Pt100 cable Vetrotex probe -200 up to +600°C cable -50 up to +350°C probe ø6x100mm cable length 1.4m without screw connection 3-wire resistance at 0°C 100Ohm		
	GEV No.	Ref. No.	—
	temperature probe thermocouple K (NiCr-Ni) probe -50 up to 1150°C cable -50 up to +180°C cable length 1.5m thread M10x1 adapter length 93mm adapter ø 6mm cable colours silver/yellow probe L 90/14mm probe ø 6/3mm		
accessories for	403498		
	GEV No.	Ref. No.	—
	temperature probe thermocouple K (NiCr-Ni) probe -50 up to 1150°C cable -50 up to +180°C cable length 1.5m thread M10x1 adapter length 93mm adapter ø 6mm cable colours silver/yellow probe L 90/14mm probe ø 6/3mm		





GEV No.	401958	Ref. No.	R65302150 R65302190
description	keypad PCB combi-steamer without steam generator suitable for LAINOX 2 type K probes		
For models:	CKEP06, CKEP06B, CKEP10, CKEP10B, CKEP20, CKEP20B, CKEP21, CKEP21B, CKEP40, CKEP40B, CKGP06, CKGP06B, CKGP10, CKGP10B, CKGP20, CKGP20B, CKGP21, CKGP21B, CKGP40, CKGP40B		
spare parts for	401958		
	GEV No.	Ref. No.	R65325000
	temperature probe Pt100 cable Vetrotex probe -200 up to +600°C cable -50 up to +350°C probe ø6x100mm cable length 1.4m without screw connection 3-wire resistance at 0°C 100Ohm		
	GEV No.	Ref. No.	—
	temperature probe thermocouple K (NiCr-Ni) probe -50 up to 1150°C cable -50 up to +180°C cable length 1.5m thread M10x1 adapter length 93mm adapter ø 6mm cable colours silver/yellow probe L 90/14mm probe ø 6/3mm		
accessories for	401958		
	GEV No.	Ref. No.	—
	temperature probe thermocouple K (NiCr-Ni) probe -50 up to 1150°C cable -50 up to +180°C cable length 1.5m thread M10x1 adapter length 93mm adapter ø 6mm cable colours silver/yellow probe L 90/14mm probe ø 6/3mm		

			
1			
GEV No.	403231	Ref. No.	50570/D
description	keypad PCB dishwasher 80E/81E L 155mm W 100mm with display H 25mm buttons 6		
For models:	OLLP2-1080742, OLLP2-PLUS, OLLP3-1080743, OLLP3-PLUS, OLLP4-1081258, OLLP4-PLUS		

			
1			
GEV No.	401192	Ref. No.	3103249 BN3103249
description	main PCB		
For models:	ECVM10ES2, ECVM10ES2-1324290, ECVM10ES2-1324290MN, ECVM10ES2-1326120, ECVM10GS2, ECVM10GS2-1314290, ECVM10GS2-1316120, ECVM20ES2, ECVM20ES2-1324390, ECVM20ES2-1326140, ECVM20GS2, ECVM20GS2-1314390, ECVM20GS2-1316140, ECVM21ES2, ECVM21ES2-1324490, ECVM21ES2-1326160, ECVM21GS2-1314490, ECVM21GS2-1316160, ECVM6ES2, ECVM6ES2-1324190, ECVM6ES2-1326100, ECVM6ES2-1326100H, ECVM6GS2, ECVM6GS2-1314190, ECVM6GS2-1316100, ECVP10ES2, ECVP10ES2-1324690, ECVP10ES2-1326200, ECVP10GS2, ECVP10GS2-1314690, ECVP10GS2-1316200, ECVP20ES2, ECVP20ES2-1324790, ECVP20ES2-1326220, ECVP20GS2, ECVP20GS2-1314790, ECVP20GS2-1316220, ECVP21ES2, ECVP21ES2-1324890, ECVP21ES2-1326240, ECVP21GS2, ECVP21GS2-1314890, ECVP21GS2-1316240, ECVP6ES2, ECVP6ES2-1324590, ECVP6ES2-1326180, ECVP6GS2, ECVP6GS2-1314590, ECVP6GS2-1316180, NECVM10ES2...(Other models you can see in the webshop)		

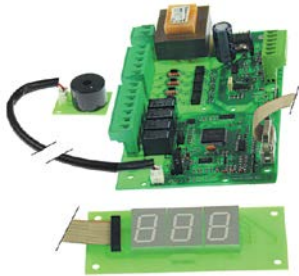
			
1			
GEV No.	403221	Ref. No.	3006164
description	main PCB dishwasher AX 250/300/310/320/330 L 168mm W 148mm for display PCB Qty 1 pcs		
For models:	OLAX250, OLAX250E-1080760, OLAX250E-1080761, OLAX250V-1080765, OLAX250V-1080766, OLAX300, OLAX300E-1080770, OLAX300E-1080771, OLAX300E-1081033, OLAX300E-1081035, OLAX300E-1081036, OLAX300LC, OLAX300LCE-1081034, OLAX300V-1080775, OLAX300V-1080776, OLAX310, OLAX310E-1081110, OLAX310E-1081111, OLAX310LC, OLAX310LCE-1081114, OLAX310LCE-1081115, OLAX310LCV-1081116, OLAX310LCV-1081117, OLAX310V-1081112, OLAX310V-1081113, OLAX320, OLAX320E-1081118, OLAX320E-1081119, OLAX320V-1081120, OLAX320V-1081121, OLAX320V-1081125, OLAX330, OLAX330E-1081122, OLAX330E-1081123, OLAX330V-1081124, OLAX380, OLAX380E-1080780, OLAX380E-1080781, OLAX380E-1081037, OLAX380E-1081038, OLAX380E-1081039, OLAX380E-1081040, OLAX380E-1081043, OLAX380E-1081044, OLAX380E-1081046, OLAX380E-1081047, OLAX380E-1081048, OLAX380E-1081051, OLAX380E-1081052, OLAX380E-1081053...(Other models you can see in the webshop)		

			
1			
GEV No.	401195	Ref. No.	3103245 3198400 BN3103245
description	PCB combi-steamer CV10E complete without potentiometer		
For models:	CMV6ES2-1320392, CV10E, CV10E-1320100, CV10E-1320110, CV10E-2, CV10E2-1320140, CV10EB-1321100, CV10E-S, CV10ES-1320150, CV10E-S2, CV10ES2-1320190, CV10G, CV10G-1310100, CV10G-2, CV10G2-1310140, CV10GB-1311100, CV10G-S, CV10GS-1310150, CV10G-S2, CV10GS2-1310190, CV20E, CV20E-1320200, CV20E-2, CV20E2-1320240, CV20EB-1321200, CV20E-S, CV20ES-1320250, CV20E-S2, CV20ES2-1320290, CV20G, CV20G-1310200, CV20G-2, CV20G2-1310240, CV20GB-1311200, CV20G-S, CV20GS-1310250, CV20G-S2, CV20GS2-1310290, CV21E, CV21E-1322100, CV21E-2, CV21E2-1322140, CV21E-S, CV21ES-1322150, CV21E-S2, CV21ES2-1322190, CV21G, CV21G-1312100, CV21G-2, CV21G2-1312140...(Other models you can see in the webshop)		

			
1			
GEV No.	402825	Ref. No.	R65301480
description	PCB combi-steamer GEMT L 130mm W 86mm new edition level control steam generator EVCO		
For models:	CKEP06B, CKEP10B, CKEP20B, CKEP21B, CKEP40B, CKGP06B, CKGP10B, CKGP20B, CKGP21B, CKGP40B		

			
1			
GEV No.	402687	Ref. No.	50584
description	PCB dishwasher DS40/DS50 for flow meter		
For models:	OLDS40, OLDS40-1081065, OLDS40D-1081066, OLDS40E-1081067, OLDS40ED-1081068, OLDS40-Neutra, OLDS50, OLDS50-1081088, OLDS50D-1081089, OLDS50E-1081090, OLDS50ED-1081091, OLDS50-Neutra, OLDW020H, OLElectron1000, OLElectron400, OLElectron500, OLELELECTRON1000-1081084, OLELELECTRON1000D-1081085, OLG50, OLG50-1080705, OLG50D-1080706, OLG50E-1080730, OLG50ECO-1081014, OLG50ECOD-1081015, OLG50ED-1080731, OLG50-Neutra, OLLP1S5-1081087		



1

GEV No.	402677	Ref. No.	50580
description	PCB dishwasher DS40/DS50 L 161mm W 90mm		
For models:	OLDS40, OLDS40-1081065, OLDS40D-1081066, OLDS40E-1081067, OLDS40ED-1081068, OLDS40-Neutra, OLDS50, OLDS50-1081088, OLDS50D-1081089, OLDS50E-1081090, OLDS50ED-1081091, OLDS50-Neutra, OLDW020H, OLElectron1000, OLElectron400, OLElectron500, OLELELECTRON1000-1081084, OLELELECTRON1000D-1081085, OLG550, OLG550-1080705, OLG550D-1080706, OLG550E-1080730, OLG550ECO-1081014, OLG550ECOD-1081015, OLG550ED-1080731, OLG550-Neutra, OLLP1S5-1081087		



1

GEV No.	402676	Ref. No.	50559
description	PCB dishwasher HT11/12 L 102mm W 62mm timer		
For models:	OLDW020H, OLElectron1000, OLElectron500, OLELELECTRON1000-1081084, OLELELECTRON1000D-1081085, OLGRANUL900, OLH600Electronic, OLHT12-1081075, OLHT12EL-1081080, OLHT12EL-1081083, OLHT12ELD-1081081, OLHT12ELPLUS-1081086, OLHT12S, OLHT12SElectronic, OLHT12S-Neutra, OLLP1-1081059, OLLP1-800, OLLP1-800-1080721, OLLP1-800EL, OLLP1S5-1081087, OLLP1-S8, OLLP1-S8EL, OLLP2-1080722, OLLP2-1080742, OLLP2Electronic-Neutra, OLLP-2PLUS, OLLP3-1080723, OLLP3-1080743, OLLP3Electronic-Neutra, OLLP-3PLUS, OLLP4-1081258, OLLP4-800-1081058, OLLP4-800Electronic-Neutra, OLLP-4PLUS		



1

GEV No.	402682	Ref. No.	50557
description	PCB dishwasher HT600/HT11/HT12 L 160mm W 102mm timer run-time 60/100/180s		
For models:	OLHT-11-Neutra		



1

GEV No.	402675	Ref. No.	50581
description	PCB dishwasher KD60 L 185mm W 30mm buttons 4		
For models:	OLDS40, OLDS40-1081065, OLDS40D-1081066, OLDS40E-1081067, OLDS40ED-1081068, OLDS40-Neutra, OLDS50, OLDS50-1081088, OLDS50D-1081089, OLDS50E-1081090, OLDS50ED-1081091, OLDS50-Neutra, OLDW020H, OLElectron1000, OLElectron400, OLElectron500, OLELELECTRON1000-1081084, OLELELECTRON1000D-1081085, OLG550, OLG550-1080705, OLG550D-1080706, OLG550E-1080730, OLG550ECO-1081014, OLG550ECOD-1081015, OLG550ED-1080731, OLG550-Neutra, OLLP1S5-1081087		
accessories for	402675		
	GEV No.	400066	Ref. No. 50589
	 ribbon cable 10-pole L 1000mm plug type FC-10P raster size 2.54mm		

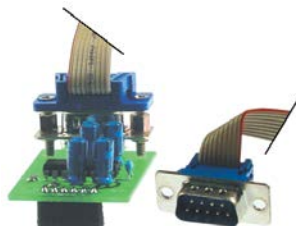

1

GEV No.	401193	Ref. No.	3103246 BN3103246
description	PCB HACCP interface		
For models:	ECVM10ES2, ECVM10ES2-1324290, ECVM10ES2-1324290MN, ECVM10ES2-1326120, ECVM10GS2, ECVM10GS2-1314290, ECVM10GS2-1316120, ECVM20ES2, ECVM20ES2-1324390, ECVM20ES2-1326140, ECVM20GS2, ECVM20GS2-1314390, ECVM20GS2-1316140, ECVM21ES2, ECVM21ES2-1324490, ECVM21ES2-1326160, ECVM21GS2-1314490, ECVM21GS2-1316160, ECVM6ES2, ECVM6ES2-1324190, ECVM6ES2-1326100, ECVM6ES2-1326100H, ECVM6GS2, ECVM6GS2-1314190, ECVM6GS2-1316100, ECVP10ES2, ECVP10ES2-1324690, ECVP10ES2-1326200, ECVP10GS2, ECVP10GS2-1314690, ECVP10GS2-1316200, ECVP20ES2, ECVP20ES2-1324790, ECVP20ES2-1326220, ECVP20GS2, ECVP20GS2-1314790, ECVP20GS2-1316220, ECVP21ES2, ECVP21ES2-1324890, ECVP21ES2-1326240, ECVP21GS2, ECVP21GS2-1314890, ECVP21GS2-1316240, ECVP6ES2, ECVP6ES2-1324590, ECVP6ES2-1326180, ECVP6GS2, ECVP6GS2-1314590, ECVP6GS2-1316180, NECVM10ES2...(Other models you can see in the webshop)		

1

GEV No.	402924	Ref. No.	3103241 BN3103241
description	PCB L 83mm W 74mm suitable for Olis		
For models:	CMV6ES2-1320392, CV10E, CV10E-1320100, CV10E-1320110, CV10E-2, CV10E2-1320140, CV10EB-1321100, CV10E-S, CV10ES-1320150, CV10E-S2, CV10ES2-1320190, CV10G, CV10G-1310100, CV10G-2, CV10G2-1310140, CV10GB-1311100, CV10G-S, CV10GS-1310150, CV10G-S2, CV10GS2-1310190, CV20E, CV20E-1320200, CV20E-2, CV20E2-1320240, CV20EB-1321200, CV20E-S, CV20ES-1320250, CV20E-S2, CV20ES2-1320290, CV20G, CV20G-1310200, CV20G-2, CV20G2-1310240, CV20GB-1311200, CV20G-S, CV20GS-1310250, CV20G-S2, CV20GS2-1310290, CV21E, CV21E-1322100, CV21E-2, CV21E2-1322140, CV21E-S, CV21ES-1322150, CV21E-S2, CV21ES2-1322190, CV21G, CV21G-1312100, CV21G-2, CV21G2-1312140...(Other models you can see in the webshop)		



2

GEV No.	402973	Ref. No.	R63130050
description	PCB oven BPG044-104 L 140mm W 80mm for cooler control		
For models:	CCG051M, CCG071M, CCG101M, CCG102M, CKGP06, CKGP06B, CKGP10, CKGP10B, CKGP20, CKGP20B, CKGP21, CKGP21B, CKGP40, CKGP40B, CKGT06, CKGT06B, CKGT10B, CKGT20, CKGT20B, CKGT21, CKGT21B, CKGT40, CKGT40B		

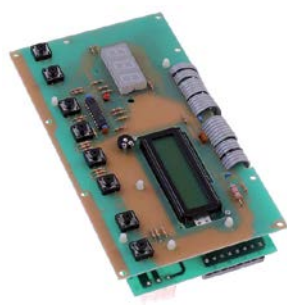

1

GEV No.	401776	Ref. No.	16811299
description	power PCB		
For models:	KSABT70G-2045370CJD, OLKSABT140-2045240CIW, OLKSABT144-2045240CJO, OLKSABT70-2045170CIO, OLKSABT72-2045170CIT, OLKSABTV140-2045240CIY, OLKSABTV70-2045170CIR, OLKSAP70-2045270CIP, OLKSATN140-2045140CIV, OLKSATN144-2045140CIZ, OLKSATN70-2045070CIN, OLKSATN72-2045070CIS, OLKSATNV140-2045140CIX, OLKSATNV70-2045070CIQ		



1

GEV No.	401757	Ref. No.	995857
description	power PCB blast freezer ESP2000 suitable for FRIULINOX		
For models:	KBC201-20355201, KBC201-PASS-THROUGH-20355221, KBC202-20355202, KBC202-PASS-THROUGH-20355222, KRC061-20357061, KRC101-20357101, KRC102-20357102, KRC201-20358201, KRC202-20358202, OLB201-20365201OL, OLB201-20365221OL, OLB202-20365202OL, OLB202-20365222OL, OLF061-20367061OL, OLF101-20367101OL, OLF101P-20367103OL, OLF102-20367102OL, OLF201-20368201OL, OLF202-20368202OL, OLUF061-20364061OL		



1

GEV No.	401758	Ref. No.	FR6632410 FR965101
description	power PCB blast freezer ESP2000 suitable for FRIULINOX		

central units



1

GEV No.	402683	Ref. No.	50556
description	control box timer operation time 3/6/9min		
For models:	OLLP1-1081059, OLLP2-1080722, OLLP2Electronic-Neutra, OLLP3-1080723, OLLP3Electronic-Neutra, OLLP4-800-1081058, OLLP4-800Electronic-Neutra		



1

GEV No.	402681	Ref. No.	50553/A DW50553/A
description	control box timer run-time 50/120/180s		
For models:	OLHT11-1081071, OLHT11D-1081072, OLHT11ECO-1081070, OLHT11S, OLHT11S-Neutra		



2

GEV No.	402684	Ref. No.	50569
description	control box without EPROM		
For models:	OLDW020H, OLElectron1000, OLElectron500, OLELELECTRON1000-1081084, OLELELECTRON1000D-1081085, OLGRANUL900, OLH600Electronic, OLHT12-1081075, OLHT12EL-1081080, OLHT12EL-1081083, OLHT12ELD-1081081, OLHT12ELPLUS-1081086, OLHT12S, OLHT12SElectronic, OLHT12S-Neutra, OLLP1-800, OLLP1-800-1080721, OLLP1-800EL, OLLP1S5-1081087, OLLP1-S8, OLLP1-S8EL, OLLP2-1080742, OLLP-2PLUS, OLLP3-1080743, OLLP-3PLUS, OLLP4-1081258, OLLP-4PLUS		



1

GEV No.	379026	Ref. No.	50553
description	electronic timer for dishwasher		
For models:	OLDS35, OLDS35-1081061, OLDS35D-1081062, OLDS35-Neutra, OLDS37, OLDS37-1081063, OLDS37D-1081064, OLDS37-Neutra, OLDS40, OLDS40-1081065, OLDS40D-1081066, OLDS40E-1081067, OLDS40ED-1081068, OLDS40-Neutra, OLDS45, OLDS50, OLDS50-1081088, OLDS50D-1081089, OLDS50E-1081090, OLDS50ED-1081091, OLDS50-Neutra, OLG35, OLG35-1080702, OLG35D-1081000, OLG35-Neutra, OLG600, OLG537, OLG537-1080700, OLG537D-1080707, OLG537LS-1081001, OLG537LSD-1081002, OLG537-Neutra, OLG540, OLG540-1080701, OLG540D-1080708, OLG540D-1081003, OLG540-Neutra, OLG545, OLG545LSD-1081004, OLG550, OLG550-1080705, OLG550D-1080706, OLG550E-1080730, OLG550ECO-1081014, OLG550ECOD-1081015, OLG550ED-1080731, OLG550-Neutra, OLHT11S-Neutra		

keypads

front foils



1

GEV No.	401773	Ref. No.	14261052
description	front foil L 500mm W 50mm		
For models:	KSABT70G-2045370CJD, OLKSABT140-2045240CIW, OLKSABT144-2045240CJ0, OLKSABT70-2045170CIO, OLKSABT72-2045170CIT, OLKSABTV140-2045240CIY, OLKSABTV70-2045170CIR, OLKSAP70-2045270CIP, OLKSATN140-2045140CIV, OLKSATN144-2045140CIZ, OLKSATN70-2045070CIN, OLKSATN72-2045070CIS, OLKSATNV140-2045140CIX, OLKSATNV70-2045070CIQ		



1

GEV No.	403256	Ref. No.	560039
description	keypad foil dishwasher 20/29/83ELK 2055 blue L 557mm W 36mm buttons 4		
For models:	OLDW020H, OLElectron1000, OLElectron500, OLELELECTRON1000-1081084, OLELELECTRON1000D-1081085, OLLP1S5-1081087		



1

GEV No.	402685	Ref. No.	50571 50575 50578
description	keypad foil dishwasher H63/373E/144E L 134mm W 79mm buttons 6		
For models:	OLH600Electronic, OLHT12-1081075, OLHT12EL-1081080, OLHT12EL-1081083, OLHT12ELD-1081081, OLHT12ELPLUS-1081086, OLHT12S, OLHT12SElectronic, OLHT12S-Neutra, OLLP1-1081059, OLLP1-800, OLLP1-800-1080721, OLLP1-800EL, OLLP1-S8, OLLP1-S8EL, OLLP2-1080722, OLLP2-1080742, OLLP2Electronic-Neutra, OLLP-2PLUS, OLLP3-1080723, OLLP3-1080743, OLLP3Electronic-Neutra, OLLP-3PLUS, OLLP4-1081258, OLLP4-800-1081058, OLLP4-800Electronic-Neutra, OLLP-4PLUS		



keypad units



1

GEV No.	402679	Ref. No.	50570/C
description	keypad unit dishwasher 17U/70U buttons 6 L 158mm W 103mm		
For models:	OLLP1-800, OLLP1-800-1080721, OLLP1-800EL, OLLP1-S8, OLLP1-S8EL		

			
1			
GEV No.	402913	Ref. No.	50570/A
description	keypad unit dishwasher 37E/80E/81E/18ER/19E buttons 6 suitable for Dühr L 145mm W 90mm with cable		
For models:	OLLP1-1081059, OLLP2-1080722, OLLP2Electronic-Neutra, OLLP3-1080723, OLLP3Electronic-Neutra, OLLP4-800-1081058, OLLP4-800Electronic-Neutra		

			
1			
GEV No.	402678	Ref. No.	50570
description	keypad unit dishwasher H63/373E/144E buttons 6 L 158mm W 103mm		
For models:	OLH600Electronic, OLHT12-1081075, OLHT12EL-1081080, OLHT12EL-1081083, OLHT12ELD-1081081, OLHT12ELPLUS-1081086, OLHT12S, OLHT12SElectronic, OLHT12S-Neutra, OLLP1-1081059, OLLP2-1080722, OLLP2Electronic-Neutra, OLLP3-1080723, OLLP3Electronic-Neutra, OLLP4-800-1081058, OLLP4-800Electronic-Neutra		
accessories for	402678		
		GEV No.	402685
		Ref. No.	50571 50575 50578
	keypad foil dishwasher H63/373E/144E L 134mm W 79mm buttons 6		

control panel

			
1			
GEV No.	697946	Ref. No.	3108550 BN3108550
description	control panel combi-steamer CV6E W 212mm H 725mm D 6mm suitable for Olis glas		
For models:	CMV6ES2-1320392, CV6E, CV6E-1320000, CV6E-1320050, CV6E-2, CV6E2-1320040, CV6EB-1321000, CV6E-S, CV6E-S2, CV6ES2-1320090, CVM6E, CVM6E-1320300, CVM6E-1320340, CVM6E-1320390, CVM6E-2, CVM6E-S, CVM6ES-1320350, CVM6ES-1320350MN, CVM6ES-1320360, CVM6E-S2, CVM6ES2-1320395, CVM6G, CVM6G-1310300, CVM6G-1310310, CVM6G-2, CVM6G2-1310340, CVM6G-S, CVM6GS-1310350, CVM6GS-1310360, CVM6G-S2, CVM6GS2-1310390, CVM6GS2-1310395, CVP6E, CVP6E-1320600, CVP6E-2, CVP6E2-1320640, CVP6E-S, CVP6ES-1320650, CVP6E-S2, CVP6ES2-1320690, CVP6G, CVP6G-1310600, CVP6G-2, CVP6G2-1310640, CVP6G-S, CVP6GS-1310650, CVP6G-S2, CVP6GS2-1310690, CVP6GS2-1310690MN		

accessories

			
1			
GEV No.	401777	Ref. No.	16671299
description	buttons strip 8 buttons L 200mm W 37mm		
For models:	KSABT70G-2045370CJD, OLKSABT140-2045240CIW, OLKSABT144-2045240CJO, OLKSABT70-2045170CIO, OLKSABT72-2045170CIT, OLKSABTV140-2045240CIY, OLKSABTV70-2045170CIR, OLKSAP70-2045270CIP, OLKSATN140-2045140CIV, OLKSATN144-2045140CIZ, OLKSATN70-2045070CIN, OLKSATN72-2045070CIS, OLKSATNV140-2045140CIX, OLKSATNV70-2045070CIQ		



solenoid valves

solenoid valves (water)

ELBI

straight





GEV No.	373025	Ref. No.	15099
description	solenoid valve triple straight 230VAC inlet 3/4" outlet 11.5mm DN10 ELBI		
For models:	OLDS37-1081006, OLDS37D-1081007, OLDS37LS-1081008, OLDS37LSD-1081009, OLDS40-1081010, OLDS40D-1081011, OLDS40LS-1081012, OLDS40LSD-1081013, OLElectron400, OLGastro450, OLG540, OLLinear, OLLP1-S8, OLLP1-S8EL, OLStar		
spare parts for	373025		
	GEV No.	370467	Ref. No. —
solenoid valve filter suitable for ELBI			

RPE



GEV No.	374021	Ref. No.	3103610 BN3103610
description	solenoid valve double straight 230VAC inlet 3/4" outlet 10mm DN10 RPE		
For models:	CVP10E, CVP10E-1320700, CVP10E-1320710, CVP10E-2, CVP10E2-1320740, CVP10E2S-1320790, CVP10E-S, CVP10ES-1320750, CVP10ES-1320760, CVP10E-S2, CVP10G, CVP10G-1310700, CVP10G-1310750, CVP10G-2, CVP10G2-1310740, CVP10GP-1310700, CVP10G-S, CVP10G-S2, CVP10GS2-1310790, CVP20E, CVP20E-1320800, CVP20E-2, CVP20E2-1320840, CVP20E-S, CVP20ES-1320850, CVP20E-S2, CVP20ES2-1320890, CVP20G, CVP20G-1310800, CVP20G-1310850, CVP20G-2, CVP20G-S, CVP20GS-1310840, CVP20G-S2, CVP20GS2-1310890, CVP21E, CVP21E-1322700, CVP21E-2, CVP21E-S, CVP21ES-1322750, CVP21E-S2, CVP21ES2-1322790, CVP21G, CVP21G-1312700, CVP21G-2, CVP21G2-1312740, CVP21G-S, CVP21GS-1312750, CVP21G-S2, CVP21GS2-1312790...(Other models you can see in the webshop)		

	GEV No.	374017	Ref. No.	10703 3103620 BN3103620
description	solenoid valve single straight 230VAC inlet 3/4" outlet 10mm input 6l/min DN10 RPE polyamide flow regulating valve inlet white membranes NBR pressure range 0.2-10bar			
For models:	CMV6ES2-1320392, CV10E, CV10E-1320100, CV10E-1320110, CV10E-2, CV10E2-1320140, CV10EB-1321100, CV10E-S, CV10ES-1320150, CV10E-S2, CV10ES2-1320190, CV10G, CV10G-1310100, CV10G-2, CV10G2-1310140, CV10GB-1311100, CV10G-S, CV10GS-1310150, CV10G-S2, CV10GS2-1310190, CV20E, CV20E-1320200, CV20E-2, CV20E2-1320240, CV20EB-1321200, CV20E-S, CV20ES-1320250, CV20E-S2, CV20ES2-1320290, CV20G, CV20G-1310200, CV20G-2, CV20G2-1310240, CV20GB-1311200, CV20G-S, CV20GS-1310250, CV20G-S2, CV20GS2-1310290, CV21E, CV21E-1322100, CV21E-2, CV21E2-1322140, CV21E-S, CV21ES-1322150, CV21E-S2, CV21ES2-1322190, CV21G, CV21G-1312100, CV21G-2, CV21G2-1312140...(Other models you can see in the webshop)			

	GEV No.	374016	Ref. No.	30001000
description	solenoid valve single angled 230VAC inlet 3/4" outlet 13mm DN10 duty cycle 100% RPE polyamide			
For models:	G12S, OLV600, OLHT11-1081071, OLHT11D-1081072, OLHT11E-CO-1081070, OLHT-11-Neutra, OLHT11S, OLHT11S-Neutra, OLHT12-1081075, OLHT12EL-1081080, OLHT12EL-1081083, OLHT12ELD-1081081, OLHT12ELPLUS-1081086, OLHT12S, OLHT-12SElectronic, OLHT12S-Neutra, OLLP1-800, OLLP1-800-1080721, OLLP1-800EL, OLLP1-800-Neutra, OLLP1-S8, OLLP1-S8EL, OLLP-ZERO, OLLPZERO-1081057			

	GEV No.	374060	Ref. No.	2000093
description	solenoid valve single angled 24V inlet 3/4" outlet 13mm DN10 duty cycle 100% RPE polyamide			
For models:	OLAX151, OLAX151EDX-1080725, OLAX151ELEFT-1080727, OLAX151-highspeed			





JOHN GUEST			
			
GEV No.	374032 ¹	Ref. No.	R65110230
description	solenoid valve double straight 230VAC inlet 3/4" outlet 10mm DN10 plastic output A w/t membrane (constantly open)		
For models:	CKEP06, CKEP10, CKEP20, CKET06, CKET10, CKET20B, CKGP06, CKGP10, CKGP20, CKGT06, CKGT20, CKGT20B		

¹cylindrical outlet

			
GEV No.	370768 ¹	Ref. No.	R65110200
description	solenoid valve single straight 230VAC inlet 3/4" outlet 10mm input/min outputl/min DN10 t.max. 90°C duty cycle 100% RPE		
For models:	CCE042M, CCE051M, CCE071M, CCE101M, CCE102M, CCG051M, CCG071M, CCG101M, CCG102M, CKEP06, CKEP06B, CKEP10, CKEP10B, CKEP20, CKEP20B, CKEP21, CKEP21B, CKEP40, CKEP40B, CKET06, CKET10, CKET10B, CKET21, CKET21B, CKET40, CKET40B, CKGP06, CKGP06B, CKGP10, CKGP10B, CKGP20, CKGP20B, CKGP21, CKGP21B, CKGP40, CKGP40B, CKGT06, CKGT10B, CKGT21, CKGT21B, CKGT40, CKGT40B		

¹cylindrical outlet

reducers			
outlet side			
			
GEV No.	371269	Ref. No.	R65110500
description	reducer flow rate 0.07-0.14l/min brown		
For models:	CCE042M, CCE051M, CCE071M, CCG051M, CCG071M, CKEP06, CKEP06B, CKEP40, CKEP40B, CKET06, CKET06B, CKET40, CKET40B, CKGP06, CKGP06B, CKGP40, CKGP40B, CKGT06, CKGT06B, CKGT40, CKGT40B		

solenoid valves with reducers			
2-fold			
			
GEV No.	374031	Ref. No.	R65110210
description	solenoid valve double straight 230VAC inlet 3/4 outlet JG 10 input 10-12l/min t.max. 90°C RPE plastic flow regulating valve inlet white + outlet reducer red		
For models:	CKEP06, CKEP06B, CKEP10, CKEP10B, CKEP20, CKEP20B, CKEP21, CKEP21B, CKET06, CKET06B, CKET10, CKET10B, CKET20, CKET20B, CKET21B, CKGP06, CKGP06B, CKGP10, CKGP10B, CKGP20, CKGP20B, CKGT06, CKGT06B, CKGT10, CKGT10B, CKGT20, CKGT20B		

3-fold			
			
GEV No.	374014 ¹	Ref. No.	R65110280
description	solenoid valve triple straight 230VAC inlet 3/4" outlet 10mm input 10-12l/min RPE plastic flow regulating valve inlet white flow regulating valve outlet A red/green flow regulating valve outlet B red/green flow regulating valve outlet C red/green		
For models:	CKEP21, CKEP21B, CKEP40, CKEP40B, CKET21, CKET21B, CKET40, CKET40B, CKGP21, CKGP21B, CKGP40, CKGP40B, CKGT21, CKGT21B, CKGT40, CKGT40B		

¹cylindrical outlet

			
GEV No.	374033	Ref. No.	R65110240
description	solenoid valve triple straight 230VAC inlet 3/4" outlet 10mm input 10-12l/min t.max. 90°C RPE plastic flow regulating valve inlet white output B w/t membrane (constantly open)		
For models:	CKEP40, CKET21, CKET40, CKGP21, CKGT21		









TP				
				
GEV No.	370021	Ref. No.	15098	
description	solenoid valve double straight 230VAC inlet 3/4" outlet 11.5mm DN10 TP flow regulating valve inlet white			
For models:	OLDerby, OLDS35, OLDS35-1081005, OLDS35-1081061, OLDS35D-1081062, OLDS35-Neutra, OLDS37, OLDS37-1081006, OLDS37-1081063, OLDS37D-1081007, OLDS37D-1081064, OLDS37LS-1081008, OLDS37LSD-1081009, OLDS37-Neutra, OLDS40, OLDS40-1081010, OLDS40-1081065, OLDS40D-1081011, OLDS40D-1081066, OLDS40E-1081067, OLDS40ED-1081068, OLDS40LS-1081012, OLDS40LSD-1081013, OLDS40-Neutra, OLDS45, OLDS50, OLDS50-1081088, OLDS50D-1081089, OLDS50E-1081090, OLDS50ED-1081091, OLDS50-Neutra, OLDS50P-1081018, OLDS50PD-1081019, OLDW020H, OLElectron1000, OLElectron400, OLElectron500, OLELELECTRON1000-1081084, OLELELECTRON1000D-1081085, OLG35, OLG35-1080702, OLG35D-1081000, OLG35-Neutra, OLG600, OLGastro450, OLGastro500Plus, OLGastro500S, OLGastro750Plus, OLGastro750S, OLG537...(Other models you can see in the webshop)			
spare parts for	370021			
	GEV No.	371013	Ref. No.	—
	solenoid coil TP 230VAC 50/60Hz			
accessories for	370021			
	GEV No.	371220	Ref. No.	—
	reducer TP flow rate 3l/min red tolerance ±15%			
	GEV No.	371221	Ref. No.	—
	reducer TP flow rate 5.5l/min yellow tolerance ±15%			

Table continues overleaf



accessories for		370021		
GEV No.		371222	Ref. No.	—
	reducer TP flow rate 6l/min grey tolerance ±15%			
	reducer TP flow rate 10l/min white tolerance ±15%			
	reducer TP flow rate 12l/min bronze tolerance ±15%			
	reducer TP flow rate 16l/min light brown tolerance ±15%			
	reducer TP flow rate 20l/min red tolerance ±15%			
	reducer TP flow rate 0.25l/min red tolerance ±25%			
	reducer TP flow rate 0.35l/min violet tolerance ±25%			
	reducer TP flow rate 0.5l/min orange tolerance ±25%			
	reducer TP flow rate 0.8l/min white tolerance ±25%			
	reducer TP flow rate 1l/min light blue tolerance ±25%			
	reducer TP flow rate 1.2l/min brown tolerance ±25%			
	reducer TP flow rate 1.5l/min light brown tolerance ±25%			
	reducer TP flow rate 2.5l/min yellow tolerance ±25%			
	reducer TP flow rate 3.4l/min dark green tolerance ±25%			15115
	reducer TP flow rate 5l/min black tolerance ±25%			
	reducer TP flow rate 8l/min blue tolerance ±20%			

spare parts and accessories

reducers

outlet side



GEV No.	371238	Ref. No.	15115
description	reducer TP flow rate 3.4l/min dark green tolerance ±25%		
For models:	OLDS35, OLDS35-1081061, OLDS35D-1081062, OLDS35-Neutra, OLDS37, OLDS37-1081006, OLDS37-1081063, OLDS37D-1081007, OLDS37D-1081064, OLDS37LS-1081008, OLDS37LSD-1081009, OLDS37-Neutra, OLDS40, OLDS40-1081010, OLDS40-1081065, OLDS40D-1081011, OLDS40D-1081066, OLDS40E-1081067, OLDS40ED-1081068, OLDS40LS-1081012, OLDS40LSD-1081013, OLDS40-Neutra, OLDS45, OLDS50, OLDS50-1081088, OLDS50D-1081089, OLDS50E-1081090, OLDS50ED-1081091, OLDS50-Neutra, OLDS50P-1081018, OLDS50PD-1081019, OLDW020H, OLElectron1000, OLElectron400, OLElectron500, OLELELECTRON1000-1081084, OLELELECTRON1000D-1081085, OLG35, OLG35-1080702, OLG35D-1081000, OLG35-Neutra, OLGastro450, OLGastro500Plus, OLGastro500S, OLGastro750Plus, OLGastro750S, OLG537, OLG537-1080700, OLG537D-1080707, OLG537LS-1081001... (Other models you can see in the webshop)		

inlet side



GEV No.	371209	Ref. No.	3103643 BN3103643
description	reducer red ø 1.7mm mounting measurements 19.5mm		
For models:	CVP10E, CVP10E-1320700, CVP10E-1320710, CVP10E-2, CVP10E2-1320740, CVP10E2S-1320790, CVP10E-S, CVP10ES-1320750, CVP10ES-1320760, CVP10E-S2, CVP10G, CVP10G-1310700, CVP10G-1310750, CVP10G-2, CVP10G2-1310740, CVP10GP-1310700, CVP10G-S, CVP10G-S2, CVP10GS2-1310790, CVP20E, CVP20E-1320800, CVP20E-2, CVP20E2-1320840, CVP20E-S, CVP20ES-1320850, CVP20E-S2, CVP20ES2-1320890, CVP20G, CVP20G-1310800, CVP20G-1310850, CVP20G-2, CVP20G-S, CVP20GS-1310840, CVP20G-S2, CVP20GS2-1310890, CVP21E, CVP21E-1322700, CVP21E-2, CVP21E-S, CVP21ES-1322750, CVP21E-S2, CVP21ES2-1322790, CVP21G, CVP21G-1312700, CVP21G-2, CVP21G2-1312740, CVP21G-S, CVP21GS-1312750, CVP21G-S2, CVP21GS2-1312790... (Other models you can see in the webshop)		



metal

BÜRKERT

solenoid valves (various)



GEV No.	370464	Ref. No.	3002030
description	solenoid valve 2-ways 24VAC connection 1/2" DN 13mm t.max. -10 up to +90°C membranes NBR p max 10bar brass water		
For models:	OLAX151, OLAX151EDX-1080725, OLAX151ELEFT-1080727, OLAX151-highspeed, OLAX160, OLAX160E-1080750, OLAX160E-1080751, OLAX160V-1080755, OLAX160V-1080756, OLAX160V-1081031, OLAX160V-1081032, OLAX210, OLAX210E-1081029, OLAX210E-1081030, OLAX220, OLAX220E-1080787, OLAX220E-1080788, OLAX220V-1080789, OLAX220V-1080790, OLAX230, OLAX230E-1080791, OLAX230E-1080792, OLAX230V-1080793, OLAX230V-1080794, OLAX240, OLAX240E-1080795, OLAX240E-1080796, OLAX240V-1080797, OLAX240V-1080798, OLAX250, OLAX250E-1080760, OLAX250E-1080761, OLAX250V-1080765, OLAX250V-1080766, OLAX300, OLAX300E-1080770, OLAX300E-1080771, OLAX300E-1081033, OLAX300E-1081035, OLAX300E-1081036, OLAX300LC, OLAX300LCE-1081034, OLAX300V-1080775, OLAX300V-1080776, OLAX310, OLAX310E-1081110, OLAX310E-1081111, OLAX310LC, OLAX310LCE-1081114, OLAX310LCE-1081115...(Other models you can see in the webshop)		

CEME

solenoid valves



GEV No.	370353	Ref. No.	3103600 BN3103600
description	solenoid valve 2-ways 230VAC inlet 1/2" IT outlet 1/2" IT L 61mm brass		
For models:	CVP10E-1320700, CVP10G-1310700, CVP10GP-1310700, CVP20E-1320800, CVP20G-1310800, CVP21E52-1322790, CVP21G52-1312790, CVP6E-1320600, CVP6G-1310600		

solenoid valves (refrigeration)

CASTEL

valve bodies

STANDARD series

suitable for refrigerants R22, R134a, R404A, R407C, R410A, R507



GEV No.	370382	Ref. No.	14970245
description	solenoid valve body NC type 1028/M10S p max 45bar connection 10mm soldering connection DN 3mm -35 up to +105°C L 125mm refrigeration straight CASTEL		
For models:	KBT40-21091640, KC41-210916400BDC, KSABT70G-2045370CJD		
accessories for	370382		
	GEV No.	371084	Ref. No. —
	solenoid coil CASTEL 230VAC 8VA 50/60Hz connection cable 1000mm type CM2		
	GEV No.	371090	Ref. No. 14970511
	power socket plug type DIN 43650A screw		
	GEV No.	371301	Ref. No. —
	solenoid coil CASTEL 110VAC 8VA 50/60Hz seat ø 11.5mm connection DIN 43650A type HF2		
	GEV No.	371314	Ref. No. —
	solenoid coil CASTEL 240VAC 8VA 50/60Hz seat ø 11.5mm		
	GEV No.	371321	Ref. No. —
	solenoid coil CASTEL 12/24VAC 50/60Hz seat ø 11.5mm connection DIN 43650A type HF2		



spare parts and accessories



1

GEV No.	371041	Ref. No.	14970502
description	solenoid coil CASTEL 240VAC 8VA 50/60Hz seat ø 11.5mm connection DIN 43650A type HM2		
For models:	KSABT70G-2045370CJD, KTRE21-202108010BL5, KTRE2-202108010BFC, KTRE2A-202108010BGP, KTRE3-202113010BHF, KTRE32A-202113010BLQ, KTRE34-202113010BLW, KTRE3A-202113010BFW, KTRE4-202117010BLG, KTRE42-202117010BMO, KTRE42A-202117010BM6, KTRE44-202117010BMB, KTRE4A-202117010BFF, KTRE5-202122010BG2, KTRE52-202122010BNK, KTRE54-202122010BGC, KTRE54A-202122010BNP, KTRE5A-202122010BL3, TSR01-202108010BL7, TSR01-202108010BL8, TSR01-202108010BL9, TSR01-202108010BLA, TSR02-202113010BLK, TSR02-202113010BLL, TSR02-202113010BLP, TSR02-202113010BLR, TSR02-202113010BLV, TSR02-202113010BLX, TSR03-202117010BLY, TSR03-202117010BLZ, TSR03-202117010BM8, TSR03-202117010BMA, TSR03-202117010BMC, TSR04-202122010BMD, TSR04-202122010BME, TSR04-202122010BNM, TSR04-202122010BNN, TSR04-202122010BNO		
accessories for	371041		
	GEV No.	371090	Ref. No.
			14970511
	power socket plug type DIN 43650A screw		
	GEV No.	371092	Ref. No.
			—
	power socket plug type DIN large cable length 1000mm		



1

GEV No.	371090	Ref. No.	14970511
description	power socket plug type DIN 43650A screw		
For models:	KSABT70G-2045370CJD, KTRE21-202108010BL5, KTRE2-202108010BFC, KTRE2A-202108010BGP, KTRE3-202113010BHF, KTRE32A-202113010BLQ, KTRE34-202113010BLW, KTRE3A-202113010BFW, KTRE4-202117010BLG, KTRE42-202117010BMO, KTRE42A-202117010BM6, KTRE44-202117010BMB, KTRE4A-202117010BFF, KTRE5-202122010BG2, KTRE52-202122010BNK, KTRE54-202122010BGC, KTRE54A-202122010BNP, KTRE5A-202122010BL3, TSR01-202108010BL7, TSR01-202108010BL8, TSR01-202108010BL9, TSR01-202108010BLA, TSR02-202113010BLK, TSR02-202113010BLL, TSR02-202113010BLP, TSR02-202113010BLR, TSR02-202113010BLV, TSR02-202113010BLX, TSR03-202117010BLY, TSR03-202117010BLZ, TSR03-202117010BM8, TSR03-202117010BMA, TSR03-202117010BMC, TSR04-202122010BMD, TSR04-202122010BME, TSR04-202122010BNM, TSR04-202122010BNN, TSR04-202122010BNO		

SANHUA

valves



1

GEV No.	370757	Ref. No.	995508
description	solenoid valve type MDF-A03-6H001 230VAC p max 45bar pressure range 2 up to 31bar connection 10mm soldering connection -30 up to +105°C SANHUA refrigeration tube ø 10mm L 111mm		
For models:	081, 121, 161, OBC081AF-ASX-6V221285220OL, OBC121DF-ASX-6V23A285220OL, OBC161DF-ASX-6V24A485220OL		

ball valves electric



1

GEV No.	403042	Ref. No.	R65110560
description	ball valve inlet 3/4" IT outlet 3/4" IT 230V L 68mm closed off-current mode of operation electric connection cable 400mm		
For models:	CKEP06B, CKEP10B, CKEP20B, CKEP21B, CKEP40B, CKET06B, CKET10B, CKET20B, CKET21B, CKET40B, CKGP06B, CKGP10B, CKGP20B, CKGP21B, CKGT06B, CKGT10B, CKGT20B, CKGT21B, CKGT40B		



1

GEV No.	401190	Ref. No.	3103590 3198150 BN3103590 BN3198150
description	ball valve inlet 3/4" IT outlet 3/4" IT IP42 230V L 68mm 50/60Hz closed off-current mode of operation electric connection cable 300mm 3.5W duty cycle 50%		
For models:	CVP10E, CVP10E-1320700, CVP10E-1320710, CVP10E-2, CVP10E2-1320740, CVP10E2S-1320790, CVP10E-S, CVP10ES-1320750, CVP10ES-1320760, CVP10E-S2, CVP10G, CVP10G-1310700, CVP10G-1310750, CVP10G-2, CVP10G2-1310740, CVP10G-S, CVP10G-S2, CVP10GS2-1310790, CVP20E, CVP20E-1320800, CVP20E-2, CVP20E2-1320840, CVP20E-S, CVP20ES-1320850, CVP20E-S2, CVP20ES2-1320890, CVP20G, CVP20G-1310800, CVP20G-1310850, CVP20G-2, CVP20G-S, CVP20GS-1310840, CVP20G-S2, CVP20GS2-1310890, CVP21E, CVP21E-1322700, CVP21E-2, CVP21E-S, CVP21ES-1322750, CVP21E-S2, CVP21ES2-1322790, CVP21G, CVP21G-1312700, CVP21G-2, CVP21G2-1312740, CVP21G-S, CVP21GS-1312750, CVP21G-S2, CVP21GS2-1312790, CVP6E...(Other models you can see in the webshop)		



1

GEV No.	541619	Ref. No.	88110
description	pressure control pressure range 250/40mbar connection 6mm ø 58mm pressure connection ø 6mm		
For models:	G12S, OLAX151, OLAX151EDX-1080725, OLAX151ELEFT-1080727, OLAX151-highspeed, OLAX160, OLAX160E-1080750, OLAX160E-1080751, OLAX160V-1080755, OLAX160V-1080756, OLAX160V-1081031, OLAX160V-1081032, OLAX210, OLAX210E-1081029, OLAX210E-1081030, OLAX220, OLAX220E-1080787, OLAX220E-1080788, OLAX220V-1080789, OLAX220V-1080790, OLAX230, OLAX230E-1080791, OLAX230E-1080792, OLAX230V-1080793, OLAX230V-1080794, OLAX240, OLAX240E-1080795, OLAX240E-1080796, OLAX240V-1080797, OLAX240V-1080798, OLAX250, OLAX250E-1080760, OLAX250E-1080761, OLAX250V-1080765, OLAX250V-1080766, OLAX300, OLAX300E-1080770, OLAX300E-1080771, OLAX300E-1081033, OLAX300E-1081035, OLAX300E-1081036, OLAX300LC, OLAX300LCE-1081034, OLAX300V-1080775, OLAX300V-1080776, OLAX310, OLAX310E-1081110, OLAX310E-1081111, OLAX310LC, OLAX310LCE-1081114...(Other models you can see in the webshop)		

pressure switches

for warewashing

ø 58mm with male faston 6.3mm

with connection horizontal



1

GEV No.	541136	Ref. No.	80225
description	pressure control pressure range 100/18mbar connection 6mm ø 58mm pressure connection horizontal warewashing		
For models:	OLLP2-1080722, OLLP2Electronic-Neutra		



1

GEV No.	541314	Ref. No.	10706/A
description	pressure control pressure range 46/26mbar connection 6mm ø 58mm pressure connection horizontal warewashing pressure connection ø 6mm		
For models:	OLAX250, OLAX250E-1080760, OLAX250E-1080761, OLAX250V-1080765, OLAX250V-1080766, OLAX300V-1080776, OLAX380, OLAX380E-1080780, OLAX380E-1080781, OLAX380E-1081037, OLAX380E-1081038, OLAX380E-1081039, OLAX380E-1081040, OLAX380E-1081043, OLAX380E-1081044, OLAX380E-1081046, OLAX380E-1081047, OLAX380E-1081048, OLAX380E-1081051, OLAX380E-1081052, OLAX380E-1081053, OLAX380E-1081054, OLAX380E-1081055, OLAX380E-1081056, OLAX380LC, OLAX380V-1080785, OLAX380V-1080786, OLAX400, OLAX400E-1081126, OLAX400E-1081127, OLAX400V-1081128, OLAX400V-1081129, OLAX440, OLAX440E-1081041, OLAX440E-1081042, OLAX440LC, OLAX440LCE-1081045, OLAX510, OLAX510E-1081130, OLAX510E-1081131, OLAX510LC, OLAX510LCE-1081134, OLAX510LCE-1081135, OLAX510LCV-1081136, OLAX510LCV-1081137, OLAX510V-1081132, OLAX510V-1081133, OLAX540, OLAX540E-1081049, OLAX540E-1081050...(Other models you can see in the webshop)		



1

GEV No.	541975	Ref. No.	90023
description	pressure control pressure range 190/60mbar connection 6mm ø 58mm pressure connection horizontal warewashing pressure connection ø 5.5mm		
For models:	OLLP1-S8, OLLP1-S8EL		



1

GEV No.	541133	Ref. No.	540450
description	pressure control pressure range 60/25mbar connection male faston 6.3mm ø 58mm pressure connection horizontal warewashing pressure connection ø 6mm		
For models:	OLElectron400		



			
1			
GEV No.	541311	Ref. No.	10300026
description	pressure control pressure range 76/38mbar connection 6mm ø 58mm pressure connection horizontal warewashing pressure connection ø 6mm		
For models:	OLDW020H, OLElectron1000, OLELELECTRON1000-1081084, OLELELECTRON1000D-1081085, OLLP1S5-1081087		

			
1			
GEV No.	541312	Ref. No.	75950
description	pressure control pressure range 86/59mbar connection 6mm ø 58mm pressure connection horizontal warewashing pressure connection ø 6mm		
For models:	OLHT11-1081071, OLHT11D-1081072, OLHT11ECO-1081070, OLHT-11-Neutra, OLHT11S, OLHT11S-Neutra, OLLP1-800, OLLP1-800-1080721, OLLP1-800EL, OLLP1-800-Neutra, OLLP-ZERO, OLLPZERO-1081057		

for gas equipment

			
1			
GEV No.	541073	Ref. No.	R63070010
description	pressure control ø 45mm pressure range adjustable 5-20mbar pressure connection vertical gas technology connection 1/4" pressure connection ø 1/4"mm		
For models:	CCG051M, CCG071M, CCG101M, CCG102M, CKGP06, CKGP06B, CKGP10, CKGP10B, CKGP20, CKGP20B, CKGP21, CKGP21B, CKGP40, CKGP40B, CKGT06, CKGT06B, CKGT10, CKGT10B, CKGT20, CKGT20B, CKGT21, CKGT21B, CKGT40, CKGT40B		

for steam control

			
1			
GEV No.	541074	Ref. No.	3103630 6A03630 BN3103630 LAR63070050
description	pressure control ø 45mm triggering pressure 0.5bar reset pressure 0.35bar pressure connection vertical steam control pressure range 0.35/0.51bar connection 1/8" pressure connection 1/8"		
For models:	CKEP06, CKEP10, CKEP20, CKEP21, CKEP40, CKET06, CKET10, CKET20, CKET21, CKET40, CKGP06, CKGP10, CKGP20, CKGP21, CKGP40, CKGT06, CKGT10, CKGT20, CKGT21, CKGT40, CMV6ES2-1320392, CVM10E, CVM10E-1320400, CVM10E-1320410, CVM10E-2, CVM10E2-1320440, CVM10E-S, CVM10ES-1320450, CVM10E-S2, CVM10ES2-1320490, CVM10ES2-1320495, CVM10G, CVM10G-1310400, CVM10G-1310410, CVM10G-1310430, CVM10G-1310450, CVM10G-2, CVM10G2-1310440, CVM10GP-1310400, CVM10G-S, CVM10GS-1310460, CVM10G-S2, CVM10GS2-1310490, CVM10GS2-1310495, CVM20E, CVM20E-1320500, CVM20E-2, CVM20E2-1320540, CVM20E-S, CVM20ES-1320550...(Other models you can see in the webshop)		

			
1			
GEV No.	541350	Ref. No.	6A022200 BN6A022200
description	pressure control pressure range adjustable 0.3-0.8bar connection 1/4" CO 250V 10A ambient temperature max. 60°C pressure connection 1/4"		
For models:	74-02NPEI, 74-02NPEI-12701755, 7PN-EI50		

electrodes

			
1			
GEV No.	401208	Ref. No.	6A037482 BN6A037482
description	level electrode 1/4" total length 150mm probe L 124mm insulated probe length 69mm PTFE insulated connection male faston 6.3mm stainless steel ø 2.5mm		
For models:	CVP10E, CVP10E-1320700, CVP10E-2, CVP10E2-1320740, CVP10E2S-1320790, CVP10E-S, CVP10ES-1320750, CVP10E-S2, CVP10G, CVP10G-1310700, CVP10G-1310750, CVP10G-2, CVP10G2-1310740, CVP10GP-1310700, CVP10G-S, CVP10G-S2, CVP10GS2-1310790, CVP20E, CVP20E-1320800, CVP20E-2, CVP20E2-1320840, CVP20E-S, CVP20ES-1320850, CVP20E-S2, CVP20ES2-1320890, CVP20G, CVP20G-1310800, CVP20G-1310850, CVP20G-2, CVP20G-S, CVP20GS-1310840, CVP20G-S2, CVP20GS2-1310890, CVP21E, CVP21E-1322700, CVP21E-2, CVP21E-S, CVP21ES-1322750, CVP21E-S2, CVP21ES2-1322790, CVP21G, CVP21G-1312700, CVP21G-2, CVP21G2-1312740, CVP21G-S, CVP21GS-1312750, CVP21G-S2, CVP21GS2-1312790, CVP6E, CVP6E-1320600...(Other models you can see in the webshop)		



1



GEV No.	401209	Ref. No.	6A037481 BN6A037481
description	level electrode 1/4" total length 180mm probe L 155mm insulated probe length 70mm PTFE insulated connection male faston 6.3mm stainless steel ø 2.5mm		
For models:	CVP10E, CVP10E-1320700, CVP10E-2, CVP10E2-1320740, CVP10E2S-1320790, CVP10E-S, CVP10ES-1320750, CVP10E-S2, CVP10G, CVP10G-1310700, CVP10G-1310750, CVP10G-2, CVP10G2-1310740, CVP10GP-1310700, CVP10G-S, CVP10G-S2, CVP10GS2-1310790, CVP20E, CVP20E-1320800, CVP20E-2, CVP20E2-1320840, CVP20E-S, CVP20ES-1320850, CVP20E-S2, CVP20ES2-1320890, CVP20G, CVP20G-1310800, CVP20G-1310850, CVP20G-2, CVP20G-S, CVP20GS-1310840, CVP20G-S2, CVP20GS2-1310890, CVP21E, CVP21E-1322700, CVP21E-2, CVP21E-S, CVP21ES-1322750, CVP21E-S2, CVP21ES2-1322790, CVP21G, CVP21G-1312700, CVP21G-2, CVP21G2-1312740, CVP21G-S, CVP21GS-1312750, CVP21GS2-1312790, CVP6E, CVP6E-1320600...(Other models you can see in the webshop)		

1



GEV No.	400130	Ref. No.	R65320010
description	level electrode M14x1.25 total length 220mm probe L 194mm insulated probe length 26mm connection male faston 6.3mm ø 2.5mm		
For models:	CKEP06B, CKEP10B, CKEP20B, CKEP21B, CKEP40B, CKET06B, CKET10B, CKET20B, CKET21B, CKET40B, CKGP06B, CKGP10B, CKGP20B, CKGP21B, CKGP40B, CKGT06B, CKGT10B, CKGT20B, CKGT21B, CKGT40B		

flow meters and flow sensors

flow meters

miscellaneous

1



GEV No.	402680	Ref. No.	50583
description	flow meter pressure range 0.2-10bar connection 10mm L 69mm		
For models:	OLDS40, OLDS40-1081065, OLDS40D-1081066, OLDS40E-1081067, OLDS40ED-1081068, OLDS40-Neutra, OLDS50, OLDS50-1081088, OLDS50D-1081089, OLDS50E-1081090, OLDS50ED-1081091, OLDS50-Neutra, OLDW020H, OLElectron1000, OLElectron400, OLElectron500, OLELELECTRON1000-1081084, OLELELECTRON1000D-1081085, OLG550, OLG550-1080705, OLG550D-1080706, OLG550E-1080730, OLG550ECO-1081014, OLG550ECOD-1081015, OLG550ED-1080731, OLG550-Neutra, OLLP1S5-1081087		

compressors

ACC/ZEL

R134A

HMBP monophase

High/Medium evaporation temperature above -20/-15 °C

1



GEV No.	605007	Ref. No.	141514200595 141565100035
description	compressor coolant R134a type GL60TB 220-240V 50Hz HMBP fully hermetic 9.5kg 1/5HP power input 437W cylinder capacity 5.7cm ³ CSIR H 175.5mm 95W 128W 170W 222W 284W 355W 437W 528W test method ASHRAE ambient temperature max. 43°C		
For models:	KR41-210906400BFA, KTAR01, KTAR01N, KTAR02, KTAR02N, KTAR03, KTAR03N, KTAR04, KTAR04N, KTN40-21090640, KTRE21-202108010BL5, KTRE2-202108010BFC, KTRE2A-202108010BGP, KTRE3-202113010BHF, KTRE32A-202113010BLQ, KTRE34-202113010BLW, KTRE3A-202113010BFW, KTRE4-202117010BLG, KTRE42-202117010BMO, KTRE42A-202117010BM6, KTRE44-202117010BMB, KTRE4A-202117010BFF, KTRE5-202122010BG2, KTRE52-202122010BNK, KTRE54-202122010BGC, KTRE54A-202122010BNP, KTRE5A-202122010BL3, KTREP3-202611010C2F, KTREP34-20261101096L, KTREP34A-20261101096K, KTREP3A-202611010C1L, KTREP4-202615010BNQ, KTREP4A-202615010BNR, KTREP52A-202620010BO5, KTRN200012-202010050495, KTRN200012A-2020100507UK, KTRN200013-2020100507UV, KTRN200013A-2020100507UU, KTRN200014-2020100507UM, KTRN200014A-2020100507UL, KTRN200015-2020100507UR, KTRN200015A-2020100507UT, KTRN300122-202013050479, KTRN300122A-2020130504DY, KTRN300142-2020130506BG, KTRN300142A-2020130507GY, KTRN300144-2020130505UU, KTRN300144A-20201305079X, KTRN300152-2020130507GW, KTRN300152A-2020130507GX...(Other models you can see in the webshop)		



1

GEV No.	605008	Ref. No.	141565100030
description	compressor coolant R134a type GL80TB 220-240V 50Hz HMBP fully hermetic 9.5kg 1/5HP power input 554W cylinder capacity 7.6cm ³ CSIR H 175.5mm 165W 215W 290W 390W 500W 615W 727W 840W test method ASHRAE ambient temperature max. 43°C		
For models:	KTAR01, KTAR01N, KTAR02, KTAR02N, KTAR03, KTAR03N, KTAR04, KTAR04N, KTRE21-202108010BL5, KTRE2-202108010BFC, KTRE2A-202108010BGP, KTRE3-202113010BHF, KTRE32A-202113010BLQ, KTRE34-202113010BLW, KTRE3A-202113010BFW, KTRE4-202117010BLG, KTRE42-202117010BMO, KTRE42A-202117010BM6, KTRE44-202117010BMB, KTRE4A-202117010BFF, KTRE5-202122010BG2, KTRE52-202122010BNK, KTRE54-202122010BGC, KTRE54A-202122010BNP, KTRE5A-202122010BL3, KTREP3-202611010C2F, KTREP34-20261101096L, KTREP34A-20261101096K, KTREP3A-202611010C1L, KTREP4-202615010BNQ, KTREP4A-202615010BNR, KTREP5A-202620010BO5, KTRN200012-202010050495, KTRN200012A-2020100507UK, KTRN200013-2020100507UV, KTRN200013A-2020100507UU, KTRN200014-2020100507UM, KTRN200014A-2020100507UL, KTRN200015-2020100507UR, KTRN200015A-2020100507UT, KTRN300122-202013050479, KTRN300122A-2020130504DY, KTRN300142-2020130506BG, KTRN300142A-2020130507GY, KTRN300144-2020130505UU, KTRN300144A-20201305079X, KTRN300152-2020130507GW, KTRN300152A-2020130507GX, KTRN300155-2020130507HC, KTRN300155A-202013050559...(Other models you can see in the webshop)		



2

GEV No.	605010	Ref. No.	141565100050
description	compressor coolant R134a type GP12TB 220-240V 50Hz HMBP fully hermetic 11.2kg 3/8HP power input 661W cylinder capacity 12cm ³ CSIR H 203.6mm 143W 194W 259W 339W 432W 539W 661W 796W test method ASHRAE ambient temperature max. 43°C		
For models:	KTAR01, KTAR01N, KTAR02, KTAR02N, KTAR03, KTAR03N, KTAR04, KTAR04N, KTRE21-202108010BL5, KTRE2-202108010BFC, KTRE2A-202108010BGP, KTRE3-202113010BHF, KTRE32A-202113010BLQ, KTRE34-202113010BLW, KTRE3A-202113010BFW, KTRE4-202117010BLG, KTRE42-202117010BMO, KTRE42A-202117010BM6, KTRE44-202117010BMB, KTRE4A-202117010BFF, KTRE5-202122010BG2, KTRE52-202122010BNK, KTRE54-202122010BGC, KTRE54A-202122010BNP, KTRE5A-202122010BL3, KTREP3-202611010C2F, KTREP34-20261101096L, KTREP34A-20261101096K, KTREP3A-202611010C1L, KTREP4-202615010BNQ, KTREP4A-202615010BNR, KTREP5A-202620010BO5, KTRN200012-202010050495, KTRN200012A-2020100507UK, KTRN200013-2020100507UV, KTRN200013A-2020100507UU, KTRN200014-2020100507UM, KTRN200014A-2020100507UL, KTRN200015-2020100507UR, KTRN200015A-2020100507UT, KTRN300122-202013050479, KTRN300122A-2020130504DY, KTRN300142-2020130506BG, KTRN300142A-2020130507GY, KTRN300144-2020130505UU, KTRN300144A-20201305079X, KTRN300152-2020130507GW, KTRN300152A-2020130507GX, KTRN300155-2020130507HC, KTRN300155A-202013050559...(Other models you can see in the webshop)		

R404a/R507

LBP monophase

Lower evaporation temperature below -20°C



1

GEV No.	605073	Ref. No.	141565100180
description	compressor coolant R404a/R507 type MP14FB 220-240V 50Hz LBP fully hermetic 13.9kg 1/2HP cylinder capacity 14cm ³ CSIR H 203.6mm 439W 584W 746W 926W 1124W test method ASHRAE		
For models:	KTRE4-202117010BLG, KTRE42-202117010BMO, KTRE42A-202117010BM6, KTRE44-202117010BMB, KTRE4A-202117010BFF, KTRE5-202122010BG2, KTRE52-202122010BNK, KTRE54-202122010BGC, KTRE54A-202122010BNP, KTRE5A-202122010BL3, TSR03-202117010BLY, TSR03-202117010BLZ, TSR03-202117010BM8, TSR03-202117010BMA, TSR03-202117010BMC, TSR04-202122010BMD, TSR04-202122010BME, TSR04-202122010BNN, TSR04-202122010BNO		



CUBIGEL

R404a/R507

LBP monophase

Lower evaporation temperature below -20°C



1

GEV No.	605176	Ref. No.	141565100021
description	compressor coolant R404a/R507 type ML90FB 220-240V 50Hz LBP 11kg 1/3HP cylinder capacity 8.85cm ³ CSIR H 198mm 305W 394W 495W 606W 729W test method ASHRAE		
For models:	KTRE3-202113010BHF, KTRE32A-202113010BLQ, KTRE34-202113010BLW, KTRE3A-202113010BFW, TSR02-202113010BLK, TSR02-202113010BLL, TSR02-202113010BLP, TSR02-202113010BLR, TSR02-202113010BLV, TSR02-202113010BLX		

EMBRACO / ASPERA

R404a/R507

LBP monophase

Lower evaporation temperature below -20°C



1

GEV No.	605144	Ref. No.	995745
description	compressor coolant R404a/R507 type NEK2168GK 220-240V 50Hz LBP 22.9kg 3/4HP cylinder capacity 14.28cm ³ CSR H 200mm 345W 454W 587W 742W 921W 1123W test method ASHRAE		
For models:	031, BBF031AF-ASX-4186V204286210, OBF031AF-ASX-6V204286210OL		



1

GEV No.	605078	Ref. No.	141514202580
description	compressor coolant R404a/R507 type NT2180GK 220-240V 50Hz LBP fully hermetic 17.3kg 1HP cylinder capacity 20.44cm ³ CSIR H 221mm 515W 598W 682W 769W 859W 956W test method ASHRAE		
For models:	ROLL-IN1P-211008120CJE, ROLL-IN1P-211008120CJG, ROLL-IN2P-211016120CJL, ROLL-IN2P-211016120CJM, ROLL-IN2P-211016220CJN, ROLL-IN2P-211016220CJP, ROLL-IN-2PMTN-211016220CJO, ROLL-INP1P-211008220CJH, ROLL-INP1P-211008220CJK, ROLL-INP1PPMTN-211008220CJJ		

SECOP DANFOSS

R134A

HMBP monophase

High/Medium evaporation temperature above -20/-15 °C



1

GEV No.	605089	Ref. No.	141514208850
description	compressor coolant R134a type NL8.4MF 220-240V 50Hz HMBP fully hermetic 10.5kg 1/4HP cylinder capacity 8.35cm ³ RSIR/CSIR H 197mmW 235W 305W 390W 491W 610W 749W 912W test method ASHRAE		
For models:	ROLL-IN1P-211008120CJE, ROLL-IN1P-211008120CJG, ROLL-IN2P-211016120CJL, ROLL-IN2P-211016120CJM, ROLL-IN2P-211016220CJN, ROLL-IN2P-211016220CJP, ROLL-IN-2PMTN-211016220CJO, ROLL-INP1P-211008220CJH, ROLL-INP1P-211008220CJK, ROLL-INP1PPMTN-211008220CJJ		

spare parts for	605089		
	GEV No.	381528	Ref. No.
			—
	start relay DANFOSS 117U6016 HST		



R404a/R507

LBP monophase

Lower evaporation temperature below -20°C

SECCP



GEV No.	605058	Ref. No.	141555100055
description	compressor coolant R404a/R507 type SC15CL 220-240V 50Hz LBP fully hermetic 13.8kg 1/2HP cylinder capacity 15.28cm ³ CSIR H 219mm 486W 637W 813W 1017W 1251W 1699WWWWW test method ASHRAE 175W 358W		
For models:	KSABT70G-2045370CJD, OLKSABT70-2045170CIO, OLKSABT72-2045170CIT, OLKSABTV70-2045170CIR, OLSPABT60-201716030CIC, OLSPABT70-201717030CHW, OLSPABT72-201717030CIO, OLSPABTV70-201717030CHY		
spare parts for	605058		
	GEV No.	380058	Ref. No. —
	start relay DANFOSS 117U6019/F278 HST		

evaporation and condensing trays

condensing trays heated

universal

heating cartridges





GEV No.	417227	Ref. No.	1666090 1666150
description	heating cartridge 90W 230V ø 12mm L 124mm thread 3/8" cable length 4000mm Hmm Wmm condensate evaporation		
For models:	KBT40-21091640, KC41-210916400BDC, KR41-210906400BFA, KSABT70G-2045370CJD, KTAP01-BASE-20220901044U, KTAP02-BASE-20221301048K, KTAP02BT-BASE-2022630105KW, KTAP03-BASE-2022180109UA, KTAP04-2022230109X0, KTAP04-BASE-2022230109RY, KTAP82-202282020AY0, KTAP82-202282020AY1, KTAP83-202283020AY3, KTAP84-202284020AY4, KTAP84-202284020AY5, KTN40-21090640, KTRP00522-2022130107K4, KTRP200022-202209010500, KTRP200022A-2022090104EB, KTRP200042-2022090107HY, KTRP200042A-20220901077B, KTRP200044-2022090105CF, KTRP200044A-2022090107HZ, KTRP200052-2022090107HW, KTRP200052A-2022090107HK, KTRP200055-2022090107K1, KTRP200055A-2022090107K0, KTRP300222-2022130105HP, KTRP300222A-2022130104EC, KTRP300422-2022130106TB, KTRP300422A-2022130105XL, KTRP300442-2022130107K6, KTRP300442A-2022130107K7, KTRP300522-2022130107K2, KTRP300522A-2022130107K3, KTRP300552A-2022130107K5, KTRP402222A-2022180109WR, KTRP404222-2022180109WV, KTRP404222A-2022180109WU, KTRP404422-2022180104VV, KTRP404422A-2022180107KE, KTRP405222-2022180109WT, KTRP405222A-2022180109WS, KTRP405522-2022180107KB, KTRP405522A-2022180107KC, KTRP522222-2022230109WW, KTRP522222A-2022230109WX, KTRP542222A-2022230109X1, KTRP544222-2022230107KR, KTRP544222A-2022230107KP...(Other models you can see in the webshop)		

fans

axial fans

ebm-papst



GEV No.	601030 ¹	Ref. No.	3102350 65060050 BN3102350 LA65060050 LAR65060050
description	axial fan L 119mm W 119mm H 38mm 230VAC 50Hz 18W bearing ball bearing manuf. no. 4656Z metal connection male faston 2.8mm ebm-papst fan wheel ø 110mm temp.-resist. 75°C		
For models:	7PCV-WOK400, 92-04VTCI-12901035, 92-04VTCIWOK, CCE071M, CCE101M, CCE102M, CCG071M, CCG101M, CCG102M, CKEP06, CKEP06B, CKEP10, CKEP10B, CKEP20, CKEP20B, CKEP21, CKEP21B, CKEP40, CKEP40B, CKET06, CKET06B, CKET10, CKET10B, CKET20, CKET20B, CKET21, CKET21B, CKET40, CKET40B, CKGP06, CKGP06B, CKGP10, CKGP10B, CKGP20, CKGP20B, CKGP21, CKGP21B, CKGP40, CKGP40B, CKGT06, CKGT06B, CKGT10B, CKGT20, CKGT20B, CKGT21, CKGT21B, CKGT40, CKGT40B, CMV6ES2-1320392, CV10E...(Other models you can see in the webshop)		
accessories for	601030		
	GEV No.	550898	Ref. No. —
	connecting cable cable length 2000mm connection F 2.8 connection distance 7.9mm for axial flow fan		
	GEV No.	692497	Ref. No. —
	guard ø 105mm mounting distance 150mm for axial fan ebm-papst-mm		

¹with ball bearings

import



1

GEV No.	601601 ¹	Ref. No.	3000118
description	axial fan L 119mm W 119mm H 38mm 230VAC 50/60Hz 22W bearing slide bearing manuf. no. DP200A2123XST.GN SUNON input current 0.14A		
For models:	OLAX151, OLAX151EDX-1080725, OLAX151LEFT-1080727, OLAX151-highspeed, OLAX160, OLAX160E-1080750, OLAX160E-1080751, OLAX160V-1080755, OLAX160V-1080756, OLAX160V-1081031, OLAX160V-1081032, OLAX210, OLAX210E-1081029, OLAX210E-1081030, OLAX220, OLAX220E-1080787, OLAX220E-1080788, OLAX220V-1080789, OLAX220V-1080790, OLAX230, OLAX230E-1080791, OLAX230E-1080792, OLAX230V-1080793, OLAX230V-1080794, OLAX240, OLAX240E-1080795, OLAX240E-1080796, OLAX240V-1080797, OLAX240V-1080798, OLAX250, OLAX250E-1080760, OLAX250E-1080761, OLAX250V-1080765, OLAX250V-1080766, OLAX300, OLAX300E-1080770, OLAX300E-1080771, OLAX300E-1081033, OLAX300E-1081035, OLAX300E-1081036, OLAX300LC, OLAX300LCE-1081034, OLAX300V-1080775, OLAX300V-1080776, OLAX310, OLAX310E-1081110, OLAX310E-1081111, OLAX310LC, OLAX310LCE-1081114, OLAX310LCE-1081115...(Other models you can see in the webshop)		

¹with slide bearings



2

GEV No.	601080 ¹	Ref. No.	1648110107
description	axial fan L 119mm W 119mm H 38mm 230VAC 50/60Hz 23/20W bearing ball bearing connection male faston 2.8mm metal ADDA fan wheel ø 110mm temp.-resist. 70°C		
For models:	KBT40-21091640, KC41-210916400BDC, KR41-210906400BFA, KTAP02BT-BASE-2022630105KW, KTN40-21090640, KTRPBT300222-2022630107KT, KTRPBT300222A-2022630107KU, ROLL-IN1P-211008120CJE, ROLL-IN1P-211008120CJG, ROLL-IN1PBT-211009120CJF, ROLL-IN2P-211016120CJL, ROLL-IN2P-211016120CJM, ROLL-IN2P-211016220CJN, ROLL-IN2P-211016220CJP, ROLL-IN-2PMTN-211016220CJO, ROLL-INP1P-211008220CJH, ROLL-INP1P-211008220CJL, ROLL-INP1PBT-211009220CJI, ROLL-INP1PP-MTN-211008220CJJ		
accessories for	601080		
	GEV No.	550898	Ref. No. —
	connecting cable cable length 2000mm connection F 2.8 connection distance 7.9mm for axial flow fan		
	GEV No.	692519	Ref. No. —
	guard L 120mm W 120mm plastic		

¹with ball bearings



1

GEV No.	601081 ¹	Ref. No.	R65060010
description	axial fan L 80mm W 80mm H 38mm 230VAC 50/60Hz 14/13.5W bearing ball bearing connection male faston 2.8mm metal ADDA fan wheel ø 75mm temp.-resist. 70°C		
For models:	CCG051M		
accessories for	601081		
	GEV No.	691102	Ref. No. —
	guard ø 75mm mounting distance 71mm for axial fan 80mm		

¹with ball bearings



1

GEV No.	601055 ¹	Ref. No.	1648110150 6A036420 BN6A036420
description	axial fan L 92mm W 92mm H 25mm 230VAC 50/60Hz 14.5/14W bearing ball bearing connection male faston 2.8mm metal ADDA fan wheel ø 85mm temp.-resist. 70°C		
For models:	72-02TVTCV, 72-02TVTCV-12731005, 72-02VTC, 72-02VTCV, 72-02VTG-12701005, 74-02TVTCV, 74-02TVTCV-12731006, 74-02VTCEV, 74-02VTCEV-12701020, 74-02VTCV, 74-02VTCV-12701006, 7NPCF-VCE800, 7NPC-VCE400, 7NPC-VCE800, 7NPCVP-VCE400, 7NPCVP-VCE800, 7NPCV-VCE400, 7NPCV-VCE800, 92-04TVTC, 92-04VTVC-12931005, 92-04VTVCV-12931055, 92-04VTC, 92-04VTCV-12901055, 94-04TVTC, 94-04TVTC-12931006, 94-04TVTCV-12931056, 94-04VTC, 94-04VTCV, 94-04VTCV-12901050, 94-04VTCV-12901056, 9NPCF-VCE800, 9NPC-VCE400, 9NPC-VCE800, 9NPCVP-VCE400, 9NPCVP-VCE800, 9NPCV-VCE400, 9NPCV-VCE800, KTRE21-202108010BL5, KTRE2-202108010BFC, KTRE2A-202108010BGP, KTRE3-202113010BHF, KTRE32A-202113010BLQ, KTRE34-202113010BLW, KTRE3A-202113010BFW, KTRE4-202117010BLG, KTRE42-202117010BMO, KTRE42A-202117010BM6, KTRE44-202117010BMB, KTRE4A-202117010BFF, KTRE5-202122010BG2...(Other models you can see in the webshop)		
accessories for	601055		
	GEV No.	550898	Ref. No. —
	connecting cable cable length 2000mm connection F 2.8 connection distance 7.9mm for axial flow fan		
	GEV No.	691103	Ref. No. —
	guard ø 90mm mounting distance 83mm for axial fan 92mm		

¹with ball bearings



refrigeration fans

refrigeration motors universal

ELCO

N series - multi fit



GEV No.	601430	Ref. No.	1648000510
description	fan motor ELCO 5W 230V 50/60Hz bearing slide bearing L1 48mm L2 52mm L3 79.5mm W 83mm connection cable 500mm 1300/1550rpm 5 mounting options VNT5-13/027		
For models:	SAL22R-2124922093V		
spare parts for	601430		
	GEV No.	560140	Ref. No. —
	hexagonal nut thread M4 H 4.8mm SS WS 7 Qty 20 pcs DIN/ISO DIN 985 self-locking		
	GEV No.	560332	Ref. No. —
	plain washer ID ø 4.3mm ED ø 9mm thickness 0.8mm SS Qty 1 pcs		
	GEV No.	560340	Ref. No. 11703
	hexagonal nut thread M4 H 3.2mm WS 7 SS DIN/ISO DIN 934 / ISO 4032/8673 Qty 1 pcs		
	GEV No.	601413	Ref. No. —
	fixing plate suitable for fanwheel ED ø 32mm shaft ø 7 mounting distance 26mm		

N series - standard



GEV No.	601442	Ref. No.	1648001017
description	fan motor ELCO 10W 230V 50-60Hz bearing slide bearing L1 45mm L3 83mm W 83mm cable length 1800mm 1300/1550rpm 3 mounting options VN10-20/507 triple		
For models:	OLKSABT70-2045170CIO, OLKSABT72-2045170CIT, OLKSABTV70-2045170CIR, OLKSAP70-2045270CIP, OLKSATN140-2045140CIV, OLKSATN144-2045140CIZ, OLKSATN70-2045070CIN, OLKSATN72-2045070CIS, OLKSATNV140-2045140CIX, OLKSATNV70-2045070CIQ, OLSPAB100-201706030CLP, OLSPAB120-201707030CLN, OLSPAB200-201712030CLQ, OLSPAB240-201714030CLO, OLSPAB60-201716030CIC, OLSPAB70-201717030CHW, OLSPABT72-201717030CIO, OLSPABTV70-201717030CHY, OLSPATNN120-201712030CIH, OLSPATNN124-201712030CIL, OLSPATNN140-201714030CI1, OLSPATNN144-201714030CI5, OLSPATNN60-201706030CIB, OLSPATNN62-201706030CIF, OLSPATNN70-201707030CEM, OLSPATNN72-201707030CHZ, OLSPATNV120-201712030CIJ, OLSPATNV140-201714030CI3, OLSPATNV60-201706030CID, OLSPATNV70-201707030CHX		
spare parts for	601442		
	GEV No.	601413	Ref. No. —
	fixing plate suitable for fanwheel ED ø 32mm shaft ø 7 mounting distance 26mm		

electric components

IMPORT

multi fit fan motors



1

GEV No.	601022	Ref. No.	1648001010 1648001015
description	fan motor 10W 230V 50-60Hz L1 44mm L2 54mm L3 85mm W 84mm cable length 500mm 1300rpm YZF10-20-18/26 5 mounting options bearing slide bearing		
For models:	KBT40-21091640, KC41-210916400BDC, KR41-210906400BFA, KSABT70G-2045370CJD, KTAR01, KTAR01N, KTAR02, KTAR02N, KTAR03, KTAR03N, KTAR04, KTAR04N, KTN40-21090640, KTRE21-202108010BL5, KTRE2-202108010BFC, KTRE2A-202108010BGP, KTRE3-202113010BHF, KTRE32A-202113010BLQ, KTRE34-202113010BLW, KTRE3A-202113010BFW, KTRE4-202117010BLG, KTRE42-202117010BMO, KTRE42A-202117010BM6, KTRE44-202117010BMB, KTRE4A-202117010BFF, KTRE5-202122010BG2, KTRE52-202122010BNK, KTRE54-202122010BGC, KTRE54A-202122010BNP, KTRE5A-202122010BL3, KTREP3-202611010C2F, KTREP34-20261101096L, KTREP34A-20261101096K, KTREP3A-202611010C1L, KTREP4-202615010BNQ, KTREP4A-202615010BNR, KTREP52A-202620010BO5, KTRN200012-202010050495, KTRN200012A-2020100507UK, KTRN200013-2020100507UV, KTRN200013A-2020100507UU, KTRN200014-2020100507UM, KTRN200014A-2020100507UL, KTRN200015-2020100507UR, KTRN200015A-2020100507UT, KTRN300122-202013050479, KTRN300122A-2020130504DY, KTRN300142-2020130506BG, KTRN300142A-2020130507GY, KTRN300144-2020130505UU...(Other models you can see in the webshop)		



2

GEV No.	601023	Ref. No.	1648001600
description	fan motor 16W 230V 50-60Hz L1 45mm L2 61mm L3 92mm W 84mm cable length 500mm 1300rpm YZF16-25-18/26 5 mounting options bearing slide bearing		
For models:	KTRNBT401222-2025180107LE, KTRNBT401222A-20251801045Z, KTRNBT512222-2025230107LF, KTRNBT512222A-2025230104XX, ROLL-IN1P-211008120CJE, ROLL-IN1P-211008120CJG, ROLL-IN2P-211016120CJL, ROLL-IN2P-211016120CJM, ROLL-IN2P-211016220CJN, ROLL-IN2P-211016220CJP, ROLL-IN-2PMTN-211016220CJO, ROLL-INP1P-211008220CJH, ROLL-INP1P-211008220CJL, ROLL-INP1PMTN-211008220CJ		

accessories

fan wheels

aluminium

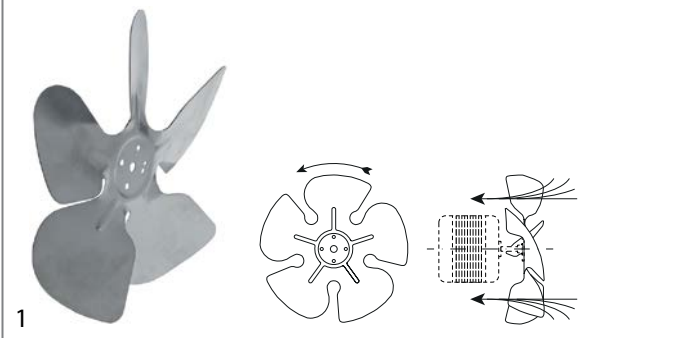

1

GEV No.	601070	Ref. No.	1495200028
description	fan wheel sucking ø 200mm fan wheel mounting 25.4mm blade angle 28° W 38mm aluminium		
For models:	KBT40-21091640, KC41-210916400BDC, KR41-210906400BFA, KTN40-21090640, SAL22R-2124922093V		

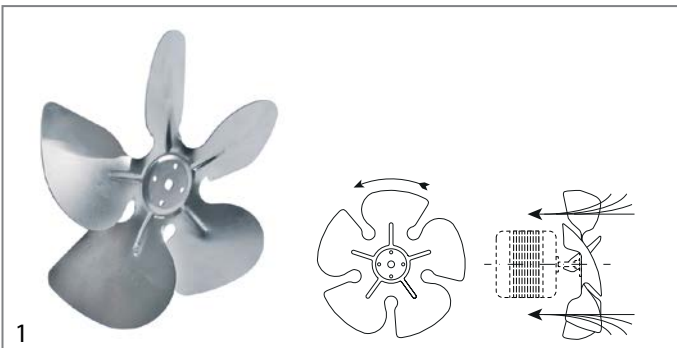

1

GEV No.	601282	Ref. No.	1495200034
description	fan wheel sucking ø 200mm fan wheel mounting 25.4mm blade angle 34° W 44mm aluminium		
For models:	KSABT70G-2045370CJD, OLKSABT140-2045240CIW, OLKSABT144-2045240CJ0, OLKSABT70-2045170CIO, OLKSABT72-2045170CIT, OLKSABTV140-2045240CIY, OLKSABTV70-2045170CIR, OLKSAP70-2045270CIP, OLKSATN140-2045140CIV, OLKSATN144-2045140CIZ, OLKSATN70-2045070CIN, OLKSATN72-2045070CIS, OLKSATNV140-2045140CIX, OLKSATNV70-2045070CIQ		

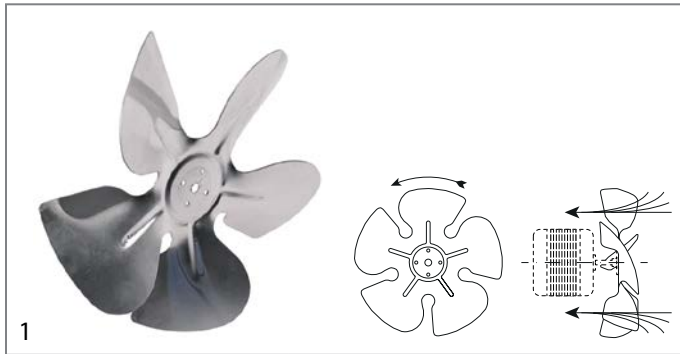

GEV No.	601172	Ref. No.	1495230034
description	fan wheel sucking ø 230mm fan wheel mounting 25.4mm blade angle 34° W 50mm aluminium		
For models:	KSABT70G-2045370CJD, KTAR01, KTAR01N, KTAR02, KTAR02N, KTAR03, KTAR03N, KTAR04, KTAR04N, KTRE21-202108010BL5, KTRE2-202108010BFC, KTRE2A-202108010BGP, KTRE3-202113010BHF, KTRE32A-202113010BLQ, KTRE34-202113010BLW, KTRE3A-202113010BFW, KTRE4-202117010BLG, KTRE42-202117010BMO, KTRE42A-202117010BM6, KTRE44-202117010BMB, KTRE4A-202117010BFF, KTRE5-202122010BG2, KTRE52-202122010BNK, KTRE54-202122010BGC, KTRE54A-202122010BNP, KTRE5A-202122010BL3, KTREP3-202611010C2F, KTREP34-20261101096L, KTREP34A-20261101096K, KTREP3A-202611010C1L, KTREP4-202615010BNQ, KTREP4A-202615010BNR, KTRP52A-202620010BOS, KTRN200012-202010050495, KTRN200012A-2020100507UK, KTRN200013-2020100507UV, KTRN200013A-2020100507UU, KTRN200014-2020100507UM, KTRN200014A-2020100507UL, KTRN200015-2020100507UR, KTRN200015A-2020100507UT, KTRN300122-202013050479, KTRN300122A-2020130504DY, KTRN300142-2020130506BG, KTRN300142A-2020130507GY, KTRN300144-2020130505UU, KTRN300144A-20201305079X, KTRN300152-2020130507GW, KTRN300152A-2020130507GX, KTRN300155-2020130507HC...(Other models you can see in the webshop)		

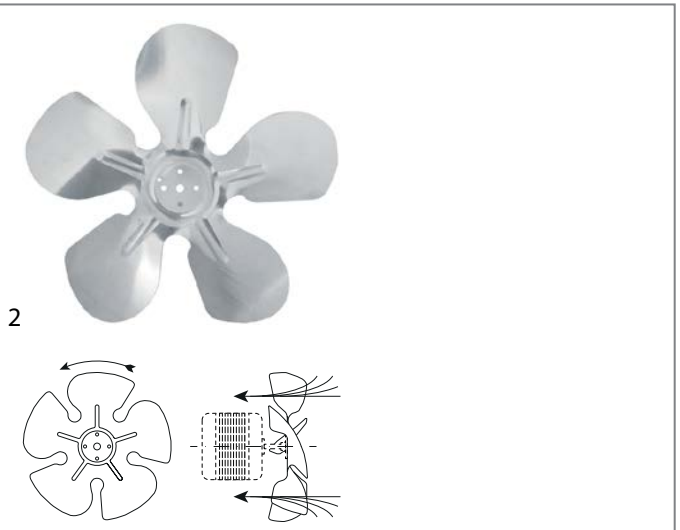

GEV No.	601387	Ref. No.	1495254028
description	fan wheel sucking ø 254mm fan wheel mounting 25.4mm blade angle 34° W 50mm aluminium		
For models:	KTRNBT401222-2025180107LE, KTRNBT401222A-20251801045Z, KTRNBT512222-2025230107LF, KTRNBT512222A-2025230104XK, ROLL-IN1P-211008120CJE, ROLL-IN1P-211008120CJG, ROLL-IN2P-211016120CJL, ROLL-IN2P-211016120CJM, ROLL-IN2P-211016220CJN, ROLL-IN2P-211016220CJP, ROLL-IN2PMTN-211016220CJO, ROLL-INP1P-211008220CJH, ROLL-INP1P-211008220CJL, ROLL-INP1PPMTN-211008220CJJ		

cold air circulating fans (complete)

HIDRIA

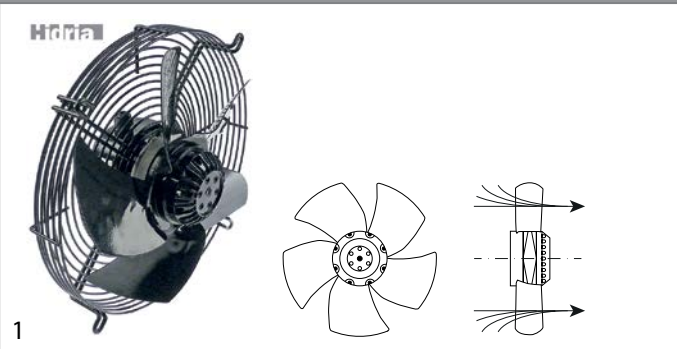

GEV No.	601811	Ref. No.	995870
description	fan type R09R-3030HP-4M-2543 fan wheel ø 300mm 230V 50/60Hz 65/90W suitable capacitor 2.5µF HIDRIA suitable for blast chiller suitable for FRIULINOX 1400/1500rpm blowing H 138mm cable lengthmm mounting distance 265mm		
For models:	081, 121, 161, KBC051-20354051, KBC151-20354151, KBC201-20355201, KBC201-PASS-THROUGH-20355221, KRC061-20357061, KRC101-20357101, KRC201-20358201, OBC081AF-ASX-6V221285220OL, OBC121DF-ASX-6V23A285220OL, OBC161DF-ASX-6V24A485220OL, OLBFO51-20364051OL, OLBFO151-20364151OL, OLBFO201-20365201OL, OLBFO201-20365221OL, OLRFO61-20367061OL, OLRFO101-20367101OL, OLRFO101P-20367103OL, OLRFO201-20368201OL, OLFU061-20364061OL		

miscellaneous



GEV No.	601858	Ref. No.	996074
description	fan 52W REH190X62-1CN fan wheel ø 190mm blades 16 230V 50/60Hz input current 0.39/0.49A H 70mm 2600/2900rpm connection 4-wire cable length 450mm rotation direction right XFAN with capacitor suitable capacitor 2.5µF		
For models:	BBF030AF-GOLD-4186V004284200, KBF030-20362030, OBF030AF-GOLD-6V004284200OL, OLBFO30-20362030OL		
spare parts for	601858		
	GEV No.	365170	Ref. No.
	capacitor capacity 2µF 425V tolerance 5% 50/60Hz ambient temperature max. -25 to +85°C ø 25mm L 49mm M8 plastic connection cable 250mm 416.17.74 protection		

cross flow fans

ebm-papst



1

GEV No.	601000	Ref. No.	1648106045
description	cross flow fan ebm-papst QLK45/0006-2513 roller ø 45mm roller length 60mm laminated core thickness 13mm motor position left 230V/50Hz 15W refrigeration bearing rubber connection male faston 6.3mm airflow 36m ³ /h 0 up to +60°C		
For models:	KTAP01-BASE-20220901044U, KTAP02-BASE-20221301048K, KTAP03-BASE-2022180109UA, KTAP04-2022230109X0, KTAP04-BASE-2022230109RY, KTRP00522-2022130107K4, KTRP200022-202209010500, KTRP200022A-2022090104EB, KTRP200042-2022090107HY, KTRP200042A-20220901077B, KTRP200044-2022090105CF, KTRP200044A-2022090107HZ, KTRP200052-2022090107HW, KTRP200052A-2022090107HX, KTRP200055-2022090107K1, KTRP200055A-2022090107K0, KTRP300222-2022130105HP, KTRP300222A-2022130104EC, KTRP300422-2022130106TB, KTRP300422A-2022130105XL, KTRP300442-2022130107K6, KTRP300442A-2022130107K7, KTRP300522-2022130107K2, KTRP300522A-2022130107K3, KTRP300552A-2022130107K5, KTRP402222A-2022180109WR, KTRP404222-2022180109WV, KTRP404222A-2022180109WU, KTRP404422-2022180104VV, KTRP404422A-2022180107KE, KTRP405222-2022180109WT, KTRP405222A-2022180109WS, KTRP405522-2022180107KB, KTRP405522A-2022180107KC, KTRP522222-2022230109WW, KTRP522222A-2022230109WX, KTRP542222A-2022230109X1, KTRP544222-2022230107KR, KTRP544222A-2022230107KP, KTRP552222-2022230109WZ, KTRP552222A-2022230109WV, KTRP552222-2022230107KM, KTRP552222A-2022230107KN		

EMMEVI - FERGAS

with moulded coils



1

GEV No.	601110	Ref. No.	1648106018
description	cross flow fan TGO 60/1-180/20 roller ø 60mm roller length 180mm laminated core thickness 20mm motor position left 230V/50Hz 28W refrigeration bearing rubber connection male faston 6.3mm -30 up to +100°C 230V cable length 1800mm		
For models:	KTAP82, KTAP82-202282020AY0, KTAP82-202282020AY1, KTAP83, KTAP83-202283020AY3, KTAP84, KTAP84-202284020AY4, KTAP84-202284020AY5, KTAR01, KTAR01N, KTAR02, KTAR02N, KTAR03, KTAR03N, KTAR04, KTAR04N, KTR21-202108010BL5, KTR2-202108010BFC, KTR2A-202108010BGP, KTR3-202113010BHF, KTR32A-202113010BLQ, KTR34-202113010BLW, KTR3A-202113010BFW, KTR4-202117010BLG, KTR42-202117010BMQ, KTR42A-202117010BM6, KTR44-202117010BMB, KTR4A-202117010BFF, KTR5-202122010BG2, KTR52-202122010BNK, KTR54-202122010BGC, KTR54A-202122010BNP, KTR5A-202122010BL3, KTRP3-202611010C2F, KTRP34-20261101096L, KTRP34A-20261101096K, KTRP3A-202611010C1L, KTRP4-202615010BNQ, KTRP4A-202615010BNR, KTRP52A-202620010B05, KTRN200012-202010050495, KTRN200012A-2020100507UK, KTRN200013-2020100507UV, KTRN200013A-2020100507UU, KTRN200014-2020100507UM, KTRN200014A-2020100507UL, KTRN200015-2020100507UR, KTRN200015A-2020100507UT, KTRN300122-202013050479, KTRN300122A-2020130504DY...(Other models you can see in the webshop)		

hot air motors



1

GEV No.	550857	Ref. No.	R58003870
description	counterflange for fan motor ED ø 50mm int. ø 1 25mm int. ø 2 16mm thickness 6mm brass		
For models:	CCE071M, CCG071M, CKEP06, CKEP06B, CKET06, CKET06B, CKGP06, CKGP06B, CKGT06, CKGT06B		



1

GEV No.	550859	Ref. No.	R58003850
description	counterflange for fan motor ED ø 60mm int. ø 1 34mm int. ø 2 25mm thickness 6mm brass		
For models:	CCE101M, CCE102M, CCG101M, CCG102M, CKEP10, CKEP10B, CKEP20, CKEP20B, CKEP21, CKEP21B, CKEP40, CKEP40B, CKET10, CKET10B, CKET20, CKET20B, CKET21, CKET21B, CKET40, CKET40B, CKGP10, CKGP10B, CKGP20, CKGP20B, CKGP21, CKGP21B, CKGP40, CKGP40B, CKGT10B, CKGT20, CKGT20B, CKGT21, CKGT21B, CKGT40, CKGT40B		



1

GEV No.	500656	Ref. No.	R65040520	
description	fan motor 200-240/415V 3 phase 50/60Hz 0.15/0.55kW 900/1400rpm speeds 2 L1 150mm L2 50mm L3 48mm D1 ø 24mm D2 ø 20mm M12L IT 2.3/1.3-1.2/0.7A at 50Hz 200-240/415V at 60Hz 200-240/480V at 50Hz 900/1400rpm at 60Hz 1100/1700rpm type 3042D4050			
For models:	CKEP10, CKEP10B, CKEP20, CKEP20B, CKEP21, CKEP21B, CKEP40, CKEP40B			
spare parts for	500656			
	GEV No.	511172	Ref. No.	R70020050
				shaft sealing ID ø 24mm ED ø 29mm thickness 3mm

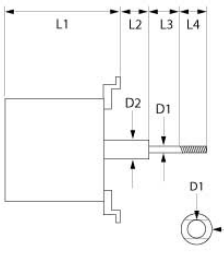
1

GEV No.	500662	Ref. No.	R65041000
description	fan motor 220-240V 1 phase 50/60Hz 0.12kW 2800/3200rpm speeds 1 L1 85mm L2 7mm L3 47mm L4 12mm D1 ø 8/6mm D2 ø 12mm M5R ET 1.6A power input 0.25W suitable capacitor 5µF/400V		
For models:	CCE042M, CCE051M, CCG051M		



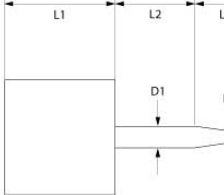

2

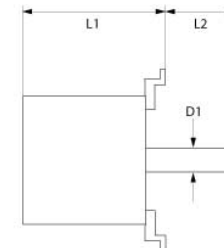
GEV No.	500661	Ref. No.	R65040431
description	fan motor 220-240V 1 phase 50Hz 0.03/0.2kW 0.05/0.25HP 1400/2700rpm speeds 2 L1 123mm L2 77mm L3 30mm D1 ø 15mm D2 ø 12mm M10L ET 1.6/0.6A suitable capacitor 10µF/450 V at 50Hz 1400/2700rpm type 1057D1901		
For models:	CKEP06, CKEP06B, CKGP06, CKGP06B		





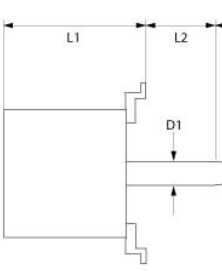

1

GEV No.	500644	Ref. No.	3102300 BN3102300
description	fan motor 230/400V 3 phase 50/60Hz 0.55kW 0.58HP 1420/1700rpm speeds 1 L1 188mm L2 67mm L3 46mm D1 ø 24mm D2 ø 20mm M12L IT 1.1/1.9A Cos(φ) 0.6 at 50Hz 1420/1700rpm type ST80/4 no. 654282 mounting distance 185mm		
For models:	CV10E, CV10E-1320100, CV10E-1320110, CV10EB-1321100, CV10E-S, CV10ES-1320150, CV10G, CV10G-1310100, CV10G-S, CV10GS-1310150, CV20E, CV20E-1320200, CV20EB-1321200, CV20E-S, CV20ES-1320250, CV20G, CV20G-1310200, CV20G-S, CV20GS-1310250, CV21E, CV21E-1322100, CV21E-S, CV21ES-1322150, CV6E, CV6E-1320000, CV6E-1320010, CV6E-1320050, CV6EB-1321000, CV6E-S, CV6G, CV6G-1310000, CV6G-S, CV6GS-1310050, CVM10E, CVM10E-1320400, CVM10E-1320410, CVM10E-S, CVM10ES-1320450, CVM10G, CVM10G-1310400, CVM10G-1310430, CVM10G-1310450, CVM10G-S, CVM20E, CVM20E-1320500, CVM20E-S, CVM20ES-1320550, CVM20G, CVM20G-1310500, CVM20G-S...(Other models you can see in the webshop)		
accessories for	500644		
	GEV No.	560449	Ref. No. 3102250 BN3102250 R58004000
	hexagonal screw thread M12x1.5 L thread L 22mm bore ø 6.3mm WS 19 total length 30mm		





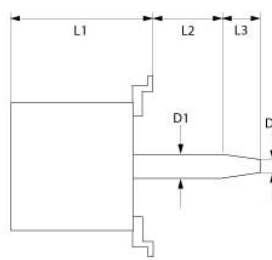

1

GEV No.	500658	Ref. No.	R65040530
description	fan motor 230/400V 3 phase 50/60Hz 0.55kW 1400/1700rpm speeds 1 L1 145mm L2 47mm L3 47mm D1 ø 24mm D2 ø 20mm M12L IT 2.6-2.3/1.5-1.3A (at 50-60Hz)A Cos(φ) 0.73 at 50Hz 200-240/415V at 60Hz 200-240/480V at 50Hz 1400rpm at 60Hz 1700rpm		
For models:	CCE101M, CCE102M, CKEP10, CKEP10B, CKEP20, CKEP20B, CKEP21, CKEP21B, CKEP40, CKEP40B, CKET10, CKET10B, CKET20, CKET20B, CKET21, CKET21B, CKET40, CKET40B, CKGT10B, CKGT20, CKGT20B, CKGT21, CKGT21B, CKGT40, CKGT40B		
spare parts for	500658		
	GEV No.	511172	Ref. No. R70020050
	shaft sealing ID ø 24mm ED ø 29mm thickness 3mm		
accessories for	500658		
	GEV No.	560449	Ref. No. 3102250 BN3102250 R58004000
	hexagonal screw thread M12x1.5 L thread L 22mm bore ø 6.3mm WS 19 total length 30mm		
	GEV No.	601244	Ref. No. R75400440
	fan wheel D1 ø 350mm H1 114mm blades 12 D2 ø 19.5mm D3 ø 23mm H2 45mm		

1

GEV No.	500646	Ref. No.	3102200 BN3102200
description	fan motor 230V 1 phase 50/60Hz 0.55kW 1400/1680rpm speeds 1 L1 188mm L2 67mm L3 47mm D1 ø 24mm D2 ø 20mm M12L IT 2.4A suitable capacitor 20µF/450V Cos(φ) 0.95 at 50Hz 1400rpm at 60Hz 1680rpm type LM80/4 no. 601259		
For models:	CV10G, CV10G-1310100, CV10GB-1311100, CV10G-S, CV10GS-1310150, CV20G, CV20G-1310200, CV20GB-1311200, CV20G-S, CV20GS-1310250, CV21G, CV21G-1312100, CV21G-S, CV21GS-1312150, CV6G, CV6G-1310000, CV6G-1310010, CV6GB-1311000, CV6G-S, CV6GS-1310050, CV-M10G-1310400, CVM10G-1310410, CVM10G-1310430, CVM10G-1310450, CVM10GP-1310400, CVM10GS-1310460, CVM20G-1310500, CVM20GS-1310550, CVM21G, CVM21G-1312400, CVM21G-S, CVM21GS-1312450, CVM6G-1310300, CVM6G-1310310, CVM6GS-1310350, CVM6GS-1310360, FC10G-418035410100, FC10G-S-418035410150, FC20G-418035410200, FC20G-S-418035410250, FC21G-B-418035412100, FC21G-S-418035412150, FC6G-418035410000, FC6G-S-418035410050, FCM10G-418035410400, FCM10G-S-418035410450, FCM10G-S-418035410450AU, FCM20G-418035410500, FCM20G-S-418035410550, FCM21G-418035412400...(Other models you can see in the webshop)		
accessories for	500646		
	GEV No.	Ref. No.	—
	365019		
	operating capacitor capacity 20µF 400V tolerance 5% 50/60Hz ambient temperature max. -25 to +85°C ø 39.5mm L 70mm M8 plastic connection male faston 6.3mm 16.10.25. protection		
	GEV No.	Ref. No.	3102250 BN3102250 R58004000
	560449		
	hexagonal screw thread M12x1.5 L thread L 22mm bore ø 6.3mm WS 19 total length 30mm		



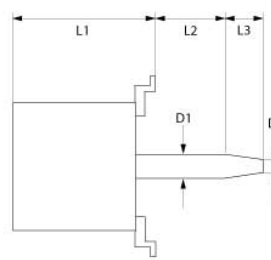

1

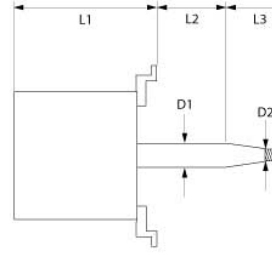
GEV No.	500647	Ref. No.	3102210 BN3102210
description	fan motor 230V 1 phase 50Hz 0.13/0.55kW 700/1400rpm speeds 2 L1 188mm L2 64mm L3 46mm D1 ø 24mm D2 ø 20mm 0.66/2.4A suitable capacitor 25µF Cos(φ) 0.98 at 50Hz 700/1400rpm at 60Hz 850/1700rpm 4P/8P type LM/FB80 no. 483823		
For models:	CMV6ES2-1320392, CV10G-2, CV10G2-1310140, CV10G-S2, CV10GS2-1310190, CV20G-2, CV20G2-1310240, CV20G-S2, CV20GS2-1310290, CV21G-2, CV21G2-1312140, CV21G-S2, CV21GS2-1312190, CV6G-2, CV6G2-1310040, CV6G-S2, CV6GS2-1310090, CVM10G2-1310440, CVM10GS2-1310490, CVM20G2-1310540, CVM20GS2-1310590, CVM21G-2, CVM21G2-1312440, CVM21G-S2, CVM21GS2-1312490, CVM6G2-1310340, CVM6GS2-1310390, FC10G-2-418035410140, FC10G-2S-418035410190, FC20G-2-418035410240, FC20G-2S-418035410290, FC21G-2-418035412140, FC21G-2S-418035412190, FC6G-2-418035410040, FC6G-2S-418035410090, FCM10G-2-418035410440, FCM10G-2S-418035410490, FCM20G-2-418035410540, FCM20G-2S-418035410590, FCM21G-2-418035412440, FCM21G-2S-418035412490, FCM6G-2-418035410340, FCM6G-2S-418035410390		

1

GEV No.	500659	Ref. No.	R65040550
description	fan motor 230V 1 phase 50/60Hz 0.55kW 1400/1700rpm speeds 1 L1 150mm L2 52mm L3 45mm D1 ø 24mm D2 ø 20mm M12L IT 3A suitable capacitor 20µF/450V Cos(φ) 0.9 at 50Hz 1400rpm at 60Hz 1700rpm type 3042A2350		
For models:	CCG101M, CCG102M, CKGP10, CKGP10B, CKGP20, CKGP20B, CKGP21, CKGP21B, CKGP40, CKGP40B		
spare parts for	500659		
	GEV No.	Ref. No.	R70020050
	511172		
	shaft sealing ID ø 24mm ED ø 29mm thickness 3mm		



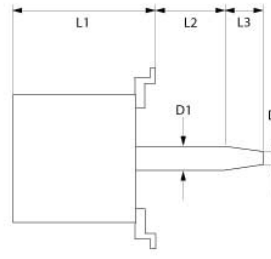

1

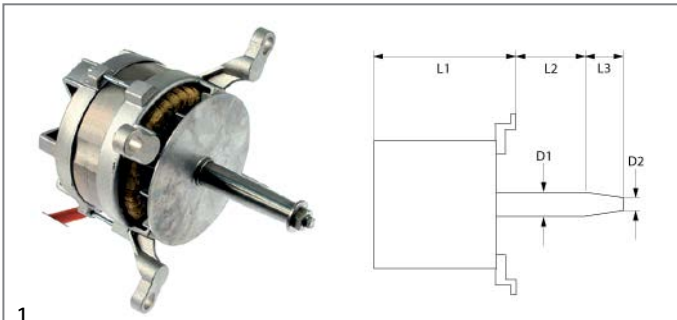
GEV No.	500649	Ref. No.	3102212 BN3102212
description	fan motor 230V 1 phase 50Hz 0.13/0.55kW 700/1400rpm speeds 2 L1 200mm L2 67mm L3 47mm D1 ø 24mm D2 ø 20mm M12L IT 0.66/2.4A suitable capacitor 8/25 µF Cos(φ) 0.98 at 50Hz 700/1400rpm at 60Hz 850/1700rpm 4P/8P type LM/FB80 no. 635521		
For models:	ECVM10ES2, ECVM10ES2-1324290, ECVM10ES2-1326120, ECVM10GS2, ECVM10GS2-1314290, ECVM10GS2-1316120, ECVM20ES2, ECVM20ES2-1324390, ECVM20ES2-1326140, ECVM20GS2, ECVM20GS2-1314390, ECVM20GS2-1316140, ECVM21ES2, ECVM21GS2, ECVM21GS2-1314490, ECVM21GS2-1316160, ECVM6ES2, ECVM6ES2-1324190, ECVM6ES2-1326100, ECVM6ES2-1326100H, ECVM6GS2, ECVM6GS2-1314190, ECVM6GS2-1316100, ECVP10ES2, ECVP10ES2-1324690, ECVP10ES2-1326200, ECVP20ES2, ECVP20ES2-1324790, ECVP20ES2-1326220, ECVP21ES2, ECVP21ES2-1324890, ECVP21ES2-1326240, ECVP6ES2, ECVP6ES2-1324590, ECVP6ES2-1326180, NECVM10ES2, NECVM10ES2-1327290, NECVM10ES2-1328120, NECVM10ES2-1328120H, NECVM10GS2, NECVM10GS2-1317290, NECVM10GS2-1318120, NECVM20ES2, NECVM20ES2-1327390, NECVM20ES2-1328140, NECVM20GS2, NECVM20GS2-1317390, NECVM20GS2-1318140, NECVM21ES2, NECVM21ES2-1327490...(Other models you can see in the webshop)		

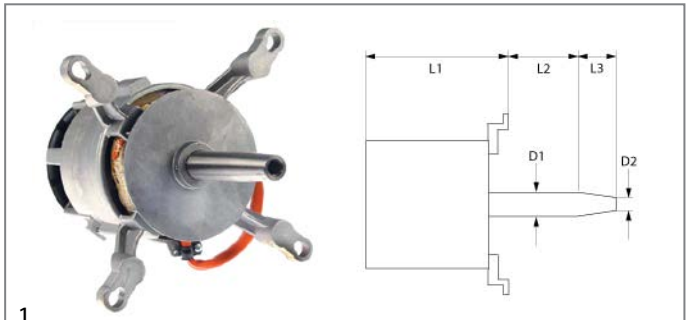

GEV No.	500657	Ref. No.	R65040540
description	fan motor 230V 1 phase 50Hz 0.15/0.55kW 900/1400rpm speeds 2 L1 150mm L2 45mm L3 47mm D1 ø 24mm D2 ø 20mm M12L IT 1.3/3.0A suitable capacitor 20/10µF Cos(f) 0.98 at 50Hz 900/1400rpm at 60Hz 1100/1700rpm 4P/6P type LM/FB 100L no. 472986		
For models:	CKGP10, CKGP10B, CKGP20, CKGP20B, CKGP21, CKGP21B, CKGP40, CKGP40B		
spare parts for	500657		
	GEV No.	511172	Ref. No. R70020050
shaft sealing ID ø 24mm ED ø 29mm thickness 3mm			



GEV No.	500645	Ref. No.	3102310 BN3102310
description	fan motor 400V 3 phase 50Hz 0.13/0.55kW 720/1440rpm speeds 2 L1 188mm L2 64mm L3 46mm D1 ø 24mm D2 ø 20mm 0.4/0.85A Cos(f) 0.60/0.75 at 50Hz 720/1440rpm at 60Hz 860/1720rpm type FB80 4/8 no. 520481		
For models:	CV10E-2, CV10E2-1320140, CV10E-S2, CV10ES2-1320190, CV10G, CV10G-2, CV10G2-1310140, CV10G-S, CV10G-S2, CV10GS2-1310190, CV20E-2, CV20E2-1320240, CV20E-S2, CV20ES2-1320290, CV20G, CV20G-2, CV20G2-1310240, CV20G-S, CV20G-S2, CV20GS2-1310290, CV21E-2, CV21E2-1322140, CV21E-S2, CV21ES2-1322190, CV6E-2, CV6E2-1320040, CV6E-S2, CV6ES2-1320090, CV6G-2, CV6G2-1310040, CV6G-S2, CV6GS2-1310090, CVM10E-2, CVM10E2-1320440, CVM10E-S2, CVM10ES2-1320490, CVM10G-2, CVM10G2-1310440, CVM10G-S2, CVM10GS2-1310490, CVM20E-2, CVM20E2-1320540, CVM20E-S2, CVM20ES2-1320590, CVM20G-2, CVM20G2-1310540, CVM20G-S2, CVM20GS2-1310590, CVM21E-2, CVM21E2-1322440... (Other models you can see in the webshop)		

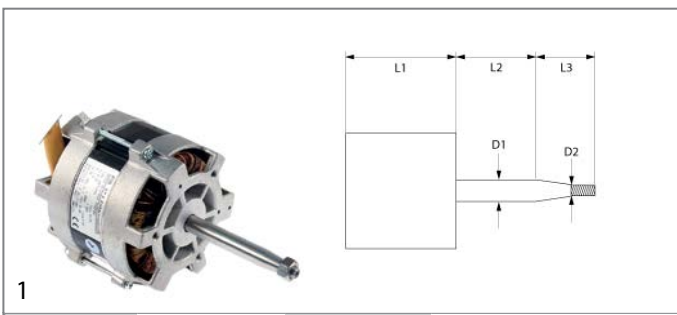

GEV No.	500663	Ref. No.	R65040421
description	fan motor 230V 1 phase 50Hz 0.18kW 0.25HP 2800rpm speeds 1 L1 123mm L2 77mm L3 30mm D1 ø 15mm D2 ø 12mm M10L ET 1.6A suitable capacitor 10µF/400V Cos(f) 0.95 at 50Hz 2800rpm type 1057C2401		
For models:	CCE071M, CCG071M, CKEP06, CKEP06B, CKGP06, CKGP06B		

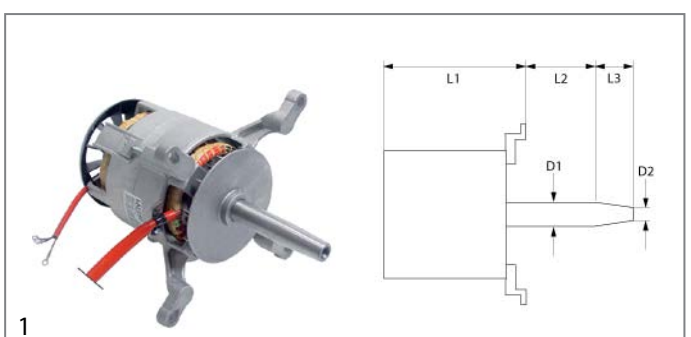

GEV No.	500648	Ref. No.	3102312 BN3102312
description	fan motor 400V 3 phase 50Hz 0.13/0.55kW 720/1440rpm speeds 2 L1 198mm L2 65mm L3 47mm D1 ø 24mm D2 ø 20mm M12L IT 400 0.4/0.85A Cos(f) 0.60/0.75 at 50Hz 720/1440rpm at 60Hz 860/1720rpm type FB80 4/8 no. 500256		
For models:	ECVM10ES2, ECVM10ES2-1324290, ECVM10ES2-1326120, ECVM20ES2, ECVM20ES2-1324390, ECVM20ES2-1326140, ECVM21ES2, ECVM6ES2, ECVM6ES2-1324190, ECVM6ES2-1326100, ECVM6ES2-1326100H, ECVP10ES2, ECVP10ES2-1324690, ECVP10ES2-1326200, ECVP10GS2, ECVP10GS2-1314690, ECVP10GS2-1316200, ECVP20ES2, ECVP20ES2-1324790, ECVP20ES2-1326220, ECVP20GS2, ECVP20GS2-1314790, ECVP20GS2-1316220, ECVP21ES2, ECVP21ES2-1324890, ECVP21ES2-1326240, ECVP21GS2, ECVP21GS2-1314890, ECVP21GS2-1316240, ECVP6ES2, ECVP6ES2-1324590, ECVP6ES2-1326180, ECVP6GS2, ECVP6GS2-1314590, ECVP6GS2-1316180, NECVM10ES2, NECVM10ES2-1327290, NECVM10ES2-1328120, NECVM10ES2-1328120H, NECVM20ES2, NECVM20ES2-1327390, NECVM20ES2-1328140, NECVM21ES2, NECVM21ES2-1327490, NECVM21ES2-1328160, NECVM6ES2, NECVM6ES2-1327190, NECVM6ES2-1328100, NECVP10ES2, NECVP10ES2-1327690...(Other models you can see in the webshop)		



GEV No.	501566	Ref. No.	R65040600
description	fan motor 230V 3 phase 50Hz 0.25kW 2700rpm L1 122mm L2 77mm L3 30mm D1 ø 15mm D2 ø 8mm M10 1.5A type FIR no. 1057.2650		
For models:	CKET06, CKET06B, CKGT06, CKGT06B		



1

GEV No.	602148	Ref. No.	R75400470
description	fan wheel blades 12 D1 ø 350mm D2 ø 19.5mm D3 ø 23mm H1 118mm H2 50mm		
For models:	CKEP10, CKEP10B, CKEP20, CKEP20B, CKEP21, CKEP21B, CKEP40, CKEP40B, CKGP10, CKGP10B, CKGP20, CKGP20B, CKGP21, CKGP21B, CKGP40, CKGP40B		



1

GEV No.	602146	Ref. No.	R75400490
description	fan wheel blades 8 D1 ø 220mm D2 ø 11mm D3 ø 16mm H1 83mm H2 25mm		
For models:	CKEP06, CKEP06B, CKET06, CKET06B		



1

GEV No.	601353	Ref. No.	R75400510
description	fan wheel D1 ø 150mm H1 50mm blades 36 D2 ø 8mm D3 ø 6/8mm H2 26mm		
For models:	CCE042M		



1

GEV No.	601246	Ref. No.	R75400410
description	fan wheel D1 ø 180mm H1 77mm blades 12 D2 ø 8mm D3 ø 6mm H2 25.5mm		
For models:	CCE051M, CCG051M		



1

GEV No.	601243	Ref. No.	R75400400
description	fan wheel D1 ø 220mm H1 78mm blades 12 D2 ø 11mm D3 ø 16mm H2 29mm		
For models:	CCE071M, CCG071M, CKEP06, CKEP06B, CKET06, CKET06B, CKGP06, CKGP06B, CKGT06, CKGT06B		



1

GEV No.	601214	Ref. No.	3101630 BN3101630	
description	fan wheel D1 ø 335mm H1 135mm blades 12 D2 ø 19.5mm D3 ø 23.5mm H2 51mm			
For models:	CV20E, CV20E-1320200, CV20E-2, CV20E2-1320240, CV20EB-1321200, CV20E-S, CV20ES-1320250, CV20E-S2, CV20ES2-1320290, CV20G, CV20G-1310200, CV20G-2, CV20G2-1310240, CV20GB-1311200, CV20G-S, CV20GS-1310250, CV20G-S2, CV20GS2-1310290, CVM20E, CVM20E-1320500, CVM20E-2, CVM20E2-1320540, CVM20E-S, CVM20ES-1320550, CVM20E-S2, CVM20ES2-1320590, CVM20G, CVM20G-1310500, CVM20G-2, CVM20G2-1310540, CVM20G-S, CVM20GS-1310550, CVM20G-S2, CVM20GS2-1310590, CVP20E, CVP20E-1320800, CVP20E-2, CVP20E2-1320840, CVP20EB-1321200, CVP20E-S, CVP20ES-1320850, CVP20E-S2, CVP20ES2-1320890, CVP20G, CVP20G-1310800, CVP20G-1310850, CVP20G-2, CVP20G-S, CVP20GS-1310840, CVP20G-S2...(Other models you can see in the webshop)			
accessories for	601214			
	GEV No.	560449	Ref. No.	3102250 BN3102250 R58004000
	hexagonal screw thread M12x1.5 L thread L 22mm bore ø 6.3mm WS 19 total length 30mm			



1

GEV No.	601213	Ref. No.	3101600 BN3101600
description	fan wheel D1 ø 335mm H1 135mm blades 16 D2 ø 19.5mm D3 ø 23.5mm H2 50.5mm		
For models:	CMV6ES2-1320392, CV10E, CV10E-1320100, CV10E-1320110, CV10E-2, CV10E2-1320140, CV10EB-1321100, CV10E-S, CV10ES-1320150, CV10E-S2, CV10ES2-1320190, CV10G, CV10G-1310100, CV10G-2, CV10G2-1310140, CV10GB-1311100, CV10G-S, CV10GS-1310150, CV10G-S2, CV10GS2-1310190, CV21E, CV21E-1322100, CV21E-2, CV21E2-1322140, CV21E-S, CV21ES-1322150, CV21E-S2, CV21ES2-1322190, CV21G, CV21G-1312100, CV21G-2, CV21G2-1312140, CV21G-S, CV21GS-1312150, CV21G-S2, CV21GS2-1312190, CV6E, CV6E-1320000, CV6E-1320010, CV6E-1320050, CV6E-2, CV6E2-1320040, CV6EB-1321000, CV6E-S, CV6E-S2, CV6ES2-1320090, CV6G, CV6G-1310000, CV6G-1310010, CV6G-2...(Other models you can see in the webshop)		



2

GEV No.	601244	Ref. No.	R75400440
description	fan wheel D1 ø 350mm H1 114mm blades 12 D2 ø 19.5mm D3 ø 23mm H2 45mm		
For models:	CCE101M, CCE102M, CCG101M, CCG102M, CKEP10, CKEP10B, CKEP20, CKEP20B, CKEP21, CKEP21B, CKEP40, CKEP40B, CKET10, CKET10B, CKET20, CKET20B, CKET21, CKET21B, CKET40, CKET40B, CKGP10, CKGP10B, CKGP20, CKGP20B, CKGP21, CKGP21B, CKGP40, CKGP40B, CKGT10B, CKGT20, CKGT20B, CKGT21, CKGT21B, CKGT40, CKGT40B		



1

GEV No.	550856	Ref. No.	R58003860
description	flange for fan motor ED ø 50mm int. ø 1 19.5mm int. ø 2 16mm thickness 3mm brass		
For models:	CCE071M, CCG071M, CKEP06, CKEP06B, CKET06, CKET06B, CKGP06, CKGP06B, CKGT06, CKGT06B		



1

GEV No.	550858	Ref. No.	R58003840
description	flange for fan motor ED ø 60mm int. ø 1 28.5mm int. ø 2 25mm thickness 4mm brass		
For models:	CCE101M, CCE102M, CCG101M, CCG102M, CKEP10, CKEP10B, CKEP20, CKEP20B, CKEP21, CKEP21B, CKEP40, CKEP40B, CKET10, CKET10B, CKET20, CKET20B, CKET21, CKET21B, CKET40, CKET40B, CKGP10, CKGP10B, CKGP20, CKGP20B, CKGP21, CKGP21B, CKGP40, CKGP40B, CKGT10B, CKGT20, CKGT20B, CKGT21, CKGT21B, CKGT40, CKGT40B		



1

GEV No.	550860	Ref. No.	R58005500
description	flange for gasket ED ø 35mm int. ø 1 22mm int. ø 2 9mm thickness 8mm brass		
For models:	CCE042M, CCE051M, CCG051M		



1

GEV No.	550850	Ref. No.	3102500 BN3102500
description	flange pair for fan motor ED ø 70mm int. ø 1 43.5mm int. ø 2 24.5mm thickness 5mm brass		
For models:	CMV6ES2-1320392, CV10E, CV10E-1320100, CV10E-1320110, CV10E-2, CV10E2-1320140, CV10EB-1321100, CV10E-S, CV10ES-1320150, CV10E-S2, CV10ES2-1320190, CV10G, CV10G-1310100, CV10G-2, CV10G2-1310140, CV10GB-1311100, CV10G-S, CV10GS-1310150, CV10G-S2, CV10GS2-1310190, CV20E, CV20E-1320200, CV20E-2, CV20E2-1320240, CV20EB-1321200, CV20E-S, CV20ES-1320250, CV20E-S2, CV20ES2-1320290, CV20G, CV20G-1310200, CV20G-2, CV20G2-1310240, CV20GB-1311200, CV20G-S, CV20GS-1310250, CV20G-S2, CV20GS2-1310290, CV21E, CV21E-1322100, CV21E-2, CV21E2-1322140, CV21E-S, CV21ES-1322150, CV21E-S2, CV21ES2-1322190, CV21G, CV21G-1312100, CV21G-2, CV21G2-1312140...(Other models you can see in the webshop)		





1

GEV No.	550849	Ref. No.	3102400 BN3102400
description	gasket for fan motor ID ø 24mm ED ø 36mm thickness 4.5mm		
For models:	CMV6ES2-1320392, CV10E, CV10E-1320100, CV10E-1320110, CV10E-2, CV10E2-1320140, CV10EB-1321100, CV10E-S, CV10ES-1320150, CV10E-S2, CV10ES2-1320190, CV10G, CV10G-1310100, CV10G-2, CV10G2-1310140, CV10GB-1311100, CV10G-S, CV10GS-1310150, CV10G-S2, CV10GS2-1310190, CV20E, CV20E-1320200, CV20E-2, CV20E2-1320240, CV20EB-1321200, CV20E-S, CV20ES-1320250, CV20E-S2, CV20ES2-1320290, CV20G, CV20G-1310200, CV20G-2, CV20G2-1310240, CV20GB-1311200, CV20G-S, CV20GS-1310250, CV20G-S2, CV20GS2-1310290, CV21E, CV21E-1322100, CV21E-2, CV21E2-1322140, CV21E-S, CV21ES-1322150, CV21E-S2, CV21ES2-1322190, CV21G, CV21G-1312100, CV21G-2, CV21G2-1312140...(Other models you can see in the webshop)		

 <p>1</p>			
GEV No.	560449	Ref. No.	3102250 BN3102250 R58004000
description	hexagonal screw thread M12x1.5 L thread L 22mm bore ϕ 6.3mm WS 19 total length 30mm		
For models:	CCE101M, CCE102M, CCG101M, CCG102M, CKEP10, CKEP10B, CKEP20, CKEP20B, CKEP21, CKEP21B, CKEP40, CKEP40B, CKET10, CKET10B, CKET20, CKET20B, CKET21, CKET21B, CKET40, CKET40B, CKGP10, CKGP10B, CKGP20, CKGP20B, CKGP21, CKGP21B, CKGP40, CKGP40B, CKGT10B, CKGT20, CKGT20B, CKGT21, CKGT21B, CKGT40, CKGT40B		

 <p>1</p>			
GEV No.	550861	Ref. No.	R70020020
description	shaft seal for fan motor ID ϕ 7.5mm ED ϕ 22mm thickness 7mm		
For models:	CCE042M, CCE051M, CCG051M		

 <p>1</p>			
GEV No.	511171	Ref. No.	R70020040
description	shaft seal ID ϕ 14.5mm ED ϕ 20mm thickness 3mm		
For models:	CCE071M, CCG071M, CKEP06, CKEP06B, CKEP10, CKEP10B, CKEP21, CKEP21B, CKET06, CKET06B, CKET10, CKET10B, CKET21, CKET21B, CKGP06, CKGP06B, CKGT06, CKGT06B		

 <p>1</p>			
GEV No.	511172	Ref. No.	R70020050
description	shaft sealing ID ϕ 24mm ED ϕ 29mm thickness 3mm		
For models:	CCE101M, CCE102M, CCG101M, CCG102M, CKEP20, CKEP20B, CKEP40, CKEP40B, CKET20, CKET20B, CKET40, CKET40B, CKGP10, CKGP10B, CKGP20, CKGP20B, CKGP21, CKGP21B, CKGP40, CKGP40B, CKGT10B, CKGT20, CKGT20B, CKGT21, CKGT21B, CKGT40, CKGT40B		

hot air fans

miscellaneous



1

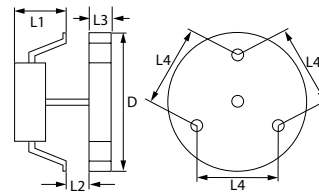

GEV No.	601054	Ref. No.	1037117200
description	hot air fan 220-240V 32W 50/60Hz L1 60mm L2 10mm L3 25mm L4 87mm fan wheel ϕ 150mm FIME type C20X0E01/46		
For models:	CFE60, CFE60P, OCFE60, OCFE-60-12601005, OCFE-60-12601005MN, OCFGE61		
accessories for	601054		
	GEV No.	550879	Ref. No. —
	 insulation ϕ 130mm thickness 3mm hole ϕ 20mm for hot air fan		

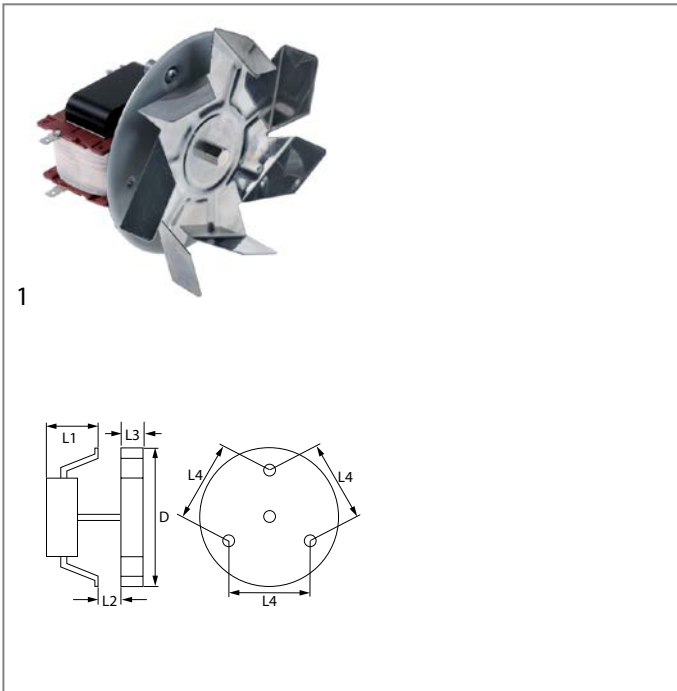

GEV No.	601125	Ref. No.	6A036410 BN6A036410
description	hot air fan 220-240V 45W 50/60Hz L1 70mm L2 11mm L3 25mm L4 87mm fan wheel ø 150mm FIME type C30R0479CLF		
For models:	61FE-1826050, 61SCGFE3S-1826055, 61SCGFE4S-1827055, 61SECFE-1826075, 941CEAC-1292164, 941FTE1-2RAC-1292562, 941FTE1-2RAC-1292662, 941FTEAC-1292462, 941FTEACC-1292464, 941FTEACC1-2R-1292465, 941FTEAC-1292562, 94CBEAC-1192362, 94CBGAC-1191362, 94CGAC-1191164, 94CTGAC-1191760, 98CGAC-1191168, TAC100-1022005, TAC101-1022006, TAC102-1022007, TAC130-1022105, TAC131-1022106, TAC132-1022107, TAC170-1022205, TAC171-1022206, TAC172-1022207, TAC210-1019505, TAC211-1019506, TAC212-1019507, TAC6100-1622005, TAC6130-1622105, TAC6131-1622106, TAC6170-1622205		
accessories for	601125		
		GEV No.	550879
		Ref. No.	—
	insulation ø 130mm thickness 3mm hole ø 20mm for hot air fan		

GEV No.	602149	Ref. No.	3000300
description	fan motor 230/400V 0.55W type N552		
For models:	OLAX151, OLAX151EDX-1080725, OLAX151LEFT-1080727, OLAX151-highspeed, OLAX160, OLAX160E-1080750, OLAX160E-1080751, OLAX160V-1080755, OLAX160V-1080756, OLAX160V-1081031, OLAX160V-1081032, OLAX210, OLAX210E-1081029, OLAX210E-1081030, OLAX220, OLAX220E-1080787, OLAX220E-1080788, OLAX220V-1080789, OLAX220V-1080790, OLAX230, OLAX230E-1080791, OLAX230E-1080792, OLAX230V-1080793, OLAX230V-1080794, OLAX240, OLAX240E-1080795, OLAX240E-1080796, OLAX240V-1080797, OLAX240V-1080798, OLAX250, OLAX250E-1080760, OLAX250E-1080761, OLAX250V-1080765, OLAX250V-1080766, OLAX300, OLAX300E-1080770, OLAX300E-1080771, OLAX300E-1081033, OLAX300E-1081035, OLAX300E-1081036, OLAX300LC, OLAX300LCE-1081034, OLAX300V-1080775, OLAX300V-1080776, OLAX310, OLAX310E-1081110, OLAX310E-1081111, OLAX310LC, OLAX310LCE-1081114, OLAX310LCE-1081115...(Other models you can see in the webshop)		

accessories

fan wheels for hot air fans

GEV No.	601630	Ref. No.	1034400200
description	fan wheel ø 150mm W 25mm shaft intake ø 6x5mm chrome-plated blades 7		
For models:	CFE60, CFE60P, OCFE60, OCFE-60-12601005, OCFE-60-12601005MN, OCFGE61		

miscellaneous

GEV No.	551434	Ref. No.	R58004010
description	plain washer ø 30mm thickness 3mm hole ø 12.5mm for fan wheel combi-steamer		
For models:	CCE101M, CCE102M, CCG101M, CCG102M, CKEP10, CKEP10B, CKEP20, CKEP20B, CKEP21, CKEP21B, CKEP40, CKEP40B, CKET10, CKET10B, CKET20, CKET20B, CKET21, CKET21B, CKET40, CKET40B, CKGP10, CKGP10B, CKGP20, CKGP20B, CKGP21, CKGP21B, CKGP40, CKGP40B, CKGT10B, CKGT20, CKGT20B, CKGT21, CKGT21B, CKGT40, CKGT40B		

radial fans

GEV No.	601181	Ref. No.	R65060360
description	radial fan 230V voltage AC 50Hz 100W H1 170mm L1 175mm D1 ø 50mm W1 115mm W2 40mm H2 45mm		
For models:	CCG051M, CCG071M, CCG101M, CCG102M, CKGP06, CKGP06B, CKGP10, CKGP10B, CKGP20, CKGP20B, CKGP21, CKGP21B, CKGP40, CKGP40B, CKGT06, CKGT06B, CKGT10, CKGT10B, CKGT20, CKGT20B, CKGT21, CKGT21B, CKGT40, CKGT40B		

motors

gear motors

for combi-steamers



GEV No.	502288	Ref. No.	R65090250
description	gear kit 8W 230V voltage AC 30rpm shaft ø 6mm L 75mm W 87mm H 84mm conversion kit		
For models:	CKEP06, CKEP06B, CKEP10, CKEP10B, CKEP20, CKEP20B, CKEP21, CKEP21B, CKEP40, CKEP40B, CKET06, CKET06B, CKET10, CKET10B, CKET20, CKET20B, CKET21, CKET21B, CKET40, CKET40B, CKGP06, CKGP06B, CKGP10, CKGP10B, CKGP20, CKGP20B, CKGP21, CKGP21B, CKGP40, CKGP40B, CKGT06, CKGT06B, CKGT10, CKGT10B, CKGT20, CKGT20B, CKGT21, CKGT21B, CKGT40, CKGT40B		
spare parts for	502288		
	GEV No.	502291	Ref. No. —
	gear motor METEOR type 58U59DB4A1/00 8W 230V voltage AC 50Hz 30rpm shaft ø 6x5mm L 69mm W 49mm H 65mm		

for dishwashers



GEV No.	501405	Ref. No.	3000120
description	motor without gearbox 180/220W 230/400-280/480V 50/60Hz 3 phase 1.2/0.7-1.15/0.67A shaft ø 11mm shaft length 26mm flange ø 89mm 1340/1608rpm type MS63B-4 ø 119mm H 163mm L 215mm E.M.C. for drying 0.18/0.22kW		
For models:	OLAX160, OLAX160E-1080750, OLAX160E-1080751, OLAX160V-1080755, OLAX160V-1080756, OLAX160V-1081031, OLAX160V-1081032, OLAX210, OLAX210E-1081029, OLAX210E-1081030, OLAX220, OLAX220E-1080787, OLAX220E-1080788, OLAX220V-1080789, OLAX220V-1080790, OLAX230, OLAX230E-1080791, OLAX230E-1080792, OLAX230V-1080793, OLAX230V-1080794, OLAX240, OLAX240E-1080795, OLAX240E-1080796, OLAX240V-1080797, OLAX240V-1080798, OLAX250, OLAX250E-1080760, OLAX250E-1080761, OLAX250V-1080765, OLAX250V-1080766, OLAX300, OLAX300E-1080770, OLAX300E-1080771, OLAX300E-1081033, OLAX300E-1081035, OLAX300E-1081036, OLAX300LC, OLAX300LCE-1081034, OLAX300V-1080775, OLAX300V-1080776, OLAX310, OLAX310E-1081110, OLAX310E-1081111, OLAX310LC, OLAX310LCE-1081114, OLAX310LCE-1081115, OLAX310LCV-1081116, OLAX310LCV-1081117, OLAX310V-1081112, OLAX310V-1081113...(Other models you can see in the webshop)		

motors

for dishwashers



GEV No.	501477	Ref. No.	3000110
description	motor 260W 400V 50Hz 0.8A shaft ø 14mm shaft length 40mm flange ø 156mm 900rpm ø 140mm H 215mm OLYMPIA 0.26kW		
For models:	OLAX151-highspeed, OLAX160V-1081031, OLAX160V-1081032, OLAX210, OLAX210E-1081029, OLAX210E-1081030, OLAX220, OLAX220E-1080787, OLAX220E-1080788, OLAX220V-1080789, OLAX220V-1080790, OLAX230, OLAX230E-1080791, OLAX230E-1080792, OLAX230V-1080793, OLAX230V-1080794, OLAX240, OLAX240E-1080795, OLAX240E-1080796, OLAX240V-1080797, OLAX240V-1080798, OLAX250, OLAX250E-1080760, OLAX250E-1080761, OLAX250V-1080765, OLAX250V-1080766, OLAX300, OLAX300E-1080770, OLAX300E-1080771, OLAX300E-1081033, OLAX300E-1081035, OLAX300E-1081036, OLAX300LC, OLAX300LCE-1081034, OLAX300V-1080775, OLAX300V-1080776, OLAX310, OLAX310E-1081110, OLAX310E-1081111, OLAX310LC, OLAX310LCE-1081114, OLAX310LCE-1081115, OLAX310LCV-1081116, OLAX310LCV-1081117, OLAX310V-1081112, OLAX310V-1081113, OLAX320, OLAX320E-1081118, OLAX320E-1081119, OLAX320V-1081120...(Other models you can see in the webshop)		



GEV No.	501405	Ref. No.	3000120
description	motor without gearbox 180/220W 230/400-280/480V 50/60Hz 3 phase 1.2/0.7-1.15/0.67A shaft ø 11mm shaft length 26mm flange ø 89mm 1340/1608rpm type MS63B-4 ø 119mm H 163mm L 215mm E.M.C. for drying 0.18/0.22kW		
For models:	OLAX160, OLAX160E-1080750, OLAX160E-1080751, OLAX160V-1080755, OLAX160V-1080756, OLAX160V-1081031, OLAX160V-1081032, OLAX210, OLAX210E-1081029, OLAX210E-1081030, OLAX220, OLAX220E-1080787, OLAX220E-1080788, OLAX220V-1080789, OLAX220V-1080790, OLAX230, OLAX230E-1080791, OLAX230E-1080792, OLAX230V-1080793, OLAX230V-1080794, OLAX240, OLAX240E-1080795, OLAX240E-1080796, OLAX240V-1080797, OLAX240V-1080798, OLAX250, OLAX250E-1080760, OLAX250E-1080761, OLAX250V-1080765, OLAX250V-1080766, OLAX300, OLAX300E-1080770, OLAX300E-1080771, OLAX300E-1081033, OLAX300E-1081035, OLAX300E-1081036, OLAX300LC, OLAX300LCE-1081034, OLAX300V-1080775, OLAX300V-1080776, OLAX310, OLAX310E-1081110, OLAX310E-1081111, OLAX310LC, OLAX310LCE-1081114, OLAX310LCE-1081115, OLAX310LCV-1081116, OLAX310LCV-1081117, OLAX310V-1081112, OLAX310V-1081113...(Other models you can see in the webshop)		



universal



1

GEV No.	601463	Ref. No.	2510631 BN2510631
description	motor 90W 230V 50Hz 1 phase shaft \varnothing 9mm flange \varnothing 80mm 1300rpm type AMM56ZAA4 \varnothing 110mm H 150mm L 170mm Lafert 0.09kW		
For models:	725KBEM-000200, 725KBEM-1000210, 725KB-EM-1000210R, 725KB-EMB-1000211, 725KBEMB-1000211, 725KBGM-000120, 725KB-GM-1000120, 725KB-GM-1000120R, 725KB-GMB-1000121, 725KB-GMB-1000121R, 74-02KBEMB, 74-02KBEMB-12701120, 74-02KBEMBI, 74-02KBEMBI-12701125, 74-02KBEMBI-12701125HB, 74-02KBGMB, 74-02KBGMB-12700120, 74-02KBGMBI, 74-02KBGMBI-12700125, 94-04KBEM, 94-04KBEM-12901125, 94-04KBEM-12901125BN, 94-04KBEM-12901128, 94-04KBGM, 94-04KBGM-12900125, 94-04KBGM-12900125TA, 94-04KBGM-12900128, 94-04KBGM-12900128TA, 9BR-EM80, 9BR-G80, 9BR-G81, 9BR-GM80		

accessories

fan wheels



1

GEV No.	601749	Ref. No.	3000125
description	fan wheel \varnothing 174mm shaft intake \varnothing 11mm H 54.5mm		
For models:	OLAX160, OLAX160E-1080750, OLAX160E-1080751, OLAX160V-1080755, OLAX160V-1080756, OLAX160V-1081031, OLAX160V-1081032, OLAX210, OLAX210E-1081029, OLAX210E-1081030, OLAX220, OLAX220E-1080787, OLAX220E-1080788, OLAX220V-1080789, OLAX220V-1080790, OLAX230, OLAX230E-1080791, OLAX230E-1080792, OLAX230V-1080793, OLAX230V-1080794, OLAX240, OLAX240E-1080795, OLAX240E-1080796, OLAX240V-1080797, OLAX240V-1080798, OLAX250, OLAX250E-1080760, OLAX250E-1080761, OLAX250V-1080765, OLAX250V-1080766, OLAX300, OLAX300E-1080770, OLAX300E-1080771, OLAX300E-1081033, OLAX300E-1081035, OLAX300E-1081036, OLAX300LC, OLAX300LCE-1081034, OLAX300V-1080775, OLAX300V-1080776, OLAX310, OLAX310E-1081110, OLAX310E-1081111, OLAX310LC, OLAX310LCE-1081114, OLAX310LCE-1081115, OLAX310LCV-1081116, OLAX310LCV-1081117, OLAX310V-1081112, OLAX310V-1081113...(Other models you can see in the webshop)		

pumps

wash and rinse pumps

FIR

pumps







1

GEV No.	500532	Ref. No.	10300057/A
description	pump		
For models:	G12S, OLDW020H, OLLP1S5-1081087, OLLP-ZERO, OLLPZE-RO-1081057		







1

GEV No.	501446	Ref. No.	10508
description	pump inlet \varnothing 28mm outlet \varnothing 26mm type 4213E2250 220-240V 50Hz 1 phase 0.19kW 0.26HP L 190mm rotation direction left capacitor 5 μ F FIR		
For models:	OLHT12-1081075, OLHT12EL-1081080, OLHT12EL-1081083, OLHT12ELD-1081081, OLHT12ELPLUS-1081086, OLHT12S, OLHT12SElectronic, OLHT12S-Neutra		
spare parts for	501446		
	GEV No.	365017	Ref. No. 10702
	operating capacitor capacity 5 μ F 450V tolerance 5% 50/60Hz ambient temperature max. -25 to +85°C \varnothing 28mm L 54mm M8 plastic connection male faston 6.3mm 16.10.08 protection		
	GEV No.	510384	Ref. No. —
	pump cover inlet \varnothing 28mm outlet \varnothing 26mm \varnothing 100mm ID \varnothing 76mm		
	GEV No.	510695	Ref. No. 10505
	mechanical shaft seal height counter ring 5.5mm ID \varnothing 11mm		
	GEV No.	521203	Ref. No. —
	impellor \varnothing 72mm H 18mm thread M7 shaft \varnothing 11mm shaft length 32mm blades 3		
	GEV No.	521703	Ref. No. 10506
	pump cover gasket EPDM thickness 2.5mm ID \varnothing 75mm Qty 1 pcs		









1

GEV No.	500527	Ref. No.	15908/A
description	pump inlet ø 60mm outlet ø 50/30mm type 2233.B140 230V 50Hz 1 phase 0.55kW 0.75HP L 210mm rotation direction right capacitor 12.5µF FIR inlet ø 60mm		
For models:	OLDS50P-1081018, OLDS50PD-1081019, OLElectron500, OLGastro500Plus, OLGastro500S, OLGastro750Plus, OLGastro750S, OLG550, OLG550-1080705, OLG550D-1080706, OLG550E-1080730, OLG550ECO-1081014, OLG550ECOD-1081015, OLG550ED-1080731, OLG550-Neutra		
spare parts for	500527		
	GEV No.	365014	Ref. No. —
	operating capacitor capacity 12.5µF 450V tolerance 5%Hz ambient temperature max. -25 to +85°C ø 35mm L 70mm M8 plastic connection male faston 6.3mm 45S.C3DS.12.5 protection		
	GEV No.	510552	Ref. No. 15079/D
	pump cover gasket pump type 1292-2/3942/3981/3911/3983		
	GEV No.	510608	Ref. No. 15079/B
	impellor ø 93mm H 32mm shaft intake ø 9/8mm blades 6 inner height 11mm		
	GEV No.	510692	Ref. No. —
	mechanical shaft seal for shaft ø 11mm slide ringext. ø 24mm slide ring H 13mm counter ring mounting ø 26mm height counter ring 8mm counter ring int. ø 14mm		
	GEV No.	521511	Ref. No. 15031/E
	pump cover inlet ø 60mm outlet ø 50/30mm supporting pressure M12x1.75 supporting pressure open pump type 2233 turn direction right ø 160mm ID ø 120mm inner height 23mm		



1





GEV No.	500528	Ref. No.	15908/D
description	pump inlet ø 60mm outlet ø 50mm type 4233.1500 230V 50Hz 1 phase 0.74kW 1HP L 220mm rotation direction right capacitor 16µF FIR		
For models:	OLElectron500, OLG600, OLGastro750Plus, OLGastro750S, OLG550, OLG550-1080705, OLG550D-1080706, OLG550E-1080730, OLG550ECO-1081014, OLG550ECOD-1081015, OLG550ED-1080731, OLG550-Neutra		
spare parts for	500528		
	GEV No.	365021	Ref. No. —
	operating capacitor capacity 16µF 425V tolerance 5% 50/60Hz ambient temperature max. -25 to +85°C ø 35mm L 73mm single M8 plastic connection male faston 6.3mm 416.10.99 protection		
	GEV No.	510552	Ref. No. 15079/D
	pump cover gasket pump type 1292-2/3942/3981/3911/3983		
	GEV No.	510693	Ref. No. 15080 15080/E
	mechanical shaft seal for shaft ø 12mm slide ringext. ø 24mm slide ring H 15.5mm slide ring int. ø 11mm counter ring mounting ø 24mm height counter ring 8mm counter ring int. ø 13.5mm		
	GEV No.	517319	Ref. No. —
	hose connector T1: M12x1.75 hose ø 11mm brass		
	GEV No.	521177	Ref. No. 15912
	impellor ø 93mm H 23mm thread M10L suitable for FIR		
	GEV No.	521511	Ref. No. 15031/E
	pump cover inlet ø 60mm outlet ø 50/30mm supporting pressure M12x1.75 supporting pressure open pump type 2233 turn direction right ø 160mm ID ø 120mm inner height 23mm		



1			
GEV No.	499139	Ref. No.	80912
description	pump inlet ø 62mm outlet ø 62mm type 2275.2722 230/400V 50Hz 3 phase 2.6kW L 400mm rotation direction right FIR		
For models:	OLLP1-1081059, OLLP4-1081258, OLLP4-800-1081058, OLLP4-800Electronic-Neutra, OLLP-4PLUS		
spare parts for	499139		
	GEV No.	510687	Ref. No. 80912/B
	mechanical shaft seal for shaft ø 18mm height counter ring 8mm ID ø 17mm ED ø 39mm H 15mm mounting ø 42mm int. ø 1 21mm		
	GEV No.	521026	Ref. No. 80912/D
	pump cover gasket ID ø 182.5mm thickness 5x4.5mm		
	GEV No.	521028	Ref. No. 80912/C
	pump cover FIR inlet ø 62mm outlet ø 62mm turn direction right ø 215mm ID ø 175mm inner hight 40mm		
	GEV No.	521277	Ref. No. 80912/A
	impellor ø 135mm H 39mm pump type Fir 2275 - 3.6HP thread M14L		
	GEV No.	524676	Ref. No. —
	fan wheel ø 160mm shaft intake ø 24mm plastic blades 12 W 30mm		



1			
GEV No.	500155	Ref. No.	10300058
description	pump inlet ø 63mm outlet ø 47mm type 1225 230V 50Hz 1 phase 1.1kW 1.5HP L 335mm rotation direction right capacitor 31.5µF FIR		
For models:	OLHT-11-Neutra		
spare parts for	500155		
	GEV No.	365016	Ref. No. —
	operating capacitor capacity 31.5µF 400V tolerance 5%Hz ambient temperature max. -25 to +85°C ø 45mm L 95mm M8 plastic connection male faston 6.3mm protection		

spare parts for	500155		
	GEV No.	510602	Ref. No. —
	impellor ø 110mm H 34mm rotation direction right thread M8L shaft ø 28mm seat ø 12.2mm blades 6		
	GEV No.	510693	Ref. No. 15080 15080/E
	mechanical shaft seal for shaft ø 12mm slide ring ext. ø 24mm slide ring H 15.5mm slide ring int. ø 11mm counter ring mounting ø 24mm height counter ring 8mm counter ring int. ø 13.5mm		
	GEV No.	521513	Ref. No. 10200222
	pump cover FIR inlet ø 63mm outlet ø 47mm turn direction right ID ø 150mm inner hight 32mm		
	GEV No.	524416	Ref. No. 10200290
	pump cover gasket thickness 4x4mm Qty 1 pcs		



1			
GEV No.	499297	Ref. No.	88106
description	pump inlet ø 63mm outlet ø 53mm type 1205.2820 230/400V 50Hz 3 phase 2.7HP L 330mm rotation direction left FIR		
For models:	OLAX160V-1081031, OLAX160V-1081032, OLAX210, OLAX210E-1081029, OLAX210E-1081030, OLAX220, OLAX220E-1080787, OLAX220E-1080788, OLAX220V-1080789, OLAX220V-1080790, OLAX230, OLAX230E-1080791, OLAX230E-1080792, OLAX230V-1080793, OLAX230V-1080794, OLAX240, OLAX240E-1080795, OLAX240E-1080796, OLAX240V-1080797, OLAX240V-1080798, OLAX250, OLAX250E-1080760, OLAX250E-1080761, OLAX250V-1080765, OLAX250V-1080766, OLAX300, OLAX300E-1080770, OLAX300E-1080771, OLAX300E-1081033, OLAX300E-1081035, OLAX300E-1081036, OLAX300LC, OLAX300LCE-1081034, OLAX300V-1080775, OLAX300V-1080776, OLAX310, OLAX310E-1081110, OLAX310E-1081111, OLAX310LC, OLAX310LCE-1081114, OLAX310LCE-1081115, OLAX310LCV-1081116, OLAX310LCV-1081117, OLAX310V-1081112, OLAX310V-1081113, OLAX320, OLAX320E-1081118, OLAX320E-1081119, OLAX320V-1081120, OLAX320V-1081121... (Other models you can see in the webshop)		





spare parts for	499297		
	GEV No.	510357	Ref. No. 88222
	impellor ø 124mm H 34/16mm thread M8R blades 6		
	GEV No.	510523	Ref. No. —
	fan wheel ø 142mm shaft intake ø 15mm blades 12		
	GEV No.	510531	Ref. No. —
	pump cover FIR inlet ø 63mm outlet ø 53mm auxiliary pressure connection M16x1.5mm supporting pressure open turn direction left ø 185mm ID ø 150mm inner hight 37mm		
	GEV No.	510693	Ref. No. 15080 15080/E
	mechanical shaft seal for shaft ø 12mm slide ring ext. ø 24mm slide ring H 15.5mm slide ring int. ø 11mm counter ring mounting ø 24mm height counter ring 8mm counter ring int. ø 13.5mm		

Table continues overleaf

spare parts for 499297			
	GEV No.	524416	Ref. No. 10200290
pump cover gasket thickness 4x4mm Qty 1 pcs			

LOWARA

pumps





1			
GEV No.	499255	Ref. No.	15100/L
description	pump inlet \varnothing 1 1/4" IT outlet \varnothing 1" IT type CEAM/70/3/A 220-240V 50Hz 1 phase 0.6kW L 310mm rotation direction left capacitor 14 μ F LOWARA		
For models:	OLLP1-1081059, OLLP4-800-1081058, OLLP4-800Electronic-Neutra		

OLYMPIA

pumps



1			
GEV No.	500521	Ref. No.	135501
description	pump inlet \varnothing 1" IT outlet \varnothing 26mm type T33 230V 50Hz 1 phase 0.25kW 0.34HP L 225mm rotation direction right capacitor 5 μ F auxiliary pressure connection 11mm supporting pressure closed OLYMPIA		
For models:	OLGS40, OLGS40, OLGS40-1080701, OLGS40D-1080708, OLGS40D-1081003, OLGS40-Neutra, OLGS40LSD-1081004		
spare parts for 500521			
	GEV No.	365017	Ref. No. 10702
operating capacitor capacity 5 μ F 450V tolerance 5% 50/60Hz ambient temperature max. -25 to +85°C \varnothing 28mm L 54mm M8 plastic connection male faston 6.3mm 16.10.08 protection			
	GEV No.	510693	Ref. No. 15080 15080/E
mechanical shaft seal for shaft \varnothing 12mm slide ring ext. \varnothing 24mm slide ring H 15.5mm slide ring int. \varnothing 11mm counter ring mounting \varnothing 24mm height counter ring 8mm counter ring int. \varnothing 13.5mm			
	GEV No.	521256	Ref. No. 135505
impellor \varnothing 74mm H 14mm thread M10L shaft \varnothing 12mm shaft length 7.5mm blades 8			

spare parts for 500521			
	GEV No.	521554	Ref. No. 135503
pump cover OLYMPIA inlet 1" \varnothing 90mm ID \varnothing 66mm inner height 5mm			
	GEV No.	521724	Ref. No. 135506
O-ring EPDM thickness 1.78mm ID \varnothing 72.75mm Qty 1 pcs			
	GEV No.	528800	Ref. No. 135502
O-ring EPDM thickness 2.62mm ID \varnothing 75.87mm Qty 1 pcs			







1			
GEV No.	499257	Ref. No.	401402
description	pump inlet \varnothing 1" IT outlet \varnothing 30mm type L63.T45F_2V 230V 50Hz 1 phase 0.33kW L 230mm rotation direction left capacitor 8 μ F OLYMPIA		
For models:	OLDS40, OLDS40-1081065, OLDS40D-1081066, OLDS40E-1081067, OLDS40ED-1081068, OLDS40-Neutra		
spare parts for 499257			
	GEV No.	365013	Ref. No. —
operating capacitor capacity 8 μ F 400V tolerance 5%Hz ambient temperature max. -25 to +85°C \varnothing 31.5mm L 55mm M8 plastic connection male faston 6.3mm protection			
	GEV No.	509007	Ref. No. —
impellor \varnothing 85mm H 20mm rotation direction left thread M10R shaft \varnothing 12mm shaft length 7.5mm blades 12			
	GEV No.	510693	Ref. No. 15080 15080/E
mechanical shaft seal for shaft \varnothing 12mm slide ring ext. \varnothing 24mm slide ring H 15.5mm slide ring int. \varnothing 11mm counter ring mounting \varnothing 24mm height counter ring 8mm counter ring int. \varnothing 13.5mm			
	GEV No.	521167	Ref. No. —
pump cover OLYMPIA inlet \varnothing 1"mm outlet \varnothing 30/30mm ID \varnothing 94mm			
	GEV No.	521723	Ref. No. 18245
pump cover gasket EPDM thickness 2mm ID \varnothing 90mm Qty 1 pcs			

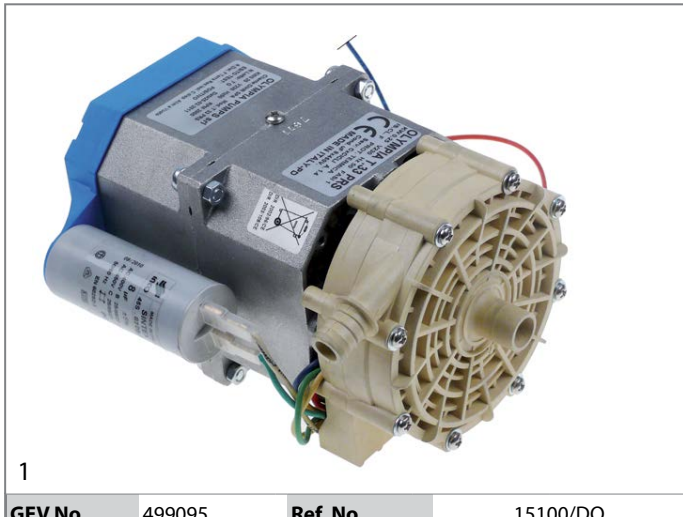

1			
GEV No.	499131	Ref. No.	351400
description	pump inlet ø 1" IT outlet ø 30mm type T.19DX 230V 50Hz 1 phase 0.19kW L 195mm rotation direction left capacitor 5µF OLYMPIA outlet ø 30mm		
For models:	OLDS35, OLDS35-1081061, OLDS35D-1081062, OLDS35-Neutra, OLDS37, OLDS37-1081063, OLDS37D-1081064, OLDS37-Neutra		
spare parts for	499131		
	GEV No.	365017	Ref. No. 10702
	operating capacitor capacity 5µF 450V tolerance 5% 50/60Hz ambient temperature max. -25 to +85°C ø 28mm L 54mm M8 plastic connection male faston 6.3mm 16.10.08 protection		
	GEV No.	510693	Ref. No. 15080 15080/E
	mechanical shaft seal for shaft ø 12mm slide ring ext. ø 24mm slide ring H 15.5mm slide ring int. ø 11mm counter ring mounting ø 24mm height counter ring 8mm counter ring int. ø 13.5mm		
	GEV No.	521168	Ref. No. 371402/A
	pump cover OLYMPIA inlet ø 1"mm outlet ø 30mm pump type T.19DX		
	GEV No.	521169	Ref. No. —
	impellor ø 64mm H 15mm pump type T.19DX thread M7R shaft ø 12mm shaft length 30mm		
	GEV No.	521723	Ref. No. 18245
	pump cover gasket EPDM thickness 2mm ID ø 90mm Qty 1 pcs		



1			
GEV No.	499095	Ref. No.	15100/DO
description	pump inlet ø 15mm outlet ø 14mm type T.33PRS 230V 50Hz 1 phase 0.25kW L 185mm rotation direction right capacitor 8µF OLYMPIA		
For models:	OLDW020H, OLElectron1000, OLELELECTRON1000-1081084, OLELELECTRON1000D-1081085, OLEH600, OLEH600Electronic, OLHT11-1081071, OLHT11D-1081072, OLHT11ECO-1081070, OLHT11S, OLHT12-1081075, OLHT12EL-1081080, OLHT12EL-1081083, OLHT12ELD-1081081, OLHT12ELPLUS-1081086, OLHT12S, OLHT12SElectronic, OLLP1-800, OLLP1-800-1080721, OLLP1-800EL, OLLP1S5-1081087, OLLP1-S8, OLLP1-S8EL		
spare parts for	499095		
	GEV No.	365013	Ref. No. —
	operating capacitor capacity 8µF 400V tolerance 5%Hz ambient temperature max. -25 to +85°C ø 31.5mm L 55mm M8 plastic connection male faston 6.3mm protection		
	GEV No.	510693	Ref. No. 15080 15080/E
	mechanical shaft seal for shaft ø 12mm slide ring ext. ø 24mm slide ring H 15.5mm slide ring int. ø 11mm counter ring mounting ø 24mm height counter ring 8mm counter ring int. ø 13.5mm		
	GEV No.	521165	Ref. No. —
	pump cover OLYMPIA inlet ø 15mm outlet ø 13mm pump type R63. T33 PRS		
	GEV No.	521166	Ref. No. 15100/U
	impellor ø 90mm H 9mm pump type R63.T33 PRS thread M10R shaft ø 12mm shaft length 8mm		







1

GEV No.	499318	Ref. No.	10501/A
description	pump inlet ø 28mm outlet ø 28mm type L63.T19 230V 50Hz 1 phase 0.19kW L 185mm rotation direction right capacitor 5µF OLYMPIA inlet ø 28mm outlet ø 28mm		
For models:	OLDerby, OLDS35-1081005, OLDW020H, OLElectron1000, OLELELECTRON1000-1081084, OLELELECTRON1000D-1081085, OLG35, OLG35-1080702, OLG35D-1081000, OLG35-Neutra, OLG37, OLG37-1080700, OLG37D-1080707, OLG37LS-1081001, OLG37LSD-1081002, OLG37-Neutra, OLH600, OLH600Electronic, OLHT-11-Neutra, OLHT12-1081075, OLHT12EL-1081080, OLHT12EL-1081083, OLHT12ELD-1081081, OLHT12ELPLUS-1081086, OLHT12S, OLHT12SElectronic, OLHT12S-Neutra, OLLP1-800, OLLP1-800-1080721, OLLP1-800EL, OLLP1-800-Neutra, OLLP155-1081087, OLLP2-1080722, OLLP2-1080742, OLLP2Electronic-Neutra, OLLP2PLUS, OLLP3-1080723, OLLP3-1080743, OLLP3Electronic-Neutra, OLLP3PLUS, OLLP-ZERO, OLLPZERO-1081057		
spare parts for	499318		
	GEV No.	365017	Ref. No. 10702
	operating capacitor capacity 5µF 450V tolerance 5% 50/60Hz ambient temperature max. -25 to +85°C ø 28mm L 54mm M8 plastic connection male faston 6.3mm 16.10.08 protection		
	GEV No.	510693	Ref. No. 15080 15080/E
	mechanical shaft seal for shaft ø 12mm slide ring ext. ø 24mm slide ring H 15.5mm slide ring int. ø 11mm counter ring mounting ø 24mm height counter ring 8mm counter ring int. ø 13.5mm		
	GEV No.	521163	Ref. No. —
	pump cover OLYMPIA inlet ø 28mm outlet ø 26mm pump type L63.T19		
	GEV No.	521164	Ref. No. —
	impellor ø 64mm H 15mm pump type L63.T19 thread M7L shaft ø 12mm shaft length 30mm		
	GEV No.	521724	Ref. No. 135506
	O-ring EPDM thickness 1.78mm ID ø 72.75mm Qty 1 pcs		



1

GEV No.	500522	Ref. No.	16042
description	pump inlet ø 29mm outlet ø 27mm type T41 230V 50Hz 1 phase 0.29kW 0.4HP L 200mm rotation direction left capacitor 8µF OLYMPIA		
For models:	OLDS40-1081010, OLDS40D-1081011, OLDS40LS-1081012, OLDS40LSD-1081013, OLLinear		
spare parts for	500522		
	GEV No.	365013	Ref. No. —
	operating capacitor capacity 8µF 400V tolerance 5%Hz ambient temperature max. -25 to +85°C ø 31.5mm L 55mm M8 plastic connection male faston 6.3mm protection		
	GEV No.	510693	Ref. No. 15080 15080/E
	mechanical shaft seal for shaft ø 12mm slide ring ext. ø 24mm slide ring H 15.5mm slide ring int. ø 11mm counter ring mounting ø 24mm height counter ring 8mm counter ring int. ø 13.5mm		
	GEV No.	521259	Ref. No. 7135
	impellor ø 94mm H 11mm rotation direction left thread M10R blades 6		
	GEV No.	521555	Ref. No. 7133
	pump cover OLYMPIA inlet ø 29mm outlet ø 28mm ø 132mm ID ø 123mm inner height 18mm		
	GEV No.	521726	Ref. No. —
	pump cover gasket EPDM thickness 2mm ID ø 120mm Qty 1 pcs		

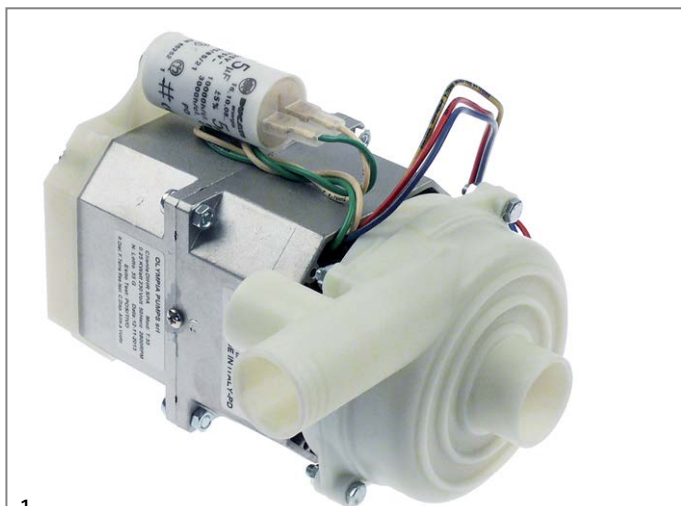





1

GEV No.	500520	Ref. No.	18242 18242/B
description	pump inlet ø 33mm outlet ø 30/28mm type T33 230V 50Hz 1 phase 0.25kW 0.34HP L 190mm rotation direction left capacitor 5µF OLYMPIA		
For models:	OLDS37-1081006, OLDS37D-1081007, OLDS37LS-1081008, OLDS37LSD-1081009, OLElectron400, OLG35-1080702, OLG537, OLG537-1080700, OLG537D-1080707, OLG537LS-1081001, OLG537LSD-1081002, OLG537-Neutra, OLG540, OLG540, OLG540-1080701, OLG540D-1080708, OLG540D-1081003, OLG540-Neutra, OLG540S0LSD-1081004, OLSar		
spare parts for	500520		
	GEV No.	Ref. No.	10702
	operating capacitor capacity 5µF 450V tolerance 5% 50/60Hz ambient temperature max. -25 to +85°C ø 28mm L 54mm M8 plastic connection male faston 6.3mm 16.10.08 protection		
	GEV No.	Ref. No.	15080 15080/E
	mechanical shaft seal for shaft ø 12mm slide ring ext. ø 24mm slide ring H 15.5mm slide ring int. ø 11mm counter ring mounting ø 24mm height counter ring 8mm counter ring int. ø 13.5mm		
	GEV No.	Ref. No.	—
	impellor ø 71mm H 19mm pump type OLYMPIA thread M10R shaft ø 12mm shaft length 8mm		
	GEV No.	Ref. No.	18247
	pump cover OLYMPIA inlet ø 33mm outlet ø 30mm outlet 2 ø 28 turn direction left ø 103mm ID ø 93mm inner height 30mm		



1

GEV No.	500958	Ref. No.	18300
description	pump inlet ø 33mm outlet ø 30/28mm type T45 230V 50Hz 1 phase 0.33kW 0.45HP L 215mm rotation direction left capacitor 8µF OLYMPIA		
For models:	OLGS40, OLG540, OLG540-1080701, OLG540D-1080708, OLG540D-1081003, OLG540-Neutra, OLG540S0LSD-1081004		
spare parts for	500958		
	GEV No.	Ref. No.	—
	operating capacitor capacity 8µF 400V tolerance 5%Hz ambient temperature max. -25 to +85°C ø 31.5mm L 55mm M8 plastic connection male faston 6.3mm protection		
	GEV No.	Ref. No.	15080 15080/E
	mechanical shaft seal for shaft ø 12mm slide ring ext. ø 24mm slide ring H 15.5mm slide ring int. ø 11mm counter ring mounting ø 24mm height counter ring 8mm counter ring int. ø 13.5mm		
	GEV No.	Ref. No.	18246
	impellor ø 80mm H 12mm rotation direction left thread M10R shaft ø 12mm shaft length 7.5mm blades 6		
	GEV No.	Ref. No.	18247
	pump cover OLYMPIA inlet ø 33mm outlet ø 30mm outlet 2 ø 28 turn direction left ø 103mm ID ø 93mm inner height 30mm		

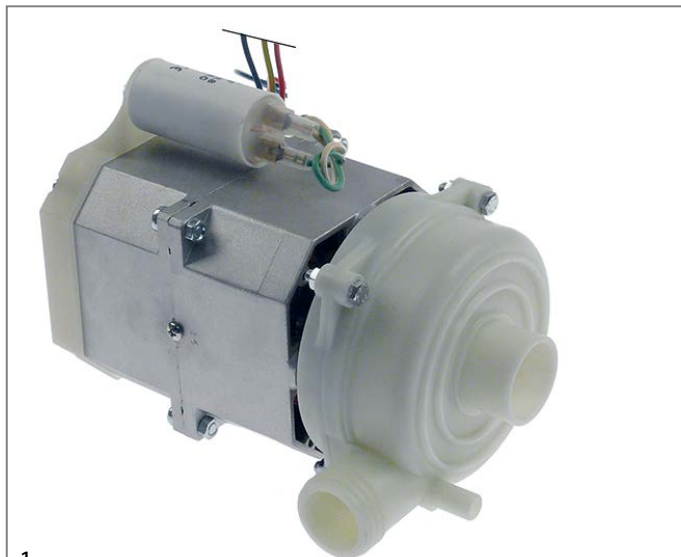



1





GEV No.	499320	Ref. No.	10501/C
description	pump inlet ø 33mm outlet ø 30mm type L63.T20SX 230V 50Hz 1 phase 0.2kW L 200mm rotation direction right capacitor 5µF auxiliary pressure connection 10mm supporting pressure closed OLYMPIA		
For models:	OLAX160V-1081031, OLAX160V-1081032, OLAX210, OLAX210E-1081029, OLAX210E-1081030, OLAX220, OLAX220E-1080787, OLAX220E-1080788, OLAX220V-1080789, OLAX220V-1080790, OLAX230, OLAX230E-1080791, OLAX230E-1080792, OLAX230V-1080793, OLAX230V-1080794, OLAX240, OLAX240E-1080795, OLAX240E-1080796, OLAX240V-1080797, OLAX240V-1080798, OLAX250, OLAX250E-1080760, OLAX250E-1080761, OLAX250V-1080765, OLAX250V-1080766, OLAX300, OLAX300E-1080770, OLAX300E-1080771, OLAX300E-1081033, OLAX300E-1081035, OLAX300E-1081036, OLAX300LC, OLAX300LCE-1081034, OLAX300V-1080775, OLAX300V-1080776, OLAX310, OLAX310E-1081110, OLAX310E-1081111, OLAX310LC, OLAX310LCE-1081114, OLAX310LCE-1081115, OLAX310LCV-1081116, OLAX310LCV-1081117, OLAX310V-1081112, OLAX310V-1081113, OLAX320, OLAX320E-1081118, OLAX320E-1081119, OLAX320V-1081120, OLAX320V-1081121... (Other models you can see in the webshop)		
spare parts for	499320		
	GEV No.	Ref. No.	10702
	operating capacitor capacity 5µF 450V tolerance 5% 50/60Hz ambient temperature max. -25 to +85°C ø 28mm L 54mm M8 plastic connection male faston 6.3mm 16.10.08 protection		
	GEV No.	Ref. No.	15080 15080/E
	mechanical shaft seal for shaft ø 12mm slide ring ext. ø 24mm slide ring H 15.5mm slide ring int. ø 11mm counter ring mounting ø 24mm height counter ring 8mm counter ring int. ø 13.5mm		
	GEV No.	Ref. No.	—
	pump cover OLYMPIA inlet ø 33mm outlet ø 30mm auxiliary pressure connection 10mm pump type L63.T20SX		
	GEV No.	Ref. No.	—
	impellor ø 60mm H 16mm pump type L63.T20SX shaft ø 12mm shaft length 8mm		

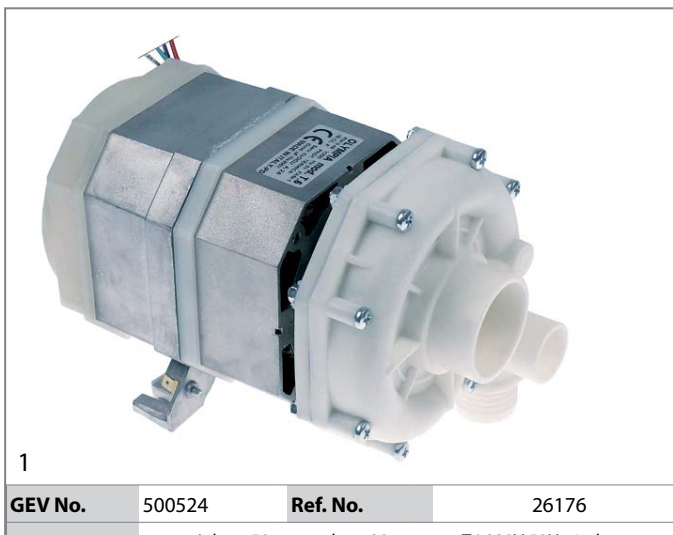

1

GEV No.	500519	Ref. No.	18243
description	pump inlet ø 33mm outlet ø 30mm type T33 230V 50Hz 1 phase 0.25kW 0.34HP L 195mm rotation direction left capacitor 5µF OLYMPIA		
For models:	OLDS37-1081006, OLDS37D-1081007, OLDS37LS-1081008, OLDS37LSD-1081009, OLElectron400, OLStar		
spare parts for	500519		
	GEV No.	Ref. No.	10702
	operating capacitor capacity 5µF 450V tolerance 5% 50/60Hz ambient temperature max. -25 to +85°C ø 28mm L 54mm M8 plastic connection male faston 6.3mm 16.10.08 protection		
	GEV No.	Ref. No.	15080 15080/E
	mechanical shaft seal for shaft ø 12mm slide ring ext. ø 24mm slide ring H 15.5mm slide ring int. ø 11mm counter ring mounting ø 24mm height counter ring 8mm counter ring int. ø 13.5mm		
	GEV No.	Ref. No.	18246
	impellor ø 80mm H 12mm rotation direction left thread M10R shaft ø 12mm shaft length 7.5mm blades 6		
	GEV No.	Ref. No.	18248
	pump cover OLYMPIA inlet ø 33mm outlet ø 30mm turn direction left ø 103mm ID ø 93mm inner height 25mm		
	GEV No.	Ref. No.	18245
	pump cover gasket EPDM thickness 2mm ID ø 90mm Qty 1 pcs		







GEV No.	500523	Ref. No.	16176
description	pump inlet \varnothing 50mm outlet \varnothing 30mm type T5 230V 50Hz 1 phase 0.35kW 0.48HP L 205mm rotation direction right capacitor 10 μ F auxiliary pressure connection 10mm supporting pressure open OLYMPIA		
For models:	OLDS40-1081010, OLDS40D-1081011, OLDS40LS-1081012, OLDS40LSD-1081013, OLLinear		
spare parts for	500523		
	GEV No.	365015	Ref. No. 18043 R65190180
	operating capacitor capacity 10 μ F 400V tolerance 5%Hz ambient temperature max. -25 to +85°C \varnothing 35.5mm L 59mm M8 plastic connection male faston 6.3mm protection		
	GEV No.	510554	Ref. No. 7130
	O-ring EPDM thickness 2mm ID \varnothing 120mm Qty 1 pcs		
	GEV No.	510693	Ref. No. 15080 15080/E
	mechanical shaft seal for shaft \varnothing 12mm slide ring ext. \varnothing 24mm slide ring H 15.5mm slide ring int. \varnothing 11mm counter ring mounting \varnothing 24mm height counter ring 8mm counter ring int. \varnothing 13.5mm		
	GEV No.	521260	Ref. No. 15079
	impellor \varnothing 90mm H 12mm M10L type B		
	GEV No.	521556	Ref. No. 16182
	pump cover OLYMPIA inlet \varnothing 50mm outlet \varnothing 30mm outlet 2 \varnothing 30 auxiliary pressure connection 10mm supporting pressure open turn direction right \varnothing 130mm ID \varnothing 124mm inner height 20mm		

GEV No.	500524	Ref. No.	26176
description	pump inlet \varnothing 50mm outlet \varnothing 30mm type T6 230V 50Hz 1 phase 0.48kW 0.65HP L 215mm rotation direction right capacitor 10 μ F OLYMPIA		
For models:	OLGastro450		
spare parts for	500524		
	GEV No.	365015	Ref. No. 18043 R65190180
	operating capacitor capacity 10 μ F 400V tolerance 5%Hz ambient temperature max. -25 to +85°C \varnothing 35.5mm L 59mm M8 plastic connection male faston 6.3mm protection		
	GEV No.	510554	Ref. No. 7130
	O-ring EPDM thickness 2mm ID \varnothing 120mm Qty 1 pcs		
	GEV No.	510693	Ref. No. 15080 15080/E
	mechanical shaft seal for shaft \varnothing 12mm slide ring ext. \varnothing 24mm slide ring H 15.5mm slide ring int. \varnothing 11mm counter ring mounting \varnothing 24mm height counter ring 8mm counter ring int. \varnothing 13.5mm		
	GEV No.	521262	Ref. No. 22009/A
	impellor \varnothing 102mm H 19mm rotation direction right thread M10L blades 6		
	GEV No.	521556	Ref. No. 16182
	pump cover OLYMPIA inlet \varnothing 50mm outlet \varnothing 30mm outlet 2 \varnothing 30 auxiliary pressure connection 10mm supporting pressure open turn direction right \varnothing 130mm ID \varnothing 124mm inner height 20mm		



1

GEV No.	500525	Ref. No.	150914
description	pump inlet ø 50mm outlet ø 30mm type T7 230V 50Hz 1 phase 0.52kW 0.71HP L 230mm rotation direction right capacitor 12.5µF OLYMPIA		
For models:	OLDS45, OLDS50, OLDS50-1081088, OLDS50D-1081089, OLDS50E-1081090, OLDS50ED-1081091, OLDS50-Neutra, OLG545, OLG550, OLG550-1080705, OLG550D-1080706, OLG550E-1080730, OLG550ECO-1081014, OLG550ECOD-1081015, OLG550ED-1080731, OLG550-Neutra		
spare parts for	500525		
	GEV No.	365014	Ref. No. —
	operating capacitor capacity 12.5µF 450V tolerance 5%Hz ambient temperature max. -25 to +85°C ø 35mm L 70mm M8 plastic connection male faston 6.3mm 45S.C3DS.12.5 protection		
	GEV No.	510554	Ref. No. 7130
	O-ring EPDM thickness 2mm ID ø 120mm Qty 1 pcs		
	GEV No.	510693	Ref. No. 15080 15080/E
	mechanical shaft seal for shaft ø 12mm slide ring ext. ø 24mm slide ring H 15.5mm slide ring int. ø 11mm counter ring mounting ø 24mm height counter ring 8mm counter ring int. ø 13.5mm		
	GEV No.	517368	Ref. No. 15079/F
	impellor ø 102mm H 21mm rotation direction right thread M10L suitable for Dühr blades 8		
	GEV No.	521556	Ref. No. 16182
	pump cover OLYMPIA inlet ø 50mm outlet ø 30mm outlet 2 ø 30 auxiliary pressure connection 10mm supporting pressure open turn direction right ø 130mm ID ø 124mm inner height 20mm		







1

GEV No.	499260	Ref. No.	22041
description	pump inlet ø 60mm outlet ø 48mm type A.4.5/2.6 220-240/380-415V 50Hz 3 phase 1.12kW 1.5HP L 310mm rotation direction right OLYMPIA		
For models:	OLHT11-1081071, OLHT11D-1081072, OLHT11ECO-1081070, OLHT-11-Neutra, OLHT11S, OLHT11S-Neutra		
spare parts for	499260		
	GEV No.	510693	Ref. No. 15080 15080/E
	mechanical shaft seal for shaft ø 12mm slide ring ext. ø 24mm slide ring H 15.5mm slide ring int. ø 11mm counter ring mounting ø 24mm height counter ring 8mm counter ring int. ø 13.5mm		
	GEV No.	521175	Ref. No. —
	pump cover OLYMPIA inlet ø 60mm outlet ø 48mm outlet 2 ø 31 auxiliary pressure connection 10mm		
	GEV No.	521262	Ref. No. 22009/A
	impellor ø 102mm H 19mm rotation direction right thread M10L blades 6		
	GEV No.	521727	Ref. No. 15080/A
	pump cover gasket EPDM thickness 1.78mm ID ø 145mm Qty 1 pcs		



1

GEV No.	500529	Ref. No.	15913
description	pump inlet ø 60mm outlet ø 48mm type T12 230V 50Hz 1 phase 0.88kW 1.2HP L 270mm rotation direction right capacitor 16µF auxiliary pressure connection 10mm supporting pressure open OLYMPIA		
For models:	OLGS85, OLGS85-1081016, OLGS85D-1081017, OLGS85-Neutra, OLHT11-1081071, OLHT11D-1081072, OLHT11ECO-1081070, OLHT11S		
spare parts for	500529		
	GEV No.	365021	Ref. No. —
	operating capacitor capacity 16µF 425V tolerance 5% 50/60Hz ambient temperature max. -25 to +85°C ø 35mm L 73mm single M8 plastic connection male faston 6.3mm 416.10.99 protection		
	GEV No.	510693	Ref. No. 15080 15080/E
	mechanical shaft seal for shaft ø 12mm slide ring ext. ø 24mm slide ring H 15.5mm slide ring int. ø 11mm counter ring mounting ø 24mm height counter ring 8mm counter ring int. ø 13.5mm		
	GEV No.	521010	Ref. No. —
	impellor ø 98mm H 12mm M10L blades 8		
	GEV No.	521559	Ref. No. 15078
	pump cover OLYMPIA inlet ø 60mm outlet ø 48mm outlet 2 ø 31 auxiliary pressure connection 10mm supporting pressure open turn direction right ø 170mm ID ø 150mm inner height 22mm		
	GEV No.	521727	Ref. No. 15080/A
	pump cover gasket EPDM thickness 1.78mm ID ø 145mm Qty 1 pcs		







1

GEV No.	500530	Ref. No.	22009
description	pump inlet ø 60mm outlet ø 48mm type T15 230V 50Hz 1 phase 1.1kW 1.5HP L 305mm rotation direction right OLYMPIA		
For models:	OLDW020H, OLElectron1000, OLELELECTRON1000-1081084, OLELELECTRON1000D-1081085, OLHT11-1081071, OLHT11D-1081072, OLHT11ECO-1081070, OLHT-11-Neutra, OLHT11S, OLHT11S-Neutra		
spare parts for	500530		
	GEV No.	365021	Ref. No. —
	operating capacitor capacity 16µF 425V tolerance 5% 50/60Hz ambient temperature max. -25 to +85°C ø 35mm L 73mm single M8 plastic connection male faston 6.3mm 416.10.99 protection		
	GEV No.	510693	Ref. No. 15080 15080/E
	mechanical shaft seal for shaft ø 12mm slide ring ext. ø 24mm slide ring H 15.5mm slide ring int. ø 11mm counter ring mounting ø 24mm height counter ring 8mm counter ring int. ø 13.5mm		
	GEV No.	521039	Ref. No. —
	fanwheel cover ID ø 156mm ED ø 161mm H 76mm for wash pump		
	GEV No.	521262	Ref. No. 22009/A
	impellor ø 102mm H 19mm rotation direction right thread M10L blades 6		
	GEV No.	521559	Ref. No. 15078
	pump cover OLYMPIA inlet ø 60mm outlet ø 48mm outlet 2 ø 31 auxiliary pressure connection 10mm supporting pressure open turn direction right ø 170mm ID ø 150mm inner height 22mm		
	GEV No.	521727	Ref. No. 15080/A
	pump cover gasket EPDM thickness 1.78mm ID ø 145mm Qty 1 pcs		





1

GEV No.	499259	Ref. No.	300082
description	pump inlet ø 62mm outlet ø 52mm type MEC.T120DX 220-240/380-415V 50Hz 3 phase 0.89kW 1.2HP L 310mm rotation direction left OLYMPIA		
For models:	OLAX300, OLAX300E-1080770, OLAX300E-1080771, OLAX300E-1081033, OLAX300E-1081035, OLAX300E-1081036, OLAX300LC, OLAX300LCE-1081034, OLAX300V-1080775, OLAX310, OLAX310E-1081110, OLAX310E-1081111, OLAX310LC, OLAX310LCE-1081114, OLAX310LCE-1081115, OLAX310LCV-1081116, OLAX310LCV-1081117, OLAX310V-1081112, OLAX310V-1081113, OLAX320, OLAX320E-1081118, OLAX320E-1081119, OLAX320V-1081120, OLAX320V-1081121, OLAX320V-1081125, OLAX330, OLAX330E-1081122, OLAX330E-1081123, OLAX330V-1081124, OLAX380, OLAX380E-1080780, OLAX380E-1080781, OLAX380E-1081037, OLAX380E-1081038, OLAX380E-1081039, OLAX380E-1081040, OLAX380E-1081043, OLAX380E-1081044, OLAX380E-1081046, OLAX380E-1081047, OLAX380E-1081048, OLAX380E-1081051, OLAX380E-1081052, OLAX380E-1081053, OLAX380E-1081054, OLAX380E-1081055, OLAX380E-1081056, OLAX380LC, OLAX380V-1080785, OLAX380V-1080786...(Other models you can see in the webshop)		
spare parts for	499259		
	GEV No.	510693	Ref. No. 15080 15080/E
	mechanical shaft seal for shaft ø 12mm slide ringext. ø 24mm slide ring H 15.5mm slide ring int. ø 11mm counter ring mounting ø 24mm height counter ring 8mm counter ring int. ø 13.5mm		
	GEV No.	521152	Ref. No. —
	pump cover OLYMPIA inlet 62 ø 190mm		
	GEV No.	521153	Ref. No. —
	pump casing OLYMPIA outlet ø 52mm		
	GEV No.	521154	Ref. No. —
	O-ring ID ø 152.7mm thickness 2.62mm EPDM Qty 1 pcs		
	GEV No.	521172	Ref. No. —
	impellor ø 107mm H 28mm pump type MEC.T120DX thread M8R		



1

GEV No.	499226	Ref. No.	22037
description	pump inlet ø 62mm outlet ø 52mm type MEC80.T200SX 230/400V 50Hz 3 phase 1.5kW 2HP L 340mm rotation direction right OLYMPIA		
For models:	OLAX151, OLAX160, OLAX160E-1080750, OLAX160E-1080751, OLAX160V-1080755, OLAX160V-1080756, OLAX160V-1081031, OLAX160V-1081032, OLAX210, OLAX210E-1081029, OLAX210E-1081030, OLAX220, OLAX220E-1080787, OLAX220E-1080788, OLAX220V-1080789, OLAX220V-1080790, OLAX230, OLAX230E-1080791, OLAX230E-1080792, OLAX230V-1080793, OLAX230V-1080794, OLAX240, OLAX240E-1080795, OLAX240E-1080796, OLAX240V-1080797, OLAX240V-1080798, OLAX300, OLAX300E-1080770, OLAX300E-1080771, OLAX300E-1081033, OLAX300E-1081035, OLAX300E-1081036, OLAX300LC, OLAX300LCE-1081034, OLAX300V-1080775, OLAX310, OLAX310E-1081110, OLAX310E-1081111, OLAX310LC, OLAX310LCE-1081114, OLAX310LCE-1081115, OLAX310LCV-1081116, OLAX310LCV-1081117, OLAX310V-1081112, OLAX310V-1081113, OLAX320, OLAX320E-1081118, OLAX320E-1081119, OLAX320V-1081120, OLAX320V-1081121...(Other models you can see in the webshop)		
spare parts for	499226		
	GEV No.	510693	Ref. No. 15080 15080/E
	mechanical shaft seal for shaft ø 12mm slide ringext. ø 24mm slide ring H 15.5mm slide ring int. ø 11mm counter ring mounting ø 24mm height counter ring 8mm counter ring int. ø 13.5mm		
	GEV No.	521152	Ref. No. —
	pump cover OLYMPIA inlet 62 ø 190mm		
	GEV No.	521153	Ref. No. —
	pump casing OLYMPIA outlet ø 52mm		
	GEV No.	521154	Ref. No. —
	O-ring ID ø 152.7mm thickness 2.62mm EPDM Qty 1 pcs		
	GEV No.	521155	Ref. No. —
	impellor ø 107mm H 34mm pump type OLYMPIA thread M8L blades 6		
accessories for	499226		
	GEV No.	542157	Ref. No. —
	bracket for wash pump L 267mm W 132mm H 43mm		



booster pumps I



1

GEV No.	500060	Ref. No.	15100
description	pump inlet ø 1" outlet ø 1" type PQM60 230V 50Hz 1 phase 0.37kW PEDRELLLO		
For models:	OLAX151, OLAX151EDX-1080725, OLAX151ELEFF-1080727, OLAX151-highspeed, OLAX160, OLAX160E-1080750, OLAX160E-1080751, OLAX160V-1080755, OLAX160V-1080756, OLAX160V-1081031, OLAX160V-1081032, OLAX210, OLAX210E-1081029, OLAX210E-1081030, OLAX220, OLAX220E-1080787, OLAX220E-1080788, OLAX220V-1080789, OLAX220V-1080790, OLAX230, OLAX230E-1080791, OLAX230E-1080792, OLAX230V-1080793, OLAX230V-1080794, OLAX240, OLAX240E-1080795, OLAX240E-1080796, OLAX240V-1080797, OLAX240V-1080798, OLAX250, OLAX250E-1080760, OLAX250E-1080761, OLAX250V-1080765, OLAX250V-1080766, OLAX300, OLAX300E-1080770, OLAX300E-1080771, OLAX300E-1081033, OLAX300E-1081035, OLAX300E-1081036, OLAX300LC, OLAX300LCE-1081034, OLAX300V-1080775, OLAX300V-1080776, OLAX310, OLAX310E-1081110, OLAX310E-1081111, OLAX310LC, OLAX310LCE-1081114, OLAX310LCE-1081115...(Other models you can see in the webshop)		
accessories for	500060		
	GEV No.	365015	Ref. No. 18043 R65190180
	operating capacitor capacity 10µF 400V tolerance 5%Hz ambient temperature max. -25 to +85°C ø 35.5mm L 59mm M8 plastic connection male faston 6.3mm protection		



1

GEV No.	499294	Ref. No.	15100/D
description	pump inlet ø 3/8" outlet ø 3/8" type B299.2351 230V 50Hz 1 phase 0.15kW 2800rpm L 170mm capacitor 6.3µF FIR		
For models:	OLDS35, OLDS35-1081061, OLDS35D-1081062, OLDS35-Neutra, OLDS37, OLDS37-1081063, OLDS37D-1081064, OLDS37-Neutra, OLDS40, OLDS40-1081010, OLDS40-1081065, OLDS40D-1081011, OLDS40D-1081066, OLDS40E-1081067, OLDS40ED-1081068, OLDS40LS-1081012, OLDS40LSD-1081013, OLDS40-Neutra, OLDS45, OLDS50, OLDS50-1081088, OLDS50D-1081089, OLDS50E-1081090, OLDS50ED-1081091, OLDS50-Neutra, OLDS50P-1081018, OLDS50PD-1081019, OLDS50W20H, OLElectron1000, OLElectron400, OLElectron500, OLELELECTRON1000-1081084, OLELELECTRON1000D-1081085, OLG600, OLGastro450, OLGastro500Plus, OLGastro500S, OLGastro750Plus, OLGastro750S, OLGRA-NUL900, OLG540, OLG540, OLG540-1080701, OLG540D-1080708, OLG540D-1081003, OLG540-Neutra, OLG545, OLG545LSD-1081004, OLG550, OLG550-1080705...(Other models you can see in the webshop)		
accessories for	499294		
	GEV No.	365017	Ref. No. 10702
	operating capacitor capacity 5µF 450V tolerance 5% 50/60Hz ambient temperature max. -25 to +85°C ø 28mm L 54mm M8 plastic connection male faston 6.3mm 16.10.08 protection		

drain pumps

ASKOLL



1

GEV No.	500515	Ref. No.	15101/A
description	drain pump inlet ø 30mm outlet ø 22mm 230V 25W 50Hz ASKOLL type M253 with thermal fuse		
For models:	OLDS50P-1081018, OLDS50PD-1081019, OLElectron400, OLElectron500, OLGastro500Plus, OLGastro500S, OLGastro750Plus, OLGastro750S		

PLASET



1

GEV No.	499298	Ref. No.	15101
description	drain pump inlet ø 30mm outlet ø 22mm 220-240V 22W 50Hz PLASET type 59491		
For models:	OLDS35, OLDS35-1081061, OLDS35D-1081062, OLDS35-Neutra, OLDS37, OLDS37-1081063, OLDS37-1081063, OLDS37D-1081007, OLDS37D-1081064, OLDS37LS-1081008, OLDS37LSD-1081009, OLDS37-Neutra, OLDS40, OLDS40-1081010, OLDS40-1081065, OLDS40D-1081011, OLDS40D-1081066, OLDS40E-1081067, OLDS40ED-1081068, OLDS40LS-1081012, OLDS40LSD-1081013, OLDS40-Neutra, OLDS45, OLDS50, OLDS50-1081088, OLDS50D-1081089, OLDS50E-1081090, OLDS50ED-1081091, OLDS50-Neutra, OLElectron400, OLG35, OLG35-1080702, OLG35D-1081000, OLG35-Neutra, OLG600, OLGastro450, OLG537, OLG537-1080700, OLG537D-1080707, OLG537LS-1081001, OLG537LSD-1081002, OLG537-Neutra, OLG540, OLG540, OLG540-1080701, OLG540D-1080708, OLG540D-1081003, OLG540-Neutra, OLG545, OLG545LSD-1081004...(Other models you can see in the webshop)		



booster pumps II

accessories



GEV No.	365015	Ref. No.	18043 R65190180
description	operating capacitor capacity 10µF 400V tolerance 5%Hz ambient temperature max. -25 to +85°C ø 35.5mm L 59mm M8 plastic connection male faston 6.3mm protection		
For models:	CCE042M, CCE051M, CCG051M, CCG071M, CKGP06, CKGP06B, OLDS37-1081006, OLDS37D-1081007, OLDS37LS-1081008, OLDS37LSD-1081009, OLDS40-1081010, OLDS40D-1081011, OLDS40LS-1081012, OLDS40LSD-1081013, OLElectron400, OLGastro450, OLLinear, OLStar		



GEV No.	365017	Ref. No.	10702
description	operating capacitor capacity 5µF 450V tolerance 5% 50/60Hz ambient temperature max. -25 to +85°C ø 28mm L 54mm M8 plastic connection male faston 6.3mm 16.10.08 protection		
For models:	OLAX250, OLAX250E-1080760, OLAX250E-1080761, OLAX250V-1080765, OLAX250V-1080766, OLAX300V-1080776, OLAX380, OLAX380E-1080780, OLAX380E-1080781, OLAX380E-1081037, OLAX380E-1081038, OLAX380E-1081039, OLAX380E-1081040, OLAX380E-1081043, OLAX380E-1081044, OLAX380E-1081046, OLAX380E-1081047, OLAX380E-1081048, OLAX380E-1081051, OLAX380E-1081052, OLAX380E-1081053, OLAX380E-1081054, OLAX380E-1081055, OLAX380E-1081056, OLAX380LC, OLAX380V-1080785, OLAX380V-1080786, OLAX400, OLAX400E-1081126, OLAX400E-1081127, OLAX400V-1081128, OLAX400V-1081129, OLAX440, OLAX440E-1081041, OLAX440E-1081042, OLAX440LC, OLAX440LCE-1081045, OLAX510, OLAX510E-1081130, OLAX510E-1081131, OLAX510LC, OLAX510LCE-1081134, OLAX510LCE-1081135, OLAX510LCV-1081136, OLAX510LCV-1081137, OLAX510V-1081132, OLAX510V-1081133, OLAX540, OLAX540E-1081049, OLAX540E-1081050...(Other models you can see in the webshop)		

vibration pumps

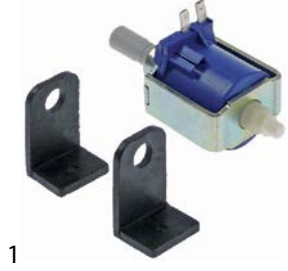

GEV No.	500568	Ref. No.	R65110600
description	vibration pump 230V 32W 50Hz inlet ø 7 outlet ø 1/8" IT CEME type E512/A32		
For models:	CKEP06, CKEP06B, CKEP10, CKEP10B, CKEP20, CKEP20B, CKEP21, CKEP21B, CKEP40, CKEP40B, CKET06, CKET06B, CKET10, CKET10B, CKET20, CKET20B, CKET21, CKET21B, CKET40, CKET40B, CKGP06, CKGP06B, CKGP10, CKGP10B, CKGP20, CKGP20B, CKGP21, CKGP21B, CKGP40, CKGP40B, CKGT06, CKGT06B, CKGT10, CKGT10B, CKGT20, CKGT20B, CKGT21, CKGT21B, CKGT40, CKGT40B		
spare parts for	500568		
	GEV No.	390698	Ref. No. —
	thermal fuse switch-off temp. 110°C suitable for ULKA pump		

condensators & interference suppression filters

operating capacitors

plastic



GEV No.	365015	Ref. No.	18043 R65190180
description	operating capacitor capacity 10µF 400V tolerance 5%Hz ambient temperature max. -25 to +85°C ø 35.5mm L 59mm M8 plastic connection male faston 6.3mm protection		
For models:	CCE042M, CCE051M, CCG051M, CCG071M, CKGP06, CKGP06B, OLDS37-1081006, OLDS37D-1081007, OLDS37LS-1081008, OLDS37LSD-1081009, OLDS40-1081010, OLDS40D-1081011, OLDS40LS-1081012, OLDS40LSD-1081013, OLElectron400, OLGastro450, OLLinear, OLStar		





			
1			
GEV No.	365017	Ref. No.	10702
description	operating capacitor capacity 5µF 450V tolerance 5% 50/60Hz ambient temperature max. -25 to +85°C ø 28mm L 54mm M8 plastic connection male faston 6.3mm 16.10.08 protection		
For models:	OLAX250, OLAX250E-1080760, OLAX250E-1080761, OLAX250V-1080765, OLAX250V-1080766, OLAX300V-1080776, OLAX380, OLAX380E-1080780, OLAX380E-1080781, OLAX380E-1081037, OLAX380E-1081038, OLAX380E-1081039, OLAX380E-1081040, OLAX380E-1081043, OLAX380E-1081044, OLAX380E-1081046, OLAX380E-1081047, OLAX380E-1081048, OLAX380E-1081051, OLAX380E-1081052, OLAX380E-1081053, OLAX380E-1081054, OLAX380E-1081055, OLAX380E-1081056, OLAX380LC, OLAX380V-1080785, OLAX380V-1080786, OLAX400, OLAX400E-1081126, OLAX400E-1081127, OLAX400V-1081128, OLAX400V-1081129, OLAX440, OLAX440E-1081041, OLAX440E-1081042, OLAX440LC, OLAX440LCE-1081045, OLAX510, OLAX510E-1081130, OLAX510E-1081131, OLAX510LC, OLAX510LCE-1081134, OLAX510LCE-1081135, OLAX510LCV-1081136, OLAX510LCV-1081137, OLAX510V-1081132, OLAX510V-1081133, OLAX540, OLAX540E-1081049, OLAX540E-1081050...(Other models you can see in the webshop)		

metal			
			
1			
GEV No.	365140	Ref. No.	15081
description	operating capacitor capacity 12.5µF 450V tolerance 5% 60Hz ambient temperature max. -25 up to +70°C ø 40mm L 83mm M8 aluminium connection male faston 6.3mm C.87.8BF2 MKP protection		
For models:	OLDS45, OLDS50, OLDS50-1081088, OLDS50D-1081089, OLDS50E-1081090, OLDS50ED-1081091, OLDS50-Neutra, OLDS50P-1081018, OLDS50PD-1081019, OLElectron500, OLG600, OLGastro500Plus, OLGastro500S, OLGastro750Plus, OLGastro750S, OLG545, OLG550, OLG550-1080705, OLG550D-1080706, OLG550E-1080730, OLG550ECO-1081014, OLG550ECOD-1081015, OLG550ED-1080731, OLG550-Neutra, OLG585, OLG585-1081016, OLG585D-1081017, OLG585-Neutra		

ferrite rings			
			
1			
GEV No.	365054	Ref. No.	R65280490
description	ferrite ring ID ø 22mm ED ø 38mm H 17mm for protection		
For models:	CKEP06, CKEP06B, CKEP10, CKEP10B, CKEP20, CKEP20B, CKEP21, CKEP21B, CKEP40, CKEP40B, CKET06, CKET06B, CKET10, CKET10B, CKET20, CKET20B, CKET21, CKET21B, CKET40, CKET40B, CKGP06, CKGP06B, CKGP10, CKGP10B, CKGP20, CKGP20B, CKGP21, CKGP21B, CKGP40, CKGP40B, CKGT06, CKGT06B, CKGT10B, CKGT20, CKGT20B, CKGT21, CKGT21B, CKGT40, CKGT40B		

filters

interference suppression filters			
			
1			
GEV No.	365045	Ref. No.	1037116500
description	interference suppression filter type FC701Y2F 250V 50-60Hz conductor 2 with E connection cable 200mm L 40mm ø 30mm Hmm Wmm plastic Qty 1 pcs		
For models:	FQE41, FQE41L, FQE41L2, FQE61, FQE61L, FQE61L2, OFQE41, OFQE41-12601510, OFQE-41-12601510MN, OFQE41L, OFQE61, OFQE-61-12601610, OFQE-61-12601610MN, OFQE61L		

			
1			
GEV No.	365044	Ref. No.	R65280200
description	interference suppression filter type FC701Y2F 250V 50-60Hz conductor 2 with E connection cable 200mm L 42mm ø 23mm Hmm Wmm plastic Qty 1 pcs		
For models:	CCE042M, CCE051M, CCE071M, CCE101M, CCE102M, CKEP06, CKEP06B, CKEP10, CKEP10B, CKEP20, CKEP20B, CKEP21, CKEP21B, CKEP40, CKEP40B, CKET06, CKET06B, CKET10, CKET10B, CKET20, CKET20B, CKET21, CKET21B, CKET40, CKET40B		

RC circuits			
			
1			
GEV No.	365155	Ref. No.	R65280130
description	RC circuit 250/630V connection male faston 6.3mm cable length 65mm capacity 47nF 100Ohm		
For models:	CCE042M		

fuses

fine fuses

 <p>1</p>			
GEV No.	358610	Ref. No.	15160
description	fine fuse size ø5x20mm 10A fast-acting rated 250V Qty 10 pcs		
For models:	OLAX151, OLAX151EDX-1080725, OLAX151ELEFT-1080727, OLAX151-highspeed, OLAX160, OLAX160E-1080750, OLAX160E-1080751, OLAX160V-1080755, OLAX160V-1080756, OLAX160V-1081031, OLAX160V-1081032, OLAX210, OLAX210E-1081029, OLAX210E-1081030, OLAX220, OLAX220E-1080787, OLAX220E-1080788, OLAX220V-1080789, OLAX220V-1080790, OLAX230, OLAX230E-1080791, OLAX230E-1080792, OLAX230V-1080793, OLAX230V-1080794, OLAX240, OLAX240E-1080795, OLAX240E-1080796, OLAX240V-1080797, OLAX240V-1080798, OLAX250, OLAX250E-1080760, OLAX250E-1080761, OLAX250V-1080765, OLAX250V-1080766, OLAX300, OLAX300E-1080770, OLAX300E-1080771, OLAX300E-1081033, OLAX300E-1081035, OLAX300E-1081036, OLAX300LC, OLAX300LCE-1081034, OLAX300V-1080775, OLAX300V-1080776, OLAX310, OLAX310E-1081110, OLAX310E-1081111, OLAX310LC, OLAX310LCE-1081114, OLAX310LCE-1081115...(Other models you can see in the webshop)		

 <p>2</p>			
GEV No.	358671	Ref. No.	15163
description	fine fuse size ø5x20mm 1A fast-acting rated 250V Qty 10 pcs		
For models:	OLAX151, OLAX151EDX-1080725, OLAX151ELEFT-1080727, OLAX151-highspeed, OLAX160, OLAX160E-1080750, OLAX160E-1080751, OLAX160V-1080755, OLAX160V-1080756, OLAX160V-1081031, OLAX160V-1081032, OLAX210, OLAX210E-1081029, OLAX210E-1081030, OLAX220, OLAX220E-1080787, OLAX220E-1080788, OLAX220V-1080789, OLAX220V-1080790, OLAX230, OLAX230E-1080791, OLAX230E-1080792, OLAX230V-1080793, OLAX230V-1080794, OLAX240, OLAX240E-1080795, OLAX240E-1080796, OLAX240V-1080797, OLAX240V-1080798, OLAX250, OLAX250E-1080760, OLAX250E-1080761, OLAX250V-1080765, OLAX250V-1080766, OLAX300, OLAX300E-1080770, OLAX300E-1080771, OLAX300E-1081033, OLAX300E-1081035, OLAX300E-1081036, OLAX300LC, OLAX300LCE-1081034, OLAX300V-1080775, OLAX300V-1080776, OLAX310, OLAX310E-1081110, OLAX310E-1081111, OLAX310LC, OLAX310LCE-1081114, OLAX310LCE-1081115...(Other models you can see in the webshop)		

 <p>1</p>			
GEV No.	358532	Ref. No.	R65200200
description	fine fuse size ø5x20mm 2A fast-acting rated 250V Qty 10 pcs		
For models:	CCE042M, CCE051M, CCE071M, CCE101M, CCE102M, CCG051M, CCG071M, CCG101M, CCG102M, CKEP06, CKEP06B, CKEP10, CKEP10B, CKEP20, CKEP20B, CKEP21, CKEP21B, CKEP40, CKEP40B, CKET06, CKET06B, CKET10, CKET10B, CKET20, CKET20B, CKET21, CKET21B, CKET40, CKET40B, CKGP06, CKGP06B, CKGP10, CKGP10B, CKGP20, CKGP20B, CKGP21, CKGP21B, CKGP40, CKGP40B, CKGT06, CKGT06B, CKGT10B, CKGT20, CKGT20B, CKGT21, CKGT21B, CKGT40, CKGT40B		

 <p>1</p>			
GEV No.	358593	Ref. No.	R65200086
description	fine fuse size ø5x20mm 0.125A slow-acting rated 250V Qty 10 pcs		
For models:	CKEP06, CKEP06B, CKEP10, CKEP10B, CKEP20, CKEP20B, CKEP21, CKEP21B, CKEP40, CKEP40B, CKET06, CKET06B, CKET10, CKET10B, CKET20, CKET20B, CKET21, CKET21B, CKET40, CKET40B, CKGP06, CKGP06B, CKGP10, CKGP10B, CKGP20, CKGP20B, CKGP21, CKGP21B, CKGP40, CKGP40B, CKGT06, CKGT06B, CKGT10B, CKGT20, CKGT20B, CKGT21, CKGT21B, CKGT40, CKGT40B		

 <p>1</p>			
GEV No.	358595	Ref. No.	R65200320
description	fine fuse size ø5x20mm 0.2A slow-acting rated 250V Qty 10 pcs		
For models:	CCE071M, CCE101M, CCE102M, CCG071M, CCG101M, CCG102M, CKEP06, CKEP06B, CKET06, CKET06B, CKGP06, CKGP06B, CKGT06, CKGT06B		

 <p>1</p>			
GEV No.	358703	Ref. No.	R65200350
description	fine fuse size ø5x20mm 0.4A slow-acting rated 250V Qty 10 pcs		
For models:	CKEP10, CKEP10B, CKEP20, CKEP20B, CKEP21, CKEP21B, CKEP40, CKEP40B, CKET10, CKET10B, CKET20, CKET20B, CKET21, CKET21B, CKET40, CKET40B, CKGP10, CKGP10B, CKGP20, CKGP20B, CKGP21, CKGP21B, CKGP40, CKGP40B, CKGT10B, CKGT20, CKGT20B, CKGT21, CKGT21B, CKGT40, CKGT40B		

 <p>1</p>			
GEV No.	358605	Ref. No.	6A001420 BN6A001420
description	fine fuse size ø5x20mm 3.15A slow-acting rated 250V Qty 10 pcs		
For models:	94-04PEI100L, 94-04PEI100L-12901765, 94-04PEI110L-12901765BN, 94-04PEI150L, 94-04PEI150L-12901767, 94-04PEI150L-12901767BN, 9PN-EI100, 9PN-EI150		

 <p>1</p>			
GEV No.	358609	Ref. No.	R65200240
description	fine fuse size ø5x20mm 5A slow-acting rated 250V Qty 10 pcs		
For models:	CKET06, CKET06B, CKGT06, CKGT06B		





fine fuse holders

			
1			
GEV No.	358512	Ref. No.	R65210020
description	fuse holder		
For models:	CCE042M, CCE051M, CCE071M, CCE101M, CCE102M, CCG051M, CCG071M, CCG101M, CCG102M, CKEP06, CKEP06B, CKEP10, CKEP10B, CKEP20, CKEP20B, CKEP21, CKEP21B, CKEP40, CKEP40B, CKET06, CKET06B, CKET10, CKET10B, CKET20, CKET20B, CKET21, CKET21B, CKET40, CKET40B, CKGP06, CKGP06B, CKGP10, CKGP10B, CKGP20, CKGP20B, CKGP21, CKGP21B, CKGP40, CKGP40B, CKGT06, CKGT06B, CKGT10B, CKGT20, CKGT20B, CKGT21, CKGT21B, CKGT40, CKGT40B		

			
1			
GEV No.	550848	Ref. No.	6A034500 BN6A034500
description	fuse holder suitable fuse ø5x20mm		
For models:	CV10E, CV10E-1320100, CV10E-2, CV10E2-1320140, CV10EB-1321100, CV10E-S, CV10ES-1320150, CV10E-S2, CV10ES2-1320190, CV10G, CV10G-1310100, CV10G-2, CV10G2-1310140, CV10GB-1311100, CV10G-S, CV10GS-1310150, CV10G-S2, CV10GS2-1310190, CV20E, CV20E-1320200, CV20E-2, CV20E2-1320240, CV20EB-1321200, CV20E-S, CV20ES-1320250, CV20E-S2, CV20ES2-1320290, CV20G, CV20G-1310200, CV20G-2, CV20G2-1310240, CV20GB-1311200, CV20G-S, CV20GS-1310250, CV20G-S2, CV20GS2-1310290, CV21E, CV21E-1322100, CV21E-2, CV21E2-1322140, CV21E-S, CV21ES-1322150, CV21E-S2, CV21ES2-1322190, CV21G, CV21G-1312100, CV21G-2, CV21G2-1312140, CV21G-S, CV21GS-1312150...(Other models you can see in the webshop)		

overload switches

			
1			
GEV No.	358514	Ref. No.	R65160300
description	overload switch drop-away current 0.8A		
For models:	CKEP06, CKEP06B, CKGP06, CKGP06B		

			
1			
GEV No.	358516	Ref. No.	R65160320
description	overload switch drop-away current 2A		
For models:	CCE071M, CCG071M, CKEP06, CKEP06B, CKGP06, CKGP06B		

electric accessories

cables

accessories

cable glands

cable glands

			
1			
GEV No.	550311	Ref. No.	8217570 BN8217570
description	cable gland ID ø 6mm mounting ø 9mm ED ø 14mm Neoprene -30 up to +90°C Qty 10 pcs		
For models:	421SEFR-1826125, 55-45FRE, 55-90FRE, 621SEFR-1826135, 72-02FRE, 72-02FRE-12701500, 72-02FREM, 72-02FREM-12701530, 73-02FRE, 73-02FRE-12701550, 73-02FREM, 73-02FREM-12701580, 74-02FRE, 74-02FRE-12701600, 74-02FREM, 74-02FREM-12701630, 92-04FRE15L-12901510, 92-04FRE20L-12901500, 92-04FRE20L-12901500BN, 93-04FRE-12901550, 94-04FRE-12901600		

threaded cable glands

screw connections

			
1			
GEV No.	550971	Ref. No.	1037115100
description	cable gland thread PG16 cable ø 14mm mounting ø 22.5mm Qty 1 pcs plastic WS 27		
For models:	BRE40, BRE40D, BRE40DB, BRE40DG, BRE40DGB, BRE40G, BSEI40M, FTE100B, FTE100BR, FTE100CRL, FTE40B, FTE40BR, FTE40C, FTE40D, FTE40DC, FTE60B, FTE60BR, FTE60C, FTE60D, FTE60DC, FTE60DR, FTE60DRCL, OBME41M, OBME61M, OBRE40, OBRE-40-12601110, OBRE-40-12601110MN, OBSEI40M, OBSEI-40M-12601700, OFTE-100C-12601136, OFTE-100C-12601136MN, OFTE100CRL, OFTE-100CRL-12601138, OFTE40B, OFTE-40B-12601130, OFTE-40B-12601130MN, OFTE40BR, OFTE-40BR-12601132, OFTE-40BR-12601132MN, OFTE40C, OFTE-40C-12601135, OFTE-40C-12601135MN, OFTE60B, OFTE-60B-12601140, OFTE-60B-12601140MN, OFTE60BR, OFTE-60BR-12601141, OFTE-60BR-12601141MN, OFTE60BRR, OFTE-60BRR-12601142...(Other models you can see in the webshop)		

			
1			
GEV No.	550973	Ref. No.	1037112400
description	cable gland thread PG21 cable ø 17mm mounting ø 28mm Qty 1 pcs plastic WS 34		
For models:	FQE41, FQE41L, FQE41L2, FQE61, FQE61L, FQE61L2, OFQE41, OFQE-41-12601510, OFQE-41-12601510MN, OFQE41L, OFQE61, OFQE-61-12601610, OFQE-61-12601610MN, OFQE61L, OPCE40, OPCE-40-12601010, OPCE-40-12601010MN, OPCE60, OPCE-60-12601015, OPCE-60-12601015MN, PCE40, PCE40D, PCE40DB, PCE60, PCE60D, PCE60DB		



fastening nuts			
			
1			
GEV No.	550972	Ref. No.	1037115200
description	nut thread PG16 WS 30 plastic Qty 1 pcs thickness 6mm mounting ømm cable ømm		
For models:	BRE40, BRE40D, BRE40DB, BRE40DG, BRE40DGB, BRE40G, BSEI40M, FTE100B, FTE100BR, FTE100CRL, FTE40B, FTE40BR, FTE40C, FTE40D, FTE40DC, FTE60B, FTE60BR, FTE60C, FTE60D, FTE60DC, FTE60DR, FTE60DRCL, OBME41M, OBME61M, OBRE40, OBRE-40-12601110, OBRE-40-12601110MN, OBSEI40M, OFTE-100C-12601136, OFTE-100C-12601136MN, OFTE100CRL, OFTE-100CRL-12601138, OFTE40B, OFTE-40B-12601130, OFTE-40B-12601130MN, OFTE-40BR, OFTE-40BR-12601132, OFTE-40BR-12601132MN, OFTE40C, OFTE-40C-12601135, OFTE-40C-12601135MN, OFTE60B, OFTE-60B-12601140, OFTE-60B-12601140MN, OFTE60BR, OFTE-60BR-12601141, OFTE-60BR-12601141MN, OFTE60BRR, OFTE-60BRR-12601142, OFTE-60BRR-12601142MN...(Other models you can see in the webshop)		

			
1			
GEV No.	550974	Ref. No.	1037114500
description	nut thread PG21 WS 34 plastic Qty 1 pcs thickness 7.5mm mounting ømm cable ømm		
For models:	FQE41, FQE41L, FQE41L2, FQE61, FQE61L, FQE61L2, OFQE41, OFQE-41-12601510, OFQE-41-12601510MN, OFQE41L, OFQE61, OFQE-61-12601610, OFQE-61-12601610MN, OFQE61L, OPCE40, OPCE-40-12601010, OPCE-40-12601010MN, OPCE60, OPCE-60-12601015, OPCE-60-12601015MN, PCE40, PCE40D, PCE40DB, PCE60, PCE60D, PCE60DB		

ribbon cables			
group 1			
			
1			
GEV No.	400066	Ref. No.	50589
description	ribbon cable 10-pole L 1000mm plug type FC-10P raster size 2.54mm		
For models:	OLDS40, OLDS40-1081065, OLDS40D-1081066, OLDS40E-1081067, OLDS40ED-1081068, OLDS40-Neutra, OLDS50, OLDS50-1081088, OLDS50D-1081089, OLDS50E-1081090, OLDS50ED-1081091, OLDS50-Neutra, OLDW020H, OLElectron1000, OLElectron400, OLELELECTRON1000-1081084, OLELELECTRON1000D-1081085, OLG550, OLG550-1080705, OLG550D-1080706, OLG550E-1080730, OLG550ECO-1081014, OLG550ECOD-1081015, OLG550ED-1080731, OLG550-Neutra, OLLP155-1081087		

miscellaneous			
			
1			
GEV No.	401960	Ref. No.	R66110320
description	kable set		
For models:	CCE071M, CCE101M, CCE102M, CCG071M, CCG101M, CCG102M, CKEP10, CKEP10B, CKEP20, CKEP20B, CKEP40, CKEP40B, CKET10, CKET10B, CKET20, CKET20B, CKET40, CKET40B, CKGP10, CKGP10B, CKGP20, CKGP20B, CKGP40, CKGP40B, CKGT10, CKGT10B, CKGT20B, CKGT40, CKGT40B		

terminals			
porcelain clamps			
			
1			
GEV No.	550115	Ref. No.	1037117600
description	porcelain terminal block 2-pole 10mm ² max. 30A max 450V L 37mm W 37mm H 23mm mounting distancemm Qty 1 pcs		
For models:	BSEI40M, OBSEI40M, OBSEI-40M-12601700		

terminal blocks			
			
1			
GEV No.	550239	Ref. No.	6A036360 BN6A036360
description	lustre terminal 12-pole cross section 16mm ² max. 75A max 500V temp.-resist. 150°C		
For models:	74-02KBGB, 74-02KBGBI, 74-02KBGMB, 74-02KBGMBI, 74CE-000400, 76CEAC-000500, 96-04CGFL-12900019, 96-04CGFL2P-12900037, 96-04CGFLP-12900069, 961CEEE-1292246, 96CGEAC-1191246, 96CGGAC-1191236, 96CGGE-1191236, 96CTGGAC-1191732, C-GV906FL-1050200		

connection terminals with screw/faston connections			
			
1			
GEV No.	550278	Ref. No.	1037117300
description	power terminal block 3-pole max. 40A max 400V connection ø6mm ² / F6.3 temp.-resist. 150°C cross section 6mm ²		
For models:	BSEI40M, OBME41M, OBME61M, OBSEI40M, OBSEI-40M-12601700		



1

GEV No.	550349	Ref. No.	6A036204 BN6A036204
description	power terminal block 4-pole max. 40A max 400V connection ø6mm ² / F6.3 temp.-resist. 150°C cross section 6mm ²		
For models:	40SEBM-1826100, 40SEBM2S-1826100, 40SEC-1825060, 40SECC-1826260, 40SECP-1825080, 40SECP-1825080E, 40SEFR, 40SEFR-1826140, 40SEFR2S-1826140, 40SEFT-1825040, 40SEFT-1825045, 40SEFTC-1825045, 40SEFTR-1825041, 40SEKB-1825200, 40SKE-1825200, 41SEFR-1826120, 41SEFR2S-1826120, 421SEFR-1826125, 60SEBM-1826110, 60SEBM2S-1826110, 60SEC-1825070, 60SEFR, 60SEFR-1826150, 60SEFR2S-1826150, 60SEFT1-2R-1825051, 60SEFT1-3RIG-1825050, 60SEFT-1825050, 60SEFTC-1825050, 60SEFTC-1825055, 60SEFTR-1825052, 60SEFTRIG-1825050, 61SCGFE3S-1826055, 61SCGFE4S-1827055, 61SECFE-1826075, 61SEFR-1826130, 61SEFR2S-1826130, 621SEFR-1826135, 7101FR-E-1077750R, 710FRE-077700, 710FRE-1077700, 7121FR-E-1077950R, 712FRE-077900, 712FRE-1077900, 7201FR-E-1077850R, 72-02CBE, 72-02CBE-12701150, 72-02KBEB-12701127, 72-02SPE-12701700, 72-02TCBE, 72-02TCBE-12731150...(Other models you can see in the webshop)		



2

GEV No.	550411	Ref. No.	1037104000 500551
description	power terminal block 6-pole max. 40A max 450V connection ø6mm ² / F6.3 temp.-resist. 150°C cross section 6mm ²		
For models:	BRE40, BRE40D, BRE40DB, BRE40DG, BRE40DGB, BRE40G, FQE41, FQE41L, FQE41L2, FQE61, FQE61L, FQE61L2, FTE100B, FTE100BR, FTE100CRL, FTE40B, FTE40BR, FTE40C, FTE40D, FTE40DC, FTE60B, FTE60BR, FTE60C, FTE60D, FTE60DC, FTE60DR, FTE60DRCL, OBRE40, OBRE-40-12601110, OBRE-40-12601110MN, OFQE41, OFQE-41-12601510, OFQE-41-12601510MN, OFQE41L, OFQE61, OFQE-61-12601610, OFQE-61-12601610MN, OFQE61L, OFTE-100C-12601136, OFTE-100C-12601136MN, OFTE100CRL, OFTE-100CRL-12601138, OFTE40B, OFTE-40B-12601130, OFTE-40B-12601130MN, OFTE40BR, OFTE-40BR-12601132, OFTE-40BR-12601132MN, OFTE40C, OFTE-40C-12601135...(Other models you can see in the webshop)		



1

GEV No.	550977 ¹	Ref. No.	6A036206 CR0588170
description	power terminal block 6-pole max. 40A max 450V connection ø6mm ² / F6.3 temp.-resist. 150°C cross section 6mm ² with ground lug		
For models:	40SEW-1825190, 74-02CEEPP, 74-02CEEPPQ-12701210, 74-02CEEPT, 74-02CEEPT-12701010, 74-02CGE, 74-02CGE-12700011, 74-02CGE-12700011TA, 74-02CTEE-12701180, 74-02CTGE, 74-02CTGE-12700190, 74-02CTGE-12700190TA, 74-02KBEB-12701128, 74-02VTCEV-12701020, 76-02CEEANPQ, 76-02CEEANPT, 76-02CEEEACQP, 76-02CEEEACPT, 76-02CEEEPPQ-12701216, 76-02CEEEPT-12701016, 76-02CEEPPQ-12701215, 76-02CEEPT-12701015, 76-02CGE, 76-02CGE-12700017, 76-02CGE-12700017TA, 76-02CGEE, 76-02CGEE-12700018, 76-02CGEE-12700018TA, 92-04CE, 92-04CEPQ-12901201, 92-04FTE-12901130, 92-04FTEC-12901135, 92-04FTECR-12901137, 92-04FTE-12901132, 92-04TCE, 92-04TCE-12931201, 92-04TFTE-12931130, 92-04TFTEC-12931135, 92-04TFTECR-12931137, 92-04TFTE-12931132, 92-04TVTC-12931005, 92-04VTCL-12901030, 92-04VTCL-12901035, 92FE-1192220, 93FE-1192230, 94-04CE, 94-04CE-12901202, 94-04CEE, 94-04CEE-12901210, 94-04CEE-12901210BN...(Other models you can see in the webshop)		

connection terminals with screw connection



1

GEV No.	550470	Ref. No.	500550
description	power terminal block 3-pole max. 40A max 400V connection M6/M6 temp.-resist. 150°C cross section 6mm ²		
For models:	OLDS45, OLDS50, OLDS50-1081088, OLDS50D-1081089, OLDS50E-1081090, OLDS50ED-1081091, OLDS50-Neutra, OLDW020H, OLElectron1000, OLElectron400, OLELELECTRON1000-1081084, OLELELECTRON1000D-1081085, OLGastro450, OLG540, OLG545, OLG550, OLG550-1080705, OLG550D-1080706, OLG550E-1080730, OLG550ECO-1081014, OLG550ECOD-1081015, OLG550ED-1080731, OLG550-Neutra, OLLP155-1081087		

terminal boards



1

GEV No.	550413	Ref. No.	6A046400 MA1229800
description	terminal board 3-pole thread M5 L 55mm W 36mm		
For models:	725KB-E-1000200, 725KBE-1000200, 725KB-E-1000200R, 725KB-EB-1000201, 725KBEB-1000201, 725KB-EB-1000201R, 725KBEM-000200, 725KBEM-1000210, 725KB-EM-1000210R, 725KB-EMB-1000211, 725KBEMB-1000211, 74-02KBEB, 74-02KBEB-12701110, 74-02KBEBI, 74-02KBEBI-12701115, 74-02KBEMB, 74-02KBEMB-12701120, 74-02KBEMBI, 74-02KBEMBI-12701125, 74-02KBEMBI-12701125HB, FR-E925N-1050730, FR-E950N-1050732, FT-E940-1050510, FT-E940-1050511, FT-E980-1050520, FT-E980-1050521, FT-E980R1-2-1050522		

rail-mounted terminals

rail-mounted terminal blocks



1

GEV No.	550421 ¹	Ref. No.	R65220090 R65220091
description	rail-mounted terminal block 5-pole contacts 3P+N+E cross section 1.0-10mm ²		
For models:	CCE042M, CCE051M, CCE071M, CKEP06, CKEP06B, CKET06, CKET06B		

¹with fused terminal block

¹with ground lug

1

GEV No.	550420	Ref. No.	R65220080 R65220081
description	rail-mounted terminal block 5-pole contacts 3P+N+E cross section 1.5-16mm ²		
For models:	CCE101M, CKEP10, CKEP10B, CKET10, CKET10B		



1

GEV No.	550422	Ref. No.	R65220131
description	rail-mounted terminal block 9-pole		
For models:	CKEP40, CKEP40B, CKET40, CKET40B		

various



1

GEV No.	693955	Ref. No.	1878400 MA1878400
description	terminal grounding cable		
For models:	BRE40, BRE40D, BRE40DB, BRE40DG, BRE40DGB, BRE40G, BSEI40M, FOE30-1008310, FTE100B, FTE100BR, FTE100CRL, FTE40B, FTE40BR, FTE40C, FTE40D, FTE40DC, FTE60B, FTE60BR, FTE60C, FTE60D, FTE60DC, FTE60DR, FTE60DRCL, OBME41M, OBME-41M-12601150, OBME61M, OBME-61M-12601155, OBRE40, OBRE-40-12601110, OBRE-40-12601110MN, OBSEI40M, OBSEI-40M-12601700, OFTE-100C-12601136, OFTE-100C-12601136MN, OFTE100CRL, OFTE-100CRL-12601138, OFTE40B, OFTE-40B-12601130, OFTE-40B-12601130MN, OFTE40BR, OFTE-40BR-12601132, OFTE-40BR-12601132MN, OFTE40C, OFTE-40C-12601135, OFTE-40C-12601135MN, OFTE60B, OFTE-60B-12601140, OFTE-60B-12601140MN, OFTE60BR, OFTE-60BR-12601141...(Other models you can see in the webshop)		

gas taps

PEL

21S series



1

GEV No.	103329	Ref. No.	6A011490 BN6A011490
description	gas tap PEL type 21S gas inlet M16x1.5 (tube ø 10mm) bypass nozzle ø 0.35mm gas outlet M16x1.5 (tube ø 10/8mm) thermocouple connection M8x1 pilot connection M10x1 shaft ø 8x6.5mm shaft L 22/15mm shaft flat upper		
For models:	110-135CG, 110-135CG2P, 110-135CGE, 110-135CGE2P, 110-135CGEE, 110-135CGEE2P, 110-135CGEEP, 110-135CGEP, 110-135CGG, 110-135CGG2P, 110-135CGGE, 110-135CGGE2P, 110-135CGGEP, 110-135CGGP, 110-135CGP, 110-135TCG, 110-135TCG2P, 110-135TCGP, 110-45CG, 110-45CG1P, 110-45CGP, 110-45TCG, 110-45TCG1P, 110-45TCGP, 110-90CG, 110-90CG1P, 110-90CGE, 110-90CGE1P, 110-90CGEP, 110-90CGG, 110-90CGG1P, 110-90CGGP, 110-90CGP, 110-90CTG, 110-90CTGE, 110-90CTGG, 110-90TCG, 110-90TCG1P, 110-90TCGP, 110-90TCTG, 2FX+PCF, 4FX, 4FX+PCF, 55-45CPG, 55-90CPG, 72+2CTGG-12700013, 72-02CG, 72-02CG-12700001, 72-02CG-12700001TA, 72-02CPG...(Other models you can see in the webshop)		















1





GEV No.	101397	Ref. No.	826920040 BN41826920040	
description	gas tap PEL type 21S gas inlet M16x1.5 (tube ø 10mm) bypass nozzle ø 0.35mm gas outlet M16x1.5 (tube ø 10/8mm) thermocouple connection M9x1 pilot connection M10x1 shaft ø 8x6.5mm shaft L 22/15mm shaft flat lower			
spare parts for	101397			
	GEV No.	100408	Ref. No.	—
	bypass nozzle type PEL20/21 bore ø 0.35mm thread M5x0.5			
	GEV No.	101060	Ref. No.	—
	magnet unit standard L 39mm D1 ø 15.4mm D2 ø 11mm suitable for PEL20-21/JUNKERS/EGA			
	GEV No.	101206	Ref. No.	—
	gas tap front part shaft ø 8x6.5mm shaft L 22/15mm shaft flat upper/lower suitable for PEL21			
	GEV No.	101231	Ref. No.	—
	thermocouple nut T1: M9x1 T2: M18x1			
accessories for	101397			
	GEV No.	100908	Ref. No.	673500 6A016110 6A017000 A016110 A017000 BN6A016110 BN6A017000 MA673500
	union screw thread M10x1 for pipe ø 4mm Qty 1 pcs			

Table continues overleaf

accessories for		101397	
	GEV No.	100909	Ref. No. —
union screw thread M10x1 for pipe ø 6mm Qty 1 pcs			
	GEV No.	101246	Ref. No. 673600 6A016120 A016120 MA673600
olive for pipe ø 4mm Qty 1 pcs			
	GEV No.	101278	Ref. No. 6A011480 86720 A011480 BN6A011480 MA86720
olive for pipe ø 10mm Qty 1 pcs			
	GEV No.	101286	Ref. No. —
olive ID ø 6mm Qty 1 pcs			
	GEV No.	101300	Ref. No. 1326500 6A011485 A011485 BN6A011485
union nut thread M16x1.5 tube ø 10mm			
	GEV No.	101450	Ref. No. —
olive for pipe ø 8mm L 12.7mm Qty 1 pcs ED ø 10mm			
	GEV No.	101451	Ref. No. —
union nut thread M16x1.5 tube ø 8mm			
	GEV No.	110081	Ref. No. —
knob ø 70mm shaft ø 8x6.5mm shaft flat universal			
	GEV No.	112206	Ref. No. —
knob dial plate silver gas tap PEL21/22/23 t.max.°C ED ø 63mm ID ø 45.5mm			

accessories for		101693	
	GEV No.	100908	Ref. No. 673500 6A016110 6A017000 A016110 A017000 BN6A016110 BN6A017000 MA673500
union screw thread M10x1 for pipe ø 4mm Qty 1 pcs			
	GEV No.	100909	Ref. No. —
union screw thread M10x1 for pipe ø 6mm Qty 1 pcs			
	GEV No.	101246	Ref. No. 673600 6A016120 A016120 MA673600
olive for pipe ø 4mm Qty 1 pcs			
	GEV No.	101278	Ref. No. 6A011480 86720 A011480 BN6A011480 MA86720
olive for pipe ø 10mm Qty 1 pcs			
	GEV No.	101286	Ref. No. —
olive ID ø 6mm Qty 1 pcs			
	GEV No.	101300	Ref. No. 1326500 6A011485 A011485 BN6A011485
union nut thread M16x1.5 tube ø 10mm			
	GEV No.	101450	Ref. No. —
olive for pipe ø 8mm L 12.7mm Qty 1 pcs ED ø 10mm			
	GEV No.	101451	Ref. No. —
union nut thread M16x1.5 tube ø 8mm			

accessories for		101693	
	GEV No.	100552	Ref. No. 1884200 BN6A023721
bypass nozzle type PEL20/21 bore ø 0.7mm thread M5x0.5			
	GEV No.	101060	Ref. No. —
magnet unit standard L 39mm D1 ø 15.4mm D2 ø 11mm suitable for PEL20-21/JUNKERS/EGA			
	GEV No.	101230	Ref. No. —
thermocouple nut T1: M8x1 T2: M18x1 aluminium			
	GEV No.	101877	Ref. No. —
gas tap front part shaft ø 6x4.6mm type PEL21			

accessories for		101693	
	GEV No.	100528	Ref. No. 1033720200 1889000
bypass nozzle type PEL20/21 bore ø 0.9mm thread M5x0.5			
	GEV No.	101060	Ref. No. —
magnet unit standard L 39mm D1 ø 15.4mm D2 ø 11mm suitable for PEL20-21/JUNKERS/EGA			
	GEV No.	101230	Ref. No. —
thermocouple nut T1: M8x1 T2: M18x1 aluminium			
	GEV No.	101877	Ref. No. —
gas tap front part shaft ø 6x4.6mm type PEL21			





accessories for		101693	
	GEV No.	101693	Ref. No. 1031500200
gas tap PEL type 21S gas inlet M16x1.5 (tube ø 10mm) bypass nozzle ø 0.7mm gas outlet M16x1.5 (tube ø 10/8mm) thermocouple connection M8x1 pilot connection M10x1 shaft ø 6x4.6mm shaft L 35/28mm shaft flat right			
For models: CFG101, CFG70, OCFG101, OCFG-101-12600025, OCFG70, OCFG-70-12600000, OPCG41, OPCG-41-12600010, OPCG61			
spare parts for 101693			
	GEV No.	100552	Ref. No. 1884200 BN6A023721
bypass nozzle type PEL20/21 bore ø 0.7mm thread M5x0.5			
	GEV No.	101060	Ref. No. —
magnet unit standard L 39mm D1 ø 15.4mm D2 ø 11mm suitable for PEL20-21/JUNKERS/EGA			
	GEV No.	101230	Ref. No. —
thermocouple nut T1: M8x1 T2: M18x1 aluminium			
	GEV No.	101877	Ref. No. —
gas tap front part shaft ø 6x4.6mm type PEL21			

Table continues overleaf



accessories for 101913				
	GEV No.	100908	Ref. No.	673500 6A016110 6A017000 A016110 A017000 BN6A016110 BN6A017000 MA673500
union screw thread M10x1 for pipe ø 4mm Qty 1 pcs				
	GEV No.	100909	Ref. No.	—
union screw thread M10x1 for pipe ø 6mm Qty 1 pcs				
	GEV No.	101246	Ref. No.	673600 6A016120 A016120 MA673600
olive for pipe ø 4mm Qty 1 pcs				
	GEV No.	101278	Ref. No.	6A011480 86720 A011480 BN6A011480 MA86720
olive for pipe ø 10mm Qty 1 pcs				
	GEV No.	101286	Ref. No.	—
olive ID ø 6mm Qty 1 pcs				
	GEV No.	101300	Ref. No.	1326500 6A011485 A011485 BN6A011485
union nut thread M16x1.5 tube ø 10mm				
	GEV No.	101450	Ref. No.	—
olive for pipe ø 8mm L 12.7mm Qty 1 pcs ED ø 10mm				
	GEV No.	101451	Ref. No.	—
union nut thread M16x1.5 tube ø 8mm				
	GEV No.	110078	Ref. No.	—
knob without symbol ø 70mm shaft ø 6x4.6mm shaft flat universal				
	GEV No.	112206	Ref. No.	—
knob dial plate silver gas tap PEL21/22/23 t.max.°C ED ø 63mm ID ø 45.5mm				





22S/O series















				
1				
GEV No.	101086	Ref. No.	6A011500 BN6A011500	
description	gas tap PEL type 22S/O gas inlet M20x1.5 (tube ø 12mm) bypass nozzle ø 0.35mm gas outlet M20x1.5 (tube ø 12/10mm) thermocouple connection M9x1 pilot connection M10x1 shaft ø 10x8mm shaft L 25/17mm shaft flat lower			
For models:	2FX+PCF, 31FOGV-1950001, 31FOGV-1950002, 31FOGVG-1000003, 31FOGVM-1000007, 32FOGV2-1000002, 32FOGVG-1000004, 32FOGVM-1000015, 4FX+PCF, 716CTG-000195, 716CTGV-000195, 72+2CTGG-12700013, 72-02CPG, 72-02CPG-12700900, 72-02PLG, 72-02PLG-12700850, 72-02PLG-12700850TA, 72-02TPLG, 72-02TPLG-12730850, 72-02TPLG-12730850TA, 729CAGV-000009, 729CAGV-1950009, 729CAGV-1950009R, 729TCGV-1959009, 729TCGV-1959009R, 72CAGV-000010, 74+2CTGGAN-12700025, 74-02+2CTGG, 74-02+2CTGG-12700030, 74-02CPG, 74-02CPG-12700905, 74-02CPG-12700905TA, 74-02CTG, 74-02CTG-12700170, 74-02CTG-12700170TA, 74-02CTGE, 74-02CTGE-12700190, 74-02CTGE-12700190TA, 74-02CTGG, 74-02CTGG-12700180, 74-02CTGG-12700180TA, 74-02PLG, 74-02PLG-12700855, 74-02PLG-12700855TA, 74-02TCTG, 74-02TCTG-12730170, 74-02TCTG-12730170TA, 74-02TPLG, 74-02TPLG-12730855, 74-02TPLG-12730855TA...(Other models you can see in the webshop)			
spare parts for	101086			
	GEV No.	100259	Ref. No.	—
bypass nozzle type PEL22 bore ø 0.35mm thread M6x0.5				
	GEV No.	101058	Ref. No.	—
magnet unit L 39mm D1 ø 15.4mm D2 ø 13.5mm suitable for PEL22/EGA24197 standard				
	GEV No.	101201	Ref. No.	—
gas tap front part shaft ø 10x8mm shaft L 25/17mm shaft flat upper/lower suitable for PEL22				
	GEV No.	101231	Ref. No.	—
thermocouple nut T1: M9x1 T2: M18x1				
	GEV No.	101240	Ref. No.	—
gas connection thread M20x1.5 tube ø 12/10mm for PEL gas taps with gasket and screws horizontal				
	GEV No.	101460	Ref. No.	—
O-ring ø 12.37mm D1 ø 2.62mm suitable for PEL22				
accessories for 101086				
	GEV No.	100908	Ref. No.	673500 6A016110 6A017000 A016110 A017000 BN6A016110 BN6A017000 MA673500
union screw thread M10x1 for pipe ø 4mm Qty 1 pcs				
	GEV No.	100909	Ref. No.	—
union screw thread M10x1 for pipe ø 6mm Qty 1 pcs				
	GEV No.	101241	Ref. No.	—
gas connection thread M20x1.5 tube ø 12/10mm for PEL gas taps vertical				
	GEV No.	101246	Ref. No.	673600 6A016120 A016120 MA673600
olive for pipe ø 4mm Qty 1 pcs				

Table continues overleaf

accessories for		101086	
	GEV No.	101248	Ref. No. —
olive for pipe ø 12mm Qty 1 pcs suitable for PEL			
	GEV No.	101249	Ref. No. 673400 6A011470 A011470 BN6A011470
olive for pipe ø 10mm Qty 1 pcs			
	GEV No.	101250	Ref. No. 6A011475 A011475 BN6A011475
union nut thread M20x1.5 for pipe ø 10mm			
	GEV No.	101251	Ref. No. 6A016200 A016200 BN6A016200
union nut thread M20x1.5 for pipe ø 12mm			
	GEV No.	101286	Ref. No. —
olive ID ø 6mm Qty 1 pcs			
	GEV No.	110080	Ref. No. —
knob ø 70mm shaft ø 10x8mm shaft flat universal			
	GEV No.	112206	Ref. No. —
knob dial plate silver gas tap PEL21/22/23 t.max.°C ED ø 63mm ID ø 45.5mm			

23S/O series

			
1			
GEV No.	101092	Ref. No.	6A013600 BN6A013600
description	gas tap PEL type 23S/O gas inlet M28x1.5 (tube ø 20mm) bypass nozzle ø 0.35mm gas outlet M24x1.5 (tube ø 16mm) thermocouple connection M10x1 pilot connection M10x1 shaft ø 10x8mm shaft L 25/17mm shaft flat upper		
For models:	714CTGV-000190, 714CT-GV-1000170, 714CTGV-1000170, 714CT-GV-1000170R, 714CT-GVFE-1000180, 714CTGVFE-1000180, 714CT-GVFE-1000180R, 714TAGV-000190, 714TA-GV-1000190, 714TA-GV-1000190R, 716CTG-000195, 716CTGV-000195, 769CT-GV-1950194, 769CTGV-1950194, 769CT-GV-1950194R, 910PG-1191810, 910PG-191810, 910PGB-1191800, 910PGB-191800, 911PGB-1191805, 911RPGB-1391830, 914PCTGE-1103721, 914PCTGG-1103711, 914PTCTG-1103791, 915PG-1191815, 915PG-191815, 92-04CPG, 92-04CPG-12900900, 92-04CPG-12900900TA, 92-04PLG, 92-04PLG-12900850, 92-04PLG-12900850TA, 92-04TPLG, 92-04TPLG-12930850, 92-04TPLG-12930850TA, 94-04CPG, 94-04CPG-12900905, 94-04CPG-12900905TA, 94-04CTG-12900170TA, 94-04CTGE-12900190TA, 94-04CTGG-12900180TA, 94-04CTGGSS, 94-04CTGSS, 94-04PLG, 94-04PLG-12900855, 94-04PLG-12900855TA, 94-04TCTG-12930170TA, 94-04TCTGSS, 94-04TPLG, 94-04TPLG-12930855...(Other models you can see in the webshop)		
spare parts for		101092	
	GEV No.	100455	Ref. No. —
bypass nozzle type PEL23/24 bore ø 0.35mm thread M8x0.5			
	GEV No.	101059	Ref. No. —
magnet unit T1: M10x1 T2: M22x1 L 46mm ø 18mm suitable for PEL23S M10x1			
	GEV No.	101204	Ref. No. —
gas tap front part shaft ø 10x8mm shaft L 25/17mm shaft flat upper/lower suitable for PEL23S			

spare parts for		101092	
	GEV No.	101244	Ref. No. —
gas connection thread M24x1.5 tube ø 12/16mm horizontal for PEL gas taps			
	GEV No.	101463	Ref. No. —
screw suitable for PEL23S Qty 4 pcs			
	GEV No.	528455	Ref. No. —
O-ring Viton thickness 2.62mm ID ø 18.72mm Qty 1 pcs			
accessories for		101092	
	GEV No.	100908	Ref. No. 673500 6A016110 6A017000 A016110 A017000 BN6A016110 BN6A017000 MA673500
union screw thread M10x1 for pipe ø 4mm Qty 1 pcs			
	GEV No.	100909	Ref. No. —
union screw thread M10x1 for pipe ø 6mm Qty 1 pcs			
	GEV No.	101246	Ref. No. 673600 6A016120 A016120 MA673600
olive for pipe ø 4mm Qty 1 pcs			
	GEV No.	101252	Ref. No. —
union nut thread M24x1.5 for pipe ø 12mm			
	GEV No.	101253	Ref. No. —
union nut thread M24x1.5 PEL for pipe ø 16mm			
	GEV No.	101254	Ref. No. —
union nut thread M28x1.5 tube ø 20mm			
	GEV No.	101255	Ref. No. —
olive for pipe ø 12mm Qty 1 pcs			
	GEV No.	101256	Ref. No. —
olive for pipe ø 16mm Qty 1 pcs			
	GEV No.	101257	Ref. No. —
olive for pipe ø 20mm Qty 1 pcs			
	GEV No.	101286	Ref. No. —
olive ID ø 6mm Qty 1 pcs			
	GEV No.	110080	Ref. No. —
knob ø 70mm shaft ø 10x8mm shaft flat universal			
	GEV No.	112206	Ref. No. —
knob dial plate silver gas tap PEL21/22/23 t.max.°C ED ø 63mm ID ø 45.5mm			



gas thermostats

SIT





630 Eurosit series

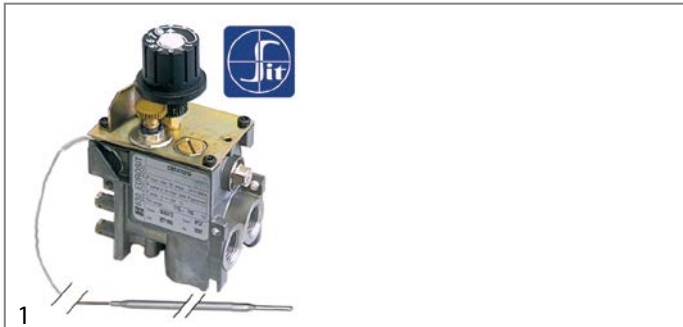

GEV No.	107688	Ref. No.	CR0585671
description	gas thermostat 100-340°C gas inlet 3/8" gas outlet 3/8" thermocouple connection M9x1 pilot connection M10x1 probe ø 4mm probe L 72mm capillary pipe 1050mm		



GEV No.	101188	Ref. No.	2590083 8219900 MACM097000
description	gas thermostat type 630 Eurosit series t.max. 190°C 110-190°C gas inlet 3/8" gas outlet 3/8" thermocouple connection M9x1 pilot connection M10x1 probe ø 4mm probe L 202mm capillary pipe 1050mm SIT		
For models:	40SGFR, 40SGFR-1826160, 40SGFR2S-1826160, 55-45FRG, 55-90FRG, 60SGFR, 60SGFR-1826170, 60SGFR2S-1826170, 72-02FRG, 72-02FRG-12700500, 72-02FRG17-12700505, 73-02FRG, 73-02FRG-12700550, 74-02FRG, 74-02FRG-12700600, 74-02FRG17-12700605, 7FRI-G415, 7FRI-G610, 7FRI-G815, 9122PFRG-1103930, 92-04FRG15L, 92-04FRG15L-12900510, 92-04FRG17L-12900515, 922FRG-1191930, 922RFRG-1391930, 93-04FRG, 93-04FRG-12900550, 93-04FRG-12900550H, 9FRI-G415, 9FRI-G610, 9FRI-G815		

accessories for	101188		
	GEV No.	100904	Ref. No. 1394700 6A011608 A011608 BN6A011608 MA1394700
locking screw M10x1 for pipe ø 4mm Qty 1 pcs			
	GEV No.	100905	Ref. No. 6A011705 A011705 BN6A011705
locking screw M10x1 for pipe ø 6mm Qty 1 pcs			
	GEV No.	101273	Ref. No. 417810 6A011625 A011625 MA417810
olive for pipe ø 12mm L 9.5mm brass Qty 1 pcs suitable for universal			
	GEV No.	101276	Ref. No. 459300 6A011620 A011620
union screw thread 3/8" tube ø 12mm Qty 1 pcs			

accessories for	101188		
	GEV No.	101333	Ref. No. 1888200 8219951 MA1888200
plug thread 3/8" with O-ring			

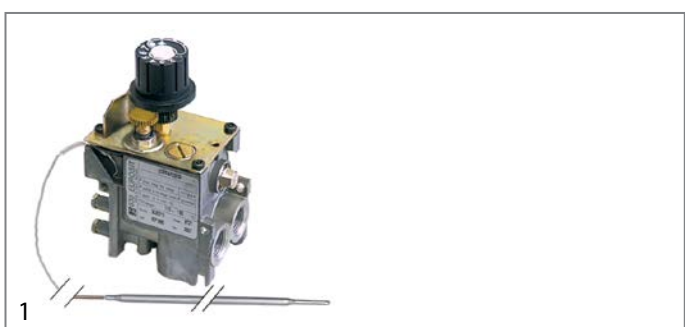



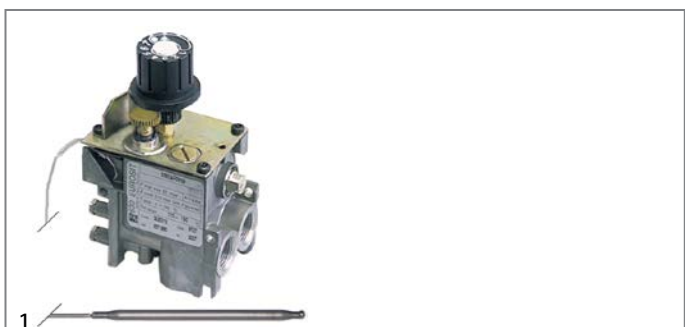

GEV No.	103076	Ref. No.	CR0508680
description	gas thermostat type 630 Eurosit series t.max. 190°C 110-190°C gas inlet 3/8" gas outlet 3/8" thermocouple connection M9x1 pilot connection M10x1 probe ø 4mm probe L 202mm capillary pipe 1050mm SIT		
For models:	FQG41, FQG61, OFQG41, OFQG-41-12600500, OFQG61, OFQG-61-12600600		



GEV No.	101409	Ref. No.	1031504800
description	gas thermostat type 630 Eurosit series t.max. 280°C 40-280°C gas inlet 3/8" gas outlet 3/8" thermocouple connection M9x1 pilot connection M10x1 probe ø 4mm probe L 72mm capillary pipe 1050mm SIT		
For models:	OFTG40BLC, OFTG-40BLC-12600135, OFTG60BLC, OFTG-60BLC-12600145, OFTG80BLC, OFTG-80BLC-12600138		

accessories for	101409		
	GEV No.	101333	Ref. No. 1888200 8219951 MA1888200
plug thread 3/8" with O-ring			

accessories for	101409		
	GEV No.	100904	Ref. No. 1394700 6A011608 A011608 BN6A011608 MA1394700
locking screw M10x1 for pipe ø 4mm Qty 1 pcs			
	GEV No.	100905	Ref. No. 6A011705 A011705 BN6A011705
locking screw M10x1 for pipe ø 6mm Qty 1 pcs			
	GEV No.	101273	Ref. No. 417810 6A011625 A011625 MA417810
olive for pipe ø 12mm L 9.5mm brass Qty 1 pcs suitable for universal			
	GEV No.	101276	Ref. No. 459300 6A011620 A011620
union screw thread 3/8" tube ø 12mm Qty 1 pcs			

1 gas components

			
GEV No.	101915	Ref. No.	26920012 BN826920012
description	gas thermostat type 630 Eurosit series t.max. 320°C 80-320°C gas inlet 3/8" gas outlet 3/8" thermocouple connection M9x1 pilot connection M10x1 probe ø 4mm probe L 72mm capillary pipe 1050mm SIT		
accessories for	101915		
	GEV No.	100825	Ref. No. —
gas tap spindle shaft ø 8x6.5mm shaft L 22/14mm suitable for EUROSIT			
	GEV No.	100904	Ref. No. 1394700 6A011608 A011608 BN6A011608 MA1394700
locking screw M10x1 for pipe ø 4mm Qty 1 pcs			
	GEV No.	100905	Ref. No. 6A011705 A011705 BN6A011705
locking screw M10x1 for pipe ø 6mm Qty 1 pcs			
	GEV No.	100949	Ref. No. —
gasket suitable for 630 Eurosit series			
	GEV No.	101273	Ref. No. 417810 6A011625 A011625 MA417810
olive for pipe ø 12mm L 9.5mm brass Qty 1 pcs suitable for universal			
	GEV No.	101276	Ref. No. 459300 6A011620 A011620
union screw thread 3/8" tube ø 12mm Qty 1 pcs			
	GEV No.	101333	Ref. No. 1888200 8219951 MA1888200
plug thread 3/8" with O-ring			
	GEV No.	101390	Ref. No. —
gas tap spindle shaft ø 6x4.6mm shaft L 32/15mm gas tap with ignition flame suitable for ZANUSSI, MARENO for gas thermostat EUROSIT			
	GEV No.	101392	Ref. No. —
adapter suitable for 630 Eurosit series			
	GEV No.	110357	Ref. No. —
gas tap spindle shaft ø 8x6.5mm shaft L 36/12mm suitable for 630 Eurosit series			
	GEV No.	110358	Ref. No. —
adapter shaft ø 10x8mm shaft L 29/18mm suitable for 630 Eurosit series			













			
GEV No.	101125	Ref. No.	1887600 8219950 MA1887600
description	gas thermostat type 630 Eurosit series t.max. 340°C 100-340°C gas inlet 3/8" gas outlet 3/8" thermocouple connection M9x1 pilot connection M10x1 probe ø 4mm probe L 72mm capillary pipe 1050mm SIT		
For models:	110-135CGG, 110-135CGG2P, 110-135CGGE, 110-135CGGE2P, 110-135CGGEP, 110-135CGGP, 110-90CGG, 110-90CGG1P, 110-90CGGP, 110-90CTGG, 110-90FTTG, 110-90FTTG1-2R, 110-90FTTGC, 110-90FTTGC1-2R, 110-90FTTGC2R, 110-90FTTGE, 110-90FTTGG, 110-90FTTGR, 110-90FTTGG1-2R, 110-90FTTGG2R, 110-90FTTGC1-2R, 110-90FTTGC2R, 110-90FTTGR, 2FX+PCF, 40SGFT, 40SGFT-1825020, 40SGFT, 40SGFT-1825025, 40SGFT, 40SGFT-1825021, 4FX+PCF, 60SGFT, 60SGFT1-2R-1825031, 60SGFT1-3R-1825030, 60SGFT-1825030, 60SGFT, 60SGFT-1825035, 60SGFT-1825032, 72+2CTGG-12700013, 72-02FTG, 72-02FTG-12700130TA, 72-02FTG-12700300, 72-02FTG-12700300TA, 72-02FTGC-12700135, 72-02FTGC-12700135TA, 72-02FTGCVAL, 72-02FTGR, 72-02FTGR-12700132TA, 72-02FTGR-12700300... (Other models you can see in the webshop)		
accessories for	101125		
	GEV No.	100825	Ref. No. —
gas tap spindle shaft ø 8x6.5mm shaft L 22/14mm suitable for EUROSIT			
	GEV No.	100904	Ref. No. 1394700 6A011608 A011608 BN6A011608 MA1394700
locking screw M10x1 for pipe ø 4mm Qty 1 pcs			
	GEV No.	100905	Ref. No. 6A011705 A011705 BN6A011705
locking screw M10x1 for pipe ø 6mm Qty 1 pcs			
	GEV No.	100949	Ref. No. —
gasket suitable for 630 Eurosit series			
	GEV No.	101273	Ref. No. 417810 6A011625 A011625 MA417810
olive for pipe ø 12mm L 9.5mm brass Qty 1 pcs suitable for universal			
	GEV No.	101276	Ref. No. 459300 6A011620 A011620
union screw thread 3/8" tube ø 12mm Qty 1 pcs			
	GEV No.	101333	Ref. No. 1888200 8219951 MA1888200
plug thread 3/8" with O-ring			
	GEV No.	101390	Ref. No. —
gas tap spindle shaft ø 6x4.6mm shaft L 32/15mm gas tap with ignition flame suitable for ZANUSSI, MARENO for gas thermostat EUROSIT			
	GEV No.	101392	Ref. No. —
adapter suitable for 630 Eurosit series			







Table continues overleaf

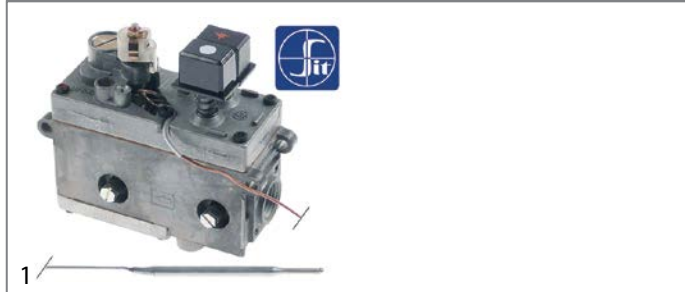

accessories for 101125	
	GEV No. 110357 Ref. No. — gas tap spindle shaft ø 8x6.5mm shaft L 36/12mm suitable for 630 Eurosit series
	GEV No. 110358 Ref. No. — adapter shaft ø 10x8mm shaft L 29/18mm suitable for 630 Eurosit series









710 Minisit series



GEV No.	101135	Ref. No.	9000150 BN4185327020200 BN9000150 MA1393200
description	gas thermostat SIT type MINISIT 710 t.max. 190°C 110-190°C gas inlet 1/2" gas outlet 3/8" thermocouple connection M9x1 pilot connection M10x1 probe ø 6mm probe L 102mm capillary pipe 1050mm probe type type A3 pressure controller no pressure regulator mbar gland nut		
For models:	710FRG-077300, 710FRG-1077300, 710FR-G-1077350, 710FR-G-1077350R, 712FRG-077500, 712FR-G-1077550, 712FRG-1077550, 712FR-G-1077550R, 720FRG-077400, 720FRG-1077400, 720FR-G-1077450, 720FRG-1077450, 720FR-G-1077450R, 720FR-G-1077650, 722FRG-077600, 722FRG-1077600, 722FR-G-1077650R, FR-G925N-1050731, FR-G950N-1050733		
spare parts for 101135			
	GEV No. 101053 Ref. No. —	magnet unit T1: M9x1 T2: M24x1 L 45mm ø 17mm suitable for Minisit	
	GEV No. 102118 Ref. No. —	probe 110-190°C probe ø 6mm probe L 102mm capillary pipe 1050mm t.max. 190°C fryer probe type type A3 suitable for MINISIT 710	
accessories for 101135			
	GEV No. 100809 Ref. No. 1394000 6A011606 A011606 BN6A011606	O-ring EPDM thickness 2mm ID ø 21mm Qty 1 pcs	
	GEV No. 100820 Ref. No. —	gland duct ET M14x1.5 IT M10x0.75 probe ø max. 6.5mm WS 22	
	GEV No. 100904 Ref. No. 1394700 6A011608 A011608 BN6A011608 MA1394700	locking screw M10x1 for pipe ø 4mm Qty 1 pcs	
	GEV No. 100905 Ref. No. 6A011705 A011705 BN6A011705	locking screw M10x1 for pipe ø 6mm Qty 1 pcs	
	GEV No. 101054 Ref. No. —	magnet unit T1: M10x1 T2: M24x1 L 45mm ø 17mm suitable for Minisit	

accessories for 101135			
	GEV No. 101136 Ref. No. 6A011603 6A011610 A011603 A011610 BN6A011603	piezoelectric igniter suitable for Minisit with cover cap ømm connection F6.3x0.8	
	GEV No. 101137 Ref. No. —	cover cap without piezoelectric igniter	
	GEV No. 101267 Ref. No. —	reducer IT 3/8" ET 1/2" L 21mm	
	GEV No. 101268 Ref. No. —	gas connection thread 3/8" angled with O-ring MINISIT 710	
	GEV No. 101269 Ref. No. 1393900	gas connection thread 1/2" angled with O-ring MINISIT 710	
	GEV No. 101270 Ref. No. —	screw connection IT 3/8" ET 3/8" L 28mm	
	GEV No. 101272 Ref. No. —	screw connection IT 1/2" ET 3/8" L 57mm	
	GEV No. 101273 Ref. No. 417810 6A011625 A011625 MA417810	olive for pipe ø 12mm L 9.5mm brass Qty 1 pcs suitable for universal	
	GEV No. 101274 Ref. No. —	olive for pipe ø 16mm Qty 1 pcs	
	GEV No. 101275 Ref. No. —	union screw thread 1/2" for pipe ø 16mm Qty 1 pcs	
	GEV No. 101276 Ref. No. 459300 6A011620 A011620	union screw thread 3/8" tube ø 12mm Qty 1 pcs	
	GEV No. 110068 Ref. No. 6A011602 A011602 BN6A011602	knob suitable for Minisit ø 37mm	

			
GEV No.	101437	Ref. No.	1393300
description	gas thermostat SIT type MINISIT 710 t.max. 190°C 110-190°C gas inlet 1/2" gas outlet 3/8" thermocouple connection M9x1 pilot connection M10x1 probe ø 6mm probe L 102mm capillary pipe 1050mm probe type type A3 pressure controller yes pressure regulator 3-18mbar gland nut		
For models:	FQG40, FQG60		
spare parts for	101437		
	GEV No.	101053	Ref. No. —
	magnet unit T1: M9x1 T2: M24x1 L 45mm ø 17mm suitable for Minisit		
	GEV No.	102118	Ref. No. —
	probe 110-190°C probe ø 6mm probe L 102mm capillary pipe 1050mm t.max. 190°C fryer probe type type A3 suitable for MINISIT 710		
accessories for	101437		
	GEV No.	100809	Ref. No. 1394000 6A011606 A011606 BN6A011606
	O-ring EPDM thickness 2mm ID ø 21mm Qty 1 pcs		
	GEV No.	100820	Ref. No. —
	gland duct ET M14x1.5 IT M10x0.75 probe ø max. 6.5mm WS 22		
	GEV No.	100904	Ref. No. 1394700 6A011608 A011608 BN6A011608 MA1394700
	locking screw M10x1 for pipe ø 4mm Qty 1 pcs		
	GEV No.	100905	Ref. No. 6A011705 A011705 BN6A011705
	locking screw M10x1 for pipe ø 6mm Qty 1 pcs		
	GEV No.	101054	Ref. No. —
	magnet unit T1: M10x1 T2: M24x1 L 45mm ø 17mm suitable for Minisit		
	GEV No.	101136	Ref. No. 6A011603 6A011610 A011603 A011610 BN6A011603
	piezoelectric igniter suitable for Minisit with cover cap ømm connection F6.3x0.8		
	GEV No.	101137	Ref. No. —
	cover cap without piezoelectric igniter		
	GEV No.	101267	Ref. No. —
	reducer IT 3/8" ET 1/2" L 21mm		
	GEV No.	101268	Ref. No. —
	gas connection thread 3/8" angled with O-ring MINISIT 710		

accessories for	101437		
	GEV No.	101269	Ref. No. 1393900
	gas connection thread 1/2" angled with O-ring MINISIT 710		
	GEV No.	101270	Ref. No. —
	screw connection IT 3/8" ET 3/8" L 28mm		
	GEV No.	101272	Ref. No. —
	screw connection IT 1/2" ET 3/8" L 57mm		
	GEV No.	101273	Ref. No. 417810 6A011625 A011625 MAA17810
	olive for pipe ø 12mm L 9.5mm brass Qty 1 pcs suitable for universal		
	GEV No.	101274	Ref. No. —
	olive for pipe ø 16mm Qty 1 pcs		
	GEV No.	101275	Ref. No. —
	union screw thread 1/2" for pipe ø 16mm Qty 1 pcs		
	GEV No.	101276	Ref. No. 459300 6A011620 A011620
	union screw thread 3/8" tube ø 12mm Qty 1 pcs		
	GEV No.	110068	Ref. No. 6A011602 A011602 BN6A011602
	knob suitable for Minisit ø 37mm		



			
GEV No.	101132	Ref. No.	1011700 6A011700 6A011701 BN6A011701 MA1393100
description	gas thermostat SIT type MINISIT 710 t.max. 340°C 100-340°C gas inlet 1/2" gas outlet 3/8" thermocouple connection M9x1 pilot connection M10x1 probe ø 5mm probe L 68mm capillary pipe 1050mm probe type type B1 pressure controller no pressure regulator mbar gland nut ignition gas no		
For models:	714CTGV-000190, 714CT-GV-1000170, 714CTGV-1000170, 714CT-GV-1000170R, 714TAGV-000190, 716CTG-000195, 716CTGV-000195, 749CGV-000039, 749CGV-1950039, 749CGV-1950039R, 74CGV-000040, 769CGV-000049, 769CGV-1950049, 769CGV-1950049R, 769CGVAC-1950079, 769CGVAC-1950079R, 769CGVFL-000069, 769CGVFL-1950069, 769CGVFL-1950069R, 769CT-GV-1950194, 769CTGV-1950194, 769CT-GV-1950194R, 76CGV-000050, 76CGVFL-000070, 914PCGG-1103214, 914PCTGG-1103711, 914PFTGG-1103413, 914PFTGG-1103415, 916PCGGAN-1103216, 916PCGGE-1103236, 918PCGG-1103218, 92FG-1191220, 941CTGG-1291710, 941FTGG-1291412, 941FTGG1-2R-1291512, 941FTGG1-2R-1291612, 941FTGG-1291414, 941FTGG1-2R-1291415, 941FTG-GR-1291512, 94CGG-1191214, 94CGG-191214, 94CTGG-1191710, 94CTGG-191710, 96CGG-1191216, 96CGG-191216, 96CGG-191236, 96CGGAC-1191236, 96CGGE-1191236, 96CTGG-1191712, 96CTGG-191712...(Other models you can see in the webshop)		
spare parts for	101132		
	GEV No.	101053	Ref. No. —
	magnet unit T1: M9x1 T2: M24x1 L 45mm ø 17mm suitable for Minisit		

Table continues overleaf



spare parts for 101132				
	GEV No.	102102	Ref. No.	6A011709 A011709 BN6A011709
probe 100-340°C probe ø 5mm probe L 68mm capillary pipe 1750mm t.max. 340°C oven/grill probe type type B1 suitable for MINISIT 710				
accessories for 101132				
	GEV No.	100809	Ref. No.	1394000 6A011606 A011606 BN6A011606
O-ring EPDM thickness 2mm ID ø 21mm Qty 1 pcs				
	GEV No.	100904	Ref. No.	1394700 6A011608 A011608 BN6A011608 MA1394700
locking screw M10x1 for pipe ø 4mm Qty 1 pcs				
	GEV No.	100905	Ref. No.	6A011705 A011705 BN6A011705
locking screw M10x1 for pipe ø 6mm Qty 1 pcs				
	GEV No.	101054	Ref. No.	—
magnet unit T1: M10x1 T2: M24x1 L 45mm ø 17mm suitable for Minisit				
	GEV No.	101136	Ref. No.	6A011603 6A011610 A011603 A011610 BN6A011603
piezoelectric igniter suitable for Minisit with cover cap ømm connection F6.3x0.8				
	GEV No.	101137	Ref. No.	—
cover cap without piezoelectric igniter				
	GEV No.	101267	Ref. No.	—
reducer IT 3/8" ET 1/2" L 21mm				
	GEV No.	101268	Ref. No.	—
gas connection thread 3/8" angled with O-ring MINISIT 710				
	GEV No.	101269	Ref. No.	1393900
gas connection thread 1/2" angled with O-ring MINISIT 710				
	GEV No.	101270	Ref. No.	—
screw connection IT 3/8" ET 3/8" L 28mm				
	GEV No.	101272	Ref. No.	—
screw connection IT 1/2" ET 3/8" L 57mm				
	GEV No.	101273	Ref. No.	417810 6A011625 A011625 MA417810
olive for pipe ø 12mm L 9.5mm brass Qty 1 pcs suitable for universal				
	GEV No.	101274	Ref. No.	—
olive for pipe ø 16mm Qty 1 pcs				
	GEV No.	101275	Ref. No.	—
union screw thread 1/2" for pipe ø 16mm Qty 1 pcs				
	GEV No.	101276	Ref. No.	459300 6A011620 A011620
union screw thread 3/8" tube ø 12mm Qty 1 pcs				
	GEV No.	110068	Ref. No.	6A011602 A011602 BN6A011602
knob suitable for Minisit ø 37mm				











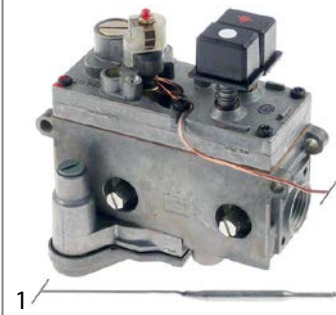



				
GEV No.	101438	Ref. No.	6A011601 SIR0100855	
description	gas thermostat SIT type MINISIT 710 t.max. 340°C 100-340°C gas inlet 1/2" gas outlet 3/8" thermocouple connection M9x1 pilot connection M10x1 probe ø 5mm probe L 68mm capillary pipe 1050mm probe type type B1 pressure controller yes pressure regulator 3-18mbar gland nut			
For models:	96CGG-191236, C-GV904-1050110, C-GV906-1050120, C-GV908-1050130, CT-GV904-1050220, FT-G940-1050530, FT-G940-1050531, FT-G980-1050540, FT-G980-1050541, FT-G980R1-2-1050542			
spare parts for 101438				
	GEV No.	101053	Ref. No.	—
magnet unit T1: M9x1 T2: M24x1 L 45mm ø 17mm suitable for Minisit				
	GEV No.	102102	Ref. No.	6A011709 A011709 BN6A011709
probe 100-340°C probe ø 5mm probe L 68mm capillary pipe 1750mm t.max. 340°C oven/grill probe type type B1 suitable for MINISIT 710				
accessories for 101438				
	GEV No.	100809	Ref. No.	1394000 6A011606 A011606 BN6A011606
O-ring EPDM thickness 2mm ID ø 21mm Qty 1 pcs				
	GEV No.	100904	Ref. No.	1394700 6A011608 A011608 BN6A011608 MA1394700
locking screw M10x1 for pipe ø 4mm Qty 1 pcs				
	GEV No.	100905	Ref. No.	6A011705 A011705 BN6A011705
locking screw M10x1 for pipe ø 6mm Qty 1 pcs				
	GEV No.	101054	Ref. No.	—
magnet unit T1: M10x1 T2: M24x1 L 45mm ø 17mm suitable for Minisit				
	GEV No.	101136	Ref. No.	6A011603 6A011610 A011603 A011610 BN6A011603
piezoelectric igniter suitable for Minisit with cover cap ømm connection F6.3x0.8				
	GEV No.	101137	Ref. No.	—
cover cap without piezoelectric igniter				
	GEV No.	101267	Ref. No.	—
reducer IT 3/8" ET 1/2" L 21mm				
	GEV No.	101268	Ref. No.	—
gas connection thread 3/8" angled with O-ring MINISIT 710				

Table continues overleaf

accessories for		101438	
	GEV No.	101269	Ref. No. 1393900
gas connection thread 1/2" angled with O-ring MINISIT 710			
	GEV No.	101270	Ref. No. —
screw connection IT 3/8" ET 3/8" L 28mm			
	GEV No.	101272	Ref. No. —
screw connection IT 1/2" ET 3/8" L 57mm			
	GEV No.	101273	Ref. No. 417810 6A011625 A011625 MA417810
olive for pipe ø 12mm L 9.5mm brass Qty 1 pcs suitable for universal			
	GEV No.	101274	Ref. No. —
olive for pipe ø 16mm Qty 1 pcs			
	GEV No.	101275	Ref. No. —
union screw thread 1/2" for pipe ø 16mm Qty 1 pcs			
	GEV No.	101276	Ref. No. 459300 6A011620 A011620
union screw thread 3/8" tube ø 12mm Qty 1 pcs			
	GEV No.	110068	Ref. No. 6A011602 A011602 BN6A011602
knob suitable for Minisit ø 37mm			

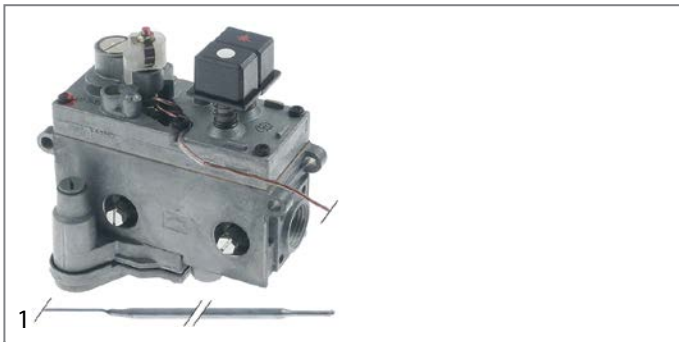



GEV No.	101088	Ref. No.	6A012501 MA1031501100
description	gas thermostat with pressure controller SIT type MINISIT 710 t.max. 100°C 30-100°C gas inlet 1/2" gas outlet 3/8" thermocouple connection M9x1 pilot connection M10x1 probe ø 5mm probe L 125mm capillary pipe 1050mm probe type type A1 pressure controller yes pressure regulator 3-18mbar gland nut		
spare parts for	101088		
	GEV No.	101053	Ref. No. —
magnet unit T1: M9x1 T2: M24x1 L 45mm ø 17mm suitable for Minisit			
	GEV No.	102100	Ref. No. —
probe 30-100°C probe ø 5mm probe L 122mm capillary pipe 1050mm t.max. 100°C bain marie probe type type A1 suitable for MINISIT 710			
accessories for	101088		
	GEV No.	100809	Ref. No. 1394000 6A011606 A011606 BN6A011606
O-ring EPDM thickness 2mm ID ø 21mm Qty 1 pcs			
	GEV No.	100820	Ref. No. —
gland duct ET M14x1.5 IT M10x0.75 probe ø max. 6.5mm WS 22			

accessories for		101088	
	GEV No.	100904	Ref. No. 1394700 6A011608 A011608 BN6A011608 MA1394700
locking screw M10x1 for pipe ø 4mm Qty 1 pcs			
	GEV No.	100905	Ref. No. 6A011705 A011705 BN6A011705
locking screw M10x1 for pipe ø 6mm Qty 1 pcs			
	GEV No.	101054	Ref. No. —
magnet unit T1: M10x1 T2: M24x1 L 45mm ø 17mm suitable for Minisit			
	GEV No.	101136	Ref. No. 6A011603 6A011610 A011603 A011610 BN6A011603
piezoelectric igniter suitable for Minisit with cover cap ømm connection F6.3x0.8			
	GEV No.	101137	Ref. No. —
cover cap without piezoelectric igniter			
	GEV No.	101267	Ref. No. —
reducer IT 3/8" ET 1/2" L 21mm			
	GEV No.	101268	Ref. No. —
gas connection thread 3/8" angled with O-ring MINISIT 710			
	GEV No.	101269	Ref. No. 1393900
gas connection thread 1/2" angled with O-ring MINISIT 710			
	GEV No.	101270	Ref. No. —
screw connection IT 3/8" ET 3/8" L 28mm			
	GEV No.	101272	Ref. No. —
screw connection IT 1/2" ET 3/8" L 57mm			
	GEV No.	101273	Ref. No. 417810 6A011625 A011625 MA417810
olive for pipe ø 12mm L 9.5mm brass Qty 1 pcs suitable for universal			
	GEV No.	101274	Ref. No. —
olive for pipe ø 16mm Qty 1 pcs			
	GEV No.	101275	Ref. No. —
union screw thread 1/2" for pipe ø 16mm Qty 1 pcs			
	GEV No.	101276	Ref. No. 459300 6A011620 A011620
union screw thread 3/8" tube ø 12mm Qty 1 pcs			
	GEV No.	110680	Ref. No. —
knob graduated Min/Max ø 82mm shaft ø 6x4.6mm shaft flat upper black			



			
GEV No.	101131	Ref. No.	1031500300
description	gas thermostat without cap, button and angle SIT type MINISIT 710 t.max. 190°C 50-190°C gas inlet 1/2" gas outlet 3/8" thermocouple connection M9x1 pilot connection M10x1 probe ø 5mm probe L 98mm capillary pipe 1200mm probe type type A2 pressure controller no pressure regulator mbar gland nut		
For models:	OPCG41, OPCG61		
spare parts for	101131		
	GEV No.	101053	Ref. No. —
	magnet unit T1: M9x1 T2: M24x1 L 45mm ø 17mm suitable for Minisit		
	GEV No.	102103	Ref. No. 6A015201 A015201 BN6A015201
	probe 60-200°C probe ø 5mm probe L 98mm capillary pipe 1050mm t.max. 200°C fryer probe type type A2 suitable for MINISIT 710		
accessories for	101131		
	GEV No.	100809	Ref. No. 1394000 6A011606 A011606 BN6A011606
	O-ring EPDM thickness 2mm ID ø 21mm Qty 1 pcs		
	GEV No.	100820	Ref. No. —
	gland duct ET M14x1.5 IT M10x0.75 probe ø max. 6.5mm WS 22		
	GEV No.	100904	Ref. No. 1394700 6A011608 A011608 BN6A011608 MA1394700
	locking screw M10x1 for pipe ø 4mm Qty 1 pcs		
	GEV No.	100905	Ref. No. 6A011705 A011705 BN6A011705
	locking screw M10x1 for pipe ø 6mm Qty 1 pcs		
	GEV No.	101054	Ref. No. —
	magnet unit T1: M10x1 T2: M24x1 L 45mm ø 17mm suitable for Minisit		
	GEV No.	101136	Ref. No. 6A011603 6A011610 A011603 A011610 BN6A011603
	piezoelectric igniter suitable for Minisit with cover cap ømm connection F6.3x0.8		
	GEV No.	101137	Ref. No. —
	cover cap without piezoelectric igniter		
	GEV No.	101267	Ref. No. —
	reducer IT 3/8" ET 1/2" L 21mm		
	GEV No.	101268	Ref. No. —
	gas connection thread 3/8" angled with O-ring MINISIT 710		
	GEV No.	101269	Ref. No. 1393900
	gas connection thread 1/2" angled with O-ring MINISIT 710		

accessories for	101131		
	GEV No.	101270	Ref. No. —
	screw connection IT 3/8" ET 3/8" L 28mm		
	GEV No.	101272	Ref. No. —
	screw connection IT 1/2" ET 3/8" L 57mm		
	GEV No.	101273	Ref. No. 417810 6A011625 A011625 MA417810
	olive for pipe ø 12mm L 9.5mm brass Qty 1 pcs suitable for universal		
	GEV No.	101274	Ref. No. —
	olive for pipe ø 16mm Qty 1 pcs		
	GEV No.	101275	Ref. No. —
	union screw thread 1/2" for pipe ø 16mm Qty 1 pcs		
	GEV No.	101276	Ref. No. 459300 6A011620 A011620
	union screw thread 3/8" tube ø 12mm Qty 1 pcs		
	GEV No.	110068	Ref. No. 6A011602 A011602 BN6A011602
	knob suitable for Minisit ø 37mm		





accessories			
probes			
			
GEV No.	102102	Ref. No.	6A011709 BN6A011709
description	probe 100-340°C probe ø 5mm probe L 68mm capillary pipe 1750mm t.max. 340°C oven/grill probe type type B1 suitable for MINISIT 710		
			
GEV No.	102103	Ref. No.	6A015201 BN6A015201
description	probe 60-200°C probe ø 5mm probe L 98mm capillary pipe 1050mm t.max. 200°C fryer probe type type A2 suitable for MINISIT 710		

PEL

24ST series



GEV No.	101076	Ref. No.	6A023700 BN6A023700
description	gas thermostat PEL type 24ST 120-320°C gas inlet M20x1.5 (tube ø 12mm) bypass nozzle ø 0.35mm gas outlet M20x1.5 (tube ø 12/10mm) thermocouple connection M9x1 pilot connection M10x1 capillary pipe 1200mm probe ø 6mm probe L 100mm shaft ø 10x8mm shaft L 27/17mm shaft flat upper		
For models:	74FTG-000130, 74FT-G-1000130, 74FTG-1000130, 74FT-G-1000130R, 74FT-G-1000131, 74FT-G-1000131R, 74FT-GC-1000135, 74FTGC-1000135, 74FT-GC-1000135R, 74FTGR-1000131, 74TFTG-1009130, 74TFTG-1009130R, 74TFTG1-1R-1009131, 74TFTG1-1R-1009131R, 74TFTGC-1009135, 74TFTGC-1009135R, 78FTG-000140, 78FT-G-1000140, 78FTG-1000140, 78FT-G-1000140R, 78FT-GR1-1-1000142, 78FT-GR1-1-1000142R, 78FT-GR1-2-1000141, 78FT-GR1-2-1000141R, 78TFTG-1009140, 78TFTG-1009140R, 78TFTG1-1R-1009142, 78TFTG1-2R-1009141, 78TFTG1-2R-1009141R, 912PTFTG-1103491, 912PTFTGR-1103591, 914PFTGE-1103423, 914PFTGEC-1103425, 914PFTGG-1103413, 914PFTFG-1103493, 914PFTFG1-2R-1103693, 914PFTFGC-1103497, 914PFTFTGR-1103593, 921FTG-1291401, 921FTG-1291401V, 921FTGC-1291403, 921FTGR-1291501, 921TFTG-1291491, 921TFTGC-1291493, 921TFTGR-1291591, 92FTG-191401, 941FTG-1291402, 941FTG1-2R-1291502, 941FTG1-2R-1291602, 941FTGC-1291404...(Other models you can see in the webshop)		
spare parts for	101076		
	GEV No.	100455	Ref. No. —
	bypass nozzle type PEL23/24 bore ø 0.35mm thread M8x0.5		
	GEV No.	101058	Ref. No. —
	magnet unit L 39mm D1 ø 15.4mm D2 ø 13.5mm suitable for PEL22/EGA24197 standard		
	GEV No.	106200	Ref. No. —
	nut thread M9x1 suitable for PEL 24/25S		
accessories for	101076		
	GEV No.	100908	Ref. No. 673500 6A016110 6A017000 A016110 A017000 BN6A016110 BN6A017000 MA673500
	union screw thread M10x1 for pipe ø 4mm Qty 1 pcs		
	GEV No.	100909	Ref. No. —
	union screw thread M10x1 for pipe ø 6mm Qty 1 pcs		
	GEV No.	101246	Ref. No. 673600 6A016120 A016120 MA673600
	olive for pipe ø 4mm Qty 1 pcs		
	GEV No.	101248	Ref. No. —
	olive for pipe ø 12mm Qty 1 pcs suitable for PEL		
	GEV No.	101249	Ref. No. 673400 6A011470 A011470 BN6A011470
	olive for pipe ø 10mm Qty 1 pcs		

accessories for	101076			
	GEV No.	101250	Ref. No.	6A011475 A011475 BN6A011475
	union nut thread M20x1.5 for pipe ø 10mm			
	GEV No.	101251	Ref. No.	6A016200 A016200 BN6A016200
	union nut thread M20x1.5 for pipe ø 12mm			
	GEV No.	101286	Ref. No.	—
	olive ID ø 6mm Qty 1 pcs			
	GEV No.	110079	Ref. No.	—
	knob dial plate gas thermostat 1-8 silver			
	GEV No.	110080	Ref. No.	—
	knob ø 70mm shaft ø 10x8mm shaft flat universal			









	1			
GEV No.	101078	Ref. No.	6A023750 BN6A023750	
description	gas thermostat PEL type 24ST 55-110°C gas inlet M20x1.5 (tube ø 12mm) bypass nozzle ø 0.35mm gas outlet M20x1.5 (tube ø 12/10mm) thermocouple connection M9x1 pilot connection M10x1 capillary pipe 1200mm probe ø 6mm probe L 160mm shaft ø 10x8mm shaft L 27/17mm shaft flat upper			
For models:	74CBG-000150, 74CB-G-1000150, 74CBG-1000150, 74CB-G-1000150R, 78CBG-000160, 78CB-G-1000160, 78CBG-1000160, 78CB-G-1000160R, 78CB-GAC-1000165, 78CBGAC-1000165, 912PTCBG-1103391, 92CBG-1191301, 92CBG-191301, 92TCBG-1191391, 94CBG-1191302, 94CBG-191302, 94CBGAC-1191362, 94TCBG-1191392			
spare parts for	101078			
	GEV No.	100455	Ref. No. —	
	bypass nozzle type PEL23/24 bore ø 0.35mm thread M8x0.5			
	GEV No.	101058	Ref. No. —	
	magnet unit L 39mm D1 ø 15.4mm D2 ø 13.5mm suitable for PEL22/EGA24197 standard			
	GEV No.	106200	Ref. No. —	
	nut thread M9x1 suitable for PEL 24/25S			
accessories for	101078			
	GEV No.	100908	Ref. No. 673500 6A016110 6A017000 A016110 A017000 BN6A016110 BN6A017000 MA673500	
	union screw thread M10x1 for pipe ø 4mm Qty 1 pcs			
	GEV No.	100909	Ref. No. —	
	union screw thread M10x1 for pipe ø 6mm Qty 1 pcs			
	GEV No.	101246	Ref. No. 673600 6A016120 A016120 MA673600	
	olive for pipe ø 4mm Qty 1 pcs			
	GEV No.	101248	Ref. No. —	
	olive for pipe ø 12mm Qty 1 pcs suitable for PEL			

Table continues overleaf



accessories for		101078	
	GEV No.	101249	Ref. No.
			673400 6A011470 A011470 BN6A011470
olive for pipe ø 10mm Qty 1 pcs			
	GEV No.	101250	Ref. No.
			6A011475 A011475 BN6A011475
union nut thread M20x1.5 for pipe ø 10mm			
	GEV No.	101251	Ref. No.
			6A016200 A016200 BN6A016200
union nut thread M20x1.5 for pipe ø 12mm			
	GEV No.	101286	Ref. No.
			—
olive ID ø 6mm Qty 1 pcs			
	GEV No.	110079	Ref. No.
			—
knob dial plate gas thermostat 1-8 silver			
	GEV No.	110080	Ref. No.
			—
knob ø 70mm shaft ø 10x8mm shaft flat universal			

accessories for		101907	
	GEV No.	101278	Ref. No.
			6A011480 86720 A011480 BN6A011480 MA86720
olive for pipe ø 10mm Qty 1 pcs			
	GEV No.	101286	Ref. No.
			—
olive ID ø 6mm Qty 1 pcs			
	GEV No.	101300	Ref. No.
			1326500 6A011485 A011485 BN6A011485
union nut thread M16x1.5 tube ø 10mm			
	GEV No.	101450	Ref. No.
			—
olive for pipe ø 8mm L 12.7mm Qty 1 pcs ED ø 10mm			
	GEV No.	101451	Ref. No.
			—
union nut thread M16x1.5 tube ø 8mm			
	GEV No.	110078	Ref. No.
			—
knob without symbol ø 70mm shaft ø 6x4.6mm shaft flat universal			
	GEV No.	110079	Ref. No.
			—
knob dial plate gas thermostat 1-8 silver			

25ST series





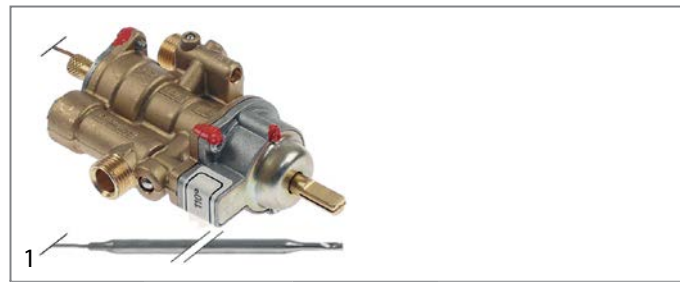





GEV No.	101907	Ref. No.	1031503900
description	gas thermostat PEL type 25ST up to 280°C gas inlet M16x1.5 (tube ø 10mm) bypass nozzle ø 1mm gas outlet M16x1.5 (tube ø 10/8mm) thermocouple connection M8x1 pilot connection M10x1 capillary pipe 1200mm probe ø 6mm probe L 120mm shaft ø 6x4.6mm shaft L 36/20mm shaft flat lower		
For models:	FTG40B, FTG60B, FTG60BR, FTG80B, FTG80BR, OFTG40B, OFTG60B, OFTG60BR, OFTG80B, OFTG80BR		
spare parts for	101907		
	GEV No.	100407	Ref. No.
			—
bypass nozzle type PEL22 bore ø 1mm thread M6x0.5			
	GEV No.	101060	Ref. No.
			—
magnet unit standard L 39mm D1 ø 15.4mm D2 ø 11mm suitable for PEL20-21/JUNKERS/EGA			
	GEV No.	106199	Ref. No.
			—
nut thread M8x1			



GEV No.	107459	Ref. No.	6A023752 BN6A023752
description	gas thermostat PEL type 25ST"V" up to 110°C gas inlet M16x1.5 (tube ø 10mm) bypass nozzle ø 0mm gas outlet M16x1.5 (tube ø 10/8mm) thermocouple connection M9x1 pilot connection M10x1 capillary pipe 1200mm probe ø 6mm probe L 160mm shaft ø 8x6.5mm shaft L 21/15mm shaft flat upper ignition gas M10x1		
For models:	110-45CBG, 110-45TCBG, 72-02CBG, 72-02CBG-12700150, 72-02TCBG, 72-02TCBG-12730150, 74-02CBG, 74-02CBG-12700155, 74-02TCBG, 74-02TCBG-12730155, 92-04CBG, 92-04CBG-12900150, 92-04TCBG, 92-04TCBG-12930150, 94-04CBG, 94-04CBG-12900155, 94-04TCBG, 94-04TCBG-12930155		

accessories for		101907	
	GEV No.	100908	Ref. No.
			673500 6A016110 6A017000 A016110 A017000 BN6A016110 BN6A017000 MA673500
union screw thread M10x1 for pipe ø 4mm Qty 1 pcs			
	GEV No.	100909	Ref. No.
			—
union screw thread M10x1 for pipe ø 6mm Qty 1 pcs			
	GEV No.	101246	Ref. No.
			673600 6A016120 A016120 MA673600
olive for pipe ø 4mm Qty 1 pcs			



SABAF

			
GEV No.	101173	Ref. No.	1699400
description	gas thermostat SABAF type SABAF t.max. 300°C gas inlet M13x1 ET (tube ø 8mm) bypass nozzle ø 0.8mm gas outlet 3/8" ET (tube ø 10mm) gas outlet 2 thermocouple connection M8x1 pilot connection capillary pipe 850mm probe ø 4mm probe L 140mm shaft ø 6x4.6mm shaft L 37/15mm shaft flat lower		
For models:	CFG101, CFG120, CFG70, OCFG101, OCFG-101-12600025, OCFG120, OCFG70, OCFG-70-12600000, OPGC-41-12600010		
spare parts for	101173		
	GEV No.	101060	Ref. No. —
accessories for	101173		
	GEV No.	101277	Ref. No. —
	olive ID ø 8mm Qty 1 pcs		
	GEV No.	101278	Ref. No. 6A011480 86720 A011480 BN6A011480 MA86720
	olive for pipe ø 10mm Qty 1 pcs		
	GEV No.	101474	Ref. No. —
	air mixing tube for pilot burner		
	GEV No.	101476	Ref. No. 1665300
	union nut thread M13x1 for pipe ø 8mm		
	GEV No.	101478	Ref. No. 1665200
	union nut thread 3/8" for pipe ø 10mm		
	GEV No.	110361	Ref. No. 1036702900 1036703300
	knob without symbol ø 65mm shaft ø 6x4.6mm shaft flat lower black		
	GEV No.	110603	Ref. No. —
	knob dial plate gas thermostat t.max. 300°C 90-300°C		

gas valves and ignition boxes

gas control valves

HONEYWELL

			
GEV No.	106012	Ref. No.	R63020170
description	gas valve type VK4115V 220-240V 50/60Hz gas inlet flange 32x32mm gas outlet flange 32x32mm thermocouple connection pilot connection pressure range 15-60mbar max 60mbar operator type HONEYWELL flange 32x32mm		
For models:	CCG051M, CCG071M, CCG101M, CCG102M, CKGP06, CKGP06B, CKGP10, CKGP10B, CKGP20, CKGP20B, CKGP21, CKGP21B, CKGP40, CKGP40B, CKGT06, CKGT06B, CKGT10, CKGT10B, CKGT20, CKGT20B, CKGT21, CKGT21B, CKGT40, CKGT40B		
accessories for	106012		
	GEV No.	102845	Ref. No. —
	gas connection angled 1/2" flange 32x32mm hole distance 24x24mm Tandem		
	GEV No.	102846	Ref. No. —
	gas connection straight 1/2" flange 32x32mm hole distance 24x24mm suitable for Tandem		

SIT

ELETTROSIT





			
GEV No.	101126	Ref. No.	9000201 BN9000201
description	gas valve SIT type ELETTROSIT 230V gas inlet 1/2" gas outlet 1/2" thermocouple connection M9x1 pilot connection M10x1 bottom equiv. no. 0.810.136		
For models:	912PFRG-1103925, 914PFRG-1103950, 922FRE-1192930, 92FRG, 92FRG-1191925, 92RFRG-1391925, 94FRG, 94FRG-1191950, 94FRG-191950, 94RFRG-1391950		
spare parts for	101126		
	GEV No.	101312	Ref. No. 6A050003 A050003 BN6A050003
	microswitch		
	GEV No.	101352	Ref. No. —
	solenoid coil 230V 50Hz suitable for ELETTROSIT		



Table continues overleaf







accessories for		101126	
	GEV No.	100006	Ref. No. —
piezoelectric igniter suitable for ELETTROSIT body plastic blowing connection ø2.4mm ø 14mm			
	GEV No.	100904	Ref. No. 1394700 6A011608 A011608 BN6A011608 MA1394700
locking screw M10x1 for pipe ø 4mm Qty 1 pcs			
	GEV No.	100905	Ref. No. 6A011705 A011705 BN6A011705
locking screw M10x1 for pipe ø 6mm Qty 1 pcs			
	GEV No.	101301	Ref. No. —
gas connection thread 1/2" straight ELETTROSIT screw with O-ring			
	GEV No.	101303	Ref. No. —
gas connection straight thread 3/4" ELETTROSIT			
	GEV No.	101309	Ref. No. —
extension			



accessories for		101127	
	GEV No.	100006	Ref. No. —
piezoelectric igniter suitable for ELETTROSIT body plastic blowing connection ø2.4mm ø 14mm			
	GEV No.	100904	Ref. No. 1394700 6A011608 A011608 BN6A011608 MA1394700
locking screw M10x1 for pipe ø 4mm Qty 1 pcs			

1	GEV No.	101127	Ref. No.	6A050000 LAR63025030
description	gas valve SIT type ELETTROSIT 230V gas inlet 3/4" gas outlet 3/4" thermocouple connection M9x1 pilot connection M10x1 lateral equiv. no. 0.810.175			
For models:	725KB-G-1000110, 725KBG-1000110, 725KB-G-1000110R, 725KB-GB-1000111, 725KB-GB-1000111R, 725KBGM-000120, 725KB-GM-1000120, 725KB-GM-1000120R, 725KB-GMB-1000121, 725KB-GMB-1000121R, 94KBG-1191870, 94KBG-191870, 94KBGM-1191880, 94KBGM-191600, 94RKBG-1391870, 94RKBGM-1391880, KB-G970-1050450, KB-G970A-1050451			
spare parts for	101127			
	GEV No.	101312	Ref. No.	6A050003 A050003 BN6A050003
microswitch				
	GEV No.	101352	Ref. No.	—
solenoid coil 230V 50Hz suitable for ELETTROSIT				
accessories for	101127			

accessories for		101127	
	GEV No.	100905	Ref. No. 6A011705 A011705 BN6A011705
locking screw M10x1 for pipe ø 6mm Qty 1 pcs			
	GEV No.	101301	Ref. No. —
gas connection thread 1/2" straight ELETTROSIT screw with O-ring			
	GEV No.	101303	Ref. No. —
gas connection straight thread 3/4" ELETTROSIT			
	GEV No.	101309	Ref. No. —
extension			

NOVASIT













1	GEV No.	101908	Ref. No.	6A050010 BN6A050010 MA1871200
description	gas valve SIT series Novasit 820 230V 50Hz gas inlet 1/2" gas outlet 1/2" thermocouple connection M9x1 pilot connection M10x1 ignition pressurebar pressure regulator connection blind equiv. no. 0.820.018 output pilot burner M10x1 input pressure max. 60bar setting range 3-30bar			
For models:	74-02KBGB, 74-02KBGB-12700110, 74-02KBGBI, 74-02KBG-BI-12700115, 74-02KBGMB, 74-02KBGMB-12700120, 74-02KBGMBI, 74-02KBGMBI-12700125, 92-04FRG20L, 92-04FRG20L-12900500, 92-04FRG20L-12900500TA, 94-04FRG-12900600, 94-04FRG20L, 94-04FRG20L-12900600TA, 94-04FRG23L-12900605, 94-04KBG, 94-04KBG-12900115, 94-04KBG-12900115TA, 94-04KBG-12900118, 94-04KBG-12900118TA, 94-04KBGM, 94-04KBGM-12900125, 94-04KBGM-12900125TA, 94-04KBGM-12900128, 94-04KBGM-12900128TA, 9BR-G80, 9BR-G81, 9BR-GM80			
spare parts for	101908			
	GEV No.	101065	Ref. No.	—
magnet unit with cable L 44mm D1 ø 30mm D2 ø 20mm suitable for NOVASIT				
	GEV No.	101313	Ref. No.	—
solenoid coil 230V 50Hz				
accessories for	101908			
	GEV No.	100006	Ref. No.	—
piezoelectric igniter suitable for ELETTROSIT body plastic blowing connection ø2.4mm ø 14mm				
	GEV No.	101305	Ref. No.	—
gas connection straight 1/2" flange 45x45mm ELETTROSIT/V4400/4600/4605 suitable for SIT/HONEYWELL hole distance 36x36mm				
	GEV No.	101306	Ref. No.	—
gas connection angled flange 45x45mm hole distance 36x36mm 1/2" ELETTROSIT/V4400/4600/4605 screw with O-ring suitable for SIT/HONEYWELL				



Table continues overleaf



accessories for		101908	
GEV No.	101307	Ref. No.	—
	gas connection straight flange 45x45mm hole distance 36x36mm 3/4" ELETTROSIT/V4400/4600/4605 screw with O-ring suitable for SIT/HONEYWELL		
	gas connection angled flange 45x45mm hole distance 36x36mm 3/4" ELETTROSIT/V4400/4600/4605 screw with O-ring suitable for SIT/HONEYWELL		
	GEV No. 101312 Ref. No. 6A050003 A050003 BN6A050003		
	GEV No. 101314 Ref. No. —		
	GEV No. 101317 Ref. No. —		
	GEV No. 101318 Ref. No. —		





GEV No.	106001	Ref. No.	3103650 BN3103650
description	gas valve SIT series Novasit 826 230V 50Hz gas inlet 1/2" gas outlet 1/2" thermocouple connection pilot connection closed ignition pressure 3-5mbar pressure range 2-50mbar pressure regulator connection standard equiv. no. 0.826.011 power supply for modulator 230VAC rectified		
For models:	CV10G, CV10G-1310100, CV10G-2, CV10G2-1310140, CV10GB-1311100, CV10G-S, CV10GS-1310150, CV10G-S2, CV10GS2-1310190, CV20G, CV20G-1310200, CV20G-2, CV20G2-1310240, CV20GB-1311200, CV20G-S, CV20GS-1310250, CV20G-S2, CV20GS2-1310290, CV21G, CV21G-1312100, CV21G-2, CV21G2-1312140, CV21G-S, CV21GS-1312150, CV21G-S2, CV21GS2-1312190, CV6G, CV6G-1310000, CV6G-1310010, CV6G-2, CV6G2-1310040, CV6GB-1311000, CV6G-S, CV6GS-1310050, CV6G-S2, CV6GS2-1310090, CVM10G, CVM10G-1310400, CVM10G-1310410, CVM10G-1310430, CVM10G-1310450, CVM10G-2, CVM10G2-1310440, CVM10GP-1310400, CVM10G-S, CVM10GS-1310460, CVM10G-S2, CVM10GS2-1310490, CVM10GS2-1310495, CVM20G... (Other models you can see in the webshop)		

spare parts for		106001	
GEV No.	101542	Ref. No.	—
	solenoid coil 50Hz NOVA 822/826/827 suitable for NOVASIT 230V		

accessories for		106001	
GEV No.	101305	Ref. No.	—
	gas connection straight 1/2" flange 45x45mm ELETTROSIT/V4400/4600/4605 suitable for SIT/HONEYWELL hole distance 36x36mm		
	gas connection angled flange 45x45mm hole distance 36x36mm 1/2" ELETTROSIT/V4400/4600/4605 screw with O-ring suitable for SIT/HONEYWELL		

accessories for		106001	
GEV No.	101307	Ref. No.	—
	gas connection straight flange 45x45mm hole distance 36x36mm 3/4" ELETTROSIT/V4400/4600/4605 screw with O-ring suitable for SIT/HONEYWELL		
	gas connection angled flange 45x45mm hole distance 36x36mm 3/4" ELETTROSIT/V4400/4600/4605 screw with O-ring suitable for SIT/HONEYWELL		
	GEV No. 101859 Ref. No. —		

accessories	
	1
GEV No.	101674 Ref. No. 6A050020 BN6A050020
description	knob extension L 57mm NOVA 822/826/827
For models:	7BR-G100, 7BR-G105, 7BRS-G100, 7BRS-G105, 94-04KBG, 94-04KBG-12900115, 94-04KBG-12900115TA, 94-04KBG-12900118, 94-04KBG-12900118TA, 94-04KBGM, 94-04KBGM-12900125, 94-04KBGM-12900125TA, 94-04KBGM-12900128, 94-04KBGM-12900128TA, 96-04KBGC, 96-04KBGC-12900105, 96-04KBGC-12900105TA, 9BR-G100, 9BR-G105, 9BR-G125, 9BR-G80, 9BR-G81, 9BR-GM80

	1
GEV No.	100905 Ref. No. 6A011705 BN6A011705
description	locking screw M10x1 for pipe ø 6mm Qty 1 pcs
For models:	7741C-GVGAS-1950266, 7742C-GV-1950267, 7961C-GVGAS-1950276, 7962C-GV-1950277

	1
GEV No.	101312 Ref. No. 6A050003 BN6A050003
description	microswitch
For models:	725KB-G-1000110, 725KB-G-1000110R, 725KB-GB-1000111, 725KB-GB-1000111R, 725KB-GM-1000120, 725KB-GM-1000120R, 725KB-GMB-1000121, 725KB-GMB-1000121R, 74-02KBGB, 74-02KBGB-12700110, 74-02KBGBI, 74-02KBGBI-12700115, 74-02KBGMB, 74-02KBGMB-12700120, 74-02KBGMBI, 74-02KBGMBI-12700125, 912PFRG-1103925, 914PFRG-1103950, 92-04FRG20L, 92-04FRG20L-12900500, 92-04FRG20L-12900500TA, 922FRE-1192930, 92FRG-1191925, 94-04FRG-12900600, 94-04FRG20L, 94-04FRG20L-12900600TA, 94-04FRG23L-12900605, 94-04KBG, 94-04KBG-12900115, 94-04KBG-12900115TA, 94-04KBG-12900118, 94-04KBG-12900118TA, 94-04KBGM, 94-04KBGM-12900125, 94-04KBGM-12900125TA, 94-04KBGM-12900128, 94-04KBGM-12900128TA, 94FRG-1191950, 94KBG-1191870, 94KBGM-1191880, 94RFRG-1391950, 94RKBG-1391870, 94RKBGM-1391880, 9BR-G80, 9BR-G81, 9BR-GM80, KB-G970-1050450, KB-G970A-1050451



ignition boxes

BRAHMA



1			
GEV No.	102337	Ref. No.	3103675 BN3103675
description	ignition box BRAHMA type CM11F electrodes 2 waiting time 1.5s safety time 5s 220-240V 7VA 50-60Hz		
For models:	CV10G, CV10G-1310100, CV10G-2, CV10G2-1310140, CV10GB-1311100, CV10G-S, CV10GS-1310150, CV10G-S2, CV10GS2-1310190, CV20G, CV20G-1310200, CV20G-2, CV20G2-1310240, CV20GB-1311200, CV20G-S, CV20GS-1310250, CV20G-S2, CV20GS2-1310290, CV21G, CV21G-1312100, CV21G-2, CV21G2-1312140, CV21G-S, CV21GS-1312150, CV21G-S2, CV21GS2-1312190, CV6G, CV6G-1310000, CV6G-1310010, CV6G-2, CV6G2-1310040, CV6GB-1311000, CV6G-S, CV6GS-1310050, CV6G-S2, CV6GS2-1310090, CVM10G-1310400, CVM10G-1310410, CVM10G-1310430, CVM10G-1310450, CVM10G2-1310440, CVM10GS-1310460, CVM10GS2-1310490, CVM10GS2-1310495, CVM20G-1310500, CVM20G2-1310540, CVM20GS-1310550, CVM20GS2-1310590, CVM21G, CVM21G-1312400...(Other models you can see in the webshop)		

HONEYWELL



1			
GEV No.	101184	Ref. No.	R63060140
description	ignition box HONEYWELL type S4565C 1033 equiv. no. S4565C 1033 electrodes 2 waiting times safety time 5s 220-240V 4VA 50/60Hz		
For models:	CCG051M, CCG071M, CCG101M, CCG102M		



1			
GEV No.	103109	Ref. No.	R63060160
description	ignition box HONEYWELL type S4565C 1116 electrodes 2 waiting times safety time 5s 220-240V 4VA 50/60Hz		
For models:	CKGP06, CKGP06B, CKGP10, CKGP10B, CKGP20, CKGP20B, CKGP21, CKGP21B, CKGP40, CKGP40B, CKGT06, CKGT06B, CKGT10B, CKGT20, CKGT20B, CKGT21, CKGT21B, CKGT40, CKGT40B		

ignition parts

pilot burners





SIT





100 series









1			
GEV No.	107103	Ref. No.	6A013100 BN6A013100
description	pilot burner SIT 1 flame nozzle ø 0.2mm gas connection 6mm		
spare parts for	107103		
	GEV No.	100245	Ref. No.
			1415100 6A013101 A013101 MA1415100
	pilot burner nozzle LPG code 20 bore ø 0.2mm Qty 1 pcs thread M8x0.75		
	GEV No.	100885	Ref. No.
			6A013104 A013104 BN6A013104
	air mixing sleeve for pilot burner Qty 1 pcs		
	GEV No.	100916	Ref. No.
			—
	compression spring for pilot burner Qty 1 pcs		
	GEV No.	100917	Ref. No.
			—
	gasket for pilot burner Qty 1 pcs aluminium		
	GEV No.	100918	Ref. No.
			—
	screw for pilot burner		
	GEV No.	107160	Ref. No.
			—
	pilot burner cap SIT 1 flame Hmm Lmm Qty 1 pcs		
	GEV No.	107166	Ref. No.
			—
	pilot burner head SIT 1 flame Hmm Lmm Qty 1 pcs		
	GEV No.	107701	Ref. No.
			2510359 BN2510359
	pilot burner bottom part SIT 100 series nozzle ø 0.2mm		
accessories for	107103		
	GEV No.	100246	Ref. No.
			—
	pilot burner nozzle natural gas bore ø 0.35mm Qty 1 pcs thread M8x0.75		
	GEV No.	100904	Ref. No.
			1394700 6A011608 A011608 BN6A011608 MA1394700
	locking screw M10x1 for pipe ø 4mm Qty 1 pcs		
	GEV No.	100905	Ref. No.
			6A011705 A011705 BN6A011705
	locking screw M10x1 for pipe ø 6mm Qty 1 pcs		
	GEV No.	102110	Ref. No.
			—
	pilot tube copper pipe ø 4mm thickness 1mm L 3000mm		

Table continues overleaf

accessories for		107103	
	GEV No.	102111	Ref. No. —
pilot tube copper pipe ø 6mm thickness 1mm L 3000mm			
	GEV No.	107171	Ref. No. —
pilot burner nozzle SIT natural/liquid gas bore ø 0.25mm Qty 1 pcs			
	GEV No.	107700	Ref. No. —
pilot burner bottom part SIT 100 series nozzle ø 0.25mm			
	GEV No.	107702	Ref. No. —
pilot burner bottom part SIT 100 series nozzle ø 0.35mm			

 <p>1</p>			
GEV No.	106902	Ref. No.	6A013105
description	pilot burner SIT type 100 series 2 flames nozzle ø 0.2mm gas connection 6mm		
spare parts for	106902		
	GEV No.	100245	Ref. No. 1415100 6A013101 A013101 MA1415100
pilot burner nozzle LPG code 20 bore ø 0.2mm Qty 1 pcs thread M8x0.75			
	GEV No.	100842	Ref. No. —
pilot burner cap 2 flames Qty 1 pcs			
	GEV No.	100885	Ref. No. 6A013104 A013104 BN6A013104
air mixing sleeve for pilot burner Qty 1 pcs			
	GEV No.	100916	Ref. No. —
compression spring for pilot burner Qty 1 pcs			
	GEV No.	100917	Ref. No. —
gasket for pilot burner Qty 1 pcs aluminium			
	GEV No.	100918	Ref. No. —
screw for pilot burner			
	GEV No.	107161	Ref. No. —
pilot burner cap SIT 2 flames Hmm Lmm Qty 1 pcs			
	GEV No.	107701	Ref. No. 2510359 BN2510359
pilot burner bottom part SIT 100 series nozzle ø 0.2mm			
accessories for		106902	
	GEV No.	100246	Ref. No. —
pilot burner nozzle natural gas bore ø 0.35mm Qty 1 pcs thread M8x0.75			
	GEV No.	100904	Ref. No. 1394700 6A011608 A011608 BN6A011608 MA1394700
locking screw M10x1 for pipe ø 4mm Qty 1 pcs			

accessories for		106902	
	GEV No.	100905	Ref. No. 6A011705 A011705 BN6A011705
locking screw M10x1 for pipe ø 6mm Qty 1 pcs			
	GEV No.	102110	Ref. No. —
pilot tube copper pipe ø 4mm thickness 1mm L 3000mm			
	GEV No.	102111	Ref. No. —
pilot tube copper pipe ø 6mm thickness 1mm L 3000mm			
	GEV No.	107171	Ref. No. —
pilot burner nozzle SIT natural/liquid gas bore ø 0.25mm Qty 1 pcs			
	GEV No.	107700	Ref. No. —
pilot burner bottom part SIT 100 series nozzle ø 0.25mm			
	GEV No.	107702	Ref. No. —
pilot burner bottom part SIT 100 series nozzle ø 0.35mm			

























 <p>1</p>			
GEV No.	106906	Ref. No.	6A013200 BN6A013200 LAR63050020
description	pilot burner SIT type 100 series 3 flames nozzle ø 0.2mm gas connection 6mm		
For models:	720FRG-1077400, 720FR-G-1077450, 720FRG-1077450, 720FR-G-1077450R, 720FR-G-1077650, 722FRG-1077600, 722FR-G-1077650R, 725KB-G-1000110, 725KBG-1000110, 725KB-G-1000110R, 725KB-G-1000111, 725KB-G-1000111R, 725KBGM-000120, 725KB-GM-1000120, 725KB-GM-1000120R, 725KB-GMB-1000121, 725KB-GMB-1000121R, 912PFRG-1103925, 914PFRG-1103950, 922FRE-1192930, 92FRG-1191925, 92RFRG-1391925, 94FRG, 94FRG-1191950, 94RFRG-1391950, C-GV904-1050110, C-GV906-1050120, C-GV908-1050130, CT-GV904-1050220, FOGV50, FO-GV50-1959100, FOGV50-1959100, FO-GV51-1959150, FR-G925N-1050731, FR-G950N-1050733, FT-G940-1050530, FT-G940-1050531, FT-G980-1050540, FT-G980-1050541, FT-G980R1-2-1050542, KB-G970-1050450, KB-G970A-1050451, TA-GV904-1050210		
spare parts for	106906		
	GEV No.	100245	Ref. No. 1415100 6A013101 A013101 MA1415100
pilot burner nozzle LPG code 20 bore ø 0.2mm Qty 1 pcs thread M8x0.75			
	GEV No.	100855	Ref. No. —
pilot burner bracket triple			
	GEV No.	100885	Ref. No. 6A013104 A013104 BN6A013104
air mixing sleeve for pilot burner Qty 1 pcs			
	GEV No.	100916	Ref. No. —
compression spring for pilot burner Qty 1 pcs			
	GEV No.	100917	Ref. No. —
gasket for pilot burner Qty 1 pcs aluminium			









Table continues overleaf







spare parts for 106906				
	GEV No.	100918	Ref. No.	—
	screw for pilot burner			
	GEV No.	107162	Ref. No.	—
	pilot burner cap SIT 3 flames Hmm Lmm Qty 1 pcs			
	GEV No.	107701	Ref. No.	2510359 BN2510359
	pilot burner bottom part SIT 100 series nozzle ø 0.2mm			
accessories for 106906				
	GEV No.	100245	Ref. No.	1415100 6A013101 A013101 MA1415100
	pilot burner nozzle LPG code 20 bore ø 0.2mm Qty 1 pcs thread M8x0.75			
	GEV No.	100246	Ref. No.	—
	pilot burner nozzle natural gas bore ø 0.35mm Qty 1 pcs thread M8x0.75			
	GEV No.	100904	Ref. No.	1394700 6A011608 A011608 BN6A011608 MA1394700
	locking screw M10x1 for pipe ø 4mm Qty 1 pcs			
	GEV No.	100905	Ref. No.	6A011705 A011705 BN6A011705
	locking screw M10x1 for pipe ø 6mm Qty 1 pcs			
	GEV No.	102110	Ref. No.	—
	pilot tube copper pipe ø 4mm thickness 1mm L 3000mm			
	GEV No.	102111	Ref. No.	—
	pilot tube copper pipe ø 6mm thickness 1mm L 3000mm			
	GEV No.	107171	Ref. No.	—
	pilot burner nozzle SIT natural/liquid gas bore ø 0.25mm Qty 1 pcs			
	GEV No.	107700	Ref. No.	—
	pilot burner bottom part SIT 100 series nozzle ø 0.25mm			
	GEV No.	107702	Ref. No.	—
	pilot burner bottom part SIT 100 series nozzle ø 0.35mm			

accessories				
pilot burner bottom parts				
	1			
GEV No.	107701	Ref. No.	2510359 BN2510359	
description	pilot burner bottom part SIT 100 series nozzle ø 0.2mm			
For models:	110-135CG, 110-135CG2P, 110-135CGE, 110-135CGE2P, 110-135CGEE, 110-135CGEE2P, 110-135CGEEP, 110-135CGEP, 110-135CGG, 110-135CGG2P, 110-135CGGE, 110-135CGGE2P, 110-135CGGEP, 110-135CGGP, 110-135CGP, 110-135TCG, 110-135TCG2P, 110-135TCGP, 110-45CG, 110-45CG1P, 110-45CGP, 110-45TCG, 110-45TCG1P, 110-45TCGP, 110-90CG, 110-90CG1P, 110-90CGE, 110-90CGE1P, 110-90CGEP, 110-90CGG, 110-90CGG1P, 110-90CGGP, 110-90CGP, 110-90TCG, 110-90TCG1P, 110-90TCGP, 31FOGV-1950001, 31FOGV-1950002, 31FOGVG-1000003, 31FOGVM-1000007, 32FOGV2-1000002, 32FOGVG-1000004, 32FOGVM-1000015, 4FX, 4FX+PCF, 72+2CTGG-12700013, 72-02CG, 72-02CG-12700001, 72-02CG-12700001TA, 72-02TCG...(Other models you can see in the webshop)			
spare parts for 107701				
	GEV No.	100245	Ref. No.	1415100 6A013101 A013101 MA1415100
	pilot burner nozzle LPG code 20 bore ø 0.2mm Qty 1 pcs thread M8x0.75			
	GEV No.	100916	Ref. No.	—
	compression spring for pilot burner Qty 1 pcs			
	GEV No.	100917	Ref. No.	—
	gasket for pilot burner Qty 1 pcs aluminium			
accessories for 107701				
	GEV No.	100246	Ref. No.	—
	pilot burner nozzle natural gas bore ø 0.35mm Qty 1 pcs thread M8x0.75			
	GEV No.	100904	Ref. No.	1394700 6A011608 A011608 BN6A011608 MA1394700
	locking screw M10x1 for pipe ø 4mm Qty 1 pcs			
	GEV No.	100905	Ref. No.	6A011705 A011705 BN6A011705
	locking screw M10x1 for pipe ø 6mm Qty 1 pcs			
	GEV No.	102110	Ref. No.	—
	pilot tube copper pipe ø 4mm thickness 1mm L 3000mm			
	GEV No.	102111	Ref. No.	—
	pilot tube copper pipe ø 6mm thickness 1mm L 3000mm			
	GEV No.	102742	Ref. No.	—
	pilot burner nozzle LPG code 25 bore ø 0.25mm Qty 1 pcs			



 <p>1</p>			
GEV No.	107114 ¹	Ref. No.	CM029000
description	pilot burner SIT type 140 series 2 flames nozzle ømm gas connecti- onmm		
For models:	OFTG40B, OFTG-40B-12600130, OFTG40BLC, OFTG-40BLC-12600135, OFTG40BR, OFTG-40BR-12600132, OFTG60B, OFTG-60B-12600140, OFTG60BLC, OFTG-60BLC-12600145, OFTG60BR, OFTG- 60BR-12600141, OFTG60BRR, OFTG-60BRR-12600142, OFTG80BLC, OFTG-80BLC-12600138		
spare parts for	107114		
	GEV No.	100907	Ref. No. 1891700
	screw connection thread M10x1 Qty 1 pcs type SEF 1 ømm for thermocouple		
accessories for	107114		
	GEV No.	100204	Ref. No. 1888000 6A013109 A013109 MA1888000
	pilot burner nozzle SIT LPG code 14 bore ø 0.18/0.20mm Qty 1 pcs suitable for 140 series		
	GEV No.	100205	Ref. No. 1033722000 22140380 822140380 BN822140380
	pilot burner nozzle SIT LPG code 19 bore ø 0.23/0.26mm Qty 1 pcs suitable for SIT 150 series		
	GEV No.	100206	Ref. No. —
	pilot burner nozzle SIT natural gas code 36 bore ø 0.60/0.55mm Qty 1 pcs suitable for SIT 150 series		
	GEV No.	100207	Ref. No. 1887800 6A013107 A013107 MA1887800
	pilot burner nozzle SIT natural gas code 27 bore ø 0.40/0.38mm suitable for SIT 140 series		
	GEV No.	100216	Ref. No. —
	pilot burner nozzle SIT natural gas code 38 bore ø 0.45mm Qty 1 pcs suitable for SIT 150 series		
	GEV No.	100701	Ref. No. 1888300 1949900 41826650010 826650010 BN41826650010 MA1888300 MA1949900
	ignition electrode connection M4 Qty 1 pcs		
	GEV No.	100801	Ref. No. —
	gasket for pilot burner Qty 1 pcs		
	GEV No.	100897	Ref. No. 1881000 1888100 22450050 MA1888100
	olive for pipe ø 4mm Qty 1 pcs for pilot burner		
	GEV No.	100898	Ref. No. 41822450470 6A011706 A011706 BN41822450470 BN6A011706
	olive for pipe ø 6mm Qty 1 pcs for pilot burner		

¹incl. thermocouple fitting

accessories for	107114			
	GEV No.	100906	Ref. No.	1888400 6A011707 A011707 MA1888400
	screw connection thread M10x1 for ignition electrode brass Qty 1 pcs WS 10			
	GEV No.	100908	Ref. No.	673500 6A016110 6A017000 A016110 A017000 BN6A016110 BN6A017000 MA673500
	union screw thread M10x1 for pipe ø 4mm Qty 1 pcs			
	GEV No.	100909	Ref. No.	—
	union screw thread M10x1 for pipe ø 6mm Qty 1 pcs			
	GEV No.	102110	Ref. No.	—
	pilot tube copper pipe ø 4mm thickness 1mm L 3000mm			
	GEV No.	102111	Ref. No.	—
	pilot tube copper pipe ø 6mm thickness 1mm L 3000mm			















 <p>1</p>			
GEV No.	107132	Ref. No.	6A013106 6A013206 BN6A013106
description	pilot burner SIT type 140 series 2 flames nozzle ømm gas connecti- onmm		
For models:	7741CGV-1950226, 7741CGV-1950266, 7741C-GVGAS-1950266, 7742C-GV-1950267, 7742CGV-1950267, 7961CGV-1950276, 7961C-GVGAS-1950276, 7962C-GV-1950277, 7962CGV-1950277		
accessories for	107132		
	GEV No.	100204	Ref. No. 1888000 6A013109 A013109 MA1888000
	pilot burner nozzle SIT LPG code 14 bore ø 0.18/0.20mm Qty 1 pcs suitable for 140 series		
	GEV No.	100205	Ref. No. 1033722000 22140380 822140380 BN822140380
	pilot burner nozzle SIT LPG code 19 bore ø 0.23/0.26mm Qty 1 pcs suitable for SIT 150 series		
	GEV No.	100206	Ref. No. —
	pilot burner nozzle SIT natural gas code 36 bore ø 0.60/0.55mm Qty 1 pcs suitable for SIT 150 series		
	GEV No.	100207	Ref. No. 1887800 6A013107 A013107 MA1887800
	pilot burner nozzle SIT natural gas code 27 bore ø 0.40/0.38mm suitable for SIT 140 series		
	GEV No.	100216	Ref. No. —
	pilot burner nozzle SIT natural gas code 38 bore ø 0.45mm Qty 1 pcs suitable for SIT 150 series		

Table continues overleaf

accessories for		107132	
	GEV No.	100701	Ref. No.
			1888300 1949900 41826650010 826650010 BN41826650010 MA1888300 MA1949900
ignition electrode connection M4 Qty 1 pcs			
	GEV No.	100897	Ref. No.
			1881000 1888100 22450050 MA1888100
olive for pipe ø 4mm Qty 1 pcs for pilot burner			
	GEV No.	100898	Ref. No.
			41822450470 6A011706 A011706 BN41822450470 BN6A011706
olive for pipe ø 6mm Qty 1 pcs for pilot burner			
	GEV No.	100906	Ref. No.
			1888400 6A011707 A011707 MA1888400
screw connection thread M10x1 for ignition electrode brass Qty 1 pcs WS 10			
	GEV No.	100907	Ref. No.
			1891700
screw connection thread M10x1 Qty 1 pcs type SEF 1 ømm for thermocouple			
	GEV No.	100908	Ref. No.
			673500 6A016110 6A017000 A016110 A017000 BN6A016110 BN6A017000 MA673500
union screw thread M10x1 for pipe ø 4mm Qty 1 pcs			
	GEV No.	100909	Ref. No.
			—
union screw thread M10x1 for pipe ø 6mm Qty 1 pcs			
	GEV No.	102110	Ref. No.
			—
pilot tube copper pipe ø 4mm thickness 1mm L 3000mm			
	GEV No.	102111	Ref. No.
			—
pilot tube copper pipe ø 6mm thickness 1mm L 3000mm			

spare parts for		100073	
	GEV No.	100703	Ref. No.
			—
ignition electrode D1 ø 9mm connection M4 D2 ø 11mm L1 8mm BL1 13mm BL2 4mm BL3 22mm to clip			
	GEV No.	100907	Ref. No.
			1891700
screw connection thread M10x1 Qty 1 pcs type SEF 1 ømm for thermocouple			
	GEV No.	101282	Ref. No.
			469000
olive for pipe ø 4mm L 7.4mm Qty 1 pcs			
	GEV No.	101283	Ref. No.
			468800
union screw thread M10x1 for pipe ø 4mm Qty 1 pcs			
	GEV No.	101292	Ref. No.
			636600
union screw for igniter suitable for CB 502/505 Qty 1 pcs			
accessories for		100073	
	GEV No.	100217	Ref. No.
			—
pilot burner nozzle LPG gas pressure 30mbar code 3 Qty 1 pcs suitable for JUNKERS CB5050_			
	GEV No.	100230	Ref. No.
			932900
pilot burner nozzle LPG gas pressure 50mbar code 2 Qty 1 pcs suitable for JUNKERS CB5050_			
	GEV No.	100232	Ref. No.
			—
pilot burner nozzle natural gas gas pressure 25mbar code 9 Qty 1 pcs suitable for JUNKERS CB5050_			
	GEV No.	100233	Ref. No.
			—
pilot burner nozzle LPG gas pressure 50mbar code 8 Qty 1 pcs suitable for JUNKERS CB5050_			
	GEV No.	100234	Ref. No.
			—
pilot burner nozzle natural gas gas pressure 20mbar code 14 Qty 1 pcs suitable for JUNKERS CB5050_			
	GEV No.	100909	Ref. No.
			—
union screw thread M10x1 for pipe ø 6mm Qty 1 pcs			
	GEV No.	101288	Ref. No.
			—
olive for pipe ø 6mm L 6mm aluminium Qty 1 pcs ED ø 8.5mm			

JUNKERS

CB 505 series









pilot burners













1











GEV No.	100073	Ref. No.	509900
description	pilot burner JUNKERS type CB505018 3 flames natural gas nozzle no.9 gas connection 6mm with primary air		
For models:	FQG40, FQG60, FTG40B, FTG40BLC, FTG60B, FTG60BLC, FTG60BR, FTG80B, FTG80BR, OFTG40B, OFTG40BLC, OFTG60B, OFTG60BLC, OFTG60BR, OFTG80B, OFTG80BR		
spare parts for		100073	
	GEV No.	100231	Ref. No.
			—
pilot burner nozzle natural gas gas pressure 25mbar code 4 Qty 1 pcs suitable for JUNKERS CB5050_			











POLIDORO			
pilot burners			
			
1			
GEV No.	100863	Ref. No.	2510389 BN2510389
description	pilot burner POLIDORO 2 flames code gas connection 6mm		
For models:	110-45CBG, 110-45TCBG, 40SGFT, 40SGFT-1825020, 40SGFTC, 40SGFTC-1825025, 40SGFTR, 40SGFTR-1825021, 60SGFT, 60SGFT-1-2R-1825031, 60SGFT-3R-1825030, 60SGFT-1825030, 60SGFTC, 60SGFTC-1825035, 60SGFTR-1825032, 710FRG-1077300, 710FR-G-1077350, 710FR-G-1077350R, 712FR-G-1077550, 712FRG-1077550, 712FR-G-1077550R, 72-02CBG, 72-02CBG-12700150, 72-02TCBG, 72-02TCBG-12730150, 74-02CBG, 74-02CBG-12700155, 74-02TCBG, 74-02TCBG-12730155, 74CP-G-1000955, 74CPG-1000955, 74CP-G-1000955R, 78CP-G-1000960, 78CPG-1000960, 78CP-G-1000960R, 80SGFTC-1825038, 910PG-1191810, 910PG-191810, 910PGB-1191800, 910PGB-191800, 911PGB-1191805, 911RPG-1391830, 912PCCPG-1104855, 912PTCBG-1103391, 914PCCPG-1104860, 914PFTGE-1103423, 914PFTGEC-1103425, 914PFTGG-1103413, 914PFTGGC-1103415, 914PTFTG-1103493...(Other models you can see in the webshop)		
spare parts for	100863		
	GEV No.	100906	Ref. No. 1888400 6A011707 A011707 MA1888400
	screw connection thread M10x1 for ignition electrode brass Qty 1 pcs WS 10		
	GEV No.	100907	Ref. No. 1891700
	screw connection thread M10x1 Qty 1 pcs type SEF 1 ømm for thermocouple		
accessories for	100863		
	GEV No.	100000	Ref. No. —
	pilot burner nozzle POLIDORO LPG code 22 bore ø 0.22mm Qty 1 pcs		
	GEV No.	100208	Ref. No. —
	pilot burner nozzle POLIDORO LPG code 20 bore ø 0.2mm Qty 1 pcs		
	GEV No.	100209	Ref. No. —
	pilot burner nozzle POLIDORO natural gas code 40 bore ø 0.4mm Qty 1 pcs		
	GEV No.	100701	Ref. No. 1888300 1949900 41826650010 826650010 BN41826650010 MA1888300 MA1949900
	ignition electrode connection M4 Qty 1 pcs		
	GEV No.	100906	Ref. No. 1888400 6A011707 A011707 MA1888400
	screw connection thread M10x1 for ignition electrode brass Qty 1 pcs WS 10		
	GEV No.	100907	Ref. No. 1891700
	screw connection thread M10x1 Qty 1 pcs type SEF 1 ømm for thermocouple		

accessories for 100863			
	GEV No.	100908	Ref. No. 673500 6A016110 6A017000 A016110 A017000 BN6A016110 BN6A017000 MA673500
	union screw thread M10x1 for pipe ø 4mm Qty 1 pcs		
	GEV No.	100909	Ref. No. —
	union screw thread M10x1 for pipe ø 6mm Qty 1 pcs		
	GEV No.	102110	Ref. No. —
	pilot tube copper pipe ø 4mm thickness 1mm L 3000mm		
	GEV No.	102111	Ref. No. —
	pilot tube copper pipe ø 6mm thickness 1mm L 3000mm		
	GEV No.	102699	Ref. No. —
	pilot burner nozzle POLIDORO natural gas code 25.2 bore ø 2x0.25mm Qty 1 pcs 2 bores		
	GEV No.	102795	Ref. No. —
	olive for pipe ø 4mm Qty 1 pcs		
	GEV No.	102797	Ref. No. —
	olive for pipe ø 6mm Qty 1 pcs		
	GEV No.	106703	Ref. No. 6A013230 A013230 BN6A013230
	pilot burner nozzle POLIDORO natural gas code 27.2 bore ø 2x0.27mm Qty 1 pcs		
	GEV No.	106704	Ref. No. 6A013240 A013240 BN6A013240
	pilot burner nozzle POLIDORO LPG code 16.2 bore ø 2x0.16mm Qty 1 pcs		
	GEV No.	106763	Ref. No. —
	pilot burner nozzle POLIDORO natural gas code 27.2A bore ø 2x 0.27mm Qty 1 pcs		
	GEV No.	106859	Ref. No. —
	pilot burner nozzle POLIDORO LPG code 24 bore ø 0.24mm Qty 1 pcs		





			
GEV No.	100076	Ref. No.	6A013220 BN6A013220
description	pilot burner POLIDORO 3 flames natural gas code 29.2 gas connection 6mm		
For models:	110-135CGG, 110-135CGG2P, 110-135CGGE, 110-135CGGE2P, 110-135CGGEP, 110-135CGGP, 110-90CGG, 110-90CGG1P, 110-90CGGP, 110-90CTG, 110-90CTGE, 110-90CTGG, 110-90FTTG, 110-90FTTG1-2R, 110-90FTTGC, 110-90FTTGC1-2R, 110-90FTT-GCR, 110-90FTTGE, 110-90FTTGG, 110-90FTTGR, 110-90TCTG, 110-90FTTG, 110-90FTTG1-2R, 110-90FTTGC, 110-90FTTGC1-2R, 110-90FTTGCGR, 110-90FTTGR, 2FX+PCF, 40SGFR, 40SGFR-1826160, 40SGFR2S-1826160, 4FX+PCF, 55-45CPG, 55-45FRG, 55-90CPG, 55-90FRG, 60SGFR, 60SGFR-1826170, 60SGFR2S-1826170, 714CTGV-000190, 714CT-GV-1000170, 714CTGV-1000170, 714CTGV-1000170R, 714CT-GVFE-1000180, 714CTGVFE-1000180, 714CT-GVFE-1000180R, 714TAGV-000190, 714TA-GV-1000190, 714TA-GV-1000190R, 716CTG-000195...(Other models you can see in the webshop)		
accessories for	100076		
	GEV No.	100000	Ref. No. —
	pilot burner nozzle POLIDORO LPG code 22 bore ø 0.22mm Qty 1 pcs		
	GEV No.	100208	Ref. No. —
	pilot burner nozzle POLIDORO LPG code 20 bore ø 0.2mm Qty 1 pcs		
	GEV No.	100209	Ref. No. —
	pilot burner nozzle POLIDORO natural gas code 40 bore ø 0.4mm Qty 1 pcs		
	GEV No.	100701	Ref. No. 1888300 1949900 41826650010 826650010 BN41826650010 MA1888300 MA1949900
	ignition electrode connection M4 Qty 1 pcs		
	GEV No.	100906	Ref. No. 1888400 6A011707 A011707 MA1888400
	screw connection thread M10x1 for ignition electrode brass Qty 1 pcs WS 10		
	GEV No.	100907	Ref. No. 1891700
	screw connection thread M10x1 Qty 1 pcs type SEF 1 ømm for thermocouple		
	GEV No.	100908	Ref. No. 673500 6A016110 6A017000 A016110 A017000 BN6A016110 BN6A017000 MA673500
	union screw thread M10x1 for pipe ø 4mm Qty 1 pcs		
	GEV No.	100909	Ref. No. —
	union screw thread M10x1 for pipe ø 6mm Qty 1 pcs		
	GEV No.	102110	Ref. No. —
	pilot tube copper pipe ø 4mm thickness 1mm L 3000mm		
	GEV No.	102111	Ref. No. —
	pilot tube copper pipe ø 6mm thickness 1mm L 3000mm		

accessories for	100076		
	GEV No.	102508	Ref. No. —
	union screw thread M10x1 for pipe ø 4mm Qty 5 pcs		
	GEV No.	102509	Ref. No. —
	union screw thread M10x1 for pipe ø 6mm Qty 5 pcs		
	GEV No.	102699	Ref. No. —
	pilot burner nozzle POLIDORO natural gas code 25.2 bore ø 2x0.25mm Qty 1 pcs 2 bores		
	GEV No.	102795	Ref. No. —
	olive for pipe ø 4mm Qty 1 pcs		
	GEV No.	102797	Ref. No. —
	olive for pipe ø 6mm Qty 1 pcs		
	GEV No.	106703	Ref. No. 6A013230 A013230 BN6A013230
	pilot burner nozzle POLIDORO natural gas code 27.2 bore ø 2x0.27mm Qty 1 pcs		
	GEV No.	106704	Ref. No. 6A013240 A013240 BN6A013240
	pilot burner nozzle POLIDORO LPG code 16.2 bore ø 2x0.16mm Qty 1 pcs		
	GEV No.	106763	Ref. No. —
	pilot burner nozzle POLIDORO natural gas code 27.2A bore ø 2x 0.27mm Qty 1 pcs		
	GEV No.	106859	Ref. No. —
	pilot burner nozzle POLIDORO LPG code 24 bore ø 0.24mm Qty 1 pcs		











PRO-GAS





140 - 145 - 150 series

pilot burners

			
GEV No.	103185	Ref. No.	N/A
description	pilot burner 2 flames natural/liquid gas gas connection 6mm nozzle 14/27		
spare parts for	103185		
	GEV No.	100204	Ref. No. 1888000 6A013109 A013109 MA1888000
	pilot burner nozzle SIT LPG code 14 bore ø 0.18/0.20mm Qty 1 pcs suitable for 140 series		
	GEV No.	100207	Ref. No. 1887800 6A013107 A013107 MA1887800
	pilot burner nozzle SIT natural gas code 27 bore ø 0.40/0.38mm suitable for SIT 140 series		



 <p>1</p>			
GEV No.	100074	Ref. No.	2590057 BN2590057
description	pilot burner type 140 series 2 flames with additional strap		
For models:	716CTG-000195, 716CTGV-000195, 72CAGV-000010, 74CAGV-000020, 74CGV-000040, 76CAGV-000030, 76CGV-000050		
accessories for	100074		
	GEV No.	100204	Ref. No. 1888000 6A013109 A013109 MA1888000
	pilot burner nozzle SIT LPG code 14 bore ø 0.18/0.20mm Qty 1 pcs suitable for 140 series		
	GEV No.	100205	Ref. No. 1033722000 22140380 822140380 BN822140380
	pilot burner nozzle SIT LPG code 19 bore ø 0.23/0.26mm Qty 1 pcs suitable for SIT 150 series		
	GEV No.	100206	Ref. No. —
	pilot burner nozzle SIT natural gas code 36 bore ø 0.60/0.55mm Qty 1 pcs suitable for SIT 150 series		
	GEV No.	100207	Ref. No. 1887800 6A013107 A013107 MA1887800
	pilot burner nozzle SIT natural gas code 27 bore ø 0.40/0.38mm suitable for SIT 140 series		
	GEV No.	100216	Ref. No. —
	pilot burner nozzle SIT natural gas code 38 bore ø 0.45mm Qty 1 pcs suitable for SIT 150 series		
	GEV No.	100701	Ref. No. 1888300 1949900 41826650010 826650010 BN41826650010 MA1888300 MA1949900
	ignition electrode connection M4 Qty 1 pcs		
	GEV No.	100897	Ref. No. 1881000 1888100 22450050 MA1888100
	olive for pipe ø 4mm Qty 1 pcs for pilot burner		
	GEV No.	100898	Ref. No. 41822450470 6A011706 A011706 BN41822450470 BN6A011706
	olive for pipe ø 6mm Qty 1 pcs for pilot burner		
	GEV No.	100906	Ref. No. 1888400 6A011707 A011707 MA1888400
	screw connection thread M10x1 for ignition electrode brass Qty 1 pcs WS 10		
	GEV No.	100907	Ref. No. 1891700
	screw connection thread M10x1 Qty 1 pcs type SEF 1 ømm for thermocouple		

accessories for	100074		
	GEV No.	100908	Ref. No. 673500 6A016110 6A017000 A016110 A017000 BN6A016110 BN6A017000 MA673500
	union screw thread M10x1 for pipe ø 4mm Qty 1 pcs		
	GEV No.	100909	Ref. No. —
	union screw thread M10x1 for pipe ø 6mm Qty 1 pcs		
	GEV No.	102110	Ref. No. —
	pilot tube copper pipe ø 4mm thickness 1mm L 3000mm		
	GEV No.	102111	Ref. No. —
	pilot tube copper pipe ø 6mm thickness 1mm L 3000mm		

producer-specific pilot burners

OLIS

650 series

 <p>1</p>			
GEV No.	101929	Ref. No.	822160360 BN41822160361
description	mushroom cap suitable for BARON		

 <p>1</p>			
GEV No.	101899	Ref. No.	822410310 BN41822410311
description	pilot burner type angled suitable for BARON		

Snack / 700 / 900 series



1

GEV No.	107479	Ref. No.	N/A
description	pilot burner 1 flame LPG nozzle ø 0.2mm		







1











GEV No.	107480	Ref. No.	N/A
description	pilot burner 1 flame natural gas nozzle ø 0.35mm		

700 / CUCINE ECO GAS SER70 series



1

GEV No.	100074	Ref. No.	2590057 BN2590057
description	pilot burner type 140 series 2 flames with additional strap		
For models:	716CTG-000195, 716CTGV-000195, 72CAGV-000010, 74CAGV-000020, 74CGV-000040, 76CAGV-000030, 76CGV-000050		
accessories for	100074		
	GEV No.	100204	Ref. No. 1888000 6A013109 A013109 MA1888000
	pilot burner nozzle SIT LPG code 14 bore ø 0.18/0.20mm Qty 1 pcs suitable for 140 series		
	GEV No.	100205	Ref. No. 1033722000 22140380 822140380 BN822140380
	pilot burner nozzle SIT LPG code 19 bore ø 0.23/0.26mm Qty 1 pcs suitable for SIT 150 series		
	GEV No.	100206	Ref. No.
	pilot burner nozzle SIT natural gas code 36 bore ø 0.60/0.55mm Qty 1 pcs suitable for SIT 150 series		
	GEV No.	100207	Ref. No. 1887800 6A013107 A013107 MA1887800
	pilot burner nozzle SIT natural gas code 27 bore ø 0.40/0.38mm suitable for SIT 140 series		

accessories for	100074		
	GEV No.	100216	Ref. No.
	pilot burner nozzle SIT natural gas code 38 bore ø 0.45mm Qty 1 pcs suitable for SIT 150 series		
	GEV No.	100701	Ref. No. 1888300 1949900 41826650010 826650010 BN41826650010 MA1888300 MA1949900
	ignition electrode connection M4 Qty 1 pcs		
	GEV No.	100897	Ref. No. 1881000 1888100 22450050 MA1888100
	olive for pipe ø 4mm Qty 1 pcs for pilot burner		
	GEV No.	100898	Ref. No. 41822450470 6A011706 A011706 BN41822450470 BN6A011706
	olive for pipe ø 6mm Qty 1 pcs for pilot burner		
	GEV No.	100906	Ref. No. 1888400 6A011707 A011707 MA1888400
	screw connection thread M10x1 for ignition electrode brass Qty 1 pcs WS 10		
	GEV No.	100907	Ref. No.
	screw connection thread M10x1 Qty 1 pcs type SEF 1 ømm for thermocouple		
	GEV No.	100908	Ref. No. 673500 6A016110 6A017000 A016110 A017000 BN6A016110 BN6A017000 MA673500
	union screw thread M10x1 for pipe ø 4mm Qty 1 pcs		
	GEV No.	100909	Ref. No.
	union screw thread M10x1 for pipe ø 6mm Qty 1 pcs		
	GEV No.	102110	Ref. No.
	pilot tube copper pipe ø 4mm thickness 1mm L 3000mm		
	GEV No.	102111	Ref. No.
	pilot tube copper pipe ø 6mm thickness 1mm L 3000mm		

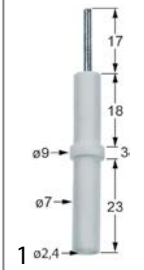

GEV No.	106619	Ref. No.	6A013301 BN6A013301
description	ignition electrode D1 ø 7mm D2 ø 9mm L1 17mm BL1 18mm BL2 3mm BL3 23mm to clip connection ø 2.4mm		
For models:	40SGFR, 40SGFT, 40SGFTC, 40SGFTR, 60SGFR, 60SGFT, 60SGFTC, 716CTG-000195, 716CTGV-000195, 72CAGV-000010, 74CAGV-000020, 74CGV-000040, 76CAGV-000030, 76CGV-000050, 76CGVFL-000070, 78PLG, 7BR-G100, 7BR-G105, 7BR-S-G100, 7BR-S-G105, 7FT-G400, 7FT-G410, 7FT-G800, 7FT-G810, 7FT-G820, 7FTTF-G800, 7FTTF-G805, 7FTTF-G820, 7FTTF-G825, 7FTTF-GE800, 7FTTF-GE805, 7FTTF-GE820, 7FTTF-GE825, 7FTT-G400, 7FTT-G405, 7FTT-G410, 7FTT-G415, 7FTT-G800, 7FTT-G805, 7FTT-G810, 7FTT-G815, 7FTT-G820, 7FTT-G825, 7FTTV-G400, 7FTTV-G405, 7FTTV-G410, 7FTTV-G415, 7FTTV-G800, 7FTTV-G805, 7FTTV-G810...(Other models you can see in the webshop)		

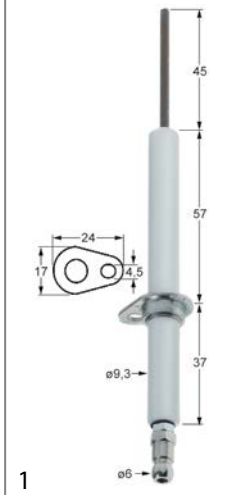

GEV No.	106756	Ref. No.	R63050130
description	ignition electrode flange length 24mm flange width 17mm D1 ø 9.3mm L1 45mm BL1 57mm BL2 37mm connection ø 4.5mm fixing dimensions ø 4.5mm A1/B13/C2		
For models:	CCG051M, CCG071M, CCG101M, CCG102M, CKGP06, CKGP06B, CKGP10, CKGP10B, CKGP20, CKGP20B, CKGP21, CKGP21B, CKGP40, CKGP40B, CKGT06, CKGT06B, CKGT10, CKGT10B, CKGT20, CKGT20B, CKGT21, CKGT21B, CKGT40, CKGT40B		

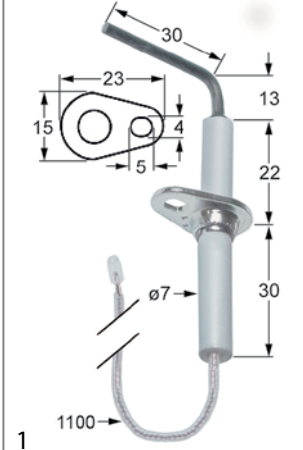

GEV No.	102335	Ref. No.	3104900 BN3104900
description	ignition electrode flange length 23mm flange width 15mm D1 ø 7mm L1 13mm L2 30mm BL1 22mm BL2 30mm cable length 1100mm fixing dimensions ø 5x4mm with flange		
For models:	CV10G, CV10G-1310100, CV10G-2, CV10G2-1310140, CV10GB-1311100, CV10G-S, CV10GS-1310150, CV10G-S2, CV10GS2-1310190, CV20G, CV20G-1310200, CV20G-2, CV20G2-1310240, CV20GB-1311200, CV20G-S, CV20GS-1310250, CV20G-S2, CV20GS2-1310290, CV21G, CV21G-1312100, CV21G-2, CV21G2-1312140, CV21G-S, CV21GS-1312150, CV21G-S2, CV21GS2-1312190, CV6G, CV6G-1310000, CV6G-1310010, CV6G-2, CV6G2-1310040, CV6GB-1311000, CV6G-S, CV6GS-1310050, CV6G-S2, CV6GS2-1310090, CVM10G, CVM10G-1310400, CVM10G-1310410, CVM10G-1310430, CVM10G-1310450, CVM10G-2, CVM10G2-1310440, CVM10GP-1310400, CVM10G-S, CVM10GS-1310460, CVM10G-S2, CVM10GS2-1310490, CVM10GS2-1310495, CVM20G...(Other models you can see in the webshop)		

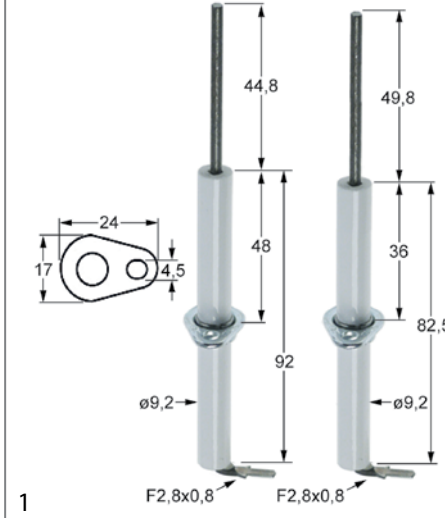

GEV No.	106647	Ref. No.	R63050100
description	ignition electrode set flange length 24mm flange width 17mm D1 ø 9.5mm L1 45mm BL1 48mm BL2 48mm connection male faston 2.8mm with screw connection 1x ignition 1x flame monitoring		
For models:	CKGP06, CKGP06B, CKGT06, CKGT06B		



			
1			
GEV No.	100906	Ref. No.	1888400 6A011707 MA1888400
description	screw connection thread M10x1 for ignition electrode brass Qty 1 pcs WS 10		
For models:	7FT-G400, 7FT-G410, 7FT-G800, 7FT-G810, 7FT-G820, 7FTTF-G800, 7FTTF-G805, 7FTTF-G820, 7FTTF-G825, 7FTTF-GE800, 7FTTF-GE805, 7FTTF-GE820, 7FTTF-GE825, 7FTT-G400, 7FTT-G405, 7FTT-G410, 7FTT-G415, 7FTT-G800, 7FTT-G805, 7FTT-G810, 7FTT-G815, 7FTT-G820, 7FTT-G825, 7FTTV-G400, 7FTTV-G405, 7FTTV-G410, 7FTTV-G415, 7FTTV-G800, 7FTTV-G805, 7FTTV-G810, 7FTTV-G815, 7FTTV-G820, 7FTTV-G825, 7FTV-G400, 7FTV-G410, 7FTV-G800, 7FTV-G810, 7FTV-G820, 7PCF-G120, 7PCF-G121, 7PCF-G160, 7PCF-G161, 7PCF-G800, 7PCF-G811, 7PCF-GE121, 7PCF-GE161, 7PCF-GE411, 7PC-G121, 7PC-G161, 7PC-G411...(Other models you can see in the webshop)		

			
1			
GEV No.	100026	Ref. No.	2532997 6A013000 BN2532997 BN6A013000
description	ignition cable cable length 1000mm connection ø4mm / F6.3mm		
For models:	710FR-G-1077350, 712FR-G-1077550, 714CTGV-000190, 714CTGV-1000170, 714CTGV-1000170R, 714TAGV-000190, 716CTG-000195, 716CTGV-000195, 720FRG-1077400, 720FRG-1077450, 720FRG-1077450R, 720FRG-1077450R, 722FRG-1077600, 722FRG-1077650R, 725KB-G-1000110, 725KBG-1000110, 725KB-G-1000110R, 725KB-G-1000111, 725KB-G-1000111R, 725KBGM-000120, 725KB-GM-1000120, 725KB-GM-1000120R, 725KB-GMB-1000121, 725KB-GMB-1000121R, 749CGV-000039, 749CGV-1950039, 749CGV-1950039R, 74CGV-000040, 769CGV-000049, 769CGV-1950049, 769CGV-1950049R, 769CGVAC-1950079, 769CGVAC-1950079R, 769CGVFL-000069, 769CGVFL-1950069, 769CGVFL-1950069R, 769CT-GV-1950194, 769CT-GV-1950194R, 76CGVFL-000070, 914PCGG-1103214, 914PCTGG-1103711, 914PFTGG-1103413, 914PFTGG-1103415, 916PCGGAN-1103216, 916PCGGE-1103236, 918PCGG-1103218, 92FG-1191220, 941CTGG-1291710...(Other models you can see in the webshop)		

ignition cables

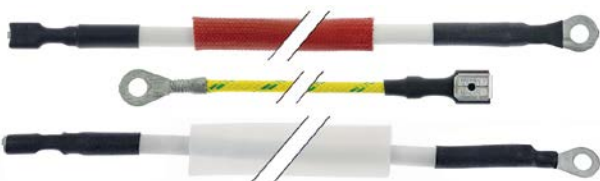
pre-assembled cables			
			
1			
GEV No.	107856	Ref. No.	R66605810
description	ignition cable 3-piece L 1080mm		
For models:	CKGP40, CKGP40B, CKGT40, CKGT40B		

			
1			
GEV No.	100195	Ref. No.	1950324
description	ignition cable cable length 1200mm connection ø2.4mm / lug M4		
For models:	CFG101, CFG120, CFG70, OCFG101, OCFG-101-12600025, OCFG120, OCFG70, OCFG-70-12600000, OPCG-41-12600010		

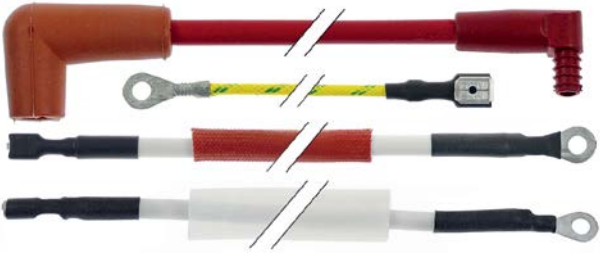
			
1			
GEV No.	107857	Ref. No.	R66605820
description	ignition cable 4-piece L 520mm		
For models:	CCG051M, CCG071M, CCG101M, CCG102M, CKGP06B, CKGP10B, CKGP21, CKGP21B, CKGT06B, CKGT10B, CKGT21, CKGT21B		

			
1			
GEV No.	102181	Ref. No.	6A041300 6A041410 BN6A041410
description	ignition cable cable length 1500mm connection ø2.4mm / ø2.4mm		
For models:	2FX+PCF, 4FX+PCF, 72+2CTGG-12700013, 74+2CTGGAN-12700025, 74-02+2CTGG, 74-02+2CTGG-12700030, 74-02CGG, 74-02CGG-12700010, 74-02CGG-12700010TA, 74-02CTGG, 74-02CTGG-12700180, 74-02CTGG-12700180TA, 74-02KBGB, 74-02KBGB-12700110, 74-02KBGBI, 74-02KBGBI-12700115, 74-02KBGMB, 74-02KBGMB-12700120, 74-02KBGMBI, 74-02KBGMBI-12700125, 76-02+4CTGG, 76-02+4CTGG-12700031, 76-02CGFL, 76-02CGFL-12700020, 76-02CGFL-12700020TA, 76-02CGG, 76-02CGG-12700015, 76-02CGG-12700015TA, 76-02CGGE, 76-02CGGE-12700016, 76-02CGGE-12700016TA, 76-02CTGG, 76-02CTGG-12700195, 76-02CTGG-12700195TA, 76-02CTGGE, 76-02CTGGE-12700196, 76-02CTGGE-12700196TA, 7741C-GVGAS-1950266, 7742C-GV-1950267, 7961C-GVGAS-1950276, 7962C-GV-1950277, 796CG-000270, 7PCFL-G120, 96-04CGFL, 96-04CGFL-12900019, 96-04CGFL2P, 96-04CGFL2P-12900037, 96-04CGFLP, 96-04CGFLP-12900069, CG796-000270...(Other models you can see in the webshop)		

			
1			
GEV No.	102189	Ref. No.	CR0508710
description	ignition cable cable length 300mm connection ø2.4mm / lug M4		
For models:	FQG41, FQG61, OFQG41, OFQG-41-12600500, OFQG61, OFQG-61-12600600		

			
1			
GEV No.	100140	Ref. No.	835909
description	ignition cable cable length 400mm connection ø2.4mm / ø4mm		



miscellaneous



1

GEV No.	nla ¹	Ref. No.	6A011603 6A011610 BN6A011603
description	piezoelectric igniter suitable for Minisit with cover cap ømm connection F6.3x0.8		
For models:	40SGFTC-1825025, 710FRG-1077300, 710FR-G-1077350, 710FR-G-1077350R, 712FR-G-1077550, 712FRG-1077550, 712FR-G-1077550R, 714CTGV-000190, 714CT-GV-1000170, 714CTGV-1000170, 714CT-GV-1000170R, 714TAGV-000190, 716CTG-000195, 716CTGV-000195, 720FRG-1077400, 720FR-G-1077450, 720FRG-1077450, 720FR-G-1077450R, 720FR-G-1077650, 722FRG-1077600, 722FR-G-1077650R, 749CGV-000039, 749CGV-1950039, 749CGV-1950039R, 74CGV-000040, 769CGV-000049, 769CGV-1950049, 769CGV-1950049R, 769CGVAC-1950079, 769CGVAC-1950079R, 769CGVFL-000069, 769CGVFL-1950069, 769CGVFL-1950069R, 769CT-GV-1950194, 769CT-GV-1950194R, 76CGV-000050, 76CGVFL-000070, 914PCGG-1103214, 914PCTGG-1103711, 914PFTGG-1103413, 914PFTGGC-1103415, 916PCGGAN-1103216, 916PCGGE-1103236, 918PCGG-1103218, 92FG-1191220, 941CTGG-1291710, 941FTGG-1291412, 941FTGG1-2R-1291612, 941FTGGC-1291414, 941FTGGC1-2R-1291415...(Other models you can see in the webshop)		
spare parts for	101136		
	GEV No.	100001	Ref. No. —
	piezoelectric igniter suitable for Minisit connection F6.3x0.8 ømm		

¹no longer available

accessories



1

GEV No.	691392	Ref. No.	822160540
description	ring for piezoelectric igniter ID ø 18mm ED ø 30mm H 2mm mounting ø 22mm		
For models:	110-135CGG, 110-135CGG2P, 110-135CGGE, 110-135CGGE2P, 110-135CGGEP, 110-135CGGP, 110-45CBG, 110-45TCBG, 110-90CGG, 110-90CGG1P, 110-90CGGP, 110-90CTG, 110-90CTGE, 110-90CTGG, 110-90FTTG, 110-90FTTG1-2R, 110-90FTTGC, 110-90FTTGC1-2R, 110-90FTTGCR, 110-90FTTGE, 110-90FTTGG, 110-90FTTGR, 110-90FTTG1-2R, 110-90FTTGT, 110-90FTTGT1-2R, 110-90FTTGTG, 110-90FTTGTG1-2R, 110-90FTTGTGR, 55-45CPG, 55-45FRG, 55-90CPG, 55-90FRG, 7BR-G100, 7BR-G105, 7BRS-G100, 7BRS-G105, 7CP-G400, 7CP-G800, 7FRI-G415, 7FRI-G610, 7FRI-G815, 7FT-G400, 7FT-G410, 7FT-G800, 7FT-G810, 7FT-G820, 7FTTF-G800, 7FTTF-G805, 7FTTF-G820...(Other models you can see in the webshop)		

			
1			
GEV No.	102485	Ref. No.	6A050100 6A050105 BN6A050100 MA2971400
description	ignition unit outputs 2 220-240VAC 0.6VA 50-60Hz		
For models:	2FX+PCF, 4FX+PCF, 72+2CTGG-12700013, 72-02FRGM, 72-02FRGM-12700530, 72-02FRGM-12700530TA, 725KB-G-1000110, 725KB-G-1000110R, 725KB-GB-1000111, 725KB-GB-1000111R, 725KB-GM-1000120, 725KB-GM-1000120R, 725KB-GMB-1000121, 725KB-GMB-1000121R, 73-02FRGM, 73-02FRGM-12700580, 73-02FRGM-12700580TA, 74+2CTGGAN-12700025, 74-02FRGM, 74-02FRGM-12700630, 74-02KBGB, 74-02KBGB-12700110, 74-02KBGBI, 74-02KBGBI-12700115, 74-02KBGMB, 74-02KBGMB-12700120, 74-02KBGMBI, 74-02KBGMBI-12700125, 796CG-000270, 912PFRG-1103925, 914PFRG-1103950, 92-04FRG20L, 92-04FRG20L-12900500, 92-04FRG20L-12900500TA, 922FRE-1192930, 92FRG-1191925, 92RFRG-1391925, 94-04FRG-12900600, 94-04FRG20L, 94-04FRG20L-12900600TA, 94-04FRG23L-12900605, 94-04KBG, 94-04KBG-12900115, 94-04KBG-12900115TA, 94-04KBG-12900118, 94-04KBG-12900118TA, 94-04KBGM, 94-04KBGM-12900125, 94-04KBGM-12900125TA, 94-04KBGM-12900128...(Other models you can see in the webshop)		

			
1			
GEV No.	101002	Ref. No.	6A050101
description	ignition unit outputs 2 230VAC dimensions 88x23x34mm mounting distance 73mm inlet F6.3x0.8 outlet F2.8x0.8 0.6VA 50/60Hz		
For models:	716CTG-000195, 716CTGV-000195, 72CAGV-000010		

			
1			
GEV No.	101003	Ref. No.	6A050102
description	ignition unit outputs 4 230VAC 50Hz		
For models:	74CAGV-000020, 74CGV-000040		

ignition units



1

GEV No.	104688	Ref. No.	R65180270
description	ignition unit outputs 1 220-240VAC dimensions 84x62x38mm mounting distance 59mm inlet F6.3x0.8 outlet ø4mm type TRK2-30PVD 69VA 50/60Hz 0.3A protection IP00		
For models:	CKGP06, CKGP06B, CKGP10, CKGP10B, CKGP20, CKGP20B, CKGP21, CKGP21B, CKGP40, CKGP40B, CKGT06, CKGT06B, CKGT10B, CKGT20, CKGT20B, CKGT21, CKGT21B, CKGT40, CKGT40B		

			
1			
GEV No.	101004	Ref. No.	6A050103
description	ignition unit outputs 6 230VAC inlet F6.3x0.8 outlet F2.8x0.8 50Hz mounting ø 88mm		
For models:	76CAGV-000030, 76CGV-000050, 76CGVFL-000070		

thermocouples

plug-in thermocouples

plug-in thermocouples standard

with barrel socket ø6mm

SIT

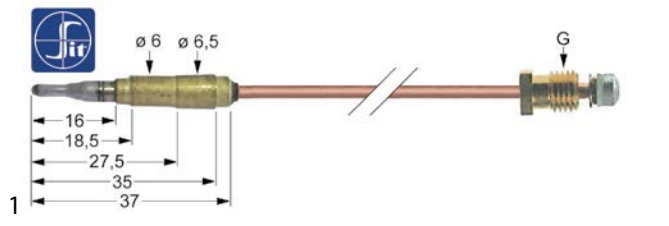

GEV No.	102246	Ref. No.	6A011907 BN6A011907
description	thermocouple M9x1 L 600mm plug connection ø6.0mm		
For models:	716CTG-000195, 716CTGV-000195, 72CAGV-000010, 74CAGV-000020, 74CGV-000040, 76CAGV-000030, 76CGV-000050, 76CGVFL-000070, 7741CGV-1950226, 7741CGV-1950266, 7741C-GVGAS-1950266, 7742C-GV-1950267, 7742CGV-1950267, 7961CGV-1950276, 7961C-GVGAS-1950276, 7962C-GV-1950277, 7962CGV-1950277		

with barrel socket ø6(6.5)mm

thermocouples SIT

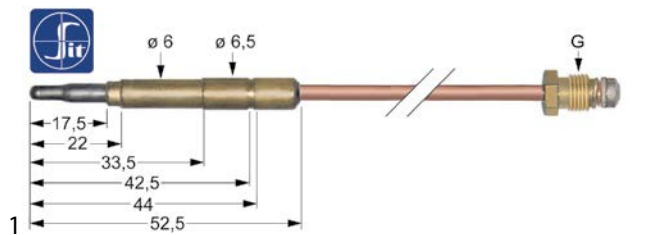

GEV No.	107601	Ref. No.	1033027800 1206400
description	thermocouple SIT M8x1 L 600mm plug connection ø6.0(6.5)mm		
For models:	CFG101, CFG120, CFG70, CFGE61, CFGE61D, CFGE61L, CFGE61P, FTG40B, FTG40BLC, FTG60B, FTG60BLC, FTG60BR, FTG80B, FTG80BR, OCFG101, OCFG-101-12600025, OCFG120, OCFG70, OCFG-70-12600000, OCFG61, OFTG40B, OFTG40BLC, OFTG60B, OFTG60BLC, OFTG60BR, OFTG80B, OFTG80BR, OPCG41, OPCG-41-12600010, OPCG61		

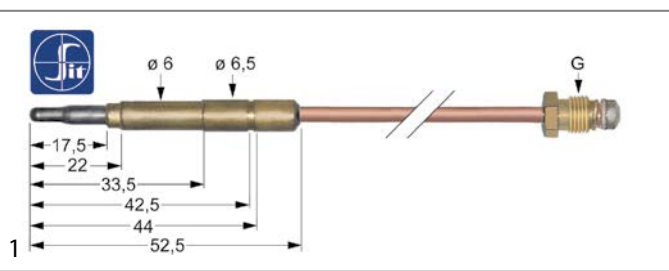

GEV No.	107606	Ref. No.	1031500400 6A011906
description	thermocouple SIT M9x1 L 320mm plug connection ø6.0(6.5)mm		
For models:	716CTG-000195, 716CTGV-000195, 72CAGV-000010, 74CAGV-000020, 74CGV-000040, 76CAGV-000030, 76CGV-000050, 76CGVFL-000070, 7741CGV-1950226, 7741CGV-1950266, 7741C-GVGAS-1950266, 7742C-GV-1950267, 7742CGV-1950267, 7961CGV-1950276, 7961C-GVGAS-1950276, 7962C-GV-1950277, 7962CGV-1950277, FQG40, FQG60		

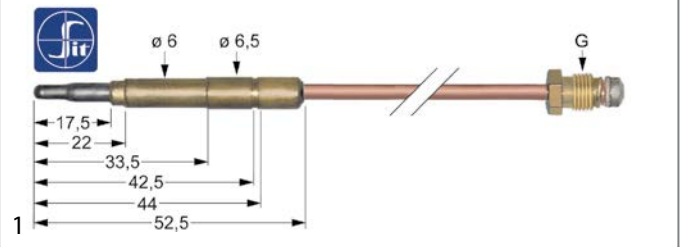

GEV No.	107608	Ref. No.	1031504300 6A011901 6A011902 6A011912 BN6A011901 BN6A011902 BN6A011912 MA1031504300
description	thermocouple SIT M9x1 L 500mm plug connection ø6.0(6.5)mm		
For models:	110-45CBG, 110-45TCBG, 2FX+PCF, 4FX+PCF, 72+2CTGG-12700013, 72-02CBG, 72-02CBG-12700150, 72-02FTG, 72-02FTG-12700130TA, 72-02FTG-12700300, 72-02FTG-12700300TA, 72-02FTGC-12700135, 72-02FTGC-12700135TA, 72-02FTGCVL, 72-02FTGR, 72-02FTGR-12700132TA, 72-02FTGR-12700302, 72-02FTGR-12700302TA, 72-02FTGRVAL, 72-02FTGVAL, 72-02FTTG-12700130, 72-02FTTG-12700132, 72-02PLG, 72-02PLG-12700850, 72-02PLG-12700850TA, 72-02TCBG, 72-02TCBG-12730150, 72-02TFTG, 72-02TFTG-12730130, 72-02TFTG-12730130TA, 72-02TFTG-12730300, 72-02TFTG-12730300TA, 72-02TFTGC-12730135, 72-02TFTGC-12730135TA, 72-02TFTGCVAL, 72-02TFTGR, 72-02TFTGR-12730132, 72-02TFTGR-12730132TA, 72-02TFTGR-12730302, 72-02TFTGR-12730302TA, 72-02TFTGRVAL, 72-02TFTGVAL, 72-02TPLG, 72-02TPLG-12730850, 72-02TPLG-12730850TA, 725KB-G-1000110, 725KBG-1000110, 725KB-G-1000110R, 725KB-GB-1000111, 725KB-GB-1000111R... (Other models you can see in the webshop)		

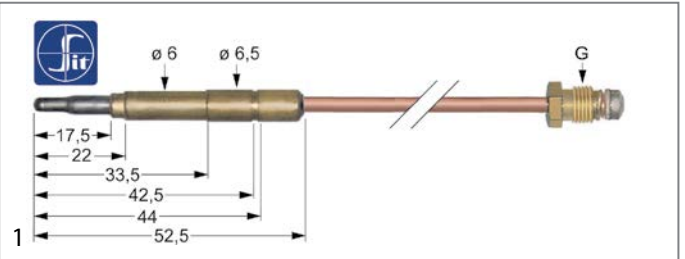

GEV No.	107609	Ref. No.	6A011903 A011909 BN6A011903
description	thermocouple SIT M9x1 L 600mm plug connection ø6.0(6.5)mm		
For models:	40SGFR, 40SGFR-1826160, 40SGFR2S-1826160, 60SGFR, 60SGFR-1826170, 60SGFR2S-1826170, 710FRG-1077300, 710FR-G-1077350, 710FR-G-1077350R, 712FR-G-1077550, 712FRG-1077550, 712FR-G-1077550R, 72-02CPG, 72-02CPG-12700900, 72-02FRG, 72-02FRG-12700500, 720FRG-1077400, 720FR-G-1077450, 720FRG-1077450, 720FR-G-1077450R, 720FR-G-1077650, 722FRG-1077600, 722FR-G-1077650R, 73-02FRG, 73-02FRG-12700550, 74-02CPG, 74-02CPG-12700905, 74-02CPG-12700905TA, 74-02FRG, 74-02FRG-12700600, 74-02FRG17-12700605, 7CP-G400, 7CP-G800, 9122PFRG-1103930, 912PFRG-1103925, 914PFRG-1103950, 914PFTG-1103423, 914PFTGEC-1103425, 914PFTGG-1103413, 914PFTGGC-1103415, 914PTFTG-1103493, 914PTFTG1-2R-1103693, 914PTFTGC-1103497, 914PTFTGR-1103593, 92-04CPG, 92-04CPG-12900900, 92-04CPG-12900900TA, 92-04FTTG, 922FRE-1192930, 922FRG-1191930... (Other models you can see in the webshop)		

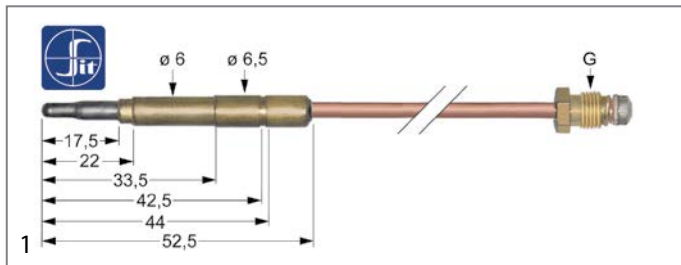

GEV No.	107611	Ref. No.	1916000 6A011900 6A011904 826920080
description	thermocouple SIT M9x1 L 850mm plug connection ø6.0(6.5)mm		
For models:	110-135CGG, 110-135CGG2P, 110-135CGGE, 110-135CGGE2P, 110-135CGGEP, 110-135CGGP, 110-90CGG, 110-90CGG1P, 110-90CGGP, 110-90CTG, 110-90CTGE, 110-90CTGG, 110-90FTTG, 110-90FTTG1-2R, 110-90FTTGE, 110-90FTTGG, 110-90FTTGR, 110-90TCTG, 110-90TCTGR, 2FX+PCF, 40SGFT, 40SGFT-1825020, 40SGFTC, 40SGFTC-1825025, 40SGFTR, 40SGFTR-1825021, 4FX+PCF, 55-45CPG, 55-90CPG, 60SGFT, 60SGFT1-2R-1825031, 60SGFT1-3R-1825030, 60SGFT-1825030, 60SGFTC, 60SGFTC-1825035, 60SGFTR-1825032, 714CTGV-000190, 714CT-GV-1000170, 714CTGV-1000170, 714CTGV-1000170R, 714CT-GVFE-1000180, 714CTGVFE-1000180, 714CT-GVFE-1000180R, 714TAGV-000190, 714TAGV-1000190, 714TA-GV-1000190R, 716CTG-000195, 716CTGV-000195, 72+2CTGG-12700013, 74+2CTGGAN-12700025...(Other models you can see in the webshop)		

plug-in thermocouples with interruption

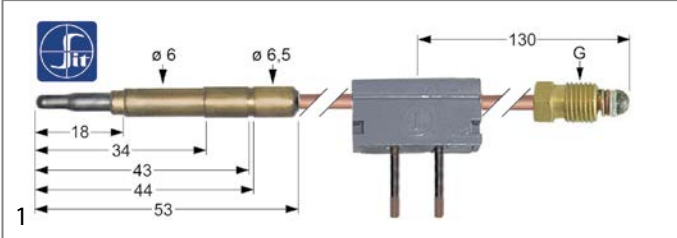

GEV No.	107164	Ref. No.	6A011910 BN6A011910
description	thermocouple SIT with interrupter M9x1 L 1000mm plug connection ø6.0(6.5)mm soldering connection		
For models:	74-02NPGI, 74-02NPGI-12700755, 7FRI-G415, 7FRI-G610, 7FRI-G815, 7NP-GI50, 910PGB-1191800, 911PGB-1191805, 911RPG-1391830, 92-04FRG15L, 92-04FRG15L-12900510, 92-04FRG17L-12900515, 92-04FRG20L, 92-04FRG20L-12900500, 92-04FRG20L-12900500TA, 93-04FRG, 93-04FRG-12900550, 93-04FRG-12900550H, 94-04FRG-12900600, 94-04FRG20L, 94-04FRG20L-12900600TA, 94-04FRG23L-12900605, 9FRI-G415, 9FRI-G610, 9FRI-G815		

thermocouples with aluminised tip

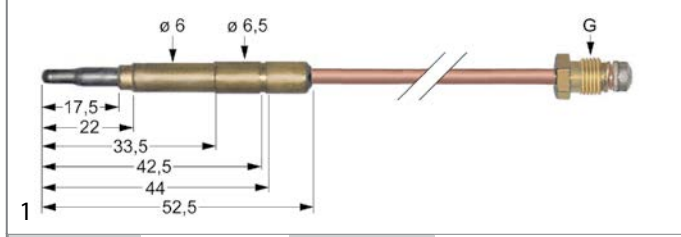

GEV No.	102045	Ref. No.	6A011800 BN6A011800
description	thermocouple M9x1 L 1500mm plug connection ø6.0(6.5)mm		
For models:	2FX+PCF, 4FX+PCF, 72+2CTGG-12700013, 74+2CTGGAN-12700025, 74-02+2CTGG, 74-02+2CTGG-12700030, 74-02CGG, 74-02CGG-12700010, 74-02CGG-12700010TA, 74-02CTGG, 74-02CTGG-12700180, 74-02CTGG-12700180TA, 76-02+4CTGG, 76-02+4CTGG-12700031, 76-02CGFL, 76-02CGFL-12700020, 76-02CGFL-12700020TA, 76-02CGG, 76-02CGG-12700015, 76-02CGG-12700015TA, 76-02CGGE, 76-02CGGE-12700016, 76-02CGGE-12700016TA, 76-02CTGG, 76-02CTGG-12700195, 76-02CTGG-12700195TA, 76-02CTGGE, 76-02CTGGE-12700196, 76-02CTGGE-12700196TA, 796CG-000270, 7PCFL-G120, 94-04KBG, 94-04KBG-12900115, 94-04KBG-12900115TA, 94-04KBG-12900118, 94-04KBG-12900118TA, 94-04KBGM, 94-04KBGM-12900125, 94-04KBGM-12900125TA, 94-04KBGM-12900128, 94-04KBGM-12900128TA, 96-04CGFL, 96-04CGFL-12900019, 96-04CGFL2P, 96-04CGFL2P-12900037, 96-04CGFLP, 96-04CGFLP-12900069, 9BR-G80, 9BR-G81, 9BR-GM80...(Other models you can see in the webshop)		

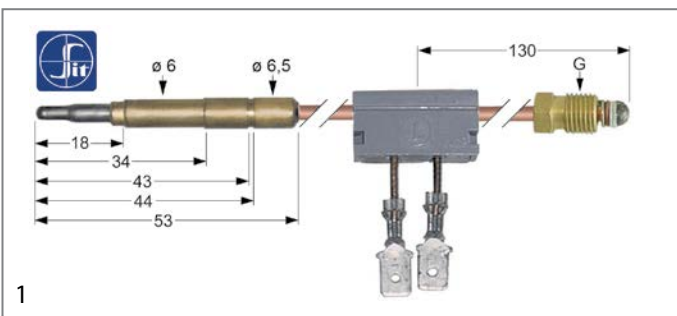

GEV No.	107177	Ref. No.	6A011909 BN6A011909
description	thermocouple SIT with interrupter M9x1 L 600mm plug connection ø6.0mm F 6.3mm		
For models:	40SGFR2S-1826160, 55-45FRG, 55-90FRG, 60SGFR2S-1826170, 72-02FRG-12700500, 72-02FRG17-12700505, 72-02FRGM, 72-02FRGM-12700530, 72-02FRGM-12700530TA, 73-02FRG-12700550, 73-02FRGM, 73-02FRGM-12700580, 73-02FRGM-12700580TA, 74-02FRG-12700600, 74-02FRG17-12700605, 74-02FRGM, 74-02FRGM-12700630, 7FT-G400, 7FT-G410, 7FT-G800, 7FT-G810, 7FT-G820, 7FTTF-G800, 7FTTF-G805, 7FTTF-G820, 7FTTF-G825, 7FTTF-GE800, 7FTTF-GE805, 7FTTF-GE820, 7FTTF-GE825, 7FTT-G400, 7FTT-G405, 7FTT-G410, 7FTT-G415, 7FTT-G800, 7FTT-G805, 7FTT-G810, 7FTT-G815, 7FTT-G820, 7FTT-G825, 7FTTV-G400, 7FTTV-G405, 7FTTV-G410, 7FTTV-G415, 7FTTV-G800, 7FTTV-G805, 7FTTV-G810, 7FTTV-G815, 7FTTV-G820, 7FTTV-G825...(Other models you can see in the webshop)		

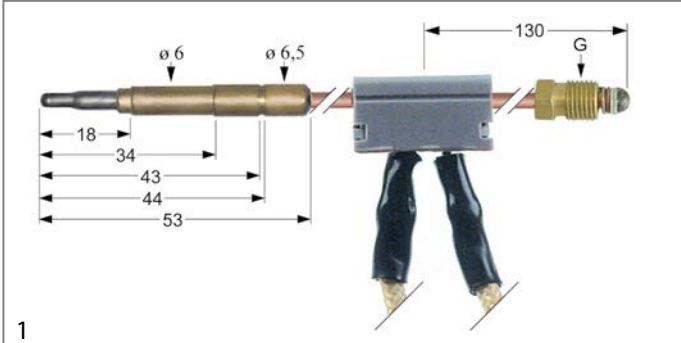

GEV No.	102247	Ref. No.	1955500 CR0508700
description	thermocouple with interrupter M9x1 L 600mm plug connection ø6.0mm cable 700mm		
For models:	FQG41, FQG61, FTG40B, FTG40BLC, FTG60B, FTG60BLC, FTG60BR, FTG80B, FTG80BR, OFQG41, OFQG-41-12600500, OFQG61, OFQG-61-12600600, OFTG40B, OFTG40BLC, OFTG-40BLC-12600135, OFTG60B, OFTG60BLC, OFTG-60BLC-12600145, OFTG60BR, OFTG80B, OFTG-80BLC, OFTG-80BLC-12600138, OFTG80BR		

threaded thermocouples

threaded thermocouples standard

with socket with thread M8x1

SIT

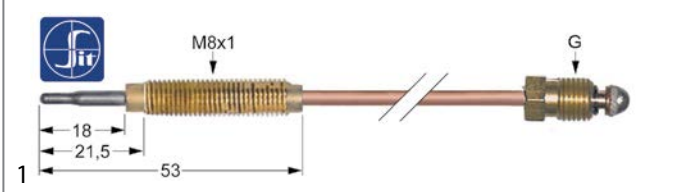

GEV No.	107633	Ref. No.	1665000
description	thermocouple SIT M8x1 L 1200mm M8x1		
For models:	CFG101, CFG120, CFG70, OCFG101, OCFG-101-12600025, OCFG120, OCFG70, OCFG-70-12600000, OPGC-41-12600010		
accessories for	107633		

	GEV No.	102067	Ref. No.	939300
		nut thread M8x1 H 3mm brass Qty 1 pcs type SEF 1		

threaded thermocouples (miscellaneous)

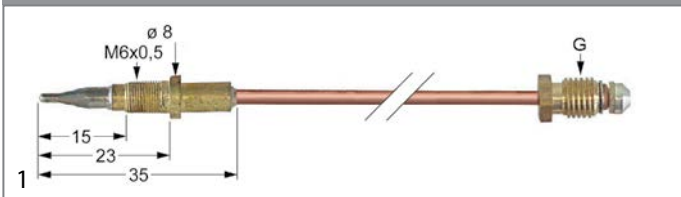

GEV No.	102245	Ref. No.	8220180
description	thermocouple M8x1 L 500mm M6x0.5		
For models:	40SCG, 40SCG-1825000, 40SCG35-1826000, 60SCG, 60SCG-1825010, 60SCG25-1826010, 60SCG35-1826010, 61SCGF35-1826055		
accessories for	102245		

	GEV No.	100892	Ref. No.	8220181
		thermocouple nut thread M6x0.5 H 6.5mm WS 8 brass Qty 1 pcs		

threaded thermocouples flexible

miscellaneous

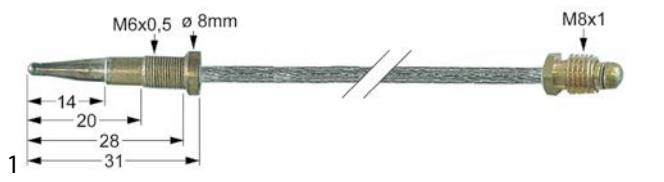

GEV No.	102244	Ref. No.	8220185
description	thermocouple flexible M6x0.5 M8x1 L 500mm		
For models:	40SCG35-1826000, 60SCG25-1826010, 60SCG35-1826010, 61SCGF35-1826055		

accessories

nuts

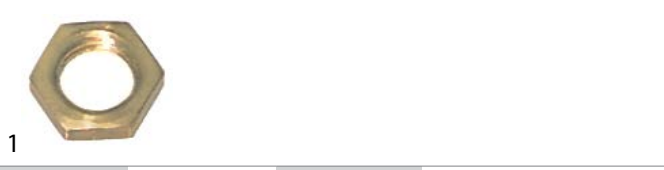

GEV No.	102067	Ref. No.	939300
description	nut thread M8x1 H 3mm brass Qty 1 pcs type SEF 1		
For models:	CFG101, CFG120, CFG70, OCFG101, OCFG-101-12600025, OCFG120, OCFG70, OCFG-70-12600000, OPGC-41-12600010		



GEV No.	100892	Ref. No.	8220181
description	thermocouple nut thread M6x0.5 H 6.5mm WS 8 brass Qty 1 pcs		
For models:	40SCG, 40SCG-1825000, 40SCG35-1826000, 60SCG, 60SCG-1825010, 60SCG25-1826010, 60SCG35-1826010, 61SCGF35-1826055		

screws

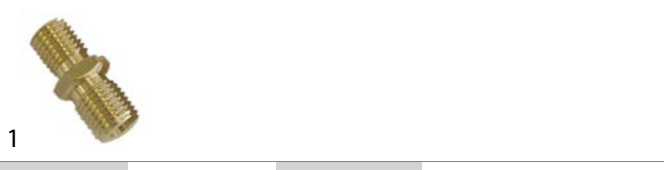



GEV No.	100920	Ref. No.	6A013401 BN6A013401
description	thermocouple fitting thread M8x1 / M9x1 Qty 1 pcs		

For models: 110-90CTG, 110-90CTGE, 110-90CTGG, 110-90TCTG, 31FOGV-1950001, 31FOGV-1950002, 31FOGVG-1000003, 31FOGVM-1000007, 32FOGV2-1000002, 32FOGVG-1000004, 32FOGVM-1000015, 55-45CPG, 55-90CPG, 72+2CTGG-12700013, 72-02CPG, 72-02CPG-12700900, 72-02FTG, 72-02FTG-12700130TA, 72-02FTG-12700300, 72-02FTG-12700300TA, 72-02FTGR, 72-02FTGR-12700132TA, 72-02FTGR-12700302, 72-02FTGR-12700302TA, 72-02FTTG-12700130, 72-02FTTG-12700132, 72-02FTTG-12700850, 72-02FTTG, 72-02FTTG-12730130, 72-02FTTG-12730130TA, 72-02FTTG-12730300, 72-02FTTG-12730300TA, 72-02FTTGR, 72-02FTTGR-12730132, 72-02FTTGR-12730132TA, 72-02FTTGR-12730302, 72-02FTTGR-12730302TA, 72-02FTPLG-12730850, 729CAGV-1950009, 729CAGV-1950009R, 729TCGV-1959009, 729TCGV-1959009R, 74+2CTGGAN-12700025, 74-02+2CTGG-12700030, 74-02CPG, 74-02CPG-12700905, 74-02CPG-12700905TA, 74-02CTG-12700170, 74-02CTGE-12700190, 74-02CTGG-12700180...(Other models you can see in the webshop)







			
1			
GEV No.	101260	Ref. No.	1359100
description	thermocouple fitting thread M8x1 Qty 1 pcs		
For models:	OPLG40, OPLG-40-12600850, OPLG80, OPLG-80-12600855, PLG40, PLG80		



interrupters			
			
1			
GEV No.	101265	Ref. No.	1533400 6A013603 9000158
description	interrupter thread M9x1		
For models:	710FRG-077300, 710FRG-1077300, 710FR-G-1077350, 710FR-G-1077350R, 712FRG-077500, 712FR-G-1077550, 712FRG-1077550, 712FR-G-1077550R, 720FRG-077400, 720FRG-1077400, 720FR-G-1077450, 720FRG-1077450, 720FR-G-1077450R, 720FR-G-1077650, 722FRG-077600, 722FRG-1077600, 722FR-G-1077650, 912PFRG-1103925, 914PFRG-1103950, 922FRE-1192930, 92FRG-1191925, 94FRG-1191950, 94RFRG-1391950, FQG40, FQG60, FR-G925N-1050731, FR-G950N-1050733		

ignition bridges			
			
1			
GEV No.	105439	Ref. No.	8210000
description	ignition bridge		
For models:	60SGFT, 60SGFT1-2R-1825031, 60SGFT1-3R-1825030, 60SGFT-1825030, 60SGFTC, 60SGFTC-1825035, 60SGFTR-1825032		

gas burners

hob burners

universal hob burners			
GEV			
			
1			
GEV No.	103068	Ref. No.	6A042200
description	burner cap ø 100mm		
accessories for	103068		
	GEV No.	103067	Ref. No.
			6A042000 A042000 SIR0100247
burner ring for burner cap ø 100mm			
	GEV No.	104102	Ref. No.
			6A041800 A041800
burner head for burner cap ø 100mm ext. ø 130			
	GEV No.	104103	Ref. No.
			6A041600 A041600
burner holder suitable for burner ø100mm with nozzle holder			

			
1			
GEV No.	103066	Ref. No.	6A042100 SIR0100250
description	burner cap ø 80mm		
accessories for	103066		
	GEV No.	103065	Ref. No.
			6A041900 A041900
burner ring for burner cap ø 80mm			
	GEV No.	104100	Ref. No.
			6A041700 A041700
burner head for burner cap ø 80mm			
	GEV No.	104101	Ref. No.
			6A041500 A041500 SIR0100260
burner holder for burner cap ø 80mm with nozzle holder with mixing sleeve			

			
1			
GEV No.	104102	Ref. No.	6A041800
description	burner head for burner cap ø 100mm ext. ø 130		

			
1			
GEV No.	104100	Ref. No.	6A041700
description	burner head for burner cap ø 80mm		
accessories for	104100		
	GEV No.	103065	Ref. No.
			6A041900 A041900
burner ring for burner cap ø 80mm			
	GEV No.	103066	Ref. No.
			6A042100 A042100 SIR0100250
burner cap ø 80mm			
	GEV No.	104103	Ref. No.
			6A041600 A041600
burner holder suitable for burner ø100mm with nozzle holder			

















			
1			
GEV No.	104101	Ref. No.	6A041500 SIR0100260
description	burner holder for burner cap ø 80mm with nozzle holder with mixing sleeve		
accessories for	104101		
	GEV No.	103065	Ref. No.
			6A041900 A041900
burner ring for burner cap ø 80mm			
	GEV No.	103066	Ref. No.
			6A042100 A042100 SIR0100250
burner cap ø 80mm			

Table continues overleaf

accessories for	104101		
	GEV No.	104100	Ref. No. 6A041700 A041700
burner head for burner cap ø 80mm			

1			
GEV No.	104103	Ref. No.	6A041600
description	burner holder suitable for burner ø100mm with nozzle holder		
accessories for	104103		
	GEV No.	103067	Ref. No. 6A042000 A042000 SIR0100247
burner ring for burner cap ø 100mm			
	GEV No.	103068	Ref. No. 6A042200 A042200
burner cap ø 100mm			
	GEV No.	104102	Ref. No. 6A041800 A041800
burner head for burner cap ø 100mm ext. ø 130			

1			
GEV No.	103067	Ref. No.	6A042000 SIR0100247
description	burner ring for burner cap ø 100mm		
accessories for	103067		
	GEV No.	103068	Ref. No. 6A042200 A042200
burner cap ø 100mm			
	GEV No.	104102	Ref. No. 6A041800 A041800
burner head for burner cap ø 100mm ext. ø 130			
	GEV No.	104103	Ref. No. 6A041600 A041600
burner holder suitable for burner ø100mm with nozzle holder			

1			
GEV No.	103065	Ref. No.	6A041900
description	burner ring for burner cap ø 80mm		
accessories for	103065		
	GEV No.	103066	Ref. No. 6A042100 A042100 SIR0100250
burner cap ø 80mm			
	GEV No.	104100	Ref. No. 6A041700 A041700
burner head for burner cap ø 80mm			
	GEV No.	104101	Ref. No. 6A041500 A041500 SIR0100260
burner holder for burner cap ø 80mm with nozzle holder with mixing sleeve			

producer-specific hob burners

OLIS

Snack series

1			
Image not available			
GEV No.	105804	Ref. No.	8220154
description	burner cap 4kW		
For models:	40SCG3S-1826000, 60SCG2S-1826010, 60SCG3S-1826010, 61SCGFE3S-1826055		

1			
GEV No.	105781	Ref. No.	8220162
description	burner cap 4kW mounting pos. inner		
For models:	40SCG3S-1826000, 60SCG2S-1826010, 60SCG3S-1826010, 61SCGFE3S-1826055		

1			
GEV No.	105553	Ref. No.	8220134
description	burner cap ø 65mm 2kW		
For models:	40SCG, 40SCG-1825000, 40SCG3S-1826000, 60SCG, 60SCG-1825010, 60SCG2S-1826010, 60SCG3S-1826010, 61SCGFE3S-1826055		

1			
GEV No.	105662	Ref. No.	8220144
description	burner cap ø 92mm 3.5kW		
For models:	40SCG, 40SCG-1825000, 60SCG, 60SCG-1825010		

1			
Image not available			
GEV No.	105805	Ref. No.	8220152
description	burner head 4kW		
For models:	40SCG3S-1826000, 60SCG2S-1826010, 60SCG3S-1826010, 61SCGFE3S-1826055		

1			
GEV No.	105728	Ref. No.	8220132
description	burner head for burner cap ø 65mm 2kW		
For models:	40SCG, 40SCG-1825000, 40SCG3S-1826000, 60SCG, 60SCG-1825010, 60SCG2S-1826010, 60SCG3S-1826010, 61SCGFE3S-1826055		





			
1			
GEV No.	105729	Ref. No.	8220142
description	burner head for burner cap ø 92mm 3.5kW		
For models:	40SCG, 40SCG-1825000, 60SCG, 60SCG-1825010		

			
1			
GEV No.	105551	Ref. No.	8220151
description	burner lower part 4kW		
For models:	40SCG3S-1826000, 60SCG2S-1826010, 60SCG3S-1826010, 61SCGFE3S-1826055		







			
1			
GEV No.	105550	Ref. No.	8220131
description	burner lower part for burner cap ø 65mm 2kW		
For models:	40SCG, 40SCG-1825000, 40SCG3S-1826000, 60SCG, 60SCG-1825010, 60SCG2S-1826010, 60SCG3S-1826010, 61SCGFE3S-1826055		







			
1			
GEV No.	105780	Ref. No.	8220141
description	burner lower part for burner cap ø 92mm 3.5kW		
For models:	40SCG, 40SCG-1825000, 60SCG, 60SCG-1825010		

			
1			
GEV No.	105692	Ref. No.	8220133 BN8220133
description	burner ring for burner cap ø 65mm 2kW		
For models:	40SCG, 40SCG-1825000, 40SCG3S-1826000, 60SCG, 60SCG-1825010, 60SCG2S-1826010, 60SCG3S-1826010, 61SCGFE3S-1826055		







			
1			
GEV No.	105693	Ref. No.	8220143
description	burner ring for burner cap ø 92mm 3.5kW		
For models:	40SCG, 40SCG-1825000, 60SCG, 60SCG-1825010		







			
1			
GEV No.	105552	Ref. No.	8220153
description	burner ring suitable for burner 4kW		
For models:	40SCG3S-1826000, 60SCG2S-1826010, 60SCG3S-1826010, 61SCGFE3S-1826055		







700 (1) series			
			
1			
GEV No.	104056	Ref. No.	2510140 BN2510140
description	air mixing sleeve		
For models:	716CTG-000195, 716CTGV-000195, 72CAGV-000010, 74CAGV-000020, 74CGV-000040, 76CAGV-000030, 76CGV-000050, 76CGVFL-000070, 7741CGV-1950226, 7741CGV-1950266, 7741C-GVGAS-1950266, 7742C-GV-1950267, 7742CGV-1950267, 7961CGV-1950276, 7961C-GVGAS-1950276, 7962C-GV-1950277, 7962CGV-1950277, 796CG-000270, CG796-000270		
accessories for	104056		
	GEV No.	105291	Ref. No.
			2510600 BN2510600
	burner head for burner cap ø 70mm 3.5kW		
	GEV No.	105292	Ref. No.
			2510601 BN2510601
	burner cap ø 70mm 3.5kW		
	GEV No.	105293	Ref. No.
			2510602 BN2510602
	venturi		
	GEV No.	105294	Ref. No.
			2510603 BN2510603
	burner holder with nozzle holder		
	GEV No.	105296	Ref. No.
			2531789 BN2531789
	cover for pilot burner suitable for 700 series Qty 1 pcs		

			
1			
GEV No.	105292	Ref. No.	2510601 BN2510601
description	burner cap ø 70mm 3.5kW		
For models:	716CTG-000195, 716CTGV-000195, 72CAGV-000010, 74CAGV-000020, 74CGV-000040, 76CAGV-000030, 76CGV-000050, 76CGVFL-000070, 7741CGV-1950226, 7741CGV-1950266, 7741C-GVGAS-1950266, 7742C-GV-1950267, 7742CGV-1950267, 7961CGV-1950276, 7961C-GVGAS-1950276, 7962C-GV-1950277, 7962CGV-1950277, 796CG-000270, CG796-000270		
accessories for	105292		
	GEV No.	104056	Ref. No.
			2510140 BN2510140
	air mixing sleeve		
	GEV No.	105291	Ref. No.
			2510600 BN2510600
	burner head for burner cap ø 70mm 3.5kW		
	GEV No.	105293	Ref. No.
			2510602 BN2510602
	venturi		
	GEV No.	105294	Ref. No.
			2510603 BN2510603
	burner holder with nozzle holder		
	GEV No.	105296	Ref. No.
			2531789 BN2531789
	cover for pilot burner suitable for 700 series Qty 1 pcs		



				
GEV No.	105291	Ref. No.	2510600 BN2510600	
description	burner head for burner cap ø 70mm 3.5kW			
For models:	716CTG-000195, 716CTGV-000195, 72CAGV-000010, 74CAGV-000020, 74CGV-000040, 76CAGV-000030, 76CGV-000050, 76CGVFL-000070, 7741CGV-1950226, 7741CGV-1950266, 7741C-GVGAS-1950266, 7742C-GV-1950267, 7742CGV-1950267, 7961CGV-1950276, 7961C-GVGAS-1950276, 7962C-GV-1950277, 7962CGV-1950277			
accessories for	105291			
	GEV No.	104056	Ref. No.	2510140 BN2510140
air mixing sleeve				
	GEV No.	105292	Ref. No.	2510601 BN2510601
burner cap ø 70mm 3.5kW				
	GEV No.	105293	Ref. No.	2510602 BN2510602
venturi				
	GEV No.	105294	Ref. No.	2510603 BN2510603
burner holder with nozzle holder				
	GEV No.	105296	Ref. No.	2531789 BN2531789
cover for pilot burner suitable for 700 series Qty 1 pcs				

				
GEV No.	105294	Ref. No.	2510603 BN2510603	
description	burner holder with nozzle holder			
For models:	716CTG-000195, 716CTGV-000195, 72CAGV-000010, 74CAGV-000020, 74CGV-000040, 76CAGV-000030, 76CGV-000050, 76CGVFL-000070, 7741CGV-1950226, 7741CGV-1950266, 7741C-GVGAS-1950266, 7742C-GV-1950267, 7742CGV-1950267, 7961CGV-1950276, 7961C-GVGAS-1950276, 7962C-GV-1950277, 7962CGV-1950277, 796CG-000270, CG796-000270			
accessories for	105294			
	GEV No.	104056	Ref. No.	2510140 BN2510140
air mixing sleeve				
	GEV No.	105291	Ref. No.	2510600 BN2510600
burner head for burner cap ø 70mm 3.5kW				
	GEV No.	105292	Ref. No.	2510601 BN2510601
burner cap ø 70mm 3.5kW				
	GEV No.	105293	Ref. No.	2510602 BN2510602
venturi				
	GEV No.	105296	Ref. No.	2531789 BN2531789
cover for pilot burner suitable for 700 series Qty 1 pcs				

				
GEV No.	105293	Ref. No.	2510602 BN2510602	
description	venturi			
For models:	716CTG-000195, 716CTGV-000195, 72CAGV-000010, 74CAGV-000020, 74CGV-000040, 76CAGV-000030, 76CGV-000050, 76CGVFL-000070, 7741CGV-1950226, 7741CGV-1950266, 7741C-GVGAS-1950266, 7742C-GV-1950267, 7742CGV-1950267, 7961CGV-1950276, 7961C-GVGAS-1950276, 7962C-GV-1950277, 7962CGV-1950277, 796CG-000270, CG796-000270			
accessories for	105293			
	GEV No.	104056	Ref. No.	2510140 BN2510140
air mixing sleeve				
	GEV No.	105291	Ref. No.	2510600 BN2510600
burner head for burner cap ø 70mm 3.5kW				
	GEV No.	105292	Ref. No.	2510601 BN2510601
burner cap ø 70mm 3.5kW				
	GEV No.	105294	Ref. No.	2510603 BN2510603
burner holder with nozzle holder				
	GEV No.	105296	Ref. No.	2531789 BN2531789
cover for pilot burner suitable for 700 series Qty 1 pcs				

700 (2), 900 (2) series















				
GEV No.	105289	Ref. No.	0100264 2519002 BN2519002 R0100264 SIR0100264	
description	air mixing sleeve L 50mm ED ø 45mm ID ø 42mm aluminium			
For models:	110-135CG, 110-135CG2P, 110-135CGE, 110-135CGE2P, 110-135CGEE, 110-135CGEE2P, 110-135CGEEP, 110-135CGEP, 110-135CGG, 110-135CGG2P, 110-135CGGE, 110-135CGGE2P, 110-135CGGEP, 110-135CGGP, 110-135CGP, 110-135TCG, 110-135TCG2P, 110-135TCGP, 110-45CG, 110-45CG1P, 110-45CGP, 110-45TCG, 110-45TCG1P, 110-45TCGP, 110-90CG, 110-90CG1P, 110-90CGE, 110-90CGE1P, 110-90CGEP, 110-90CGG, 110-90CGG1P, 110-90CGGP, 110-90CGP, 110-90TCG, 110-90TCG1P, 110-90TCGP, 31FOGV-1950001, 31FOGV-1950002, 31FOGVG-1000003, 31FOGVM-1000007, 32FOGV2-1000002, 32FOGVG-1000004, 32FOGVM-1000015, 4FX, 72+2CTGG-12700013, 72-02CG, 72-02CG-12700001, 72-02CG-12700001TA, 72-02TCG, 72-02TCG-12730001...(Other models you can see in the webshop)			
accessories for	105289			
	GEV No.	105280	Ref. No.	2510351 BN2510351
burner head C for burner cap ø 80mm 3.5kW				
	GEV No.	105281	Ref. No.	2510352 BN2510352
burner cap C ø 80mm 3.5kW with central hole ID ø 32mm				
	GEV No.	105282	Ref. No.	—
venturi C for burner cap ø 80mm 3.5kW				

Table continues overleaf



accessories for 105289				
	GEV No.	105283	Ref. No.	2510354 BN2510354
burner head D for burner cap ø 105mm 5.6kW				
	GEV No.	105284	Ref. No.	2510355 BN2510355
burner cap ID ø 54mm D ø 105mm 5.6kW with central hole				
	GEV No.	105285	Ref. No.	2510353 BN2510353
venturi D for burner cap ø 105mm 5.6kW				
	GEV No.	105286	Ref. No.	2510357 BN2510357
burner head E for burner cap ø 125mm 7kW				
	GEV No.	105287	Ref. No.	2510341 2510358 BN2510341
burner cap E ø 125mm 7kW with central hole				
	GEV No.	105288	Ref. No.	2510340 2510356 BN2510340
venturi E for burner cap ø 125mm 7kW				
	GEV No.	105290	Ref. No.	6A014708 A014708 BN6A014708
nozzle holder nozzle mounting M11x1				

				
1				
GEV No.	105281	Ref. No.	2510352 BN2510352	
description burner cap C ø 80mm 3.5kW with central hole ID ø 32mm				
For models: 110-135CG, 110-135CG2P, 110-135CGE, 110-135CGE2P, 110-135CGEE, 110-135CGEE2P, 110-135CGEEP, 110-135CGEP, 110-135CGG, 110-135CGG2P, 110-135CGGE, 110-135CGGE2P, 110-135CGGEP, 110-135CGGGP, 110-135CGP, 110-45CG, 110-45CG1P, 110-45CGP, 110-90CG, 110-90CG1P, 110-90CGE, 110-90CGE1P, 110-90CGEP, 110-90CGG, 110-90CGG1P, 110-90CGGP, 110-90CGP, 31FOGV-1950001, 31FOGV-1000003, 32FOGV2-1000002, 4FX, 4FX+PCF, 72-02CG, 72-02CG-12700001, 72-02CG-12700001TA, 72-02TCG, 72-02TCG-12730001, 72-02TCG-12730001TA, 72-02TGC, 729CAGV-000009, 729CAGV-1950009, 729CAGV-1950009R, 729TCGV-1959009, 729TCGV-1959009R, 74-02+2CTGG, 74-02+2CTGG-12700030, 74-02CG, 74-02CG-12700002, 74-02CG-12700002TA, 74-02CGE...(Other models you can see in the webshop)				
accessories for 105281				
	GEV No.	105280	Ref. No.	2510351 BN2510351
burner head C for burner cap ø 80mm 3.5kW				
	GEV No.	105282	Ref. No.	—
venturi C for burner cap ø 80mm 3.5kW				
	GEV No.	105289	Ref. No.	0100264 2519002 BN2519002 R0100264 SIR0100264
air mixing sleeve L 50mm ED ø 45mm ID ø 42mm aluminium				
	GEV No.	105290	Ref. No.	6A014708 A014708 BN6A014708
nozzle holder nozzle mounting M11x1				

				
1				
GEV No.	105287	Ref. No.	2510341 2510358 BN2510341	
description burner cap E ø 125mm 7kW with central hole				
For models: 110-135CG, 110-135CG2P, 110-135CGE, 110-135CGE2P, 110-135CGEE, 110-135CGEE2P, 110-135CGEEP, 110-135CGEP, 110-135CGG, 110-135CGG2P, 110-135CGGE, 110-135CGGE2P, 110-135CGGEP, 110-135CGGGP, 110-135CGP, 110-135TCG, 110-135TCG2P, 110-135TCGP, 110-45CG, 110-45CG1P, 110-45CGP, 110-45TCG, 110-45TCG1P, 110-45TCGP, 110-90CG, 110-90CG1P, 110-90CGE, 110-90CGE1P, 110-90CGEP, 110-90CGG, 110-90CGG1P, 110-90CGGP, 110-90CGP, 110-90TCG, 110-90TCG1P, 110-90TCGP, 32FOGVG-1000004, 32FOGV-1000015, 912PCG-1103102, 912PTCG-1103092, 914PCG-1103104, 914PCGE-1103224, 914PCGG-1103214, 914PTCG-1103094, 916PCG-1103106, 916PCGEE-1103246, 916PCGGAN-1103216, 916PCGGE-1103236, 916PTCG-1103096, 918PCG-1103108...(Other models you can see in the webshop)				
accessories for 105287				
	GEV No.	105286	Ref. No.	2510357 BN2510357
burner head E for burner cap ø 125mm 7kW				
	GEV No.	105288	Ref. No.	2510340 2510356 BN2510340
venturi E for burner cap ø 125mm 7kW				
	GEV No.	105289	Ref. No.	0100264 2519002 BN2519002 R0100264 SIR0100264
air mixing sleeve L 50mm ED ø 45mm ID ø 42mm aluminium				
	GEV No.	105290	Ref. No.	6A014708 A014708 BN6A014708
nozzle holder nozzle mounting M11x1				









				
1				
GEV No.	105284	Ref. No.	2510355 BN2510355	
description burner cap ID ø 54mm D ø 105mm 5.6kW with central hole				
For models: 110-135CG, 110-135CG2P, 110-135CGE, 110-135CGE2P, 110-135CGEE, 110-135CGEE2P, 110-135CGG, 110-135CGG2P, 110-135CGGE, 110-135CGGE2P, 110-135TCG, 110-135TCG2P, 110-90CG, 110-90CG1P, 110-90CGE, 110-90CGE1P, 110-90CGG, 110-90CGG1P, 110-90TCG, 110-90TCG1P, 31FOGV-1950002, 31FOGV-1000007, 32FOGV2-1000002, 32FOGVG-1000004, 32FOGV-1000015, 4FX, 4FX+PCF, 72+2CTGG-12700013, 72-02CG, 72-02CG-12700001, 72-02CG-12700001TA, 72-02TCG, 72-02TCG-12730001, 72-02TCG-12730001TA, 72-02TGC, 729CAGV-000009, 729CAGV-1950009, 729CAGV-1950009R, 729TCGV-1959009, 729TCGV-1959009R, 74-02+2CTGG, 74-02+2CTGG-12700030, 74-02CG, 74-02CG-12700002, 74-02CG-12700002TA, 74-02CGE, 74-02CGE-12700011, 74-02CGE-12700011TA, 74-02CGG...(Other models you can see in the webshop)				
accessories for 105284				
	GEV No.	105283	Ref. No.	2510354 BN2510354
burner head D for burner cap ø 105mm 5.6kW				
	GEV No.	105285	Ref. No.	2510353 BN2510353
venturi D for burner cap ø 105mm 5.6kW				

Table continues overleaf



accessories for 105284				
	GEV No.	105289	Ref. No.	0100264 2519002 BN2519002 R0100264 SIR0100264
air mixing sleeve L 50mm ED ø 45mm ID ø 42mm aluminium				
	GEV No.	105290	Ref. No.	6A014708 A014708 BN6A014708
nozzle holder nozzle mounting M11x1				

				
1				
GEV No.	105280	Ref. No.	2510351 BN2510351	
description	burner head C for burner cap ø 80mm 3.5kW			
For models:	110-135CG, 110-135CG2P, 110-135CGE, 110-135CGE2P, 110-135CGEE, 110-135CGEE2P, 110-135CGEEP, 110-135CGEP, 110-135CGG, 110-135CGG2P, 110-135CGGE, 110-135CGGE2P, 110-135CGGEP, 110-135CGGP, 110-135CGP, 110-45CG, 110-45CG1P, 110-45CGP, 110-90CG, 110-90CG1P, 110-90CGE, 110-90CGE1P, 110-90CGEP, 110-90CGG, 110-90CGG1P, 110-90CGGP, 110-90CGP, 31FOGV-1950001, 31FOGVG-1000003, 32FOGV2-1000002, 4FX, 4FX+PCF, 72-02CG, 72-02CG-12700001, 72-02CG-12700001TA, 72-02TCG, 72-02TCG-12730001, 72-02TCG-12730001TA, 72-02TGC, 729CAGV-000009, 729CAGV-1950009, 729CAGV-1950009R, 729TCGV-1959009, 729TCGV-1959009R, 74-02+2CTGG, 74-02+2CTGG-12700030, 74-02CG, 74-02CG-12700002, 74-02CG-12700002TA, 74-02CGE...(Other models you can see in the webshop)			
accessories for	105280			
	GEV No.	105281	Ref. No.	2510352 BN2510352
burner cap C ø 80mm 3.5kW with central hole ID ø 32mm				
	GEV No.	105282	Ref. No.	—
venturi C for burner cap ø 80mm 3.5kW				
	GEV No.	105289	Ref. No.	0100264 2519002 BN2519002 R0100264 SIR0100264
air mixing sleeve L 50mm ED ø 45mm ID ø 42mm aluminium				
	GEV No.	105290	Ref. No.	6A014708 A014708 BN6A014708
nozzle holder nozzle mounting M11x1				

				
1				
GEV No.	105283	Ref. No.	2510354 BN2510354	
description	burner head D for burner cap ø 105mm 5.6kW			
For models:	110-135CG, 110-135CG2P, 110-135CGE, 110-135CGE2P, 110-135CGEE, 110-135CGEE2P, 110-135CGG, 110-135CGG2P, 110-135CGGE, 110-135CGGE2P, 110-135TCG, 110-135TCG2P, 110-90CG, 110-90CG1P, 110-90CGE, 110-90CGE1P, 110-90CGG, 110-90CGG1P, 110-90TCG, 110-90TCG1P, 31FOGV-1950002, 31FOGV-1000007, 32FOGV2-1000002, 32FOGVG-1000004, 32FOGV-1000015, 4FX, 4FX+PCF, 72+2CTGG-12700013, 72-02CG, 72-02CG-12700001, 72-02CG-12700001TA, 72-02TCG, 72-02TCG-12730001, 72-02TCG-12730001TA, 72-02TGC, 729CAGV-000009, 729CAGV-1950009, 729CAGV-1950009R, 729TCGV-1959009, 729TCGV-1959009R, 74+2CTGG-AN-12700025, 74-02+2CTGG, 74-02+2CTGG-12700030, 74-02CG, 74-02CG-12700002, 74-02CG-12700002TA, 74-02CGE, 74-02CGE-12700011, 74-02CGE-12700011TA, 74-02CGE...(Other models you can see in the webshop)			
accessories for	105283			
	GEV No.	105284	Ref. No.	2510355 BN2510355
burner cap ID ø 54mm D ø 105mm 5.6kW with central hole				
	GEV No.	105285	Ref. No.	2510353 BN2510353
venturi D for burner cap ø 105mm 5.6kW				
	GEV No.	105289	Ref. No.	0100264 2519002 BN2519002 R0100264 SIR0100264
air mixing sleeve L 50mm ED ø 45mm ID ø 42mm aluminium				
	GEV No.	105290	Ref. No.	6A014708 A014708 BN6A014708
nozzle holder nozzle mounting M11x1				















				
1				
GEV No.	105286	Ref. No.	2510357 BN2510357	
description	burner head E for burner cap ø 125mm 7kW			
For models:	110-135CG, 110-135CG2P, 110-135CGE, 110-135CGE2P, 110-135CGEE, 110-135CGEE2P, 110-135CGEEP, 110-135CGEP, 110-135CGG, 110-135CGG2P, 110-135CGGE, 110-135CGGE2P, 110-135CGGEP, 110-135CGGP, 110-135CGP, 110-135TCG, 110-135TCG2P, 110-135TCGP, 110-45CG, 110-45CG1P, 110-45CGP, 110-45TCG, 110-45TCG1P, 110-45TCGP, 110-90CG, 110-90CG1P, 110-90CGE, 110-90CGE1P, 110-90CGEP, 110-90CGG, 110-90CGG1P, 110-90CGGP, 110-90CGP, 110-90TCG, 110-90TCG1P, 110-90TCGP, 32FOGVG-1000004, 32FOGV-VM-1000015, 912PCG-1103102, 912PTCG-1103092, 914PCG-1103104, 914PCGE-1103224, 914PCGG-1103214, 914PTCG-1103094, 916PCG-1103106, 916PCGEE-1103246, 916PCGGAN-1103216, 916PCGE-1103236, 916PTCG-1103096, 918PCG-1103108...(Other models you can see in the webshop)			
accessories for	105286			
	GEV No.	105287	Ref. No.	2510341 2510358 BN2510341
burner cap E ø 125mm 7kW with central hole				
	GEV No.	105288	Ref. No.	2510340 2510356 BN2510340
venturi E for burner cap ø 125mm 7kW				

Table continues overleaf



accessories for 105286					
	<table border="1"> <tr> <td>GEV No.</td> <td>105289</td> <td>Ref. No.</td> <td>0100264 2519002 BN2519002 R0100264 SIR0100264</td> </tr> </table> <p>air mixing sleeve L 50mm ED ø 45mm ID ø 42mm aluminium</p>	GEV No.	105289	Ref. No.	0100264 2519002 BN2519002 R0100264 SIR0100264
GEV No.	105289	Ref. No.	0100264 2519002 BN2519002 R0100264 SIR0100264		
	<table border="1"> <tr> <td>GEV No.</td> <td>105290</td> <td>Ref. No.</td> <td>6A014708 A014708 BN6A014708</td> </tr> </table> <p>nozzle holder nozzle mounting M11x1</p>	GEV No.	105290	Ref. No.	6A014708 A014708 BN6A014708
GEV No.	105290	Ref. No.	6A014708 A014708 BN6A014708		

	1		
GEV No.	105290	Ref. No.	6A014708 BN6A014708
description	nozzle holder nozzle mounting M11x1		
For models:	110-135CG, 110-135CG2P, 110-135CGE, 110-135CGE2P, 110-135CGEE, 110-135CGEE2P, 110-135CGEEP, 110-135CGEP, 110-135CGG, 110-135CGG2P, 110-135CGGE, 110-135CGGE2P, 110-135CGGEP, 110-135CGGP, 110-135CGP, 110-135TCG, 110-135TCG2P, 110-135TCGP, 110-45CBG, 110-45CG, 110-45CG1P, 110-45CGP, 110-45TCBG, 110-45TCG, 110-45TCG1P, 110-45TCGP, 110-90CG, 110-90CG1P, 110-90CGE, 110-90CGE1P, 110-90CGEP, 110-90CGG, 110-90CGG1P, 110-90CGGP, 110-90CGP, 110-90CTG, 110-90CTGE, 110-90CTGG, 110-90FTTG, 110-90FTTG1-2R, 110-90FTTGC, 110-90FTTGC1-2R, 110-90FTTGR, 110-90FTTGE, 110-90FTTGG, 110-90FTTGR, 110-90TCG, 110-90TCG1P, 110-90TCGP, 110-90TCG... (Other models you can see in the webshop)		



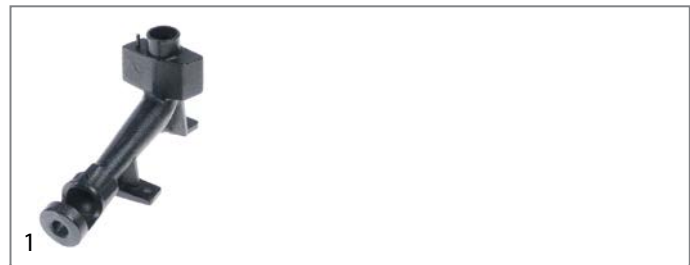

accessories for 105290					
	<table border="1"> <tr> <td>GEV No.</td> <td>105280</td> <td>Ref. No.</td> <td>2510351 BN2510351</td> </tr> </table> <p>burner head C for burner cap ø 80mm 3.5kW</p>	GEV No.	105280	Ref. No.	2510351 BN2510351
GEV No.	105280	Ref. No.	2510351 BN2510351		
	<table border="1"> <tr> <td>GEV No.</td> <td>105281</td> <td>Ref. No.</td> <td>2510352 BN2510352</td> </tr> </table> <p>burner cap C ø 80mm 3.5kW with central hole ID ø 32mm</p>	GEV No.	105281	Ref. No.	2510352 BN2510352
GEV No.	105281	Ref. No.	2510352 BN2510352		
	<table border="1"> <tr> <td>GEV No.</td> <td>105282</td> <td>Ref. No.</td> <td>—</td> </tr> </table> <p>venturi C for burner cap ø 80mm 3.5kW</p>	GEV No.	105282	Ref. No.	—
GEV No.	105282	Ref. No.	—		
	<table border="1"> <tr> <td>GEV No.</td> <td>105283</td> <td>Ref. No.</td> <td>2510354 BN2510354</td> </tr> </table> <p>burner head D for burner cap ø 105mm 5.6kW</p>	GEV No.	105283	Ref. No.	2510354 BN2510354
GEV No.	105283	Ref. No.	2510354 BN2510354		
	<table border="1"> <tr> <td>GEV No.</td> <td>105284</td> <td>Ref. No.</td> <td>2510355 BN2510355</td> </tr> </table> <p>burner cap ID ø 54mm D ø 105mm 5.6kW with central hole</p>	GEV No.	105284	Ref. No.	2510355 BN2510355
GEV No.	105284	Ref. No.	2510355 BN2510355		
	<table border="1"> <tr> <td>GEV No.</td> <td>105285</td> <td>Ref. No.</td> <td>2510353 BN2510353</td> </tr> </table> <p>venturi D for burner cap ø 105mm 5.6kW</p>	GEV No.	105285	Ref. No.	2510353 BN2510353
GEV No.	105285	Ref. No.	2510353 BN2510353		
	<table border="1"> <tr> <td>GEV No.</td> <td>105286</td> <td>Ref. No.</td> <td>2510357 BN2510357</td> </tr> </table> <p>burner head E for burner cap ø 125mm 7kW</p>	GEV No.	105286	Ref. No.	2510357 BN2510357
GEV No.	105286	Ref. No.	2510357 BN2510357		
	<table border="1"> <tr> <td>GEV No.</td> <td>105287</td> <td>Ref. No.</td> <td>2510341 2510358 BN2510341</td> </tr> </table> <p>burner cap E ø 125mm 7kW with central hole</p>	GEV No.	105287	Ref. No.	2510341 2510358 BN2510341
GEV No.	105287	Ref. No.	2510341 2510358 BN2510341		
	<table border="1"> <tr> <td>GEV No.</td> <td>105288</td> <td>Ref. No.</td> <td>2510340 2510356 BN2510340</td> </tr> </table> <p>venturi E for burner cap ø 125mm 7kW</p>	GEV No.	105288	Ref. No.	2510340 2510356 BN2510340
GEV No.	105288	Ref. No.	2510340 2510356 BN2510340		
	<table border="1"> <tr> <td>GEV No.</td> <td>105289</td> <td>Ref. No.</td> <td>0100264 2519002 BN2519002 R0100264 SIR0100264</td> </tr> </table> <p>air mixing sleeve L 50mm ED ø 45mm ID ø 42mm aluminium</p>	GEV No.	105289	Ref. No.	0100264 2519002 BN2519002 R0100264 SIR0100264
GEV No.	105289	Ref. No.	0100264 2519002 BN2519002 R0100264 SIR0100264		

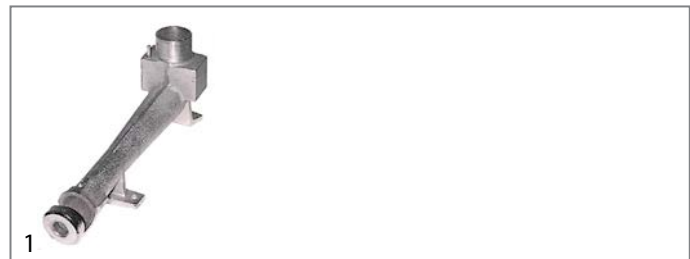









GEV No.	104452	Ref. No.	2510350 BN2510350
description	venturi C for burner cap ø 80mm 3.5kW		
For models:	4FX, 4FX+PCF, 72-02CG, 72-02CG-12700001, 72-02CG-12700001TA, 72-02TCG, 72-02TCG-12730001, 72-02TCG-12730001TA, 72-02TGC, 729CAGV-000009, 729CAGV-1950009, 729CAGV-1950009R, 729TCGV-1959009, 729TCGV-1959009R, 74-02+2CTGG, 74-02+2CTGG-12700030, 74-02CG, 74-02CG-12700002, 74-02CG-12700002TA, 74-02CGE, 74-02CGE-12700011, 74-02CGE-12700011TA, 74-02CGG, 74-02CGG-12700010, 74-02CGG-12700010TA, 74-02TCG, 74-02TCG-12730002, 74-02TCG-12730002TA, 74-02TGC, 749CAGV-000019, 749CAGV-1950019, 749CAGV-1950019R, 749TCGV-1959019, 749TCGV-1959019R, 76-02CG, 76-02CG-12700003, 76-02CG-12700003TA, 76-02CGE, 76-02CGE-12700017, 76-02CGE-12700017TA, 76-02CGEE, 76-02CGEE-12700018, 76-02CGEE-12700018TA, 76-02CGFL, 76-02CGFL-12700020... (Other models you can see in the webshop)		













GEV No.	105285	Ref. No.	2510353 BN2510353
description	venturi D for burner cap ø 105mm 5.6kW		
For models:	4FX, 4FX+PCF, 72+2CTGG-12700013, 72-02CG, 72-02CG-12700001, 72-02CG-12700001TA, 72-02TCG, 72-02TCG-12730001, 72-02TCG-12730001TA, 72-02TGC, 729CAGV-000009, 729CAGV-1950009, 729CAGV-1950009R, 729TCGV-1959009, 729TCGV-1959009R, 74+2CTGGAN-12700025, 74-02+2CTGG, 74-02+2CTGG-12700030, 74-02CG, 74-02CG-12700002, 74-02CG-12700002TA, 74-02CGE, 74-02CGE-12700011, 74-02CGE-12700011TA, 74-02CGG, 74-02CGG-12700010, 74-02CGG-12700010TA, 74-02TCG, 74-02TCG-12730002, 74-02TCG-12730002TA, 74-02TGC, 749CAGV-000019, 749CAGV-1950019, 749CAGV-1950019R, 749CGV-000039, 749CGV-1950039, 749CGV-1950039R, 749CGVFE-1950059, 749CGVFE-1950059R, 749TCGV-1959019, 749TCGV-1959019R, 76-02+4CTGG-12700031, 76-02CG, 76-02CG-12700003, 76-02CG-12700003TA, 76-02CGE, 76-02CGE-12700017, 76-02CGE-12700017TA, 76-02CGEE, 76-02CGEE-12700018... (Other models you can see in the webshop)		





accessories for 105285					
	<table border="1"> <tr> <td>GEV No.</td> <td>105283</td> <td>Ref. No.</td> <td>2510354 BN2510354</td> </tr> </table> <p>burner head D for burner cap ø 105mm 5.6kW</p>	GEV No.	105283	Ref. No.	2510354 BN2510354
GEV No.	105283	Ref. No.	2510354 BN2510354		
	<table border="1"> <tr> <td>GEV No.</td> <td>105284</td> <td>Ref. No.</td> <td>2510355 BN2510355</td> </tr> </table> <p>burner cap ID ø 54mm D ø 105mm 5.6kW with central hole</p>	GEV No.	105284	Ref. No.	2510355 BN2510355
GEV No.	105284	Ref. No.	2510355 BN2510355		
	<table border="1"> <tr> <td>GEV No.</td> <td>105289</td> <td>Ref. No.</td> <td>0100264 2519002 BN2519002 R0100264 SIR0100264</td> </tr> </table> <p>air mixing sleeve L 50mm ED ø 45mm ID ø 42mm aluminium</p>	GEV No.	105289	Ref. No.	0100264 2519002 BN2519002 R0100264 SIR0100264
GEV No.	105289	Ref. No.	0100264 2519002 BN2519002 R0100264 SIR0100264		
	<table border="1"> <tr> <td>GEV No.</td> <td>105290</td> <td>Ref. No.</td> <td>6A014708 A014708 BN6A014708</td> </tr> </table> <p>nozzle holder nozzle mounting M11x1</p>	GEV No.	105290	Ref. No.	6A014708 A014708 BN6A014708
GEV No.	105290	Ref. No.	6A014708 A014708 BN6A014708		

			
1			
GEV No.	105288	Ref. No.	2510340 2510356 BN2510340
description	venturi E for burner cap ø 125mm 7kW		
For models:	92-04CG, 92-04CG-12900001, 92-04CG-12900001TA, 92-04CG1P, 92-04CG1P-12900025, 92-04CG1P-12900025TA, 92-04CGP, 92-04CGP-12900051, 92-04CGP-12900051TA, 92-04TCG, 92-04TCG-12930001, 92-04TCG-12930001TA, 92-04TCG1P, 92-04TCG1P-12930025, 92-04TCG1P-12930025TA, 92-04TCGP, 92-04TCGP-12930051, 92-04TCGP-12930051TA, 92CG-1191102, 92CG-191102, 92TCG-1191092, 92TCG-1191092S, 94-04CG, 94-04CG-12900002, 94-04CG-12900002TA, 94-04CG1P, 94-04CG1P-12900026, 94-04CG1P-12900026TA, 94-04CGE, 94-04CGE-12900011, 94-04CGE-12900011TA, 94-04CGE1P, 94-04CGE1P-12900031, 94-04CGEP, 94-04CGEP-12900061, 94-04CGEP-12900061TA, 94-04CGG, 94-04CGG-12900010, 94-04CGG-12900010TA, 94-04CGG1P, 94-04CGG1P-12900030, 94-04CGG1P-12900030TA, 94-04CGG1P-12900031TA, 94-04CGGP, 94-04CGGP-12900060, 94-04CGGP-12900060TA, 94-04CGP, 94-04CGP-12900052, 94-04CGP-12900052TA, 94-04CTGGSS...(Other models you can see in the webshop)		
accessories for	105288		
	GEV No.	105286	Ref. No. 2510357 BN2510357
burner head E for burner cap ø 125mm 7kW			
	GEV No.	105287	Ref. No. 2510341 2510358 BN2510341
burner cap E ø 125mm 7kW with central hole			
	GEV No.	105289	Ref. No. 0100264 2519002 BN2519002 R0100264 SIR0100264
air mixing sleeve L 50mm ED ø 45mm ID ø 42mm aluminium			
	GEV No.	105290	Ref. No. 6A014708 A014708 BN6A014708
nozzle holder nozzle mounting M11x1			





900 (1) series			
			
1			
GEV No.	104051	Ref. No.	2510197 BN2510197
description	air mixing sleeve		
For models:	CA-GV92-1050010, CA-GV94-1050020, CA-GV96-1050030, C-GV904-1050110, C-GV904FE-1050135, C-GV906-1050120, C-GV906FL-1050200, C-GV908-1050130		
accessories for	104051		
	GEV No.	103030	Ref. No. 2510190 BN2510190
burner cap C ø 85mm 3.5kW			
	GEV No.	103031	Ref. No. 2510193 BN2510193
burner cap D ø 115mm 5.5kW			
	GEV No.	103032	Ref. No. 2510196 BN2510196
burner cap E ø 125mm 7kW with central hole			

accessories for	104051		
	GEV No.	104045	Ref. No. 2510189 BN2510189
burner head C for burner cap ø 85mm 3.5kW			
	GEV No.	104046	Ref. No. 2510192 BN2510192
burner head D for burner cap ø 115mm 5.5kW			
	GEV No.	104047	Ref. No. 2510194 BN2510194
burner head E for burner cap ø 125mm 7kW			
	GEV No.	104048	Ref. No. 2510195 BN2510195
venturi C for burner cap ø 85mm 3.5kW			
	GEV No.	104049	Ref. No. 2510201
venturi D for burner cap ø 115mm 5.5kW			
	GEV No.	104050	Ref. No. 2510202 BN2510202
venturi E for burner cap ø 125mm 7kW			



			
1			
GEV No.	103030	Ref. No.	2510190 BN2510190
description	burner cap C ø 85mm 3.5kW		
For models:	CA-GV92-1050010, CA-GV94-1050020, CA-GV96-1050030, C-GV904-1050110, C-GV904FE-1050135, C-GV906-1050120, C-GV906FL-1050200, C-GV908-1050130		
accessories for	103030		
	GEV No.	104045	Ref. No. 2510189 BN2510189
burner head C for burner cap ø 85mm 3.5kW			
	GEV No.	104048	Ref. No. 2510195 BN2510195
venturi C for burner cap ø 85mm 3.5kW			
	GEV No.	104051	Ref. No. 2510197 BN2510197
air mixing sleeve			

			
1			
GEV No.	103031	Ref. No.	2510193 BN2510193
description	burner cap D ø 115mm 5.5kW		
For models:	CA-GV94-1050020, CA-GV96-1050030, C-GV904-1050110, C-GV-904FE-1050135, C-GV906-1050120, C-GV906FL-1050200, C-GV908-1050130		
accessories for	103031		
	GEV No.	104046	Ref. No. 2510192 BN2510192
burner head D for burner cap ø 115mm 5.5kW			
	GEV No.	104049	Ref. No. 2510201
venturi D for burner cap ø 115mm 5.5kW			
	GEV No.	104051	Ref. No. 2510197 BN2510197
air mixing sleeve			



 <p>1</p>			
GEV No.	103032	Ref. No.	2510196 BN2510196
description	burner cap E ø 125mm 7kW with central hole		
For models:	CA-GV92-1050010, CA-GV94-1050020, CA-GV96-1050030, C-GV904-1050110, C-GV904FE-1050135, C-GV906-1050120, C-GV906FL-1050200, C-GV908-1050130		
accessories for	103032		
	GEV No.	104047	Ref. No. 2510194 BN2510194
burner head E for burner cap ø 125mm 7kW			
	GEV No.	104050	Ref. No. 2510202 BN2510202
venturi E for burner cap ø 125mm 7kW			
	GEV No.	104051	Ref. No. 2510197 BN2510197
air mixing sleeve			

 <p>1</p>			
GEV No.	104045	Ref. No.	2510189 BN2510189
description	burner head C for burner cap ø 85mm 3.5kW		
For models:	CA-GV92-1050010, CA-GV94-1050020, CA-GV96-1050030, C-GV904-1050110, C-GV904FE-1050135, C-GV906-1050120, C-GV906FL-1050200, C-GV908-1050130		
accessories for	104045		
	GEV No.	103030	Ref. No. 2510190 BN2510190
burner cap C ø 85mm 3.5kW			
	GEV No.	104048	Ref. No. 2510195 BN2510195
venturi C for burner cap ø 85mm 3.5kW			
	GEV No.	104051	Ref. No. 2510197 BN2510197
air mixing sleeve			





 <p>1</p>			
GEV No.	104046	Ref. No.	2510192 BN2510192
description	burner head D for burner cap ø 115mm 5.5kW		
For models:	CA-GV94-1050020, CA-GV96-1050030, C-GV904-1050110, C-GV-904FE-1050135, C-GV906-1050120, C-GV906FL-1050200, C-GV908-1050130		
accessories for	104046		
	GEV No.	103031	Ref. No. 2510193 BN2510193
burner cap D ø 115mm 5.5kW			
	GEV No.	104049	Ref. No. 2510201
venturi D for burner cap ø 115mm 5.5kW			

accessories for	104046		
	GEV No.	104051	Ref. No. 2510197 BN2510197
air mixing sleeve			

 <p>1</p>			
GEV No.	104047	Ref. No.	2510194 BN2510194
description	burner head E for burner cap ø 125mm 7kW		
For models:	CA-GV92-1050010, CA-GV94-1050020, CA-GV96-1050030, C-GV904-1050110, C-GV904FE-1050135, C-GV906-1050120, C-GV906FL-1050200, C-GV908-1050130		
accessories for	104047		
	GEV No.	103032	Ref. No. 2510196 BN2510196
burner cap E ø 125mm 7kW with central hole			
	GEV No.	104050	Ref. No. 2510202 BN2510202
venturi E for burner cap ø 125mm 7kW			
	GEV No.	104051	Ref. No. 2510197 BN2510197
air mixing sleeve			

 <p>1</p>			
GEV No.	104048	Ref. No.	2510195 BN2510195
description	venturi C for burner cap ø 85mm 3.5kW		
For models:	CA-GV92-1050010, CA-GV94-1050020, CA-GV96-1050030, C-GV904-1050110, C-GV904FE-1050135, C-GV906-1050120, C-GV906FL-1050200, C-GV908-1050130		
accessories for	104048		
	GEV No.	103030	Ref. No. 2510190 BN2510190
burner cap C ø 85mm 3.5kW			
	GEV No.	104045	Ref. No. 2510189 BN2510189
burner head C for burner cap ø 85mm 3.5kW			
	GEV No.	104051	Ref. No. 2510197 BN2510197
air mixing sleeve			





			
GEV No.	104049	Ref. No.	2510201
description	venturi D for burner cap ø 115mm 5.5kW		
For models:	CA-GV94-1050020, CA-GV96-1050030, C-GV904-1050110, C-GV-904FE-1050135, C-GV906-1050120, C-GV906FL-1050200, C-GV908-1050130		
accessories for	104049		
	GEV No.	103031	Ref. No. 2510193 BN2510193
burner cap D ø 115mm 5.5kW			
	GEV No.	104046	Ref. No. 2510192 BN2510192
burner head D for burner cap ø 115mm 5.5kW			
	GEV No.	104051	Ref. No. 2510197 BN2510197
air mixing sleeve			

			
GEV No.	104050	Ref. No.	2510202 BN2510202
description	venturi E for burner cap ø 125mm 7kW		
For models:	CA-GV92-1050010, CA-GV94-1050020, CA-GV96-1050030, C-GV904-1050110, C-GV904FE-1050135, C-GV906-1050120, C-GV906FL-1050200, C-GV908-1050130		
accessories for	104050		
	GEV No.	103032	Ref. No. 2510196 BN2510196
burner cap E ø 125mm 7kW with central hole			
	GEV No.	104047	Ref. No. 2510194 BN2510194
burner head E for burner cap ø 125mm 7kW			
	GEV No.	104051	Ref. No. 2510197 BN2510197
air mixing sleeve			

pan supports

			
GEV No.	210185	Ref. No.	6A003200
description	pan support		
For models:	729CAGV-000009, 749CAGV-000019, 749CGV-000039, 769CAGV-000029, 769CGV-000049, 769CGVFL-000069		

			
GEV No.	210184	Ref. No.	2510797 BN2510797
description	pan support W 295mm L 510mm		
For models:	7741CGV-1950226, 7741CGV-1950266, 7741C-GVGAS-1950266, 7742C-GV-1950267, 7742CGV-1950267, 7961CGV-1950276, 7961C-GVGAS-1950276, 7962C-GV-1950277, 7962CGV-1950277, 796CG-000270, CG796-000270		

			
GEV No.	107885	Ref. No.	6A003400 BN6A003400
description	pan support W 318mm L 548mm H 45mm suitable for LAINOX		
For models:	4FX, 72-02CG, 72-02CG-12700001, 72-02CG-12700001TA, 72-02TCG, 72-02TCG-12730001, 72-02TCG-12730001TA, 72-02TGC, 74-02+2CTGG, 74-02+2CTGG-12700030, 74-02CG, 74-02CG-12700002, 74-02CG-12700002TA, 74-02CGE, 74-02CGE-12700011, 74-02CGE-12700011TA, 74-02CGG, 74-02CGG-12700010, 74-02CGG-12700010TA, 74-02TCG, 74-02TCG-12730002, 74-02TCG-12730002TA, 74-02TGC, 76-02+4CTGG, 76-02+4CTGG-12700031, 76-02CG, 76-02CG-12700003, 76-02CG-12700003TA, 76-02CGE, 76-02CGE-12700017, 76-02CGE-12700017TA, 76-02CGEE, 76-02CGEE-12700018, 76-02CGEE-12700018TA, 76-02CGFL, 76-02CGFL-12700020, 76-02CGFL-12700020TA, 76-02CGG, 76-02CGG-12700015, 76-02CGG-12700015TA, 76-02CGGE, 76-02CGGE-12700016, 76-02CGGE-12700016TA, 76-02CTG, 76-02CTG-12700193, 76-02CTG-12700193TA, 76-02CTGG, 76-02CTGG-12700195, 76-02CTGG-12700195TA, 76-02CTGGE...(Other models you can see in the webshop)		

			
GEV No.	210108	Ref. No.	6A001900 BN6A001900
description	pan support W 340mm L 400mm suitable for 900 series		
For models:	CA-GV92-1050010, CA-GV94-1050020, CA-GV96-1050030, C-GV904-1050110, C-GV904FE-1050135, C-GV906-1050120, C-GV906FL-1050200, C-GV908-1050130		

1

GEV No.	210268	Ref. No.	6A003900 BN6A003900
description	pan support W 345mm L 395mm H 24mm suitable for 1100 series		
For models:	110-135CG, 110-135CG2P, 110-135CGE, 110-135CGE2P, 110-135CGEE, 110-135CGEE2P, 110-135CGEEP, 110-135CGEP, 110-135CGG, 110-135CGG2P, 110-135CGGE, 110-135CGGE2P, 110-135CGGEP, 110-135CGGP, 110-135CGP, 110-135TCG, 110-135TCG2P, 110-135TCGP, 110-45CG, 110-45CG1P, 110-45CGP, 110-45TCG, 110-45TCG1P, 110-45TCGP, 110-90CG, 110-90CG1P, 110-90CGE, 110-90CGE1P, 110-90CGEP, 110-90CGG, 110-90CGG1P, 110-90CGGP, 110-90CGP, 110-90TCG, 110-90TCG1P, 110-90TCGP, 92-04CG, 92-04CG-12900001, 92-04CG-12900001TA, 92-04CG1P, 92-04CG1P-12900025, 92-04CG1P-12900025TA, 92-04CGP, 92-04CGP-12900051, 92-04CGP-12900051TA, 92-04TCG, 92-04TCG-12930001, 92-04TCG-12930001TA, 92-04TCG1P, 92-04TCG1P-12930025...(Other models you can see in the webshop)		



1

GEV No.	210267	Ref. No.	0797410 CR0797410
description	pan support W 348mm L 348mm H 36mm suitable for GHISA 900		



1

GEV No.	210186	Ref. No.	2510363 BN2510363
description	pan support W 450mm L 355mm		
For models:	31FOGV-1950001, 31FOGV-1950002, 31FOGVG-1000003, 31FOGVM-1000007, 32FOGV2-1000002, 32FOGVG-1000004, 32FOGVM-1000015, 92CG-1191102, 92CG-191102, 92TCG-1191092, 92TCG-1191092S, 94ICTGG-1291710, 94CG-1191104, 94CG-191104, 94CGAC-1191164, 94CGE-1191224, 94CGG-1191214, 94CGG-191214, 94TCG-1191094, 94TCG-1191094S, 96CG-1191106, 96CG-191106, 96CGEAC-1191246, 96CGEAN-1191226, 96CGEE-1191246, 96CGG-1191216, 96CGG-191216, 96CGG-191236, 96CGGAC-1191236, 96CGGE-1191236, 96CTG-1191702, 96CTG-191702, 96CTGG-1191712, 96CTGG-191712, 96CTGGAC-1191732, 96TCG-1191096, 96TCG-1191096S, 96TCTG-1191792, 98CG-1191108, 98CG-191108, 98CGAC-1191168, 98CGE-1191228, 98CGG-1191218, 98CGG-191218, 98TCG-1191098		

accessories

pan supports



1

GEV No.	210185	Ref. No.	6A003200
description	pan support		
For models:	729CAGV-000009, 749CAGV-000019, 749CGV-000039, 769CAGV-000029, 769CGV-000049, 769CGVFL-000069		



1

GEV No.	210184	Ref. No.	2510797 BN2510797
description	pan support W 295mm L 510mm		
For models:	7741CGV-1950226, 7741CGV-1950266, 7741C-GVGAS-1950266, 7742C-GV-1950267, 7742CGV-1950267, 7961CGV-1950276, 7961C-GVGAS-1950276, 7962C-GV-1950277, 7962CGV-1950277, 796CG-000270, CG796-000270		



1

GEV No.	210151	Ref. No.	1032101100 1032101101 MA1032101101
description	pan support W 295mm L 545mm gas range		
For models:	OPCG61		



1

GEV No.	210108	Ref. No.	6A001900 BN6A001900
description	pan support W 340mm L 400mm suitable for 900 series		
For models:	CA-GV92-1050010, CA-GV94-1050020, CA-GV96-1050030, C-GV904-1050110, C-GV904FE-1050135, C-GV906-1050120, C-GV906FL-1050200, C-GV908-1050130		



1

GEV No.	210150	Ref. No.	1032101000 1032101001 MA1032101001
description	pan support W 340mm L 545mm		
For models:	CFG101, CFG70, OCFG101, OCFG-101-12600025, OCFG70, OCFG-70-12600000, OPCG41, OPCG-41-12600010		



1

GEV No.	210104	Ref. No.	1316522
description	pan support W 400mm L 430mm for 900		
For models:	CFG120, OCFG120		



1

GEV No.	210186	Ref. No.	2510363 BN2510363
description	pan support W 450mm L 355mm		
For models:	31FOGV-1950001, 31FOGV-1950002, 31FOGVG-1000003, 31FOGVM-1000007, 32FOGV2-1000002, 32FOGVG-1000004, 32FOGVM-1000015, 92CG-1191102, 92CG-191102, 92TCG-1191092, 92TCG-1191092S, 941CTGG-1291710, 94CG-1191104, 94CG-191104, 94CGAC-1191164, 94CGE-1191224, 94CGG-1191214, 94CGG-191214, 94TCG-1191094, 94TCG-1191094S, 96CG-1191106, 96CG-191106, 96CGEAC-1191246, 96CGEAN-1191226, 96CGEE-1191246, 96CGG-1191216, 96CGG-191216, 96CGG-191236, 96CGGAC-1191236, 96CGGE-1191236, 96CTG-1191702, 96CTG-191702, 96CTGG-1191712, 96CTGG-191712, 96CTGGAC-1191732, 96TCG-1191096, 96TCG-1191096S, 96TCG-1191792, 98CG-1191108, 98CG-191108, 98CGAC-1191168, 98CGE-1191228, 98CGG-1191218, 98CGG-191218, 98TCG-1191098		

air mixers



1

GEV No.	106804	Ref. No.	CR0508690
description	air mixer		
For models:	FQG41, FQG61, OFQG41, OFQG-41-12600500, OFQG61, OFQG-61-12600600		



1

GEV No.	106805	Ref. No.	CR0508400
description	air mixer		
For models:	FQG41, FQG61, OFQG41, OFQG-41-12600500, OFQG61, OFQG-61-12600600		



1

GEV No.	106066	Ref. No.	CM136600
description	air mixing tube dimensions 18x42mm ED ø 24mm		
For models:	OFTG40B, OFTG-40B-12600130, OFTG40BLC, OFTG-40BLC-12600135, OFTG40BR, OFTG-40BR-12600132, OFTG60B, OFTG-60B-12600140, OFTG60BLC, OFTG-60BLC-12600145, OFTG60BR, OFTG-60BR-12600141, OFTG60BRR, OFTG-60BRR-12600142, OFTG80BLC, OFTG-80BLC-12600138		



1

GEV No.	105711	Ref. No.	2510517 BN2510517
description	air mixing tube L 42mm ED ø 20mm brass		
For models:	110-90FTTG, 110-90FTTG1-2R, 110-90FTTGC, 110-90FTTGC1-2R, 110-90FTTGCR, 110-90FTTGE, 110-90FTTGG, 110-90FTTGR, 110-90FTTGG, 110-90FTTGG1-2R, 110-90FTTGGC, 110-90FTTGGC1-2R, 110-90FTTGCRCR, 110-90FTTGR, 9122PFRG-1103930, 922FRG-1191930, 922RFRG-1391930		

bar burners

bar burners



1

GEV No.	105438	Ref. No.	2510695 BN2510695
description	bar burner 1-row ø 50mm Wmm Hmm L 345mm flange width 65mm flange length 71mm chargrill		
For models:	72-02FTG, 72-02FTG-12700130TA, 72-02FTG-12700300, 72-02FTG-12700300TA, 72-02FTGC-12700135, 72-02FTGC-12700135TA, 72-02FTGCVAL, 72-02FTGR, 72-02FTGR-12700132TA, 72-02FTGR-12700302, 72-02FTGR-12700302TA, 72-02FTGRVAL, 72-02FTGVAL, 72-02FTTG-12700130, 72-02FTTGR-12700132, 72-02FTTG, 72-02FTTG-12730130, 72-02FTTG-12730130TA, 72-02FTTG-12730300, 72-02FTTG-12730300TA, 72-02FTTGC-12730135, 72-02FTTGC-12730135TA, 72-02FTTGCVAL, 72-02FTTGR, 72-02FTTGR-12730132, 72-02FTTGR-12730132TA, 72-02FTTGR-12730302, 72-02FTTGR-12730302TA, 72-02FTTGRVAL, 72-02FTTGV, 74-02FTG, 74-02FTG-12700140TA, 74-02FTG-12700310, 74-02FTG1-2R, 74-02FTG1-2R-12700141, 74-02FTG1-2R-12700141TA, 74-02FTG1-2R-12700311, 74-02FTG1-2R-12700311HB, 74-02FTG1-2RVAL, 74-02FTGC-12700145, 74-02FTGC-12700145TA, 74-02FTGCVAL, 74-02FTGR, 74-02FTGR-12700142, 74-02FTGR-12700142TA, 74-02FTGR-12700312, 74-02FTGRVAL, 74-02FTGVAL, 74-02FTTG-12700140, 74-02FTTG...(Other models you can see in the webshop)		





			
1			
GEV No.	105684	Ref. No.	826390020 BN41826390023
description	bar burner 2 row L 437mm W 220mm ømm H 144mm griddle		

			
1			
GEV No.	105260	Ref. No.	1031504600
description	bar burner 2 row L 450mm W 300mm ømm H 50mm 8.5kW griddle		
For models:	OFTG60B, OFTG-60B-12600140, OFTG60BLC, OFTG-60BLC-12600145, OFTG60BR, OFTG-60BR-12600141, OFTG60BRR, OFTG-60BRR-12600142		

			
1			
GEV No.	105441	Ref. No.	2519250 BN2519250
description	bar burner 3 row L 450mm W 280mm ømm H 65mm chargrill		
For models:	72-02PLG, 72-02PLG-12700850, 72-02PLG-12700850TA, 72-02TPLG, 72-02TPLG-12730850, 72-02TPLG-12730850TA, 74-02PLG, 74-02PLG-12700855, 74-02PLG-12700855TA, 74-02TPLG, 74-02TPLG-12730855, 74-02TPLG-12730855TA, 74PL-G-1000940, 74PLG-1000940, 74PL-G-1000940R, 74TPLG-1009940, 74TPLG-1009940R, 78PLG, 78PL-G-1000980, 78PLG-1000980, 78PL-G-1000980R, 78TPLG-1009980, 78TPLG-1009980R, 7GL-G400, 7GL-G800, 7GLT-G400, 7GLT-G800, 7TGL-G400, 7TGL-G800		
accessories for	105441		
		GEV No.	105044
	air mixing tube ø 20mm L 38mm	Ref. No.	—

			
1			
GEV No.	103155	Ref. No.	2519270 BN2519270
description	bar burner 3 row L 610mm W 280mm ømm H 60mm chargrill		
For models:	92-04PLG, 92-04PLG-12900850, 92-04PLG-12900850TA, 92-04TPLG, 92-04TPLG-12930850, 92-04TPLG-12930850TA, 94-04PLG, 94-04PLG-12900855, 94-04PLG-12900855TA, 94-04TPLG, 94-04TPLG-12930855, 94-04TPLG-12930855TA, 9GL-G400, 9GL-G800, 9TGL-G400, 9TGL-G800		

			
1			
GEV No.	105695	Ref. No.	826390063 BN826390063
description	bar burner 6 row L 510mm W 620mm ømm H 50mm tilting bratt pan		
For models:	7BR-G100, 7BR-G105, 7BRS-G100, 7BRS-G105, 94-04KBG, 94-04KBG-12900115, 94-04KBG-12900115TA, 94-04KBG-12900118, 94-04KBG-12900118TA, 94-04KBGM, 94-04KBGM-12900125, 94-04KBGM-12900125TA, 94-04KBGM-12900128, 94-04KBGM-12900128TA, 9BR-G100, 9BR-G105, 9BR-G80, 9BR-G81, 9BR-GM80		

			
1			
GEV No.	105486	Ref. No.	1664300
description	bar burner angled L 440mm W 200mm ømm Hmm oven		
For models:	CFG101, CFG120, CFG70, OCFG101, OCFG-101-12600025, OCFG120, OCFG70, OCFG-70-12600000, OPGC-41-12600010		

			
Image not available			
1			
GEV No.	105682	Ref. No.	2519260 BN2519260
description	bar burner L 630mm W 345mm chargrill		
For models:	92PLG-1192840, 92TPLG-1191840, 94PLG-1192865, 94TPLG-1191865		

			
1			
GEV No.	105446	Ref. No.	2510390 BN2510390
description	bar burner ø 40mm Wmm Hmm L 254mm bain marie flange ø 61mm		
For models:	110-45CBG, 110-45TCBG, 72-02CBG-12700150, 72-02TCBG-12730150, 912PTCBG-1103391, 92-04CBG, 92-04CBG-12900150, 92-04TCBG, 92-04TCBG-12930150, 92CBG-1191301, 92CBG-191301, 92TCBG-1191391		

			
1			
GEV No.	104240	Ref. No.	1031501000
description	bar burner ø 40mm Wmm Hmm L 400mm flange ø 61mm 1-row chargrill with bolt M5x12		
For models:	FTG40B, FTG40BLC, FTG60B, FTG60BLC, FTG60BR, FTG80B, FTG80BR, OFTG40B, OFTG40BLC, OFTG60B, OFTG60BLC, OFTG60BR, OFTG80B, OFTG80BR		





			
GEV No.	103154	Ref. No.	2519430 BN2519430
description	bar burner ø 40mm Wmm Hmm L 420mm flange width 43mm flange length 43mm fryer		
For models:	72-02FRG, 72-02FRG-12700500, 72-02FRG17-12700505, 72-02FRGM, 72-02FRGM-12700530, 72-02FRGM-12700530TA, 73-02FRG, 73-02FRG-12700550, 73-02FRGM, 73-02FRGM-12700580, 73-02FRGM-12700580TA, 74-02FRG, 74-02FRG-12700600, 74-02FRG17-12700605, 74-02FRGM, 74-02FRGM-12700630, 7FRI-G415, 7FRI-G610, 7FRI-G815, 92-04FRG15L, 92-04FRG15L-12900510, 92-04FRG17L-12900515, 93-04FRG, 93-04FRG-12900550, 93-04FRG-12900550H, 9FRI-G415, 9FRI-G610, 9FRI-G815		

			
GEV No.	105443	Ref. No.	2519038 BN2519038
description	bar burner ø 40mm Wmm Hmm L 490mm flange width 43mm flange length 43mm pasta cooker		
For models:	910PG-1191810, 910PG-191810, 910PGB-1191800, 910PGB-191800, 911PGB-1191805, 911RPG-1391830, 912PCCPG-1104855, 914PC-CPG-1104860, 915PG-1191815, 915PG-191815, 92CCPG-1192855, 92RCCPG-1392855, 94CCPG-1192860, 94RCCPG-1392860		

			
GEV No.	105453	Ref. No.	2519034 BN2519034
description	bar burner ø 40mm Wmm Hmm L 500mm flange width 43mm flange length 43mm tilting bratt pan		
For models:	94KBG-1191870, 94KBG-191870, 94KBGM-1191880, 94KBGM-191600, 94RKBG-1391870, 94RKBGM-1391880		

			
GEV No.	105447	Ref. No.	2510391 BN2510391
description	bar burner ø 40mm Wmm Hmm L 600mm bain marie flange ø 61mm		
For models:	94CBG-1191302, 94CBG-191302, 94CBGAC-1191362, 94TCBG-1191392		

			
GEV No.	109077	Ref. No.	2519433 BN2519433
description	bar burner ø 50mm L 402mm pasta cooker		
For models:	92-04CPG, 92-04CPG-12900900, 92-04CPG-12900900TA, 94-04CPG, 94-04CPG-12900905, 94-04CPG-12900905TA, 9CP-G400, 9CP-G800		

			
GEV No.	105444	Ref. No.	2510654
description	bar burner ø 50mm Wmm Hmm L 253mm flange width 71mm bain marie flange ø 75mm		
For models:	74CBG-000150, 74CB-G-1000150, 74CBG-1000150, 74CB-G-1000150R		

			
GEV No.	103156	Ref. No.	2519410 BN2519410
description	bar burner ø 50mm Wmm Hmm L 280mm flange width 71mm fryer		
For models:	55-45CPG, 55-90CPG, 72-02CPG, 72-02CPG-12700900, 74-02CPG, 74-02CPG-12700905, 74-02CPG-12700905TA, 74-02NPGD, 74-02NPGD-12700750, 74-02NPGI, 74-02NPGI-12700755, 7CP-G400, 7CP-G800, 7NP-G50, 7NP-GI50		

			
GEV No.	105442	Ref. No.	2510651 BN2510651
description	bar burner ø 50mm Wmm Hmm L 345mm flange with bolt M4 flange width 65mm flange length 71mm fryer		
For models:	725KB-G-1000110, 725KBG-1000110, 725KB-G-1000110R, 725KB-GB-1000111, 725KB-GB-1000111R, 725KBGM-000120, 725KB-GM-1000120, 725KB-GM-1000120R, 725KB-GMB-1000121, 725KB-GMB-1000121R, 74-02KBGB, 74-02KBGB-12700110, 74-02KBGBI, 74-02KBGBI-12700115, 74-02KBGMB, 74-02KBGMB-12700120, 74-02KBGMBI, 74-02KBGMBI-12700125, 74CP-G-1000955, 74CPG-1000955, 74CP-G-1000955R, 78CP-G-1000960, 78CPG-1000960, 78CP-G-1000960R		



			
GEV No.	105777 ¹	Ref. No.	3104830 BN3104830
description	bar burner ø 50mm Wmm Hmm L 440mm with bolt M5x25 flange width 57mm flange length 57mm combi-steamer		
For models:	CV10G, CV10G-1310100, CV10G-2, CV10G2-1310140, CV10GB-1311100, CV10G-S, CV10GS-1310150, CV10G-S2, CV10GS2-1310190, CV6G, CV6G-1310000, CV6G-1310010, CV6G-2, CV6G2-1310040, CV6GB-1311000, CV6G-S, CV6GS-1310050, CV6G-S2, CV6GS2-1310090, CVM10G, CVM10G-1310400, CVM10G-1310410, CVM10G-1310430, CVM10G-1310450, CVM10G-2, CVM10G2-1310440, CVM10GP-1310400, CVM10G-S, CVM10GS-1310460, CVM10G-S2, CVM10GS2-1310490, CVM10GS2-1310495, CVM6G, CVM6G-1310300, CVM6G-1310310, CVM6G-2, CVM6G2-1310340, CVM6G-S, CVM6GS-1310350, CVM6GS-1310360, CVM6G-S2, CVM6GS2-1310390, CVM6GS2-1310395, CVP10G, CVP10G-1310700, CVP10G-1310750, CVP10G-2, CVP10G2-1310740, CVP10GP-1310700, CVP10G-S...(Other models you can see in the webshop)		

¹for ovens with 6+10 grids

			
GEV No.	105920	Ref. No.	110053
description	bar burner ø 50mm Wmm Hmm L 450mm flange with bolt M4 flange width 65mm flange length 71mm kettle		

			
GEV No.	105445	Ref. No.	2510655 BN2510655
description	bar burner ø 50mm Wmm Hmm L 578mm flange width 71mm bain marie flange ø 75mm		
For models:	74-02CBG, 74-02CBG-12700155, 74-02TCBG, 74-02TCBG-12730155, 78CBG-000160, 78CB-G-1000160, 78CBG-1000160, 78CB-G-1000160R, 78CB-GAC-1000165, 78CBGAC-1000165, 94-04CBG, 94-04CBG-12900155, 94-04TCBG, 94-04TCBG-12930155		

			
GEV No.	105779 ¹	Ref. No.	3104840 BN3104840
description	bar burner ø 50mm Wmm Hmm L 440mm with bolt M5x25 flange width 57mm flange length 57mm gas range		
For models:	CV21G, CV21G-1312100, CV21G-2, CV21G2-1312140, CV21G-S, CV21GS-1312150, CV21G-S2, CV21GS2-1312190, CVM21G, CVM21G-1312400, CVM21G-2, CVM21G2-1312440, CVM21G-S, CVM21GS-1312450, CVM21G-S2, CVM21GS2-1312490, CVM21GS2-1312495, CVP21G, CVP21G-1312700, CVP21G-2, CVP21G2-1312740, CVP21G-S, CVP21GS-1312750, CVP21G-S2, CVP21GS2-1312790, ECV21G, ECV21G-S, ECV21GS-1314490, ECV21GS2-1316160, ECV21GS2, ECV21GS2-1314890, ECV21GS2-1316240, FC21G-2-418035412140, FC21G-2S-418035412190, FC21G-B-418035412100, FC21G-S-418035412150, FCM21G-2-418035412440, FCM21G-2S-418035412490, FCM21G-418035412400, FCM21G-S-418035412450, FCV21G-2-418035412740, FCV21G-2S-418035412790, FCV21G-418035412700, FCV21G-S-418035412750, NECV-M21GS2, NECVM21GS2-1317490, NECVM21GS2-1318160, NECVP21GS2, NECVP21GS2-1317890, NECVP21GS2-1318240, NFCV21G-PS2-418035417890...(Other models you can see in the webshop)		

¹for ovens with 20 grids

			
GEV No.	105778	Ref. No.	3104850 BN3104850
description	bar burner ø 50mm Wmm Hmm L 600mm flange width 57mm flange length 57mm convection oven		
For models:	CV20G, CV20G-1310200, CV20G-2, CV20G2-1310240, CV20GB-1311200, CV20G-S, CV20GS-1310250, CV20G-S2, CV20GS2-1310290, CVM20G, CVM20G-1310500, CVM20G-2, CVM20G2-1310540, CVM20G-S, CVM20GS-1310550, CVM20GS2-1310590, CVP20G, CVP20G-1310800, CVP20G-1310850, CVP20G-2, CVP20G-S, CVP20GS-1310840, CVP20G-S2, CVP20GS2-1310890, ECV20G, ECV20G-S, ECV20GS-1314390, ECV20GS2-1316140, ECV20GS2, ECV20GS2-1314790, ECV20GS2-1316220, FC20G-2-418035410240, FC20G-2S-418035410290, FC20G-418035410200, FC20G-S-418035410250, FCM20G-2-418035410540, FCM20G-2S-418035410590, FCM20G-418035410500, FCM20G-S-418035410550, FCV20G-2-418035410840, FCV20G-2S-418035410890, FCV20G-418035410800, FCV20G-S-418035410850, NECV-M20GS2, NECVM20GS2-1317390, NECVM20GS2-1318140, NECVP20GS2, NECVP20GS2-1317790, NECVP20GS2-1318220, NFCV20G-PS2-418035417790...(Other models you can see in the webshop)		

			
GEV No.	105437	Ref. No.	8220050 BN8220050
description	bar burner ø 50mm Wmm Hmm L 445mm oven		
For models:	40SGFT, 40SGFT-1825020, 40SGFTC, 40SGFTC-1825025, 40SG-FTR, 40SGFTR-1825021, 60SGFT, 60SGFT1-2R-1825031, 60SG-FT1-3R-1825030, 60SGFT-1825030, 60SGFTC, 60SGFTC-1825035, 60SGFTR-1825032, 7741CGV-1950226, 7741C-GVGAS-1950266, 7742C-GV-1950267, 7742CGV-1950267, 80SGFTC-1825038		

			
1			
GEV No.	105436	Ref. No.	2510697 BN2510697
description	bar burner ø 50mm Wmm Hmm L 608mm flange width 71mm gas range flange ø 75mm		
For models:	76-02CGFL, 76-02CGFL-12700020, 76-02CGFL-12700020TA, 769CG-VFL-000069, 769CGVFL-1950069, 769CGVFL-1950069R, 76CG-VFL-000070, 7961C-GVGAS-1950276, 7962C-GV-1950277, 7962CGV-1950277, 796CG-000270, 7PCFL-G120, 7TP2F-G160, 7TPF-G120, 7TPF-G800, 7TPMF-G120, 7TPMF-G800SX, 912PTFTG-1103491, 912PTFTGR-1103591, 914PCGG-1103214, 914PCTGG-1103711, 914PFTGG-1103413, 914PFTGGC-1103415, 916PCGGAN-1103216, 916PCGGE-1103236, 918PCGG-1103218, 92FG-1191220, 94-04CGG, 94-04CGG-12900010, 94-04CGG-12900010TA, 94-04CGG1P, 94-04CGG1P-12900030, 94-04CGG1P-12900030TA, 94-04CGG1P-12900031TA, 94-04CGGP, 94-04CGGP-12900060, 94-04CGGP-12900060TA, 94-04CTGG, 94-04CTGG-12900180, 94-04CTGG-12900180TA, 94-04CTGGSS, 94-04CTGGSS-12900185, 94-04CTGGSS-12900185TA, 941CTGG-1291710, 941FTGG-1291412, 941FTGG1-2R-1291512, 941FTGG1-2R-1291612, 941FTGGC-1291414, 941FTGGC1-2R-1291415, 941FTGGR-1291512...(Other models you can see in the webshop)		

			
2			
GEV No.	105255	Ref. No.	1031504500
description	bar burner ømm W 41mm H 34mm L 490mm flange width 70mm 5.5kW griddle		
For models:	OFTG40B, OFTG-40B-12600130, OFTG40BLC, OFTG-40BLC-12600135, OFTG40BR, OFTG-40BR-12600132, OFTG80BLC, OFTG-80BLC-12600138		

			
1			
GEV No.	210257	Ref. No.	1041301200
description	chargrill grid L 500mm W 330mm		
For models:	OPLG80, OPLG-80-12600855, PLG80		

			
1			
GEV No.	210258	Ref. No.	1041301900
description	chargrill grid L 500mm W 370mm		
For models:	OPLG40, OPLG-40-12600850, PLG40		

			
1			
GEV No.	211027	Ref. No.	2521504 alt
description	chargrill grid L 500mm W 410mm H 40mm		

			
1			
GEV No.	211054	Ref. No.	2521504
description	chargrill grid L 785mm W 490mm stainless steel		
For models:	74PL-G-1000940, 74PLG-1000940, 74PL-G-1000940R, 74TPLG-1009940, 74TPLG-1009940R, 78PLG, 78PL-G-1000980, 78PLG-1000980, 78PL-G-1000980R, 78TPLG-1009980, 78TPLG-1009980R		

			
1			
GEV No.	210259	Ref. No.	2519600 BN2519600
description	lava rock grid L 420mm W 305mm H 25mm		
For models:	72-02PLG, 72-02PLG-12700850, 72-02PLG-12700850TA, 72-02TPLG, 72-02TPLG-12730850, 72-02TPLG-12730850TA, 74-02PLG, 74-02PLG-12700855, 74-02PLG-12700855TA, 74-02TPLG, 74-02TPLG-12730855, 74-02TPLG-12730855TA, 7GL-G400, 7GL-G800, 7GLT-G400, 7GLT-G800, 7TGL-G400, 7TGL-G800		

			
1			
GEV No.	211026	Ref. No.	2521507 BN2521507
description	lava rock grid L 420mm W 328mm H 23mm		
For models:	74PL-G-1000940, 74PLG-1000940, 74PL-G-1000940R, 74TPLG-1009940, 74TPLG-1009940R, 78PLG, 78PL-G-1000980, 78PLG-1000980, 78PL-G-1000980R, 78TPLG-1009980, 78TPLG-1009980R		

			
1			
GEV No.	211029	Ref. No.	1829522
description	lava rock grid L 464mm W 310mm		
For models:	OPLG40, OPLG-40-12600850, OPLG80, OPLG-80-12600855, PLG40, PLG80		





			
1			
GEV No.	211048	Ref. No.	2519602 BN2519602
description	lava rock grid L 575mm W 305mm H 25mm		
For models:	7GL-G400, 7GL-G800, 7GLT-G400, 7GLT-G800, 92-04PLG, 92-04PLG-12900850, 92-04PLG-12900850TA, 92-04TPLG, 92-04TPLG-12930850, 92-04TPLG-12930850TA, 94-04PLG, 94-04PLG-12900855, 94-04PLG-12900855TA, 94-04TPLG, 94-04TPLG-12930855, 94-04TPLG-12930855TA, 9GL-G400, 9GL-G800, 9TGL-G400, 9TGL-G800		

			
1			
GEV No.	211026	Ref. No.	2521507 BN2521507
description	lava rock grid L 420mm W 328mm H 23mm		
For models:	74PL-G-1000940, 74PLG-1000940, 74PL-G-1000940R, 74TPLG-1009940, 74TPLG-1009940R, 78PLG, 78PL-G-1000980, 78PLG-1000980, 78PL-G-1000980R, 78TPLG-1009980, 78TPLG-1009980R		

chargrill grids

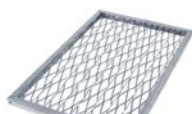
			
1			
GEV No.	210257	Ref. No.	1041301200
description	chargrill grid L 500mm W 330mm		
For models:	OPLG80, OPLG-80-12600855, PLG80		

			
1			
GEV No.	211029	Ref. No.	1829522
description	lava rock grid L 464mm W 310mm		
For models:	OPLG40, OPLG-40-12600850, OPLG80, OPLG-80-12600855, PLG40, PLG80		

			
1			
GEV No.	210258	Ref. No.	1041301900
description	chargrill grid L 500mm W 370mm		
For models:	OPLG40, OPLG-40-12600850, PLG40		

			
1			
GEV No.	211048	Ref. No.	2519602 BN2519602
description	lava rock grid L 575mm W 305mm H 25mm		
For models:	7GL-G400, 7GL-G800, 7GLT-G400, 7GLT-G800, 92-04PLG, 92-04PLG-12900850, 92-04PLG-12900850TA, 92-04TPLG, 92-04TPLG-12930850, 92-04TPLG-12930850TA, 94-04PLG, 94-04PLG-12900855, 94-04PLG-12900855TA, 94-04TPLG, 94-04TPLG-12930855, 94-04TPLG-12930855TA, 9GL-G400, 9GL-G800, 9TGL-G400, 9TGL-G800		



			
1			
GEV No.	211027	Ref. No.	2521504 alt
description	chargrill grid L 500mm W 410mm H 40mm		

tube burners

			
1			
GEV No.	210259	Ref. No.	2519600 BN2519600
description	lava rock grid L 420mm W 305mm H 25mm		
For models:	72-02PLG, 72-02PLG-12700850, 72-02PLG-12700850TA, 72-02TPLG, 72-02TPLG-12730850, 72-02TPLG-12730850TA, 74-02PLG, 74-02PLG-12700855, 74-02PLG-12700855TA, 74-02TPLG, 74-02TPLG-12730855, 74-02TPLG-12730855TA, 7GL-G400, 7GL-G800, 7GLT-G400, 7GLT-G800, 7TGL-G400, 7TGL-G800		

			
1			
GEV No.	105452	Ref. No.	9000240 BN9000240
description	tubular burner L 260mm W 50mm H 70mm for fryer oval		
For models:	9122PFRG-1103930, 922FRG-1191930, 922RFRG-1391930		

			
GEV No.	105451	Ref. No.	9000248 BN9000248
description	tubular burner L 295mm W 55mm H 78mm mounting pos. centre for fryer oval		
For models:	720FRG-077400, 720FRG-1077400, 720FR-G-1077450, 720FRG-1077450, 720FR-G-1077450R, 720FR-G-1077650, 722FRG-077600, 722FRG-1077600, 722FR-G-1077650R, 912PFRG-1103925, 914PFRG-1103950, 922FRE-1192930, 92FRG, 92FRG-1191925, 92RFRG-1391925, 94FRG, 94FRG-1191950, 94FRG-191950, 94RFRG-1391950		
accessories for	105451		
	GEV No.	100501	Ref. No. —
	gas injector thread M9x1 WS 10 bore ø 0.95mm		
	GEV No.	107346	Ref. No. —
	gas injector thread M9x1 WS 10 bore ø 1.4mm		

			
GEV No.	105449	Ref. No.	9000246 BN9000246
description	tubular burner L 295mm W 55mm H 78mm mounting pos. right for fryer oval		
For models:	710FRG-077300, 712FRG-077500, 720FRG-077400, 720FRG-1077400, 720FR-G-1077450, 720FRG-1077450, 720FR-G-1077450R, 720FR-G-1077650, 722FRG-077600, 722FRG-1077600, 722FR-G-1077650R, 912PFRG-1103925, 914PFRG-1103950, 922FRE-1192930, 92FRG, 92FRG-1191925, 92RFRG-1391925, 94FRG, 94FRG-1191950, 94FRG-191950, 94RFRG-1391950		
accessories for	105449		
	GEV No.	100501	Ref. No. —
	gas injector thread M9x1 WS 10 bore ø 0.95mm		
	GEV No.	107346	Ref. No. —
	gas injector thread M9x1 WS 10 bore ø 1.4mm		

			
GEV No.	105450	Ref. No.	9000247 BN9000247
description	tubular burner L 295mm W 55mm H 78mm mounting pos. left for fryer oval		
For models:	710FRG-077300, 710FRG-1077300, 710FR-G-1077350, 710FR-G-1077350R, 712FRG-077500, 712FR-G-1077550, 712FRG-1077550, 712FR-G-1077550R, 720FRG-077400, 720FRG-1077400, 720FR-G-1077450, 720FRG-1077450, 720FR-G-1077450R, 720FR-G-1077650, 722FRG-077600, 722FRG-1077600, 722FR-G-1077650R, 912PFRG-1103925, 914PFRG-1103950, 922FRE-1192930, 92FRG, 92FRG-1191925, 92RFRG-1391925, 94FRG, 94FRG-1191950, 94FRG-191950, 94RFRG-1391950		
accessories for	105450		
	GEV No.	100501	Ref. No. —
	gas injector thread M9x1 WS 10 bore ø 0.95mm		
	GEV No.	107346	Ref. No. —
	gas injector thread M9x1 WS 10 bore ø 1.4mm		

			
GEV No.	104241	Ref. No.	1032001212
description	tubular burner ø 67mm L 165mm H 44mm mounting pos. left round for fryer		
For models:	FQG40, FQG60		

solid top burners

			
GEV No.	105251	Ref. No.	0100294 R0100294 S10100294 SIR0100294
description	solid top burner ø 120mm H 102mm L 340mm		



forced air burners

			
1			
GEV No.	104314	Ref. No.	R63140060
description	gasket L 108mm W 103mm H 3mm 6 holes		
For models:	CKGP10B, CKGP20B, CKGP21B, CKGP40B, CKGT10B, CKGT20B, CKGT21B, CKGT40B		

			
1			
GEV No.	108149	Ref. No.	R63120020 R63120030 R63120040
description	venturi for combi-steamer LAINOX		
For models:	CCG051M, CCG071M, CCG101M, CCG102M, CKGP06, CKGP06B, CKGP10, CKGP10B, CKGP20, CKGP20B, CKGP21, CKGP21B, CKGP40, CKGP40B, CKGT06, CKGT06B, CKGT10, CKGT10B, CKGT20, CKGT20B, CKGT21, CKGT21B, CKGT40, CKGT40B		

accessories

nozzle holders

				
1				
GEV No.	105230	Ref. No.	1033717200	
description	nozzle holder			
For models:	CFGE61, CFGE61D, CFGE61L, CFGE61P, OCFGE61			
accessories for	105230			
	GEV No.	103140	Ref. No.	1032101400 1032101422
burner head seat ø 75mm for burner cap ø 85mm 3.5kW				
	GEV No.	103141	Ref. No.	1032101500 MAC-
burner head ø 95mm suitable for burner 5.5kW				
	GEV No.	103146	Ref. No.	1032101200 MA1032101200
burner lower part for burner cap ø 85mm 3.5kW				
	GEV No.	103147	Ref. No.	1032101300
burner lower part for burner cap ø 95mm 5.5/7kW				
	GEV No.	107143	Ref. No.	—
burner head for burner cap ø 95mm 5.5kW				







				
1				
GEV No.	105052	Ref. No.	1306615	
description	nozzle holder ID ø 10mm nozzle mounting M10x1			
For models:	CFG101, CFG120, CFG70, OCFG101, OCFG-101-12600025, OCFG120, OCFG70, OCFG-70-12600000, OPCG-41-12600010			
accessories for	105052			
	GEV No.	100469	Ref. No.	521611
gas injector thread M10x1 WS 12 bore ø 1.15mm				
	GEV No.	100478	Ref. No.	522811
gas injector thread M10x1 WS 12 bore ø 1.75mm				
	GEV No.	103150	Ref. No.	1892500
burner lower part for burner cap ø 110/120mm				
	GEV No.	104030	Ref. No.	1315422
burner head for burner cap ø 80mm				
	GEV No.	104031	Ref. No.	—
burner head for burner cap ø 110mm				
	GEV No.	104032	Ref. No.	1315922
burner head for burner cap ø 120mm				
	GEV No.	104033	Ref. No.	—
burner lower part for burner cap ø 80mm 1. generation				
	GEV No.	104034	Ref. No.	—
burner lower part for burner cap ø 110mm				
	GEV No.	105051	Ref. No.	1314700
air mixing sleeve L 45mm ED ø 45mm ID ø 42mm aluminium				



			
1			
GEV No.	106599	Ref. No.	CR0508630
description	nozzle holder nozzle M10x1 M14x1 screw pipe fitting M16x1.5 tube ø 10mm		
For models:	FQG41, FQG61, OFQG41, OFQG-41-12600500, OFQG61, OFQG-61-12600600		



			
1			
GEV No.	106600	Ref. No.	CM021700
description	nozzle holder nozzle M10x1 M14x1 screw pipe fitting M16x1.5 tube ø 10mm		
For models:	FQG40, FQG60, OPLG40, OPLG-40-12600850, OPLG80, OPLG-80-12600855, PLG40, PLG80		

			
1			
GEV No.	106601	Ref. No.	1031504900
description	nozzle holder nozzle M10x1 M14x1 screw pipe fitting M16x1.5 tube ø 10mm		
For models:	OFTG40B, OFTG-40B-12600130, OFTG40BLC, OFTG-40BLC-12600135, OFTG40BR, OFTG-40BR-12600132, OFTG60B, OFTG-60B-12600140, OFTG60BLC, OFTG-60BLC-12600145, OFTG60BR, OFTG-60BR-12600141, OFTG60BRR, OFTG-60BRR-12600142, OFTG80BLC, OFTG-80BLC-12600138		

			
1			
GEV No.	105290	Ref. No.	6A014708 BN6A014708
description	nozzle holder nozzle mounting M11x1		
For models:	110-135CG, 110-135CG2P, 110-135CGE, 110-135CGE2P, 110-135CGEE, 110-135CGEE2P, 110-135CGEEP, 110-135CGEP, 110-135CGG, 110-135CGG2P, 110-135CGGE, 110-135CGGE2P, 110-135CGGEP, 110-135CGGP, 110-135CGP, 110-135TCG, 110-135TCG2P, 110-135TCGP, 110-45CBG, 110-45CG, 110-45CG1P, 110-45CGP, 110-45TCBG, 110-45TCG, 110-45TCG1P, 110-45TCGP, 110-90CG, 110-90CG1P, 110-90CGE, 110-90CGE1P, 110-90CGEP, 110-90CGG, 110-90CGG1P, 110-90CGGP, 110-90CGP, 110-90CTG, 110-90CTGE, 110-90CTGG, 110-90FTTG, 110-90FTTG1-2R, 110-90FTTGC, 110-90FTTGC1-2R, 110-90FTTGC2R, 110-90FTTGE, 110-90FTTGG, 110-90FTTGR, 110-90TCG, 110-90TCG1P, 110-90TCGP, 110-90TCTG...(Other models you can see in the webshop)		
accessories for	105290		
	GEV No.	105280	Ref. No. 2510351 BN2510351
burner head C for burner cap ø 80mm 3.5kW			
	GEV No.	105281	Ref. No. 2510352 BN2510352
burner cap C ø 80mm 3.5kW with central hole ID ø 32mm			
	GEV No.	105283	Ref. No. 2510354 BN2510354
burner head D for burner cap ø 105mm 5.6kW			
	GEV No.	105284	Ref. No. 2510355 BN2510355
burner cap ID ø 54mm D ø 105mm 5.6kW with central hole			
	GEV No.	105285	Ref. No. 2510353 BN2510353
venturi D for burner cap ø 105mm 5.6kW			
	GEV No.	105286	Ref. No. 2510357 BN2510357
burner head E for burner cap ø 125mm 7kW			

accessories for	105290		
	GEV No.	105287	Ref. No. 2510341 2510358 BN2510341
burner cap E ø 125mm 7kW with central hole			
	GEV No.	105288	Ref. No. 2510340 2510356 BN2510340
venturi E for burner cap ø 125mm 7kW			
	GEV No.	105289	Ref. No. 0100264 2519002 BN2519002 R0100264 SIR0100264
air mixing sleeve L 50mm ED ø 45mm ID ø 42mm aluminium			

miscellaneous

			
1			
GEV No.	109078	Ref. No.	1033600
description	level glass for burner		
For models:	FQG41, FQG61, OFQG41, OFQG-41-12600500, OFQG61, OFQG-61-12600600		

			
1			
GEV No.	100813	Ref. No.	8220161
description	screw connection for igniter		
For models:	40SCG, 40SCG-1825000, 40SCG3S-1826000, 60SCG, 60SCG-1825010, 60SCG2S-1826010, 60SCG3S-1826010, 61SCGFE3S-1826055		

gas nozzles

main nozzles

gas nozzles M6x0.75

			
1			
GEV No.	106591	Ref. No.	1033718900
description	gas injector thread M6x0.75 WS 7 bore ø 1.15mm		
For models:	CFG101, CFG70, CFGE61, CFGE61D, CFGE61L, CFGE61P, OCFG101, OCFG-101-12600025, OCFG70, OCFG-70-12600000, OCFG61, OPCG41, OPCG-41-12600010, OPCG61		

			
1			
GEV No.	106483	Ref. No.	1033718300
description	gas injector thread M6x0.75 WS 7 bore ø 1.35mm		
For models:	CFG101, CFG70, CFGE61, CFGE61D, CFGE61L, CFGE61P, OCFG101, OCFG-101-12600025, OCFG70, OCFG-70-12600000, OCFG61, OPCG41, OPCG-41-12600010, OPCG61		





			
1			
GEV No.	106590	Ref. No.	1033718500
description	gas injector thread M6x0.75 WS 7 bore ø 0.8mm		
For models:	CFG101, CFG70, CFGE61, CFGE61D, CFGE61L, CFGE61P, OCFG101, OCFG-101-12600025, OCFG70, OCFG-70-12600000, OCFGE61, OPCG41, OPCG-41-12600010, OPCG61		

			
1			
GEV No.	106589	Ref. No.	1033719000
description	gas injector thread M6x0.75 WS 7 bore ø 1.9mm		
For models:	CFG101, CFG70, CFGE61, CFGE61D, CFGE61L, CFGE61P, OCFG101, OCFG-101-12600025, OCFG70, OCFG-70-12600000, OCFGE61, OPCG41, OPCG-41-12600010, OPCG61		

			
1			
GEV No.	106588	Ref. No.	1033718600
description	gas injector thread M6x0.75 WS 7 bore ø 0.9mm		
For models:	CFG101, CFG70, CFGE61, CFGE61D, CFGE61L, CFGE61P, OCFG101, OCFG-101-12600025, OCFG70, OCFG-70-12600000, OCFGE61, OPCG41, OPCG-41-12600010, OPCG61		

			
1			
gas nozzles M9x1			
GEV No.	100506	Ref. No.	2510372 BN2510372
description	gas injector thread M9x1 WS 10 bore ø 1.25mm		
For models:	40SGFT-1825020, 40SGFT-1825025, 40SGFTR-1825021, 7741C-GV-GAS-1950266, 7742C-GV-1950267, 7PCFL-G120		

			
1			
GEV No.	106592	Ref. No.	1033719100
description	gas injector thread M6x0.75 WS 7 bore ø 1mm		
For models:	CFG101, CFG70, CFGE61, CFGE61D, CFGE61L, CFGE61P, OCFG101, OCFG-101-12600025, OCFG70, OCFG-70-12600000, OCFGE61, OPCG41, OPCG-41-12600010, OPCG61		

			
1			
GEV No.	100513	Ref. No.	2510384
description	gas injector thread M9x1 WS 10 bore ø 2.15mm		
For models:	7PCFL-G120		

			
1			
GEV No.	106593	Ref. No.	1033718400
description	gas injector thread M6x0.75 WS 7 bore ø 1.5mm		
For models:	CFG101, CFG70, CFGE61, CFGE61D, CFGE61L, CFGE61P, OCFG101, OCFG-101-12600025, OCFG70, OCFG-70-12600000, OCFGE61, OPCG41, OPCG-41-12600010, OPCG61		

			
1			
GEV No.	100515	Ref. No.	2510429
description	gas injector thread M9x1 WS 10 bore ø 2.5mm		
For models:	7GL-G400, 7GL-G800, 7GLT-G400, 7GLT-G800		

			
1			
GEV No.	106594	Ref. No.	1033718700
description	gas injector thread M6x0.75 WS 7 bore ø 1.75mm		
For models:	CFG101, CFG70, CFGE61, CFGE61D, CFGE61L, CFGE61P, OCFG101, OCFG-101-12600025, OCFG70, OCFG-70-12600000, OCFGE61, OPCG41, OPCG-41-12600010, OPCG61		

			
1			
GEV No.	100512	Ref. No.	2510383 BN2510383
description	gas injector thread M9x1 WS 10 bore ø 2mm		
For models:	32FOGVG-1000004, 32FOGVM-1000015, 40SGFT-1825020, 40SGFT-1825025, 40SGFTR-1825021, 76-02CGFL-12700020, 76-02CGFL-12700020TA, 769CGVFL-1950069, 769CGVFL-1950069R, 7961C-GV-GAS-1950276, 7962C-GV-1950277, 7PCFL-G120, 914PCGG-1103214, 914PCTGG-1103711, 914PFTGG-1103413, 914PFTGG-1103415, 916PCGGAN-1103216, 916PCGGE-1103236, 918PCGG-1103218, 92FG-1191220, 941CTGG-1291710, 941FTGG-1291412, 941FTGG1-2R-1291612, 941FTGGC-1291414, 941FTGGC1-2R-1291415, 941FTGGR-1291512, 94CGG-1191214, 94CTGG-1191710, 96CGG-1191216, 96CGGAC-1191236, 96CTGG-1191712, 96CTGGAC-1191732, 98CGG-1191218		



gas nozzles M10x1



1

GEV No.	106595	Ref. No.	CR0508730
description	gas injector thread M10x1 bore \varnothing 0.83mm L 30mm WS 12		
For models:	FQG41, FQG61, OFQG41, OFQG-41-12600500, OFQG61, OFQG-61-12600600		



1

GEV No.	100150	Ref. No.	1491100
description	gas injector thread M10x1 bore \varnothing 0.95mm L 30mm WS 12		
For models:	FQG41, FQG61, OFQG41, OFQG-41-12600500, OFQG61, OFQG-61-12600600		



1

GEV No.	100670	Ref. No.	1695400
description	gas injector thread M10x1 bore \varnothing 0.9mm L 30mm WS 12		
For models:	FQG41, FQG61, FTG80B, FTG80BR, OFQG41, OFQG-41-12600500, OFQG61, OFQG-61-12600600, OFTG80B, OFTG80BR		



1

GEV No.	100671	Ref. No.	1513000
description	gas injector thread M10x1 bore \varnothing 1.25mm L 30mm WS 12		
For models:	FQG40, FQG60		



1

GEV No.	101974	Ref. No.	2715400
description	gas injector thread M10x1 bore \varnothing 1.35mm L 30mm WS 12		
For models:	FQG40, FQG41, FQG60, FQG61, FTG40B, FTG40BLC, FTG60B, FTG-60BLC, FTG60BR, FTG80B, FTG80BR, OFQG41, OFQG-41-12600500, OFQG61, OFQG-61-12600600, OFTG40B, OFTG40BLC, OFTG60B, OFTG60BLC, OFTG60BR, OFTG80B, OFTG80BR		



1

GEV No.	100155	Ref. No.	2902500
description	gas injector thread M10x1 bore \varnothing 1.45mm L 30mm WS 12		
For models:	FQG41, FQG61, OFQG41, OFQG-41-12600500, OFQG61, OFQG-61-12600600		



1

GEV No.	100816	Ref. No.	2715300
description	gas injector thread M10x1 bore \varnothing 1.5mm WS 12		
For models:	FQG41, FQG61, FTG80B, FTG80BR, OFQG41, OFQG-41-12600500, OFQG61, OFQG-61-12600600, OFTG80B, OFTG80BR		



1

GEV No.	100153	Ref. No.	1631200
description	gas injector thread M10x1 bore \varnothing 1.6mm L 30mm WS 12		
For models:	FQG41, FQG61, OFQG41, OFQG-41-12600500, OFQG61, OFQG-61-12600600		



1

GEV No.	100464	Ref. No.	520811
description	gas injector thread M10x1 WS 12 bore \varnothing 0.75mm		
For models:	FQG40, FQG60		



1

GEV No.	100444	Ref. No.	520911
description	gas injector thread M10x1 WS 12 bore \varnothing 0.8mm		
For models:	CFG120, FQG40, FQG60, OCFG120		



1

GEV No.	100466	Ref. No.	521211
description	gas injector thread M10x1 WS 12 bore \varnothing 0.95mm		
For models:	CFG120, OCFG120		



1

GEV No.	100469	Ref. No.	521611
description	gas injector thread M10x1 WS 12 bore \varnothing 1.15mm		
For models:	CFG101, CFG120, CFG70, OCFG101, OCFG-101-12600025, OCFG120, OCFG70, OCFG-70-12600000, OPG-41-12600010, OPLG40, OPLG-40-12600850, OPLG80, OPLG-80-12600855, PLG40, PLG80		





1

GEV No.	100468	Ref. No.	521511
description	gas injector thread M10x1 WS 12 bore \varnothing 1.1mm		
For models:	CFG120, OCFG120		





			
1			
GEV No.	102721	Ref. No.	521911
description	gas injector thread M10x1 WS 12 bore ø 1.3mm		
For models:	CFG120, OCFG120, OPLG40, OPLG-40-12600850, OPLG80, OPLG-80-12600855, PLG40, PLG80		

			
1			
GEV No.	100485	Ref. No.	523711
description	gas injector thread M10x1 WS 12 bore ø 2.2mm		
For models:	OPLG40, OPLG-40-12600850, OPLG80, OPLG-80-12600855, PLG40, PLG80		

			
1			
GEV No.	100472	Ref. No.	522111
description	gas injector thread M10x1 WS 12 bore ø 1.4mm		
For models:	CFG120, OCFG120		

			
1			
GEV No.	106262	Ref. No.	2510705 BN2510705
description	gas injector thread 2x M10x1 WS 12 bore ø 1.25mm L 30mm		

			
1			
GEV No.	100478	Ref. No.	522811
description	gas injector thread M10x1 WS 12 bore ø 1.75mm		
For models:	CFG101, CFG120, CFG70, OCFG101, OCFG-101-12600025, OCFG120, OCFG70, OCFG-70-12600000, OPG-41-12600010		

gas nozzles M11x1			
			
1			
GEV No.	106643	Ref. No.	2510467 BN2510467
description	gas injector thread M11x1 WS 13 bore ø 0.8mm		
For models:	72-02CBG, 72-02TCBG		

			
1			
GEV No.	100482	Ref. No.	523211
description	gas injector thread M10x1 WS 12 bore ø 1.95mm		
For models:	CFG101, CFG120, CFG70, OCFG101, OCFG-101-12600025, OCFG120, OCFG70, OCFG-70-12600000, OPG-41-12600010		

			
1			
GEV No.	106277	Ref. No.	2510410 BN2510410
description	gas injector thread M11x1 WS 13 bore ø 0.9mm		
For models:	31FOGV-1950001, 31FOGVG-1000003, 32FOGV2-1000002, 72-02CG-12700001, 72-02CG-12700001TA, 72-02TCG-12730001, 72-02TCG-12730001TA, 729CAGV-1950009, 729CAGV-1950009R, 729TCGV-1959009, 729TCGV-1959009R, 74-02+2CTGG-12700030, 74-02CG-12700002, 74-02CG-12700002TA, 74-02CGE-12700011, 74-02CGE-12700011TA, 74-02CGG-12700010, 74-02CGG-12700010TA, 74-02TCG-12730002, 74-02TCG-12730002TA, 749CAGV-1950019, 749CAGV-1950019R, 749CGV-1950039, 749CGV-1950039R, 749CGVFE-1950059, 749CGVFE-1950059R, 749TCGV-1959019, 749TCGV-1959019R, 76-02CG-12700003, 76-02CG-12700003TA, 76-02CGE-12700017, 76-02CGE-12700017TA, 76-02CGEE-12700018, 76-02CGEE-12700018TA, 76-02CGFL-12700020, 76-02CG-FL-12700020TA, 76-02CGG-12700015, 76-02CGG-12700015TA, 76-02CGGE-12700016, 76-02CGGE-12700016TA, 76-02CTG-12700193, 76-02CTG-12700193TA, 76-02CTGG-12700195, 76-02CTGG-12700195TA, 76-02CTGGE-12700196, 76-02CTGGE-12700196TA, 76-02TCG-12730003, 76-02TCG-12730003TA, 76-02TCTG-12730195, 76-02TCTG-12730195TA...(Other models you can see in the webshop)		

			
1			
GEV No.	100484	Ref. No.	523411 MA523411
description	gas injector thread M10x1 WS 12 bore ø 2.05mm		
For models:	OPLG40, OPLG-40-12600850, OPLG80, OPLG-80-12600855, PLG40, PLG80		

			
1			
GEV No.	100486	Ref. No.	523811
description	gas injector thread M10x1 WS 12 bore ø 2.25mm		
For models:	CFG120, OCFG120		



1

GEV No.	106642	Ref. No.	2510368 BN2510368
description	gas injector thread M11x1 WS 13 bore ø 1.05mm		
For models:	2FX+PCF, 31FOGVM-1000007, 32FOGVG-1000004, 32FOGVM-1000015, 4FX+PCF, 74-02+2CTGG, 74-02+2CTGG-12700030, 76-02+4CTGG, 76-02+4CTGG-12700031, 912PFRG-1103925, 914PFRG-1103950, 922FRE-1192930, 92FRG-1191925, 94FRG-1191950, 94RFRG-1391950		



1

GEV No.	106621	Ref. No.	2510411 BN2510411
description	gas injector thread M11x1 WS 13 bore ø 1.3mm		
For models:	72-02FRG-12700500, 72-02FRG17-12700505, 72-02FRGM-12700530, 72-02FRGM-12700530TA, 72-02FTG-12700130TA, 72-02FTG-12700300, 72-02FTG-12700300TA, 72-02FTGC-12700135, 72-02FTGC-12700135TA, 72-02FTGR-12700132TA, 72-02FTGR-12700302, 72-02FTGR-12700302TA, 72-02FTTG-12700130, 72-02FTTG-12700132, 72-02FTTG-12700130TA, 72-02FTTG-12700132TA, 72-02FTTG-12700300, 72-02FTTG-12700300TA, 72-02FTTGC-12730135, 72-02FTTGC-12730135TA, 72-02FTTGR-12730132, 72-02FTTGR-12730132TA, 72-02FTTGR-12730302, 72-02FTTGR-12730302TA, 74-02CBG, 74-02CBG-12700155, 74-02FRG-12700600, 74-02FRG17-12700605, 74-02FRGM-12700630, 74-02FTG-12700140TA, 74-02FTG-12700310, 74-02FTG1-2R-12700141, 74-02FTG1-2R-12700141TA, 74-02FTG1-2R-12700311, 74-02FTGC-12700145, 74-02FTGC-12700145TA, 74-02FTGR-12700142, 74-02FTGR-12700142TA, 74-02FTGR-12700312, 74-02FTGR-12700140, 74-02TCBG, 74-02TCBG-12730155, 74-02FTTG-12730140, 74-02FTTG-12730140TA, 74-02FTTG-12730310, 74-02FTTG-12730310TA, 74-02FTTG1-2R-12730141, 74-02FTTG1-2R-12730141TA, 74-02FTTG1-2R-12730311, 74-02FTTG1-2R-12730311TA... (Other models you can see in the webshop)		



1

GEV No.	100682	Ref. No.	2510370 BN2510370
description	gas injector thread M11x1 WS 13 bore ø 1.15mm		
For models:	2FX+PCF, 31FOGV-1950002, 32FOGV2-1000002, 32FOGVG-1000004, 32FOGVM-1000015, 40SGFR-1826160, 40SGFR2S-1826160, 4FX+PCF, 60SGFR-1826170, 60SGFR2S-1826170, 72+2CTGG-12700013, 72-02CG-12700001, 72-02CG-12700001TA, 72-02TCG-12730001, 72-02TCG-12730001TA, 729CAGV-1950009, 729CAGV-1950009R, 729TCGV-1959009, 729TCGV-1959009R, 74+2CTGGAN-12700025, 74-02+2CTGG, 74-02+2CTGG-12700030, 74-02CBG, 74-02CG-12700002, 74-02CG-12700002TA, 74-02CGE-12700011, 74-02CGE-12700011TA, 74-02CGG-12700010, 74-02CGG-12700010TA, 74-02TCBG, 74-02TCG-12730002, 74-02TCG-12730002TA, 749CAGV-1950019, 749CAGV-1950019R, 749CGV-1950039, 749CGV-1950039R, 749CGVFE-1950059, 749CGVFE-1950059R, 749TCGV-1959019, 749TCGV-1959019R, 76-02+4CTGG, 76-02+4CTGG-12700031, 76-02CG-12700003, 76-02CG-12700003TA, 76-02CGE-12700017, 76-02CGE-12700017TA, 76-02CGEE-12700018, 76-02CGEE-12700018TA, 76-02CGFL-12700020, 76-02CGFL-12700020TA... (Other models you can see in the webshop)		



1

GEV No.	106278	Ref. No.	2510749 BN2510749
description	gas injector thread M11x1 WS 13 bore ø 1.45mm		
For models:	72+2CTGG-12700013, 72-02CBG-12700150, 72-02TCBG-12730150, 74+2CTGGAN-12700025, 74-02+2CTGG-12700030, 74-02CGG-12700010, 74-02CGG-12700010TA, 74-02CTGG-12700180, 74-02CTGG-12700180TA, 76-02+4CTGG-12700031, 76-02CGFL-12700020, 76-02CGFL-12700020TA, 76-02CGG-12700015, 76-02CGG-12700015TA, 76-02CGGE-12700016, 76-02CGGE-12700016TA, 76-02CTGG-12700195, 76-02CTGG-12700195TA, 76-02CTGGE-12700196, 76-02CTGGE-12700196TA, 769CGVFL-1950069, 769CGVFL-1950069R, 7961C-GVGAS-1950276, 7962C-GV-1950277, 7PCFL-G120, 914PCGG-1103214, 914PCTGG-1103711, 914PFTGG-1103413, 914PFTGG-1103415, 916PCGGAN-1103216, 916PCGGE-1103236, 918PCGG-1103218, 92-04CBG-12900150, 92-04TCBG-12930150, 92FG-1191220, 941CTGG-1291710, 941FTGG-1291412, 941FTGG1-2R-1291612, 941FTGGC-1291414, 941FTGGC1-2R-1291415, 941FTGGR-1291512, 94CGG-1191214, 94CTGG-1191710, 96CGG-1191216, 96CGG-1191236, 96CTGG-1191712, 96CTGGAC-1191732, 98CGG-1191218		



1

GEV No.	100681	Ref. No.	8220065 BN8220065
description	gas injector thread M11x1 WS 13 bore ø 1.1mm		
For models:	40SGFT-1825020, 40SGFTC-1825025, 40SGFTR-1825021, 60SGFT1-2R-1825031, 60SGFT-1825030, 60SGFTC-1825035, 60SGFTR-1825032, 73-02FRG-12700550, 73-02FRGM-12700580, 73-02FRGM-12700580TA, 7FRI-G610, 9122PFRG-1103930, 922FRG-1191930, 922RFRG-1391930, 93-04FRG-12900550, 93-04FRG-12900550H, 9FRI-G610		



1

GEV No.	106326	Ref. No.	2510441 BN2510441
description	gas injector thread M11x1 WS 13 bore ø 1.35mm		
For models:	40SGFR-1826160, 40SGFR2S-1826160, 60SGFR-1826170, 60SGFR2S-1826170		



			
1			
GEV No.	106622	Ref. No.	2510365 BN2510365
description	gas injector thread M11x1 WS 13 bore ø 1.4mm		
For models:	31FOGV-1950001, 31FOGVG-1000003, 32FOGV2-1000002, 72-02CBG, 72-02CBG-12700150, 72-02CG-12700001, 72-02CG-12700001TA, 72-02TCBG, 72-02TCBG-12730150, 72-02TCG-12730001, 72-02TCG-12730001TA, 729CAGV-1950009, 729CAGV-1950009R, 729TCGV-1959009, 729TCGV-1959009R, 74-02+2CTGG-12700030, 74-02CG-12700002, 74-02CG-12700002TA, 74-02CGE-12700011, 74-02CGE-12700011TA, 74-02CGG-12700010, 74-02CGG-12700010TA, 74-02TCG-12730002, 74-02TCG-12730002TA, 749CAGV-1950019, 749CAGV-1950019R, 749CGV-1950039, 749CGV-1950039R, 749CGVFE-1950059, 749CGVFE-1950059R, 749TCGV-1959019, 749TCGV-1959019R, 74PLG-1000940, 74PLG-1000940R, 76-02CG-12700003, 76-02CG-12700003TA, 76-02CGE-12700017, 76-02CGE-12700017TA, 76-02CGEE-12700018, 76-02CGEE-12700018TA, 76-02CGFL-12700020, 76-02CGFL-12700020TA, 76-02CGG-12700015, 76-02CGG-12700015TA, 76-02CGGE-12700016, 76-02CGGE-12700016TA, 76-02CTG-12700193, 76-02CTG-12700193TA, 76-02CTGG-12700195, 76-02CTGG-12700195TA...(Other models you can see in the webshop)		

			
1			
GEV No.	100686	Ref. No.	2510367 2510717 BN2510367
description	gas injector thread M11x1 WS 13 bore ø 1.7mm		
For models:	2FX+PCF, 31FOGV-1950002, 31FOGVM-1000007, 32FOGV2-1000002, 32FOGVG-1000004, 32FOGVM-1000015, 4FX+PCF, 72+2CTGG-12700013, 72-02CG-12700001, 72-02CG-12700001TA, 72-02TCG-12730001, 72-02TCG-12730001TA, 729CAGV-1950009, 729CAGV-1950009R, 729TCGV-1959009, 729TCGV-1959009R, 73-02FRG-12700550, 73-02FRGM-12700580, 74+2CTGGAN-12700025, 74-02+2CTGG, 74-02+2CTGG-12700030, 74-02CG-12700002, 74-02CG-12700002TA, 74-02CGE-12700011, 74-02CGE-12700011TA, 74-02CGG-12700010, 74-02CGG-12700010TA, 74-02TCG-12730002, 74-02TCG-12730002TA, 749CAGV-1950019, 749CAGV-1950019R, 749CGV-1950039, 749CGV-1950039R, 749CGVFE-1950059, 749CGVFE-1950059R, 749TCGV-1959019, 749TCGV-1959019R, 76-02+4CTGG, 76-02+4CTGG-12700031, 76-02CG-12700003, 76-02CG-12700003TA, 76-02CGE-12700017, 76-02CGE-12700017TA, 76-02CGEE-12700018, 76-02CGEE-12700018TA, 76-02CGFL-12700020, 76-02CGFL-12700020TA, 76-02CGG-12700015, 76-02CGG-12700015TA, 76-02CGGE-12700016, 76-02CGGE-12700016TA...(Other models you can see in the webshop)		

			
2			
GEV No.	100684	Ref. No.	2510381 BN2510381
description	gas injector thread M11x1 WS 13 bore ø 1.55mm		
For models:	72-02CBG, 72-02TCBG, 7GL-G400, 7GL-G800, 7GLT-G400, 7GLT-G800, 92-04CG1P-12900025, 92-04CG1P-12900025TA, 92-04CGP-12900051, 92-04CGP-12900051TA, 92-04TCG1P-12930025, 92-04TCG1P-12930025TA, 92-04TCGP-12930051, 92-04TCGP-12930051TA, 94-04CG1P-12900026, 94-04CG1P-12900026TA, 94-04CGE1P-12900031, 94-04CGEP-12900061, 94-04CGEP-12900061TA, 94-04CGG1P-12900030, 94-04CGG1P-12900030TA, 94-04CGG1P-12900031TA, 94-04CGGP-12900060, 94-04CGGP-12900060TA, 94-04CGP-12900052, 94-04CGP-12900052TA, 94-04TCG1P-12930026, 94-04TCG1P-12930026TA, 94-04TCGP-12930052, 94-04TCGP-12930052TA, 96-04CG2P-12900027, 96-04CG2P-12900027TA, 96-04CGE2P-12900034, 96-04CGE2P-12900034TA, 96-04CGEE2P-12900035, 96-04CGEE2P-12900035TA, 96-04CGEEP-12900068, 96-04CGEEP-12900068TA, 96-04CGEP-12900066TA, 96-04CGEP-12900066, 96-04CGEP-12900067TA, 96-04CGFL2P-12900037, 96-04CGFLP-12900069, 96-04CGG2P-12900032, 96-04CGG2P-12900032TA, 96-04CGGE2P-12900033, 96-04CGGE2P-12900033TA, 96-04CGGP-12900066, 96-04CGGP-12900065, 96-04CGGP-12900065TA...(Other models you can see in the webshop)		

			
1			
GEV No.	100689	Ref. No.	2510369 2510507 BN2510369
description	gas injector thread M11x1 WS 13 bore ø 1.85mm		
For models:	2FX+PCF, 31FOGVM-1000007, 32FOGVG-1000004, 32FOGVM-1000015, 40SGFT-1825020, 40SGFT-1825025, 40SGFTR-1825021, 4FX+PCF, 73-02FRG-12700550, 74-02+2CTGG, 74-02+2CTGG-12700030, 74-02NPGD-12700750, 74-02NPGI-12700755, 76-02+4CTGG, 76-02+4CTGG-12700031, 7FRI-G610, 80SGFT-1825038, 912PCG-1103102, 912PTCG-1103092, 914PCG-1103104, 914PCGE-1103224, 914PCGG-1103214, 914PTCG-1103094, 916PCG-1103106, 916PCGEE-1103246, 916PCGGAN-1103216, 916PCGGE-1103236, 916PTCG-1103096, 918PCG-1103108, 918PCGE-1103228, 918PCGG-1103218, 918PTCG-1103098, 92-04CG-12900001, 92-04CG-12900001TA, 92-04TCG-12930001, 92-04TCG-12930001TA, 92CG-1191102, 92TCG-1191092, 92TCG-1191092S, 93-04FRG-12900550, 93-04FRG-12900550H, 94-04CG-12900002, 94-04CG-12900002TA, 94-04CGE-12900011, 94-04CGE-12900011TA, 94-04CGG-12900010, 94-04CGG-12900010TA, 94-04CTGSS-12900185, 94-04CTGSS-12900185TA, 94-04CTGSS-12900175...(Other models you can see in the webshop)		

			
1			
GEV No.	100685	Ref. No.	2510488 BN2510488
description	gas injector thread M11x1 WS 13 bore ø 1.6mm		
For models:	72-02PLG-12700850, 72-02PLG-12700850TA, 72-02TPLG-12730850, 72-02TPLG-12730850TA, 74-02PLG-12700855, 74-02PLG-12700855TA, 74-02TPLG-12730855, 74-02TPLG-12730855TA, 74PLG-1000940, 74PLG-1000940R, 74PLG-1000940R, 74TPLG-1009940, 74TPLG-1009940R, 78PLG-1000980, 78PLG-1000980R, 78PLG-1000980R, 78TPLG-1009980, 78TPLG-1009980R, 7CP-G400, 7CP-G800, 7GL-G400, 7GL-G800, 7GLT-G400, 7GLT-G800, 96-04CGFL-12900019, 96-04CGFL2P-12900037, 96-04CGFLP-12900069, C-GV906FL-1050200		



			
1			
GEV No.	106628	Ref. No.	9000208
description	gas injector thread M11x1 WS 13 bore ø 2.8mm		
For models:	74-02CTG-12700170, 74-02CTG-12700170TA, 74-02CTGE-12700190, 74-02CTGE-12700190TA, 74-02CTGG-12700180, 74-02CTGG-12700180TA, 74-02NPGD-12700750, 74-02NPGI-12700755, 74-02TCTG-12730170, 74-02TCTG-12730170TA, 76-02CTG-12700193, 76-02CTG-12700193TA, 76-02CTGG-12700195, 76-02CTGG-12700195TA, 76-02CTGGE-12700196, 76-02CTGGE-12700196TA, 76-02TCTG-12730195, 76-02TCTG-12730195TA, 7GL-G400, 7GL-G800, 7GLT-G400, 7GLT-G800, 92-04PLG-12900850, 92-04PLG-12900850TA, 92-04TPLG-12930850, 92-04TPLG-12930850TA, 94-04PLG-12900855, 94-04PLG-12900855TA, 94-04TPLG-12930855, 94-04TPLG-12930855TA, 9GL-G400, 9GL-G800, 9TGL-G400, 9TGL-G800		

			
1			
GEV No.	106705	Ref. No.	2510332 BN2510332
description	pilot burner nozzle POLIDORO LPG code 38-R bore ø 0.38mm Qty 1 pcs		
For models:	110-135CGG, 110-135CGG2P, 110-135CGGE, 110-135CGGE2P, 110-135CGGEP, 110-135CGGP, 110-45CBG, 110-45TCBG, 110-90CGG, 110-90CGG1P, 110-90CGGP, 110-90CTG, 110-90CTGE, 110-90CTGG, 110-90FTTG, 110-90FTTG1-2R, 110-90FTTGC, 110-90FTTGC1-2R, 110-90FTTGCR, 110-90FTTGE, 110-90FTTGG, 110-90FTTGR, 110-90CTG, 110-90FTTG, 110-90FTTG1-2R, 110-90FTTGC, 110-90FTTGC1-2R, 110-90FTTGCR, 110-90FTTGR, 2FX+PCF, 4FX+PCF, 55-45CPG, 55-45FRG, 55-90CPG, 55-90FRG, 72+2CTGG-12700013, 72-02CPG, 72-02CPG-12700900, 72-02FRG, 72-02FRGM, 72-02FRGM-12700530, 72-02FRGM-12700530TA, 72-02FTG, 72-02FTG-12700130TA, 72-02FTG-12700300, 72-02FTG-12700300TA, 72-02FTGC-12700135, 72-02FTGC-12700135TA, 72-02FTGCVAL, 72-02FTGR...(Other models you can see in the webshop)		

pilot burner nozzles

pilot burner nozzles JUNKERS

<p>CB 5050_ series</p>			
			
1			
GEV No.	100230	Ref. No.	932900
description	pilot burner nozzle LPG gas pressure 50mbar code 2 Qty 1 pcs suitable for JUNKERS CB5050_		
For models:	FQG40, FQG60, FTG40B, FTG40BLC, FTG60B, FTG60BLC, FTG60BR, FTG80B, FTG80BR, OFTG40B, OFTG40BLC, OFTG60B, OFTG60BLC, OFTG60BR, OFTG80B, OFTG80BR		

			
1			
GEV No.	106703	Ref. No.	6A013230 BN6A013230
description	pilot burner nozzle POLIDORO natural gas code 27.2 bore ø 2x0.27mm Qty 1 pcs		
For models:	110-135CGG, 110-135CGG2P, 110-135CGGE, 110-135CGGE2P, 110-135CGGEP, 110-135CGGP, 110-45CBG, 110-45TCBG, 110-90CGG, 110-90CGG1P, 110-90CGGP, 110-90CTG, 110-90CTGE, 110-90CTGG, 110-90FTTG, 110-90FTTG1-2R, 110-90FTTGC, 110-90FTTGC1-2R, 110-90FTTGCR, 110-90FTTGE, 110-90FTTGG, 110-90FTTGR, 110-90CTG, 110-90FTTG, 110-90FTTG1-2R, 110-90FTTGC, 110-90FTTGC1-2R, 110-90FTTGCR, 110-90FTTGR, 2FX+PCF, 40SGFR-1826160, 40SGFR2S-1826160, 40SGFT-1825020, 40SGFTC-1825025, 40SGFTR-1825021, 4FX+PCF, 55-45CPG, 55-45FRG, 55-90CPG, 55-90FRG, 60SGFR-1826170, 60SGFR2S-1826170, 60SGFT1-2R-1825031, 60SGFT-1825030, 60SGFTC-1825035, 60SGFTR-1825032, 710FR-G-1077350, 710FR-G-1077350R, 712FR-G-1077550, 712FR-G-1077550R...(Other models you can see in the webshop)		

pilot burner nozzles POLIDORO

			
1			
GEV No.	106704	Ref. No.	6A013240 BN6A013240
description	pilot burner nozzle POLIDORO LPG code 16.2 bore ø 2x0.16mm Qty 1 pcs		
For models:	110-135CGG, 110-135CGG2P, 110-135CGGE, 110-135CGGE2P, 110-135CGGEP, 110-135CGGP, 110-45CBG, 110-45TCBG, 110-90CGG, 110-90CGG1P, 110-90CGGP, 110-90CTG, 110-90CTGE, 110-90CTGG, 110-90FTTG, 110-90FTTG1-2R, 110-90FTTGC, 110-90FTTGC1-2R, 110-90FTTGCR, 110-90FTTGE, 110-90FTTGG, 110-90FTTGR, 110-90CTG, 110-90FTTG, 110-90FTTG1-2R, 110-90FTTGC, 110-90FTTGC1-2R, 110-90FTTGCR, 110-90FTTGR, 2FX+PCF, 40SGFR-1826160, 40SGFR2S-1826160, 40SGFT-1825020, 40SGFTC-1825025, 40SGFTR-1825021, 4FX+PCF, 55-45CPG, 55-45FRG, 55-90CPG, 55-90FRG, 60SGFR-1826170, 60SGFR2S-1826170, 60SGFT1-2R-1825031, 60SGFT-1825030, 60SGFTC-1825035, 60SGFTR-1825032, 710FR-G-1077350, 710FR-G-1077350R, 712FR-G-1077550, 712FR-G-1077550R...(Other models you can see in the webshop)		

pilot burner nozzles SIT

<p>100 series</p>			
			
1			
GEV No.	100245	Ref. No.	1415100 6A013101 MA1415100
description	pilot burner nozzle LPG code 20 bore ø 0.2mm Qty 1 pcs thread M8x0.75		
For models:	110-135CG, 110-135CG2P, 110-135CGE, 110-135CGE2P, 110-135CGEE, 110-135CGEE2P, 110-135CGGEP, 110-135CGGP, 110-135CGG, 110-135CGG2P, 110-135CGGE, 110-135CGGE2P, 110-135CGGEP, 110-135CGGP, 110-45CBG, 110-45TCG, 110-135TCG, 110-135TCG2P, 110-135TCGP, 110-45CG, 110-45CG1P, 110-45CGP, 110-45TCG, 110-45TCG1P, 110-45TCGP, 110-90CG, 110-90CG1P, 110-90CGE, 110-90CGE1P, 110-90CGEP, 110-90CGG, 110-90CGG1P, 110-90CGGP, 110-90CGP, 110-90CTG, 110-90CTG1P, 110-90CTGP, 4FX, 4FX+PCF, 72-02CG, 72-02TCG, 722FRG-1077600, 74-02+2CTGG, 74-02+2CTGG-12700030, 74-02CG, 74-02CGE, 74-02CGG, 74-02TCG, 76-02CG, 76-02CGE, 76-02CGEE...(Other models you can see in the webshop)		

			
GEV No.	107170	Ref. No.	6A013103 BN6A013103
description	pilot burner nozzle SIT natural gas bore ø 0.35mm Qty 1 pcs		
For models:	110-135CG, 110-135CG2P, 110-135CGE, 110-135CGE2P, 110-135CGEE, 110-135CGEE2P, 110-135CGEEP, 110-135CGEP, 110-135CGG, 110-135CGG2P, 110-135CGGE, 110-135CGGE2P, 110-135CGGEP, 110-135CGGP, 110-135CGP, 110-135TCG, 110-135TCG2P, 110-135TCGP, 110-45CG, 110-45CG1P, 110-45CGP, 110-45TCG, 110-45TCG1P, 110-45TCGP, 110-90CG, 110-90CG1P, 110-90CGE, 110-90CGE1P, 110-90CGEP, 110-90CGG, 110-90CGG1P, 110-90CGGP, 110-90CGP, 110-90TCG, 110-90TCG1P, 110-90TCGP, 31FOGV-1950001, 31FOGV-1950002, 31FOGVG-1000003, 31FOGVM-1000007, 32FOGV2-1000002, 32FOGVG-1000004, 32FOGVM-1000015, 4FX, 4FX+PCF, 72+2CTGG-12700013, 72-02CG, 72-02CG-12700001, 72-02CG-1270001TA, 72-02TCG...(Other models you can see in the webshop)		

140/150 series			
			
GEV No.	100204	Ref. No.	1888000 6A013109 MA1888000
description	pilot burner nozzle SIT LPG code 14 bore ø 0.18/0.20mm Qty 1 pcs suitable for 140 series		
For models:	CFG120, OCFG120, OPLG40, OPLG-40-12600850, OPLG80, OPLG-80-12600855, PLG40, PLG80		

			
GEV No.	100205	Ref. No.	1033722000 22140380 822140380 BN822140380
description	pilot burner nozzle SIT LPG code 19 bore ø 0.23/0.26mm Qty 1 pcs suitable for SIT 150 series		
For models:	7FT-G400, 7FT-G410, 7FT-G800, 7FT-G810, 7FT-G820, 7FTTF-G800, 7FTTF-G805, 7FTTF-G820, 7FTTF-G825, 7FTTF-G800, 7FTTF-GE805, 7FTTF-GE820, 7FTTF-GE825, 7FTT-G400, 7FTT-G405, 7FTT-G410, 7FTT-G415, 7FTT-G800, 7FTT-G805, 7FTT-G806, 7FTT-G810, 7FTT-G815, 7FTT-G820, 7FTT-G825, 7FTTV-G400, 7FTTV-G405, 7FTTV-G410, 7FTTV-G415, 7FTTV-G800, 7FTTV-G805, 7FTTV-G810, 7FTTV-G815, 7FTTV-G820, 7FTTV-G825, 7FTV-G400, 7FTV-G410, 7FTV-G800, 7FTV-G810, 7FTV-G820, 7PCF-G120, 7PCF-G121, 7PCF-G160, 7PCF-G161, 7PCF-G800, 7PCF-G811, 7PCF-GE120, 7PCF-GE121, 7PCF-GE160, 7PCF-GE161, 7PCF-GE411...(Other models you can see in the webshop)		

			
GEV No.	100207	Ref. No.	1887800 6A013107 MA1887800
description	pilot burner nozzle SIT natural gas code 27 bore ø 0.40/0.38mm suitable for SIT 140 series		
For models:	7741C-GVGAS-1950266, 7742C-GV-1950267, 7961C-GVGAS-1950276, 7962C-GV-1950277, 7FT-G400, 7FT-G410, 7FT-G800, 7FT-G810, 7FT-G820, 7FTTF-G800, 7FTTF-G805, 7FTTF-G820, 7FTTF-G825, 7FTTF-GE800, 7FTTF-GE805, 7FTTF-GE820, 7FTTF-GE825, 7FTT-G400, 7FTT-G405, 7FTT-G410, 7FTT-G415, 7FTT-G800, 7FTT-G805, 7FTT-G806, 7FTT-G810, 7FTT-G815, 7FTT-G820, 7FTT-G825, 7FTTV-G400, 7FTTV-G405, 7FTTV-G410, 7FTTV-G415, 7FTTV-G800, 7FTTV-G805, 7FTTV-G810, 7FTTV-G815, 7FTTV-G820, 7FTTV-G825, 7FTV-G400, 7FTV-G410, 7FTV-G800, 7FTV-G810, 7FTV-G820, 7PCF-G120, 7PCF-G121, 7PCF-G160, 7PCF-G161, 7PCF-G800, 7PCF-G811, 7PCF-GE120...(Other models you can see in the webshop)		

			
GEV No.	103288	Ref. No.	1887900
description	pilot burner nozzle SIT natural gas code 50 bore ø 0.50mm suitable for 140 series		
For models:	CFG120, OCFG120		

160 series			
			
GEV No.	107649	Ref. No.	1033719600
description	pilot burner nozzle SIT LPG code 20 Qty 1 pcs		
For models:	CFG101, CFG70, CFGE61, CFGE61D, CFGE61L, CFGE61P, FQG41, FQG61, OCFG101, OCFG-101-12600025, OCFG70, OCFG-70-12600000, OCFGE61, OFQG41, OFQG-41-12600500, OFQG61, OFQG-61-12600600, OPGC41, OPGC-41-12600010, OPGC61		

			
GEV No.	107172	Ref. No.	1874700
description	pilot burner nozzle SIT LPG code 25 Qty 1 pcs		
For models:	FQG41, FQG61, OFQG41, OFQG-41-12600500, OFQG61, OFQG-61-12600600		

			
GEV No.	107174	Ref. No.	1033719700
description	pilot burner nozzle SIT natural gas code 41 Qty 1 pcs		
For models:	CFG101, CFG70, CFGE61, CFGE61D, CFGE61L, CFGE61P, FQG41, FQG61, OCFG101, OCFG-101-12600025, OCFG70, OCFG-70-12600000, OCFGE61, OFQG41, OFQG-41-12600500, OFQG61, OFQG-61-12600600, OPGC41, OPGC-41-12600010, OPGC61		



bypass nozzles

bypass nozzles PEL20/21



GEV No.	100554	Ref. No.	6A023722 BN6A023722
description	bypass nozzle type PEL20/21 bore ø 0.45mm thread M5x0.5		
For models:	72+2CTGG-12700013, 72-02CG-12700001, 72-02CG-12700001TA, 72-02TCG-12730001, 72-02TCG-12730001TA, 74-02+2CTGG-12700030, 74-02CG-12700002, 74-02CG-12700002TA, 74-02CGE-12700011, 74-02CGE-12700011TA, 74-02CGG-12700010, 74-02CGG-12700010TA, 74-02TCG-12730002, 74-02TCG-12730002TA, 76-02CG-12700003, 76-02CG-12700003TA, 76-02CGE-12700017, 76-02CGE-12700017TA, 76-02CGEE-12700018, 76-02CGEE-12700018TA, 76-02CGFL-12700020, 76-02CGFL-12700020TA, 76-02CGG-12700015, 76-02CGG-12700015TA, 76-02CGGE-12700016, 76-02CGGE-12700016TA, 76-02CTG-12700193, 76-02CTG-12700193TA, 76-02CTGG-12700195, 76-02CTGG-12700195TA, 76-02CTGGE-12700196, 76-02CTGGE-12700196TA, 76-02CTCG-12730003, 76-02CTCG-12730003TA, 76-02TCTG-12730195, 76-02TCTG-12730195TA, 7PCF-G120, 7PCF-G121, 7PCF-G160, 7PCF-G161, 7PCF-G800, 7PCF-G811, 7PCF-GE120, 7PCF-GE121, 7PCF-GE160, 7PCF-GE161, 7PCF-GE411, 7PCF-GE800, 7PCFL-G120, 7PC-G120...(Other models you can see in the webshop)		



GEV No.	100550	Ref. No.	1033720000
description	bypass nozzle type PEL20/21 bore ø 0.55mm thread M5x0.5		
For models:	CFG101, CFG120, CFG70, CFGE61, CFGE61D, CFGE61L, CFGE61P, OCFG101, OCFG-101-12600025, OCFG120, OCFG70, OCFG-70-12600000, OCFG61, OPCG41, OPCG-41-12600010, OPCG61		



GEV No.	100548	Ref. No.	6A023723 BN6A023723
description	bypass nozzle type PEL20/21 bore ø 0.65mm thread M5x0.5		
For models:	72+2CTGG-12700013, 72-02CG-12700001, 72-02CG-12700001TA, 72-02TCG-12730001, 72-02TCG-12730001TA, 74+2CTGGAN-12700025, 74-02+2CTGG-12700030, 74-02CG-12700002, 74-02CG-12700002TA, 74-02CGE-12700011, 74-02CGE-12700011TA, 74-02CGG-12700010, 74-02CGG-12700010TA, 74-02TCG-12730002, 74-02TCG-12730002TA, 76-02+4CTGG-12700031, 76-02CG-12700003, 76-02CG-12700003TA, 76-02CGE-12700017, 76-02CGE-12700017TA, 76-02CGEE-12700018, 76-02CGEE-12700018TA, 76-02CGFL-12700020, 76-02CGFL-12700020TA, 76-02CGG-12700015, 76-02CGG-12700015TA, 76-02CGGE-12700016, 76-02CGGE-12700016TA, 76-02CTG-12700193, 76-02CTG-12700193TA, 76-02CTGG-12700195, 76-02CTGG-12700195TA, 76-02CTGGE-12700196, 76-02CTGGE-12700196TA, 76-02TCTG-12730003, 76-02TCTG-12730003TA, 76-02TCTG-12730195, 76-02TCTG-12730195TA, 7PCF-G120, 7PCF-G121, 7PCF-G160, 7PCF-G161, 7PCF-G800, 7PCF-G811, 7PCF-GE120, 7PCF-GE121, 7PCF-GE160, 7PCF-GE161, 7PCF-GE411, 7PCF-GE800...(Other models you can see in the webshop)		



GEV No.	100552	Ref. No.	1884200 BN6A023721
description	bypass nozzle type PEL20/21 bore ø 0.7mm thread M5x0.5		
For models:	CFG101, CFG70, CFGE61, CFGE61D, CFGE61L, CFGE61P, OCFG101, OCFG-101-12600025, OCFG70, OCFG-70-12600000, OCFG61, OPCG41, OPCG-41-12600010, OPCG61		



GEV No.	100528	Ref. No.	1033720200 1889000
description	bypass nozzle type PEL20/21 bore ø 0.9mm thread M5x0.5		
For models:	CFG101, CFG120, CFG70, CFGE61, CFGE61D, CFGE61L, CFGE61P, OCFG101, OCFG-101-12600025, OCFG120, OCFG70, OCFG-70-12600000, OCFG61, OPCG41, OPCG-41-12600010, OPCG61, OPLG40, OPLG-40-12600850, OPLG80, OPLG-80-12600855, PLG40, PLG80		



GEV No.	100534	Ref. No.	1883400 MA1883400
description	bypass nozzle type PEL20/21 bore ø 1.4mm thread M5x0.5		
For models:	OPLG40, OPLG-40-12600850, OPLG80, OPLG-80-12600855, PLG40, PLG80		



GEV No.	100529	Ref. No.	1889100
description	bypass nozzle type PEL20/21 bore ø 1mm thread M5x0.5		
For models:	FTG40B, FTG40BLC, FTG60B, FTG60BLC, FTG60BR, FTG80B, FTG80BR, OFTG40B, OFTG40BLC, OFTG60B, OFTG60BLC, OFTG60BR, OFTG80B, OFTG80BR		

bypass nozzles SABAF



GEV No.	106586	Ref. No.	18850-00
description	bypass nozzle bore ø 0.5mm thread M4x0.5 SABAF		
For models:	CFG101, CFG120, CFG70, OCFG101, OCFG-101-12600025, OCFG120, OCFG70, OCFG-70-12600000, OPCG-41-12600010		



GEV No.	106587	Ref. No.	18856-00
description	bypass nozzle bore ø 0.8mm thread M4x0.5 SABAF		
For models:	CFG101, CFG120, CFG70, OCFG101, OCFG-101-12600025, OCFG120, OCFG70, OCFG-70-12600000, OPCG-41-12600010		

gas nozzles sets



GEV No.	106632	Ref. No.	2591665
description	gas injector set		
For models:	74-02NPGD, 74-02NPGI, 7NP-G50, 7NP-GI50		



1

GEV No.	106633	Ref. No.	2591666
description	gas injector set		
For models:	74-02NPGD, 74-02NPGI, 7NP-G50, 7NP-GI50		

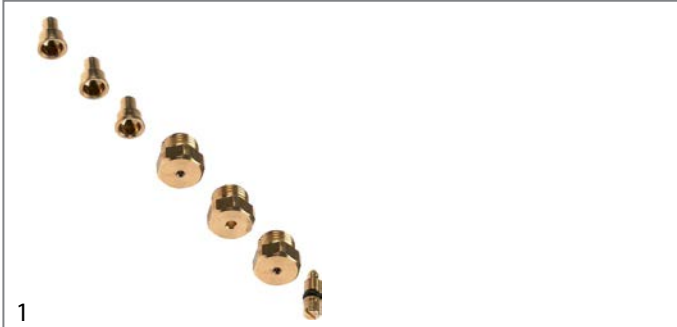

1

GEV No.	106634	Ref. No.	2591667
description	gas injector set		
For models:	74-02NPGD, 74-02NPGI, 7NP-G50, 7NP-GI50		



1

GEV No.	106635	Ref. No.	2591721
description	gas injector set		
For models:	74-02KBGB, 74-02KBGB-12700110, 74-02KBGBI, 74-02KBG-BI-12700115, 74-02KBGMB, 74-02KBGMB-12700120, 74-02KBGM-BI, 74-02KBGM-BI-12700125		



1

GEV No.	106636	Ref. No.	2591720
description	gas injector set		
For models:	74-02KBGB, 74-02KBGB-12700110, 74-02KBGBI, 74-02KBG-BI-12700115, 74-02KBGMB, 74-02KBGMB-12700120, 74-02KBGM-BI, 74-02KBGM-BI-12700125		



1

GEV No.	106640	Ref. No.	2591722
description	gas injector set for tilting bratt pan		
For models:	74-02KBGB, 74-02KBGB-12700110, 74-02KBGBI, 74-02KBG-BI-12700115, 74-02KBGMB, 74-02KBGMB-12700120, 74-02KBGM-BI, 74-02KBGM-BI-12700125		

auxiliary gas parts

screw connections

olives



1

GEV No.	101249	Ref. No.	673400 6A011470 BN6A011470	
description	olive for pipe ø 10mm Qty 1 pcs			
For models:	110-135CG, 110-135CG2P, 110-135CGE, 110-135CGE2P, 110-135CGEE, 110-135CGEE2P, 110-135CGEEP, 110-135CGEP, 110-135CGG, 110-135CGG2P, 110-135CGGE, 110-135CGGE2P, 110-135CGGEP, 110-135CGGP, 110-135CGP, 110-135TCG, 110-135TCG2P, 110-135TCGP, 110-45CBG, 110-45CG, 110-45CG1P, 110-45CGP, 110-45TCBG, 110-45TCG, 110-45TCG1P, 110-45TCGP, 110-90CG, 110-90CG1P, 110-90CGE, 110-90CGE1P, 110-90CGEP, 110-90CGG, 110-90CGG1P, 110-90CGGP, 110-90CGP, 110-90CTG, 110-90CTGE, 110-90CTGG, 110-90TCG, 110-90TCG1P, 110-90TCGP, 110-90TCGT, 2FX+PCF, 4FX, 4FX+PCF, 55-45CPG, 55-90CPG, 72+2CTGG-12700013, 72-02CBG-12700150, 72-02CG...(Other models you can see in the webshop)			
accessories for	101249			
	GEV No.	101250	Ref. No.	6A011475 A011475 BN6A011475
union nut thread M20x1.5 for pipe ø 10mm				



1







GEV No.	101278	Ref. No.	6A011480 86720 BN6A011480 MA86720	
description	olive for pipe ø 10mm Qty 1 pcs			
For models:	110-135CG, 110-135CG2P, 110-135CGE, 110-135CGE2P, 110-135CGEE, 110-135CGEE2P, 110-135CGEEP, 110-135CGEP, 110-135CGG, 110-135CGG2P, 110-135CGGE, 110-135CGGE2P, 110-135CGGEP, 110-135CGGP, 110-135CGP, 110-135TCG, 110-135TCG2P, 110-135TCGP, 110-45CBG, 110-45CG, 110-45CG1P, 110-45CGP, 110-45TCBG, 110-45TCG, 110-45TCG1P, 110-45TCGP, 110-90CG, 110-90CG1P, 110-90CGE, 110-90CGE1P, 110-90CGEP, 110-90CGG, 110-90CGG1P, 110-90CGGP, 110-90CGP, 110-90CTG, 110-90CTGE, 110-90CTGG, 110-90TCG, 110-90TCG1P, 110-90TCGP, 110-90TCGT, 2FX+PCF, 4FX, 4FX+PCF, 55-45CPG, 55-90CPG, 72+2CTGG-12700013, 72-02CBG-12700150, 72-02CG...(Other models you can see in the webshop)			
accessories for	101278			
	GEV No.	100943	Ref. No.	—
union nut thread M17x1 tube ø 10mm				

Table continues overleaf







accessories for 101278					
	<table border="1"> <tr> <td>GEV No.</td> <td>101300</td> <td>Ref. No.</td> <td>1326500 6A011485 A011485 BN6A011485</td> </tr> </table> <p>union nut thread M16x1.5 tube ø 10mm</p>	GEV No.	101300	Ref. No.	1326500 6A011485 A011485 BN6A011485
GEV No.	101300	Ref. No.	1326500 6A011485 A011485 BN6A011485		
	<table border="1"> <tr> <td>GEV No.</td> <td>101478</td> <td>Ref. No.</td> <td>1665200</td> </tr> </table> <p>union nut thread 3/8" for pipe ø 10mm</p>	GEV No.	101478	Ref. No.	1665200
GEV No.	101478	Ref. No.	1665200		

			
1			
GEV No.	106638	Ref. No.	6A016300 BN6A016300
description	olive for pipe ø 12mm L 10mm Qty 1 pcs		
For models:	110-90FTTG, 110-90FTTG1-2R, 110-90FTTGC, 110-90FTTGC1-2R, 110-90FTTGCR, 110-90FTTGE, 110-90FTTGG, 110-90FTTGR, 110-90FTTTG, 110-90FTTTG1-2R, 110-90FTTTGC, 110-90FTTTGC1-2R, 110-90FTTTGCR, 110-90FTTTGR, 2FX+PCF, 31FOGV-1950001, 31FOGV-1950002, 31FOGVG-1000003, 31FOGVM-1000007, 32FOGV2-1000002, 32FOGVG-1000004, 32FOGVM-1000015, 40SECP-1825080, 40SECP-1825080E, 40SGFR-1826160, 40SGFR2S-1826160, 40SGFT-1825020, 40SGFTC-1825025, 40SGFTR-1825021, 4FX+PCF, 55-45FRG, 55-90FRG, 60SGFR-1826170, 60SGFR2S-1826170, 60SGFT1-2R-1825031, 60SGFT-1825030, 60SGFTC-1825035, 60SGFTR-1825032, 710FR-G-1077350, 710FR-G-1077350R, 712FR-G-1077550, 712FR-G-1077550R, 714CT-GV-1000170, 714CT-GV-1000170R, 72+2CTGG-12700013, 72-02FRG, 72-02FRG-12700500, 72-02FRG17-12700505, 72-02FRGM, 72-02FRGM-12700530...(Other models you can see in the webshop)		

					
1					
GEV No.	101273	Ref. No.	417810 6A011625 MA417810		
description	olive for pipe ø 12mm L 9.5mm brass Qty 1 pcs suitable for universal				
For models:	110-90FTTG, 110-90FTTG1-2R, 110-90FTTGC, 110-90FTTGC1-2R, 110-90FTTGCR, 110-90FTTGE, 110-90FTTGG, 110-90FTTGR, 110-90FTTTG, 110-90FTTTG1-2R, 110-90FTTTGC, 110-90FTTTGC1-2R, 110-90FTTTGCR, 110-90FTTTGR, 2FX+PCF, 40SGFR-1826160, 40SGFR2S-1826160, 40SGFT-1825020, 40SGFTC-1825025, 40SGFTR-1825021, 4FX+PCF, 55-45FRG, 55-90FRG, 60SGFR-1826170, 60SGFR2S-1826170, 60SGFT1-2R-1825031, 60SGFT-1825030, 60SGFTC-1825035, 60SGFTR-1825032, 72+2CTGG-12700013, 72-02FRG, 72-02FRG-12700500, 72-02FRG17-12700505, 72-02FTG, 72-02FTG-12700130TA, 72-02FTG-12700300, 72-02FTG-12700300TA, 72-02FTGC-12700135, 72-02FTGC-12700135TA, 72-02FTGCVL, 72-02FTGR, 72-02FTGR-12700132TA, 72-02FTGR-12700302, 72-02FTGR-12700302TA, 72-02FTGRVAL, 72-02FTGVAL, 72-02FTTG-12700130, 72-02FTTGR-12700132, 72-02FTTG, 72-02FTTG-12730130...(Other models you can see in the webshop)				
accessories for 101273					
	<table border="1"> <tr> <td>GEV No.</td> <td>100944</td> <td>Ref. No.</td> <td>—</td> </tr> </table> <p>union nut thread M18x1.5 for pipe ø 12mm</p>	GEV No.	100944	Ref. No.	—
GEV No.	100944	Ref. No.	—		
	<table border="1"> <tr> <td>GEV No.</td> <td>101276</td> <td>Ref. No.</td> <td>459300 6A011620 A011620</td> </tr> </table> <p>union screw thread 3/8" tube ø 12mm Qty 1 pcs</p>	GEV No.	101276	Ref. No.	459300 6A011620 A011620
GEV No.	101276	Ref. No.	459300 6A011620 A011620		

			
1			
GEV No.	106598	Ref. No.	866200
description	olive for pipe ø 18mm Qty 1 pcs ED ø 21mm		
For models:	CPE60, CPE60DB, FQE41, FQE41L, FQE41L2, FQE61, FQE61L, FQE61L2, FQG41, FQG61, OBME41M, OBME61M, OCPE60, OCPE-60-12601900, OCPE-60-12601900MN, OFQE41, OFQE-41-12601510, OFQE-41-12601510MN, OFQE41L, OFQE61, OFQE-61-12601610, OFQE-61-12601610MN, OFQE61L, OFQG41, OFQG-41-12600500, OFQG61, OFQG-61-12600600		



					
1					
GEV No.	101282	Ref. No.	469000		
description	olive for pipe ø 4mm L 7.4mm Qty 1 pcs				
For models:	FQG40, FQG60, FTG40B, FTG40BLC, FTG60B, FTG60BLC, FTG60BR, FTG80B, FTG80BR, OFTG40B, OFTG40BLC, OFTG60B, OFTG60BLC, OFTG60BR, OFTG80B, OFTG80BR				
accessories for 101282					
	<table border="1"> <tr> <td>GEV No.</td> <td>100908</td> <td>Ref. No.</td> <td>673500 6A016110 6A017000 A016110 A017000 BN6A016110 BN6A017000 MA673500</td> </tr> </table> <p>union screw thread M10x1 for pipe ø 4mm Qty 1 pcs</p>	GEV No.	100908	Ref. No.	673500 6A016110 6A017000 A016110 A017000 BN6A016110 BN6A017000 MA673500
GEV No.	100908	Ref. No.	673500 6A016110 6A017000 A016110 A017000 BN6A016110 BN6A017000 MA673500		
	<table border="1"> <tr> <td>GEV No.</td> <td>101283</td> <td>Ref. No.</td> <td>468800</td> </tr> </table> <p>union screw thread M10x1 for pipe ø 4mm Qty 1 pcs</p>	GEV No.	101283	Ref. No.	468800
GEV No.	101283	Ref. No.	468800		

			
1			
GEV No.	106637	Ref. No.	6A016900 BN6A016900
description	olive for pipe ø 4mm L 7mm Qty 1 pcs		
For models:	110-135CGG, 110-135CGG2P, 110-135CGGE, 110-135CGGE2P, 110-135CGGEP, 110-135CGGP, 110-45CBG, 110-45TCBG, 110-90CGG, 110-90CGG1P, 110-90CGGP, 110-90CTG, 110-90CTGE, 110-90CTGG, 110-90FTTG, 110-90FTTG1-2R, 110-90FTTGC, 110-90FTTGC1-2R, 110-90FTTGCR, 110-90FTTGE, 110-90FTTGG, 110-90FTTGR, 110-90TCTG, 110-90FTTTG, 110-90FTTTG1-2R, 110-90FTTTGC, 110-90FTTTGC1-2R, 110-90FTTTGCR, 110-90FTTTGR, 40SGFR-1826160, 40SGFR2S-1826160, 40SGFT-1825020, 40SGFTC-1825025, 40SGFTR-1825021, 55-45CPG, 55-45FRG, 55-90CPG, 55-90FRG, 60SGFR-1826170, 60SGFR2S-1826170, 60SGFT1-2R-1825031, 60SGFT-1825030, 60SGFTC-1825035, 60SGFTR-1825032, 72+2CTGG-12700013, 72-02CBG, 72-02CBG-12700150, 72-02CPG, 72-02CPG-12700900, 72-02FRG...(Other models you can see in the webshop)		

			
1			
GEV No.	101246	Ref. No.	673600 6A016120 MA673600
description	olive for pipe ø 4mm Qty 1 pcs		
For models:	110-45CBG, 110-45TCBG, 2FX+PCF, 4FX, 4FX+PCF, 55-45CPG, 55-90CPG, 72+2CTGG-12700013, 72-02CBG, 72-02CBG-12700150, 72-02CG, 72-02CG-12700001, 72-02CG-12700001TA, 72-02CPG, 72-02CPG-12700900, 72-02FRGM, 72-02FRGM-12700530, 72-02FRGM-12700530TA, 72-02FTG-12700300, 72-02FTG-12700300TA, 72-02FTGR-12700302, 72-02FTGR-12700302TA, 72-02PLG, 72-02PLG-12700850, 72-02PLG-12700850TA, 72-02TCBG, 72-02TCBG-12730150, 72-02TCG, 72-02TCG-12730001, 72-02TCG-12730001TA, 72-02FTTG-12730300, 72-02FTTG-12730300TA, 72-02FTTGR-12730302, 72-02FTTGR-12730302TA, 72-02TFTG-12730302TA, 72-02TGC, 72-02TPLG, 72-02TPLG-12730850, 72-02TPLG-12730850TA, 729CAGV-1950009, 729CAGV-1950009R, 729TCGV-1959009, 729TCGV-1959009R, 73-02FRGM, 73-02FRGM-12700580, 73-02FRGM-12700580TA, 74+2CTGGAN-12700025, 74-02+2CTGG, 74-02+2CTGG-12700030, 74-02CBG, 74-02CBG-12700155...(Other models you can see in the webshop)		
accessories for	101246		
	GEV No.	100908	Ref. No. 673500 6A016110 6A017000 A016110 A017000 BN6A016110 BN6A017000 MA673500
union screw thread M10x1 for pipe ø 4mm Qty 1 pcs			

			
1			
GEV No.	100897	Ref. No.	1881000 1888100 22450050 MA1888100
description	olive for pipe ø 4mm Qty 1 pcs for pilot burner		
For models:	CFG120, OCFG120, OFTG40B, OFTG40B-12600130, OFTG40BLC, OFTG40BLC-12600135, OFTG40BR, OFTG40BR-12600132, OFTG60B, OFTG60B-12600140, OFTG60BLC, OFTG60BLC-12600145, OFTG60BR, OFTG60BR-12600141, OFTG60BRR, OFTG60BRR-12600142, OFTG80BLC, OFTG80BLC-12600138, OPLG40, OPLG40-12600850, OPLG80, OPLG80-12600855, PLG40, PLG80		

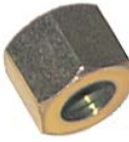

			
1			
GEV No.	100870	Ref. No.	BN822450380
description	olive for pipe ø 4mm Qty 1 pcs suitable for 160 series for pilot burner		

			
1			
GEV No.	100898	Ref. No.	41822450470 6A011706 BN41822450470 BN6A011706
description	olive for pipe ø 6mm Qty 1 pcs for pilot burner		
For models:	7741C-GVGAS-1950266, 7742C-GV-1950267, 7961C-GVGAS-1950276, 7962C-GV-1950277		
accessories for	100898		
	GEV No.	100909	Ref. No. —
union screw thread M10x1 for pipe ø 6mm Qty 1 pcs			

union nuts			
			
1			
GEV No.	101478	Ref. No.	1665200
description	union nut thread 3/8" for pipe ø 10mm		
For models:	CFG101, CFG120, CFG70, OCFG101, OCFG-101-12600025, OCFG120, OCFG70, OCFG-70-12600000, OPGC-41-12600010		

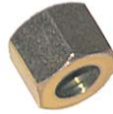
			
1			
GEV No.	101476	Ref. No.	1665300
description	union nut thread M13x1 for pipe ø 8mm		
For models:	CFG101, CFG120, CFG70, OCFG101, OCFG-101-12600025, OCFG120, OCFG70, OCFG-70-12600000, OPGC-41-12600010		

			
1			
GEV No.	520223	Ref. No.	86643
description	union nut thread M16x1 WS 19 L 15mm for pipe ø 10mm		
For models:	CFG101, CFG120, CFG70, OCFG101, OCFG-101-12600025, OCFG120, OCFG70, OCFG-70-12600000, OPGC-41-12600010		

			
1			
GEV No.	101300	Ref. No.	1326500 6A011485 BN6A011485
description	union nut thread M16x1.5 tube ø 10mm		
For models:	110-135CG, 110-135CG2P, 110-135CGE, 110-135CGE2P, 110-135CGEE, 110-135CGEE2P, 110-135CGEEP, 110-135CGEP, 110-135CGG, 110-135CGG2P, 110-135CGGE, 110-135CGGE2P, 110-135CGGEP, 110-135CGGP, 110-135CGP, 110-135TCG, 110-135TCG2P, 110-135TCGP, 110-45CBG, 110-45CG, 110-45CG1P, 110-45CGP, 110-45TCBG, 110-45TCG, 110-45TCG1P, 110-45TCGP, 110-90CG, 110-90CG1P, 110-90CGE, 110-90CGE1P, 110-90CGEP, 110-90CGG, 110-90CGG1P, 110-90CGGP, 110-90CGP, 110-90CTG, 110-90CTGE, 110-90CTGG, 110-90TCG, 110-90TCG1P, 110-90TCGP, 110-90TCTG, 2FX+PCF, 4FX, 4FX+PCF, 55-45CPG, 55-90CPG, 72+2CTGG-12700013, 72-02CBG-12700150, 72-02CG...(Other models you can see in the webshop)		
accessories for	101300		
	GEV No.	101278	Ref. No. 6A011480 86720 A011480 BN6A011480 MA86720
olive for pipe ø 10mm Qty 1 pcs			





			
1			
GEV No.	101250	Ref. No.	6A011475 BN6A011475
description	union nut thread M20x1.5 for pipe ø 10mm		
For models:	110-135CG, 110-135CG2P, 110-135CGE, 110-135CGE2P, 110-135CGEE, 110-135CGEE2P, 110-135CGEEP, 110-135CGEP, 110-135CGG, 110-135CGG2P, 110-135CGGE, 110-135CGGE2P, 110-135CGGEP, 110-135CGGP, 110-135CGP, 110-135TCG, 110-135TCG2P, 110-135TCGP, 110-45CBG, 110-45CG, 110-45CG1P, 110-45CGP, 110-45TCBG, 110-45TCG, 110-45TCG1P, 110-45TCGP, 110-90CG, 110-90CG1P, 110-90CGE, 110-90CGE1P, 110-90CGEP, 110-90CGG, 110-90CGG1P, 110-90CGGP, 110-90CGP, 110-90CTG, 110-90CTGE, 110-90CTGG, 110-90CTG, 110-90CTG1P, 110-90CTGP, 110-90CTGT, 2FX+PCF, 4FX, 4FX+PCF, 55-45CPG, 55-90CPG, 72+2CTGG-12700013, 72-02CBG-12700150, 72-02CG...(Other models you can see in the webshop)		
accessories for	101250		
			
GEV No.	101249	Ref. No.	673400 6A011470 A011470 BN6A011470
olive for pipe ø 10mm Qty 1 pcs			

			
1			
GEV No.	101251	Ref. No.	6A016200 BN6A016200
description	union nut thread M20x1.5 for pipe ø 12mm		
For models:	110-90FTTG, 110-90FTTG1-2R, 110-90FTTGC, 110-90FTTGC1-2R, 110-90FTTGCR, 110-90FTTGE, 110-90FTTGG, 110-90FTTGR, 110-90FTTGT, 110-90FTTGT1-2R, 110-90FTTGC, 110-90FTTGC1-2R, 110-90FTTGCRCR, 110-90FTTGR, 2FX+PCF, 31FOGV-1950001, 31FOGV-1950002, 31FOGVG-1000003, 31FOGVM-1000007, 32FOGV2-1000002, 32FOGVG-1000004, 32FOGVM-1000015, 40SECP-1825080, 40SECP-1825080E, 40SGFR-1826160, 40SGFR2S-1826160, 40SGFT-1825020, 40SGFTC-1825025, 40SGFTR-1825021, 4FX+PCF, 55-45FRG, 55-90FRG, 60SGFR-1826170, 60SGFR2S-1826170, 60SGFT1-2R-1825031, 60SGFT-1825030, 60SGFTC-1825035, 60SGFTR-1825032, 710FRG-1077300, 710FRG-1077350, 710FRG-1077350R, 712FR-G-1077550, 712FRG-1077550, 712FR-G-1077550R, 714CTGV-1000170, 714CTGV-1000170R, 72+2CTGG-12700013, 72-02FRG, 72-02FRG-12700500, 72-02FRG17-12700505...(Other models you can see in the webshop)		
accessories for	101251		
			
GEV No.	101248	Ref. No.	—
olive for pipe ø 12mm Qty 1 pcs suitable for PEL			





			
1			
GEV No.	100904	Ref. No.	1394700 6A011608 BN6A011608 MA1394700
description	locking screw M10x1 for pipe ø 4mm Qty 1 pcs		
For models:	110-135CG, 110-135CG2P, 110-135CGE, 110-135CGE2P, 110-135CGEE, 110-135CGEE2P, 110-135CGEEP, 110-135CGEP, 110-135CGG, 110-135CGG2P, 110-135CGGE, 110-135CGGE2P, 110-135CGGEP, 110-135CGGP, 110-135CGP, 110-135TCG, 110-135TCG2P, 110-135TCGP, 110-45CG, 110-45CG1P, 110-45CGP, 110-45TCG, 110-45TCG1P, 110-45TCGP, 110-90CG, 110-90CG1P, 110-90CGE, 110-90CGE1P, 110-90CGEP, 110-90CGG, 110-90CGG1P, 110-90CGGP, 110-90CGP, 110-90CTGG, 110-90FTTG, 110-90FTTG1-2R, 110-90FTTGC, 110-90FTTGC1-2R, 110-90FTTGCRCR, 110-90FTTGE, 110-90FTTGG, 110-90FTTGR, 110-90FTTGT, 110-90FTTGT1-2R, 110-90FTTGC, 110-90FTTGC1-2R, 110-90FTTGCRCR...(Other models you can see in the webshop)		



			
1			
GEV No.	100905	Ref. No.	6A011705 BN6A011705
description	locking screw M10x1 for pipe ø 6mm Qty 1 pcs		
For models:	7741C-GVGAS-1950266, 7742C-GV-1950267, 7961C-GVGAS-1950276, 7962C-GV-1950277		

			
1			
GEV No.	100906	Ref. No.	1888400 6A011707 MA1888400
description	screw connection thread M10x1 for ignition electrode brass Qty 1 pcs WS 10		
For models:	7FT-G400, 7FT-G410, 7FT-G800, 7FT-G810, 7FT-G820, 7FTTF-G800, 7FTTF-G805, 7FTTF-G820, 7FTTF-G825, 7FTTF-GE800, 7FTTF-GE805, 7FTTF-GE820, 7FTTF-GE825, 7FTT-G400, 7FTT-G405, 7FTT-G410, 7FTT-G415, 7FTT-G800, 7FTT-G805, 7FTT-G810, 7FTT-G815, 7FTT-G820, 7FTT-G825, 7FTTV-G400, 7FTTV-G405, 7FTTV-G410, 7FTTV-G415, 7FTTV-G800, 7FTTV-G805, 7FTTV-G810, 7FTTV-G815, 7FTTV-G820, 7FTTV-G825, 7FTV-G400, 7FTV-G410, 7FTV-G800, 7FTV-G810, 7FTV-G820, 7PCF-G120, 7PCF-G121, 7PCF-G160, 7PCF-G161, 7PCF-G800, 7PCF-G811, 7PCF-GE121, 7PCF-GE161, 7PCF-GE411, 7PC-G121, 7PC-G161, 7PC-G411...(Other models you can see in the webshop)		

			
1			
GEV No.	100907	Ref. No.	1891700
description	screw connection thread M10x1 Qty 1 pcs type SEF 1 ømm for thermocouple		
For models:	CFG120, OCFG120, OFTG40B, OFTG-40B-12600130, OFTG40BLC, OFTG-40BLC-12600135, OFTG40BR, OFTG-40BR-12600132, OFTG60B, OFTG-60B-12600140, OFTG60BLC, OFTG-60BLC-12600145, OFTG-60BR, OFTG-60BR-12600141, OFTG60BRR, OFTG-60BRR-12600142, OFTG80BLC, OFTG-80BLC-12600138		

			
1			
GEV No.	106597	Ref. No.	866000
description	union screw thread 3/4" for pipe ø 18mm L 20mm Qty 1 pcs WS 27		
For models:	CPE60, CPE60DB, FQG40, FQG41, FQG60, FQG61, OBME41M, OBME61M, OCPPE60, OCPPE-60-12601900, OCPPE-60-12601900MN, OFQG41, OFQG-41-12600500, OFQG61, OFQG-61-12600600		

			
1			
GEV No.	100908	Ref. No.	673500 6A016110 6A017000 BN6A016110 BN6A017000 MA673500
description	union screw thread M10x1 for pipe ø 4mm Qty 1 pcs		
For models:	110-135CGG, 110-135CGG2P, 110-135CGGE, 110-135CGGE2P, 110-135CGGEP, 110-135CGGP, 110-45CBG, 110-45TCBG, 110-90CCGG, 110-90CCGP, 110-90CTG, 110-90CTGE, 110-90CTGG, 110-90FTTG, 110-90FTTG1-2R, 110-90FTTGC, 110-90FTTGC1-2R, 110-90FTTGC2R, 110-90FTTGE, 110-90FTTGG, 110-90FTTGR, 110-90FTTGT, 110-90FTTGT1-2R, 110-90FTTGC, 110-90FTTGC1-2R, 110-90FTTGC2R, 110-90FTTGR, 2FX+PCF, 40SGFR-1826160, 40SGFR2S-1826160, 40SGFT-1825020, 40SGFTC-1825025, 40SGFTR-1825021, 4FX, 4FX+PCF, 55-45CPG, 55-45FRG, 55-90CPG, 55-90FRG, 60SGFR-1826170, 60SGFR2S-1826170, 60SGFT1-2R-1825031, 60SGFT-1825030, 60SGFTC-1825035, 60SGFTR-1825032, 72+2CTGG-12700013, 72-02CBG, 72-02CBG-12700150...(Other models you can see in the webshop)		
accessories for	100908		
	GEV No.	100897	Ref. No. 1881000 1888100 22450050 MA1888100
olive for pipe ø 4mm Qty 1 pcs for pilot burner			
	GEV No.	101246	Ref. No. 673600 6A016120 A016120 MA673600
olive for pipe ø 4mm Qty 1 pcs			
	GEV No.	101280	Ref. No. —
olive for pipe ø 4mm Qty 1 pcs			
	GEV No.	101282	Ref. No. 469000
olive for pipe ø 4mm L 7.4mm Qty 1 pcs			

			
1			
GEV No.	101283	Ref. No.	468800
description	union screw thread M10x1 for pipe ø 4mm Qty 1 pcs		
For models:	FQG40, FQG60, FTG40B, FTG40BLC, FTG60B, FTG60BLC, FTG60BR, FTG80B, FTG80BR, OFTG40B, OFTG40BLC, OFTG60B, OFTG60BLC, OFTG60BR, OFTG80B, OFTG80BR		
accessories for	101283		
	GEV No.	101282	Ref. No. 469000
olive for pipe ø 4mm L 7.4mm Qty 1 pcs			

			
1			
GEV No.	103237	Ref. No.	459500 MA459500
description	union screw thread M14x1.5 for pipe ø 10mm Qty 1 pcs		
For models:	FQG40, FQG60, OFTG40B, OFTG-40B-12600130, OFTG40BLC, OFTG-40BLC-12600135, OFTG40BR, OFTG-40BR-12600132, OFTG60B, OFTG-60B-12600140, OFTG60BLC, OFTG-60BLC-12600145, OFTG-60BR, OFTG-60BR-12600141, OFTG60BRR, OFTG-60BRR-12600142, OFTG80BLC, OFTG-80BLC-12600138		

pressure switches

			
1			
GEV No.	541073	Ref. No.	R63070010
description	pressure control ø 45mm pressure range adjustable 5-20mbar pressure connection vertical gas technology connection 1/4" pressure connection ø 1/4"mm		
For models:	CCG051M, CCG071M, CCG101M, CCG102M, CKGP06, CKGP06B, CKGP10, CKGP10B, CKGP20, CKGP20B, CKGP21, CKGP21B, CKGP40, CKGP40B, CKGT06, CKGT06B, CKGT10, CKGT10B, CKGT20, CKGT20B, CKGT21, CKGT21B, CKGT40, CKGT40B		





consumables

thread sealants

			
1			
GEV No.	890135	Ref. No.	Loctite 511
description	thread sealing LOCTITE 511 tube 50ml approval DVGW		
description	LOCTITE® 511™ - tube 50ml It is designed for the locking and sealing of metal threaded pipes and fittings. The product cures rapidly when confined in the absence of air between close fitting metal surfaces.		
For models:	OLAX151, OLAX151EDX-1080725, OLAX151ELEFT-1080727, OLAX151-highspeed, OLAX160, OLAX160E-1080750, OLAX160E-1080751, OLAX160V-1080755, OLAX160V-1080756, OLAX160V-1081031, OLAX160V-1081032, OLAX210, OLAX210E-1081029, OLAX210E-1081030, OLAX220, OLAX220E-1080787, OLAX220E-1080788, OLAX220V-1080789, OLAX220V-1080790, OLAX230, OLAX230E-1080791, OLAX230E-1080792, OLAX230V-1080793, OLAX230V-1080794, OLAX240, OLAX240E-1080795, OLAX240E-1080796, OLAX240V-1080797, OLAX240V-1080798, OLAX250, OLAX250E-1080760, OLAX250E-1080761, OLAX250V-1080765, OLAX250V-1080766, OLAX300, OLAX300E-1080770, OLAX300E-1080771, OLAX300E-1081033, OLAX300E-1081035, OLAX300E-1081036, OLAX300LC, OLAX300LCE-1081034, OLAX300V-1080775, OLAX300V-1080776, OLAX310, OLAX310E-1081110, OLAX310E-1081111, OLAX310LC, OLAX310LCE-1081114, OLAX310LCE-1081115...(Other models you can see in the webshop)		

			
1			
GEV No.	890097	Ref. No.	Loctite 577
description	thread sealing LOCTITE 577 medium-strength bottle 50ml pipe thread sealing t.max. 150°C approval BAM and DVGW		
description	LOCTITE® 577™ - bottle 50ml It is designed for the locking and sealing of metal pipes and fittings as well as other cylindrical metal assemblies. The product provides an instant, low-pressure seal for metal pipes and fittings. It will not creep, shrink or block systems by shredding. Suitable for fast application at low temperatures. It has excellent chemical and thermal resistance and offers less migration of liquid product after application to the part.		
For models:	OLAX151, OLAX151EDX-1080725, OLAX151ELEFT-1080727, OLAX151-highspeed, OLAX160, OLAX160E-1080750, OLAX160E-1080751, OLAX160V-1080755, OLAX160V-1080756, OLAX160V-1081031, OLAX160V-1081032, OLAX210, OLAX210E-1081029, OLAX210E-1081030, OLAX220, OLAX220E-1080787, OLAX220E-1080788, OLAX220V-1080789, OLAX220V-1080790, OLAX230, OLAX230E-1080791, OLAX230E-1080792, OLAX230V-1080793, OLAX230V-1080794, OLAX240, OLAX240E-1080795, OLAX240E-1080796, OLAX240V-1080797, OLAX240V-1080798, OLAX250, OLAX250E-1080760, OLAX250E-1080761, OLAX250V-1080765, OLAX250V-1080766, OLAX300, OLAX300E-1080770, OLAX300E-1080771, OLAX300E-1081033, OLAX300E-1081035, OLAX300E-1081036, OLAX300LC, OLAX300LCE-1081034, OLAX300V-1080775, OLAX300V-1080776, OLAX310, OLAX310E-1081110, OLAX310E-1081111, OLAX310LC, OLAX310LCE-1081114, OLAX310LCE-1081115...(Other models you can see in the webshop)		

			
1			
GEV No.	890128	Ref. No.	Loctite 542
description	thread sealing LOCTITE 542 medium-strength bottle 50ml approval DVGW		
description	LOCTITE® 542™ - bottle 50ml It is designed for the locking and sealing of metal pipes and fittings as well as other cylindrical metal assemblies. The product cures when confined in the absence of air between close-fitting metal surfaces and prevents loosening and leakage due to shock and vibration. The thixotropic nature of LOCTITE 542 reduces the migration of liquid product after application to the part.		
For models:	OLAX151, OLAX151EDX-1080725, OLAX151ELEFT-1080727, OLAX151-highspeed, OLAX160, OLAX160E-1080750, OLAX160E-1080751, OLAX160V-1080755, OLAX160V-1080756, OLAX160V-1081031, OLAX160V-1081032, OLAX210, OLAX210E-1081029, OLAX210E-1081030, OLAX220, OLAX220E-1080787, OLAX220E-1080788, OLAX220V-1080789, OLAX220V-1080790, OLAX230, OLAX230E-1080791, OLAX230E-1080792, OLAX230V-1080793, OLAX230V-1080794, OLAX240, OLAX240E-1080795, OLAX240E-1080796, OLAX240V-1080797, OLAX240V-1080798, OLAX250, OLAX250E-1080760, OLAX250E-1080761, OLAX250V-1080765, OLAX250V-1080766, OLAX300, OLAX300E-1080770, OLAX300E-1080771, OLAX300E-1081033, OLAX300E-1081035, OLAX300E-1081036, OLAX300LC, OLAX300LCE-1081034, OLAX300V-1080775, OLAX300V-1080776, OLAX310, OLAX310E-1081110, OLAX310E-1081111, OLAX310LC, OLAX310LCE-1081114, OLAX310LCE-1081115...(Other models you can see in the webshop)		

<p>lava rocks / ceramic briquettes</p> 			
1			
GEV No.	211008	Ref. No.	6A014900 BN6A014900
description	lava rocks size ca.20-70mm Qty 5kg		
For models:	72-02PLG-12700850, 72-02PLG-12700850TA, 72-02TPLG-12730850, 72-02TPLG-12730850TA, 74-02PLG-12700855, 74-02PLG-12700855TA, 74-02TPLG-12730855, 74-02TPLG-12730855TA, 74PL-G-1000940, 74PL-G-1000940R, 74TPLG-1009940, 74TPLG-1009940R, 78PL-G-1000980, 78PL-G-1000980R, 78TPLG-1009980, 78TPLG-1009980R, 7GL-G400, 7GL-G800, 7GLT-G400, 7GLT-G800, 92-04PLG-12900850, 92-04PLG-12900850TA, 92-04TPLG-12930850, 92-04TPLG-12930850TA, 92PLG-1192840, 92TPLG-1191840, 94-04PLG-12900855TA, 94-04TPLG-12930855, 94-04TPLG-12930855TA, 94PLG-1192865, 94TPLG-1191865, 9GL-G400, 9GL-G800, 9TGL-G400, 9TGL-G800		

equipment-specific units

for vegetable slicers

miscellaneous



1

GEV No.	110703	Ref. No.	1829200
description	cylindrical handle thread M10 ø 28mm L 87mm		
For models:	OPLG40, OPLG-40-12600850, OPLG80, OPLG-80-12600855, PLG40, PLG80		

for cheese graters

miscellaneous



1

GEV No.	110703	Ref. No.	1829200
description	cylindrical handle thread M10 ø 28mm L 87mm		
For models:	OPLG40, OPLG-40-12600850, OPLG80, OPLG-80-12600855, PLG40, PLG80		

for cold storage cells

pressure compensation valves



1

GEV No.	750332	Ref. No.	14970302
description	pressure compensation valve mounting ø 61mm MiniElebar T.N. unheated for walk-in fridge +1 up to +10°C built-in depth 60mm mounting pos. horizontal		
For models:	KSABT70G-2045370CJD, ROLL-IN1P-211008120CJE, ROLL-IN1P-211008120CJG, ROLL-IN1PBT-211009120CJF, ROLL-IN2P-211016120CJL, ROLL-IN2P-211016120CJM, ROLL-IN2P-211016220CJN, ROLL-IN2P-211016220CJP, ROLL-IN-2PMTN-211016220CJO, ROLL-IN1P-211008220CJH, ROLL-IN-P1P-211008220CJK, ROLL-IN1PBT-211009220CJI, ROLL-IN1PP-MTN-211008220CJJ		
spare parts for	750332		
	GEV No.	750335	Ref. No. —
	ventilation grille suitable for MiniElebar ø 86mm mounting distance 69.5mm H 14.5mm		

for espresso machines

brewing units

filter holder gaskets

O-rings



1

GEV No.	510409	Ref. No.	13015 R70045010
description	O-ring EPDM thickness 5.34mm ID ø 56.52mm Qty 1 pcs		
For models:	CKEP06B, CKEP10B, CKEP20B, CKEP21, CKEP21B, CKET06B, CKET10B, CKET20B, CKET21, CKET21B, CKGP21, CKGP21B, CKGT21, CKGT21B, G12S, OLAX151, OLAX151EDX-1080725, OLAX151ELEFT-1080727, OLAX151-highspeed, OLAX160, OLAX160E-1080750, OLAX160E-1080751, OLAX160V-1080755, OLAX160V-1080756, OLAX160V-1081031, OLAX160V-1081032, OLAX210, OLAX210E-1081029, OLAX210E-1081030, OLAX220, OLAX220E-1080787, OLAX220E-1080788, OLAX220V-1080789, OLAX220V-1080790, OLAX230, OLAX230E-1080791, OLAX230E-1080792, OLAX230V-1080793, OLAX230V-1080794, OLAX240, OLAX240E-1080795, OLAX240E-1080796, OLAX240V-1080797, OLAX240V-1080798, OLAX250, OLAX250E-1080760, OLAX250E-1080761, OLAX250V-1080765, OLAX250V-1080766, OLAX300...(Other models you can see in the webshop)		

water dispersions

accessories



1

GEV No.	529494	Ref. No.	96115
description	gasket water dispersion		
For models:	OLGRANUL900		

steam/water taps

steam/water pipes

accessories

gaskets



1

GEV No.	510893	Ref. No.	13003
description	O-ring EPDM thickness 2.62mm ID ø 9.92mm Qty 1 pcs		
For models:	G12S, OLDerby, OLDS35, OLDS35-1081005, OLDS35-1081061, OLDS35D-1081062, OLDS35-Neutra, OLDS37, OLDS37-1081006, OLDS37-1081063, OLDS37D-1081007, OLDS37D-1081064, OLDS37LS-1081008, OLDS37LSD-1081009, OLDS37-Neutra, OLDS40, OLDS40-1081010, OLDS40-1081065, OLDS40D-1081011, OLDS40D-1081066, OLDS40E-1081067, OLDS40ED-1081068, OLDS40LS-1081012, OLDS40LSD-1081013, OLDS40-Neutra, OLG35, OLG35-1080702, OLG35D-1081000, OLG35-Neutra, OLG600, OLGastro450, OLG37, OLG37-1080700, OLG37D-1080707, OLG37LS-1081001, OLG37LSD-1081002, OLG37-Neutra, OLG40, OLG40, OLG40-1080701, OLG40D-1080708, OLG40D-1081003, OLG40-Neutra, OLG40LSD-1081004, OLG600, OLG600Electronic, OLHT11-1081071, OLHT11D-1081072, OLHT11ECO-1081070, OLHT-11-Neutra...(Other models you can see in the webshop)		



pipes

union nuts

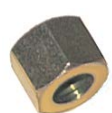

1

GEV No.	101478	Ref. No.	1665200
description	union nut thread 3/8" for pipe ø 10mm		
For models:	CFG101, CFG120, CFG70, OCFG101, OCFG-101-12600025, OCFG120, OCFG70, OCFG-70-12600000, OPGC-41-12600010		

for coffee grinders

grinding burrs

screws



1

GEV No.	560365	Ref. No.	11121
description	flat-headed bolt thread M4 thread L 8mm SS DIN 7985/ISO 7045 Qty 1 pcs intake Phillips head ø 8mm head thickness 3mm		
For models:	OLDS35, OLDS35-1081061, OLDS35D-1081062, OLDS35-Neutra, OLDS37, OLDS37-1081063, OLDS37D-1081064, OLDS37-Neutra, OLDS40, OLDS40-1081065, OLDS40D-1081066, OLDS40E-1081067, OLDS40ED-1081068, OLDS40-Neutra, OLDS45, OLDS50, OLDS50-1081088, OLDS50D-1081089, OLDS50E-1081090, OLDS50ED-1081091, OLDS50-Neutra, OLG35, OLG35-1080702, OLG35D-1081000, OLG35-Neutra, OLG600, OLG35, OLG35-1080700, OLG35D-1080707, OLG35LS-1081001, OLG35LSD-1081002, OLG35-Neutra, OLG35, OLG35-1080701, OLG35D-1080708, OLG35D-1081003, OLG35-Neutra, OLG35, OLG35-1080705, OLG35D-1080706, OLG35E-1080730, OLG35ECO-1081014, OLG35ECOD-1081015, OLG35ED-1080731, OLG35-Neutra, OLH600, OLH600Electronic...(Other models you can see in the webshop)		

for pyroceram ranges

ceramic hobs

ceramic glass plates



1

GEV No.	691407	Ref. No.	6A001400 BN6A001400
description	ceramic plate L 550mm W 320mm thickness 6mm		
For models:	72-02TVTC, 72-02TVTCV, 72-02TVTCV-12731005, 72-02VTC, 72-02VTCV, 72-02VTG-12701005, 74-02TVTC, 74-02TVTCV, 74-02TVTCV-12731006, 74-02VTC, 74-02VTCE, 74-02VTCEV, 74-02VTCEV-12701020, 74-02VTCV, 74-02VTCV-12701006, 7NPCF-VCE800, 7NPC-VCE400, 7NPC-VCE800, 7NPCVP-VCE400, 7NPCVP-VCE800, 7NPCV-VCE400, 7NPCV-VCE800		

for griddles

housing and bezels



1

GEV No.	691349	Ref. No.	1044314900
description	spraying protection L 520mm W 390mm H 75mm		
For models:	FTE40B, FTE40BR, FTE40C, FTE40D, FTE40DC, OFTE40B, OFTE-40B-12601130, OFTE-40B-12601130MN, OFTE40BR, OFTE-40BR-12601132, OFTE-40BR-12601132MN, OFTE40C, OFTE-40C-12601135, OFTE-40C-12601135MN, OFTG40B, OFTG-40B-12600130, OFTG40BLC, OFTG-40BLC-12600135, OFTG40BR, OFTG-40BR-12600132		



1

GEV No.	691350	Ref. No.	1044315000
description	spraying protection L 520mm W 590mm H 75mm		
For models:	FTE60B, FTE60BR, FTE60C, FTE60D, FTE60DC, FTE60DR, FTE60DRCL, OFTE60B, OFTE-60B-12601140, OFTE-60B-12601140MN, OFTE60BR, OFTE-60BR-12601141, OFTE-60BR-12601141MN, OFTE60BRR, OFTE-60BRR-12601142, OFTE-60BRR-12601142MN, OFTE60C, OFTE-60C-12601145, OFTE-60C-12601145MN, OFTG60B, OFTG-60B-12600140, OFTG60BLC, OFTG-60BLC-12600145, OFTG60BR, OFTG-60BR-12600141, OFTG60BRR, OFTG-60BRR-12600142		



1

GEV No.	691351	Ref. No.	1044320700
description	spraying protection L 520mm W 790mm H 75mm		
For models:	OFTG80BLC, OFTG-80BLC-12600138		



1

GEV No.	691454	Ref. No.	2515000 BN2515000
description	outflow plug ø 62mm L 130mm		
For models:	72-02KBEF, 72-02KBEF-12701127, 74-02KBEF, 74-02KBEF-12701128, 7BRF-E405, 7BRF-E805		

drain stoppers



1

GEV No.	691331	Ref. No.	MA97313000
description	outflow plug for grease drain flange 30x70mm H 100mm		
For models:	FTE100B, FTE100BR, FTE100CRL, FTE40B, FTE40BR, FTE40C, FTE40D, FTE40DC, FTE60B, FTE60BR, FTE60C, FTE60D, FTE60DC, FTE60DR, FTE60DRCL, FTG40B, FTG40BLC, FTG60B, FTG60BLC, FTG60BR, FTG80B, FTG80BR, OFTE-100C-12601136, OFTE-100C-12601136MN, OFTE100CRL, OFTE-100CRL-12601138, OFTE40B, OFTE-40B-12601130, OFTE-40B-12601130MN, OFTE40BR, OFTE-40BR-12601132, OFTE-40BR-12601132MN, OFTE40C, OFTE-40C-12601135, OFTE-40C-12601135MN, OFTE60B, OFTE-60B-12601140, OFTE-60B-12601140MN, OFTE60BR, OFTE-60BR-12601141, OFTE-60BR-12601141MN, OFTE60BRR, OFTE-60BRR-12601142, OFTE-60BRR-12601142MN, OFTE60C, OFTE-60C-12601145, OFTE-60C-12601145MN, OFTG40B, OFTG-40B-12600130, OFTG40BLC...(Other models you can see in the webshop)		



1

GEV No.	691330	Ref. No.	1033705600
description	outflow plug for grease drain ø 32mm L 50mm ID ø 17.8mm ED ø 25.5mm		
For models:	FTE100B, FTE100BR, FTE100CRL, FTE40B, FTE40BR, FTE40C, FTE40D, FTE40DC, FTE60B, FTE60BR, FTE60C, FTE60D, FTE60DC, FTE60DR, FTE60DRCL, FTG40B, FTG40BLC, FTG60B, FTG60BLC, FTG60BR, FTG80B, FTG80BR, OFTE-100C-12601136, OFTE-100C-12601136MN, OFTE100CRL, OFTE-100CRL-12601138, OFTE40B, OFTE-40B-12601130, OFTE-40B-12601130MN, OFTE40BR, OFTE-40BR-12601132, OFTE-40BR-12601132MN, OFTE40C, OFTE-40C-12601135, OFTE-40C-12601135MN, OFTE60B, OFTE-60B-12601140, OFTE-60B-12601140MN, OFTE60BR, OFTE-60BR-12601141, OFTE-60BR-12601141MN, OFTE60BRR, OFTE-60BRR-12601142, OFTE-60BRR-12601142MN, OFTE60C, OFTE-60C-12601145, OFTE-60C-12601145MN, OFTG40B, OFTG-40B-12600130, OFTG40BLC...(Other models you can see in the webshop)		

for convection ovens/combi-steamers

drain units

drip rails



1

GEV No.	691961	Ref. No.	R69180000
description	drain unit L 90mm edition since 2009		
For models:	CKEP06, CKEP06B, CKEP10, CKEP10B, CKEP20, CKEP20B, CKET06, CKET06B, CKET10, CKET10B, CKET20, CKET20B, CKGP06, CKGP06B, CKGP10, CKGP10B, CKGP20, CKGP20B, CKGT06, CKGT06B, CKGT10, CKGT10B, CKGT20B		



1

GEV No.	692807	Ref. No.	R69180170
description	drip rail with screw connection L 750mm plastic W 70mm for combi-steamer		
For models:	CKEP20, CKEP20B, CKET20, CKET20B, CKGP20, CKGP20B, CKGT20, CKGT20B		



injection nozzles



GEV No.	691278	Ref. No.	R58006130
description	injection nozzle bore \varnothing 1mm for combi-steamer		
For models:	CKEP06, CKEP06B, CKEP10, CKEP10B, CKEP20, CKEP20B, CKEP21, CKEP21B, CKEP40, CKEP40B, CKET06, CKET06B, CKET10, CKET10B, CKET20, CKET20B, CKET21, CKET21B, CKET40, CKET40B, CKGP06, CKGP06B, CKGP10, CKGP10B, CKGP20, CKGP20B, CKGP21, CKGP21B, CKGP40, CKGP40B, CKGT06, CKGT06B, CKGT10, CKGT10B, CKGT20, CKGT20B, CKGT21, CKGT21B, CKGT40, CKGT40B		

injection pipes



GEV No.	692821	Ref. No.	R18200540
description	injection pipe for combi-steamer H 75mm ED \varnothing 8mm ID \varnothing 6mm L 105mm		
For models:	CCE042M, CCE051M, CCG051M		



GEV No.	692832	Ref. No.	R11201990
description	injection pipe for combi-steamer U-shape ED \varnothing 8mm ID \varnothing 6mm		
For models:	CCG101M, CCG102M, CKEP21, CKEP21B, CKEP40, CKEP40B, CKET21, CKET21B, CKET40, CKET40B, CKGP20, CKGP20B, CKGP21, CKGP21B, CKGP40, CKGP40B, CKGT20, CKGT20B, CKGT21, CKGT21B, CKGT40, CKGT40B		



GEV No.	692820	Ref. No.	R11200650
description	injection pipe with holder for combi-steamer ED \varnothing 8mm ID \varnothing 6mm L 150mm H 75mm		
For models:	CCE071M, CCG071M, CKEP06, CKEP06B, CKET06, CKET06B, CKGP06, CKGP06B, CKGT06, CKGT06B		

spare parts and accessories



GEV No.	692835	Ref. No.	R58003110
description	pin for air baffle combi-steamer L 38mm \varnothing 7mm		
For models:	CKEP06, CKEP06B, CKEP10, CKEP10B, CKEP21, CKEP21B, CKET06, CKET06B, CKET10, CKET10B, CKET21, CKET21B, CKGP06, CKGP06B, CKGP10, CKGP10B, CKGP21, CKGP21B, CKGT06, CKGT06B, CKGT10, CKGT10B, CKGT21, CKGT21B		

filters



GEV No.	691269	Ref. No.	R18200260
description	drain filter \varnothing 43mm		
For models:	CCE042M		



GEV No.	691270	Ref. No.	R10201700
description	drain filter \varnothing 76mm		
For models:	CCE071M, CCG071M, CKEP06, CKEP06B, CKEP10, CKEP10B, CKEP20, CKEP20B, CKEP21, CKEP21B, CKET06, CKET06B, CKET10, CKET10B, CKET20, CKET20B, CKET21, CKET21B, CKGP06, CKGP06B, CKGP10, CKGP10B, CKGP20, CKGP20B, CKGT06, CKGT06B, CKGT10, CKGT10B, CKGT20, CKGT20B		



GEV No.	691271	Ref. No.	R10201710
description	drain filter \varnothing 87mm		
For models:	CCE101M, CCE102M, CCG101M, CCG102M, CKEP40, CKEP40B, CKET40, CKET40B, CKGP21, CKGP21B, CKGP40, CKGP40B, CKGT21, CKGT21B, CKGT40, CKGT40B		

glass panels

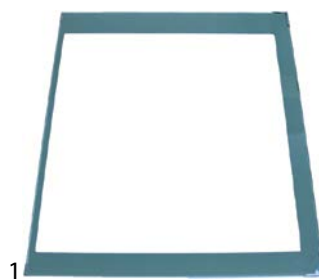

GEV No.	696396	Ref. No.	R11100140
description	glass panel L 860mm W 730mm thickness 6mm mounting pos. inner for combi-steamer		
For models:	CKEP20, CKEP20B, CKET20, CKET20B, CKGP20, CKGP20B, CKGT20B		

cleaning system

cleaning arms



GEV No.	542409	Ref. No.	R58007020
description	mounting flange with gasket for wash arm suitable for LAINOX combi-steamer		
For models:	CKEP06, CKEP06B, CKEP10, CKEP10B, CKEP20, CKEP20B, CKEP21, CKEP21B, CKEP40, CKEP40B, CKET06, CKET06B, CKET10, CKET10B, CKET20, CKET20B, CKET21, CKET21B, CKET40, CKET40B, CKGP06, CKGP06B, CKGP10, CKGP10B, CKGP20, CKGP20B, CKGP21, CKGP21B, CKGP40, CKGP40B, CKGT06, CKGT06B, CKGT10, CKGT10B, CKGT20, CKGT20B, CKGT21, CKGT21B, CKGT40, CKGT40B		

pipes



GEV No.	520970	Ref. No.	R62180022
description	drain pipe flexible L 135mm ID ø 18mm ED ø 27.5mm connection 3/4" ET - 3/4" IT SS for combi-steamer		
For models:	CKGP06B, CKGP10, CKGP10B, CKGP20B, CKGP21B, CKGP40B, CKGT06B, CKGT10, CKGT10B, CKGT20B, CKGT21B, CKGT40B		

hoses



GEV No.	530904	Ref. No.	R77700056
description	hose ID ø 30mm ED ø 36mm L 3000mm for combi-steamer		
For models:	CCG051M, CCG071M, CCG101M, CCG102M, CKGP06, CKGP06B, CKGP10, CKGP10B, CKGP20, CKGP20B, CKGP21, CKGP21B, CKGP40, CKGP40B, CKGT06, CKGT06B, CKGT10, CKGT10B, CKGT20, CKGT20B, CKGT21, CKGT21B, CKGT40, CKGT40B		



GEV No.	520534	Ref. No.	R70060040
description	hose ID ø 50mm ED ø 58mm L 50mm silicone Qty 1 for combi-steamer thickness 4mm		
For models:	CKEP06, CKEP06B, CKEP10, CKEP10B, CKEP20, CKEP20B, CKEP21, CKEP21B, CKEP40, CKEP40B, CKET06, CKET06B, CKET10, CKET10B, CKET20, CKET20B, CKET21, CKET21B, CKET40, CKET40B, CKGP06, CKGP06B, CKGP10, CKGP10B, CKGP20, CKGP20B, CKGP21, CKGP21B, CKGP40, CKGP40B, CKGT06, CKGT06B, CKGT10, CKGT10B, CKGT20, CKGT20B, CKGT21, CKGT21B, CKGT40, CKGT40B		



GEV No.	530901	Ref. No.	R70060050
description	hose ID ø 54mm ED ø 60mm L 50mm for combi-steamer		
For models:	CKEP20, CKEP20B, CKEP40, CKEP40B, CKET20, CKET20B, CKET40, CKET40B, CKGP40, CKGP40B, CKGT40, CKGT40B		

service kits



GEV No.	699468	Ref. No.	R58003100
description	mounting set for air baffle 4-piece		
For models:	CKEP20, CKEP20B, CKEP40, CKEP40B, CKET20, CKET20B, CKET40, CKET40B, CKGP20, CKGP20B, CKGP40, CKGP40B, CKGT20, CKGT20B, CKGT40, CKGT40B		

drip water trays



GEV No.	699854	Ref. No.	R69180190
description	drip tray L 520mm W 35mm H 70mm		
For models:	CKEP06, CKEP06B, CKEP10, CKEP10B, CKET06, CKET06B, CKET10, CKET10B, CKGP06, CKGP06B, CKGP10, CKGP10B, CKGT06, CKGT06B, CKGT10, CKGT10B		



GEV No.	699242	Ref. No.	R69180200
description	drip tray L 576mm W 32mm H 51mm		
For models:	CKEP06, CKEP06B, CKEP10, CKEP10B, CKET06, CKET06B, CKET10, CKET10B, CKGP06, CKGP06B, CKGP10, CKGP10B, CKGT06, CKGT06B, CKGT10, CKGT10B		



doors



1

GEV No.	697863	Ref. No.	3106355 BN3106355
description	locking screw for oven door		
For models:	CMV6ES2-1320392, CV10E, CV10E-1320100, CV10E-1320110, CV10E-2, CV10E2-1320140, CV10EB-1321100, CV10E-S, CV10ES-1320150, CV10E-S2, CV10ES2-1320190, CV10G, CV10G-1310100, CV10G-2, CV10G2-1310140, CV10GB-1311100, CV10G-S, CV10GS-1310150, CV10G-S2, CV10GS2-1310190, CV20E, CV20E-1320200, CV20E-2, CV20E2-1320240, CV20EB-1321200, CV20E-S, CV20ES-1320250, CV20E-S2, CV20ES2-1320290, CV20G, CV20G-1310200, CV20G-2, CV20G2-1310240, CV20GB-1311200, CV20G-S, CV20GS-1310250, CV20G-S2, CV20GS2-1310290, CV21E, CV21E-1322100, CV21E-2, CV21E2-1322140, CV21E-S, CV21ES-1322150, CV21E-S2, CV21ES2-1322190, CV21G, CV21G-1312100, CV21G-2, CV21G2-1312140...(Other models you can see in the webshop)		



1

GEV No.	691298	Ref. No.	R18100000
description	oven door complete		
For models:	CCE042M		



1

GEV No.	692836	Ref. No.	R11401360
description	protective plate lower for glass plate combi-steamer H 8mm W 8mm		
For models:	CKEP06, CKEP06B, CKEP10, CKEP10B, CKEP20, CKEP20B, CKET06, CKET06B, CKET10, CKET10B, CKET20, CKET20B, CKGP06, CKGP06B, CKGP10, CKGP10B, CKGP20, CKGP20B, CKGT06, CKGT06B, CKGT10, CKGT10B, CKGT20B		



1

GEV No.	692837	Ref. No.	R11401340
description	protective plate upper for glass plate combi-steamer H 8mm W 8mm		
For models:	CCE071M, CCE101M, CCE102M, CCG071M, CCG101M, CCG102M, CKEP06, CKEP06B, CKEP10, CKEP10B, CKEP20, CKEP20B, CKET06, CKET06B, CKET10, CKET10B, CKET20, CKET20B, CKGP06, CKGP06B, CKGP10, CKGP10B, CKGP20, CKGP20B, CKGT06, CKGT06B, CKGT10, CKGT10B, CKGT20B		

door mechanics

holders



1

GEV No.	691272	Ref. No.	R18203910
description	bracket for glass plate mounting pos. lower		
For models:	CCE071M, CCE101M, CCE102M, CCG071M, CCG101M, CCG102M		



1

GEV No.	691273	Ref. No.	R18203920
description	bracket for glass plate mounting pos. upper		
For models:	CCE071M, CCE101M, CCE102M, CCG071M, CCG101M, CCG102M		

accessories



1

GEV No.	692834	Ref. No.	R10207680
description	fixing plate for door W 30mm L 50mm		
For models:	CKEP21, CKEP21B, CKEP40, CKEP40B, CKET21, CKET21B, CKET40, CKET40B, CKGP21, CKGP21B, CKGP40, CKGP40B, CKGT21, CKGT21B, CKGT40, CKGT40B		

vibration pumps

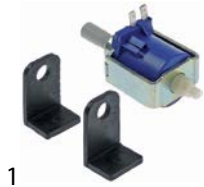

1

GEV No.	500568	Ref. No.	R65110600
description	vibration pump 230V 32W 50Hz inlet \varnothing 7 outlet \varnothing 1/8" IT CEME type E512/A32		
For models:	CKEP06, CKEP06B, CKEP10, CKEP10B, CKEP20, CKEP20B, CKEP21, CKEP21B, CKEP40, CKEP40B, CKET06, CKET06B, CKET10, CKET10B, CKET20, CKET20B, CKET21, CKET21B, CKET40, CKET40B, CKGP06, CKGP06B, CKGP10, CKGP10B, CKGP20, CKGP20B, CKGP21, CKGP21B, CKGP40, CKGP40B, CKGT06, CKGT06B, CKGT10, CKGT10B, CKGT20, CKGT20B, CKGT21, CKGT21B, CKGT40, CKGT40B		
spare parts for	500568		
		GEV No.	390698
		Ref. No.	—
	thermal fuse switch-off temp. 110°C suitable for ULKA pump		

heat exchangers



1

GEV No.	520509	Ref. No.	R58004170
description	reducing washer gas burner brass ID \varnothing 3mm ED \varnothing 16mm thickness 2.2mm code 3		
For models:	CCG051M, CCG071M, CKGP06, CKGP06B, CKGT06, CKGT06B		

miscellaneous



1

GEV No.	696428	Ref. No.	R11201970
description	extension U-shape for injection pipe D1 \varnothing 8mm D2 \varnothing 10mm L 212mm WS 12 stainless steel		
For models:	CCE101M, CCE102M, CKEP10, CKEP10B, CKEP20, CKEP20B, CKET10, CKET10B, CKET20, CKET20B, CKGP10, CKGP10B, CKGT10, CKGT10B		

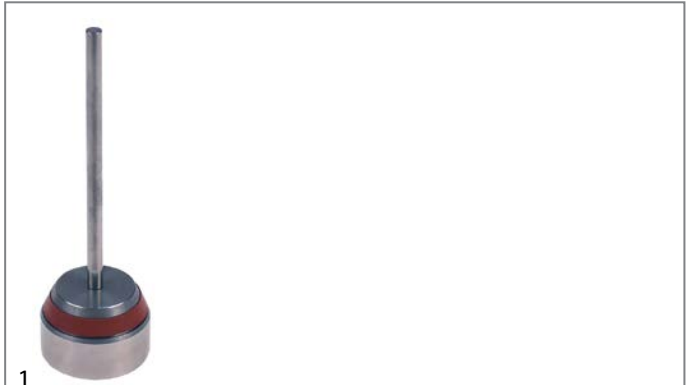

1

GEV No.	691290	Ref. No.	R10100140
description	extractor stubs complete		
For models:	CKEP06, CKEP06B, CKEP10, CKEP10B, CKEP20, CKEP20B, CKEP21, CKEP21B, CKET06, CKET06B, CKET10, CKET10B, CKET20, CKET20B, CKET21, CKET21B, CKGP06, CKGP06B, CKGP10, CKGP10B, CKGP20, CKGP20B, CKGT06, CKGT06B, CKGT10, CKGT10B, CKGT20, CKGT20B		



1

GEV No.	691282	Ref. No.	R58005350
description	gasket for door handle D1 \varnothing 30mm D2 \varnothing 18mm mounting pos. upper H 1.4mm		
For models:	CCE042M, CCE051M, CCE071M, CCE101M, CCE102M, CCG051M, CCG071M, CCG101M, CCG102M		



1

GEV No.	691291	Ref. No.	R70060020
description	gasket for extractor stubs D1 \varnothing 30mm D2 \varnothing 35mm W 9mm		
For models:	CKEP06, CKEP06B, CKEP10, CKEP10B, CKEP20, CKEP20B, CKEP21, CKEP21B, CKET06, CKET06B, CKET10, CKET10B, CKET20, CKET20B, CKET21, CKET21B, CKGP06, CKGP06B, CKGP10, CKGP10B, CKGP20, CKGP20B, CKGT06, CKGT06B, CKGT10, CKGT10B, CKGT20, CKGT20B		



1

GEV No.	690762	Ref. No.	R69180180
description	gutter for inner door L 790mm plastic W 34mm with screws		
For models:	CKEP20, CKEP20B, CKET20, CKET20B, CKGP20, CKGP20B, CKGT20B		





 <p>1</p>			
GEV No.	690099	Ref. No.	R58002150
description	hinge pin mounting pos. upper for door		
For models:	CCE071M, CCE101M, CCE102M, CCG071M, CCG101M, CCG102M, CKEP06, CKEP06B, CKEP10, CKEP10B, CKEP20, CKEP20B, CKEP21, CKEP21B, CKEP40, CKEP40B, CKET06, CKET06B, CKET10, CKET10B, CKET20, CKET20B, CKET21, CKET21B, CKET40, CKET40B, CKGP06, CKGP06B, CKGP10, CKGP10B, CKGP20, CKGP20B, CKGP21, CKGP21B, CKGP40, CKGP40B, CKGT06, CKGT06B, CKGT10, CKGT10B, CKGT20B, CKGT21, CKGT21B, CKGT40, CKGT40B		

 <p>1</p>			
GEV No.	696547	Ref. No.	R11202270
description	injection pipe angled for combi-steamer D1 ø 10mm D2 ø 8mm L 170mm		
For models:	CCE071M, CCE101M, CCE102M, CCG071M, CCG101M, CCG102M, CKEP20, CKEP20B, CKEP21, CKEP21B, CKEP40, CKEP40B, CKET20, CKET20B, CKET21, CKET21B, CKET40, CKET40B, CKGP20, CKGP20B, CKGP21, CKGP21B, CKGP40, CKGP40B, CKGT20, CKGT20B, CKGT21, CKGT21B, CKGT40, CKGT40B		

 <p>1</p>			
GEV No.	506229	Ref. No.	R11200380
description	injection pipe for combi-steamer L 205mm ø 10mm		
For models:	CKEP06, CKEP06B, CKEP10, CKEP10B, CKET06, CKET06B, CKET10, CKET10B, CKGP06, CKGP06B, CKGP10, CKGP10B, CKGT06, CKGT06B, CKGT10, CKGT10B		

 <p>1</p>			
GEV No.	691289	Ref. No.	R58004830
description	nut thread M18x1 H 5mm WS 22 brass Qty 1 pcs for door handle		
For models:	CCE042M, CCE051M, CCE071M, CCE101M, CCE102M, CCG051M, CCG071M, CCG101M, CCG102M		

 <p>1</p>			
GEV No.	691296	Ref. No.	R61400052
description	plain washer ID ø 10.5mm ED ø 21mm thickness 2mm SS Qty 1 pcs for fan wheel		
For models:	CCE071M, CCG071M, CKEP06, CKEP06B, CKET06, CKET06B, CKGP06, CKGP06B, CKGT06, CKGT06B		

 <p>1</p>			
GEV No.	691292	Ref. No.	R10401710
description	plain washer ID ø 12mm ED ø 17.5mm thickness 1mm SS Qty 1 pcs		
For models:	CCE071M, CCE101M, CCE102M, CCG071M, CCG101M, CCG102M, CKEP06, CKEP06B, CKEP10, CKEP10B, CKEP20, CKEP20B, CKET06, CKET06B, CKET10, CKET10B, CKET20, CKET20B, CKGP06, CKGP06B, CKGP10, CKGP10B, CKGP20, CKGP20B, CKGT06, CKGT06B, CKGT10, CKGT10B, CKGT20B		

 <p>1</p>			
GEV No.	691283	Ref. No.	R58003240
description	pressure bolt for door handle D1 ø 8mm D2 ø 11mm L 73mm thread M6 bolt 16mm bolt ø 5mm		
For models:	CCE042M, CCE051M, CCE071M, CCE101M, CCE102M, CCG051M, CCG071M, CCG101M, CCG102M		

 <p>1</p>			
GEV No.	691297	Ref. No.	R62030118
description	reducer thread 1/4 / 1/8		
For models:	CKEP06, CKEP10, CKEP20, CKEP21, CKEP40, CKET06, CKET10, CKET20, CKET21, CKET40, CKGP06, CKGP10, CKGP20, CKGP21, CKGP40, CKGT06, CKGT10, CKGT20, CKGT21, CKGT40		

 <p>1</p>			
GEV No.	691280	Ref. No.	R58005340
description	sealing disc for door handle mounting pos. lower ED ø 25mm ID ø 5.5mm H 5mm		
For models:	CCE042M, CCE051M, CCE071M, CCE101M, CCE102M, CCG051M, CCG071M, CCG101M, CCG102M		

 <p>1</p>			
GEV No.	691281	Ref. No.	R58004270
description	spacer piece for door handle L 34mm ID ø 6mm ED ø 8mm		
For models:	CCE042M, CCE051M, CCE071M, CCE101M, CCE102M, CCG051M, CCG071M, CCG101M, CCG102M		

			
1			
GEV No.	692300	Ref. No.	LAR70050100
description	stopper with screw connection for glass plate D1 ø 15mm L 8mm thread M4		
For models:	CCE071M, CCE101M, CCE102M, CCG071M, CCG101M, CCG102M, CKEP06, CKEP06B, CKEP10, CKEP10B, CKEP20, CKEP20B, CKEP21, CKEP21B, CKEP40, CKEP40B, CKET06, CKET06B, CKET10, CKET10B, CKET20, CKET20B, CKET21, CKET21B, CKET40, CKET40B, CKGP06, CKGP06B, CKGP10, CKGP10B, CKGP20, CKGP20B, CKGP21, CKGP21B, CKGP40, CKGP40B, CKGT06, CKGT06B, CKGT10, CKGT10B, CKGT20B, CKGT21, CKGT21B, CKGT40, CKGT40B		

for tilting bratt pans

gearboxes

			
1			
GEV No.	691411	Ref. No.	2510632 2518600 BN2518600
description	gearbox motor shaft ø 9mm flange ø 70mm transmission 1/28 drive shaft ø 14mm		
For models:	725KBEM-000200, 725KBEM-1000210, 725KB-EM-1000210R, 725KB-EMB-1000211, 725KBEMB-1000211, 725KBGM-000120, 725KB-GM-1000120, 725KB-GM-1000120R, 725KB-GMB-1000121, 725KB-GMB-1000121R, 74-02KBEMB, 74-02KBEMB-12701120, 74-02KBEMBI, 74-02KBEMBI-12701125, 74-02KBEMBI-12701125HB, 74-02KBGMB, 74-02KBGMB-12700120, 74-02KBGMBI, 74-02KBGMBI-12700125, 94-04KBEM, 94-04KBEM-12901125, 94-04KBEM-12901125BN, 94-04KBEM-12901128, 94-04KBGM, 94-04KBGM-12900125, 94-04KBGM-12900125TA, 94-04KBGM-12900128, 94-04KBGM-12900128TA, 9BR-EM80, 9BR-G80, 9BR-G81, 9BR-GM80		

motors

			
1			
GEV No.	601463	Ref. No.	2510631 BN2510631
description	motor 90W 230V 50Hz 1 phase shaft ø 9mm flange ø 80mm 1300rpm type AMM56ZAA4 ø 110mm H 150mm L 170mm Lafert 0.09kW		
For models:	725KBEM-000200, 725KBEM-1000210, 725KB-EM-1000210R, 725KB-EMB-1000211, 725KBEMB-1000211, 725KBGM-000120, 725KB-GM-1000120, 725KB-GM-1000120R, 725KB-GMB-1000121, 725KB-GMB-1000121R, 74-02KBEMB, 74-02KBEMB-12701120, 74-02KBEMBI, 74-02KBEMBI-12701125, 74-02KBEMBI-12701125HB, 74-02KBGMB, 74-02KBGMB-12700120, 74-02KBGMBI, 74-02KBGMBI-12700125, 94-04KBEM, 94-04KBEM-12901125, 94-04KBEM-12901125BN, 94-04KBEM-12901128, 94-04KBGM, 94-04KBGM-12900125, 94-04KBGM-12900125TA, 94-04KBGM-12900128, 94-04KBGM-12900128TA, 9BR-EM80, 9BR-G80, 9BR-G81, 9BR-GM80		

spindles

			
1			
GEV No.	691448	Ref. No.	2934500 BN2934500
description	bush ø 25mm		
For models:	74-02KBEB, 74-02KBEB-12701110, 74-02KBEBI, 74-02KBEBI-12701115, 74-02KBEMB, 74-02KBEMB-12701120, 74-02KBEMBI, 74-02KBEMBI-12701125, 74-02KBEMBI-12701125HB, 74-02KBGB, 74-02KBGB-12700110, 74-02KBGBI, 74-02KBGBI-12700115, 74-02KBGMB, 74-02KBGMB-12700120, 74-02KBGMBI, 74-02KBGMBI-12700125, 94-04KBE-12901115, 94-04KBE-12901115BN, 94-04KBE-12901118, 94-04KBEM-12901125, 94-04KBEM-12901125BN, 94-04KBEM-12901128, 94-04KBG-12900115, 94-04KBG-12900115TA, 94-04KBG-12900118, 94-04KBG-12900118TA, 94-04KBGM-12900125, 94-04KBGM-12900125TA, 94-04KBGM-12900128, 94-04KBGM-12900128TA, 94KBEM-1192880, 94KBGM-1191880, 94RKBE-1392880, 94RKBM-1391880		

			
1			
GEV No.	693158	Ref. No.	2931100 BN2931100
description	threaded rod		
For models:	94-04KBE-12901115, 94-04KBE-12901115BN, 94-04KBE-12901118, 94-04KBG-12900115, 94-04KBG-12900115TA, 94-04KBG-12900118, 94-04KBG-12900118TA, 94KBE, 94KBE-1192870, 94KBG-1191870, 94RKBE-1392870, 94RKBG-1391870		



miscellaneous



1			
GEV No.	691352	Ref. No.	1041724100
description	stockpot L 650mm W 350mm H 95mm		
For models:	BRE40, BRE40D, BRE40DB, BRE40DG, BRE40DGB, BRE40G, OBRE40, OBRE-40-12601110, OBRE-40-12601110MN		



1			
GEV No.	693321	Ref. No.	2160162 822160162 BN822160162
description	threaded bush		
For models:	7BR-E100, 7BR-E105, 7BR-G100, 7BR-G105, 7BRS-E100, 7BRS-E105, 7BRS-G100, 7BRS-G105, 96-04KBEC, 96-04KBGC, 96-04KBGC-12900105, 96-04KBGC-12900105TA, 9BR-E100, 9BR-E105, 9BR-E125, 9BR-G100, 9BR-G105, 9BR-G125, 9BRS-E100, 9BRS-E105		



1			
GEV No.	693154	Ref. No.	2510076 BN2510076
description	threaded bush for tilting bratt pan		
For models:	725KB-E-1000200, 725KBE-1000200, 725KB-E-1000200R, 725KB-EB-1000201, 725KBEB-1000201, 725KB-EB-1000201R, 725KBEM-000200, 725KBEM-1000210, 725KB-EM-1000210R, 725KB-EMB-1000211, 725KBEMB-1000211, 725KB-G-1000110, 725KBG-1000110, 725KB-G-1000110R, 725KB-GB-1000111, 725KB-GB-1000111R, 725KBGM-000120, 725KB-GM-1000120, 725KB-GM-1000120R, 725KB-GMB-1000121, 725KB-GMB-1000121R, 74-02KBEB-12701110, 74-02KBEBI-12701115, 74-02KBEMB-12701120, 74-02KBEMBI-12701125, 74-02KBGB-12700110, 74-02KBG-BI-12700115, 74-02KBGMB-12700120, 74-02KBGMBI-12700125, KB-E970-1050410, KBE970-1050410, KB-E970A-1050411, KB-G970-1050450, KB-G970A-1050451		



1			
GEV No.	693157	Ref. No.	2932200 BN2932200
description	threaded bush for tilting bratt pan		
For models:	94-04KBE-12901115, 94-04KBE-12901115BN, 94-04KBE-12901118, 94-04KBEM-12901125, 94-04KBEM-12901125BN, 94-04KBEM-12901128, 94-04KBG, 94-04KBG-12900115, 94-04KBG-12900115TA, 94-04KBG-12900118, 94-04KBG-12900118TA, 94-04KBGM, 94-04KBGM-12900125, 94-04KBGM-12900125TA, 94-04KBGM-12900128, 94-04KBGM-12900128TA, 94KBE, 94KBE-1192870, 94KBEM-1192880, 94KBG-1191870, 94KBG-191870, 94KBGM-1191880, 94KBGM-191600, 94RKBE-1392870, 94RKBE-1392880, 94RKBE-1391870, 94RKBM-1391880		

for dishwashers

containers





salt tanks



1			
GEV No.	517398	Ref. No.	16067/B
description	flat gasket rubber ED ø 82mm ID ø 66mm thickness 4mm for salt tank Qty 1 pcs		
For models:	OLDS35, OLDS35-1081061, OLDS35D-1081062, OLDS35-Neutra, OLDS37, OLDS37-1081006, OLDS37-1081063, OLDS37D-1081007, OLDS37D-1081064, OLDS37LS-1081008, OLDS37LSD-1081009, OLDS37-Neutra, OLDS40, OLDS40-1081010, OLDS40-1081065, OLDS40D-1081011, OLDS40D-1081066, OLDS40E-1081067, OLDS40ED-1081068, OLDS40LS-1081012, OLDS40LSD-1081013, OLDS40-Neutra, OLDS45, OLDS50, OLDS50-1081088, OLDS50D-1081089, OLDS50E-1081090, OLDS50ED-1081091, OLDS50-Neutra, OLDS50P-1081018, OLDS50PD-1081019, OLDS50W020H, OLElectron1000, OLElectron400, OLElectron500, OLELELECTRON1000-1081084, OLELELECTRON1000D-1081085, OLG35, OLG35-1080702, OLG35D-1081000, OLG35-Neutra, OLG600, OLGastro450, OLGastro500Plus, OLGastro500S, OLGastro750Plus, OLGastro750S, OLG37, OLG37-1080700, OLG37D-1080707...(Other models you can see in the webshop)		

			
1			
GEV No.	517396	Ref. No.	16067/D
description	lid ø 69mm H 19mm for salt tank ID ø 50.5mm		
For models:	OLDS35, OLDS35-1081061, OLDS35D-1081062, OLDS35-Neutra, OLDS37, OLDS37-1081006, OLDS37-1081063, OLDS37D-1081007, OLDS37D-1081064, OLDS37LS-1081008, OLDS37LSD-1081009, OLDS37-Neutra, OLDS40, OLDS40-1081010, OLDS40-1081065, OLDS40D-1081011, OLDS40D-1081066, OLDS40E-1081067, OLDS40ED-1081068, OLDS40LS-1081012, OLDS40LSD-1081013, OLDS40-Neutra, OLDS45, OLDS50, OLDS50-1081088, OLDS50D-1081089, OLDS50E-1081090, OLDS50ED-1081091, OLDS50-Neutra, OLDS50P-1081018, OLDS50PD-1081019, OLDW020H, OLElectron1000, OLElectron400, OLElectron500, OLELELECTRON1000-1081084, OLELELECTRON1000D-1081085, OLG35, OLG35-1080702, OLG35D-1081000, OLG35-Neutra, OLG600, OLGastro450, OLGastro500Plus, OLGastro500S, OLGastro750Plus, OLGastro750S, OLG37, OLG37-1080700, OLG37D-1080707...(Other models you can see in the webshop)		

			
2			
GEV No.	517397	Ref. No.	16067/C
description	nut ø 93mm H 13mm for salt tank ID ø 64mm		
For models:	OLDS35, OLDS35-1081061, OLDS35D-1081062, OLDS35-Neutra, OLDS37, OLDS37-1081006, OLDS37-1081063, OLDS37D-1081007, OLDS37D-1081064, OLDS37LS-1081008, OLDS37LSD-1081009, OLDS37-Neutra, OLDS40, OLDS40-1081010, OLDS40-1081065, OLDS40D-1081011, OLDS40D-1081066, OLDS40E-1081067, OLDS40ED-1081068, OLDS40LS-1081012, OLDS40LSD-1081013, OLDS40-Neutra, OLDS45, OLDS50, OLDS50-1081088, OLDS50D-1081089, OLDS50E-1081090, OLDS50ED-1081091, OLDS50-Neutra, OLDS50P-1081018, OLDS50PD-1081019, OLDW020H, OLElectron1000, OLElectron400, OLElectron500, OLELELECTRON1000-1081084, OLELELECTRON1000D-1081085, OLG35, OLG35-1080702, OLG35D-1081000, OLG35-Neutra, OLG600, OLGastro450, OLGastro500Plus, OLGastro500S, OLGastro750Plus, OLGastro750S, OLG37, OLG37-1080700, OLG37D-1080707...(Other models you can see in the webshop)		

			
1			
GEV No.	517347	Ref. No.	16065
description	salt tank ø 90mm H 88mm complete		
For models:	OLDS35, OLDS35-1081061, OLDS35D-1081062, OLDS35-Neutra, OLDS37, OLDS37-1081006, OLDS37-1081063, OLDS37D-1081007, OLDS37D-1081064, OLDS37LS-1081008, OLDS37LSD-1081009, OLDS37-Neutra, OLDS40, OLDS40-1081010, OLDS40-1081065, OLDS40D-1081011, OLDS40D-1081066, OLDS40E-1081067, OLDS40ED-1081068, OLDS40LS-1081012, OLDS40LSD-1081013, OLDS40-Neutra, OLDS45, OLDS50, OLDS50-1081088, OLDS50D-1081089, OLDS50E-1081090, OLDS50ED-1081091, OLDS50-Neutra, OLDS50P-1081018, OLDS50PD-1081019, OLDW020H, OLElectron1000, OLElectron400, OLElectron500, OLELELECTRON1000-1081084, OLELELECTRON1000D-1081085, OLG35, OLG35-1080702, OLG35D-1081000, OLG35-Neutra, OLG600, OLGastro450, OLGastro500Plus, OLGastro500S, OLGastro750Plus, OLGastro750S, OLG37, OLG37-1080700, OLG37D-1080707...(Other models you can see in the webshop)		
spare parts for	517347		
	GEV No.	506015	Ref. No. 16067/A
	O-ring EPDM thickness 3.53mm ID ø 39.69mm Qty 1 pcs		
	GEV No.	517396	Ref. No. 16067/D
	lid ø 69mm H 19mm for salt tank ID ø 50.5mm		
	GEV No.	517397	Ref. No. 16067/C
	nut ø 93mm H 13mm for salt tank ID ø 64mm		

boilers

boilers for dishwashers

			
1			
GEV No.	517296	Ref. No.	540006
description	boiler		
For models:	OLElectron400		

			
1			
GEV No.	517297	Ref. No.	16904
description	boiler		
For models:	OLDS40-1081010, OLDS40D-1081011, OLDS40LS-1081012, OLDS40LSD-1081013, OLLinear		



			
1			
GEV No.	517402	Ref. No.	3007013
description	boiler		
For models:	OLAX151, OLAX151EDX-1080725, OLAX151LEFT-1080727, OLAX151-highspeed, OLAX160, OLAX160E-1080750, OLAX160E-1080751, OLAX160V-1080755, OLAX160V-1080756, OLAX160V-1081031, OLAX160V-1081032, OLAX210, OLAX210E-1081029, OLAX210E-1081030, OLAX220, OLAX220E-1080787, OLAX220E-1080788, OLAX220V-1080789, OLAX220V-1080790, OLAX230, OLAX230E-1080791, OLAX230E-1080792, OLAX230V-1080793, OLAX230V-1080794, OLAX240, OLAX240E-1080795, OLAX240E-1080796, OLAX240V-1080797, OLAX240V-1080798, OLAX250, OLAX250E-1080760, OLAX250E-1080761, OLAX250V-1080765, OLAX250V-1080766, OLAX300, OLAX300E-1080770, OLAX300E-1080771, OLAX300E-1081033, OLAX300E-1081035, OLAX300E-1081036, OLAX300LC, OLAX300LCE-1081034, OLAX300V-1080775, OLAX300V-1080776, OLAX310, OLAX310E-1081110, OLAX310E-1081111, OLAX310LC, OLAX310LCE-1081114, OLAX310LCE-1081115...(Other models you can see in the webshop)		

			
1			
GEV No.	517294	Ref. No.	135905
description	boiler ø 113mm L 320mm		
For models:	OLDS35, OLDS35-1081061, OLDS35D-1081062, OLDS35-Neutra, OLDS37, OLDS37-1081063, OLDS37D-1081064, OLDS37-Neutra, OLG35-1080702, OLG3537, OLG3537-1080700, OLG3537D-1080707, OLG3537LS-1081001, OLG3537LSD-1081002, OLG3537-Neutra		

			
1			
GEV No.	517295	Ref. No.	140905
description	boiler ø 113mm L 370mm		
For models:	OLDS40, OLDS40-1081065, OLDS40D-1081066, OLDS40E-1081067, OLDS40ED-1081068, OLDS40-Neutra, OLG540, OLG540, OLG540-1080701, OLG540D-1080708, OLG540D-1081003, OLG540-Neutra, OLG5450LSD-1081004		

			
1			
GEV No.	517299	Ref. No.	26905
description	boiler ø 140mm L 335mm		
For models:	OLGastro450		

			
1			
GEV No.	517300	Ref. No.	150905
description	boiler ø 140mm L 390mm		
For models:	OLDS45, OLDS50, OLDS50-1081088, OLDS50D-1081089, OLDS50E-1081090, OLDS50ED-1081091, OLDS50-Neutra, OLDS50P-1081018, OLDS50PD-1081019, OLElectron500, OLG600, OLGastro500Plus, OLGastro500S, OLGastro750Plus, OLGastro750S, OLG545, OLG550, OLG550-1080705, OLG550D-1080706, OLG550E-1080730, OLG550ECO-1081014, OLG550ECOD-1081015, OLG550ED-1080731, OLG550-Neutra, OLG585, OLG585-1081016, OLG585D-1081017, OLG585-Neutra		

			
1			
GEV No.	517394	Ref. No.	3007012
description	boiler ø 160mm L 530mm with insulation		
For models:	OLAX151, OLAX151EDX-1080725, OLAX151LEFT-1080727, OLAX151-highspeed, OLAX160, OLAX160E-1080750, OLAX160E-1080751, OLAX160V-1080755, OLAX160V-1080756, OLAX160V-1081031, OLAX160V-1081032, OLAX210, OLAX210E-1081029, OLAX210E-1081030, OLAX220, OLAX220E-1080787, OLAX220E-1080788, OLAX220V-1080789, OLAX220V-1080790, OLAX230, OLAX230E-1080791, OLAX230E-1080792, OLAX230V-1080793, OLAX230V-1080794, OLAX240, OLAX240E-1080795, OLAX240E-1080796, OLAX240V-1080797, OLAX240V-1080798, OLAX250, OLAX250E-1080760, OLAX250E-1080761, OLAX250V-1080765, OLAX250V-1080766, OLAX300, OLAX300E-1080770, OLAX300E-1080771, OLAX300E-1081033, OLAX300E-1081035, OLAX300E-1081036, OLAX300LC, OLAX300LCE-1081034, OLAX300V-1080775, OLAX300V-1080776, OLAX310, OLAX310E-1081110, OLAX310E-1081111, OLAX310LC, OLAX310LCE-1081114, OLAX310LCE-1081115...(Other models you can see in the webshop)		
spare parts for	517394		
	GEV No.	Ref. No.	30002030
	517336		
	insulating mat boiler L 500mm W 155mm		
	GEV No.	Ref. No.	75205
	517337		
	insulating mat boiler ø 160mm		

			
1			
GEV No.	517302	Ref. No.	22002
description	boiler with insulation ø 160mm L 500mm		
For models:	G12S, OLDW020H, OLElectron1000, OLELELECTRON1000-1081084, OLELELECTRON1000D-1081085, OLH600, OLH600Electronic, OLHT11-1081071, OLHT11D-1081072, OLHT11ECO-1081070, OLHT-11-Neutra, OLHT11S, OLHT11S-Neutra, OLHT12-1081075, OLHT12EL-1081080, OLHT12EL-1081083, OLHT12ELD-1081081, OLHT12ELPLUS-1081086, OLHT12S, OLHT12SElectronic, OLHT12S-Neutra, OLLP1-800, OLLP1-800-1080721, OLLP1-800EL, OLLP1-800-Neutra, OLLP1S5-1081087, OLLP1-S8, OLLP1-S8EL, OLLP-ZERO, OLLPZERO-1081057		
accessories for	517302		
	GEV No.	517337	Ref. No. 75205
	insulating mat boiler ø 160mm		

accessories

			
1			
GEV No.	517125	Ref. No.	12506
description	hose connector		
For models:	OLDS45, OLElectron400, OLElectron500, OLG600, OLGastro500Plus, OLGastro500S, OLGastro750Plus, OLGastro750S, OLGRANUL900, OLG540, OLG540-1080701, OLG540D-1080708, OLG540D-1081003, OLG540-Neutra, OLG540LSD-1081004, OLG550, OLG550-1080705, OLG550D-1080706, OLG550E-1080730, OLG550ECO-1081014, OLG550ED-1080731, OLG550-Neutra, OLG585, OLG585-1081016, OLG585D-1081017, OLHT11-1081071, OLHT11D-1081072, OLHT11ECO-1081070, OLHT11-Neutra, OLHT11S, OLHT12-1081075, OLHT12EL-1081080, OLHT12EL-1081083, OLHT12ELD-1081081, OLHT12ELPLUS-1081086, OLHT12S, OLHT12SElectronic, OLLP1-800, OLLP1-800-1080721, OLLP1-800EL, OLLP1-800-Neutra, OLLP2-1080742, OLLP-2PLUS, OLLP3-1080743, OLLP-3PLUS, OLLP4-1081258, OLLP-4PLUS, OLLP-ZERO, OLLPZERO-1081057		

			
1			
GEV No.	517336	Ref. No.	30002030
description	insulating mat boiler L 500mm W 155mm		
For models:	OLAX151, OLAX151EDX-1080725, OLAX151ELEFT-1080727, OLAX151-highspeed, OLAX160, OLAX160E-1080750, OLAX160E-1080751, OLAX160V-1080755, OLAX160V-1080756, OLAX160V-1081031, OLAX160V-1081032, OLAX210, OLAX210E-1081029, OLAX210E-1081030, OLAX220, OLAX220E-1080787, OLAX220E-1080788, OLAX220V-1080789, OLAX220V-1080790, OLAX230, OLAX230E-1080791, OLAX230E-1080792, OLAX230V-1080793, OLAX230V-1080794, OLAX240, OLAX240E-1080795, OLAX240E-1080796, OLAX240V-1080797, OLAX240V-1080798, OLAX250, OLAX250E-1080760, OLAX250E-1080761, OLAX250V-1080765, OLAX250V-1080766, OLAX300, OLAX300E-1080770, OLAX300E-1080771, OLAX300E-1081033, OLAX300E-1081035, OLAX300E-1081036, OLAX300LC, OLAX300LCE-1081034, OLAX300V-1080775, OLAX300V-1080776, OLAX310, OLAX310E-1081110, OLAX310E-1081111, OLAX310LC, OLAX310LCE-1081114, OLAX310LCE-1081115...(Other models you can see in the webshop)		

			
1			
GEV No.	517337	Ref. No.	75205
description	insulating mat boiler ø 160mm		
For models:	OLAX151, OLAX151EDX-1080725, OLAX151ELEFT-1080727, OLAX151-highspeed, OLAX160, OLAX160E-1080750, OLAX160E-1080751, OLAX160V-1080755, OLAX160V-1080756, OLAX160V-1081031, OLAX160V-1081032, OLAX210, OLAX210E-1081029, OLAX210E-1081030, OLAX220, OLAX220E-1080787, OLAX220E-1080788, OLAX220V-1080789, OLAX220V-1080790, OLAX230, OLAX230E-1080791, OLAX230E-1080792, OLAX230V-1080793, OLAX230V-1080794, OLAX240, OLAX240E-1080795, OLAX240E-1080796, OLAX240V-1080797, OLAX240V-1080798, OLAX250, OLAX250E-1080760, OLAX250E-1080761, OLAX250V-1080765, OLAX250V-1080766, OLAX300, OLAX300E-1080770, OLAX300E-1080771, OLAX300E-1081033, OLAX300E-1081035, OLAX300E-1081036, OLAX300LC, OLAX300LCE-1081034, OLAX300V-1080775, OLAX300V-1080776, OLAX310, OLAX310E-1081110, OLAX310E-1081111, OLAX310LC, OLAX310LCE-1081114, OLAX310LCE-1081115...(Other models you can see in the webshop)		

			
1			
GEV No.	699262	Ref. No.	15066
description	insulation for boiler L 455mm W 395mm thickness 2mm		
For models:	OLDS45, OLDS50, OLDS50-1081088, OLDS50D-1081089, OLDS50E-1081090, OLDS50ED-1081091, OLDS50-Neutra, OLDS50P-1081018, OLDS50PD-1081019, OLElectron500, OLG600, OLGastro500Plus, OLGastro500S, OLGastro750Plus, OLGastro750S, OLG545, OLG550, OLG550-1080705, OLG550D-1080706, OLG550E-1080730, OLG550ECO-1081014, OLG550ECOD-1081015, OLG550ED-1080731, OLG550-Neutra, OLG585, OLG585-1081016, OLG585D-1081017, OLG585-Neutra		

softener cartridges

softening columns

			
1			
GEV No.	530084	Ref. No.	16066
description	softener 4-fold L 380mm W 180mm		
For models:	OLDS35, OLDS35-1081061, OLDS35D-1081062, OLDS35-Neutra, OLDS37, OLDS37-1081006, OLDS37-1081063, OLDS37D-1081007, OLDS37D-1081064, OLDS37LS-1081008, OLDS37LSD-1081009, OLDS37-Neutra, OLDS40, OLDS40-1081010, OLDS40-1081065, OLDS40D-1081011, OLDS40D-1081066, OLDS40E-1081067, OLDS40ED-1081068, OLDS40LS-1081012, OLDS40LSD-1081013, OLDS40-Neutra, OLDS45, OLDS50, OLDS50-1081088, OLDS50D-1081089, OLDS50E-1081090, OLDS50ED-1081091, OLDS50-Neutra, OLDS50P-1081018, OLDS50PD-1081019, OLDW020H, OLElectron1000, OLElectron400, OLElectron500, OLELELECTRON1000-1081084, OLELELECTRON1000D-1081085, OLG35-1080702, OLG600, OLGastro450, OLGastro500Plus, OLGastro500S, OLGastro750Plus, OLGastro750S, OLG537, OLG537-1080700, OLG537D-1080707, OLG537LS-1081001, OLG537LSD-1081002, OLG537-Neutra...(Other models you can see in the webshop)		

housing and bezels

fascias



1

GEV No.	517422	Ref. No.	89306
description	bezel for thermometer L 90mm H 53.5mm		
For models:	OLH600, OLHT11-1081071, OLHT11D-1081072, OLHT11E-CO-1081070, OLHT11S, OLHT12-1081075, OLHT12EL-1081080, OLHT12EL-1081083, OLHT12ELD-1081081, OLHT12ELPLUS-1081086, OLHT12S, OLLP1-800, OLLP1-800-1080721, OLLP1-800EL, OLLP1-S8, OLLP1-S8EL, OLLP-ZERO, OLLPZERO-1081057		



1

GEV No.	996014	Ref. No.	75311
description	cover for boiler H 40mm ø 125mm		
For models:	OLAX151, OLAX151EDX-1080725, OLAX151ELEFT-1080727, OLAX151-highspeed, OLAX160, OLAX160E-1080750, OLAX160E-1080751, OLAX160V-1080755, OLAX160V-1080756, OLAX160V-1081031, OLAX160V-1081032, OLAX210, OLAX210E-1081029, OLAX210E-1081030, OLAX220, OLAX220E-1080787, OLAX220E-1080788, OLAX220V-1080789, OLAX220V-1080790, OLAX230, OLAX230E-1080791, OLAX230E-1080792, OLAX230V-1080793, OLAX230V-1080794, OLAX240, OLAX240E-1080795, OLAX240E-1080796, OLAX240V-1080797, OLAX240V-1080798, OLAX250, OLAX250E-1080760, OLAX250E-1080761, OLAX250V-1080765, OLAX250V-1080766, OLAX300, OLAX300E-1080770, OLAX300E-1080771, OLAX300E-1081033, OLAX300E-1081035, OLAX300E-1081036, OLAX300LC, OLAX300LCE-1081034, OLAX300V-1080775, OLAX300V-1080776, OLAX310, OLAX310E-1081110, OLAX310E-1081111, OLAX310LC, OLAX310LCE-1081114, OLAX310LCE-1081115...(Other models you can see in the webshop)		

miscellaneous



1

GEV No.	517400	Ref. No.	560007
description	bearing for door rubber ID ø 12mm mounting pos. left		
For models:	OLDS50P-1081018, OLDS50PD-1081019, OLElectron500, OLGastro500Plus, OLGastro500S, OLGastro750Plus, OLGastro750S		



1

GEV No.	524803	Ref. No.	11600018
description	bracket for dishwasher rack SS L 25mm ED ø 10mm thread M6		
For models:	G12S, OLH600, OLH600Electronic, OLHT11-1081071, OLHT11D-1081072, OLHT11ECO-1081070, OLHT11S, OLHT11S-Neutra, OLHT12-1081075, OLHT12EL-1081080, OLHT12EL-1081083, OLHT12ELD-1081081, OLHT12ELPLUS-1081086, OLHT12S, OLHT12SElectronic, OLHT12S-Neutra		



1

GEV No.	698297	Ref. No.	76081
description	duct ID ø 35mm ED ø 51mm thickness 14mm		
For models:	OLH600, OLH600Electronic, OLHT11-1081071, OLHT11D-1081072, OLHT11ECO-1081070, OLHT11S, OLHT11S-Neutra, OLHT12-1081075, OLHT12EL-1081080, OLHT12EL-1081083, OLHT12ELD-1081081, OLHT12ELPLUS-1081086, OLHT12S, OLHT12SElectronic, OLHT12S-Neutra		



1

GEV No.	524076	Ref. No.	3003058
description	magnet holder internal size 13mm H 60mm for dishwasher		
For models:	OLAX151, OLAX151EDX-1080725, OLAX151ELEFT-1080727, OLAX151-highspeed, OLAX160, OLAX160E-1080750, OLAX160E-1080751, OLAX160V-1080755, OLAX160V-1080756, OLAX160V-1081031, OLAX160V-1081032, OLAX210, OLAX210E-1081029, OLAX210E-1081030, OLAX220, OLAX220E-1080787, OLAX220E-1080788, OLAX220V-1080789, OLAX220V-1080790, OLAX230, OLAX230E-1080791, OLAX230E-1080792, OLAX230V-1080793, OLAX230V-1080794, OLAX240, OLAX240E-1080795, OLAX240E-1080796, OLAX240V-1080797, OLAX240V-1080798, OLAX250, OLAX250E-1080760, OLAX250E-1080761, OLAX250V-1080765, OLAX250V-1080766, OLAX300, OLAX300E-1080770, OLAX300E-1080771, OLAX300E-1081033, OLAX300E-1081035, OLAX300E-1081036, OLAX300LC, OLAX300LCE-1081034, OLAX300V-1080775, OLAX300V-1080776, OLAX310, OLAX310E-1081110, OLAX310E-1081111, OLAX310LC, OLAX310LCE-1081114, OLAX310LCE-1081115...(Other models you can see in the webshop)		
accessories for	524076		
	GEV No.	524655	Ref. No.
			—
	screw cap for magnet holder thread M16x1.25 SS WS 19		

hood mechanics for dishwashers

bushes



1

GEV No.	512423	Ref. No.	11600055
description	bush for hood handle		
For models:	OLH600, OLH600Electronic, OLHT11-1081071, OLHT11D-1081072, OLHT11ECO-1081070, OLHT11S, OLHT11S-Neutra, OLHT12-1081075, OLHT12EL-1081080, OLHT12EL-1081083, OLHT12ELD-1081081, OLHT12ELPLUS-1081086, OLHT12S, OLHT12SElectronic, OLHT12S-Neutra		



1

GEV No.	517284	Ref. No.	10800130
description	bush hood mechanics		
For models:	OLHT-11-Neutra		



1

GEV No.	517279	Ref. No.	75204
description	bush hood mechanics PTFE		
For models:	OLHT-11-Neutra		



1

GEV No.	517282	Ref. No.	10800231
description	cylinder liner hood mechanics		
For models:	OLHT-11-Neutra		



1

GEV No.	694679	Ref. No.	11600014
description	roller ID \varnothing 10.5mm L 33mm for hood mechanics D1 \varnothing 22mm D2 \varnothing 19.8mm		
For models:	G12S, OLH600, OLH600Electronic, OLHT11-1081071, OLHT11D-1081072, OLHT11ECO-1081070, OLHT11S, OLHT11S-Neutra, OLHT12-1081075, OLHT12EL-1081080, OLHT12EL-1081083, OLHT12ELD-1081081, OLHT12ELPLUS-1081086, OLHT12S, OLHT12SElectronic, OLHT12S-Neutra		

spring holders



1

GEV No.	517285	Ref. No.	70306
description	spring holder		
For models:	OLHT11-1081071, OLHT11D-1081072, OLHT11ECO-1081070, OLHT-11-Neutra, OLHT11S, OLHT11S-Neutra		

guide bars



1

GEV No.	517378	Ref. No.	11600029
description	guide bar L 650mm mounting pos. left for hood mechanics thickness 25mm		
For models:	OLH600, OLH600Electronic, OLHT11-1081071, OLHT11D-1081072, OLHT11ECO-1081070, OLHT11S, OLHT11S-Neutra, OLHT12-1081075, OLHT12EL-1081080, OLHT12EL-1081083, OLHT12ELD-1081081, OLHT12ELPLUS-1081086, OLHT12S, OLHT12SElectronic, OLHT12S-Neutra		



1

GEV No.	513019	Ref. No.	11600028
description	guide bar L 695mm mounting pos. right thickness 25mm		
For models:	OLH600, OLH600Electronic, OLHT11-1081071, OLHT11D-1081072, OLHT11ECO-1081070, OLHT11S, OLHT11S-Neutra, OLHT12-1081075, OLHT12EL-1081080, OLHT12EL-1081083, OLHT12ELD-1081081, OLHT12ELPLUS-1081086, OLHT12S, OLHT12SElectronic, OLHT12S-Neutra		





1

GEV No.	524800	Ref. No.	76080
description	guide bar L 700mm for hood W 26mm H 21mm		
For models:	OLHT11-1081071, OLHT11D-1081072, OLHT11ECO-1081070, OLHT11S, OLHT11S-Neutra		



rollers			
 <p>1</p>			
GEV No.	524805	Ref. No.	89919
description	roller ø 23mm H 9.6mm for hood mechanics plastic white hole ø 8mm		
For models:	OLH600, OLH600Electronic, OLHT11-1081071, OLHT11D-1081072, OLHT11ECO-1081070, OLHT11S, OLHT11S-Neutra, OLHT12-1081075, OLHT12EL-1081080, OLHT12EL-1081083, OLHT12ELD-1081081, OLHT12ELPLUS-1081086, OLHT12S, OLHT12SElectronic, OLHT12S-Neutra, OLLP3-1080743, OLLP-3PLUS, OLLP4-1081258, OLLP-4PLUS		

miscellaneous			
 <p>1</p>			
GEV No.	517280	Ref. No.	75203
description	bush with thread hood mechanics brass		
For models:	OLHT-11-Neutra		

 <p>1</p>			
GEV No.	517281	Ref. No.	75202
description	nut hood mechanics		
For models:	OLHT-11-Neutra		

 <p>1</p>			
GEV No.	517283	Ref. No.	10800244
description	roller for hood handle		
For models:	OLHT-11-Neutra		



basket guides			
guide bars			
 <p>1</p>			
GEV No.	517813	Ref. No.	10600923
description	basket guide mounting pos. left/right L 450mm W 3.5mm H 37.5mm		
For models:	G12S, OLH600, OLH600Electronic, OLHT11-1081071, OLHT11D-1081072, OLHT11ECO-1081070, OLHT11S, OLHT11S-Neutra, OLHT12-1081075, OLHT12EL-1081080, OLHT12EL-1081083, OLHT12ELD-1081081, OLHT12ELPLUS-1081086, OLHT12S, OLHT12SElectronic, OLHT12S-Neutra		

air traps			
air traps			
 <p>1</p>			
GEV No.	517168	Ref. No.	10911/D 135911/D
description	air trap H 56mm		
For models:	OLDS35, OLDS35-1081061, OLDS35D-1081062, OLDS35-Neutra, OLDS37, OLDS37-1081063, OLDS37D-1081064, OLDS37-Neutra, OLDS40, OLDS40-1081065, OLDS40D-1081066, OLDS40E-1081067, OLDS40ED-1081068, OLDS40-Neutra, OLDS50P-1081018, OLDS50PD-1081019, OLElectron500, OLG35-1080702, OLG600, OLGastro450, OLGastro500Plus, OLGastro500S, OLGastro750Plus, OLGastro750S, OLG537, OLG537-1080700, OLG537D-1080707, OLG537LS-1081001, OLG537LSD-1081002, OLG537-Neutra		
accessories for	517168		
GEV No.	517173	Ref. No.	13301
description	flat gasket FIBER ED ø 14mm ID ø 8mm thickness 1.5mm Qty 1 pcs		
GEV No.	517174	Ref. No.	11702
description	nut thread M8 H 6.5mm WS 13 SS DIN/ISO DIN 934 / ISO 4032/8673 Qty 1 pcs		

 <p>1</p>			
GEV No.	517308	Ref. No.	10911/C 135911/C
description	air trap H 65mm		
For models:	OLDW020H, OLElectron1000, OLELELECTRON1000-1081084, OLELELECTRON1000D-1081085, OLG35, OLG35D-1081000, OLG35-Neutra, OLHT-11-Neutra, OLLP1-800, OLLP1-800-1080721, OLLP1-800EL, OLLP1-800-Neutra, OLLP155-1081087, OLLP-ZERO, OLLPZERO-1081057		



 <p>1</p>			
GEV No.	517170	Ref. No.	135911/B
description	air trap H 75mm		
For models:	OLDS45, OLDS50, OLDS50-1081088, OLDS50D-1081089, OLDS50E-1081090, OLDS50ED-1081091, OLDS50-Neutra, OLElectron400, OLG540, OLG540-1080701, OLG540D-1080708, OLG540D-1081003, OLG540-Neutra, OLG545, OLG545LSD-1081004, OLG550, OLG550-1080705, OLG550D-1080706, OLG550E-1080730, OLG550ECO-1081014, OLG550ECOD-1081015, OLG550ED-1080731, OLG550-Neutra, OLG585, OLG585-1081016, OLG585D-1081017, OLG585-Neutra, OLH600, OLH600Electronic, OLHT11-1081071, OLHT11D-1081072, OLHT11ECO-1081070, OLHT11S, OLHT11S-Neutra		
accessories for	517170		
GEV No.	517173	Ref. No.	13301
description	flat gasket FIBER ED ø 14mm ID ø 8mm thickness 1.5mm Qty 1 pcs		
GEV No.	517174	Ref. No.	11702
description	nut thread M8 H 6.5mm WS 13 SS DIN/ISO DIN 934 / ISO 4032/8673 Qty 1 pcs		

			
1			
GEV No.	517172	Ref. No.	80106
description	air trap L 90mm ø 45mm stainless steel		
For models:	OLAX151, OLAX151EDX-1080725, OLAX151ELEFT-1080727, OLAX151-highspeed, OLAX160, OLAX160E-1080750, OLAX160E-1080751, OLAX160V-1080755, OLAX160V-1080756, OLAX160V-1081031, OLAX160V-1081032, OLAX210, OLAX210E-1081029, OLAX210E-1081030, OLAX220, OLAX220E-1080787, OLAX220E-1080788, OLAX220V-1080789, OLAX220V-1080790, OLAX230, OLAX230E-1080791, OLAX230E-1080792, OLAX230V-1080793, OLAX230V-1080794, OLAX240, OLAX240E-1080795, OLAX240E-1080796, OLAX240V-1080797, OLAX240V-1080798, OLAX250, OLAX250E-1080760, OLAX250E-1080761, OLAX250V-1080765, OLAX250V-1080766, OLAX300, OLAX300E-1080770, OLAX300E-1080771, OLAX300E-1081033, OLAX300E-1081035, OLAX300E-1081036, OLAX300LC, OLAX300LCE-1081034, OLAX300V-1080775, OLAX300V-1080776, OLAX310, OLAX310E-1081110, OLAX310E-1081111, OLAX310LC, OLAX310LCE-1081114, OLAX310LCE-1081115...(Other models you can see in the webshop)		
accessories for	517172		
	GEV No.	517173	Ref. No. 13301
	flat gasket FIBER ED ø 14mm ID ø 8mm thickness 1.5mm Qty 1 pcs		
	GEV No.	517174	Ref. No. 11702
	nut thread M8 H 6.5mm WS 13 SS DIN/ISO DIN 934 / ISO 4032/8673 Qty 1 pcs		

			
1			
GEV No.	517171	Ref. No.	10911 135911
description	air trap L 90mm W 55mm H 31mm		
For models:	G12S, OLDerby, OLDS35-1081005, OLDS37-1081006, OLDS37D-1081007, OLDS37LS-1081008, OLDS37LSD-1081009, OLGRANUL900, OLH600Electronic, OLHT12-1081075, OLHT12EL-1081080, OLHT12EL-1081083, OLHT12ELD-1081081, OLHT12ELPLUS-1081086, OLHT12S, OLHT12SElectronic, OLHT12S-Neutra, OLLP1-S8, OLLP1-S8EL, OLLP2-1080722, OLLP2-1080742, OLLP2Electronic-Neutra, OLLP2PLUS, OLLP3-1080743, OLLP3PLUS, OLLP4-1081258, OLLP4PLUS, OLStar		
accessories for	517171		
	GEV No.	517173	Ref. No. 13301
	flat gasket FIBER ED ø 14mm ID ø 8mm thickness 1.5mm Qty 1 pcs		
	GEV No.	517174	Ref. No. 11702
	nut thread M8 H 6.5mm WS 13 SS DIN/ISO DIN 934 / ISO 4032/8673 Qty 1 pcs		

mechanics for flight type dishwashers

			
1			
GEV No.	517818	Ref. No.	3060014
description	distance washers for tape L 46mm ø 15mm ID ø 9mm		
For models:	OLCX, OLFX, OLFX250E-1081151, OLFX250V-1081152, OLFX250V-1081153, OLFX380E-1081154, OLFX380E-1081155, OLFX380V-1081156, OLFX380V-1081157, OLFX420E-1081158, OLFX420E-1081159, OLFX420V-1081160, OLFX420V-1081161, OLFX540E-1081162, OLFX540E-1081163, OLFX540V-1081164, OLFX540V-1081165, OLFX600E-1081166, OLFX600E-1081167, OLFX600V-1081168, OLFX600V-1081169, OLFX680E-1081170, OLFX680E-1081171, OLFX680V-1081172, OLFX680V-1081173, OLFX780E-1081174, OLFX780E-1081175, OLFX780V-1081176, OLFX780V-1081177, OLFX900E-1081178, OLFX900E-1081179, OLFX900V-1081180, OLFX900V-1081181, WASHER-1081150		

			
1			
GEV No.	524455	Ref. No.	3003116
description	drive shaft for transport system L 225mm ø 120mm suitable for Dihr		
For models:	OLAX151, OLAX151EDX-1080725, OLAX151ELEFT-1080727, OLAX151-highspeed, OLAX160, OLAX160E-1080750, OLAX160E-1080751, OLAX160V-1080755, OLAX160V-1080756, OLAX160V-1081031, OLAX160V-1081032, OLAX210, OLAX210E-1081029, OLAX210E-1081030, OLAX220, OLAX220E-1080787, OLAX220E-1080788, OLAX220V-1080789, OLAX220V-1080790, OLAX230, OLAX230E-1080791, OLAX230E-1080792, OLAX230V-1080793, OLAX230V-1080794, OLAX240, OLAX240E-1080795, OLAX240E-1080796, OLAX240V-1080797, OLAX240V-1080798, OLAX250, OLAX250E-1080760, OLAX250E-1080761, OLAX250V-1080765, OLAX250V-1080766, OLAX300, OLAX300E-1080770, OLAX300E-1080771, OLAX300E-1081033, OLAX300E-1081035, OLAX300E-1081036, OLAX300LC, OLAX300LCE-1081034, OLAX300V-1080775, OLAX300V-1080776, OLAX310, OLAX310E-1081110, OLAX310E-1081111, OLAX310LC, OLAX310LCE-1081114, OLAX310LCE-1081115...(Other models you can see in the webshop)		
accessories for	524455		
	GEV No.	524456	Ref. No. 3003012
	roller for drive shaft L 27.3mm ø 30mm hole ø 12.5mm suitable for Dihr		



			
1			
GEV No.	699563	Ref. No.	3060134
description	gear wheel for impulse ø 150mm ID ø 35.5mm suitable for Dihr		
For models:	OLCX, OLFX, OLFX250E-1081151, OLFX250V-1081152, OLFX250V-1081153, OLFX380E-1081154, OLFX380E-1081155, OLFX380V-1081156, OLFX380V-1081157, OLFX420E-1081158, OLFX420E-1081159, OLFX420V-1081160, OLFX420V-1081161, OLFX540E-1081162, OLFX540E-1081163, OLFX540V-1081164, OLFX540V-1081165, OLFX600E-1081166, OLFX600E-1081167, OLFX600V-1081168, OLFX600V-1081169, OLFX680E-1081170, OLFX680E-1081171, OLFX680V-1081172, OLFX680V-1081173, OLFX780E-1081174, OLFX780E-1081175, OLFX780V-1081176, OLFX780V-1081177, OLFX900E-1081178, OLFX900E-1081179, OLFX900V-1081180, OLFX900V-1081181, OLUX220, WASHER-1081150		



			
1			
GEV No.	699261	Ref. No.	3060022
description	gear wheel plastic W 37.5mm ID ø 25mm ED ø 150mm		
For models:	OLCX, OLFX, OLFX250E-1081151, OLFX250V-1081152, OLFX250V-1081153, OLFX380E-1081154, OLFX380E-1081155, OLFX380V-1081156, OLFX380V-1081157, OLFX420E-1081158, OLFX420E-1081159, OLFX420V-1081160, OLFX420V-1081161, OLFX540E-1081162, OLFX540E-1081163, OLFX540V-1081164, OLFX540V-1081165, OLFX600E-1081166, OLFX600E-1081167, OLFX600V-1081168, OLFX600V-1081169, OLFX680E-1081170, OLFX680E-1081171, OLFX680V-1081172, OLFX680V-1081173, OLFX780E-1081174, OLFX780E-1081175, OLFX780V-1081176, OLFX780V-1081177, OLFX900E-1081178, OLFX900E-1081179, OLFX900V-1081180, OLFX900V-1081181, OLUX220, WASHER-1081150		

			
1			
GEV No.	698412	Ref. No.	3000261
description	gear wheel teeth 8 shaft intake ø 20mm ø 133mm tooth width 11mm plastic W 40mm for transport system suitable for dishwasher		
For models:	OLAX151, OLAX151EDX-1080725, OLAX151ELEFT-1080727, OLAX151-highspeed, OLAX160, OLAX160E-1080750, OLAX160E-1080751, OLAX160V-1080755, OLAX160V-1080756, OLAX160V-1081031, OLAX160V-1081032, OLAX210, OLAX210E-1081029, OLAX210E-1081030, OLAX220, OLAX220E-1080787, OLAX220E-1080788, OLAX220V-1080789, OLAX220V-1080790, OLAX230, OLAX230E-1080791, OLAX230E-1080792, OLAX230V-1080793, OLAX230V-1080794, OLAX240, OLAX240E-1080795, OLAX240E-1080796, OLAX240V-1080797, OLAX240V-1080798, OLAX250, OLAX250E-1080760, OLAX250E-1080761, OLAX250V-1080765, OLAX250V-1080766, OLAX300, OLAX300E-1080770, OLAX300E-1080771, OLAX300E-1081033, OLAX300E-1081035, OLAX300E-1081036, OLAX300LC, OLAX300LCE-1081034, OLAX300V-1080775, OLAX300V-1080776, OLAX310, OLAX310E-1081110, OLAX310E-1081111, OLAX310LC, OLAX310LCE-1081114, OLAX310LCE-1081115...(Other models you can see in the webshop)		

			
1			
GEV No.	517317	Ref. No.	3060001
description	roller		
For models:	OLCX, OLFX, OLFX250E-1081151, OLFX250V-1081152, OLFX250V-1081153, OLFX380E-1081154, OLFX380E-1081155, OLFX380V-1081156, OLFX380V-1081157, OLFX420E-1081158, OLFX420E-1081159, OLFX420V-1081160, OLFX420V-1081161, OLFX540E-1081162, OLFX540E-1081163, OLFX540V-1081164, OLFX540V-1081165, OLFX600E-1081166, OLFX600E-1081167, OLFX600V-1081168, OLFX600V-1081169, OLFX680E-1081170, OLFX680E-1081171, OLFX680V-1081172, OLFX680V-1081173, OLFX780E-1081174, OLFX780E-1081175, OLFX780V-1081176, OLFX780V-1081177, OLFX900E-1081178, OLFX900E-1081179, OLFX900V-1081180, OLFX900V-1081181, WASHER-1081150		

			
1			
GEV No.	524456	Ref. No.	3003012
description	roller for drive shaft L 27.3mm ø 30mm hole ø 12.5mm suitable for Dühr		
For models:	OLAX151, OLAX151EDX-1080725, OLAX151ELEFT-1080727, OLAX151-highspeed, OLAX160, OLAX160E-1080750, OLAX160E-1080751, OLAX160V-1080755, OLAX160V-1080756, OLAX160V-1081031, OLAX160V-1081032, OLAX210, OLAX210E-1081029, OLAX210E-1081030, OLAX220, OLAX220E-1080787, OLAX220E-1080788, OLAX220V-1080789, OLAX220V-1080790, OLAX230, OLAX230E-1080791, OLAX230E-1080792, OLAX230V-1080793, OLAX230V-1080794, OLAX240, OLAX240E-1080795, OLAX240E-1080796, OLAX240V-1080797, OLAX240V-1080798, OLAX250, OLAX250E-1080760, OLAX250E-1080761, OLAX250V-1080765, OLAX250V-1080766, OLAX300, OLAX300E-1080770, OLAX300E-1080771, OLAX300E-1081033, OLAX300E-1081035, OLAX300E-1081036, OLAX300LC, OLAX300LCE-1081034, OLAX300V-1080775, OLAX300V-1080776, OLAX310, OLAX310E-1081110, OLAX310E-1081111, OLAX310LC, OLAX310LCE-1081114, OLAX310LCE-1081115...(Other models you can see in the webshop)		
accessories for	524456		
	GEV No.	524455	Ref. No.
			3003116
	 drive shaft for transport system L 225mm ø 120mm suitable for Dühr		

			
1			
GEV No.	517371	Ref. No.	3003026
description	roller L 22mm ø 24.5mm hole ø 8mm suitable for Dühr		
For models:	OLAX151, OLAX151EDX-1080725, OLAX151ELEFT-1080727, OLAX151-highspeed, OLAX160, OLAX160E-1080750, OLAX160E-1080751, OLAX160V-1080755, OLAX160V-1080756, OLAX160V-1081031, OLAX160V-1081032, OLAX210, OLAX210E-1081029, OLAX210E-1081030, OLAX220, OLAX220E-1080787, OLAX220E-1080788, OLAX220V-1080789, OLAX220V-1080790, OLAX230, OLAX230E-1080791, OLAX230E-1080792, OLAX230V-1080793, OLAX230V-1080794, OLAX240, OLAX240E-1080795, OLAX240E-1080796, OLAX240V-1080797, OLAX240V-1080798, OLAX250, OLAX250E-1080760, OLAX250E-1080761, OLAX250V-1080765, OLAX250V-1080766, OLAX300, OLAX300E-1080770, OLAX300E-1080771, OLAX300E-1081033, OLAX300E-1081035, OLAX300E-1081036, OLAX300LC, OLAX300LCE-1081034, OLAX300V-1080775, OLAX300V-1080776, OLAX310, OLAX310E-1081110, OLAX310E-1081111, OLAX310LC, OLAX310LCE-1081114, OLAX310LCE-1081115...(Other models you can see in the webshop)		



1

GEV No.	517356	Ref. No.	3003048
description	spacer for spindle \varnothing 32mm		
For models:	OLAX151, OLAX151EDX-1080725, OLAX151ELEFT-1080727, OLAX151-highspeed, OLAX160, OLAX160E-1080750, OLAX160E-1080751, OLAX160V-1080755, OLAX160V-1080756, OLAX160V-1081031, OLAX160V-1081032, OLAX210, OLAX210E-1081029, OLAX210E-1081030, OLAX220, OLAX220E-1080787, OLAX220E-1080788, OLAX220V-1080789, OLAX220V-1080790, OLAX230, OLAX230E-1080791, OLAX230E-1080792, OLAX230V-1080793, OLAX230V-1080794, OLAX240, OLAX240E-1080795, OLAX240E-1080796, OLAX240V-1080797, OLAX240V-1080798, OLAX250, OLAX250E-1080760, OLAX250E-1080761, OLAX250V-1080765, OLAX250V-1080766, OLAX300, OLAX300E-1080770, OLAX300E-1080771, OLAX300E-1081033, OLAX300E-1081035, OLAX300E-1081036, OLAX300LC, OLAX300LCE-1081034, OLAX300V-1080775, OLAX300V-1080776, OLAX310, OLAX310E-1081110, OLAX310E-1081111, OLAX310LC, OLAX310LCE-1081114, OLAX310LCE-1081115...(Other models you can see in the webshop)		



2

GEV No.	524971	Ref. No.	3060035
description	tappet for dishwasher L 75mm W 36mm H 90mm hole \varnothing 9mm suitable for Dihr		
For models:	OLCX, OLFX, OLFX250E-1081151, OLFX250V-1081152, OLFX250V-1081153, OLFX380E-1081154, OLFX380E-1081155, OLFX380V-1081156, OLFX380V-1081157, OLFX420E-1081158, OLFX420E-1081159, OLFX420V-1081160, OLFX420V-1081161, OLFX540E-1081162, OLFX540E-1081163, OLFX540V-1081164, OLFX540V-1081165, OLFX600E-1081166, OLFX600E-1081167, OLFX600V-1081168, OLFX600V-1081169, OLFX680E-1081170, OLFX680E-1081171, OLFX680V-1081172, OLFX680V-1081173, OLFX780E-1081174, OLFX780E-1081175, OLFX780V-1081176, OLFX780V-1081177, OLFX900E-1081178, OLFX900E-1081179, OLFX900V-1081180, OLFX900V-1081181, WASHER-1081150		

backflow preventers

backflow preventers



1

GEV No.	516101	Ref. No.	999900006
description	backflow preventer dishwasher hose \varnothing 12mm		
For models:	OLAX151, OLAX151EDX-1080725, OLAX151ELEFT-1080727, OLAX151-highspeed, OLAX160, OLAX160E-1080750, OLAX160E-1080751, OLAX160V-1080755, OLAX160V-1080756, OLAX160V-1081031, OLAX160V-1081032, OLAX210, OLAX210E-1081029, OLAX210E-1081030, OLAX220, OLAX220E-1080787, OLAX220E-1080788, OLAX220V-1080789, OLAX220V-1080790, OLAX230, OLAX230E-1080791, OLAX230E-1080792, OLAX230V-1080793, OLAX230V-1080794, OLAX240, OLAX240E-1080795, OLAX240E-1080796, OLAX240V-1080797, OLAX240V-1080798, OLAX250, OLAX250E-1080760, OLAX250E-1080761, OLAX250V-1080765, OLAX250V-1080766, OLAX300, OLAX300E-1080770, OLAX300E-1080771, OLAX300E-1081033, OLAX300E-1081035, OLAX300E-1081036, OLAX300LC, OLAX300LCE-1081034, OLAX300V-1080775, OLAX300V-1080776, OLAX310, OLAX310E-1081110, OLAX310E-1081111, OLAX310LC, OLAX310LCE-1081114, OLAX310LCE-1081115...(Other models you can see in the webshop)		
spare parts for	516101		
	GEV No.	506367	Ref. No.
			—
	flat gasket rubber ED \varnothing 40mm ID \varnothing 28mm thickness 1.8mm Qty 1 pcs		

non-return valves



1

GEV No.	520886	Ref. No.	R65110640
description	non-return valve plastic total length 67mm		
For models:	CKEP06, CKEP06B, CKEP10, CKEP10B, CKEP20, CKEP20B, CKEP21, CKEP21B, CKEP40, CKEP40B, CKET06, CKET06B, CKET10, CKET10B, CKET20, CKET20B, CKET21, CKET21B, CKET40, CKET40B, CKGP06, CKGP06B, CKGP10, CKGP10B, CKGP20, CKGP20B, CKGP21, CKGP21B, CKGP40, CKGP40B, CKGT06, CKGT06B, CKGT10, CKGT10B, CKGT20, CKGT20B, CKGT21, CKGT21B, CKGT40, CKGT40B		

accessories





1

GEV No.	996010	Ref. No.	15284
description	ball \varnothing 16mm		
For models:	OLAX380, OLAX380LC, OLAX400		



			
1			
GEV No.	996012	Ref. No.	15280
description	body for back flow restrictor L 71mm W 56mm H 32mm hose ø 12mm		
For models:	OLAX380, OLAX380LC, OLAX400		

			
1			
GEV No.	996013	Ref. No.	15282
description	lid for back flow restrictor ø 40mm H 14.5mm plastic		
For models:	OLAX380, OLAX380LC, OLAX400		

			
1			
GEV No.	996011	Ref. No.	15281
description	nut with hole L 32mm W 32mm H 25mm thread M26x1.5 WS 32 plastic		
For models:	OLAX380, OLAX380LC, OLAX400		

<p>miscellaneous</p>			
			
1			
GEV No.	506160	Ref. No.	11185 11611
description	plain washer ID ø 8.6mm ED ø 16mm thickness 1.5mm SS Qty 1 pcs		
For models:	OLAX151, OLAX151EDX-1080725, OLAX151ELEFT-1080727, OLAX151-highspeed, OLAX160, OLAX160E-1080750, OLAX160E-1080751, OLAX160V-1080755, OLAX160V-1080756, OLAX160V-1081031, OLAX160V-1081032, OLAX210, OLAX210E-1081029, OLAX210E-1081030, OLAX220, OLAX220E-1080787, OLAX220E-1080788, OLAX220V-1080789, OLAX220V-1080790, OLAX230, OLAX230E-1080791, OLAX230E-1080792, OLAX230V-1080793, OLAX230V-1080794, OLAX240, OLAX240E-1080795, OLAX240E-1080796, OLAX240V-1080797, OLAX240V-1080798, OLAX250, OLAX250E-1080760, OLAX250E-1080761, OLAX250V-1080765, OLAX250V-1080766, OLAX300, OLAX300E-1080770, OLAX300E-1080771, OLAX300E-1081033, OLAX300E-1081035, OLAX300E-1081036, OLAX300LC, OLAX300LCE-1081034, OLAX300V-1080775, OLAX300V-1080776, OLAX310, OLAX310E-1081110, OLAX310E-1081111, OLAX310LC, OLAX310LCE-1081114, OLAX310LCE-1081115...(Other models you can see in the webshop)		

			
1			
GEV No.	517819	Ref. No.	3009387
description	spacer ring for intake tap D1 ø 30mm ID ø 17mm		
For models:	OLAX151, OLAX151EDX-1080725, OLAX151ELEFT-1080727, OLAX151-highspeed, OLAX160, OLAX160E-1080750, OLAX160E-1080751, OLAX160V-1080755, OLAX160V-1080756, OLAX160V-1081031, OLAX160V-1081032, OLAX210, OLAX210E-1081029, OLAX210E-1081030, OLAX220, OLAX220E-1080787, OLAX220E-1080788, OLAX220V-1080789, OLAX220V-1080790, OLAX230, OLAX230E-1080791, OLAX230E-1080792, OLAX230V-1080793, OLAX230V-1080794, OLAX240, OLAX240E-1080795, OLAX240E-1080796, OLAX240V-1080797, OLAX240V-1080798, OLAX250, OLAX250E-1080760, OLAX250E-1080761, OLAX250V-1080765, OLAX250V-1080766, OLAX300, OLAX300E-1080770, OLAX300E-1080771, OLAX300E-1081033, OLAX300E-1081035, OLAX300E-1081036, OLAX300LC, OLAX300LCE-1081034, OLAX300V-1080775, OLAX300V-1080776, OLAX310, OLAX310E-1081110, OLAX310E-1081111, OLAX310LC, OLAX310LCE-1081114, OLAX310LCE-1081115...(Other models you can see in the webshop)		

door mechanics

<p>bolts</p>			
			
1			
GEV No.	517290	Ref. No.	75201
description	door bolt SS		
For models:	OLHT-11-Neutra		

linkage

			
1			
GEV No.	512425	Ref. No.	250041
description	door pin L 190mm mounting pos. left/right		
For models:	OLDS35, OLDS35-1081061, OLDS35D-1081062, OLDS35-Neutra, OLDS37, OLDS37-1081063, OLDS37D-1081064, OLDS37-Neutra, OLDS40, OLDS40-1081065, OLDS40D-1081066, OLDS40E-1081067, OLDS40ED-1081068, OLDS40-Neutra, OLG35, OLG35-1080702, OLG35D-1081000, OLG35-Neutra, OLG37, OLG37-1080700, OLG37D-1080707, OLG37LS-1081001, OLG37LSD-1081002, OLG37-Neutra, OLG540, OLG540-1080701, OLG540D-1080708, OLG540D-1081003, OLG540-Neutra, OLG540LSD-1081004		

			
1			
GEV No.	517388	Ref. No.	150221
description	door pin L 193mm mounting pos. left/right		
For models:	OLDS45, OLDS50, OLDS50-1081088, OLDS50D-1081089, OLDS50E-1081090, OLDS50ED-1081091, OLDS50-Neutra, OLG540, OLG545, OLG550, OLG550-1080705, OLG550D-1080706, OLG550E-1080730, OLG550ECO-1081014, OLG550ECOD-1081015, OLG550ED-1080731, OLG550-Neutra, OLG585, OLG585-1081016, OLG585D-1081017, OLG585-Neutra		

			
1			
GEV No.	524951	Ref. No.	15009
description	door pin L 580mm ø 8mm		
For models:	OLG600		



			
1			
GEV No.	517274	Ref. No.	150221/A
description	door pin tie bar		
For models:	OLDW020H, OLElectron1000, OLELELECTRON1000-1081084, OLELELECTRON1000D-1081085, OLLP155-1081087		



sliding plates

			
1			
GEV No.	517264	Ref. No.	150401
description	sliding plate sliding plate		
For models:	OLDS35, OLDS35-1081061, OLDS35D-1081062, OLDS35-Neutra, OLDS37, OLDS37-1081063, OLDS37D-1081064, OLDS37-Neutra, OLDS40, OLDS40-1081065, OLDS40D-1081066, OLDS40E-1081067, OLDS40ED-1081068, OLDS40-Neutra, OLDS45, OLDS50, OLDS50-1081088, OLDS50D-1081089, OLDS50E-1081090, OLDS50ED-1081091, OLDS50-Neutra, OLDW020H, OLElectron1000, OLELELECTRON1000-1081084, OLELELECTRON1000D-1081085, OLG35, OLG35-1080702, OLG35D-1081000, OLG35-Neutra, OLG37, OLG37-1080700, OLG37D-1080707, OLG37LS-1081001, OLG37LSD-1081002, OLG37-Neutra, OLG540, OLG540, OLG540-1080701, OLG540D-1080708, OLG540D-1081003, OLG540-Neutra, OLG545, OLG545LSD-1081004, OLG550, OLG550-1080705, OLG550D-1080706, OLG550E-1080730, OLG550ECO-1081014, OLG550ECOD-1081015, OLG550ED-1080731...(Other models you can see in the webshop)		

hinges

			
1			
GEV No.	517268	Ref. No.	11835/A
description	bush ID ø 8mm H 9mm bush thread M11x1 WS 13		
For models:	OLGS40, OLGS45, OLGS50, OLGS50-1080705, OLGS50D-1080706, OLGS50E-1080730, OLGS50ECO-1081014, OLGS50ECOD-1081015, OLGS50ED-1080731, OLGS50-Neutra, OLGS85, OLGS85-1081016, OLGS85D-1081017, OLGS85-Neutra		

			
1			
GEV No.	517267	Ref. No.	150211
description	door hinge hinge mounting pos. left		
For models:	OLGS40, OLGS45, OLGS50, OLGS50-1080705, OLGS50D-1080706, OLGS50E-1080730, OLGS50ECO-1081014, OLGS50ECOD-1081015, OLGS50ED-1080731, OLGS50-Neutra, OLGS85, OLGS85-1081016, OLGS85D-1081017, OLGS85-Neutra		
accessories for	517267		
	GEV No.	517266	Ref. No.
			150210
	GEV No.	517268	Ref. No.
			11835/A
	bush ID ø 8mm H 9mm bush thread M11x1 WS 13		

			
1			
GEV No.	517266	Ref. No.	150210
description	door hinge hinge mounting pos. right		
For models:	OLGS40, OLGS45, OLGS50, OLGS50-1080705, OLGS50D-1080706, OLGS50E-1080730, OLGS50ECO-1081014, OLGS50ECOD-1081015, OLGS50ED-1080731, OLGS50-Neutra, OLGS85, OLGS85-1081016, OLGS85D-1081017, OLGS85-Neutra		
accessories for	517266		
	GEV No.	517267	Ref. No.
			150211
	GEV No.	517268	Ref. No.
			11835/A
	bush ID ø 8mm H 9mm bush thread M11x1 WS 13		

			
1			
GEV No.	517271	Ref. No.	550909
description	spring holder spring holder mounting pos. left		
For models:	OLDW020H, OLElectron1000, OLELELECTRON1000-1081084, OLELELECTRON1000D-1081085, OLLP155-1081087		

			
1			
GEV No.	517270	Ref. No.	550908
description	spring holder spring holder mounting pos. right		
For models:	OLDW020H, OLElectron1000, OLELELECTRON1000-1081084, OLELELECTRON1000D-1081085, OLLP155-1081087		

door guides

			
1			
GEV No.	508421	Ref. No.	11600030 11600036
description	opposite support conversion kit		
For models:	G12S, OLH600, OLH600Electronic, OLHT11-1081071, OLHT11D-1081072, OLHT11ECO-1081070, OLHT11S, OLHT11S-Neutra, OLHT12-1081075, OLHT12EL-1081080, OLHT12EL-1081083, OLHT12ELD-1081081, OLHT12ELPLUS-1081086, OLHT12S, OLHT12SElectronic, OLHT12S-Neutra		



door bumpers

 <p>1</p>			
GEV No.	517265	Ref. No.	135222
description	door bumper end stop		
For models:	OLDS45, OLDS50, OLDS50-1081088, OLDS50D-1081089, OLDS50E-1081090, OLDS50ED-1081091, OLDS50-Neutra, OLDS50E-1081090, OLELELETRON1000-1081084, OLELELETRON1000D-1081085, OLG540, OLG545, OLG550, OLG550-1080705, OLG550D-1080706, OLG550E-1080730, OLG550ECO-1081014, OLG550ECOD-1081015, OLG550ED-1080731, OLG550-Neutra, OLG585, OLG585-1081016, OLG585D-1081017, OLG585-Neutra, OLLP155-1081087		

 <p>1</p>			
GEV No.	512426	Ref. No.	250042
description	door bumper L 16mm W 12mm		
For models:	OLDS35, OLDS35-1081061, OLDS35D-1081062, OLDS35-Neutra, OLDS37, OLDS37-1081063, OLDS37D-1081064, OLDS37-Neutra, OLDS40, OLDS40-1081065, OLDS40D-1081066, OLDS40E-1081067, OLDS40ED-1081068, OLDS40-Neutra, OLG35, OLG35-1080702, OLG35D-1081000, OLG35-Neutra, OLG537, OLG537-1080700, OLG537D-1080707, OLG537LS-1081001, OLG537LSD-1081002, OLG537-Neutra, OLG540, OLG540-1080701, OLG540D-1080708, OLG540D-1081003, OLG540-Neutra, OLG540LSD-1081004		

door shafts



 <p>1</p>			
GEV No.	517814	Ref. No.	16046
description	door guides ø 8mm L 490mm		
For models:	OLDS40-1081010, OLDS40D-1081011, OLDS40LS-1081012, OLDS40LSD-1081013, OLLinear		

 <p>1</p>			
GEV No.	517372	Ref. No.	18136
description	door shaft ø 8mm L 432mm for dishwasher		
For models:	OLDS37-1081006, OLDS37D-1081007, OLDS37LS-1081008, OLDS37LSD-1081009, OLStar		

locks

 <p>1</p>			
GEV No.	517278	Ref. No.	150402/D
description	counterpart door catch		
For models:	OLDS35, OLDS35-1081061, OLDS35D-1081062, OLDS35-Neutra, OLDS37, OLDS37-1081063, OLDS37D-1081064, OLDS37-Neutra, OLDS40, OLDS40-1081065, OLDS40D-1081066, OLDS40E-1081067, OLDS40ED-1081068, OLDS40-Neutra, OLG35, OLG35-1080702, OLG35D-1081000, OLG35-Neutra, OLG537, OLG537-1080700, OLG537D-1080707, OLG537LS-1081001, OLG537LSD-1081002, OLG537-Neutra, OLG540, OLG540-1080701, OLG540D-1080708, OLG540D-1081003, OLG540-Neutra, OLG540LSD-1081004		

 <p>1</p>			
GEV No.	517275	Ref. No.	10775
description	door catch catch		
For models:	OLDS45, OLDS50, OLDS50-1081088, OLDS50D-1081089, OLDS50E-1081090, OLDS50ED-1081091, OLDS50-Neutra, OLG540, OLG545, OLG550, OLG550-1080705, OLG550D-1080706, OLG550E-1080730, OLG550ECO-1081014, OLG550ECOD-1081015, OLG550ED-1080731, OLG550-Neutra, OLG585, OLG585-1081016, OLG585D-1081017, OLG585-Neutra, OLLP-ZERO, OLLPZERO-1081057		

 <p>1</p>							
GEV No.	517276	Ref. No.	150402				
description	door catch catch						
For models:	OLDS35, OLDS35-1081061, OLDS35D-1081062, OLDS35-Neutra, OLDS37, OLDS37-1081063, OLDS37D-1081064, OLDS37-Neutra, OLDS40, OLDS40-1081065, OLDS40D-1081066, OLDS40E-1081067, OLDS40ED-1081068, OLDS40-Neutra, OLG35, OLG35-1080702, OLG35D-1081000, OLG35-Neutra, OLG537, OLG537-1080700, OLG537D-1080707, OLG537LS-1081001, OLG537LSD-1081002, OLG537-Neutra, OLG540, OLG540-1080701, OLG540D-1080708, OLG540D-1081003, OLG540-Neutra, OLG540LSD-1081004						
accessories for	517276						
	<table border="1"> <tr> <td>GEV No.</td> <td>517277</td> <td>Ref. No.</td> <td>150403</td> </tr> </table>  <p>gasket for catch</p>	GEV No.	517277	Ref. No.	150403		
GEV No.	517277	Ref. No.	150403				
	<table border="1"> <tr> <td>GEV No.</td> <td>517278</td> <td>Ref. No.</td> <td>150402/D</td> </tr> </table>  <p>counterpart door catch</p>	GEV No.	517278	Ref. No.	150402/D		
GEV No.	517278	Ref. No.	150402/D				

miscellaneous



1

GEV No.	524955	Ref. No.	560006
description	bearing for door ID ø 12mm H 22mm L 32mm W 9mm mounting pos. right		
For models:	OLDS50P-1081018, OLDS50PD-1081019, OLElectron500, OLGastro-500Plus, OLGastro500S, OLGastro750Plus, OLGastro750S		



1

GEV No.	507552	Ref. No.	3009269
description	stop for door SS H 60mm L 72mm W 38mm		
For models:	OLAX151, OLAX151EDX-1080725, OLAX151ELEFT-1080727, OLAX151-highspeed, OLAX160, OLAX160E-1080750, OLAX160E-1080751, OLAX160V-1080755, OLAX160V-1080756, OLAX160V-1081031, OLAX160V-1081032, OLAX210, OLAX210E-1081029, OLAX210E-1081030, OLAX220, OLAX220E-1080787, OLAX220E-1080788, OLAX220V-1080789, OLAX220V-1080790, OLAX230, OLAX230E-1080791, OLAX230E-1080792, OLAX230V-1080793, OLAX230V-1080794, OLAX240, OLAX240E-1080795, OLAX240E-1080796, OLAX240V-1080797, OLAX240V-1080798, OLAX250, OLAX250E-1080760, OLAX250E-1080761, OLAX250V-1080765, OLAX250V-1080766, OLAX300, OLAX300E-1080770, OLAX300E-1080771, OLAX300E-1081033, OLAX300E-1081035, OLAX300E-1081036, OLAX300LC, OLAX300LCE-1081034, OLAX300V-1080775, OLAX300V-1080776, OLAX310, OLAX310E-1081110, OLAX310E-1081111, OLAX310LC, OLAX310LCE-1081114, OLAX310LCE-1081115...(Other models you can see in the webshop)		

screw connections



1

GEV No.	517007	Ref. No.	15042
description	screw connection		
For models:	G12S, OLG600, OLHT-11-Neutra, OLLP1-800, OLLP1-800-1080721, OLLP1-800EL, OLLP1-800-Neutra, OLLP-ZERO, OLLPZERO-1081057		

curtains

curtains



1

GEV No.	533006	Ref. No.	3004050
description	curtain W 545mm H 590mm LANG thickness 1.6mm		
For models:	OLAX151, OLAX151EDX-1080725, OLAX151ELEFT-1080727, OLAX151-highspeed, OLAX160, OLAX160E-1080750, OLAX160E-1080751, OLAX160V-1080755, OLAX160V-1080756, OLAX160V-1081031, OLAX160V-1081032, OLAX210, OLAX210E-1081029, OLAX210E-1081030, OLAX220, OLAX220E-1080787, OLAX220E-1080788, OLAX220V-1080789, OLAX220V-1080790, OLAX230, OLAX230E-1080791, OLAX230E-1080792, OLAX230V-1080793, OLAX230V-1080794, OLAX240, OLAX240E-1080795, OLAX240E-1080796, OLAX240V-1080797, OLAX240V-1080798, OLAX250, OLAX250E-1080760, OLAX250E-1080761, OLAX250V-1080765, OLAX250V-1080766, OLAX300, OLAX300E-1080770, OLAX300E-1080771, OLAX300E-1081033, OLAX300E-1081035, OLAX300E-1081036, OLAX300LC, OLAX300LCE-1081034, OLAX300V-1080775, OLAX300V-1080776, OLAX310, OLAX310E-1081110, OLAX310E-1081111, OLAX310LC, OLAX310LCE-1081114, OLAX310LCE-1081115...(Other models you can see in the webshop)		

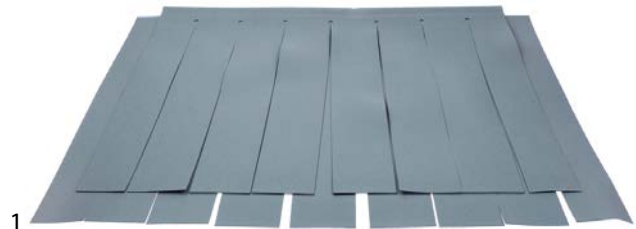

1

GEV No.	524801	Ref. No.	3004051
description	curtain W 620mm H 500mm plastic thickness 1.4mm for dishwasher		
For models:	OLAX151, OLAX151EDX-1080725, OLAX151ELEFT-1080727, OLAX151-highspeed, OLAX160, OLAX160E-1080750, OLAX160E-1080751, OLAX160V-1080755, OLAX160V-1080756, OLAX160V-1081031, OLAX160V-1081032, OLAX210, OLAX210E-1081029, OLAX210E-1081030, OLAX220, OLAX220E-1080787, OLAX220E-1080788, OLAX220V-1080789, OLAX220V-1080790, OLAX230, OLAX230E-1080791, OLAX230E-1080792, OLAX230V-1080793, OLAX230V-1080794, OLAX240, OLAX240E-1080795, OLAX240E-1080796, OLAX240V-1080797, OLAX240V-1080798, OLAX250, OLAX250E-1080760, OLAX250E-1080761, OLAX250V-1080765, OLAX250V-1080766, OLAX300, OLAX300E-1080770, OLAX300E-1080771, OLAX300E-1081033, OLAX300E-1081035, OLAX300E-1081036, OLAX300LC, OLAX300LCE-1081034, OLAX300V-1080775, OLAX300V-1080776, OLAX310, OLAX310E-1081110, OLAX310E-1081111, OLAX310LC, OLAX310LCE-1081114, OLAX310LCE-1081115...(Other models you can see in the webshop)		



1			
GEV No.	533020	Ref. No.	3060023
description	curtain W 725mm mounting pos. 500 thickness 1.5mm		
For models:	OLCX, OLFX, OLFX250E-1081151, OLFX250V-1081152, OLFX250V-1081153, OLFX380E-1081154, OLFX380E-1081155, OLFX380V-1081156, OLFX380V-1081157, OLFX420E-1081158, OLFX420E-1081159, OLFX420V-1081160, OLFX420V-1081161, OLFX540E-1081162, OLFX540E-1081163, OLFX540V-1081164, OLFX540V-1081165, OLFX600E-1081166, OLFX600E-1081167, OLFX600V-1081168, OLFX600V-1081169, OLFX680E-1081170, OLFX680E-1081171, OLFX680V-1081172, OLFX680V-1081173, OLFX780E-1081174, OLFX780E-1081175, OLFX780V-1081176, OLFX780V-1081177, OLFX900E-1081178, OLFX900E-1081179, OLFX900V-1081180, OLFX900V-1081181, WASHER-1081150		

<p>curtain rods</p>			
1			
GEV No.	533017	Ref. No.	3004052
description	curtain rod L 635mm ø 8mm		
For models:	OLAX151, OLAX151EDX-1080725, OLAX151ELEFT-1080727, OLAX151-highspeed, OLAX160, OLAX160E-1080750, OLAX160E-1080751, OLAX160V-1080755, OLAX160V-1080756, OLAX160V-1081031, OLAX160V-1081032, OLAX210, OLAX210E-1081029, OLAX210E-1081030, OLAX220, OLAX220E-1080787, OLAX220E-1080788, OLAX220V-1080789, OLAX220V-1080790, OLAX230, OLAX230E-1080791, OLAX230E-1080792, OLAX230V-1080793, OLAX230V-1080794, OLAX240, OLAX240E-1080795, OLAX240E-1080796, OLAX240V-1080797, OLAX240V-1080798, OLAX250, OLAX250E-1080760, OLAX250E-1080761, OLAX250V-1080765, OLAX250V-1080766, OLAX300, OLAX300E-1080770, OLAX300E-1080771, OLAX300E-1081033, OLAX300E-1081035, OLAX300E-1081036, OLAX300LC, OLAX300LCE-1081034, OLAX300V-1080775, OLAX300V-1080776, OLAX310, OLAX310E-1081110, OLAX310E-1081111, OLAX310LC, OLAX310LCE-1081114, OLAX310LCE-1081115...(Other models you can see in the webshop)		

<p>washing and rinsing systems</p>			
1			
GEV No.	517341	Ref. No.	75320
description	bush ID ø 16mm ED ø 48mm		
For models:	G12S, OLCX, OLFX, OLFX250E-1081151, OLFX250V-1081152, OLFX250V-1081153, OLFX380E-1081154, OLFX380E-1081155, OLFX380V-1081156, OLFX380V-1081157, OLFX420E-1081158, OLFX420E-1081159, OLFX420V-1081160, OLFX420V-1081161, OLFX540E-1081162, OLFX540E-1081163, OLFX540V-1081164, OLFX540V-1081165, OLFX600E-1081166, OLFX600E-1081167, OLFX600V-1081168, OLFX600V-1081169, OLFX680E-1081170, OLFX680E-1081171, OLFX680V-1081172, OLFX680V-1081173, OLFX780E-1081174, OLFX780E-1081175, OLFX780V-1081176, OLFX780V-1081177, OLFX900E-1081178, OLFX900E-1081179, OLFX900V-1081180, OLFX900V-1081181, OLH600, OLH600Electronic, OLHT11-1081071, OLHT11D-1081072, OLHT11ECO-1081070, OLHT11-Neutra, OLHT11S, OLHT11S-Neutra, OLHT12-1081075, OLHT12EL-1081080, OLHT12EL-1081083, OLHT12ELD-1081081, OLHT12ELPLUS-1081086, OLHT12S, OLHT12SElectronic, OLHT12S-Neutra...(Other models you can see in the webshop)		

1			
GEV No.	517310	Ref. No.	10260
description	connector holder		
For models:	OLDS45, OLDS50, OLDS50-1081088, OLDS50D-1081089, OLDS50E-1081090, OLDS50ED-1081091, OLDS50-Neutra, OLG600, OLGastro450, OLGastro500Plus, OLGastro500S, OLGastro750Plus, OLGastro750S, OLG550, OLG550-1080705, OLG550D-1080706, OLG550E-1080730, OLG550ECO-1081014, OLG550ECOD-1081015, OLG550ED-1080731, OLG550-Neutra, OLG585, OLG585-1081016, OLG585D-1081017, OLG585-Neutra, OLHT11-1081071, OLHT11D-1081072, OLHT11ECO-1081070, OLHT11S		

1			
GEV No.	517103	Ref. No.	10204
description	cover		
For models:	OLDerby, OLDS35-1081005		

1			
GEV No.	517094	Ref. No.	19250
description	cover for rinse arm shaft H 108mm D1 ø 28mm		
For models:	OLDS35, OLDS35-1081061, OLDS35D-1081062, OLDS35-Neutra, OLDS37, OLDS37-1081063, OLDS37D-1081064, OLDS37-Neutra, OLG35, OLG35D-1081000, OLG35-Neutra, OLGastro450		



1

GEV No.	517098	Ref. No.	135250
description	cover for rinse arm shaft mounting pos. lower		
For models:	OLG35-1080702, OLG37, OLG37-1080700, OLG37D-1080707, OLG37LS-1081001, OLG37LSD-1081002, OLG37-Neutra		



1

GEV No.	504370	Ref. No.	16250
description	cover for rinse arm shaft mounting pos. lower H 102mm D1 ø 27.5mm D2 ø 30mm L1 32mm L2 59mm ID ø 25mm		
For models:	OLDS40, OLDS40-1081010, OLDS40-1081065, OLDS40D-1081011, OLDS40D-1081066, OLDS40E-1081067, OLDS40ED-1081068, OLDS40LS-1081012, OLDS40LSD-1081013, OLDS40-Neutra, OLG540, OLG540, OLG540-1080701, OLG540D-1080708, OLG540D-1081003, OLG540-Neutra, OLG540LSD-1081004, OLLinear		



1

GEV No.	517129	Ref. No.	550225
description	cover wash arm support mounting pos. lower		
For models:	OLDS45, OLDS50, OLDS50-1081088, OLDS50D-1081089, OLDS50E-1081090, OLDS50ED-1081091, OLDS50-Neutra, OLDW020H, OLElectron1000, OLELELECTRON1000-1081084, OLELELECTRON1000D-1081085, OLG545, OLG550, OLG550-1080705, OLG550D-1080706, OLG550E-1080730, OLG550ECO-1081014, OLG550ECOD-1081015, OLG550ED-1080731, OLG550-Neutra, OLG585, OLG585-1081016, OLG585D-1081017, OLG585-Neutra, OLLP155-1081087		



1

GEV No.	517130	Ref. No.	560004 560024
description	cover wash arm support mounting pos. lower		
For models:	OLDS50P-1081018, OLDS50PD-1081019, OLGastro500Plus, OLGastro500S, OLGastro750Plus, OLGastro750S, OLG545, OLG550, OLG550-1080705, OLG550D-1080706, OLG550E-1080730, OLG550ECO-1081014, OLG550ECOD-1081015, OLG550ED-1080731, OLG550-Neutra, OLG585, OLG585-1081016, OLG585D-1081017, OLG585-Neutra		



1

GEV No.	517374	Ref. No.	13304
description	duct D1 ø 20mm D2 ø 14mm L 17mm int. ø 110mm		
For models:	G12S, OLDerby, OLDS35-1081005, OLDS37-1081006, OLDS37D-1081007, OLDS37LS-1081008, OLDS37LSD-1081009, OLDS40-1081010, OLDS40D-1081011, OLDS40LS-1081012, OLDS40LSD-1081013, OLG600, OLGastro450, OLH600, OLH600Electronic, OLHT11-1081071, OLHT11D-1081072, OLHT11ECO-1081070, OLHT-11-Neutra, OLHT11S, OLHT11S-Neutra, OLHT12-1081075, OLHT12EL-1081080, OLHT12EL-1081083, OLHT12ELD-1081081, OLHT12ELPLUS-1081086, OLHT12S, OLHT12SElectronic, OLHT12S-Neutra, OLLinear, OLLP1-800, OLLP1-800-1080721, OLLP1-800EL, OLLP1-800-Neutra, OLLP-ZERO, OLLPZERO-1081057, OLStar		



1

GEV No.	517112	Ref. No.	15039/A
description	extension for wash arm support		
For models:	OLG600		



1

GEV No.	517114	Ref. No.	15039
description	extension for wash arm support		
For models:	OLHT-11-Neutra		



1

GEV No.	517120	Ref. No.	22050
description	extension for wash arm support		
For models:	OLLP1-800, OLLP1-800-1080721, OLLP1-800EL, OLLP1-800-Neutra, OLLP-ZERO, OLLPZERO-1081057		



1

GEV No.	517095	Ref. No.	16038
description	flange ø 60mm		
For models:	OLDS35, OLDS35-1081061, OLDS35D-1081062, OLDS35-Neutra, OLDS37, OLDS37-1081063, OLDS37D-1081064, OLDS37-Neutra, OLDS40, OLDS40-1081010, OLDS40-1081065, OLDS40D-1081011, OLDS40D-1081066, OLDS40E-1081067, OLDS40ED-1081068, OLDS40LS-1081012, OLDS40LSD-1081013, OLDS40-Neutra, OLG35, OLG35-1080702, OLG35D-1081000, OLG35-Neutra, OLGastro450, OLG37, OLG37-1080700, OLG37D-1080707, OLG37LS-1081001, OLG37LSD-1081002, OLG37-Neutra, OLG540, OLG540, OLG540-1080701, OLG540D-1080708, OLG540D-1081003, OLG540-Neutra, OLG540LSD-1081004, OLLinear		



GEV No.	517148	Ref. No.	540032
description	flat gasket rubber ED ø 57mm ID ø 43mm thickness 2mm Qty 1 pcs		
For models:	OLDS40, OLDS40-1081065, OLDS40D-1081066, OLDS40E-1081067, OLDS40ED-1081068, OLDS40-Neutra, OLElectron400		



GEV No.	511944	Ref. No.	13306/A
description	gasket for wash pipe ø 41mm thickness 10mm ID ø 27mm		
For models:	OLDS37-1081006, OLDS37D-1081007, OLDS37LS-1081008, OLDS37LSD-1081009, OLDS40-1081010, OLDS40D-1081011, OLDS40LS-1081012, OLDS40LSD-1081013, OLG35-1080702, OLGastro450, OLG37, OLG37-1080700, OLG37D-1080707, OLG37LS-1081001, OLG37LSD-1081002, OLG37-Neutra, OLG540, OLG540, OLG540-1080701, OLG540D-1080708, OLG540D-1081003, OLG540-Neutra, OLG540LSD-1081004, OLLinear, OLStar		



GEV No.	517138	Ref. No.	10225
description	guide for rinse arm shaft		
For models:	OLElectron400		



GEV No.	517163	Ref. No.	15151
description	manifold connection 4-way		
For models:	OLDerby, OLDS35-1081005, OLDS37-1081006, OLDS37D-1081007, OLDS37LS-1081008, OLDS37LSD-1081009, OLDS40-1081010, OLDS40D-1081011, OLDS40LS-1081012, OLDS40LSD-1081013, OLG35, OLG35D-1081000, OLG540, OLLinear, OLStar		



GEV No.	517134	Ref. No.	540069
description	nut		
For models:	OLDS40, OLDS40-1081065, OLDS40D-1081066, OLDS40E-1081067, OLDS40ED-1081068, OLDS40-Neutra, OLElectron400		



GEV No.	517070	Ref. No.	75317
description	nut for wash arm		
For models:	G12S, OLCX, OLDW020H, OLElectron1000, OLELELECTRON1000-1081084, OLELELECTRON1000D-1081085, OLFX, OLFX250E-1081151, OLFX250V-1081152, OLFX250V-1081153, OLFX380E-1081154, OLFX380E-1081155, OLFX380V-1081156, OLFX380V-1081157, OLFX420E-1081158, OLFX420E-1081159, OLFX420V-1081160, OLFX420V-1081161, OLFX540E-1081162, OLFX540E-1081163, OLFX540V-1081164, OLFX540V-1081165, OLFX600E-1081166, OLFX600E-1081167, OLFX600V-1081168, OLFX600V-1081169, OLFX680E-1081170, OLFX680E-1081171, OLFX680V-1081172, OLFX680V-1081173, OLFX780E-1081174, OLFX780E-1081175, OLFX780V-1081176, OLFX780V-1081177, OLFX900E-1081178, OLFX900E-1081179, OLFX900V-1081180, OLFX900V-1081181, OLFH600, OLFH600Electronic, OLHT11-1081071, OLHT11D-1081072, OLHT11ECO-1081070, OLHT-11-Neutra, OLHT11S, OLHT11S-Neutra, OLHT12-1081075, OLHT12EL-1081080, OLHT12EL-1081083, OLHT12ELD-1081081...(Other models you can see in the webshop)		



GEV No.	517085	Ref. No.	80222
description	nut for wash arm		
For models:	OLLP2-1080722, OLLP2Electronic-Neutra		



GEV No.	524959	Ref. No.	500702
description	nut for wash arm mounting pos. upper/lower ø 35mm H 34mm PTFE		
For models:	OLDS50, OLDS50-1081088, OLDS50D-1081089, OLDS50E-1081090, OLDS50ED-1081091, OLDS50-Neutra, OLElectron500, OLG550, OLG550-1080705, OLG550D-1080706, OLG550E-1080730, OLG550ECO-1081014, OLG550ECOD-1081015, OLG550ED-1080731, OLG550-Neutra		



1

GEV No.	517154	Ref. No.	500610 500623
description	nut mounting pos. upper for wash arm support		
For models:	OLDS45, OLDS50, OLDS50-1081088, OLDS50D-1081089, OLDS50E-1081090, OLDS50ED-1081091, OLDS50-Neutra, OLDS50P-1081018, OLDS50PD-1081019, OLDW020H, OLElectron1000, OLElectron500, OLELELECTRON1000-1081084, OLELELECTRON1000D-1081085, OLGastro500Plus, OLGastro500S, OLGastro750Plus, OLGastro750S, OLGs45, OLGs50, OLGs50-1080705, OLGs50D-1080706, OLGs50E-1080730, OLGs50ECO-1081014, OLGs50ECOD-1081015, OLGs50ED-1080731, OLGs50-Neutra, OLGs85, OLGs85-1081016, OLGs85D-1081017, OLGs85-Neutra, OLLP155-1081087		



2

GEV No.	524853	Ref. No.	12518
description	reducer for wash arm support \varnothing 30mm ID \varnothing 14mm ED \varnothing 24.5mm H 9mm		
For models:	OLElectron400, OLG35-1080702, OLGs37, OLGs37-1080700, OLGs37D-1080707, OLGs37LS-1081001, OLGs37LSD-1081002, OLGs37-Neutra, OLGs40, OLGs40, OLGs40-1080701, OLGs40D-1080708, OLGs40D-1081003, OLGs40-Neutra, OLGs450LSD-1081004		



1

GEV No.	517155	Ref. No.	75319
description	rinse arm support for stationary arms mounting pos. upper		
For models:	G12S, OLH600, OLH600Electronic, OLHT11-1081071, OLHT11D-1081072, OLHT11ECO-1081070, OLHT-11-Neutra, OLHT11S, OLHT11S-Neutra, OLHT12-1081075, OLHT12EL-1081080, OLHT12EL-1081083, OLHT12ELD-1081081, OLHT12ELPLUS-1081086, OLHT12S, OLHT12SElectronic, OLHT12S-Neutra, OLLP1-800, OLLP1-800-1080721, OLLP1-800EL, OLLP1-800-Neutra, OLLP-ZERO, OLLPZERO-1081057		



1

GEV No.	517143	Ref. No.	10909
description	rinse arm support mounting pos. upper		
For models:	OLDerby, OLDS35-1081005, OLDS37-1081006, OLDS37D-1081007, OLDS37LS-1081008, OLDS37LSD-1081009, OLDS40-1081010, OLDS40D-1081011, OLDS40LS-1081012, OLDS40LSD-1081013, OLLinear, OLStar		
accessories for	517143		
	GEV No.	517066	Ref. No. 11101/A
	Thumb screw thread M8 thread L 8mm \varnothing 30mm H 3mm SS mounting pos. upper		



1

GEV No.	517161	Ref. No.	10600202
description	rinse arm support mounting pos. upper		
For models:	OLLP1-1081059, OLLP2-1080722, OLLP2Electronic-Neutra, OLLP3-1080723, OLLP3Electronic-Neutra, OLLP4-800-1081058, OLLP4-800Electronic-Neutra		



1

GEV No.	524952	Ref. No.	3003129
description	rinse arm support mounting pos. upper/lower thread 3/8" hose \varnothing 11.5mm		
For models:	OLAX380, OLAX380LC, OLAX400		



1

GEV No.	517111	Ref. No.	15303
description	rinse pipe		
For models:	OLG600		



1

GEV No.	517113	Ref. No.	15304
description	rinse pipe		
For models:	OLHT-11-Neutra		



1

GEV No.	517116	Ref. No.	75315
description	rinse pipe		
For models:	OLDS50, OLDS50-1081088, OLDS50D-1081089, OLDS50E-1081090, OLDS50ED-1081091, OLDS50-Neutra, OLDW020H, OLElectron1000, OLELELECTRON1000-1081084, OLELELECTRON1000D-1081085, OLGs50, OLGs50-1080705, OLGs50D-1080706, OLGs50E-1080730, OLGs50ECO-1081014, OLGs50ECOD-1081015, OLGs50ED-1080731, OLGs50-Neutra, OLHT-11-Neutra, OLLP1-800, OLLP1-800-1080721, OLLP1-800EL, OLLP1-800-Neutra, OLLP155-1081087, OLLP-ZERO, OLLPZERO-1081057		





1

GEV No.	517119	Ref. No.	22026
description	rinse pipe		
For models:	OLLP1-800, OLLP1-800-1080721, OLLP1-800EL, OLLP1-800-Neutra, OLLP-ZERO, OLLPZERO-1081057		





			
GEV No.	517126	Ref. No.	550226
description	rinse pipe		
For models:	OLDS45, OLDS50, OLDS50-1081088, OLDS50D-1081089, OLDS50E-1081090, OLDS50ED-1081091, OLDS50-Neutra, OLG545, OLG550, OLG550-1080705, OLG550D-1080706, OLG550E-1080730, OLG550ECO-1081014, OLG550ECOD-1081015, OLG550ED-1080731, OLG550-Neutra, OLG585, OLG585-1081016, OLG585D-1081017, OLG585-Neutra		

			
GEV No.	517140	Ref. No.	11600021
description	rinse pipe mounting pos. lower		
For models:	G12S, OLH600, OLH600Electronic, OLHT12-1081075, OLHT12EL-1081080, OLHT12EL-1081083, OLHT12ELD-1081081, OLHT12ELPLUS-1081086, OLHT12S, OLHT12SElectronic, OLHT12S-Neutra		

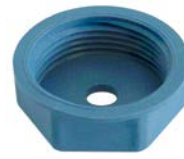
			
GEV No.	517132	Ref. No.	560005
description	rinse pipe		
For models:	OLDS50P-1081018, OLDS50PD-1081019, OLGastro500Plus, OLGastro500S, OLGastro750Plus, OLGastro750S		

			
GEV No.	517149	Ref. No.	540070
description	screw connection ø 10mm with hole		
For models:	OLElectron400		

			
GEV No.	517157	Ref. No.	75322
description	rinse pipe		
For models:	G12S, OLH600, OLH600Electronic, OLHT11-1081071, OLHT11D-1081072, OLHT11ECO-1081070, OLHT11-Neutra, OLHT11S, OLHT11S-Neutra, OLHT12-1081075, OLHT12EL-1081080, OLHT12EL-1081083, OLHT12ELD-1081081, OLHT12ELPLUS-1081086, OLHT12S, OLHT12SElectronic, OLHT12S-Neutra, OLLP1-800, OLLP1-800-1080721, OLLP1-800EL, OLLP1-800-Neutra, OLLP-ZERO, OLLPZERO-1081057		

			
GEV No.	517115	Ref. No.	75321
description	spacer piece		
For models:	OLHT11-1081071, OLHT11D-1081072, OLHT11ECO-1081070, OLHT11-Neutra, OLHT11S, OLHT11S-Neutra, OLLP1-800, OLLP1-800-1080721, OLLP1-800EL, OLLP1-800-Neutra, OLLP-ZERO, OLLPZERO-1081057		



			
GEV No.	517144	Ref. No.	350402
description	rinse pipe angled mounting pos. upper		
For models:	OLDS35, OLDS35-1081061, OLDS35D-1081062, OLDS35-Neutra, OLDS37, OLDS37-1081063, OLDS37D-1081064, OLDS37-Neutra, OLG35, OLG35-1080702, OLG35D-1081000, OLG35-Neutra, OLG37, OLG37-1080700, OLG37D-1080707, OLG37LS-1081001, OLG37LSD-1081002, OLG37-Neutra, OLG540, OLG540, OLG540-1080701, OLG540D-1080708, OLG540D-1081003, OLG540-Neutra, OLG540LSD-1081004		

			
GEV No.	517127	Ref. No.	550220
description	spacer piece		
For models:	OLDS50, OLDS50-1081088, OLDS50D-1081089, OLDS50E-1081090, OLDS50ED-1081091, OLDS50-Neutra, OLW020H, OLElectron1000, OLElectron500, OLELELECTRON1000-1081084, OLELELECTRON1000D-1081085, OLG550, OLG550-1080705, OLG550D-1080706, OLG550E-1080730, OLG550ECO-1081014, OLG550ECOD-1081015, OLG550ED-1080731, OLG550-Neutra, OLLP1S5-1081087		

			
GEV No.	511638	Ref. No.	3003951
description	rinse pipe L 600mm		
For models:	OLAX300, OLAX300E-1080770, OLAX300E-1080771, OLAX300E-1081033, OLAX300E-1081035, OLAX300E-1081036, OLAX300LC, OLAX300LCE-1081034, OLAX300V-1080775, OLAX310, OLAX310E-1081110, OLAX310E-1081111, OLAX310LC, OLAX310LCE-1081114, OLAX310LCE-1081115, OLAX310LCV-1081116, OLAX310LCV-1081117, OLAX310V-1081112, OLAX310V-1081113, OLAX320, OLAX320E-1081118, OLAX320E-1081119, OLAX320V-1081120, OLAX320V-1081121, OLAX320V-1081125, OLAX330, OLAX330E-1081122, OLAX330E-1081123, OLAX330V-1081124		

			
GEV No.	517139	Ref. No.	11600033
description	throttle disc		
For models:	G12S, OLH600, OLH600Electronic, OLHT12-1081075, OLHT12EL-1081080, OLHT12EL-1081083, OLHT12ELD-1081081, OLHT12ELPLUS-1081086, OLHT12S, OLHT12SElectronic, OLHT12S-Neutra, OLLP1-1081059, OLLP2-1080722, OLLP2Electronic-Neutra, OLLP3-1080723, OLLP3Electronic-Neutra, OLLP4-800-1081058, OLLP4-800Electronic-Neutra		

			
1			
GEV No.	517158	Ref. No.	10377
description	Thumb screw ø 8mm		
For models:	OLDS35, OLDS35-1081061, OLDS35D-1081062, OLDS35-Neutra, OLDS37, OLDS37-1081063, OLDS37D-1081064, OLDS37-Neutra, OLDS40, OLDS40-1081065, OLDS40D-1081066, OLDS40E-1081067, OLDS40ED-1081068, OLDS40-Neutra, OLElectron400, OLG35-Neutra, OLG540, OLG540-1080701, OLG540D-1080708, OLG540D-1081003, OLG540-Neutra, OLG540SLSD-1081004		

			
1			
GEV No.	524804	Ref. No.	10652
description	Thumb screw thread M5 thread L 7mm ø 30mm H 5mm SS Qty 1 pcs		
For models:	OLDS40, OLDS40-1081065, OLDS40D-1081066, OLDS40E-1081067, OLDS40ED-1081068, OLDS40-Neutra, OLDS50, OLDS50-1081088, OLDS50D-1081089, OLDS50E-1081090, OLDS50ED-1081091, OLDS50-Neutra, OLDW020H, OLElectron1000, OLElectron400, OLElectron500, OLELELECTRON1000-1081084, OLELELECTRON1000D-1081085, OLG550, OLG550-1080705, OLG550D-1080706, OLG550E-1080730, OLG550ECO-1081014, OLG550ECOD-1081015, OLG550ED-1080731, OLG550-Neutra, OLH600, OLH600Electronic, OLHT11-1081071, OLHT11D-1081072, OLHT11ECO-1081070, OLHT11S, OLHT11S-Neutra, OLHT12-1081075, OLHT12EL-1081080, OLHT12EL-1081083, OLHT12ELD-1081081, OLHT12ELPLUS-1081086, OLHT12S, OLHT12SElectronic, OLHT12S-Neutra, OLLP1-1081059, OLLP1-800, OLLP1-800-1080721, OLLP1-800EL, OLLP1-800-Neutra, OLLP1S5-1081087, OLLP1-S8, OLLP1-S8EL, OLLP2-1080722...(Other models you can see in the webshop)		
accessories for	524804		
	GEV No.	505277	Ref. No. 10651
	rinse arm shaft warewashing ø 14mm H 38mm thread 1/4"		

			
1			
GEV No.	517071	Ref. No.	75316
description	wash arm bearing		
For models:	OLDW020H, OLElectron1000, OLELELECTRON1000-1081084, OLELELECTRON1000D-1081085, OLLP1S5-1081087, OLLP1-S8, OLLP1-S8EL, OLLP2-1080742, OLLP2PLUS, OLLP3-1080743, OLLP-3PLUS, OLLP4-1081258, OLLP-4PLUS		

			
1			
GEV No.	517084	Ref. No.	80221
description	wash arm bearing		
For models:	OLLP2-1080722, OLLP2Electronic-Neutra		

			
1			
GEV No.	524798	Ref. No.	540077
description	wash arm bearing mounting pos. lower 3 holes hole ø 3mm seat ø 20mm ø 46mm H 35mm		
For models:	OLElectron400		

			
1			
GEV No.	524799	Ref. No.	540078
description	wash arm bearing mounting pos. upper/lower 3 holes hole ø 3mm seat ø 20mm ø 46mm H 32mm		
For models:	OLDS40, OLDS40-1081065, OLDS40D-1081066, OLDS40E-1081067, OLDS40ED-1081068, OLDS40-Neutra, OLElectron400		

			
1			
GEV No.	517369	Ref. No.	500701
description	wash arm bearing ø 16.5mm H 18.5mm		
For models:	OLDS50, OLDS50-1081088, OLDS50D-1081089, OLDS50E-1081090, OLDS50ED-1081091, OLDS50-Neutra, OLElectron500, OLG550, OLG550-1080705, OLG550D-1080706, OLG550E-1080730, OLG550ECO-1081014, OLG550ECOD-1081015, OLG550ED-1080731, OLG550-Neutra		

			
1			
GEV No.	517471	Ref. No.	3060204
description	wash distributor mounting pos. lower ø 32mm L 177mm SS		
For models:	OLCX, OLFX, OLFX250E-1081151, OLFX250V-1081152, OLFX250V-1081153, OLFX380E-1081154, OLFX380E-1081155, OLFX380V-1081156, OLFX380V-1081157, OLFX420E-1081158, OLFX420E-1081159, OLFX420V-1081160, OLFX420V-1081161, OLFX540E-1081162, OLFX540E-1081163, OLFX540V-1081164, OLFX540V-1081165, OLFX600E-1081166, OLFX600E-1081167, OLFX600V-1081168, OLFX600V-1081169, OLFX680E-1081170, OLFX680E-1081171, OLFX680V-1081172, OLFX680V-1081173, OLFX780E-1081174, OLFX780E-1081175, OLFX780V-1081176, OLFX780V-1081177, OLFX900E-1081178, OLFX900E-1081179, OLFX900V-1081180, OLFX900V-1081181, WASHER-1081150		



			
1			
GEV No.	517469	Ref. No.	3060151
description	wash distributor mounting pos. lower ø 32mm L 355mm SS		
For models:	OLCX, OLFX, OLFX250E-1081151, OLFX250V-1081152, OLFX250V-1081153, OLFX380E-1081154, OLFX380E-1081155, OLFX380V-1081156, OLFX380V-1081157, OLFX420E-1081158, OLFX420E-1081159, OLFX420V-1081160, OLFX420V-1081161, OLFX540E-1081162, OLFX540E-1081163, OLFX540V-1081164, OLFX540V-1081165, OLFX600E-1081166, OLFX600E-1081167, OLFX600V-1081168, OLFX600V-1081169, OLFX680E-1081170, OLFX680E-1081171, OLFX680V-1081172, OLFX680V-1081173, OLFX780E-1081174, OLFX780E-1081175, OLFX780V-1081176, OLFX780V-1081177, OLFX900E-1081178, OLFX900E-1081179, OLFX900V-1081180, OLFX900V-1081181, WASHER-1081150		

			
1			
GEV No.	517382	Ref. No.	11600103
description	wash pipe L 635mm stainless steel suitable for Dihr		
For models:	OLFX600, OLFX600Electronic, OLHT11-1081071, OLHT11D-1081072, OLHT11ECO-1081070, OLHT11S, OLHT11S-Neutra, OLHT12-1081075, OLHT12EL-1081080, OLHT12EL-1081083, OLHT12ELD-1081081, OLHT12ELPLUS-1081086, OLHT12S, OLHT12SElectronic, OLHT12S-Neutra		

<h3>gear wheels</h3>			
			
1			
GEV No.	699261	Ref. No.	3060022
description	gear wheel plastic W 37.5mm ID ø 25mm ED ø 150mm		
For models:	OLCX, OLFX, OLFX250E-1081151, OLFX250V-1081152, OLFX250V-1081153, OLFX380E-1081154, OLFX380E-1081155, OLFX380V-1081156, OLFX380V-1081157, OLFX420E-1081158, OLFX420E-1081159, OLFX420V-1081160, OLFX420V-1081161, OLFX540E-1081162, OLFX540E-1081163, OLFX540V-1081164, OLFX540V-1081165, OLFX600E-1081166, OLFX600E-1081167, OLFX600V-1081168, OLFX600V-1081169, OLFX680E-1081170, OLFX680E-1081171, OLFX680V-1081172, OLFX680V-1081173, OLFX780E-1081174, OLFX780E-1081175, OLFX780V-1081176, OLFX780V-1081177, OLFX900E-1081178, OLFX900E-1081179, OLFX900V-1081180, OLFX900V-1081181, OLUX220, WASHER-1081150		

knobs

producer-specific knobs

<h3>OLIS</h3>			
			
1			
GEV No.	110950	Ref. No.	8215400 9998191006 BN8215400 BN9998191006
description	knob gas tap with ignition flame t.max.°C ø 65mm shaft ø 6x4.6mm shaft flat upper black		
For models:	40SCG, 40SCG-1825000, 40SCG3S-1826000, 40SCG4S-1827000, 60SCG, 60SCG-1825010, 60SCG2S-1826010, 60SCG3S-1826010, 61SCGFE3S-1826055, 61SCGFE4S-1827055, TOP-1827010		

			
1			
GEV No.	110973	Ref. No.	8215503 BN8215503
description	knob gas thermostat t.max. 190°C 110-190°C ø 65mm shaft ø 10x8mm shaft flat upper black		
For models:	40SGFR, 40SGFR-1826160, 40SGFR2S-1826160, 60SGFR, 60SGFR-1826170, 60SGFR2S-1826170		

			
1			
GEV No.	110957	Ref. No.	8215502 BN8215502
description	knob gas thermostat t.max. 260°C 80-200°C ø 65mm shaft ø 10x8mm shaft flat upper black		
For models:	40SGFT, 40SGFT-1825020, 40SGFTC, 40SGFTC-1825025, 40SGFTR, 40SGFTR-1825021, 60SGFT, 60SGFT1-3R-1825030, 60SGFT-1825030, 60SGFTC, 60SGFTC-1825035, 80SGFTC-1825038		



1

GEV No.	110956	Ref. No.	8215500 BN8215500
description	knob gas thermostat t.max. 320°C 90-320°C ø 65mm shaft ø 10x8mm shaft flat upper black		
For models:	40SGFT, 40SGFT-1825020, 40SGFTC, 40SGFTC-1825025, 40SGFTR, 40SGFTR-1825021, 60SGFT, 60SGFT1-2R-1825031, 60SGFT1-3R-1825030, 60SGFT-1825030, 60SGFTC, 60SGFTC-1825035, 60SGFTR-1825032		



1

GEV No.	110954	Ref. No.	8219307 9998191007 BN9998191007
description	knob thermostat t.max. 110°C ø 65mm shaft ø 6x4.6mm shaft flat upper black temperature range 30-110°C		



2

GEV No.	110965	Ref. No.	8215800 9998191012 BN8215800
description	knob graduated ø 65mm shaft ø 6x4.6mm shaft flat upper black		
For models:	40SEW, 40SEW-1825190, 760P-EI-1000770R		



1

GEV No.	110967	Ref. No.	8215303 9998191005
description	knob thermostat t.max. 150°C 50-150°C ø 65mm shaft ø 6x4.6mm shaft flat upper black rotation 270°		
For models:	40SECP, 40SECP-1825080		



1

GEV No.	110972	Ref. No.	8215700 9998191011
description	knob switch 0-1 ø 65mm shaft ø 6x4.6mm shaft flat upper black		
For models:	40SECC, 40SECC-1826260, 725KB-G-1000110, 725KBG-1000110, 725KB-G-1000110R, 725KB-GB-1000111R, 725KB-GM-1000120R, 725KB-GMB-1000121R		



1

GEV No.	110975	Ref. No.	8215304 9998191002 BN8215304 BN9998191002
description	knob thermostat t.max. 190°C ø 65mm shaft ø 6x4.6mm shaft flat upper black temperature range 100-190°C rotation 270°		
For models:	40SEFR, 40SEFR-1826140, 40SEFR2S-1826140, 41SEFR, 41SEFR-1826120, 421SEFR-1826125, 60SEFR, 60SEFR-1826150, 60SEFR2S-1826150, 61SEFR, 61SEFR-1826130, 621SEFR-1826135		



1

GEV No.	110951	Ref. No.	8215600 9998191001 BN8215600 BN9998191001
description	knob switch 7-position ø 65mm shaft ø 6x4.6mm shaft flat upper black		
For models:	40SEC, 40SEC-1825060, 60SEC, 60SEC-1825070, 61SECFE-1826075		





1

GEV No.	110962	Ref. No.	8215302 9998191009 BN8215302 BN9998191009
description	knob thermostat t.max. 240°C ø 65mm shaft ø 6x4.6mm shaft flat upper black temperature range 160-240°C		
For models:	40SEFT-1825045, 40SEFTC-1825045, 40SEFTR-1825041, 60SEFT1-3RIG-1825050, 60SEFT-1825050, 60SEFTC-1825050, 60SEFTC-1825055, 60SEFTRIG-1825050, 80SEFTC-1825058		

			
1			
GEV No.	110966	Ref. No.	8215305 9998191010
description	knob thermostat t.max. 300°C ø 65mm shaft ø 6x4.6mm shaft flat upper black temperature range 100-300°C rotation 270°		
For models:	40SEKB-1825200, 40SKE, 40SKE-1825200		

			
1			
GEV No.	110961	Ref. No.	8215300 9998191003 BN8215300 BN9998191003
description	knob thermostat t.max. 300°C ø 65mm shaft ø 6x4.6mm shaft flat upper black temperature range 150-300°C		
For models:	40SEFT, 40SEFT-1825040, 40SEFT-1825045, 40SEFTC, 40SEFTC-1825045, 40SEFTR, 40SEFTR-1825041, 60SEFT, 60SEFT1-3RIG-1825050, 60SEFT-1825050, 60SEFTC, 60SEFTC-1825050, 60SEFTRIG-1825050		

			
1			
GEV No.	110963	Ref. No.	2599008 2994310 9998191000 BN2599008 BN2994310 BN9998191000
description	knob thermostat t.max. 300°C ø 65mm shaft ø 6x4.6mm shaft flat upper black temperature range 50-300°C		
For models:	74FTE-1000800, 74FTE-1000801, 78FT-E-1000900, 78FTE-1000900, 921FTE-1292401, 921FTE-1292403, 921FTE-1292501, 921TFTE-1292491, 921TFTE-1292493, 921TFTE-1292591, 941FTE-1292402, 941FTE1-2R-1292502, 941FTE1-2RAC-1292562, 941FTEAC-1292462, 941FTEACC-1292464, 941FTE-1292404, 941FTE-1292502, 941FTEAC-1292562, 941TFTE-1292492, 941TFTE1-2R-1292592, 941TFTE-1292494, 941TFTE-1292592		

			
1			
GEV No.	110969	Ref. No.	8215301 BN8215301
description	knob thermostat t.max. 80°C ø 65mm shaft ø 6x4.6mm shaft flat lower black temperature range 60-80°C rotation 270°		
For models:	40SEBM, 40SEBM-1826100, 40SEBM2S-1826100, 60SEBM, 60SEBM-1826110, 60SEBM2S-1826110		

			
1			
GEV No.	110353	Ref. No.	2599001 BN2599001
description	knob gas tap with ignition flame t.max.°C ø 77mm shaft ø 10x8mm shaft flat lower black		
For models:	31FOGV-1950001, 31FOGV-1950002, 31FOGV-1000003, 31FOGVM-1000007, 32FOGV2-1000002, 32FOGVG-1000004, 32FOGVM-1000015, 70P-GI-1000750R, 714CT-GV-1000170, 714CTGV-1000170, 714CTGV-1000170R, 714CTGVFE-1000180, 714CT-GVFE-1000180R, 714TA-GV-1000190R, 729CAGV-1950009, 729CAGV-1950009R, 729TCGV-1959009R, 749CAGV-1950019, 749CAGV-1950019R, 749CGV-1950039, 749CGV-1950039R, 749CGVFE-1950059, 749CGVFE-1950059R, 749TCGV-1959019R, 74CPG-1000955, 74CP-G-1000955R, 74PLG-1000940, 74PL-G-1000940R, 74TPLG-1009940, 74TPLG-1009940R, 760P-GD-1000760R, 769CAGV-1950029, 769CAGV-1950029R, 769CGV-1950049, 769CGV-1950049R, 769CGVAC-1950079, 769CGVAC-1950079R, 769CGVFE-1950089, 769CGVFE-1950089R, 769CGVFE-1950099, 769CGVFEAC-1950099, 769CGVFL-1950069, 769CGVFL-1950069R, 769CTGV-1950194, 769CT-GV-1950194R, 769TCGV-1959029R, 78CPG-1000960, 78CP-G-1000960R, 78PLG, 78PL-G-1000980...(Other models you can see in the webshop)		

			
1			
GEV No.	110959	Ref. No.	2599006 BN2599006
description	knob gas thermostat 1-8 ø 77mm shaft ø 10x8mm shaft flat lower black		
For models:	74FTG-1000130, 74FT-G-1000130R, 74FT-G-1000131R, 74FTGC-1000135, 74FT-GC-1000135R, 74FTGR-1000131, 74FTTG-1009130R, 74FTTG1-1R-1009131R, 74FTTG-1009135R, 78FT-G-1000140, 78FTG-1000140, 78FT-G-1000140R, 78FT-GR1-1-1000142R, 78FT-GR1-2-1000141R, 78FTTG-1009140R, 78FTTG1-2R-1009141R		

			
1			
GEV No.	110952	Ref. No.	2599013 2994360 BN2994360
description	knob switch 7-position t.max.°C ø 77mm shaft ø 6x4.6mm shaft flat upper black		
For models:	741CE-1000405, 74CE-1000400, 761CE-1000455, 761CEAC-1000505, 76CE-1000450, 76CEAC-1000500, 921CE-1292102, 921TCE-1292092, 941CE-1292104, 941CEAC-1292164, 941CEE-1292224, 941TCE-1292094, 961CE-1292106, 961CEEE-1292246, 961TCE-1292096		

			
1			
GEV No.	110974	Ref. No.	2994380 BN2994380
description	knob thermostat t.max. 180°C ø 77mm shaft ø 6x4.6mm shaft flat upper black temperature range 100-180°C rotation 270°		
For models:	710FRE-1077700, 712FRE-1077900, 720FRE-1077800, 722FRE-1078000, 912PFRG-1103925, 914PFRG-1103950, 92FRG-1191925, 92RFRG-1391925, 94FRG, 94FRG-1191950, 94RFRG-1391950		

			
1			
GEV No.	110978	Ref. No.	2599011 2994340 BN2599011 BN2994340
description	knob thermostat t.max. 300°C ø 77mm shaft ø 6x4.6mm shaft flat upper black temperature range 50-300°C		
For models:	92FRE-192925, 92FRG, 94FRE-192950, 94FRG-191950, 94KBE, 94KBE-1192870, 94KBEM-1192880, 94KBG-1191870, 94KBG-191870, 94KBGM-1191880, 94KBGM-191600, 94RKBE-1392870, 94RKBE-1392880, 94RKBG-1391870, 94RKBGM-1391880		

			
1			
GEV No.	110052	Ref. No.	6A019390 BN6A019301 BN6A019390
description	knob gas tap with ignition flame ø 72mm shaft ø 10x8mm shaft flat lower black		
For models:	714CTGV-000190, 714TAGV-000190, 716CTG-000195, 716CTGV-000195, 729CAGV-000009, 72CAGV-000010, 749CAGV-000019, 749CGV-000039, 74CAGV-000020, 74CGV-000040, 769CAGV-000029, 769CGV-000049, 769CGVFL-000069, 76CAGV-000030, 76CGV-000050, 76CGVFL-000070, 7741CGV-1950226, 7741CGV-1950266, 7741C-GV-GAS-1950266, 7742C-GV-1950267, 7742CGV-1950267, 7961CGV-1950276, 7961C-GVGAS-1950276, 7962C-GV-1950277, 7962CGV-1950277, CG796-000270		

			
1			
GEV No.	110958	Ref. No.	6A019391 BN6A019391
description	knob gas thermostat 1-8 ø 72mm shaft ø 10x8mm shaft flat lower black		
For models:	74FTG-000130, 7741CGV-1950226, 7742CGV-1950267, 78FTG-000140, 7962C-GV-1950277, 7962CGV-1950277		

			
1			
GEV No.	112645	Ref. No.	2599223 BN2599223
description	knob 1-6 ø 65mm shaft ø 6x4.6mm shaft flat upper black		
For models:	94-04CTEES, 94-04CTEES-12901185, 94-04CTEES-12901185BN, 94-04CTES, 94-04CTES-12901175, 94-04CTES, 94-04CTES-12931175		

			
1			
GEV No.	112557	Ref. No.	2599200 BN2599200
description	knob gas tap with ignition flame t.max.°C ø 65mm shaft ø 8x6.5mm shaft flat upper black		
For models:	110-90CTG, 110-90CTGE, 110-90CTGG, 110-90CTG, 4FX, 72+2CTGG-12700013, 72-02CG, 72-02CG-12700001, 72-02CG-12700001TA, 72-02CPG, 72-02CPG-12700900, 72-02FTG, 72-02FTG-12700130TA, 72-02FTG-12700300, 72-02FTG-12700300TA, 72-02FTGR, 72-02FTGR-12700132TA, 72-02FTGR-12700302, 72-02FTGR-12700302TA, 72-02FTTG-12700130, 72-02FTTG-12700132, 72-02PLG, 72-02PLG-12700850, 72-02PLG-12700850TA, 72-02TCG, 72-02TCG-12730001, 72-02TCG-12730001TA, 72-02TFTG, 72-02TFTG-12730130, 72-02TFTG-12730130TA, 72-02TFTG-12730300, 72-02TFTG-12730300TA, 72-02TFTGR, 72-02TFTGR-12730132, 72-02TFTGR-12730132TA, 72-02TFTGR-12730302, 72-02TFTGR-12730302TA, 72-02TGC, 72-02TGC, 72-02TGC-12730850, 72-02TGC-12730850TA, 74+2CTGG-AN-12700025, 74-02+2CTGG, 74-02+2CTGG-12700030, 74-02CG, 74-02CG-12700002, 74-02CG-12700002TA, 74-02CGE, 74-02CGE-12700011, 74-02CGE-12700011TA...(Other models you can see in the webshop)		

			
1			
GEV No.	580138	Ref. No.	BN2599300
description	knob gas tap with ignition flame t.max.°C ø 79mm shaft ø 8x6.5mm shaft flat upper black		

			
1			
GEV No.	112660	Ref. No.	2599206 BN2599206
description	knob ø 79mm shaft ø 6x4.6mm t.max. 90°C shaft flat upper black		
For models:	72-02CPE, 72-02CPE-12701900, 74-02CPE, 74-02CPE-12701905, 92-04CPE, 92-04CPE-12901900, 94-04CPE, 94-04CPE-12901905		



1

GEV No.	112737	Ref. No.	CR0795740
description	knob thermostat t.max. 185°C 115-185°C ø 79mm shaft ø 6x4.6mm shaft flat upper black for fryer		



1

GEV No.	112736	Ref. No.	2599209 BN2599209
description	knob thermostat t.max. 190°C 100-190°C ø 65mm shaft ø 6x4.6mm shaft flat upper black for fryer		
For models:	72-02FRE, 72-02FRE-12701500, 73-02FRE, 73-02FRE-12701550, 74-02FRE, 74-02FRE-12701600, 92-04FRE15L, 92-04FRE15L-12901510, 92-04FRE20L, 92-04FRE20L-12901500, 92-04FRE20L-12901500BN, 92-04FRG20L, 92-04FRG20L-12900500, 92-04FRG20L-12900500TA, 93-04FRE10L, 93-04FRE-12901550, 94-04FRE-12901600, 94-04FRE20L, 94-04FRG-12900600, 94-04FRG20L, 94-04FRG20L-12900600TA, 94-04FRG23L-12900605		



1

GEV No.	112628	Ref. No.	2599208 BN2599208
description	knob thermostat t.max. 300°C 60-300°C ø 65mm shaft ø 6x4.6mm shaft flat upper		
For models:	110-135CGE, 110-135CGE2P, 110-135CGEE, 110-135CGEE2P, 110-135CGEEP, 110-135CGEP, 110-90CGE, 110-90CGE1P, 110-90CGEP, 110-90CTEE, 110-90CTGE, 110-90FTEE, 110-90FTTGE, 74-02CEE-PQ, 74-02CEEPQ-12701210, 74-02CEEPT, 74-02CEEPT-12701010, 74-02CGE, 74-02CGE-12700011, 74-02CGE-12700011TA, 74-02CTEE, 74-02CTEE-12701180, 74-02CTGE, 74-02CTGE-12700190, 74-02CT-GE-12700190TA, 74-02VTCE, 74-02VTCEV, 74-02VTCEV-12701020, 76-02CEEANPQ, 76-02CEEANPT, 76-02CEEEACPO, 76-02CEEEACPT, 76-02CEEEAPQ-12701216, 76-02CEEEPT-12701016, 76-02CEE-PQ-12701215, 76-02CEEPT-12701015, 76-02CGE, 76-02CGE-12700017, 76-02CGE-12700017TA, 76-02CGEE, 76-02CGEE-12700018, 76-02CGEE-12700018TA, 94-04CEE, 94-04CGE, 94-04CGE1P, 94-04CGEP, 94-04CTGE, 96-04CGE, 96-04CGE2P, 96-04CGEE...(Other models you can see in the webshop)		



1

GEV No.	112517	Ref. No.	2599214 BN2599214
description	knob thermostat t.max. 300°C ø 65mm shaft ø 6x4.6mm shaft flat upper black temperature range 50-300°C rotation 370°		
For models:	72-02KBEF, 72-02KBEF-12701127, 74-02KBEB, 74-02KBEB-12701110, 74-02KBEBI, 74-02KBEBI-12701115, 74-02KBEF, 74-02KBEF-12701128, 74-02KBEMB, 74-02KBEMB-12701120, 74-02KBEMBI, 74-02KBEMBI-12701125, 74-02KBEMBI-12701125HB, 74-02KBGB, 74-02KBGB-12700110, 74-02KBGBI, 74-02KBGBI-12700115, 74-02KBGMB, 74-02KBGMB-12700120, 74-02KBGMBI, 74-02KBGMBI-12700125, 92-04FTE, 92-04FTE-12901130, 92-04FTEC, 92-04FTEC-12901135, 92-04FTECR, 92-04FTECR-12901137, 92-04FTER, 92-04FTER-12901132, 92-04TFTE, 92-04TFTE-12931130, 92-04TFTEC, 92-04TFTEC-12931135, 92-04TFTECR, 92-04TFTECR-12931137, 92-04TFTER, 92-04TFTER-12931132, 94-04CEE, 94-04CEE-12901210, 94-04CEE-12901210BN, 94-04CGE, 94-04CGE-12900011, 94-04CGE-12900011TA, 94-04CGE1P, 94-04CGE1P-12900031, 94-04CGEP, 94-04CGEP-12900061, 94-04CGEP-12900061TA, 94-04CGG1P-12900031TA, 94-04CTEE-12901180...(Other models you can see in the webshop)		



1

GEV No.	112644	Ref. No.	2599207 BN2599207
description	knob upper/lower heat ø 65mm shaft ø 6x4.6mm shaft flat upper black		
For models:	110-135CGE, 110-135CGE2P, 110-135CGEE, 110-135CGEE2P, 110-135CGEEP, 110-135CGEP, 110-90CGE, 110-90CGE1P, 110-90CGEP, 110-90CTEE, 110-90CTGE, 110-90FTEE, 110-90FTTGE, 74-02CEE-PQ, 74-02CEEPQ-12701210, 74-02CEEPT, 74-02CEEPT-12701010, 74-02CGE, 74-02CGE-12700011, 74-02CGE-12700011TA, 74-02CTEE, 74-02CTEE-12701180, 74-02CTGE, 74-02CTGE-12700190, 74-02CT-GE-12700190TA, 74-02VTCE, 74-02VTCEV, 74-02VTCEV-12701020, 76-02CEEANPQ, 76-02CEEANPT, 76-02CEEEACPO, 76-02CEEEACPT, 76-02CEEEAPQ-12701216, 76-02CEEEPT-12701016, 76-02CEE-PQ-12701215, 76-02CEEPT-12701015, 76-02CGE, 76-02CGE-12700017, 76-02CGE-12700017TA, 76-02CGEE, 76-02CGEE-12700018, 76-02CGEE-12700018TA, 94-04CEE, 94-04CEE-12901210, 94-04CEE-12901210BN, 94-04CGE, 94-04CGE-12900011, 94-04CGE-12900011TA, 94-04CGE1P, 94-04CGE1P-12900031...(Other models you can see in the webshop)		



1

GEV No.	110053	Ref. No.	6A019300 BN6A019300
description	knob gas tap with ignition flame ø 60mm shaft ø 10x8mm shaft flat upper black		

accessories

gaskets



1

GEV No.	112529	Ref. No.	2519490 BN2519490
description	gasket for knob rubber D1 ø 36mm D2 ø 46mm thickness 9mm		
For models:	110-135CGE, 110-135CGE2P, 110-135CGEE, 110-135CGEE2P, 110-135CGEEP, 110-135CGEP, 110-135CGGE, 110-135CGGE2P, 110-135CGGEP, 110-45CBE, 110-45TCBE, 110-90CGE, 110-90CGE1P, 110-90CGEP, 110-90CTE, 110-90CTEE, 110-90CTGE, 110-90FTE, 110-90FTE1-2R, 110-90FTEC, 110-90FTEC1-2R, 110-90FTECR, 110-90FTTE, 110-90FTER, 110-90FTTGE, 110-90TCTE, 110-90TFTE, 110-90TFTE1-2R, 110-90TFTEC, 110-90TFTEC1-2R, 110-90TFTECR, 110-90TFTER, 55-45CPE, 55-45FRE, 55-90CPE, 55-90FRE, 72-02CBE, 72-02CBE-12701150, 72-02CEPQ, 72-02CEPQ-12701201, 72-02CEPT, 72-02CEPT-12701001, 72-02CEPT-2212701001, 72-02CPE, 72-02CPE-12701900, 72-02FRE, 72-02FRE-12701500, 72-02FREM, 72-02FREM-12701530, 72-02FTE...(Other models you can see in the webshop)		

handles and hand wheels

hand wheels

hand wheels



1

GEV No.	693156	Ref. No.	6A039705 BN6A039705
description	hand wheel ø 150mm D1 ø 32mm bore ø 15mm depth of bore 20mm thread M6 hole distance 6mm groove widthmm L1 22mm L2 45mm handle length 70mm no fold-away handle		
For models:	725KB-E-1000200, 725KBE-1000200, 725KB-E-1000200R, 725KB-EB-1000201, 725KBEB-1000201, 725KB-EB-1000201R, 725KB-G-1000110, 725KBG-1000110, 725KB-G-1000110R, 725KB-GB-1000111, 725KB-GB-1000111R, 725KBGM-000120		



1

GEV No.	691441	Ref. No.	6A039710 BN6A039710
description	hand wheel ø 160mm D1 ø 32mm bore ø 20mm depth of bore 24mm thread M6 hole distance 6mm groove widthmm L1 35mm L2 60mm handle length 70mm no fold-away handle		
For models:	74-02KBEB, 74-02KBEB-12701110, 74-02KBEBI, 74-02KBEBI-12701115, 74-02KBGB, 74-02KBGB-12700110, 74-02KBGBI, 74-02KBGBI-12700115, 94-04KBE, 94-04KBE-12901115, 94-04KBE-12901115BN, 94-04KBE-12901118, 94-04KBG, 94-04KBG-12900115, 94-04KBG-12900115TA, 94-04KBG-12900118, 94-04KBG-12900118TA, 94-04NKBE-12901215, 94-04NKBE-12901215BN, 9BR-G80, 9BR-G81		

	GEV No.	112558	Ref. No.	2599250 BN2599250
description	knob gas tap with ignition flame ø 65mm shaft ø 8x6.5mm shaft flat upper grey			
For models:	2FX+PCF, 4FX, 72+2CTGG-12700013, 74+2CTGGAN-12700025			

	GEV No.	111747	Ref. No.	3199020 BN3199020
description	knob switch zero mark ø 40mm shaft ø 6x4.6mm shaft flat upper black			
For models:	61FE-1826050, CV10E, CV10E-1320100, CV10E-2, CV10E2-1320140, CV10EB-1321100, CV10E-S, CV10ES-1320150, CV10E-S2, CV10ES2-1320190, CV10G, CV10G-1310100, CV10G-2, CV10G2-1310140, CV10GB-1311100, CV10G-S, CV10GS-1310150, CV10G-S2, CV10GS2-1310190, CV20E, CV20E-1320200, CV20E-2, CV20E2-1320240, CV20EB-1321200, CV20E-S, CV20ES-1320250, CV20E-S2, CV20ES2-1320290, CV20G, CV20G-1310200, CV20G-2, CV20G2-1310240, CV20GB-1311200, CV20G-S, CV20GS-1310250, CV20G-S2, CV20GS2-1310290, CV21E, CV21E-1322100, CV21E-2, CV21E2-1322140, CV21E-S, CV21ES-1322150, CV21E-S2, CV21ES2-1322190, CV21G, CV21G-1312100, CV21G-2, CV21G2-1312140, CV21G-S...(Other models you can see in the webshop)			

	GEV No.	110977	Ref. No.	6A037800 BN6A037800
description	knob switch zero mark ø 57mm shaft ø 6x4.6mm shaft flat upper black			
For models:	710FRE-077700, 712FRE-077900, 714CT-GVFE-1000180, 720FRE-077800, 721CAE-1000255, 721TCE-1009255, 722FRE-078000, 725KB-E-1000200, 725KB-EB-1000201, 725KBEM-000200, 725KB-EMB-1000211, 725KB-G-1000110, 725KB-GB-1000111, 725KBGM-000120, 725KB-GM-1000120, 725KB-GMB-1000121, 72CAE-000250, 72CA-E-1000250, 72TCE-1009250, 741CAE-1000305, 741CE-1000405, 741TCE-1009305, 749CGVFE-1950059, 74CAE-000300, 74CA-E-1000300, 74CBE-000550, 74CB-E-1000550, 74CE-000400, 74CE-1000400, 74FTE-000800, 74FT-E-1000800, 74FT-EC-1000805, 74FT-ER1-1-1000801, 74TCE-1009300, 74TFTE-1009800, 74TFTE1-1R-1009801, 74TFTEC-1009805, 761CAE-1000355, 761CEAC-1000505, 761CEAN-1000455, 761TCE-1009355, 769CGVAC-1950079, 769CGVFE-1950089, 769CGVFE-1950099, 76CA-E-1000350, 76CAE-272106, 76CEAC-000500, 76CEAC-1000500, 76CEAN-1000450, 76TCE-1009350...(Other models you can see in the webshop)			



 <p>1</p>			
GEV No.	693159	Ref. No.	6A039702 A039700 BN6A039702
description	hand wheel ø 200mm D1 ø 40mm bore ø 20mm depth of bore 26mm thread M6 hole distance 6mm groove widthmm L1 40mm L2 70mm handle length 90mm with folding handle		
For models:	94KBE, 94KBE-1192870, 94KBE-1191870, 94KBE-1191870, 94KBE-1392870, 94KBE-1391870, KB-E970-1050410, KBE970-1050410, KB-E970A-1050411, KB-G970-1050450, KB-G970A-1050451		

ball handles

 <p>1</p>			
GEV No.	691438	Ref. No.	6A019360 BN6A019360
description	ball handle thread M8 ø 40mm black		
For models:	74-02KBEB, 74-02KBEB-12701110, 74-02KBEBI, 74-02KBEBI-12701115, 74-02KBEMB, 74-02KBEMB-12701120, 74-02KBEMBI, 74-02KBEMBI-12701125, 74-02KBEMBI-12701125HB, 74-02KBGB, 74-02KBGB-12700110, 74-02KBGBI, 74-02KBGBI-12700115, 74-02KBGMB, 74-02KBGMB-12700120, 74-02KBGMBI, 74-02KBGMBI-12700125, 74-02NPEI-12701755, 74-02NPGD-12700750, 74-02NPGI-12700755, 910PG-1191810, 910PGB-1191800, 911PEB-1192805, 911PGB-1191805, 911RPG-1391830, 915PEB-1192800, 915PG-1191815		

cylindrical handles

fixed

 <p>1</p>			
GEV No.	110703	Ref. No.	1829200
description	cylindrical handle thread M10 ø 28mm L 87mm		
For models:	OPLG40, OPLG-40-12600850, OPLG80, OPLG-80-12600855, PLG40, PLG80		

 <p>1</p>			
GEV No.	540235	Ref. No.	6A019302 BN6A019302
description	cylindrical handle thread M6 ø 17mm L 40mm		
For models:	40SEBM, 40SEBM2S-1826100, 40SECP, 40SECP-1825080, 40SECP-1825080E, 40SEFR, 40SEFR-1826140, 40SEFR2S-1826140, 40SEW, 40SEW-1825190, 40SGFR, 40SGFR-1826160, 40SGFR2S-1826160, 41SEFR, 41SEFR-1826120, 41SEFR2S-1826120, 421SEFR-1826125, 60SEBM, 60SEBM-1826110, 60SEBM2S-1826110, 60SEFR, 60SEFR-1826150, 60SEFR2S-1826150, 60SGFR, 60SGFR-1826170, 60SGFR2S-1826170, 61SEFR, 61SEFR-1826130, 61SEFR2S-1826130, 621SEFR-1826135, 72-02CBE, 72-02CBE-12701150, 72-02CBG, 72-02CBG-12700150, 72-02TCBE, 72-02TCBE-12731150, 72-02TCBG, 72-02TCBG-12730150, 74-02CBE, 74-02CBE-12701155, 74-02CBG, 74-02CBG-12700155, 74-02TCBE, 74-02TCBE-12731155, 74-02TCBG, 74-02TCBG-12730155, 74CB-E-1000550, 74CB-E-1000550R, 74CBG-000150, 74CB-G-1000150...(Other models you can see in the webshop)		

bracket handles

 <p>1</p>			
GEV No.	691327	Ref. No.	8222510 CM073100 MACM073100
description	pull handle L 119mm H 37mm mounting distance 105mm handle M6		
For models:	40SEFR, 40SEFR-1826140, 40SEFR2S-1826140, 40SGFR-1826160, 40SGFR2S-1826160, 41SEFR-1826120, 41SEFR2S-1826120, 421SEFR-1826125, 55-45FRE, 55-90FRE, 60SEFR, 60SEFR-1826150, 60SEFR2S-1826150, 60SGFR-1826170, 60SGFR2S-1826170, 61SEFR-1826130, 61SEFR2S-1826130, 621SEFR-1826135, 7101FR-E-1077750R, 710FRE-1077700, 710FRG-1077300, 710FR-G-1077350, 710FR-G-1077350R, 7121FR-E-1077950R, 712FRE-1077900, 712FR-G-1077550, 712FRG-1077550, 712FR-G-1077550R, 7201FR-E-1077850R, 72-02FRE, 72-02FRE-12701500, 72-02FREM, 72-02FREM-12701530, 72-02FRG, 72-02FRG-12700500, 72-02FRG17-12700505, 72-02FRGM, 72-02FRGM-12700530, 72-02FRGM-12700530TA, 720FRE-1077800, 720FRG-1077400, 720FR-G-1077450, 720FRG-1077450, 720FR-G-1077450R, 720FR-G-1077650, 7221FR-E-1078050R, 722FRE-1078000, 722FRG-1077600, 722FR-G-1077650R, 73-02FRE...(Other models you can see in the webshop)		

 <p>1</p>			
GEV No.	691328	Ref. No.	1031110900
description	pull handle L 248mm H 56mm mounting distance 235mm handle M6		
For models:	CFG120, OCFG120		





			
1			
GEV No.	691336	Ref. No.	1031111000
description	pull handle L 544mm H 55mm mounting distance 530mm handle M6		
For models:	CFE60, CFE60P, CFG101, CFG120, CFG70, OCFE60, OCPE-60-12601005, OCPE-60-12601005MN, OCFG101, OCFG-101-12600025, OCFG120, OCFG70, OCFG-70-12600000, OCFGE61, OPGC-41-12600010		

levers

without handle

			
1			
GEV No.	514007	Ref. No.	1044109600
description	lever		
For models:	OBME41M, OBME61M		

			
1			
GEV No.	514013	Ref. No.	1031400400
description	lever equiv. no. 1031400400		
For models:	CPE60, CPE60DB, OCPE60, OCPE-60-12601900, OCPE-60-12601900MN		

			
1			
GEV No.	514011	Ref. No.	1031400100
description	lever right equiv. no. 1031400100		
For models:	FQG40, FQG41, FQG60, FQG61, OFQG41, OFQG-41-12600500, OFQG61, OFQG-61-12600600		

lever handles

			
1			
GEV No.	514015	Ref. No.	1036702000
description	lever handle plastic black		
For models:	CPE60, CPE60DB, FQE41, FQE41L, FQE41L2, FQE61, FQE61L, FQE61L2, FQG40, FQG41, FQG60, FQG61, OBME41M, OBME61M, OCPE60, OCPE-60-12601900, OCPE-60-12601900MN, OFQE41, OFQE-41-12601510, OFQE-41-12601510MN, OFQE41L, OFQE61, OFQE-61-12601610, OFQE-61-12601610MN, OFQE61L, OFQG41, OFQG-41-12600500, OFQG61, OFQG-61-12600600, OPL40, OPL60, PL40, PL6, PL60		

			
1			
GEV No.	514008	Ref. No.	1036700000
description	lever handle plastic green		
For models:	CPE60, CPE60DB, FQE41, FQE41L, FQE41L2, FQE61, FQE61L, FQE61L2, OCPE60, OCPE-60-12601900MN, OFQE41, OFQE-41-12601510MN, OFQE61, OFQE-61-12601610MN		

locks

espagnolette locks

producer-specific

OLIS

			
1			
GEV No.	514302	Ref. No.	6A011409 BN6A011409
description	ball ø 8mm		
For models:	CMV6ES2-1320392, CV10E, CV10E-1320100, CV10E-1320110, CV10E-2, CV10E2-1320140, CV10EB-1321100, CV10E-S, CV10ES-1320150, CV10E-S2, CV10ES2-1320190, CV10G, CV10G-1310100, CV10G-2, CV10G2-1310140, CV10GB-1311100, CV10G-S, CV10GS-1310150, CV10G-S2, CV10GS2-1310190, CV20E, CV20E-1320200, CV20E-2, CV20E2-1320240, CV20EB-1321200, CV20E-S, CV20ES-1320250, CV20E-S2, CV20ES2-1320290, CV20G, CV20G-1310200, CV20G-2, CV20G2-1310240, CV20GB-1311200, CV20G-S, CV20GS-1310250, CV20G-S2, CV20GS2-1310290, CV21E, CV21E-1322100, CV21E-2, CV21E2-1322140, CV21E-S, CV21ES-1322150, CV21E-S2, CV21ES2-1322190, CV21G, CV21G-1312100, CV21G-2, CV21G2-1312140...(Other models you can see in the webshop)		

			
GEV No.	514300	Ref. No.	3107935 BN3107935
description	bush		
For models:	CMV6ES2-1320392, CV10E, CV10E-1320100, CV10E-2, CV10E2-1320140, CV10EB-1321100, CV10E-S, CV10ES-1320150, CV10E-S2, CV10ES2-1320190, CV10G, CV10G-1310100, CV10G-2, CV10G2-1310140, CV10GB-1311100, CV10G-S, CV10GS-1310150, CV10G-S2, CV10GS2-1310190, CV20E, CV20E-1320200, CV20E-2, CV20E2-1320240, CV20EB-1321200, CV20E-S, CV20ES-1320250, CV20E-S2, CV20ES2-1320290, CV20G, CV20G-1310200, CV20G-2, CV20G2-1310240, CV20GB-1311200, CV20G-S, CV20GS-1310250, CV20G-S2, CV20GS2-1310290, CV21E, CV21E-1322100, CV21E-2, CV21E2-1322140, CV21E-S, CV21ES-1322150, CV21E-S2, CV21ES2-1322190, CV21G, CV21G-1312100, CV21G-2, CV21G2-1312140, CV21G-S...(Other models you can see in the webshop)		

			
GEV No.	514301	Ref. No.	3107955 BN3107955
description	compression spring ø 6.5mm L 14mm wire gauge ø 1.2mm		
For models:	CMV6ES2-1320392, CV10E, CV10E-1320100, CV10E-1320110, CV10E-2, CV10E2-1320140, CV10EB-1321100, CV10E-S, CV10ES-1320150, CV10E-S2, CV10ES2-1320190, CV10G, CV10G-1310100, CV10G-2, CV10G2-1310140, CV10GB-1311100, CV10G-S, CV10GS-1310150, CV10G-S2, CV10GS2-1310190, CV20E, CV20E-1320200, CV20E-2, CV20E2-1320240, CV20EB-1321200, CV20E-S, CV20ES-1320250, CV20E-S2, CV20ES2-1320290, CV20G, CV20G-1310200, CV20G-2, CV20G2-1310240, CV20GB-1311200, CV20G-S, CV20GS-1310250, CV20G-S2, CV20GS2-1310290, CV21E, CV21E-1322100, CV21E-2, CV21E2-1322140, CV21E-S, CV21ES-1322150, CV21E-S2, CV21ES2-1322190, CV21G, CV21G-1312100, CV21G-2, CV21G2-1312140...(Other models you can see in the webshop)		

			
GEV No.	514297	Ref. No.	3107915 BN3107915
description	catch hook L 78.6mm D1 ø 28mm D2 ø 32mm D3 ø 40mm		
For models:	CMV6ES2-1320392, CV10E, CV10E-1320100, CV10E-2, CV10E2-1320140, CV10EB-1321100, CV10E-S, CV10ES-1320150, CV10E-S2, CV10ES2-1320190, CV10G, CV10G-1310100, CV10G-2, CV10G2-1310140, CV10GB-1311100, CV10G-S, CV10GS-1310150, CV10G-S2, CV10GS2-1310190, CV20E, CV20E-1320200, CV20E-2, CV20E2-1320240, CV20EB-1321200, CV20E-S, CV20ES-1320250, CV20E-S2, CV20ES2-1320290, CV20G, CV20G-1310200, CV20G-2, CV20G2-1310240, CV20GB-1311200, CV20G-S, CV20GS-1310250, CV20G-S2, CV20GS2-1310290, CV6E, CV6E-1320000, CV6E-1320050, CV6E-2, CV6E2-1320040, CV6EB-1321000, CV6E-S, CV6E-S2, CV6ES2-1320090, CV6G, CV6G-1310000, CV6G-2, CV6G2-1310040...(Other models you can see in the webshop)		

			
GEV No.	514296	Ref. No.	3107910 BN3107910
description	door catch H 28mm D1 ø 44mm D2 ø 35mm D3 ø 32mm mounting distance 10mm		
For models:	CMV6ES2-1320392, CV10E, CV10E-1320100, CV10E-1320110, CV10E-2, CV10E2-1320140, CV10EB-1321100, CV10E-S, CV10ES-1320150, CV10E-S2, CV10ES2-1320190, CV10G, CV10G-1310100, CV10G-2, CV10G2-1310140, CV10GB-1311100, CV10G-S, CV10GS-1310150, CV10G-S2, CV10GS2-1310190, CV20E, CV20E-1320200, CV20E-2, CV20E2-1320240, CV20EB-1321200, CV20E-S, CV20ES-1320250, CV20E-S2, CV20ES2-1320290, CV20G, CV20G-1310200, CV20G-2, CV20G2-1310240, CV20GB-1311200, CV20G-S, CV20GS-1310250, CV20G-S2, CV20GS2-1310290, CV21E, CV21E-1322100, CV21E-2, CV21E2-1322140, CV21E-S, CV21ES-1322150, CV21E-S2, CV21ES2-1322190, CV21G, CV21G-1312100, CV21G-2, CV21G2-1312140...(Other models you can see in the webshop)		

			
GEV No.	514416	Ref. No.	3107991 BN3107991
description	catch hook L 92.5mm D1 ø 28mm D2 ø 32mm D3 ø 40mm		
For models:	CV10E, CV10E-2, CV10E-S, CV10E-S2, CV10G, CV10G-2, CV10G-S, CV10G-S2, CV20E, CV20E-2, CV20E-S, CV20E-S2, CV20G, CV20G-2, CV20G-S, CV20G-S2, CV21E, CV21E-1322100, CV21E-2, CV21E2-1322140, CV21E-S, CV21ES-1322150, CV21E-S2, CV21ES2-1322190, CV21G, CV21G-1312100, CV21G-2, CV21G2-1312140, CV21G-S, CV21GS-1312150, CV21G-S2, CV21GS2-1312190, CV6E, CV6E-2, CV6E-S, CV6E-S2, CV6G, CV6G-2, CV6G-S, CV6G-S2, CVM10E, CVM10E-2, CVM10E-S, CVM10E-S2, CVM20E, CVM20E-2, CVM20E-S, CVM20E-S2, CVM21E, CVM21E-1322400...(Other models you can see in the webshop)		



			
GEV No.	514295	Ref. No.	3107990 BN3107990
description	door handle complete		
For models:	CV21E-1322100, CV21E2-1322140, CV21ES-1322150, CV21ES2-1322190, CV21G-1312100, CV21G2-1312140, CV21GS-1312150, CV21GS2-1312190, CVM21E-1322400, CVM21E2-1322440, CVM21ES-1322450, CVM21ES2-1322490, CVM21ES2-1322495, CVM21G-1312400, CVM21G2-1312440, CVM21GS-1312450, CVM21GS2-1312490, CVM21GS2-1312495, CVP21E-1322700, CVP21ES-1322750, CVP21ES2-1322790, CVP21G-1312700, CVP21G2-1312740, CVP21GS-1312750, CVP21GS2-1312790, ECVM21ES2-1324490, ECVM21ES2-1326160, ECVM21GS2-1314490, ECVM21GS2-1316160, ECVP21ES2-1324890, ECVP21ES2-1326240, ECVP21GS2-1314890, ECVP21GS2-1316240, NECVM21ES2-1327490, NECVM21ES2-1328160, NECVM21GS2-1317490, NECVM21GS2-1318160, NECVP21ES2-1327890, NECVP21ES2-1328240, NECVP21GS2-1317890, NECVP21GS2-1318240		
spare parts for	514295		
	GEV No.	514298	Ref. No. 3107945 BN3107945
	plate		





Table continues overleaf

spare parts for		514295		
	GEV No.	514299	Ref. No.	3107941 BN3107941
	ring			
	GEV No.	514300	Ref. No.	3107935 BN3107935
	bush			
	GEV No.	514301	Ref. No.	3107955 BN3107955
	compression spring ø 6.5mm L 14mm wire gauge ø 1.2mm			
	GEV No.	514302	Ref. No.	6A011409 A011409 BN6A011409
	ball ø 8mm			
	GEV No.	514303	Ref. No.	3107930 BN3107930
	pin ø 8mm L 19.5mm			
	GEV No.	514416	Ref. No.	3107991 BN3107991
	catch hook L 92.5mm D1 ø 28mm D2 ø 32mm D3 ø 40mm			
accessories for		514295		
	GEV No.	514296	Ref. No.	3107910 BN3107910
	door catch H 28mm D1 ø 44mm D2 ø 35mm D3 ø 32mm mounting distance 10mm			

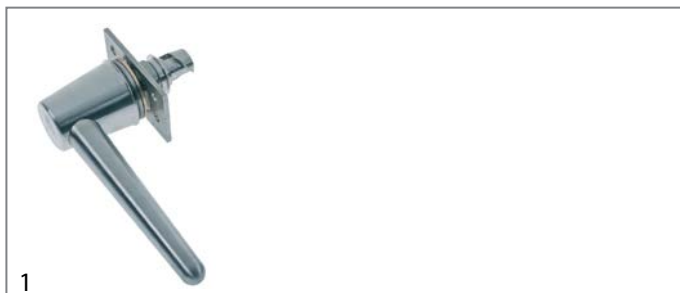

1

GEV No.	514394	Ref. No.	3107900 BN3107900	
description	door handle complete			
For models:	CMV6ES2-1320392, CV10E-1320100, CV10E2-1320140, CV10EB-1321100, CV10ES-1320150, CV10ES2-1320190, CV10G-1310100, CV10G2-1310140, CV10GB-1311100, CV10GS-1310150, CV10GS2-1310190, CV20E-1320200, CV20E2-1320240, CV20EB-1321200, CV20ES-1320250, CV20ES2-1320290, CV20G-1310200, CV20G2-1310240, CV20GB-1311200, CV20GS-1310250, CV20GS2-1310290, CV6E-1320000, CV6E-1320050, CV6E2-1320040, CV6EB-1321000, CV6ES2-1320090, CV6G-1310000, CV6G2-1310040, CV6GB-1311000, CV6GS-1310050, CV6GS2-1310090, CVM10E-1320400, CVM10E2-1320440, CVM10ES-1320450, CVM10ES2-1320490, CVM10ES2-1320495, CVM10G-1310400, CVM10G2-1310410, CVM10G-1310430, CVM10G-1310450, CVM10G2-1310440, CVM10GP-1310400, CVM10GS2-1310490, CVM10GS2-1310495, CVM20E-1320500, CVM20E2-1320540, CVM20ES-1320550, CVM20ES2-1320590, CVM20G-1310500, CVM20G2-1310540...(Other models you can see in the webshop)			
spare parts for		514394		
	GEV No.	514297	Ref. No.	3107915 BN3107915
	catch hook L 78.6mm D1 ø 28mm D2 ø 32mm D3 ø 40mm			
	GEV No.	514298	Ref. No.	3107945 BN3107945
	plate			
	GEV No.	514299	Ref. No.	3107941 BN3107941
	ring			
	GEV No.	514300	Ref. No.	3107935 BN3107935
	bush			

spare parts for		514394		
	GEV No.	514301	Ref. No.	3107955 BN3107955
	compression spring ø 6.5mm L 14mm wire gauge ø 1.2mm			
	GEV No.	514302	Ref. No.	6A011409 A011409 BN6A011409
	ball ø 8mm			
	GEV No.	514303	Ref. No.	3107930 BN3107930
	pin ø 8mm L 19.5mm			
accessories for		514394		
	GEV No.	514296	Ref. No.	3107910 BN3107910
	door catch H 28mm D1 ø 44mm D2 ø 35mm D3 ø 32mm mounting distance 10mm			



1

GEV No.	514303	Ref. No.	3107930 BN3107930	
description	pin ø 8mm L 19.5mm			
For models:	CMV6ES2-1320392, CV10E, CV10E-1320100, CV10E-1320110, CV10E-2, CV10E2-1320140, CV10EB-1321100, CV10E-S, CV10ES-1320150, CV10E-S2, CV10ES2-1320190, CV10G, CV10G-1310100, CV10G-2, CV10G2-1310140, CV10GB-1311100, CV10G-S, CV10GS-1310150, CV10G-S2, CV10GS2-1310190, CV20E, CV20E-1320200, CV20E-2, CV20E2-1320240, CV20EB-1321200, CV20E-S, CV20ES-1320250, CV20E-S2, CV20ES2-1320290, CV20G, CV20G-1310200, CV20G-2, CV20G2-1310240, CV20GB-1311200, CV20G-S, CV20GS-1310250, CV20G-S2, CV20GS2-1310290, CV21E, CV21E-1322100, CV21E-2, CV21E2-1322140, CV21E-S, CV21ES-1322150, CV21E-S2, CV21ES2-1322190, CV21G, CV21G-1312100, CV21G-2, CV21G2-1312140...(Other models you can see in the webshop)			

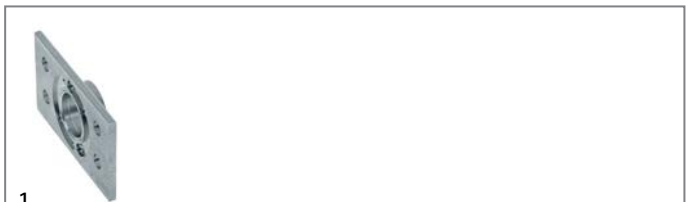

1

GEV No.	514298	Ref. No.	3107945 BN3107945	
description	plate			
For models:	CMV6ES2-1320392, CV10E, CV10E-1320100, CV10E-2, CV10E2-1320140, CV10EB-1321100, CV10E-S, CV10ES-1320150, CV10E-S2, CV10ES2-1320190, CV10G, CV10G-1310100, CV10G-2, CV10G2-1310140, CV10GB-1311100, CV10G-S, CV10GS-1310150, CV10G-S2, CV10GS2-1310190, CV20E, CV20E-1320200, CV20E-2, CV20E2-1320240, CV20EB-1321200, CV20E-S, CV20ES-1320250, CV20E-S2, CV20ES2-1320290, CV20G, CV20G-1310200, CV20G-2, CV20G2-1310240, CV20GB-1311200, CV20G-S, CV20GS-1310250, CV20G-S2, CV20GS2-1310290, CV21E, CV21E-1322100, CV21E-2, CV21E2-1322140, CV21E-S, CV21ES-1322150, CV21E-S2, CV21ES2-1322190, CV21G, CV21G-1312100, CV21G-2, CV21G2-1312140, CV21G-S...(Other models you can see in the webshop)			



			
1			
GEV No.	514299	Ref. No.	3107941 BN3107941
description	ring		
For models:	CMV6ES2-1320392, CV10E, CV10E-1320100, CV10E-1320110, CV10E-2, CV10E2-1320140, CV10EB-1321100, CV10E-S, CV10ES-1320150, CV10E-S2, CV10ES2-1320190, CV10G, CV10G-1310100, CV10G-2, CV10G2-1310140, CV10GB-1311100, CV10G-S, CV10GS-1310150, CV10G-S2, CV10GS2-1310190, CV20E, CV20E-1320200, CV20E-2, CV20E2-1320240, CV20EB-1321200, CV20E-S, CV20ES-1320250, CV20E-S2, CV20ES2-1320290, CV20G, CV20G-1310200, CV20G-2, CV20G2-1310240, CV20GB-1311200, CV20G-S, CV20GS-1310250, CV20G-S2, CV20GS2-1310290, CV21E, CV21E-1322100, CV21E-2, CV21E2-1322140, CV21E-S, CV21ES-1322150, CV21E-S2, CV21ES2-1322190, CV21G, CV21G-1312100, CV21G-2, CV21G2-1312140...(Other models you can see in the webshop)		

miscellaneous

			
1			
GEV No.	691286	Ref. No.	R58001780
description	catch for glass plate		
For models:	CCE071M, CCE101M, CCE102M, CCG071M, CCG101M, CCG102M, CKEP06, CKEP06B, CKEP10, CKEP10B, CKEP20, CKEP20B, CKEP21, CKEP21B, CKEP40, CKEP40B, CKET06, CKET06B, CKET10, CKET10B, CKET20, CKET20B, CKET21, CKET21B, CKET40, CKET40B, CKGP06, CKGP06B, CKGP10, CKGP10B, CKGP20, CKGP20B, CKGP21, CKGP21B, CKGP40, CKGP40B, CKGT06, CKGT06B, CKGT10, CKGT10B, CKGT20B, CKGT21, CKGT21B, CKGT40, CKGT40B		

hinges

spring assisted hinges

universal

CAFF/FERMOD

group 2

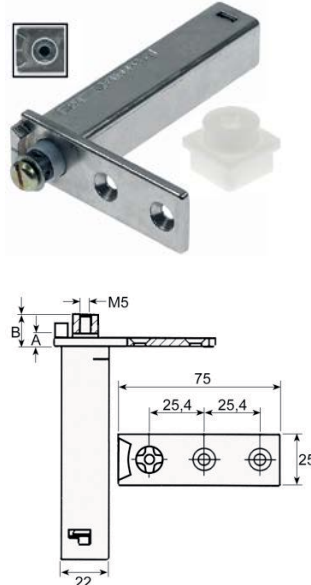

Technical drawing showing dimensions: M5, A, B, 75, 25.4, 25.4, 25, 22.

GEV No.	690494	Ref. No.	1412001
description	spring assisted hinge series 175 mounting pos. left/right torx L 75mm W 25.6mm H 100mm A 4mm B 11mm mounting measurements 22x22mm intake torx refrigeration units mounting distance 25mm		
For models:	KBT40-21091640, KC41-210916400BDC, KR41-210906400BFA, KTN40-21090640		

oven hinges

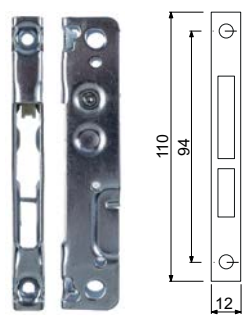

Technical drawing showing dimensions: 110, 94, 12.

GEV No.	693045	Ref. No.	6A035990 BN6A035990
description	opposite support L 110mm W 12mm mounting distance 94mm		
For models:	61FE-1826050, 61SCGFE3S-1826055, 61SCGFE4S-1827055, 61SECFE-1826075		

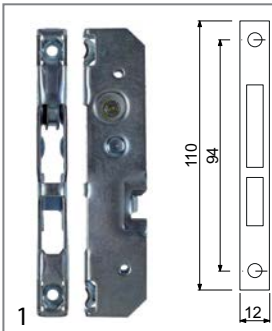

GEV No.	700003	Ref. No.	1031106000 1034400800
description	opposite support L 110mm W 12mm mounting distance 94mm		
For models:	CFE60, CFE60P, FOE60M, OCFE60, OCFE-60-12601005, OCFE-60-12601005MN, OCFGE61, OFOE60M, OFOE-60M-12601001		

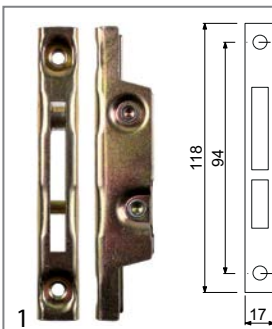

GEV No.	700001	Ref. No.	1304500 6A035930 MA1304500
description	opposite support L 118mm W 17mm mounting distance 94mm		
For models:	110-135CGE, 110-135CGE2P, 110-135CGEE, 110-135CGEE2P, 110-135CGEEP, 110-135CGEP, 110-135CGG, 110-135CGG2P, 110-135CGGE, 110-135CGGE2P, 110-135CGGEP, 110-135CGGP, 110-90CGE, 110-90CGE1P, 110-90CGEP, 110-90CGG, 110-90CGG1P, 110-90CGGP, 110-90CTEE, 110-90CTGE, 110-90CTGG, 110-90FTEE, 110-90FTTGE, 110-90FTTGG, 2FX+PCF, 4FX+PCF, 714CT-GV-1000170, 714CTGV-1000170R, 714CT-GVFE-1000180, 714CT-GVFE-1000180R, 72+2CTGG-12700013, 74+2CTGGAN-12700025, 74-02+2CTGG, 74-02+2CTGG-12700030, 74-02CEEPQ-12701210, 74-02CEEPT-12701010, 74-02CGE, 74-02CGE-12700011, 74-02CGE-12700011TA, 74-02CGG, 74-02CGG-12700010, 74-02CGG-12700010TA, 74-02CTEE, 74-02CTEE-12701180, 74-02CTGE, 74-02CTGE-12700190, 74-02CTGE-12700190TA, 74-02CTGG, 74-02CTGG-12700180, 74-02CTGG-12700180TA...(Other models you can see in the webshop)		



GEV No.	700189	Ref. No.	6A035950 BN6A035950
description	oven hinge complete		
For models:	74-02VTCE		

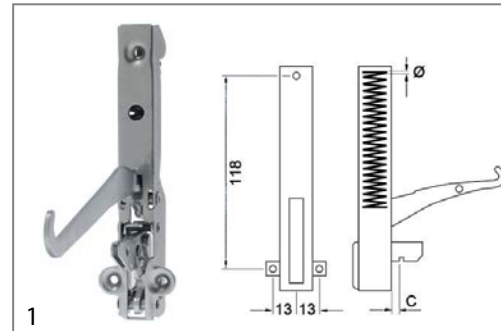

GEV No.	690030	Ref. No.	1034400400	
description	oven hinge mounting distance 118mm lug mounting 13mm lever length 117mm groove distance 10mm spring thickness 3.5mm mounting ear position left/right spring length 60mm L 155mm W 21mm			
For models:	CFE60, CFE60P, OCFE60, OCFE-60-12601005, OCFE-60-12601005MN, OCFGE61			
accessories for	690030			
	GEV No.	700003	Ref. No.	1031106000 1034400800
	opposite support L 110mm W 12mm mounting distance 94mm			

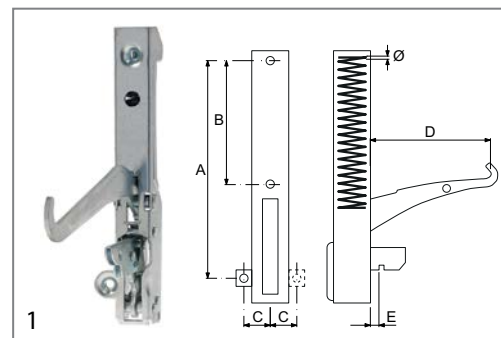



GEV No.	700016	Ref. No.	1031105900	
description	oven hinge mounting distance 118mm mounting distance 2mm lug mounting 13mm lever length 116mm groove distance 11mm spring thickness 3.5mm mounting ear position left spring length 61mm L 153mm W 20mm			
For models:	FOE60M, OFOE60M, OFOE-60M-12601001			
accessories for	700016			
	GEV No.	700003	Ref. No.	1031106000 1034400800
	opposite support L 110mm W 12mm mounting distance 94mm			



GEV No.	700015	Ref. No.	1031105800
description	oven hinge mounting distance 118mm mounting distance 2mm lug mounting 13mm lever length 116mm groove distance 11mm spring thickness 3.5mm mounting ear position right spring length 61mm L 153mm W 20mm		
For models:	FOE60M, OFOE60M, OFOE-60M-12601001		
accessories for	700015		
	GEV No.	700003	Ref. No. 1031106000 1034400800
opposite support L 110mm W 12mm mounting distance 94mm			

GEV No.	700005	Ref. No.	1304700
description	oven hinge mounting distance 173mm mounting distance 2 105mm lug mounting 14mm lever length 118mm groove distance 7mm spring thickness 3.5mm mounting ear position left spring length 112mm W 25mm		
For models:	CFG101, CFG120, CFG70, OCFG101, OCFG-101-12600025, OCFG120, OCFG70, OCFG-70-12600000, OPCG-41-12600010		
accessories for	700005		
	GEV No.	700001	Ref. No. 1304500 6A035930 A035930 MA1304500
opposite support L 118mm W 17mm mounting distance 94mm			

GEV No.	700459	Ref. No.	6A035980 BN6A035980
description	oven hinge mounting distance 142mm mounting distance 2mm lug mountingmm lever length 117mm groove distance 7mm spring thickness 3.5mm mounting ear position spring length 58mm L 156mm W 22mm		
For models:	61FE-1826050, 61SCGFE3S-1826055, 61SCGFE4S-1827055, 61SECFE-1826075		
accessories for	700459		
	GEV No.	693045	Ref. No. 6A035990 A035990 BN6A035990
opposite support L 110mm W 12mm mounting distance 94mm			

GEV No.	700004	Ref. No.	1304600
description	oven hinge mounting distance 173mm mounting distance 2 105mm lug mounting 14mm lever length 119mm groove distance 7mm spring thickness 3.5mm mounting ear position right spring length 112mm L 206mm W 25mm		
For models:	CFG101, CFG120, CFG70, OCFG101, OCFG-101-12600025, OCFG120, OCFG70, OCFG-70-12600000, OPCG-41-12600010		
accessories for	700004		
	GEV No.	700001	Ref. No. 1304500 6A035930 A035930 MA1304500
opposite support L 118mm W 17mm mounting distance 94mm			

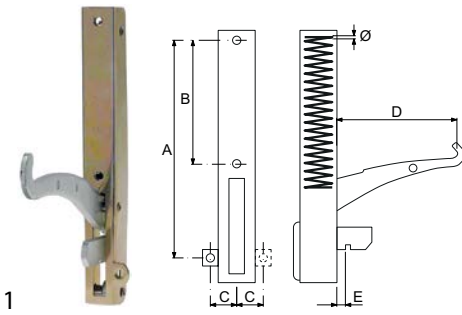
			
GEV No.	700006	Ref. No.	1035910 6A035910 BN6A035910
description	oven hinge mounting distance 173mm mounting distance 2 105mm lug mounting 14mm lever length 120mm groove distance 11mm spring thickness 3.5mm mounting ear position left spring length 112mm W 25mm		
For models:	110-135CGE, 110-135CGE2P, 110-135CGEE, 110-135CGEE2P, 110-135CGEEP, 110-135CGEP, 110-135CGG, 110-135CGG2P, 110-135CGGE, 110-135CGGE2P, 110-135CGGEP, 110-135CGGP, 110-90CGE, 110-90CGE1P, 110-90CGEP, 110-90CGG, 110-90CGG1P, 110-90CGGP, 110-90CTEE, 110-90CTGE, 110-90CTGG, 110-90FTEE, 110-90FTTGE, 110-90FTTGG, 2FX+PCF, 4FX+PCF, 714CT-GV-1000170, 714CTGV-1000170, 714CTGV-1000170R, 714CT-GVFE-1000180, 714CT-GVFE-1000180R, 72+2CTGG-12700013, 74+2CTGGAN-12700025, 74-02+2CTGG, 74-02+2CTGG-12700030, 74-02CEEQP-12701210, 74-02CEEPT-12701010, 74-02CGE, 74-02CGE-12700011, 74-02CGE-12700011TA, 74-02CGG, 74-02CGG-12700010, 74-02CGG-12700010TA, 74-02CTEE, 74-02CTEE-12701180, 74-02CTGE, 74-02CTGE-12700190, 74-02CTGE-12700190TA, 74-02CTGG, 74-02CTGG-12700180...(Other models you can see in the webshop)		
accessories for	700006		
	GEV No.	700001	Ref. No. 1304500 6A035930 A035930 MA1304500
	opposite support L 118mm W 17mm mounting distance 94mm		
	GEV No.	700007	Ref. No. 6A035920 A035920 BN6A035920
	oven hinge mounting distance 173mm mounting distance 2 105mm lug mounting 14mm lever length 120mm groove distance 11mm spring thickness 3.5mm mounting ear position right spring length 112mm W 25mm		

			
GEV No.	700007	Ref. No.	6A035920 BN6A035920
description	oven hinge mounting distance 173mm mounting distance 2 105mm lug mounting 14mm lever length 120mm groove distance 11mm spring thickness 3.5mm mounting ear position right spring length 112mm W 25mm		
For models:	110-135CGE, 110-135CGE2P, 110-135CGEE, 110-135CGEE2P, 110-135CGEEP, 110-135CGEP, 110-135CGG, 110-135CGG2P, 110-135CGGE, 110-135CGGE2P, 110-135CGGEP, 110-135CGGP, 110-90CGE, 110-90CGE1P, 110-90CGEP, 110-90CGG, 110-90CGG1P, 110-90CGGP, 110-90CTEE, 110-90CTGE, 110-90CTGG, 110-90FTEE, 110-90FTTGE, 110-90FTTGG, 2FX+PCF, 4FX+PCF, 714CT-GV-1000170, 714CTGV-1000170, 714CTGV-1000170R, 714CT-GVFE-1000180, 714CT-GVFE-1000180R, 72+2CTGG-12700013, 74+2CTGGAN-12700025, 74-02+2CTGG, 74-02+2CTGG-12700030, 74-02CEEQP-12701210, 74-02CEEPT-12701010, 74-02CGE, 74-02CGE-12700011, 74-02CGE-12700011TA, 74-02CGG, 74-02CGG-12700010, 74-02CGG-12700010TA, 74-02CTEE, 74-02CTEE-12701180, 74-02CTGE, 74-02CTGE-12700190, 74-02CTGE-12700190TA, 74-02CTGG, 74-02CTGG-12700180...(Other models you can see in the webshop)		
accessories for	700007		
	GEV No.	700001	Ref. No. 1304500 6A035930 A035930 MA1304500
	opposite support L 118mm W 17mm mounting distance 94mm		
	GEV No.	700006	Ref. No. 1035910 6A035910 A035910 BN6A035910
	oven hinge mounting distance 173mm mounting distance 2 105mm lug mounting 14mm lever length 120mm groove distance 11mm spring thickness 3.5mm mounting ear position left spring length 112mm W 25mm		

door bearing

			
GEV No.	519397	Ref. No.	540036
description	bush mounting pos. left for hinge		
For models:	OLElectron400		

			
GEV No.	519396	Ref. No.	540035
description	bush mounting pos. right for hinge		
For models:	OLElectron400		



1

GEV No.	691288	Ref. No.	R58002520
description	door bolt		
For models:	CCE071M, CCE101M, CCE102M, CCG071M, CCG101M, CCG102M		



1

GEV No.	692831	Ref. No.	R58002670
description	door bolt mounting pos. bottom left thread M12 bolt 15mm bolt ø 10mm		
For models:	CKEP06, CKEP06B, CKEP10, CKEP10B, CKEP20, CKEP20B, CKET06, CKET06B, CKET10, CKET10B, CKET20, CKET20B, CKGP06, CKGP06B, CKGP10, CKGP10B, CKGP20, CKGP20B, CKGT06, CKGT06B, CKGT10, CKGT10B, CKGT20B		



1

GEV No.	691287	Ref. No.	R18404500
description	hinge		
For models:	CCE071M, CCE101M, CCE102M, CCG071M, CCG101M, CCG102M		



1

GEV No.	691284	Ref. No.	R58001760
description	hinge for glass plate		
For models:	CCE071M, CCE101M, CCE102M, CCG071M, CCG101M, CCG102M, CKEP06, CKEP06B, CKEP10, CKEP10B, CKEP20, CKEP20B, CKEP21, CKEP21B, CKEP40, CKEP40B, CKET06, CKET06B, CKET10, CKET10B, CKET20, CKET20B, CKET21, CKET21B, CKET40, CKET40B, CKGP06, CKGP06B, CKGP10, CKGP10B, CKGP20, CKGP20B, CKGP21, CKGP21B, CKGP40, CKGP40B, CKGT06, CKGT06B, CKGT10, CKGT10B, CKGT20B, CKGT21, CKGT21B, CKGT40, CKGT40B		



1

GEV No.	691453	Ref. No.	2519910
description	hinge for tilting bratt pan		
For models:	74-02KBEB, 74-02KBEB-12701110, 74-02KBEBI, 74-02KBEBI-12701115, 74-02KBEMB, 74-02KBEMB-12701120, 74-02KBEMBI, 74-02KBEMBI-12701125, 74-02KBEMBI-12701125HB, 74-02KBGB-12700110, 74-02KBGBI-12700115, 74-02KBGMB-12700120, 74-02KBGMBI-12700125		



1

GEV No.	691277	Ref. No.	R18201270
description	hinge mounting pos. bottom left		
For models:	CCE042M, CCE051M, CCG051M		



1

GEV No.	691451	Ref. No.	2547860 BN2547860
description	hinge bearing mounting pos. bottom left/upper right with bolt		
For models:	110-135CG, 110-135CG2P, 110-135CGE, 110-135CGE2P, 110-135CGEE, 110-135CGEE2P, 110-135CGEEP, 110-135CGEP, 110-135CGG, 110-135CGG2P, 110-135CGGE, 110-135CGGE2P, 110-135CGGEP, 110-135CGGP, 110-135CGP, 110-45CG, 110-45CG1P, 110-45CGP, 110-90CG, 110-90CG1P, 110-90CGP, 110-90CTE, 110-90CTG, 110-90FTE1-2R, 110-90FTEC, 110-90FTEC1-2R, 110-90FTECR, 110-90FTEFR, 110-90FTTG1-2R, 110-90FTTGC, 110-90FTTGC1-2R, 110-90FTTGCR, 110-90FTTGR, 55-45CPE, 55-45CPG, 55-45FRE, 55-45FRG, 55-90CPE, 55-90CPG, 55-90FRE, 55-90FRG, 7BRF-E405, 7BRF-E805, 7CP-E400, 7CP-E800, 7CP-G400, 7CP-G800, 7FRI-E415, 7FRI-E610, 7FRI-E815...(Other models you can see in the webshop)		



1

GEV No.	691347	Ref. No.	1044230423
description	hinge bearing mounting pos. bottom right without bolt		
For models:	CFG120, OCFG120		



1

GEV No.	514292	Ref. No.	3106800 BN3106800
description	hinge bearing mounting pos. lower without bolt		
For models:	CMV6ES2-1320392, CV10E, CV10E-1320100, CV10E-2, CV10E2-1320140, CV10EB-1321100, CV10E-S, CV10ES-1320150, CV10E-S2, CV10ES2-1320190, CV10G, CV10G-1310100, CV10G-2, CV10G2-1310140, CV10GB-1311100, CV10G-S, CV10GS-1310150, CV10G-S2, CV10GS2-1310190, CV20E, CV20E-1320200, CV20E-2, CV20E2-1320240, CV20EB-1321200, CV20E-S, CV20ES-1320250, CV20E-S2, CV20ES2-1320290, CV20G, CV20G-1310200, CV20G-2, CV20G2-1310240, CV20GB-1311200, CV20G-S, CV20GS-1310250, CV20G-S2, CV20GS2-1310290, CV6E, CV6E-1320000, CV6E-1320050, CV6E-2, CV6E2-1320040, CV6EB-1321000, CV6E-S, CV6E-S2, CV6ES2-1320090, CV6G, CV6G-1310000, CV6G-2, CV6G2-1310040...(Other models you can see in the webshop)		



1			
GEV No.	514294	Ref. No.	3106850 BN3106850
description	hinge bearing mounting pos. lower without bolt		
For models:	CV21E, CV21E-1322100, CV21E-2, CV21E2-1322140, CV21E-S, CV21E5-1322150, CV21E-S2, CV21E52-1322190, CV21G, CV21G-1312100, CV21G-2, CV21G2-1312140, CV21G-S, CV21GS-1312150, CV21G-S2, CV21GS2-1312190, CVM21E, CVM21E-1322400, CVM21E-2, CVM21E2-1322440, CVM21E-S, CVM21ES-1322450, CVM21E-S2, CVM21ES2-1322490, CVM21E52-1322495, CVM21G, CVM21G-1312400, CVM21G-2, CVM21G2-1312440, CVM21G-S, CVM21GS-1312450, CVM21G-S2, CVM21GS2-1312490, CVM21GS2-1312495, CVP21E, CVP21E-1322700, CVP21E-2, CVP21E-S, CVP21ES-1322750, CVP21E-S2, CVP21ES2-1322790, CVP21G, CVP21G-1312700, CVP21G-2, CVP21G2-1312740, CVP21G-S, CVP21GS-1312750, CVP21G-S2, CVP21GS2-1312790, ECVM21E52-1324490...(Other models you can see in the webshop)		



1			
GEV No.	691276	Ref. No.	R18201260
description	hinge bearing mounting pos. upper left		
For models:	CCE042M, CCE051M, CCG051M		



1			
GEV No.	514291	Ref. No.	3106700 BN3106700
description	hinge bearing mounting pos. upper left without bolt		
For models:	CMV6E52-1320392, CV10E, CV10E-1320100, CV10E-1320110, CV10E-2, CV10E2-1320140, CV10EB-1321100, CV10E-S, CV10ES-1320150, CV10E-S2, CV10ES2-1320190, CV10G, CV10G-1310100, CV10G-2, CV10G2-1310140, CV10GB-1311100, CV10G-S, CV10GS-1310150, CV10G-S2, CV10GS2-1310190, CV20E, CV20E-1320200, CV20E-2, CV20E2-1320240, CV20EB-1321200, CV20E-S, CV20ES-1320250, CV20E-S2, CV20ES2-1320290, CV20G, CV20G-1310200, CV20G-2, CV20G2-1310240, CV20GB-1311200, CV20G-S, CV20GS-1310250, CV20G-S2, CV20GS2-1310290, CV6E, CV6E-1320000, CV6E-1320010, CV6E-1320050, CV6E-2, CV6E2-1320040, CV6EB-1321000, CV6E-S, CV6E-S2, CV6ES2-1320090, CV6G, CV6G-1310000...(Other models you can see in the webshop)		



1			
GEV No.	690586	Ref. No.	R11200560
description	hinge bearing mounting pos. upper left without bolt		
For models:	CCE071M, CCE101M, CCE102M, CCG071M, CCG101M, CCG102M, CKEP06, CKEP06B, CKEP10, CKEP10B, CKEP20, CKEP20B, CKEP21, CKEP21B, CKEP40, CKEP40B, CKET06, CKET06B, CKET10, CKET10B, CKET20, CKET20B, CKET21, CKET21B, CKET40, CKET40B, CKGP06, CKGP06B, CKGP10, CKGP10B, CKGP20, CKGP20B, CKGP21, CKGP21B, CKGP40, CKGP40B, CKGT06, CKGT06B, CKGT10, CKGT10B, CKGT20B, CKGT21, CKGT21B, CKGT40, CKGT40B		



1			
GEV No.	691452	Ref. No.	2547870 BN2547870
description	hinge bearing mounting pos. upper left/bottom right with bolt		
For models:	110-135CG, 110-135CG2P, 110-135CGE, 110-135CGE2P, 110-135CGEE, 110-135CGEE2P, 110-135CGEEP, 110-135CGEP, 110-135CGG, 110-135CGG2P, 110-135CGGE, 110-135CGGE2P, 110-135CGGEP, 110-135CGGP, 110-135CGP, 110-45CG, 110-45CG1P, 110-45CGP, 110-90CG, 110-90CG1P, 110-90CGP, 110-90CTE, 110-90CTG, 110-90FTE1-2R, 110-90FTEC, 110-90FTEC1-2R, 110-90FTECR, 110-90FTECR, 110-90FT-2R, 110-90FTTGC, 110-90FTTGC1-2R, 110-90FTTGC1-2R, 110-90FTTGR, 55-45CPE, 55-45CPG, 55-45FRE, 55-45FRG, 55-90CPE, 55-90CPG, 55-90FRE, 55-90FRG, 7BRF-E405, 7BRF-E805, 7CP-E400, 7CP-E800, 7CP-G400, 7CP-G800, 7FRI-E415, 7FRI-E610, 7FRI-E815...(Other models you can see in the webshop)		



1			
GEV No.	514293	Ref. No.	3106750 BN3106750
description	hinge bearing mounting pos. upper right without bolt		
For models:	CV21E, CV21E-1322100, CV21E-2, CV21E2-1322140, CV21E-S, CV21ES-1322150, CV21E-S2, CV21ES2-1322190, CV21G, CV21G-1312100, CV21G-2, CV21G2-1312140, CV21G-S, CV21GS-1312150, CV21G-S2, CV21GS2-1312190, CVM21E, CVM21E-1322400, CVM21E-2, CVM21E2-1322440, CVM21E-S, CVM21ES-1322450, CVM21E-S2, CVM21ES2-1322490, CVM21E52-1322495, CVM21G, CVM21G-1312400, CVM21G-2, CVM21G2-1312440, CVM21G-S, CVM21GS-1312450, CVM21G-S2, CVM21GS2-1312490, CVM21GS2-1312495, CVP21E, CVP21E-1322700, CVP21E-2, CVP21E-S, CVP21ES-1322750, CVP21E-S2, CVP21ES2-1322790, CVP21G, CVP21G-1312700, CVP21G-2, CVP21G2-1312740, CVP21G-S, CVP21GS-1312750, CVP21G-S2, CVP21GS2-1312790, ECVM21E52-1324490...(Other models you can see in the webshop)		



1			
GEV No.	691346	Ref. No.	1044237100
description	hinge bearing mounting pos. upper right without bolt		
For models:	CFG120, OCFG120		





1			
GEV No.	690583	Ref. No.	N/A
description	hinge bearing without bolt		



 <p>1</p>			
GEV No.	514524	Ref. No.	R11207240
description	hinge bearing without bolt for combi-steamer mounting pos. bottom left		
For models:	CKEP06, CKEP06B, CKEP10, CKEP10B, CKEP20, CKEP20B, CKET06, CKET06B, CKET10, CKET10B, CKET20, CKET20B, CKGP06, CKGP06B, CKGP10, CKGP10B, CKGP20, CKGP20B, CKGT06, CKGT06B, CKGT10, CKGT10B, CKGT20B		

 <p>1</p>			
GEV No.	691285	Ref. No.	R58001770
description	hinge bolt		
For models:	CCE071M, CCE101M, CCE102M, CCG071M, CCG101M, CCG102M, CKEP06, CKEP06B, CKEP10, CKEP10B, CKEP20, CKEP20B, CKEP21, CKEP21B, CKEP40, CKEP40B, CKET06, CKET06B, CKET10, CKET10B, CKET20, CKET20B, CKET21, CKET21B, CKET40, CKET40B, CKGP06, CKGP06B, CKGP10, CKGP10B, CKGP20, CKGP20B, CKGP21, CKGP21B, CKGP40, CKGP40B, CKGT06, CKGT06B, CKGT10, CKGT10B, CKGT20B, CKGT21, CKGT21B, CKGT40, CKGT40B		

 <p>1</p>			
GEV No.	690099	Ref. No.	R58002150
description	hinge pin mounting pos. upper for door		
For models:	CCE071M, CCE101M, CCE102M, CCG071M, CCG101M, CCG102M, CKEP06, CKEP06B, CKEP10, CKEP10B, CKEP20, CKEP20B, CKEP21, CKEP21B, CKEP40, CKEP40B, CKET06, CKET06B, CKET10, CKET10B, CKET20, CKET20B, CKET21, CKET21B, CKET40, CKET40B, CKGP06, CKGP06B, CKGP10, CKGP10B, CKGP20, CKGP20B, CKGP21, CKGP21B, CKGP40, CKGP40B, CKGT06, CKGT06B, CKGT10, CKGT10B, CKGT20B, CKGT21, CKGT21B, CKGT40, CKGT40B		

miscellaneous

 <p>1</p>			
GEV No.	519399	Ref. No.	540629
description	door hinge mounting pos. left		
For models:	OLElectron400		
accessories for	519399		
		GEV No.	519397
		Ref. No.	540036
	bush mounting pos. left for hinge		

 <p>1</p>			
GEV No.	519398	Ref. No.	540624
description	door hinge mounting pos. right		
For models:	OLElectron400		
accessories for	519398		
		GEV No.	519396
		Ref. No.	540035
	bush mounting pos. right for hinge		

accessories

miscellaneous

 <p>1</p>			
GEV No.	690595	Ref. No.	R58002550
description	bush for door hinge		
For models:	CKEP21, CKEP21B, CKEP40, CKEP40B, CKET21, CKET21B, CKET40, CKET40B, CKGP21, CKGP21B, CKGP40, CKGP40B, CKGT21, CKGT21B, CKGT40, CKGT40B		

 <p>1</p>			
GEV No.	690592	Ref. No.	R58002540
description	pin for hinge		
For models:	CKEP21, CKEP21B, CKEP40, CKEP40B, CKET21, CKET21B, CKET40, CKET40B, CKGP21, CKGP21B, CKGP40, CKGP40B, CKGT21, CKGT21B, CKGT40, CKGT40B		

 <p>1</p>			
GEV No.	690593	Ref. No.	R58002570
description	plain washer ID ø 15mm ED ø 30mm thickness 3mm Qty 1 pcs for door hinge		
For models:	CKEP21, CKEP21B, CKEP40, CKEP40B, CKET21, CKET21B, CKET40, CKET40B, CKGP21, CKGP21B, CKGP40, CKGP40B, CKGT21, CKGT21B, CKGT40, CKGT40B		



1

GEV No.	690594	Ref. No.	R58002560
description	pressure screw for door hinge		
For models:	CKEP21, CKEP21B, CKEP40, CKEP40B, CKET21, CKET21B, CKET40, CKET40B, CKGP21, CKGP21B, CKGP40, CKGP40B, CKGT21, CKGT21B, CKGT40, CKGT40B		



1

GEV No.	541529	Ref. No.	9000619 BN9000619
description	drain pipe L 110mm thread		
For models:	55-45FRE, 55-90FRE, 72-02FRE, 72-02FRE-12701500, 72-02FREM, 72-02FREM-12701530, 72-02FRG, 72-02FRG-12700500, 72-02FRGM, 72-02FRGM-12700530, 72-02FRGM-12700530TA, 73-02FRE, 73-02FRE-12701550, 73-02FREM, 73-02FREM-12701580, 73-02FRG, 73-02FRG-12700550, 73-02FRGM, 73-02FRGM-12700580, 73-02FRGM-12700580TA, 74-02FRE, 74-02FRE-12701600, 74-02FREM, 74-02FREM-12701630, 74-02FRG, 74-02FRG-12700600, 74-02FRG17-12700605, 74-02FRGM, 74-02FRGM-12700630		

pullouts

drawer slides

producer-specific









1

GEV No.	691339	Ref. No.	1031006100
description	drawer slide L 525mm pull-out lengthmm W 57mm H 15mm mounting pos. right		
For models:	OPL40, OPL60, PL40, PL6, PL60		
accessories for	691339		
	GEV No.	692500	Ref. No. 1031006200
	drawer slide L 525mm W 57mm H 15mm mounting pos. left		



1

GEV No.	540763	Ref. No.	6A022501 BN6A022501
description	outlet tap L 84mm without handle thread 3/4" IT		
For models:	72-02CBE, 72-02CBE-12701150, 72-02CBG, 72-02CBG-12700150, 72-02TCBE, 72-02TCBE-12731150, 72-02TCBG, 72-02TCBG-12730150, 74-02CBE, 74-02CBE-12701155, 74-02CBG, 74-02CBG-12700155, 74-02TCBE, 74-02TCBE-12731155, 74-02TCBG, 74-02TCBG-12730155, 74CB-E-1000550, 74CBE-1000550, 74CB-E-1000550R, 74CBG-000150, 74CB-G-1000150, 74CBG-1000150, 74CB-G-1000150R, 78CBE-000560, 78CB-E-1000560, 78CBE-1000560, 78CB-E-1000560R, 78CB-EAC-1000565, 78CBEAC-1000565, 78CB-EAC-1000565R, 78CBG-000160, 78CB-G-1000160, 78CBG-1000160, 78CB-G-1000160R, 78CBGAC-1000165, 78CBGAC-1000165, 7-BME		
spare parts for	540763		
	GEV No.	532453	Ref. No. —
	O-ring EPDM thickness 2.62mm ID ø 21.89mm Qty 1 pcs		
accessories for	540763		
	GEV No.	110704	Ref. No. —
	cone handle thread M6 ø 16mm L 25mm plastic black		
	GEV No.	514006	Ref. No. —
	drain pipe L 200mm thread ø 22mm		
	GEV No.	540651	Ref. No. 1033300300
	drain pipe total length 210mm shaft ø 22mm		
	GEV No.	540734	Ref. No. —
	drain pipe thread		
	GEV No.	691355	Ref. No. —
	lever L 64mm for outlet tap thread M6 ET - M6 ET		

fittings for catering equipment

outlet taps

producer-specific

OLIS



1

GEV No.	540761	Ref. No.	8217500 BN8217500
description	drain pipe grommet length 39mm thread		
For models:	40SEBM, 40SEBM-1826100, 40SEBM2S-1826100, 40SECP, 40SECP-1825080, 40SECP-1825080E, 40SEFR, 40SEFR-1826140, 40SEFR2S-1826140, 40SEW, 40SEW-1825190, 40SGFR, 40SGFR-1826160, 40SGFR2S-1826160, 41SEFR, 41SEFR-1826120, 421SEFR-1826125, 60SEBM, 60SEBM-1826110, 60SEBM2S-1826110, 60SEFR, 60SEFR-1826150, 60SEFR2S-1826150, 60SGFR, 60SGFR-1826170, 60SGFR2S-1826170, 61SEFR, 61SEFR-1826130, 621SEFR-1826135		



			
1			
GEV No.	540759	Ref. No.	6A023020 BN6A023020
description	outlet tap without handle thread 1" IT		
For models:	40SEBM, 40SEBM-1826100, 40SEBM2S-1826100, 40SECP, 40SECP-1825080, 40SECP-1825080E, 40SEFR, 40SEFR-1826140, 40SEFR2S-1826140, 40SEW, 40SEW-1825190, 40SGFR, 40SGFR-1826160, 40SGFR2S-1826160, 41SEFR, 41SEFR-1826120, 41SEFR2S-1826120, 421SEFR-1826125, 55-45FRE, 55-45FRG, 55-90FRE, 55-90FRG, 60SEBM, 60SEBM-1826110, 60SEBM2S-1826110, 60SEFR, 60SEFR-1826150, 60SEFR2S-1826150, 60SGFR, 60SGFR-1826170, 60SGFR2S-1826170, 61SEFR, 61SEFR-1826130, 61SEFR2S-1826130, 621SEFR-1826135, 72-02FRE, 72-02FRE-12701500, 72-02FREM, 72-02FREM-12701530, 72-02FRG, 72-02FRG-12700500, 72-02FRG17-12700505, 72-02FRGM, 72-02FRGM-12700530, 72-02FRGM-12700530TA, 73-02FRE, 73-02FRE-12701550, 73-02FREM, 73-02FREM-12701580, 73-02FRG...(Other models you can see in the webshop)		
accessories for	540759		
	GEV No.	504561	Ref. No. 8217550 BN8217550
	O-ring EPDM thickness 2.62mm ID ø 29.82mm Qty 1 pcs		
	GEV No.	540530	Ref. No. —
	handle plastic white L 109mm		
	GEV No.	541529	Ref. No. 9000619 BN9000619
	drain pipe L 110mm thread		

drain taps

brass

drain taps

			
1			
GEV No.	548001	Ref. No.	6A021050 BN6A021050
description	drain tap 1 1/2" IT O-ring seal kettle connection with union nut A 80mm B1 68mm B2 132mm		
For models:	74-02NPEI, 74-02NPEI-12701755, 74-02NPGD, 74-02NPGD-12700750, 74-02NPGI, 74-02NPGI-12700755, 7NP-G50, 7NP-GI50, 7PN-EI50		
spare parts for	548001		
	GEV No.	505092	Ref. No. BN0119472130
	O-ring EPDM thickness 5.34mm ID ø 43.82mm Qty 1 pcs		
	GEV No.	540213	Ref. No. —
	handle ID ø 5mm L 117mm		

aerators and air bleeders

			
1			
GEV No.	540827	Ref. No.	6A021600 BN6A021600
description	aerator and air bleeder thread 3/4" ET chrome-plated L 45mm ø 36mm		
For models:	910PGB-1191800, 910PGB-191800, 911PEB-1192805, 911PGB-1191805, 911RPEB-1392890, 911RPG-1391830, 915PEB-1192800		

			
1			
GEV No.	540825	Ref. No.	6A022231 BN6A022231 CR0587810
description	aerator and air bleeder thread 3/8" ET WS 24 chrome-plated L 37mm		
For models:	74-02NPEI, 74-02NPEI-12701755, 74-02NPGI, 74-02NPGI-12700755, 7NP-GI50, 7PN-EI50		

			
1			
GEV No.	540275	Ref. No.	6A021000 BN6A021000
description	drain tap 2" IT with union nut A 90mm B 151mm B1 80mm chrome-plated brass		
For models:	910PG-1191810, 910PG-191810, 910PGB-1191800, 910PGB-191800, 911PEB-1192805, 911PGB-1191805, 911RPEB-1392890, 911RPG-1391830, 915PEB-1192800, 915PG-1191815, 915PG-191815		
spare parts for	540275		
	GEV No.	540214	Ref. No. —
	handle ID ø 6mm L 145mm		
accessories for	540275		
	GEV No.	529484	Ref. No. —
	flat gasket fibre ED ø 58mm ID ø 50mm thickness 2mm Qty 1 pcs		
	GEV No.	542448	Ref. No. —
	gasket silicone 60x49x2 for drain tap 2"		

accessories



GEV No.	540959	Ref. No.	6A001451 BN6A001451
description	gasket for drain tap hose ext. ø 60mm ID ø 50mm H 2mm		
For models:	94-04PEI100L, 94-04PEI100L-12901765, 94-04PEI110L-12901765BN, 94-04PEI150L, 94-04PEI150L-12901767, 94-04PEI150L-12901767BN, 94-04PGD100L, 94-04PGD110L-12900760, 94-04PGD150L, 94-04PGD-150LGAS-12900762, 94-04PGI100L, 94-04PGI110L-12900765, 94-04PGI150L, 94-04PGI150L-12900767, 9PF-G100, 9PF-G150, 9PF-GI100, 9PF-GI150, 9PN-EI100, 9PN-EI150		

test taps

test taps

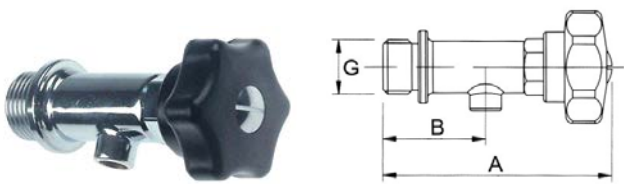





GEV No.	540818	Ref. No.	6A022250 BN6A022250
description	test tap thread 1/2" ET W 88mm W1 38mm		
For models:	74-02NPEI, 74-02NPEI-12701755, 74-02NPGI, 74-02NPGI-12700755, 7NP-GI50, 7PN-EI50		

safety fittings

safety fittings



GEV No.	514404	Ref. No.	2591677
description	safety fitting thread 3/4" 0.45bar conversion kit with manometer		
For models:	74-02NPEI, 74-02NPGI, 7NP-GI50, 7PN-EI50		
spare parts for	514404		
	GEV No.	514276	Ref. No.
			6A022230 A022230 BN6A022230
	safety fitting thread 3/4" 0.45bar H 165mm ø 65mm		
	GEV No.	540825	Ref. No.
			6A022231 A022231 BN6A022231 CR0587810
	aerator and air bleeder thread 3/8" ET WS 24 chrome-plated L 37mm		
	GEV No.	540832	Ref. No.
			6A022233 A022233
	fitting support thread 1/2" ET suitable for manometer		
	GEV No.	540835	Ref. No.
			6A022235 A022235
	screw cap thread 3/4"		

spare parts for	514404		
	GEV No.	541901	Ref. No.
			CR0589110
	manometer ø 63mm pressure range 0 up to 1bar 0 up to 14.5PSI thread 1/4" connection on the backside		

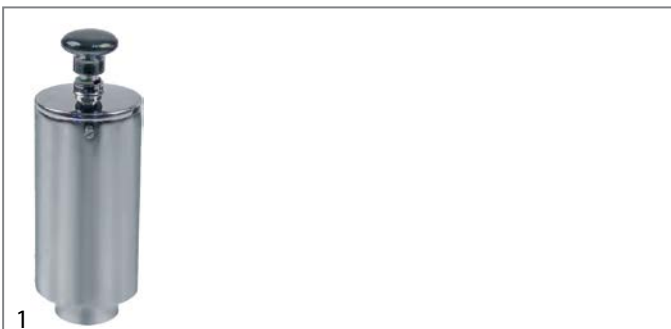

GEV No.	514276	Ref. No.	6A022230 BN6A022230
description	safety fitting thread 3/4" 0.45bar H 165mm ø 65mm		
For models:	74-02NPEI, 74-02NPEI-12701755, 74-02NPGI, 74-02NPGI-12700755, 7NP-GI50, 7PN-EI50		

spare parts for	514276		
	GEV No.	514094	Ref. No.
			—
	angle piece thread 3/8"		

	GEV No.	514276	Ref. No.
			6A022230 A022230 BN6A022230
	safety fitting thread 3/4" 0.45bar H 165mm ø 65mm		

	GEV No.	540825	Ref. No.
			6A022231 A022231 BN6A022231 CR0587810
	aerator and air bleeder thread 3/8" ET WS 24 chrome-plated L 37mm		

	GEV No.	540828	Ref. No.
			6A022010 A022010
	manometer siphon thread 3/8"		

	GEV No.	541579	Ref. No.
			—
	manometer ø 52mm pressure range 0 up to 1bar connection marking 0.5 thread 1/4"		

accessories





GEV No.	540832	Ref. No.	6A022233
description	fitting support thread 1/2" ET suitable for manometer		
For models:	74-02NPEI, 74-02NPEI-12701755, 74-02NPGI, 74-02NPGI-12700755, 7NP-GI50, 7PN-EI50		
accessories for	540832		
	GEV No.	510166	Ref. No.
			—
	flat gasket fibre ED ø 31.3mm ID ø 26.3mm thickness 1.2mm Qty 1 pcs		



			
1			
GEV No.	540821	Ref. No.	6A021400
description	fitting support thread 1 1/4"		
For models:	910PGB-1191800, 910PGB-191800, 911PEB-1192805, 911PGB-1191805, 911RPEB-1392890, 911RPGB-1391830, 915PEB-1192800		

			
1			
GEV No.	540828	Ref. No.	6A022010
description	manometer siphon thread 3/8"		
For models:	910PGB-1191800, 910PGB-191800, 911PEB-1192805, 911PGB-1191805, 911RPEB-1392890, 911RPGB-1391830, 915PEB-1192800		

			
1			
GEV No.	540860	Ref. No.	6A021410
description	fitting support thread 3/4" ET suitable for manometer		
For models:	910PGB-1191800, 910PGB-191800, 911PEB-1192805, 911PGB-1191805, 911RPEB-1392890, 911RPGB-1391830, 915PEB-1192800		



			
1			
GEV No.	514405	Ref. No.	6A022232
description	ring for safety fitting ø 23.5mm		
For models:	74-02NPEI, 74-02NPEI-12701755, 74-02NPGI, 74-02NPGI-12700755, 7NP-GI50, 7PN-EI50		

			
1			
GEV No.	540836	Ref. No.	6A021700 BN6A021700
description	funnel thread 1/2" with shut-off valve		
For models:	910PGB-1191800, 910PGB-191800, 911PEB-1192805, 911PGB-1191805, 911RPEB-1392890, 911RPGB-1391830, 915PEB-1192800		

safety valves

			
1			
GEV No.	540721	Ref. No.	6A021510 BN6A021510
description	safety valve triggering pressure 0.5bar M88 thread 1 1/4"		
For models:	910PGB-1191800, 910PGB-191800, 911PEB-1192805, 911PGB-1191805, 911RPEB-1392890, 911RPGB-1391830, 915PEB-1192800		
accessories for	540721		
	GEV No.	541501	Ref. No. —
reducer for safety fitting IT 1 1/4" ET 3/4"			

			
1			
GEV No.	540770	Ref. No.	6A021800 BN6A021800
description	pressure gauge tap		
For models:	910PGB-1191800, 910PGB-191800, 911PEB-1192805, 911PGB-1191805, 911RPEB-1392890, 911RPGB-1391830, 915PEB-1192800		

			
1			
GEV No.	540835	Ref. No.	6A022235
description	screw cap thread 3/4"		
For models:	74-02NPEI, 74-02NPEI-12701755, 74-02NPGI, 74-02NPGI-12700755, 7NP-GI50, 7PN-EI50		
spare parts for	540835		
	GEV No.	513016	Ref. No. —
O-ring EPDM thickness 3.53mm ID ø 26.58mm Qty 1 pcs			
accessories for	540835		
	GEV No.	513016	Ref. No. —
O-ring EPDM thickness 3.53mm ID ø 26.58mm Qty 1 pcs			

equipment feet and end caps

equipment feet

with fixing plate



GEV No.	701204	Ref. No.	2519500 BN2519500
description	equipment foot tube ø 52mm plate size 67x67mm hole distance 51x51mm H 120-190mm SS size 2" Qty 1 pcs		
For models:	2FX+PCF, 4FX, 4FX+PCF, 72+2CTGG-12700013, 72-02CBE, 72-02CBE-12701150, 72-02CBG, 72-02CBG-12700150, 72-02CEPQ, 72-02CEPQ-12701201, 72-02CEPT, 72-02CEPT-12701001, 72-02CEPT-2212701001, 72-02CG, 72-02CG-12700001, 72-02CG-12700001TA, 72-02CPE, 72-02CPE-12701900, 72-02CPG, 72-02CPG-12700900, 72-02EN-12700210, 72-02FRE, 72-02FRE-12701500, 72-02FREM, 72-02FREM-12701530, 72-02FRG, 72-02FRG-12700500, 72-02FRG17-12700505, 72-02FRGM, 72-02FRGM-12700530, 72-02FRGM-12700530TA, 72-02FTE, 72-02FTE-12701130, 72-02FTEC, 72-02FTEC-12701135, 72-02FTEC, 72-02FTEC-12701132, 72-02FTG, 72-02FTG-12700130TA, 72-02FTG-12700300, 72-02FTG-12700300TA, 72-02FTGC-12700135, 72-02FTGC-12700135TA, 72-02FTGCVAL, 72-02FTGR, 72-02FTGR-12700132TA, 72-02FTGR-12700302, 72-02FTGR-12700302TA, 72-02FTGRVAL, 72-02FTGRVAL...(Other models you can see in the webshop)		



GEV No.	700724	Ref. No.	6086113
description	equipment foot tube ø 58mm plate size 70x70mm hole distance 56x56mm H 130-210mm SS size 2 1/4" Qty 1 pcs		
For models:	CFE60, CFE60P, CFG120, OCFE60, OCFE-60-12601005, OCFE-60-12601005MN, OCFG120, OCFGE61		



GEV No.	700220	Ref. No.	1467516
description	equipment foot tube ø 64mm plate size 76/90mm hole distance 60x80mm H 115-170mm SS size 2 1/2" Qty 1 pcs		
For models:	KSABT70G-2045370CJD, OLKSABT140-2045240CIW, OLKSABT144-2045240CJO, OLKSABT70-2045170CJO, OLKSABT72-2045170CIT, OLKSABTV140-2045240CIY, OLKSABTV70-2045170CIR, OLKSAP70-2045270CIP, OLKSATN140-2045140CIV, OLKSATN144-2045140CIZ, OLKSATN70-2045070CIN, OLKSATN72-2045070CIS, OLKSATNV140-2045140CIX, OLKSATNV70-2045070CII, OLKSATNV72-2045070CIS, OLSPAB100-201706030CLP, OLSPAB120-201707030CLN, OLSPAB200-201712030CLQ, OLSPAB240-201714030CLO, OLSPABT120-201722030CII, OLSPABT124-201722030CIM, OLSPABT140-201724030CII, OLSPABT144-201724030CII, OLSPABT60-201716030CIC, OLSPABT70-201717030CHW, OLSPABT72-201717030CII, OLSPABTV120-201722030CIK, OLSPABTV140-201724030CII, OLSPABTV70-201717030CHY, OLSPATNN120-201712030CIH, OLSPATNN124-201712030CIL, OLSPATNN140-201714030CI1, OLSPATNN144-201714030CIS, OLSPATNN60-201706030CIB, OLSPATNN62-201706030CIF, OLSPATNN70-201707030CEM, OLSPATNN72-201707030CHZ, OLSPATNV120-201712030CIJ, OLSPATNV140-201714030CI3, OLSPATNV60-201706030CID, OLSPATNV70-201707030CHX		

screw-in feet



GEV No.	701292	Ref. No.	10786
description	equipment foot thread M10 thread L 23mm ø 38mm H 12.5mm WS 17 Qty 1 pcs		
For models:	OLDerby, OLDS35-1081005, OLDS37-1081006, OLDS37D-1081007, OLDS37LS-1081008, OLDS37LSD-1081009, OLDS40-1081010, OLDS40D-1081011, OLDS40LS-1081012, OLDS40LSD-1081013, OLDS50P-1081018, OLDS50PD-1081019, OLElectron500, OLG600, OLGastro450, OLGastro500Plus, OLGastro500S, OLGastro750Plus, OLGastro750S, OLLinear, OLStar		



GEV No.	695601	Ref. No.	10850
description	equipment foot thread M17 thread L 23mm ø 24mm H 11mm plastic WS 24 Qty 1 pcs		
For models:	OLDS35, OLDS35-1081061, OLDS35D-1081062, OLDS35-Neutra, OLDS37, OLDS37-1081063, OLDS37D-1081064, OLDS37-Neutra, OLDS40, OLDS40-1081065, OLDS40D-1081066, OLDS40E-1081067, OLDS40ED-1081068, OLDS40-Neutra, OLElectron400, OLG35, OLG35-1080702, OLG35D-1081000, OLG35-Neutra, OLG3537, OLG3537-1080700, OLG3537D-1080707, OLG3537LS-1081001, OLG3537LSD-1081002, OLG3537-Neutra, OLG3540, OLG3540, OLG3540-1080701, OLG3540D-1080708, OLG3540D-1081003, OLG3540-Neutra, OLG3545, OLG3545LSD-1081004, OLG3550ECOD-1081015, OLG3550-Neutra		



GEV No.	696536	Ref. No.	10851
description	equipment foot thread M17 thread L 30mm ø 17mm H 20mm plastic WS 24 Qty 1 pcs		
For models:	OLDS45, OLDS50, OLDS50-1081088, OLDS50D-1081089, OLDS50E-1081090, OLDS50ED-1081091, OLDS50-Neutra, OLG550, OLG550-1080705, OLG550D-1080706, OLG550E-1080730, OLG550E-CO-1081014, OLG550ED-1080731		



bolting feet

			
1			
GEV No.	514009	Ref. No.	1036021613
description	equipment foot L 50mm W 29mm H 25mm bore ø 10mm mounting distance 40mm Qty 1 pcs		
For models:	BRE40, BRE40D, BRE40DB, BRE40DG, BRE40DGB, BRE40G, BSEI40M, CPE60, CPE60DB, FQE41, FQE41L, FQE41L2, FQE61, FQE61L, FQE61L2, FQG40, FQG41, FQG60, FQG61, FTE100B, FTE100BR, FTE100CRL, FTE40B, FTE40BR, FTE40C, FTE40D, FTE40DC, FTE60B, FTE60BR, FTE60C, FTE60D, FTE60DC, FTE60DR, FTE60DRCL, LA60, OBME41M, OBME61M, OBRE40, OBRE-40-12601110, OBRE-40-12601110MN, OBSEI40M, OBSEI-40M-12601700, OCPE60, OCPE-60-12601900, OCPE-60-12601900MN, OFQE41, OFQE-41-12601510, OFQE-41-12601510MN, OFQE41L, OFQE61...(Other models you can see in the webshop)		

DERBY RUOTE

with fixing plate

chrome-plated steel

			
1			
GEV No.	700851	Ref. No.	147802
description	swivel castor with brake ø 80mm with flange plate bearing slide bearing		
For models:	KTAP01-BASE-20220901044U, KTAP02-BASE-20221301048K, KTAP02BT-BASE-2022630105KW, KTAP03-BASE-2022180109UA, KTAP04-2022230109X0, KTAP04-BASE-2022230109RY, KTAR01, KTAR01N, KTAR02, KTAR02N, KTAR03, KTAR03N, KTAR04, KTAR04N, KTRE21-202108010BL5, KTRE2-202108010BFC, KTRE2A-202108010BGP, KTRE3-202113010BHF, KTRE32A-202113010BLQ, KTRE34-202113010BLW, KTRE3A-202113010BFW, KTRE4-202117010BLG, KTRE42-202117010BMO, KTRE42A-202117010BM6, KTRE44-202117010BMB, KTRE4A-202117010BFF, KTRE5-202122010BG2, KTRE52-202122010BNK, KTRE54-202122010BGC, KTRE54A-202122010BNP, KTRE5A-202122010BL3, KTREP3-202611010C2F, KTREP34-20261101096L, KTREP34A-20261101096K, KTREP3A-202611010C1L, KTREP4-202615010BNQ, KTREP4A-202615010BNR, KTREP52A-202620010BO5, KTRN200012-202010050495, KTRN200012A-2020100507UK, KTRN200013-2020100507UV, KTRN200013A-2020100507UU, KTRN200014-2020100507UM, KTRN200014A-2020100507UL, KTRN200015-2020100507UR, KTRN200015A-2020100507UT, KTRN300122-202013050479, KTRN300122A-2020130504DY, KTRN300142-2020130506BG, KTRN300142A-2020130507GY...(Other models you can see in the webshop)		

			
Image not available			
1			
GEV No.	700852	Ref. No.	147801
description	swivel castor without brake ø 80mm with flange plate		
For models:	KTAP01-BASE-20220901044U, KTAP02-BASE-20221301048K, KTAP02BT-BASE-2022630105KW, KTAP03-BASE-2022180109UA, KTAP04-2022230109X0, KTAP04-BASE-2022230109RY, KTAR01, KTAR01N, KTAR02, KTAR02N, KTAR03, KTAR03N, KTAR04, KTAR04N, KTRE21-202108010BL5, KTRE2-202108010BFC, KTRE2A-202108010BGP, KTRE3-202113010BHF, KTRE32A-202113010BLQ, KTRE34-202113010BLW, KTRE3A-202113010BFW, KTRE4-202117010BLG, KTRE42-202117010BMO, KTRE42A-202117010BM6, KTRE44-202117010BMB, KTRE4A-202117010BFF, KTRE5-202122010BG2, KTRE52-202122010BNK, KTRE54-202122010BGC, KTRE54A-202122010BNP, KTRE5A-202122010BL3, KTREP3-202611010C2F, KTREP34-20261101096L, KTREP34A-20261101096K, KTREP3A-202611010C1L, KTREP4-202615010BNQ, KTREP4A-202615010BNR, KTREP52A-202620010BO5, KTRN200012-202010050495, KTRN200012A-2020100507UK, KTRN200013-2020100507UV, KTRN200013A-2020100507UU, KTRN200014-2020100507UM, KTRN200014A-2020100507UL, KTRN200015-2020100507UR, KTRN200015A-2020100507UT, KTRN300122-202013050479, KTRN300122A-2020130504DY, KTRN300142-2020130506BG, KTRN300142A-2020130507GY...(Other models you can see in the webshop)		

spare parts and accessories

miscellaneous

			
1			
GEV No.	560193	Ref. No.	15812699
description	tooth lock washer ID ø 10.4mm ED ø 18mm zinc-coated steel DIN/ISO DIN 6798A Qty 1 pcs for thread M10		
For models:	CPE60, CPE60DB, OCPE60, OCPE-60-12601900, OCPE-60-12601900MN		

TENTE

with fixing plate

chrome-plated steel



GEV No.	700214	Ref. No.	147805
----------------	--------	-----------------	--------

description
swivel castor ø 100mm plate fixing housing zinc-plated sheet steel plate size 105x85mm hole distance 60x78mm capacity 80kg bearing slide bearing wheel body polypropylene tread TPE tyres H 128mm wheel width 32mm

For models:
KTAP01-BASE-20220901044U, KTAP02-BASE-20221301048K, KTAP02BT-BASE-2022630105KW, KTAP03-BASE-2022180109UA, KTAP04-2022230109X0, KTAP04-BASE-2022230109RY, KTAR01, KTAR01N, KTAR02, KTAR02N, KTAR03, KTAR03N, KTAR04, KTAR04N, KTR21-202108010BL5, KTR22-202108010BFC, KTR2A-202108010BGP, KTR3-202113010BHF, KTR32A-202113010BLQ, KTR34-202113010BLW, KTR3A-202113010BFW, KTR4-202117010BLG, KTR42-202117010BMO, KTR42A-202117010BM6, KTR44-202117010BMB, KTR4A-202117010BFF, KTR5-202122010BG2, KTR52-202122010BNK, KTR54-202122010BGC, KTR54A-202122010BNP, KTR5A-202122010BL3, KTR3P-202611010C2F, KTR3P3-20261101096L, KTR3P3A-20261101096K, KTR3P3A-202611010C1L, KTR3P4-202615010BNQ, KTR3P4A-202615010BNR, KTRP52A-202620010BOS, KTRN200012-202010050495, KTRN200012A-2020100507UK, KTRN200013-2020100507UV, KTRN200013A-2020100507UU, KTRN200014-2020100507UM, KTRN200014A-2020100507UL, KTRN200015-2020100507UR, KTRN200015A-2020100507UT, KTRN300122-202013050479, KTRN300122A-2020130504DY, KTRN300142-2020130506BG, KTRN300142A-2020130507GY...(Other models you can see in the webshop)



GEV No.	700213 ¹	Ref. No.	147806
----------------	---------------------	-----------------	--------

description
swivel castor with swivel brake ø 100mm plate fixing housing zinc-plated sheet steel plate size 105x85mm hole distance 60x78mm capacity 80kg bearing slide bearing wheel body polypropylene tread TPE tyres H 128mm wheel width 32mm Qty 1 pcs

For models:
KTAP01-BASE-20220901044U, KTAP02-BASE-20221301048K, KTAP02BT-BASE-2022630105KW, KTAP03-BASE-2022180109UA, KTAP04-2022230109X0, KTAP04-BASE-2022230109RY, KTAR01, KTAR01N, KTAR02, KTAR02N, KTAR03, KTAR03N, KTAR04, KTAR04N, KTR21-202108010BL5, KTR22-202108010BFC, KTR2A-202108010BGP, KTR3-202113010BHF, KTR32A-202113010BLQ, KTR34-202113010BLW, KTR3A-202113010BFW, KTR4-202117010BLG, KTR42-202117010BMO, KTR42A-202117010BM6, KTR44-202117010BMB, KTR4A-202117010BFF, KTR5-202122010BG2, KTR52-202122010BNK, KTR54-202122010BGC, KTR54A-202122010BNP, KTR5A-202122010BL3, KTR3P-202611010C2F, KTR3P3-20261101096L, KTR3P3A-20261101096K, KTR3P3A-202611010C1L, KTR3P4-202615010BNQ, KTR3P4A-202615010BNR, KTRP52A-202620010BOS, KTRN200012-202010050495, KTRN200012A-2020100507UK, KTRN200013-2020100507UV, KTRN200013A-2020100507UU, KTRN200014-2020100507UM, KTRN200014A-2020100507UL, KTRN200015-2020100507UR, KTRN200015A-2020100507UT, KTRN300122-202013050479, KTRN300122A-2020130504DY, KTRN300142-2020130506BG, KTRN300142A-2020130507GY...(Other models you can see in the webshop)

¹with swivel brake

EQUIPMENT FEET AND END CAPS/BASKETS OLIS

stainless steel



GEV No.	701624	Ref. No.	R69090100
description	swivel castor with swivel brake ø 125mm plate fixing housing stainless steel plate size 105x85mm hole distance 78x60mm capacity 200kg bearing slide bearing wheel body polyamide tread polyurethane H 155mm wheel width 32mm		
For models:	CKEP21, CKEP21B, CKEP40, CKEP40B, CKET21, CKET21B, CKET40, CKET40B, CKGP21, CKGP21B, CKGP40, CKGP40B, CKGT21, CKGT21B, CKGT40, CKGT40B		



GEV No.	701622	Ref. No.	R69090090
description	swivel castor without brake ø 125mm plate fixing housing stainless steel plate size 105x85mm hole distance 78x60mm capacity 200kg bearing slide bearing wheel body polyamide tread polyurethane H 155mm wheel width 32mm		
For models:	CKEP21, CKEP21B, CKEP40, CKEP40B, CKET21, CKET21B, CKET40, CKET40B, CKGP21, CKGP21B, CKGP40, CKGP40B, CKGT21, CKGT21B, CKGT40, CKGT40B		

baskets

fryer baskets

OLIS



GEV No.	970343	Ref. No.	9000336 BN9000336
description	fryer basket L1 255mm W1 155mm H1 120mm chrome-plated steel		
For models:	7101FR-E-1077750R, 710FRE-077700, 710FRE-1077700, 710FRG-077300, 710FRG-1077300, 710FR-G-1077350, 710FR-G-1077350R, 7121FR-E-1077950R, 712FRE-077900, 712FRE-1077900, 712FRG-077500, 712FR-G-1077550, 712FRG-1077550, 712FR-G-1077550R, 720FR-G-1077650, 7221FR-E-1078050R, 722FRE-078000, 722FRE-1078000, 722FRG-077600, 722FRG-1077600, 722FR-G-1077650R		



1

GEV No.	970344	Ref. No.	9000335 BN9000335
description	fryer basket L1 255mm W1 320mm H1 120mm L2 510mm H2 220mm chrome-plated steel		
For models:	7201FR-E-1077850R, 720FRE-077800, 720FRE-1077800, 720FRG-077400, 720FRG-1077400, 720FR-G-1077450, 720FRG-1077450, 720FR-G-1077450R, 720FR-G-1077650, 7221FR-E-1078050R, 722FRE-078000, 722FRE-1078000, 722FRG-077600, 722FRG-1077600, 722FR-G-1077650R		



1

GEV No.	970342	Ref. No.	8219300 BN8219300
description	fryer basket L1 285mm W1 215mm H1 120mm L2 510mm H2 135mm chrome-plated steel		
For models:	40SEFR, 40SEFR-1826140, 40SEFR2S-1826140, 41SEFR, 41SEFR-1826120, 41SEFR2S-1826120, 421SEFR-1826125, 60SEFR, 60SEFR-1826150, 60SEFR2S-1826150, 61SEFR, 61SEFR-1826130, 61SEFR2S-1826130, 621SEFR-1826135, 914PFRTE-1204940		



1

GEV No.	970341	Ref. No.	8219200 BN8219200
description	fryer basket L1 310mm W1 197mm H1 167mm		
For models:	40SGFR, 40SGFR-1826160, 40SGFR2S-1826160, 60SGFR, 60SGFR-1826170, 60SGFR2S-1826170		



1

GEV No.	970624	Ref. No.	9000339 BN9000339
description	fryer basket L1 320mm W1 120mm H1 120mm		
For models:	72-02FRGM, 72-02FRGM-12700530, 72-02FRGM-12700530TA, 74-02FRE-12701600, 74-02FREM, 74-02FREM-12701630, 74-02FRG-12700600, 74-02FRG17-12700605, 74-02FRGM, 74-02FRGM-12700630, 7FRI-G815, 92-04FRE15L, 92-04FRG15L, 92-04FRG15L-12900510		



1

GEV No.	970622	Ref. No.	9000337 BN9000337
description	fryer basket L1 320mm W1 160mm H1 120mm L2 430mm H2 184mm H3 210mm		
For models:	55-45FRE, 55-45FRG, 55-90FRE, 55-90FRG, 73-02FRE, 73-02FRE-12701550, 73-02FREM, 73-02FREM-12701580, 73-02FRG, 73-02FRG-12700550, 73-02FRGM, 73-02FRGM-12700580, 73-02FRGM-12700580TA, 7FRI-E610, 7FRI-G610, 93-04FRE10L, 93-04FRE-12901550, 93-04FRG, 93-04FRG-12900550, 93-04FRG-12900550H, 9FRI-E415, 9FRI-E420, 9FRI-E610, 9FRI-G610		



1

GEV No.	970623	Ref. No.	9000338 BN9000338
description	fryer basket L1 320mm W1 245mm H1 120mm		
For models:	72-02FRE, 72-02FRE-12701500, 72-02FREM, 72-02FREM-12701530, 72-02FRG, 72-02FRG-12700500, 72-02FRG17-12700505, 72-02FRGM, 72-02FRGM-12700530, 72-02FRGM-12700530TA, 74-02FRE, 74-02FRE-12701600, 74-02FREM, 74-02FREM-12701630, 74-02FRG, 74-02FRG-12700600, 74-02FRG17-12700605, 74-02FRGM, 74-02FRGM-12700630, 7FRI-E415, 7FRI-E815, 7FRI-G415, 92-04FRE15L, 92-04FRE15L-12901510, 92-04FRG15L, 92-04FRG15L-12900510, 92-04FRG17L-12900515, 9FRI-E415, 9FRI-E420, 9FRI-E610, 9FRI-E815, 9FRI-G415, 9FRI-G815		

pasta baskets

OLIS



1

GEV No.	970713	Ref. No.	CM182700 MACM182700
description	pasta basket H1 180mm W1 145mm L1 146mm size GN 1/6 L2 150mm H2 323mm H3 340mm SS left 70/10-90/10 series		



1

GEV No.	970677	Ref. No.	2519572 BN2519572
description	pasta basket H1 215mm W1 145mm L1 290mm		



1

GEV No.	970405	Ref. No.	2510533 BN2510533
description	pasta basket H1 240mm W1 155mm L1 155mm L2 120mm H2 300mm H3 380mm stainless steel right 70/02-90/04 series		

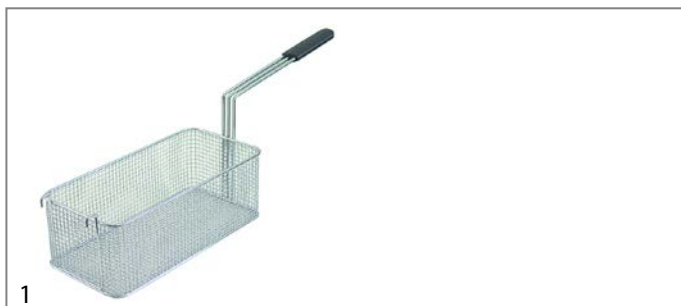

1

GEV No.	970346	Ref. No.	9000334 BN9000334
description	fryer basket L1 350mm W1 162mm H1 120mm L2 660mm H2 190mm H3 210mm chrome-plated steel		
For models:	9122PFRE-1104930, 9122PFRG-1103930, 9141PFRE-1204950, 914PFRG-1103950, 922FRE-1192930, 922FRG-1191930, 922RFRE-1392930, 922RFRG-1391930, 941FRE-1292950, 941RFRE-1392950, 94FRE-192950, 94FRG, 94FRG-1191950, 94FRG-191950, 94FRG-1391950		



1

GEV No.	970345	Ref. No.	9000330 BN9000330
description	fryer basket L1 355mm W1 345mm H1 120mm chrome-plated steel		
For models:	9121PFRE-1204925, 912PFRG-1103925, 9141PFRE-1204950, 914PFRG-1103950, 921FRE, 921FRE-1292925, 921RFRE-1392925, 922FRE-1192930, 92FRE-192925, 92FRG, 92FRG-1191925, 92RFRG-1391925, 941FRE-1292950, 941RFRE-1392950, 94FRE-192950, 94FRG, 94FRG-1191950, 94FRG-191950, 94RFRG-1391950		



1

GEV No.	970676	Ref. No.	9000332 BN9000332
description	fryer basket W1 160mm L1 355mm H1 120mm		
For models:	FR-E950N-1050732, FR-G950N-1050733		



1

GEV No.	993287	Ref. No.	9000413 BN9000413
description	fryer basket W1 275mm L1 375mm H1 120mm		
For models:	92-04FRE20L, 92-04FRE20L-12901500, 92-04FRE20L-12901500BN, 92-04FRG20L, 92-04FRG20L-12900500, 92-04FRG20L-12900500TA, 94-04FRE-12901600, 94-04FRE20L, 94-04FRG-12900600, 94-04FRG20L, 94-04FRG20L-12900600TA, 94-04FRG23L-12900605, 9FRI-E415, 9FRI-E420, 9FRI-E610, 9FRI-E820		

1

GEV No.	970083	Ref. No.	2510536 BN2510536
description	pasta basket H1 240mm W1 155mm L1 155mm size GN 1/6 L2 120mm H2 300mm H3 380mm stainless steel left 70/02-90/04 series		



1

GEV No.	970668	Ref. No.	2510532 BN2510532
description	pasta basket H1 240mm W1 160mm L1 310mm		



1

GEV No.	970669	Ref. No.	2510535 BN2510535
description	pasta basket H1 240mm W1 310mm L1 160mm		



1

GEV No.	970424	Ref. No.	2519571 BN2519571
description	pasta basket L1 290mm W1 97mm H1 215mm L2 505mm H2 295mm H3 325mm stainless steel		

crumb screens



1

GEV No.	970614	Ref. No.	CR0508560
description	crumb screen L 400mm W 220mm suitable for fryer		
For models:	FQG41, FQG61, OFQG41, OFQG-41-12600500, OFQG61, OFQG-61-12600600		

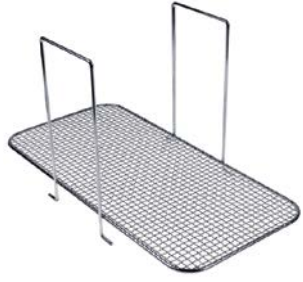

1

GEV No.	970615	Ref. No.	1031112600
description	crumb screen L 388mm W 186mm suitable for fryer		
For models:	FQE41, FQE41L, FQE41L2, FQE61, FQE61L, FQE61L2, OFQE41, OFQE-41-12601510, OFQE-41-12601510MN, OFQE41L, OFQE61, OFQE-61-12601610, OFQE-61-12601610MN, OFQE61L		

shelves and shelf rails

shelf rails and supports

producer-specific



1

GEV No.	690258	Ref. No.	BN1231190 FR1231190
description	guide U-shape L 615mm W 13mm H 20mm mounting pos. left/right		



1

GEV No.	690566	Ref. No.	33510071 BN33510071
description	pair of setting bar U-shape L 615mm W 26mm inner high 18mm mounting pos. left/right		

gaskets

refrigeration gaskets

plug-in gaskets

profile 9048

We offer custom-made gaskets for this profile

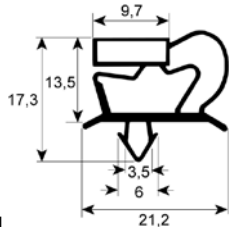

GEV No.	901021	Ref. No.	14414300150
description	refrigeration gasket profile 9048 W 142mm L 396mm plug size		
For models:	KTAP01-BASE-20220901044U, KTAP02-BASE-20221301048K, KTAP03-BASE-2022180109UA, KTAP04-2022230109X0, KTAP04-BASE-2022230109RY, KTAR01, KTAR01N, KTAR02, KTAR02N, KTAR03, KTAR03N, KTAR04, KTAR04N, KTRE21-202108010BL5, KTRE2-202108010BFC, KTRE2A-202108010BGP, KTRE3-202113010BHF, KTRE3A-202113010BLQ, KTRE34-202113010BLW, KTRE3A-202113010BFW, KTRE4-202117010BLG, KTRE42-202117010BMO, KTRE42A-202117010BM6, KTRE44-202117010BMB, KTRE4A-202117010BFF, KTRE5-202122010BG2, KTRE52-202122010BNK, KTRE54-202122010BGC, KTRE54A-202122010BNP, KTRE5A-202122010BL3, KTREP3-202611010C2F, KTREP34-20261101096L, KTREP34A-20261101096K, KTREP3A-202611010C1L, KTREP4-202615010BNQ, KTREP4A-202615010BNR, KTRP52A-202620010B05, KTRN200012-202010050495, KTRN200012A-2020100507UK, KTRN200013-2020100507UV, KTRN200013A-2020100507UU, KTRN200014-2020100507UM, KTRN200014A-2020100507UL, KTRN200015-2020100507UR, KTRN200015A-2020100507UT, KTRN300122-202013050479, KTRN300122A-2020130504DY, KTRN300142-2020130506BG, KTRN300142A-2020130507GY, KTRN300144-2020130505UU...(Other models you can see in the webshop)		

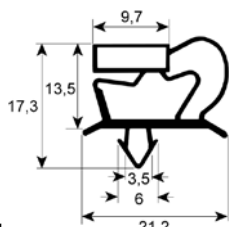

GEV No.	900347	Ref. No.	14414300200
description	refrigeration gasket profile 9048 W 178mm L 396mm plug size		
For models:	KTAP01-BASE-20220901044U, KTAP02-BASE-20221301048K, KTAP03-BASE-2022180109UA, KTAP04-2022230109X0, KTAP04-BASE-2022230109RY, KTAR01, KTAR01N, KTAR02, KTAR02N, KTAR03, KTAR03N, KTAR04, KTAR04N, KTRE21-202108010BL5, KTRE2-202108010BFC, KTRE2A-202108010BGP, KTRE3-202113010BHF, KTRE3A-202113010BLQ, KTRE34-202113010BLW, KTRE3A-202113010BFW, KTRE4-202117010BLG, KTRE42-202117010BMO, KTRE42A-202117010BM6, KTRE44-202117010BMB, KTRE4A-202117010BFF, KTRE5-202122010BG2, KTRE52-202122010BNK, KTRE54-202122010BGC, KTRE54A-202122010BNP, KTRE5A-202122010BL3, KTREP3-202611010C2F, KTREP34-20261101096L, KTREP34A-20261101096K, KTREP3A-202611010C1L, KTREP4-202615010BNQ, KTREP4A-202615010BNR, KTRP52A-202620010B05, KTRN200012-202010050495, KTRN200012A-2020100507UK, KTRN200013-2020100507UV, KTRN200013A-2020100507UU, KTRN200014-2020100507UM, KTRN200014A-2020100507UL, KTRN200015-2020100507UR, KTRN200015A-2020100507UT, KTRN300122-202013050479, KTRN300122A-2020130504DY, KTRN300142-2020130506BG, KTRN300142A-2020130507GY, KTRN300144-2020130505UU...(Other models you can see in the webshop)		

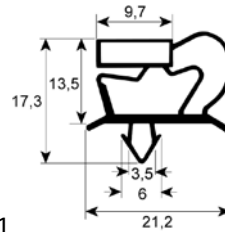

GEV No.	900548	Ref. No.	14414300290
description	refrigeration gasket profile 9048 W 267mm L 394mm plug size		
For models:	KTAP01-BASE-20220901044U, KTAP02-BASE-20221301048K, KTAP03-BASE-2022180109UA, KTAP04-2022230109X0, KTAP04-BASE-2022230109RY, KTAR01, KTAR01N, KTAR02, KTAR02N, KTAR03, KTAR03N, KTAR04, KTAR04N, KTRE21-202108010BL5, KTRE2-202108010BFC, KTRE2A-202108010BGP, KTRE3-202113010BHF, KTRE3A-202113010BLQ, KTRE34-202113010BLW, KTRE3A-202113010BFW, KTRE4-202117010BLG, KTRE42-202117010BMO, KTRE42A-202117010BM6, KTRE44-202117010BMB, KTRE4A-202117010BFF, KTRE5-202122010BG2, KTRE52-202122010BNK, KTRE54-202122010BGC, KTRE54A-202122010BNP, KTRE5A-202122010BL3, KTREP3-202611010C2F, KTREP34-20261101096L, KTREP34A-20261101096K, KTREP3A-202611010C1L, KTREP4-202615010BNQ, KTREP4A-202615010BNR, KTRP52A-202620010B05, KTRN200012-202010050495, KTRN200012A-2020100507UK, KTRN200013-2020100507UV, KTRN200013A-2020100507UU, KTRN200014-2020100507UM, KTRN200014A-2020100507UL, KTRN200015-2020100507UR, KTRN200015A-2020100507UT, KTRN300122-202013050479, KTRN300122A-2020130504DY, KTRN300142-2020130506BG, KTRN300142A-2020130507GY, KTRN300144-2020130505UU...(Other models you can see in the webshop)		

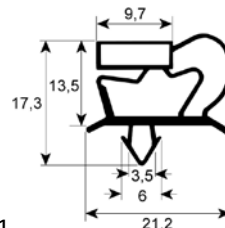

GEV No.	900831	Ref. No.	14414300390
description	refrigeration gasket profile 9048 W 354mm L 396mm plug size drawer size 2/3		
For models:	KTAP01-BASE-20220901044U, KTAP02-BASE-20221301048K, KTAP03-BASE-2022180109UA, KTAP04-2022230109X0, KTAP04-BASE-2022230109RY, KTAR01, KTAR01N, KTAR02, KTAR02N, KTAR03, KTAR03N, KTAR04, KTAR04N, KTRE21-202108010BL5, KTRE2-202108010BFC, KTRE2A-202108010BGP, KTRE3-202113010BHF, KTRE3A-202113010BLQ, KTRE34-202113010BLW, KTRE3A-202113010BFW, KTRE4-202117010BLG, KTRE42-202117010BMO, KTRE42A-202117010BM6, KTRE44-202117010BMB, KTRE4A-202117010BFF, KTRE5-202122010BG2, KTRE52-202122010BNK, KTRE54-202122010BGC, KTRE54A-202122010BNP, KTRE5A-202122010BL3, KTREP3-202611010C2F, KTREP34-20261101096L, KTREP34A-20261101096K, KTREP3A-202611010C1L, KTREP4-202615010BNQ, KTREP4A-202615010BNR, KTRP52A-202620010B05, KTRN200012-202010050495, KTRN200012A-2020100507UK, KTRN200013-2020100507UV, KTRN200013A-2020100507UU, KTRN200014-2020100507UM, KTRN200014A-2020100507UL, KTRN200015-2020100507UR, KTRN200015A-2020100507UT, KTRN300122-202013050479, KTRN300122A-2020130504DY, KTRN300142-2020130506BG, KTRN300142A-2020130507GY, KTRN300144-2020130505UU...(Other models you can see in the webshop)		



GEV No.	900842	Ref. No.	14413690499
description	refrigeration gasket profile 9048 W 370mm L 500mm plug size		
For models:	SAL22R-2124922093V		

GEV No.	901061	Ref. No.	14415465626
description	refrigeration gasket profile 9048 W 468mm L 636mm plug size		
For models:	KTAP82, KTAP82-202282020AY0, KTAP82-202282020AY1, KTAP83, KTAP83-202283020AY3, KTAP84, KTAP84-202284020AY4, KTAP84-202284020AY5, KTRP83-202283020AY2		

GEV No.	900734	Ref. No.	14415396458 BN14415396458
description	refrigeration gasket profile 9048 W 396mm L 458mm plug size		

GEV No.	900832	Ref. No.	14415396405
description	refrigeration gasket profile 9048 W 471mm L 626mm plug size door		
For models:	KTAP82-202282020AY0, KTAP82-202282020AY1, KTAP83-202283020AY3, KTAP84-202284020AY4, KTAP84-202284020AY5, KTRP83-202283020AY2		

GEV No.	900731	Ref. No.	14414300620
description	refrigeration gasket profile 9048 W 396mm L 566mm plug size		
For models:	KTAP01-BASE-20220901044U, KTAP02-BASE-20221301048K, KTAP02BT-BASE-2022630105KW, KTAP03-BASE-2022180109UA, KTAP04-2022230109X0, KTAP04-BASE-2022230109RY, KTR2-202108010BFC, KTR2A-202108010BGP, KTR3-202113010BHF, KTR32A-202113010BLQ, KTR3A-202113010BFW, KTR4-202117010BLG, KTR42-202117010BM0, KTR42A-202117010BM6, KTR44-202117010BMB, KTR4A-202117010BFF, KTR5-202122010BG2, KTR52-202122010BNK, KTR54-202122010BGC, KTR54A-202122010BNP, KTR5A-202122010BL3, KTRP3-202611010C2F, KTRP3A-202611010C1L, KTRP4-202615010BNQ, KTRP4A-202615010BNR, KTRP52A-202620010BO5, KTRN200012-202010050495, KTRN200012A-2020100507UK, KTRN300122-202013050479, KTRN300122A-2020130504DY, KTRN300142-2020130506BG, KTRN300142A-2020130507GY, KTRN300152-2020130507GW, KTRN300152A-2020130507GX, KTRN401222-2020180504K1, KTRN401222A-20201805042X, KTRN401422-2020180506K1, KTRN401422-20201805054X, KTRN401442A-2020180507HE, KTRN401522-2020180507HD, KTRN401522A-2020180506PX, KTRN401552-2020180507L8, KTRN401552A-2020180507L9, KTRN512222-2020230509WK, KTRN512222A-2020230509WL, KTRN514222-2020230509WO, KTRN514222A-2020230509WP, KTRN514422-2020230507HF, KTRN514422A-2020230507HG, KTRN515522-2020230507LC...(Other models you can see in the webshop)		

GEV No.	901015	Ref. No.	14415601460
description	refrigeration gasket profile 9048 W 560mm L 1460mm plug size		
For models:	KBT40-21091640, KC41-210916400BDC, KR41-210906400BFA, KTN40-21090640		

GEV No.	900839	Ref. No.	14415990738
description	refrigeration gasket profile 9048 W 606mm L 744mm plug size door		
For models:	OLSPABT124-201722030CIM, OLSPABT144-201724030CI6, OLSPABT72-201717030CI0, OLSPATNN124-201712030CIL, OLSPATNN144-201714030CI5, OLSPATNN62-201706030CIF, OLSPATNN72-201707030CHZ, TN144, TN72, TNV144, TNV72		

GEV No.	900833	Ref. No.	14416191489
description	refrigeration gasket profile 9048 W 619mm L 1489mm plug size door		
For models:	KSABT70G-2045370CJD, OLKSABT140-2045240CIW, OLKSABT144-2045240CJO, OLKSABT70-2045170CIO, OLKSABT72-2045170CIT, OLKSAP70-2045270CIP, OLKSATN140-2045140CIV, OLKSATN144-2045140CIZ, OLKSATN70-2045070CIN, OLKSATN72-2045070CIS		

GEV No.	900356	Ref. No.	BN14416761594
description	refrigeration gasket profile 9048 W 660mm L 1580mm plug size		

GEV No.	900847	Ref. No.	14417511862
description	refrigeration gasket profile 9048 W 751mm L 1862mm plug size door		
For models:	ROLL-IN1P-211008120CJE, ROLL-IN1P-211008120CJG, ROLL-IN1PBT-211009120CJF, ROLL-IN2P-211016120CJL, ROLL-IN2P-211016120CJM, ROLL-IN2P-211016220CJN, ROLL-IN2P-211016220CJP, ROLL-IN-2PMTN-211016220CJO, ROLL-INP1P-211008220CJH, ROLL-IN-P1P-211008220CJK, ROLL-INP1PBT-211009220CJI, ROLL-INP1PP-MTN-211008220CJJ		

profile 9794

We offer custom-made gaskets for this profile

GEV No.	900344	Ref. No.	14415991559
description	refrigeration gasket profile 9794 W 595mm L 1565mm plug size		
For models:	OLSPABT120-201722030CII, OLSPABT140-201724030CI2, OLSPABT60-201716030CIC, OLSPABT70-201717030CHW, OLSPABTV120-201722030CIK, OLSPABTV140-201724030CI4, OLSPABTV70-201717030CHY, OLSPATNN120-201712030CIH, OLSPATNN140-201714030CI1, OLSPATNN60-201706030CIB, OLSPATNN70-201707030CEM, OLSPATNV120-201712030CIJ, OLSPATNV140-201714030CI3, OLSPATNV60-201706030CID, OLSPATNV70-201707030CHX, TN140, TN70, TNV140, TNV70		

profile 9794Z (blast freezer)

GEV No.	901820 ¹	Ref. No.	FR4501151 FR965128
description	blast freezer gasket profile 9794Z W 336mm L 692mm suitable for FRIULINOX		

¹for blast freezer

GEV No.	901800 ¹	Ref. No.	996457
description	blast freezer gasket profile 9794Z W 847mm L 685mm for blast chiller suitable for FRIULINOX		
For models:	121, OBC121DF-ASX-6V23A285220OL		

¹for blast freezer

profile 9195

We offer custom-made gaskets for this profile

GEV No.	902435	Ref. No.	996453
description	refrigeration gasket profile 9195 W 400mm L 690mm		
For models:	051, BBC051DF-ASX-4186V21A286220, OBC051DF-ASX-6V21A-286220OL		

gaskets for heated units

window seals

GEV No.	900787	Ref. No.	R70044650
description	window gasket profile 1515 L 2200mm suitable for LAINOX		
For models:	CCE071M, CCG071M		



GEV No.	900501	Ref. No.	R70044260
description	window gasket profile 1530 L 1200mm Qty 1		
For models:	CCE101M, CCE102M, CCG101M, CCG102M		



GEV No.	900637	Ref. No.	R70040640
description	window gasket profile 1530 Qty supplied by meter		
For models:	CKEP10, CKEP10B, CKET10, CKET10B, CKGP10, CKGP10B, CKGT10, CKGT10B		

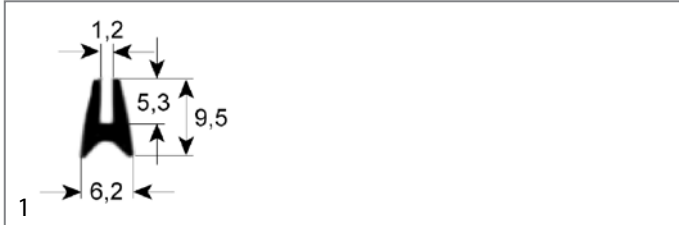

GEV No.	900504	Ref. No.	R70044290
description	window gasket profile 1530 L 1950mm Qty 1		
For models:	CKEP40, CKEP40B, CKET40, CKET40B, CKGP40, CKGP40B, CKGT40, CKGT40B		



GEV No.	900483	Ref. No.	R70044150
description	window gasket profile 1530 L 2400mm Qty 1		
For models:	CCE101M, CCE102M, CCG101M, CCG102M, CKEP20, CKEP20B, CKET20, CKET20B, CKGP20, CKGP20B, CKGT20B		

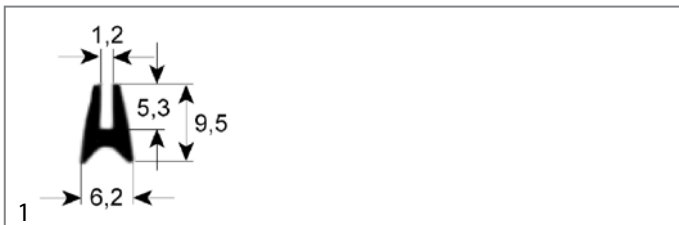

GEV No.	900484	Ref. No.	R70044160
description	window gasket profile 1530 L 3720mm Qty 1		
For models:	CKEP40, CKEP40B, CKET40, CKET40B, CKGP40, CKGP40B, CKGT40, CKGT40B		



GEV No.	900500	Ref. No.	R70044250
description	window gasket profile 1530 L 900mm Qty 1		
For models:	CCE051M, CCE071M, CCG051M, CCG071M, CKEP06, CKEP06B, CKET06, CKET06B, CKGP06, CKGP06B, CKGT06, CKGT06B		

door seals

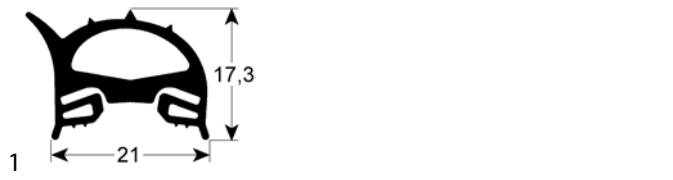

GEV No.	900454	Ref. No.	3108820 BN3108820
description	door seal profile 2510 W 447mm L 1448mm external size		
For models:	CV21E, CV21E-1322100, CV21E-2, CV21E2-1322140, CV21E-S, CV21ES-1322150, CV21E-S2, CV21ES2-1322190, CV21G, CV21G-1312100, CV21G-2, CV21G2-1312140, CV21G-S, CV21GS-1312150, CV21G-S2, CV21GS2-1312190, CVM21E, CVM21E-1322400, CVM21E-2, CVM21E2-1322440, CVM21E-S, CVM21ES-1322450, CVM21E-S2, CVM21ES2-1322490, CVM21ES2-1322495, CVM21G, CVM21G-1312400, CVM21G-2, CVM21G2-1312440, CVM21G-S, CVM21GS-1312450, CVM21G-S2, CVM21GS2-1312490, CVM21GS2-1312495, CVP21E, CVP21E-1322700, CVP21E-2, CVP21E-S, CVP21ES-1322750, CVP21E-S2, CVP21ES2-1322790, CVP21G, CVP21G-1312700, CVP21G-2, CVP21G2-1312740, CVP21G-S, CVP21GS-1312750, CVP21G-S2, CVP21GS2-1312790, ECVM21ES2...(Other models you can see in the webshop)		



GEV No.	900451	Ref. No.	3108600 BN3108600
description	door seal profile 2510 W 450mm L 540mm external size Qty 1		
For models:	CMV6ES2-1320392, CV6E, CV6E-1320000, CV6E-1320010, CV6E-1320050, CV6E-2, CV6E2-1320040, CV6EB-1321000, CV6E-S, CV6E-S2, CV6ES2-1320090, CV6G, CV6G-1310000, CV6G-1310010, CV6G-2, CV6G2-1310040, CV6GB-1311000, CV6G-S, CV6GS-1310050, CV6G-S2, CV6GS2-1310090, CVM6E, CVM6E-1320300, CVM6E-1320340, CVM6E-1320390, CVM6E-2, CVM6E-S, CVM6ES-1320350, CVM6ES-1320350MN, CVM6ES-1320360, CVM6E-S2, CVM6ES2-1320395, CVM6G, CVM6G-1310300, CVM6G-1310310, CVM6G-2, CVM6G2-1310340, CVM6G-S, CVM6GS-1310350, CVM6GS-1310360, CVM6G-S2, CVM6GS2-1310390, CVM6GS2-1310395, CVP6E, CVP6E-1320600, CVP6E-2, CVP6E2-1320640, CVP6E-S, CVP6ES-1320650, CVP6E-S2...(Other models you can see in the webshop)		

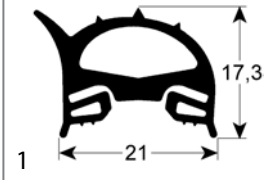

GEV No.	900452	Ref. No.	3108700 BN3108700
description	door seal profile 2510 W 450mm L 780mm external size Qty 1		
For models:	CV10E, CV10E-1320100, CV10E-1320110, CV10E-2, CV10E2-1320140, CV10EB-1321100, CV10E-S, CV10ES-1320150, CV10E-S2, CV10ES2-1320190, CV10G, CV10G-1310100, CV10G-2, CV10G2-1310140, CV10GB-1311100, CV10G-S, CV10GS-1310150, CV10G-S2, CV10GS2-1310190, CVM10E, CVM10E-1320400, CVM10E-1320410, CVM10E-2, CVM10E2-1320440, CVM10E-S, CVM10ES-1320450, CVM10E-S2, CVM10ES2-1320490, CVM10E2-1320495, CVM10G, CVM10G-1310400, CVM10G-1310410, CVM10G-1310430, CVM10G-1310450, CVM10G-2, CVM10G2-1310440, CVM10GP-1310400, CVM10G-S, CVM10GS-1310460, CVM10G-S2, CVM10GS2-1310490, CVM10GS2-1310495, CVP10E, CVP10E-1320700, CVP10E-1320710, CVP10E-2, CVP10E2-1320740, CVP10E2S-1320790, CVP10E-S, CVP10ES-1320750...(Other models you can see in the webshop)		



GEV No.	901573	Ref. No.	R70044270
description	door seal profile 2770/2771 H 1550mm W 470mm outer plug size Qty 1		
For models:	CKEP10, CKEP10B, CKEP20, CKEP20B, CKEP21, CKEP21B, CKET10, CKET10B, CKET20, CKET20B, CKET21, CKET21B, CKGP10, CKGP10B, CKGP20, CKGP20B, CKGP21, CKGP21B, CKGT10, CKGT10B, CKGT20, CKGT20B, CKGT21, CKGT21B		



GEV No.	900453	Ref. No.	3108800 BN3108800
description	door seal profile 2510 W 640mm L 770mm external size Qty 1		
For models:	CV20E, CV20E-1320200, CV20E-2, CV20E2-1320240, CV20EB-1321200, CV20E-S, CV20ES-1320250, CV20E-S2, CV20ES2-1320290, CV20G, CV20G-1310200, CV20G-2, CV20G2-1310240, CV20GB-1311200, CV20G-S, CV20GS-1310250, CV20G-S2, CV20GS2-1310290, CVM20E, CVM20E-1320500, CVM20E-2, CVM20E2-1320540, CVM20E-S, CVM20ES-1320550, CVM20E-S2, CVM20ES2-1320590, CVM20G, CVM20G-1310500, CVM20G-2, CVM20G2-1310540, CVM20G-S, CVM20GS-1310550, CVM20G-S2, CVM20GS2-1310590, CVP20E, CVP20E-1320800, CVP20E-2, CVP20E2-1320840, CVP20EB-1321200, CVP20E-S, CVP20ES-1320850, CVP20E-S2, CVP20ES2-1320890, CVP20G, CVP20G-1310800, CVP20G-1310850, CVP20G-2, CVP20G-S, CVP20GS-1310840, CVP20G-S2...(Other models you can see in the webshop)		



GEV No.	900494	Ref. No.	R70044140
description	door seal profile 2770/2771 H 1550mm W 700mm outer plug size Qty 1		
For models:	CKEP40, CKEP40B, CKET40, CKET40B, CKGP40, CKGP40B, CKGT40, CKGT40B		

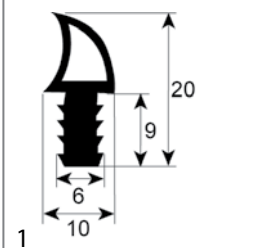

GEV No.	900829	Ref. No.	2510674 BN2510674
description	door seal profile 2741 Qty supplied by meter		
For models:	2FX+PCF, 4FX+PCF, 72+2CTGG-12700013, 74+2CTGGAN-12700025, 74-02+2CTGG, 74-02+2CTGG-12700030, 74-02CEEPPQ, 74-02CEEPPQ-12701210, 74-02CEEPT-12701010, 74-02CGE, 74-02CGE-12700011, 74-02CGE-12700011TA, 74-02CGG, 74-02CGG-12700010, 74-02CGG-12700010TA, 74-02CTEE, 74-02CTEE-12701180, 74-02CTGE, 74-02CTGE-12700190, 74-02CTGE-12700190TA, 74-02CTGG, 74-02CTGG-12700180, 74-02CTGG-12700180TA, 74-02VTCE, 74-02VTCEV, 74-02VTCEV-12701020, 76-02+4CTGG, 76-02+4CTGG-12700031, 76-02CEEANPQ, 76-02CEEEACPO, 76-02CEEEPPQ-12701216, 76-02CEEEPT-12701016, 76-02CEEPPQ-12701215, 76-02CEEPT-12701015, 76-02CGE, 76-02CGE-12700017, 76-02CGE-12700017TA, 76-02CGEE, 76-02CGEE-12700018, 76-02CGEE-12700018TA, 76-02CGFL, 76-02CGFL-12700020, 76-02CGFL-12700020TA, 76-02CGG, 76-02CGG-12700015, 76-02CGG-12700015TA, 76-02CGGE, 76-02CGGE-12700016, 76-02CGGE-12700016TA, 76-02CTGG...(Other models you can see in the webshop)		



GEV No.	900488	Ref. No.	R70044330
description	door seal profile 2770/2771 H 380mm W 420mm outer plug size Qty 1		
For models:	CCE042M		



1

GEV No.	900489	Ref. No.	R70044340
description	door seal profile 2770/2771 H 440mm W 600mm outer plug size Qty 1		
For models:	CCE051M, CCG051M		



1

GEV No.	901276	Ref. No.	R70044220
description	door seal profile 2770/2771 H 800mm W 470mm outer plug size Qty 1 suitable for LAINOX		
For models:	CKEP10, CKEP10B, CKET10, CKET10B, CKGP10, CKGP10B, CKGT10, CKGT10B		



1

GEV No.	901679	Ref. No.	R70044210
description	door seal profile 2770/2771 H 520mm W 470mm outer plug size suitable for LAINOX		
For models:	CKEP06, CKEP06B, CKET06, CKET06B, CKGP06, CKGP06B, CKGT06, CKGT06B		



1

GEV No.	900491	Ref. No.	R70044110
description	door seal profile 2770/2771 H 800mm W 680mm outer plug size Qty 1		
For models:	CCE101M, CCG101M		

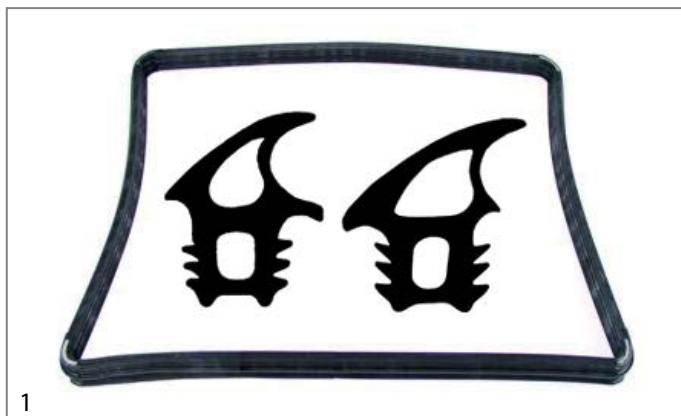

1

GEV No.	900788	Ref. No.	R70044230
description	door seal profile 2770/2771 H 580mm W 680mm outer plug size Qty 1		
For models:	CCE071M, CCG071M		

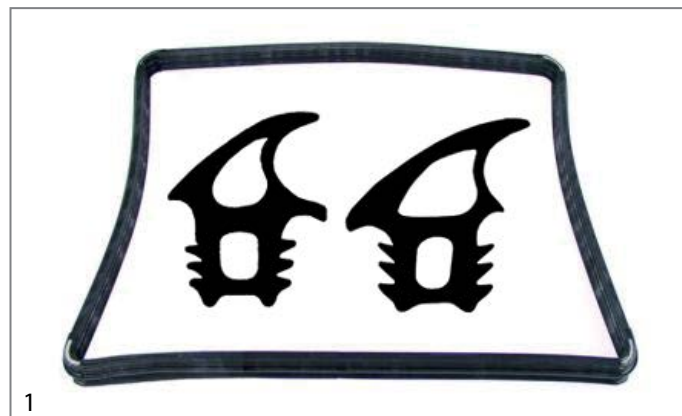

1

GEV No.	900492	Ref. No.	R70044120
description	door seal profile 2770/2771 H 800mm W 700mm outer plug size Qty 1		
For models:	CKEP20, CKEP20B, CKET20, CKET20B, CKGP20, CKGP20B, CKGT20, CKGT20B		



GEV No.	901603	Ref. No.	R70044240
description	door seal profile 2770/2771 H 800mm W 760mm outer plug size Qty 1		
For models:	CCE102M, CCG102M		

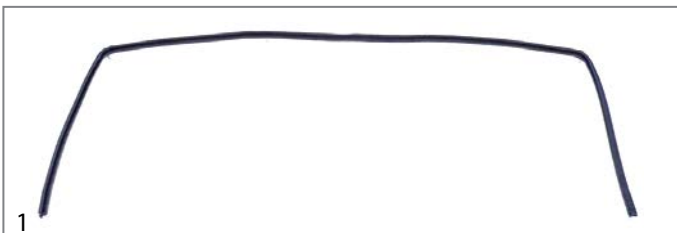

GEV No.	900682	Ref. No.	2510685 BN2510685
description	door seal W 250mm L 550mm 3-sided		

For models:

714CT-GV-1000170, 714CTGV-1000170, 714CTGV-1000170R, 714CT-GVFE-1000180, 714CT-GVFE-1000180R, 716CTG-000195, 716CTGV-000195, 741CE-1000405, 741CE-1000405R, 749CGV-000039, 749CGV-1950039, 749CGV-1950039R, 749CGVFE-1950059, 749CGVFE-1950059R, 74CE-1000400, 74CE-1000400R, 74CGV-000040, 761CEAC-1000505, 761CEAC-1000505R, 761CEAN-1000455, 761CEAN-1000455R, 769CGV-000049, 769CGV-1950049, 769CGV-1950049R, 769CGVAC-1950079, 769CGVAC-1950079R, 769CGVFE-1950089, 769CGVFE-1950089R, 769CGVFE-1950099, 769CGVFE-1950099R, 769CT-GV-1950194, 769CT-GV-1950194R, 76CEAC-1000500, 76CEAC-1000500R, 76CEAN-1000450, 76CEAN-1000450R, 76CGV-000050, 9141PCEE-1103394, 914PCGE-1103224, 914PCGG-1103214, 914PCTGE-1103721, 914PCTGG-1103711, 914PFTGE-1103423, 914PFTGEC-1103425, 914PFTGG-1103413, 914PFTGGC-1103415, 916PCGEE-1103246, 916PCGGAN-1103216, 916PCGGE-1103236, 918PCGE-1103228...(Other models you can see in the webshop)

door seals with fixing hook



GEV No.	901323	Ref. No.	2510686 BN2510686
description	door seal W 770mm long side open with 8 mounting clips H 315mm		
For models:	769CGVFL-000069, 769CGVFL-1950069, 769CGVFL-1950069R, 76CGVFL-000070, 7961C-GVGAS-1950276, 7962C-GV-1950277		



GEV No.	900455	Ref. No.	8219340 BN8219340
description	oven gasket L 450mm W 330mm external size		
For models:	61FE-1826050, 61SCGFE3S-1826055, 61SCGFE4S-1827055, 61SECFE-1826075		

door seals with tension springs



GEV No.	900103	Ref. No.	1336100
description	oven gasket profile 2960 L 575mm Qty 1 mounting pos. lower		
For models:	CFG101, CFG120, CFG70, OCFG101, OCFG120, OCFG70		



GEV No.	900102	Ref. No.	1706300
description	oven gasket profile 2960 L 650mm Qty 1 mounting pos. upper		
For models:	CFG101, CFG120, CFG70, OCFG101, OCFG120, OCFG70		



GEV No.	514003	Ref. No.	1662614
description	spring L 370mm for gasket mounting pos. lateral		
For models:	CFG101, CFG120, CFG70, OCFG101, OCFG120, OCFG70		

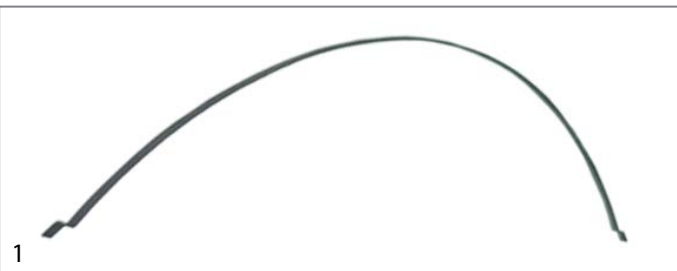

GEV No.	514002	Ref. No.	1335900
description	spring L 595mm for gasket mounting pos. upper		
For models:	CFG101, CFG120, CFG70, OCFG101, OCFG120, OCFG70		

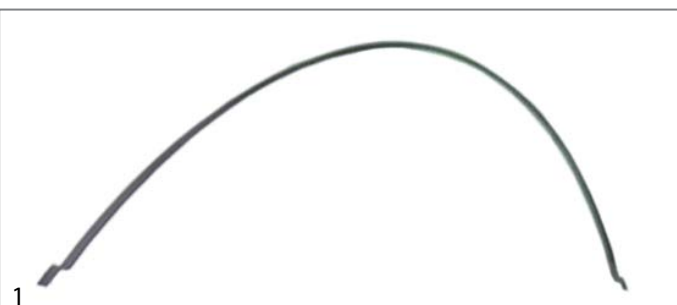

GEV No.	514001	Ref. No.	1706200
description	spring L 655mm for gasket mounting pos. upper		
For models:	CFG101, CFG120, CFG70, OCFG101, OCFG120, OCFG70		



gaskets for tray rack trolleys



GEV No.	901160	Ref. No.	R70044360
description	tray rack trolley gasket L <700mm 3-piece		
For models:	CKEP40, CKEP40B, CKET40, CKET40B, CKGP40, CKGP40B, CKGT40, CKGT40B		



GEV No.	901161	Ref. No.	R80100910
description	tray rack trolley gasket L 1000mm		
For models:	CKEP21, CKEP21B, CKEP40, CKEP40B, CKET21, CKET21B, CKET40, CKET40B, CKGP21, CKGP21B, CKGP40, CKGP40B, CKGT21, CKGT21B, CKGT40, CKGT40B		



GEV No.	901711	Ref. No.	R70044370
description	tray rack trolley gasket L 510mm 3-piece		
For models:	CKEP21, CKEP21B, CKET21, CKET21B, CKGP21, CKGP21B, CKGT21, CKGT21B		

O-rings

EPDM

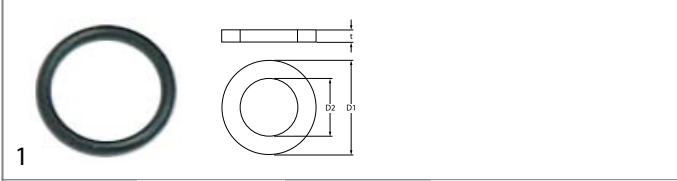

GEV No.	510302	Ref. No.	13009
description	O-ring EPDM ID ø 12.42mm thickness 1.78mm Qty 1 pcs		
For models:	OLAX160V-1081031, OLAX160V-1081032, OLAX210, OLAX210E-1081029, OLAX210E-1081030, OLAX220, OLAX220E-1080787, OLAX220E-1080788, OLAX220V-1080789, OLAX220V-1080790, OLAX230, OLAX230E-1080791, OLAX230E-1080792, OLAX230V-1080793, OLAX230V-1080794, OLAX240, OLAX240E-1080795, OLAX240E-1080796, OLAX240V-1080797, OLAX240V-1080798, OLAX250, OLAX250E-1080760, OLAX250E-1080761, OLAX250V-1080765, OLAX250V-1080766, OLAX300, OLAX300E-1080770, OLAX300E-1080771, OLAX300E-1081033, OLAX300E-1081035, OLAX300E-1081036, OLAX300LC, OLAX300LCE-1081034, OLAX300V-1080775, OLAX300V-1080776, OLAX310, OLAX310E-1081110, OLAX310E-1081111, OLAX310LC, OLAX310LCE-1081114, OLAX310LCE-1081115, OLAX310LCV-1081116, OLAX310LCV-1081117, OLAX310V-1081112, OLAX310V-1081113, OLAX320, OLAX320E-1081118, OLAX320E-1081119, OLAX320V-1081120, OLAX320V-1081121... (Other models you can see in the webshop)		

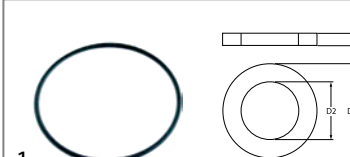

GEV No.	345896	Ref. No.	89332
description	O-ring EPDM thickness 1.5mm ID ø 37mm Qty 1 pcs		
For models:	OLDerby, OLDS35-1081005, OLDS37-1081006, OLDS37D-1081007, OLDS37LS-1081008, OLDS37LSD-1081009, OLDS40-1081010, OLDS40D-1081011, OLDS40LS-1081012, OLDS40LSD-1081013, OLG600, OLGastro450, OLG600, OLHT11-1081071, OLHT11D-1081072, OLHT11ECO-1081070, OLHT11S, OLHT12-1081075, OLHT12EL-1081080, OLHT12EL-1081083, OLHT12ELD-1081081, OLHT12ELPLUS-1081086, OLHT12S, OLLinear, OLLP1-800, OLLP1-800-1080721, OLLP1-800EL, OLLP1-S8, OLLP1-S8EL, OLLP-ZERO, OLLPZERO-1081057, OLStar		



GEV No.	517045	Ref. No.	13018
description	O-ring EPDM thickness 1.78mm ID ø 21.95mm Qty 1 pcs		
For models:	OLDS50, OLDS50-1081088, OLDS50D-1081089, OLDS50E-1081090, OLDS50ED-1081091, OLDS50-Neutra, OLDS50P-1081018, OLDS50PD-1081019, OLG600, OLGastro450, OLGastro500Plus, OLGastro500S, OLGastro750Plus, OLGastro750S, OLG545, OLG550, OLG550-1080705, OLG550D-1080706, OLG550E-1080730, OLG550ECO-1081014, OLG550ECOD-1081015, OLG550ED-1080731, OLG550-Neutra, OLG85, OLG85-1081016, OLG85D-1081017, OLG85S-Neutra		



GEV No.	345908	Ref. No.	89331
description	O-ring EPDM thickness 1.5mm ID ø 58.5mm Qty 1 pcs		
For models:	OLDS35, OLDS35-1081061, OLDS35D-1081062, OLDS37, OLDS37-1081063, OLDS37D-1081064, OLG35, OLG35-1080702, OLG35D-1081000, OLG37, OLG37-1080700, OLG37D-1080707, OLG37LS-1081001, OLG37LSD-1081002, OLG600, OLHT11-1081071, OLHT11D-1081072, OLHT11ECO-1081070, OLHT11S, OLHT12-1081075, OLHT12EL-1081080, OLHT12EL-1081083, OLHT12ELD-1081081, OLHT12ELPLUS-1081086, OLHT12S, OLLP1-800, OLLP1-800-1080721, OLLP1-800EL, OLLP1-S8, OLLP1-S8EL, OLLP-ZERO, OLLPZERO-1081057		



GEV No.	517035	Ref. No.	13016
description	O-ring EPDM thickness 1.78mm ID ø 4.48mm Qty 1 pcs		
For models:	OLDS40-1081010, OLDS40D-1081011, OLDS40LS-1081012, OLDS40LSD-1081013, OLDS50, OLDS50-1081088, OLDS50D-1081089, OLDS50E-1081090, OLDS50ED-1081091, OLDS50-Neutra, OLDS50P-1081018, OLDS50PD-1081019, OLG600, OLGastro450, OLGastro500Plus, OLGastro500S, OLGastro750Plus, OLGastro750S, OLG545, OLG550, OLG550-1080705, OLG550D-1080706, OLG550E-1080730, OLG550ECO-1081014, OLG550ECOD-1081015, OLG550ED-1080731, OLG550-Neutra, OLG85, OLG85-1081016, OLG85D-1081017, OLG85S-Neutra, OLLinear		



GEV No.	510824	Ref. No.	13025
description	O-ring EPDM thickness 1.78mm ID ø 20.35mm Qty 1 pcs		
For models:	OLAX151, OLAX151EDX-1080725, OLAX151ELEFT-1080727, OLAX151-highspeed, OLAX160, OLAX160E-1080750, OLAX160E-1080751, OLAX160V-1080755, OLAX160V-1080756, OLAX160V-1081031, OLAX160V-1081032, OLAX210, OLAX210E-1081029, OLAX210E-1081030, OLAX220, OLAX220E-1080787, OLAX220E-1080788, OLAX220V-1080789, OLAX220V-1080790, OLAX230, OLAX230E-1080791, OLAX230E-1080792, OLAX230V-1080793, OLAX230V-1080794, OLAX240, OLAX240E-1080795, OLAX240E-1080796, OLAX240V-1080797, OLAX240V-1080798, OLAX250, OLAX250E-1080760, OLAX250E-1080761, OLAX250V-1080765, OLAX250V-1080766, OLAX300, OLAX300E-1080770, OLAX300E-1080771, OLAX300E-1081033, OLAX300E-1081035, OLAX300E-1081036, OLAX300LC, OLAX300LCE-1081034, OLAX300V-1080775, OLAX300V-1080776, OLAX310, OLAX310E-1081110, OLAX310E-1081111, OLAX310LC, OLAX310LCE-1081114, OLAX310LCE-1081115...(Other models you can see in the webshop)		



GEV No.	521724	Ref. No.	135506
description	O-ring EPDM thickness 1.78mm ID ø 72.75mm Qty 1 pcs		
For models:	OLG540, OLG540, OLG540-1080701, OLG540D-1080708, OLG540D-1081003, OLG540-Neutra, OLG540LSD-1081004		



GEV No.	532680	Ref. No.	15285
description	O-ring EPDM thickness 2.5mm ID ø 12mm Qty 1 pcs		
For models:	OLAX380, OLAX380LC, OLAX400		

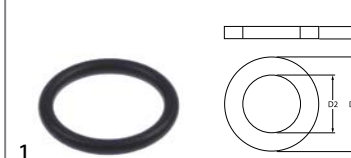

GEV No.	516026	Ref. No.	3003130
description	O-ring EPDM thickness 2.62mm ID ø 17.86mm Qty 1 pcs		
For models:	OLAX380, OLAX380LC, OLAX400		

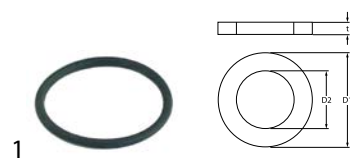
GEV No.	504561	Ref. No.	8217550 BN8217550
description	O-ring EPDM thickness 2.62mm ID ø 29.82mm Qty 1 pcs		
For models:	40SEBM-1826100, 40SEBM25-1826100, 40SECP-1825080, 40SECP-1825080E, 40SEFR, 40SEFR-1826140, 40SEFR2S-1826140, 40SEW-1825190, 40SGFR-1826160, 40SGFR2S-1826160, 41SEFR-1826120, 41SEFR2S-1826120, 421SEFR-1826125, 55-45FRG, 55-90FRG, 60SEBM-1826110, 60SEBM25-1826110, 60SEFR, 60SEFR-1826150, 60SEFR2S-1826150, 60SGFR-1826170, 60SGFR2S-1826170, 61SEFR-1826130, 61SEFR2S-1826130, 621SEFR-1826135, 72-02FRE-12701500, 72-02FREM-12701530, 72-02FRG, 72-02FRG-12700500, 72-02FRG17-12700505, 72-02FRGM, 72-02FRGM-12700530, 72-02FRGM-12700530TA, 73-02FRE-12701550, 73-02FREM-12701580, 73-02FRG, 73-02FRG-12700550, 73-02FRGM, 73-02FRGM-12700580, 73-02FRGM-12700580TA, 74-02FRE-12701600, 74-02FREM-12701630, 74-02FRG, 74-02FRG-12700600, 74-02FRG17-12700605, 74-02FRGM, 74-02FRGM-12700630, 912PTCBG-1103391, 92-04FRE15L-12901510, 92-04FRE20L-12901500...(Other models you can see in the webshop)		

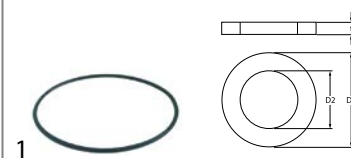

GEV No.	528800	Ref. No.	135502
description	O-ring EPDM thickness 2.62mm ID ø 75.87mm Qty 1 pcs		
For models:	OLGS40, OLG540, OLG540-1080701, OLG540D-1080708, OLG540D-1081003, OLG540-Neutra, OLG540LSD-1081004		

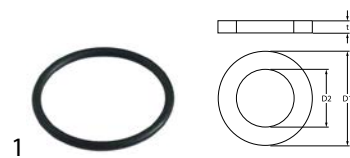

GEV No.	517104	Ref. No.	13000
description	O-ring EPDM thickness 2.62mm ID ø 31.42mm Qty 1 pcs		
For models:	OLBX230, OLBX230Special, OLBX280, OLBX300, OLCX, OLDerby, OLDS35, OLDS35-1081005, OLDS35-1081061, OLDS35D-1081062, OLDS35-Neutra, OLDS37, OLDS37-1081006, OLDS37-1081063, OLDS37D-1081007, OLDS37D-1081064, OLDS37LS-1081008, OLDS37LSD-1081009, OLDS37-Neutra, OLDS40, OLDS40-1081010, OLDS40-1081065, OLDS40D-1081011, OLDS40D-1081066, OLDS40E-1081067, OLDS40ED-1081068, OLDS40LS-1081012, OLDS40LSD-1081013, OLDS40-Neutra, OLFX, OLFX250E-1081151, OLFX250V-1081152, OLFX250V-1081153, OLFX380E-1081154, OLFX380E-1081155, OLFX380V-1081156, OLFX380V-1081157, OLFX420E-1081158, OLFX420E-1081159, OLFX420V-1081160, OLFX420V-1081161, OLFX540E-1081162, OLFX540E-1081163, OLFX540V-1081164, OLFX540V-1081165, OLFX600E-1081166, OLFX600E-1081167, OLFX600V-1081168, OLFX600V-1081169, OLFX680E-1081170...(Other models you can see in the webshop)		

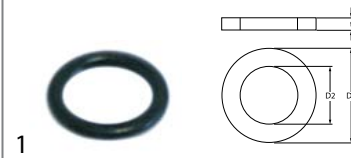

GEV No.	510893	Ref. No.	13003
description	O-ring EPDM thickness 2.62mm ID ø 9.92mm Qty 1 pcs		
For models:	G12S, OLDerby, OLDS35, OLDS35-1081005, OLDS35-1081061, OLDS35D-1081062, OLDS35-Neutra, OLDS37, OLDS37-1081006, OLDS37-1081063, OLDS37D-1081007, OLDS37D-1081064, OLDS37LS-1081008, OLDS37LSD-1081009, OLDS37-Neutra, OLDS40, OLDS40-1081010, OLDS40-1081065, OLDS40D-1081011, OLDS40D-1081066, OLDS40E-1081067, OLDS40ED-1081068, OLDS40LS-1081012, OLDS40LSD-1081013, OLDS40-Neutra, OLG35, OLG35-1080702, OLG35D-1081000, OLG35-Neutra, OLG600, OLGastro450, OLG37, OLG37-1080700, OLG37D-1080707, OLG37LS-1081001, OLG37LSD-1081002, OLG37-Neutra, OLG540, OLG540-1080701, OLG540D-1080708, OLG540D-1081003, OLG540-Neutra, OLG540LSD-1081004, OLH600, OLH600Electronic, OLHT11-1081071, OLHT11D-1081072, OLHT11ECO-1081070, OLHT-11-Neutra...(Other models you can see in the webshop)		

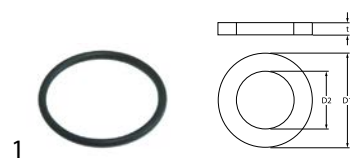

GEV No.	517004	Ref. No.	13004
description	O-ring EPDM thickness 2.62mm ID ø 34.6mm Qty 1 pcs		
For models:	OLG600, OLHT-11-Neutra, OLLP1-800, OLLP1-800-1080721, OLLP1-800EL, OLLP1-800-Neutra, OLLP-ZERO, OLLPZERO-1081057		

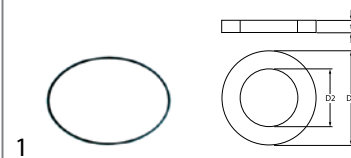

GEV No.	510554	Ref. No.	7130
description	O-ring EPDM thickness 2mm ID ø 120mm Qty 1 pcs		
For models:	OLDS40-1081010, OLDS40D-1081011, OLDS40LS-1081012, OLDS40LSD-1081013, OLDS45, OLDS50, OLDS50-1081088, OLDS50D-1081089, OLDS50E-1081090, OLDS50ED-1081091, OLDS50-Neutra, OLG545, OLG550, OLG550-1080705, OLG550D-1080706, OLG550E-1080730, OLG550ECO-1081014, OLG550ECOD-1081015, OLG550ED-1080731, OLG550-Neutra, OLLinear		

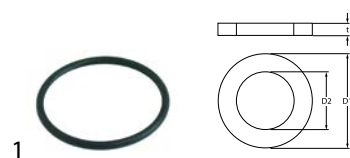

GEV No.	505192	Ref. No.	13006
description	O-ring EPDM thickness 2.62mm ID ø 39.34mm Qty 1 pcs		
For models:	OLG600		



GEV No.	100809	Ref. No.	1394000 6A011606 BN6A011606
description	O-ring EPDM thickness 2mm ID ø 21mm Qty 1 pcs		
For models:	710FR-G-1077350, 710FR-G-1077350R, 712FR-G-1077550, 712FR-G-1077550R, 714CT-GV-1000170, 714CTGV-1000170R, 720FR-G-1077450, 720FR-G-1077450R, 720FR-G-1077650, 722FRG-1077600, 722FR-G-1077650R, 749CGV-1950039, 749CGV-1950039R, 769CGV-1950049, 769CGV-1950049R, 769CGVAC-1950079, 769CGVAC-1950079R, 769CGVFL-1950069, 769CGVFL-1950069R, 769CT-GV-1950194, 769CT-GV-1950194R, 914PCGG-1103214, 914PCTGG-1103711, 914PFTGG-1103413, 914PFTGGC-1103415, 916PCGGAN-1103216, 916PCGGE-1103236, 918PCGG-1103218, 92FG-1191220, 941CTGG-1291710, 941FTGG-1291412, 941FTGG1-2R-1291612, 941FTGGC-1291414, 941FTGGC1-2R-1291415, 941FTGGR-1291512, 94CGG-1191214, 94CTGG-1191710, 96CGG-1191216, 96CGGAC-1191236, 96CTGG-1191712, 96CTGGAC-1191732, 98CGG-1191218, C-GV904-1050110, C-GV906-1050120, C-GV908-1050130, CT-GV904-1050220, FQG40, FQG60, FR-G925N-1050731, FR-G950N-1050733...(Other models you can see in the webshop)		



GEV No.	517056	Ref. No.	13002
description	O-ring EPDM thickness 2mm ID ø 6.5mm Qty 1 pcs		
For models:	OLDerby, OLDS35, OLDS35-1081005, OLDS35-1081061, OLDS35D-1081062, OLDS35-Neutra, OLDS37, OLDS37-1081006, OLDS37-1081063, OLDS37D-1081007, OLDS37D-1081064, OLDS37LS-1081008, OLDS37LSD-1081009, OLDS37-Neutra, OLDS40, OLDS40-1081010, OLDS40-1081065, OLDS40D-1081011, OLDS40D-1081066, OLDS40E-1081067, OLDS40ED-1081068, OLDS40LS-1081012, OLDS40LSD-1081013, OLDS40-Neutra, OLDS45, OLElectron400, OLG35, OLG35-1080702, OLG35D-1081000, OLG35-Neutra, OLG37, OLG37-1080700, OLG37D-1080707, OLG37LS-1081001, OLG37LSD-1081002, OLG37-Neutra, OLG540, OLG540, OLG540-1080701, OLG540D-1080708, OLG540D-1081003, OLG540-Neutra, OLG540LSD-1081004, OLG550, OLG550-1080705, OLG550D-1080706, OLG550E-1080730, OLG550ECO-1081014, OLG550ED-1080731, OLG550-Neutra...(Other models you can see in the webshop)		

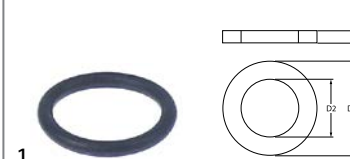

GEV No.	517087	Ref. No.	13023
description	O-ring EPDM thickness 3.53mm ID ø 23.4mm Qty 1 pcs		
For models:	OLAX151, OLAX151EDX-1080725, OLAX151ELEF-1080727, OLAX151-highspeed, OLAX160, OLAX160E-1080750, OLAX160E-1080751, OLAX160V-1080755, OLAX160V-1080756, OLAX160V-1081031, OLAX160V-1081032, OLAX210, OLAX210E-1081029, OLAX210E-1081030, OLAX220, OLAX220E-1080787, OLAX220E-1080788, OLAX220V-1080789, OLAX220V-1080790, OLAX230, OLAX230E-1080791, OLAX230E-1080792, OLAX230V-1080793, OLAX230V-1080794, OLAX240, OLAX240E-1080795, OLAX240E-1080796, OLAX240V-1080797, OLAX240V-1080798, OLAX250, OLAX250E-1080760, OLAX250E-1080761, OLAX250V-1080765, OLAX250V-1080766, OLAX300, OLAX300E-1080770, OLAX300E-1080771, OLAX300E-1081033, OLAX300E-1081035, OLAX300E-1081036, OLAX300LC, OLAX300LCE-1081034, OLAX300V-1080775, OLAX300V-1080776, OLAX310, OLAX310E-1081110, OLAX310E-1081111, OLAX310LC, OLAX310LCE-1081114, OLAX310LCE-1081115...(Other models you can see in the webshop)		



GEV No.	510895	Ref. No.	13019
description	O-ring EPDM thickness 3.53mm ID ø 34.52mm Qty 1 pcs		
For models:	OLAX151, OLDS35, OLDS35-1081061, OLDS35D-1081062, OLDS35-Neutra, OLDS37, OLDS37-1081063, OLDS37D-1081064, OLDS37-Neutra, OLDS40, OLDS40-1081065, OLDS40D-1081066, OLDS40E-1081067, OLDS40ED-1081068, OLDS40-Neutra, OLG540, OLG540-1080701, OLG540D-1080708, OLG540D-1081003, OLG540-Neutra, OLG540LSD-1081004		

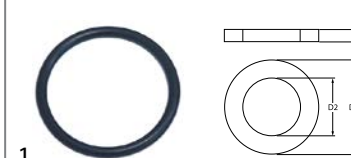

GEV No.	510899	Ref. No.	13022
description	O-ring EPDM thickness 3.53mm ID ø 37.69mm Qty 1 pcs		
For models:	OLHT-11-Neutra, OLLP1-800, OLLP1-800-1080721, OLLP1-800EL, OLLP1-800-Neutra, OLLP-ZERO, OLLPZERO-1081057		

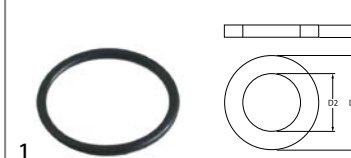

GEV No.	506015	Ref. No.	16067/A
description	O-ring EPDM thickness 3.53mm ID ø 39.69mm Qty 1 pcs		
For models:	OLDS35, OLDS35-1081061, OLDS35D-1081062, OLDS35-Neutra, OLDS37, OLDS37-1081006, OLDS37-1081063, OLDS37D-1081007, OLDS37D-1081064, OLDS37LS-1081008, OLDS37LSD-1081009, OLDS37-Neutra, OLDS40, OLDS40-1081010, OLDS40-1081065, OLDS40D-1081011, OLDS40D-1081066, OLDS40E-1081067, OLDS40ED-1081068, OLDS40LS-1081012, OLDS40LSD-1081013, OLDS40-Neutra, OLDS45, OLDS50, OLDS50-1081088, OLDS50D-1081089, OLDS50E-1081090, OLDS50ED-1081091, OLDS50-Neutra, OLDS50P-1081018, OLDS50PD-1081019, OLDS50H, OLElectron1000, OLElectron400, OLElectron500, OLELELECTRON1000-1081084, OLELELECTRON1000D-1081085, OLG35, OLG35-1080702, OLG35D-1081000, OLG35-Neutra, OLG600, OLGastro450, OLGastro500Plus, OLGastro500S, OLGastro750Plus, OLGastro750S, OLG537, OLG537-1080700, OLG537D-1080707...(Other models you can see in the webshop)		



GEV No.	508061	Ref. No.	13008
description	O-ring EPDM thickness 3.53mm ID ø 42.86mm Qty 1 pcs		
For models:	G12S, OLCX, OLFX, OLFX250E-1081151, OLFX250V-1081152, OLFX250V-1081153, OLFX380E-1081154, OLFX380E-1081155, OLFX380V-1081156, OLFX380V-1081157, OLFX420E-1081158, OLFX420E-1081159, OLFX420V-1081160, OLFX420V-1081161, OLFX540E-1081162, OLFX540E-1081163, OLFX540V-1081164, OLFX540V-1081165, OLFX600E-1081166, OLFX600E-1081167, OLFX600V-1081168, OLFX600V-1081169, OLFX680E-1081170, OLFX680E-1081171, OLFX680V-1081172, OLFX680V-1081173, OLFX780E-1081174, OLFX780E-1081175, OLFX780V-1081176, OLFX780V-1081177, OLFX900E-1081178, OLFX900E-1081179, OLFX900V-1081180, OLFX900V-1081181, OLG600, OLHT-11-Neutra, OLLP1-800, OLLP1-800-1080721, OLLP1-800EL, OLLP1-800-Neutra, OLLP-ZERO, OLLPZERO-1081057, OLLUX220, WASHER-1081150		



GEV No.	521120	Ref. No.	13010
description	O-ring EPDM thickness 5.34mm ID ϕ 37.47mm Qty 1 pcs		
For models:	OLDS35, OLDS35-1081061, OLDS35D-1081062, OLDS35-Neutra, OLDS37, OLDS37-1081006, OLDS37-1081063, OLDS37D-1081007, OLDS37D-1081064, OLDS37LS-1081008, OLDS37LSD-1081009, OLDS37-Neutra, OLDS40, OLDS40-1081065, OLDS40D-1081066, OLDS40E-1081067, OLDS40ED-1081068, OLDS40-Neutra, OLElectron400, OLG35-1080702, OLG37, OLG37-1080700, OLG37D-1080707, OLG37LS-1081001, OLG37LSD-1081002, OLG37-Neutra, OLG540, OLG540, OLG540-1080701, OLG540D-1080708, OLG540D-1081003, OLG540-Neutra, OLG540LSD-1081004, OLStar		



GEV No.	532653	Ref. No.	80302
description	O-ring EPDM thickness 5mm ID ϕ 20mm Qty 1 pcs		
For models:	OLAX151		

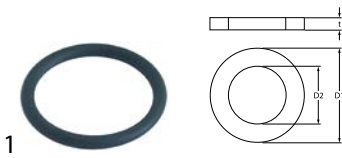

GEV No.	505092	Ref. No.	BN0119472130
description	O-ring EPDM thickness 5.34mm ID ϕ 43.82mm Qty 1 pcs		

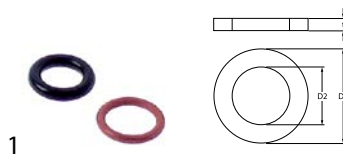

GEV No.	532492	Ref. No.	R70010050
description	O-ring set EPDM thickness 1.78/2.62mm ID ϕ 9.25/7.59mm Qty 2 pcs		
For models:	CKEP06, CKEP06B, CKEP10, CKEP10B, CKEP20, CKEP20B, CKEP21, CKEP21B, CKEP40, CKEP40B, CKET06, CKET06B, CKET10, CKET10B, CKET20, CKET20B, CKET21, CKET21B, CKET40, CKET40B, CKGP06, CKGP06B, CKGP10, CKGP10B, CKGP20, CKGP20B, CKGP21, CKGP21B, CKGP40, CKGP40B, CKGT06, CKGT06B, CKGT10, CKGT10B, CKGT20, CKGT20B, CKGT21, CKGT21B, CKGT40, CKGT40B		

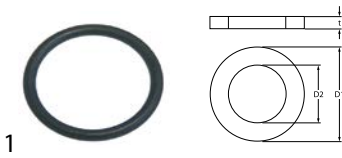

GEV No.	510408	Ref. No.	13005
description	O-ring EPDM thickness 5.34mm ID ϕ 47mm Qty 1 pcs		
For models:	OLDS40-1081010, OLDS40D-1081011, OLDS40LS-1081012, OLDS40LSD-1081013, OLDS45, OLDS50, OLDS50-1081088, OLDS50D-1081089, OLDS50E-1081090, OLDS50ED-1081091, OLDS50-Neutra, OLDS50P-1081018, OLDS50PD-1081019, OLElectron500, OLG600, OLGastro450, OLGastro500Plus, OLGastro500S, OLGastro750Plus, OLGastro750S, OLG545, OLG550, OLG550-1080705, OLG550D-1080706, OLG550E-1080730, OLG550ECO-1081014, OLG550ECOD-1081015, OLG550ED-1080731, OLG550-Neutra, OLG585, OLG585-1081016, OLG585D-1081017, OLG585-Neutra, OLLinear, OLLP-ZERO, OLLPZERO-1081057		

silicone

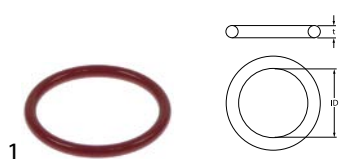

GEV No.	514017	Ref. No.	1814400
description	O-ring silicone thickness 3.53mm ID ϕ 32.93mm Qty 1 pcs		
For models:	CPE60, CPE60DB, OCPE60, OCPE-60-12601900, OCPE-60-12601900MN		



GEV No.	510409	Ref. No.	13015 R70045010
description	O-ring EPDM thickness 5.34mm ID ϕ 56.52mm Qty 1 pcs		
For models:	CKEP06B, CKEP10B, CKEP20B, CKEP21, CKEP21B, CKET06B, CKET10B, CKET20B, CKET21, CKET21B, CKGP21, CKGP21B, CKGT21, CKGT21B, G12S, OLAX151, OLAX151EDX-1080725, OLAX151LEFT-1080727, OLAX151-highspeed, OLAX160, OLAX160E-1080750, OLAX160E-1080751, OLAX160V-1080755, OLAX160V-1080756, OLAX160V-1081031, OLAX160V-1081032, OLAX210, OLAX210E-1081029, OLAX210E-1081030, OLAX220, OLAX220E-1080787, OLAX220E-1080788, OLAX220V-1080789, OLAX220V-1080790, OLAX230, OLAX230E-1080791, OLAX230E-1080792, OLAX230V-1080793, OLAX230V-1080794, OLAX240, OLAX240E-1080795, OLAX240E-1080796, OLAX240V-1080797, OLAX240V-1080798, OLAX250, OLAX250E-1080760, OLAX250E-1080761, OLAX250V-1080765, OLAX250V-1080766, OLAX300...(Other models you can see in the webshop)		

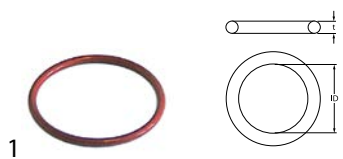

GEV No.	514021	Ref. No.	1814700
description	O-ring silicone thickness 3.53mm ID ϕ 49.21mm Qty 1 pcs		
For models:	CPE60, CPE60DB, OCPE60, OCPE-60-12601900, OCPE-60-12601900MN		

Viton



GEV No.	528687	Ref. No.	CM097900
description	O-ring Viton thickness 1.78mm ID ϕ 3.69mm Qty 1 pcs		
For models:	FQG41, FQG61, OFQG41, OFQG-41-12600500, OFQG61, OFQG-61-12600600		

NBR



GEV No.	532654	Ref. No.	13028
description	O-ring NBR thickness 3.6mm ID ø 30.8mm Qty 1 pcs		
For models:	OLAX160, OLAX160E-1080750, OLAX160E-1080751, OLAX160V-1080755, OLAX160V-1080756, OLAX160V-1081031, OLAX160V-1081032, OLAX210, OLAX210E-1081029, OLAX210E-1081030, OLAX220, OLAX220E-1080787, OLAX220E-1080788, OLAX220V-1080789, OLAX220V-1080790, OLAX230, OLAX230E-1080791, OLAX230E-1080792, OLAX230V-1080793, OLAX230V-1080794, OLAX240, OLAX240E-1080795, OLAX240E-1080796, OLAX240V-1080797, OLAX240V-1080798, OLAX250, OLAX250E-1080760, OLAX250E-1080761, OLAX250V-1080765, OLAX250V-1080766, OLAX300, OLAX300E-1080770, OLAX300E-1080771, OLAX300E-1081033, OLAX300E-1081035, OLAX300E-1081036, OLAX300LC, OLAX300LCE-1081034, OLAX300V-1080775, OLAX300V-1080776, OLAX310, OLAX310E-1081110, OLAX310E-1081111, OLAX310LC, OLAX310LCE-1081114, OLAX310LCE-1081115, OLAX310LCV-1081116, OLAX310LCV-1081117, OLAX310V-1081112, OLAX310V-1081113...(Other models you can see in the webshop)		

sealing washers

fibre gaskets



GEV No.	517789	Ref. No.	13303
description	flat gasket ED ø 10mm ID ø 5mm thickness 1.2mm suitable for Dühr Qty 1 pcs		
For models:	OLDS40-1081010, OLDS40D-1081011, OLDS40LS-1081012, OLDS40LSD-1081013, OLLinear		



GEV No.	517173	Ref. No.	13301
description	flat gasket FIBER ED ø 14mm ID ø 8mm thickness 1.5mm Qty 1 pcs		
For models:	G12S, OLAX151, OLAX151EDX-1080725, OLAX151ELEFT-1080727, OLAX151-highspeed, OLAX160, OLAX160E-1080750, OLAX160E-1080751, OLAX160V-1080755, OLAX160V-1080756, OLAX160V-1081031, OLAX160V-1081032, OLAX210, OLAX210E-1081029, OLAX210E-1081030, OLAX220, OLAX220E-1080787, OLAX220E-1080788, OLAX220V-1080789, OLAX220V-1080790, OLAX230, OLAX230E-1080791, OLAX230E-1080792, OLAX230V-1080793, OLAX230V-1080794, OLAX240, OLAX240E-1080795, OLAX240E-1080796, OLAX240V-1080797, OLAX240V-1080798, OLAX250, OLAX250E-1080760, OLAX250E-1080761, OLAX250V-1080765, OLAX250V-1080766, OLAX300, OLAX300E-1080770, OLAX300E-1080771, OLAX300E-1081033, OLAX300E-1081035, OLAX300E-1081036, OLAX300LC, OLAX300LCE-1081034, OLAX300V-1080775, OLAX300V-1080776, OLAX310, OLAX310E-1081110, OLAX310E-1081111, OLAX310LC, OLAX310LCE-1081114...(Other models you can see in the webshop)		



GEV No.	508017	Ref. No.	10200171
description	flat gasket FIBER ED ø 24mm ID ø 17mm thickness 2mm Qty 1 pcs		
For models:	OLAX151, OLAX151EDX-1080725, OLAX151ELEFT-1080727, OLAX151-highspeed, OLAX160, OLAX160E-1080750, OLAX160E-1080751, OLAX160V-1080755, OLAX160V-1080756, OLAX160V-1081031, OLAX160V-1081032, OLAX210, OLAX210E-1081029, OLAX210E-1081030, OLAX220, OLAX220E-1080787, OLAX220E-1080788, OLAX220V-1080789, OLAX220V-1080790, OLAX230, OLAX230E-1080791, OLAX230E-1080792, OLAX230V-1080793, OLAX230V-1080794, OLAX240, OLAX240E-1080795, OLAX240E-1080796, OLAX240V-1080797, OLAX240V-1080798, OLAX250, OLAX250E-1080760, OLAX250E-1080761, OLAX250V-1080765, OLAX250V-1080766, OLAX300, OLAX300E-1080770, OLAX300E-1080771, OLAX300E-1081033, OLAX300E-1081035, OLAX300E-1081036, OLAX300LC, OLAX300LCE-1081034, OLAX300V-1080775, OLAX300V-1080776, OLAX310, OLAX310E-1081110, OLAX310E-1081111, OLAX310LC, OLAX310LCE-1081114, OLAX310LCE-1081115...(Other models you can see in the webshop)		



GEV No.	506072	Ref. No.	13326
description	flat gasket fibre ED ø 38mm ID ø 27mm thickness 2mm outflow for thread 1¼" Qty 1 pcs		
For models:	OLAX151, OLAX151EDX-1080725, OLAX151ELEFT-1080727, OLAX151-highspeed, OLAX160, OLAX160E-1080750, OLAX160E-1080751, OLAX160V-1080755, OLAX160V-1080756, OLAX160V-1081031, OLAX160V-1081032, OLAX210, OLAX210E-1081029, OLAX210E-1081030, OLAX220, OLAX220E-1080787, OLAX220E-1080788, OLAX220V-1080789, OLAX220V-1080790, OLAX230, OLAX230E-1080791, OLAX230E-1080792, OLAX230V-1080793, OLAX230V-1080794, OLAX240, OLAX240E-1080795, OLAX240E-1080796, OLAX240V-1080797, OLAX240V-1080798, OLAX250, OLAX250E-1080760, OLAX250E-1080761, OLAX250V-1080765, OLAX250V-1080766, OLAX300, OLAX300E-1080770, OLAX300E-1080771, OLAX300E-1081033, OLAX300E-1081035, OLAX300E-1081036, OLAX300LC, OLAX300LCE-1081034, OLAX300V-1080775, OLAX300V-1080776, OLAX310, OLAX310E-1081110, OLAX310E-1081111, OLAX310LC, OLAX310LCE-1081114, OLAX310LCE-1081115...(Other models you can see in the webshop)		



GEV No.	510404	Ref. No.	6A022280 BN6A022280
description	flat gasket fibre ED ø 44mm ID ø 34mm thickness 2mm Qty 1 pcs		
For models:	74-02NPEI, 74-02NPEI-12701755, 74-02NPGD, 74-02NPGD-12700750, 74-02NPGI, 74-02NPGI-12700755, 7NP-G50, 7NP-GI50, 7PN-EI50		

graphite gaskets





GEV No.	696702	Ref. No.	R63140070
description	gasket graphite ED ø 84mm ID ø 61mm thickness 3mm Qty 1 pcs		
For models:	CCG051M, CCG071M, CKGP06, CKGP06B, CKGT06, CKGT06B		





rubber gaskets

			
1			
GEV No.	550851	Ref. No.	6A040170 6A040700
description	flat gasket rubber ED ø 14.5mm ID ø 7mm thickness 1.3mm Qty 1 pcs		
For models:	40SCG, 40SCG-1825000, 40SCG3S-1826000, 60SCG, 60SCG-1825010, 60SCG3S-1826010, 61SCGFE3S-1826055		

			
1			
GEV No.	511943	Ref. No.	13313
description	flat gasket rubber ED ø 24mm ID ø 8mm thickness 2mm Qty 1 pcs		
For models:	OLG600, OLHT-11-Neutra, OLLP1-800, OLLP1-800-1080721, OLLP1-800EL, OLLP1-800-Neutra, OLLP-ZERO, OLLPZERO-1081057		

			
1			
GEV No.	508423	Ref. No.	15283
description	flat gasket rubber ED ø 40mm ID ø 25.5mm thickness 1.7mm Qty 1 pcs		
For models:	OLAX380, OLAX380LC, OLAX400		

			
1			
GEV No.	519341	Ref. No.	80305
description	flat gasket rubber ED ø 40mm ID ø 5.5mm thickness 2mm Qty 1 pcs		
For models:	OLAX151, OLAX160, OLAX160E-1080750, OLAX160E-1080751, OLAX160V-1080755, OLAX160V-1080756, OLAX160V-1081031, OLAX160V-1081032, OLAX210, OLAX210E-1081029, OLAX210E-1081030, OLAX220, OLAX220E-1080787, OLAX220E-1080788, OLAX220V-1080789, OLAX220V-1080790, OLAX230, OLAX230E-1080791, OLAX230E-1080792, OLAX230V-1080793, OLAX230V-1080794, OLAX240, OLAX240E-1080795, OLAX240E-1080796, OLAX240V-1080797, OLAX240V-1080798, OLAX250, OLAX250E-1080760, OLAX250E-1080761, OLAX250V-1080765, OLAX250V-1080766, OLAX300, OLAX300E-1080770, OLAX300E-1080771, OLAX300E-1081033, OLAX300E-1081035, OLAX300E-1081036, OLAX300LC, OLAX300LCE-1081034, OLAX300V-1080775, OLAX300V-1080776, OLAX310, OLAX310E-1081110, OLAX310E-1081111, OLAX310LC, OLAX310LCE-1081114, OLAX310LCE-1081115, OLAX310LCV-1081116, OLAX310LCV-1081117, OLAX310V-1081112... (Other models you can see in the webshop)		

			
1			
GEV No.	517181	Ref. No.	13305
description	flat gasket rubber ED ø 44mm ID ø 32mm thickness 3mm Qty 1 pcs		
For models:	OLAX250, OLAX250E-1080760, OLAX250E-1080761, OLAX250V-1080765, OLAX250V-1080766, OLAX300V-1080776, OLAX380, OLAX380E-1080780, OLAX380E-1080781, OLAX380E-1081037, OLAX380E-1081038, OLAX380E-1081039, OLAX380E-1081040, OLAX380E-1081043, OLAX380E-1081044, OLAX380E-1081046, OLAX380E-1081047, OLAX380E-1081048, OLAX380E-1081051, OLAX380E-1081052, OLAX380E-1081053, OLAX380E-1081054, OLAX380E-1081055, OLAX380E-1081056, OLAX380LC, OLAX380V-1080785, OLAX380V-1080786, OLAX400, OLAX400E-1081126, OLAX400E-1081127, OLAX400V-1081128, OLAX400V-1081129, OLAX440, OLAX440E-1081041, OLAX440E-1081042, OLAX440LC, OLAX440LCE-1081045, OLAX510, OLAX510E-1081130, OLAX510E-1081131, OLAX510LC, OLAX510LCE-1081134, OLAX510LCE-1081135, OLAX510LCV-1081136, OLAX510LCV-1081137, OLAX510V-1081132, OLAX510V-1081133, OLAX540, OLAX540E-1081049, OLAX540E-1081050...(Other models you can see in the webshop)		

			
1			
GEV No.	517135	Ref. No.	540034
description	flat gasket rubber ED ø 56mm ID ø 44mm thickness 4.5mm Qty 1 pcs equiv. no. 540034 suitable for Dihr		
For models:	OLElectron400		

			
1			
GEV No.	517148	Ref. No.	540032
description	flat gasket rubber ED ø 57mm ID ø 43mm thickness 2mm Qty 1 pcs		
For models:	OLDS40, OLDS40-1081065, OLDS40D-1081066, OLDS40E-1081067, OLDS40ED-1081068, OLDS40-Neutra, OLElectron400		

			
1			
GEV No.	517205	Ref. No.	10200173 10200173/A
description	flat gasket rubber ED ø 75mm ID ø 58mm thickness 3mm Qty 1 pcs		
For models:	OLAX151, OLAX151EDX-1080725, OLAX151LEFT-1080727, OLAX151-highspeed, OLAX160, OLAX160E-1080750, OLAX160E-1080751, OLAX160V-1080755, OLAX160V-1080756, OLAX160V-1081031, OLAX160V-1081032, OLAX210, OLAX210E-1081029, OLAX210E-1081030, OLAX220, OLAX220E-1080787, OLAX220E-1080788, OLAX220V-1080789, OLAX220V-1080790, OLAX230, OLAX230E-1080791, OLAX230E-1080792, OLAX230V-1080793, OLAX230V-1080794, OLAX240, OLAX240E-1080795, OLAX240E-1080796, OLAX240V-1080797, OLAX240V-1080798, OLAX250, OLAX250E-1080760, OLAX250E-1080761, OLAX250V-1080765, OLAX250V-1080766, OLAX300, OLAX300E-1080770, OLAX300E-1080771, OLAX300E-1081033, OLAX300E-1081035, OLAX300E-1081036, OLAX300LC, OLAX300LCE-1081034, OLAX300V-1080775, OLAX300V-1080776, OLAX310, OLAX310E-1081110, OLAX310E-1081111, OLAX310LC, OLAX310LCE-1081114, OLAX310LCE-1081115...(Other models you can see in the webshop)		

			
GEV No.	517398	Ref. No.	16067/B
description	flat gasket rubber ED ø 82mm ID ø 66mm thickness 4mm for salt tank Qty 1 pcs		
For models:	OLDS35, OLDS35-1081061, OLDS35D-1081062, OLDS35-Neutra, OLDS37, OLDS37-1081006, OLDS37-1081063, OLDS37D-1081007, OLDS37D-1081064, OLDS37LS-1081008, OLDS37LSD-1081009, OLDS37-Neutra, OLDS40, OLDS40-1081010, OLDS40-1081065, OLDS40D-1081011, OLDS40D-1081066, OLDS40E-1081067, OLDS40ED-1081068, OLDS40LS-1081012, OLDS40LSD-1081013, OLDS40-Neutra, OLDS45, OLDS50, OLDS50-1081088, OLDS50D-1081089, OLDS50E-1081090, OLDS50ED-1081091, OLDS50-Neutra, OLDS50P-1081018, OLDS50PD-1081019, OLDW20H, OLElectron1000, OLElectron400, OLElectron500, OLELELECTRON1000-1081084, OLELELECTRON1000D-1081085, OLG35, OLG35-1080702, OLG35D-1081000, OLG35-Neutra, OLG600, OLGastro450, OLGastro500Plus, OLGastro500S, OLGastro750Plus, OLGastro750S, OLG537, OLG537-1080700, OLG537D-1080707...(Other models you can see in the webshop)		

			
GEV No.	517194	Ref. No.	80208
description	flat gasket rubber ED ø 95mm ID ø 75mm thickness 3mm Qty 1 pcs		
For models:	OLAX160V-1081031, OLAX160V-1081032, OLAX210, OLAX210E-1081029, OLAX210E-1081030, OLAX220, OLAX220E-1080787, OLAX220E-1080788, OLAX220V-1080789, OLAX220V-1080790, OLAX230, OLAX230E-1080791, OLAX230E-1080792, OLAX230V-1080793, OLAX230V-1080794, OLAX240, OLAX240E-1080795, OLAX240E-1080796, OLAX240V-1080797, OLAX240V-1080798, OLAX300, OLAX300E-1080770, OLAX300E-1080771, OLAX300E-1081033, OLAX300E-1081035, OLAX300E-1081036, OLAX300LC, OLAX300LCE-1081034, OLAX300V-1080775, OLAX310, OLAX310E-1081110, OLAX310E-1081111, OLAX310LC, OLAX310LCE-1081114, OLAX310LCE-1081115, OLAX310LCV-1081116, OLAX310LCV-1081117, OLAX310V-1081112, OLAX310V-1081113, OLAX320, OLAX320E-1081118, OLAX320E-1081119, OLAX320V-1081120, OLAX320V-1081121, OLAX320V-1081125, OLAX330, OLAX330E-1081122, OLAX330E-1081123, OLAX330V-1081124, OLAX380E-1081051...(Other models you can see in the webshop)		

PTFE gaskets

			
GEV No.	514016	Ref. No.	1814500
description	flat gasket PTFE ED ø 45mm ID ø 40mm thickness 4mm Qty 1 pcs equiv. no. 1036500400/1814500 suitable for MARENO		
For models:	CPE60, CPE60DB, OCPE60, OCPE-60-12601900, OCPE-60-12601900MN		

			
GEV No.	517101	Ref. No.	13302
description	gasket PTFE ED ø 16mm ID ø 10mm thickness 2.5mm Qty 1 pcs		
For models:	OLDerby, OLDS35-1081005		

silicone gaskets

			
GEV No.	691332	Ref. No.	2993700
description	flat gasket silicone ED ø 13.8mm ID ø 6mm thickness 1.5mm Qty 1 pcs		
For models:	BRE40, BRE40D, BRE40DB, BRE40DG, BRE40DGB, BRE40G, BSEI40M, CFE60, CFE60P, CPE60, CPE60DB, FQE41, FQE41L, FQE41L2, FQE61, FQE61L, FQE61L2, FTE100B, FTE100BR, FTE100CRL, FTE40B, FTE40BR, FTE40C, FTE40D, FTE40DC, FTE60B, FTE60BR, FTE60C, FTE60D, FTE60DC, FTE60DR, FTE60DRCL, OBME41M, OBME61M, OBRE40, OBRE-40-12601110, OBRE-40-12601110MN, OBSEI40M, OBSEI-40M-12601700, OCPE60, OCPE-60-12601005, OCPE-60-12601005MN, OCPE61, OCPE60, OCPE-60-12601900, OCPE-60-12601900MN, OFQE41, OFQE-41-12601510, OFQE-41-12601510MN, OFQE41L...(Other models you can see in the webshop)		

foam rubber gaskets

			
GEV No.	691329	Ref. No.	1036607700
description	foam rubber gasket W 10mm thickness 5mm self-adhesive Qty supplied by meter		
For models:	FQE41, FQE41L, FQE41L2, FQE61, FQE61L, FQE61L2, OFQE41, OFQE-41-12601510, OFQE-41-12601510MN, OFQE41L, OFQE61, OFQE-61-12601610, OFQE-61-12601610MN, OFQE61L		

sealing cords

round			
			
GEV No.	691631	Ref. No.	6A098400 BN6A098400
description	sealing cord round ø 16mm braided L 1m Qty 1		
For models:	2FX+PCF, 4FX+PCF, 714CT-GV-1000170, 714CTGV-1000170, 714CTGV-1000170R, 714CT-GVFE-1000180, 714CTGVFE-1000180, 714CTGVFE-1000180R, 714TAGV-000190, 714TA-GV-1000190, 714TA-GV-1000190R, 716CTG-000195, 716CTGV-000195, 72+2CTGG-12700013, 72-02FTG-12700130TA, 72-02FTG-12700300, 72-02FTG-12700300TA, 72-02FTGC-12700135, 72-02FTGC-12700135TA, 72-02FTGR-12700132TA, 72-02FTGR-12700302, 72-02FTGVAL, 72-02FTTG-12700130, 72-02FTTGR-12700132, 72-02FTTG-12730130, 72-02FTTG-12730130TA, 72-02FTTG-12730300, 72-02FTTG-12730300TA, 72-02FTTGC-12730135, 72-02FTTGC-12730135TA, 72-02FTTGR-12730132TA, 72-02FTTGR-12730302, 72-02FTTGR-12730302TA, 725KB-G-1000110, 725KB-G-1000110R, 725KB-G-1000111, 725KB-G-1000111R, 725KB-GM-1000120, 725KB-GM-1000120R, 725KB-GMB-1000121, 725KB-GMB-1000121R, 74+2CTGGAN-12700025, 74-02+2CTGG, 74-02+2CTGG-12700030, 74-02CTE-12701170, 74-02CTEE-12701180, 74-02CTG, 74-02CTG-12700170...(Other models you can see in the webshop)		



shaft gaskets

shaft gaskets



1

GEV No.	511171	Ref. No.	R70020040
description	shaft seal ID \varnothing 14.5mm ED \varnothing 20mm thickness 3mm		
For models:	CCE071M, CCG071M, CKEP06, CKEP06B, CKEP10, CKEP10B, CKEP21, CKEP21B, CKET06, CKET06B, CKET10, CKET10B, CKET21, CKET21B, CKGP06, CKGP06B, CKGT06, CKGT06B		



1

GEV No.	512424	Ref. No.	13024
description	shaft seal ID \varnothing 30mm ED \varnothing 42mm thickness 7mm		
For models:	OLAX151, OLAX151EDX-1080725, OLAX151ELEF-1080727, OLAX151-highspeed, OLAX160, OLAX160E-1080750, OLAX160E-1080751, OLAX160V-1080755, OLAX160V-1080756, OLAX160V-1081031, OLAX160V-1081032, OLAX210, OLAX210E-1081029, OLAX210E-1081030, OLAX220, OLAX220E-1080787, OLAX220E-1080788, OLAX220V-1080789, OLAX220V-1080790, OLAX230, OLAX230E-1080791, OLAX230E-1080792, OLAX230V-1080793, OLAX230V-1080794, OLAX240, OLAX240E-1080795, OLAX240E-1080796, OLAX240V-1080797, OLAX240V-1080798, OLAX250, OLAX250E-1080760, OLAX250E-1080761, OLAX250V-1080765, OLAX250V-1080766, OLAX300, OLAX300E-1080770, OLAX300E-1080771, OLAX300E-1081033, OLAX300E-1081035, OLAX300E-1081036, OLAX300LC, OLAX300LCE-1081034, OLAX300V-1080775, OLAX300V-1080776, OLAX310, OLAX310E-1081110, OLAX310E-1081111, OLAX310LC, OLAX310LCE-1081114, OLAX310LCE-1081115...(Other models you can see in the webshop)		



1

GEV No.	511172	Ref. No.	R70020050
description	shaft sealing ID \varnothing 24mm ED \varnothing 29mm thickness 3mm		
For models:	CCE101M, CCE102M, CCG101M, CCG102M, CKEP20, CKEP20B, CKEP40, CKEP40B, CKET20, CKET20B, CKET40, CKET40B, CKGP10, CKGP10B, CKGP20, CKGP20B, CKGP21, CKGP21B, CKGP40, CKGP40B, CKGT10B, CKGT20, CKGT20B, CKGT21, CKGT21B, CKGT40, CKGT40B		

special gaskets

for combi-steamers



1

GEV No.	699384	Ref. No.	R63140050
description	gasket suitable for LAINOX ED \varnothing 84mm ID \varnothing 50mm fibre thickness 2mm hole distance 50mm hole \varnothing 6mm		
For models:	CCG051M, CCG071M, CCG101M, CCG102M, CKGP06, CKGP06B, CKGP10, CKGP10B, CKGP20, CKGP20B, CKGP21, CKGP21B, CKGP40, CKGP40B, CKGT06, CKGT06B, CKGT10, CKGT10B, CKGT20, CKGT20B, CKGT21, CKGT21B, CKGT40, CKGT40B		



1

GEV No.	694955	Ref. No.	R63140010
description	gasket suitable for LAINOX L 80mm W 65mm combi-steamer ID \varnothing 51mm graphite thickness 3mm hole distance 45x60mm		
For models:	CCG051M, CCG071M, CCG101M, CCG102M, CKGP06, CKGP06B, CKGP10, CKGP10B, CKGP20, CKGP20B, CKGP21, CKGP21B, CKGP40, CKGP40B, CKGT06, CKGT06B, CKGT10, CKGT10B, CKGT20, CKGT20B, CKGT21, CKGT21B, CKGT40, CKGT40B		



1

GEV No.	699383	Ref. No.	R63140080
description	gasket suitable for LAINOX Qty 1m ED \varnothing 126mm ID \varnothing 90mm graphite thickness 3mm hole distance 42mm hole \varnothing 7mm		
For models:	CCG101M, CCG102M, CKGP10, CKGP10B, CKGP20, CKGP20B, CKGP21, CKGP21B, CKGP40, CKGP40B, CKGT10, CKGT10B, CKGT20, CKGT20B, CKGT21, CKGT21B, CKGT40, CKGT40B		



1

GEV No.	699385	Ref. No.	R70045100
description	gasket set suitable for LAINOX for cleaning system		
For models:	CKEP06, CKEP06B, CKEP10, CKEP10B, CKEP20, CKEP20B, CKEP21, CKEP21B, CKEP40, CKEP40B, CKET06, CKET06B, CKET10, CKET10B, CKET20, CKET20B, CKET21, CKET21B, CKET40, CKET40B, CKGP06, CKGP06B, CKGP10, CKGP10B, CKGP20, CKGP20B, CKGP21, CKGP21B, CKGP40, CKGP40B, CKGT06, CKGT06B, CKGT10, CKGT10B, CKGT20, CKGT20B, CKGT21, CKGT21B, CKGT40, CKGT40B		

door seals for dishwashers

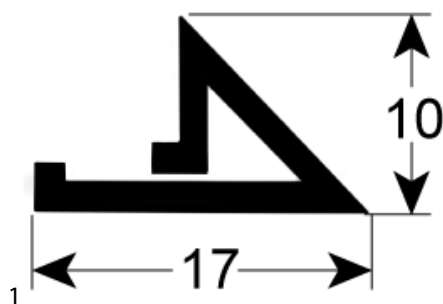

GEV No.	517385	Ref. No.	135205
description	door seal		
For models:	OLDS40, OLDS40-1081065, OLDS40D-1081066, OLDS40E-1081067, OLDS40ED-1081068, OLDS45, OLDS50, OLDS50-1081088, OLDS50D-1081089, OLDS50E-1081090, OLDS50ED-1081091, OLG540, OLG540-1080701, OLG540D-1080708, OLG540D-1081003, OLG545, OLG540LSD-1081004, OLG550, OLG550-1080705, OLG550D-1080706, OLG550E-1080730, OLG550ECO-1081014, OLG550ECOD-1081015, OLG550ED-1080731, OLG550-Neutra, OLG585, OLG585-1081016, OLG585D-1081017		

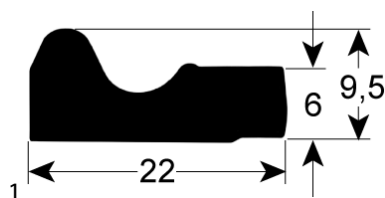

GEV No.	517384	Ref. No.	560021
description	door seal L 1050mm W 22mm H 9.5mm Qty 1		
For models:	OLDS50P-1081018, OLDS50PD-1081019, OLElectron400, OLElectron500, OLGastro500Plus, OLGastro500S, OLGastro750Plus, OLGastro750S		

sealing discs



GEV No.	511945	Ref. No.	13316/A
description	gasket ø 38mm thickness 10mm rubber Qty 1 pcs ID ø 24mm		
For models:	OLDS35, OLDS35-1081061, OLDS35D-1081062, OLDS35-Neutra, OLDS37, OLDS37-1081063, OLDS37D-1081064, OLDS37-Neutra, OLDS40, OLDS40-1081010, OLDS40-1081065, OLDS40D-1081011, OLDS40D-1081066, OLDS40E-1081067, OLDS40ED-1081068, OLDS40LS-1081012, OLDS40LSD-1081013, OLDS40-Neutra, OLDS50, OLDS50-1081088, OLDS50D-1081089, OLDS50E-1081090, OLDS50ED-1081091, OLDS50-Neutra, OLDS50P-1081018, OLDS50PD-1081019, OLDS50H, OLElectron1000, OLElectron400, OLElectron500, OLELELECTRON1000-1081084, OLELELECTRON1000D-1081085, OLG35-1080702, OLG600, OLGastro450, OLGastro500Plus, OLGastro500S, OLGastro750Plus, OLGastro750S, OLG537, OLG537-1080700, OLG537D-1080707, OLG537LS-1081001, OLG537LSD-1081002, OLG537-Neutra, OLG540, OLG540, OLG540-1080701, OLG540D-1080708, OLG540D-1081003...(Other models you can see in the webshop)		

miscellaneous



GEV No.	517219	Ref. No.	13306
description	boot for suction connection		
For models:	OLDerby, OLDS35-1081005		



GEV No.	517277	Ref. No.	150403
description	gasket for catch		
For models:	OLDS35, OLDS35-1081061, OLDS35D-1081062, OLDS35-Neutra, OLDS37, OLDS37-1081063, OLDS37D-1081064, OLDS37-Neutra, OLDS40, OLDS40-1081065, OLDS40D-1081066, OLDS40E-1081067, OLDS40ED-1081068, OLDS40-Neutra, OLG35, OLG35-1080702, OLG35D-1081000, OLG35-Neutra, OLG537, OLG537-1080700, OLG537D-1080707, OLG537LS-1081001, OLG537LSD-1081002, OLG537-Neutra, OLG540, OLG540-1080701, OLG540D-1080708, OLG540D-1081003, OLG540-Neutra, OLG540LSD-1081004		



GEV No.	511944	Ref. No.	13306/A
description	gasket for wash pipe ø 41mm thickness 10mm ID ø 27mm		
For models:	OLDS37-1081006, OLDS37D-1081007, OLDS37LS-1081008, OLDS37LSD-1081009, OLDS40-1081010, OLDS40D-1081011, OLDS40LS-1081012, OLDS40LSD-1081013, OLG35-1080702, OLGastro450, OLG537, OLG537-1080700, OLG537D-1080707, OLG537LS-1081001, OLG537LSD-1081002, OLG537-Neutra, OLG540, OLG540, OLG540-1080701, OLG540D-1080708, OLG540D-1081003, OLG540-Neutra, OLG540LSD-1081004, OLLinear, OLStar		



GEV No.	511945	Ref. No.	13316/A
description	gasket ø 38mm thickness 10mm rubber Qty 1 pcs ID ø 24mm		
For models:	OLDS35, OLDS35-1081061, OLDS35D-1081062, OLDS35-Neutra, OLDS37, OLDS37-1081063, OLDS37D-1081064, OLDS37-Neutra, OLDS40, OLDS40-1081010, OLDS40-1081065, OLDS40D-1081011, OLDS40D-1081066, OLDS40E-1081067, OLDS40ED-1081068, OLDS40LS-1081012, OLDS40LSD-1081013, OLDS40-Neutra, OLDS50, OLDS50-1081088, OLDS50D-1081089, OLDS50E-1081090, OLDS50ED-1081091, OLDS50-Neutra, OLDS50P-1081018, OLDS50PD-1081019, OLDS50H, OLElectron1000, OLElectron400, OLElectron500, OLELELECTRON1000-1081084, OLELELECTRON1000D-1081085, OLG35-1080702, OLG600, OLGastro450, OLGastro500Plus, OLGastro500S, OLGastro750Plus, OLGastro750S, OLG537, OLG537-1080700, OLG537D-1080707, OLG537LS-1081001, OLG537LSD-1081002, OLG537-Neutra, OLG540, OLG540, OLG540-1080701, OLG540D-1080708, OLG540D-1081003...(Other models you can see in the webshop)		

evaporators

for fridges

producer-specific



1

GEV No.	750305	Ref. No.	14330070134
description	evaporator L 300mm W 195mm H 235mm		
For models:	KSABT70G-2045370CJD, OLKSABT70-2045170CIO, OLKSABT72-2045170CIT, OLKSABTV70-2045170CIR, OLKSAP70-2045270CIP, OLKSATN70-2045070CIN, OLKSATN72-2045070CIS, OLKSATNV70-2045070CIQ		



1

GEV No.	750386	Ref. No.	14330210187
description	evaporator L 350mm W 90mm H 375mm Dmm overall width 395mm connection 3/8"mm mounting distance 1 350mm		
For models:	KTAP04-2022230109X0, KTRN401222-2020180504K1, KTRN401222A-20201805042X, KTRN401422-2020180506K1, KTRN401442-20201805054X, KTRN401442A-2020180507HE, KTRN401522-2020180507HD, KTRN401522A-2020180506PX, KTRN401552-2020180507L8, KTRN401552A-2020180507L9, KTRN512222-2020230509WK, KTRN512222A-2020230509WL, KTRN514222-2020230509WO, KTRN514222A-2020230509WP, KTRN514422-2020230507HF, KTRN514422A-2020230507HG, KTRN515522-2020230507LC, KTRN515522A-2020230507LD, KTRP00522-2022130107K4, KTRP200022-202209010500, KTRP200022A-2022090104EB, KTRP200042-2022090107HY, KTRP200042A-20220901077B, KTRP200044-2022090105CF, KTRP200044A-2022090107HZ, KTRP200052-2022090107HW, KTRP200052A-2022090107HX, KTRP200055-2022090107K1, KTRP200055A-2022090107K0, KTRP300222-2022130105HP, KTRP300222A-2022130104EC, KTRP300422-2022130106TB, KTRP300422A-2022130105XL, KTRP300442-2022130107K6, KTRP300442A-2022130107K7, KTRP300522-2022130107K2, KTRP300522A-2022130107K3, KTRP300552A-2022130107K5, KTRP402222A-2022180109WR, KTRP404222-2022180109WV, KTRP404222A-2022180109WU, KTRP404422-2022180104VV, KTRP404422A-2022180107KE, KTRP405222-2022180109WT, KTRP405222A-2022180109WS, KTRP405522-2022180107KB, KTRP405522A-2022180107KC, KTRP522222-2022230109WW, KTRP522222A-2022230109WX, KTRP542222A-2022230109X1...(Other models you can see in the webshop)		



1

GEV No.	750269	Ref. No.	14330210179 14330210186
description	evaporator L 350mm W 90mm H 375mm overall width 400mm connection 3/8"mm mounting distance 1 350mm with boiler		
For models:	KTAR01, KTAR01N, KTAR02, KTAR02N, KTAR03, KTAR03N, KTAR04, KTAR04N, KTR21-202108010BL5, KTR2-202108010BFC, KTR2A-202108010BGP, KTR3-202113010BHF, KTR32A-202113010BLQ, KTR34-202113010BLW, KTR3A-202113010BFW, KTR4-202117010BLG, KTR42-202117010BMO, KTR42A-202117010BMM6, KTR44-202117010BMB, KTR4A-202117010BFF, KTR5-202122010BG2, KTR52-202122010BNK, KTR54-202122010BGC, KTR54A-202122010BNP, KTR5A-202122010BL3, KTR3-202611010C2F, KTR34-20261101096L, KTR34A-20261101096K, KTR3A-202611010C1L, KTR34-202615010BNQ, KTR34A-202615010BNR, KTRP52A-202620010BO5, KTRN200012-202010050495, KTRN200012A-2020100507UK, KTRN200013-2020100507UV, KTRN200013A-2020100507UU, KTRN200014-2020100507UM, KTRN200014A-2020100507UL, KTRN200015-2020100507UR, KTRN200015A-2020100507UT, KTRN300122-202013050479, KTRN300122A-2020130504DY, KTRN300142-2020130506BG, KTRN300142A-2020130507GY, KTRN300144-2020130505UU, KTRN300144A-20201305079X, KTRN300152-2020130507GW, KTRN300152A-2020130507GX, KTRN300155-2020130507HC, KTRN300155A-202013050559...(Other models you can see in the webshop)		



1

GEV No.	750104	Ref. No.	14330570134
description	evaporator L 410mm W 120mm H 490mm complete with fan		
For models:	OLSPAB100-201706030CLP, OLSPAB120-201707030CLN, OLSPABT60-201716030CIC, OLSPABT70-201717030CHW, OLSPABT72-201717030CIO, OLSPABTV70-201717030CHY, OLSPATNN60-201706030CIB, OLSPATNN62-201706030CIF, OLSPATNN70-201707030CEM, OLSPATNN72-201707030CHZ, OLSPATNV60-201706030CID, OLSPATNV70-201707030CHX, TN70, TN72, TNV70		



GEV No.	750547	Ref. No.	14330540134
description	evaporator L 550mm W 400mm H 115mm suitable for POLARIS		
For models:	OLSPAB200-201712030CLO, OLSPAB240-201714030CLO, OLSPABT120-201722030CII, OLSPABT124-201722030CIM, OLSPABT140-201724030CI2, OLSPABT144-201724030CI6, OLSPABTV120-201722030CIK, OLSPABTV140-201724030CI4, OLSPATNN120-201712030CIH, OLSPATNN124-201712030CIL, OLSPATNN140-201714030CI1, OLSPATNN144-201714030CI5, OLSPATNV120-201712030CIJ, OLSPATNV140-201714030CI3, TN140, TN144, TNV140		



GEV No.	690271	Ref. No.	1412083 935696
description	torsion spring ø 15mm L2 80mm wire gauge ø 2.5mm mounting pos. right L1 27mm L3 16mm		
For models:	031, 051, 081, 121, 161, BBC051DF-ASX-4186V21A286220, BBF031AF-ASX-4186V204286210, KSABT70G-2045370CJD, OBC051DF-ASX-6V21A286220OL, OBC081AF-ASX-6V221285220OL, OBC121DF-ASX-6V23A285220OL, OBC161DF-ASX-6V24A-485220OL, OBF031AF-ASX-6V204286210OL, OLKSABT140-2045240CIW, OLKSABT144-2045240CJO, OLKSABT70-2045170CIO, OLKSABT72-2045170CIT, OLKSAP70-2045270CIP, OLKSATN140-2045140CIV, OLKSATN144-2045140CIZ, OLKSATN70-2045070CIN, OLKSATN72-2045070CIS, OLSPABT120-201722030CII, OLSPABT124-201722030CIM, OLSPABT140-201724030CI2, OLSPABT144-201724030CI6, OLSPABT60-201716030CIC, OLSPABT70-201717030CHW, OLSPABT72-201717030CIO, OLSPATNN120-201712030CIH, OLSPATNN124-201712030CIL, OLSPATNN140-201714030CI1, OLSPATNN144-201714030CI5, OLSPATNN60-201706030CIB, OLSPATNN62-201706030CIF, OLSPATNN70-201707030CEM, OLSPATNN72-201707030CHZ, TN140, TN144, TN70, TN72		
accessories for	690271		
	GEV No.	690272	Ref. No. 1412084
			torsion spring ø 15mm L2 80mm wire gauge ø 2.5mm mounting pos. left L1 27mm L3 16mm

springs

torsion springs



GEV No.	690272	Ref. No.	1412084
description	torsion spring ø 15mm L2 80mm wire gauge ø 2.5mm mounting pos. left L1 27mm L3 16mm		
For models:	KSABT70G-2045370CJD, OLKSABT140-2045240CIW, OLKSABT144-2045240CJO, OLKSABT70-2045170CIO, OLKSABT72-2045170CIT, OLKSAP70-2045270CIP, OLKSATN140-2045140CIV, OLKSATN144-2045140CIZ, OLKSATN70-2045070CIN, OLKSATN72-2045070CIS, OLSPABT120-201722030CII, OLSPABT124-201722030CIM, OLSPABT140-201724030CI2, OLSPABT144-201724030CI6, OLSPABT60-201716030CIC, OLSPABT70-201717030CHW, OLSPABT72-201717030CIO, OLSPATNN120-201712030CIH, OLSPATNN124-201712030CIL, OLSPATNN140-201714030CI1, OLSPATNN144-201714030CI5, OLSPATNN60-201706030CIB, OLSPATNN62-201706030CIF, OLSPATNN70-201707030CEM, OLSPATNN72-201707030CHZ, TN140, TN144, TN70, TN72		
accessories for	690272		
	GEV No.	690271	Ref. No. 1412083 935696
			torsion spring ø 15mm L2 80mm wire gauge ø 2.5mm mounting pos. right L1 27mm L3 16mm



GEV No.	690095	Ref. No.	R61620012
description	torsion spring ø 6mm L2 15mm wire gauge ø 0.9mm L1 2x6mm L3 15mm Qty 1 pcs for closing hub		
For models:	CCE042M, CCE051M, CCE071M, CCE101M, CCE102M, CCG051M, CCG071M, CCG101M, CCG102M		

compression springs



GEV No.	690091	Ref. No.	R61620041
description	compression spring ø 12mm L 49mm wire gauge ø 1mm		
For models:	CCE042M, CCE051M, CCE071M, CCE101M, CCE102M, CCG051M, CCG071M, CCG101M, CCG102M		

			
GEV No.	514301	Ref. No.	3107955 BN3107955
description	compression spring ø 6.5mm L 14mm wire gauge ø 1.2mm		
For models:	CMV6ES2-1320392, CV10E, CV10E-1320100, CV10E-1320110, CV10E-2, CV10E2-1320140, CV10EB-1321100, CV10E-S, CV10ES-1320150, CV10E-S2, CV10ES2-1320190, CV10G, CV10G-1310100, CV10G-2, CV10G2-1310140, CV10GB-1311100, CV10G-S, CV10GS-1310150, CV10G-S2, CV10GS2-1310190, CV20E, CV20E-1320200, CV20E-2, CV20E2-1320240, CV20EB-1321200, CV20E-S, CV20ES-1320250, CV20E-S2, CV20ES2-1320290, CV20G, CV20G-1310200, CV20G-2, CV20G2-1310240, CV20GB-1311200, CV20G-S, CV20GS-1310250, CV20G-S2, CV20GS2-1310290, CV21E, CV21E-1322100, CV21E-2, CV21E2-1322140, CV21E-S, CV21ES-1322150, CV21E-S2, CV21ES2-1322190, CV21G, CV21G-1312100, CV21G-2, CV21G2-1312140...(Other models you can see in the webshop)		

			
GEV No.	517367	Ref. No.	3004013
description	roller spring L 70mm W 50mm ID ømm lug length 50mm		
For models:	OLAX250, OLAX250E-1080760, OLAX250E-1080761, OLAX250V-1080765, OLAX250V-1080766, OLAX300, OLAX300E-1080770, OLAX300E-1080771, OLAX300E-1081033, OLAX300E-1081035, OLAX300E-1081036, OLAX300LC, OLAX300LCE-1081034, OLAX300V-1080775, OLAX300V-1080776, OLAX310, OLAX310E-1081110, OLAX310E-1081111, OLAX310LC, OLAX310LCE-1081114, OLAX310LCE-1081115, OLAX310LCV-1081116, OLAX310LCV-1081117, OLAX310V-1081112, OLAX310V-1081113, OLAX320, OLAX320E-1081118, OLAX320E-1081119, OLAX320V-1081120, OLAX320V-1081121, OLAX320V-1081125, OLAX330, OLAX330E-1081122, OLAX330E-1081123, OLAX330V-1081124, OLAX380, OLAX380E-1080780, OLAX380E-1080781, OLAX380E-1081037, OLAX380E-1081038, OLAX380E-1081039, OLAX380E-1081040, OLAX380E-1081043, OLAX380E-1081044, OLAX380E-1081046, OLAX380E-1081047, OLAX380E-1081048, OLAX380E-1081051, OLAX380E-1081052, OLAX380E-1081053...(Other models you can see in the webshop)		

spring compressors

			
GEV No.	517160	Ref. No.	10800210
description	spring compressor thread M10		
For models:	G12S, OLH600, OLH600Electronic, OLHT11-1081071, OLHT11D-1081072, OLHT11ECO-1081070, OLHT11-Neutra, OLHT11S, OLHT11S-Neutra, OLHT12-1081075, OLHT12EL-1081080, OLHT12EL-1081083, OLHT12ELD-1081081, OLHT12ELPLUS-1081086, OLHT12S, OLHT12SElectronic, OLHT12S-Neutra		

roller springs

roller springs

			
GEV No.	517419	Ref. No.	3009906
description	roller spring complete incl. holder type BBSR 22		
For models:	OLAX250, OLAX250E-1080760, OLAX250E-1080761, OLAX250V-1080765, OLAX250V-1080766, OLAX300, OLAX300E-1080770, OLAX300E-1080771, OLAX300E-1081033, OLAX300E-1081035, OLAX300E-1081036, OLAX300LC, OLAX300LCE-1081034, OLAX300V-1080775, OLAX300V-1080776, OLAX310, OLAX310E-1081110, OLAX310E-1081111, OLAX310LC, OLAX310LCE-1081114, OLAX310LCE-1081115, OLAX310LCV-1081116, OLAX310LCV-1081117, OLAX310V-1081112, OLAX310V-1081113, OLAX320, OLAX320E-1081118, OLAX320E-1081119, OLAX320V-1081120, OLAX320V-1081121, OLAX320V-1081125, OLAX330, OLAX330E-1081122, OLAX330E-1081123, OLAX330V-1081124, OLAX380, OLAX380E-1080780, OLAX380E-1080781, OLAX380E-1081037, OLAX380E-1081038, OLAX380E-1081039, OLAX380E-1081040, OLAX380E-1081043, OLAX380E-1081044, OLAX380E-1081046, OLAX380E-1081047, OLAX380E-1081048, OLAX380E-1081051, OLAX380E-1081052, OLAX380E-1081053...(Other models you can see in the webshop)		

			
GEV No.	517321	Ref. No.	3004011 3009905
description	roller spring type BBSR 23 W 51mm ID ø 45mm lug length 50mm		
For models:	OLAX160, OLAX160E-1080750, OLAX160E-1080751, OLAX160V-1080755, OLAX160V-1080756, OLAX160V-1081031, OLAX160V-1081032, OLAX210, OLAX210E-1081029, OLAX210E-1081030, OLAX220, OLAX220E-1080787, OLAX220E-1080788, OLAX220V-1080789, OLAX220V-1080790, OLAX230, OLAX230E-1080791, OLAX230E-1080792, OLAX230V-1080793, OLAX230V-1080794, OLAX240, OLAX240E-1080795, OLAX240E-1080796, OLAX240V-1080797, OLAX240V-1080798, OLAX250, OLAX250E-1080760, OLAX250E-1080761, OLAX250V-1080765, OLAX250V-1080766, OLAX300, OLAX300E-1080770, OLAX300E-1080771, OLAX300E-1081033, OLAX300E-1081035, OLAX300E-1081036, OLAX300LC, OLAX300LCE-1081034, OLAX300V-1080775, OLAX300V-1080776, OLAX310, OLAX310E-1081110, OLAX310E-1081111, OLAX310LC, OLAX310LCE-1081114, OLAX310LCE-1081115, OLAX310LCV-1081116, OLAX310LCV-1081117, OLAX310V-1081112, OLAX310V-1081113...(Other models you can see in the webshop)		

							
GEV No.	517315	Ref. No.	3004010				
description	roller spring W 50mm ID ømm lug length 49mm						
For models:	OLAX151, OLAX151EDX-1080725, OLAX151ELEFT-1080727, OLAX151-highspeed, OLCX, OLFX, OLFX250E-1081151, OLFX250V-1081152, OLFX250V-1081153, OLFX380E-1081154, OLFX380E-1081155, OLFX380V-1081156, OLFX380V-1081157, OLFX420E-1081158, OLFX420E-1081159, OLFX420V-1081160, OLFX420V-1081161, OLFX540E-1081162, OLFX540E-1081163, OLFX540V-1081164, OLFX540V-1081165, OLFX600E-1081166, OLFX600E-1081167, OLFX600V-1081168, OLFX600V-1081169, OLFX680E-1081170, OLFX680E-1081171, OLFX680V-1081172, OLFX680V-1081173, OLFX780E-1081174, OLFX780E-1081175, OLFX780V-1081176, OLFX780V-1081177, OLFX900E-1081178, OLFX900E-1081179, OLFX900V-1081180, OLFX900V-1081181, OLUX220, WASHER-1081150						
accessories for	517315						
		<table border="1"> <tr> <td>GEV No.</td> <td>517314</td> <td>Ref. No.</td> <td>3004012</td> </tr> </table>	GEV No.	517314	Ref. No.	3004012	spring holder for roller spring Lmm Wmm H 9mm 10 ED ø 29mm
GEV No.	517314	Ref. No.	3004012				

accessories			
holders			
			
GEV No.	517314	Ref. No.	3004012
description	spring holder for roller spring Lmm Wmm H 9mm 10 ED ø 29mm		
For models:	OLAX151, OLAX151EDX-1080725, OLAX151ELEFT-1080727, OLAX151-highspeed, OLAX160, OLAX160E-1080750, OLAX160E-1080751, OLAX160V-1080755, OLAX160V-1080756, OLAX160V-1081031, OLAX160V-1081032, OLAX210, OLAX210E-1081029, OLAX210E-1081030, OLAX220, OLAX220E-1080787, OLAX220E-1080788, OLAX220V-1080789, OLAX220V-1080790, OLAX230, OLAX230E-1080791, OLAX230E-1080792, OLAX230V-1080793, OLAX230V-1080794, OLAX240, OLAX240E-1080795, OLAX240E-1080796, OLAX240V-1080797, OLAX240V-1080798, OLAX250, OLAX250E-1080760, OLAX250E-1080761, OLAX250V-1080765, OLAX250V-1080766, OLAX300, OLAX300E-1080770, OLAX300E-1080771, OLAX300E-1081033, OLAX300E-1081035, OLAX300E-1081036, OLAX300LC, OLAX300LCE-1081034, OLAX300V-1080775, OLAX300V-1080776, OLAX310, OLAX310E-1081110, OLAX310E-1081111, OLAX310LC, OLAX310LCE-1081114, OLAX310LCE-1081115...(Other models you can see in the webshop)		

tension springs			
			
GEV No.	517273	Ref. No.	550206/A
description	tension spring ø 10mm total length 225mm wire gauge ø 1.5mm mounting pos. upper		
For models:	OLCX, OLFX, OLFX250E-1081151, OLFX250V-1081152, OLFX250V-1081153, OLFX380E-1081154, OLFX380E-1081155, OLFX380V-1081156, OLFX380V-1081157, OLFX420E-1081158, OLFX420E-1081159, OLFX420V-1081160, OLFX420V-1081161, OLFX540E-1081162, OLFX540E-1081163, OLFX540V-1081164, OLFX540V-1081165, OLFX600E-1081166, OLFX600E-1081167, OLFX600V-1081168, OLFX600V-1081169, OLFX680E-1081170, OLFX680E-1081171, OLFX680V-1081172, OLFX680V-1081173, OLFX780E-1081174, OLFX780E-1081175, OLFX780V-1081176, OLFX780V-1081177, OLFX900E-1081178, OLFX900E-1081179, OLFX900V-1081180, OLFX900V-1081181, WASHER-1081150		

			
GEV No.	501296	Ref. No.	560003
description	tension spring ø 12mm total length 275mm wire gauge ø 1.6mm		
For models:	OLCX, OLDS50P-1081018, OLDS50PD-1081019, OLElectron400, OLElectron500, OLFX, OLFX250E-1081151, OLFX250V-1081152, OLFX250V-1081153, OLFX380E-1081154, OLFX380E-1081155, OLFX380V-1081156, OLFX380V-1081157, OLFX420E-1081158, OLFX420E-1081159, OLFX420V-1081160, OLFX420V-1081161, OLFX540E-1081162, OLFX540E-1081163, OLFX540V-1081164, OLFX540V-1081165, OLFX600E-1081166, OLFX600E-1081167, OLFX600V-1081168, OLFX600V-1081169, OLFX680E-1081170, OLFX680E-1081171, OLFX680V-1081172, OLFX680V-1081173, OLFX780E-1081174, OLFX780E-1081175, OLFX780V-1081176, OLFX780V-1081177, OLFX900E-1081178, OLFX900E-1081179, OLFX900V-1081180, OLFX900V-1081181, OLGastro500Plus, OLGastro500S, OLGastro750Plus, OLGastro750S, OLUX220, WASHER-1081150		

			
GEV No.	517259	Ref. No.	10700
description	tension spring ø 15.3mm total length 130mm wire gauge ø 2mm for door		
For models:	OLDerby, OLDS35-1081005, OLH600, OLH600Electronic, OLHT11-1081071, OLHT11D-1081072, OLHT11ECO-1081070, OLHT11S, OLHT11S-Neutra, OLHT12-1081075, OLHT12EL-1081080, OLHT12EL-1081083, OLHT12ELD-1081081, OLHT12ELPLUS-1081086, OLHT12S, OLHT12SElectronic, OLHT12S-Neutra		

			
GEV No.	517272	Ref. No.	550212
description	tension spring ø 15mm total length 540mm wire gauge ø 2mm mounting pos. lower		
For models:	OLDW020H, OLElectron1000, OLELELECTRON1000-1081084, OLELELECTRON1000D-1081085, OLLP15S-1081087		

			
GEV No.	517260	Ref. No.	10700/B
description	tension spring ø 17.3mm total length 140mm wire gauge ø 2.2mm for door		
For models:	OLDS37-1081006, OLDS37D-1081007, OLDS37LS-1081008, OLDS37LSD-1081009, OLDS40-1081010, OLDS40D-1081011, OLDS40LS-1081012, OLDS40LSD-1081013, OLLinear, OLStar		

			
GEV No.	517261	Ref. No.	10700/A
description	tension spring ø 20mm total length 140mm wire gauge ø 2.5mm for door		
For models:	OLG600, OLGastro450		



			
GEV No.	691455	Ref. No.	2510545 BN2510545
description	tension spring ø 24.8mm total length 270mm wire gauge ø 3mm		
For models:	725KB-EB-1000201, 725KB-EB-1000201R, 725KB-EMB-1000211, 725KB-GB-1000111, 725KB-GB-1000111R, 725KB-GMB-1000121, 725KB-GMB-1000121R, 74-02KBEB, 74-02KBEB-12701110, 74-02KBEBI, 74-02KBEBI-12701115, 74-02KBEMB, 74-02KBEMB-12701120, 74-02KBEMB, 74-02KBEMB-12701125, 74-02KBEMB-12701125HB, 74-02KBGB, 74-02KBGB-12700110, 74-02KBGBI, 74-02KBGBI-12700115, 74-02KBGMB, 74-02KBGMB-12700120, 74-02KBGMBI, 74-02KBGMBI-12700125, 94-04KBE, 94-04KBE-12901115, 94-04KBE-12901115BN, 94-04KBE-12901118, 94-04KBEM, 94-04KBEM-12901125, 94-04KBEM-12901125BN, 94-04KBEM-12901128, 94-04KBG, 94-04KBG-12900115, 94-04KBG-12900115TA, 94-04KBG-12900118, 94-04KBG-12900118TA, 94-04KBGM, 94-04KBGM-12900125, 94-04KBGM-12900125TA, 94-04KBGM-12900128, 94-04KBGM-12900128TA, 94-04NKBE-12901215, 94-04NKBE-12901215BN, 9BR-E80, 9BR-E81, 9BR-EM80, 9BR-G80, 9BR-G81, 9BR-GM80		

			
GEV No.	517286	Ref. No.	75303
description	tension spring ø 35mm total length 865mm wire gauge ø 5mm		
For models:	OLHT11-1081071, OLHT11D-1081072, OLHT11ECO-1081070, OLHT-11-Neutra, OLHT11S, OLHT11S-Neutra		

			
GEV No.	517287	Ref. No.	70302
description	tension spring ø 38.8mm total length 663mm wire gauge ø 4.2mm		
For models:	OLH600, OLH600Electronic, OLHT11-1081071, OLHT11D-1081072, OLHT11ECO-1081070, OLHT11S, OLHT11S-Neutra, OLHT12-1081075, OLHT12EL-1081080, OLHT12EL-1081083, OLHT12ELD-1081081, OLHT12ELPLUS-1081086, OLHT12S, OLHT12SElectronic, OLHT12S-Neutra		

kitchen accessories

gastronorm

bridges



			
GEV No.	691337	Ref. No.	CR0506490
description	bridge for Gastronorm container L1 525mm L2 505mm SS W 72mm H 15mm Qty 1 pcs		
For models:	OBME61M		

manometers

			
GEV No.	541876	Ref. No.	2000244
description	manometer ø 49mm pressure range 0-4bar connection lower marking adjustable thread 1/4"		
For models:	OLAX151, OLAX151EDX-1080725, OLAX151ELEFT-1080727, OLAX151-highspeed, OLAX160, OLAX160E-1080750, OLAX160E-1080751, OLAX160V-1080755, OLAX160V-1080756, OLAX160V-1081031, OLAX160V-1081032, OLAX210, OLAX210E-1081029, OLAX210E-1081030, OLAX220, OLAX220E-1080787, OLAX220E-1080788, OLAX220V-1080789, OLAX220V-1080790, OLAX230, OLAX230E-1080791, OLAX230E-1080792, OLAX230V-1080793, OLAX230V-1080794, OLAX240, OLAX240E-1080795, OLAX240E-1080796, OLAX240V-1080797, OLAX240V-1080798, OLAX250, OLAX250E-1080760, OLAX250E-1080761, OLAX250V-1080765, OLAX250V-1080766, OLAX300, OLAX300E-1080770, OLAX300E-1080771, OLAX300E-1081033, OLAX300E-1081035, OLAX300E-1081036, OLAX300LC, OLAX300LCE-1081034, OLAX300V-1080775, OLAX300V-1080776, OLAX310, OLAX310E-1081110, OLAX310E-1081111, OLAX310LC, OLAX310LCE-1081114, OLAX310LCE-1081115...(Other models you can see in the webshop)		

			
GEV No.	541525	Ref. No.	6A022210
description	manometer ø 61mm pressure range 0 up to 1bar thread 1/4" connection on the backside		
For models:	74-02NPEI, 74-02NPEI-12701755, 74-02NPGI, 74-02NPGI-12700755, 7NP-GI50, 7PN-EI50		

			
GEV No.	541901	Ref. No.	CR0589110
description	manometer ø 63mm pressure range 0 up to 1bar 0 up to 14.5PSI thread 1/4" connection on the backside		

			
GEV No.	541062	Ref. No.	6A021900 BN6A021900
description	manometer ø 63mm pressure range 0 up to 1bar connection marking adjustable kettle thread 1/4"		
For models:	910PGB-1191800, 910PGB-191800, 911PEB-1192805, 911PGB-1191805, 911RPEB-1392890, 911RPG-1391830, 915PEB-1192800		
spare parts for	541062		
	GEV No.	Ref. No.	—
	 glass panel ø 58mm thickness 2mm		



water taps

spare parts of other producers

suitable for RUBINETTERIE DEL FRIULI



GEV No.	540415	Ref. No.	6A022453 BN6A022453
description	star handle connection cold total lengthmm mounting pos. shaft diameter 7x7mm ø 55mm 35 built-in depth 22mm		
For models:	110-45CBE, 110-45CBG, 110-45TCBE, 110-45TCBG, 40SECP-1825080, 40SECP-1825080E, 55-45CPE, 55-45CPG, 55-90CPE, 55-90CPG, 72-02CBE, 72-02CBE-12701150, 72-02CBG, 72-02CBG-12700150, 72-02CPE, 72-02CPE-12701900, 72-02CPG, 72-02CPG-12700900, 72-02TCBE, 72-02TCBE-12731150, 72-02TCBG, 72-02TCBG-12730150, 725KB-E-1000200, 725KB-E-1000200R, 725KB-EB-1000201, 725KB-EB-1000201R, 725KB-EM-1000210R, 725KB-EMB-1000211, 725KB-G-1000110, 725KB-G-1000110R, 725KB-GB-1000111, 725KB-GB-1000111R, 725KB-GM-1000120, 725KB-GM-1000120R, 725KB-GMB-1000121, 725KB-GMB-1000121R, 74-02CBE, 74-02CBE-12701155, 74-02CBG, 74-02CBG-12700155, 74-02CPE, 74-02CPE-12701905, 74-02CPG, 74-02CPG-12700905, 74-02CPG-12700905TA, 74-02KBEB, 74-02KBEB-12701110, 74-02KBEBI, 74-02KBEBI-12701115, 74-02KBEMB...(Other models you can see in the webshop)		



GEV No.	540414	Ref. No.	6A022456 BN6A022456
description	star handle connection hot total lengthmm mounting pos. shaft diameter 7x7mm ø 55mm 35 built-in depth 22mm		
For models:	74-02NPEI, 74-02NPEI-12701755, 74-02NPGD, 74-02NPGD-12700750, 74-02NPGI, 74-02NPGI-12700755, 74-02PEI, 74-02PEI-12701765, 74-02PGD, 74-02PGD-12700760, 74-02PGI, 74-02PGI-12700765, 7NP-G50, 7NP-GI50, 7PN-EI50, 910PG-1191810, 910PG-191810, 910PGB-1191800, 910PGB-191800, 911PEB-1192805, 911PGB-1191805, 911RPEB-1392890, 911RPGB-1391830, 915PEB-1192800, 915PG-1191815, 915PG-191815		

dosing pumps

peristaltic dosing pumps

GERMAC

spare parts



GEV No.	361060	Ref. No.	15108/E
description	pump hose GERMAC rinse aid hose type silicone hose ø 4x6mm for model G80/G82/G600		
For models:	OLDerby, OLDS35, OLDS35-1081005, OLDS35-1081061, OLDS35D-1081062, OLDS35-Neutra, OLDS37, OLDS37-1081006, OLDS37-1081063, OLDS37D-1081007, OLDS37D-1081064, OLDS37LS-1081008, OLDS37LSD-1081009, OLDS37-Neutra, OLDS40, OLDS40-1081010, OLDS40-1081065, OLDS40D-1081011, OLDS40D-1081066, OLDS40E-1081067, OLDS40ED-1081068, OLDS40LS-1081012, OLDS40LSD-1081013, OLDS40-Neutra, OLDS45, OLDS50, OLDS50-1081088, OLDS50D-1081089, OLDS50E-1081090, OLDS50ED-1081091, OLDS50-Neutra, OLDS50P-1081018, OLDS50PD-1081019, OLDS50-20H, OLElectron1000, OLElectron400, OLElectron500, OLELELECTRON1000-1081084, OLELELECTRON1000D-1081085, OLG35, OLG35-1080702, OLG35D-1081000, OLG35-Neutra, OLG600, OLGastro450, OLGastro500Plus, OLGastro500S, OLGastro750Plus, OLGastro750S, OLG37...(Other models you can see in the webshop)		

SEKO

built-in version

with frequency control





GEV No.	361791 ¹	Ref. No.	15985
description	dosing pump SEKO frequency control 3l/h 230VAC detergent hose ø 4x6mm hose type K hose Santoprene suction level 1.5m type NBR 3		
For models:	OLDerby, OLDS35, OLDS35-1081005, OLDS35-1081061, OLDS35D-1081062, OLDS35-Neutra, OLDS37, OLDS37-1081006, OLDS37-1081063, OLDS37D-1081007, OLDS37D-1081064, OLDS37LS-1081008, OLDS37LSD-1081009, OLDS37-Neutra, OLDS40, OLDS40-1081010, OLDS40-1081065, OLDS40D-1081011, OLDS40D-1081066, OLDS40E-1081067, OLDS40ED-1081068, OLDS40LS-1081012, OLDS40LSD-1081013, OLDS40-Neutra, OLDS45, OLDS50, OLDS50-1081088, OLDS50D-1081089, OLDS50E-1081090, OLDS50ED-1081091, OLDS50-Neutra, OLDS50P-1081018, OLDS50PD-1081019, OLDS50-20H, OLElectron1000, OLElectron400, OLElectron500, OLELELECTRON1000-1081084, OLELELECTRON1000D-1081085, OLG35, OLG35-1080702, OLG35D-1081000, OLG35-Neutra, OLG600, OLGastro450, OLGastro500Plus, OLGastro500S, OLGastro750Plus, OLGastro750S, OLG37...(Other models you can see in the webshop)		
spare parts for	361791		
GEV No.	361815	Ref. No.	15185
description	pump hose detergent hose ø 6x10mm hose ø 4x6mm hose type K hose Santoprene type SEKO		

¹with accessories

spare parts for		361009	
	GEV No.	361080	Ref. No. —
	O-ring EPDM thickness 2mm ID ø 16mm Qty 1 pcs		
	GEV No.	361085	Ref. No. —
	O-ring EPDM thickness 2mm ID ø 8mm Qty 1 pcs		
	GEV No.	361309	Ref. No. —
	ball for type N5/N6		
	GEV No.	361310	Ref. No. —
	bracket for type N6 ball guide		
	GEV No.	361311	Ref. No. —
	O-ring EPDM thickness 2mm ID ø 6mm Qty 1 pcs for type N6		
	GEV No.	361314	Ref. No. —
	valve ring for type N6 holder for O-ring		
	GEV No.	361317	Ref. No. —
	sealing disc for type N6		
	GEV No.	361886	Ref. No. —
	non-return valve inletmm outletmm outlet ø 12.4mm L 12.7mm		

various

	1		
GEV No.	361731	Ref. No.	10599999
description	dosing pump without auxiliary pressure connection rinse aid inlet 4mm outlet 8mm pressure connection ø 8mm suction connection ø 4mm		
For models:	OLDW020H, OLG35, OLG35D-1081000, OLG35-Neutra, OLH600, OLH600Electronic, OLHT12-1081075, OLHT12EL-1081080, OLHT12EL-1081083, OLHT12ELD-1081081, OLHT12ELPLUS-1081086, OLHT12S, OLHT12SElectronic, OLHT12S-Neutra, OLLP1-800, OLLP1-800-1080721, OLLP1-800EL, OLLP1-800-Neutra, OLLP1S5-1081087, OLLP2-1080722, OLLP2Electronic-Neutra, OLLP3-1080723, OLLP3Electronic-Neutra, OLLP-ZERO, OLLPZERO-1081057		

spare parts			
	1		
GEV No.	510298	Ref. No.	10705/D 16070
description	lip valve dosing pump suitable for DB2/DS5		
For models:	OLDS37-1081006, OLDS37D-1081007, OLDS37LS-1081008, OLDS37LSD-1081009, OLDS40-1081010, OLDS40D-1081011, OLDS40LS-1081012, OLDS40LSD-1081013, OLDS45, OLDS50P-1081018, OLDS50PD-1081019, OLDW020H, OLElectron1000, OLElectron400, OLElectron500, OLELELECTRON1000-1081084, OLELELECTRON1000D-1081085, OLGastro500Plus, OLGastro500S, OLGastro750Plus, OLGastro750S, OLGRANUL900, OLG540, OLG540D, OLG540-1080701, OLG540D-1080708, OLG540D-1081003, OLG540-Neutra, OLG545, OLG545LSD-1081004, OLG550, OLG550-1080705, OLG550D-1080706, OLG550E-1080730, OLG550ECO-1081014, OLG550ED-1080731, OLG550-Neutra, OLG585, OLG585-1081016, OLG585D-1081017, OLH600, OLH600Electronic, OLHT11-1081071, OLHT11D-1081072, OLHT11ECO-1081070, OLHT11-Neutra, OLHT11S, OLHT11S-Neutra, OLHT12-1081075, OLHT12EL-1081080... (Other models you can see in the webshop)		

self-priming with supporting pressure

DIHR			
	1		
GEV No.	361912	Ref. No.	10799/G
description	dosing pump kit inlet 5mm outlet 8mm suction connection ø 5mm auxiliary pressure connection 10mm		
For models:	OLDS35, OLDS35-1081061, OLDS35D-1081062, OLDS35-Neutra, OLDS37, OLDS37-1081063, OLDS37D-1081064, OLDS37-Neutra, OLDS40, OLDS40-1081065, OLDS40D-1081066, OLDS40E-1081067, OLDS40ED-1081068, OLDS40-Neutra, OLDS45, OLElectron400, OLElectron500, OLG35-1080702, OLGastro500Plus, OLGastro500S, OLGastro750Plus, OLGastro750S, OLGRANUL900, OLG537, OLG537-1080700, OLG537D-1080707, OLG537LS-1081001, OLG537LSD-1081002, OLG537-Neutra, OLG540, OLG540-1080701, OLG540D-1080708, OLG540D-1081003, OLG540-Neutra, OLG545LSD-1081004, OLG550, OLG550-1080705, OLG550D-1080706, OLG550E-1080730, OLG550ECO-1081014, OLG550ED-1080731, OLG550-Neutra, OLG585, OLG585-1081016, OLG585D-1081017, OLHT11-1081071, OLHT11D-1081072, OLHT11ECO-1081070, OLHT11S, OLHT12-1081075...(Other models you can see in the webshop)		









Image not available

1

GEV No.	361744	Ref. No.	10799
description	dosing pump type DW with auxiliary pressure connection rinse aid inlet 4mm outlet 8mm suction connection ø 4mm auxiliary pressure connection 10mm		
For models:	OLDS35, OLDS35-1081061, OLDS35D-1081062, OLDS35-Neutra, OLDS37, OLDS37-1081006, OLDS37-1081063, OLDS37D-1081007, OLDS37D-1081064, OLDS37LS-1081008, OLDS37LSD-1081009, OLDS37-Neutra, OLDS40, OLDS40-1081010, OLDS40-1081065, OLDS40D-1081011, OLDS40D-1081066, OLDS40E-1081067, OLDS40ED-1081068, OLDS40LS-1081012, OLDS40LSD-1081013, OLDS40-Neutra, OLDS45, OLDS50, OLDS50-1081088, OLDS50D-1081089, OLDS50E-1081090, OLDS50ED-1081091, OLDS50-Neutra, OLDS50P-1081018, OLDS50PD-1081019, OLElectron1000, OLElectron400, OLElectron500, OLELELECTRON1000-1081084, OLELELECTRON1000D-1081085, OLG35, OLG35-1080702, OLG35D-1081000, OLG35-Neutra, OLG600, OLGastro450, OLGastro500Plus, OLGastro500S, OLGastro750Plus, OLGastro750S, OLG537, OLG537-1080700, OLG537D-1080707, OLG537LS-1081001... (Other models you can see in the webshop)		
spare parts for	361744		
	GEV No.	520026	Ref. No. —
	PVC hose ID ø 4mm ED ø 6mm L 10m thickness 1mm t.max. 60°C transparent		



1

GEV No.	362012	Ref. No.	10705
description	dosing pump type DW with auxiliary pressure connection rinse aid inlet 4x6mm outlet M10x1mm auxiliary pressure connection 10mm		
For models:	OLDerby, OLDS35-1081005		
spare parts for	362012		
	GEV No.	520026	Ref. No. —
	PVC hose ID ø 4mm ED ø 6mm L 10m thickness 1mm t.max. 60°C transparent		
	GEV No.	520090	Ref. No. —
	PVC hose ID ø 4mm ED ø 6mm L 2m thickness 1mm t.max. 60°C transparent		

ELETTROBAR



1

GEV No.	510298	Ref. No.	10705/D 16070
description	lip valve dosing pump suitable for DB2/DS5		
For models:	OLDS37-1081006, OLDS37D-1081007, OLDS37LS-1081008, OLDS37LSD-1081009, OLDS40-1081010, OLDS40D-1081011, OLDS40LS-1081012, OLDS40LSD-1081013, OLDS45, OLDS50P-1081018, OLDS50PD-1081019, OLWDW020H, OLElectron1000, OLElectron400, OLElectron500, OLELELECTRON1000-1081084, OLELELECTRON1000D-1081085, OLGastro500Plus, OLGastro500S, OLGastro750Plus, OLGastro750S, OLGRANUL900, OLG540, OLG540, OLG540-1080701, OLG540D-1080708, OLG540D-1081003, OLG540-Neutra, OLG545, OLG545LSD-1081004, OLG550, OLG550-1080705, OLG550D-1080706, OLG550E-1080730, OLG550ECO-1081014, OLG550ED-1080731, OLG550-Neutra, OLG585, OLG585-1081016, OLG585D-1081017, OLH600, OLH600Electronic, OLHT11-1081071, OLHT11D-1081072, OLHT11ECO-1081070, OLHT11-Neutra, OLHT11S, OLHT11S-Neutra, OLHT12-1081075, OLHT12EL-1081080... (Other models you can see in the webshop)		

GERMAC

spare parts



1

GEV No.	510298	Ref. No.	10705/D 16070
description	lip valve dosing pump suitable for DB2/DS5		
For models:	OLDS37-1081006, OLDS37D-1081007, OLDS37LS-1081008, OLDS37LSD-1081009, OLDS40-1081010, OLDS40D-1081011, OLDS40LS-1081012, OLDS40LSD-1081013, OLDS45, OLDS50P-1081018, OLDS50PD-1081019, OLWDW020H, OLElectron1000, OLElectron400, OLElectron500, OLELELECTRON1000-1081084, OLELELECTRON1000D-1081085, OLGastro500Plus, OLGastro500S, OLGastro750Plus, OLGastro750S, OLGRANUL900, OLG540, OLG540, OLG540-1080701, OLG540D-1080708, OLG540D-1081003, OLG540-Neutra, OLG545, OLG545LSD-1081004, OLG550, OLG550-1080705, OLG550D-1080706, OLG550E-1080730, OLG550ECO-1081014, OLG550ED-1080731, OLG550-Neutra, OLG585, OLG585-1081016, OLG585D-1081017, OLH600, OLH600Electronic, OLHT11-1081071, OLHT11D-1081072, OLHT11ECO-1081070, OLHT11-Neutra, OLHT11S, OLHT11S-Neutra, OLHT12-1081075, OLHT12EL-1081080... (Other models you can see in the webshop)		



1

GEV No.	510296	Ref. No.	10705/O
description	membrane silicone		
For models:	OLHT11-1081071, OLHT11D-1081072, OLHT11ECO-1081070, OLHT11S, OLHT12-1081075, OLHT12EL-1081080, OLHT12EL-1081083, OLHT12ELD-1081081, OLHT12ELPLUS-1081086, OLHT12S, OLHT12SElectronic		

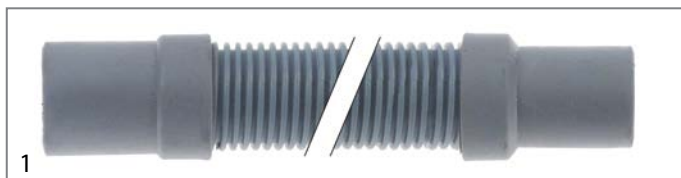

GEV No.	530083	Ref. No.	10200112
description	drain hose DN31 L 1500mm A int. ø 31mm A ext. ø 35mm B int. ø 40mm B ext. ø 46mm outer hose ø 38mm		
For models:	OLAX151, OLAX151EDX-1080725, OLAX151LEFT-1080727, OLAX151-highspeed, OLAX160, OLAX160E-1080750, OLAX160E-1080751, OLAX160V-1080755, OLAX160V-1080756, OLAX160V-1081031, OLAX160V-1081032, OLAX210, OLAX210E-1081029, OLAX210E-1081030, OLAX220, OLAX220E-1080787, OLAX220E-1080788, OLAX220V-1080789, OLAX220V-1080790, OLAX230, OLAX230E-1080791, OLAX230E-1080792, OLAX230V-1080793, OLAX230V-1080794, OLAX240, OLAX240E-1080795, OLAX240E-1080796, OLAX240V-1080797, OLAX240V-1080798, OLAX250, OLAX250E-1080760, OLAX250E-1080761, OLAX250V-1080765, OLAX250V-1080766, OLAX300, OLAX300E-1080770, OLAX300E-1080771, OLAX300E-1081033, OLAX300E-1081035, OLAX300E-1081036, OLAX300LC, OLAX300LCE-1081034, OLAX300V-1080775, OLAX300V-1080776, OLAX310, OLAX310E-1081110, OLAX310E-1081111, OLAX310LC, OLAX310LCE-1081114, OLAX310LCE-1081115...(Other models you can see in the webshop)		

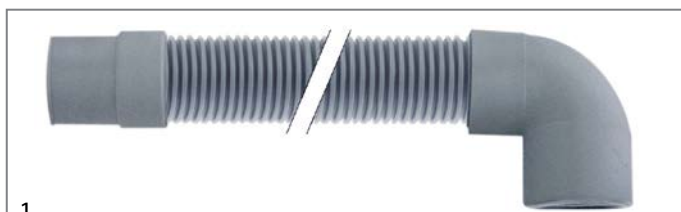

GEV No.	530571	Ref. No.	15721
description	drain hose DN24 L 1500mm straight ø inside 24mm straight ext. ø 29mm elbow ø inside 29mm elbow ext. ø 35mm outer hose ø 28mm		
For models:	OLDS40, OLDS40-1081065, OLDS40D-1081066, OLDS40E-1081067, OLDS40ED-1081068, OLDS40-Neutra, OLDS45, OLDS50, OLDS50-1081088, OLDS50D-1081089, OLDS50E-1081090, OLDS50ED-1081091, OLDS50-Neutra, OLDSW020H, OLElectron1000, OLElectron400, OLElectron500, OLELELECTRON1000-1081084, OLELELECTRON1000D-1081085, OLGastro450, OLGastro500Plus, OLGastro500S, OLGastro750Plus, OLGastro750S, OLSG40, OLSG40-1080701, OLSG40D-1080708, OLSG40D-1081003, OLSG40-Neutra, OLSG45, OLSG450LSD-1081004, OLSG50, OLSG50-1080705, OLSG50D-1080706, OLSG50E-1080730, OLSG50ECO-1081014, OLSG50ECOD-1081015, OLSG50ED-1080731, OLSG50-Neutra, OLSG585, OLSG585-1081016, OLSG585D-1081017, OLSG585-Neutra, OLH600, OLH600Electronic, OLHT11-1081071, OLHT11D-1081072, OLHT11ECO-1081070, OLHT11S, OLHT11S-Neutra...(Other models you can see in the webshop)		

industrial hoses

Niplaflex hoses



GEV No.	530562	Ref. No.	2907350
description	pressure hose ID ø 13mm ED ø 21mm L 5m operating p. 10bar burst p. 30bar t.max. 110°C		
For models:	OLAX151, OLAX151EDX-1080725, OLAX151LEFT-1080727, OLAX151-highspeed, OLAX160, OLAX160E-1080750, OLAX160E-1080751, OLAX160V-1080755, OLAX160V-1080756, OLAX160V-1081031, OLAX160V-1081032, OLAX210, OLAX210E-1081029, OLAX210E-1081030, OLAX220, OLAX220E-1080787, OLAX220E-1080788, OLAX220V-1080789, OLAX220V-1080790, OLAX230, OLAX230E-1080791, OLAX230E-1080792, OLAX230V-1080793, OLAX230V-1080794, OLAX240, OLAX240E-1080795, OLAX240E-1080796, OLAX240V-1080797, OLAX240V-1080798, OLAX250, OLAX250E-1080760, OLAX250E-1080761, OLAX250V-1080765, OLAX250V-1080766, OLAX300, OLAX300E-1080770, OLAX300E-1080771, OLAX300E-1081033, OLAX300E-1081035, OLAX300E-1081036, OLAX300LC, OLAX300LCE-1081034, OLAX300V-1080775, OLAX300V-1080776, OLAX310, OLAX310E-1081110, OLAX310E-1081111, OLAX310LC, OLAX310LCE-1081114, OLAX310LCE-1081115...(Other models you can see in the webshop)		

PE hoses



GEV No.	520973	Ref. No.	R70070040
description	hose John Guest thickness 1.5mm LLDPE blue ID ø 7mm ED ø 10mm		
For models:	CCG071M, CCG101M, CCG102M, CKEP06, CKEP06B, CKEP10, CKEP10B, CKEP20, CKEP20B, CKEP21, CKEP21B, CKEP40, CKEP40B, CKET06, CKET06B, CKET10, CKET10B, CKET20, CKET20B, CKET21, CKET21B, CKET40, CKET40B, CKGP06, CKGP06B, CKGP10, CKGP10B, CKGP20, CKGP20B, CKGP21, CKGP21B, CKGP40, CKGP40B, CKGT06, CKGT06B, CKGT10, CKGT10B, CKGT20, CKGT20B, CKGT21, CKGT21B, CKGT40, CKGT40B		
accessories for	520973		
	GEV No.	440564	Ref. No. —
	push-in fitting John Guest straight thread 1/4" BSP pipe connection ø10mm		
	GEV No.	440565	Ref. No. —
	push-in fitting John Guest straight thread 3/8" BSP pipe connection ø10mm		
	GEV No.	440608	Ref. No. —
	push-in fitting John Guest straight thread 1/2" BSP stub ø 10mm		
	GEV No.	440639	Ref. No. —
	push-in fitting John Guest angled thread 1/4" BSP pipe connection ø10mm		
	GEV No.	520359	Ref. No. R62090528
	push-in fitting John Guest angled pipe connection ø10mm grommet ø 10mm		
	GEV No.	520363	Ref. No. R62090468
	push-in fitting John Guest T-piece pipe connection ø10mm - ø10mm		
	GEV No.	520494	Ref. No. R62090478
	push-in fitting John Guest angled pipe connection ø10mm - ø10mm		

pressure control hoses

GEV No.	530560	Ref. No.	14508
description	pressure control hose ID \varnothing 5mm ED \varnothing 9mm L 5m operating p. 30bar burst p. 90bar temp.-resist. 60°C		
For models:	OLDS35, OLDS35-1081061, OLDS35D-1081062, OLDS35-Neutra, OLDS37, OLDS37-1081063, OLDS37D-1081064, OLDS37-Neutra, OLDS40, OLDS40-1081065, OLDS40D-1081066, OLDS40E-1081067, OLDS40ED-1081068, OLDS40-Neutra, OLDS45, OLDS50, OLDS50-1081088, OLDS50D-1081089, OLDS50E-1081090, OLDS50ED-1081091, OLDS50-Neutra, OLDW020H, OLElectron1000, OLElectron400, OLElectron500, OLELELECTRON1000-1081084, OLELELECTRON1000D-1081085, OLG35, OLG35-1080702, OLG35D-1081000, OLG35-Neutra, OLG600, OLGastro450, OLGastro500Plus, OLGastro500S, OLGastro750Plus, OLGastro750S, OLGANUL900, OLG37, OLG37-1080700, OLG37D-1080707, OLG37LS-1081001, OLG37LSD-1081002, OLG37-Neutra, OLG540, OLG540-1080701, OLG540D-1080708, OLG540D-1081003, OLG540-Neutra, OLG545...(Other models you can see in the webshop)		

PVC hoses
PVC hoses without fabric

GEV No.	520278	Ref. No.	R70070100
description	PVC hose ID \varnothing 6mm ED \varnothing 8mm L 2m thickness 1mm t.max. 60°C transparent		
For models:	CKEP06, CKEP06B, CKEP10, CKEP10B, CKEP20, CKEP20B, CKEP21, CKEP21B, CKEP40, CKEP40B, CKET06, CKET06B, CKET10, CKET10B, CKET20, CKET20B, CKET21, CKET21B, CKET40, CKET40B, CKGP06, CKGP06B, CKGP10, CKGP10B, CKGP20, CKGP20B, CKGP21, CKGP21B, CKGP40, CKGP40B, CKGT06, CKGT06B, CKGT10, CKGT10B, CKGT20, CKGT20B, CKGT21, CKGT21B, CKGT40, CKGT40B		

silicone hoses
without fabric

GEV No.	530899	Ref. No.	R70060080
description	silicone hose ID \varnothing 13mm ED \varnothing 18mm L 0.08m thickness 2.5mm red for combi-steamer		
For models:	CKEP06, CKEP06B, CKEP10, CKEP10B, CKEP20, CKEP20B, CKEP21, CKEP21B, CKEP40, CKEP40B, CKET06, CKET06B, CKET10, CKET10B, CKET20, CKET20B, CKET21, CKET21B, CKET40, CKET40B, CKGP06, CKGP06B, CKGP10, CKGP10B, CKGP20, CKGP20B, CKGP21, CKGP21B, CKGP40, CKGP40B, CKGT06, CKGT06B, CKGT10, CKGT10B, CKGT20, CKGT20B, CKGT21, CKGT21B, CKGT40, CKGT40B		

GEV No.	570157	Ref. No.	R70070090
description	silicone hose ID \varnothing 7mm ED \varnothing 12mm L 1m thickness 2.5mm transparent for combi-steamer		
For models:	CKEP06, CKEP06B, CKEP10, CKEP10B, CKEP20, CKEP20B, CKEP21, CKEP21B, CKEP40, CKEP40B, CKET06, CKET06B, CKET10, CKET10B, CKET20, CKET20B, CKET21, CKET21B, CKET40, CKET40B, CKGP06, CKGP06B, CKGP10, CKGP10B, CKGP20, CKGP20B, CKGP21, CKGP21B, CKGP40, CKGP40B, CKGT06, CKGT06B, CKGT10, CKGT10B, CKGT20, CKGT20B, CKGT21, CKGT21B, CKGT40, CKGT40B		

formed hoses
straight

GEV No.	517231	Ref. No.	10718
description	formed hose D1 \varnothing 36mm D2 \varnothing 28mm L 75mm dishwasher straight equiv. no. 10718, 440718		
For models:	OLAX250, OLAX250E-1080760, OLAX250E-1080761, OLAX250V-1080765, OLAX250V-1080766, OLAX300V-1080776, OLAX380, OLAX380E-1080780, OLAX380E-1080781, OLAX380E-1081037, OLAX380E-1081038, OLAX380E-1081039, OLAX380E-1081040, OLAX380E-1081043, OLAX380E-1081044, OLAX380E-1081046, OLAX380E-1081047, OLAX380E-1081048, OLAX380E-1081051, OLAX380E-1081052, OLAX380E-1081053, OLAX380E-1081054, OLAX380E-1081055, OLAX380E-1081056, OLAX380LC, OLAX380V-1080785, OLAX380V-1080786, OLAX400, OLAX400E-1081126, OLAX400E-1081127, OLAX400V-1081128, OLAX400V-1081129, OLAX440, OLAX440E-1081041, OLAX440E-1081042, OLAX440LC, OLAX440LCE-1081045, OLAX510, OLAX510E-1081130, OLAX510E-1081131, OLAX510LC, OLAX510LCE-1081134, OLAX510LCE-1081135, OLAX510LCV-1081136, OLAX510LCV-1081137, OLAX510V-1081132, OLAX510V-1081133, OLAX540, OLAX540E-1081049, OLAX540E-1081050...(Other models you can see in the webshop)		



GEV No.	517224	Ref. No.	540005
description	formed hose dishwasher straight equiv. no. 540005		
For models:	OLAX160V-1081031, OLAX160V-1081032, OLAX210, OLAX210E-1081029, OLAX210E-1081030, OLAX220, OLAX220E-1080787, OLAX220E-1080788, OLAX220V-1080789, OLAX220V-1080790, OLAX230, OLAX230E-1080791, OLAX230E-1080792, OLAX230V-1080793, OLAX230V-1080794, OLAX240, OLAX240E-1080795, OLAX240E-1080796, OLAX240V-1080797, OLAX240V-1080798, OLAX300, OLAX300E-1080770, OLAX300E-1080771, OLAX300E-1081033, OLAX300E-1081035, OLAX300E-1081036, OLAX300LC, OLAX300LCE-1081034, OLAX300V-1080775, OLAX310, OLAX310E-1081110, OLAX310E-1081111, OLAX310LC, OLAX310LCE-1081114, OLAX310LCE-1081115, OLAX310LCV-1081116, OLAX310LCV-1081117, OLAX310V-1081112, OLAX310V-1081113, OLAX320, OLAX320E-1081118, OLAX320E-1081119, OLAX320V-1081120, OLAX320V-1081121, OLAX320V-1081125, OLAX330, OLAX330E-1081122, OLAX330E-1081123, OLAX330V-1081124, OLAX380E-1081051...(Other models you can see in the webshop)		

1

GEV No.	517239	Ref. No.	80502
description	formed hose dishwasher straight equiv. no. 80502		
For models:	OLLP2-1080722, OLLP2Electronic-Neutra		



1

GEV No.	517247	Ref. No.	15034
description	formed hose dishwasher straight mounting pos. upper equiv. no. 15034		
For models:	OLG600		



1

GEV No.	520534	Ref. No.	R70060040
description	hose ID ø 50mm ED ø 58mm L 50mm silicone Qty 1 for combi-steamer thickness 4mm		
For models:	CKEP06, CKEP06B, CKEP10, CKEP10B, CKEP20, CKEP20B, CKEP21, CKEP21B, CKEP40, CKEP40B, CKET06, CKET06B, CKET10, CKET10B, CKET20, CKET20B, CKET21, CKET21B, CKET40, CKET40B, CKGP06, CKGP06B, CKGP10, CKGP10B, CKGP20, CKGP20B, CKGP21, CKGP21B, CKGP40, CKGP40B, CKGT06, CKGT06B, CKGT10, CKGT10B, CKGT20, CKGT20B, CKGT21, CKGT21B, CKGT40, CKGT40B		



1

GEV No.	530901	Ref. No.	R70060050
description	hose ID ø 54mm ED ø 60mm L 50mm for combi-steamer		
For models:	CKEP20, CKEP20B, CKEP40, CKEP40B, CKET20, CKET20B, CKET40, CKET40B, CKGP40, CKGP40B, CKGT40, CKGT40B		

form L



1

GEV No.	524850	Ref. No.	76078
description	formed hose end piece A ext. ø 43mm end piece A int. ø 35mm AD2 ø 58mm ø end piece B 49mm L 450mm Qty 1 warewashing L-shape		
For models:	OLHT11-1081071, OLHT11D-1081072, OLHT11ECO-1081070, OLHT11S, OLHT11S-Neutra		



1

GEV No.	996015	Ref. No.	92102
description	formed hose end piece A ext. ø 61.5mm end piece A int. ø 51mm AD2 ø 55mm ø end piece B 46mm L 390mm		
For models:	OLLP3-1080743, OLLP-3PLUS, OLLP4-1081258, OLLP-4PLUS		



1

GEV No.	517225	Ref. No.	15032
description	formed hose warewashing L-shape equiv. no. 15032		
For models:	OLGastro450		



1

GEV No.	517228	Ref. No.	11600100 15032/A
description	formed hose warewashing L-shape equiv. no. 15032/A		
For models:	G12S, OLG600, OLG600, OLG600Electronic, OLHT-11-Neutra, OLHT12-1081075, OLHT12EL-1081080, OLHT12EL-1081083, OLHT12ELD-1081081, OLHT12ELPLUS-1081086, OLHT12S, OLHT12SElectronic, OLHT12S-Neutra, OLLP1-800, OLLP1-800-1080721, OLLP1-800EL, OLLP1-800-Neutra, OLLP-ZERO, OLLPZERO-1081057		



form S



GEV No.	517237	Ref. No.	10200124/A
description	formed hose S-shape warewashing equiv. no. 10200124/A		
For models:	OLLP1-1081059, OLLP4-800-1081058, OLLP4-800Electronic-Neutra		



GEV No.	517221	Ref. No.	16170
description	formed hose S-shape warewashing equiv. no. 16170		
For models:	OLDS40-1081010, OLDS40D-1081011, OLDS40LS-1081012, OLDS40LSD-1081013, OLLinear		



GEV No.	517227	Ref. No.	25032
description	formed hose S-shape warewashing equiv. no. 25032		
For models:	OLDS50P-1081018, OLDS50PD-1081019, OLElectron500, OLGastro500Plus, OLGastro500S, OLGastro750Plus, OLGastro750S, OLG550, OLG550-1080705, OLG550D-1080706, OLG550E-1080730, OLG550ECO-1081014, OLG550ECOD-1081015, OLG550ED-1080731, OLG550-Neutra, OLG585, OLG585-1081016, OLG585D-1081017, OLG585-Neutra, OLHT11-1081071, OLHT11D-1081072, OLHT11E-CO-1081070, OLHT11S, OLHT11S-Neutra		



GEV No.	517226	Ref. No.	25032/A
description	formed hose S-shape warewashing equiv. no. 25032/A		
For models:	OLDS45, OLDS50, OLDS50-1081088, OLDS50D-1081089, OLDS50E-1081090, OLDS50ED-1081091, OLDS50-Neutra, OLG545, OLG550, OLG550-1080705, OLG550D-1080706, OLG550E-1080730, OLG550ECO-1081014, OLG550ECOD-1081015, OLG550ED-1080731, OLG550-Neutra		

form U



GEV No.	517252	Ref. No.	15131 18044 18767 18767/A
description	formed hose ext. ø 35 D1 ø 28mm D2 ø 28mm warewashing U-shape		
For models:	OLAX250, OLAX250E-1080760, OLAX250E-1080761, OLAX250V-1080765, OLAX250V-1080766, OLAX300V-1080776, OLAX380, OLAX380E-1080780, OLAX380E-1080781, OLAX380E-1081037, OLAX380E-1081038, OLAX380E-1081039, OLAX380E-1081040, OLAX380E-1081043, OLAX380E-1081044, OLAX380E-1081046, OLAX380E-1081047, OLAX380E-1081048, OLAX380E-1081051, OLAX380E-1081052, OLAX380E-1081053, OLAX380E-1081054, OLAX380E-1081055, OLAX380E-1081056, OLAX380LC, OLAX380V-1080785, OLAX380V-1080786, OLAX400, OLAX400E-1081126, OLAX400E-1081127, OLAX400V-1081128, OLAX400V-1081129, OLAX440, OLAX440E-1081041, OLAX440E-1081042, OLAX440LC, OLAX440LCE-1081045, OLAX510, OLAX510E-1081130, OLAX510E-1081131, OLAX510LC, OLAX510LCE-1081134, OLAX510LCE-1081135, OLAX510LCV-1081136, OLAX510LCV-1081137, OLAX510V-1081132, OLAX510V-1081133, OLAX540, OLAX540E-1081049, OLAX540E-1081050...(Other models you can see in the webshop)		



1

GEV No.	517363	Ref. No.	15033
description	formed hose ext. ø 38 D1 ø 30mm L 255mm Qty 1		
For models:	OLG600, OLGastro450		



1

GEV No.	517249	Ref. No.	11600000
description	formed hose warewashing U-shape equiv. no. 11600000 mounting pos. upper/lower		
For models:	G12S		



1

GEV No.	517257	Ref. No.	30002021
description	formed hose warewashing U-shape equiv. no. 30002021 mounting pos. upper		
For models:	OLGastro450		



1

GEV No.	517255	Ref. No.	560008
description	formed hose warewashing U-shape equiv. no. 560008 mounting pos. upper		
For models:	OLDS50P-1081018, OLDS50PD-1081019, OLElectron500, OLGastro500Plus, OLGastro500S, OLGastro750Plus, OLGastro750S, OLG550, OLG550-1080705, OLG550D-1080706, OLG550E-1080730, OLG550ECO-1081014, OLG550ECOD-1081015, OLG550ED-1080731, OLG550-Neutra, OLG585, OLG585-1081016, OLG585D-1081017, OLG585-Neutra		



1

GEV No.	517242	Ref. No.	560014
description	formed hose warewashing U-shape equiv. no. 560014 mounting pos. lower		
For models:	OLDS50P-1081018, OLDS50PD-1081019, OLElectron500, OLGastro500Plus, OLGastro500S, OLGastro750Plus, OLGastro750S, OLG550, OLG550-1080705, OLG550D-1080706, OLG550E-1080730, OLG550ECO-1081014, OLG550ECOD-1081015, OLG550ED-1080731, OLG550-Neutra		

miscellaneous



1

GEV No.	524824	Ref. No.	92103
description	formed hose ID ø 47/53mm ED ø 60/66mm L 340mm warewashing Qty 1 black		
For models:	OLLP3-1080743, OLLP-3PLUS		



1

GEV No.	517256	Ref. No.	150048/A
description	formed hose warewashing equiv. no. 150048/A mounting pos. upper		
For models:	OLDS45, OLDS50, OLDS50-1081088, OLDS50D-1081089, OLDS50E-1081090, OLDS50ED-1081091, OLDS50-Neutra, OLG545, OLG550, OLG550-1080705, OLG550D-1080706, OLG550E-1080730, OLG550ECO-1081014, OLG550ECOD-1081015, OLG550ED-1080731, OLG550-Neutra		



1

GEV No.	517243	Ref. No.	150049
description	formed hose warewashing equiv. no. 150049 mounting pos. lower		
For models:	OLDS45, OLDS50, OLDS50-1081088, OLDS50D-1081089, OLDS50E-1081090, OLDS50ED-1081091, OLDS50-Neutra, OLG545, OLG550, OLG550-1080705, OLG550D-1080706, OLG550E-1080730, OLG550ECO-1081014, OLG550ECOD-1081015, OLG550ED-1080731, OLG550-Neutra, OLG585, OLG585-1081016, OLG585D-1081017, OLG585-Neutra		



1

GEV No.	517166	Ref. No.	540091
description	Y-piece plastic hose ø 10-10-10mm 3-way		
For models:	OLAX380, OLAX380LC, OLAX400, OLDS45, OLDS50, OLDS50-1081088, OLDS50D-1081089, OLDS50E-1081090, OLDS50ED-1081091, OLDS50-Neutra, OLDS50P-1081018, OLDS50PD-1081019, OLDW020H, OLElectron1000, OLElectron400, OLElectron500, OLELELECTRON1000-1081084, OLELELECTRON1000D-1081085, OLGastro500Plus, OLGastro500S, OLGastro750Plus, OLGastro750S, OLG540, OLG540-1080701, OLG540D-1080708, OLG540D-1081003, OLG540-Neutra, OLG545, OLG5450LSD-1081004, OLG550, OLG550-1080705, OLG550D-1080706, OLG550E-1080730, OLG550ECO-1081014, OLG550ECOD-1081015, OLG550ED-1080731, OLG550-Neutra, OLG585, OLG585-1081016, OLG585D-1081017, OLG585-Neutra, OLHT11S-Neutra, OLHT12SElectronic, OLHT12S-Neutra, OLLP1-1081059, OLLP1S5-1081087, OLLP1-S8, OLLP1-S8EL, OLLP2-1080722, OLLP2Electronic-Neutra...(Other models you can see in the webshop)		

fittings

double nipples



1

GEV No.	517005	Ref. No.	12006
description	double nipple		
For models:	G12S, OLG600, OLGastro450, OLH600, OLH600Electronic, OLHT11-1081071, OLHT11D-1081072, OLHT11ECO-1081070, OLHT11-Neutra, OLHT11S, OLHT11S-Neutra, OLHT12-1081075, OLHT12EL-1081080, OLHT12EL-1081083, OLHT12ELD-1081081, OLHT12ELPLUS-1081086, OLHT12S, OLHT12SElectronic, OLHT12S-Neutra, OLLP1-800, OLLP1-800-1080721, OLLP1-800EL, OLLP1-800-Neutra, OLLP-ZERO, OLLPZERO-1081057		

reducers



1

GEV No.	520177	Ref. No.	12032
description	reducer thread 1/4" ET - 1/8" IT nickel-plated brass total length 13mm WS 17		
For models:	OLAX151, OLAX151EDX-1080725, OLAX151ELEFT-1080727, OLAX151-highspeed, OLAX160, OLAX160E-1080750, OLAX160E-1080751, OLAX160V-1080755, OLAX160V-1080756, OLAX160V-1081031, OLAX160V-1081032, OLAX210, OLAX210E-1081029, OLAX210E-1081030, OLAX220, OLAX220E-1080787, OLAX220E-1080788, OLAX220V-1080789, OLAX220V-1080790, OLAX230, OLAX230E-1080791, OLAX230E-1080792, OLAX230V-1080793, OLAX230V-1080794, OLAX240, OLAX240E-1080795, OLAX240E-1080796, OLAX240V-1080797, OLAX240V-1080798, OLAX250, OLAX250E-1080760, OLAX250E-1080761, OLAX250V-1080765, OLAX250V-1080766, OLAX300, OLAX300E-1080770, OLAX300E-1080771, OLAX300E-1081033, OLAX300E-1081035, OLAX300E-1081036, OLAX300LC, OLAX300LCE-1081034, OLAX300V-1080775, OLAX300V-1080776, OLAX310, OLAX310E-1081110, OLAX310E-1081111, OLAX310LC, OLAX310LCE-1081114, OLAX310LCE-1081115...(Other models you can see in the webshop)		

T-pieces

nickel-plated brass



1

GEV No.	520340	Ref. No.	12008
description	T-piece thread 1/4" IT - 1/4" IT - 1/4" IT nickel-plated brass L 46mm		
For models:	OLAX151, OLAX151EDX-1080725, OLAX151ELEFT-1080727, OLAX151-highspeed, OLAX160, OLAX160E-1080750, OLAX160E-1080751, OLAX160V-1080755, OLAX160V-1080756, OLAX160V-1081031, OLAX160V-1081032, OLAX210, OLAX210E-1081029, OLAX210E-1081030, OLAX220, OLAX220E-1080787, OLAX220E-1080788, OLAX220V-1080789, OLAX220V-1080790, OLAX230, OLAX230E-1080791, OLAX230E-1080792, OLAX230V-1080793, OLAX230V-1080794, OLAX240, OLAX240E-1080795, OLAX240E-1080796, OLAX240V-1080797, OLAX240V-1080798, OLAX250, OLAX250E-1080760, OLAX250E-1080761, OLAX250V-1080765, OLAX250V-1080766, OLAX300, OLAX300E-1080770, OLAX300E-1080771, OLAX300E-1081033, OLAX300E-1081035, OLAX300E-1081036, OLAX300LC, OLAX300LCE-1081034, OLAX300V-1080775, OLAX300V-1080776, OLAX310, OLAX310E-1081110, OLAX310E-1081111, OLAX310LC, OLAX310LCE-1081114, OLAX310LCE-1081115...(Other models you can see in the webshop)		



screw pipe fittings

angle pieces



1

GEV No.	699452	Ref. No.	R62090633
description	angle piece thread M14x1 tube ø 10mm brass		
For models:	CKEP06, CKEP06B, CKEP10, CKEP10B, CKEP20, CKEP20B, CKEP21, CKEP21B, CKEP40, CKEP40B, CKET06, CKET06B, CKET10, CKET10B, CKET20, CKET20B, CKET21, CKET21B, CKET40, CKET40B, CKGP06, CKGP06B, CKGP10, CKGP10B, CKGP20, CKGP20B, CKGP21, CKGP21B, CKGP40, CKGP40B, CKGT06, CKGT06B, CKGT10, CKGT10B, CKGT20, CKGT20B, CKGT21, CKGT21B, CKGT40, CKGT40B		

hose connectors

plastic



1

GEV No.	362011	Ref. No.	R62090538
description	hose connector plastic straight thread 1/4" hose ø 8x6mm Qty 1 pcs		
For models:	CKEP06, CKEP06B, CKEP10, CKEP10B, CKEP20, CKEP20B, CKEP21, CKEP21B, CKEP40, CKEP40B, CKET06, CKET06B, CKET10, CKET10B, CKET20, CKET20B, CKET21, CKET21B, CKET40, CKET40B, CKGP06, CKGP06B, CKGP10, CKGP10B, CKGP20, CKGP20B, CKGP21, CKGP21B, CKGP40, CKGP40B, CKGT06, CKGT06B, CKGT10, CKGT10B, CKGT20, CKGT20B, CKGT21, CKGT21B, CKGT40, CKGT40B		

nickel-plated brass



1

GEV No.	520203	Ref. No.	12023
description	hose connector nickel-plated brass straight thread 1/2" hose ø 12mm Qty 1 pcs		
For models:	OLAX151, OLAX151EDX-1080725, OLAX151ELEFT-1080727, OLAX151-highspeed, OLAX160, OLAX160E-1080750, OLAX160E-1080751, OLAX160V-1080755, OLAX160V-1080756, OLAX160V-1081031, OLAX160V-1081032, OLAX210, OLAX210E-1081029, OLAX210E-1081030, OLAX220, OLAX220E-1080787, OLAX220E-1080788, OLAX220V-1080789, OLAX220V-1080790, OLAX230, OLAX230E-1080791, OLAX230E-1080792, OLAX230V-1080793, OLAX230V-1080794, OLAX240, OLAX240E-1080795, OLAX240E-1080796, OLAX240V-1080797, OLAX240V-1080798, OLAX250, OLAX250E-1080760, OLAX250E-1080761, OLAX250V-1080765, OLAX250V-1080766, OLAX300, OLAX300E-1080770, OLAX300E-1080771, OLAX300E-1081033, OLAX300E-1081035, OLAX300E-1081036, OLAX300LC, OLAX300LCE-1081034, OLAX300V-1080775, OLAX300V-1080776, OLAX310, OLAX310E-1081110, OLAX310E-1081111, OLAX310LC, OLAX310LCE-1081114, OLAX310LCE-1081115...(Other models you can see in the webshop)		



1



GEV No.	520201	Ref. No.	12005
description	hose connector nickel-plated brass straight thread 1/4" hose ø 12mm Qty 1 pcs		
For models:	OLAX151, OLAX151EDX-1080725, OLAX151ELEFT-1080727, OLAX151-highspeed, OLAX160, OLAX160E-1080750, OLAX160E-1080751, OLAX160V-1080755, OLAX160V-1080756, OLAX160V-1081031, OLAX160V-1081032, OLAX210, OLAX210E-1081029, OLAX210E-1081030, OLAX220, OLAX220E-1080787, OLAX220E-1080788, OLAX220V-1080789, OLAX220V-1080790, OLAX230, OLAX230E-1080791, OLAX230E-1080792, OLAX230V-1080793, OLAX230V-1080794, OLAX240, OLAX240E-1080795, OLAX240E-1080796, OLAX240V-1080797, OLAX240V-1080798, OLAX250, OLAX250E-1080760, OLAX250E-1080761, OLAX250V-1080765, OLAX250V-1080766, OLAX300, OLAX300E-1080770, OLAX300E-1080771, OLAX300E-1081033, OLAX300E-1081035, OLAX300E-1081036, OLAX300LC, OLAX300LCE-1081034, OLAX300V-1080775, OLAX300V-1080776, OLAX310, OLAX310E-1081110, OLAX310E-1081111, OLAX310LC, OLAX310LCE-1081114, OLAX310LCE-1081115...(Other models you can see in the webshop)		





1

GEV No.	520202	Ref. No.	10221311
description	hose connector nickel-plated brass straight thread 3/8" hose ø 12mm Qty 1 pcs		
For models:	OLAX151, OLAX151EDX-1080725, OLAX151ELEFT-1080727, OLAX151-highspeed, OLAX160, OLAX160E-1080750, OLAX160E-1080751, OLAX160V-1080755, OLAX160V-1080756, OLAX160V-1081031, OLAX160V-1081032, OLAX210, OLAX210E-1081029, OLAX210E-1081030, OLAX220, OLAX220E-1080787, OLAX220E-1080788, OLAX220V-1080789, OLAX220V-1080790, OLAX230, OLAX230E-1080791, OLAX230E-1080792, OLAX230V-1080793, OLAX230V-1080794, OLAX240, OLAX240E-1080795, OLAX240E-1080796, OLAX240V-1080797, OLAX240V-1080798, OLAX250, OLAX250E-1080760, OLAX250E-1080761, OLAX250V-1080765, OLAX250V-1080766, OLAX300, OLAX300E-1080770, OLAX300E-1080771, OLAX300E-1081033, OLAX300E-1081035, OLAX300E-1081036, OLAX300LC, OLAX300LCE-1081034, OLAX300V-1080775, OLAX300V-1080776, OLAX310, OLAX310E-1081110, OLAX310E-1081111, OLAX310LC, OLAX310LCE-1081114, OLAX310LCE-1081115...(Other models you can see in the webshop)		

			
GEV No.	517108	Ref. No.	12030
description	hose connector nickel-plated brass angled thread 3/8" ET - M10x1 IT hose ø 12mm Qty 1 pcs		
For models:	OLAX151, OLAX151EDX-1080725, OLAX151ELEF-1080727, OLAX151-highspeed, OLAX160, OLAX160E-1080750, OLAX160E-1080751, OLAX160V-1080755, OLAX160V-1080756, OLAX160V-1081031, OLAX160V-1081032, OLAX210, OLAX210E-1081029, OLAX210E-1081030, OLAX220, OLAX220E-1080787, OLAX220E-1080788, OLAX220V-1080789, OLAX220V-1080790, OLAX230, OLAX230E-1080791, OLAX230E-1080792, OLAX230V-1080793, OLAX230V-1080794, OLAX240, OLAX240E-1080795, OLAX240E-1080796, OLAX240V-1080797, OLAX240V-1080798, OLAX250, OLAX250E-1080760, OLAX250E-1080761, OLAX250V-1080765, OLAX250V-1080766, OLAX300, OLAX300E-1080770, OLAX300E-1080771, OLAX300E-1081033, OLAX300E-1081035, OLAX300E-1081036, OLAX300LC, OLAX300LCE-1081034, OLAX300V-1080775, OLAX300V-1080776, OLAX310, OLAX310E-1081110, OLAX310E-1081111, OLAX310LC, OLAX310LCE-1081114, OLAX310LCE-1081115...(Other models you can see in the webshop)		

push-in fittings			
JOHN GUEST			
			
GEV No.	520359	Ref. No.	R62090528
description	push-in fitting John Guest angled pipe connection ø10mm grommet ø 10mm		
For models:	CKEP06, CKEP06B, CKEP10, CKEP10B, CKEP20, CKEP20B, CKEP21, CKEP21B, CKEP40, CKEP40B, CKET06, CKET06B, CKET10, CKET10B, CKET20, CKET20B, CKET21, CKET21B, CKET40, CKET40B, CKGP06, CKGP06B, CKGP10, CKGP10B, CKGP20, CKGP20B, CKGP21, CKGP21B, CKGP40, CKGP40B, CKGT06, CKGT06B, CKGT10, CKGT10B, CKGT20, CKGT20B, CKGT21, CKGT21B, CKGT40, CKGT40B		
accessories for	520359		
	GEV No.	520973	Ref. No.
		hose John Guest thickness 1.5mm LLDPE blue ID ø 7mm ED ø 10mm	

producer-specific			
			
GEV No.	440027	Ref. No.	R62090482
description	connecting piece for hose ID 6mm WS 15 total length 79mm plastic John Guest		
For models:	CKEP06, CKEP06B, CKEP10, CKEP10B, CKEP20, CKEP20B, CKEP21, CKEP21B, CKEP40, CKEP40B, CKET06, CKET06B, CKET10, CKET10B, CKET20, CKET20B, CKET21, CKET21B, CKET40, CKET40B, CKGP06, CKGP06B, CKGP10, CKGP10B, CKGP20, CKGP20B, CKGP21, CKGP21B, CKGP40, CKGP40B, CKGT06, CKGT06B, CKGT10, CKGT10B, CKGT20, CKGT20B, CKGT21, CKGT21B, CKGT40, CKGT40B		

			
GEV No.	440671	Ref. No.	R62090648
description	push-in fitting John Guest angled pipe connection ø8mm grommet ø 8mm		
For models:	CKEP06, CKEP06B, CKEP10, CKEP10B, CKEP20, CKEP20B, CKEP21, CKEP21B, CKEP40, CKEP40B, CKET06, CKET06B, CKET10, CKET10B, CKET20, CKET20B, CKET21, CKET21B, CKET40, CKET40B, CKGP06, CKGP06B, CKGP10, CKGP10B, CKGP20, CKGP20B, CKGP21, CKGP21B, CKGP40, CKGP40B, CKGT06, CKGT06B, CKGT10, CKGT10B, CKGT20, CKGT20B, CKGT21, CKGT21B, CKGT40, CKGT40B		
accessories for	440671		
	GEV No.	520972	Ref. No.
		hose John Guest thickness 1mm LLDPE blue ID ø 6mm ED ø 8mm	

			
GEV No.	520339	Ref. No.	R62090518
description	hose connector thread 1/4" straight grommet ø 10mm grommet length 20mm WS 20 total length 37mm thread L 11mm plastic		
For models:	CKEP06, CKEP06B, CKEP10, CKEP10B, CKEP20, CKEP20B, CKEP21, CKEP21B, CKEP40, CKEP40B, CKET06, CKET06B, CKET10, CKET10B, CKET20, CKET20B, CKET21, CKET21B, CKET40, CKET40B, CKGP06, CKGP06B, CKGP10, CKGP10B, CKGP20, CKGP20B, CKGP21, CKGP21B, CKGP40, CKGP40B, CKGT06, CKGT06B, CKGT10, CKGT10B, CKGT20, CKGT20B, CKGT21, CKGT21B, CKGT40, CKGT40B		

			
GEV No.	520493	Ref. No.	R62090618
description	hose connector John Guest straight pipe connection ø8mm - ø10mm L 41mm PM201008E NSF, SK		
For models:	CKEP06, CKEP06B, CKEP10, CKEP10B, CKEP20, CKEP20B, CKEP21, CKEP21B, CKEP40, CKEP40B, CKET06, CKET06B, CKET10, CKET10B, CKET20, CKET20B, CKET21, CKET21B, CKET40, CKET40B, CKGP06, CKGP06B, CKGP10, CKGP10B, CKGP20, CKGP20B, CKGP21, CKGP21B, CKGP40, CKGP40B, CKGT06, CKGT06B, CKGT10, CKGT10B, CKGT20, CKGT20B, CKGT21, CKGT21B, CKGT40, CKGT40B		

			
GEV No.	520360	Ref. No.	R62090508
description	hose connector thread 1/4" with coupling straight plastic		
For models:	CCE102M, CKEP06, CKEP06B, CKEP10, CKEP10B, CKEP20, CKEP20B, CKEP21, CKEP21B, CKEP40, CKEP40B, CKET06, CKET06B, CKET10, CKET10B, CKET20, CKET20B, CKET21, CKET21B, CKET40, CKET40B, CKGP06, CKGP06B, CKGP10, CKGP10B, CKGP20, CKGP20B, CKGP21, CKGP21B, CKGP40, CKGP40B, CKGT06, CKGT06B, CKGT10, CKGT10B, CKGT20, CKGT20B, CKGT21, CKGT21B, CKGT40, CKGT40B		





1

GEV No.	520492	Ref. No.	R62090458
description	push-in fitting John Guest straight pipe connection ϕ 10mm - ϕ 10mm		
For models:	CCE042M, CCE051M, CCE071M, CCE101M, CCG051M, CCG071M, CCG101M, CCG102M, CKEP06, CKEP06B, CKEP10, CKEP10B, CKEP20, CKEP20B, CKEP21, CKEP21B, CKEP40, CKEP40B, CKET06, CKET06B, CKET10, CKET10B, CKET20, CKET20B, CKET21, CKET21B, CKET40, CKET40B, CKGP06, CKGP06B, CKGP10, CKGP10B, CKGP20, CKGP20B, CKGP21, CKGP21B, CKGP40, CKGP40B, CKGT06, CKGT06B, CKGT10, CKGT10B, CKGT20, CKGT20B, CKGT21, CKGT21B, CKGT40, CKGT40B		
accessories for	520495		
	GEV No.	520971	Ref. No.
			—
	hose thickness 1mm LLDPE blue ID ϕ 4mm ED ϕ 6mm operating pressure at 20°C 16bar		



1

GEV No.	520494	Ref. No.	R62090478
description	push-in fitting John Guest angled pipe connection ϕ 10mm - ϕ 10mm		
For models:	CCE042M, CCE051M, CCE071M, CCE101M, CCE102M, CCG051M, CCG071M, CCG101M, CCG102M, CKEP06, CKEP06B, CKEP10, CKEP10B, CKEP20, CKEP20B, CKEP21, CKEP21B, CKEP40, CKEP40B, CKET06, CKET06B, CKET10, CKET10B, CKET20, CKET20B, CKET21, CKET21B, CKET40, CKET40B, CKGP06, CKGP06B, CKGP10, CKGP10B, CKGP20, CKGP20B, CKGP21, CKGP21B, CKGP40, CKGP40B, CKGT06, CKGT06B, CKGT10, CKGT10B, CKGT20, CKGT20B, CKGT21, CKGT21B, CKGT40, CKGT40B		
accessories for	520494		
	GEV No.	520973	Ref. No.
			R70070040
	hose John Guest thickness 1.5mm LLDPE blue ID ϕ 7mm ED ϕ 10mm		



1

GEV No.	520363	Ref. No.	R62090468
description	push-in fitting John Guest T-piece pipe connection ϕ 10mm - ϕ 10mm - ϕ 10mm		
For models:	CKEP06, CKEP06B, CKEP10, CKEP10B, CKEP20, CKEP20B, CKEP21, CKEP21B, CKEP40, CKEP40B, CKET06, CKET06B, CKET10, CKET10B, CKET20, CKET20B, CKET21, CKET21B, CKET40, CKET40B, CKGP06, CKGP06B, CKGP10, CKGP10B, CKGP20, CKGP20B, CKGP21, CKGP21B, CKGP40, CKGP40B, CKGT06, CKGT06B, CKGT10, CKGT10B, CKGT20, CKGT20B, CKGT21, CKGT21B, CKGT40, CKGT40B		
accessories for	520363		
	GEV No.	520973	Ref. No.
			R70070040
	hose John Guest thickness 1.5mm LLDPE blue ID ϕ 7mm ED ϕ 10mm		



1

GEV No.	520495	Ref. No.	R62090608
description	push-in fitting John Guest straight thread 1/8" BSP stub ϕ 8mm		
For models:	CKEP06, CKEP06B, CKEP10, CKEP10B, CKEP20, CKEP20B, CKEP21, CKEP21B, CKEP40, CKEP40B, CKET06, CKET06B, CKET10, CKET10B, CKET20, CKET20B, CKET21, CKET21B, CKET40, CKET40B, CKGP06, CKGP06B, CKGP10, CKGP10B, CKGP20, CKGP20B, CKGP21, CKGP21B, CKGP40, CKGP40B, CKGT06, CKGT06B, CKGT10, CKGT10B, CKGT20, CKGT20B, CKGT21, CKGT21B, CKGT40, CKGT40B		
accessories for	520495		
	GEV No.	520971	Ref. No.
			—
	hose thickness 1mm LLDPE blue ID ϕ 4mm ED ϕ 6mm operating pressure at 20°C 16bar		

valves and tank inlets

ball valves

universal

ball valves with butterfly handle



1

GEV No.	540658	Ref. No.	1450500
description	ball valve connection 3/4" IT - 3/4" IT DN20 total length 69mm		
For models:	CPE60, CPE60DB, OCPE60, OCPE-60-12601900, OCPE-60-12601900MN		

ball valves with lever handle

			
1			
GEV No.	540758	Ref. No.	6A023010 BN6A023010
description	ball valve connection 1" IT - 1" ET DN25 total length 90mm with lever handle handle length 95mm		
For models:	55-45CPE, 55-45CPG, 55-90CPE, 55-90CPG, 72-02CPE, 72-02CPE-12701900, 72-02CPG, 72-02CPG-12700900, 74-02CPE, 74-02CPE-12701905, 74-02CPG, 74-02CPG-12700905, 74-02CPG-12700905TA, 74CP-G-1000955, 74CPG-1000955, 74CP-G-1000955R, 78CP-G-1000960, 78CPG-1000960, 78CP-G-1000960R, 7FRI-E415, 7FRI-E415M, 7FRI-E610, 7FRI-E815, 7FRI-G415, 7FRI-G610, 7FRI-G815, 912PC-CPG-1104855, 914PCCPG-1104860, 92-04CPE, 92-04CPE-12901900, 92-04CPG, 92-04CPG-12900900, 92-04CPG-12900900TA, 92CCPE-1192856, 92CCPE-1192856V, 92CCPG-1192855, 92RCCPE-1392856, 92RCCPG-1392855, 94-04CPE, 94-04CPE-12901905, 94-04CPG, 94-04CPG-12900905, 94-04CPG-12900905TA, 94CCPE-1192861, 94CCPG-1192860, 94RCCPE-1392861, 94RCCPG-1392860, 9FRI-E415, 9FRI-E420, 9FRI-E610...(Other models you can see in the webshop)		

producer-specific
OLIS

			
1			
GEV No.	540765	Ref. No.	2519004 BN2519004
description	ball valve		
For models:	110-45CBE, 110-45CBG, 110-45TCBE, 110-45TCBG, 55-45CPE, 55-45CPG, 55-90CPE, 55-90CPG, 72-02CBE, 72-02CBE-12701150, 72-02CBG, 72-02CBG-12700150, 72-02TCBE, 72-02TCBE-12731150, 72-02TCBG, 72-02TCBG-12730150, 74-02CBE, 74-02CBE-12701155, 74-02CBG, 74-02CBG-12700155, 74-02TCBE, 74-02TCBE-12731155, 74-02TCBG, 74-02TCBG-12730155, 7-BME, 912PCCPE-1104856, 912PTCBE-1104391, 912PTCBG-1103391, 92-04CBG, 92-04CBG-12900150, 92-04TCBG, 92-04TCBG-12930150, 92CBE-1192301, 92CBG-1191301, 92CBG-191301, 92TCBE-1192391, 92TCBG-1191391, 94-04CBG, 94-04CBG-12900155, 94-04TCBG, 94-04TCBG-12930155, 94CBE-1192302, 94CBEAC-1192362, 94CBG-1191302, 94CBG-191302, 94CBGAC-1191362, 94TCBE-1192392, 94TCBG-1191392		

			
1			
GEV No.	540767	Ref. No.	6A033000 BN6A033000
description	star handle shaft 12x12mm ø 74mm L 28mm black thermoplastic		
For models:	7101FR-E-1077750R, 710FRE-077700, 710FRE-1077700, 710FRG-077300, 710FRG-1077300, 710FR-G-1077350, 710FR-G-1077350R, 7121FR-E-1077950R, 712FRE-077900, 712FRE-1077900, 712FRG-077500, 712FR-G-1077550, 712FRG-1077550, 712FR-G-1077550R, 7201FR-E-1077850R, 720FRE-077800, 720FRE-1077800, 720FRG-077400, 720FRG-1077400, 720FR-G-1077450, 720FRG-1077450, 720FR-G-1077450R, 720FR-G-1077650, 7221FR-E-1078050R, 722FRE-1078000, 722FRG-077600, 722FRG-1077600, 722FR-G-1077650R, 9121PFRE-1204925, 9122PFRE-1104930, 9122PFRE-1103930, 912PFRG-1103925, 9141PFRE-1204950, 914PFRG-1103950, 921FRE, 921FRE-1292925, 921RFRE-1392925, 922FRE-1192930, 922FRG-1191930, 922RFRE-1392930, 922RFRG-1391930, 92FRE-192925, 92FRG, 92FRG-1191925, 92RFRG-1391925, 941FRE-1292950, 941RFRE-1392950, 94FRE-192950, 94FRG, 94FRG-1191950...(Other models you can see in the webshop)		

ball valves electric

			
1			
GEV No.	403042	Ref. No.	R65110560
description	ball valve inlet 3/4" IT outlet 3/4" IT 230V L 68mm closed off-current mode of operation electric connection cable 400mm		
For models:	CKEP06B, CKEP10B, CKEP20B, CKEP21B, CKEP40B, CKET06B, CKET10B, CKET20B, CKET21B, CKET40B, CKGP06B, CKGP10B, CKGP20B, CKGP21B, CKGP40B, CKGT06B, CKGT10B, CKGT20B, CKGT21B, CKGT40B		



			
GEV No.	401190	Ref. No.	3103590 3198150 BN3103590 BN3198150
description	ball valve inlet 3/4" IT outlet 3/4" IT IP42 230V L 68mm 50/60Hz closed off-current mode of operation electric connection cable 300mm 3.5W duty cycle 50%		
For models:	CVP10E, CVP10E-1320700, CVP10E-1320710, CVP10E-2, CVP10E2-1320740, CVP10E2S-1320790, CVP10E-S, CVP10ES-1320750, CVP10ES-1320760, CVP10E-S2, CVP10G, CVP10G-1310700, CVP10G-1310750, CVP10G-2, CVP10G2-1310740, CVP10G-S, CVP10G-S2, CVP10GS2-1310790, CVP20E, CVP20E-1320800, CVP20E-2, CVP20E2-1320840, CVP20E-S, CVP20ES-1320850, CVP20E-S2, CVP20ES2-1320890, CVP20G, CVP20G-1310800, CVP20G-1310850, CVP20G-2, CVP20G-S, CVP20GS-1310840, CVP20G-S2, CVP20GS2-1310890, CVP21E, CVP21E-1322700, CVP21E-2, CVP21E-S, CVP21ES-1322750, CVP21E-S2, CVP21ES2-1322790, CVP21G, CVP21G-1312700, CVP21G-2, CVP21G2-1312740, CVP21G-S, CVP21GS-1312750, CVP21G-S2, CVP21GS2-1312790, CVP6E...(Other models you can see in the webshop)		

			
GEV No.	514409	Ref. No.	6A022440 BN6A022440
description	shut-off valve connection 1/2" 1/2" straight total length 58mm mounting pos. square shaft 7x7		
For models:	725KB-E-1000200, 725KB-E-1000200R, 725KB-EB-1000201, 725KB-EB-1000201R, 725KB-EM-1000210R, 725KB-EMB-1000211, 725KB-G-1000110, 725KB-G-1000110R, 725KB-GB-1000111, 725KB-GB-1000111R, 725KB-GM-1000120, 725KB-GM-1000120R, 725KB-GMB-1000121, 725KB-GMB-1000121R, 74-02KBEB, 74-02KBEB-12701110, 74-02KBEBI, 74-02KBEBI-12701115, 74-02KBEMB, 74-02KBEMB-12701120, 74-02KBEMBI, 74-02KBEMBI-12701125, 74-02KBEMBI-12701125HB, 74-02KBGB, 74-02KBGB-12700110, 74-02KBGBI, 74-02KBGBI-12700115, 74-02KBGMB, 74-02KBGMB-12700120, 74-02KBGMBI, 74-02KBGMBI-12700125		

shut-off valves

universal

			
GEV No.	540415	Ref. No.	6A022453 BN6A022453
description	star handle connection cold total lengthmm mounting pos. shaft diameter 7x7mm ø 55mm 35 built-in depth 22mm		
For models:	110-45CBE, 110-45CBG, 110-45TCBE, 110-45TCBG, 40SECP-1825080, 40SECP-1825080E, 55-45CPE, 55-45CPG, 55-90CPE, 55-90CPG, 72-02CBE, 72-02CBE-12701150, 72-02CBG, 72-02CBG-12700150, 72-02CPE, 72-02CPE-12701900, 72-02CPG, 72-02CPG-12700900, 72-02TCBE, 72-02TCBE-12731150, 72-02TCBG, 72-02TCBG-12730150, 725KB-E-1000200, 725KB-E-1000200R, 725KB-EB-1000201, 725KB-EB-1000201R, 725KB-EM-1000210R, 725KB-EMB-1000211, 725KB-G-1000110, 725KB-G-1000110R, 725KB-GB-1000111, 725KB-GB-1000111R, 725KB-GM-1000120, 725KB-GM-1000120R, 725KB-GMB-1000121, 725KB-GMB-1000121R, 74-02CBE, 74-02CBE-12701155, 74-02CBG, 74-02CBG-12700155, 74-02CPE, 74-02CPE-12701905, 74-02CPG, 74-02CPG-12700905, 74-02CPG-12700905TA, 74-02KBEB, 74-02KBEB-12701110, 74-02KBEBI, 74-02KBEBI-12701115, 74-02KBEMB...(Other models you can see in the webshop)		



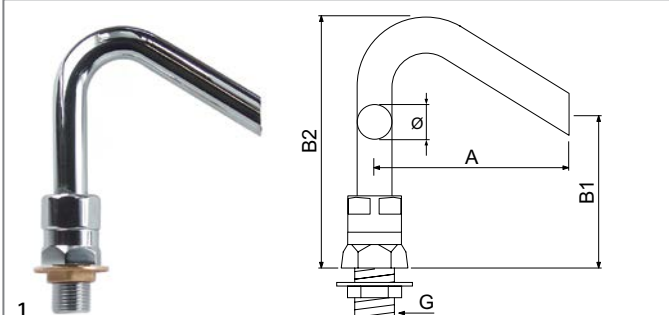

inlet taps

			
GEV No.	514406	Ref. No.	6A022442 BN6A022442
description	inlet spout connection 1/2" ET tube ø 18mm projection 105mm overall height 115mm spout height 60mm rotation 90°		
For models:	725KB-E-1000200, 725KB-E-1000200R, 725KB-EB-1000201, 725KB-EB-1000201R, 725KB-EM-1000210R, 725KB-EMB-1000211, 725KB-G-1000110, 725KB-G-1000110R, 725KB-GB-1000111, 725KB-GB-1000111R, 725KB-GM-1000120, 725KB-GM-1000120R, 725KB-GMB-1000121, 725KB-GMB-1000121R, 74-02KBEB, 74-02KBEB-12701110, 74-02KBEBI, 74-02KBEBI-12701115, 74-02KBEMB, 74-02KBEMB-12701120, 74-02KBEMBI, 74-02KBEMBI-12701125, 74-02KBEMBI-12701125HB, 74-02KBGB, 74-02KBGB-12700110, 74-02KBGBI, 74-02KBGBI-12700115, 74-02KBGMB, 74-02KBGMB-12700120, 74-02KBGMBI, 74-02KBGMBI-12700125		

			
GEV No.	540414	Ref. No.	6A022456 BN6A022456
description	star handle connection hot total lengthmm mounting pos. shaft diameter 7x7mm ø 55mm 35 built-in depth 22mm		
For models:	74-02NPEI, 74-02NPEI-12701755, 74-02NPGD, 74-02NPGD-12700750, 74-02NPGI, 74-02NPGI-12700755, 74-02PEI, 74-02PEI-12701765, 74-02PGD, 74-02PGD-12700760, 74-02PGI, 74-02PGI-12700765, 7NP-G50, 7NP-GI50, 7PN-EI50, 910PG-1191810, 910PG-191810, 910PGB-1191800, 910PGB-191800, 911PEB-1192805, 911PGB-1191805, 911RPEB-1392890, 911RPG-1391830, 915PEB-1192800, 915PG-1191815, 915PG-191815		



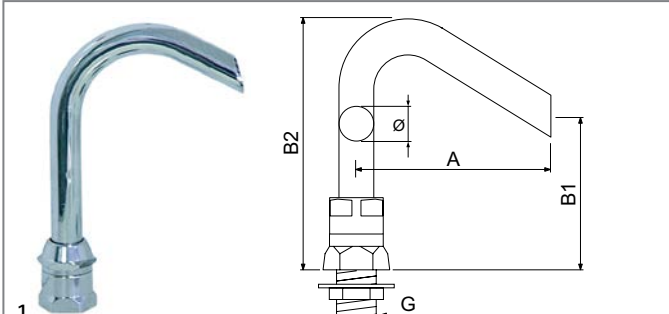

1

GEV No.	540950	Ref. No.	6A022452 MA450000
description	inlet spout connection 1/2" ET tube ø 18mm projection 105mm overall height 130mm spout height 70mm rotation 90°		
For models:	94KBE-1192870, 94KBEM-1192880, 94KBG-1191870, 94KBG-191870, 94KBGM-1191880, 94KBGM-191600, 94RKBE-1392870, 94RK-BEM-1392880, 94RKBG-1391870, 94RKBM-1391880		
spare parts for	540950		
	GEV No.	511470	Ref. No. —
	nut thread 1/2" ø 40mm H 8mm WS 25 brass Qty 1 pcs		
	GEV No.	512071	Ref. No. —
	O-ring EPDM thickness 2.62mm ID ø 22.22mm Qty 1 pcs		
accessories for	540950		
	GEV No.	511474	Ref. No. —
	flat washer for thread 1/2"		
	GEV No.	511477	Ref. No. —
	flat gasket rubber ED ø 42mm ID ø 21mm thickness 2mm Qty 1 pcs		



1

GEV No.	540360	Ref. No.	6A022240 BN6A022240
description	inlet spout connection 1/2" ET tube ø 18mm projection 105mm overall height 165mm spout height 110mm rotation 360°		
For models:	74-02NPEI, 74-02NPEI-12701755, 74-02NPGD-12700750, 74-02NPGI, 74-02NPGI-12700755, 7NP-GI50, 7PN-EI50		
accessories for	540360		
	GEV No.	511470	Ref. No. —
	nut thread 1/2" ø 40mm H 8mm WS 25 brass Qty 1 pcs		
	GEV No.	511474	Ref. No. —
	flat washer for thread 1/2"		
	GEV No.	511477	Ref. No. —
	flat gasket rubber ED ø 42mm ID ø 21mm thickness 2mm Qty 1 pcs		



1

GEV No.	514408	Ref. No.	6A022910 BN6A022910
description	inlet spout connection 3/8" ET tube ø 12mm projection 58mm overall height 76mm spout height 30mm rotation 90°		
For models:	110-45CBE, 110-45CBG, 110-45TCBE, 110-45TCBG, 55-45CPE, 55-45CPG, 55-90CPE, 55-90CPG, 72-02CBE, 72-02CBE-12701150, 72-02CBG-12700150, 72-02CPE, 72-02CPE-12701900, 72-02CPG, 72-02CPG-12700900, 72-02TCBE, 72-02TCBE-12731150, 72-02TCBG-12730150, 74-02CBE, 74-02CBE-12701155, 74-02CBG-12700155, 74-02CPE, 74-02CPE-12701905, 74-02CPG, 74-02CPG-12700905, 74-02CPG-12700905TA, 74-02TCBE, 74-02TCBE-12731155, 74-02TCBG-12730155, 7-BME, 7CP-E400, 7CP-E800, 7CP-G400, 7CP-G800, 92-04CBG, 92-04CBG-12900150, 92-04CPE, 92-04CPE-12901900, 92-04CPG, 92-04CPG-12900900, 92-04CPG-12900900TA, 92-04TCBG, 92-04TCBG-12930150, 94-04CBG, 94-04CBG-12900155, 94-04CPE, 94-04CPE-12901905, 94-04CPG, 94-04CPG-12900905, 94-04CPG-12900905TA...(Other models you can see in the webshop)		



1

GEV No.	514401	Ref. No.	1031112300
description	inlet spout connection M16x1.5 tube ø 10mm projection 48mm overall height 35mm spout height 15mm rotation 90°		
For models:	CPE60, CPE60DB, OCPE60, OCPE-60-12601900, OCPE-60-12601900MN		
accessories for	514401		
	GEV No.	101278	Ref. No.
	olive for pipe ø 10mm Qty 1 pcs		
	GEV No.	101300	Ref. No.
	union nut thread M16x1.5 tube ø 10mm		









drain systems and wash basins

drain fittings

universal



1





GEV No.	515042	Ref. No.	1031402200
description	drain fitting size 1½" usable heightmm overall height 32mm ED ø 69mm chrome-plated brass		
For models:	LA60, OLA60		
accessories for	515042		
	GEV No.	515051	Ref. No. —
	standpipe size 1½" usable height 170mm overall height 185mm ED ø 40mm SS		
	GEV No.	515052	Ref. No. —
	standpipe size 1½" usable height 220mm overall height 235mm ED ø 40mm SS		
	GEV No.	515053	Ref. No. —
	standpipe size 1½" usable height 260mm overall height 275mm ED ø 40mm SS		
	GEV No.	515054	Ref. No. —
	standpipe size 1½" usable height 310mm overall height 325mm ED ø 40mm SS		
	GEV No.	515062	Ref. No. —
	standpipe size 1½" usable height 190mm overall height 200mm ED ø 46mm chrome-plated brass with filter		
	GEV No.	515063	Ref. No. —
	standpipe size 1½" usable height 230mm overall height 240mm ED ø 46mm chrome-plated brass with filter		
	GEV No.	515064	Ref. No. —
	standpipe size 1½" usable height 280mm overall height 290mm ED ø 46mm chrome-plated brass with filter		



standpipes

1¼"



1







GEV No.	515042	Ref. No.	1031402200
description	drain fitting size 1½" usable heightmm overall height 32mm ED ø 69mm chrome-plated brass		
For models:	LA60, OLA60		
accessories for	515042		
	GEV No.	515051	Ref. No. —
	standpipe size 1½" usable height 170mm overall height 185mm ED ø 40mm SS		
	GEV No.	515052	Ref. No. —
	standpipe size 1½" usable height 220mm overall height 235mm ED ø 40mm SS		
	GEV No.	515053	Ref. No. —
	standpipe size 1½" usable height 260mm overall height 275mm ED ø 40mm SS		
	GEV No.	515054	Ref. No. —
	standpipe size 1½" usable height 310mm overall height 325mm ED ø 40mm SS		

accessories for	515042		
	GEV No.	515062	Ref. No. —
	standpipe size 1½" usable height 190mm overall height 200mm ED ø 46mm chrome-plated brass with filter		
	GEV No.	515063	Ref. No. —
	standpipe size 1½" usable height 230mm overall height 240mm ED ø 46mm chrome-plated brass with filter		
	GEV No.	515064	Ref. No. —
	standpipe size 1½" usable height 280mm overall height 290mm ED ø 46mm chrome-plated brass with filter		

1½"



1

GEV No.	515042	Ref. No.	1031402200
description	drain fitting size 1½" usable heightmm overall height 32mm ED ø 69mm chrome-plated brass		
For models:	LA60, OLA60		
accessories for	515042		
	GEV No.	515051	Ref. No. —
	standpipe size 1½" usable height 170mm overall height 185mm ED ø 40mm SS		
	GEV No.	515052	Ref. No. —
	standpipe size 1½" usable height 220mm overall height 235mm ED ø 40mm SS		
	GEV No.	515053	Ref. No. —
	standpipe size 1½" usable height 260mm overall height 275mm ED ø 40mm SS		
	GEV No.	515054	Ref. No. —
	standpipe size 1½" usable height 310mm overall height 325mm ED ø 40mm SS		
	GEV No.	515062	Ref. No. —
	standpipe size 1½" usable height 190mm overall height 200mm ED ø 46mm chrome-plated brass with filter		
	GEV No.	515063	Ref. No. —
	standpipe size 1½" usable height 230mm overall height 240mm ED ø 46mm chrome-plated brass with filter		
	GEV No.	515064	Ref. No. —
	standpipe size 1½" usable height 280mm overall height 290mm ED ø 46mm chrome-plated brass with filter		





















GEV No.	515042	Ref. No.	1031402200
description	drain fitting size 1½" usable heightmm overall height 32mm ED ø 69mm chrome-plated brass		
For models:	LA60, OLA60		
accessories for	515042		
	GEV No.	515051	Ref. No. —
	standpipe size 1½" usable height 170mm overall height 185mm ED ø 40mm SS		
	GEV No.	515052	Ref. No. —
	standpipe size 1½" usable height 220mm overall height 235mm ED ø 40mm SS		

Table continues overleaf

accessories for		515042		
	GEV No.	515053	Ref. No.	—
standpipe size 1½" usable height 260mm overall height 275mm ED ø 40mm SS				
	GEV No.	515054	Ref. No.	—
standpipe size 1½" usable height 310mm overall height 325mm ED ø 40mm SS				
	GEV No.	515062	Ref. No.	—
standpipe size 1½" usable height 190mm overall height 200mm ED ø 46mm chrome-plated brass with filter				
	GEV No.	515063	Ref. No.	—
standpipe size 1½" usable height 230mm overall height 240mm ED ø 46mm chrome-plated brass with filter				
	GEV No.	515064	Ref. No.	—
standpipe size 1½" usable height 280mm overall height 290mm ED ø 46mm chrome-plated brass with filter				

 <p>1</p>				
GEV No.	515042	Ref. No.	1031402200	
description	drain fitting size 1½" usable heightmm overall height 32mm ED ø 69mm chrome-plated brass			
For models:	LA60, OLA60			
accessories for		515042		
	GEV No.	515051	Ref. No.	—
standpipe size 1½" usable height 170mm overall height 185mm ED ø 40mm SS				
	GEV No.	515052	Ref. No.	—
standpipe size 1½" usable height 220mm overall height 235mm ED ø 40mm SS				
	GEV No.	515053	Ref. No.	—
standpipe size 1½" usable height 260mm overall height 275mm ED ø 40mm SS				
	GEV No.	515054	Ref. No.	—
standpipe size 1½" usable height 310mm overall height 325mm ED ø 40mm SS				
	GEV No.	515062	Ref. No.	—
standpipe size 1½" usable height 190mm overall height 200mm ED ø 46mm chrome-plated brass with filter				
	GEV No.	515063	Ref. No.	—
standpipe size 1½" usable height 230mm overall height 240mm ED ø 46mm chrome-plated brass with filter				
	GEV No.	515064	Ref. No.	—
standpipe size 1½" usable height 280mm overall height 290mm ED ø 46mm chrome-plated brass with filter				

 <p>1</p>				
GEV No.	515042	Ref. No.	1031402200	
description	drain fitting size 1½" usable heightmm overall height 32mm ED ø 69mm chrome-plated brass			
For models:	LA60, OLA60			
accessories for		515042		
	GEV No.	515051	Ref. No.	—
standpipe size 1½" usable height 170mm overall height 185mm ED ø 40mm SS				

accessories for		515042		
	GEV No.	515052	Ref. No.	—
standpipe size 1½" usable height 220mm overall height 235mm ED ø 40mm SS				
	GEV No.	515053	Ref. No.	—
standpipe size 1½" usable height 260mm overall height 275mm ED ø 40mm SS				
	GEV No.	515054	Ref. No.	—
standpipe size 1½" usable height 310mm overall height 325mm ED ø 40mm SS				
	GEV No.	515062	Ref. No.	—
standpipe size 1½" usable height 190mm overall height 200mm ED ø 46mm chrome-plated brass with filter				
	GEV No.	515063	Ref. No.	—
standpipe size 1½" usable height 230mm overall height 240mm ED ø 46mm chrome-plated brass with filter				
	GEV No.	515064	Ref. No.	—
standpipe size 1½" usable height 280mm overall height 290mm ED ø 46mm chrome-plated brass with filter				

producer-specific

OLIS

 <p>1</p>				
GEV No.	540764	Ref. No.	6A023150 BN6A023150	
description	overflow pipe			
For models:	912PCCPE-1104856, 912PTCBE-1104391, 92CBE-1192301, 92CBG-1191301, 92CBG-191301, 92TCBE-1192391, 92TCBG-1191391, 94CBE-1192302, 94CBEAC-1192362, 94CBG-1191302, 94CBG-191302, 94CBGAC-1191362, 94TCBE-1192392, 94TCBG-1191392			

U-bends

 <p>1</p>				
GEV No.	515122	Ref. No.	1031402400	
description	drain connection thread 1½" hose ø 50mm			
For models:	LA60, OLA60			



water cycle components

pressure reduction valves

pressure reduction valves

universal



1			
GEV No.	520789	Ref. No.	2000364
description	pressure reduction valve Caleffi series 5362 connection 1/2" default setting 3bar setting range 0.5 up to 6bar p max 25bar t.max. 80°C brass DVGW/SVGW/WRAS/ACS		
For models:	OLAX151, OLAX151EDX-1080725, OLAX151ELEFT-1080727, OLAX151-highspeed, OLAX160, OLAX160E-1080750, OLAX160E-1080751, OLAX160V-1080755, OLAX160V-1080756, OLAX160V-1081031, OLAX160V-1081032, OLAX210, OLAX210E-1081029, OLAX210E-1081030, OLAX220, OLAX220E-1080787, OLAX220E-1080788, OLAX220V-1080789, OLAX220V-1080790, OLAX230, OLAX230E-1080791, OLAX230E-1080792, OLAX230V-1080793, OLAX230V-1080794, OLAX240, OLAX240E-1080795, OLAX240E-1080796, OLAX240V-1080797, OLAX240V-1080798, OLAX250, OLAX250E-1080760, OLAX250E-1080761, OLAX250V-1080765, OLAX250V-1080766, OLAX300, OLAX300E-1080770, OLAX300E-1080771, OLAX300E-1081033, OLAX300E-1081035, OLAX300E-1081036, OLAX300LC, OLAX300LCE-1081034, OLAX300V-1080775, OLAX300V-1080776, OLAX310, OLAX310E-1081110, OLAX310E-1081111, OLAX310LC, OLAX310LCE-1081114, OLAX310LCE-1081115...(Other models you can see in the webshop)		



1			
GEV No.	520271	Ref. No.	3103634 BN3103634
description	pressure reduction valve connection 1/2" default setting 3bar setting range 1 up to 7bar p max 20bar t.max. 80°C		
For models:	CMV6ES2-1320392, CVM10E, CVM10E-1320400, CVM10E-1320410, CVM10E-2, CVM10E2-1320440, CVM10E-S, CVM10ES-1320450, CVM10E-S2, CVM10ES2-1320490, CVM10ES2-1320495, CVM10G, CVM10G-1310400, CVM10G-1310410, CVM10G-1310430, CVM10G-1310450, CVM10G-2, CVM10G2-1310440, CVM10GP-1310400, CVM10G-S, CVM10GS-1310460, CVM10G-S2, CVM10GS2-1310490, CVM10GS2-1310495, CVM20E, CVM20E-1320500, CVM20E-2, CVM20E2-1320540, CVM20E-S, CVM20ES-1320550, CVM20E-S2, CVM20ES2-1320590, CVM20G, CVM20G-1310500, CVM20G-2, CVM20G2-1310540, CVM20G-S, CVM20GS-1310550, CVM20G-S2, CVM20GS2-1310590, CVM21E, CVM21E-1322400, CVM21E-2, CVM21E2-1322440, CVM21E-S, CVM21ES-1322450, CVM21E-S2, CVM21ES2-1322490, CVM21ES2-1322495, CVM21G...(Other models you can see in the webshop)		

supply filters



1			
GEV No.	520790	Ref. No.	2000121
description	supply filter thread 3/4" IT - 3/4" ET total length 72mm nickel-plated brass H 66mm W 46mm		
For models:	OLAX151, OLAX151EDX-1080725, OLAX151ELEFT-1080727, OLAX151-highspeed, OLAX160, OLAX160E-1080750, OLAX160E-1080751, OLAX160V-1080755, OLAX160V-1080756, OLAX160V-1081031, OLAX160V-1081032, OLAX210, OLAX210E-1081029, OLAX210E-1081030, OLAX220, OLAX220E-1080787, OLAX220E-1080788, OLAX220V-1080789, OLAX220V-1080790, OLAX230, OLAX230E-1080791, OLAX230E-1080792, OLAX230V-1080793, OLAX230V-1080794, OLAX240, OLAX240E-1080795, OLAX240E-1080796, OLAX240V-1080797, OLAX240V-1080798, OLAX250, OLAX250E-1080760, OLAX250E-1080761, OLAX250V-1080765, OLAX250V-1080766, OLAX300, OLAX300E-1080770, OLAX300E-1080771, OLAX300E-1081033, OLAX300E-1081035, OLAX300E-1081036, OLAX300LC, OLAX300LCE-1081034, OLAX300V-1080775, OLAX300V-1080776, OLAX310, OLAX310E-1081110, OLAX310E-1081111, OLAX310LC, OLAX310LCE-1081114, OLAX310LCE-1081115...(Other models you can see in the webshop)		

ancillary products

thread sealants



1			
GEV No.	890135	Ref. No.	Loctite 511
description	thread sealing LOCTITE 511 tube 50ml approval DVGW		
description	LOCTITE® 511™ - tube 50ml It is designed for the locking and sealing of metal threaded pipes and fittings. The product cures rapidly when confined in the absence of air between close fitting metal surfaces.		
For models:	OLAX151, OLAX151EDX-1080725, OLAX151ELEFT-1080727, OLAX151-highspeed, OLAX160, OLAX160E-1080750, OLAX160E-1080751, OLAX160V-1080755, OLAX160V-1080756, OLAX160V-1081031, OLAX160V-1081032, OLAX210, OLAX210E-1081029, OLAX210E-1081030, OLAX220, OLAX220E-1080787, OLAX220E-1080788, OLAX220V-1080789, OLAX220V-1080790, OLAX230, OLAX230E-1080791, OLAX230E-1080792, OLAX230V-1080793, OLAX230V-1080794, OLAX240, OLAX240E-1080795, OLAX240E-1080796, OLAX240V-1080797, OLAX240V-1080798, OLAX250, OLAX250E-1080760, OLAX250E-1080761, OLAX250V-1080765, OLAX250V-1080766, OLAX300, OLAX300E-1080770, OLAX300E-1080771, OLAX300E-1081033, OLAX300E-1081035, OLAX300E-1081036, OLAX300LC, OLAX300LCE-1081034, OLAX300V-1080775, OLAX300V-1080776, OLAX310, OLAX310E-1081110, OLAX310E-1081111, OLAX310LC, OLAX310LCE-1081114, OLAX310LCE-1081115...(Other models you can see in the webshop)		

			
GEV No.	890128	Ref. No.	Loctite 542
description	thread sealing LOCTITE 542 medium-strength bottle 50ml approval DVGW		
description	<p>LOCTITE® 542™ - bottle 50ml</p> <p>It is designed for the locking and sealing of metal pipes and fittings as well as other cylindrical metal assemblies. The product cures when confined in the absence of air between close-fitting metal surfaces and prevents loosening and leakage due to shock and vibration. The thixotropic nature of LOCTITE 542 reduces the migration of liquid product after application to the part.</p>		
For models:	<p>OLAX151, OLAX151EDX-1080725, OLAX151ELEFT-1080727, OLAX151-highspeed, OLAX160, OLAX160E-1080750, OLAX160E-1080751, OLAX160V-1080755, OLAX160V-1080756, OLAX160V-1081031, OLAX160V-1081032, OLAX210, OLAX210E-1081029, OLAX210E-1081030, OLAX220, OLAX220E-1080787, OLAX220E-1080788, OLAX220V-1080789, OLAX220V-1080790, OLAX230, OLAX230E-1080791, OLAX230E-1080792, OLAX230V-1080793, OLAX230V-1080794, OLAX240, OLAX240E-1080795, OLAX240E-1080796, OLAX240V-1080797, OLAX240V-1080798, OLAX250, OLAX250E-1080760, OLAX250E-1080761, OLAX250V-1080765, OLAX250V-1080766, OLAX300, OLAX300E-1080770, OLAX300E-1080771, OLAX300E-1081033, OLAX300E-1081035, OLAX300E-1081036, OLAX300LC, OLAX300LCE-1081034, OLAX300V-1080775, OLAX300V-1080776, OLAX310, OLAX310E-1081110, OLAX310E-1081111, OLAX310LC, OLAX310LCE-1081114, OLAX310LCE-1081115...(Other models you can see in the webshop)</p>		

			
GEV No.	890097	Ref. No.	Loctite 577
description	thread sealing LOCTITE 577 medium-strength bottle 50ml pipe thread sealing t.max. 150°C approval BAM and DVGW		
description	<p>LOCTITE® 577™ - bottle 50ml</p> <p>It is designed for the locking and sealing of metal pipes and fittings as well as other cylindrical metal assemblies. The product provides an instant, low-pressure seal for metal pipes and fittings. It will not creep, shrink or block systems by shredding. Suitable for fast application at low temperatures. It has excellent chemical and thermal resistance and offers less migration of liquid product after application to the part.</p>		
For models:	<p>OLAX151, OLAX151EDX-1080725, OLAX151ELEFT-1080727, OLAX151-highspeed, OLAX160, OLAX160E-1080750, OLAX160E-1080751, OLAX160V-1080755, OLAX160V-1080756, OLAX160V-1081031, OLAX160V-1081032, OLAX210, OLAX210E-1081029, OLAX210E-1081030, OLAX220, OLAX220E-1080787, OLAX220E-1080788, OLAX220V-1080789, OLAX220V-1080790, OLAX230, OLAX230E-1080791, OLAX230E-1080792, OLAX230V-1080793, OLAX230V-1080794, OLAX240, OLAX240E-1080795, OLAX240E-1080796, OLAX240V-1080797, OLAX240V-1080798, OLAX250, OLAX250E-1080760, OLAX250E-1080761, OLAX250V-1080765, OLAX250V-1080766, OLAX300, OLAX300E-1080770, OLAX300E-1080771, OLAX300E-1081033, OLAX300E-1081035, OLAX300E-1081036, OLAX300LC, OLAX300LCE-1081034, OLAX300V-1080775, OLAX300V-1080776, OLAX310, OLAX310E-1081110, OLAX310E-1081111, OLAX310LC, OLAX310LCE-1081114, OLAX310LCE-1081115...(Other models you can see in the webshop)</p>		

clamps

hose clamps

DIN 3017 - W2

			
GEV No.	520112	Ref. No.	11807 R61630011
description	hose clamp ø 12-20mm width 9mm Qty 10 pcs DIN 3017		
For models:	<p>CKEP06, CKEP06B, CKEP10, CKEP10B, CKEP20, CKEP20B, CKEP21, CKEP21B, CKEP40, CKEP40B, CKET06, CKET06B, CKET10, CKET10B, CKET20, CKET20B, CKET21, CKET21B, CKET40, CKET40B, CKGP06, CKGP06B, CKGP10, CKGP10B, CKGP20, CKGP20B, CKGP21, CKGP21B, CKGP40, CKGP40B, CKGT06, CKGT06B, CKGT10, CKGT10B, CKGT20, CKGT20B, CKGT21, CKGT21B, CKGT40, CKGT40B, G12S, OLAX151, OLAX151EDX-1080725, OLAX151ELEFT-1080727, OLAX151-high-speed, OLAX160, OLAX160E-1080750, OLAX160E-1080751, OLAX160V-1080755, OLAX160V-1080756...(Other models you can see in the webshop)</p>		

			
GEV No.	520115	Ref. No.	11806
description	hose clamp ø 25-40mm width 9mm Qty 10 pcs DIN 3017		
For models:	<p>OLAX151, OLAX151EDX-1080725, OLAX151ELEFT-1080727, OLAX151-highspeed, OLAX160, OLAX160E-1080750, OLAX160E-1080751, OLAX160V-1080755, OLAX160V-1080756, OLAX160V-1081031, OLAX160V-1081032, OLAX210, OLAX210E-1081029, OLAX210E-1081030, OLAX220, OLAX220E-1080787, OLAX220E-1080788, OLAX220V-1080789, OLAX220V-1080790, OLAX230, OLAX230E-1080791, OLAX230E-1080792, OLAX230V-1080793, OLAX230V-1080794, OLAX240, OLAX240E-1080795, OLAX240E-1080796, OLAX240V-1080797, OLAX240V-1080798, OLAX250, OLAX250E-1080760, OLAX250E-1080761, OLAX250V-1080765, OLAX250V-1080766, OLAX300, OLAX300E-1080770, OLAX300E-1080771, OLAX300E-1081033, OLAX300E-1081035, OLAX300E-1081036, OLAX300LC, OLAX300LCE-1081034, OLAX300V-1080775, OLAX300V-1080776, OLAX310, OLAX310E-1081110, OLAX310E-1081111, OLAX310LC, OLAX310LCE-1081114, OLAX310LCE-1081115...(Other models you can see in the webshop)</p>		



tools

cleaning tools

scrapers



GEV No.	705009	Ref. No.	1030000600
description	scraper for griddle W 80mm		
For models:	FTE100B, FTE100BR, FTE100CRL, FTE40B, FTE40BR, FTE40C, FTE40D, FTE40DC, FTE60B, FTE60BR, FTE60C, FTE60D, FTE60DC, FTE60DR, FTE60DRCL, OFTE-100C-12601136, OFTE-100C-12601136MN, OFTE100CRL, OFTE-100CRL-12601138, OFTE40B, OFTE-40B-12601130, OFTE-40B-12601130MN, OFTE40BR, OFTE-40BR-12601132, OFTE-40BR-12601132MN, OFTE40C, OFTE-40C-12601135, OFTE-40C-12601135MN, OFTE60B, OFTE-60B-12601140, OFTE-60B-12601140MN, OFTE60BR, OFTE-60BR-12601141, OFTE-60BR-12601141MN, OFTE60BRR, OFTE-60BRR-12601142, OFTE-60BRR-12601142MN, OFTE60C, OFTE-60C-12601145, OFTE-60C-12601145MN		

flat-headed bolts



GEV No.	560365	Ref. No.	11121
description	flat-headed bolt thread M4 thread L 8mm SS DIN 7985/ISO 7045 Qty 1 pcs intake Phillips head ø 8mm head thickness 3mm		
For models:	OLDS35, OLDS35-1081061, OLDS35D-1081062, OLDS35-Neutra, OLDS37, OLDS37-1081063, OLDS37D-1081064, OLDS37-Neutra, OLDS40, OLDS40-1081065, OLDS40D-1081066, OLDS40E-1081067, OLDS40ED-1081068, OLDS40-Neutra, OLDS45, OLDS50, OLDS50-1081088, OLDS50D-1081089, OLDS50E-1081090, OLDS50ED-1081091, OLDS50-Neutra, OLG35, OLG35-1080702, OLG35D-1081000, OLG35-Neutra, OLG600, OLG537, OLG537-1080700, OLG537D-1080707, OLG537LS-1081001, OLG537LSD-1081002, OLG537-Neutra, OLG540, OLG540, OLG540-1080701, OLG540D-1080708, OLG540D-1081003, OLG540-Neutra, OLG545, OLG545LSD-1081004, OLG550, OLG550-1080705, OLG550D-1080706, OLG550E-1080730, OLG550ECO-1081014, OLG550ECOD-1081015, OLG550ED-1080731, OLG550-Neutra, OLH600, OLH600Electronic...(Other models you can see in the webshop)		

measuring equipment

thermometers

built-in thermometers



GEV No.	541305	Ref. No.	10500011
description	thermometer mounting measurements 62x11mm +20 up to +120°C capillary pipe 1500mm probe ø 6.5mm probe L 16mm		
For models:	OLH600, OLHT11-1081071, OLHT11D-1081072, OLHT11E-CO-1081070, OLHT11S, OLHT12-1081075, OLHT12EL-1081080, OLHT12EL-1081083, OLHT12ELD-1081081, OLHT12ELPLUS-1081086, OLHT12S, OLHT12S-Neutra, OLLP1-800, OLLP1-800-1080721, OLLP1-800EL, OLLP1-S8, OLLP1-S8EL, OLLP-ZERO, OLLPZERO-1081057		

raised countersunk head screws



GEV No.	560541	Ref. No.	R61040272
description	raised countersunk head screw thread M6 thread L 13mm SS DIN 966/ISO 7047 Qty 1 pcs intake slotted head ø 11mm head thickness 5mm		
For models:	CKEP21B, CKEP21B, CKEP40, CKEP40B, CKET21, CKET21B, CKET40, CKET40B, CKGP21, CKGP21B, CKGP40, CKGP40B, CKGT21, CKGT21B, CKGT40, CKGT40B		

fastening material

screws

sheet metal screws



GEV No.	560521	Ref. No.	11004
description	sheet-metal screw ø 4mm L 10mm SS Qty 1 pcs 14585 intake Phillips head ø 8mm		
For models:	OLDerby, OLDS35-1081005, OLDS37-1081006, OLDS37D-1081007, OLDS37LS-1081008, OLDS37LSD-1081009, OLDS40, OLDS40-1081065, OLDS40D-1081066, OLDS40E-1081067, OLDS40ED-1081068, OLDS40-Neutra, OLDS45, OLDS50, OLDS50-1081088, OLDS50D-1081089, OLDS50E-1081090, OLDS50ED-1081091, OLDS50-Neutra, OLDS50P-1081018, OLDS50PD-1081019, OLElectron400, OLGastro500Plus, OLGastro500S, OLGastro750Plus, OLGastro750S, OLG540, OLG540, OLG540-1080701, OLG540D-1080708, OLG540D-1081003, OLG540-Neutra, OLG545, OLG545LSD-1081004, OLG550, OLG550-1080705, OLG550D-1080706, OLG550E-1080730, OLG550ECO-1081014, OLG550ECOD-1081015, OLG550ED-1080731, OLG550-Neutra, OLG585, OLG585-1081016, OLG585D-1081017, OLG585-Neutra, OLHT11-1081071, OLHT11D-1081072, OLHT11E-CO-1081070, OLHT11S...(Other models you can see in the webshop)		

hexagonal screws



GEV No.	560520	Ref. No.	11109
description	hexagonal screw thread M10 thread L 18mm SS WS 17 Qty 1 pcs head thickness 7mm DIN 933 / ISO 4017		
For models:	OLAX151, OLAX151EDX-1080725, OLAX151ELEFT-1080727, OLAX151-highspeed, OLAX160, OLAX160E-1080750, OLAX160E-1080751, OLAX160V-1080755, OLAX160V-1080756, OLAX160V-1081031, OLAX160V-1081032, OLAX210, OLAX210E-1081029, OLAX210E-1081030, OLAX220, OLAX220E-1080787, OLAX220E-1080788, OLAX220V-1080789, OLAX220V-1080790, OLAX230, OLAX230E-1080791, OLAX230E-1080792, OLAX230V-1080793, OLAX230V-1080794, OLAX240, OLAX240E-1080795, OLAX240E-1080796, OLAX240V-1080797, OLAX240V-1080798, OLAX250, OLAX250E-1080760, OLAX250E-1080761, OLAX250V-1080765, OLAX250V-1080766, OLAX300, OLAX300E-1080770, OLAX300E-1080771, OLAX300E-1081033, OLAX300E-1081035, OLAX300E-1081036, OLAX300LC, OLAX300LCE-1081034, OLAX300V-1080775, OLAX300V-1080776, OLAX310, OLAX310E-1081110, OLAX310E-1081111, OLAX310LC, OLAX310LCE-1081114, OLAX310LCE-1081115...(Other models you can see in the webshop)		



1			
GEV No.	560087	Ref. No.	11104/B
description	hexagonal screw thread M6 thread L 16mm SS WS 10 Qty 20 pcs DIN 933 / ISO 4017		
For models:	OLLP1-S8, OLLP1-S8EL, OLLP2-1080742, OLLP-2PLUS, OLLP3-1080743, OLLP-3PLUS, OLLP4-1081258, OLLP-4PLUS		



1			
GEV No.	550682	Ref. No.	11216
description	hexagonal screw thread M8 thread L 20mm SS WS 13 Qty 1 pcs DIN 933 / ISO 4017		
For models:	OLHT11-1081071, OLHT11D-1081072, OLHT11ECO-1081070, OLHT11S, OLHT11S-Neutra		



1			
GEV No.	560522	Ref. No.	15159
description	hexagonal screw thread M12x1.75 thread L 15mm plastic WS 19 Qty 1 pcs head thickness 10mm		
For models:	OLDerby, OLDS35, OLDS35-1081005, OLDS35-1081061, OLDS35D-1081062, OLDS35-Neutra, OLDS37, OLDS37-1081006, OLDS37-1081063, OLDS37D-1081007, OLDS37D-1081064, OLDS37LS-1081008, OLDS37LSD-1081009, OLDS37-Neutra, OLDS40, OLDS40-1081010, OLDS40-1081065, OLDS40D-1081011, OLDS40D-1081066, OLDS40E-1081067, OLDS40ED-1081068, OLDS40LS-1081012, OLDS40LSD-1081013, OLDS40-Neutra, OLDS50P-1081018, OLDS50PD-1081019, OLElectron400, OLG35, OLG35-1080702, OLG35D-1081000, OLG35-Neutra, OLG600, OLGastro500Plus, OLG37, OLG37-1080700, OLG37D-1080707, OLG37LS-1081001, OLG37LSD-1081002, OLG37-Neutra, OLG540, OLG540, OLG540-1080701, OLG540D-1080708, OLG540D-1081003, OLG540-Neutra, OLG545, OLG545LSD-1081004, OLG585-Neutra, OLHT11-1081071, OLHT11D-1081072...(Other models you can see in the webshop)		



1			
GEV No.	560594	Ref. No.	R61020562
description	hexagonal screw thread M6 thread L 20mm WS 10 total length 59mm		
For models:	CCE101M, CCE102M, CCG101M, CCG102M, CKEP10, CKEP10B, CKEP20, CKEP20B, CKEP21, CKEP21B, CKEP40, CKEP40B, CKET10, CKET10B, CKET20, CKET20B, CKET21, CKET21B, CKET40, CKET40B, CKGP10, CKGP10B, CKGP20, CKGP20B, CKGP21, CKGP21B, CKGP40, CKGP40B, CKGT10B, CKGT20, CKGT20B, CKGT21, CKGT21B, CKGT40, CKGT40B		

cylinder head bolts

DIN 912/ISO 4762



1			
GEV No.	520455	Ref. No.	R61030601
description	screw thread M8 thread L 20mm WS 6 SS Qty 1 pcs DIN 912/ISO 4762		
For models:	CKEP21, CKEP21B, CKEP40, CKEP40B, CKET21, CKET21B, CKET40, CKET40B, CKGP21, CKGP21B, CKGP40, CKGP40B, CKGT21, CKGT21B, CKGT40, CKGT40B		

side bolts



1			
GEV No.	560289	Ref. No.	11168
description	side bolts thread M6 L 12mm SS Qty 1 pcs intake Phillips head ø 12.6mm		
For models:	OLDS45, OLDS50, OLDS50-1081088, OLDS50D-1081089, OLDS50E-1081090, OLDS50ED-1081091, OLDS50-Neutra		

grub screws

DIN 913/ISO 4026



1			
GEV No.	560024	Ref. No.	R61090052
description	grub screw thread M6 L 16mm SS DIN 913/ISO 4026 intake internal hexagon WS 3 Qty 20 pcs		
For models:	CKEP21, CKEP21B, CKEP40, CKEP40B, CKET21, CKET21B, CKET40, CKET40B, CKGP21, CKGP21B, CKGP40, CKGP40B, CKGT21, CKGT21B, CKGT40, CKGT40B		



DIN 914/ISO 4027





1			
GEV No.	560457	Ref. No.	11170
description	grub screw thread M5 L 25mm stainless steel DIN 914/ISO 4027 intake hexagonal WS 2.5 Qty 1 pcs		
For models:	OLDerby, OLDS35-1081005, OLDS37-1081006, OLDS37D-1081007, OLDS37LS-1081008, OLDS37LSD-1081009, OLDS40-1081010, OLDS40D-1081011, OLDS40LS-1081012, OLDS40LSD-1081013, OLLinear, OLStar		





DIN 916/ISO 4029			
 <p>1</p>			
GEV No.	560173	Ref. No.	6A009190 BN6A009190
description	grub screw thread M4 L 10mm SS DIN 916/ISO 4029 intake internal hexagon WS 2 Qty 20 pcs		
For models:	72-02FRG-12700500, 72-02FRG17-12700505, 72-02FTG-12700130TA, 72-02FTGC-12700135TA, 72-02FTGR-12700132TA, 72-02TFTG-12730130TA, 72-02TFTGC-12730135TA, 72-02TFTGR-12730132TA, 73-02FRG-12700550, 74-02CGG-12700010, 74-02CGG-12700010TA, 74-02CTGG-12700180, 74-02CTGG-12700180TA, 74-02FRG-12700600, 74-02FRG17-12700605, 74-02FTG-12700140TA, 74-02FTG1-2R-12700141TA, 74-02FTGC-12700145TA, 74-02FTGR-12700142TA, 74-02TFTG-12730140TA, 74-02TFTG1-2R-12730141TA, 74-02TFTGC-12730145TA, 74-02TFTGR-12730142TA, 76-02CGFL-12700020, 76-02CGFL-12700020TA, 76-02CGG-12700015, 76-02CGG-12700015TA, 76-02CGGE-12700016, 76-02CGGE-12700016TA, 76-02CTGG-12700195, 76-02CTGG-12700195TA, 76-02CTGGE-12700196, 76-02CTGGE-12700196TA, 7FT-G400, 7FT-G410, 7FT-G800, 7FT-G810, 7FT-G820, 7FTT-G800, 7FTT-G805, 7FTT-G820, 7FTT-G825, 7FTT-GE800, 7FTT-GE805, 7FTT-GE820, 7FTT-GE825, 7FTT-G400, 7FTT-G405, 7FTT-G410, 7FTT-G415...(Other models you can see in the webshop)		

knurled screws							
 <p>1</p>							
GEV No.	524804	Ref. No.	10652				
description	Thumb screw thread M5 thread L 7mm ø 30mm H 5mm SS Qty 1 pcs						
For models:	OLDS40, OLDS40-1081065, OLDS40D-1081066, OLDS40E-1081067, OLDS40ED-1081068, OLDS40-Neutra, OLDS50, OLDS50-1081088, OLDS50D-1081089, OLDS50E-1081090, OLDS50ED-1081091, OLDS50-Neutra, OLDW020H, OLElectron1000, OLElectron400, OLElectron500, OLELELECTRON1000-1081084, OLELELECTRON1000D-1081085, OLG50, OLG550-1080705, OLG550D-1080706, OLG550E-1080730, OLG550ECO-1081014, OLG550ECOD-1081015, OLG550ED-1080731, OLG550-Neutra, OLH600, OLH600Electronic, OLHT11-1081071, OLHT11D-1081072, OLHT11ECO-1081070, OLHT11S, OLHT11S-Neutra, OLHT12-1081075, OLHT12EL-1081080, OLHT12EL-1081083, OLHT12ELD-1081081, OLHT12ELPLUS-1081086, OLHT12S, OLHT12SElectronic, OLHT12S-Neutra, OLLP1-1081059, OLLP1-800, OLLP1-800-1080721, OLLP1-800EL, OLLP1-800-Neutra, OLLP155-1081087, OLLP1-S8, OLLP1-S8EL, OLLP2-1080722...(Other models you can see in the webshop)						
accessories for	524804						
	 <table border="1"> <tr> <td>GEV No.</td> <td>505277</td> <td>Ref. No.</td> <td>10651</td> </tr> </table>	GEV No.	505277	Ref. No.	10651	rinse arm shaft warewashing ø 14mm H 38mm thread 1/4"	
GEV No.	505277	Ref. No.	10651				

 <p>1</p>			
GEV No.	517075	Ref. No.	11101/B
description	Thumb screw thread M8 SS ø 30mm H 3mm thread L 8mm		
For models:	OLHT-11-Neutra, OLLP1-800, OLLP1-800-1080721, OLLP1-800EL, OLLP1-800-Neutra, OLLP-ZERO, OLLPZERO-1081057		

 <p>1</p>			
GEV No.	517066	Ref. No.	11101/A
description	Thumb screw thread M8 thread L 8mm ø 30mm H 3mm SS mounting pos. upper		
For models:	OLDS40-1081010, OLDS40D-1081011, OLDS40LS-1081012, OLDS40LSD-1081013, OLGastro450, OLG540, OLLinear		

 <p>1</p>			
GEV No.	517039	Ref. No.	11101/I
description	Thumb screw thread M8x1.25 thread L 8mm ø 30mm H 3mm SS mounting pos. lower		
For models:	OLDS45, OLDS50, OLDS50-1081088, OLDS50D-1081089, OLDS50E-1081090, OLDS50ED-1081091, OLDS50-Neutra, OLDS50P-1081018, OLDS50PD-1081019, OLG600, OLGastro450, OLGastro500Plus, OLGastro500S, OLGastro750Plus, OLGastro750S, OLG540, OLG545, OLG550, OLG550-1080705, OLG550D-1080706, OLG550E-1080730, OLG550ECO-1081014, OLG550ECOD-1081015, OLG550ED-1080731, OLG550-Neutra, OLG585, OLG585-1081016, OLG585D-1081017, OLG585-Neutra, OLHT11-1081071, OLHT11D-1081072, OLHT11ECO-1081070, OLHT11S		

miscellaneous			
 <p>1</p>			
GEV No.	690594	Ref. No.	R58002560
description	pressure screw for door hinge		
For models:	CKEP21, CKEP21B, CKEP40, CKEP40B, CKET21, CKET21B, CKET40, CKET40B, CKGP21, CKGP21B, CKGP40, CKGP40B, CKGT21, CKGT21B, CKGT40, CKGT40B		

 <p>1</p>			
GEV No.	694991	Ref. No.	R58006400
description	screw thread M6 L 16mm for air baffle combi-steamer		
For models:	CCE042M, CCE051M, CCE071M, CCE101M, CCE102M, CCG051M, CCG071M, CCG101M, CCG102M		

nuts			
 <p>1</p>			
GEV No.	540438	Ref. No.	1868700
description	long nut thread M10 L 25mm WS 13 brass Qty 1 pcs		
For models:	CPE60, CPE60DB, OCPE60, OCPE-60-12601900, OCPE-60-12601900MN		

hexagonal nuts

DIN 934 / ISO 4032/8673



1

GEV No.	560340	Ref. No.	11703
description	hexagonal nut thread M4 H 3.2mm WS 7 SS DIN/ISO DIN 934 / ISO 4032/8673 Qty 1 pcs		
For models:	OLDS35, OLDS35-1081061, OLDS35D-1081062, OLDS35-Neutra, OLDS37, OLDS37-1081063, OLDS37D-1081064, OLDS37-Neutra, OLDS40, OLDS40-1081065, OLDS40D-1081066, OLDS40E-1081067, OLDS40ED-1081068, OLDS40-Neutra, OLDS45, OLDS50, OLDS50-1081088, OLDS50D-1081089, OLDS50E-1081090, OLDS50ED-1081091, OLDS50-Neutra, OLG35, OLG35-1080702, OLG35D-1081000, OLG35-Neutra, OLG537, OLG537-1080700, OLG537D-1080707, OLG537LS-1081001, OLG537LSD-1081002, OLG537-Neutra, OLG540, OLG540-1080701, OLG540D-1080708, OLG540D-1081003, OLG540-Neutra, OLG540LSD-1081004		



1

GEV No.	560197	Ref. No.	11719
description	nut thread M10 H 8mm WS 17 SS DIN/ISO DIN 934 / ISO 4032/8673 Qty 1 pcs		
For models:	OLAX151, OLAX151EDX-1080725, OLAX151ELEFT-1080727, OLAX151-highspeed, OLAX160, OLAX160E-1080750, OLAX160E-1080751, OLAX160V-1080755, OLAX160V-1080756, OLAX160V-1081031, OLAX160V-1081032, OLAX210, OLAX210E-1081029, OLAX210E-1081030, OLAX220, OLAX220E-1080787, OLAX220E-1080788, OLAX220V-1080789, OLAX220V-1080790, OLAX230, OLAX230E-1080791, OLAX230E-1080792, OLAX230V-1080793, OLAX230V-1080794, OLAX240, OLAX240E-1080795, OLAX240E-1080796, OLAX240V-1080797, OLAX240V-1080798, OLAX250, OLAX250E-1080760, OLAX250E-1080761, OLAX250V-1080765, OLAX250V-1080766, OLAX300, OLAX300E-1080770, OLAX300E-1080771, OLAX300E-1081033, OLAX300E-1081035, OLAX300E-1081036, OLAX300LC, OLAX300LCE-1081034, OLAX300V-1080775, OLAX300V-1080776, OLAX310, OLAX310E-1081110, OLAX310E-1081111, OLAX310LC, OLAX310LCE-1081114, OLAX310LCE-1081115...(Other models you can see in the webshop)		



1

GEV No.	517174	Ref. No.	11702
description	nut thread M8 H 6.5mm WS 13 SS DIN/ISO DIN 934 / ISO 4032/8673 Qty 1 pcs		
For models:	G125, OLAX151, OLAX151EDX-1080725, OLAX151ELEFT-1080727, OLAX151-highspeed, OLAX160, OLAX160E-1080750, OLAX160E-1080751, OLAX160V-1080755, OLAX160V-1080756, OLAX160V-1081031, OLAX160V-1081032, OLAX210, OLAX210E-1081029, OLAX210E-1081030, OLAX220, OLAX220E-1080787, OLAX220E-1080788, OLAX220V-1080789, OLAX220V-1080790, OLAX230, OLAX230E-1080791, OLAX230E-1080792, OLAX230V-1080793, OLAX230V-1080794, OLAX240, OLAX240E-1080795, OLAX240E-1080796, OLAX240V-1080797, OLAX240V-1080798, OLAX250, OLAX250E-1080760, OLAX250E-1080761, OLAX250V-1080765, OLAX250V-1080766, OLAX300, OLAX300E-1080770, OLAX300E-1080771, OLAX300E-1081033, OLAX300E-1081035, OLAX300E-1081036, OLAX300LC, OLAX300LCE-1081034, OLAX300V-1080775, OLAX300V-1080776, OLAX310, OLAX310E-1081110, OLAX310E-1081111, OLAX310LC, OLAX310LCE-1081114...(Other models you can see in the webshop)		

ISO 4033 / UNI5587



1

GEV No.	550866	Ref. No.	R58004020
description	nut thread M10x1.5 H 10mm SS WS 17 Qty 1 pcs DIN/ISO DIN 934 / ISO 4032/8673 left-hand thread		
For models:	CCE071M, CCG071M		

hexagonal nuts metric (without norm)



1

GEV No.	540436	Ref. No.	1033514900
description	hexagonal nut thread M10x1.25 H 4mm WS 13 brass Qty 1 pcs		
For models:	CFGE61, CFGE61D, CFGE61L, CFGE61P, CPE60, CPE60DB, OCFGE61, OCFPE60, OCFPE-60-12601900, OCFPE-60-12601900MN, OPCG41, OPCG61		



1

GEV No.	560519	Ref. No.	10200205
description	nut thread M12x1 H 5mm WS 17 SS Qty 1 pcs		
For models:	OLDerby, OLDS35, OLDS35-1081005, OLDS35-1081061, OLDS35D-1081062, OLDS35-Neutra, OLDS37, OLDS37-1081006, OLDS37-1081063, OLDS37D-1081007, OLDS37D-1081064, OLDS37LS-1081008, OLDS37LSD-1081009, OLDS37-Neutra, OLDS40, OLDS40-1081010, OLDS40-1081065, OLDS40D-1081011, OLDS40D-1081066, OLDS40E-1081067, OLDS40ED-1081068, OLDS40LS-1081012, OLDS40LSD-1081013, OLDS40-Neutra, OLDS50P-1081018, OLDS50PD-1081019, OLElectron400, OLG35, OLG35-1080702, OLG35D-1081000, OLG35-Neutra, OLG600, OLGastro500Plus, OLG537, OLG537-1080700, OLG537D-1080707, OLG537LS-1081001, OLG537LSD-1081002, OLG537-Neutra, OLG540, OLG540, OLG540-1080701, OLG540D-1080708, OLG540D-1081003, OLG540-Neutra, OLG545, OLG545LSD-1081004, OLG585-Neutra, OLHT11-1081071, OLHT11D-1081072...(Other models you can see in the webshop)		





1

GEV No.	550681	Ref. No.	R58004050
description	nut thread M12x1.25 H 5mm WS 17 brass Qty 1 pcs		
For models:	CCE071M, CCE101M, CCE102M, CCG071M, CCG101M, CCG102M, CKEP06, CKEP06B, CKEP10, CKEP10B, CKEP20, CKEP20B, CKEP21, CKEP21B, CKEP40, CKEP40B, CKET06, CKET06B, CKET10, CKET10B, CKET20, CKET20B, CKET21, CKET21B, CKET40, CKET40B, CKGP06, CKGP06B, CKGP10, CKGP10B, CKGP20, CKGP20B, CKGP21, CKGP21B, CKGP40, CKGP40B, CKGT06, CKGT06B, CKGT10, CKGT10B, CKGT20B, CKGT21, CKGT21B, CKGT40, CKGT40B		





			
1			
GEV No.	102382	Ref. No.	1033700200
description	nut thread M14x1 H 3.5mm WS 18 brass Qty 1 pcs		
For models:	FQG41, FQG61, OFQG41, OFQG-41-12600500, OFQG61, OFQG-61-12600600, OFTG40B, OFTG-40B-12600130, OFTG40BLC, OFTG-40BLC-12600135, OFTG40BR, OFTG-40BR-12600132, OFTG60B, OFTG-60B-12600140, OFTG60BLC, OFTG-60BLC-12600145, OFTG-60BR, OFTG-60BR-12600141, OFTG60BRR, OFTG-60BRR-12600142, OFTG80BLC, OFTG-80BLC-12600138		

			
1			
GEV No.	521133	Ref. No.	1325313
description	nut thread M14x1.5 H 6mm WS 19 zinc-coated steel Qty 1 pcs		
For models:	CFG101, CFG120, CFG70, OCFG101, OCFG-101-12600025, OCFG120, OCFG70, OCFG-70-12600000, OPCG-41-12600010		

			
1			
GEV No.	101345	Ref. No.	6A010820 BN6A010820
description	nut thread M15x1 H 3mm WS 19 brass Qty 1 pcs		
For models:	110-135CG, 110-135CG2P, 110-135CGE, 110-135CGE2P, 110-135CGEE, 110-135CGEE2P, 110-135CGEEP, 110-135CGEP, 110-135CGG, 110-135CGG2P, 110-135CGGE, 110-135CGGE2P, 110-135CGGEP, 110-135CGGP, 110-135CGP, 110-135TCG, 110-135TCG2P, 110-135TCGP, 110-45CBG, 110-45CG, 110-45CG1P, 110-45CGP, 110-45TCBG, 110-45TCG, 110-45TCG1P, 110-45TCGP, 110-90CG, 110-90CG1P, 110-90CGE, 110-90CGE1P, 110-90CGEP, 110-90CGG, 110-90CGG1P, 110-90CGGP, 110-90CGP, 110-90CTG, 110-90CTGE, 110-90CTGG, 110-90FTTG, 110-90FTTG1-2R, 110-90FTTGC, 110-90FTTGC1-2R, 110-90FTTGC1R, 110-90FTTGE, 110-90FTTGG, 110-90FTTGR, 110-90TCG, 110-90TCG1P, 110-90TCGP, 110-90CTG... (Other models you can see in the webshop)		

			
1			
GEV No.	691289	Ref. No.	R58004830
description	nut thread M18x1 H 5mm WS 22 brass Qty 1 pcs for door handle		
For models:	CCE042M, CCE051M, CCE071M, CCE101M, CCE102M, CCG051M, CCG071M, CCG101M, CCG102M		

			
1			
GEV No.	102067	Ref. No.	939300
description	nut thread M8x1 H 3mm brass Qty 1 pcs type SEF 1		
For models:	CFG101, CFG120, CFG70, OCFG101, OCFG-101-12600025, OCFG120, OCFG70, OCFG-70-12600000, OPCG-41-12600010		

<p>hexagonal nuts inch thread</p> 			
1			
GEV No.	517180	Ref. No.	11701/A
description	nut thread 1" H 5mm WS 36 SS Qty 1 pcs		
For models:	OLAX250, OLAX250E-1080760, OLAX250E-1080761, OLAX250V-1080765, OLAX250V-1080766, OLAX300V-1080776, OLAX380, OLAX380E-1080780, OLAX380E-1080781, OLAX380E-1081037, OLAX380E-1081038, OLAX380E-1081039, OLAX380E-1081040, OLAX380E-1081043, OLAX380E-1081044, OLAX380E-1081046, OLAX380E-1081047, OLAX380E-1081048, OLAX380E-1081051, OLAX380E-1081052, OLAX380E-1081053, OLAX380E-1081054, OLAX380E-1081055, OLAX380E-1081056, OLAX380LC, OLAX380V-1080785, OLAX380V-1080786, OLAX400, OLAX400E-1081126, OLAX400E-1081127, OLAX400V-1081128, OLAX400V-1081129, OLAX440, OLAX440E-1081041, OLAX440E-1081042, OLAX440LC, OLAX440LCE-1081045, OLAX510, OLAX510E-1081130, OLAX510E-1081131, OLAX510LC, OLAX510LCE-1081134, OLAX510LCE-1081135, OLAX510LCV-1081136, OLAX510LCV-1081137, OLAX510V-1081132, OLAX510V-1081133, OLAX540, OLAX540E-1081049, OLAX540E-1081050... (Other models you can see in the webshop)		

			
1			
GEV No.	520499	Ref. No.	15042/A
description	nut thread 1 1/4" H 6mm WS 50 brass Qty 1 pcs		
For models:	G12S, OLG600, OLHT-11-Neutra, OLLP1-800-Neutra, OLLP-ZERO, OLLPZERO-1081057		

			
1			
GEV No.	514022	Ref. No.	14044599
description	nut thread 1 1/2" H 12mm SS WS 59 Qty 1 pcs		
For models:	CPE60, CPE60DB, OCPE60, OCPE-60-12601900, OCPE-60-12601900MN		

			
1			
GEV No.	507528	Ref. No.	2200103
description	nut thread 3/4" H 8mm WS 32 brass Qty 1 pcs		
For models:	OLAX151, OLAX151EDX-1080725, OLAX151LEFT-1080727, OLAX151-highspeed, OLAX160, OLAX160E-1080750, OLAX160E-1080751, OLAX160V-1080755, OLAX160V-1080756, OLAX160V-1081031, OLAX160V-1081032, OLAX210, OLAX210E-1081029, OLAX210E-1081030, OLAX220, OLAX220E-1080787, OLAX220E-1080788, OLAX220V-1080789, OLAX220V-1080790, OLAX230, OLAX230E-1080791, OLAX230E-1080792, OLAX230V-1080793, OLAX230V-1080794, OLAX240, OLAX240E-1080795, OLAX240E-1080796, OLAX240V-1080797, OLAX240V-1080798, OLAX250, OLAX250E-1080760, OLAX250E-1080761, OLAX250V-1080765, OLAX250V-1080766, OLAX300, OLAX300E-1080770, OLAX300E-1080771, OLAX300E-1081033, OLAX300E-1081035, OLAX300E-1081036, OLAX300LC, OLAX300LCE-1081034, OLAX300V-1080775, OLAX300V-1080776, OLAX310, OLAX310E-1081110, OLAX310E-1081111, OLAX310LC, OLAX310LCE-1081114, OLAX310LCE-1081115... (Other models you can see in the webshop)		

washers

spring rings



1

GEV No.	560122	Ref. No.	11608
description	lock washer ID ø 5.2mm ED ø 9mm SS DIN127 Qty 20 pcs for thread M5		
For models:	OLG35, OLG35D-1081000, OLG35-Neutra		



1

GEV No.	560208	Ref. No.	11609
description	lock washer ID ø 8.3mm ED ø 15mm SS Qty 1 pcs		
For models:	OLAX151, OLAX151EDX-1080725, OLAX151ELEFT-1080727, OLAX151-highspeed, OLAX160, OLAX160E-1080750, OLAX160E-1080751, OLAX160V-1080755, OLAX160V-1080756, OLAX160V-1081031, OLAX160V-1081032, OLAX210, OLAX210E-1081029, OLAX210E-1081030, OLAX220, OLAX220E-1080787, OLAX220E-1080788, OLAX220V-1080789, OLAX220V-1080790, OLAX230, OLAX230E-1080791, OLAX230E-1080792, OLAX230V-1080793, OLAX230V-1080794, OLAX240, OLAX240E-1080795, OLAX240E-1080796, OLAX240V-1080797, OLAX240V-1080798, OLAX250, OLAX250E-1080760, OLAX250E-1080761, OLAX250V-1080765, OLAX250V-1080766, OLAX300, OLAX300E-1080770, OLAX300E-1080771, OLAX300E-1081033, OLAX300E-1081035, OLAX300E-1081036, OLAX300LC, OLAX300LCE-1081034, OLAX300V-1080775, OLAX300V-1080776, OLAX310, OLAX310E-1081110, OLAX310E-1081111, OLAX310LC, OLAX310LCE-1081114, OLAX310LCE-1081115...(Other models you can see in the webshop)		

spring washers



1

GEV No.	697933	Ref. No.	R61420021
description	spring washer ID ø 13mm ED ø 24mm Qty 1 pcs		
For models:	CKEP21, CKEP21B, CKEP40, CKEP40B, CKET21, CKET21B, CKET40, CKET40B, CKGP21, CKGP21B, CKGP40, CKGP40B, CKGT21, CKGT21B, CKGT40, CKGT40B		



1

GEV No.	696397	Ref. No.	R61620091
description	spring washer ID ø 6.3mm ED ø 14mm Qty 1 pcs		
For models:	CKEP21, CKEP21B, CKEP40, CKEP40B, CKET21, CKET21B, CKET40, CKET40B, CKGP21, CKGP21B, CKGP40, CKGP40B, CKGT21, CKGT21B, CKGT40, CKGT40B		

washers

DIN 125A



1

GEV No.	540437	Ref. No.	15800699
description	plain washer ED ø 20mm for thread M10		
For models:	CPE60, CPE60DB, OCPE60, OCPE-60-12601900, OCPE-60-12601900MN		

miscellaneous



1

GEV No.	691296	Ref. No.	R61400052
description	plain washer ID ø 10.5mm ED ø 21mm thickness 2mm SS Qty 1 pcs for fan wheel		
For models:	CCE071M, CCG071M, CKEP06, CKEP06B, CKET06, CKET06B, CKGP06, CKGP06B, CKGT06, CKGT06B		



1

GEV No.	691292	Ref. No.	R10401710
description	plain washer ID ø 12mm ED ø 17.5mm thickness 1mm SS Qty 1 pcs		
For models:	CCE071M, CCE101M, CCE102M, CCG071M, CCG101M, CCG102M, CKEP06, CKEP06B, CKEP10, CKEP10B, CKEP20, CKEP20B, CKET06, CKET06B, CKET10, CKET10B, CKET20, CKET20B, CKGP06, CKGP06B, CKGP10, CKGP10B, CKGP20, CKGP20B, CKGT06, CKGT06B, CKGT10, CKGT10B, CKGT20B		



1

GEV No.	690593	Ref. No.	R58002570
description	plain washer ID ø 15mm ED ø 30mm thickness 3mm Qty 1 pcs for door hinge		
For models:	CKEP21, CKEP21B, CKEP40, CKEP40B, CKET21, CKET21B, CKET40, CKET40B, CKGP21, CKGP21B, CKGP40, CKGP40B, CKGT21, CKGT21B, CKGT40, CKGT40B		



 <p>1</p>			
GEV No.	506160	Ref. No.	11185 11611
description	plain washer ID ø 8.6mm ED ø 16mm thickness 1.5mm SS Qty 1 pcs		
For models:	OLAX151, OLAX151EDX-1080725, OLAX151ELEFT-1080727, OLAX151-highspeed, OLAX160, OLAX160E-1080750, OLAX160E-1080751, OLAX160V-1080755, OLAX160V-1080756, OLAX160V-1081031, OLAX160V-1081032, OLAX210, OLAX210E-1081029, OLAX210E-1081030, OLAX220, OLAX220E-1080787, OLAX220E-1080788, OLAX220V-1080789, OLAX220V-1080790, OLAX230, OLAX230E-1080791, OLAX230E-1080792, OLAX230V-1080793, OLAX230V-1080794, OLAX240, OLAX240E-1080795, OLAX240E-1080796, OLAX240V-1080797, OLAX240V-1080798, OLAX250, OLAX250E-1080760, OLAX250E-1080761, OLAX250V-1080765, OLAX250V-1080766, OLAX300, OLAX300E-1080770, OLAX300E-1080771, OLAX300E-1081033, OLAX300E-1081035, OLAX300E-1081036, OLAX300LC, OLAX300LCE-1081034, OLAX300V-1080775, OLAX300V-1080776, OLAX310, OLAX310E-1081110, OLAX310E-1081111, OLAX310LC, OLAX310LCE-1081114, OLAX310LCE-1081115...(Other models you can see in the webshop)		

 <p>2</p>			
GEV No.	551434	Ref. No.	R58004010
description	plain washer ø 30mm thickness 3mm hole ø 12.5mm for fan wheel combi-steamer		
For models:	CCE101M, CCE102M, CCG101M, CCG102M, CKEP10, CKEP10B, CKEP20, CKEP20B, CKEP21, CKEP21B, CKEP40, CKEP40B, CKET10, CKET10B, CKET20, CKET20B, CKET21, CKET21B, CKET40, CKET40B, CKGP10, CKGP10B, CKGP20, CKGP20B, CKGP21, CKGP21B, CKGP40, CKGP40B, CKGT10B, CKGT20, CKGT20B, CKGT21, CKGT21B, CKGT40, CKGT40B		

tooth lock washers

DIN 6798A

 <p>1</p>			
GEV No.	560193	Ref. No.	15812699
description	tooth lock washer ID ø 10.4mm ED ø 18mm zinc-coated steel DIN/ISO DIN 6798A Qty 1 pcs for thread M10		
For models:	CPE60, CPE60DB, OCPE60, OCPE-60-12601900, OCPE-60-12601900MN		

fasteners

slot nuts

 <p>1</p>			
GEV No.	560285	Ref. No.	2001046
description	slot nut W 8mm H 7mm L 30mm		
For models:	OLAX151, OLAX151EDX-1080725, OLAX151ELEFT-1080727, OLAX151-highspeed, OLAX160, OLAX160E-1080750, OLAX160E-1080751, OLAX160V-1080755, OLAX160V-1080756, OLAX160V-1081031, OLAX160V-1081032, OLAX210, OLAX210E-1081029, OLAX210E-1081030, OLAX220, OLAX220E-1080787, OLAX220E-1080788, OLAX220V-1080789, OLAX220V-1080790, OLAX230, OLAX230E-1080791, OLAX230E-1080792, OLAX230V-1080793, OLAX230V-1080794, OLAX240, OLAX240E-1080795, OLAX240E-1080796, OLAX240V-1080797, OLAX240V-1080798, OLAX250, OLAX250E-1080760, OLAX250E-1080761, OLAX250V-1080765, OLAX250V-1080766, OLAX300, OLAX300E-1080770, OLAX300E-1080771, OLAX300E-1081033, OLAX300E-1081035, OLAX300E-1081036, OLAX300LC, OLAX300LCE-1081034, OLAX300V-1080775, OLAX300V-1080776, OLAX310, OLAX310E-1081110, OLAX310E-1081111, OLAX310LC, OLAX310LCE-1081114, OLAX310LCE-1081115...(Other models you can see in the webshop)		

clamps

hose clamps

DIN 3017 - W2

 <p>1</p>			
GEV No.	520112	Ref. No.	11807 R61630011
description	hose clamp ø 12-20mm width 9mm Qty 10 pcs DIN 3017		
For models:	CKEP06, CKEP06B, CKEP10, CKEP10B, CKEP20, CKEP20B, CKEP21, CKEP21B, CKEP40, CKEP40B, CKET06, CKET06B, CKET10, CKET10B, CKET20, CKET20B, CKET21, CKET21B, CKET40, CKET40B, CKGP06, CKGP06B, CKGP10, CKGP10B, CKGP20, CKGP20B, CKGP21, CKGP21B, CKGP40, CKGP40B, CKGT06, CKGT06B, CKGT10, CKGT10B, CKGT20, CKGT20B, CKGT21, CKGT21B, CKGT40, CKGT40B, G12S, OLAX151, OLAX151EDX-1080725, OLAX151ELEFT-1080727, OLAX151-high-speed, OLAX160, OLAX160E-1080750, OLAX160E-1080751, OLAX160V-1080755, OLAX160V-1080756...(Other models you can see in the webshop)		



1

GEV No.	520115	Ref. No.	11806
description	hose clamp ø 25-40mm width 9mm Qty 10 pcs DIN 3017		
For models:	OLAX151, OLAX151EDX-1080725, OLAX151ELEFT-1080727, OLAX151-highspeed, OLAX160, OLAX160E-1080750, OLAX160E-1080751, OLAX160V-1080755, OLAX160V-1080756, OLAX160V-1081031, OLAX160V-1081032, OLAX210, OLAX210E-1081029, OLAX210E-1081030, OLAX220, OLAX220E-1080787, OLAX220E-1080788, OLAX220V-1080789, OLAX220V-1080790, OLAX230, OLAX230E-1080791, OLAX230E-1080792, OLAX230V-1080793, OLAX230V-1080794, OLAX240, OLAX240E-1080795, OLAX240E-1080796, OLAX240V-1080797, OLAX240V-1080798, OLAX250, OLAX250E-1080760, OLAX250E-1080761, OLAX250V-1080765, OLAX250V-1080766, OLAX300, OLAX300E-1080770, OLAX300E-1080771, OLAX300E-1081033, OLAX300E-1081035, OLAX300E-1081036, OLAX300LC, OLAX300LCE-1081034, OLAX300V-1080775, OLAX300V-1080776, OLAX310, OLAX310E-1081110, OLAX310E-1081111, OLAX310LC, OLAX310LCE-1081114, OLAX310LCE-1081115...(Other models you can see in the webshop)		

consumables

sealants and adhesives

screw fixings



1

GEV No.	890137	Ref. No.	Loctite 243
description	screw fixing LOCTITE 243 medium-strength bottle 5ml		
description	<p>LOCTITE® 243™ - bottle 5ml</p> <p>Is a general purpose threadlocker of medium bond strength. This threadlocker secures and seal bolts, nuts and studs to prevent loosening due to vibration. The product works on all metals, including passive substrates such as stainless steel, aluminium and plated surfaces. It is proven to be tolerant of minor contamination due to industrial oils, e.g. engine oils, corrosion prevention oils and cutting fluids.</p>		
For models:	OLAX151, OLAX151EDX-1080725, OLAX151ELEFT-1080727, OLAX151-highspeed, OLAX160, OLAX160E-1080750, OLAX160E-1080751, OLAX160V-1080755, OLAX160V-1080756, OLAX160V-1081031, OLAX160V-1081032, OLAX210, OLAX210E-1081029, OLAX210E-1081030, OLAX220, OLAX220E-1080787, OLAX220E-1080788, OLAX220V-1080789, OLAX220V-1080790, OLAX230, OLAX230E-1080791, OLAX230E-1080792, OLAX230V-1080793, OLAX230V-1080794, OLAX240, OLAX240E-1080795, OLAX240E-1080796, OLAX240V-1080797, OLAX240V-1080798, OLAX250, OLAX250E-1080760, OLAX250E-1080761, OLAX250V-1080765, OLAX250V-1080766, OLAX300, OLAX300E-1080770, OLAX300E-1080771, OLAX300E-1081033, OLAX300E-1081035, OLAX300E-1081036, OLAX300LC, OLAX300LCE-1081034, OLAX300V-1080775, OLAX300V-1080776, OLAX310, OLAX310E-1081110, OLAX310E-1081111, OLAX310LC, OLAX310LCE-1081114, OLAX310LCE-1081115...(Other models you can see in the webshop)		

thread sealants



1

GEV No.	890135	Ref. No.	Loctite 511
description	thread sealing LOCTITE 511 tube 50ml approval DVGW		
description	<p>LOCTITE® 511™ - tube 50ml</p> <p>It is designed for the locking and sealing of metal threaded pipes and fittings. The product cures rapidly when confined in the absence of air between close fitting metal surfaces.</p>		
For models:	OLAX151, OLAX151EDX-1080725, OLAX151ELEFT-1080727, OLAX151-highspeed, OLAX160, OLAX160E-1080750, OLAX160E-1080751, OLAX160V-1080755, OLAX160V-1080756, OLAX160V-1081031, OLAX160V-1081032, OLAX210, OLAX210E-1081029, OLAX210E-1081030, OLAX220, OLAX220E-1080787, OLAX220E-1080788, OLAX220V-1080789, OLAX220V-1080790, OLAX230, OLAX230E-1080791, OLAX230E-1080792, OLAX230V-1080793, OLAX230V-1080794, OLAX240, OLAX240E-1080795, OLAX240E-1080796, OLAX240V-1080797, OLAX240V-1080798, OLAX250, OLAX250E-1080760, OLAX250E-1080761, OLAX250V-1080765, OLAX250V-1080766, OLAX300, OLAX300E-1080770, OLAX300E-1080771, OLAX300E-1081033, OLAX300E-1081035, OLAX300E-1081036, OLAX300LC, OLAX300LCE-1081034, OLAX300V-1080775, OLAX300V-1080776, OLAX310, OLAX310E-1081110, OLAX310E-1081111, OLAX310LC, OLAX310LCE-1081114, OLAX310LCE-1081115...(Other models you can see in the webshop)		



1

GEV No.	890128	Ref. No.	Loctite 542
description	thread sealing LOCTITE 542 medium-strength bottle 50ml approval DVGW		
description	<p>LOCTITE® 542™ - bottle 50ml</p> <p>It is designed for the locking and sealing of metal pipes and fittings as well as other cylindrical metal assemblies. The product cures when confined in the absence of air between close-fitting metal surfaces and prevents loosening and leakage due to shock and vibration. The thixotropic nature of LOCTITE 542 reduces the migration of liquid product after application to the part.</p>		
For models:	OLAX151, OLAX151EDX-1080725, OLAX151ELEFT-1080727, OLAX151-highspeed, OLAX160, OLAX160E-1080750, OLAX160E-1080751, OLAX160V-1080755, OLAX160V-1080756, OLAX160V-1081031, OLAX160V-1081032, OLAX210, OLAX210E-1081029, OLAX210E-1081030, OLAX220, OLAX220E-1080787, OLAX220E-1080788, OLAX220V-1080789, OLAX220V-1080790, OLAX230, OLAX230E-1080791, OLAX230E-1080792, OLAX230V-1080793, OLAX230V-1080794, OLAX240, OLAX240E-1080795, OLAX240E-1080796, OLAX240V-1080797, OLAX240V-1080798, OLAX250, OLAX250E-1080760, OLAX250E-1080761, OLAX250V-1080765, OLAX250V-1080766, OLAX300, OLAX300E-1080770, OLAX300E-1080771, OLAX300E-1081033, OLAX300E-1081035, OLAX300E-1081036, OLAX300LC, OLAX300LCE-1081034, OLAX300V-1080775, OLAX300V-1080776, OLAX310, OLAX310E-1081110, OLAX310E-1081111, OLAX310LC, OLAX310LCE-1081114, OLAX310LCE-1081115...(Other models you can see in the webshop)		



			
1			
GEV No.	890097	Ref. No.	Loctite 577
description	thread sealing LOCTITE 577 medium-strength bottle 50ml pipe thread sealing t.max. 150°C approval BAM and DVGW		
description	LOCTITE® 577™ - bottle 50ml It is designed for the locking and sealing of metal pipes and fittings as well as other cylindrical metal assemblies. The product provides an instant, low-pressure seal for metal pipes and fittings. It will not creep, shrink or block systems by shredding. Suitable for fast application at low temperatures. It has excellent chemical and thermal resistance and offers less migration of liquid product after application to the part.		
For models:	OLAX151, OLAX151EDX-1080725, OLAX151ELEFT-1080727, OLAX151-highspeed, OLAX160, OLAX160E-1080750, OLAX160E-1080751, OLAX160V-1080755, OLAX160V-1080756, OLAX160V-1081031, OLAX160V-1081032, OLAX210, OLAX210E-1081029, OLAX210E-1081030, OLAX220, OLAX220E-1080787, OLAX220E-1080788, OLAX220V-1080789, OLAX220V-1080790, OLAX230, OLAX230E-1080791, OLAX230E-1080792, OLAX230V-1080793, OLAX230V-1080794, OLAX240, OLAX240E-1080795, OLAX240E-1080796, OLAX240V-1080797, OLAX240V-1080798, OLAX250, OLAX250E-1080760, OLAX250E-1080761, OLAX250V-1080765, OLAX250V-1080766, OLAX300, OLAX300E-1080770, OLAX300E-1080771, OLAX300E-1081033, OLAX300E-1081035, OLAX300E-1081036, OLAX300LC, OLAX300LCE-1081034, OLAX300V-1080775, OLAX300V-1080776, OLAX310, OLAX310E-1081110, OLAX310E-1081111, OLAX310LC, OLAX310LCE-1081114, OLAX310LCE-1081115...(Other models you can see in the webshop)		

cleaning agents

combi-steamer detergents/descalers

Notice: Articles labelled 'DANGEROUS GOODS' are delivered by road through a forwarder for reasons of safety and are charged separately!

			
1			
GEV No.	802056	Ref. No.	3123000 BN3123000 CR3123000
description	detergent for combi-steamer Combi Clean content 11kg		
description			

			
1			
GEV No.	802039 ¹	Ref. No.	0331520 85150020 CR0331520 LA85150020
description	detergent for combi-steamer LAINOX Combi Clean 10 litres		
description	Lainox Combi Clean - detergent - canister 10l Triple-action alkaline detergent, specially designed for cleaning the cooking chambers of Lainox combi steamers. With its special 3-in-1 formula with detergent, rinse aid and descaler the detergent removes food residue and gives the cooking chamber a streak-free shine. The detergent helps ensure a long seal life. Can corrode metals.		

¹DANGEROUS GOODS

lubricants

high-temperature greases

			
1			
GEV No.	890120	Ref. No.	Grease High Temp
description	lubricant GM 5 up to +450°C 100g tubeml		
description	Turmopast GM 5 - tube 100g Special thermally stable paste with synergetic solid lubricant combination, generates low coefficients of friction. The extremely effective lubricant paste has a good pressure capability, protects reliably against friction and wear, and thus results in lowered lubricant consumption. Paste-like lubricant film at temperatures < 200 °C, transition to dry lubrication > 200 °C. Temperature resistance: -40°C to +450°C		
For models:	OLAX151, OLAX151EDX-1080725, OLAX151ELEFT-1080727, OLAX151-highspeed, OLAX160, OLAX160E-1080750, OLAX160E-1080751, OLAX160V-1080755, OLAX160V-1080756, OLAX160V-1081031, OLAX160V-1081032, OLAX210, OLAX210E-1081029, OLAX210E-1081030, OLAX220, OLAX220E-1080787, OLAX220E-1080788, OLAX220V-1080789, OLAX220V-1080790, OLAX230, OLAX230E-1080791, OLAX230E-1080792, OLAX230V-1080793, OLAX230V-1080794, OLAX240, OLAX240E-1080795, OLAX240E-1080796, OLAX240V-1080797, OLAX240V-1080798, OLAX250, OLAX250E-1080760, OLAX250E-1080761, OLAX250V-1080765, OLAX250V-1080766, OLAX300, OLAX300E-1080770, OLAX300E-1080771, OLAX300E-1081033, OLAX300E-1081035, OLAX300E-1081036, OLAX300LC, OLAX300LCE-1081034, OLAX300V-1080775, OLAX300V-1080776, OLAX310, OLAX310E-1081110, OLAX310E-1081111, OLAX310LC, OLAX310LCE-1081114, OLAX310LCE-1081115...(Other models you can see in the webshop)		

lava rocks / ceramic briquetts

			
GEV No.	211008	Ref. No.	6A014900 BN6A014900
description	lava rocks size ca.20-70mm Qty 5kg		
For models:	72-02PLG-12700850, 72-02PLG-12700850TA, 72-02TPLG-12730850, 72-02TPLG-12730850TA, 74-02PLG-12700855, 74-02PLG-12700855TA, 74-02TPLG-12730855, 74-02TPLG-12730855TA, 74PL-G-1000940, 74PL-G-1000940R, 74TPLG-1009940, 74TPLG-1009940R, 78PL-G-1000980, 78PL-G-1000980R, 78TPLG-1009980, 78TPLG-1009980R, 7GL-G400, 7GL-G800, 7GLT-G400, 7GLT-G800, 92-04PLG-12900850, 92-04PLG-12900850TA, 92-04TPLG-12930850, 92-04TPLG-12930850TA, 92PLG-1192840, 92TPLG-1191840, 94-04PLG-12900855TA, 94-04TPLG-12930855, 94-04TPLG-12930855TA, 94PLG-1192865, 94TPLG-1191865, 9GL-G400, 9GL-G800, 9TGL-G400, 9TGL-G800		

fuses

fine fuses

			
GEV No.	358610	Ref. No.	15160
description	fine fuse size ø5x20mm 10A fast-acting rated 250V Qty 10 pcs		
For models:	OLAX151, OLAX151EDX-1080725, OLAX151ELEFT-1080727, OLAX151-highspeed, OLAX160, OLAX160E-1080750, OLAX160E-1080751, OLAX160V-1080755, OLAX160V-1080756, OLAX160V-1081031, OLAX160V-1081032, OLAX210, OLAX210E-1081029, OLAX210E-1081030, OLAX220, OLAX220E-1080787, OLAX220E-1080788, OLAX220V-1080789, OLAX220V-1080790, OLAX230, OLAX230E-1080791, OLAX230E-1080792, OLAX230V-1080793, OLAX230V-1080794, OLAX240, OLAX240E-1080795, OLAX240E-1080796, OLAX240V-1080797, OLAX240V-1080798, OLAX250, OLAX250E-1080760, OLAX250E-1080761, OLAX250V-1080765, OLAX250V-1080766, OLAX300, OLAX300E-1080770, OLAX300E-1080771, OLAX300E-1081033, OLAX300E-1081035, OLAX300E-1081036, OLAX300LC, OLAX300LCE-1081034, OLAX300V-1080775, OLAX300V-1080776, OLAX310, OLAX310E-1081110, OLAX310E-1081111, OLAX310LC, OLAX310LCE-1081114, OLAX310LCE-1081115...(Other models you can see in the webshop)		

			
GEV No.	358671	Ref. No.	15163
description	fine fuse size ø5x20mm 1A fast-acting rated 250V Qty 10 pcs		
For models:	OLAX151, OLAX151EDX-1080725, OLAX151ELEFT-1080727, OLAX151-highspeed, OLAX160, OLAX160E-1080750, OLAX160E-1080751, OLAX160V-1080755, OLAX160V-1080756, OLAX160V-1081031, OLAX160V-1081032, OLAX210, OLAX210E-1081029, OLAX210E-1081030, OLAX220, OLAX220E-1080787, OLAX220E-1080788, OLAX220V-1080789, OLAX220V-1080790, OLAX230, OLAX230E-1080791, OLAX230E-1080792, OLAX230V-1080793, OLAX230V-1080794, OLAX240, OLAX240E-1080795, OLAX240E-1080796, OLAX240V-1080797, OLAX240V-1080798, OLAX250, OLAX250E-1080760, OLAX250E-1080761, OLAX250V-1080765, OLAX250V-1080766, OLAX300, OLAX300E-1080770, OLAX300E-1080771, OLAX300E-1081033, OLAX300E-1081035, OLAX300E-1081036, OLAX300LC, OLAX300LCE-1081034, OLAX300V-1080775, OLAX300V-1080776, OLAX310, OLAX310E-1081110, OLAX310E-1081111, OLAX310LC, OLAX310LCE-1081114, OLAX310LCE-1081115...(Other models you can see in the webshop)		

			
GEV No.	358532	Ref. No.	R65200200
description	fine fuse size ø5x20mm 2A fast-acting rated 250V Qty 10 pcs		
For models:	CCE042M, CCE051M, CCE071M, CCE101M, CCE102M, CCG051M, CCG071M, CCG101M, CCG102M, CKEP06, CKEP06B, CKEP10, CKEP10B, CKEP20, CKEP20B, CKEP21, CKEP21B, CKEP40, CKEP40B, CKET06, CKET06B, CKET10, CKET10B, CKET20, CKET20B, CKET21, CKET21B, CKET40, CKET40B, CKGP06, CKGP06B, CKGP10, CKGP10B, CKGP20, CKGP20B, CKGP21, CKGP21B, CKGP40, CKGP40B, CKGT06, CKGT06B, CKGT10B, CKGT20, CKGT20B, CKGT21, CKGT21B, CKGT40, CKGT40B		

			
GEV No.	358593	Ref. No.	R65200086
description	fine fuse size ø5x20mm 0.125A slow-acting rated 250V Qty 10 pcs		
For models:	CKEP06, CKEP06B, CKEP10, CKEP10B, CKEP20, CKEP20B, CKEP21, CKEP21B, CKEP40, CKEP40B, CKET06, CKET06B, CKET10, CKET10B, CKET20, CKET20B, CKET21, CKET21B, CKET40, CKET40B, CKGP06, CKGP06B, CKGP10, CKGP10B, CKGP20, CKGP20B, CKGP21, CKGP21B, CKGP40, CKGP40B, CKGT06, CKGT06B, CKGT10B, CKGT20, CKGT20B, CKGT21, CKGT21B, CKGT40, CKGT40B		

			
GEV No.	358595	Ref. No.	R65200320
description	fine fuse size ø5x20mm 0.2A slow-acting rated 250V Qty 10 pcs		
For models:	CCE071M, CCE101M, CCE102M, CCG071M, CCG101M, CCG102M, CKEP06, CKEP06B, CKET06, CKET06B, CKGP06, CKGP06B, CKGT06, CKGT06B		

			
GEV No.	358703	Ref. No.	R65200350
description	fine fuse size ø5x20mm 0.4A slow-acting rated 250V Qty 10 pcs		
For models:	CKEP10, CKEP10B, CKEP20, CKEP20B, CKEP21, CKEP21B, CKEP40, CKEP40B, CKET10, CKET10B, CKET20, CKET20B, CKET21, CKET21B, CKET40, CKET40B, CKGP10, CKGP10B, CKGP20, CKGP20B, CKGP21, CKGP21B, CKGP40, CKGP40B, CKGT10B, CKGT20, CKGT20B, CKGT21, CKGT21B, CKGT40, CKGT40B		

			
GEV No.	358605	Ref. No.	6A001420 BN6A001420
description	fine fuse size ø5x20mm 3.15A slow-acting rated 250V Qty 10 pcs		
For models:	94-04PEI100L, 94-04PEI100L-12901765, 94-04PEI110L-12901765BN, 94-04PEI150L, 94-04PEI150L-12901767, 94-04PEI150L-12901767BN, 9PN-EI100, 9PN-EI150		

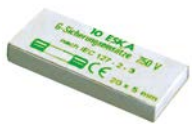

			
1			
GEV No.	358609	Ref. No.	R65200240
description	fine fuse size ø5x20mm 5A slow-acting rated 250V Qty 10 pcs		
For models:	CKET06, CKET06B, CKGT06, CKGT06B		

fine fuse holders			
			
1			
GEV No.	358512	Ref. No.	R65210020
description	fuse holder		
For models:	CCE042M, CCE051M, CCE071M, CCE101M, CCE102M, CCG051M, CCG071M, CCG101M, CCG102M, CKEP06, CKEP06B, CKEP10, CKEP10B, CKEP20, CKEP20B, CKEP21, CKEP21B, CKEP40, CKEP40B, CKET06, CKET06B, CKET10, CKET10B, CKET20, CKET20B, CKET21, CKET21B, CKET40, CKET40B, CKGP06, CKGP06B, CKGP10, CKGP10B, CKGP20, CKGP20B, CKGP21, CKGP21B, CKGP40, CKGP40B, CKGT06, CKGT06B, CKGT10B, CKGT20, CKGT20B, CKGT21, CKGT21B, CKGT40, CKGT40B		

			
1			
GEV No.	550848	Ref. No.	6A034500 BN6A034500
description	fuse holder suitable fuse ø5x20mm		
For models:	CV10E, CV10E-1320100, CV10E-2, CV10E2-1320140, CV10EB-1321100, CV10E-S, CV10ES-1320150, CV10E-S2, CV10ES2-1320190, CV10G, CV10G-1310100, CV10G-2, CV10G2-1310140, CV10GB-1311100, CV10G-S, CV10GS-1310150, CV10G-S2, CV10GS2-1310190, CV20E, CV20E-1320200, CV20E-2, CV20E2-1320240, CV20EB-1321200, CV20E-S, CV20ES-1320250, CV20E-S2, CV20ES2-1320290, CV20G, CV20G-1310200, CV20G-2, CV20G2-1310240, CV20GB-1311200, CV20G-S, CV20GS-1310250, CV20G-S2, CV20GS2-1310290, CV21E, CV21E-1322100, CV21E-2, CV21E2-1322140, CV21E-S, CV21ES-1322150, CV21E-S2, CV21ES2-1322190, CV21G, CV21G-1312100, CV21G-2, CV21G2-1312140, CV21G-S, CV21GS-1312150...(Other models you can see in the webshop)		

A		E	
alarm devices	70	electric accessories	134
audible timers	69	electrodes	100
axial fans	104	electronic controllers	81
B		energy regulators	27
ball valves	299	espagnolette locks	242
ball valves electric	98, 300	evaporators	279
ballasts	63	F	
bar burners	182	fans	104
bi-metal thermostats	27, 28	fasteners	313
booster pumps I	130	fastening material	307
booster pumps II	131	ferrite rings	132
C		filters	132
cable glands	134, 134	fine fuses	316
cables	134	fittings	296
cam switches	49	flat-headed bolts	307
capillary tube clips	40	float switches	49
castors and bumper angles	257	flow meters	101
ceramic heaters	12	fluorescent lamps	63
clamps	306, 313	foam rubber gaskets	276
cleaning agents	315	forced air burners	189
cleaning tools	307	formed hoses	290
coil heating elements	12	fridge lamps	63
cold air circulating fans (complete)	108	fuses	133, 316
combi-steamer detergents/descalers	315	G	
compressors	101	gas burners	171
condensators & interference suppression filters	131	gas control valves	150
condensing trays heated	104	gas nozzles	190
consumables	314	gas taps	137
contactors	70	gas thermostats	141
container filters	288	gaskets for heated units	264
control equipment	55	gaskets for tray rack trolleys	269
control thermostats	28, 38	gastronorm	283
core probes	85	grub screws	308
cross flow fans	109	H	
cylinder head bolts	308	halogen lamp	63
D		heating cartridges	12
door seals	265	heating elements	3
door seals for dishwashers	278	heating elements for bain maries	4
door seals with fixing hook	268	heating elements for charrills	11
door seals with tension springs	268	heating elements for chip scuttles	5
dosing pumps	284	heating elements for convection	18
double nipples	296	heating elements for defrosting	9
drain fittings	303	heating elements for fryers	5
drain hoses	288	heating elements for frying pans	5
drain pumps	130	heating elements for griddles	8
drain systems and wash basins	303	heating elements for heated cabinets	11
		heating elements for ovens	3
		heating elements for pasta cookers	10

heating elements for refrigeration	9
heating elements for tilting bratt pan	9
hexagonal nuts	310
hexagonal screws	307
high-temperature greases	315
hob burners	171
hose clamps	306, 313
hose connectors	295, 297
hoses	288
hot air fans	115
hot air motors	109
hot plates	25
I	
ignition boxes	153
ignition bridges	171
ignition cables	165
ignition units	167
immersion heating elements	12
indicator lights	60
indicator lights (complete)	61
industrial hoses	289
inlet spouts	301
inlet taps	301
K	
knurled screws	309
L	
lamps	60
lava rocks / ceramic briquettes	205, 316
light bulbs	63
long nuts	309
lubricants	315
M	
magnetic switches	53
measuring equipment	307
microswitches	43
motors	117
N	
Niplaflex hoses	289
non-return valves	288
nuts	309
O	
operating capacitors	131
O-rings	269
oven hinges	245
oven lamps	64
P	
PE hoses	289
piezoelectric igniters	166
pilot burners	153
plug-in gaskets	262
plunger sockets	41
pressure control hoses	290
pressure reduction valves	305, 305
pressure switches	99, 204
probe clips	40
probes	84
programme timers	65
pumps	118
push/momentary push switches	42
push-in fittings	298
PVC hoses	290
R	
radial fans	116
radiation heaters	20
raised countersunk head screws	307
reducers	296
refrigeration fans	106
refrigeration gaskets	262
refrigeration motors universal	106
relays	77
residual heat indicators	64
ribbon cables	135
rocker/momentary rocker switches	42
rotary switches	51
S	
safety bi-metal thermostats	27
safety thermostats	33
screw fixings	314
screw pipe fittings	297
screws	307
sealants and adhesives	314
sealing cords	276
sealing discs	278
sealing washers	274
shaft gaskets	277
sheet metal screws	307
shelves and shelf rails	261
shut-off valves	301
side bolts	308
silicone hoses	290
slot nuts	313
solenoid valves	94
solid top burners	188
spring assisted hinges	245
spring clips	40

spring rings	312
spring washers	312
standpipes	303
supply filters	305, 305
switches and momentary switches	42
system switches (ROLD)	44

T

tank inlets	288
temperature probes	84
terminals	135
thermocouples	168
thermostats	27
thread sealants	205, 305, 314
threaded cable glands	134
time relays	79
timers	65
tools	307
tooth lock washers	313
touch sensitive light switches	52
transformers	80
tube burners	187

U

U-bends	304
universal probes	84

V

valves and tank inlets	299
vibration pumps	131

W

wash and rinse pumps	118
washers	312
water cycle components	305
water taps	284
window seals	264