



GAS COMPONENTS



ELECTRIC COMPONENTS



WATER TECHNOLOGY



MECHANICAL COMPONENTS



TOOLS

Spare parts suitable for

OFFCAR

Find the complete and up-to-date range of products in our GEV Webshop



Manufacturer catalogue

The most important spare parts and accessories arranged clearly for every manufacturer

- ✓ Complete product range and all appliance data always up to date in the GEV Webshop
- ✓ Alphabetical Index at the end of the catalogue

GEV Webshop

www.gev-online.co.uk

www.gev-online.com



- 🔍 Add to Favourites
- 🔍 Sign In with email address and usual password
- 🔍 Easy-order – place several items in your basket at the same time
- 🔍 Quick Item search – no login needed



heating elements

heating elements for ovens

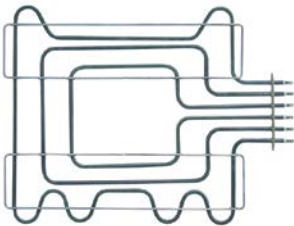

1

GEV No.	416666	Ref. No.	843641
description	heating element 1800W 230/400V heating circuits 3 L 535mm W 448mm L1 75mm L2 460mm W1 150mm W2 128mm flange length 160mm flange width 22mm hole distance 144mm tube ø 8.5mm connection male faston 6.3mm rectangular flange oven mounting thread M5		

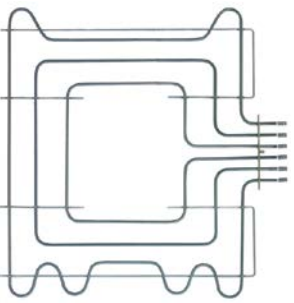

1

GEV No.	416667	Ref. No.	843645
description	heating element 2750W 230/400V heating circuits 3 L 555mm W 618mm L1 58mm L2 497mm W1 248mm W2 122mm flange length 160mm flange width 22mm hole distance 144mm hole ø 4mm tube ø 8.5mm connection male faston 6.3mm connection length 58mm rectangular flange dry heating element oven		



heating elements for fryers

off-center connection

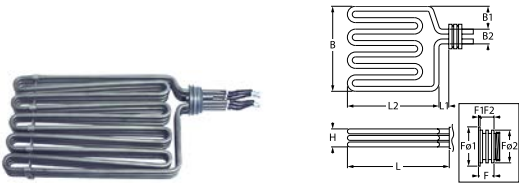
with thread



1

GEV No.	416070	Ref. No.	862029
description	heating element 10200W 230/400V heating circuits 3 L 300mm W 180mm H 33mm flange length 19.5mm flange length 1 9.5mm flange length 2 9.8mm flange ø1 62mm flange ø2 57mm thermostat sleeves ø 6.5mm sensor screw connection 2x M10x1 thermostat sleeve upper/lower L1 18mm L2 282mm W1 30mm W2 35mm thread M54x1.5 windings 5 tube ø 8.5mm cable length 450mm rotation flange immersion heater fryer connection length 130mm 2		
spare parts for	416070		
	GEV No.	510243	Ref. No. —
	O-ring Viton thickness 3.53mm ID ø 55.56mm Qty 1 pcs		
	GEV No.	550496	Ref. No. —
	O-ring Viton thickness 3.53mm ID ø 50.39mm Qty 1 pcs		
accessories for	416070		
	GEV No.	510243	Ref. No. —
	O-ring Viton thickness 3.53mm ID ø 55.56mm Qty 1 pcs		

accessories for	416070		
	GEV No.	550662	Ref. No. 862047
	ring nut thread M54x1.5 H 7mm		

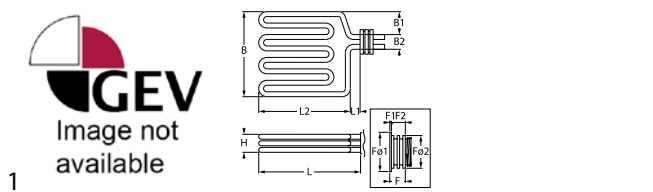

1

GEV No.	416690	Ref. No.	862029
description	heating element 10200W 230V heating circuits 3		

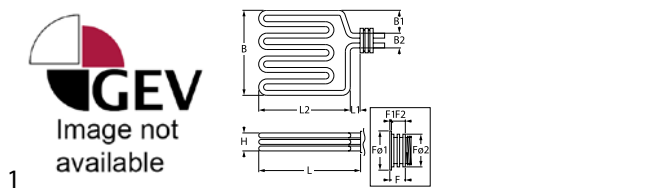



1

GEV No.	416691	Ref. No.	862021
description	heating element 15000W 230V heating circuits 3		

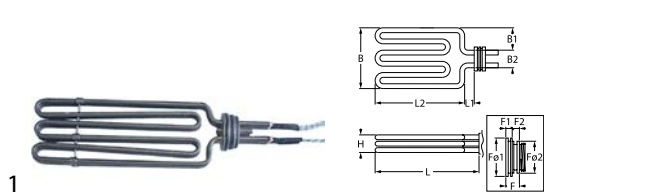
center connection



1

GEV No.	415297	Ref. No.	862033
description	heating element 6800W 230/400V heating circuits 3 L 299mm W 107mm H 35mm flange length 19.5mm flange length 1 9.5mm flange length 2 9.8mm flange ø1 62mm flange ø2 57mm thermostat sleeves ø 8.5mm sensor screw connection 2x M10x1 thermostat sleeve upper/lower L1 16mm L2 283mm W1 30mm W2 77mm thread M54x1.5 tube ø 8.5mm cable length 450mm rotation flange immersion heater		
accessories for	415297		
	GEV No.	510243	Ref. No. —
	O-ring Viton thickness 3.53mm ID ø 55.56mm Qty 1 pcs		
	GEV No.	510245	Ref. No. 862051 ACQ6507 ACQ6508
	O-ring Viton thickness 3.53mm ID ø 50.8mm Qty 1 pcs		
	GEV No.	550447	Ref. No. —
	ring nut thread M54x1.5		

heating elements for griddles



1

GEV No.	416668	Ref. No.	843627
description	heating element 1600W 230V heating circuits 1 L 366mm W 65mm H 62mm tube ø 8.5mm connection male faston 6.3mm dry heating element		





			
GEV No.	416669	Ref. No.	843629
description	heating element 2000W 230V L 520mm W 83mm H 64mm tube ø 8.5mm connection male faston 6.3mm griddle dry heating element		

heating elements for tilting bratt pan

			
GEV No.	416692	Ref. No.	FX40400082
description	heating element tilting bratt pan 2900W 230V L 312mm W 200mm H 82mm connection M5 dry heating element heating circuits 1 tube ø 8.5mm W1 66mm W2 68mm connection distance 61mm		

heating elements for pasta cookers

			
GEV No.	416671	Ref. No.	443651 898983
description	heating element 1800W 230V heating circuits 1 L 315mm flange with thread thread 1 1/2" ø 30mm flange ø 70mm flange width 60mm thermostat sleeves ø 6.5mm length thermostat sleeves 255mm cable length 1000mm number of thermostat sleeves 1 pasta cooker thermostat sleeve eccentric, non clinging immersion heater		
For models:	CPE726, CPE730, CPE760		

			
GEV No.	416670	Ref. No.	443655 898981
description	heating element 1800W 230V heating circuits 1 L 315mm Wmm Hmm flange with thread thread 1" ø 30mm flange ø 50mm flange width 45mm cable length 1000mm immersion heater		
For models:	CPE726, CPE730, CPE760		

			
GEV No.	416686	Ref. No.	443681 898986
description	heating element 2500W 230V heating circuits 1 L 490mm flange with thread thread 1 1/2" ø 30mm flange ø 70mm flange width 60mm thermostat sleeves ø 6.5mm length thermostat sleeves 255mm cable length 1000mm number of thermostat sleeves 1 pasta cooker immersion heater		

			
GEV No.	416685	Ref. No.	443685 898985
description	heating element 2500W 230V heating circuits 1 L 490mm Wmm Hmm thread 1" ø 30mm flange ø 50mm flange width 45mm cable length 1000mm pasta cooker immersion heater		

heating cartridges

			
GEV No.	416671	Ref. No.	443651 898983
description	heating element 1800W 230V heating circuits 1 L 315mm flange with thread thread 1 1/2" ø 30mm flange ø 70mm flange width 60mm thermostat sleeves ø 6.5mm length thermostat sleeves 255mm cable length 1000mm number of thermostat sleeves 1 pasta cooker thermostat sleeve eccentric, non clinging immersion heater		
For models:	CPE726, CPE730, CPE760		

			
GEV No.	416670	Ref. No.	443655 898981
description	heating element 1800W 230V heating circuits 1 L 315mm Wmm Hmm flange with thread thread 1" ø 30mm flange ø 50mm flange width 45mm cable length 1000mm immersion heater		
For models:	CPE726, CPE730, CPE760		

			
GEV No.	416686	Ref. No.	443681 898986
description	heating element 2500W 230V heating circuits 1 L 490mm flange with thread thread 1 1/2" ø 30mm flange ø 70mm flange width 60mm thermostat sleeves ø 6.5mm length thermostat sleeves 255mm cable length 1000mm number of thermostat sleeves 1 pasta cooker immersion heater		

			
GEV No.	416685	Ref. No.	443685 898985
description	heating element 2500W 230V heating circuits 1 L 490mm Wmm Hmm thread 1" ø 30mm flange ø 50mm flange width 45mm cable length 1000mm pasta cooker immersion heater		



immersion heating elements

3 hole flange ø47.5mm

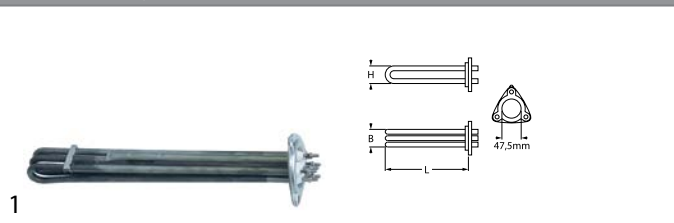

GEV No.	416834	Ref. No.	FX40400040
----------------	--------	-----------------	------------

description heating element 8000W 230V mounting ø 47.5mm heating circuits 3 L 323mm W 35mm H 45mm number of thermostat sleeves 1 thermostat sleeves ø 7mm length thermostat sleeves 263mm thermostat sleeve eccentric, clinging tube ø 8.5mm hole distance 64mm hole ø 8mm connection M4 3 hole flange immersion heater

accessories for 416834

	GEV No.	510408	Ref. No.	FX10500100
	O-ring EPDM thickness 5.34mm ID ø 47mm Qty 1 pcs			
	GEV No.	510562	Ref. No.	—
	O-ring silicone thickness 5.34mm ID ø 47mm Qty 1 pcs			

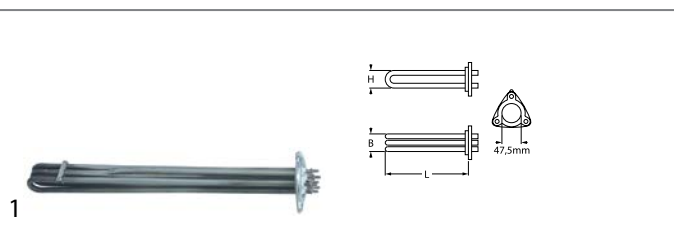

GEV No.	416835	Ref. No.	FX40400042
----------------	--------	-----------------	------------

description heating element 9000W 230V mounting ø 47.5mm heating circuits 3 L 415mm W 30mm H 46mm number of thermostat sleeves 1 thermostat sleeves ø 7.5mm length thermostat sleeves 255mm thermostat sleeve eccentric, clinging hole distance 62mm hole ø 8mm connection M4 3 hole flange immersion heater

accessories for 416835

	GEV No.	510408	Ref. No.	FX10500100
	O-ring EPDM thickness 5.34mm ID ø 47mm Qty 1 pcs			
	GEV No.	510562	Ref. No.	—
	O-ring silicone thickness 5.34mm ID ø 47mm Qty 1 pcs			

foil heating elements

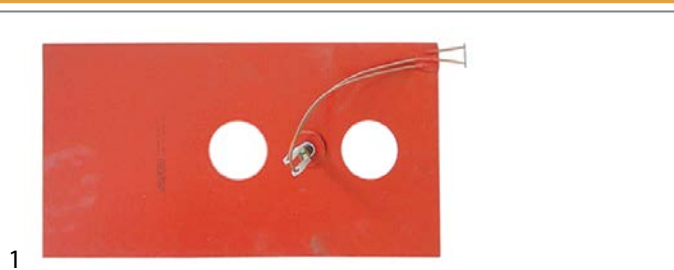

GEV No.	416687	Ref. No.	843613
----------------	--------	-----------------	--------

description foil heating element L 460mm W 250mm 1000W 230V t.max. 175°C with temperature limiter silicone cable length 500mm thickness 1mm



GEV No.	416688	Ref. No.	843611
----------------	--------	-----------------	--------

description foil heating element L 500mm W 290mm 1350W 230V t.max. 175°C with temperature limiter silicone cable length 500mm thickness 1mm

accessories

ring nuts

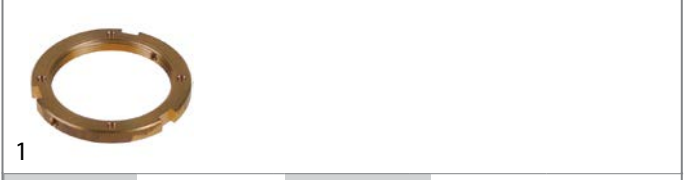

GEV No.	550662	Ref. No.	862047
----------------	--------	-----------------	--------

description ring nut thread M54x1.5 H 7mm

accessories for 550662

	GEV No.	550449	Ref. No.	—
	special wrench for ring nut			

sealing washers

O-rings

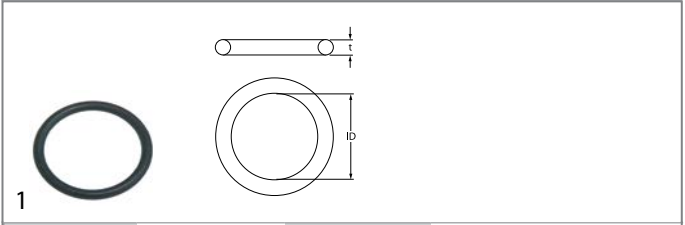

GEV No.	510408	Ref. No.	FX10500100
----------------	--------	-----------------	------------

description O-ring EPDM thickness 5.34mm ID ø 47mm Qty 1 pcs

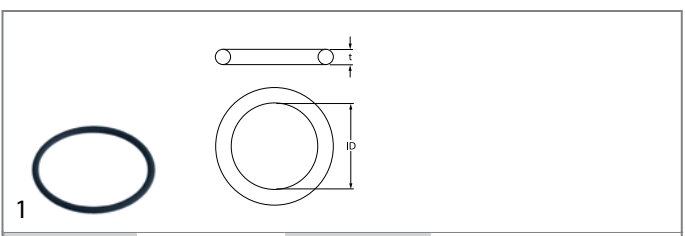

GEV No.	510245	Ref. No.	862051 ACQ6507 ACQ6508
----------------	--------	-----------------	------------------------------

description O-ring Viton thickness 3.53mm ID ø 50.8mm Qty 1 pcs



hot plates

square & rectangular

with radiused edge



1

GEV No.	490066 ¹	Ref. No.	843405
description	hot plate dimensions 220x220mm 2600W 230V with spill ring connection 4 screw clamps protector yes square		

¹incl. protector

1

GEV No.	490068 ¹	Ref. No.	843402
description	hot plate dimensions 220x220mm 2600W 400V with spill ring connection 4 screw clamps protector yes square		

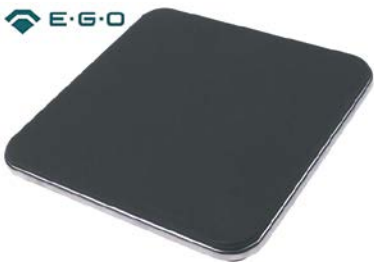
¹incl. protector

1

GEV No.	490070	Ref. No.	843401
description	hot plate dimensions 300x300mm 3000W 230V with spill ring connection 4 screw clamps protector no square		



1

GEV No.	490057 ¹	Ref. No.	843407
description	hot plate dimensions 300x300mm 3000W 400V with spill ring connection 4 screw clamps protector yes square		

¹incl. protector

1

GEV No.	490071 ¹	Ref. No.	843373
description	hot plate dimensions 300x300mm 4000W 230V with spill ring connection 4 screw clamps protector yes square		

¹incl. protector

round

with radiused edge

for domestic and commercial kitchens



1

GEV No.	490020	Ref. No.	843412 843413
description	hot plate ø 220mm 2600W 230V connection 4 screw clamps with 8mm spill ring		

accessories for	490020		
------------------------	--------	--	--

GEV No.	550796	Ref. No.	—
----------------	--------	-----------------	---

fixing plate for hot plate ø220mm

thermostats

control and safety thermostats

EGO

control thermostats

55.10/19_ series

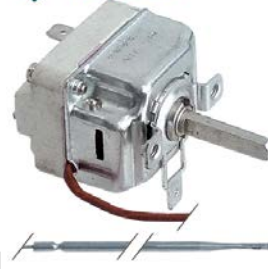

1

GEV No.	375363	Ref. No.	FX40100050
description	thermostat t.max. 161°C temperature range 73-161°C 1-pole 1NO 16A probe ø 3mm probe L 144mm capillary pipe 1600mm capillary pipe isolated 1600mm gland nut shaft ø 6x4.6mm shaft L 23mm shaft position upper rotation 270°		



E·G·O



GEV No. 375270 **Ref. No.** FX40100042

description thermostat t.max. 295°C temperature range 45-295°C 1-pole 1NO 16A probe ø 4mm probe L 100mm capillary pipe 900mm capillary pipe isolated 350mm gland nut shaft L 23mm shaft position upper rotation 270°

safety thermostats

55.10/19_ series

E·G·O



GEV No. 375376 **Ref. No.** 862133

description safety thermostat capillary pipe 870mm probe ø 6mm 1-pole probe L 133mm 0.5A capillary pipe isolatedmm gland nut M10x1 switch-off temp. 224°C probe

55.13_ series

E·G·O



GEV No. 375492 **Ref. No.** 862115
990301

description thermostat t.max. 190°C temperature range 94-190°C 1-pole 1NO 16A probe ø 6mm probe L 94mm capillary pipe 1090mm capillary pipe isolated 960mm gland nut M10x1 shaft ø 6x4.6mm shaft L 23mm shaft position upper rotation 310° probe material SS

55.32_ series

E·G·O



GEV No. 375993 **Ref. No.** 898979

description safety thermostat switch-off temp. 135°C 3-pole 1CO/2NC 20A probe ø 6mm probe L 89mm capillary pipe 390mm capillary pipe isolated 380mm gland nut

55.34_ series

E·G·O



GEV No. 375362 **Ref. No.** 843735

description thermostat t.max. 320°C temperature range 55-320°C 3-pole 3NO 10A probe ø 4mm probe L 128mm capillary pipe 900mm capillary pipe isolatedmm gland nut shaft ø 6x4.6mm shaft L 23mm shaft position upper rotation 270°

E·G·O



GEV No. 375364 **Ref. No.** FX40100041

description safety thermostat switch-off temp. 190°C 3-pole 20A probe ø 4mm probe L 120mm capillary pipe 3000mm capillary pipe isolated 3000mm gland nut probe



GEV No.	375984	Ref. No.	862124
description	safety thermostat switch-off temp. 225°C 3-pole 3NC 20A probe ø 6mm probe L 94mm capillary pipe 900mm capillary pipe isolated 670mm gland nut M10x1 probe SS		

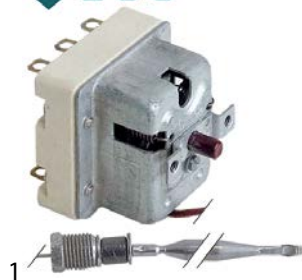

GEV No.	375375	Ref. No.	862123
description	safety thermostat switch-off temp. 230°C 3-pole 20A probe ø 6mm probe L 94mm capillary pipe 900mm capillary pipe isolated 670mm gland nut M10x1 probe SS		



GEV No.	375228	Ref. No.	843737
description	safety thermostat switch-off temp. 350°C 3-pole 20A probe ø 3mm probe L 188mm capillary pipe 900mm capillary pipe isolated 900mm gland nut probe SS		

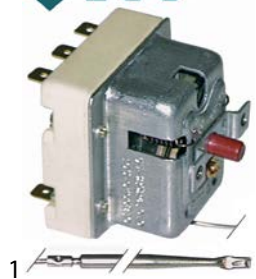

GEV No.	375350	Ref. No.	FX40100062
description	safety thermostat switch-off temp. 360°C 3-pole 20A probe ø 4mm probe L 120mm capillary pipe 1800mm capillary pipe isolated 1800mm gland nut probe SS		

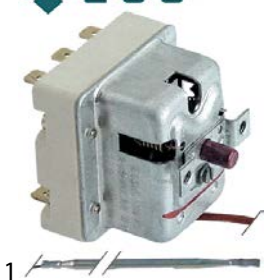

GEV No.	390227	Ref. No.	FX40100062
description	safety thermostat switch-off temp. 360°C 3-pole 20A probe ø 4mm probe L 120mm capillary pipe 1800mm capillary pipe isolated 1800mm gland nut probe SS		

56._series



GEV No.	375783	Ref. No.	ACQ6000
description	safety thermostat switch-off temp. 240°C 1-pole 0.5A probe ø 6mm probe L 77mm capillary pipe 860mm capillary pipe isolated 750mm gland nut M10x1 probe SS		

IMIT / TEMPOMATIC / ARTHERMO

control thermostats



GEV No.	375564	Ref. No.	843791
description	thermostat t.max. 90°C temperature range 0-90°C 1-pole 1CO 15A probe ø 11mm probe L 36mm capillary pipe 600mm capillary pipe isolated 600mm gland nut shaft ø 6x4.6mm shaft L 19mm shaft position upper rotation 270° screw-in probe probe thread M14x1		

accessories for	375564			
	GEV No.	550261	Ref. No.	—
	nut thread M14x1 H 4mm WS 19 SS Qty 1 pcs			

accessories

connecting bows



GEV No.	550060	Ref. No.	843753
description	connecting bow long for thermostat Qty 1 pcs		



switches and momentary switches

rocker/momentary rocker switches

30x22mm

labelled



1

GEV No.	300125	Ref. No.	849451
----------------	--------	-----------------	--------

description rocker switch mounting measurements 30x22mm green 2NO 230V 16A 0-1 connection male faston 6.3mm ambient temperature max. 125/55°C protection IP65 with cover cap

accessories for 300125



GEV No.	301036	Ref. No.	—
description protective cover internal size 30x22mm for rocker switch mounting measurementsmm			

microswitches

lever actuated



1

GEV No.	345254	Ref. No.	862311
----------------	--------	-----------------	--------

description microswitch with lever 250V 16A 1CO connection male faston 6.3mm ambient temperature max. 120°C mounting distance 22mm actuating force: 60g lever length 58mm



1

GEV No.	345044	Ref. No.	FX4010007
----------------	--------	-----------------	-----------

description microswitch with lever 250V 16A 1CO connection male faston 6.3mm ambient temperature max. 85°C mounting distance 25mm type C99ZP3 actuating force: 25g lever length 71mm

cam switches

on/off



1

GEV No.	300129	Ref. No.	862323
----------------	--------	-----------------	--------

description cam switch 2 operating positions 2NO sequence 0-1 16A shaft ø 6x4.6mm shaft L 23mm connection male faston 6.3mm ceramic

7-position



1

GEV No.	300025	Ref. No.	843751
----------------	--------	-----------------	--------

description cam switch 7 operating positions 1NO/2CO sequence 0-1-2-3-4-5-6 16A shaft ø 6x4.6mm shaft L 23mm connection screw 7-position ceramic

accessories for 300025



GEV No.	112172	Ref. No.	—
description knob universal ø 70mm black without adaptor/dial plate			



GEV No.	112213	Ref. No.	—
description knob dial plate silver switch 7-position t.max.°C ED ø 63mm ID ø 45.5mm			



GEV No.	112311	Ref. No.	—
description knob adapter shaft ø 6x4.6mm L 0mm with spring			

3 operating positions



1

GEV No.	300167	Ref. No.	FX4010004 FX-SMP0936-00 FX-SMP0938-00
----------------	--------	-----------------	---

description cam switch 3 operating positions 2NO/1CO sequence 0-1-2 16A shaft ø 6x4.6mm shaft L 23mm connection screw

4 operating positions



1

GEV No.	300145	Ref. No.	898973
----------------	--------	-----------------	--------

description cam switch 4 operating positions 4NO sequence 0-1-2-3 32A shaft ø 6x4.6mm shaft L 23mm connection screw ceramic

For models: CPE



operation switches



1			
GEV No.	300166	Ref. No.	862317
description	cam switch 2 operating positions 4NO 16A sequence 0-1 shaft ø 6x4.6mm shaft L 23mm connection male faston 6.3mm ceramic 4-pole ambient temperature max. 318°C		



1			
GEV No.	300080	Ref. No.	843746 FX40100006
description	cam switch 2 operating positions 4NO 16A sequence 0-1 shaft ø 6x4.6mm shaft L 23mm connection screw operation switch ceramic ambient temperature max. 150°C		

accessories for 300080

	GEV No.	551456	Ref. No.	—
	gasket for switch ED ø 14mm ID ø 2.5mm thickness 3.5mm white			



1			
GEV No.	300115	Ref. No.	843745
description	cam switch 2 operating positions operation switch sequence 0-1 shaft ø 6x4.6mm connection screw clamp 5-pole ambient temperature max. 318°C		

rotary switches

BREMAS

A3200 series



1			
GEV No.	345817	Ref. No.	862325
description	rotary switch 2 0-1 sets of contacts 4 type CS0327690 600V 32A shaft ø 5x5mm shaft L 26mm shaft square connection screw		

lamps

indicator lights

indicator lights 2-piece (lens and indicator lamp)

indicator light lenses

ø13mm (type SFK-3)



1			
GEV No.	359225	Ref. No.	862339 863339
description	indicator light housings mounting measurements ø13mm clear Qty 1 pcs		



1			
GEV No.	359126	Ref. No.	862333
description	indicator light housings mounting measurements ø13mm green Qty 1 pcs		

indicator lamps for socket type SRZ / SDK / SDY / SFK



1			
GEV No.	359130	Ref. No.	862337
description	indicator lamp 230V clear connection male faston 6.3mm ø 8mm		



1			
GEV No.	359133	Ref. No.	FX40200154
description	indicator lamp 400V green connection male faston 6.3mm		



1			
GEV No.	359132	Ref. No.	862331
description	indicator lamp green 250V connection male faston 6.3mm protection IP54 ambient temperature max. 85°C		

indicator lights (complete)

ø12mm

with screw socket





1			
GEV No.	359291	Ref. No.	FX40200152
description	indicator light ø 12mm 400V green connection male faston 6.3mm		



			
1			
GEV No.	359292	Ref. No.	FX40200148
description	indicator light ø 12mm 400V red connection male faston 6.3mm		

			
1			
GEV No.	359290	Ref. No.	FX40200150
description	indicator light ø 12mm 400V yellow connection male faston 6.3mm		

30x22mm			
			
1			
GEV No.	359157	Ref. No.	849461
description	indicator light mounting measurements 30x22mm 230V green connection male faston 6.3mm temp.-resist. 125/55°C type RL2		
accessories for	359157		
	GEV No.	Ref. No.	—
	301036		
	protective cover internal size 30x22mm for rocker switch mounting measurementsmm		

			
1			
GEV No.	359156	Ref. No.	849457
description	indicator light mounting measurements 30x22mm 230V yellow connection male faston 6.3mm temp.-resist. 125/55°C type RL2		

contactors

GENERAL ELECTRIC (AEG)

power contactors			
			
1			
GEV No.	380244	Ref. No.	FX40100023
description	power contactor resistive load 25A 230VAC (AC3/400V) 9A/4kW main contacts 3NO auxiliary contacts 1NO connection screw connection type AEG LS4K 10A type GE CL00A 310		

ISKRA (FANAL)

power contactors

			
1			
GEV No.	380204	Ref. No.	862329
description	power contactor resistive load 25A 230VAC (AC3/400V) 9A/4kW main contacts 3NO auxiliary contacts 1NO connection screw connection type Fanal DSL9 10 type ISKRA KNL9 10		

SIEMENS

power contactors

			
1			
GEV No.	380389	Ref. No.	862329
description	power contactor resistive load 22A 230VAC (AC3/400V) 9A/4kW main contacts 3NO auxiliary contacts 1NO connection screw connection type 3RT10-16-1AP01		

probes

universal probes

temperature probes

			
1			
GEV No.	379222 ¹	Ref. No.	862143
description	temperature probe Pt100 cable Vetrotex probe -200 up to +600°C cable -50 up to +350°C probe ø4x110mm cable length 1.4m 3-wire		

¹3-wire



electronics

PCBs



1

GEV No.	401171	Ref. No.	6010084
----------------	--------	-----------------	---------

description	PCB combi-steamer		
--------------------	-------------------	--	--



1

GEV No.	401167	Ref. No.	862221
----------------	--------	-----------------	--------

description	PCB combi-steamer VE 06/10 230V 50/60Hz		
--------------------	---	--	--

accessories for	401167		
------------------------	--------	--	--



GEV No.	401062	Ref. No.	—
description	buzzer board 230VAC L 48mm W 45mm connection Faston 6.3mm		

fuses

fine fuses

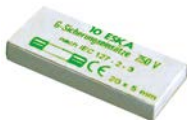

1

GEV No.	358597	Ref. No.	40200084
----------------	--------	-----------------	----------

description	fine fuse size ø5x20mm 0.5A slow-acting rated 250V Qty 10 pcs		
--------------------	---	--	--

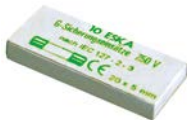

1

GEV No.	358605	Ref. No.	40200080
----------------	--------	-----------------	----------

Ref. No.	FX-40200084
-----------------	-------------

description	fine fuse size ø5x20mm 3.15A slow-acting rated 250V Qty 10 pcs		
--------------------	--	--	--

gas taps

PEL

21S series



1

GEV No.	101397	Ref. No.	401101
----------------	--------	-----------------	--------

description	gas tap PEL type 21S gas inlet M16x1.5 (tube ø 10mm) bypass nozzle ø 0.35mm gas outlet M16x1.5 (tube ø 10/8mm) thermocouple connection M9x1 pilot connection M10x1 shaft ø 8x6.5mm shaft L 22/15mm shaft flat lower		
--------------------	---	--	--

spare parts for	101397		
------------------------	--------	--	--



GEV No.	100408	Ref. No.	—
----------------	--------	-----------------	---

description	bypass nozzle type PEL20/21 bore ø 0.35mm thread M5x0.5		
--------------------	---	--	--



GEV No.	101060	Ref. No.	835337
----------------	--------	-----------------	--------

description	magnet unit standard L 39mm D1 ø 15.4mm D2 ø 11mm suitable for PEL20-21/JUNKERS/EGA		
--------------------	---	--	--



GEV No.	101206	Ref. No.	—
----------------	--------	-----------------	---

description	gas tap front part shaft ø 8x6.5mm shaft L 22/15mm shaft flat upper/lower suitable for PEL21		
--------------------	--	--	--



GEV No.	101231	Ref. No.	—
----------------	--------	-----------------	---

description	thermocouple nut T1: M9x1 T2: M18x1		
--------------------	-------------------------------------	--	--

accessories for	101397		
------------------------	--------	--	--



GEV No.	100908	Ref. No.	—
----------------	--------	-----------------	---

description	union screw thread M10x1 for pipe ø 4mm Qty 1 pcs		
--------------------	---	--	--



GEV No.	100909	Ref. No.	—
----------------	--------	-----------------	---

description	union screw thread M10x1 for pipe ø 6mm Qty 1 pcs		
--------------------	---	--	--



GEV No.	101246	Ref. No.	—
----------------	--------	-----------------	---

description	olive for pipe ø 4mm Qty 1 pcs		
--------------------	--------------------------------	--	--



GEV No.	101278	Ref. No.	—
----------------	--------	-----------------	---

description	olive for pipe ø 10mm Qty 1 pcs		
--------------------	---------------------------------	--	--



GEV No.	101286	Ref. No.	—
----------------	--------	-----------------	---

description	olive ID ø 6mm Qty 1 pcs		
--------------------	--------------------------	--	--



GEV No.	101300	Ref. No.	—
----------------	--------	-----------------	---

description	union nut thread M16x1.5 tube ø 10mm		
--------------------	--------------------------------------	--	--



GEV No.	101450	Ref. No.	—
----------------	--------	-----------------	---

description	olive for pipe ø 8mm L 12.7mm Qty 1 pcs ED ø 10mm		
--------------------	---	--	--



GEV No.	101451	Ref. No.	—
----------------	--------	-----------------	---

description	union nut thread M16x1.5 tube ø 8mm		
--------------------	-------------------------------------	--	--



GEV No.	110081	Ref. No.	—
----------------	--------	-----------------	---









description	knob ø 70mm shaft ø 8x6.5mm shaft flat universal		
--------------------	--	--	--







GEV No.	112206	Ref. No.	—
----------------	--------	-----------------	---













description	knob dial plate silver gas tap PEL21/22/23 t.max.°C ED ø 63mm ID ø 45.5mm		
--------------------	---	--	--



			
1			
GEV No.	106145	Ref. No.	401121
description	gas tap PEL type 21S gas inlet pipe flange ø21mm bypass nozzle ø 0.35mm gas outlet M16x1.5 (tube ø 10/8mm) thermocouple connection M9x1 pilot connection M10x1 shaft ø 8x6.5mm shaft L 22/15mm shaft flat lower		
spare parts for	106145		
	GEV No.	100408	Ref. No. —
	bypass nozzle type PEL20/21 bore ø 0.35mm thread M5x0.5		
	GEV No.	101060	Ref. No. 835337
	magnet unit standard L 39mm D1 ø 15.4mm D2 ø 11mm suitable for PEL20-21/JUNKERS/EGA		
	GEV No.	101231	Ref. No. —
	thermocouple nut T1: M9x1 T2: M18x1		
	GEV No.	101880	Ref. No. —
	gasket Viton ED ø 14mm ID ø 9mm thickness 7.7mm Qty 1 pcs		
accessories for	106145		
	GEV No.	101277	Ref. No. —
	olive ID ø 8mm Qty 1 pcs		
	GEV No.	101278	Ref. No. —
	olive for pipe ø 10mm Qty 1 pcs		
	GEV No.	101300	Ref. No. —
	union nut thread M16x1.5 tube ø 10mm		
	GEV No.	101451	Ref. No. —
	union nut thread M16x1.5 tube ø 8mm		

22S/O series

			
1			
GEV No.	101086	Ref. No.	401151
description	gas tap PEL type 22S/O gas inlet M20x1.5 (tube ø 12mm) bypass nozzle ø 0.35mm gas outlet M20x1.5 (tube ø 12/10mm) thermocouple connection M9x1 pilot connection M10x1 shaft ø 10x8mm shaft L 25/17mm shaft flat lower		
spare parts for	101086		
	GEV No.	100259	Ref. No. —
	bypass nozzle type PEL22 bore ø 0.35mm thread M6x0.5		
	GEV No.	101058	Ref. No. —
	magnet unit L 39mm D1 ø 15.4mm D2 ø 13.5mm suitable for PEL22/EGA24197 standard		
	GEV No.	101201	Ref. No. —
	gas tap front part shaft ø 10x8mm shaft L 25/17mm shaft flat upper/lower suitable for PEL22		
	GEV No.	101231	Ref. No. —
	thermocouple nut T1: M9x1 T2: M18x1		

spare parts for	101086		
	GEV No.	101240	Ref. No. —
	gas connection thread M20x1.5 tube ø 12/10mm for PEL gas taps with gasket and screws horizontal		
	GEV No.	101460	Ref. No. —
	O-ring ø 12.37mm D1 ø 2.62mm suitable for PEL22		
	GEV No.	101461	Ref. No. —
	screw kit suitable for PEL22 Qty 4 pcs		
accessories for	101086		
	GEV No.	100908	Ref. No. —
	union screw thread M10x1 for pipe ø 4mm Qty 1 pcs		
	GEV No.	100909	Ref. No. —
	union screw thread M10x1 for pipe ø 6mm Qty 1 pcs		
	GEV No.	101241	Ref. No. —
	gas connection thread M20x1.5 tube ø 12/10mm for PEL gas taps vertical		
	GEV No.	101246	Ref. No. —
	olive for pipe ø 4mm Qty 1 pcs		
	GEV No.	101248	Ref. No. —
	olive for pipe ø 12mm Qty 1 pcs suitable for PEL		
	GEV No.	101249	Ref. No. 835325
	olive for pipe ø 10mm Qty 1 pcs		
	GEV No.	101250	Ref. No. —
	union nut thread M20x1.5 for pipe ø 10mm		
	GEV No.	101251	Ref. No. —
	union nut thread M20x1.5 for pipe ø 12mm		
	GEV No.	101286	Ref. No. —
	olive ID ø 6mm Qty 1 pcs		
	GEV No.	110080	Ref. No. —
	knob ø 70mm shaft ø 10x8mm shaft flat universal		
	GEV No.	112206	Ref. No. —
	knob dial plate silver gas tap PEL21/22/23 t.max.°C ED ø 63mm ID ø 45.5mm		



			
1			
GEV No.	101892	Ref. No.	FX30100009
description	gas tap PEL type 22S/O gas inlet M20x1.5 (tube ø 12mm) bypass nozzle ø 0.35mm gas outlet M20x1.5 (tube ø 12/10mm) thermocouple connection M9x1 pilot connection M10x1 shaft ø 10x8mm shaft L 25/17mm shaft flat lower		
spare parts for	101892		
	GEV No.	101058	Ref. No. —
	magnet unit L 39mm D1 ø 15.4mm D2 ø 13.5mm suitable for PEL22/EGA24197 standard		

Table continues overleaf



spare parts for		101892	
	GEV No.	101201	Ref. No. —
gas tap front part shaft \varnothing 10x8mm shaft L 25/17mm shaft flat upper/lower suitable for PEL22			
	GEV No.	101231	Ref. No. —
thermocouple nut T1: M9x1 T2: M18x1			
	GEV No.	101240	Ref. No. —
gas connection thread M20x1.5 tube \varnothing 12/10mm for PEL gas taps with gasket and screws horizontal			
	GEV No.	101460	Ref. No. —
O-ring \varnothing 12.37mm D1 \varnothing 2.62mm suitable for PEL22			
	GEV No.	101461	Ref. No. —
screw kit suitable for PEL22 Qty 4 pcs			
accessories for		101892	
	GEV No.	100908	Ref. No. —
union screw thread M10x1 for pipe \varnothing 4mm Qty 1 pcs			
	GEV No.	100909	Ref. No. —
union screw thread M10x1 for pipe \varnothing 6mm Qty 1 pcs			
	GEV No.	101246	Ref. No. —
olive for pipe \varnothing 4mm Qty 1 pcs			
	GEV No.	101248	Ref. No. —
olive for pipe \varnothing 12mm Qty 1 pcs suitable for PEL			
	GEV No.	101249	Ref. No. 835325
olive for pipe \varnothing 10mm Qty 1 pcs			
	GEV No.	101250	Ref. No. —
union nut thread M20x1.5 for pipe \varnothing 10mm			
	GEV No.	101251	Ref. No. —
union nut thread M20x1.5 for pipe \varnothing 12mm			
	GEV No.	101286	Ref. No. —
olive ID \varnothing 6mm Qty 1 pcs			
	GEV No.	110080	Ref. No. —
knob \varnothing 70mm shaft \varnothing 10x8mm shaft flat universal			
	GEV No.	112206	Ref. No. —
knob dial plate silver gas tap PEL21/22/23 t.max.°C ED \varnothing 63mm ID \varnothing 45.5mm			

23S/O series



















spare parts for		101893	
	GEV No.	101045	Ref. No. —
magnet unit T1: M9x1 T2: M22x1 L 46mm \varnothing 18mm suitable for PEL23S M9x1			
	GEV No.	101204	Ref. No. —
gas tap front part shaft \varnothing 10x8mm shaft L 25/17mm shaft flat upper/lower suitable for PEL23S			
	GEV No.	101244	Ref. No. —
gas connection thread M24x1.5 tube \varnothing 12/16mm horizontal for PEL gas taps			
	GEV No.	101463	Ref. No. —
screw suitable for PEL23S Qty 4 pcs			
	GEV No.	528455	Ref. No. —
O-ring Viton thickness 2.62mm ID \varnothing 18.72mm Qty 1 pcs			
accessories for		101893	
	GEV No.	100908	Ref. No. —
union screw thread M10x1 for pipe \varnothing 4mm Qty 1 pcs			
	GEV No.	100909	Ref. No. —
union screw thread M10x1 for pipe \varnothing 6mm Qty 1 pcs			
	GEV No.	101246	Ref. No. —
olive for pipe \varnothing 4mm Qty 1 pcs			
	GEV No.	101252	Ref. No. —
union nut thread M24x1.5 for pipe \varnothing 12mm			
	GEV No.	101253	Ref. No. —
union nut thread M24x1.5 PEL for pipe \varnothing 16mm			
	GEV No.	101254	Ref. No. —
union nut thread M28x1.5 tube \varnothing 20mm			
	GEV No.	101255	Ref. No. —
olive for pipe \varnothing 12mm Qty 1 pcs			
	GEV No.	101256	Ref. No. —
olive for pipe \varnothing 16mm Qty 1 pcs			
	GEV No.	101257	Ref. No. —
olive for pipe \varnothing 20mm Qty 1 pcs			
	GEV No.	101286	Ref. No. —
olive ID \varnothing 6mm Qty 1 pcs			

Table continues overleaf















accessories for	101893			
	GEV No.	110080	Ref. No.	—
	knob ø 70mm shaft ø 10x8mm shaft flat universal			
	GEV No.	112206	Ref. No.	—
	knob dial plate silver gas tap PEL21/22/23 t.max.°C ED ø 63mm ID ø 45.5mm			

gas thermostats

SIT





630 Eurosit series

	1			
GEV No.	101125	Ref. No.	FX30100080	
description	gas thermostat type 630 Eurosit series t.max. 340°C 100-340°C gas inlet 3/8" gas outlet 3/8" thermocouple connection M9x1 pilot connection M10x1 probe ø 4mm probe L 72mm capillary pipe 1050mm SIT			
accessories for	101125			
	GEV No.	100825	Ref. No.	—
	gas tap spindle shaft ø 8x6.5mm shaft L 22/14mm suitable for EUROSIT			
	GEV No.	100904	Ref. No.	—
	locking screw M10x1 for pipe ø 4mm Qty 1 pcs			
	GEV No.	100905	Ref. No.	—
	locking screw M10x1 for pipe ø 6mm Qty 1 pcs			
	GEV No.	100949	Ref. No.	—
	gasket suitable for 630 Eurosit series			
	GEV No.	101273	Ref. No.	—
	olive for pipe ø 12mm L 9.5mm brass Qty 1 pcs suitable for universal			
	GEV No.	101276	Ref. No.	—
	union screw thread 3/8" tube ø 12mm Qty 1 pcs			
	GEV No.	101333	Ref. No.	—
	plug thread 3/8" with O-ring			
	GEV No.	101390	Ref. No.	—
	gas tap spindle shaft ø 6x4.6mm shaft L 32/15mm gas tap with ignition flame suitable for ZANUSSI, MARENO for gas thermostat EUROSIT			
	GEV No.	101392	Ref. No.	—
	adapter suitable for 630 Eurosit series			
	GEV No.	110357	Ref. No.	—
	gas tap spindle shaft ø 8x6.5mm shaft L 36/12mm suitable for 630 Eurosit series			
	GEV No.	110358	Ref. No.	—
	adapter shaft ø 10x8mm shaft L 29/18mm suitable for 630 Eurosit series			

710 Minisit series

	1			
GEV No.	101135	Ref. No.	863811	
description	gas thermostat SIT type MINISIT 710 t.max. 190°C 110-190°C gas inlet 1/2" gas outlet 3/8" thermocouple connection M9x1 pilot connection M10x1 probe ø 6mm probe L 102mm capillary pipe 1050mm probe type type A3 pressure controller no pressure regulator mbar gland nut			
spare parts for	101135			
	GEV No.	101053	Ref. No.	837119
	magnet unit T1: M9x1 T2: M24x1 L 45mm ø 17mm suitable for Minisit			
	GEV No.	102118	Ref. No.	863801
	probe 110-190°C probe ø 6mm probe L 102mm capillary pipe 1050mm t.max. 190°C fryer probe type type A3 suitable for MINISIT 710			
accessories for	101135			
	GEV No.	100809	Ref. No.	—
	O-ring EPDM thickness 2mm ID ø 21mm Qty 1 pcs			
	GEV No.	100820	Ref. No.	—
	gland duct ET M14x1.5 IT M10x0.75 probe ø max. 6.5mm WS 22			
	GEV No.	100904	Ref. No.	—
	locking screw M10x1 for pipe ø 4mm Qty 1 pcs			
	GEV No.	100905	Ref. No.	—
	locking screw M10x1 for pipe ø 6mm Qty 1 pcs			
	GEV No.	101054	Ref. No.	—
	magnet unit T1: M10x1 T2: M24x1 L 45mm ø 17mm suitable for Minisit			
	GEV No.	101136	Ref. No.	835729
	piezoelectric igniter suitable for Minisit with cover cap ømm connection F6.3x0.8			
	GEV No.	101137	Ref. No.	—
	cover cap without piezoelectric igniter			
	GEV No.	101267	Ref. No.	—
	reducer IT 3/8" ET 1/2" L 21mm			
	GEV No.	101268	Ref. No.	—
	gas connection thread 3/8" angled with O-ring MINISIT 710			
	GEV No.	101269	Ref. No.	—
	gas connection thread 1/2" angled with O-ring MINISIT 710			
	GEV No.	101270	Ref. No.	—
	screw connection IT 3/8" ET 3/8" L 28mm			
	GEV No.	101272	Ref. No.	—
	screw connection IT 1/2" ET 3/8" L 57mm			

Table continues overleaf

accessories for		101135		
GEV No.	101273	Ref. No.	—	
	olive for pipe ø 12mm L 9.5mm brass Qty 1 pcs suitable for universal			
GEV No.	101274	Ref. No.	—	
	olive for pipe ø 16mm Qty 1 pcs			
GEV No.	101275	Ref. No.	—	
	union screw thread 1/2" for pipe ø 16mm Qty 1 pcs			
GEV No.	101276	Ref. No.	—	
	union screw thread 3/8" tube ø 12mm Qty 1 pcs			
GEV No.	110068	Ref. No.	835721	
	knob suitable for Minisit ø 37mm			

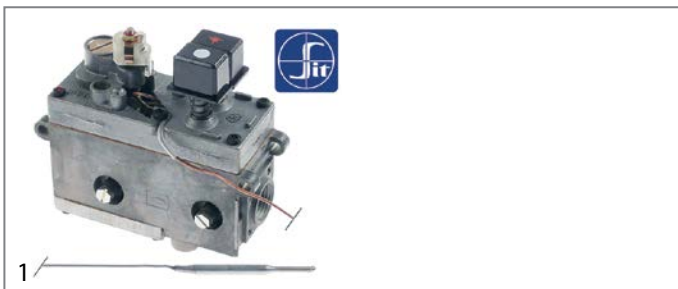

GEV No.	101132	Ref. No.	835701	
---------	--------	----------	--------	--

description
gas thermostat SIT type MINISIT 710 t.max. 340°C 100-340°C gas inlet 1/2" gas outlet 3/8" thermocouple connection M9x1 pilot connection M10x1 probe ø 5mm probe L 68mm capillary pipe 1050mm probe type type B1 pressure controller no pressure regulator mbar gland nut ignition gas no

spare parts for 101132

GEV No.	101053	Ref. No.	837119	
---------	--------	----------	--------	--

 magnet unit T1: M9x1 T2: M24x1 L 45mm ø 17mm suitable for Minisit

GEV No.	102102	Ref. No.	837111	
---------	--------	----------	--------	--

 probe 100-340°C probe ø 5mm probe L 68mm capillary pipe 1750mm t.max. 340°C oven/grill probe type type B1 suitable for MINISIT 710

accessories for 101132

GEV No.	100809	Ref. No.	—	
---------	--------	----------	---	--

 O-ring EPDM thickness 2mm ID ø 21mm Qty 1 pcs

GEV No.	100904	Ref. No.	—	
---------	--------	----------	---	--

 locking screw M10x1 for pipe ø 4mm Qty 1 pcs

GEV No.	100905	Ref. No.	—	
---------	--------	----------	---	--

 locking screw M10x1 for pipe ø 6mm Qty 1 pcs

GEV No.	101054	Ref. No.	—	
---------	--------	----------	---	--

 magnet unit T1: M10x1 T2: M24x1 L 45mm ø 17mm suitable for Minisit

GEV No.	101136	Ref. No.	835729	
---------	--------	----------	--------	--

 piezoelectric igniter suitable for Minisit with cover cap ømm connection F6.3x0.8

GEV No.	101137	Ref. No.	—	
---------	--------	----------	---	--

 cover cap without piezoelectric igniter

GEV No.	101267	Ref. No.	—	
---------	--------	----------	---	--

 reducer IT 3/8" ET 1/2" L 21mm

accessories for		101132		
GEV No.	101268	Ref. No.	—	
	gas connection thread 3/8" angled with O-ring MINISIT 710			
GEV No.	101269	Ref. No.	—	
	gas connection thread 1/2" angled with O-ring MINISIT 710			
GEV No.	101270	Ref. No.	—	
	screw connection IT 3/8" ET 3/8" L 28mm			
GEV No.	101272	Ref. No.	—	
	screw connection IT 1/2" ET 3/8" L 57mm			
GEV No.	101273	Ref. No.	—	
	olive for pipe ø 12mm L 9.5mm brass Qty 1 pcs suitable for universal			
GEV No.	101274	Ref. No.	—	
	olive for pipe ø 16mm Qty 1 pcs			
GEV No.	101275	Ref. No.	—	
	union screw thread 1/2" for pipe ø 16mm Qty 1 pcs			
GEV No.	101276	Ref. No.	—	
	union screw thread 3/8" tube ø 12mm Qty 1 pcs			
GEV No.	110068	Ref. No.	835721	
	knob suitable for Minisit ø 37mm			

accessories

probes



GEV No.	102102	Ref. No.	837111	
---------	--------	----------	--------	--

description
probe 100-340°C probe ø 5mm probe L 68mm capillary pipe 1750mm t.max. 340°C oven/grill probe type type B1 suitable for MINISIT 710

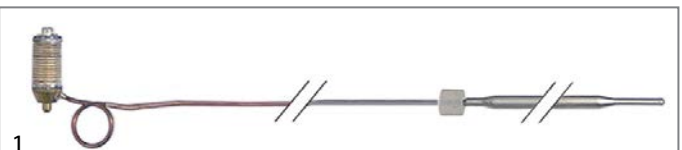

GEV No.	102118	Ref. No.	863801	
---------	--------	----------	--------	--

description
probe 110-190°C probe ø 6mm probe L 102mm capillary pipe 1050mm t.max. 190°C fryer probe type type A3 suitable for MINISIT 710

accessories for 102118

GEV No.	100820	Ref. No.	—	
---------	--------	----------	---	--

 gland duct ET M14x1.5 IT M10x0.75 probe ø max. 6.5mm WS 22



PEL

24ST series



GEV No.	101076	Ref. No.	401201
description	gas thermostat PEL type 24ST 120-320°C gas inlet M20x1.5 (tube ø 12mm) bypass nozzle ø 0.35mm gas outlet M20x1.5 (tube ø 12/10mm) thermocouple connection M9x1 pilot connection M10x1 capillary pipe 1200mm probe ø 6mm probe L 100mm shaft ø 10x8mm shaft L 27/17mm shaft flat upper		
spare parts for	101076		
	GEV No.	100455	Ref. No. —
	bypass nozzle type PEL23/24 bore ø 0.35mm thread M8x0.5		
	GEV No.	101058	Ref. No. —
	magnet unit L 39mm D1 ø 15.4mm D2 ø 13.5mm suitable for PEL22/EGA24197 standard		
	GEV No.	106200	Ref. No. —
	nut thread M9x1 suitable for PEL 24/255		
accessories for	101076		
	GEV No.	100908	Ref. No. —
	union screw thread M10x1 for pipe ø 4mm Qty 1 pcs		
	GEV No.	100909	Ref. No. —
	union screw thread M10x1 for pipe ø 6mm Qty 1 pcs		
	GEV No.	101246	Ref. No. —
	olive for pipe ø 4mm Qty 1 pcs		
	GEV No.	101248	Ref. No. —
	olive for pipe ø 12mm Qty 1 pcs suitable for PEL		
	GEV No.	101249	Ref. No. 835325
	olive for pipe ø 10mm Qty 1 pcs		
	GEV No.	101250	Ref. No. —
	union nut thread M20x1.5 for pipe ø 10mm		
	GEV No.	101251	Ref. No. —
	union nut thread M20x1.5 for pipe ø 12mm		
	GEV No.	101286	Ref. No. —
	olive ID ø 6mm Qty 1 pcs		
	GEV No.	110079	Ref. No. —
	knob dial plate gas thermostat 1-8 silver		
	GEV No.	110080	Ref. No. —
	knob ø 70mm shaft ø 10x8mm shaft flat universal		

25ST series



GEV No.	101172	Ref. No.	401251
description	gas thermostat PEL type 25ST 100-300°C gas inlet M16x1.5 (tube ø 10mm) bypass nozzle ø 0.35mm gas outlet M16x1.5 (tube ø 10/8mm) thermocouple connection M9x1 pilot connection M10x1 capillary pipe 1200mm probe ø 6mm probe L 100mm shaft ø 8x6.5mm shaft L 21/15mm shaft flat upper		
spare parts for	101172		
	GEV No.	100259	Ref. No. —
	bypass nozzle type PEL22 bore ø 0.35mm thread M6x0.5		
	GEV No.	101060	Ref. No. 835337
	magnet unit standard L 39mm D1 ø 15.4mm D2 ø 11mm suitable for PEL20-21/JUNKERS/EGA		
	GEV No.	106200	Ref. No. —
	nut thread M9x1 suitable for PEL 24/255		
accessories for	101172		
	GEV No.	100908	Ref. No. —
	union screw thread M10x1 for pipe ø 4mm Qty 1 pcs		
	GEV No.	100909	Ref. No. —
	union screw thread M10x1 for pipe ø 6mm Qty 1 pcs		
	GEV No.	101246	Ref. No. —
	olive for pipe ø 4mm Qty 1 pcs		
	GEV No.	101278	Ref. No. —
	olive for pipe ø 10mm Qty 1 pcs		
	GEV No.	101286	Ref. No. —
	olive ID ø 6mm Qty 1 pcs		
	GEV No.	101300	Ref. No. —
	union nut thread M16x1.5 tube ø 10mm		
	GEV No.	101450	Ref. No. —
	olive for pipe ø 8mm L 12.7mm Qty 1 pcs ED ø 10mm		
	GEV No.	101451	Ref. No. —
	union nut thread M16x1.5 tube ø 8mm		
	GEV No.	110079	Ref. No. —
	knob dial plate gas thermostat 1-8 silver		
	GEV No.	110081	Ref. No. —
	knob ø 70mm shaft ø 8x6.5mm shaft flat universal		



ignition parts

pilot burners

SIT

100 series

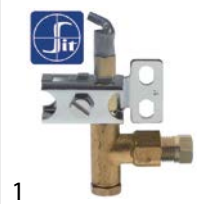

1

GEV No.	106901	Ref. No.	837201 899969
description	pilot burner SIT type 100 series 1 flame nozzle ø 0.2mm gas connection 6mm		
spare parts for	106901		
	GEV No.	100854	Ref. No. —
pilot burner bracket double			
	GEV No.	100916	Ref. No. —
compression spring for pilot burner Qty 1 pcs			
	GEV No.	100917	Ref. No. —
gasket for pilot burner Qty 1 pcs aluminium			
	GEV No.	100918	Ref. No. —
screw for pilot burner			
accessories for	106901		
	GEV No.	100904	Ref. No. —
locking screw M10x1 for pipe ø 4mm Qty 1 pcs			
	GEV No.	100905	Ref. No. —
locking screw M10x1 for pipe ø 6mm Qty 1 pcs			
	GEV No.	102110	Ref. No. —
pilot tube copper pipe ø 4mm thickness 1mm L 3000mm			
	GEV No.	102111	Ref. No. —
pilot tube copper pipe ø 6mm thickness 1mm L 3000mm			
	GEV No.	102742	Ref. No. —
pilot burner nozzle LPG code 25 bore ø 0.25mm Qty 1 pcs			



1

GEV No.	106906	Ref. No.	837221
description	pilot burner SIT type 100 series 3 flames nozzle ø 0.2mm gas connection 6mm		
spare parts for	106906		
	GEV No.	100245	Ref. No. 837297
pilot burner nozzle LPG code 20 bore ø 0.2mm Qty 1 pcs thread M8x0.75			



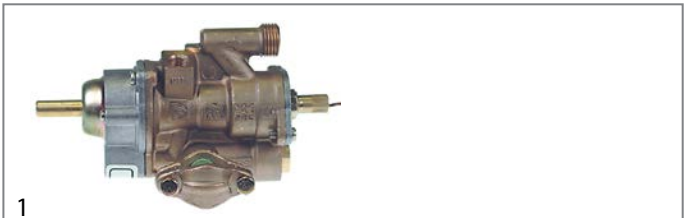













Table continues overleaf











1

GEV No.	101901	Ref. No.	401261
description	gas thermostat PEL type 25ST 50-300°C gas inlet pipe flange ø21mm bypass nozzle ø 0.35mm gas outlet M16x1.5 (tube ø 10/8mm) thermocouple connection M9x1 pilot connection M10x1 capillary pipe 1200mm probe ø 6mm probe L 100mm shaft ø 8x6.5mm shaft L 21/15mm shaft flat upper		
spare parts for	101901		
	GEV No.	100259	Ref. No. —
bypass nozzle type PEL22 bore ø 0.35mm thread M6x0.5			
	GEV No.	101060	Ref. No. 835337
magnet unit standard L 39mm D1 ø 15.4mm D2 ø 11mm suitable for PEL20-21/JUNKERS/EGA			
	GEV No.	106200	Ref. No. —
nut thread M9x1 suitable for PEL 24/25S			
accessories for	101901		
	GEV No.	100908	Ref. No. —
union screw thread M10x1 for pipe ø 4mm Qty 1 pcs			
	GEV No.	100909	Ref. No. —
union screw thread M10x1 for pipe ø 6mm Qty 1 pcs			
	GEV No.	101246	Ref. No. —
olive for pipe ø 4mm Qty 1 pcs			
	GEV No.	101278	Ref. No. —
olive for pipe ø 10mm Qty 1 pcs			
	GEV No.	101286	Ref. No. —
olive ID ø 6mm Qty 1 pcs			
	GEV No.	101300	Ref. No. —
union nut thread M16x1.5 tube ø 10mm			
	GEV No.	101450	Ref. No. —
olive for pipe ø 8mm L 12.7mm Qty 1 pcs ED ø 10mm			
	GEV No.	101451	Ref. No. —
union nut thread M16x1.5 tube ø 8mm			
	GEV No.	110079	Ref. No. —
knob dial plate gas thermostat 1-8 silver			
	GEV No.	110081	Ref. No. —
knob ø 70mm shaft ø 8x6.5mm shaft flat universal			



spare parts for 106906	
	GEV No. 100855 Ref. No. — pilot burner bracket triple
	GEV No. 100885 Ref. No. — air mixing sleeve for pilot burner Qty 1 pcs
	GEV No. 100916 Ref. No. — compression spring for pilot burner Qty 1 pcs
	GEV No. 100917 Ref. No. — gasket for pilot burner Qty 1 pcs aluminium
	GEV No. 100918 Ref. No. — screw for pilot burner
	GEV No. 107162 Ref. No. — pilot burner cap SIT 3 flames Hmm Lmm Qty 1 pcs
	GEV No. 107701 Ref. No. — pilot burner bottom part SIT 100 series nozzle ø 0.2mm
accessories for 106906	
	GEV No. 100245 Ref. No. 837297 pilot burner nozzle LPG code 20 bore ø 0.2mm Qty 1 pcs thread M8x0.75
	GEV No. 100246 Ref. No. — pilot burner nozzle natural gas bore ø 0.35mm Qty 1 pcs thread M8x0.75
	GEV No. 100904 Ref. No. — locking screw M10x1 for pipe ø 4mm Qty 1 pcs
	GEV No. 100905 Ref. No. — locking screw M10x1 for pipe ø 6mm Qty 1 pcs
	GEV No. 102110 Ref. No. — pilot tube copper pipe ø 4mm thickness 1mm L 3000mm
	GEV No. 102111 Ref. No. — pilot tube copper pipe ø 6mm thickness 1mm L 3000mm
	GEV No. 107171 Ref. No. — pilot burner nozzle SIT natural/liquid gas bore ø 0.25mm Qty 1 pcs
	GEV No. 107700 Ref. No. — pilot burner bottom part SIT 100 series nozzle ø 0.25mm
	GEV No. 107702 Ref. No. — pilot burner bottom part SIT 100 series nozzle ø 0.35mm

accessories			
pilot burner brackets			
producer-specific			
			
1			
GEV No.	105457	Ref. No.	831841
description	pilot burner bracket suitable for 100 series		
accessories for	105457		
	GEV No. 105454	Ref. No.	828125
burner cap ø 90mm with central hole			
	GEV No. 105455	Ref. No.	827345
burner head for burner cap ø 90mm			
	GEV No. 105456	Ref. No.	827665+829591 827665+829593
burner holder for burner cap ø 90/115mm H 122mm with mixing sleeve			

			
1			
GEV No.	105460	Ref. No.	831837
description	pilot burner bracket suitable for 100 series		
accessories for	105460		
	GEV No. 105456	Ref. No.	827665+829591 827665+829593
burner holder for burner cap ø 90/115mm H 122mm with mixing sleeve			
	GEV No. 105458	Ref. No.	828131
burner cap ø 115mm with central hole			
	GEV No. 105459	Ref. No.	827351
burner head for burner cap ø 115mm			













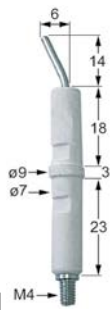

			
1			
GEV No.	105464	Ref. No.	831847
description	pilot burner bracket suitable for 100 series		
accessories for	105464		
	GEV No. 105461	Ref. No.	828137 828137/1
burner cap ø 135mm with central hole			
	GEV No. 105462	Ref. No.	827357 827357/1
burner head for burner cap ø 135mm			





Table continues overleaf













accessories for	105464			
	GEV No.	105463	Ref. No.	827661+829589
	burner holder for burner cap ø 135mm H 102mm with mixing sleeve			

pilot burner nozzles			
			
GEV No.	100245	Ref. No.	837297
description	pilot burner nozzle LPG code 20 bore ø 0.2mm Qty 1 pcs thread M8x0.75		

ignition electrodes			
			
GEV No.	100706	Ref. No.	835911
description	ignition electrode connection M4 Qty 1 pcs		



140 - 145 -150 series				
				
GEV No.	100126	Ref. No.	865881	
description	pilot burner SIT type 140 series 1 flame nozzle ømm gas connectionmm			
accessories for	100126			
	GEV No.	100204	Ref. No.	—
	pilot burner nozzle SIT LPG code 14 bore ø 0.18/0.20mm Qty 1 pcs suitable for 140 series			
	GEV No.	100205	Ref. No.	—
	pilot burner nozzle SIT LPG code 19 bore ø 0.23/0.26mm Qty 1 pcs suitable for SIT 150 series			
	GEV No.	100206	Ref. No.	—
	pilot burner nozzle SIT natural gas code 36 bore ø 0.60/0.55mm Qty 1 pcs suitable for SIT 150 series			
	GEV No.	100207	Ref. No.	—
	pilot burner nozzle SIT natural gas code 27 bore ø 0.40/0.38mm suitable for SIT 140 series			
	GEV No.	100216	Ref. No.	—
	pilot burner nozzle SIT natural gas code 38 bore ø 0.45mm Qty 1 pcs suitable for SIT 150 series			
	GEV No.	100701	Ref. No.	835915
	ignition electrode connection M4 Qty 1 pcs			
	GEV No.	100897	Ref. No.	—
	olive for pipe ø 4mm Qty 1 pcs for pilot burner			
	GEV No.	100898	Ref. No.	—
	olive for pipe ø 6mm Qty 1 pcs for pilot burner			

accessories for	100126			
	GEV No.	100906	Ref. No.	—
	screw connection thread M10x1 for ignition electrode brass Qty 1 pcs WS 10			
	GEV No.	100907	Ref. No.	—
	screw connection thread M10x1 Qty 1 pcs type SEF 1 ømm for thermocouple			
	GEV No.	100908	Ref. No.	—
	union screw thread M10x1 for pipe ø 4mm Qty 1 pcs			
	GEV No.	100909	Ref. No.	—
	union screw thread M10x1 for pipe ø 6mm Qty 1 pcs			

				
GEV No.	107114 ¹	Ref. No.	837223	
description	pilot burner SIT type 140 series 2 flames nozzle ømm gas connectionmm			
spare parts for	107114			
	GEV No.	100907	Ref. No.	—
	screw connection thread M10x1 Qty 1 pcs type SEF 1 ømm for thermocouple			
accessories for	107114			
	GEV No.	100204	Ref. No.	—
	pilot burner nozzle SIT LPG code 14 bore ø 0.18/0.20mm Qty 1 pcs suitable for 140 series			
	GEV No.	100205	Ref. No.	—
	pilot burner nozzle SIT LPG code 19 bore ø 0.23/0.26mm Qty 1 pcs suitable for SIT 150 series			
	GEV No.	100206	Ref. No.	—
	pilot burner nozzle SIT natural gas code 36 bore ø 0.60/0.55mm Qty 1 pcs suitable for SIT 150 series			
	GEV No.	100207	Ref. No.	—
	pilot burner nozzle SIT natural gas code 27 bore ø 0.40/0.38mm suitable for SIT 140 series			
	GEV No.	100216	Ref. No.	—
	pilot burner nozzle SIT natural gas code 38 bore ø 0.45mm Qty 1 pcs suitable for SIT 150 series			
	GEV No.	100701	Ref. No.	835915
	ignition electrode connection M4 Qty 1 pcs			
	GEV No.	100801	Ref. No.	—
	gasket for pilot burner Qty 1 pcs			
	GEV No.	100897	Ref. No.	—
	olive for pipe ø 4mm Qty 1 pcs for pilot burner			
	GEV No.	100898	Ref. No.	—
	olive for pipe ø 6mm Qty 1 pcs for pilot burner			
	GEV No.	100906	Ref. No.	—
	screw connection thread M10x1 for ignition electrode brass Qty 1 pcs WS 10			
	GEV No.	100908	Ref. No.	—
	union screw thread M10x1 for pipe ø 4mm Qty 1 pcs			

¹incl. thermocouple fitting
Table continues overleaf



accessories for	107114		
	GEV No.	100909	Ref. No. —
	union screw thread M10x1 for pipe ø 6mm Qty 1 pcs		
	GEV No.	102110	Ref. No. —
	pilot tube copper pipe ø 4mm thickness 1mm L 3000mm		
	GEV No.	102111	Ref. No. —
	pilot tube copper pipe ø 6mm thickness 1mm L 3000mm		

160 series			
	1		
GEV No.	100056	Ref. No.	898969
description	pilot burner SIT type 160 series 3 flames nozzle ømm gas connectionmm		
spare parts for	100056		
	GEV No.	100907	Ref. No. —
	screw connection thread M10x1 Qty 1 pcs type SEF 1 ømm for thermocouple		
accessories for	100056		
	GEV No.	100202	Ref. No. —
	pilot burner nozzle natural gas code 41 Qty 1 pcs nozzle ø 0.41mm		
	GEV No.	100203	Ref. No. —
	pilot burner nozzle LPG code 25 Qty 1 pcs nozzle ø 0.25mm		
	GEV No.	100701	Ref. No. 835915
	ignition electrode connection M4 Qty 1 pcs		
	GEV No.	100801	Ref. No. —
	gasket for pilot burner Qty 1 pcs		
	GEV No.	100869	Ref. No. —
	pilot burner nozzle natural gas code 51 Qty 1 pcs suitable for 160 series nozzle ø 0.51mm		
	GEV No.	100870	Ref. No. —
	olive for pipe ø 4mm Qty 1 pcs suitable for 160 series for pilot burner		
	GEV No.	100906	Ref. No. —
	screw connection thread M10x1 for ignition electrode brass Qty 1 pcs WS 10		
	GEV No.	100908	Ref. No. —
	union screw thread M10x1 for pipe ø 4mm Qty 1 pcs		
	GEV No.	100909	Ref. No. —
	union screw thread M10x1 for pipe ø 6mm Qty 1 pcs		
	GEV No.	101287	Ref. No. —
	olive for pipe ø 6mm Qty 1 pcs		
	GEV No.	102110	Ref. No. —
	pilot tube copper pipe ø 4mm thickness 1mm L 3000mm		
	GEV No.	102111	Ref. No. —
	pilot tube copper pipe ø 6mm thickness 1mm L 3000mm		

accessories for	100056		
	GEV No.	107650	Ref. No. —
	pilot burner nozzle SIT LPG code 30 Qty 1 pcs		























POLIDORO			
pilot burners			
	1		
GEV No.	100051	Ref. No.	863981
description	pilot burner POLIDORO 3 flames code gas connectionmm		
spare parts for	100051		
	GEV No.	100907	Ref. No. —
	screw connection thread M10x1 Qty 1 pcs type SEF 1 ømm for thermocouple		
accessories for	100051		
	GEV No.	100000	Ref. No. —
	pilot burner nozzle POLIDORO LPG code 22 bore ø 0.22mm Qty 1 pcs		
	GEV No.	100208	Ref. No. —
	pilot burner nozzle POLIDORO LPG code 20 bore ø 0.2mm Qty 1 pcs		
	GEV No.	100209	Ref. No. —
	pilot burner nozzle POLIDORO natural gas code 40 bore ø 0.4mm Qty 1 pcs		
	GEV No.	100701	Ref. No. 835915
	ignition electrode connection M4 Qty 1 pcs		
	GEV No.	100906	Ref. No. —
	screw connection thread M10x1 for ignition electrode brass Qty 1 pcs WS 10		
	GEV No.	100907	Ref. No. —
	screw connection thread M10x1 Qty 1 pcs type SEF 1 ømm for thermocouple		
	GEV No.	100908	Ref. No. —
	union screw thread M10x1 for pipe ø 4mm Qty 1 pcs		
	GEV No.	100909	Ref. No. —
	union screw thread M10x1 for pipe ø 6mm Qty 1 pcs		
	GEV No.	102110	Ref. No. —
	pilot tube copper pipe ø 4mm thickness 1mm L 3000mm		
	GEV No.	102111	Ref. No. —
	pilot tube copper pipe ø 6mm thickness 1mm L 3000mm		
	GEV No.	102508	Ref. No. —
	union screw thread M10x1 for pipe ø 4mm Qty 5 pcs		
	GEV No.	102509	Ref. No. —
	union screw thread M10x1 for pipe ø 6mm Qty 5 pcs		
	GEV No.	102699	Ref. No. —
	pilot burner nozzle POLIDORO natural gas code 25.2 bore ø 2x0.25mm Qty 1 pcs 2 bores		

Table continues overleaf

accessories for		100051	
	GEV No.	102795	Ref. No. —
olive for pipe ø 4mm Qty 1 pcs			
	GEV No.	102797	Ref. No. —
olive for pipe ø 6mm Qty 1 pcs			
	GEV No.	106703	Ref. No. —
pilot burner nozzle POLIDORO natural gas code 27.2 bore ø 2x0.27mm Qty 1 pcs			
	GEV No.	106704	Ref. No. —
pilot burner nozzle POLIDORO LPG code 16.2 bore ø 2x0.16mm Qty 1 pcs			
	GEV No.	106763	Ref. No. —
pilot burner nozzle POLIDORO natural gas code 27.2A bore ø 2x0.27mm Qty 1 pcs			
	GEV No.	106859	Ref. No. —
pilot burner nozzle POLIDORO LPG code 24 bore ø 0.24mm Qty 1 pcs			

electrodes

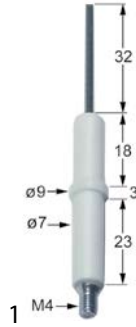
	GEV No.	100701	Ref. No.	835915
description ignition electrode connection M4 Qty 1 pcs				
accessories for 100701				
	GEV No.	100906	Ref. No.	—
screw connection thread M10x1 for ignition electrode brass Qty 1 pcs WS 10				

	GEV No.	100706	Ref. No.	835911
description ignition electrode connection M4 Qty 1 pcs				

ignition cables



pre-assembled cables

	1		
GEV No.	100176	Ref. No.	835905
description ignition cable cable length 1000mm connection ø2.4mm / ø4mm permanent temperature 200°C			



	1		
GEV No.	100026	Ref. No.	835901
description ignition cable cable length 1000mm connection ø4mm / F6.3mm			

piezoelectric igniters

mounting diameter 22mm

	1		
GEV No.	100013	Ref. No.	835733
description piezoelectric igniter body plastic blowing mounting ø 22mm connection ø2.4mm cable lengthmm			
accessories for 100013			
	GEV No.	100023	Ref. No. —
female bullet size 2.3mm 0.5-1.5mm ² CuZn t.max. 125°C Qty 20 pcs			

miscellaneous

	1		
GEV No.	nla ¹	Ref. No.	835729
description piezoelectric igniter suitable for Minisit with cover cap ømm connection F6.3x0.8			
spare parts for 101136			
	GEV No.	100001	Ref. No. —
piezoelectric igniter suitable for Minisit connection F6.3x0.8 ømm			

¹no longer available

ignition switches

	1		
GEV No.	107783	Ref. No.	835925
description ignition switch for battery type AA 1.5V mounting ø 22mm built-in depth 68mm connection F 2.8 mounting distancemm dimensions 98x58x35mm outputs 1			



thermocouples

plug-in thermocouples

plug-in thermocouples standard

with barrel socket ø6(6.5)mm

thermocouples SIT

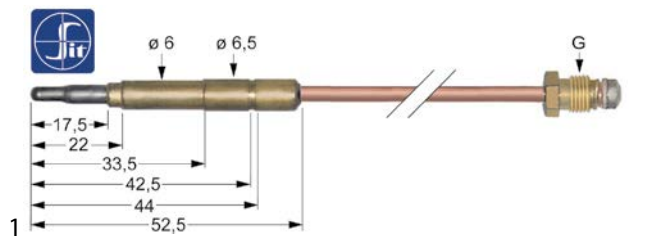

GEV No.	107612	Ref. No.	837253
description	thermocouple SIT M9x1 L 1000mm plug connection ø6.0(6.5)mm		

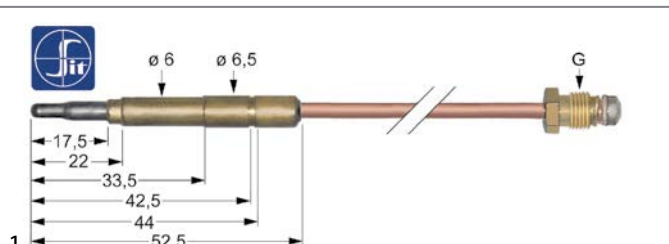

GEV No.	107606	Ref. No.	837233
description	thermocouple SIT M9x1 L 320mm plug connection ø6.0(6.5)mm		

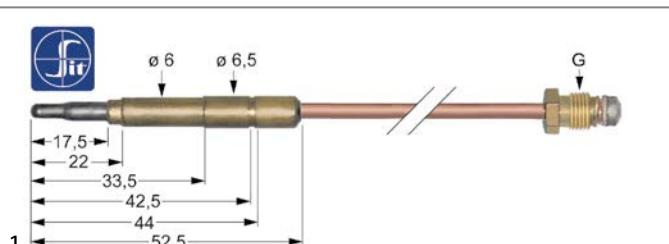

GEV No.	107608	Ref. No.	837243
description	thermocouple SIT M9x1 L 500mm plug connection ø6.0(6.5)mm		

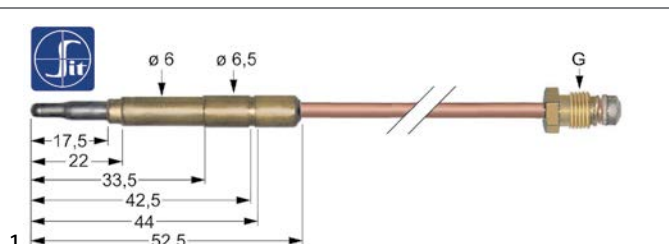

GEV No.	107609	Ref. No.	837243
description	thermocouple SIT M9x1 L 600mm plug connection ø6.0(6.5)mm		

extensions



GEV No.	102013	Ref. No.	837261
description	thermocouple extension thread M9x1 L 500mm		

accessories for	102013			
	GEV No.	101261	Ref. No.	—
	thermocouple fitting thread M9x1 Qty 1 pcs			

gas burners

hob burners

producer-specific hob burners

OFFCAR

serie 700, 900 (old)

	1		
GEV No.	104444	Ref. No.	827451
description	burner cap ø 105mm		

	1		
GEV No.	104445	Ref. No.	827405
description	burner cap ø 130mm		

	1		
GEV No.	104443	Ref. No.	827505
description	burner cap ø 85mm		

700, 900 (new) series

	1		
GEV No.	105458	Ref. No.	828131
description	burner cap ø 115mm with central hole		

accessories for	105458		
------------------------	--------	--	--

	GEV No.	105456	Ref. No.	827665+829591 827665+829593
	burner holder for burner cap ø 90/115mm H 122mm with mixing sleeve			





	GEV No.	105459	Ref. No.	827351
	burner head for burner cap ø 115mm			





	GEV No.	105460	Ref. No.	831837
	pilot burner bracket suitable for 100 series			







			
1			
GEV No.	105461	Ref. No.	828137 828137/1
description	burner cap ø 135mm with central hole		
accessories for	105461		
	GEV No.	105462	Ref. No. 827357 827357/1
	burner head for burner cap ø 135mm		
	GEV No.	105463	Ref. No. 827661+829589
	burner holder for burner cap ø 135mm H 102mm with mixing sleeve		
	GEV No.	105464	Ref. No. 831847
	pilot burner bracket suitable for 100 series		

			
1			
GEV No.	105462	Ref. No.	827357 827357/1
description	burner head for burner cap ø 135mm		
accessories for	105462		
	GEV No.	105461	Ref. No. 828137 828137/1
	burner cap ø 135mm with central hole		
	GEV No.	105463	Ref. No. 827661+829589
	burner holder for burner cap ø 135mm H 102mm with mixing sleeve		
	GEV No.	105464	Ref. No. 831847
	pilot burner bracket suitable for 100 series		

			
1			
GEV No.	105454	Ref. No.	828125
description	burner cap ø 90mm with central hole		
accessories for	105454		
	GEV No.	105455	Ref. No. 827345
	burner head for burner cap ø 90mm		
	GEV No.	105456	Ref. No. 827665+829591 827665+829593
	burner holder for burner cap ø 90/115mm H 122mm with mixing sleeve		
	GEV No.	105457	Ref. No. 831841
	pilot burner bracket suitable for 100 series		

			
1			
GEV No.	105455	Ref. No.	827345
description	burner head for burner cap ø 90mm		
accessories for	105455		
	GEV No.	105454	Ref. No. 828125
	burner cap ø 90mm with central hole		
	GEV No.	105456	Ref. No. 827665+829591 827665+829593
	burner holder for burner cap ø 90/115mm H 122mm with mixing sleeve		
	GEV No.	105457	Ref. No. 831841
	pilot burner bracket suitable for 100 series		

			
1			
GEV No.	105459	Ref. No.	827351
description	burner head for burner cap ø 115mm		
accessories for	105459		
	GEV No.	105456	Ref. No. 827665+829591 827665+829593
	burner holder for burner cap ø 90/115mm H 122mm with mixing sleeve		
	GEV No.	105458	Ref. No. 828131
	burner cap ø 115mm with central hole		
	GEV No.	105460	Ref. No. 831837
	pilot burner bracket suitable for 100 series		

			
1			
GEV No.	105463	Ref. No.	827661+829589
description	burner holder for burner cap ø 135mm H 102mm with mixing sleeve		
accessories for	105463		
	GEV No.	105461	Ref. No. 828137 828137/1
	burner cap ø 135mm with central hole		
	GEV No.	105462	Ref. No. 827357 827357/1
	burner head for burner cap ø 135mm		
	GEV No.	105464	Ref. No. 831847
	pilot burner bracket suitable for 100 series		





 <p>1</p>			
GEV No.	105456	Ref. No.	827665+829591 827665+829593
description	burner holder for burner cap ø 90/115mm H 122mm with mixing sleeve		
accessories for	105456		
	GEV No.	105454	Ref. No. 828125
	burner cap ø 90mm with central hole		
	GEV No.	105455	Ref. No. 827345
	burner head for burner cap ø 90mm		
	GEV No.	105457	Ref. No. 831841
	pilot burner bracket suitable for 100 series		

 <p>1</p>			
GEV No.	105467	Ref. No.	440059
description	drain tray L 560mm W 345mm		

accessories

reducers for pan supports

 <p>1</p>			
GEV No.	210050	Ref. No.	831733 Mod. RID9-7
description	reducer for pan support L 260mm W 260mm chrome-plated steel suitable for universal		

<p>reducers for pan supports</p>  <p>1</p>			
GEV No.	210050	Ref. No.	831733 Mod. RID9-7
description	reducer for pan support L 260mm W 260mm chrome-plated steel suitable for universal		

spillage trays

 <p>1</p>			
GEV No.	105465	Ref. No.	440081
description	drain tray L 380mm W 350mm for burner cap ø 110mm		

<p>spillage trays</p>  <p>1</p>			
GEV No.	105465	Ref. No.	440081
description	drain tray L 380mm W 350mm for burner cap ø 110mm		

 <p>1</p>			
GEV No.	105466	Ref. No.	440083
description	drain tray L 380mm W 350mm for burner cap ø 130mm		

 <p>1</p>			
GEV No.	105466	Ref. No.	440083
description	drain tray L 380mm W 350mm for burner cap ø 130mm		

			
1			
GEV No.	105467	Ref. No.	440059
description	drain tray L 560mm W 345mm		

bar burners

bar burners

 Image not available 1			
GEV No.	104441	Ref. No.	865861
description	bar burner		

			
1			
GEV No.	105474	Ref. No.	865851
description	bar burner 2 row L 370mm W 220mm ømm chargrill		

			
1			
GEV No.	105687	Ref. No.	865851
description	bar burner 2 row L 370mm W 220mm ømm H 50mm chargrill		

			
1			
GEV No.	105475	Ref. No.	865861
description	bar burner 2 row L 575mm W 225mm ømm H 45mm 11kW chargrill		

			
1			
GEV No.	105481	Ref. No.	FX30400060
description	bar burner ø 40mm Wmm Hmm L 325mm flange ø 61mm tilting bratt pan		

			
1			
GEV No.	105482	Ref. No.	FX30400050
description	bar burner ø 40mm Wmm Hmm L 396mm flange ø 61mm tilting bratt pan		

			
1			
GEV No.	105473	Ref. No.	841261
description	bar burner ø 40mm Wmm Hmm L 505mm griddle		

			
1			
GEV No.	105469	Ref. No.	841111
description	bar burner ø 50mm Wmm Hmm L 425mm flange ø 75mm flange width 71mm oven		

			
1			
GEV No.	105470	Ref. No.	841211
description	bar burner ø 50mm Wmm Hmm L 505mm flange ø 75mm flange width 71mm oven		



 <p>1</p>			
GEV No.	105471	Ref. No.	841219
description	bar burner ø 50mm Wmm Hmm L 610mm flange ø 75mm flange width 71mm oven		

 <p>1</p>			
GEV No.	105476	Ref. No.	841041 898963
description	bar burner ø 60mm Wmm Hmm L 258mm pasta cooker		

 <p>1</p>			
GEV No.	105477	Ref. No.	898961
description	bar burner ø 60mm Wmm Hmm L 385mm flange width 67mm flange length 67mm pasta cooker		

 <p>1</p>			
GEV No.	105639	Ref. No.	841091 898961
description	bar burner ø 60mm Wmm Hmm L 390mm 1-row with bolt bolt ø 10x45mm flange width 67mm flange length 67mm pasta cooker		

tube burners

 <p>1</p>			
GEV No.	105480	Ref. No.	862519
description	tubular burner L 295mm W 55mm H 70mm mounting pos. centre oval		

 <p>1</p>			
GEV No.	105479	Ref. No.	862513
description	tubular burner L 295mm W 55mm H 70mm mounting pos. left for fryer oval		

 <p>1</p>			
GEV No.	105478	Ref. No.	862511
description	tubular burner L 295mm W 55mm H 70mm mounting pos. right for fryer oval		

solid top burners

 <p>1</p>			
GEV No.	105468	Ref. No.	827981
description	solid top burner ø 120mm H 102mm L 340mm suitable for 700/900 series		

gas nozzles

main nozzles

gas nozzles M10x1

 <p>1</p>			
GEV No.	106631	Ref. No.	8293579
description	gas injector thread M10x1 WS 11 bore ø 1.9mm inner peaked		

 <p>1</p>			
GEV No.	106295	Ref. No.	829314
description	gas injector thread M10x1 WS 11 bore ø 0.9mm code 90		



GEV No.	100793	Ref. No.	829317-150
description	gas injector thread M10x1 WS 11 bore ø 1.5mm		



GEV No.	106493	Ref. No.	829317-175
description	gas injector thread M10x1 WS 11 bore ø 1.75mm		



GEV No.	106440	Ref. No.	829317-185
description	gas injector thread M10x1 WS 11 bore ø 1.85mm		



GEV No.	106498	Ref. No.	829317-195
description	gas injector thread M10x1 WS 11 bore ø 1.95mm		

pilot burner nozzles

pilot burner nozzles SIT

100 series

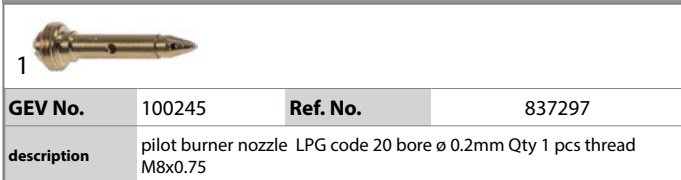

GEV No.	100245	Ref. No.	837297
description	pilot burner nozzle LPG code 20 bore ø 0.2mm Qty 1 pcs thread M8x0.75		

auxiliary gas parts

screw connections

olives

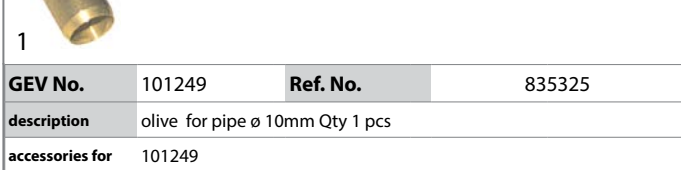

GEV No.	101249	Ref. No.	835325
description	olive for pipe ø 10mm Qty 1 pcs		
accessories for	101249		

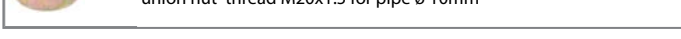

GEV No.	101250	Ref. No.	—
description	union nut thread M20x1.5 for pipe ø 10mm		

equipment-specific units

for dough mixers

flange bearings



GEV No.	693112	Ref. No.	FX20400012
description	flange bearing type UCF204 shaft ø 20mm 4 hole flange hole distance 64mm H 33mm flange length 86mm flange width 86mm hole ø 12mm flange F204 ball bearing UC204G2 FH 25.5mm		

for convection ovens/combi-steamers

door mechanics

miscellaneous



GEV No.	900708	Ref. No.	4614005 814811
description	frame for door seal		

for tilting bratt pans

spindles

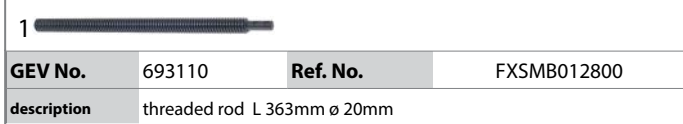

GEV No.	693110	Ref. No.	FXSMB012800
description	threaded rod L 363mm ø 20mm		

miscellaneous



GEV No.	693111	Ref. No.	FXSMB013000
description	spindle		



GEV No.	693114	Ref. No.	FXSMB063000
description	spindle		



			
1			
GEV No.	693109	Ref. No.	FXSC02200
description	threaded bush for tilting bratt pan brass thread TR20x4		

for boiling pans

filters

			
1			
GEV No.	514503	Ref. No.	FX-30700122
description	drain filter for kettle size 76x145mm		

miscellaneous

			
1			
GEV No.	540639	Ref. No.	FX10400058
description	extension		

for ovens

housing and bezels

			
1			
GEV No.	901358	Ref. No.	814821
description	frame W 371mm L 997mm L-shape stainless steel		

knobs

producer-specific knobs

OFFCAR

			
1			
GEV No.	110985	Ref. No.	401401
description	knob gas tap with ignition flame t.max.°C° ø 70mm shaft ø 10x8mm shaft flat lower black		

			
1			
GEV No.	110980	Ref. No.	401405
description	knob gas tap with ignition flame t.max.°C° ø 70mm shaft ø 8x6.5mm shaft flat lower black		

			
1			
GEV No.	110983	Ref. No.	401411
description	knob gas thermostat 1-8 ø 70mm shaft ø 10x8mm shaft flat upper black		

			
1			
GEV No.	110982	Ref. No.	401415 (old version)
description	knob gas thermostat 1-8 t.max.°C° ø 70mm shaft ø 8x6.5mm shaft flat upper black		

			
1			
GEV No.	112806	Ref. No.	401415
description	knob gas thermostat t.max. 300°C 100-300°C ø 70mm shaft ø 8x6.5mm shaft flat upper black		

		
1		
GEV No.	110988	Ref. No. 401469
description	knob switch 0-1 t.max.°C ø 70mm shaft ø 6x4.6mm shaft flat upper black	

		
1		
GEV No.	110989	Ref. No. 401461
description	knob thermostat t.max. 200°C ø 70mm shaft ø 6x4.6mm shaft flat upper temperature range 140-200°C	

		
1		
GEV No.	110992	Ref. No. 401477
description	knob switch 0-1-2 ø 70mm shaft ø 6x4.6mm shaft flat upper	

		
1		
GEV No.	110990	Ref. No. 401421
description	knob thermostat t.max. 300°C ø 70mm shaft ø 6x4.6mm shaft flat upper black temperature range 50-300°C	

		
1		
GEV No.	110986	Ref. No. 401451
description	knob switch 4-position ø 70mm shaft ø 6x4.6mm shaft flat upper black	

		
1		
GEV No.	110987	Ref. No. 401431
description	knob thermostat t.max. 90°C ø 70mm shaft ø 6x4.6mm shaft flat upper black temperature range 15-90°C rotation 270°	

		
1		
GEV No.	110981	Ref. No. 401441
description	knob switch 7-position ø 70mm shaft ø 6x4.6mm shaft flat upper black	

		
1		
GEV No.	110991	Ref. No. 401483
description	knob thermostat ø 70mm shaft ø 6x4.6mm shaft flat lower	

handles and hand wheels

hand wheels

hand wheels

		
1		
GEV No.	692443	Ref. No. FXSMB013600
description	hand wheel ø 150mm D1 ø 38mm bore ø 14mm thread groove width 6mm groove depth 13mm mounting distance 18mm L1 40mm L2 43mm handle length 65mm with folding handle	





1

GEV No.	692430	Ref. No.	FXSMB063600
description	hand wheel \varnothing 200mm D1 \varnothing 50mm bore \varnothing 20mm thread groove width 6mm groove depth 13mm mounting distance 30mm L1 47mm L2 50mm handle length 90mm with folding handle		

hinges

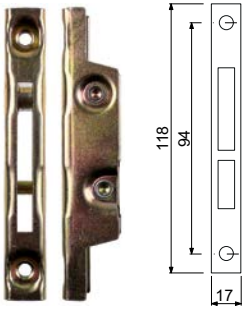
oven hinges





1

GEV No.	700001	Ref. No.	844589
description	opposite support L 118mm W 17mm mounting distance 94mm		



1

GEV No.	700006	Ref. No.	844581	
description	oven hinge mounting distance 173mm mounting distance 2 105mm lug mounting 14mm lever length 120mm groove distance 11mm spring thickness 3.5mm mounting ear position left spring length 112mm W 25mm			
accessories for	700006			
	GEV No.	700001	Ref. No.	844589
	opposite support L 118mm W 17mm mounting distance 94mm			
	GEV No.	700007	Ref. No.	844583
description	oven hinge mounting distance 173mm mounting distance 2 105mm lug mounting 14mm lever length 120mm groove distance 11mm spring thickness 3.5mm mounting ear position right spring length 112mm W 25mm			

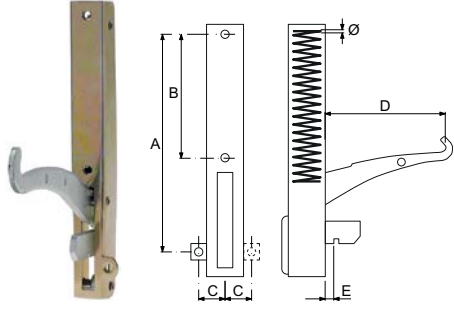

1

GEV No.	700007	Ref. No.	844583	
description	oven hinge mounting distance 173mm mounting distance 2 105mm lug mounting 14mm lever length 120mm groove distance 11mm spring thickness 3.5mm mounting ear position right spring length 112mm W 25mm			
accessories for	700007			
	GEV No.	700001	Ref. No.	844589
	opposite support L 118mm W 17mm mounting distance 94mm			

fittings for catering equipment

inlet taps



1

GEV No.	693108	Ref. No.	FX30200005
description	shut-off valve		

drain taps

brass



drain taps





1

GEV No.	540275	Ref. No.	FX30200198	
description	drain tap 2" IT with union nut A 90mm B 151mm B1 80mm chrome-plated brass			
spare parts for	540275			
	GEV No.	540214	Ref. No.	—
	handle ID \varnothing 6mm L 145mm			

Table continues overleaf

accessories for	540275		
	GEV No.	529484	Ref. No. —
	flat gasket fibre ED ø 58mm ID ø 50mm thickness 2mm Qty 1 pcs		
	GEV No.	542448	Ref. No. —
	gasket silicone 60x49x2 for drain tap 2"		





GEV No.	540276	Ref. No.	FX30200196
description	drain tap connection with union nut thread 1 1/2"		
spare parts for	540276		
	GEV No.	532374	Ref. No. —
	O-ring silicone thickness 5.34mm ID ø 43.82mm Qty 10 pcs		
accessories for	540276		
	GEV No.	514251	Ref. No. —
	gasket fibre ED ø 46mm ID ø 38mm thickness 2mm Qty 1 pcs		



GEV No.	540649	Ref. No.	FX30200198
description	drain tap connection with union nut thread 2"		

accessories

	GEV No.	540956	Ref. No.	FX10500062
description	gasket for drain tap hose ext. ø 46mm ID ø 38mm H 2mm			

	GEV No.	540959	Ref. No.	FX10500060
description	gasket for drain tap hose ext. ø 60mm ID ø 50mm H 2mm			

	GEV No.	540958	Ref. No.	FX10200002
description	rosette for drain tap hose ext. ø 120mm ID ø 60mm H 13mm			

	GEV No.	540955	Ref. No.	FX10200004
description	rosette for drain tap thread 1 1/2"			

	GEV No.	540954	Ref. No.	FX-10400009
description	screw-in socket for drain tap thread 1 1/2"			

	GEV No.	540957	Ref. No.	FX10400006
description	screw-in socket for drain tap thread 2" L 120mm			



test taps

test taps

GEV No.	540818	Ref. No.	FX30200050
description	test tap thread 1/2" ET W 88mm W1 38mm		

safety fittings

accessories

GEV No.	540835	Ref. No.	FX10400061	
description	screw cap thread 3/4"			
spare parts for	540835			
	GEV No.	513016	Ref. No.	—
	O-ring EPDM thickness 3.53mm ID ø 26.58mm Qty 1 pcs			
accessories for	540835			
	GEV No.	513016	Ref. No.	—
	O-ring EPDM thickness 3.53mm ID ø 26.58mm Qty 1 pcs			

baskets

fryer baskets

OFFCAR

GEV No.	970362	Ref. No.	863066
description	fryer basket L1 310mm W1 145mm H1 120mm chrome-plated steel		

gaskets

refrigeration gaskets

plug-in gaskets

profile 9794

We offer custom-made gaskets for this profile

GEV No.	901955	Ref. No.	G504330653
description	refrigeration gasket profile 9794 W 408mm L 630mm plug size L1 653mm W1 433mm external size		

gaskets for heated units

door seals

GEV No.	901357 ¹	Ref. No.	844445
description	door seal profile 2255 L 1000mm W 360mm external size 3-sided		

¹3-sided, long side open

GEV No.	900707 ¹	Ref. No.	844491
description	door seal profile 2255 W 300mm L 570mm external size Qty 1 3-piece		

¹3-sided, long side open

GEV No.	901359 ¹	Ref. No.	844441
description	door seal profile 2255 W 570mm L 300mm external size 3-sided		

¹3-sided, long side open

GEV No.	901158	Ref. No.	862055
description	door seal profile 2402 W 640mm L 740mm		

GEV No.	900834	Ref. No.	862073
description	door seal profile 2402 W 670mm L 750mm plug size Qty 1		

GEV No.	902409	Ref. No.	862075
description	door seal profile 2714 Qty supplied by meter suitable for GIORIK		

door seals with fixing hook

GEV No.	900256	Ref. No.	844453
description	door seal W 540mm H 200mm		

GEV No.	900399	Ref. No.	844454
description	door seal W 540mm with mounting clip H 190mm		

GEV No.	900411	Ref. No.	844475
description	door seal W 750mm with mounting clip H 280mm		

O-rings

EPDM

GEV No.	511937	Ref. No.	FX10500110
description	O-ring EPDM thickness 3.53mm ID ø 28.17mm Qty 1 pcs		

GEV No.	532118	Ref. No.	862053
description	O-ring EPDM thickness 3.53mm ID ø 55.56mm Qty 10 pcs		

GEV No.	510408	Ref. No.	FX10500100
description	O-ring EPDM thickness 5.34mm ID ø 47mm Qty 1 pcs		

Viton

GEV No.	510245	Ref. No.	862051 ACQ6507 ACQ6508
description	O-ring Viton thickness 3.53mm ID ø 50.8mm Qty 1 pcs		

transmission technology and ball bearings



ball bearings

flange bearings

GEV No.	693112	Ref. No.	FX20400012
description	flange bearing type UCF204 shaft ø 20mm 4 hole flange hole distance 64mm H 33mm flange length 86mm flange width 86mm hole ø 12mm flange F204 ball bearing UC204G2 FH 25.5mm		











manometers

			
1			
GEV No.	541062	Ref. No.	FX30300022
description	manometer ø 63mm pressure range 0 up to 1bar connection marking adjustable kettle thread 1/4"		
spare parts for	541062		
	GEV No.	541130	Ref. No. —
glass panel ø 58mm thickness 2mm			

valves and tank inlets

shut-off valves

universal

			
1			
GEV No.	693107	Ref. No.	FX30200008
description	shut-off valve connection 1/2" 1/2" cold total length 54mm L1 27mm L2 30mm marking blue rosette thread G2 26x19G connection ø M4x0.7 ITmm		
spare parts for	693107		
	GEV No.	514085	Ref. No. —
rosette connection 26x19G chrome-plated total lengthmm mounting pos.			
	GEV No.	514086	Ref. No. —
hexagonal nut connection 26x19G brass total lengthmm mounting pos. H 6mm WS 34 Qty 1 pcs			
	GEV No.	540672	Ref. No. —
gasket suitable for tap head			
	GEV No.	547711	Ref. No. —
hood handle shaft intake ø 8mm marking blue metal H2 21mm D1 ø 33mm type D suitable for MONOLITH shaft length H1 8mm			
	GEV No.	548168	Ref. No. —
star handle connection hot total lengthmm mounting pos. ø 57mm marking red			
	GEV No.	548169	Ref. No. —
star handle connection cold total lengthmm mounting pos. chrome-plated ø 57mm			
accessories for	693107		
	GEV No.	514086	Ref. No. —
hexagonal nut connection 26x19G brass total lengthmm mounting pos. H 6mm WS 34 Qty 1 pcs			

			
1			
GEV No.	693105	Ref. No.	898871
description	shut-off valve connection 1/2" 1/2" straight total length 45mm mounting pos.		

accessories

			
1			
GEV No.	694767	Ref. No.	401683
description	handle plastic thread 7.5 ø 46.5mm H 35mm WS black shaft star-shaped		

accessories

turning handles

			
1			
GEV No.	691461	Ref. No.	833485
description	handle suitable for intake tap		

			
1			
GEV No.	693106	Ref. No.	833463+833467 898873
description	star handle intake tap		

consumables

fuses

fine fuses

			
1			
GEV No.	358597	Ref. No.	40200084
description	fine fuse size ø5x20mm 0.5A slow-acting rated 250V Qty 10 pcs		



			
1			
GEV No.	358605	Ref. No.	40200080 FX-40200084
description	fine fuse size ø5x20mm 3.15A slow-acting rated 250V Qty 10 pcs		

B	
bar burners	26
C	
cam switches	9
consumables	35
contactors	11
control thermostats	6, 8
D	
door seals	33
door seals with fixing hook	34
F	
fine fuses	35
foil heating elements	5
fuses	12, 35
G	
gas burners	23
gas nozzles	27
gas taps	12
gas thermostats	15
gaskets for heated units	33
H	
heating cartridges	4
heating elements	3
heating elements for fryers	3
heating elements for griddles	3
heating elements for ovens	3
heating elements for pasta cookers	4
heating elements for tilting bratt pan	4
hob burners	23
hot plates	6
I	
ignition cables	22
ignition switches	22
immersion heating elements	5
indicator lights	10
indicator lights (complete)	10
L	
lamps	10
M	
microswitches	9
O	
O-rings	34
oven hinges	31
P	
piezoelectric igniters	22
pilot burners	18
plug-in gaskets	33
probes	11
R	
refrigeration gaskets	33
rocker/momentary rocker switches	9
rotary switches	10
S	
safety thermostats	7
shut-off valves	35
solid top burners	27
switches and momentary switches	9
T	
temperature probes	11
thermocouples	23
thermostats	6
tube burners	27
U	
universal probes	11
V	
valves and tank inlets	35