



GAS COMPONENTS



ELECTRIC COMPONENTS



WATER TECHNOLOGY



MECHANICAL COMPONENTS



TOOLS

Spare parts suitable for

OBEL

Find the complete and up-to-date range of products in our GEV Webshop



Manufacturer catalogue

The most important spare parts and accessories arranged clearly for every manufacturer

- ✓ Complete product range and all appliance data always up to date in the GEV Webshop
- ✓ Alphabetical Index at the end of the catalogue

GEV Webshop

www.gev-online.co.uk

www.gev-online.com



- 🔍 Add to Favourites
- 🔍 Sign In with email address and usual password
- 🔍 Easy-order – place several items in your basket at the same time
- 🔍 Quick Item search – no login needed



switches and momentary switches

rocker/momentary rocker switches

30x22mm



GEV No.	301002	Ref. No.	EB079 EB079T MQ79
description	rocker switch mounting measurements 30x22mm orange 2NO 250V 16A illuminated 0-I connection male faston 6.3mm ambient temperature max. 85/125°C protection IP65		
accessories for	301002		
	GEV No.	301036	Ref. No. —
	protective cover internal size 30x22mm for rocker switch mounting measurementsmm		



GEV No.	301001	Ref. No.	EB079
description	rocker switch mounting measurements 30x22mm red 2NO 250V 16A illuminated 0-I connection male faston 6.3mm ambient temperature max. 125/55°C protection IP65		
accessories for	301001		
	GEV No.	301036	Ref. No. —
	protective cover internal size 30x22mm for rocker switch mounting measurementsmm		

push/momentary push switches

ø15.2mm



GEV No.	346154	Ref. No.	EB076M
description	momentary push switch mounting ø 15.2mm black 1NO 250V 0.7A connection screw ambient temperature max. 85°C protection IP40		



GEV No.	346155	Ref. No.	EB076A EB077A
description	momentary push switch mounting ø 15.2mm red 1NC 250V 0.7A connection screw ambient temperature max. 85°C protection IP40		

microswitches

lever actuated



GEV No.	347270	Ref. No.	EB066MC EB068
description	microswitch with lever 250V 16A 1CO connection male faston 6.3mm L 22mm ambient temperature max. 120°C lever length 14.2mm		

pin-plunger actuated



GEV No.	346156	Ref. No.	EB066 EB066A EB066AC
description	microswitch 250V 16A 1CO connection male faston 6.3mm ambient temperature max. 125°C mounting distance 22mm with plunger black		

relays

power relays

with male contacts

female contact 4.8mm



GEV No.	380907	Ref. No.	EB073 MQ74ATT
description	power relays 230VAC 10A 3CO raster size 10mm plug-in connection 250V connection 4.8mm		



GEV No.	380355	Ref. No.	EB073 EB074T
description	power relays 400VAC 10A 3CO raster size 10mm plug-in connection 250V connection 4.8mm		



electronics

PCBs



1

GEV No.	400568	Ref. No.	J693/220
description	PCB		

motors

motors

for coffee grinders

complete



1

GEV No.	500240	Ref. No.	DF15
description	motor 300W 230V 50/60Hz 1 phase shaft length 47mm thread M8L 1400rpm type 102.000C ø 125mm H 200mm 0.3kW		



1

GEV No.	500241	Ref. No.	DF15
description	motor 90W 230V 50Hz 1 phase shaft ø 10mm shaft length 38mm thread M8L 1340rpm type C002801 ø 95mm H 160mm capacitor 5/6µF RPM 0.09kW		

components



1

GEV No.	500239	Ref. No.	EB73
description	motor 230V 50Hz 1 phase ø 100mm ID ø 65mm H 195mm shaft ø 16mm type T48		

condensators & interference suppression filters

operating capacitors

plastic



1

GEV No.	365014	Ref. No.	EB075
description	operating capacitor capacity 12.5µF 450V tolerance 5%Hz ambient temperature max. -25 to +85°C ø 35mm L 70mm M8 plastic connection male faston 6.3mm 45S.C3DS.12.5 protection		



1

GEV No.	365223	Ref. No.	EB075MG MQ75
description	operating capacitor capacity 16µF 400V tolerance 5% 50/60Hz ambient temperature max.°C ø 35mm L 70mm plastic connection F6.3 protection		



1

GEV No.	365126	Ref. No.	EB075MG (old version) MQ75 (old version)
description	operating capacitor capacity 16µF 400V tolerance 5% 50/60Hz ambient temperature max.°C ø 35mm L 70mm plastic protection		



1

GEV No.	365093	Ref. No.	DF75
description	operating capacitor capacity 6µF 400V tolerance 5% 50/60Hz ambient temperature max. -25 to +85°C ø 31.5mm L 55mm M8 plastic connection male faston 6.3mm protection		



equipment-specific units

for coffee grinders

grinding burrs

grinding burrs straight

standard



1

GEV No.	526216	Ref. No.	DF8
description	grinding burrs pair turn direction left D1 ø 50mm ID ø 30mm H 7.5mm tooth spacing 3mm hole ø 4.6mm bore ø 7.6mm mounting ø 38		



1

GEV No.	527229	Ref. No.	DF8
description	grinding burrs pair turn direction left D1 ø 50mm ID ø 31mm H 8mm tooth spacing 3mm hole ø 4.5mm bore ø 7.5mm mounting ø 40 suitable for RANCILIO, OBEL		



1

GEV No.	527233	Ref. No.	EB08
description	grinding burrs pair turn direction left D1 ø 63.5mm ID ø 37.5mm H 9mm tooth spacing 3mm hole ø 5.5mm bore ø 8.5mm mounting ø 50 straight suitable for OBEL, CARIMALI, BEZZERA, PAVONI		

grinding burrs holders



1

GEV No.	527264	Ref. No.	EB090
description	grinding burr holder type EB suitable for Obel equiv. no. EB090		



1

GEV No.	527265	Ref. No.	DF90
description	grinding burr holder type JUNIOR suitable for Obel equiv. no. DF90		

spillage trays



1

GEV No.	526354	Ref. No.	EB022
description	drain tray L 181mm W 154mm		

miscellaneous



1

GEV No.	526355	Ref. No.	DF85M
description	cover ø 98mm for setting ring		

dosing containers

dosing containers (complete)



1

GEV No.	527538	Ref. No.	DF71CC
description	dosing pump complete with lid		

spare parts for 527538



GEV No.	527341	Ref. No.	DF44
description	glass cylinder for dosing pump ø 109mm H 88mm plexiglas		



1

GEV No.	526365	Ref. No.	DF71C
description	dosing unit complete		



1

GEV No.	527537	Ref. No.	E71
description	dosing unit complete		

dosing container lids



1

GEV No.	527337	Ref. No.	EB051
description	lid for dosing container ø 113mm		

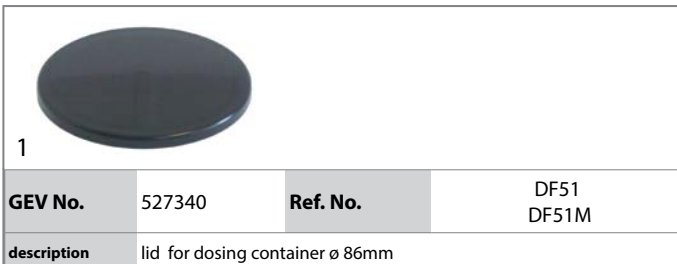

1

GEV No.	527340	Ref. No.	DF51 DF51M
description	lid for dosing container ø 86mm		

adjusting screws



1

GEV No.	527522	Ref. No.	DF48 EB048
description	adjusting screw for dosing container thread M8 L 47mm plastic		

springs

group 2



1

GEV No.	526344	Ref. No.	DF70
description	spring L 53mm W 40mm H 6mm thickness 1mm		

glass cylinders



1

GEV No.	527339	Ref. No.	EB094
description	glass cylinder		



1

GEV No.	527341	Ref. No.	DF44
description	glass cylinder for dosing pump ø 109mm H 88mm plexiglas		



1

GEV No.	527366	Ref. No.	9V504 EB094
description	glass cylinder for dosing pump ø 121mm H 116mm plexiglas		



levers

handles

			
1			
GEV No.	526362	Ref. No.	DF28
description	handle for lever L 37mm W 10mm H 17mm rubber		

			
1			
GEV No.	526363	Ref. No.	EB029A
description	handle for lever L 50mm W 10mm H 17mm rubber		

levers

			
1			
GEV No.	526356	Ref. No.	EB029P
description	lever left hole ø 17mm plastic		

			
1			
GEV No.	526357	Ref. No.	DF29
description	lever right for dosing container hole ø 17mm brass		

coffee presses

components

bolts

			
1			
GEV No.	526353	Ref. No.	EB045
description	bolt D1 ø 8mm D2 ø 12mm L 128mm T1: M8x1.25 T2: M8x1.25		

holders

			
1			
GEV No.	526358	Ref. No.	EB039P
description	bracket for coffee press H 74mm L 40mm plastic		

pressers

			
1			
GEV No.	527534	Ref. No.	E72 EB037
description	coffee press ø 56mm H 15.5mm thread M8		

buttons

			
1			
GEV No.	111308	Ref. No.	EB047
description	mushroom cap handle thread M8x1.25 handle ø 41mm L 25mm plastic black		

coffee presses

			
1			
GEV No.	527565	Ref. No.	N/A
description	coffee press		

			
1			
GEV No.	526346	Ref. No.	EB041
description	compression spring ø 10.7mm L 89mm wire gauge ø 0.8mm for coffee press		

automatic grinding

automatic grinding

			
1			
GEV No.	527338	Ref. No.	EB086
description	ring for dosing container ø 118mm H 19mm plastic		

sector plates

			
1			
GEV No.	527525	Ref. No.	EB060
description	sector plates		



1

GEV No.	527531	Ref. No.	DF60
description	sector plates		

ratches

ratches



1

GEV No.	526360	Ref. No.	EB092
description	ratchet for dosing unit \varnothing 29.7mm inner cone int. \varnothing 1 11.5mm int. \varnothing 2 15mm H 12mm brass		



1

GEV No.	526361	Ref. No.	DF92
description	ratchet for dosing unit \varnothing 29.7mm inner cone int. \varnothing 1 12mm int. \varnothing 2 15mm brass		

pins



1

GEV No.	526350	Ref. No.	EB056
description	pin for ratchet \varnothing 4mm D2 \varnothing 2.5mm L 20mm		

stars

central



1

GEV No.	527532	Ref. No.	DF59
description	star mounting pos. centre \varnothing 103mm hole \varnothing 8.2mm H 35mm		



1

GEV No.	527526	Ref. No.	EB059
description	star mounting pos. centre \varnothing 115mm		

upper



1

GEV No.	527530	Ref. No.	DF42
description	star mounting pos. upper		



1

GEV No.	527523	Ref. No.	EB042
description	star mounting pos. upper \varnothing 112mm hole \varnothing 22mm		

bottom



1

GEV No.	527533	Ref. No.	DF062 DF62
description	star mounting pos. lower \varnothing 103mm shaft \varnothing 8 shaft length 100mm thread M8		



1

GEV No.	527528	Ref. No.	EB062	
description	star mounting pos. lower \varnothing 115mm shaft \varnothing 8 shaft length 111mm thread M8			
accessories for	527528			
	GEV No.	111273	Ref. No.	DS43 EB043
	cotter pin \varnothing 1.3mm L 25mm			

accessories



1

GEV No.	527524	Ref. No.	EB050
description	brush L 80mm plastic		



adjustment mechanism

lockable adjustment



1

GEV No.	526343	Ref. No.	DF6
description	pressure pin for setting ring L 36mm W 18mm shaft ø 5mm shaft length 30mm		



1

GEV No.	526336	Ref. No.	EB06
description	pressure pin for setting ring L 36mm W 20mm shaft ø 5mm shaft length 30mm		

setting rings



1

GEV No.	527413	Ref. No.	EB053
description	setting ring suitable for Obel for EB equiv. no. EB053		



1

GEV No.	527414	Ref. No.	DF53
description	setting ring suitable for Obel for JUNIOR equiv. no. DF53		

accessories

stickers



1

GEV No.	526275	Ref. No.	MQ82
description	sticker for setting ring L 60mm W 10mm		

coffee beans containers

container lids



1

GEV No.	527333	Ref. No.	EB01
description	lid for coffee beans container ø 182mm		



1

GEV No.	527335	Ref. No.	DF1
description	lid for coffee beans container ø 182mm		

coffee beans containers



1

GEV No.	527336	Ref. No.	DF2
description	coffee beans container ø 125mm H 116mm seat ø 58mm		

spare parts for 527336



GEV No.	527335	Ref. No.	DF1
----------------	--------	-----------------	-----



lid for coffee beans container ø 182mm



1

GEV No.	527334	Ref. No.	EB02 G02
description	coffee beans container ø 185mm H 211mm seat ø 65mm		
spare parts for	527334		
	GEV No.	527333	Ref. No. EB01
	lid for coffee beans container ø 182mm		
	GEV No.	527567	Ref. No. —
	protection cap with magnet		

support for filter holder



1

GEV No.	527536	Ref. No.	DF33
description	bracket for filter holder L 66mm W 45mm H 17mm		



1

GEV No.	527535	Ref. No.	EB033
description	filter holder support for dosing pump		



1

GEV No.	526364	Ref. No.	EB033S MQ33
description	filter holder support for dosing unit L 140mm W 79mm H 41mm		

counters



1

GEV No.	526352	Ref. No.	EB054
description	counter suitable for Obel		

knobs

steam/water taps

accessories



1

GEV No.	111273	Ref. No.	DS43 EB043
description	cotter pin ø 1.3mm L 25mm		

handles and hand wheels

mushroom cap handles



1

GEV No.	111308	Ref. No.	EB047
description	mushroom cap handle thread M8x1.25 handle ø 41mm L 25mm plastic black		

equipment feet and end caps

screw-in feet



1

GEV No.	530773	Ref. No.	EB019
description	equipment foot thread M5 ø 19mm H 18mm		



1

GEV No.	526345	Ref. No.	EB019 / old version
description	equipment foot thread M5 thread L 5mm ø 20mm H 12.25mm Qty 1 pcs		



equipment feet with stem

 <p>1</p>			
GEV No.	526359	Ref. No.	DF19J
description	equipment foot push-in ø 13mm H 4mm mounting ø 10mm overall height 11mm rubber Qty 1 pcs		

springs

compression springs

 <p>1</p>			
GEV No.	526346	Ref. No.	EB041
description	compression spring ø 10.7mm L 89mm wire gauge ø 0.8mm for coffee press		

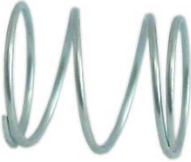
 <p>1</p>			
GEV No.	527527	Ref. No.	DF061 EB061
description	compression spring ø 28.9mm L 35mm wire gauge ø 1.9mm		

 <p>1</p>			
GEV No.	526347	Ref. No.	EB05
description	compression spring ø 4.5mm L 25mm wire gauge ø 0.55mm		

 <p>1</p>			
GEV No.	526349	Ref. No.	EB057
description	compression spring ø 4mm L 33mm wire gauge ø 0.3mm		

tension springs

 <p>1</p>			
GEV No.	526348	Ref. No.	EB055
description	tension spring ø 11mm total length 49mm wire gauge ø 1mm L1 30mm		

 <p>1</p>			
GEV No.	526351	Ref. No.	EB028
description	tension spring ø 5.2mm total length 51mm wire gauge ø 0.55mm L1 29mm		

fastening material

fasteners

cotter pins

 <p>1</p>			
GEV No.	111273	Ref. No.	DS43 EB043
description	cotter pin ø 1.3mm L 25mm		

C

condensators & interference suppression filters	4
cotter pins	11

F

fasteners	11
fastening material	11

M

microswitches	3
motors	4

O

operating capacitors	4
----------------------	---

P

push/momentary push switches	3
------------------------------	---

R

relays	3
rocker/momentary rocker switches	3

S

switches and momentary switches	3
---------------------------------	---