



GAS COMPONENTS



ELECTRIC COMPONENTS



WATER TECHNOLOGY



MECHANICAL COMPONENTS



TOOLS

Spare parts suitable for

NAYATI

Find the complete and up-to-date range of products in our GEV Webshop



Manufacturer catalogue

The most important spare parts and accessories arranged clearly for every manufacturer

- ✓ Complete product range and all appliance data always up to date in the GEV Webshop
- ✓ Alphabetical Index at the end of the catalogue

GEV Webshop

www.gev-online.co.uk

www.gev-online.com



- 🔍 Add to Favourites
- 🔍 Sign In with email address and usual password
- 🔍 Easy-order – place several items in your basket at the same time
- 🔍 Quick Item search – no login needed



induction

induction coils



GEV No.	403043	Ref. No.	PD425D-2
description	induction coils		

heating elements

heating elements for bain maries



GEV No.	418431	Ref. No.	PD411J
description	heating element 1000W 230V heating circuits 1 L 402mm L1 50mm W 246mm connection M4 connection length 20mm tube ø 8.2mm dry heating element L2 352mm H 27mm		

heating elements for fryers

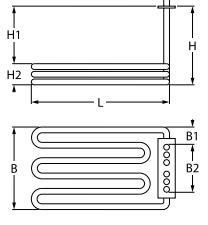

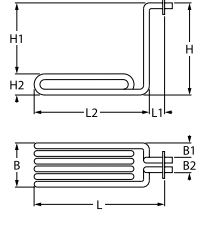

GEV No.	418432	Ref. No.	PD411L
description	heating element 6000W 230/400V heating circuits 3 L 275mm W 172mm H 161mm rectangular flange connection male faston 6.3mm fryer heaters W1 35mm W2 93mm H1 133mm H2 28mm hole distance 115mm hole ø 8mm flange length 136mm flange width 30mm		





GEV No.	415742	Ref. No.	PD.4118C
description	heating element 2300W 230V heating circuits 1 L 280mm W 90mm H 180mm L1 25mm L2 257mm W1 35mm W2 20mm H1 150mm H2 30mm windings 4 flange length 50mm flange width 20mm hole distance 40mm hole ø 5mm connection male faston 6.3mm tube ø 8.5mm rectangular flange fryer heaters		

heating elements for griddles



GEV No.	418498	Ref. No.	PD411K
description	heating element 1000W 230V heating circuits 1 L 472mm W 76mm H 38mm tube ø 8.5mm connection M4 connection length 27mm dry heating element		



GEV No.	418062	Ref. No.	SS2027
description	heating element 1000W 400V heating circuits 1 L 470mm W 78mm H 34mm tube ø 8.5mm connection M4 connection length 21mm connection distance 70mm dry heating element		



GEV No.	416668	Ref. No.	PD.4115A
description	heating element 1600W 230V heating circuits 1 L 366mm W 65mm H 62mm tube ø 8.5mm connection male faston 6.3mm dry heating element		

heating elements for chargrills



GEV No.	418428	Ref. No.	PD411T
description	heating element 1600W 230V heating circuits 1 L 471mm W 118mm H 94mm rectangular flange hole distance 75mm hole ø 6mm L1 55mm L2 416mm cable length 900mm flange length 134mm flange width 31mm tube ø 13x5mm dry heating element connection length 73mm		

bottom heaters





GEV No.	418429	Ref. No.	PD411P	
description	bottom heater 1800W 230V heating circuits 1 ø 196mm safety thermostat 250°C M5 mounting distance 180mm			
spare parts for	418429			
	GEV No.	375137	Ref. No.	—
	safety thermostat switch-off temp. 250°C 1-pole 16A probe ø 3.03mm probe L 160mm capillary pipe 880mm capillary pipe isolated 800mm gland nut probe SS with curved probe			



E-G-O



1

GEV No.	419008	Ref. No.	PD.4793
description	bottom heater 3000W 400V heating circuits 2 ø 196mm safety thermostat 250°C thermostat 128°C M5 H 180mm		
spare parts for	419008		
	GEV No.	375137	Ref. No.
	safety thermostat switch-off temp. 250°C 1-pole 16A probe ø 3.03mm probe L 160mm capillary pipe 880mm capillary pipe isolated 800mm gland nut probe SS with curved probe		
	GEV No.	375782	Ref. No.
	thermostat t.max. 128°C temperature range 30-128°C 1-pole 1NO 16A probe ø 3.03mm probe L 178mm capillary pipe 870mm capillary pipe isolated 800mm gland nut shaft ømm shaft L 23mm shaft position on upper rotation 270° outer switch 2NO with curved probe		

heating plates



1

GEV No.	418427	Ref. No.	PD411S PS.EH003
description	hot plate 1600W 230V heating circuits 1 cable length 320mm H 3mm L 360mm W 110mm		



1

GEV No.	419128	Ref. No.	PD.4113 PD.4113D PS. EH001-D
description	hot plate 2500W 400V heating circuits 1 cable length 1760mm H 3mm L 350mm W 125mm		



1



GEV No.	418433	Ref. No.	PD411R PD411RA PD411RB PS.EH002 PS.EH002-A
description	hot plate 2700W 230V heating circuits 1 cable length 1650mm L 360mm W 250mm		

ceramic heaters

245x60mm



1







GEV No.	415104	Ref. No.	PD.2300
description	ceramic emitter 1000W 230V cable beaded cord L 245mm W 60mm H 35mm		
spare parts for	415104		
	GEV No.	415109	Ref. No.
	spring clip		
accessories for	415104		
	GEV No.	415110	Ref. No.
	reflector L 245mm W 95mm H 31mm thickness 0.75mm hole ø 15x40mm		

immersion heating elements

with round flange ø47.5mm



1

GEV No.	415494	Ref. No.	PD.4119
description	heating element 4980W 230V heating circuits 3 mounting ø 47.5mm L 335mm W 30mm H 50mm round flange connection male faston 6.3mm immersion heater H1 35mm H2 15mm L1 30mm L2 45mm L3 260mm thermostat sleeves ø 6.5mm number of thermostat sleeves 1 length thermostat sleeves 215mm thermostat sleeve eccentric, clinging		
spare parts for	415494		
	GEV No.	532495	Ref. No.
	O-ring EPDM thickness 7mm ID ø 43mm Qty 1 pcs		
accessories for	415494		
	GEV No.	520235	Ref. No.
	3 hole flange hole distance 70.5mm perforation ø 6.5mm ID ø 53.5mm		
	GEV No.	520236	Ref. No.
	flange for heating element ID ø 50mm ED ø 90mm hole ø 6.5mm 3 holes		
	GEV No.	521012	Ref. No.
	gasket graphite ED ø 15mm ID ø 5mm thickness 1.2mm Qty 1 pcs		
	GEV No.	550002	Ref. No.
	tension strap H 10mm L 21mm W 10mm hole ø 6.5mm for heating element		
	GEV No.	550362	Ref. No.
	blind flange ø 64mm mounting ø 47.5mm		



radiation heaters

square

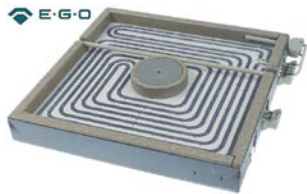

1

GEV No.	490009 ¹	Ref. No.	PD.2283
description	radiation heater L 300mm W 300mm 4000W 400V connections 3+2 square with pan detection EGO		
spare parts for	490009		
	GEV No.	499157	Ref. No. —
	protection pipe for temperature probe ceramic L 297mm ED ø 7mm ID ø 5mm		

¹with pan detection



1

GEV No.	416656	Ref. No.	PD2454
description	radiation heater rectangular 4000W 230V L 490mm W 245mm heating circuits 2 connections 2+2 IRCA		
For models:	MES 6-48		
spare parts for	416656		
	GEV No.	417727	Ref. No. —
	terminal L 20m W 8.2mm		

1-circuit



1

GEV No.	490131	Ref. No.	PD2281
description	radiation heater ø 250mm 2500W 400V heating circuits 1 energy regulation with temperature signalization with ribbon heater connections 2+2 connection type male faston 6.3mm EGO		

foil heating elements

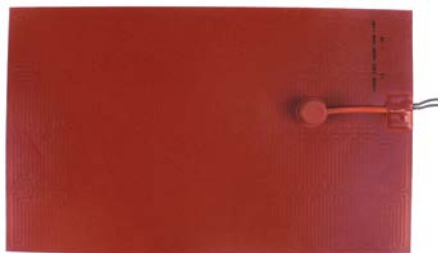

1

GEV No.	416406	Ref. No.	PD.4118D
description	foil heating element L 400mm W 240mm 1000W 230V t.max. 150°C with temperature limiter silicone cable length 2000mm thickness 1mm		

accessories

flange gaskets



1

GEV No.	520324	Ref. No.	PD.404S
description	counterflange ID ø 160mm ED ø 200mm hole distance 90/180mm hole ø 7mm SS for bottom heaters		
accessories for	520324		
	GEV No.	520323	Ref. No. PD.404F
	gasket ID ø 160mm ED ø 200mm hole distance 90/180mm hole ø 7mm silicone for bottom heaters		



1

GEV No.	520323	Ref. No.	PD.404F
description	gasket ID ø 160mm ED ø 200mm hole distance 90/180mm hole ø 7mm silicone for bottom heaters		

counterflanges



1

GEV No.	520324	Ref. No.	PD.404S
description	counterflange ID ø 160mm ED ø 200mm hole distance 90/180mm hole ø 7mm SS for bottom heaters		
accessories for	520324		
	GEV No.	520323	Ref. No. PD.404F
	gasket ID ø 160mm ED ø 200mm hole distance 90/180mm hole ø 7mm silicone for bottom heaters		



1

GEV No.	692186	Ref. No.	PD.C016
description	cover for heating element L 510mm W 371mm H 12mm hole ø 9mm aluminium for pipe ø 10mm		

hot plates

square & rectangular

with radiused edge



1

GEV No.	490065	Ref. No.	PD411M
description	hot plate dimensions 220x220mm 2000W 230V with spill ring connection 4 screw clamps protector no square		

energy regulators

EGO

1-circuit



1

GEV No.	380015	Ref. No.	PD412J
description	energy regulator 230V 13A single-circuit turn direction right shaft ø 6x4.6mm shaft L 23mm mounting thread M4 power release 6-100% no. 50.57021.010		



1

GEV No.	380014	Ref. No.	PD412L
description	energy regulator 400V 7A single-circuit turn direction left shaft ø 6x4.6mm mounting thread M4 no. 50.57030.010		

thermostats

control and safety thermostats

EGO

control thermostats

55.34_ series



1

GEV No.	375097	Ref. No.	GS2228 PD2228
description	thermostat t.max. 195°C temperature range 95-195°C 3-pole 3NO 16A probe ø 6mm probe L 117mm capillary pipe 1780mm capillary pipe isolated 1400mm gland nut M9x1 shaft ø 6x4.6mm shaft L 23mm shaft position upper rotation 270°		

safety thermostats

55.14_ series

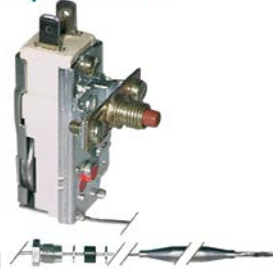

1

GEV No.	375260	Ref. No.	PD.412H
description	safety thermostat switch-off temp. 240°C 1-pole 16A probe ø 6mm probe L 77mm capillary pipe 1280mm capillary pipe isolated 1050mm gland nut M10x1 probe SS		

55.31_ series



1

GEV No.	390168	Ref. No.	GS2229 PD2229
description	safety thermostat switch-off temp. 230°C 3-pole 3NC 20A probe ø 6mm probe L 239mm capillary pipe 830mm capillary pipe isolated- mm gland nut M9x1 probe SS		



55.32_series

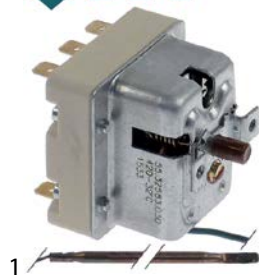

GEV No.	376052	Ref. No.	N/A
description	safety thermostat switch-off temp. 420°C 3-pole 3NC probe ø 3.9mm probe L 228mm capillary pipe 1190mm capillary pipe isolated 960mm gland nut shaft ømm		

55.33_series



GEV No.	375781	Ref. No.	PD412F
description	safety thermostat switch-off temp. 275°C 3-pole 20A probe ø 4mm probe L 157mm capillary pipe 870mm capillary pipe isolated 350mm gland nut probe SS		

56._series





GEV No.	375688	Ref. No.	GS2154
description	safety thermostat switch-off temp. 230°C 1-pole 1NC 0.5A probe ø 6mm probe L 77mm capillary pipe 700mm capillary pipe isolatedmm gland nut M9x1 probe SS		

control thermostats with operation switch

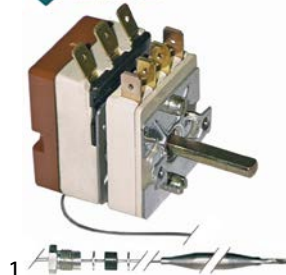
55.13_series



GEV No.	375406	Ref. No.	PD412B
description	thermostat t.max. 110°C temperature range 30-110°C 1-pole 1CO 16A probe ø 6mm probe L 113mm capillary pipe 2380mm capillary pipe isolated 1700mm gland nut M9x1 shaft ø 6x4.6mm shaft L 18mm shaft position upper rotation 270° outer switch 2NO		
accessories for	375406		
	GEV No.	110545	Ref. No. —
	knob dial plate silver thermostat t.max. 110°C 30-110°C rotation 310° ED ø 59mm ID ø 45.5mm		
	GEV No.	112173	Ref. No. —
	knob universal ø 62mm black without adaptor/dial plate		
	GEV No.	112311	Ref. No. —
	knob adapter shaft ø 6x4.6mm L 0mm with spring		

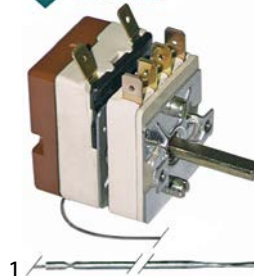

GEV No.	375408	Ref. No.	PD412C SS2624
description	thermostat t.max. 320°C temperature range 50-320°C 1-pole 1NO 16A probe ø 3.03mm probe L 160mm capillary pipe 1150mm capillary pipe isolatedmm gland nut shaft ø 6x4.6mm shaft L 23mm shaft position upper rotation 270° outer switch 2NO		

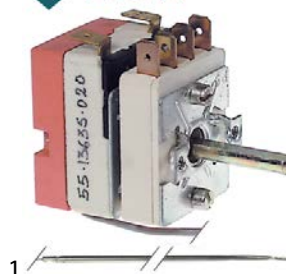

GEV No.	375780	Ref. No.	PD412E
description	thermostat temperature range 120-190°C 1-pole 1NO 16A probe ø 3mm probe L 248mm capillary pipe 1730mm capillary pipe isolated 1660mm gland nut shaft ø 6x4.6mm shaft L 23mm shaft position upper rotation 270° outer switch 2NO		



55.34_series

E-G-O

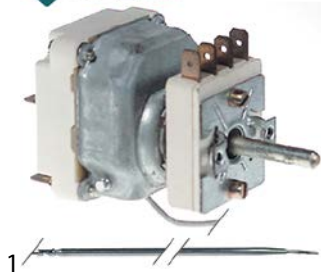

GEV No.	375690	Ref. No.	SS2028
----------------	--------	-----------------	--------

description thermostat t.max. 300°C temperature range 50-300°C 3-pole 3NO 16A probe ø 3.03mm probe L 160mm capillary pipe 1480mm capillary pipe isolated 350mm gland nut shaft ø 6x4.6mm shaft L 24mm shaft position upper rotation 270° outer switch 2NO

E-G-O

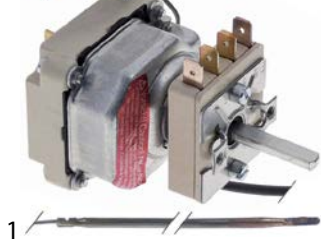

GEV No.	375140	Ref. No.	PD.412K
----------------	--------	-----------------	---------

description thermostat t.max. 650°C temperature range 50°C/50-600°C/70-650°C 3-pole 3NO 16A probe ø 4mm probe L 228mm capillary pipe 1200mm capillary pipe isolated 1200mm gland nut shaft ø 6x4.6mm shaft L 23mm shaft position left rotation 318° outer switch 2NO

INVENSYS / ROBERTSHAW

safety thermostats

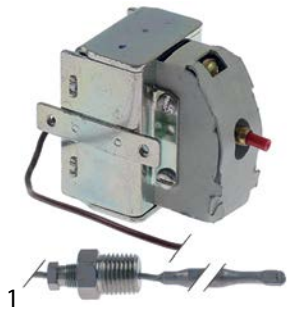

GEV No.	580045	Ref. No.	GS.2183
----------------	--------	-----------------	---------

description safety thermostat switch-off temp. 232°C 1-pole 1COA probe ø 6.4mm probe L 120mm capillary pipe 760mm capillary pipe isolated mm gland nut 3/8" NPT shaft ømm probe SS screw connection 1/4" 450°F

switches and momentary switches
rocker/momentary rocker switches

30x22mm



GEV No.	301001	Ref. No.	GS.2753
----------------	--------	-----------------	---------

description rocker switch mounting measurements 30x22mm red 2NO 250V 16A illuminated 0-1 connection male faston 6.3mm ambient temperature max. 125/55°C protection IP65

accessories for	301001
------------------------	--------



GEV No.	301036	Ref. No.	—
----------------	--------	-----------------	---

protective cover internal size 30x22mm for rocker switch mounting measurementsmm

float switches

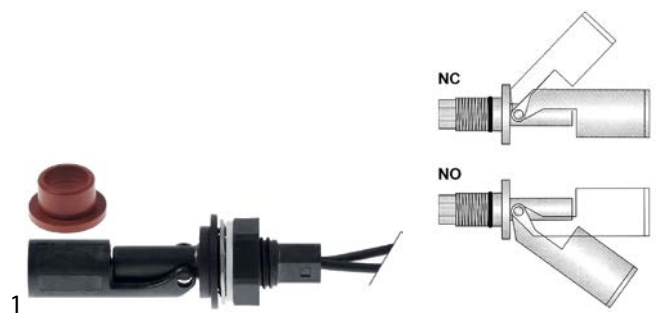

GEV No.	347494	Ref. No.	PD.404Q PD.404Q3
----------------	--------	-----------------	---------------------

description float switch thread M16x1.5 1NO or 1NC ø 17mm L 88mm mounting ø 16mm 250V 1A cable cable length 520mm temp.-resist. -20 up to +105°C

cam switches

on/off

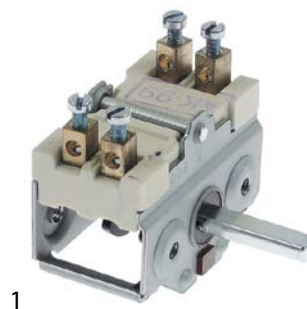

GEV No.	300020	Ref. No.	PD2247
----------------	--------	-----------------	--------

description cam switch 4 operating positions 2NO sequence 0-1-0-1 16A shaft ø 6x4.6mm shaft L 23mm connection screw ceramic

accessories for	300020
------------------------	--------



GEV No.	110135	Ref. No.	—
----------------	--------	-----------------	---

rosette knob up to ø 52mm



GEV No.	110231	Ref. No.	—
----------------	--------	-----------------	---

knob switch 0-1-0-1 t.max.°C ø 50mm shaft ø 6x4.6mm shaft flat upper black



operation switches



GEV No.	301095	Ref. No.	PD2455
description	cam switch 4 operating positions operation switch sequence 0-1-2-3 shaft \varnothing 6x4.6mm connection male faston 3-pole ambient temperature max. 270°C		
For models:	MES 6-48		

magnetic switches

36x13mm

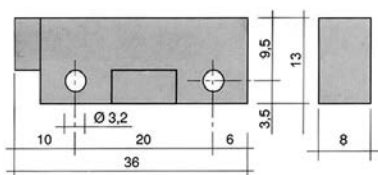

GEV No.	345118 ¹	Ref. No.	PD424D
description	magnetic switch L 36mm W 13mm 1NO 250V 1A P max. 50W connection cable cable length 980mm		
accessories for	345118		
	GEV No.	345399	Ref. No. —
	magnet \varnothing 3.3mm L 40mm H 8mm W 13mm hole distance 30mm M3		

¹with coded connector

lamps

indicator lights

indicator lights (complete)

\varnothing 16mm

with screw socket



GEV No.	359835	Ref. No.	PD414K SS2617
description	indicator light \varnothing 16mm 230V green connection male faston 6.3mm		
For models:	MES 6-48		
accessories for	359835		
	GEV No.	550559	Ref. No. —
	nut thread M16x1 H 5.5mm WS 19		

GEV No.	359831	Ref. No.	PD414Q
description	indicator light \varnothing 16mm 230V red connection male faston 6.3mm		
accessories for	359831		
	GEV No.	550559	Ref. No. —
	nut thread M16x1 H 5.5mm WS 19		

GEV No.	359834	Ref. No.	PD414J PD414JB SS2625
description	indicator light \varnothing 16mm 230V yellow connection male faston 6.3mm temp.-resist. 120°C		
For models:	MES 6-48		
accessories for	359834		
	GEV No.	550559	Ref. No. —
	nut thread M16x1 H 5.5mm WS 19		

GEV No.	359830	Ref. No.	PD.414GA
description	indicator light \varnothing 16mm 400V yellow connection male faston 6.3mm		
accessories for	359830		
	GEV No.	550559	Ref. No. —
	nut thread M16x1 H 5.5mm WS 19		

with plug-in socket

GEV No.	359166	Ref. No.	SS2077
description	indicator light \varnothing 16mm 230V white		

GEV No.	359168	Ref. No.	PD414G SS2078
description	indicator light \varnothing 16mm 400V green		

GEV No.	359169	Ref. No.	PD414H SS2079
description	indicator light \varnothing 16mm 400V yellow		



timers

programme timers





1

GEV No.	360082	Ref. No.	P195JE2L130
description	timer FIBER P19 engines 1 chambers 2 operation time 20min 230V shaft ømm shaft Lmm manuf. no. P195JE2L130		
spare parts for	360082		
	GEV No.	360674	Ref. No. —
	motor kit pinion ø 6.8mm teeth 15 230V voltage AC 50/60Hz turn direction counterclockwise motor ø 48mm H 18.5mm motor type UDS40NE1RNZ165 cable length 150mm with holder		

mechanical timers



1

GEV No.	350018	Ref. No.	PD.2453
description	timer M2 2-pole operation time 60min impulse mechanical 2CO at 250V 16A permanent position yes shaft ø 6x4.6mm shaft 6x4.6mm shaft L 23mm mounting distance 28mm connection lateral		
accessories for	350018		
	GEV No.	110366	Ref. No. —
	knob switch zero mark t.max.°C°C ø 44mm shaft ø 6x4.6mm shaft flat upper black		
	GEV No.	111202	Ref. No. —
	dial plate graduation 60min permanent position yes rotation 0-300° ø 60mm timers knob ø 45mm with permanent position		

relays

power relays

with bracket mounting



1

GEV No.	380403	Ref. No.	PD424C
description	power relays FINDER 230VAC 16A 3CO connection F6.3 bracket mounting manuf. no. 62.83.8.230.0500		

plug-in/print relays



1

GEV No.	380941	Ref. No.	PD.2476
description	print relay 250VAC 2CO at 250V 8A connection pins raster size 5mm		

electronics

PCBs



1

GEV No.	400074	Ref. No.	PD424F
description	PCB pyroceram range 400V		

pressure switches

for coffee machines

ø 38mm



1

GEV No.	541020	Ref. No.	PD2095
description	pressure control ø 38mm pressure range 0.5-1.2bar coffee machine parts pressure connection vertical preset at 1bar 16A 250V connection 1/4" pressure connection 1/4" GAS		



electric accessories

terminals

porcelain clamps



1

GEV No.	550113	Ref. No.	PD409A
description	porcelain terminal block 3-pole 2.5mm ² hole distance 14mm max. 32A max 250V L 39mm W 23mm H 20mm mounting distance 14mm Qty 1 pcs		

connection terminals with screw/faston connections



1

GEV No.	550110	Ref. No.	PD409B
description	power terminal block 5-pole max. 40A max 250V connection M6/ male faston 6.3mm temp.-resist. 130°C		
For models:	MES 6-48		



gas taps

PEL

21S series



1

GEV No.	101397	Ref. No.	GS3875	
description	gas tap PEL type 21S gas inlet M16x1.5 (tube ø 10mm) bypass nozzle ø 0.35mm gas outlet M16x1.5 (tube ø 10/8mm) thermocouple connection M9x1 pilot connection M10x1 shaft ø 8x6.5mm shaft L 22/15mm shaft flat lower			
For models:	NGER 13-130, NGER 13-70, NGER 15-60, NGER 20-60, NGER 20-70, NGER 4-60, NGER 7-70, NGER 9-60, NGETL 5-50, NGWR10-85W1S1, NGWR16-85W2S1, NGWR18-85W2S2, NGWR24-85W3S2, NGWT 3-55/SN, NGWT 7-55/SN			
spare parts for	101397			
	GEV No.	100408	Ref. No.	—
	bypass nozzle type PEL20/21 bore ø 0.35mm thread M5x0.5			
	GEV No.	101060	Ref. No.	GS8036P
	magnet unit standard L 39mm D1 ø 15.4mm D2 ø 11mm suitable for PEL20-21/JUNKERS/EGA			
	GEV No.	101206	Ref. No.	—
	gas tap front part shaft ø 8x6.5mm shaft L 22/15mm shaft flat upper/lower suitable for PEL21			
	GEV No.	101231	Ref. No.	—
	thermocouple nut T1: M9x1 T2: M18x1			

accessories for	101397			
	GEV No.	100908	Ref. No.	—
	union screw thread M10x1 for pipe ø 4mm Qty 1 pcs			
	GEV No.	100909	Ref. No.	GS.3680
	union screw thread M10x1 for pipe ø 6mm Qty 1 pcs			
	GEV No.	101246	Ref. No.	—
	olive for pipe ø 4mm Qty 1 pcs			
	GEV No.	101278	Ref. No.	—
	olive for pipe ø 10mm Qty 1 pcs			
	GEV No.	101286	Ref. No.	—
	olive ID ø 6mm Qty 1 pcs			
	GEV No.	101300	Ref. No.	—
	union nut thread M16x1.5 tube ø 10mm			
	GEV No.	101450	Ref. No.	—
	olive for pipe ø 8mm L 12.7mm Qty 1 pcs ED ø 10mm			
	GEV No.	101451	Ref. No.	—
	union nut thread M16x1.5 tube ø 8mm			
	GEV No.	110081	Ref. No.	GS3602
	knob ø 70mm shaft ø 8x6.5mm shaft flat universal			
	GEV No.	112206	Ref. No.	—
	knob dial plate silver gas tap PEL21/22/23 t.max.°C ED ø 63mm ID ø 45.5mm			



1

GEV No.	101610	Ref. No.	N/A	
description	gas tap PEL type 21S gas inlet pipe flange ø 21mm bypass nozzle ø 0.35mm gas outlet M16x1.5 (tube ø 10/8mm) thermocouple connection M8x1 pilot connection M10x1 shaft ø 6x4.6mm shaft L 30/23mm shaft flat upper			
spare parts for	101610			
	GEV No.	100408	Ref. No.	—
	bypass nozzle type PEL20/21 bore ø 0.35mm thread M5x0.5			
	GEV No.	101060	Ref. No.	GS8036P
	magnet unit standard L 39mm D1 ø 15.4mm D2 ø 11mm suitable for PEL20-21/JUNKERS/EGA			
	GEV No.	101230	Ref. No.	—
	thermocouple nut T1: M8x1 T2: M18x1 aluminium			
	GEV No.	101803	Ref. No.	—
	gas tap front part shaft ø 6x4.6mm shaft L 30/23mm shaft flat upper/lower suitable for PEL21			
	GEV No.	106250	Ref. No.	—
	gasket Viton ED ø 14mm ID ø 9mm thickness 3.3mm Qty 1 pcs			

Table continues overleaf

1 electric components















accessories for		101610	
	GEV No.	100908	Ref. No. —
union screw thread M10x1 for pipe ø 4mm Qty 1 pcs			
	GEV No.	100909	Ref. No. GS.3680
union screw thread M10x1 for pipe ø 6mm Qty 1 pcs			
	GEV No.	101246	Ref. No. —
olive for pipe ø 4mm Qty 1 pcs			
	GEV No.	101278	Ref. No. —
olive for pipe ø 10mm Qty 1 pcs			
	GEV No.	101286	Ref. No. —
olive ID ø 6mm Qty 1 pcs			
	GEV No.	101300	Ref. No. —
union nut thread M16x1.5 tube ø 10mm			
	GEV No.	101450	Ref. No. —
olive for pipe ø 8mm L 12.7mm Qty 1 pcs ED ø 10mm			
	GEV No.	101451	Ref. No. —
union nut thread M16x1.5 tube ø 8mm			
	GEV No.	110078	Ref. No. —
knob without symbol ø 70mm shaft ø 6x4.6mm shaft flat universal			
	GEV No.	112206	Ref. No. —
knob dial plate silver gas tap PEL21/22/23 t.max.°C ED ø 63mm ID ø 45.5mm			

22S/V series



1

GEV No.	101087	Ref. No.	GS3877
description	gas tap PEL type 22S/V gas inlet M20x1.5 (tube ø 12mm) bypass nozzle ø 0.35mm gas outlet M20x1.5 (tube ø 12/10mm) thermocouple connection M9x1 pilot connection M10x1 shaft ø 10x8mm shaft L 25/17mm shaft flat upper		
spare parts for		101087	
	GEV No.	100259	Ref. No. —
bypass nozzle type PEL22 bore ø 0.35mm thread M6x0.5			
	GEV No.	101058	Ref. No. —
magnet unit L 39mm D1 ø 15.4mm D2 ø 13.5mm suitable for PEL22/EGA24197 standard			
	GEV No.	101201	Ref. No. —
gas tap front part shaft ø 10x8mm shaft L 25/17mm shaft flat upper/lower suitable for PEL22			
	GEV No.	101231	Ref. No. —
thermocouple nut T1: M9x1 T2: M18x1			
	GEV No.	101241	Ref. No. —
gas connection thread M20x1.5 tube ø 12/10mm for PEL gas taps vertical			

spare parts for		101087	
	GEV No.	101460	Ref. No. —
O-ring ø 12.37mm D1 ø 2.62mm suitable for PEL22			
	GEV No.	101461	Ref. No. —
screw kit suitable for PEL22 Qty 4 pcs			
accessories for		101087	
	GEV No.	100908	Ref. No. —
union screw thread M10x1 for pipe ø 4mm Qty 1 pcs			
	GEV No.	100909	Ref. No. GS.3680
union screw thread M10x1 for pipe ø 6mm Qty 1 pcs			
	GEV No.	101240	Ref. No. —
gas connection thread M20x1.5 tube ø 12/10mm for PEL gas taps with gasket and screws horizontal			
	GEV No.	101246	Ref. No. —
olive for pipe ø 4mm Qty 1 pcs			
	GEV No.	101248	Ref. No. —
olive for pipe ø 12mm Qty 1 pcs suitable for PEL			
	GEV No.	101249	Ref. No. —
olive for pipe ø 10mm Qty 1 pcs			
	GEV No.	101250	Ref. No. —
union nut thread M20x1.5 for pipe ø 10mm			
	GEV No.	101251	Ref. No. —
union nut thread M20x1.5 for pipe ø 12mm			
	GEV No.	101286	Ref. No. —
olive ID ø 6mm Qty 1 pcs			
	GEV No.	110080	Ref. No. —
knob ø 70mm shaft ø 10x8mm shaft flat universal			
	GEV No.	112206	Ref. No. —
knob dial plate silver gas tap PEL21/22/23 t.max.°C ED ø 63mm ID ø 45.5mm			

23S/O series



1

GEV No.	101092	Ref. No.	GS3878
description	gas tap PEL type 23S/O gas inlet M28x1.5 (tube ø 20mm) bypass nozzle ø 0.35mm gas outlet M24x1.5 (tube ø 16mm) thermocouple connection M10x1 pilot connection M10x1 shaft ø 10x8mm shaft L 25/17mm shaft flat upper		
spare parts for		101092	
	GEV No.	100455	Ref. No. —
bypass nozzle type PEL23/24 bore ø 0.35mm thread M8x0.5			

Table continues overleaf



spare parts for		101092	
	GEV No.	101059	Ref. No. —
	magnet unit T1: M10x1 T2: M22x1 L 46mm ø 18mm suitable for PEL23S M10x1		
	GEV No.	101204	Ref. No. —
	gas tap front part shaft ø 10x8mm shaft L 25/17mm shaft flat upper/lower suitable for PEL23S		
	GEV No.	101244	Ref. No. —
	gas connection thread M24x1.5 tube ø 12/16mm horizontal for PEL gas taps		
	GEV No.	101463	Ref. No. —
	screw suitable for PEL23S Qty 4 pcs		
	GEV No.	528455	Ref. No. —
	O-ring Viton thickness 2.62mm ID ø 18.72mm Qty 1 pcs		
accessories for		101092	
	GEV No.	100908	Ref. No. —
	union screw thread M10x1 for pipe ø 4mm Qty 1 pcs		
	GEV No.	100909	Ref. No. GS.3680
	union screw thread M10x1 for pipe ø 6mm Qty 1 pcs		
	GEV No.	101246	Ref. No. —
	olive for pipe ø 4mm Qty 1 pcs		
	GEV No.	101252	Ref. No. —
	union nut thread M24x1.5 for pipe ø 12mm		
	GEV No.	101253	Ref. No. —
	union nut thread M24x1.5 PEL for pipe ø 16mm		
	GEV No.	101254	Ref. No. —
	union nut thread M28x1.5 tube ø 20mm		
	GEV No.	101255	Ref. No. —
	olive for pipe ø 12mm Qty 1 pcs		
	GEV No.	101256	Ref. No. —
	olive for pipe ø 16mm Qty 1 pcs		
	GEV No.	101257	Ref. No. —
	olive for pipe ø 20mm Qty 1 pcs		
	GEV No.	101286	Ref. No. —
	olive ID ø 6mm Qty 1 pcs		
	GEV No.	110080	Ref. No. —
	knob ø 70mm shaft ø 10x8mm shaft flat universal		
	GEV No.	112206	Ref. No. —
	knob dial plate silver gas tap PEL21/22/23 t.max.°C ED ø 63mm ID ø 45.5mm		

AB

gas taps



1

GEV No.	107917	Ref. No.	N/A
description	gas tap AB type A12I-120 gas inlet 3/8" BSP gas outlet 3/8" BSP thermocouple connection M9x1 pilot connection M10x1 front fixing shaft ø 8x6mm shaft L 33/17mm shaft flat right/left		



1

GEV No.	107918	Ref. No.	N/A
description	gas tap AB type A12I-150 gas inlet 3/8" BSP gas outlet 3/8" BSP thermocouple connection M9x1 pilot connection M10x1 front fixing shaft ø 8x6mm shaft L 33/17mm shaft flat right/left		



1

GEV No.	107916	Ref. No.	N/A
description	gas tap AB type A12I-95 gas inlet 3/8" BSP gas outlet 3/8" BSP thermocouple connection M9x1 pilot connection M10x1 front fixing shaft ø 8x6mm shaft L 33/17mm shaft flat right/left		



1

GEV No.	107908	Ref. No.	N/A
description	gas tap AB type A60U gas inlet pipe flange ø27mm gas outlet M16x1.5 (tube ø 10mm) thermocouple connection M9x1 pilot connection M10x1 front fixing shaft ø 8x6.5mm shaft L 22/15mm shaft flat lower		



1





GEV No.	107913	Ref. No.	N/A
description	gas tap AB type A63C gas inlet 3/4"x14 BSP-F gas outlet 3/4"x14 BSP-F thermocouple connection M9x1 pilot connection M10x1 front fixing shaft ø 9x7.7mm shaft L 41/15mm shaft flat +25°		

gas thermostats

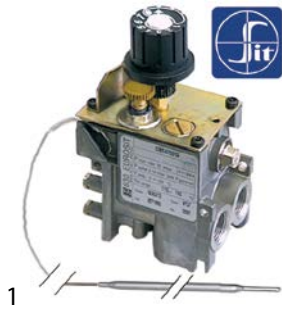

SIT



630 Eurosit series









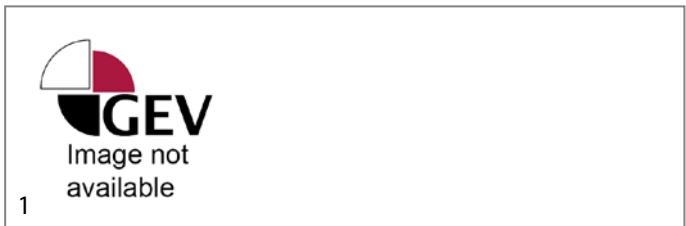

GEV No.	101188	Ref. No.	PD2045
description	gas thermostat type 630 Eurosit series t.max. 190°C 110-190°C gas inlet 3/8" gas outlet 3/8" thermocouple connection M9x1 pilot connection M10x1 probe ø 4mm probe L 202mm capillary pipe 1050mm SIT		
accessories for	101188		
	GEV No.	100904	Ref. No. —
	locking screw M10x1 for pipe ø 4mm Qty 1 pcs		
	GEV No.	100905	Ref. No. SP385E
	locking screw M10x1 for pipe ø 6mm Qty 1 pcs		
	GEV No.	101273	Ref. No. —
	olive for pipe ø 12mm L 9.5mm brass Qty 1 pcs suitable for universal		
	GEV No.	101276	Ref. No. —
	union screw thread 3/8" tube ø 12mm Qty 1 pcs		
	GEV No.	101333	Ref. No. —
	plug thread 3/8" with O-ring		



GEV No.	106164	Ref. No.	GS3060A
description	gas thermostat type 630 Eurosit series t.max. 340°C 100-340°C gas inlet 3/8" gas outlet 3/8" thermocouple connection M9x1 pilot connection M10x1 probe ø 4mm probe L 72mm capillary pipe 1050mm pressure regulator 13-18mbar ambient temperature max. 0-120°C		
accessories for	106164		
	GEV No.	100904	Ref. No. —
	locking screw M10x1 for pipe ø 4mm Qty 1 pcs		
	GEV No.	100905	Ref. No. SP385E
	locking screw M10x1 for pipe ø 6mm Qty 1 pcs		
	GEV No.	101273	Ref. No. —
	olive for pipe ø 12mm L 9.5mm brass Qty 1 pcs suitable for universal		

accessories for	106164		
	GEV No.	101276	Ref. No. —
	union screw thread 3/8" tube ø 12mm Qty 1 pcs		
	GEV No.	101333	Ref. No. —
	plug thread 3/8" with O-ring		



GEV No.	101996	Ref. No.	GS3060
description	gas thermostat type 630 Eurosit series t.max. 340°C 100-340°C SIT		
accessories for	101996		
	GEV No.	100825	Ref. No. —
	gas tap spindle shaft ø 8x6.5mm shaft L 22/14mm suitable for EUROSIT		
	GEV No.	100904	Ref. No. —
	locking screw M10x1 for pipe ø 4mm Qty 1 pcs		
	GEV No.	100905	Ref. No. SP385E
	locking screw M10x1 for pipe ø 6mm Qty 1 pcs		
	GEV No.	100949	Ref. No. —
	gasket suitable for 630 Eurosit series		
	GEV No.	101273	Ref. No. —
	olive for pipe ø 12mm L 9.5mm brass Qty 1 pcs suitable for universal		
	GEV No.	101276	Ref. No. —
	union screw thread 3/8" tube ø 12mm Qty 1 pcs		
	GEV No.	101333	Ref. No. —
	plug thread 3/8" with O-ring		

710 Minisit series



GEV No.	106014	Ref. No.	GS3820
description	gas thermostat with cover cap and knob SIT type MINISIT 710 t.max. 340°C 100-340°C gas inlet 1/2" gas outlet 3/8" thermocouple connection M9x1 pilot connection M10x1 probe ø 5mm probe L 68mm capillary pipe 1050mm probe type type B1 pressure controller no pressure regulator mbar gland nut		
spare parts for	106014		
	GEV No.	101053	Ref. No. —
	magnet unit T1: M9x1 T2: M24x1 L 45mm ø 17mm suitable for Minisit		















Table continues overleaf



spare parts for		106014	
	GEV No.	101136	Ref. No. —
	piezoelectric igniter suitable for Minisit with cover cap ømm connection F6.3x0.8		
	GEV No.	102102	Ref. No. —
	probe 100-340°C probe ø 5mm probe L 68mm capillary pipe 1750mm t.max. 340°C oven/grill probe type type B1 suitable for MINISIT 710		
	GEV No.	107564	Ref. No. —
	piezoelectric igniter body plastic blowing connection F6.3x0.8 ø 22mm		
	GEV No.	110068	Ref. No. GS3810
	knob suitable for Minisit ø 37mm		
accessories for		106014	
	GEV No.	100809	Ref. No. —
	O-ring EPDM thickness 2mm ID ø 21mm Qty 1 pcs		
	GEV No.	100904	Ref. No. —
	locking screw M10x1 for pipe ø 4mm Qty 1 pcs		
	GEV No.	100905	Ref. No. SP385E
	locking screw M10x1 for pipe ø 6mm Qty 1 pcs		
	GEV No.	101054	Ref. No. —
	magnet unit T1: M10x1 T2: M24x1 L 45mm ø 17mm suitable for Minisit		
	GEV No.	101136	Ref. No. —
	piezoelectric igniter suitable for Minisit with cover cap ømm connection F6.3x0.8		
	GEV No.	101267	Ref. No. —
	reducer IT 3/8" ET 1/2" L 21mm		
	GEV No.	101268	Ref. No. —
	gas connection thread 3/8" angled with O-ring MINISIT 710		
	GEV No.	101269	Ref. No. —
	gas connection thread 1/2" angled with O-ring MINISIT 710		
	GEV No.	101270	Ref. No. —
	screw connection IT 3/8" ET 3/8" L 28mm		
	GEV No.	101272	Ref. No. —
	screw connection IT 1/2" ET 3/8" L 57mm		
	GEV No.	101273	Ref. No. —
	olive for pipe ø 12mm L 9.5mm brass Qty 1 pcs suitable for universal		
	GEV No.	101274	Ref. No. —
	olive for pipe ø 16mm Qty 1 pcs		
	GEV No.	101275	Ref. No. —
	union screw thread 1/2" for pipe ø 16mm Qty 1 pcs		
	GEV No.	101276	Ref. No. —
	union screw thread 3/8" tube ø 12mm Qty 1 pcs		

PEL

24ST series

	1		
GEV No.	106203	Ref. No.	GS.387A
description	gas thermostat PEL type 24ST 120-280°C gas inlet M20x1.5 (tube ø 12mm) bypass nozzle ø 0.35mm gas outlet M20x1.5 (tube ø 12/10mm) thermocouple connection M9x1 pilot connection M10x1 capillary pipe 1200mm probe ø 6mm probe L 120mm shaft ø 10x9mm shaft L 27/17mm shaft flat upper		
spare parts for		106203	
	GEV No.	100455	Ref. No. —
	bypass nozzle type PEL23/24 bore ø 0.35mm thread M8x0.5		
	GEV No.	101058	Ref. No. —
	magnet unit L 39mm D1 ø 15.4mm D2 ø 13.5mm suitable for PEL22/EGA24197 standard		
	GEV No.	106200	Ref. No. —
	nut thread M9x1 suitable for PEL 24/255		
accessories for		106203	
	GEV No.	100908	Ref. No. —
	union screw thread M10x1 for pipe ø 4mm Qty 1 pcs		
	GEV No.	100909	Ref. No. GS.3680
	union screw thread M10x1 for pipe ø 6mm Qty 1 pcs		
	GEV No.	101246	Ref. No. —
	olive for pipe ø 4mm Qty 1 pcs		
	GEV No.	101248	Ref. No. —
	olive for pipe ø 12mm Qty 1 pcs suitable for PEL		
	GEV No.	101249	Ref. No. —
	olive for pipe ø 10mm Qty 1 pcs		
	GEV No.	101250	Ref. No. —
	union nut thread M20x1.5 for pipe ø 10mm		
	GEV No.	101251	Ref. No. —
	union nut thread M20x1.5 for pipe ø 12mm		
	GEV No.	101286	Ref. No. —
	olive ID ø 6mm Qty 1 pcs		
	GEV No.	110079	Ref. No. —
	knob dial plate gas thermostat 1-8 silver		
	GEV No.	110080	Ref. No. —
	knob ø 70mm shaft ø 10x8mm shaft flat universal		

ROBERTSHAW



GEV No.	107562 ¹	Ref. No.	GS.2182
description	gas thermostat type GSE100301800 93-201°C 200-393°F gas inlet 1/4" CCT (tube ø 1/4") bypass nozzle ømm gas outlet 1/4" CCT (tube ø 1/4") thermocouple connection pilot connection capillary pipe 30" - 760mm probe ø 3/8" - 9.5mm probe L 5 3/8" - 135mm gland nut 1/4" NPT shaft ø 6.4x4.8mm shaft L 21/21mm shaft flat lower Invensys approval CE		

¹with gland nut 1/4" NPT

gas valves and ignition boxes

gas control valves

ROBERTSHAW

gas controlled valves



GEV No.	580077	Ref. No.	GS.2181
description	gas valve supply Operator gas inlet 1/4" CCT outlet 1/4" CCT gas inlet 3/4" gas outlet 3/4" thermocouple connection 11/32" pilot connection 1/4" pressure regulator mbar type U7000BGOL pressure controller unregulated 0-70°C max 65mbar		

SIT

NOVASIT





GEV No.	101187	Ref. No.	GS373D PD2073
description	gas valve SIT series Novasit 820 0.17VHz gas inlet 1/2" gas outlet 1/2" thermocouple connection M9x1 pilot connection M10x1 ignition pressure mbar pressure range 5-50mbar pressure regulator connection blind equiv. no. 0.820.301 supply Operator millivolt		

spare parts for	101187
------------------------	--------

	GEV No.	101065	Ref. No.	—
magnet unit with cable L 44mm D1 ø 30mm D2 ø 20mm suitable for NOVASIT				

accessories for	101187
------------------------	--------

	GEV No.	100110	Ref. No.	—
pilot burner SIT type 190 series 3 flames nozzle ømm gas connectionmm				

	GEV No.	101305	Ref. No.	—
gas connection straight 1/2" flange 45x45mm ELETTROSIT/V4400/4600/4605 suitable for SIT/HONEYWELL hole distance 36x36mm				

	GEV No.	101306	Ref. No.	—
gas connection angled flange 45x45mm hole distance 36x36mm 1/2" ELETTROSIT/V4400/4600/4605 screw with O-ring suitable for SIT/HONEYWELL				

	GEV No.	101307	Ref. No.	—
gas connection straight flange 45x45mm hole distance 36x36mm 3/4" ELETTROSIT/V4400/4600/4605 screw with O-ring suitable for SIT/HONEYWELL				

	GEV No.	101308	Ref. No.	—
gas connection angled flange 45x45mm hole distance 36x36mm 3/4" ELETTROSIT/V4400/4600/4605 screw with O-ring suitable for SIT/HONEYWELL				

	GEV No.	102116	Ref. No.	GS373E PD4646
thermopile ROBERTSHAW L 900mm probe ø 9mm probe L 57mm 250-750mV screw connection 7/16"				

accessories



GEV No.	100905	Ref. No.	SP385E
description	locking screw M10x1 for pipe ø 6mm Qty 1 pcs		



safety valves

SIT

440 series



1

GEV No.	101101	Ref. No.	CH3713 GS3713
description	gas valve pressure range 50mbar gas inlet 3/4" gas outlet 3/4" pilot connection M10x1 (tube ø 6mm) thermocouple connection M9x1 type SIT D3		
For models:	NGWR10-85W1S1, NGWR15-85W2, NGWR16-85W2S1, NGWR18-85W2S2, NGWR22-85W3, NGWR24-85W3S2, NGWR7-85		
accessories for	101101		
	GEV No.	100904	Ref. No. —
	locking screw M10x1 for pipe ø 4mm Qty 1 pcs		
	GEV No.	100905	Ref. No. SP385E
	locking screw M10x1 for pipe ø 6mm Qty 1 pcs		

ignition parts

pilot burners

SIT

100 series

















1

GEV No.	106905	Ref. No.	WT3851
description	pilot burner SIT type 100 series 2 flames nozzle ø 0.2mm gas connection 6mm		
spare parts for	106905		
	GEV No.	100245	Ref. No. GC1001 SP385F
	pilot burner nozzle LPG code 20 bore ø 0.2mm Qty 1 pcs thread M8x0.75		
	GEV No.	100855	Ref. No. GS8042P GS8042S SP385D
	pilot burner bracket triple		
	GEV No.	100885	Ref. No. —
	air mixing sleeve for pilot burner Qty 1 pcs		
	GEV No.	100916	Ref. No. —
	compression spring for pilot burner Qty 1 pcs		
	GEV No.	100917	Ref. No. —
	gasket for pilot burner Qty 1 pcs aluminium		

spare parts for	106905		
	GEV No.	100918	Ref. No. —
	screw for pilot burner		
	GEV No.	107161	Ref. No. GS8041P GS8041S SP385A
	pilot burner cap SIT 2 flames Hmm Lmm Qty 1 pcs		
	GEV No.	107701	Ref. No. GS8040P GS8044S SP385B
	pilot burner bottom part SIT 100 series nozzle ø 0.2mm		
accessories for	106905		
	GEV No.	100246	Ref. No. GS3828 SP385C
	pilot burner nozzle natural gas bore ø 0.35mm Qty 1 pcs thread M8x0.75		
	GEV No.	100904	Ref. No. —
	locking screw M10x1 for pipe ø 4mm Qty 1 pcs		
	GEV No.	100905	Ref. No. SP385E
	locking screw M10x1 for pipe ø 6mm Qty 1 pcs		
	GEV No.	102110	Ref. No. —
	pilot tube copper pipe ø 4mm thickness 1mm L 3000mm		
	GEV No.	102111	Ref. No. —
	pilot tube copper pipe ø 6mm thickness 1mm L 3000mm		
	GEV No.	107171	Ref. No. PD2276
	pilot burner nozzle SIT natural/liquid gas bore ø 0.25mm Qty 1 pcs		
	GEV No.	107700	Ref. No. —
	pilot burner bottom part SIT 100 series nozzle ø 0.25mm		
	GEV No.	107702	Ref. No. —
	pilot burner bottom part SIT 100 series nozzle ø 0.35mm		

	1		
GEV No.	106906	Ref. No.	GS3851
description	pilot burner SIT type 100 series 3 flames nozzle ø 0.2mm gas connection 6mm		
For models:	NGER 13-130, NGER 13-70, NGER 15-60, NGER 20-60, NGER 20-70, NGER 4-60, NGER 7-70, NGER 9-60, NGETL 5-50, NGTL 6-65 SO, NGWR10-85W1S1, NGWR15-85W2, NGWR16-85W2S1, NGWR18-85W2S2, NGWR22-85W3, NGWR24-85W3S2, NGWR7-85, NGWT 3-55/SN, NGWT 7-55/SN		
spare parts for	106906		
	GEV No.	100245	Ref. No. GC1001 SP385F
	pilot burner nozzle LPG code 20 bore ø 0.2mm Qty 1 pcs thread M8x0.75		
	GEV No.	100855	Ref. No. GS8042P GS8042S SP385D
	pilot burner bracket triple		

Table continues overleaf

spare parts for		106906	
	GEV No.	100885	Ref. No. —
air mixing sleeve for pilot burner Qty 1 pcs			
	GEV No.	100916	Ref. No. —
compression spring for pilot burner Qty 1 pcs			
	GEV No.	100917	Ref. No. —
gasket for pilot burner Qty 1 pcs aluminium			
	GEV No.	100918	Ref. No. —
screw for pilot burner			
	GEV No.	107162	Ref. No. —
pilot burner cap SIT 3 flames Hmm Lmm Qty 1 pcs			
	GEV No.	107701	Ref. No. GS8040P GS8044S SP385B
pilot burner bottom part SIT 100 series nozzle ø 0.2mm			
accessories for		106906	
	GEV No.	100245	Ref. No. GC1001 SP385F
pilot burner nozzle LPG code 20 bore ø 0.2mm Qty 1 pcs thread M8x0.75			
	GEV No.	100246	Ref. No. GS3828 SP385C
pilot burner nozzle natural gas bore ø 0.35mm Qty 1 pcs thread M8x0.75			
	GEV No.	100904	Ref. No. —
locking screw M10x1 for pipe ø 4mm Qty 1 pcs			
	GEV No.	100905	Ref. No. SP385E
locking screw M10x1 for pipe ø 6mm Qty 1 pcs			
	GEV No.	102110	Ref. No. —
pilot tube copper pipe ø 4mm thickness 1mm L 3000mm			
	GEV No.	102111	Ref. No. —
pilot tube copper pipe ø 6mm thickness 1mm L 3000mm			
	GEV No.	107171	Ref. No. PD2276
pilot burner nozzle SIT natural/liquid gas bore ø 0.25mm Qty 1 pcs			
	GEV No.	107700	Ref. No. —
pilot burner bottom part SIT 100 series nozzle ø 0.25mm			
	GEV No.	107702	Ref. No. —
pilot burner bottom part SIT 100 series nozzle ø 0.35mm			

accessories			
pilot burner caps			
			
1			
GEV No.	100835	Ref. No.	PD2264
description	pilot burner cap 3 flames suitable for 100 series H 35mm L 48mm Qty 1 pcs W 52mm		

			
1			
GEV No.	107161	Ref. No.	GS8041P GS8041S SP385A
description	pilot burner cap SIT 2 flames Hmm Lmm Qty 1 pcs		

















pilot burner bottom parts			
			
1			
GEV No.	107701	Ref. No.	GS8040P GS8044S SP385B
description	pilot burner bottom part SIT 100 series nozzle ø 0.2mm		
spare parts for	107701		
	GEV No.	100245	Ref. No. GC1001 SP385F
pilot burner nozzle LPG code 20 bore ø 0.2mm Qty 1 pcs thread M8x0.75			
	GEV No.	100916	Ref. No. —
compression spring for pilot burner Qty 1 pcs			
	GEV No.	100917	Ref. No. —
gasket for pilot burner Qty 1 pcs aluminium			
	GEV No.	100918	Ref. No. —
screw for pilot burner			
accessories for	107701		
	GEV No.	100246	Ref. No. GS3828 SP385C
pilot burner nozzle natural gas bore ø 0.35mm Qty 1 pcs thread M8x0.75			
	GEV No.	100904	Ref. No. —
locking screw M10x1 for pipe ø 4mm Qty 1 pcs			
	GEV No.	100905	Ref. No. SP385E
locking screw M10x1 for pipe ø 6mm Qty 1 pcs			

Table continues overleaf



accessories for		107701	
GEV No.	102110	Ref. No.	—
	pilot tube	copper pipe	ø 4mm thickness 1mm L 3000mm
GEV No.	102111	Ref. No.	—
	pilot tube	copper pipe	ø 6mm thickness 1mm L 3000mm
GEV No.	102742	Ref. No.	—
	pilot burner nozzle	LPG code 25 bore ø 0.25mm	Qty 1 pcs

pilot burner brackets			
universal			
			
1			
GEV No.	100855	Ref. No.	GS8042P GS8042S SP385D
description	pilot burner bracket triple		
accessories for	100855		
	GEV No.	100855	Ref. No. GS8042P GS8042S SP385D
pilot burner bracket triple			
	GEV No.	100886	Ref. No. —
pilot burner bracket suitable for 100 series 3-piece			
	GEV No.	100888	Ref. No. —
screw bolt for pilot burner			

pilot burner nozzles			
			
1			
GEV No.	100245	Ref. No.	GC1001 SP385F
description	pilot burner nozzle LPG code 20 bore ø 0.2mm Qty 1 pcs thread M8x0.75		
For models:	NGER 13-130, NGER 13-70, NGER 15-60, NGER 20-60, NGER 20-70, NGER 4-60, NGER 7-70, NGER 9-60, NGETL 5-50, NGTL 6-65 SO, NGWR10-85W1S1, NGWR15-85W2, NGWR16-85W2S1, NGWR18-85W2S2, NGWR22-85W3, NGWR24-85W3S2, NGWR7-85, NGWT 3-55/SN, NGWT 7-55/SN		





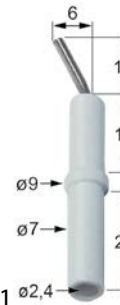



			
1			
GEV No.	100246	Ref. No.	GS3828 SP385C
description	pilot burner nozzle natural gas bore ø 0.35mm Qty 1 pcs thread M8x0.75		
For models:	NGER 13-130, NGER 13-70, NGER 15-60, NGER 20-60, NGER 20-70, NGER 4-60, NGER 7-70, NGER 9-60, NGETL 5-50, NGTL 6-65 SO, NGWR10-85W1S1, NGWR15-85W2, NGWR16-85W2S1, NGWR18-85W2S2, NGWR22-85W3, NGWR24-85W3S2, NGWR7-85, NGWT 3-55/SN, NGWT 7-55/SN		

ignition electrodes			
			
1			
GEV No.	100706	Ref. No.	GS.3856
description	ignition electrode connection M4 Qty 1 pcs		





			
1			
GEV No.	100707	Ref. No.	PD2268
description	ignition electrode D1 ø 7mm D2 ø 9mm connection ø2.4mm L1 14mm L2 6mm BL1 18mm BL2 3mm BL3 23mm to clip Qty 1 pcs		

140 - 145 - 150 series			
			
1			
GEV No.	107114 ¹	Ref. No.	GS3853
description	pilot burner SIT type 140 series 2 flames nozzle ømm gas connectionmm		
spare parts for	107114		
	GEV No.	100907	Ref. No. —
screw connection thread M10x1 Qty 1 pcs type SEF 1 ømm for thermocouple			
accessories for	107114		
	GEV No.	100204	Ref. No. GC1002
pilot burner nozzle SIT LPG code 14 bore ø 0.18/0.20mm Qty 1 pcs suitable for 140 series			
	GEV No.	100205	Ref. No. —
pilot burner nozzle SIT LPG code 19 bore ø 0.23/0.26mm Qty 1 pcs suitable for SIT 150 series			
	GEV No.	100206	Ref. No. —
pilot burner nozzle SIT natural gas code 36 bore ø 0.60/0.55mm Qty 1 pcs suitable for SIT 150 series			
	GEV No.	100207	Ref. No. GS3829
pilot burner nozzle SIT natural gas code 27 bore ø 0.40/0.38mm suitable for SIT 140 series			
	GEV No.	100216	Ref. No. —
pilot burner nozzle SIT natural gas code 38 bore ø 0.45mm Qty 1 pcs suitable for SIT 150 series			















¹incl. thermocouple fitting
Table continues overleaf

accessories for 107114			
	GEV No.	100701	Ref. No. GS3857
ignition electrode connection M4 Qty 1 pcs			
	GEV No.	100801	Ref. No. —
gasket for pilot burner Qty 1 pcs			
	GEV No.	100897	Ref. No. —
olive for pipe ø 4mm Qty 1 pcs for pilot burner			
	GEV No.	100898	Ref. No. —
olive for pipe ø 6mm Qty 1 pcs for pilot burner			
	GEV No.	100906	Ref. No. —
screw connection thread M10x1 for ignition electrode brass Qty 1 pcs WS 10			
	GEV No.	100908	Ref. No. —
union screw thread M10x1 for pipe ø 4mm Qty 1 pcs			
	GEV No.	100909	Ref. No. GS.3680
union screw thread M10x1 for pipe ø 6mm Qty 1 pcs			
	GEV No.	102110	Ref. No. —
pilot tube copper pipe ø 4mm thickness 1mm L 3000mm			
	GEV No.	102111	Ref. No. —
pilot tube copper pipe ø 6mm thickness 1mm L 3000mm			

producer-specific pilot burners
NAYATI
 Amicus, Grandis, Meritus (hob) series

			
1			
GEV No.	100856	Ref. No.	PD.2481
description	pilot burner EGA type A LPG		
spare parts for	100856		
	GEV No.	100806	Ref. No. —
gasket for pilot burner			
	GEV No.	100847	Ref. No. —
pilot burner centre part			
	GEV No.	100853	Ref. No. —
pilot burner cap			
	GEV No.	101598	Ref. No. —
pilot burner bottom part LPG bore ø 0.2mm			

Amicus (grills), Meritus (pasta cookers), Grandis (pasta cookers, tilting bratt pans) series







			
1			
GEV No.	107114 ¹	Ref. No.	GS3853
description	pilot burner SIT type 140 series 2 flames nozzle ømm gas connectionmm		
spare parts for	107114		
	GEV No.	100907	Ref. No. —
screw connection thread M10x1 Qty 1 pcs type SEF 1 ømm for thermocouple			
accessories for	107114		
	GEV No.	100204	Ref. No. GC1002
pilot burner nozzle SIT LPG code 14 bore ø 0.18/0.20mm Qty 1 pcs suitable for 140 series			
	GEV No.	100205	Ref. No. —
pilot burner nozzle SIT LPG code 19 bore ø 0.23/0.26mm Qty 1 pcs suitable for SIT 150 series			
	GEV No.	100206	Ref. No. —
pilot burner nozzle SIT natural gas code 36 bore ø 0.60/0.55mm Qty 1 pcs suitable for SIT 150 series			
	GEV No.	100207	Ref. No. GS3829
pilot burner nozzle SIT natural gas code 27 bore ø 0.40/0.38mm suitable for SIT 140 series			
	GEV No.	100216	Ref. No. —
pilot burner nozzle SIT natural gas code 38 bore ø 0.45mm Qty 1 pcs suitable for SIT 150 series			
	GEV No.	100701	Ref. No. GS3857
ignition electrode connection M4 Qty 1 pcs			
	GEV No.	100801	Ref. No. —
gasket for pilot burner Qty 1 pcs			
	GEV No.	100897	Ref. No. —
olive for pipe ø 4mm Qty 1 pcs for pilot burner			
	GEV No.	100898	Ref. No. —
olive for pipe ø 6mm Qty 1 pcs for pilot burner			
	GEV No.	100906	Ref. No. —
screw connection thread M10x1 for ignition electrode brass Qty 1 pcs WS 10			
	GEV No.	100908	Ref. No. —
union screw thread M10x1 for pipe ø 4mm Qty 1 pcs			
	GEV No.	100909	Ref. No. GS.3680
union screw thread M10x1 for pipe ø 6mm Qty 1 pcs			
	GEV No.	102110	Ref. No. —
pilot tube copper pipe ø 4mm thickness 1mm L 3000mm			
	GEV No.	102111	Ref. No. —
pilot tube copper pipe ø 6mm thickness 1mm L 3000mm			





¹incl. thermocouple fitting



Amicus (Wok), Meritus (grills, ovens), Grandis (grills, ovens, boiling pans), Teppanyaki series



GEV No.	106906	Ref. No.	GS3851
description	pilot burner SIT type 100 series 3 flames nozzle ø 0.2mm gas connection 6mm		
For models:	NGER 13-130, NGER 13-70, NGER 15-60, NGER 20-60, NGER 20-70, NGER 4-60, NGER 7-70, NGER 9-60, NGETL 5-50, NGTL 6-65 SO, NGWR10-85W1S1, NGWR15-85W2, NGWR16-85W2S1, NGWR18-85W2S2, NGWR22-85W3, NGWR24-85W3S2, NGWR7-85, NGWT 3-55/SN, NGWT 7-55/SN		
spare parts for	106906		
	GEV No.	100245	Ref. No. GC1001 SP385F
	pilot burner nozzle LPG code 20 bore ø 0.2mm Qty 1 pcs thread M8x0.75		
	GEV No.	100855	Ref. No. GS8042P GS8042S SP385D
	pilot burner bracket triple		
	GEV No.	100885	Ref. No. —
	air mixing sleeve for pilot burner Qty 1 pcs		
	GEV No.	100916	Ref. No. —
	compression spring for pilot burner Qty 1 pcs		
	GEV No.	100917	Ref. No. —
	gasket for pilot burner Qty 1 pcs aluminium		
	GEV No.	100918	Ref. No. —
	screw for pilot burner		
	GEV No.	107162	Ref. No. —
	pilot burner cap SIT 3 flames Hmm Lmm Qty 1 pcs		
	GEV No.	107701	Ref. No. GS8040P GS8044S SP385B
	pilot burner bottom part SIT 100 series nozzle ø 0.2mm		
accessories for	106906		
	GEV No.	100245	Ref. No. GC1001 SP385F
	pilot burner nozzle LPG code 20 bore ø 0.2mm Qty 1 pcs thread M8x0.75		
	GEV No.	100246	Ref. No. GS3828 SP385C
	pilot burner nozzle natural gas bore ø 0.35mm Qty 1 pcs thread M8x0.75		
	GEV No.	100904	Ref. No. —
	locking screw M10x1 for pipe ø 4mm Qty 1 pcs		
	GEV No.	100905	Ref. No. SP385E
	locking screw M10x1 for pipe ø 6mm Qty 1 pcs		
	GEV No.	102110	Ref. No. —
	pilot tube copper pipe ø 4mm thickness 1mm L 3000mm		

accessories for	106906		
	GEV No.	102111	Ref. No. —
	pilot tube copper pipe ø 6mm thickness 1mm L 3000mm		
	GEV No.	107171	Ref. No. PD2276
	pilot burner nozzle SIT natural/liquid gas bore ø 0.25mm Qty 1 pcs		
	GEV No.	107700	Ref. No. —
	pilot burner bottom part SIT 100 series nozzle ø 0.25mm		
	GEV No.	107702	Ref. No. —
	pilot burner bottom part SIT 100 series nozzle ø 0.35mm		



Chinese Pro series



GEV No.	102803	Ref. No.	GS373C PD2233
description	pilot burner		

Meritus (deep fryers), Grandis (deep fryers) series



GEV No.	103196	Ref. No.	GS.2186
description	pilot burner ROBERTSHAW type 6CH14-6 3 flames natural gas code 26		
accessories for	103196		
	GEV No.	100277	Ref. No. GS.2187B
	pilot burner nozzle natural gas code 26 suitable for ROBERTSHAW		
	GEV No.	106105	Ref. No. GS.2187A
	pilot burner nozzle LPG code 16 suitable for ROBERTSHAW		



electrodes

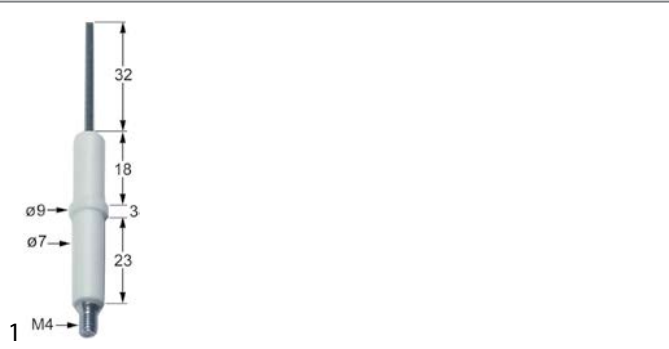

GEV No.	100701	Ref. No.	GS3857
description	ignition electrode connection M4 Qty 1 pcs		
accessories for	100701		
	GEV No.	100906	Ref. No. —
screw connection thread M10x1 for ignition electrode brass Qty 1 pcs WS 10			

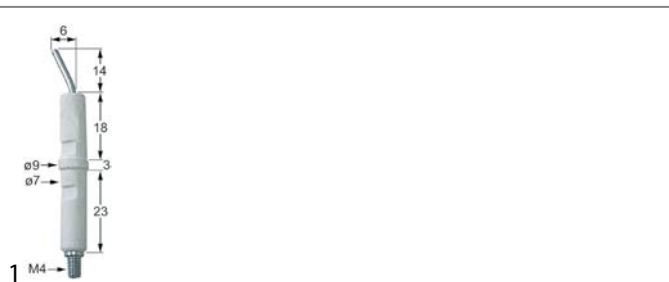

GEV No.	100706	Ref. No.	GS.3856
description	ignition electrode connection M4 Qty 1 pcs		

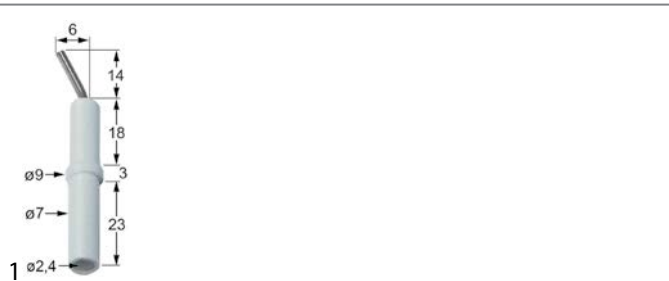

GEV No.	100707	Ref. No.	PD2268
description	ignition electrode D1 ø 7mm D2 ø 9mm connection ø2.4mm L1 14mm L2 6mm BL1 18mm BL2 3mm BL3 23mm to clip Qty 1 pcs		

ignition cables

pre-assembled cables

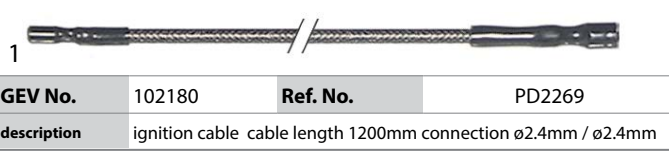

GEV No.	102180	Ref. No.	PD2269
description	ignition cable cable length 1200mm connection ø2.4mm / ø2.4mm		



GEV No.	100164	Ref. No.	GS3689
description	ignition cable cable length 1200mm connection ø4mm / F2.8mm		

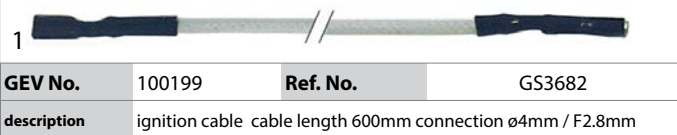

GEV No.	100199	Ref. No.	GS3682
description	ignition cable cable length 600mm connection ø4mm / F2.8mm		

piezoelectric igniters

mounting diameter 18mm





GEV No.	106782	Ref. No.	GS.3720 A
description	piezoelectric igniter body metal blowing		



GEV No.	100003	Ref. No.	GS3863
description	piezoelectric igniter body metal blowing mounting ø 18mm connection F2.8x0.8		



GEV No.	100009	Ref. No.	GS3720
description	piezoelectric igniter body plastic blowing mounting ø 18mm connection ø2.4mm front measurements 26mm M18x1.5		

accessories for	100009		
	GEV No.	101339	Ref. No. —
cover cap for piezoelectric igniter			
	GEV No.	106869	Ref. No. —
cover cap for piezoelectric igniter ID ø 22mm ED ø 35mm H 25mm			
	GEV No.	107931	Ref. No. —
cover cap for piezoelectric igniter ID ø 21mm ED ø 36mm			

mounting diameter 22mm



GEV No.	100005	Ref. No.	GS3720
description	piezoelectric igniter body plastic blowing mounting ø 22mm connection ø2.4mm cable lengthmm SIT		



thermocouples

thermocouple sets universal

GEV No.	102281	Ref. No.	GS.2185
description	thermocouple set ROBERTSHAW 5-piece L 24" - 610mm		

plug-in thermocouples

plug-in thermocouples standard

with barrel socket ø6(6.5)mm

thermocouples SIT

GEV No.	107612	Ref. No.	GS3890 WT3890
description	thermocouple SIT M9x1 L 1000mm plug connection ø6.0(6.5)mm		
For models:	NGER 13-130, NGER 13-70, NGER 15-60, NGER 20-60, NGER 20-70, NGER 4-60, NGER 7-70, NGER 9-60, NGETL 5-50, NGTL 6-65 SO, NGWR10-85W1S1, NGWR15-85W2, NGWR16-85W2S1, NGWR18-85W2S2, NGWR22-85W3, NGWR24-85W3S2, NGWR7-85, NGWT 3-55/SN, NGWT 7-55/SN		

GEV No.	107609	Ref. No.	GS3895 GS3895B
description	thermocouple SIT M9x1 L 600mm plug connection ø6.0(6.5)mm		

threaded thermocouples

threaded thermocouples standard

with socket with thread M8x1

SIT

GEV No.	107636	Ref. No.	GS3891	
description	thermocouple SIT M9x1 L 600mm M8x1			
accessories for	107636			
	GEV No.	102067	Ref. No.	—
	nut thread M8x1 H 3mm brass Qty 1 pcs type SEF 1			

thermopiles

GEV No.	102116	Ref. No.	GS373E PD4646
description	thermopile ROBERTSHAW L 900mm probe ø 9mm probe L 57mm 250-750mV screw connection 7/16"		

ignition bridges

GEV No.	104344	Ref. No.	GS.4422
description	ignition bridge L 280mm ø 10mm		

GEV No.	102802	Ref. No.	GS442C PD9558
description	ignition bridge L 300mm		

1 gas components

gas burners

hob burners

producer-specific hob burners

NAYATI

NGCR, NGES (2), NGHT (2) series



GEV No.	105570	Ref. No.	GS80005
description	air mixer complete		



GEV No.	105573	Ref. No.	GS.4357B GS4357
description	air mixer chamber housing		
For models:	NGER 13-130, NGER 13-70, NGER 15-60, NGER 20-60, NGER 20-70, NGER 4-60, NGER 7-70, NGER 9-60, NGETL 5-50, NGTL 6-65 SO, NGWR10-85W1S1, NGWR15-85W2, NGWR16-85W2S1, NGWR18-85W2S2, NGWR22-85W3, NGWR24-85W3S2, NGWR7-85		





GEV No.	105572	Ref. No.	GS2825
description	air mixing sleeve		
For models:	NGER 13-130, NGER 13-70, NGER 15-60, NGER 20-60, NGER 20-70, NGER 4-60, NGER 7-70, NGER 9-60, NGETL 5-50, NGTL 6-65 SO, NGWR10-85W1S1, NGWR15-85W2, NGWR16-85W2S1, NGWR18-85W2S2, NGWR22-85W3, NGWR24-85W3S2, NGWR7-85, NGWT 3-55/SN, NGWT 7-55/SN		



GEV No.	105562	Ref. No.	GS4232
description	blind screw connection 3/8"		
For models:	NGER 15-60, NGER 20-60, NGER 4-60, NGER 9-60, NGWR10-85W1S1, NGWR16-85W2S1, NGWR18-85W2S2, NGWR24-85W3S2		



GEV No.	105563	Ref. No.	GS8014S	
description	burner complete			
spare parts for	105563			
	GEV No.	105564	Ref. No.	GS2020
	burner cap slotted			
	GEV No.	105565	Ref. No.	GS4353
	burner pipe			



GEV No.	105714	Ref. No.	PD9557
description	burner cap		



GEV No.	105559	Ref. No.	GS4030
description	burner cap 10kW mounting pos. outer with central hole		
For models:	NGER 13-130, NGER 13-70, NGER 15-60, NGER 20-60, NGER 20-70, NGER 4-60, NGER 7-70, NGER 9-60, NGETL 5-50, NGWR10-85W1S1, NGWR16-85W2S1, NGWR18-85W2S2, NGWR24-85W3S2, NGWT 3-55/SN, NGWT 7-55/SN		



GEV No.	105578	Ref. No.	GS2025
description	burner cap 5kW mounting pos. inner slotted		
For models:	NGER 13-130, NGER 13-70, NGER 20-70, NGER 7-70, NGETL 5-50, NGWT 3-55/SN, NGWT 7-55/SN		



GEV No.	105564	Ref. No.	GS2020
description	burner cap slotted		
For models:	NGTL 6-65 SO, NGWR10-85W1S1, NGWR15-85W2, NGWR16-85W2S1, NGWR18-85W2S2, NGWR22-85W3, NGWR24-85W3S2, NGWR7-85		

accessories for	105564			
	GEV No.	696272	Ref. No.	GS.1329
	grub screw thread M5 L 6mm DIN 916/ISO 4029 intake internal hexagon WS 2.5 Qty 1 pcs			





GEV No.	105560	Ref. No.	GS4023
description	burner head ø 180mm 10/15kW connection 1" IT		
For models:	NGER 13-130, NGER 13-70, NGER 15-60, NGER 20-60, NGER 20-70, NGER 4-60, NGER 7-70, NGER 9-60, NGETL 5-50, NGWR10-85W1S1, NGWR16-85W2S1, NGWR18-85W2S2, NGWR24-85W3S2, NGWT 3-55/SN, NGWT 7-55/SN		





GEV No.	105565	Ref. No.	GS4353
description	burner pipe		
For models:	NGTL 6-65 SO, NGWR10-85W1S1, NGWR15-85W2, NGWR16-85W2S1, NGWR18-85W2S2, NGWR22-85W3, NGWR24-85W3S2, NGWR7-85		



			
GEV No.	105575	Ref. No.	GS1456
description	compression spring ø 23mm L 35mm wire gauge ø 1.5mm for air mixers		
For models:	NGER 13-130, NGER 13-70, NGER 15-60, NGER 20-60, NGER 20-70, NGER 4-60, NGER 7-70, NGER 9-60, NGETL 5-50, NGTL 6-65 SO, NGWR10-85W1S1, NGWR15-85W2, NGWR16-85W2S1, NGWR18-85W2S2, NGWR22-85W3, NGWR24-85W3S2, NGWR7-85, NGWT 3-55/SN, NGWT 7-55/SN		

			
GEV No.	105571	Ref. No.	GS2826 GS4356
description	internal pipe for air mixers		
For models:	NGER 13-130, NGER 13-70, NGER 15-60, NGER 20-60, NGER 20-70, NGER 4-60, NGER 7-70, NGER 9-60, NGETL 5-50, NGTL 6-65 SO, NGWR10-85W1S1, NGWR15-85W2, NGWR16-85W2S1, NGWR18-85W2S2, NGWR22-85W3, NGWR24-85W3S2, NGWR7-85, NGWT 3-55/SN, NGWT 7-55/SN		

			
GEV No.	105574	Ref. No.	GS4358 GS4358C GS4359
description	nut ø 72.5mm for air mixers		
For models:	NGER 13-130, NGER 13-70, NGER 15-60, NGER 20-60, NGER 20-70, NGER 4-60, NGER 7-70, NGER 9-60, NGETL 5-50, NGTL 6-65 SO, NGWR10-85W1S1, NGWR15-85W2, NGWR16-85W2S1, NGWR18-85W2S2, NGWR22-85W3, NGWR24-85W3S2, NGWR7-85, NGWT 3-55/SN, NGWT 7-55/SN		

			
GEV No.	105576	Ref. No.	GS2851
description	ring nut		
For models:	NGER 13-130, NGER 13-70, NGER 20-70, NGER 7-70, NGETL 5-50, NGTL 6-65 SO, NGWR10-85W1S1, NGWR15-85W2, NGWR16-85W2S1, NGWR18-85W2S2, NGWR22-85W3, NGWR24-85W3S2, NGWR7-85, NGWT 3-55/SN, NGWT 7-55/SN		

			
GEV No.	107193	Ref. No.	GS.8033S in Klärung s. RK22676
description	round burner 10kW connection 1" IT		
accessories for	107193		
		GEV No.	105562
		Ref. No.	GS4232
	blind screw connection 3/8"		
		GEV No.	105578
		Ref. No.	GS2025
	burner cap 5kW mounting pos. inner slotted		
		GEV No.	105579
		Ref. No.	GS4237
	venturi auxiliary pipe for 15kW burner		

			
GEV No.	105558	Ref. No.	GS8020S GS8033P
description	round burner 15kW connection 1" IT		

			
GEV No.	105579	Ref. No.	GS4237
description	venturi auxiliary pipe for 15kW burner		
For models:	NGER 13-130, NGER 13-70, NGER 15-60, NGER 20-60, NGER 20-70, NGER 4-60, NGER 7-70, NGER 9-60, NGETL 5-50, NGWT 3-55/SN, NGWT 7-55/SN		

NGR, NGTR, NGER (1), NGHT (1) series

















			
GEV No.	105068	Ref. No.	GS3601
description	air mixing sleeve		
accessories for	105068		
		GEV No.	104091
		Ref. No.	—
	burner head D ø 124mm for burner cap ø 80mm suitable for 50, 90, 92, 110 series (old)		
		GEV No.	104093
		Ref. No.	—
	venturi C/D		
		GEV No.	104096
		Ref. No.	—
	burner holder with nozzle holder connection M20x1.5		
		GEV No.	105060
		Ref. No.	—
	burner head C for burner cap ø 60mm suitable for 60, 62 series		
		GEV No.	105062
		Ref. No.	—
	venturi C		
		GEV No.	105076
		Ref. No.	—
	burner head C for burner cap ø 60mm suitable for 70, 90, 92 series (old)		
		GEV No.	105079
		Ref. No.	—
	burner head D ø 100mm		
		GEV No.	105091
		Ref. No.	—
	burner head C for burner cap ø 60mm		
		GEV No.	105098
		Ref. No.	—
	burner head D for burner cap ø 80mm		
		GEV No.	105099
		Ref. No.	—
	burner head A for burner cap ø 110mm		
		GEV No.	105100
		Ref. No.	—
	burner head A for burner cap ø 110mm		

Table continues overleaf

accessories for	105068			
	GEV No.	105119	Ref. No.	—
	burner head B for burner cap ø 90mm			
	GEV No.	105707	Ref. No.	GS4021
	burner cap ø 95mm			
	GEV No.	105708	Ref. No.	GS4022
	burner head for burner cap ø 95mm			
	GEV No.	105709	Ref. No.	GS3906
	venturi			
	GEV No.	105710	Ref. No.	GS3837
	burner holder with nozzle holder			

	1			
GEV No.	105707	Ref. No.	GS4021	
description	burner cap ø 95mm			
accessories for	105707			
	GEV No.	105068	Ref. No.	GS3601
	air mixing sleeve			
	GEV No.	105708	Ref. No.	GS4022
	burner head for burner cap ø 95mm			
	GEV No.	105709	Ref. No.	GS3906
	venturi			
	GEV No.	105710	Ref. No.	GS3837
	burner holder with nozzle holder			

	1			
GEV No.	105708	Ref. No.	GS4022	
description	burner head for burner cap ø 95mm			
accessories for	105708			
	GEV No.	105068	Ref. No.	GS3601
	air mixing sleeve			
	GEV No.	105707	Ref. No.	GS4021
	burner cap ø 95mm			
	GEV No.	105709	Ref. No.	GS3906
	venturi			
	GEV No.	105710	Ref. No.	GS3837
	burner holder with nozzle holder			

	1			
GEV No.	105710	Ref. No.	GS3837	
description	burner holder with nozzle holder			
accessories for	105710			
	GEV No.	105068	Ref. No.	GS3601
	air mixing sleeve			
	GEV No.	105707	Ref. No.	GS4021
	burner cap ø 95mm			
	GEV No.	105708	Ref. No.	GS4022
	burner head for burner cap ø 95mm			
	GEV No.	105709	Ref. No.	GS3906
	venturi			

	1			
GEV No.	105709	Ref. No.	GS3906	
description	venturi			
accessories for	105709			
	GEV No.	105068	Ref. No.	GS3601
	air mixing sleeve			
	GEV No.	105707	Ref. No.	GS4021
	burner cap ø 95mm			
	GEV No.	105708	Ref. No.	GS4022
	burner head for burner cap ø 95mm			
	GEV No.	105710	Ref. No.	GS3837
	burner holder with nozzle holder			

NGRHT series				
	1			
GEV No.	107560	Ref. No.	PD.2435-1	
description	burner cap ø 114mm 7.5kW			





 <p>1</p>			
GEV No.	107561	Ref. No.	PD.2436-1 PD.2437A1
description	burner cap ø 94mm 5.5kW		

 <p>1</p>			
GEV No.	107558	Ref. No.	PD.2439
description	burner head for burner cap ø 114mm 7.5kW		

 <p>1</p>			
GEV No.	107559	Ref. No.	PD.2440A
description	burner head for burner cap ø 94mm 5.5kW		

 <p>1</p>			
GEV No.	107557	Ref. No.	PD.2433A
description	venturi 5.5kW		

 <p>1</p>			
GEV No.	107556	Ref. No.	PD.2434A
description	venturi 7.5kW		

<p>NGWR series</p>  <p>1</p>			
GEV No.	106784	Ref. No.	PD.L148
description	burner pipe ø 34mm thread 1" steel L 149mm		

 <p>1</p>			
GEV No.	106783	Ref. No.	PD.L147
description	burner pipe ø 34mm thread 1" steel L 77mm		

<p>NGKB series</p>  <p>1</p>			
GEV No.	106788	Ref. No.	GS.8031-S
description	burner head suitable for NAYATI		
For models:	NGKB22-125DB		
spare parts for	106788		
	GEV No.	850127	Ref. No. GS.1042
	 firebrick ED ø 160mm ID ø 100mm H 55mm half-round		

<p>pan supports</p>  <p>1</p>			
GEV No.	210193	Ref. No.	GS2720
description	pan support ø 275mm		
For models:	NGER 15-60, NGER 20-60, NGER 4-60, NGER 9-60, NGWT 3-55/SN, NGWT 7-55/SN		

 <p>1</p>			
GEV No.	210214	Ref. No.	GS4024
description	pan support W 287mm L 350mm		

 <p>1</p>			
GEV No.	210238	Ref. No.	PD9614
description	pan support W 300mm L 505mm		



1

GEV No.	210196	Ref. No.	GS.4004A GS4004
description	pan support W 500mm L 500mm		
For models:	NGETL 5-50		

spillage trays



1

GEV No.	210220	Ref. No.	GS3030
description	drain tray L 560mm W 330mm H 60mm ϕ 85mm hole ϕ 85mm hole distance 285mm stainless steel		

height extensions



1

GEV No.	210195	Ref. No.	GS4029 ϕ 264 GS9401 GS9410 SP9201
description	attachment ring ϕ 264mm		
For models:	NGWT 3-55/SN, NGWT 7-55/SN		



1

GEV No.	210249	Ref. No.	GS4029 ϕ 278 GS4029 ϕ 278 Wok Ring Adaptor
description	attachment ring ϕ 278mm		



1

GEV No.	210194	Ref. No.	GS.2718A GS2718
description	attachment ring ϕ 300mm		
For models:	NGER 15-60, NGER 20-60, NGER 4-60, NGER 9-60		



1

GEV No.	210224	Ref. No.	GC9201
description	pan support ϕ 278mm		
For models:	NGETL 5-50		

accessories

pan supports



1

GEV No.	210193	Ref. No.	GS2720
description	pan support ϕ 275mm		
For models:	NGER 15-60, NGER 20-60, NGER 4-60, NGER 9-60, NGWT 3-55/SN, NGWT 7-55/SN		



1

GEV No.	210224	Ref. No.	GC9201
description	pan support ϕ 278mm		
For models:	NGETL 5-50		



1

GEV No.	210214	Ref. No.	GS4024
description	pan support W 287mm L 350mm		



1

GEV No.	210238	Ref. No.	PD9614
description	pan support W 300mm L 505mm		





			
1			
GEV No.	210196	Ref. No.	GS.4004A GS4004
description	pan support W 500mm L 500mm		
For models:	NGETL 5-50		

spillage trays

			
1			
GEV No.	210220	Ref. No.	GS3030
description	drain tray L 560mm W 330mm H 60mm ø 85mm hole ø 85mm hole distance 285mm stainless steel		

air mixers

			
1			
GEV No.	105570	Ref. No.	GS8000S
description	air mixer complete		

			
1			
GEV No.	106765	Ref. No.	GS.3660
description	air mixing tube dimensions 18x42mm ED ø 26mm		

bar burners

bar burners

			
1			
GEV No.	105865	Ref. No.	GS3654
description	bar burner 2 row L 360mm W 235mm ømm H 90mm pasta cooker		

			
1			
GEV No.	105969	Ref. No.	GS3656
description	bar burner 2 row L 413mm W 150mm ømm H 40mm fryer		

			
1			
GEV No.	105968	Ref. No.	GS3657
description	bar burner 2 row L 420mm W 200mm ømm H 45mm griddle		

			
1			
GEV No.	105864	Ref. No.	GS3649
description	bar burner 2 row L 445mm W 200mm ømm H 45mm griddle		

			
1			
GEV No.	105967	Ref. No.	GS3655
description	bar burner 2 row L 450mm W 220mm ømm H 40mm griddle		

			
1			
GEV No.	105863	Ref. No.	GS3648 GS3652
description	bar burner 2 row L 525mm W 190mm ømm H 55mm grill		

			
1			
GEV No.	105868	Ref. No.	GS3651
description	bar burner 4 row L 360mm W 435mm ømm H 60mm tilting bratt pan		

			
1			
GEV No.	105584	Ref. No.	GS3644
description	bar burner angled L 675mm W 385mm ømm Hmm oven		

			
1			
GEV No.	105867	Ref. No.	GS3045
description	bar burner ø 40mm Wmm Hmm L 480mm tilting bratt pan flange ø 61mm		

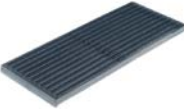
			
1			
GEV No.	211083	Ref. No.	PD3005
description	chargrill grid L 420mm W 175mm		

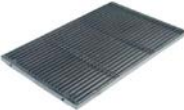
			
1			
GEV No.	211084	Ref. No.	GS4031
description	chargrill grid L 540mm W 350mm		

			
1			
GEV No.	211085	Ref. No.	GS392A
description	lava rock grid L 376mm W 328mm		

			
1			
GEV No.	211086	Ref. No.	GS3931 PS,342C
description	lava rock grid L 492mm W 329mm		

chargrill grids

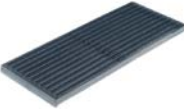
			
1			
GEV No.	211083	Ref. No.	PD3005
description	chargrill grid L 420mm W 175mm		

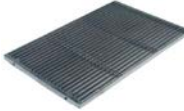
			
1			
GEV No.	211084	Ref. No.	GS4031
description	chargrill grid L 540mm W 350mm		

lava rock grids

			
1			
GEV No.	211085	Ref. No.	GS392A
description	lava rock grid L 376mm W 328mm		

			
1			
GEV No.	211086	Ref. No.	GS3931 PS,342C
description	lava rock grid L 492mm W 329mm		

tube burners

			
1			
GEV No.	105866	Ref. No.	PD.2263
description	tubular burner L 265mm W 50mm H 71mm for fryer oval		

surface burners

			
1			
GEV No.	105715	Ref. No.	GS3043
description	surface burner L 245mm W 185mm H 80mm firing range 175x155mm burner rows 9 for rice cooker		



accessories

nozzle holders



GEV No. 104654 **Ref. No.** PD.9638

description nozzle holder ET M16x1.5 IT M12x1 WS 28



GEV No. 106773 **Ref. No.** GS.3867

description nozzle holder thread M18x1.5 ET 3/8" IT M13x1

miscellaneous



GEV No. 105575 **Ref. No.** GS1456

description compression spring ø 23mm L 35mm wire gauge ø 1.5mm for air mixers

For models: NGER 13-130, NGER 13-70, NGER 15-60, NGER 20-60, NGER 20-70, NGER 4-60, NGER 7-70, NGER 9-60, NGETL 5-50, NGTL 6-65 SO, NGWR10-85W1S1, NGWR15-85W2, NGWR16-85W2S1, NGWR18-85W2S2, NGWR22-85W3, NGWR24-85W3S2, NGWR7-85, NGWT 3-55/SN, NGWT 7-55/SN



GEV No. 105576 **Ref. No.** GS2851

description ring nut

For models: NGER 13-130, NGER 13-70, NGER 20-70, NGER 7-70, NGETL 5-50, NGTL 6-65 SO, NGWR10-85W1S1, NGWR15-85W2, NGWR16-85W2S1, NGWR18-85W2S2, NGWR22-85W3, NGWR24-85W3S2, NGWR7-85, NGWT 3-55/SN, NGWT 7-55/SN

gas nozzles

main nozzles

gas nozzles 3/8"



GEV No. 100989 **Ref. No.** GS282C

description gas injector T1: 3/8" T2: M12x1.25 WS 19 bore ø 1.4mm LPG pressure range 50mbar 10kW

For models: NGER 15-60, NGER 20-60, NGER 4-60, NGER 9-60, NGTL 6-65 SO, NGWR10-85W1S1, NGWR15-85W2, NGWR16-85W2S1, NGWR18-85W2S2, NGWR22-85W3, NGWR24-85W3S2, NGWR7-85



GEV No. 100990 **Ref. No.** GS282D

description gas injector T1: 3/8" T2: M12x1.25 WS 19 bore ø 1.5mm LPG pressure range 50mbar 11kW



GEV No. 100992 **Ref. No.** GS282E

description gas injector T1: 3/8" T2: M12x1.25 WS 19 bore ø 1.6mm LPG pressure range 28-30/37mbar 10kW

For models: NGER 15-60, NGER 20-60, NGER 4-60, NGER 9-60, NGTL 6-65 SO, NGWR10-85W1S1, NGWR15-85W2, NGWR16-85W2S1, NGWR18-85W2S2, NGWR22-85W3, NGWR24-85W3S2, NGWR7-85



GEV No. 100991 **Ref. No.** GS282F

description gas injector T1: 3/8" T2: M12x1.25 WS 19 bore ø 1.7mm LPG pressure range 50mbar 13kW

For models: NGER 13-130, NGER 13-70, NGER 20-70, NGER 7-70, NGETL 5-50, NGWT 3-55/SN, NGWT 7-55/SN



GEV No. 100993 **Ref. No.** GS282G

description gas injector T1: 3/8" T2: M12x1.25 WS 19 bore ø 1.95mm LPG pressure range 28-30/37mbar 13kW

For models: NGER 13-130, NGER 13-70, NGER 20-70, NGER 7-70, NGETL 5-50, NGWT 3-55/SN, NGWT 7-55/SN



GEV No. 106836 **Ref. No.** GS.2830

description gas injector T1: 3/8" T2: M12x1.25 WS 19 bore ø 2.1mm pressure range 50mbar



GEV No. 100994 **Ref. No.** GS282H

description gas injector T1: 3/8" T2: M12x1.25 WS 19 bore ø 2.35mm natural gas pressure range 20/25mbar 9.3kW

For models: NGER 15-60, NGER 20-60, NGER 4-60, NGER 9-60, NGTL 6-65 SO, NGWR10-85W1S1, NGWR15-85W2, NGWR16-85W2S1, NGWR18-85W2S2, NGWR22-85W3, NGWR24-85W3S2, NGWR7-85



GEV No. 103261 **Ref. No.** GS282J

description gas injector T1: 3/8" T2: M12x1.25 WS 19 bore ø 2.5mm natural gas pressure range 20mbar

			
1			
GEV No.	100996	Ref. No.	GS282M
description	gas injector T1: 3/8" T2: M12x1.25 WS 19 bore ø 2.6mm natural gas pressure range 25mbar		

			
1			
GEV No.	100997	Ref. No.	GS282I
description	gas injector T1: 3/8" T2: M12x1.25 WS 19 bore ø 3.2mm natural gas pressure range 20/25mbar 15kW		
For models:	NGER 13-130, NGER 13-70, NGER 20-70, NGER 7-70, NGETL 5-50, NGWT 3-55/SN, NGWT 7-55/SN		

			
1			
GEV No.	100995	Ref. No.	GS282N
description	gas injector T1: 3/8" T2: M12x1.25 WS 19 bore ø 3.5mm natural gas pressure range 20mbar		

gas nozzles M10x1			
			
1			
GEV No.	102826	Ref. No.	GS2867
description	gas injector thread M10x1 WS 13 bore ø 0.95mm		
			
1			
GEV No.	102827	Ref. No.	GS2876
description	gas injector thread M10x1 WS 13 bore ø 1.15mm		
			
1			
GEV No.	102778	Ref. No.	GS2866
description	gas injector thread M10x1 WS 13 bore ø 1.4mm		
			
1			
GEV No.	102779	Ref. No.	GS2869
description	gas injector thread M10x1 WS 13 bore ø 1.75mm		

gas nozzles M13x1			
			
1			
GEV No.	103276	Ref. No.	GS.2898
description	gas injector bore ø 2.5mm WS 13		
			
1			
GEV No.	102915	Ref. No.	GC1101
description	gas injector thread M13x1 bore ø 0.85mm WS 13		
			
1			
GEV No.	102787	Ref. No.	PD2266
description	gas injector thread M13x1 bore ø 1.05mm WS 13		
			
1			
GEV No.	102780	Ref. No.	GS2870
description	gas injector thread M13x1 bore ø 1.15mm WS 13		
			
1			
GEV No.	102786	Ref. No.	PD2265
description	gas injector thread M13x1 bore ø 1.2mm WS 13		
			
1			
GEV No.	102823	Ref. No.	GS2868
description	gas injector thread M13x1 bore ø 1.35mm WS 13		
			
1			
GEV No.	102828	Ref. No.	GS2881
description	gas injector thread M13x1 bore ø 1.3mm WS 13		





			
1			
GEV No.	102782	Ref. No.	GS2888
description	gas injector thread M13x1 bore ø 1.45mm WS 13		

			
1			
GEV No.	102789	Ref. No.	GS2890
description	gas injector thread M13x1 bore ø 2.45mm WS 13		

			
1			
GEV No.	102784	Ref. No.	GS2878
description	gas injector thread M13x1 bore ø 1.55mm WS 13		

			
1			
GEV No.	102790	Ref. No.	GS2872
description	gas injector thread M13x1 bore ø 2.55mm WS 13		

			
1			
GEV No.	102825	Ref. No.	GS2889
description	gas injector thread M13x1 bore ø 1.65mm WS 13		

			
1			
GEV No.	102785	Ref. No.	GS2860
description	gas injector thread M13x1 bore ø 2.65mm WS 13		

			
1			
GEV No.	102788	Ref. No.	PD2267
description	gas injector thread M13x1 bore ø 1.75mm WS 13		

pilot burner nozzles

pilot burner nozzles ROBERTSHAW

			
1			
GEV No.	106105	Ref. No.	GS.2187A
description	pilot burner nozzle LPG code 16 suitable for ROBERTSHAW		

			
1			
GEV No.	102783	Ref. No.	GS2864
description	gas injector thread M13x1 bore ø 1.8mm WS 13		

			
1			
GEV No.	100277	Ref. No.	GS.2187B
description	pilot burner nozzle natural gas code 26 suitable for ROBERTSHAW		

			
1			
GEV No.	102781	Ref. No.	GS2877
description	gas injector thread M13x1 bore ø 1.95mm WS 13		

pilot burner nozzles SIT

100 series

			
1			
GEV No.	100245	Ref. No.	GC1001 SP385F
description	pilot burner nozzle LPG code 20 bore ø 0.2mm Qty 1 pcs thread M8x0.75		
For models:	NGER 13-130, NGER 13-70, NGER 15-60, NGER 20-60, NGER 20-70, NGER 4-60, NGER 7-70, NGER 9-60, NGETL 5-50, NGTL 6-65 SO, NGWR10-85W1S1, NGWR15-85W2, NGWR16-85W2S1, NGWR18-85W2S2, NGWR22-85W3, NGWR24-85W3S2, NGWR7-85, NGWT 3-55/SN, NGWT 7-55/SN		

			
1			
GEV No.	102824	Ref. No.	GS2859
description	gas injector thread M13x1 bore ø 1mm WS 13		



bypass nozzles

bypass nozzles PEL20/21



GEV No.	100556	Ref. No.	GS3687
description	bypass nozzle type PEL20/21 bore ø 0.95mm thread M5x0.5		

auxiliary gas parts

screw connections

double nipples



GEV No.	106786	Ref. No.	GS.1071
description	double nipple T1: 3/4" T2: 3/4"		
For models:	NGWR10-85W1S1, NGWR15-85W2, NGWR16-85W2S1, NGWR18-85W2S2, NGWR22-85W3, NGWR24-85W3S2, NGWR7-85		

olives



GEV No.	101857	Ref. No.	GS.3711
description	olive for pipe ø 6mm Qty 1 pcs suitable for 160 series for pilot burner		

union screws



GEV No.	100905	Ref. No.	SP385E
description	locking screw M10x1 for pipe ø 6mm Qty 1 pcs		



GEV No.	100909	Ref. No.	GS.3680
description	union screw thread M10x1 for pipe ø 6mm Qty 1 pcs		







accessories for	100909			
	GEV No.	100898	Ref. No.	—
	olive for pipe ø 6mm Qty 1 pcs for pilot burner			
	GEV No.	101286	Ref. No.	—
	olive ID ø 6mm Qty 1 pcs			
	GEV No.	101287	Ref. No.	—
	olive for pipe ø 6mm Qty 1 pcs			

Table continues overleaf

1			
GEV No.	100246	Ref. No.	GS3828 SP385C
description	pilot burner nozzle natural gas bore ø 0.35mm Qty 1 pcs thread M8x0.75		
For models:	NGER 13-130, NGER 13-70, NGER 15-60, NGER 20-60, NGER 20-70, NGER 4-60, NGER 7-70, NGER 9-60, NGETL 5-50, NGTL 6-65 SO, NGWR10-85W1S1, NGWR15-85W2, NGWR16-85W2S1, NGWR18-85W2S2, NGWR22-85W3, NGWR24-85W3S2, NGWR7-85, NGWT 3-55/SN, NGWT 7-55/SN		

1			
GEV No.	107171	Ref. No.	PD2276
description	pilot burner nozzle SIT natural/liquid gas bore ø 0.25mm Qty 1 pcs		

140/150 series

1			
GEV No.	100204	Ref. No.	GC1002
description	pilot burner nozzle SIT LPG code 14 bore ø 0.18/0.20mm Qty 1 pcs suitable for 140 series		

1			
GEV No.	100207	Ref. No.	GS3829
description	pilot burner nozzle SIT natural gas code 27 bore ø 0.40/0.38mm suitable for SIT 140 series		

160 series

1			
GEV No.	107172	Ref. No.	GS3836
description	pilot burner nozzle SIT LPG code 25 Qty 1 pcs		

1			
GEV No.	107173	Ref. No.	GS3793
description	pilot burner nozzle SIT natural gas code 35 Qty 1 pcs suitable for 160 series nozzle ø 0.35mm		



accessories for 100909			
	GEV No.	101288	Ref. No. —
olive for pipe ø 6mm L 6mm aluminium Qty 1 pcs ED ø 8.5mm			

locking screws			
	1		
GEV No.	105562	Ref. No.	GS4232
description	blind screw connection 3/8"		
For models:	NGER 15-60, NGER 20-60, NGER 4-60, NGER 9-60, NGWR10-85W1S1, NGWR16-85W2S1, NGWR18-85W2S2, NGWR24-85W3S2		

angle pieces			
	1		
GEV No.	106787	Ref. No.	GS.1161
description	angle piece T1: 3/4" T2: 3/4"		
For models:	NGWR10-85W1S1, NGWR15-85W2, NGWR16-85W2S1, NGWR18-85W2S2, NGWR22-85W3, NGWR24-85W3S2, NGWR7-85		

	1		
GEV No.	106776	Ref. No.	GS.4513
description	elbow screw joint T1: 1/4" T2: 1/8"		
For models:	NGWR10-85W1S1, NGWR15-85W2, NGWR16-85W2S1, NGWR18-85W2S2, NGWR22-85W3, NGWR24-85W3S2, NGWR7-85		

accessories			
	1		
GEV No.	693439	Ref. No.	GS4325
description	bush for wok		
For models:	NGWR10-85W1S1, NGWR15-85W2, NGWR16-85W2S1, NGWR18-85W2S2, NGWR22-85W3, NGWR24-85W3S2, NGWR7-85		

	1		
GEV No.	693434	Ref. No.	GS4326
description	connecting piece for wok		
For models:	NGWR10-85W1S1, NGWR15-85W2, NGWR16-85W2S1, NGWR18-85W2S2, NGWR22-85W3, NGWR24-85W3S2, NGWR7-85		

	1		
GEV No.	106785	Ref. No.	GC.7500
description	lid		

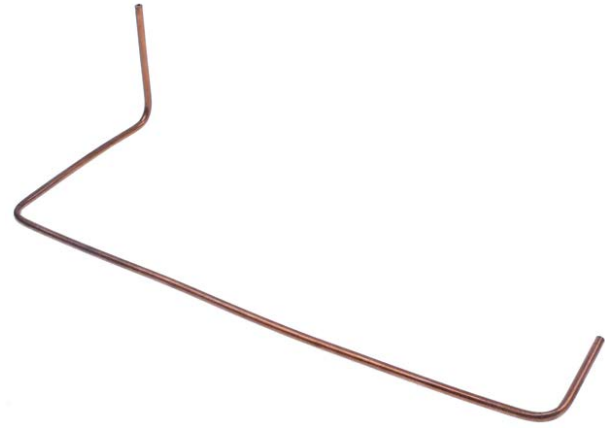
gas lines			
pilot tubes			
producer-specific			
	1		
GEV No.	106897	Ref. No.	PD.L116
description	pilot tube tube ø 6mm L 450mm copper		

equipment-specific units			
for meat mincers			
gear wheels			
	1		
GEV No.	697792	Ref. No.	11007-04-002 GC6140
description	gear wheel for gearbox ø 39mm shaft intake ø 16mm W 12mm teeth 23 splitting brass DIN/ISO		

for dough mixers			
spindles			
miscellaneous			
	1		
GEV No.	697791	Ref. No.	11007-04-001 GI4441
description	spindle for dough mixer ø 15mm D1 ø 18mm L 85mm		

miscellaneous



1

GEV No.	697794	Ref. No.	11012-04-008 GI4443
description	cover ø 20mm H 8mm		

for planetary mixers

gearboxes



1

GEV No.	698315	Ref. No.	GI.4439
description	fork lower for gear shaft L 170mm		



1

GEV No.	698314	Ref. No.	GI.4438
description	gear shaft for planetary mixer L 295mm		

gear wheels



1

GEV No.	697793	Ref. No.	11007-04-0003 GI4442
description	gear wheel for gearbox ø 39mm shaft intake ø 14mm W 12mm teeth 24 steel		

for pyroceram ranges

ceramic hobs

ceramic glass plates



1

GEV No.	693724	Ref. No.	PD2291
description	ceramic plate L 550mm W 350mm		

for tilting bratt pans

gearboxes



1

GEV No.	693642	Ref. No.	GS3020
description	gearbox motor shaft ø 19mm flange ø 118mm transmission I=1/60 drive shaft ø 30mm flange ø1 80mm fixing dimensions 105mm type VU-70		

for ovens

spare parts and accessories



1

GEV No.	691399	Ref. No.	GS4189
description	spray nozzle		



for pizza ovens

firebricks



1

GEV No.	850127	Ref. No.	GS.1042
description	firebrick ED ø 160mm ID ø 100mm H 55mm half-round		

for sliding doors

door guides



1

GEV No.	693733	Ref. No.	PD.4748 SS.4350A
description	guide sliding door L 54mm plastic 20		

for woks



1

GEV No.	541456	Ref. No.	GS9392
description	spray arm		



1

GEV No.	540666	Ref. No.	GS3846 GS3847
description	water nozzle thread 1/8"		
For models:	NGWR10-85W1S1, NGWR15-85W2, NGWR16-85W2S1, NGWR18-85W2S2, NGWR22-85W3, NGWR24-85W3S2, NGWR7-85		

knobs

universal knobs



1

GEV No.	110121	Ref. No.	GS2231
description	knob thermostat t.max. 200°C ø 50mm shaft ø 6x4.6mm shaft flat upper black temperature range 60-200°C rotation 270°		

accessories for 110121



GEV No.	110135	Ref. No.	—
description	rosette knob up to ø 52mm		

producer-specific knobs

NAYATI



1

GEV No.	111717	Ref. No.	GS3802
description	knob		



1

GEV No.	112792	Ref. No.	PD.4051FD+ PD.4055O10A
description	knob 0-12 t.max.°C ø 76mm shaft ø 6x4.6mm shaft flat upper		



1

GEV No.	112767	Ref. No.	PD.4051FD+PD.4055OH
description	knob 0-3 t.max.°C ø 72mm shaft ø 6x4.6mm shaft flat upper black		



1

GEV No.	112817	Ref. No.	PD.4051FD +PD.4055O5A
description	knob 0-300 t.max.°C ø 76mm shaft ø 6x4.6mm shaft flat upper		



1

GEV No.	112795	Ref. No.	PD.4051FD + PD40502A
description	knob 0-450 t.max.°C ø 76mm shaft ø 6x4.6mm shaft flat upper		



1

GEV No.	112707	Ref. No.	PD4051 FA + PD4055 OJ
description	knob energy regulator 1-12 ø 72mm shaft ø 6x4.6mm shaft flat upper black		



1

GEV No.	112032	Ref. No.	PD405H+PD405U
description	knob energy regulator 1-12 ø 76mm shaft ø 6x4.6mm shaft flat upper red		



1

GEV No.	112030	Ref. No.	PD405I+PD405M
description	knob gas tap with ignition flame ø 76mm shaft ø 8x6.5mm shaft flat left red		



1

GEV No.	112678	Ref. No.	PD.4052FD+PD.4055O2A
description	knob gas tap with ignition flame t.max.°C ø 76mm shaft ø 8x6mm shaft flat lower black		

spare parts for 112678

	GEV No.	112765	Ref. No.	4052FD
	description	knob zero mark t.max.°C ø 53mm shaft ø 8x7mm shaft flat lower black		



1

GEV No.	110081	Ref. No.	GS3602
description	knob ø 70mm shaft ø 8x6.5mm shaft flat universal		



1

GEV No.	112035	Ref. No.	PD405H+PD405V
description	knob switch 0-1-0-1 t.max.°C ø 76mm shaft ø 6x4.6mm shaft flat upper red		



1

GEV No.	112031	Ref. No.	PD405H+PD405S
description	knob switch 7-position ø 76mm shaft ø 6x4.6mm shaft flat upper red		



1

GEV No.	112034	Ref. No.	PD405H+PD405N
description	knob thermostat t.max. 110°C ø 76mm shaft ø 6x4.6mm shaft flat upper red temperature range 30-110°C rotation 270°		



1

GEV No.	110121	Ref. No.	GS2231
description	knob thermostat t.max. 200°C ø 50mm shaft ø 6x4.6mm shaft flat upper black temperature range 60-200°C rotation 270°		

accessories for 110121

	GEV No.	110135	Ref. No.	—
	description	rosette knob up to ø 52mm		

1

GEV No.	112036	Ref. No.	PD405H+PD405R
description	knob thermostat t.max. 200°C ø 76mm shaft ø 6x4.6mm shaft flat upper red temperature range 60-200°C rotation 270°		



1

GEV No.	112704	Ref. No.	PD.4051FA+PD.4055OE
description	knob thermostat t.max. 300°C ø 52.5mm shaft ø 6x4.6mm shaft flat upper black temperature range 50-300°C		



1

GEV No.	112033	Ref. No.	PD405H+PD405P
description	knob thermostat t.max. 300°C ø 76mm shaft ø 6x4.6mm shaft flat upper red temperature range 50-300°C		



1

GEV No.	112711	Ref. No.	PD.4052FA + PD.4052F-1
description	knob zero mark t.max.°C ø 53mm shaft ø 8x7mm shaft flat lower black		



1

GEV No.	112765	Ref. No.	4052FD
description	knob zero mark t.max.°C ø 53mm shaft ø 8x7mm shaft flat lower black		

accessories

button springs



1

GEV No.	550132	Ref. No.	PD2451
description	knob spring ø 6x4.6mm Qty 10 pcs		
For models:	MES 6-48		

handles and hand wheels

hand wheels



1

GEV No.	693437	Ref. No.	GS3790 PD.GS3790
description	hand wheel ø 150mm D1 ø 32mm bore ø 22mm depth of bore 21mm thread M6 hole distance 8mm groove widthmm L1 20mm L2 60mm handle length 65mm with folding handle		

cylindrical handles

fixed



1

GEV No.	110804	Ref. No.	GS2050
description	cylindrical handle thread M12 ø 29mm L 111mm		

ball handles



1

GEV No.	101718	Ref. No.	GS2014
description	ball handle thread M8 ø 25mm with metal bush black		
For models:	NGWR10-85W1S1, NGWR15-85W2, NGWR16-85W2S1, NGWR18-85W2S2, NGWR22-85W3, NGWR24-85W3S2, NGWR7-85		

bracket handles



GEV No.	693726	Ref. No.	GS3780
description	pull handle L 180mm H 45mm mounting distance 165mm		



GEV No.	693725	Ref. No.	GS3782
description	pull handle L 607mm H 45mm mounting distance 592mm		

accessories

extensions



GEV No.	693727	Ref. No.	GS4055 GS4055A
description	bar for handle		

hinges

oven hinges

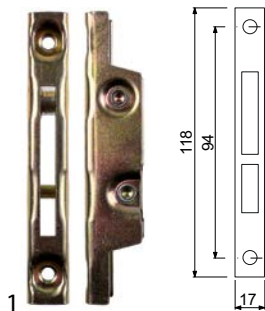

GEV No.	700001	Ref. No.	GS3776
description	opposite support L 118mm W 17mm mounting distance 94mm		

1

GEV No.	700006	Ref. No.	GS3775	
description	oven hinge mounting distance 173mm mounting distance 2 105mm lug mounting 14mm lever length 120mm groove distance 11mm spring thickness 3.5mm mounting ear position left spring length 112mm W 25mm			
accessories for	700006			
	GEV No.	700001	Ref. No.	GS3776
	opposite support L 118mm W 17mm mounting distance 94mm			
	GEV No.	700007	Ref. No.	GS3774
	oven hinge mounting distance 173mm mounting distance 2 105mm lug mounting 14mm lever length 120mm groove distance 11mm spring thickness 3.5mm mounting ear position right spring length 112mm W 25mm			

1

GEV No.	700007	Ref. No.	GS3774	
description	oven hinge mounting distance 173mm mounting distance 2 105mm lug mounting 14mm lever length 120mm groove distance 11mm spring thickness 3.5mm mounting ear position right spring length 112mm W 25mm			
accessories for	700007			
	GEV No.	700001	Ref. No.	GS3776
	opposite support L 118mm W 17mm mounting distance 94mm			

pullouts

rollers

roller with holder



GEV No.	692427	Ref. No.	SS1601B1
description	roller rollers 26mm B1 6mm with holder SS/plastic mounting pos. rear bearing ball bearing Qty 1 pcs H 4mm L 66mm mounting distance 40/50mm		



accessories



1			
GEV No.	693731	Ref. No.	SS1602
description	bracket for roller mounting pos. left		



1			
GEV No.	693733	Ref. No.	PD.4748 SS.4350A
description	guide sliding door L 54mm plastic 20		

fittings for catering equipment

outlet taps

universal



1			
GEV No.	540685	Ref. No.	PD3136
description	outlet tap stainless steel angled W 46mm H 40mm thread 3/4" IT		

producer-specific

NAYATI



1			
GEV No.	540665	Ref. No.	GS8046S
description	drain pipe connection 1/2" total length 85mm		
For models:	NGWR10-85W1S1, NGWR15-85W2, NGWR16-85W2S1, NGWR18-85W2S2, NGWR22-85W3, NGWR24-85W3S2, NGWR7-85		

equipment feet and end caps

bullet feet

plastic



1			
GEV No.	700108	Ref. No.	SS2016
description	equipment foot pipe type 40x40 thickness 1-1.2mm H 17-55mm plastic Qty 1 pcs		
spare parts for	700108		
	GEV No.	511512	Ref. No.
			—
	O-ring EPDM thickness 2.62mm ID ø 18.72mm Qty 10 pcs		

screw-in feet



1			
GEV No.	697901	Ref. No.	PS.2456 SS.2603
description	equipment foot thread M10 thread L 19.5mm ø 30mm H 34mm WS 13 Qty 1 pcs		
For models:	NGWT 3-55/SN, NGWT 7-55/SN		



1			
GEV No.	699184	Ref. No.	PD.2456
description	equipment foot thread M10 thread L 40mm ø 45mm H 53mm		
For models:	MES 6-48		

baskets

fryer baskets

NAYATI



1

GEV No.	970489	Ref. No.	GS416N
description	fryer basket L1 280mm W1 190mm H1 100mm		



1

GEV No.	970434	Ref. No.	GS416C GS416M
description	fryer basket L1 330mm W1 275mm H1 115mm		



1

GEV No.	970435	Ref. No.	GS2160
description	fryer basket L1 335mm W1 165mm H1 150mm rubber with holder		



1

GEV No.	970762	Ref. No.	PD.2167B
description	fryer basket W1 150mm L1 305mm H1 120mm		

pasta baskets

NAYATI



1

GEV No.	970378	Ref. No.	GS3205
description	pasta basket L1 160mm W1 290mm H1 175mm size GN 1/3 H3 280mm stainless steel		



1

GEV No.	970488	Ref. No.	GS9404
description	pasta basket L1 288mm W1 142mm H1 135mm H3 290mm stainless steel		

shelves and shelf rails

chargrill grids



1

GEV No.	211083	Ref. No.	PD3005
description	chargrill grid L 420mm W 175mm		



1

GEV No.	211084	Ref. No.	GS4031
description	chargrill grid L 540mm W 350mm		



grates

universal

with upstand



GEV No.	970734	Ref. No.	GS.9501
description	grate W 538mm D 640mm H 37mm chrome-plated steel wire gauge frame 8mm lengthwise wires gauge 4mm crossing wires 2		

gaskets

O-rings

EPDM



GEV No.	510177	Ref. No.	GS2308
description	O-ring EPDM thickness 1.78mm ID ø 7.66mm Qty 1 pcs		

Viton



GEV No.	103007	Ref. No.	PD.2482
description	O-ring Viton thickness 5mm ID ø 42.5mm Qty 1 pcs		

sealing washers

rubber gaskets



GEV No.	512073	Ref. No.	SS2620
description	flat gasket rubber ED ø 31mm ID ø 22mm thickness 2mm Qty 1 pcs		

PTFE gaskets



GEV No.	693435	Ref. No.	GS2307
description	gasket PTFE ED ø 14mm ID ø 10mm thickness 3mm Qty 1 pcs		

transmission technology and ball bearings

ball bearings

deep-groove ball bearings Z



GEV No.	697795	Ref. No.	BR-6000Z GI4444
description	ball bearing type 6000-Z shaft ø 10mm ED ø 26mm W 8mm DIN 625-1		



GEV No.	523016	Ref. No.	GI.4440
description	deep-groove ball bearing type 6205Z shaft ø 25mm ED ø 52mm W 15mm with sealring disc one side DIN 625-1		

springs

compression springs



GEV No.	105575	Ref. No.	GS1456
description	compression spring ø 23mm L 35mm wire gauge ø 1.5mm for air mixers		
For models:	NGER 13-130, NGER 13-70, NGER 15-60, NGER 20-60, NGER 20-70, NGER 4-60, NGER 7-70, NGER 9-60, NGETL 5-50, NGTL 6-65 SO, NGWR10-85W1S1, NGWR15-85W2, NGWR16-85W2S1, NGWR18-85W2S2, NGWR22-85W3, NGWR24-85W3S2, NGWR7-85, NGWT 3-55/SN, NGWT 7-55/SN		

fittings, hose and pipe connectors

fittings

miscellaneous



1

GEV No.	520510	Ref. No.	GS.1556
description	screw connection thread 3/4" L 45mm		

valves and tank inlets

ball valves

universal

ball valves with butterfly handle



1

GEV No.	540775	Ref. No.	SS2030
description	ball valve connection 1" IT - 1" IT DN25 total length 68mm		
accessories for	540775		
	GEV No.	514529	Ref. No.
			—
	lever handle plastic/metal L 150mm for valve W 120mm H 25mm handle ø 28mm		



1

GEV No.	101895	Ref. No.	GS2004
description	ball valve connection 1/4" IT - 1/4" IT DN10 total length 45mm		
For models:	NGWR10-85W1S1, NGWR15-85W2, NGWR16-85W2S1, NGWR18-85W2S2, NGWR22-85W3, NGWR24-85W3S2, NGWR7-85		

producer-specific

NAYATI



1

GEV No.	101718	Ref. No.	GS2014
description	ball handle thread M8 ø 25mm with metal bush black		
For models:	NGWR10-85W1S1, NGWR15-85W2, NGWR16-85W2S1, NGWR18-85W2S2, NGWR22-85W3, NGWR24-85W3S2, NGWR7-85		



1

GEV No.	101995	Ref. No.	CH2006 GS2006
description	ball valve inlet 3/4" IT outlet 3/4" IT L 70mm without handle		
For models:	NGKB22-125DB, NGWR10-85W1S1, NGWR15-85W2, NGWR16-85W2S1, NGWR18-85W2S2, NGWR22-85W3, NGWR24-85W3S2, NGWR7-85		

accessories for 101995

	GEV No.	101713	Ref. No.	GS4226
---	----------------	--------	-----------------	--------

extension

	GEV No.	101714	Ref. No.	GS8006S
---	----------------	--------	-----------------	---------

handle

	GEV No.	101718	Ref. No.	GS2014
---	----------------	--------	-----------------	--------

ball handle thread M8 ø 25mm with metal bush black



1

GEV No.	101713	Ref. No.	GS4226
----------------	--------	-----------------	--------

description extension

For models: NGWR10-85W1S1, NGWR15-85W2, NGWR16-85W2S1, NGWR18-85W2S2, NGWR22-85W3, NGWR24-85W3S2, NGWR7-85



1

GEV No.	101714	Ref. No.	GS8006S
----------------	--------	-----------------	---------

description handle

For models: NGWR10-85W1S1, NGWR15-85W2, NGWR16-85W2S1, NGWR18-85W2S2, NGWR22-85W3, NGWR24-85W3S2, NGWR7-85

accessories for 101714

	GEV No.	101718	Ref. No.	GS2014
---	----------------	--------	-----------------	--------

ball handle thread M8 ø 25mm with metal bush black

shut-off valves

universal



1



GEV No.	540660	Ref. No.	GS2305 GS2305C+PD2458A2
----------------	--------	-----------------	----------------------------

description shut-off valve total length 105mm pipe connection ø 15mm

For models: NGWR10-85W1S1, NGWR15-85W2, NGWR16-85W2S1, NGWR18-85W2S2, NGWR22-85W3, NGWR24-85W3S2, NGWR7-85



inlet taps

GEV No.	540669	Ref. No.	GS3714
description	inlet tap connection 1/2" ET tube ϕ 20mm projection 105mm overall height 140mm spout height 55mm rotation 90°		
accessories for	540669		
	GEV No.	511470	Ref. No. —
	nut thread 1/2" ϕ 40mm H 8mm WS 25 brass Qty 1 pcs		
	GEV No.	511474	Ref. No. —
	flat washer for thread 1/2"		
	GEV No.	511477	Ref. No. —
	flat gasket rubber ED ϕ 42mm ID ϕ 21mm thickness 2mm Qty 1 pcs		

tank inlets

GEV No.	693728	Ref. No.	SS2619
description	tank inlet connection 1/2" WS 30 L1 20mm L2 28mm		

tools

hand tools

pliers

riveting pliers

rivet nut pliers

GEV No.	802002	Ref. No.	GS.1329
description	grub screw thread M5 L 5mm DIN 913/ISO 4026 intake internal hexagon WS 3 Qty 1 pcs		
For models:	NGTL 6-65 SO, NGWR10-85W1S1, NGWR15-85W2, NGWR16-85W2S1, NGWR18-85W2S2, NGWR22-85W3, NGWR24-85W3S2, NGWR7-85		

fastening material

screws

grub screws

DIN 913/ISO 4026

GEV No.	802002	Ref. No.	GS.1329
description	grub screw thread M5 L 5mm DIN 913/ISO 4026 intake internal hexagon WS 3 Qty 1 pcs		
For models:	NGTL 6-65 SO, NGWR10-85W1S1, NGWR15-85W2, NGWR16-85W2S1, NGWR18-85W2S2, NGWR22-85W3, NGWR24-85W3S2, NGWR7-85		

DIN 916/ISO 4029

GEV No.	696272	Ref. No.	GS.1329
description	grub screw thread M5 L 6mm DIN 916/ISO 4029 intake internal hexagon WS 2.5 Qty 1 pcs		

nuts

hexagonal nuts

hexagonal nuts inch thread

GEV No.	693729	Ref. No.	SS2618
description	nut thread 1/2" ϕ 39mm H 8mm WS 25 brass Qty 1 pcs		

fasteners

slot nuts

GEV No.	560378	Ref. No.	GI4448 KRR-4*4*10
description	slot nut W 4mm H 4mm L 10mm		

retaining rings

DIN 471



1

GEV No.	523107	Ref. No.	CR-S12 GI4446
----------------	--------	-----------------	------------------

description retaining ring shaft \varnothing 11mm thickness 1mm SS DIN 471



1

GEV No.	692108	Ref. No.	CR-S14 GI4445
----------------	--------	-----------------	------------------

description retaining ring shaft \varnothing 13mm thickness 1mm steel DIN 471

DIN 472



1

GEV No.	523106	Ref. No.	CR-R26 GI4447
----------------	--------	-----------------	------------------

description retaining ring bore \varnothing 28mm thickness 1.3mm steel DIN 472

B			
ball valves	44		
bar burners	29		
bottom heaters	3		
C			
cam switches	8		
ceramic heaters	4		
control thermostats	6		
E			
electric accessories	11		
energy regulators	6		
F			
fasteners	45		
fastening material	45		
fittings	44		
float switches	8		
foil heating elements	5		
G			
gas burners	24		
gas control valves	16		
gas lines	35		
gas nozzles	31		
gas taps	11		
gas thermostats	14		
grates	43		
grub screws	45		
H			
hand tools	45		
heating elements	3		
heating elements for bain maries	3		
heating elements for charrills	3		
heating elements for fryers	3		
heating elements for griddles	3		
heating plates	4		
hexagonal nuts	45		
hob burners	24		
hot plates	6		
I			
ignition bridges	23		
ignition cables	22		
immersion heating elements	4		
indicator lights	9		
indicator lights (complete)	9		
induction coils	3		
inlet spouts	45		
inlet taps	45		
L			
lamps	9		
M			
magnetic switches	9		
mechanical timers	10		
N			
nuts	45		
O			
O-rings	43		
oven hinges	40		
P			
piezoelectric igniters	22		
pilot burners	17		
pliers	45		
pressure switches	10		
programme timers	10		
R			
radiation heaters	5		
relays	10		
retaining rings	46		
riveting pliers	45		
rocker/momentary rocker switches	8		
S			
safety thermostats	6		
safety valves	17		
screws	45		
sealing washers	43		
shelves and shelf rails	42		
shut-off valves	44		
slot nuts	45		
surface burners	30		
switches and momentary switches	8		
T			
tank inlets	45		
terminals	11		
thermocouples	23		
thermostats	6		
timers	10		
tools	45		
tube burners	30		
V			
valves and tank inlets	44		