



**GAS COMPONENTS**



**ELECTRIC COMPONENTS**



**WATER TECHNOLOGY**



**MECHANICAL COMPONENTS**



**TOOLS**

Spare parts suitable for

**N&W**

Find the complete and up-to-date range of products in our GEV Webshop



# Manufacturer catalogue

The most important spare parts and accessories arranged clearly for every manufacturer

- ✓ Complete product range and all appliance data always up to date in the GEV Webshop
- ✓ Alphabetical Index at the end of the catalogue

## GEV Webshop

[www.gev-online.co.uk](http://www.gev-online.co.uk)

[www.gev-online.com](http://www.gev-online.com)



- 🔍 Add to Favourites
- 🔍 Sign In with email address and usual password
- 🔍 Easy-order – place several items in your basket at the same time
- 🔍 Quick Item search – no login needed









## heating elements

### heating elements for coffee machine

|  |  |                 |                   |
|--|--|-----------------|-------------------|
|  <p>1</p> |  |                 |                   |
| <b>GEV No.</b>   | 417453   | <b>Ref. No.</b> | 098645            |
| <b>description</b>   | heating element 1000W 220V heating circuits 1 ø 55mm H 62mm W1 44mm H1 32mm H2 30mm mounting distance 40mm thread M10x1 stainless steel windings 4 tube ø 6mm coffee machine screw |                 |                   |
| <b>accessories for</b>   | 417453   |                 |                   |
|           | <b>GEV No.</b>   | 510416          | <b>Ref. No.</b> — |
|  | flat gasket fibre ED ø 19mm ID ø 10.5mm thickness 1.5mm for thread M10 Qty 1 pcs   |                 |                   |
|           | <b>GEV No.</b>   | 510893          | <b>Ref. No.</b> — |
|  | O-ring EPDM thickness 2.62mm ID ø 9.92mm Qty 1 pcs   |                 |                   |
|           | <b>GEV No.</b>   | 520231          | <b>Ref. No.</b> — |
|  | nut thread M10x1 H 6mm WS 14 zinc-coated steel Qty 1 pcs   |                 |                   |
|           | <b>GEV No.</b>   | 521129          | <b>Ref. No.</b> — |
|  | nut thread M10 H 6mm SS WS 17 Qty 1 pcs DIN/ISO DIN 439  |                 |                   |

### flow heaters

|  |  |                 |                                      |
|--|--|-----------------|--------------------------------------|
|  <p>1</p> |  |                 |                                      |
| <b>GEV No.</b>   | 417214   | <b>Ref. No.</b> | 0V2506                               |
| <b>description</b>   | flow heater 1000W 220V ø 88mm L 110mm Wmm complete coffee machine suitable for KORO ES/Tank C252X02  |                 |                                      |
| <b>spare parts for</b>   | 417214   |                 |                                      |
|           | <b>GEV No.</b>   | 370477          | <b>Ref. No.</b> 098761 258743        |
|  | solenoid valve brass 230VAC outlet 1/8" 5-way body outer cone slide-on receptacle DIN ODE coil type BDA/LBA p max 15bar coffee machine   |                 |                                      |
|           | <b>GEV No.</b>   | 390624          | <b>Ref. No.</b> 0V1318               |
|  | bi-metal safety thermostat hole distance 40mm switch-off temp. 125°C 2NC 2-pole 16A connection F6.3 2 hole fixing  |                 |                                      |
|           | <b>GEV No.</b>   | 402078          | <b>Ref. No.</b> 094372 094872 259898 |
|  | temperature probe NTC 10kOhm cable probe -40 up to +110°C cable°C connection male faston 6.3mm thread 1/4" probe ø10x25mm cable lengthm  |                 |                                      |
|           | <b>GEV No.</b>   | 417453          | <b>Ref. No.</b> 098645               |
|  | heating element 1000W 220V heating circuits 1 ø 55mm H 62mm W1 44mm H1 32mm H2 30mm mounting distance 40mm thread M10x1 stainless steel windings 4 tube ø 6mm coffee machine screw |                 |                                      |
|           | <b>GEV No.</b>   | 528110          | <b>Ref. No.</b> 093347 095624        |
|  | O-ring EPDM thickness 2.62mm ID ø 12.37mm Qty 1 pcs  |                 |                                      |

|   |   |        |                        |
|---|---|--------|------------------------|
| <b>spare parts for</b>  | 417214  |        |                        |
|  | <b>GEV No.</b>                                      | 528500 | <b>Ref. No.</b> 098701 |
|   | O-ring EPDM thickness 3.53mm ID ø 72.62mm Qty 1 pcs |        |                        |

## thermostats

### bi-metal thermostats



#### safety bi-metal thermostats

|  |   |                 |        |
|--|---|-----------------|--------|
|  <p>1</p> |   |                 |        |
| <b>GEV No.</b>   | 390624  | <b>Ref. No.</b> | 0V1318 |
| <b>description</b>   | bi-metal safety thermostat hole distance 40mm switch-off temp. 125°C 2NC 2-pole 16A connection F6.3 2 hole fixing |                 |        |

## switches and momentary switches



### rocker/momentary rocker switches

#### 30x22mm

|  |   |                 |                   |
|--|---|-----------------|-------------------|
|  <p>1</p> |   |                 |                   |
| <b>GEV No.</b>   | 346377  | <b>Ref. No.</b> | 251858            |
| <b>description</b>   | rocker switch mounting measurements 30x22mm black 2CO 230V 16A 0-1 connection male faston 6.3mm ambient temperature max. 125/55°C protection IP40 |                 |                   |
| <b>accessories for</b>   | 346377  |                 |                   |
|         | <b>GEV No.</b>  | 301036          | <b>Ref. No.</b> — |
|  | protective cover internal size 30x22mm for rocker switch mounting measurementsmm  |                 |                   |

### accessories

#### push buttons

|  |                                     |                 |                        |
|--|-------------------------------------|-----------------|------------------------|
|  <p>1</p> |                                     |                 |                        |
| <b>GEV No.</b>   | 527289                              | <b>Ref. No.</b> | 251787                 |
| <b>description</b>   | button grey                         |                 |                        |
| <b>accessories for</b>   | 527289                              |                 |                        |
|           | <b>GEV No.</b>                      | 402089          | <b>Ref. No.</b> 251865 |
|  | keypad PCB for coffee machine       |                 |                        |
|           | <b>GEV No.</b>                      | 402110          | <b>Ref. No.</b> 251785 |
|  | push button set 8-piece transparent |                 |                        |



microswitches

roller-lever actuated

microswitches



|                    |   |                 |        |
|--------------------|---|-----------------|--------|
| 1                  |   |                 |        |
| <b>GEV No.</b>     | 347028  | <b>Ref. No.</b> | 251861 |
| <b>description</b> | microswitch with handle with a switch 250V 10A 1NO connection male faston 6.3mm L 28mm ambient temperature max. 125°C black/green lever length 26mm |                 |        |

non-standard



|                    |  |                 |        |
|--------------------|--|-----------------|--------|
| 1                  |  |                 |        |
| <b>GEV No.</b>     | 347026   | <b>Ref. No.</b> | 096355 |
| <b>description</b> | microswitch with handle with a switch 250V 5A 1CO connection soldering connection L 12.5mm L1 20mm ambient temperature max. 85°C mounting distance 10mm actuating force: 55g lever length 16.6mm |                 |        |

pin-plunger actuated



|                    |   |                 |        |
|--------------------|---|-----------------|--------|
| 1                  |   |                 |        |
| <b>GEV No.</b>     | 300092  | <b>Ref. No.</b> | 097796 |
| <b>description</b> | microswitch with plunger 400V 16A 2NO connection male faston 6.3mm ambient temperature max. 85°C mounting distance 22mm type XTD22A21 actuating force: 150g fryer black |                 |        |

with push button

switches with snap-fit



|                    |  |                 |        |
|--------------------|--|-----------------|--------|
| 1                  |  |                 |        |
| <b>GEV No.</b>     | 347027   | <b>Ref. No.</b> | 0V2378 |
| <b>description</b> | microswitch with push button 250V 1A 1CO connection male faston 2.8mm L 26x12mm ambient temperature max. 85°C type XKA-304B1AAJ11 actuating force: 50g |                 |        |

accessories



|                    |  |                 |        |
|--------------------|--|-----------------|--------|
| 1                  |  |                 |        |
| <b>GEV No.</b>     | 347031                                       | <b>Ref. No.</b> | 090681 |
| <b>description</b> | insulating mat for microswitch L 42mm W 28mm |                 |        |

float switches

floats



|                    |                    |                 |        |
|--------------------|--------------------|-----------------|--------|
| 1                  |                    |                 |        |
| <b>GEV No.</b>     | 527288             | <b>Ref. No.</b> | 251851 |
| <b>description</b> | float for drip pan |                 |        |



|                    |  |                 |        |
|--------------------|--|-----------------|--------|
| 1                  |  |                 |        |
| <b>GEV No.</b>     | 527287   | <b>Ref. No.</b> | 251876 |
| <b>description</b> | float with magnet ømm L 23.5mm W 16mm H 17mm plastic |                 |        |

magnetic switches

29x19mm

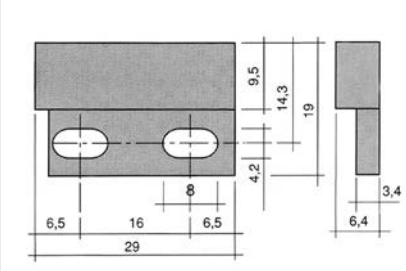

|                    |   |                 |        |
|--------------------|---|-----------------|--------|
| 1                  |   |                 |        |
| <b>GEV No.</b>     | 347030 <sup>1</sup>                                       | <b>Ref. No.</b> | 251860 |
| <b>description</b> | magnetic switch L 29mm W 19mm 1NO 250V cable length 360mm |                 |        |

<sup>1</sup>with coded connector



## transformers

### open transformers

#### with cable connection

|  |  |                 |        |
|--|--|-----------------|--------|
|  <p>1</p> |  |                 |        |
| <b>GEV No.</b>   | 400058   | <b>Ref. No.</b> | 098792 |
| <b>description</b>   | transformer primary 230V secondary 15V 15VA connection cable 250mm 50/60Hz |                 |        |

## probes

### producer-specific probes

#### probes



|   |   |                 |                            |
|---|---|-----------------|----------------------------|
|  <p>1</p>   |   |                 |                            |
| <b>GEV No.</b>  | 402078  | <b>Ref. No.</b> | 094372<br>094872<br>259898 |
| <b>description</b>  | temperature probe NTC 10kOhm cable probe -40 up to +110°C cable°C connection male faston 6.3mm thread 1/4" probe ø10x25mm cable lengthm |                 |                            |
| <b>spare parts for</b>  | 402078  |                 |                            |
|  <p>GEV No. 528110 Ref. No. 093347 095624</p> <p>O-ring EPDM thickness 2.62mm ID ø 12.37mm Qty 1 pcs</p> |   |                 |                            |

## electronics

### PCBs

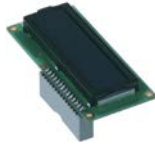
|  |                                 |                 |        |
|--|---------------------------------|-----------------|--------|
|  <p>1</p> |                                 |                 |        |
| <b>GEV No.</b>   | 402088                          | <b>Ref. No.</b> | 0V2143 |
| <b>description</b>   | control PCB coffee machine KORO |                 |        |

|  |                             |                 |                  |
|--|-----------------------------|-----------------|------------------|
|  <p>1</p> |                             |                 |                  |
| <b>GEV No.</b>   | 402090                      | <b>Ref. No.</b> | 0V3458<br>251653 |
| <b>description</b>   | display coffee machine KORO |                 |                  |



|  |                               |                 |        |
|--|-------------------------------|-----------------|--------|
|  <p>1</p>  |                               |                 |        |
| <b>GEV No.</b>   | 402089                        | <b>Ref. No.</b> | 251865 |
| <b>description</b>   | keypad PCB for coffee machine |                 |        |
| <b>accessories for</b>   | 402089                        |                 |        |
|  <p>GEV No. 402110 Ref. No. 251785</p> <p>push button set 8-piece transparent</p> |                               |                 |        |
|  <p>GEV No. 527289 Ref. No. 251787</p> <p>button grey</p>                         |                               |                 |        |

|  |                               |                 |        |
|--|-------------------------------|-----------------|--------|
|  <p>1</p> |                               |                 |        |
| <b>GEV No.</b>   | 402091                        | <b>Ref. No.</b> | 252604 |
| <b>description</b>   | PCB coffee machine KORO 16Bit |                 |        |

## keypads

### accessories

|   |                                      |                 |        |
|---|--------------------------------------|-----------------|--------|
|  <p>1</p> |                                      |                 |        |
| <b>GEV No.</b>  | 402111                               | <b>Ref. No.</b> | 251786 |
| <b>description</b>  | push button L 60mm W 11mm H 9mm grey |                 |        |

|  |                                     |                 |        |
|--|-------------------------------------|-----------------|--------|
|  <p>1</p>  |                                     |                 |        |
| <b>GEV No.</b>   | 402110                              | <b>Ref. No.</b> | 251785 |
| <b>description</b>   | push button set 8-piece transparent |                 |        |
| <b>accessories for</b>   | 402110                              |                 |        |
|  <p>GEV No. 402089 Ref. No. 251865</p> <p>keypad PCB for coffee machine</p> |                                     |                 |        |
|  <p>GEV No. 527289 Ref. No. 251787</p> <p>button grey</p>                   |                                     |                 |        |





## solenoid valves

## solenoid valves (water)

## various



1

|                    |  |                 |                  |
|--------------------|--|-----------------|------------------|
| <b>GEV No.</b>     | 372216   | <b>Ref. No.</b> | 251895<br>253818 |
| <b>description</b> | solenoid valve with pressure switch single, angled 230VAC outlet 11mm inlet 3/4"mm |                 |                  |

## metal

## ODE

## 5-way



1

|                    |  |                 |                  |
|--------------------|--|-----------------|------------------|
| <b>GEV No.</b>     | 370477   | <b>Ref. No.</b> | 098761<br>258743 |
| <b>description</b> | solenoid valve brass 230VAC outlet 1/8" 5-way body outer cone slide-on receptacle DIN ODE coil type BDA/LBA p max 15bar coffee machine |                 |                  |

## spare parts for 370477

|   |                    |  |                 |        |
|---|--------------------|--|-----------------|--------|
|  | <b>GEV No.</b>     | 371150   | <b>Ref. No.</b> | 099057 |
|   | <b>description</b> | solenoid coil ODE 230VAC 16VA coil type BDV seat ø 13.5mm 750Ohm |                 |        |
|  | <b>GEV No.</b>     | 371191   | <b>Ref. No.</b> | 099056 |
|   | <b>description</b> | solenoid coil ODE 230VAC 10VA 50Hz coil type LBA seat ø 10mm     |                 |        |
|  | <b>GEV No.</b>     | 371192   | <b>Ref. No.</b> | 099105 |
|   | <b>description</b> | solenoid valve body ø 13mm                                       |                 |        |
|  | <b>GEV No.</b>     | 371193   | <b>Ref. No.</b> | 097472 |
|   | <b>description</b> | valve insert L 30mm ø 12mm Viton                                 |                 |        |
|  | <b>GEV No.</b>     | 371194   | <b>Ref. No.</b> | 0V1953 |
|   | <b>description</b> | solenoid valve body ø 10mm                                       |                 |        |
|  | <b>GEV No.</b>     | 371195   | <b>Ref. No.</b> | 099058 |
|   | <b>description</b> | valve insert L 24mm ø 9mm Viton                                  |                 |        |
|  | <b>GEV No.</b>     | 510177   | <b>Ref. No.</b> | 094594 |
|   | <b>description</b> | O-ring EPDM thickness 1.78mm ID ø 7.66mm Qty 1 pcs               |                 |        |
|  | <b>GEV No.</b>     | 520333   | <b>Ref. No.</b> | 095529 |
|   | <b>description</b> | hose connector brass straight thread 1/8" hose ø 7mm Qty 1 pcs   |                 |        |
|  | <b>GEV No.</b>     | 520334   | <b>Ref. No.</b> | 0V2509 |
|   | <b>description</b> | angle piece thread 1/8" with coupling angled hose ø 5mm          |                 |        |

## spare parts and accessories

## gaskets



1

|                    |                              |                 |        |
|--------------------|------------------------------|-----------------|--------|
| <b>GEV No.</b>     | 371196                       | <b>Ref. No.</b> | 099059 |
| <b>description</b> | O-ring ø 12mm for valve body |                 |        |

## solenoid coils



1

|                    |  |                 |        |
|--------------------|--|-----------------|--------|
| <b>GEV No.</b>     | 371191   | <b>Ref. No.</b> | 099056 |
| <b>description</b> | solenoid coil ODE 230VAC 10VA 50Hz coil type LBA seat ø 10mm |                 |        |



1

|                    |  |                 |        |
|--------------------|--|-----------------|--------|
| <b>GEV No.</b>     | 371150   | <b>Ref. No.</b> | 099057 |
| <b>description</b> | solenoid coil ODE 230VAC 16VA coil type BDV seat ø 13.5mm 750Ohm |                 |        |

## valve inserts



1

|                    |                                 |                 |        |
|--------------------|---------------------------------|-----------------|--------|
| <b>GEV No.</b>     | 371195                          | <b>Ref. No.</b> | 099058 |
| <b>description</b> | valve insert L 24mm ø 9mm Viton |                 |        |



1

|                    |                                  |                 |        |
|--------------------|----------------------------------|-----------------|--------|
| <b>GEV No.</b>     | 371193                           | <b>Ref. No.</b> | 097472 |
| <b>description</b> | valve insert L 30mm ø 12mm Viton |                 |        |

## valve bodies



1

|                    |                            |                 |        |
|--------------------|----------------------------|-----------------|--------|
| <b>GEV No.</b>     | 371194                     | <b>Ref. No.</b> | 0V1953 |
| <b>description</b> | solenoid valve body ø 10mm |                 |        |



|   |                            |                 |        |
|---|----------------------------|-----------------|--------|
|  |                            |                 |        |
| 1   |                            |                 |        |
| <b>GEV No.</b>  | 371192                     | <b>Ref. No.</b> | 099105 |
| <b>description</b>  | solenoid valve body ø 13mm |                 |        |

## flow meters and flow sensors

### flow meters

#### GICAR

|   |   |                 |        |
|---|---|-----------------|--------|
|  |   |                 |        |
| 1   |   |                 |        |
| <b>GEV No.</b>  | 400782  | <b>Ref. No.</b> | 098707 |
| <b>description</b>  | flow meter hose ø 6mm plastic plug-in connection approval NSF |                 |        |

## fans

### axial fans

#### ebm-papst

|   |  |                 |        |
|---|--|-----------------|--------|
|  |  |                 |        |
| 1   |  |                 |        |
| <b>GEV No.</b>  | 601496 <sup>1</sup>  | <b>Ref. No.</b> | 251867 |
| <b>description</b>  | axial fan L 60mm W 60mm H 25mm 12VDC 0.8W bearing ball bearing manuf. no. 612NME plastic connection cable 310mm ebm-papst fan wheel ø 55mm with plug |                 |        |

<sup>1</sup>with ball bearings

## motors

### gear motors

#### for automatic coffee machines

|  |   |                 |        |
|--|---|-----------------|--------|
|  |   |                 |        |
| 1  |   |                 |        |
| <b>GEV No.</b>   | 601486  | <b>Ref. No.</b> | 252030 |
| <b>description</b>   | gear motor 90W 230V 50Hz 48rpm shaft ø 15mm L 95mm W 61mm H 90mm for coffee machine |                 |        |

|  |   |                 |        |
|--|---|-----------------|--------|
|  |   |                 |        |
| 1  |   |                 |        |
| <b>GEV No.</b>   | 601488  | <b>Ref. No.</b> | 251866 |
| <b>description</b>   | gear motor 90W 230V 50Hz 70rpm shaft ø 15mm L 96mm W 55mm H 90mm for coffee machine |                 |        |



|   |  |                 |        |
|---|--|-----------------|--------|
|  |  |                 |        |
| 1   |  |                 |        |
| <b>GEV No.</b>  | 601490   | <b>Ref. No.</b> | 098708 |
| <b>description</b>  | gear motor LIP type 111 48W 230V 50Hz 8rpm shaft ø 6x8.5mm L 110mm W 71mm H 80mm |                 |        |



### motors

#### for automatic coffee machines

|  |   |                 |        |
|--|---|-----------------|--------|
|  |   |                 |        |
| 1  |   |                 |        |
| <b>GEV No.</b>   | 601494  | <b>Ref. No.</b> | 251777 |
| <b>description</b>   | motor for coffee grinder 230V 48W 50/60Hz 1 phase shaft ø 7.5mm shaft length 24mm H 70mm L 120mm W 70mm KORO- ESPRESSO FISE |                 |        |



|   |   |                 |                        |
|---|---|-----------------|------------------------|
|  |   |                 |                        |
| 1   |   |                 |                        |
| <b>GEV No.</b>  | 601495  | <b>Ref. No.</b> | 098808                 |
| <b>description</b>  | motor for mixer 230V 50/60Hz 1 phase shaft ø 4mm shaft length 27mm KORO- ESPRESSO |                 |                        |
| <b>accessories for</b>  | 601495  |                 |                        |
|  | <b>GEV No.</b>  | 527278          | <b>Ref. No.</b> 097916 |
|   | impellor ø 32mm   |                 |                        |

|  |   |                 |                        |
|--|---|-----------------|------------------------|
|  |   |                 |                        |
| 1  |   |                 |                        |
| <b>GEV No.</b>   | 500124  | <b>Ref. No.</b> | 098760                 |
| <b>description</b>   | vibration pump type EX 5 230V 48W 50/60Hz inlet ø 6 outlet ø 1/8" IT flat seal ULKA brass L 123mm |                 |                        |
| <b>accessories for</b>   | 500124  |                 |                        |
|   | <b>GEV No.</b>  | 520152          | <b>Ref. No.</b> 252021 |
|  | hose connector Santoprene grommet ø 7mm grommet length 14mm                                       |                 |                        |
|   | <b>GEV No.</b>  | 520330          | <b>Ref. No.</b> 0V4275 |
|  | bracket rubber dimensions 69x44x4mm   |                 |                        |

## pumps

### vibration pumps

|   |                                     |                 |        |
|---|-------------------------------------|-----------------|--------|
|  |                                     |                 |        |
| 1   |                                     |                 |        |
| <b>GEV No.</b>  | 520330                              | <b>Ref. No.</b> | 0V4275 |
| <b>description</b>  | bracket rubber dimensions 69x44x4mm |                 |        |

|   |   |                 |        |
|---|---|-----------------|--------|
|  |   |                 |        |
| 1   |   |                 |        |
| <b>GEV No.</b>  | 520152  | <b>Ref. No.</b> | 252021 |
| <b>description</b>  | hose connector Santoprene grommet ø 7mm grommet length 14mm |                 |        |

|   |   |                 |        |
|---|---|-----------------|--------|
|  |   |                 |        |
| 1   |   |                 |        |
| <b>GEV No.</b>  | 390625  | <b>Ref. No.</b> | 0V1301 |
| <b>description</b>  | thermal fuse switch-off temp. 110°C suitable for ULKA pump Klixon |                 |        |

## condensators & interference suppression filters

### filters

#### line filters

#### with housing

|   |  |                 |                  |
|---|--|-----------------|------------------|
|  |  |                 |                  |
| 1   |  |                 |                  |
| <b>GEV No.</b>  | 365077   | <b>Ref. No.</b> | 097155<br>0V3512 |
| <b>description</b>  | line filter type 411524410 250V 50/60Hz conductor 2 with E connection male faston 6.3mm L 50mm ø 38mm Hmm Wmm M8 plastic Qty 1 pcs |                 |                  |

## fuses

### fine fuses

|  |   |                 |        |
|--|---|-----------------|--------|
|  |   |                 |        |
| 1  |   |                 |        |
| <b>GEV No.</b>   | 358593  | <b>Ref. No.</b> | 097544 |
| <b>description</b>   | fine fuse size ø5x20mm 0.125A slow-acting rated 250V Qty 10 pcs |                 |        |

|  |  |                 |        |
|--|--|-----------------|--------|
|  |  |                 |        |
| 1  |  |                 |        |
| <b>GEV No.</b>   | 358601   | <b>Ref. No.</b> | 097103 |
| <b>description</b>   | fine fuse size ø5x20mm 1.25A slow-acting rated 250V Qty 10 pcs |                 |        |







|   |  |                 |        |
|---|--|-----------------|--------|
|  |  |                 |        |
| 1   |  |                 |        |
| <b>GEV No.</b>  | 358851   | <b>Ref. No.</b> | 095636 |
| <b>description</b>  | fuse size ø6.3x32mm 15A slow-acting rated 250V Qty 1 pcs |                 |        |

| fine fuse holders   |  |                 |        |
|---|--|-----------------|--------|
|  |  |                 |        |
| 1   |  |                 |        |
| <b>GEV No.</b>  | 358852   | <b>Ref. No.</b> | 251863 |
| <b>description</b>  | fuse holder suitable fuse ø6.3x32mm ø 16mm 1-pole 16A rated 250V L 52mm connection male faston 4.8mm/6.3mm |                 |        |

## electric accessories

### terminals

| terminal blocks with fuse holder   |  |                 |        |
|--|--|-----------------|--------|
|  |  |                 |        |
| 1  |  |                 |        |
| <b>GEV No.</b>   | 358391   | <b>Ref. No.</b> | 097241 |
| <b>description</b>   | lustre terminal 2-pole max. 24A max 450V suitable fuse ø5x20mm cross section 2.5mm <sup>2</sup> with fuse holder |                 |        |



|   |  |                 |        |
|---|--|-----------------|--------|
|  |  |                 |        |
| 1   |  |                 |        |
| <b>GEV No.</b>  | 358393   | <b>Ref. No.</b> | 098793 |
| <b>description</b>  | lustre terminal 4-pole max. 24A max 450V suitable fuse ø5x20mm cross section 2.5mm <sup>2</sup> with fuse holder |                 |        |

### connection terminals with screw/faston connections

|   |   |                 |        |
|---|---|-----------------|--------|
|  |   |                 |        |
| 1   |   |                 |        |
| <b>GEV No.</b>  | 550458  | <b>Ref. No.</b> | 251856 |
| <b>description</b>  | power terminal block 3-pole max. 25A max 450V connection ø2.5mm <sup>2</sup> / F6.3 temp.-resist. 150°C |                 |        |

## equipment-specific units

### for espresso machines

| non-return valves   |   |                 |        |
|---|---|-----------------|--------|
| complete  |   |                 |        |
|  |   |                 |        |
| 1   |   |                 |        |
| <b>GEV No.</b>  | 529889  | <b>Ref. No.</b> | 099101 |
| <b>description</b>  | non-return valve thread 1/8" IT - 1/8" ET   |                 |        |
| <b>accessories for</b>  | 529889  |                 |        |
|   | <b>GEV No.</b>  | <b>Ref. No.</b> |        |
|   | 691535  | 251143          |        |
|   |  |                 |        |
|   | disc ID ø 10mm ED ø 14mm thicknessmm aluminium Qty 1 pcs                          |                 |        |

### screw connections

| washers   |  |                 |        |
|---|--|-----------------|--------|
|  |  |                 |        |
| 1   |  |                 |        |
| <b>GEV No.</b>  | 691535   | <b>Ref. No.</b> | 251143 |
| <b>description</b>  | disc ID ø 10mm ED ø 14mm thicknessmm aluminium Qty 1 pcs |                 |        |

## for coffee grinders

### coffee beans containers

| container lids  |  |                 |        |
|---|--|-----------------|--------|
|  |  |                 |        |
| 1   |  |                 |        |
| <b>GEV No.</b>  | 527843   | <b>Ref. No.</b> | 252423 |
| <b>description</b>  | lid L 180mm W 160mm H 3mm plastic transparent for coffee beans container |                 |        |

### coffee beans containers

|  |  |                 |        |
|--|--|-----------------|--------|
|  |  |                 |        |
| 1  |  |                 |        |
| <b>GEV No.</b>   | 527572   | <b>Ref. No.</b> | 251770 |
| <b>description</b>   | coffee grinder   |                 |        |
| <b>spare parts for</b>   | 527572   |                 |        |
|  | <b>GEV No.</b>   | <b>Ref. No.</b> |        |
|  | 402076   | 251779          |        |
|  |   |                 |        |
|  | sensor for coffee grinder complete   |                 |        |
|  | <b>GEV No.</b>   | <b>Ref. No.</b> |        |
|  | 527249   | 095840          |        |
|  |   |                 |        |
|  | grinding burr turn direction right D1 ø 63mm ID ø 38mm H 9mm tooth spacing 3mm hole ø 5.5mm bore ø 8.5mm mounting ø 48 straight suitable for N & W |                 |        |
|  | <b>GEV No.</b>   | <b>Ref. No.</b> |        |
|  | 601494   | 251777          |        |
|  |   |                 |        |
|  | motor for coffee grinder 230V 48W 50/60Hz 1 phase shaft ø 7.5mm shaft length 24mm H 70mm L 120mm W 70mm KORO- ESPRESSO FISE                        |                 |        |

## for cup coffee machines

## instant mixer units



1

|                |        |                 |        |
|----------------|--------|-----------------|--------|
| <b>GEV No.</b> | 527279 | <b>Ref. No.</b> | 251833 |
|----------------|--------|-----------------|--------|

|                    |                          |
|--------------------|--------------------------|
| <b>description</b> | coffee device type Z3000 |
|--------------------|--------------------------|



1

|                |        |                 |        |
|----------------|--------|-----------------|--------|
| <b>GEV No.</b> | 527277 | <b>Ref. No.</b> | 251869 |
|----------------|--------|-----------------|--------|

|                    |                          |
|--------------------|--------------------------|
| <b>description</b> | flange for mixing hopper |
|--------------------|--------------------------|



1

|                |        |                 |        |
|----------------|--------|-----------------|--------|
| <b>GEV No.</b> | 527278 | <b>Ref. No.</b> | 097916 |
|----------------|--------|-----------------|--------|

|                    |                 |
|--------------------|-----------------|
| <b>description</b> | impellor ø 32mm |
|--------------------|-----------------|



1

|                |        |                 |        |
|----------------|--------|-----------------|--------|
| <b>GEV No.</b> | 527275 | <b>Ref. No.</b> | 251768 |
|----------------|--------|-----------------|--------|

|                    |                     |
|--------------------|---------------------|
| <b>description</b> | intake body plastic |
|--------------------|---------------------|

|                        |        |
|------------------------|--------|
| <b>accessories for</b> | 527275 |
|------------------------|--------|

|                |        |                 |        |
|----------------|--------|-----------------|--------|
| <b>GEV No.</b> | 527276 | <b>Ref. No.</b> | 251767 |
|----------------|--------|-----------------|--------|

|                    |                             |
|--------------------|-----------------------------|
| <b>description</b> | lid plastic for intake body |
|--------------------|-----------------------------|



1

|                |        |                 |        |
|----------------|--------|-----------------|--------|
| <b>GEV No.</b> | 527276 | <b>Ref. No.</b> | 251767 |
|----------------|--------|-----------------|--------|

|                    |                             |
|--------------------|-----------------------------|
| <b>description</b> | lid plastic for intake body |
|--------------------|-----------------------------|



1

|                |        |                 |        |
|----------------|--------|-----------------|--------|
| <b>GEV No.</b> | 527274 | <b>Ref. No.</b> | 251874 |
|----------------|--------|-----------------|--------|

|                    |                       |
|--------------------|-----------------------|
| <b>description</b> | mixing hopper plastic |
|--------------------|-----------------------|

## coffee spouts

## coffee spouts



1

|                |        |                 |        |
|----------------|--------|-----------------|--------|
| <b>GEV No.</b> | 527283 | <b>Ref. No.</b> | 096868 |
|----------------|--------|-----------------|--------|

|                    |  |
|--------------------|--|
| <b>description</b> | coffee spout for coffee powder container rectangular |
|--------------------|--|



1

|                |        |                 |        |
|----------------|--------|-----------------|--------|
| <b>GEV No.</b> | 527282 | <b>Ref. No.</b> | 098939 |
|----------------|--------|-----------------|--------|

|                    |  |
|--------------------|--|
| <b>description</b> | coffee spout for coffee powder container round |
|--------------------|--|

## coffee beans containers

## container lids



1

|                |        |                 |        |
|----------------|--------|-----------------|--------|
| <b>GEV No.</b> | 527843 | <b>Ref. No.</b> | 252423 |
|----------------|--------|-----------------|--------|

|                    |  |
|--------------------|--|
| <b>description</b> | lid L 180mm W 160mm H 3mm plastic transparent for coffee beans container |
|--------------------|--|



coffee beans containers



1

|   |  |                 |                        |
|---|--|-----------------|------------------------|
| <b>GEV No.</b>  | 527280   | <b>Ref. No.</b> | 251908                 |
| <b>description</b>  | container complete incl. coil, lift and scraper for instant unit |                 |                        |
| <b>accessories for</b>  | 527280   |                 |                        |
|  | <b>GEV No.</b>   | 527282          | <b>Ref. No.</b> 098939 |
|   | coffee spout for coffee powder container round                   |                 |                        |



1

|   |  |                 |                        |
|---|--|-----------------|------------------------|
| <b>GEV No.</b>  | 527281   | <b>Ref. No.</b> | 251875                 |
| <b>description</b>  | container with auger gear for instant unit     |                 |                        |
| <b>accessories for</b>  | 527281   |                 |                        |
|  | <b>GEV No.</b>                                 | 527282          | <b>Ref. No.</b> 098939 |
|   | coffee spout for coffee powder container round |                 |                        |



1

|   |  |                 |                        |
|---|--|-----------------|------------------------|
| <b>GEV No.</b>  | 527834   | <b>Ref. No.</b> | 252462                 |
| <b>description</b>  | container standard                                   |                 |                        |
| <b>accessories for</b>  | 527834   |                 |                        |
|  | <b>GEV No.</b>                                       | 527283          | <b>Ref. No.</b> 096868 |
|   | coffee spout for coffee powder container rectangular |                 |                        |

accessories



1

|   |                                       |                 |                        |
|---|---------------------------------------|-----------------|------------------------|
| <b>GEV No.</b>  | 527285                                | <b>Ref. No.</b> | 252424                 |
| <b>description</b>  | base part for coffee beans container  |                 |                        |
| <b>accessories for</b>  | 527285                                |                 |                        |
|  | <b>GEV No.</b>                        | 527284          | <b>Ref. No.</b> 252536 |
|   | increasing for coffee beans container |                 |                        |



1

|   |  |                 |                        |
|---|--|-----------------|------------------------|
| <b>GEV No.</b>  | 527284   | <b>Ref. No.</b> | 252536                 |
| <b>description</b>  | increasing for coffee beans container                                    |                 |                        |
| <b>accessories for</b>  | 527284   |                 |                        |
|  | <b>GEV No.</b>   | 527843          | <b>Ref. No.</b> 252423 |
|   | lid L 180mm W 160mm H 3mm plastic transparent for coffee beans container |                 |                        |

## grinding units

## automatic grinding



1

|                |        |                 |        |
|----------------|--------|-----------------|--------|
| <b>GEV No.</b> | 402076 | <b>Ref. No.</b> | 251779 |
|----------------|--------|-----------------|--------|

|                    |                                    |  |  |
|--------------------|------------------------------------|--|--|
| <b>description</b> | sensor for coffee grinder complete |  |  |
|--------------------|------------------------------------|--|--|

## grinding burrs



1

|                |        |                 |        |
|----------------|--------|-----------------|--------|
| <b>GEV No.</b> | 527249 | <b>Ref. No.</b> | 095840 |
|----------------|--------|-----------------|--------|

|                    |  |  |  |
|--------------------|--|--|--|
| <b>description</b> | grinding burr turn direction right D1 ø 63mm ID ø 38mm H 9mm tooth spacing 3mm hole ø 5.5mm bore ø 8.5mm mounting ø 48 straight suitable for N & W |  |  |
|--------------------|--|--|--|

## mechanical components



1

|                |        |                 |        |
|----------------|--------|-----------------|--------|
| <b>GEV No.</b> | 520334 | <b>Ref. No.</b> | 0V2509 |
|----------------|--------|-----------------|--------|

|                    |   |  |  |
|--------------------|---|--|--|
| <b>description</b> | angle piece thread 1/8" with coupling angled hose ø 5mm |  |  |
|--------------------|---|--|--|

## keys



1

|                |        |                 |                  |
|----------------|--------|-----------------|------------------|
| <b>GEV No.</b> | 527290 | <b>Ref. No.</b> | 097812<br>0V1654 |
|----------------|--------|-----------------|------------------|

|                    |             |  |  |
|--------------------|-------------|--|--|
| <b>description</b> | service key |  |  |
|--------------------|-------------|--|--|

## water containers



1

|                |        |                 |        |
|----------------|--------|-----------------|--------|
| <b>GEV No.</b> | 527286 | <b>Ref. No.</b> | 251873 |
|----------------|--------|-----------------|--------|

|                    |                          |  |  |
|--------------------|--------------------------|--|--|
| <b>description</b> | water container complete |  |  |
|--------------------|--------------------------|--|--|

|                        |        |  |  |
|------------------------|--------|--|--|
| <b>spare parts for</b> | 527286 |  |  |
|------------------------|--------|--|--|

|                |        |                 |        |
|----------------|--------|-----------------|--------|
| <b>GEV No.</b> | 527287 | <b>Ref. No.</b> | 251876 |
|----------------|--------|-----------------|--------|



|                    |  |  |  |
|--------------------|--|--|--|
| <b>description</b> | float with magnet ømm L 23.5mm W 16mm H 17mm plastic |  |  |
|--------------------|--|--|--|

## counters



1

|                |        |                 |        |
|----------------|--------|-----------------|--------|
| <b>GEV No.</b> | 527273 | <b>Ref. No.</b> | 251862 |
|----------------|--------|-----------------|--------|

|                    |  |  |  |
|--------------------|--|--|--|
| <b>description</b> | counter coffee machine impulse 10imp/s mounting measurements 22x30mm 12VDC |  |  |
|--------------------|--|--|--|

## locks

## locking devices

## producer-specific

## N&amp;W



1

|                |        |                 |        |
|----------------|--------|-----------------|--------|
| <b>GEV No.</b> | 691527 | <b>Ref. No.</b> | 252137 |
|----------------|--------|-----------------|--------|

|                    |                       |  |  |
|--------------------|-----------------------|--|--|
| <b>description</b> | key cylinder with key |  |  |
|--------------------|-----------------------|--|--|

## gaskets

## O-rings

## EPDM

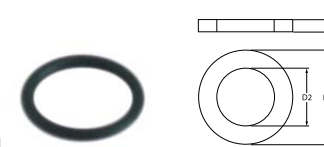

1

|                |        |                 |                  |
|----------------|--------|-----------------|------------------|
| <b>GEV No.</b> | 529545 | <b>Ref. No.</b> | 092140<br>252684 |
|----------------|--------|-----------------|------------------|

|                    |   |  |  |
|--------------------|---|--|--|
| <b>description</b> | O-ring EPDM thickness 1.78mm ID ø 10.82mm Qty 1 pcs |  |  |
|--------------------|---|--|--|



1

|                |        |                 |        |
|----------------|--------|-----------------|--------|
| <b>GEV No.</b> | 510177 | <b>Ref. No.</b> | 094594 |
|----------------|--------|-----------------|--------|

|                    |  |  |  |
|--------------------|--|--|--|
| <b>description</b> | O-ring EPDM thickness 1.78mm ID ø 7.66mm Qty 1 pcs |  |  |
|--------------------|--|--|--|

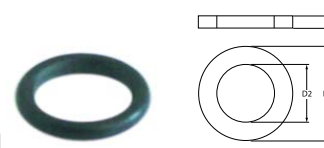

1

|                |        |                 |                  |
|----------------|--------|-----------------|------------------|
| <b>GEV No.</b> | 528110 | <b>Ref. No.</b> | 093347<br>095624 |
|----------------|--------|-----------------|------------------|

|                    |   |  |  |
|--------------------|---|--|--|
| <b>description</b> | O-ring EPDM thickness 2.62mm ID ø 12.37mm Qty 1 pcs |  |  |
|--------------------|---|--|--|

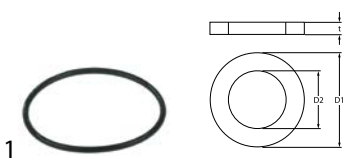
|                    |   |                 |        |
|--------------------|---|-----------------|--------|
| <b>GEV No.</b>     | 528500  | <b>Ref. No.</b> | 098701 |
| <b>description</b> | O-ring EPDM thickness 3.53mm ID ø 72.62mm Qty 1 pcs |                 |        |



|                    |   |                 |        |
|--------------------|---|-----------------|--------|
| <b>GEV No.</b>     | 520840  | <b>Ref. No.</b> | 097513 |
| <b>description</b> | silicone hose ID ø 9mm ED ø 13mm L 1m thickness 2mm operating pressure without pressure burst pressure non defined t.max. 200°C brown |                 |        |

## hoses

### industrial hoses

#### PTFE hoses

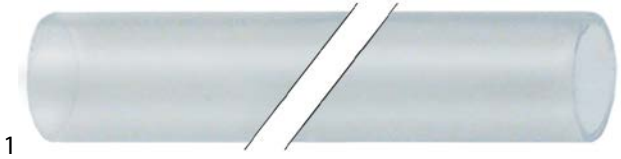

|                    |  |                 |        |
|--------------------|--|-----------------|--------|
| <b>GEV No.</b>     | 520845 <sup>1</sup>                            | <b>Ref. No.</b> | 252658 |
| <b>description</b> | PTFE hose ED ø 6mm ID ø 3mm thickness 1.5mm Lm |                 |        |

<sup>1</sup>by the meter

#### silicone hoses

##### without fabric



|                    |   |                 |        |
|--------------------|---|-----------------|--------|
| <b>GEV No.</b>     | 520842  | <b>Ref. No.</b> | 097529 |
| <b>description</b> | silicone hose ID ø 3mm ED ø 6mm L 1m thickness 1.5mm t.max. 200°C brown |                 |        |



|                    |  |                 |        |
|--------------------|--|-----------------|--------|
| <b>GEV No.</b>     | 520843   | <b>Ref. No.</b> | 097510 |
| <b>description</b> | silicone hose ID ø 5mm ED ø 9mm L 1m thickness 2mm operating pressure without pressure burst pressure non defined t.max. 200°C brown |                 |        |



|                    |  |                 |        |
|--------------------|--|-----------------|--------|
| <b>GEV No.</b>     | 520844   | <b>Ref. No.</b> | 097511 |
| <b>description</b> | silicone hose ID ø 6mm ED ø 9mm L 1m thickness 1.5mm operating pressure without pressure burst pressure non defined t.max. 200°C brown |                 |        |

## fittings, hose and pipe connectors

### hose connectors

#### brass



|                    |  |                 |        |
|--------------------|--|-----------------|--------|
| <b>GEV No.</b>     | 520333   | <b>Ref. No.</b> | 095529 |
| <b>description</b> | hose connector brass straight thread 1/8" hose ø 7mm Qty 1 pcs |                 |        |

## fastening material

### screws

#### flat-headed bolts



|                    |  |                 |        |
|--------------------|--|-----------------|--------|
| <b>GEV No.</b>     | 560062   | <b>Ref. No.</b> | 252917 |
| <b>description</b> | flat-headed bolt thread M4 thread L 10mm SS DIN 7985/ISO 7045 Qty 20 pcs intake Phillips head ø 8mm head thickness 2mm |                 |        |

### washers

#### washers

#### miscellaneous



|                    |  |                 |        |
|--------------------|--|-----------------|--------|
| <b>GEV No.</b>     | 691535   | <b>Ref. No.</b> | 251143 |
| <b>description</b> | disc ID ø 10mm ED ø 14mm thicknessmm aluminium Qty 1 pcs |                 |        |





## consumables

### fuses

#### fine fuses



1

|                    |   |                 |        |
|--------------------|---|-----------------|--------|
| <b>GEV No.</b>     | 358593  | <b>Ref. No.</b> | 097544 |
| <b>description</b> | fine fuse size ø5x20mm 0.125A slow-acting rated 250V Qty 10 pcs |                 |        |



1

|                    |  |                 |        |
|--------------------|--|-----------------|--------|
| <b>GEV No.</b>     | 358601   | <b>Ref. No.</b> | 097103 |
| <b>description</b> | fine fuse size ø5x20mm 1.25A slow-acting rated 250V Qty 10 pcs |                 |        |

#### ø6.3x32mm 250V



1

|                    |  |                 |        |
|--------------------|--|-----------------|--------|
| <b>GEV No.</b>     | 358851   | <b>Ref. No.</b> | 095636 |
| <b>description</b> | fuse size ø6.3x32mm 15A slow-acting rated 250V Qty 1 pcs |                 |        |

|   |       |                                 |    |
|---|-------|---------------------------------|----|
| <b>A</b>  |       |                                 |    |
| axial fans                                      | 7     | silicone hoses                  | 13 |
| <b>B</b>  |       |                                 |    |
| bi-metal thermostats                            | 3     | solenoid valves                 | 6  |
| <b>C</b>  |       |                                 |    |
| condensators & interference suppression filters | 8     | switches and momentary switches | 3  |
| consumables                                     | 14    | <b>T</b>                        |    |
| <b>E</b>  |       |                                 |    |
| electric accessories                            | 9     | terminals                       | 9  |
| <b>F</b>  |       |                                 |    |
| fans  | 7     | thermostats                     | 3  |
| fastening material                              | 13    | transformers                    | 5  |
| filters   | 8     | <b>V</b>                        |    |
| fine fuses                                      | 14    | vibration pumps                 | 8  |
| flat-headed bolts                               | 13    | <b>W</b>                        |    |
| float switches                                  | 4     | washers                         | 13 |
| flow heaters                                    | 3     |                                 |    |
| flow meters                                     | 7     |                                 |    |
| fuses   | 8, 14 |                                 |    |
| <b>H</b>  |       |                                 |    |
| heating elements                                | 3     |                                 |    |
| heating elements for coffee machine             | 3     |                                 |    |
| hose connectors                                 | 13    |                                 |    |
| hoses   | 13    |                                 |    |
| <b>I</b>  |       |                                 |    |
| industrial hoses                                | 13    |                                 |    |
| <b>M</b>  |       |                                 |    |
| magnetic switches                               | 4     |                                 |    |
| microswitches                                   | 4     |                                 |    |
| motors  | 7     |                                 |    |
| <b>O</b>  |       |                                 |    |
| O-rings   | 12    |                                 |    |
| <b>P</b>  |       |                                 |    |
| probes  | 5     |                                 |    |
| PTFE hoses                                      | 13    |                                 |    |
| pumps   | 8     |                                 |    |
| <b>R</b>  |       |                                 |    |
| rocker/momentary rocker switches                | 3     |                                 |    |
| <b>S</b>  |       |                                 |    |
| safety bi-metal thermostats                     | 3     |                                 |    |
| screws  | 13    |                                 |    |