



**GAS COMPONENTS**



**ELECTRIC COMPONENTS**



**WATER TECHNOLOGY**



**MECHANICAL COMPONENTS**



**TOOLS**

Spare parts suitable for

**MOVILFRIT**

Find the complete and up-to-date range of products in our GEV Webshop



# Manufacturer catalogue

The most important spare parts and accessories arranged clearly for every manufacturer

- ✓ Complete product range and all appliance data always up to date in the GEV Webshop
- ✓ Alphabetical Index at the end of the catalogue

## GEV Webshop

[www.gev-online.co.uk](http://www.gev-online.co.uk)

[www.gev-online.com](http://www.gev-online.com)



- 🔍 Add to Favourites
- 🔍 Sign In with email address and usual password
- 🔍 Easy-order – place several items in your basket at the same time
- 🔍 Quick Item search – no login needed



## heating elements

### heating elements for fryers

#### 2 hole fixing

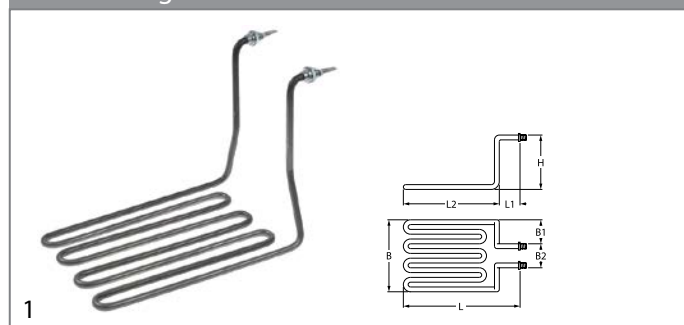

<b>GEV No.</b>	417705	<b>Ref. No.</b>	901690
<b>description</b>	heating element 4000W 230V heating circuits 1 L 290mm W 177mm H 205mm fryer heaters L1 55mm L2 260mm W1 40mm W2 125mm tube ø 8.5mm		

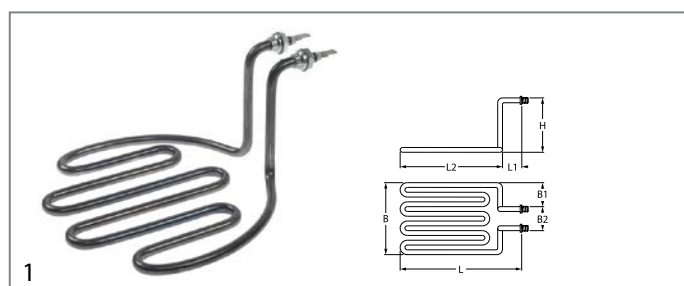

<b>GEV No.</b>	417704	<b>Ref. No.</b>	901701
<b>description</b>	heating element 2000W 230V heating circuits 1 L 240mm W 195mm H 105mm 2 hole fixing fryer heaters L1 60mm L2 180mm W2 50mm		

### heaters



<b>GEV No.</b>	970937	<b>Ref. No.</b>	907024
<b>description</b>	heater fryer 4000W 230V heating circuits 1 t.max. 200°C 60-200°C L 385mm W 245mm H 340mm cable length 1300mm F10		



<b>GEV No.</b>	970936	<b>Ref. No.</b>	907023
<b>description</b>	heater fryer 4000W 230V heating circuits 1 t.max. 200°C 60-200°C L 390mm W 245mm H 290mm cable length 1300mm FA9		

## thermostats

### control and safety thermostats

#### EGO

#### control thermostats

#### 56.\_ series

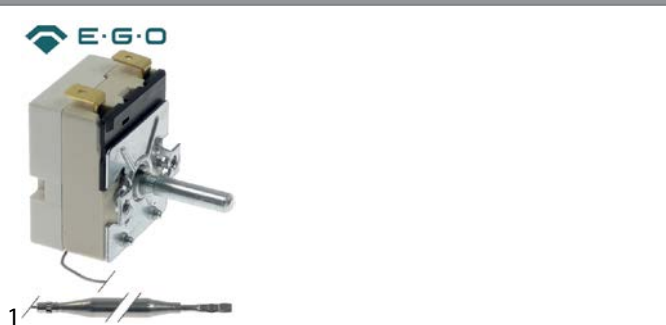

<b>GEV No.</b>	376076	<b>Ref. No.</b>	907110
<b>description</b>	thermostat t.max. 200°C temperature range 60-200°C 16A probe ø 6mm probe L 78mm capillary pipe 870mm		

#### IMIT / TEMPOMATIC / ARTERMO

#### safety thermostats



<b>GEV No.</b>	375941	<b>Ref. No.</b>	901770
<b>description</b>	safety thermostat switch-off temp. 238°C 1-pole 1NC 16A probe ø 5mm probe L 100mm capillary pipe 1050mm capillary pipe isolated-mm gland nut 250V		

electric components



## switches and momentary switches

## rotary switches

## producer-specific rotary switches

## GAVE



1

<b>GEV No.</b>	305003	<b>Ref. No.</b>	901405
<b>description</b>	rotary switch 0-1 latching ON-OFF 32A shaft $\varnothing$ 5x5mm shaft L 21.5mm		



1

<b>GEV No.</b>	305000	<b>Ref. No.</b>	901404
<b>description</b>	rotary switch 0-1 latching ON-OFF 40A shaft $\varnothing$ 5x5mm shaft L 20mm		

## lamps

## indicator lights

## indicator lights (complete)

 $\varnothing$ 10mm

with screw socket



1

<b>GEV No.</b>	359529	<b>Ref. No.</b>	901582
<b>description</b>	indicator light $\varnothing$ 10mm 400V clear connection male faston 6.3mm socket screw base		

with plug-in socket



1

<b>GEV No.</b>	359020	<b>Ref. No.</b>	901581
<b>description</b>	indicator light $\varnothing$ 10mm red 400V connection male faston 6.3mm Qty 1 pcs		



1

<b>GEV No.</b>	359034	<b>Ref. No.</b>	901580
<b>description</b>	indicator light $\varnothing$ 10mm yellow 400V connection male faston 6.3mm Qty 1 pcs		



1

<b>GEV No.</b>	357253	<b>Ref. No.</b>	901583
<b>description</b>	indicator light $\varnothing$ 10mm red 230V cable length 200mm plastic fryer for MOD.5		

30x13mm



1

<b>GEV No.</b>	346547	<b>Ref. No.</b>	901572
<b>description</b>	indicator light mounting measurements 27.4x12.4mm 230V red connection male faston 6.3mm temp.-resist. 120°C		

## contactors

## ABB

## power contactors



1

<b>GEV No.</b>	381441	<b>Ref. No.</b>	901155
<b>description</b>	power contactor resistive load 25A 250-500V AC/DC (AC3/400V) 8A/5.5kW main contacts 3NO auxiliary contacts 1NC connection screw connection type AF09-30-01-14		

## electric accessories

## cables

## power supply cables



1

<b>GEV No.</b>	551343	<b>Ref. No.</b>	901055
<b>description</b>	power lead CEE7/7 type E+F 3-pole contacts P+N+E 1.5mm <sup>2</sup> max. 16A max 230V 1.5m H05VV-F 3G1.5		





accessories			
cable glands			
threaded cable glands			
screw connections			
			
1			
<b>GEV No.</b>	551344	<b>Ref. No.</b>	901620
<b>description</b>	cable gland thread PG11 cable ø 10mm mounting ø 18mm WS 22 plastic Qty 1 pcs		

			
1			
<b>GEV No.</b>	551345	<b>Ref. No.</b>	901622
<b>description</b>	cable gland thread PG21 cable ø 18mm mounting ø 28.5mm WS 33 plastic Qty 1 pcs		

## equipment-specific units for deep fryers

spouts			
			
1			
<b>GEV No.</b>	696740	<b>Ref. No.</b>	907088
<b>description</b>	drain pipe complete ø 20mm L 175mm W 55mm H 30mm		

fasteners			
			
1			
<b>GEV No.</b>	970942	<b>Ref. No.</b>	905329
<b>description</b>	bracket L 12mm W 10mm H 10mm Mod.10		

			
1			
<b>GEV No.</b>	970945	<b>Ref. No.</b>	905029
<b>description</b>	bracket probes hole distance 21mm L 55mm W 15mm H 10mm MOD.35		

			
1			
<b>GEV No.</b>	970944	<b>Ref. No.</b>	905030
<b>description</b>	bracket probes distance 34mm L 66mm W 15mm H 10mm MOD.17 TRIFASICO		

			
1			
<b>GEV No.</b>	970941	<b>Ref. No.</b>	905028
<b>description</b>	bracket probes L 28mm W 8mm H 13mm MOD.4/6/9/10/17/25		

			
1			
<b>GEV No.</b>	970943	<b>Ref. No.</b>	905036
<b>description</b>	bracket probes L 32mm W 8mm H 13mm MOD.5		

			
1			
<b>GEV No.</b>	970940	<b>Ref. No.</b>	905420
<b>description</b>	fixing support fryer L 125mm W 30mm H 83mm		

lids			
			
1			
<b>GEV No.</b>	907000	<b>Ref. No.</b>	905116
<b>description</b>	lid plastic for fryer H 10mm ø 235mm black		

housing and bezels			
			
1			
<b>GEV No.</b>	692711	<b>Ref. No.</b>	905361
<b>description</b>	base for fryer H 65mm ø 235mm plastic black		

			
1			
<b>GEV No.</b>	699256	<b>Ref. No.</b>	905451
<b>description</b>	cover fryer L 117mm W 73mm H 23mm MOD.5		

## lifting device

## couplings

			
1			
<b>GEV No.</b>	973123	<b>Ref. No.</b>	908104
<b>description</b>	coupling ED ø 32mm ID ø 11mm thickness 12mm		

## level glasses

			
1			
<b>GEV No.</b>	692713	<b>Ref. No.</b>	907103
<b>description</b>	level glass ø 65mm ID ø 32mm thickness 18mm for MOD.25/35 with adapter adapter ø 90mm		

			
1			
<b>GEV No.</b>	692712	<b>Ref. No.</b>	907032
<b>description</b>	level glass ø 65mm ID ø 33mm thickness 18mm for MOD.10/17/25/35		

## knobs

## producer-specific knobs

## MOVILFRIT

			
1			
<b>GEV No.</b>	112805	<b>Ref. No.</b>	901504
<b>description</b>	knob thermostat t.max. 200°C 60-200°C ø 50mm shaft ø 6x4.6mm shaft flat upper black thermostat		

## accessories

## fascias

			
1			
<b>GEV No.</b>	112804	<b>Ref. No.</b>	901510
<b>description</b>	bezel with knob t.max.°C°C switch 0-1 ø 47mm dimensions 65x65mm 0-1		

## baskets

## fryer baskets

## MOVILFRIT

## baskets

			
1			
<b>GEV No.</b>	970768	<b>Ref. No.</b>	907043
<b>description</b>	fryer basket BH 160mm overall height 215mm W 330mm total length 445mm stainless steel		

			
1			
<b>GEV No.</b>	970933	<b>Ref. No.</b>	907038
<b>description</b>	fryer basket H 130mm W 183mm L 260mm stainless steel		

			
1			
<b>GEV No.</b>	970932	<b>Ref. No.</b>	907041
<b>description</b>	fryer basket H 140mm W 205mm L 297mm stainless steel		

			
1			
<b>GEV No.</b>	970934	<b>Ref. No.</b>	907047
<b>description</b>	fryer basket H 143mm W 210mm L 285mm stainless steel BH 90mm		



1 

<b>GEV No.</b>	970931	<b>Ref. No.</b>	907042
<b>description</b>	fryer basket H 144mm W 235mm L 340mm stainless steel		

1 

<b>GEV No.</b>	970935	<b>Ref. No.</b>	907044
<b>description</b>	fryer basket H 160mm W 210mm L 270mm stainless steel BH 110mm		

handles

1 

<b>GEV No.</b>	970948	<b>Ref. No.</b>	907081
<b>description</b>	handle L 145mm W 66mm H 105mm handle length 135mm handle material plastic		

1 

<b>GEV No.</b>	970938	<b>Ref. No.</b>	907085
<b>description</b>	handle W 40mm H 20mm handle length 135mm handle material plastic		

1 

<b>GEV No.</b>	970939	<b>Ref. No.</b>	907080
<b>description</b>	handle W 40mm H 25mm handle length 125mm handle material plastic		

crumb screens

1 

<b>GEV No.</b>	970766	<b>Ref. No.</b>	901099
<b>description</b>	crumb screen ø 197mm H 172mm stainless steel BH 70mm		

gaskets

sealing washers

fibre gaskets

1 

<b>GEV No.</b>	504431	<b>Ref. No.</b>	908252
<b>description</b>	flat gasket FIBER ED ø 12mm ID ø 6mm thickness 2mm Qty 1 pcs		

paper gasket

1 

<b>GEV No.</b>	512486	<b>Ref. No.</b>	905225
<b>description</b>	flat gasket paper ED ø 10mm ID ø 5mm thickness 2mm fryer		

special gaskets

for deep fryers

1 

<b>GEV No.</b>	530784	<b>Ref. No.</b>	908255
<b>description</b>	flat gasket ED ø 38mm thickness 3.5mm ID ø 26mm fibre outflow fryer		

1 

<b>GEV No.</b>	530785	<b>Ref. No.</b>	908257
<b>description</b>	flat gasket ED ø 40mm thickness 2mm level glass fibre fryer ID ø 34mm		



1

<b>GEV No.</b>	530783	<b>Ref. No.</b>	908251
<b>description</b>	flat gasket ED ø 62mm thickness 2.5mm drain system fibre fryer		



1

<b>GEV No.</b>	530786	<b>Ref. No.</b>	908253
<b>description</b>	flat gasket ED ø 69mm thickness 4mm level glass fibre fryer ID ø 37mm for MOD.10/17/25/35		



1

<b>GEV No.</b>	512486	<b>Ref. No.</b>	905225
<b>description</b>	flat gasket paper ED ø 10mm ID ø 5mm thickness 2mm fryer		

## valves and tank inlets

### ball valves

#### universal

#### mini ball valves



1

<b>GEV No.</b>	520962	<b>Ref. No.</b>	901371
<b>description</b>	ball valve connection 3/4" ET - 3/4" IT total length 53mm		

## fastening material

### screws

#### oval head screws



1

<b>GEV No.</b>	560595	<b>Ref. No.</b>	908701
<b>description</b>	oval head screw thread M5 thread L 16mm L 19mm head ø 12.5mm ø 5mm		

#### hexagonal screws



1

<b>GEV No.</b>	560079	<b>Ref. No.</b>	908501
<b>description</b>	hexagonal screw thread M6 thread L 12mm SS WS 10 Qty 20 pcs DIN 933 / ISO 4017		

### nuts

#### hexagonal nuts

#### DIN 934 / ISO 4032/8673



1

<b>GEV No.</b>	560129	<b>Ref. No.</b>	908761
<b>description</b>	hexagonal nut thread M5 H 4mm WS 8 SS DIN/ISO DIN 934 / ISO 4032/8673 Qty 1 pcs		



**B**

ball valves	8
-------------	---

**C**

cable glands	5
cables	4
contactors	4
control thermostats	3

**E**

electric accessories	4
----------------------	---

**F**

fastening material	8
--------------------	---

**H**

heaters	3
heating elements	3
heating elements for fryers	3
hexagonal nuts	8
hexagonal screws	8

**I**

indicator lights	4
indicator lights (complete)	4

**L**

lamps	4
-------	---

**N**

nuts	8
------	---

**O**

oval head screws	8
------------------	---

**P**

power supply cables	4
---------------------	---

**R**

rotary switches	4
-----------------	---

**S**

safety thermostats	3
screws	8
sealing washers	7
switches and momentary switches	4

**T**

thermostats	3
threaded cable glands	5

**V**

valves and tank inlets	8
------------------------	---