



GAS COMPONENTS



ELECTRIC COMPONENTS



WATER TECHNOLOGY



MECHANICAL COMPONENTS



TOOLS

Spare parts suitable for

MORETTI

Find the complete and up-to-date range of products in our GEV Webshop



Manufacturer catalogue

The most important spare parts and accessories arranged clearly for every manufacturer

- ✓ Complete product range and all appliance data always up to date in the GEV Webshop
- ✓ Alphabetical Index at the end of the catalogue

GEV Webshop

www.gev-online.co.uk

www.gev-online.com



- 🔍 Add to Favourites
- 🔍 Sign In with email address and usual password
- 🔍 Easy-order – place several items in your basket at the same time
- 🔍 Quick Item search – no login needed



heating elements

heating elements for pizza ovens

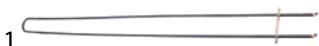

GEV No.	418173	Ref. No.	74400540 74420540
description	heating element 1000W 230V L 1236mm W 75mm flange length 110mm flange width 22mm hole distance 94mm connection length 111mm connection male faston 6.3mm tube ø 8.5mm heating circuits 1 rectangular flange hole ø 6mm dry heating element		
For models:	RHC 18B, RHC 18C, RHC 18D, RHC 18PB, RHC 18PC, RHC 18PD, RHC 25B, RHC 25C, RHC 25PB, RHC 25PC, RHC 25PD, RHC-25D, RHK - RHC - RHB		



GEV No.	418158	Ref. No.	74401130
description	heating element 1005W 115V L 660mm W 88mm flange length 124mm flange width 30mm hole distance 109mm connection length 108mm connection male faston 6.3mm tube ø 8.5mm heating circuits 1 rectangular flange mounting pos. upper hole ø 5mm dry heating element		
For models:	PIZZY DUO 105.105, PIZZY MONO 105.105		



GEV No.	418165	Ref. No.	74420570
description	heating element 1092W 115V L 603mm W 95mm flange length 124mm flange width 22mm hole distance 112mm connection length 122mm connection male faston 6.3mm tube ø 8.5mm heating circuits 1 rectangular flange mounting pos. upper hole ø 6mm dry heating element		
For models:	MHC 18A, MHC 18B, MHC 18C, MHC 30A, MHC 30B, MHC 30C, MHK - MHC - MHB		

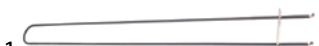

GEV No.	418160	Ref. No.	74420600
description	heating element 1275W 115V L 1045mm W 89mm flange length 124mm flange width 30mm hole distance 107mm connection length 94mm tube ø 8.5mm heating circuits 1 rectangular flange mounting pos. upper hole ø 6.3mm dry heating element		
For models:	PIZZY DUO 105.105, PIZZY MONO 105.105		



GEV No.	418168	Ref. No.	74420590
description	heating element 1275W 115V L 800mm W 94mm flange length 124mm flange width 30mm hole distance 108mm connection length 122mm connection male faston 6.3mm tube ø 8.5mm heating circuits 1 rectangular flange mounting pos. upper hole ø 6mm dry heating element		
For models:	MHC 18A, MHC 18B, MHC 18C, MHC 30A, MHC 30B, MHC 30C, MHK - MHC - MHB, PC-18C		



GEV No.	418174	Ref. No.	74400550 74420550
description	heating element 1300W 230V L 1235mm W 75mm flange length 110mm flange width 22mm hole distance 94mm connection length 110mm connection male faston 6.3mm tube ø 8.5mm heating circuits 1 rectangular flange hole ø 6mm dry heating element		
For models:	RHC 18D, RHC 18PD, RHC 25PD, RHC-25D, RHK - RHC - RHB		



GEV No.	418164	Ref. No.	74420350
description	heating element 400W 110V L 595mm W 95mm flange length 104mm flange width 22mm hole distance 112mm connection length 126mm connection male faston 6.3mm tube ø 8.5mm heating circuits 1 rectangular flange mounting pos. lower hole ø 6mm dry heating element		
For models:	MHC 18A, MHC 18PA, MHC 30A, MHC 30PA, MHK - MHC - MHB		



GEV No.	418159	Ref. No.	74401140
description	heating element 460W 115V L 657mm W 90mm flange length 124mm flange width 30mm hole distance 108mm connection length 109mm connection male faston 6.3mm tube ø 9.1mm heating circuits 1 rectangular flange mounting pos. lower hole ø 5mm dry heating element		
For models:	PIZZY DUO 65.105, PIZZY MONO 65.105		



GEV No.	418167	Ref. No.	74420370
description	heating element 500W 110V L 600mm W 95mm flange length 124mm flange width 22mm hole distance 118mm connection length 122mm connection male faston 6.3mm tube ø 8.5mm heating circuits 1 rectangular flange mounting pos. lower hole ø 6mm dry heating element		
For models:	MHC 18B, MHC 18PB, MHC 30B, MHC 30PB, MHK - MHC - MHB		



GEV No.	418170	Ref. No.	74420410
description	heating element 560W 110V L 800mm W 97mm flange length 124mm flange width 30mm hole distance 108mm connection length 123mm connection male faston 6.3mm tube ø 8.5mm heating circuits 1 rectangular flange mounting pos. lower hole ø 6.3mm dry heating element		
For models:	MHC 18C, MHC 18PC, MHC 30C, MHC 30PC, MHK - MHC - MHB		





Image not available

GEV No.	418163	Ref. No.	74420340
description	heating element 600W 110V mounting pos. upper dry heating element		
For models:	MHC 18A, MHC 18PA, MHC 30A, MHC 30PA, MHK - MHC - MHB		



GEV No.	418171	Ref. No.	74400830
description	heating element 625W 230V L 1235mm W 74mm flange length 110mm flange width 22mm hole distance 94mm connection length 106mm connection male faston 6.3mm tube ø 8.5mm heating circuits 1 rectangular flange hole ø 6mm dry heating element		
For models:	RHC 18B, RHC 18D, RHC 18PB, RHC 18PD, RHC 25B, RHC 25PB, RHC 25PD, RHC-25D, RHK - RHC - RHB		



GEV No.	416377	Ref. No.	74400720
description	heating element 700W 220V L 610mm W 80mm flange length 124mm flange width 30mm hole distance 108mm connection length 98mm connection male faston 6.3mm tube ø 8.5mm heating circuits 1 rectangular flange hole ø 4mm		

GEV No.	418172	Ref. No.	74400760
description	heating element 700W 230V L 1238mm W 74mm flange length 110mm flange width 22mm hole distance 94mm connection length 110mm connection male faston 6.3mm tube ø 8.5mm heating circuits 1 rectangular flange hole ø 6mm dry heating element		
For models:	RHC 18C, RHC 18PC, RHC 25C, RHC 25PC, RHK - RHC - RHB		

GEV No.	418161	Ref. No.	74420610
description	heating element 728W 115V L 1041mm W 89mm flange length 124mm flange width 30mm hole distance 108mm connection length 92mm connection male faston 6.3mm tube ø 8.5mm heating circuits 1 rectangular flange mounting pos. lower hole ø 5.2mm dry heating element		
For models:	PIZZY DUO 105.105, PIZZY MONO 105.105		

1			
GEV No.	418166	Ref. No.	74420360
description	heating element 750W 110V mounting pos. upper dry heating element		
For models:	MHC 18B, MHC 18PB, MHC 30B, MHC 30PB, MHK - MHC - MHB		

1			
GEV No.	418169	Ref. No.	74420400
description	heating element 850W 110V mounting pos. upper dry heating element		
For models:	MHC 18C, MHC 18PC, MHC 30C, MHC 30PC, MHK - MHC - MHB		

GEV No.	418162	Ref. No.	74420560
description	heating element 910W 115V L 603mm W 97mm flange length 124mm flange width 22mm hole distance 102mm connection length 121mm connection male faston 6.3mm tube ø 8.8mm heating circuits 1 rectangular flange mounting pos. upper hole ø 5mm dry heating element		
For models:	MHC 18A, MHC 18B, MHC 18C, MHC 30A, MHC 30B, MHC 30C, MHK - MHC - MHB		

GEV No.	418183	Ref. No.	74420850
description	heating element 1250W 230V L 1032mm mounting pos. upper ø 34mm tube ø 16mm thread M20x1.5 connection length 45mm connection M6 flange with thread heating circuits 1 dry heating element pizza oven		
For models:	T97E		

GEV No.	418182	Ref. No.	74420750
description	heating element 1400W 230V L 775mm mounting pos. lower ø 34mm tube ø 16mm thread M20x1.5 connection length 63mm connection M6 heating circuits 1 dry heating element pizza oven		
For models:	T75E		

GEV No.	418726	Ref. No.	74400260 74400390
description	heating element 1456W 230V heating circuits 1 dry heating element		
For models:	KR 9, KR 99, KRX 9, KRX 99, PIZZY DUO 105.105, PIZZY MONO 105.105		

GEV No.	418181	Ref. No.	74420740
description	heating element 1600W 230V L 770mm mounting pos. upper ø 34mm tube ø 16mm thread M20x1.5 connection length 63mm connection M6 heating circuits 1 dry heating element pizza oven		
For models:	T75E		

GEV No.	418728	Ref. No.	74400180
description	heating element 1650W 230V L 1070mm W 130mm thread 1/4" mounting distance 121mm connection length 100mm heating circuits 1 dry heating element		
For models:	KR 6, KR 66, KRX 6, KRX 66, PIZZY DUO 65.105, PIZZY MONO 65.105		

GEV No.	418729	Ref. No.	74400250
description	heating element 1750W 230V L 680mm W 260mm thread 1/4" mounting distance 251mm connection length 101mm tube ø 8.5mm heating circuits 1 dry heating element		
For models:	KR 66T, KR 6T, KRX 66T, KRX 6T, PIZZY DUO 105.65, PIZZY MONO 105.65		

GEV No.	418184	Ref. No.	74420860
description	heating element 1900W 230V L 1030mm mounting pos. lower ø 34mm tube ø 16mm thread M20x1.5 connection length 45mm connection M6 flange with thread heating circuits 1 dry heating element pizza oven		
For models:	T97E		



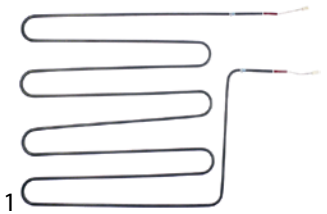

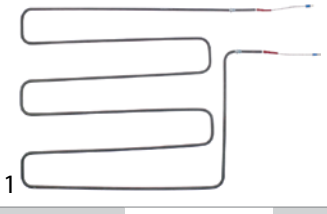
			
GEV No.	417588	Ref. No.	74401180
description	heating element 2100W 230V L 675mm W 526mm L1 40mm L2 637mm W1 420mm W2 140mm thread 1/4" tube ø 8.5mm cable length 170mm heating circuits 1 pizza oven screw		

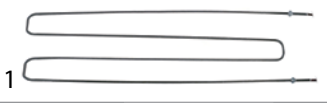
			
GEV No.	418157	Ref. No.	74400150 74420690
description	heating element 2100W 230V L 675mm W 550mm L1 35mm L2 640mm W1 415mm W2 135mm thread 1/4" mounting distance 127mm connection length 90mm connection male faston 6.3mm tube ø 8.5mm cable length 140mm heating circuits 1 dry heating element 2 hole fixing pizza oven		
For models:	KR 4, KR 44, KRX 4, KRX 44, PD60.60, PIZZY DUO 60.60, PIZZY DUO 65.105, PIZZY MONO 60.60, PIZZY MONO 65.105		

			
GEV No.	418730	Ref. No.	74400280
description	heating element 2400W 230V L 1200mm W 290mm heating circuits 1 dry heating element pizza oven		
For models:	KR 9, KR 99, KRX 9, KRX 99, PIZZY DUO 105.105, PIZZY MONO 105.105		

			
GEV No.	418187	Ref. No.	74400790
description	heating element 750W 230V dry heating element 2 hole fixing		
For models:	AHL, L105.105, L65.105, MHL, P110L, RHL		

			
GEV No.	418727	Ref. No.	74400160
description	heating element 920W 230V L 1040mm W 120mm thread 1/4" mounting distance 111mm connection length 100mm tube ø 9mm heating circuits 1 dry heating element		
For models:	KR 6, KR 66, KRX 6, KRX 66, PIZZY DUO 65.105, PIZZY MONO 65.105		

			
GEV No.	418725	Ref. No.	74400210
description	heating element 972W 230V L 645mm W 195mm thread 1/4" mounting distance 186mm connection length 102mm tube ø 8.5mm heating circuits 1 dry heating element		
For models:	KR 66T, KR 6T, KRX 66T, KRX 6T, PIZZY DUO 105.65, PIZZY MONO 105.65		

			
GEV No.	419237	Ref. No.	54600290
description	heating cable mounting pos. lower Qty 1 pcs pizza oven suitable for AHC_A/AHK		
For models:	AHC 18A, AHK		

			
GEV No.	419239	Ref. No.	54600270
description	heating cable mounting pos. lower Qty 1 pcs pizza oven suitable for AHC_B/AHB		
For models:	AHB, AHC 18B		

			
GEV No.	419241	Ref. No.	54600310
description	heating cable mounting pos. lower Qty 1 pcs pizza oven suitable for AHC_C		
For models:	AHC, AHC 18C		

			
GEV No.	419236	Ref. No.	54600300
description	heating cable mounting pos. upper Qty 1 pcs pizza oven suitable for AHC_A/AHK		
For models:	AHC 18A, AHK		

			
GEV No.	419238	Ref. No.	54600280
description	heating cable mounting pos. upper Qty 1 pcs pizza oven suitable for AHC_B/AHB		
For models:	AHB, AHC 18B		

			
GEV No.	419240	Ref. No.	54600320
description	heating cable mounting pos. upper Qty 1 pcs pizza oven suitable for AHC_C		
For models:	AHC, AHC 18C		

			
GEV No.	418176	Ref. No.	66009700
description	heating cable set mounting pos. lower Qty 3 pcs pizza oven suitable for AHC_A/AHK		



			
GEV No.	418178	Ref. No.	66009720
description	heating cable set mounting pos. lower Qty 3 pcs pizza oven suitable for AHC_B/AHB		

			
GEV No.	418180	Ref. No.	66009740
description	heating cable set mounting pos. lower Qty 3 pcs pizza oven suitable for AHC_C		

			
GEV No.	418175	Ref. No.	66009690
description	heating cable set mounting pos. upper Qty 3 pcs pizza oven suitable for AHC_A/AHK		

			
GEV No.	418177	Ref. No.	66009710
description	heating cable set mounting pos. upper Qty 3 pcs pizza oven suitable for AHC_B/AHB		

			
GEV No.	418179	Ref. No.	66009730
description	heating cable set mounting pos. upper Qty 3 pcs pizza oven suitable for AHC_C		

heating elements for pizza presses

			
GEV No.	418185	Ref. No.	74420770
description	heating element 1500W 230V L 375mm W 268mm connection male faston 6.3mm dry heating element tube ø 8.5mm windings 4		

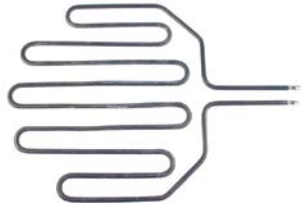
			
GEV No.	418186	Ref. No.	74420780
description	heating element 2500W 230V L 478mm W 347mm connection male faston 6.3mm connection length 23mm L1 140mm L2 337mm W1 155mm W2 32mm dry heating element tube ø 8.9mm windings 5		
For models:	PRESSY 33, PRESSY 45		

coil heating elements

			
GEV No.	418183	Ref. No.	74420850
description	heating element 1250W 230V L 1032mm mounting pos. upper ø 34mm tube ø 16mm thread M20x1.5 connection length 45mm connection M6 flange with thread heating circuits 1 dry heating element pizza oven		
For models:	T97E		

			
GEV No.	418182	Ref. No.	74420750
description	heating element 1400W 230V L 775mm mounting pos. lower ø 34mm tube ø 16mm thread M20x1.5 connection length 63mm connection M6 heating circuits 1 dry heating element pizza oven		
For models:	T75E		

			
GEV No.	418181	Ref. No.	74420740
description	heating element 1600W 230V L 770mm mounting pos. upper ø 34mm tube ø 16mm thread M20x1.5 connection length 63mm connection M6 heating circuits 1 dry heating element pizza oven		
For models:	T75E		

			
GEV No.	418184	Ref. No.	74420860
description	heating element 1900W 230V L 1030mm mounting pos. lower ø 34mm tube ø 16mm thread M20x1.5 connection length 45mm connection M6 flange with thread heating circuits 1 dry heating element pizza oven		
For models:	T97E		

			
GEV No.	419115	Ref. No.	74400300
description	heating element 2400W 230V L 1020mm ø 33.5mm tube ø 16mm thread M20x1.5 connection length 66mm connection M6 2 hole fixing heating circuits 1 dry heating element oven		
For models:	T97E		



thermostats

control and safety thermostats

EGO

control thermostats

55.10/19_series



GEV No.	375273	Ref. No.	74220840
description	thermostat t.max. 200°C temperature range 60-200°C 1-pole 1NO 16A probe ø 6mm probe L 74mm capillary pipe 1500mm capillary pipe isolated gland nut shaft L 23mm shaft position upper rotation 270°		
For models:	PRESSY 33, PRESSY 45		



GEV No.	375253	Ref. No.	74300110
description	thermostat t.max. 455°C temperature range 85-455°C 1-pole 1NO 16A probe ø 3.9mm probe L 228mm capillary pipe 870mm capillary pipe isolated 660mm gland nut shaft ø 6x4.6mm shaft L 23mm shaft position upper rotation 270°		
For models:	KR 4, KR 44, KR 6, KR 66, KR 66T, KR 6T, KR 9, KR 99, KRX 4, KRX 44, KRX 6, KRX 66, KRX 66T, KRX 6T, KRX 9, KRX 99, PIZZY DUO 105.105, PIZZY DUO 105.65, PIZZY DUO 60.60, PIZZY DUO 65.105, PIZZY MONO 105.105, PIZZY MONO 105.65, PIZZY MONO 60.60, PIZZY MONO 65.105		



GEV No.	375661	Ref. No.	74310830
description	thermostat t.max. 500°C temperature range 75-500°C 1-pole 1NO 16A probe ø 3.9mm probe L 228mm capillary pipe 1470mm capillary pipe isolated 960mm gland nut shaft ø 6x4.6mm shaft L 23mm shaft position upper rotation 270°		
For models:	PIZZY DUO 105.105, PIZZY DUO 105.65, PIZZY DUO 60.60, PIZZY DUO 65.105, PIZZY MONO 105.105, PIZZY MONO 105.65, PIZZY MONO 60.60, PIZZY MONO 65.105		

55.34_series



GEV No.	375498	Ref. No.	74200140
description	thermostat t.max. 512°C temperature range 60-512°C 3-pole 3NO 16A probe ø 3.8mm probe L 225mm capillary pipe 1150mm capillary pipe isolated 1110mm gland nut shaft ø 6x4.6mm shaft L 32mm shaft position upper rotation 270°		

safety thermostats

55.10/19_series



GEV No.	375663	Ref. No.	74220860
description	safety thermostat capillary pipe 1500mm probe ø 4mm 1-pole probe L 228mm 16A capillary pipe isolated 900mm gland nut switch-off temp. 410°C probe SS		
For models:	T75E, T97E		

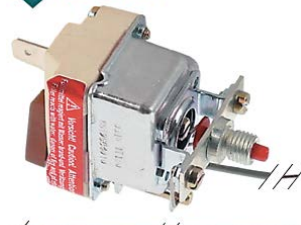

GEV No.	375662	Ref. No.	74200370	
description	safety thermostat switch-off temp. 512°C 1-pole 16A probe ø 3.9mm probe L 228mm capillary pipe 1470mm capillary pipe isolated 960mm gland nut probe SS screw connection M8x1			
For models:	AHB, AHC, AHK, MHK - MHC - MHB, P110 GAS, P110 GAS A, P110 GAS B, RHK - RHC - RHB			
accessories for	375662			
	GEV No.	102067	Ref. No.	—
	nut thread M8x1 H 3mm brass Qty 1 pcs type SEF 1			



JUMO

safety thermostats



GEV No.	390169	Ref. No.	74200260
description	safety thermostat switch-off temp. 20-500°C temperature range°C 1-pole 1NC 16A probe ø 6mm probe L 275mm capillary pipe 1000mm capillary pipe isolatedmm gland nut shaft ømm probe material copper 230V		
For models:	AHC 18A, AHC 18B, AHC 18C, MHC 18A, MHC 18B, MHC 18C, MHC 18PA, MHC 18PB, MHC 18PC, MHC 30A, MHC 30B, MHC 30C, MHC 30PA, MHC 30PB, MHC 30PC, PC/GAS, RHC 18B, RHC 18C, RHC 18D, RHC 18PB, RHC 18PC, RHC 18PD, RHC 25B, RHC 25C, RHC 25PB, RHC 25PC, RHC 25PD, RHC-25D		

switches and momentary switches

rocker/momentary rocker switches

30x22mm



GEV No.	301003	Ref. No.	74500120
description	rocker switch mounting measurements 30x22mm green 2NO 250V 16A illuminated 0-I connection male faston 6.3mm ambient temperature max. 125/55°C protection IP65		
For models:	AHB, AHC, AHC 18A, AHC 18B, AHC 18C, AHK, BAKY 5TE, BAKY 5TM, F80E, KR 6, KR 66, KR 66T, KR 6T, KR 9, KR 99, L105.105, L105.65, L60.60, L65.105, MHC 18A, MHC 18B, MHC 18C, MHC 18PA, MHC 18PB, MHC 18PC, MHC 30A, MHC 30B, MHC 30C, MHC 30PA, MHC 30PB, MHC 30PC, MHK - MHC - MHB, MHL, P110 GAS, P110 GAS A, P110 GAS B, PC/GAS, PIZZY DUO 105.105, PIZZY DUO 105.65, PIZZY DUO 65.105, PIZZY MONO 105.105, PIZZY MONO 105.65, PIZZY MONO 65.105, R08G GAS, RHC 18B, RHC 18C, RHC 18D, RHC 18PB, RHC 18PC, RHC 18PD...(Other models you can see in the webshop)		
accessories for	301003		
	GEV No.	301036	Ref. No. —
	protective cover internal size 30x22mm for rocker switch mounting measurementsmm		



GEV No.	301017	Ref. No.	74500130
description	rocker switch mounting measurements 30x22mm green 2CO 250V 16A illuminated connection male faston 6.3mm ambient temperature max. 125/55°C protection IP40		
For models:	KR 4, KR 44, PIZZY DUO 60.60, PIZZY MONO 60.60		
accessories for	301017		
	GEV No.	301036	Ref. No. —
	protective cover internal size 30x22mm for rocker switch mounting measurementsmm		



GEV No.	346377	Ref. No.	74550520
description	rocker switch mounting measurements 30x22mm black 2CO 230V 16A 0-I connection male faston 6.3mm ambient temperature max. 125/55°C protection IP40		
For models:	PIZZY DUO 60.60, PIZZY MONO 60.60		
accessories for	346377		
	GEV No.	301036	Ref. No. —
	protective cover internal size 30x22mm for rocker switch mounting measurementsmm		



GEV No.	301255	Ref. No.	74500010
description	rocker switch mounting measurements 30x22mm blue 2NO 250V 16A illuminated 0-I connection male faston 6.3mm ambient temperature max. 85°C protection IP40		
For models:	KRX 6, KRX 66, KRX 66T, KRX 6T, KRX 9, KRX 99		
accessories for	301255		
	GEV No.	301036	Ref. No. —
	protective cover internal size 30x22mm for rocker switch mounting measurementsmm		



GEV No.	347505	Ref. No.	74500040
description	rocker switch mounting measurements 30x22mm blue 2NO 250V 16A illuminated 0-lighting connection male faston 6.3mm ambient temperature max. 85°C protection IP40		
For models:	KRX 4, KRX 44, KRX 6, KRX 66, KRX 66T, KRX 6T, KRX 9, KRX 99		



GEV No.	346378	Ref. No.	74500220 74500400 74500720
description	rocker switch mounting measurements 30x22mm green 2NO 250V 16A illuminated lighting connection male faston 6.3mm ambient temperature max. 100/55°C protection IP40		
For models:	AHL, BAKY 5TM, KR 4, KR 44, KR 6, KR 66, KR 66T, KR 6T, KR 9, KR 99, L105.105, L105.65, L60.60, L65.105, MHL, P110L, PIZZY DUO 105.105, PIZZY DUO 105.65, PIZZY DUO 60.60, PIZZY DUO 65.105, PIZZY MONO 105.105, PIZZY MONO 105.65, PIZZY MONO 60.60, PIZZY MONO 65.105, RHL		



microswitches

lever actuated



GEV No.	345125	Ref. No.	74550740
description	microswitch with lever 250V 16A 1CO connection male faston 6.3mm ambient temperature max. 85°C mounting distance 25mm type C99ZP3 actuating force: 25g lever length 63.5mm		
For models:	PRESSY 33, PRESSY 45		

roller actuated

roller 0°



GEV No.	345639	Ref. No.	74550730
description	microswitch with roller plunger 230V 16A 1CO connection solder/screw connection L1 49mm ambient temperature max. 125°C thread L 14mm thread M10 mounting distance 25mm actuating force: 300g type M515-1		
For models:	PRESSY 33, PRESSY 45		

rotary switches

BRETER

rotary switches



GEV No.	346381	Ref. No.	74500440
description	rotary switch		
For models:	PRESSY 33, PRESSY 45, T75E, T97E		



GEV No.	346379 ¹	Ref. No.	74500480
description	rotary switch 2 0-1 sets of contacts 3 type 3LD2203-0TK53 600V 32A shaft ø 5x5mm shaft L 20mm shaft square with knob connection screw		
For models:	T75E		

¹incl. knob and dial plate



GEV No.	346380	Ref. No.	74500490
description	rotary switch 2 0-1 sets of contacts 3 type 3LD2504-0TK53 600V 63A shaft ø 8x9mm shaft L 20mm shaft star-shaped with switch connection screw		
For models:	T75E, T97E		

miscellaneous



GEV No.	346383	Ref. No.	74500530
description	rotary switch sets of contacts 4 2 0-1 type 3LD2003-0TK53 690V 16A shaft ø 6x6mm shaft L 24.5mm shaft square L1-L2-L3-N connection screw clamp		
For models:	PRESSY 33, PRESSY 45, T75G, T97G		

control equipment

ALLEN BRADLEY

push buttons



GEV No.	346382	Ref. No.	74550140
description	push button mounting measurements ø22mm illuminated green		



GEV No.	346396	Ref. No.	74550270
description	contact block 800E-3X10 1NO/1NC max 400V 8A		

SIEMENS

3SB series ø22mm new

push buttons



GEV No.	346618	Ref. No.	74550140
----------------	--------	-----------------	----------

description push button mounting measurements ø22mm non-illuminated green

For models: ITP/40, PRESSY 33, PRESSY 45, RFP/15

accessories for 346618



GEV No.	346632	Ref. No.	—
----------------	--------	-----------------	---

contact block SIEMENS 3SB3400-0D 1NC/1NO max 400V 10A black

screw-on/push-on fit

light bulbs

for ovens



GEV No.	359612	Ref. No.	74420260
----------------	--------	-----------------	----------

description light bulb t.max. 300°C socket E14 25W 230V ø 25mm L 56mm lens L 30mm for oven lamp type Philips

For models: AHB, AHC, AHC 18A, AHC 18B, AHC 18C, AHK, AHL, BAKY 5TE, BAKY 5TM, F80E, F80L, KR 4, KR 44, KR 6, KR 66, KR 66T, KR 6T, KR 9, KR 99, KRX 4, KRX 44, KRX 6, KRX 66, KRX 66T, KRX 6T, KRX 9, KRX 99, L105.105, L105.65, L60.60, L65.105, MHC 18A, MHC 18B, MHC 18C, MHC 18PA, MHC 18PB, MHC 18PC, MHC 30A, MHC 30B, MHC 30C, MHC 30PA, MHC 30PB, MHC 30PC, MHK - MHC - MHB, MHL, P110 GAS, P110 GAS A, P110 GAS B, P110L, PC/GAS...(Other models you can see in the webshop)

lamps

indicator lights

indicator lights (complete)

ø10mm

with plug-in socket



GEV No.	359263	Ref. No.	74420790
----------------	--------	-----------------	----------

description indicator light ø 10mm

For models: PRESSY 33, PRESSY 45

ø13mm

with plug-in socket



GEV No.	359143	Ref. No.	74420520
----------------	--------	-----------------	----------

description indicator light ø 13mm yellow 230V connection male faston 6.3mm temp.-resist. 120°C Qty 1 pcs

For models: AHL, BAKY 5TM, F80L, KR 4, KR 44, KR 6, KR 66, KR 66T, KR 6T, KR 9, KR 99, KRX 4, KRX 44, KRX 6, KRX 66, KRX 66T, KRX 6T, KRX 9, KRX 99, L105.105, L105.65, L60.60, L65.105, MHL, P110L, PIZZY DUO 105.105, PIZZY DUO 105.65, PIZZY DUO 60.60, PIZZY DUO 65.105, PIZZY MONO 105.105, PIZZY MONO 105.65, PIZZY MONO 60.60, PIZZY MONO 65.105, RHL, TVHL

halogen lamp

for socket G4 / G6.35 / G9



GEV No.	359946	Ref. No.	74401460
----------------	--------	-----------------	----------

description halogen lamp socket G9 230V 40W temp.-resist. 300°C

oven lamps

universal oven lamps

mounting diameter 47.8mm



GEV No.	359499	Ref. No.	74700070
----------------	--------	-----------------	----------

description lamp socket socket E14 mounting ø 47.8mm connection male faston 6.3mm

For models: AHB, AHC, AHC 18A, AHC 18B, AHC 18C, AHK, AHL, F80L, KR 4, KR 44, KR 6, KR 66, KR 66T, KR 6T, KR 9, KR 99, KRX 4, KRX 44, KRX 6, KRX 66, KRX 66T, KRX 6T, KRX 9, KRX 99, L105.105, L105.65, L60.60, L65.105, MHC 18A, MHC 18B, MHC 18C, MHC 18PA, MHC 18PB, MHC 18PC, MHC 30A, MHC 30B, MHC 30C, MHC 30PA, MHC 30PB, MHC 30PC, MHK - MHC - MHB, MHL, P110 GAS, P110 GAS A, P110 GAS B, P110L, PC/GAS, PIZZY DUO 105.105, PIZZY DUO 105.65, PIZZY DUO 60.60...(Other models you can see in the webshop)

accessories for 359499





GEV No.	359725	Ref. No.	—
----------------	--------	-----------------	---

oven lamp glass thread ø 44mm H 43mm ø 54mm hard glas temp.-resist. 350°C



			
1			
GEV No.	360541	Ref. No.	74700200
description	lamp socket socket G9 250V mounting ø 47.8mm connection male faston 6.3mm		
accessories for	360541		
	GEV No.	359725	Ref. No. —
	oven lamp glass thread ø 44mm H 43mm ø 54mm hard glas temp.-resist. 350°C		
	GEV No.	359946	Ref. No. 74401460
	halogen lamp socket G9 230V 40W temp.-resist. 300°C		

mounting diameter 65.5mm			
			
1			
GEV No.	359724	Ref. No.	73700690
description	oven lamp glass thread ø 62mm H 46mm ø 74mm hard glas temp.-resist. 350°C		
For models:	AHC, AHC 18A, AHC 18B, AHC 18C, AHC 18C, AHK, KR 4, KR 44, KR 6, KR 66, KR 66T, KR 6T, KR 9, KR 99, KRX 4, KRX 44, KRX 6, KRX 66, KRX 66T, KRX 6T, KRX 9, KRX 99, MHC 18A, MHC 18B, MHC 18C, MHC 18PA, MHC 18PB, MHC 18PC, MHC 30A, MHC 30B, MHC 30C, MHC 30PA, MHC 30PB, MHC 30PC, MHC - MHC - MHB, P110 GAS, P110 GAS A, P110 GAS B, PC/GAS, PIZZY DUO 105.105, PIZZY DUO 105.65, PIZZY DUO 60.60, PIZZY DUO 65.105, PIZZY MONO 105.105, PIZZY MONO 105.65, PIZZY MONO 60.60, PIZZY MONO 65.105, RHC 18B, RHC 18C, RHC 18D...(Other models you can see in the webshop)		

50x75.5mm			
			
1			
GEV No.	359303	Ref. No.	73700790
description	oven lamp glass L 88mm W 54mmVW socket connection for oven lamp		

lamps			
light bulbs			
			
1			
GEV No.	359612	Ref. No.	74420260
description	light bulb t.max. 300°C socket E14 25W 230V ø 25mm L 56mm lens L 30mm for oven lamp type Philips		
For models:	AHC, AHC 18A, AHC 18B, AHC 18C, AHC 18C, AHK, AHL, BAKY 5TE, BAKY 5TM, F80E, F80L, KR 4, KR 44, KR 6, KR 66, KR 66T, KR 6T, KR 9, KR 99, KRX 4, KRX 44, KRX 6, KRX 66, KRX 66T, KRX 6T, KRX 9, KRX 99, L105.105, L105.65, L60.60, L65.105, MHC 18A, MHC 18B, MHC 18C, MHC 18PA, MHC 18PB, MHC 18PC, MHC 30A, MHC 30B, MHC 30C, MHC 30PA, MHC 30PB, MHC 30PC, MHC - MHC - MHB, MHL, P110 GAS, P110 GAS A, P110 GAS B, P110L, PC/GAS...(Other models you can see in the webshop)		

halogen lamps			
for socket G4 / G6.35 / G9			
			
1			
GEV No.	359946	Ref. No.	74401460
description	halogen lamp socket G9 230V 40W temp.-resist. 300°C		

contactors

SIEMENS

power contactors

			
1			
GEV No.	380389	Ref. No.	74550230
description	power contactor resistive load 22A 230VAC (AC3/400V) 9A/4kW main contacts 3NO auxiliary contacts 1NO connection screw connection type 3RT10-16-1AP01		
For models:	AHC, AHC 18A, AHC 18B, AHC 18C, AHC 18C, AHK, BAKY 5TE, BAKY 5TM, F40E, F80E, KR 6, KR 66, KR 66T, KR 6T, KR 9, KR 99, KRX 6, KRX 66, KRX 66T, KRX 6T, KRX 9, KRX 99, MHC 18A, MHC 18B, MHC 18C, MHC 18PA, MHC 18PB, MHC 18PC, MHC 30A, MHC 30B, MHC 30C, MHC 30PA, MHC 30PB, MHC 30PC, MHC - MHC - MHB, PIZZY DUO 105.105, PIZZY DUO 105.65, PIZZY MONO 105.105, PIZZY MONO 105.65, PIZZY MONO 65.105, RHC 18B, RHC 18C, RHC 18D, RHC 18PB, RHC 18PC, RHC 18PD, RHC 25B, RHC 25C, RHC 25PB...(Other models you can see in the webshop)		



1

GEV No.	380390	Ref. No.	74550500
description	power contactor resistive load 40A 230VAC (AC3/400V) 12A/5.5kW main contacts 3NO auxiliary contacts connection screw connection type 3RT10-24-1AL20 50/60Hz		
For models:	AHB, AHC, AHC 18A, AHC 18B, AHC 18C, AHK, KR 9, KR 99, KRX 9, KRX 99, MHC 18A, MHC 18B, MHC 18C, MHC 18PA, MHC 18PB, MHC 18PC, MHC 30A, MHC 30B, MHC 30C, MHC 30PA, MHC 30PB, MHC 30PC, MHK - MHC - MHB, PIZZY DUO 105.105, PIZZY MONO 105.105, RHC 18B, RHC 18C, RHC 18D, RHC 18PB, RHC 18PC, RHC 18PD, RHC 25B, RHC 25C, RHC 25PB, RHC 25PC, RHC 25PD, RHC-25D, RHK - RHC - RHB, T75E, TIVOLI EL HI-TECH, TREVI ELETTRICO		

probes

producer-specific probes

probes

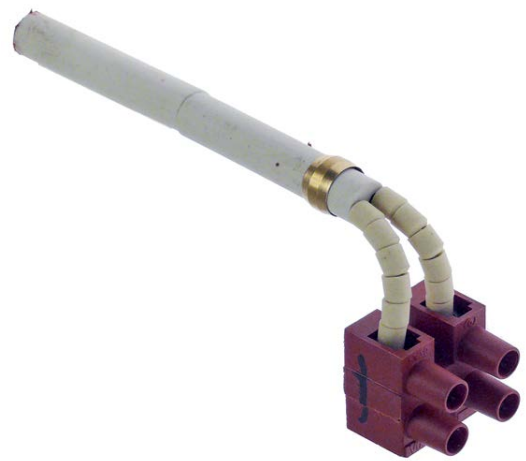

1

GEV No.	379975	Ref. No.	66081910
description	temperature probe cable ceramic probe -50 up to +750°C cable -100 up to +1300°C connection grip connection thread probe ø10x100mm cable lengthm		
For models:	BAKY 5TE, F40E, F80E, R08G GAS, R14G GAS, T75E, T75G, T97E, T97G, TEVERE HI-TECH, TIVOLI EL HI-TECH, TIVOLI GAS HI-TECH, TREVI ELETTRICO, TREVI GAS		



1

GEV No.	379972	Ref. No.	66081040
description	temperature probe cable ceramic probe -50 up to +750°C cable -100 up to +1300°C connection grip connection thread probe ø10x255mm cable lengthm		
For models:	P110 GAS, P110 GAS A, P110 GAS B, PC/GAS		

transformers

open transformers

with clamp terminal



1

GEV No.	401289	Ref. No.	74110290
description	transformer primary 230/400V secondary 12V 100VA		
For models:	F40E, F80E, R14G GAS, T75E, T75G, T97E, T97G		

encapsulated transformers

multiple connections



1

GEV No.	401285	Ref. No.	74110200
description	transformer primary 230VAC secondary 12VAC 10VA		
For models:	AHB, AHC, AHC 18A, AHC 18B, AHC 18C, AHK, MHC 18A, MHC 18B, MHC 18C, MHC 18PA, MHC 18PB, MHC 18PC, MHC 30A, MHC 30B, MHC 30C, MHC 30PA, MHC 30PB, MHC 30PC, MHK - MHC - MHB, P110 GAS, P110 GAS A, P110 GAS B, R08G GAS, R14G GAS, RHC 18B, RHC 18C, RHC 18D, RHC 18PB, RHC 18PC, RHC 18PD, RHC 25B, RHC 25C, RHC 25PB, RHC 25PC, RHC 25PD, RHC-25D, RHK - RHC - RHB		



1

GEV No.	379973	Ref. No.	66080820
description	temperature probe thermocouple cable ceramic probe -50 up to +750°C cable -100 up to +1300°C connection grip connection thread probe ø10x100mm cable lengthm		
For models:	MHC 18A, MHC 18B, MHC 18C, MHC 18PA, MHC 18PB, MHC 18PC, MHC 30A, MHC 30B, MHC 30C, MHC 30PA, MHC 30PB, MHC 30PC, MHK - MHC - MHB, RHC 18B, RHC 18C, RHC 18D, RHC 18PB, RHC 18PC, RHC 18PD, RHC 25B, RHC 25C, RHC 25PB, RHC 25PC, RHC 25PD, RHC-25D, RHK - RHC - RHB		



1

GEV No.	379974	Ref. No.	66080980
description	temperature probe thermocouple cable ceramic probe -50 up to +750°C cable -100 up to +1300°C connection grip connection thread probe ø10x150mm cable lengthm		
For models:	AHC 18A, AHC 18B, AHC 18C		



1

GEV No.	378330	Ref. No.	66000830
description	temperature probe thermocouple cable ceramic probe -50 up to +750°C cable -100 up to +1300°C connection grip connection thread probe ø10x190mm cable lengthm		
For models:	AHB, AHC, AHK		

electronics

PCBs



1

GEV No.	401271	Ref. No.	768000B0
description	keypad PCB		
For models:	AHB, AHC, AHC 18A, AHC 18B, AHC 18C, AHK, MHC 18A, MHC 18B, MHC 18C, MHC 30A, MHC 30B, MHC 30C, MHK - MHC - MHB		



1

GEV No.	401272	Ref. No.	768001C0
description	keypad PCB		
For models:	MHC 18PA, MHC 18PB, MHC 18PC, MHC 30PA, MHC 30PB, MHC 30PC, MHK - MHC - MHB, RHC 18PB, RHC 18PC, RHC 18PD, RHC 25PB, RHC 25PC, RHC 25PD, RHK - RHC - RHB		



1

GEV No.	401287	Ref. No.	74311240
description	keypad PCB		
For models:	T75E		



1	GEV No.	401291	Ref. No.	74311400
	description	keypad PCB		
	For models:	T97E		



1	GEV No.	401854	Ref. No.	768001R0
	description	keypad PCB L 144mm W 144mm		
	For models:	MHK - MHC - MHB		



1	GEV No.	401853	Ref. No.	768000C0 768000G0 768000R0
	description	keypad PCB		
	For models:	AHB, AHC, AHC 18A, AHC 18B, AHC 18C, AHK, MHC 18A, MHC 18B, MHC 18C, MHC 30A, MHC 30B, MHC 30C, MHK - MHC - MHB, RHC 18B, RHC 18C, RHC 18D, RHC 25B, RHC 25C, RHC-25D, RHK - RHC - RHB		

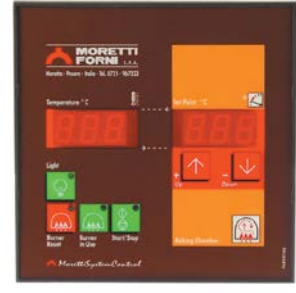

1	GEV No.	401283	Ref. No.	768002R0
	description	keypad PCB pizza oven gas		



1	GEV No.	401435	Ref. No.	768000R0
	description	keypad PCB electric pizza oven L 140mm W 140mm buttons 4		



1	GEV No.	403059	Ref. No.	768002R0
	description	keypad PCB pizza oven gas P110 L 140mm W 140mm		
	For models:	P110 GAS, P110 GAS A, P110 GAS B, PC/GAS		

spare parts for	403059			
	GEV No.	403141	Ref. No.	767002R0
		keypad foil L 140mm W 140mm		



1	GEV No.	403060	Ref. No.	768000R0
	description	keypad PCB electric pizza oven MHC L 140mm W 140mm buttons 6		
	For models:	AHB, AHC, AHC 18A, AHC 18B, AHC 18C, AHK, MHC 18A, MHC 18B, MHC 18C, MHC 30A, MHC 30B, MHC 30C, MHK - MHC - MHB		

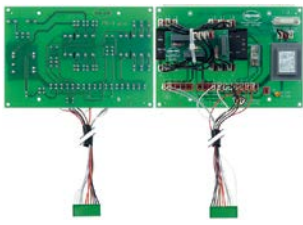

1	GEV No.	401288	Ref. No.	74311220
	description	main PCB		
	For models:	T75E, T97E		

1

GEV No.	400731	Ref. No.	74670820
description	main PCB pizza press Pressy 33/45		
For models:	PRESSY 33, PRESSY 45		



1

GEV No.	401290	Ref. No.	74220850
description	PCB time control		
For models:	PRESSY 33, PRESSY 45		

keypads

front foils



1

GEV No.	401269	Ref. No.	73523970
description	front foil		
For models:	PIZZY MONO 60.60		



1

GEV No.	401270	Ref. No.	73523980
description	front foil		
For models:	PIZZY DUO 60.60		



1

GEV No.	402352	Ref. No.	73500510
description	front foil pizza oven PIZZY DUO model DUO L 550mm W 111mm		
For models:	PIZZY DUO 105.105, PIZZY DUO 105.65, PIZZY DUO 60.60, PIZZY DUO 65.105		



1

GEV No.	401284	Ref. No.	767002R0
description	keypad foil		



1

GEV No.	401275	Ref. No.	767000C0
description	keypad foil beige		
For models:	AHB, AHC, AHC 18A, AHC 18B, AHC 18C, AHK, MHC 18A, MHC 18B, MHC 18C, MHC 30A, MHC 30B, MHC 30C, MHK - MHC - MHB, RHC 18B, RHC 18C, RHC 18D, RHC 25B, RHC 25C, RHC-25D, RHK - RHC - RHB		



1

GEV No.	401279	Ref. No.	767001B0
description	keypad foil blue		
For models:	MHC 18PA, MHC 18PB, MHC 18PC, MHC 30PA, MHC 30PB, MHC 30PC, MHK - MHC - MHB		



1

GEV No.	401280	Ref. No.	767001C0
description	keypad foil beige		
For models:	MHC 18PA, MHC 18PB, MHC 18PC, MHC 30PA, MHC 30PB, MHC 30PC, MHK - MHC - MHB, RHC 18PB, RHC 18PC, RHC 18PD, RHC 25PB, RHC 25PC, RHC 25PD, RHK - RHC - RHB		



1

GEV No.	401277	Ref. No.	767000R0 767003R0
description	keypad foil brown		
For models:	AHC, AHC 18A, AHC 18B, AHC 18C, AHK, MHC 18A, MHC 18B, MHC 18C, MHC 30A, MHC 30B, MHC 30C, MHK - MHC - MHB		



1

GEV No.	401274	Ref. No.	767000B0
description	keypad foil blue		
For models:	AHC, AHC 18A, AHC 18B, AHC 18C, AHK, MHC 18A, MHC 18B, MHC 18C, MHC 30A, MHC 30B, MHC 30C, MHK - MHC - MHB		



1

GEV No.	401282	Ref. No.	767001R0
description	keypad foil brown		
For models:	MHC 18PA, MHC 18PB, MHC 18PC, MHC 30PA, MHC 30PB, MHC 30PC, MHK - MHC - MHB		



1

GEV No.	403141	Ref. No.	767002R0
description	keypad foil L 140mm W 140mm		
For models:	P110 GAS, P110 GAS A, P110 GAS B, PC/GAS		



1

GEV No.	401273	Ref. No.	767000W0
description	keypad foil white		
For models:	AHB, AHC, AHC 18A, AHC 18B, AHC 18C, AHK, MHC 18A, MHC 18B, MHC 18C, MHC 30A, MHC 30B, MHC 30C, MHK - MHC - MHB		

1

GEV No.	401278	Ref. No.	767001W0
description	keypad foil white		
For models:	MHC 18PA, MHC 18PB, MHC 18PC, MHC 30PA, MHC 30PB, MHC 30PC, MHK - MHC - MHB		

1

GEV No.	401276	Ref. No.	767000G0
description	keypad foil yellow		
For models:	AHB, AHC, AHC 18A, AHC 18B, AHC 18C, AHK, MHC 18A, MHC 18B, MHC 18C, MHC 30A, MHC 30B, MHC 30C, MHK - MHC - MHB		

1

GEV No.	401281	Ref. No.	767001G0
description	keypad foil yellow		
For models:	MHC 18PA, MHC 18PB, MHC 18PC, MHC 30PA, MHC 30PB, MHC 30PC, MHK - MHC - MHB		

membrane keypads

1

GEV No.	401286	Ref. No.	74311230
description	membrane keypad		
For models:	T75E, T75G, T97E, T97G		

fans

hot air motors

1

GEV No.	601240	Ref. No.	74015370
description	fan motor 230/400V 3 phase 50Hz 0.55kW 1400rpm speeds 1 L1 150mm L2 45mm L3 47mm D1 ø 24mm D2 ø 20mm M8L IT 3/1.73A Cos(fi) 0.75 at 50Hz 1400rpm type 1022		
For models:	T75E, T97E		

1

GEV No.	601242	Ref. No.	72807520
description	fan wheel D1 ø 300mm H1 100mm blades 12 D2 ø 19.5mm D3 ø 23mm H2 46mm		
For models:	T97E		



1

GEV No.	601241	Ref. No.	72806860
description	fan wheel D1 ø 300mm H1 100mm blades 20 D2 ø 19.5mm D3 ø 23mm H2 46mm		
For models:	T75E, T75G		



1

GEV No.	601239	Ref. No.	72806990
description	fan wheel for motor cooling		
For models:	T75E, T75G, T97E, T97G		

motors

gear motors

for ovens

for conveyor belt



1

GEV No.	500820	Ref. No.	74015590
description	gear motor TRANSTECNO type WM26/P522CD 24V 4.3rpm shaft ø 12mm L 210mm W 95mm H 160mm for conveyor belt		
For models:	T97E, T97G		



1

GEV No.	500819	Ref. No.	74015580
description	gear motor TRANSTECNO type WMP26/522 CD-T 75E 70W 24V shaft ø 12mm L 215mm W 150mm H 100mm for conveyor belt		
For models:	T75E, T75G		

for flues



1

GEV No.	601467	Ref. No.	74310970	
description	gear motor CROUZET type 823440 3W 230V 50Hz 6rpm shaft ø 4mm L 65mm W 51mm H 34mm			
For models:	BAKY 5TE, BAKY 5TM			
accessories for	601467			
	GEV No.	691422	Ref. No.	—
	gear wheel for gear motor suitable for TURBOCHEF C3			

motors

universal



1

Image not available

GEV No.	500822	Ref. No.	74015350
description	motor		
For models:	PRESSY 33, PRESSY 45		



1

GEV No.	500821	Ref. No.	74015340
description	motor 370W 230V 50Hz 1 phase shaft ø 14mm flange ø 160mm 1400rpm ø 140mm H 180mm L 220mm ICME 0.37kW		
For models:	PRESSY 33		



1

Image not available

GEV No.	500822	Ref. No.	74015350
description	motor		
For models:	PRESSY 33, PRESSY 45		



electric accessories

terminals

connection terminals with screw/faston connections



GEV No.	550411	Ref. No.	74610340
description	power terminal block 6-pole max. 40A max 450V connection $\phi 6\text{mm}^2$ / F6.3 temp.-resist. 150°C cross section 6mm ²		
For models:	AHB, AHC, AHK, BAKY 5TE, BAKY 5TM, KR 6, KR 66, KR 66T, KR 6T, KR 9, KR 99, KRX 6, KRX 66, KRX 66T, KRX 6T, KRX 9, KRX 99, MHK - MHC - MHB, PIZZY DUO 105.105, PIZZY DUO 105.65, PIZZY DUO 65.105, PIZZY MONO 105.105, PIZZY MONO 105.65, PIZZY MONO 65.105, R08G GAS, R14G GAS, RHK - RHC - RHB, TEVERE HI-TECH, TREVI ELETTRICO		

terminal boards



GEV No.	550985	Ref. No.	74670620
description	terminal board 3-pole thread M6 L 83mm W 53mm		
For models:	KR 4, KR 44, KRX 4, KRX 44, PIZZY DUO 60.60, PIZZY MONO 60.60		

rail-mounted terminals

WIELAND

rail-mounted terminals type 9700A



GEV No.	550376	Ref. No.	74610020
description	rail-mounted terminal WIELAND type 9700A/16 S35 2.5-35mm ² top-hat rail 35mm grey W 16mm L 59mm		
For models:	AHB, AHC, AHK, KR 66, KR 66T, KR 99, KRX 66, KRX 66T, KRX 99, MHK - MHC - MHB, PIZZY DUO 105.105, PIZZY DUO 105.65, PIZZY DUO 65.105, RHK - RHC - RHB		



GEV No.	550381	Ref. No.	74610070
description	rail-mounted terminal WIELAND type 9700A/8 S35 1.0-10mm ² top-hat rail 35mm grey W 8mm L 46.6mm		
For models:	KRX 99, PIZZY DUO 105.105, PIZZY DUO 105.65		



GEV No.	550416	Ref. No.	74610190
description	rail-mounted terminal WIELAND type 9700A/8 SL2 S35 1.0-10mm ² top-hat rail 35mm yellow/green W 8mm L 53mm		
For models:	AHB, AHC, AHK, KR 66, KR 66T, KR 99, KRX 66, KRX 66T, KRX 99, MHK - MHC - MHB, PIZZY DUO 105.105, PIZZY DUO 105.65, PIZZY DUO 65.105, RHK - RHC - RHB		

accessories universal

terminal block end brackets



GEV No.	550984	Ref. No.	74610080
description	terminal block end bracket for DIN-rail		
For models:	KR 66, KR 66T, KR 99, KRX 66, KRX 66T, KRX 99, PIZZY DUO 105.105, PIZZY DUO 105.65, PIZZY DUO 65.105		

gas valves and ignition boxes

gas control valves

HONEYWELL







GEV No.	106011	Ref. No.	74311120
description	gas valve HONEYWELL		
For models:	P110 GAS, P110 GAS A, P110 GAS B, R08G GAS		

accessories for	106011			
	GEV No.	101305	Ref. No.	—
	gas connection straight 1/2" flange 45x45mm ELETTRISIT/V4400/4600/4605 suitable for SIT/HONEYWELL hole distance 36x36mm			
	GEV No.	101306	Ref. No.	—
	gas connection angled flange 45x45mm hole distance 36x36mm 1/2" ELETTRISIT/V4400/4600/4605 screw with O-ring suitable for SIT/HONEYWELL			
	GEV No.	101307	Ref. No.	—
	gas connection straight flange 45x45mm hole distance 36x36mm 3/4" ELETTRISIT/V4400/4600/4605 screw with O-ring suitable for SIT/HONEYWELL			
	GEV No.	101308	Ref. No.	—
	gas connection angled flange 45x45mm hole distance 36x36mm 3/4" ELETTRISIT/V4400/4600/4605 screw with O-ring suitable for SIT/HONEYWELL			



1



GEV No.	106010	Ref. No.	74310690
description	gas valve type VR4605A 230V 50Hz gas inlet flange 45x45mm gas outlet 1/2" thermocouple connection pilot connection pressure range 3-37mbar operator type 220/240V (V404A 1071 4) pressure controller type V5306E 1143 1 suitable for HONEYWELL		
For models:	PC/GAS, R14G GAS, TEVERE HI-TECH, TIVOLI GAS HI-TECH, TREVI GAS		
accessories for	106010		
	GEV No.	101305	Ref. No. —
	gas connection straight 1/2" flange 45x45mm ELETTROSIT/V4400/4600/4605 suitable for SIT/HONEYWELL hole distance 36x36mm		
	GEV No.	101306	Ref. No. —
	gas connection angled flange 45x45mm hole distance 36x36mm 1/2" ELETTROSIT/V4400/4600/4605 screw with O-ring suitable for SIT/HONEYWELL		
	GEV No.	101307	Ref. No. —
	gas connection straight flange 45x45mm hole distance 36x36mm 3/4" ELETTROSIT/V4400/4600/4605 screw with O-ring suitable for SIT/HONEYWELL		
	GEV No.	101308	Ref. No. —
	gas connection angled flange 45x45mm hole distance 36x36mm 3/4" ELETTROSIT/V4400/4600/4605 screw with O-ring suitable for SIT/HONEYWELL		

ignition boxes

HONEYWELL



1

GEV No.	102358	Ref. No.	74670690
description	ignition box HONEYWELL type S4570AS 1012 electrodes 1 waiting time 3s safety time 5s 220-240V 10VA 50Hz		
For models:	PC/GAS, R14G GAS, TEVERE HI-TECH, TIVOLI GAS HI-TECH, TREVI GAS		
accessories for	102358		
	GEV No.	550800	Ref. No. —
	PCB terminal block 2-pole raster size 5mm		
	GEV No.	550801	Ref. No. —
	PCB terminal block 3-pole raster size 5mm		

ignition parts

electrodes

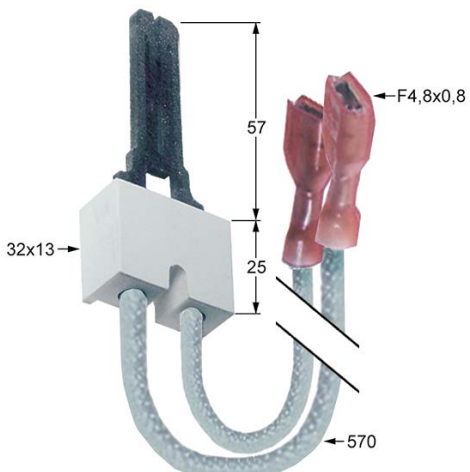

1

GEV No.	102354	Ref. No.	74110050 Q3271N1005B
description	ignition electrode D1 ø 32x13mm L1 57mm BL1 25mm connection F 4.8x0.8mm cable length 570mm		
For models:	PC/GAS, R14G GAS, TEVERE HI-TECH, TIVOLI GAS HI-TECH, TREVI GAS		



1

GEV No.	102355	Ref. No.	74110060
description	ignition electrode flange length 23mm flange width 15mm D1 ø 7mm D2 ø 8mm L1 19mm L2 10mm L3 37mm BL1 17mm BL2 17mm BL3 140mm BL4 60mm connection F 6.3 cable length 1650mm fixing dimensions ø5x4mm with flange		
For models:	PC/GAS, R14G GAS, TEVERE HI-TECH, TIVOLI GAS HI-TECH, TREVI GAS		



1

GEV No.	102357	Ref. No.	74110210
description	ignition electrode flange length 23mm flange width 15mm D1 ø 7mm D2 ø 8mm L1 19mm L2 10mm L3 37mm L4 15mm BL1 17mm BL2 17mm BL3 140mm BL4 60mm connection F 4.8x0.8mm cable length 1650mm fixing dimensions ø5x4mm with flange		
For models:	P110 GAS, P110 GAS A, P110 GAS B		

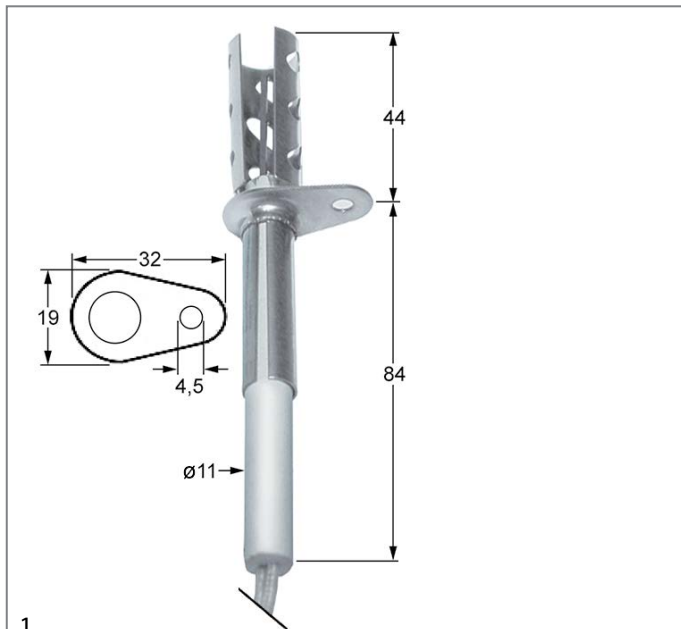

GEV No.	102356	Ref. No.	74100260
description	ignition electrode flange length 32mm flange width 19mm D1 ø 11mm L1 44mm L2 32mm BL1 8mm BL2 84mm cable length 870mm fixing dimensions ø4.5mm with flange		
For models:	P110 GAS, P110 GAS A, P110 GAS B, R08G GAS		

gas nozzles

main nozzles

gas nozzles M13x1



GEV No.	102471	Ref. No.	72093460
description	gas injector thread M13x1 bore ø 2.3mm WS 13		
For models:	R14G GAS		

equipment-specific units

for dough mixers

dough hooks

with mounting groove



GEV No.	697113	Ref. No.	71336030C 72701100
description	dough hook SP20		
For models:	SP20		

for dough roller

rollers

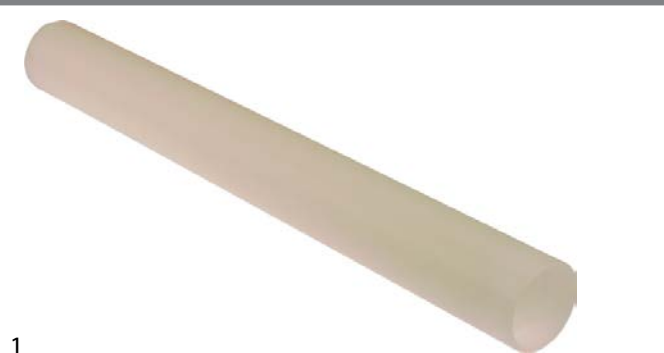

GEV No.	693909	Ref. No.	72601110
description	roller L 422mm ø 48mm mounting pos. bottom in the front		
For models:	FLATTY 40, FLATTY 40 P		

holders



GEV No.	692301	Ref. No.	72003620 72004100 72500990 73601110
description	lever complete hole ø 9.8mm H 21mm hole distance 32mm		
spare parts for	692301		

description	ball handle thread M4 ø 20mm black		
--------------------	------------------------------------	--	--

accessories for	692301		
------------------------	--------	--	--

GEV No.	697346	Ref. No.	—
----------------	--------	-----------------	---

accessories for	692301		
------------------------	--------	--	--

GEV No.	691637	Ref. No.	72500920
----------------	--------	-----------------	----------

description	roll pin ø 3mm L 20mm		
--------------------	-----------------------	--	--

for pizza press

gearboxes



GEV No.	693424	Ref. No.	74015330
description	gearbox		
For models:	PRESSY 33, PRESSY 45		



1

GEV No.	601182	Ref. No.	74015320
description	gearbox motor shaft \varnothing 14mm flange \varnothing 105mm transmission 1/80 drive shaft \varnothing 25mm fixing dimensions 86-110mm type MV 63A		



1

GEV No.	693423	Ref. No.	74015320
description	gearbox motor shaft \varnothing 14mm flange \varnothing 105mm transmission 1/80 drive shaft \varnothing 25mm fixing dimensions 86-110mm type MV 63A		
For models:	PRESSY 33		

for conveyor oven

miscellaneous



1

GEV No.	693419	Ref. No.	72091850
description	coupling mounting pos. engine side		
For models:	T75E, T75G, T97E, T97G		

for pizza ovens

spare parts and accessories



1

GEV No.	693420	Ref. No.	72601390
description	coupling centre for pizza oven		
For models:	T75E, T75G, T97E, T97G		



1

GEV No.	693421	Ref. No.	72094440
description	coupling lateral for pizza oven		
For models:	T75E, T75G, T97E, T97G		

glass panels



1

GEV No.	693412	Ref. No.	73700680 73700850
description	glass panel L 385mm W 135mm thickness 5mm rectangular with gasket		
For models:	KR 4, KR 44, KR 6, KR 66, KRX 4, KRX 44, KRX 6, KRX 66, MHC 18A, MHC 18B, MHC 18PA, MHC 18PB, MHK - MHC - MHB, PC/GAS, PIZZY DUO 60.60, PIZZY DUO 65.105, PIZZY MONO 60.60, PIZZY MONO 65.105, RHC 18B, RHC 18C, RHC 18D, RHC 18PB, RHC 18PC, RHC 18PD, RHK - RHC - RHB, T75E, T75G, T97E, T97G		



1

GEV No.	693413	Ref. No.	73700870
description	glass panel L 385mm W 163mm thickness 5mm rectangular		
For models:	AHC 18A, AHC 18B, AHC 18C, AHK, MHC 30A, MHC 30B, MHC 30PA, MHC 30PB, MHK - MHC - MHB, RHC 25B, RHC 25C, RHC 25PB, RHC 25PC, RHC 25PD, RHC-25D, RHK - RHC - RHB		





			
1			
GEV No.	693414	Ref. No.	73700840
description	glass panel L 697mm W 135mm thickness 5mm rectangular		
For models:	KR 66T, KR 6T, KR 9, KR 99, KRX 66T, KRX 6T, KRX 9, KRX 99, MHC 18C, MHC 18PC, MHK - MHC - MHB, P110 GAS, P110 GAS A, P110 GAS B, PC/GAS, PIZZY DUO 105.105, PIZZY DUO 105.65, PIZZY MONO 105.105, PIZZY MONO 105.65		

			
1			
GEV No.	693415	Ref. No.	73700860
description	glass panel L 697mm W 163mm thickness 5mm rectangular		
For models:	AHB, AHC, AHC 18A, AHC 18B, AHC 18C, MHC 30C, MHC 30PC, MHK - MHC - MHB		

<p>firebricks</p> 			
1			
GEV No.	850108	Ref. No.	49100030 76000090
description	firebrick L 1056mm W 526mm H 14mm delivery freight forwarding company only		
For models:	KR 9, KR 99, KRX 9, KRX 99, PIZZY DUO 105.105, PIZZY MONO 105.105		

			
1			
GEV No.	850070	Ref. No.	76001230 76002780
description	firebrick L 1100mm W 369mm H 20mm mounting pos. upper delivery freight forwarding company only		
For models:	P110 GAS, P110 GAS A, P110 GAS B		

			
1			
GEV No.	850073	Ref. No.	76000130 76002210
description	firebrick L 1100mm W 528mm H 13mm delivery freight forwarding company only		
For models:	PIZZY DUO 105.105, PIZZY MONO 105.105		

			
1			
GEV No.	850076	Ref. No.	76000240 76002240
description	firebrick L 1300mm W 415mm H 15mm delivery freight forwarding company only		
For models:	RHC 18B, RHC 18C, RHC 18D, RHC 18PB, RHC 18PC, RHC 18PD, RHC 25B, RHC 25C, RHC 25PB, RHC 25PC, RHC 25PD, RHC-25D, RHK - RHC - RHB		

			
1			
GEV No.	850067	Ref. No.	76001650 76001660
description	firebrick L 600mm W 425mm H 15mm delivery freight forwarding company only		
For models:	PC/GAS		

			
1			
GEV No.	850066	Ref. No.	76002690
description	firebrick L 600mm W 425mm H 20mm delivery freight forwarding company only		
For models:	PC/GAS		

			
1			
GEV No.	850077	Ref. No.	76000190 76001730
description	firebrick L 605mm W 415mm H 15mm delivery freight forwarding company only		
For models:	MHC 18A, MHC 18B, MHC 18PA, MHC 18PB, MHC 30A, MHC 30B, MHC 30PA, MHC 30PB, MHK - MHC - MHB		

			
1			
GEV No.	850071	Ref. No.	76000500 76002160 76003260
description	firebrick L 615mm W 330mm H 15mm delivery freight forwarding company only		
For models:	PIZZY DUO 60.60, PIZZY MONO 60.60		

			
1			
GEV No.	850074	Ref. No.	76000180 76001740
description	firebrick L 650mm W 415mm H 15mm delivery freight forwarding company only		
For models:	RHC 18B, RHC 18C, RHC 18D, RHC 18PB, RHC 18PC, RHC 18PD, RHC 25B, RHC 25C, RHC 25PB, RHC 25PC, RHC 25PD, RHC-25D, RHK - RHC - RHB		

			
1			
GEV No.	850106	Ref. No.	49100050 76000120
description	firebrick L 660mm W 307mm H 14mm delivery freight forwarding company only		
For models:	KR 4, KR 44, KRX 4, KRX 44, PIZZY DUO 60.60, PIZZY MONO 60.60		

			
1			
GEV No.	850107	Ref. No.	49100040 76000110
description	firebrick L 660mm W 526mm H 14mm delivery freight forwarding company only		
For models:	KR 6, KR 66, KR 66T, KR 6T, KRX 6, KRX 66, KRX 66T, KRX 6T, PIZZY DUO 105.65, PIZZY DUO 65.105, PIZZY MONO 105.65, PIZZY MONO 65.105		

			
1			
GEV No.	850072	Ref. No.	76002140 76003270
description	firebrick L 665mm W 336mm H 15mm delivery freight forwarding company only		
For models:	PIZZY DUO 65.105, PIZZY MONO 65.105		

			
1			
GEV No.	850111	Ref. No.	76000060
description	firebrick L 700mm W 528mm H 14mm delivery freight forwarding company only		
For models:	PIZZY DUO 105.65, PIZZY MONO 105.65		

			
1			
GEV No.	850069	Ref. No.	76001670 76001680
description	firebrick L 800mm W 425mm H 15mm delivery freight forwarding company only		
For models:	PC/GAS		



 <p>1</p>			
GEV No.	850068	Ref. No.	76002710
description	firebrick L 800mm W 425mm H 20mm delivery freight forwarding company only		
For models:	PC/GAS		

 <p>1</p>			
GEV No.	850078	Ref. No.	76000200 76001720
description	firebrick L 805mm W 415mm H 15mm delivery freight forwarding company only		
For models:	MHC 18C, MHC 18PC, MHC 30C, MHC 30PC, MHK - MHC - MHB		

 <p>1</p>			
GEV No.	850075	Ref. No.	76000210 76001750
description	firebrick L 850mm W 415mm H 15mm delivery freight forwarding company only		
For models:	RHC 18B, RHC 18C, RHC 18D, RHC 18PB, RHC 18PC, RHC 18PD, RHC 25B, RHC 25C, RHC 25PB, RHC 25PC, RHC 25PD, RHC-25D, RHK - RHC - RHB		

<p>miscellaneous</p>			
 <p>1</p>			
GEV No.	690992	Ref. No.	46003060 71000310
description	door hinge		
For models:	AHB, AHC, AHK, KRX 4, KRX 44, MHK - MHC - MHB, P110 GAS A, P110 GAS B, PIZZY DUO 105.65, PIZZY DUO 60.60, PIZZY MONO 105.65, PIZZY MONO 60.60, RHK - RHC - RHB		

 <p>1</p>			
GEV No.	514420	Ref. No.	46003070 71000300
description	door hinge L 76mm W 30mm mounting pos. left thickness 30mm for pizza oven		
For models:	AHB, AHC, AHK, MHK - MHC - MHB, P110 GAS A, P110 GAS B, PIZZY DUO 105.105, PIZZY DUO 105.65, PIZZY DUO 65.105, PIZZY MONO 105.105, PIZZY MONO 105.65, PIZZY MONO 65.105, RHK - RHC - RHB		

<p>gear wheels</p>			
 <p>1</p>			
GEV No.	693418	Ref. No.	71901030
description	gear wheel teeth 11 shaft intake ø 20mm ø 50mm hub ømm stainless steel		
For models:	T75E, T75G, T97E, T97G		

<p>knobs</p>			
<p>producer-specific knobs</p>			
<p>MORETTI</p>			
 <p>1</p>			
GEV No.	112944	Ref. No.	73600140
description	knob 1-10 t.max.°C ø 50mm shaft ø 6x4.6mm shaft flat lower silver		
For models:	KR 66T, KR 6T, KR 9, KR 99, KRX 4, KRX 44, KRX 6, KRX 66, KRX 66T, KRX 6T, KRX 9, KRX 99		

 <p>1</p>			
GEV No.	111769	Ref. No.	72800360
description	knob thermostat 1-10 ø 54mm shaft ø 6x4.6mm shaft flat lower		
For models:	PIZZY DUO 105.105, PIZZY DUO 105.65, PIZZY DUO 60.60, PIZZY DUO 65.105, PIZZY MONO 105.105, PIZZY MONO 105.65, PIZZY MONO 60.60, PIZZY MONO 65.105, PRESSY 33, PRESSY 45, PRESSY 50		



1

GEV No.	112940	Ref. No.	73600130
description	knob thermostat 1-10 t.max.°C ø 50mm shaft ø 6x4.6mm shaft flat lower black		
For models:	KR 4, KR 44, KR 6, KR 66, KR 66T, KR 6T, KR 9, KR 99		



1

GEV No.	111467	Ref. No.	72808120
description	knob thermostat 1-10 t.max.°C ø 54mm shaft ø 6x4.6mm shaft flat lower		



1

GEV No.	112941	Ref. No.	73601100
description	knob thermostat t.max. 500°C ø 50mm shaft ø 6x4.6mm shaft flat lower black temperature range 50-500°C rotation 270°		
For models:	KR 4, KR 44, KR 6, KR 66		

handles and hand wheels

cylindrical handles

fixed



1

GEV No.	112943	Ref. No.	73600750
description	cylindrical handle thread M10 ø 27mm L 91mm		
For models:	KR 4, KR 44, PIZZY DUO 105.105, PIZZY DUO 105.65, PIZZY DUO 60.60, PIZZY DUO 65.105, PIZZY MONO 105.105, PIZZY MONO 105.65, PIZZY MONO 60.60, PIZZY MONO 65.105, TIVOLI EL HI-TECH, TIVOLI GAS HI-TECH		



1

GEV No.	110803	Ref. No.	73601180
description	cylindrical handle thread M12 ø 29mm L 87mm		

cone handles



1

GEV No.	112942	Ref. No.	73600470
description	cone handle thread M10 ø 29mm L 67mm plastic black		
For models:	KR 4, KR 44, KR 6, KR 66, KR 66T, KR 6T, KR 9, KR 99		



1

GEV No.	693935	Ref. No.	769002B0
description	door handle thread M14 blue complete		

levers

without handle



1

GEV No.	691477	Ref. No.	72000860		
description	handle rod thread M10				
For models:	KR 4, KR 44, KR 6, KR 66, KR 66T, KR 6T, KR 9, KR 99				
accessories for	691477				
		GEV No.	112942	Ref. No.	73600470
	cone handle thread M10 ø 29mm L 67mm plastic black				
		GEV No.	112943	Ref. No.	73600750
	cylindrical handle thread M10 ø 27mm L 91mm				

accessories

miscellaneous



1

GEV No.	524876	Ref. No.	72087030
description	thread bolt for handle ø 15mm T1: M10x1.5 T2: M14x2 total length 100mm		
For models:	PIZZY DUO 105.105, PIZZY DUO 105.65, PIZZY DUO 60.60, PIZZY DUO 65.105, PIZZY MONO 105.105, PIZZY MONO 105.65, PIZZY MONO 60.60, PIZZY MONO 65.105, TIVOLI EL HI-TECH, TIVOLI GAS HI-TECH		



locks

espagnolette locks

universal



1

GEV No.	690041	Ref. No.	0751.02.0943 73600540
----------------	--------	-----------------	--------------------------

description cam L 148mm mounting distance 32mm

producer-specific

MORETTI



1

GEV No.	690041	Ref. No.	0751.02.0943 73600540
----------------	--------	-----------------	--------------------------

description cam L 148mm mounting distance 32mm



Image not available

1

GEV No.	692206	Ref. No.	68000350
----------------	--------	-----------------	----------

description espagnolette lock complete

For models: TREVI ELETTRICO, TREVI GAS



Image not available

1

GEV No.	692205	Ref. No.	0751.02.0942 73600530
----------------	--------	-----------------	--------------------------

description latch gear shaft intake ø 8x8mm L 170mm W 40mm H 30mm

hinges

door bearing



1

GEV No.	700495	Ref. No.	72083970
----------------	--------	-----------------	----------

description bolt mounting pos. left for door hinge

For models: AHB, AHC, AHC 18A, AHC 18B, AHC 18C, AHK, MHC 18A, MHC 18B, MHC 18C, MHC 18PA, MHC 18PB, MHC 18PC, MHC 30A, MHC 30B, MHC 30C, MHC 30PA, MHC 30PB, MHC 30PC, MHK - MHC - MHB, P110 GAS, P110 GAS A, P110 GAS B, PC/GAS, RHC 18B, RHC 18C, RHC 18D, RHC 18PB, RHC 18PC, RHC 18PD, RHC 25B, RHC 25C, RHC 25PB, RHC 25PC, RHC 25PD, RHC-25D, RHK - RHC - RHB



1

GEV No.	700494	Ref. No.	72005090
----------------	--------	-----------------	----------

description bush L 69mm mounting pos. left ø 14.5mm ID ø 10mm for door hinge Qty 1 pcs

For models: AHB, AHC, AHC 18A, AHC 18B, AHC 18C, AHK, MHC 18A, MHC 18B, MHC 18C, MHC 18PA, MHC 18PB, MHC 18PC, MHC 30A, MHC 30B, MHC 30C, MHC 30PA, MHC 30PB, MHC 30PC, MHK - MHC - MHB, P110 GAS, P110 GAS A, P110 GAS B, PC/GAS, RHC 18B, RHC 18C, RHC 18D, RHC 18PB, RHC 18PC, RHC 18PD, RHC 25B, RHC 25C, RHC 25PB, RHC 25PC, RHC 25PD, RHC-25D, RHK - RHC - RHB



1

GEV No.	700496	Ref. No.	72005100
----------------	--------	-----------------	----------

description bush mounting pos. right for door hinge

For models: AHB, AHC, AHC 18A, AHC 18B, AHC 18C, AHK, MHC 18A, MHC 18B, MHC 18C, MHC 18PA, MHC 18PB, MHC 18PC, MHC 30A, MHC 30B, MHC 30C, MHC 30PA, MHC 30PB, MHC 30PC, MHK - MHC - MHB, P110 GAS, P110 GAS A, P110 GAS B, PC/GAS, PIZZY DUO 105.105, PIZZY DUO 105.65, PIZZY DUO 65.105, PIZZY MONO 105.105, PIZZY MONO 105.65, PIZZY MONO 65.105



1

GEV No.	690992	Ref. No.	46003060 71000310
----------------	--------	-----------------	----------------------

description door hinge

For models: AHB, AHC, AHK, KRX 4, KRX 44, MHK - MHC - MHB, P110 GAS A, P110 GAS B, PIZZY DUO 105.65, PIZZY DUO 60.60, PIZZY MONO 105.65, PIZZY MONO 60.60, RHK - RHC - RHB



1

GEV No.	514420	Ref. No.	46003070 71000300
----------------	--------	-----------------	----------------------

description door hinge L 76mm W 30mm mounting pos. left thickness 30mm for pizza oven

For models: AHB, AHC, AHK, MHK - MHC - MHB, P110 GAS A, P110 GAS B, PIZZY DUO 105.105, PIZZY DUO 105.65, PIZZY DUO 65.105, PIZZY MONO 105.105, PIZZY MONO 105.65, PIZZY MONO 65.105, RHK - RHC - RHB



gaskets

sealing cords

square



GEV No.	693416	Ref. No.	56400120
description	sealing cord rectangular size 4x4mm L 0.09m Qty 6 motor gasket		
For models:	T75E, T75G, T97E, T97G		

transmission technology and ball bearings

ball bearings

flange bearings



GEV No.	693417	Ref. No.	73801540
description	flange bearing shaft \varnothing 12mm W 38mm 2 hole flange hole distance 48mm H 20mm		
For models:	T75E, T75G, T97E, T97G		

springs

torsion springs



GEV No.	694238	Ref. No.	72500440
description	spring \varnothing mm L2 80mm mounting pos. front wire gauge \varnothing 2mm FI32-FI42-FIP42 L1mm Qty 1 pcs		



GEV No.	694239	Ref. No.	72500320
description	spring \varnothing mm L2 80mm mounting pos. rear wire gauge \varnothing 2mm FI32-FI42-FIP42 L1mm Qty 1 pcs		

compression springs



GEV No.	693422	Ref. No.	72501190
description	compression spring \varnothing 14.8mm L 52mm wire gauge \varnothing 2.8mm		
For models:	T75E, T75G, T97E, T97G		



GEV No.	514417	Ref. No.	72500870
description	compression spring \varnothing 15mm L 40mm wire gauge \varnothing 1.4mm		



GEV No.	514216	Ref. No.	72500860
description	compression spring \varnothing 15mm L 60mm wire gauge \varnothing 1.5mm		

tension springs



GEV No.	700492	Ref. No.	72500670
description	tension spring \varnothing 20mm total length 230mm wire gauge \varnothing 2.8mm L1 125mm L2 55mm L3 50mm pizza oven		
For models:	AHC 18A, AHC 18B, AHC 18C, AHK, MHC 18A, MHC 18B, MHC 18PA, MHC 18PB, MHK - MHC - MHB, PC/GAS, PIZZY DUO 105.105, PIZZY DUO 105.65, PIZZY DUO 65.105, PIZZY MONO 105.105, PIZZY MONO 105.65, PIZZY MONO 65.105, RHC 18B, RHC 18C, RHC 18D, RHC 18PB, RHC 18PC, RHC 18PD, RHC 25B, RHC 25C, RHC 25PB, RHC 25PC, RHC 25PD, RHC-25D, RHK - RHC - RHB		



GEV No.	700493	Ref. No.	72500660
description	tension spring with thread \varnothing 29.8mm total length 230 extendable max. 275mm wire gauge \varnothing 4mm		
For models:	AHC, AHC 18A, AHC 18B, AHC 18C, MHC 18C, MHC 18PC, MHC 30A, MHC 30B, MHC 30C, MHC 30PA, MHC 30PB, MHC 30PC, MHK - MHC - MHB, P110 GAS, P110 GAS A, P110 GAS B, PC/GAS		

measuring equipment

thermometers

built-in thermometers

\varnothing 60mm



GEV No.	541879	Ref. No.	74220250
description	thermometer mounting \varnothing 60mm 0 up to +500°C probe \varnothing 8mm probe L 155mm capillary pipe 1000mm		
For models:	KR 4, KR 44, KR 6, KR 66, KR 66T, KR 6T, KR 9, KR 99, PIZZY DUO 105.105, PIZZY DUO 105.65, PIZZY DUO 60.60, PIZZY DUO 65.105, PIZZY MONO 105.105, PIZZY MONO 105.65, PIZZY MONO 60.60, PIZZY MONO 65.105		



fastening material

fasteners

roll pins



1

GEV No.	691637	Ref. No.	72500920
description	roll pin ø 3mm L 20mm		

C

coil heating elements	6
contactors	11
control equipment	9
control thermostats	7

E

electric accessories	19
espagnolette locks	27

F

fans	17
fasteners	29
fastening material	29

G

gas control valves	19
gas nozzles	21

H

halogen lamp	10
heating elements	3
heating elements for pizza ovens	3
heating elements for pizza presses	6
hot air motors	17

I

ignition boxes	20
indicator lights	10
indicator lights (complete)	10

L

lamps	10
light bulbs	10

M

measuring equipment	28
microswitches	9
motors	18

O

oven lamps	10
------------	----

P

probes	12
--------	----

R

rocker/momentary rocker switches	8
roll pins	29
rotary switches	9

S

safety thermostats	7, 8
sealing cords	28
switches and momentary switches	8

T

terminals	19
thermostats	7
transformers	12