



GAS COMPONENTS



ELECTRIC COMPONENTS



WATER TECHNOLOGY



MECHANICAL COMPONENTS



TOOLS

Spare parts suitable for

MIDDLEBY MARSHALL

Find the complete and up-to-date range of products in our GEV Webshop



Manufacturer catalogue

The most important spare parts and accessories arranged clearly for every manufacturer

- ✓ Complete product range and all appliance data always up to date in the GEV Webshop
- ✓ Alphabetical Index at the end of the catalogue

GEV Webshop

www.gev-online.co.uk

www.gev-online.com



- 🔍 Add to Favourites
- 🔍 Sign In with email address and usual password
- 🔍 Easy-order – place several items in your basket at the same time
- 🔍 Quick Item search – no login needed



switches and momentary switches

rocker/momentary rocker switches

37x21mm



1

GEV No.	348093	Ref. No.	3027A8715
description	rocker switch mounting measurements 37x21mm black 2CO 250V 10A connection male faston 6.3mm ambient temperature max. 125/55°C protection IP55		

microswitches

with push button

switches with snap-fit



1

GEV No.	348120	Ref. No.	63910
description	microswitch with push button 250V 12A 2CO connection male faston 4.8mm L 39.5mm L1 16.5mm ambient temperature max. 85°C type LAMB PP2 actuating force: 350g		



1

GEV No.	348118	Ref. No.	63909
description	microswitch with push button 250V 16A 2CO connection male faston 4.8mm L 39.5mm L1 16.5mm ambient temperature max. 85°C type LAMB PP2 actuating force: 400g		

touch sensitive light switches



1

GEV No.	403589	Ref. No.	50163
description	sensor 1NOVA accessories rangemm L 40mm W 12.6mm H 12.6mm suitable for MIDDLEBY MARSHALL		

control equipment

GENERAL ELECTRIC (AEG)

switches (complete)



1

GEV No.	348119	Ref. No.	46521
description	rotary selector mounting measurements ø22mm complete symbol 1NO		

timers

electric timers



1

GEV No.	360648	Ref. No.	M3172
description	timer 601-16B/2S operation time 2 sec time spreadmin 1NO at 250V 1A permanent position no time rangemin 1A shaft ømm shaftmm shaft Lmm connection male faston 6.3mm ACP 230V voltage AC 50/60Hz		

contactors

LOVATO

power contactors



1

GEV No.	380716	Ref. No.	28041-0011
description	power contactor resistive load 28A 230VAC (AC3/400V) 12A/5.7kW main contacts 3NO auxiliary contacts 1NO connection screw connection type BF1210A230		



SPRECHER+SCHUH

power contactors



1

GEV No.	381362	Ref. No.	44549
description	contactor resistive load 85A 220VAC (AC3/400V) 22kW main contacts 3 auxiliary contacts connection screw type CA7-43-00		

relays

power relays

with bracket mounting



1

GEV No.	381361	Ref. No.	50794
description	relay ET 240 20A 1NO connection male faston 6.3mm raster size 55mm flange dimensions 52x34x26mm at 250V 20A manuf. no. T92S7A22-240 moulded		

solid state relays

CRYDOM



1

GEV No.	403579	Ref. No.	31463
description	solid state relay CRYDOM 1 phase 75A 48-480V 90-280VAC L 58.4mm W 45.7mm screw type HA4875		



1

GEV No.	381294	Ref. No.	59132
description	relay OMRON 24VDC 10A 2CO connection F4.8 bracket mounting manuf. no. LY2F 24DC		



1

GEV No.	403578	Ref. No.	82905
description	solid state relay CRYDOM 1 phase 75A 48-530V 3-32VDC L 58.4mm W 45.7mm screw type HD4875		

time relays

time relays



1

GEV No.	381366	Ref. No.	M6519
description	time relay Relay Service Co. Chi, IL X99KUE5 240VACA 2CO connection male faston 4.8mm mounting measurements 38x35x80mm		



transformers

open transformers

with plug connection



1

GEV No.	403588	Ref. No.	41872
description	transformer primary 115/240VAC secondary 12/24VAC 625VA secondary 2.5A H 60mm L 70mm W 55mm connection male faston 4.8mm 50/60Hz type VPS24-1000		

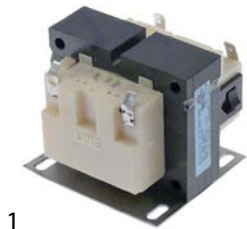

1

GEV No.	403593	Ref. No.	32108
description	transformer primary 240VAC secondary 24VAC 65VA secondary 2.7A H 65mm L 83mm W 76mm connection male faston 6.3mm 50/60Hz type BE222765LEK		



1

GEV No.	403587	Ref. No.	35818
description	transformer primary 250V secondary 12VAC 625VA secondary 2.5A H 60mm L 73mm W 56mm connection male faston 4.8mm 50/60Hz type 1241P2-RF		

power supplies



1

GEV No.	403590	Ref. No.	69533 M9608
description	power supply primary 220-240 secondary 24VDC 156VA secondary 6.5A H 38mm L 200mm W 100mm connection screw 50/60Hz type RS-150-24		

probes

producer-specific probes

probes



1

GEV No.	403592	Ref. No.	33812-1
description	probe cable fabric probe°C cable°C connection male faston 6.3mm thread flange probe cable length 2m MIDDLEBY MARSHALL		



1

GEV No.	403591	Ref. No.	M2282 M3152
description	probe cable fabric probe°C cable°C connection male faston 6.3mm thread probe cable length 2.9m MIDDLEBY MARSHALL		

electronics

PCBs



1

GEV No.	403594	Ref. No.	37503
description	display run-time conveyor oven L 38mm W 58mm suitable for MIDDLEBY MARSHALL cable length 75mm black/red		



1

GEV No.	403586	Ref. No.	64998 67050 67051
description	electronic kit control pizza oven suitable for MIDDLEBY MARSHALL display touchscreen		



fans

axial fans

ebm-papst

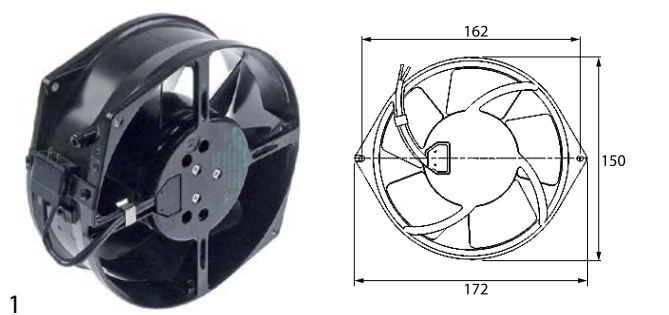

1			
GEV No.	602036	Ref. No.	36451
description	axial fan L 172mm W 150mm H 55mm 230 50/60Hz 45/39W bearing ball bearing connection male faston 2.8mm manuf. no. W2S130-AA03-44 cable lengthmm ebm-papst fan wheel ø 135mm temp.-resist. 70°C airflow 6.3m ³ /h		

import



1			
GEV No.	602037	Ref. No.	M9616
description	axial fan L 119mm W 119mm H 38mm 24VDC 11W bearing manuf. no. 4715KL-05W-B40 connection cable 330mm NMB suitable for MIDDLEBY MARSHALL fan wheel ø 110mm input current 0.46A airflow 3.34m ³ /h		



1			
GEV No.	602038	Ref. No.	M2469
description	axial fan L 120mm W 120mm H 38mm 115VAC 50/60Hz 20W bearing ball bearing manuf. no. SP101A-1123HBT.GN connection male faston 2.8mm cable lengthmm SUNON suitable for MIDDLEBY MARSHALL fan wheel ø 110mm input current 0.21A housing cast aluminum airflow 147m ³ /h		

fuses

fine fuses

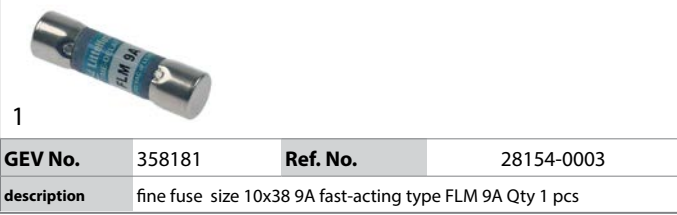

1			
GEV No.	358181	Ref. No.	28154-0003
description	fine fuse size 10x38 9A fast-acting type FLM 9A Qty 1 pcs		

gas taps

AB



1			
GEV No.	107924	Ref. No.	N/A
description	gas tap AB type ATS11 gas outlet 7/16"-24 UNS		

gas valves and ignition boxes

ignition boxes



1			
GEV No.	107756	Ref. No.	62285
description	ignition box FENWAL type 35-605313-111 electrodes 1 waiting time 15s safety time 4s 24V 0.83Hz		



1			
GEV No.	107755	Ref. No.	62341
description	ignition box FENWAL type 35-630201-005 electrodes 1 waiting time 0s 24V 0.83Hz		



safety valves

BASO



1			
GEV No.	107757	Ref. No.	52291 59465
description	gas valve pipes pressure range 50mbar gas inlet 1/2" gas outlet 1/2" pilot connection thermocouple connection type G960BBADGA-1 suitable for MIDDLEBY MARSHALL		

electrodes



1			
GEV No.	104664	Ref. No.	62288
description	ignition electrode kit flange length 48mm flange width 23mm D1 ø 9,5mm L1 32mm BL1 19mm BL2 20mm flange connection ø 6mm		

ignition parts

pilot burners

producer-specific pilot burners

MIDDLEBY MARSHALL



1			
GEV No.	107754	Ref. No.	M10593
description	pilot burner MIDDLEBY MARSHALL type W1025 3 natural/liquid gas nozzle ø 14mm gas connection 1/4"mm set bore ø 2.6mm		



1			
GEV No.	107758	Ref. No.	M6397
description	pilot burner MIDDLEBY MARSHALL type W1042 3 natural/liquid gas nozzle ø 14mm gas connection 1/4"mm set bore ø 2.6mm		

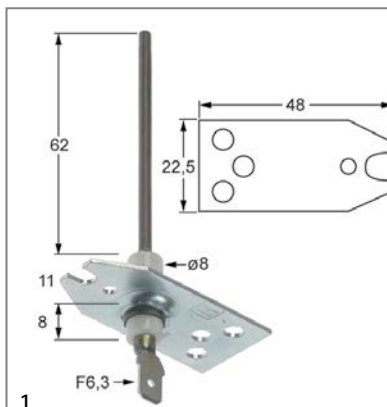

1			
GEV No.	109120	Ref. No.	45771
description	monitoring electrode flange length 48mm D1 ø 8mm flange width 22.5mm L1 62mm BL1 11mm BL2 8mm connection male faston 6.3mm		

ignition cables

various



1			
GEV No.	103253	Ref. No.	50240
description	ignition cable cable length 650mm connection ø6.3mm Qty 1m 1.5mm ² ED ø 7mm insulation silicone conductor 1 black t.max. 220°C <10hm		

thermocouples

producer-specific thermocouples



1			
GEV No.	381367	Ref. No.	33984
description	thermocouple MIDDLEBY MARSHALL suitable for conveyor oven complete auxiliary equipment L 170mm		

1 

GEV No.	381368	Ref. No.	33985
description	thermocouple MIDDLEBY MARSHALL suitable for conveyor oven complete auxiliary equipment L 360mm		

1 

GEV No.	698651	Ref. No.	34128
description	sprocket-wheel DIN/ISO splitting 25-1 teeth 20 shaft intake ø 8mm rollerø 32mm ø 43.7mm tooth width 2.7mm hub ø 32mm metal W 16mm for transport system		

equipment-specific units for milk foamers

1 

GEV No.	527373	Ref. No.	22450-0297
description	silicone hose ID ø 5mm ED ø 8mm L 115mm		

for pizza ovens

miscellaneous

1 

GEV No.	698654	Ref. No.	51077
description	V-belt pulley set disc ø 95mm shaft intake ø 40mm groove depth 12.5mm disc width 20mm groove width 11.5mm overall width 22.3mm metal MIDDLEBY MARSHALL H 22mm with poly-V-belt shaft ø 40mm		

for conveyor oven

miscellaneous

1 

GEV No.	694811	Ref. No.	30830
description	cover hinge camp angled L 267x64mm SS		

1 

GEV No.	694814	Ref. No.	50224
description	V-ripped belt pulley grooves 6 disc ø 45mm shaft intake ø 15.8mm disc width 30mm groove depth 1mm groove width 1.2mm overall width 30mm metal MIDDLEBY MARSHALL shaft ø 15mm		

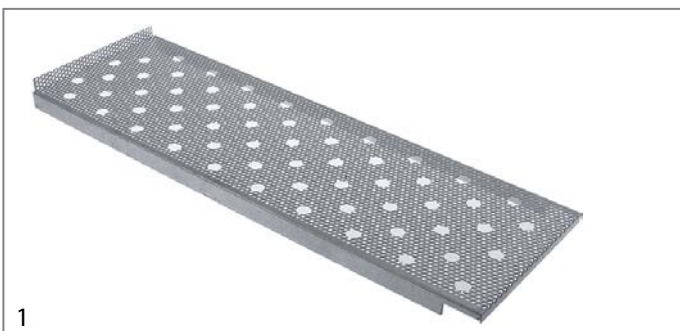
1 

GEV No.	694817	Ref. No.	42679
description	cover perforated mounting pos. control L 520x170mm SS		

transmission technology and ball bearings

ball bearings

flange bearings

1 

GEV No.	523053	Ref. No.	22072-0025 64106
description	ball bearing type P2B-SCAH-010 shaft ø 15.7mm W 31mm L 127mm hole distance 96mm		



drive belts

high-performance V-belts, cogged

1 

GEV No.	691635	Ref. No.	34259
description	V-belt belt width 13mm L 1655mm H 8mm CODE AX63 profile AX/X13		

toothed belts

1 

GEV No.	698646	Ref. No.	50584
description	toothed belt profile AX62 L 1574mm H 9mm teeth 256 splitting 5-3 rubber with textile insertion CODE 9012-2062 W 12mm		

1 

GEV No.	698649	Ref. No.	44685
description	toothed belt profile L L 450mm H 3mm teeth 46 splitting 4-6 rubber with textile insertion CODE 173L W 12mm		

1 

GEV No.	698645	Ref. No.	BL/M10572
description	toothed belt profile XL L 400mm H 2mm teeth 85 splitting 2-3 rubber with textile insertion CODE L13-4 W 9mm		

poly-v belts

1 

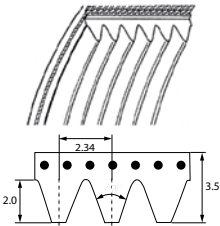

GEV No.	692604	Ref. No.	59668
description	poly-v belt grooves 6 W 14mm L 560mm profile J		

hoses

industrial hoses

silicone hoses

without fabric

1 

GEV No.	527373	Ref. No.	22450-0297
description	silicone hose ID ø 5mm ED ø 8mm L 115mm		

fastening material

screws

countersunk screws

1 

GEV No.	692603	Ref. No.	M1118
description	countersunk screw thread 1/4" UNC L 15mm SS head ø 11.6mm ø 6.14mm		

A

axial fans 6

C

contactors 3

control equipment 3

countersunk screws 9

E

electric timers 3

F

fans 6

fastening material 9

fuses 6

G

gas taps 6

H

hoses 9

I

ignition boxes 6

ignition cables 7

industrial hoses 9

M

microswitches 3

P

pilot burners 7

probes 5

R

relays 4

rocker/momentary rocker switches 3

S

safety valves 7

screws 9

silicone hoses 9

solid state relays 4

switches and momentary switches 3

T

thermocouples 7

time relays 4

timers 3

touch sensitive light switches 3

transformers 5