



**GAS COMPONENTS**



**ELECTRIC COMPONENTS**



**WATER TECHNOLOGY**



**MECHANICAL COMPONENTS**



**TOOLS**

Spare parts suitable for

**METRO-PROFESSIONAL**

Find the complete and up-to-date range of products in our GEV Webshop



# Manufacturer catalogue

The most important spare parts and accessories arranged clearly for every manufacturer

- ✓ Complete product range and all appliance data always up to date in the GEV Webshop
- ✓ Alphabetical Index at the end of the catalogue

## GEV Webshop

[www.gev-online.co.uk](http://www.gev-online.co.uk)

[www.gev-online.com](http://www.gev-online.com)



- 🔍 Add to Favourites
- 🔍 Sign In with email address and usual password
- 🔍 Easy-order – place several items in your basket at the same time
- 🔍 Quick Item search – no login needed



## induction

### induction coils



1

<b>GEV No.</b>	404010	<b>Ref. No.</b>	AD100087
<b>description</b>	induction coils ø 220mm H 10mm		
<b>For models:</b>	GIC3035		

## heating elements

### heating elements for ovens

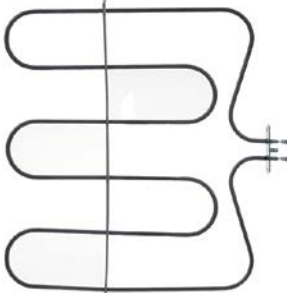

1

<b>GEV No.</b>	416969	<b>Ref. No.</b>	01203250
<b>description</b>	heating element 1400W 230V heating circuits 1 L 370mm W 400mm L1 45mm L2 325mm W1 184mm W2 30mm flange length 70mm flange width 22mm hole distance 46mm bridge length 420mm hole ø 5mm tube ø 6.3mm connection male faston 6.3mm windings 3 rectangular flange dry heating element		
<b>For models:</b>	GCO2001		
<b>accessories for</b>	416969		
	<b>GEV No.</b>	510368	<b>Ref. No.</b> —
	gasket L 70mm W 23.5mm hole ø 5mm hole distance 56mm FIBER thickness 2mm for heating element		

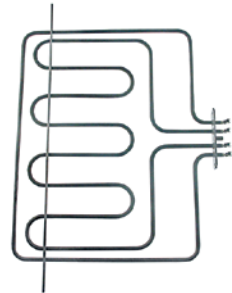

1

<b>GEV No.</b>	416970	<b>Ref. No.</b>	01203240
<b>description</b>	heating element 2800W 230V heating circuits 2 L 323mm W 393mm L1 30mm L2 293mm W1 166mm W2 61mm flange length 100mm flange width 22mm hole distance 76mm bridge length 485mm hole ø 5mm tube ø 6.3mm connection male faston 6.3mm rectangular flange dry heating element		
<b>For models:</b>	GCO2001		
<b>accessories for</b>	416970		
	<b>GEV No.</b>	528090	<b>Ref. No.</b> 01000160
	gasket L 100mm W 22mm thickness 1mm		

## heating elements for fryers

### 2 hole fixing

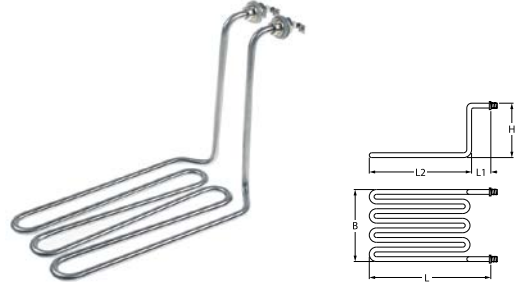

1

<b>GEV No.</b>	417598	<b>Ref. No.</b>	1.07.HDF4140403
<b>description</b>	heating element 2500W 230V heating circuits 1 L 290mm W 130mm H 200mm L1 40mm L2 230mm tube ø 8mm		
<b>For models:</b>	GDF3004, GDF3024		

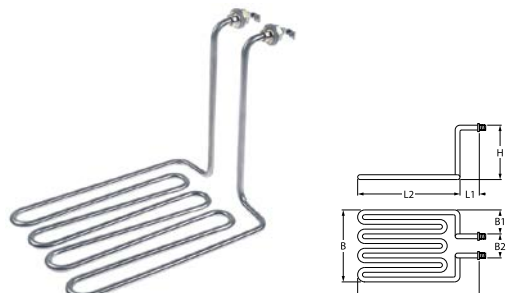

1

<b>GEV No.</b>	417599	<b>Ref. No.</b>	1.07.HDF8141903
<b>description</b>	heating element 3250W 230V heating circuits 1 thread M12x1.25 L 280mm W 190mm H 210mm L1 35mm L2 245mm W1 120mm W2 70mm tube ø 8mm connection M4		
<b>For models:</b>	GDF3008, GDF3028, GDF5008, GDF5028		

## heating elements for griddles



1

<b>GEV No.</b>	419177	<b>Ref. No.</b>	D02169
<b>description</b>	heating element 1750W 230V heating circuits 1 L 255mm W 240mm H 60mm tube ø 6.3mm cable length 600mm bain marie connection distance 234mm dry heating element		
<b>For models:</b>	GEG2001		



## heating elements for hot dog machines

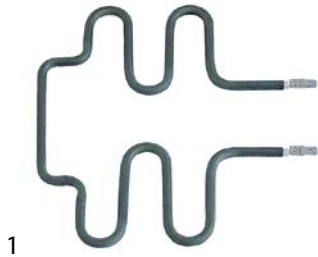

1

<b>GEV No.</b>	416718	<b>Ref. No.</b>	D02002
<b>description</b>	heating element 300W 230V L 170mm W 198mm tube $\phi$ 6.3mm L1 50mm L2 120mm W1 68mm W2 62mm connection male faston 6.3mm connection distance 56mm dry heating element heating circuits 1 hot dog machine		
<b>For models:</b>	GHM1001		

## heating cables

## miscellaneous



1

<b>GEV No.</b>	417745	<b>Ref. No.</b>	W0310067
<b>description</b>	heating cable 600W L 1100mm silicone connection plug GFR2700		
<b>For models:</b>	GFR2700		

## quartz heating elements



1

<b>GEV No.</b>	420089	<b>Ref. No.</b>	D04034	
<b>description</b>	quartz heating element 600W 115V L 365mm $\phi$ 11mm connection male faston 6.3mm			
<b>For models:</b>	GTO1001, GTO2001			
<b>accessories for</b>	420089			
	<b>GEV No.</b>	551108	<b>Ref. No.</b>	B07025
	spring clip stainless steel for quartz heating element L 39mm W 25mm H 13.5mm bore $\phi$ 10mm			

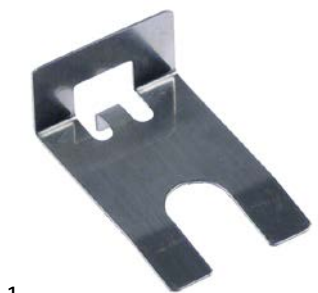



1

<b>GEV No.</b>	551108	<b>Ref. No.</b>	B07025
<b>description</b>	spring clip stainless steel for quartz heating element L 39mm W 25mm H 13.5mm bore $\phi$ 10mm		
<b>For models:</b>	GTO1001, GTO2001		

## immersion heating elements





3 hole flange  $\phi$ 38.5mm

1

<b>GEV No.</b>	416267	<b>Ref. No.</b>	905560	
<b>description</b>	heating element 4500W 230V mounting $\phi$ 38.5mm heating circuits 3 L 358mm W 32mm H 58mm L1 36mm L2 72mm L3 250mm H1 28mm H2 30mm hole distance 57mm hole $\phi$ 10mm tube $\phi$ 6.3mm connection male faston 6.3mm immersion heater 3 hole flange			
<b>For models:</b>	GDW2001			
<b>spare parts for</b>	416267			
	<b>GEV No.</b>	521120	<b>Ref. No.</b>	907981
	O-ring EPDM thickness 5.34mm ID $\phi$ 37.47mm Qty 1 pcs			
<b>accessories for</b>	416267			
	<b>GEV No.</b>	532577	<b>Ref. No.</b>	—
	O-ring EPDM thickness 5.34mm ID $\phi$ 40.65mm Qty 1 pcs			



1

<b>GEV No.</b>	416260	<b>Ref. No.</b>	905745	
<b>description</b>	heating element 2500W 230V heating circuits 1 L 357mm W 34mm H 39mm H1 4mm H2 35mm thread M10x1 mounting distance 28mm tube $\phi$ 6.3mm connection male faston 6.3mm 2 hole fixing immersion heater connection length 25mm			
<b>For models:</b>	GDW2001			
<b>accessories for</b>	416260			
	<b>GEV No.</b>	510416	<b>Ref. No.</b>	—
	flat gasket fibre ED $\phi$ 19mm ID $\phi$ 10.5mm thickness 1.5mm for thread M10 Qty 1 pcs			
	<b>GEV No.</b>	510893	<b>Ref. No.</b>	—
	O-ring EPDM thickness 2.62mm ID $\phi$ 9.92mm Qty 1 pcs			
	<b>GEV No.</b>	520231	<b>Ref. No.</b>	—
	nut thread M10x1 H 6mm WS 14 zinc-coated steel Qty 1 pcs			
	<b>GEV No.</b>	521129	<b>Ref. No.</b>	—
	nut thread M10 H 6mm SS WS 17 Qty 1 pcs DIN/ISO DIN 439			







heating elements for convection



1

<b>GEV No.</b>	418044	<b>Ref. No.</b>	01203260
<b>description</b>	heating element 2500W 230V heating circuits 1 ID ø 180mm ED ø 192mm L 245mm H 28mm L1 45mm W1 30mm H1 3mm H2 25mm flange length 70mm flange width 22mm hole distance 56mm connection male faston 6.3mm tube ø 6.3mm convection heating element hole ø 5mm rectangular flange		
<b>For models:</b>	GCO2001		
<b>accessories for</b>	418044		
	<b>GEV No.</b>	<b>Ref. No.</b>	<b>01000140</b>
	gasket L 71mm W 21mm hole ø 5mm hole distance 57mm fibre thickness 1mm for heating element		



1

<b>GEV No.</b>	419243	<b>Ref. No.</b>	RES30033
<b>description</b>	heating element 2700W 230V heating circuits 1 ID ø 180mm ED ø 193mm L 208mm H 30mm L1 8mm W1 30mm H1 7mm H2 23mm flange length 70 no to be sold in Francemm flange width 22mm hole distance 56mm connection male faston 6.3mm tube ø 6.3mm convection heating element hole ø 5mm rectangular flange 70 x 22mm with screws		
<b>For models:</b>	GCO500		
<b>spare parts for</b>	419243		
	<b>GEV No.</b>	<b>Ref. No.</b>	—
	sheet metal screws ø 3.9mm L 9.5mm SS Qty 20 pcs DIN 7981/ISO 7049 head ø 7.5mm oval head		

foil heating elements



1

<b>GEV No.</b>	419256	<b>Ref. No.</b>	W0310080
<b>description</b>	foil heating element L 520mm W 220mm 61W 220V cable length 400mm connection plug GFR2700		
<b>For models:</b>	GFR2700		

accessories

various



1

<b>GEV No.</b>	551108	<b>Ref. No.</b>	B07025
<b>description</b>	spring clip stainless steel for quartz heating element L 39mm W 25mm H 13.5mm bore ø 10mm		
<b>For models:</b>	GTO1001, GTO2001		

sealing washers

O-rings

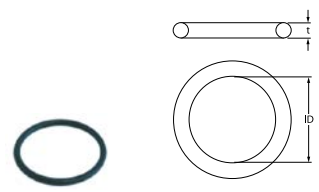

1

<b>GEV No.</b>	521120	<b>Ref. No.</b>	907981
<b>description</b>	O-ring EPDM thickness 5.34mm ID ø 37.47mm Qty 1 pcs		
<b>For models:</b>	GDW2001		

flange gaskets



1

<b>GEV No.</b>	528090	<b>Ref. No.</b>	01000160
<b>description</b>	gasket L 100mm W 22mm thickness 1mm		
<b>For models:</b>	GCO2001		



1

<b>GEV No.</b>	550937	<b>Ref. No.</b>	01000140
<b>description</b>	gasket L 71mm W 21mm hole ø 5mm hole distance 57mm fibre thickness 1mm for heating element		
<b>For models:</b>	GCO2001		

thermostats

bi-metal thermostats

safety bi-metal thermostats



1

<b>GEV No.</b>	390717	<b>Ref. No.</b>	907297
<b>description</b>	bi-metal safety thermostat hole distance 23.8mm switch-off temp. 110°C 1NC 1-pole 16A 250V connection F6.3 2 hole fixing mounting ø 18.3mm		
<b>For models:</b>	GDW2001		



bi-metal thermostats



1

<b>GEV No.</b>	390869	<b>Ref. No.</b>	253099000143
<b>description</b>	bi-metal thermostat hole distance 23.5mm switch-off temp. 140°C 1NC 1-pole 10A 250V connection F4.8 Qty 1 pcs		
<b>For models:</b>	GMW1025		



1

<b>GEV No.</b>	390634	<b>Ref. No.</b>	TER30002
<b>description</b>	bi-metal thermostat hole distance 23.5mm switch-off temp. 145°C 1NC 1-pole 16A 250V connection F6.3 2 hole fixing		
<b>For models:</b>	GCO500		



1

<b>GEV No.</b>	390867	<b>Ref. No.</b>	253099000224
<b>description</b>	bi-metal thermostat hole distance 23.5mm switch-off temp. 180°C 1NC 1-pole 10A 250V connection F4.8 Qty 1 pcs		
<b>For models:</b>	GMW1025		





1

<b>GEV No.</b>	390763	<b>Ref. No.</b>	907244
<b>description</b>	bi-metal thermostat hole distance 23.8mm switch-off temp. 55°C 1NC 1-pole 16A 250V connection F6.3 2 hole fixing for tank		
<b>For models:</b>	GDW2001		

control and safety thermostats

EGO  
control thermostats

55.17\_ series

1

<b>GEV No.</b>	371320	<b>Ref. No.</b>	A06032
<b>description</b>	thermostat t.max. 280°C temperature range 30-280°C 1-pole 1NO 16A probe ø 3mm probe L 170mm capillary pipe 860mm capillary pipe isolatedmm gland nut shaft L 14mm shaft position upper rotation 270°		
<b>For models:</b>	GEG2001		



1

<b>GEV No.</b>	391048	<b>Ref. No.</b>	TER30016
<b>description</b>	thermostat t.max. 292°C 1-pole 1NO probe ø 3mm probe L 182mm shaft ø 6x4.6mm shaft L 23mm shaft position upper° rotation 270° probe material SS with mounting accessories		
<b>For models:</b>	GCO500		

safety thermostats  
55.32\_ series



1

<b>GEV No.</b>	390999	<b>Ref. No.</b>	01202690
<b>description</b>	safety thermostat switch-off temp. 350°C temperature range°C 2-pole NC 20A probe ø 3mm probe L 187mm capillary pipe 690mm capillary pipe isolated 680mm gland nut shaft ømm probe SS		
<b>For models:</b>	GCO2001		



IMIT / TEMPOMATIC / ARTHERMO

control thermostats



<b>GEV No.</b>	390683	<b>Ref. No.</b>	TR0440
<b>description</b>	thermostat t.max. 86°C temperature range 0-86°C 1-pole 1CO 16A probe ø 6.5mm probe L 98mm capillary pipe 1000mm capillary pipe isolated 960mm gland nut shaft ø 6x4.6mm shaft L 20mm shaft position +135° rotation 270° probe material copper		
<b>For models:</b>	GDW2001		
<b>accessories for</b>	390683		
	<b>GEV No.</b>	110100	<b>Ref. No.</b> 903982
	knob thermostat t.max. 90°C 0-90°C ø 42mm shaft ø 6x4.6mm shaft flat -135° black		

TECASA

control thermostats

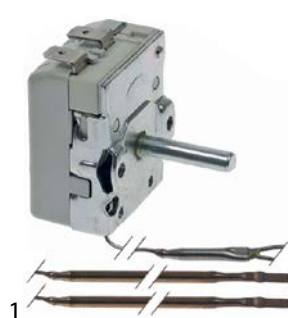

<b>GEV No.</b>	376091	<b>Ref. No.</b>	01201220
<b>description</b>	thermostat t.max. 328°C temperature range 57-328°C 1-pole 1NO 16A probe ø 3mm probe L 98mm capillary pipe 1540mm capillary pipe isolated 1500mm gland nut shaft ø 6x4.6mm shaft L 21mm rotation 270° outer switch probe thread disc ømm		
<b>For models:</b>	GCO2001		

various

control thermostats



<b>GEV No.</b>	390871	<b>Ref. No.</b>	1.1.A.A06.02
<b>description</b>	thermostat t.max. 95°C temperature range 0-95°C 1-pole 1NO 6A probe ø 6mm probe L 95mm capillary pipe 550mm capillary pipe isolated 490mm gland nut shaft ø 6x4mm shaft L 23mm shaft position 45° rotation 270° probe material zinc-coated steel 250V contacts male faston 4.8mm Qty 1 pcs		
<b>For models:</b>	GGC1078, GGC1078B		

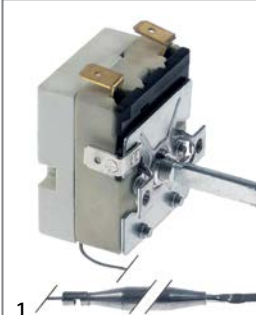

<b>GEV No.</b>	390968	<b>Ref. No.</b>	1.06.1851713
<b>description</b>	thermostatcontroller t.max. 185°C temperature range°C 2-pole 1NO 16A probe ø 6mm probe L 77mm capillary pipe 1500mm capillary pipe isolated 1500mm gland nut shaft ø 6x4.6mm shaft L 25mm shaft position upper rotation 270° probe material SS		
<b>For models:</b>	GDF3004, GDF3008, GDF3024, GDF3028, GDF5008, GDF5028		

safety thermostats



<b>GEV No.</b>	390970	<b>Ref. No.</b>	1.06.230171301
<b>description</b>	safety thermostat switch-off temp. 230°C 2-pole 1NC 16A probe ø 5mm probe L 48mm capillary pipe 440mm capillary pipe isolated 150mm gland nut probe 250V model WQS-230		
<b>For models:</b>	GDF3004, GDF3008, GDF3024, GDF3028, GDF5008, GDF5028		

refrigeration thermostats

universal with housing



<b>GEV No.</b>	698867	<b>Ref. No.</b>	GPC1046-09
<b>description</b>	thermostat probe capillary pipe 650mm 1NO threaded type WPF17C-L2		
<b>For models:</b>	GPC1046		



## switches and momentary switches

## rocker/momentary rocker switches

30x22mm



<b>GEV No.</b>	347791	<b>Ref. No.</b>	1.1.A.A07.10 205426 A07034 E2301GR00001 S900.01 W0308019
<b>description</b>	rocker switch mounting measurements 30x22mm green 2NO 230V 20A illuminated 0-I connection male faston 6.3mm ambient temperature max. 125/55°C protection IP65 with rubber collar		
<b>For models:</b>	GCV1600, GDS2600, GFR2700, GHM1001, GHS1600, GHS2600, GJU1001, GPS2600, GRE2700, GSA2600, GSD2600, GSF2600		

ø20mm



<b>GEV No.</b>	347803	<b>Ref. No.</b>	DQKA0000
<b>description</b>	rocker switch mounting measurements 20mm red 1NO 250V 15A 0-I connection male faston 4.8mm ambient temperature max. 85°C protection IP40		
<b>For models:</b>	GSC1100G, GSC2336		

## push/momentary push switches

30x22mm



<b>GEV No.</b>	345712	<b>Ref. No.</b>	00000700296
<b>description</b>	push switch mounting measurements 30x22mm red/green 2CO 250V 16A Stop / I connection male faston 6.3mm ambient temperature max. 85°C protection IP40 with indicator		
<b>For models:</b>	GFS1022, GFS1025, GFS1030, GFS2019, GFS2022, GFS2025, GFS2030		
<b>accessories for</b>	345712		
	<b>GEV No.</b>	301127	<b>Ref. No.</b> 00000000285
protective cover internal size 30x55mm transparent			

ø22mm



<b>GEV No.</b>	301127	<b>Ref. No.</b>	00000000285
<b>description</b>	protective cover internal size 30x55mm transparent		
<b>For models:</b>	GFS1022, GFS1025, GFS1030, GFS2019, GFS2025, GFS2030		

## accessories

## push buttons



<b>GEV No.</b>	348239	<b>Ref. No.</b>	905346
<b>description</b>	push button for dishwasher shaft 3.7x3.7mm blue ED ø 21mm ID ø 19mm		
<b>For models:</b>	GDW2001		

## element holders



<b>GEV No.</b>	348240	<b>Ref. No.</b>	905341
<b>description</b>	element holder ø 23.5mm ID ø 21.5mm silver		
<b>For models:</b>	GDW2001		

## microswitches

## pin-plunger actuated



<b>GEV No.</b>	347799	<b>Ref. No.</b>	253039000003
<b>description</b>	microswitch with plunger 250V 15A 1CO connection male faston 4.8mm ambient temperature max. 105°C mounting distance 22mm type W-15-102C actuating force: 180g white		
<b>For models:</b>	GMW1025		

## miscellaneous



<b>GEV No.</b>	347560	<b>Ref. No.</b>	00000000304
<b>description</b>	microswitch with plunger mounting distance 22mm thread M10 thread L 14mm 250V 12A 1NO connection male faston 6.3mm stroke 3.5mm ambient temperature max. 125°C type VRSR03AA1 actuating force: 135g		
<b>For models:</b>	GFS1025		



with push button

switches with snap-fit



1			
<b>GEV No.</b>	348227	<b>Ref. No.</b>	W0308012
<b>description</b>	microswitch 250V 0.5A connection male faston 2.8mm for fridge GFR2700/GRE2700		
<b>For models:</b>	GFR2700, GRE2700		



1			
<b>GEV No.</b>	348192	<b>Ref. No.</b>	I0202070
<b>description</b>	microswitch with push button 250VA 1NO connection male faston 6.3mm L 26x12mm ambient temperature max. 85°C actuating force: 500g		
<b>For models:</b>	GRE3600, GRE3600S		

position switches

METRO



1			
<b>GEV No.</b>	348088	<b>Ref. No.</b>	1.05.035011HDFMS116
<b>description</b>	microswitch 1NO 250V 16A L 41mm W 12mm H 44mm actuating force: 250g		
<b>For models:</b>	GDF3004, GDF3008, GDF3024, GDF3028, GDF5008, GDF5028		

system switches (ROLD)



1			
<b>GEV No.</b>	301104	<b>Ref. No.</b>	905312
<b>description</b>	momentary switch unit 1NO 250V 16A connection male faston 6.3mm		
<b>For models:</b>	GDW2001		



1			
<b>GEV No.</b>	348239	<b>Ref. No.</b>	905346
<b>description</b>	push button for dishwasher shaft 3.7x3.7mm blue ED ø 21mm ID ø 19mm		
<b>For models:</b>	GDW2001		



1			
<b>GEV No.</b>	345651	<b>Ref. No.</b>	905314
<b>description</b>	switch 2CO 250V 16A connection male faston 6.3mm		
<b>For models:</b>	GDW2001		



1			
<b>GEV No.</b>	348238	<b>Ref. No.</b>	905447
<b>description</b>	switch 2NO 250V 16A connection male faston 6.3mm type SA		
<b>For models:</b>	GDW2001		

cam switches

4-position

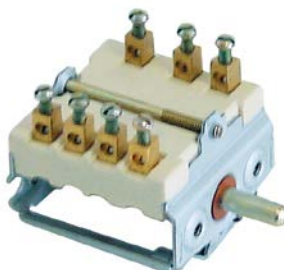

1			
<b>GEV No.</b>	300094	<b>Ref. No.</b>	A01001
<b>description</b>	cam switch 4 operating positions 1NO/2CO sequence 0-1-2-3 16A shaft ø 6x4.6mm shaft L 15mm connection screw 4-position ceramic		
<b>For models:</b>	GEG2001		





4 operating positions



<b>GEV No.</b>	347101	<b>Ref. No.</b>	A01017
<b>description</b>	cam switch 4 operating positions 1NO/1CO sequence 0-1-2-3 13A shaft $\varnothing$ 6x4.6mm shaft L 23mm connection male faston 6.3mm plastic		
<b>For models:</b>	GTO1001, GTO2001		

10 operating positions



<b>GEV No.</b>	301205	<b>Ref. No.</b>	01200040
<b>description</b>	cam switch 10 operating positions 5NO/1CO sequence 0-1-2-3-4-5-6-7-8-9 16A shaft $\varnothing$ 6x4.6mm shaft L 23mm connection male faston 6.3mm ceramic		
<b>For models:</b>	GCO2001		

magnetic switches

37x16mm

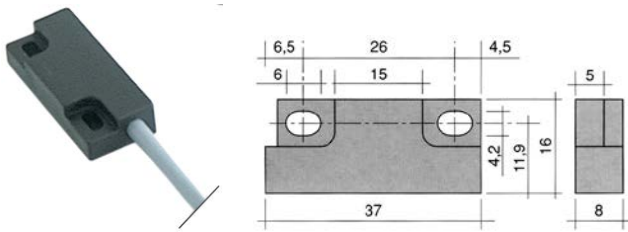

<b>GEV No.</b>	345341	<b>Ref. No.</b>	909290
<b>description</b>	magnetic switch L 37mm W 16mm 1NO 250V 0.04A P max. 10W connection cable length 1960mm		
<b>For models:</b>	GDW2001		

accessories

magnets

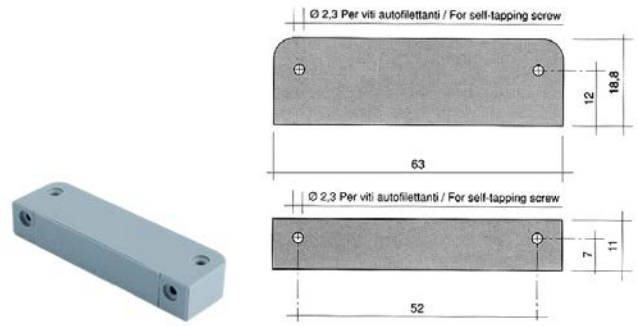

<b>GEV No.</b>	519049	<b>Ref. No.</b>	903651
<b>description</b>	magnet $\varnothing$ 8mm L 63mm H 10.7mm W 18.8mm hole distance 52mm M2 hole $\varnothing$ 2mm		
<b>For models:</b>	GDW2001		
<b>accessories for</b>	519049		
	<b>GEV No.</b>	560095	<b>Ref. No.</b> —
	sheet metal screws $\varnothing$ 2.9mm L 9.5mm SS Qty 20 pcs DIN 7981/ISO 7049 head $\varnothing$ 5.6mm oval head		

lamps

indicator lights

indicator lights 2-piece (lens and indicator lamp)

indicator light lenses

$\varnothing$  8mm (type RL-2)









<b>GEV No.</b>	359819	<b>Ref. No.</b>	00002360
<b>description</b>	indicator light lens green Qty 1 pcs $\varnothing$ 8mm		
<b>For models:</b>	GCO2001		





<b>GEV No.</b>	359820	<b>Ref. No.</b>	00002350
<b>description</b>	indicator light lens yellow Qty 1 pcs $\varnothing$ 8mm		
<b>For models:</b>	GCO2001		





indicator lamps for socket type RL			
 <p>1</p>			
<b>GEV No.</b>	359818	<b>Ref. No.</b>	01200330 IND30009
<b>description</b>	indicator light 230V clear connection male faston 6.3mm		
<b>For models:</b>	GCO2001, GCO500		
<b>accessories for</b>	359818		
	<b>GEV No.</b>	359820	<b>Ref. No.</b> 00002350
indicator light lens yellow Qty 1 pcs ø 8mm			
	<b>GEV No.</b>	359833	<b>Ref. No.</b> —
indicator light lens red Qty 1 pcs ø 8mm			
	<b>GEV No.</b>	359948	<b>Ref. No.</b> —
indicator light lens clear Qty 1 pcs ø 8mm			

 <p>1</p>			
<b>GEV No.</b>	359817	<b>Ref. No.</b>	01200340
<b>description</b>	indicator light 230V green connection male faston 6.3mm		
<b>For models:</b>	GCO2001		
<b>accessories for</b>	359817		
	<b>GEV No.</b>	359819	<b>Ref. No.</b> 00002360
indicator light lens green Qty 1 pcs ø 8mm			

indicator lights (complete)			
ø 6mm			
 <p>1</p>			
<b>GEV No.</b>	359005	<b>Ref. No.</b>	903644
<b>description</b>	indicator light ø 6mm 230V yellow cable length 400mm		
<b>For models:</b>	GDW2001		

ø 9mm			
 <p>1</p>			
<b>GEV No.</b>	360766	<b>Ref. No.</b>	903688
<b>description</b>	indicator light ø 8.5mm green 250V connection male faston 6.3mm cable length 270mm temp.-resist. 120°C		
<b>For models:</b>	GDW2001		

 <p>1</p>			
<b>GEV No.</b>	360765	<b>Ref. No.</b>	903686
<b>description</b>	indicator light ø 8.5mm yellow 250V connection male faston 6.3mm cable length 260/400mm temp.-resist. 90°C		
<b>For models:</b>	GDW2001		

 <p>1</p>			
<b>GEV No.</b>	360767	<b>Ref. No.</b>	903685
<b>description</b>	indicator light ø 8.5mm yellow 250V connection male faston 6.3mm cable length 260mm temp.-resist. 120°C		
<b>For models:</b>	GDW2001		

ø12mm  
with plug-in socket

 <p>1</p>			
<b>GEV No.</b>	359041	<b>Ref. No.</b>	A08009
<b>description</b>	indicator light ø 12mm green 230V connection male faston 6.3mm temp.-resist. 120°C Qty 1 pcs		
<b>For models:</b>	GEG2001		

 <p>1</p>			
<b>GEV No.</b>	359042	<b>Ref. No.</b>	A08003
<b>description</b>	indicator light ø 12mm yellow 230V connection male faston 6.3mm temp.-resist. 120°C Qty 1 pcs		
<b>For models:</b>	GEG2001, GTO1001, GTO2001		

ø14mm  
with screw socket

 <p>1</p>			
<b>GEV No.</b>	360622	<b>Ref. No.</b>	1.03.00020013
<b>description</b>	indicator light ø 14mm green 220V connection male faston 4.8mm plastic		
<b>For models:</b>	GDF3004, GDF3008, GDF3024, GDF3028, GDF5008, GDF5028		

 <p>1</p>			
<b>GEV No.</b>	360621	<b>Ref. No.</b>	1.03.00020017
<b>description</b>	indicator light ø 14mm yellow 220V connection male faston 4.8mm plastic		
<b>For models:</b>	GDF3004, GDF3008, GDF3024, GDF3028, GDF5008, GDF5028		

LED

LED bars

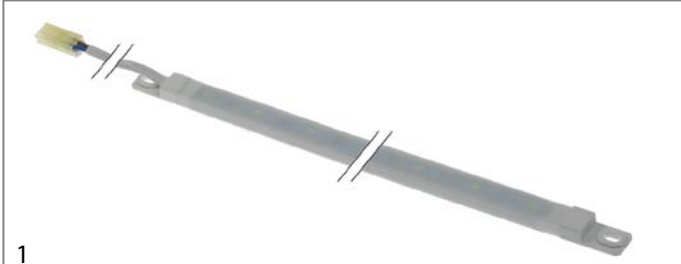

1	<b>GEV No.</b>	357257	<b>Ref. No.</b>	DQLED007
	<b>description</b>	LED bar L 1100mm W 14.4mm H 7.5mm 24VDC white number of lamps 36 cable length 120mm		
	<b>For models:</b>	GSC2336		

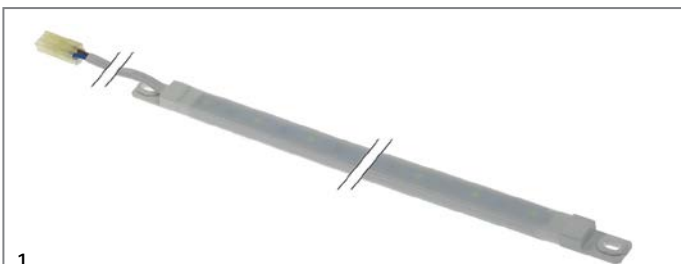

1	<b>GEV No.</b>	357256	<b>Ref. No.</b>	DQLED008
	<b>description</b>	LED bar L 1200mm W 14.4mm H 7.5mm 24VDC white number of lamps 42 cable length 120mm		
	<b>For models:</b>	GSC1100G		

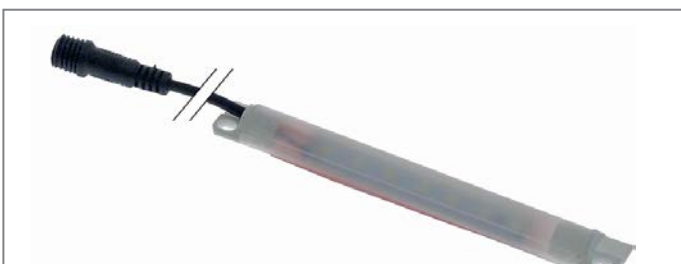

1	<b>GEV No.</b>	357260	<b>Ref. No.</b>	W0304086 W0304511	
	<b>description</b>	LED bar L 130mm W 14mm H 8mm cable length 300mm GFR2700/GRE2700			
	<b>For models:</b>	GFR2700, GRE2700			
	<b>accessories for</b>	357260			
		<b>GEV No.</b>	692879	<b>Ref. No.</b>	W0409863
		cover for lamp L 185mm W 55mm H 40mm for GFR2700/GRE2700			

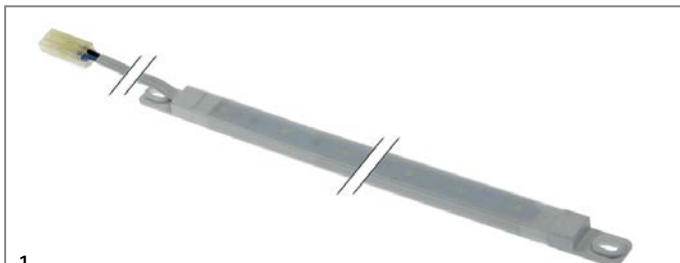

1	<b>GEV No.</b>	357255	<b>Ref. No.</b>	DQLED011
	<b>description</b>	LED bar L 370mm W 14.4mm H 7.5mm 24VDC white number of lamps 18 cable length 380mm		
	<b>For models:</b>	GSC2336		

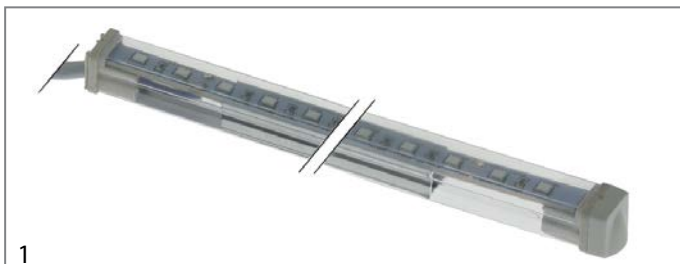

1	<b>GEV No.</b>	357251	<b>Ref. No.</b>	DQLED066
	<b>description</b>	LED bar L 400mm W 12mm H 12mm 24V blue number of lamps 30 cable length 280mm		
	<b>For models:</b>	GBC1102		

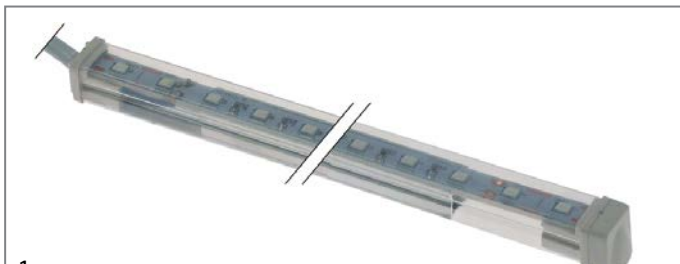

1	<b>GEV No.</b>	357241	<b>Ref. No.</b>	DQLED067
	<b>description</b>	LED bar L 600mm W 11.5mm H 12.5mm 24V number of lamps 42 cable length 285mm voltage DC		
	<b>For models:</b>	GBC1103		



1	<b>GEV No.</b>	357138	<b>Ref. No.</b>	1.1.A.A01.03.03
	<b>description</b>	LED bar L 698mm W 13mm H 13mm 230V number of lamps 27 cable length 800mm		
	<b>For models:</b>	GCV1600		

accessories



1	<b>GEV No.</b>	357152	<b>Ref. No.</b>	1.1.B.B25.20
	<b>description</b>	power supply for LEDs RT-130-2-24cm Qty 1 pcs		
	<b>For models:</b>	GCV1600		



fluorescent lamps

fluorescent lamps

G5

			
1			
<b>GEV No.</b>	357156	<b>Ref. No.</b>	DQDA0009
<b>description</b>	fluorescent lamp socket G5 L 285mm 8W ø 16mm 230VT5/865 Qty 1 pcs		
<b>For models:</b>	GBC1001, GBC1001S, GBC1001SS		

			
1			
<b>GEV No.</b>	357148	<b>Ref. No.</b>	DQDA0010
<b>description</b>	fluorescent lamp socket G5 L 547mm 14W ø 16mm 230V T5/865 Qty 1 pcs		
<b>For models:</b>	GBC1002, GBC1002S, GBC1002SS, GBC1003, GBC1003S, GBC1003SS		

accessories

sockets

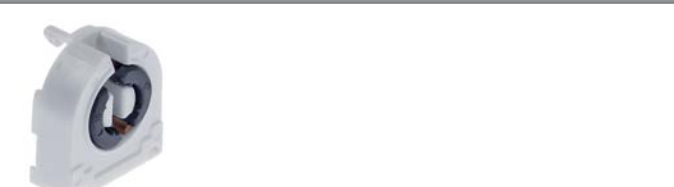
			
1			
<b>GEV No.</b>	381169	<b>Ref. No.</b>	SLJY2010
<b>description</b>	lamp holder socket G13 L 26.5mm W 24.5mm Qty 1 pcs for fluorescent lamps		

			
1			
<b>GEV No.</b>	381447	<b>Ref. No.</b>	SLZA3000
<b>description</b>	lamp socket socket G13 L 33mm W 10mm H 28mm		
<b>For models:</b>	GBC1001, GBC1001S, GBC1001SS, GBC1002, GBC1002S, GBC1002SS, GBC1003, GBC1003S, GBC1003SS		

starter holders

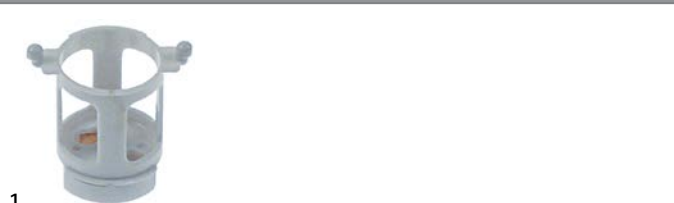
			
1			
<b>GEV No.</b>	381170	<b>Ref. No.</b>	SLZA1000
<b>description</b>	starter holder L 32mm W 24mm housing ø 23mm Qty 1 pcs		
<b>For models:</b>	GBC1001, GBC1001S, GBC1001SS, GBC1002, GBC1002S, GBC1002SS, GBC1003, GBC1003S, GBC1003SS		

starter

			
1			
<b>GEV No.</b>	380464	<b>Ref. No.</b>	DQDF0000
<b>description</b>	starter 4-65W		
<b>For models:</b>	GBC1001, GBC1001S, GBC1001SS, GBC1002, GBC1002S, GBC1002SS, GBC1003, GBC1003S, GBC1003SS		

			
1			
<b>GEV No.</b>	357150	<b>Ref. No.</b>	1.1.A.A01.02.01
<b>description</b>	starter for fluorescent lamps L 69mm W 38.5mm 11W type HG-YZ11E Qty 1 pcs		
<b>For models:</b>	GGC1078, GGC1078B, GGC2270, GGC2270B		

ballasts

			
1			
<b>GEV No.</b>	403192	<b>Ref. No.</b>	DQZB0005
<b>description</b>	electrical ballast 15W 220-240V connection screw clamp for fluorescent lamps type JF-1595M Qty 1 pcs		
<b>For models:</b>	GBC1002, GBC1002S, GBC1002SS, GBC1003, GBC1003S, GBC1003SS		

			
1			
<b>GEV No.</b>	403190	<b>Ref. No.</b>	DQZA0027
<b>description</b>	electrical ballast 30W 220-240V connection screw clamp for fluorescent lamps type JF-3095W Qty 1 pcs		

			
1			
<b>GEV No.</b>	403191	<b>Ref. No.</b>	DQZB0029
<b>description</b>	electrical ballast 9W 220V connection screw clamp for fluorescent lamps type JF-995M Qty 1 pcs		
<b>For models:</b>	GBC1001, GBC1001S, GBC1001SS		



covers

			
1			
<b>GEV No.</b>	699314	<b>Ref. No.</b>	SLZV0017
<b>description</b>	cover L 510mm W 30mm H 30mm		
<b>For models:</b>	GBC1001, GBC1001S, GBC1001SS		



			
<b>GEV No.</b>	694873	<b>Ref. No.</b>	SLSE2008
<b>description</b>	cover L 590mm W 280mm H 1mm		
<b>For models:</b>	GSC2336		

			
<b>GEV No.</b>	699312	<b>Ref. No.</b>	SLZV0018
<b>description</b>	cover L 810mm W 30mm H 30mm transparent		
<b>For models:</b>	GBC1002, GBC1002S, GBC1002SS, GBC1102		

			
<b>GEV No.</b>	694874	<b>Ref. No.</b>	SLZQ0037
<b>description</b>	cover set mounting pos. right and left W 82mm H 280mm D 34		
<b>For models:</b>	GSC1100G, GSC2336		
<b>spare parts for</b>	694874		
	<b>GEV No.</b>	<b>Ref. No.</b>	—
	692393		
bezel for cover mounting pos. right W 82mm H 280mm D 34mm plastic Qty 1 pcs			
	<b>GEV No.</b>	<b>Ref. No.</b>	—
	692394		
bezel for cover mounting pos. left W 82mm H 280mm D 34mm plastic Qty 1 pcs			

			
<b>GEV No.</b>	694872	<b>Ref. No.</b>	SLJV2040
<b>description</b>	cover support L 610mm W 20mm H 55mm mounting pos. lower		
<b>For models:</b>	GSC2336		

			
<b>GEV No.</b>	694871	<b>Ref. No.</b>	SLJV2041
<b>description</b>	cover support L 610mm W 20mm H 55mm mounting pos. upper		
<b>For models:</b>	GSC2336		



microwave lamps

light bulbs

			
<b>GEV No.</b>	357175	<b>Ref. No.</b>	253079000039
<b>description</b>	light bulb socket E14 230V 20W ø 25mm L 63mm Qty 1 pcs lens L 37mm		
<b>For models:</b>	GMW1025		

oven lamps



universal oven lamps  
mounting diameter 35.5mm

			
<b>GEV No.</b>	359718	<b>Ref. No.</b>	00002330
<b>description</b>	oven lamp mounting ø 35.5mm 230V 15W socket E14 temp.-resist. 300°C connection male faston 6.3mm hard glas		
<b>For models:</b>	GCO2001		
<b>spare parts for</b>	359718		
	<b>GEV No.</b>	<b>Ref. No.</b>	—
	359701		
lamp socket socket E14 220-230V mounting ø 35.5mm connection male faston 6.3mm 15W			
	<b>GEV No.</b>	<b>Ref. No.</b>	—
	359740		
light bulb t.max. 300°C socket E14 15W 230V ø 22mm L 48mm lens L 20mm for oven lamp IMPORT			

			
<b>GEV No.</b>	357176	<b>Ref. No.</b>	LAM30006
<b>description</b>	oven lamp mounting ø 35.5mm 230V 40W socket G9 temp.-resist. 300°C connection cable 100mm hard glas		
<b>For models:</b>	GCO500		

lamp accessories

fascias

			
<b>GEV No.</b>	692879	<b>Ref. No.</b>	W0409863
<b>description</b>	cover for lamp L 185mm W 55mm H 40mm for GFR2700/GRE2700		
<b>For models:</b>	GFR2700, GRE2700		
<b>accessories for</b>	692879		
	<b>GEV No.</b>	<b>Ref. No.</b>	W0304086 W0304511
	357260		
LED bar L 130mm W 14mm H 8mm cable length 300mm GFR2700/GRE2700			





timers

mechanical timers



1

<b>GEV No.</b>	350130	<b>Ref. No.</b>	PRG30001
<b>description</b>	timer M11 with bell 1-pole operation time 120min impulse mechanical 1NO at 250V 16A permanent position yes shaft $\varnothing$ 6x4.6mm shaft L 23mm mounting distance 28mm mounting thread M4 connection male faston 6.3mm 4 hole fixing shaft flat upper		
<b>For models:</b>	GCO500		



1

<b>GEV No.</b>	350186	<b>Ref. No.</b>	01202980
<b>description</b>	timer M2 2-pole operation time 120min impulse mechanical 2CO at 250V 16A permanent position yes shaft $\varnothing$ 6x4.6mm shaft L 23mm mounting distance 28mm		
<b>For models:</b>	GCO2001		
<b>accessories for</b>	350186		
	<b>GEV No.</b>	112627	<b>Ref. No.</b> —
	knob time 120min $\varnothing$ 58mm shaft $\varnothing$ 6x4.6mm shaft flat lower		



1

<b>GEV No.</b>	360164	<b>Ref. No.</b>	A02008
<b>description</b>	timer MT49 2-pole operation time 15min impulse mechanical 2NO at 250V 16A permanent position yes shaft 6x4.6mm shaft L 16mm mounting distance 28mm connection lateral		
<b>For models:</b>	GTO1001, GTO2001		

defrost timers

miscellaneous



1

<b>GEV No.</b>	360553	<b>Ref. No.</b>	1.1.A.A05.06
<b>description</b>	defrost timer SONXIE type DBZF-625-2G2B defrosting interval 6h defrosting time 2minmin fan delaymin 200-240V Qty 1 pcs		
<b>For models:</b>	GGC1078, GGC1078B		

alarm devices

buzzer boards



1

<b>GEV No.</b>	401062	<b>Ref. No.</b>	01201250
<b>description</b>	buzzer board 230VAC L 48mm W 45mm connection Faston 6.3mm		
<b>For models:</b>	GCO2001		

contactors

LOVATO

power contactors



1

<b>GEV No.</b>	380705	<b>Ref. No.</b>	907190
<b>description</b>	power contactor resistive load 20A 230VAC (AC3/400V) 9A/4kW main contacts 3NO auxiliary contacts 1NO connection screw connection type 11BG0910A230		
<b>For models:</b>	GDW2001		
<b>accessories for</b>	380705		
	<b>GEV No.</b>	380057	<b>Ref. No.</b> —
	auxiliary contact contacts 1NO/1NC AC1 10A for contactors BG series connection screw type BGX1011		

## solid state relays

### accessories

#### diodes

#### high voltage diodes

			
1			
<b>GEV No.</b>	403261	<b>Ref. No.</b>	253089000101
<b>description</b>	hv diode type RG501 connection F6.3mm / lug M4 cable lengthmm for microwave Qty 1 pcs		
<b>For models:</b>	GMW1025		

## relays

### power relays

#### with bracket mounting

			
1			
<b>GEV No.</b>	380867	<b>Ref. No.</b>	DQWBZJ02
<b>description</b>	relay SHANGFANG 12VDC 30A 1NO connection male faston 6.3mm screw mounting at 250V 30A manuf. no. 855AW-1A-C1		
<b>For models:</b>	GSC1100G, GSC2336		

## magnetrons

			
1			
<b>GEV No.</b>	403173	<b>Ref. No.</b>	253017000051
<b>description</b>	Magnetron type 2M248J(JT)		
<b>For models:</b>	GMW1025		

## transformers

### power supplies

			
1			
<b>GEV No.</b>	403903	<b>Ref. No.</b>	W0399114
<b>description</b>	power supply primary 100-240VAC secondary 24VDC H 30mm L 85mm W 45mm 50/60Hz type JKY36-SP2400600		
<b>For models:</b>	GFR2700		

			
1			
<b>GEV No.</b>	403902	<b>Ref. No.</b>	W0399115
<b>description</b>	power supply primary 100-240VAC secondary 24VDC H 34mm L 114mm W 45mm 50/60Hz type JKY36-SP2401500 GRE2700		
<b>For models:</b>	GRE2700		

### HV transformers

			
1			
<b>GEV No.</b>	403257	<b>Ref. No.</b>	253029000256
<b>description</b>	HV transformer primary 230-240V 50Hz type GAL-1000E-1G for microwave		
<b>For models:</b>	GMW1025		

### miscellaneous

			
1			
<b>GEV No.</b>	403660	<b>Ref. No.</b>	DQLED069
<b>description</b>	transformer primary 100-240V secondary 24VDC 20VA secondary 0.84A		
<b>For models:</b>	GBC1001, GBC1001S, GBC1002, GBC1002S, GBC1003, GBC1003S, GBC1102, GBC1103		

			
1			
<b>GEV No.</b>	403867	<b>Ref. No.</b>	DQLED055
<b>description</b>	transformer primary 100-240V secondary 24VDC secondary 0.42A H 25mm L 95mm W 40mm		
<b>For models:</b>	GSC1100G, GSC2336		



electronic controllers

DIXELL

refrigeration controllers

built-in version



1

<b>GEV No.</b>	378256	<b>Ref. No.</b>	S900.02
<b>description</b>	electronic controller DIXELL XR02CX-5N0C0 mounting measurements 71x29mm built-in depth 56mm 230V voltage AC NTC relay outputs 1 CO-8A(4) NTC protection IP54 defrosting function/time control -40 up to +110°C display 2½ digit		
<b>For models:</b>	GHS1600, GHS2600		
<b>spare parts for</b>	378256		
	<b>GEV No.</b>	<b>Ref. No.</b>	—
	379161		
	temperature probe NTC 10kOhm cable thermoplastic probe -40 up to +110°C cable -40 up to +110°C probe ø6x14mm cable length 3m without screw connection 2-wire		
<b>accessories for</b>	378256		
	<b>GEV No.</b>	<b>Ref. No.</b>	—
	378194		
	temperature probe NTC 10kOhm cable PVC probe -20 up to +80°C cable -10 up to 100°C probe ø7x24.5mm cable length 1.5m without screw connection 2-wire		
	<b>GEV No.</b>	<b>Ref. No.</b>	—
	379057		
	temperature probe NTC 10kOhm cable PVC probe -20 up to +80°C cable -10 up to 100°C probe ø6x25mm cable length 3m 2-wire		
	<b>GEV No.</b>	<b>Ref. No.</b>	E21010150001
	379160		
	temperature probe NTC 10kOhm cable thermoplastic probe -40 up to +110°C cable -40 up to +110°C probe ø6x14mm cable length 1.5m without screw connection 2-wire		
	<b>GEV No.</b>	<b>Ref. No.</b>	—
	379161		
	temperature probe NTC 10kOhm cable thermoplastic probe -40 up to +110°C cable -40 up to +110°C probe ø6x14mm cable length 3m without screw connection 2-wire		
	<b>GEV No.</b>	<b>Ref. No.</b>	—
	379343		
	temperature probe NTC 10kOhm cable silicone probe -40 up to +110°C cable -50 up to +180°C probe ø6x40mm cable length 3m 2-wire		
	<b>GEV No.</b>	<b>Ref. No.</b>	—
	379458		
	temperature probe NTC 10kOhm cable silicone probe -40 up to +110°C cable -50 up to +180°C probe ø6x40mm cable length 1.5m without screw connection 2-wire		



1

<b>GEV No.</b>	378267	<b>Ref. No.</b>	E20A111C4D00
<b>description</b>	electronic controller DIXELL XR02CX-5N0C1 mounting measurements 71x29mm built-in depth 56mm 230V voltage AC NTC relay outputs 1 NO-20A(8) NTC DI protection IP54 defrosting function/time control -40 up to +110°C display 2½ digit		
<b>For models:</b>	GDS2600, GPS2600, GSA2600, GSD2600, GSF2600		
<b>accessories for</b>	378267		
	<b>GEV No.</b>	<b>Ref. No.</b>	—
	379161		
	temperature probe NTC 10kOhm cable thermoplastic probe -40 up to +110°C cable -40 up to +110°C probe ø6x14mm cable length 3m without screw connection 2-wire		
	<b>GEV No.</b>	<b>Ref. No.</b>	—
	381249		
	temperature probe NTC 10kOhm cable PVC probe -40 up to +110°C cable -10 up to 100°C connection 2-wire thread probe ø6x14mm cable length 3m		



1

<b>GEV No.</b>	378665	<b>Ref. No.</b>	W0302160
<b>description</b>	electronic controller DIXELL XR03CX-5R0C1 mounting measurements 71x29mm built-in depth 50mm 230V voltage AC NTC relay outputs 2 NO-20A(8) CO-8A(3) NTC DI protection IP65 defrosting function/time control -55 up to +99°C display 2 digit		
<b>For models:</b>	GRE2700		



1

<b>GEV No.</b>	378363	<b>Ref. No.</b>	W0302159
<b>description</b>	electronic controller DIXELL XR06CX-5R0C1 mounting measurements 71x29mm 230V voltage AC NTC relay outputs 3 NO-20A(8) CO-8A(3) NO-5A(2) NTC NTC DI protection IP54 -40 up to +110°C display 3½ digits		
<b>For models:</b>	GFR2700		
<b>accessories for</b>	378363		
	<b>GEV No.</b>	<b>Ref. No.</b>	—
	381249		
	temperature probe NTC 10kOhm cable PVC probe -40 up to +110°C cable -10 up to 100°C connection 2-wire thread probe ø6x14mm cable length 3m		



1

<b>GEV No.</b>	379843 <sup>1</sup>	<b>Ref. No.</b>	1.1.A.A06.03.31
<b>description</b>	electronic controller kit DIXELL XR30CX-5N2C1 mounting measurements 71x29mm 230V voltage AC NTC/PTC relay outputs 2 1x NTC probe inclusive -50 up to +150°C display 3½ digits 2 RoomTempLN NTC/PTC DEF Probe DigilN1 DigilN2 DEF Relay fan relay Temp4/Dig1 NTC/PTC/DIGI evaporator probe defr. funct. compressor relay NO-20A(8) light relay alarm relay CO-8A(3) auxiliary relay		
<b>For models:</b>	GCV1600		
<b>spare parts for</b>	379843		
	GEV No.	379160	Ref. No. E21010150001
	temperature probe NTC 10kOhm cable thermoplastic probe -40 up to +110°C cable -40 up to +110°C probe ø6x14mm cable length 1.5m without screw connection 2-wire		

<sup>1</sup>incl. 1x NTC probe

## SHANGFANG

## refrigeration controllers

## built-in version



1

<b>GEV No.</b>	379799 <sup>1</sup>	<b>Ref. No.</b>	DQWBZX02
<b>description</b>	electronic controller SHANGFANG type SF-104S-2 mounting measurements 71x29mm 12V voltage AC NTC relay outputs 2 12VDC 12VDC NTC front measurements 77x35mm built-in depth 40mm protection IP54 accuracy 1% built-in version alarm without accessories defr. funct. yes -45 up to +45°C display 3 digits		
<b>For models:</b>	GSC1100G, GSC2336		
<b>spare parts for</b>	379799		
	GEV No.	379054	Ref. No. —
	transformer primary 230VAC secondary 12VAC 3VA secondary 0.25A H 40mm L 45mm W 50mm connection screw 50/60Hz type 153/M		
	GEV No.	380867	Ref. No. DQWBZJ02
	relay SHANGFANG 12VDC 30A 1NO connection male faston 6.3mm screw mounting at 250V 30A manuf. no. 855AW-1A-C1		
	GEV No.	381318	Ref. No. —
	temperature probe NTC cable silicone cable colours white cable length 3m probe -40 up to +110°C cable -50 up to +180°C probe ø7x25mm coded plug		
	GEV No.	381319	Ref. No. —
	temperature probe NTC cable silicone cable colours black cable length 3m evaporator probe -40 up to +110°C cable -50 up to +180°C probe ø7x25mm coded plug		
<b>accessories for</b>	379799		
	GEV No.	379054	Ref. No. —
	transformer primary 230VAC secondary 12VAC 3VA secondary 0.25A H 40mm L 45mm W 50mm connection screw 50/60Hz type 153/M		
	GEV No.	380867	Ref. No. DQWBZJ02
	relay SHANGFANG 12VDC 30A 1NO connection male faston 6.3mm screw mounting at 250V 30A manuf. no. 855AW-1A-C1		

<sup>1</sup>without relay, cable harness, probe and transformer

<b>accessories for</b>	379799		
	GEV No.	381318	Ref. No. —
	temperature probe NTC cable silicone cable colours white cable length 3m probe -40 up to +110°C cable -50 up to +180°C probe ø7x25mm coded plug		
	GEV No.	381319	Ref. No. —
	temperature probe NTC cable silicone cable colours black cable length 3m evaporator probe -40 up to +110°C cable -50 up to +180°C probe ø7x25mm coded plug		

## built-in version 2-piece











1

<b>GEV No.</b>	379849 <sup>1</sup>	<b>Ref. No.</b>	DQWB005
<b>description</b>	electronic controller SHANGFANG type SF-101S mounting measurements 71x29mm 230V voltage AC NTC relay outputs 1 NO-30A NTC Comp front measurements 77x35mm built-in depth 40mm protection IP54 accuracy 1% built-in version alarm incl. relay, cable harness, probe and transformer defr. funct. yes -45 up to +45°C display 3 digits		
<b>For models:</b>	GBC1001, GBC1001S, GBC1001SS, GBC1002, GBC1002S, GBC1002SS, GBC1003, GBC1003S, GBC1003SS		
<b>spare parts for</b>	379849		
	GEV No.	379054	Ref. No. —
	transformer primary 230VAC secondary 12VAC 3VA secondary 0.25A H 40mm L 45mm W 50mm connection screw 50/60Hz type 153/M		
	GEV No.	380867	Ref. No. DQWBZJ02
	relay SHANGFANG 12VDC 30A 1NO connection male faston 6.3mm screw mounting at 250V 30A manuf. no. 855AW-1A-C1		
	GEV No.	381318	Ref. No. —
	temperature probe NTC cable silicone cable colours white cable length 3m probe -40 up to +110°C cable -50 up to +180°C probe ø7x25mm coded plug		
	GEV No.	381319	Ref. No. —
	temperature probe NTC cable silicone cable colours black cable length 3m evaporator probe -40 up to +110°C cable -50 up to +180°C probe ø7x25mm coded plug		
<b>accessories for</b>	379849		
	GEV No.	379054	Ref. No. —
	transformer primary 230VAC secondary 12VAC 3VA secondary 0.25A H 40mm L 45mm W 50mm connection screw 50/60Hz type 153/M		
	GEV No.	380867	Ref. No. DQWBZJ02
	relay SHANGFANG 12VDC 30A 1NO connection male faston 6.3mm screw mounting at 250V 30A manuf. no. 855AW-1A-C1		
	GEV No.	381318	Ref. No. —
	temperature probe NTC cable silicone cable colours white cable length 3m probe -40 up to +110°C cable -50 up to +180°C probe ø7x25mm coded plug		
	GEV No.	381319	Ref. No. —
	temperature probe NTC cable silicone cable colours black cable length 3m evaporator probe -40 up to +110°C cable -50 up to +180°C probe ø7x25mm coded plug		

<sup>1</sup>incl. relay, cable harness, probe and transformer





 <p>71 x 29mm</p>			
1			
<b>GEV No.</b>	403074 <sup>1</sup>	<b>Ref. No.</b>	DQWB0002
<b>description</b>	electronic controller SHANGFANG type SF-104S-2 mounting measurements 71x29mm 230V voltage AC NTC relay outputs 2 NO-30A NO-30A NTC NTC front measurements 77x35mm built-in depth 38mm protection IP54 accuracy 1% built-in version alarm incl. relay, cable harness, probe and transformer defr. funct. yes -45 up to +45°C display 2½ digit		
<b>For models:</b>	GBC1001, GBC1001S, GBC1002, GBC1002S, GBC1003, GBC1003S, GBC1102, GBC1103, GSC1100G, GSC2336		
<b>spare parts for</b>	403074		
	<b>GEV No.</b>	379054	<b>Ref. No.</b> —
	transformer primary 230VAC secondary 12VAC 3VA secondary 0.25A H 40mm L 45mm W 50mm connection screw 50/60Hz type 153/M		
	<b>GEV No.</b>	380867	<b>Ref. No.</b> DQWBZJ02
	relay SHANGFANG 12VDC 30A 1NO connection male faston 6.3mm screw mounting at 250V 30A manuf. no. 855AW-1A-C1		
	<b>GEV No.</b>	381318	<b>Ref. No.</b> —
	temperature probe NTC cable silicone cable colours white cable length 3m probe -40 up to +110°C cable -50 up to +180°C probe ø7x25mm coded plug		
	<b>GEV No.</b>	381319	<b>Ref. No.</b> —
	temperature probe NTC cable silicone cable colours black cable length 3m evaporator probe -40 up to +110°C cable -50 up to +180°C probe ø7x25mm coded plug		
<b>accessories for</b>	403074		
	<b>GEV No.</b>	379054	<b>Ref. No.</b> —
	transformer primary 230VAC secondary 12VAC 3VA secondary 0.25A H 40mm L 45mm W 50mm connection screw 50/60Hz type 153/M		
	<b>GEV No.</b>	380867	<b>Ref. No.</b> DQWBZJ02
	relay SHANGFANG 12VDC 30A 1NO connection male faston 6.3mm screw mounting at 250V 30A manuf. no. 855AW-1A-C1		
	<b>GEV No.</b>	381318	<b>Ref. No.</b> —
	temperature probe NTC cable silicone cable colours white cable length 3m probe -40 up to +110°C cable -50 up to +180°C probe ø7x25mm coded plug		
	<b>GEV No.</b>	381319	<b>Ref. No.</b> —
	temperature probe NTC cable silicone cable colours black cable length 3m evaporator probe -40 up to +110°C cable -50 up to +180°C probe ø7x25mm coded plug		

<sup>1</sup>incl. relay, cable harness, probe and transformer

accessories

			
1			
<b>GEV No.</b>	380867	<b>Ref. No.</b>	DQWBZJ02
<b>description</b>	relay SHANGFANG 12VDC 30A 1NO connection male faston 6.3mm screw mounting at 250V 30A manuf. no. 855AW-1A-C1		
<b>For models:</b>	GSC1100G, GSC2336		

accessories universal for electronic con-

miscellaneous

			
1			
<b>GEV No.</b>	692369	<b>Ref. No.</b>	1.1.C.C63.71
<b>description</b>	bracket for thermometer W 81mm H 41mm plastic Qty 1 pcs		
<b>For models:</b>	GCV1600		

probes

universal probes

temperature probes

			
1			
<b>GEV No.</b>	379160	<b>Ref. No.</b>	E21010150001
<b>description</b>	temperature probe NTC 10kOhm cable thermoplastic probe -40 up to +110°C cable -40 up to +110°C probe ø6x14mm cable length 1.5m without screw connection 2-wire		
<b>For models:</b>	GDS2600, GPS2600, GSA2600, GSD2600, GSF2600		

producer-specific probes

probes

			
1			
<b>GEV No.</b>	403899	<b>Ref. No.</b>	W0302305
<b>description</b>	probe NTC 10kOhm cable PVC probe -40 up to +110°C cable -40 up to +110°C connection coded plug thread probe ø6x14mm cable length 600m GFR2700/GRE2700		
<b>For models:</b>	GFR2700		

			
1			
<b>GEV No.</b>	403901	<b>Ref. No.</b>	W0302304
<b>description</b>	probe NTC 10kOhm cable PVC probe -40 up to +110°C cable -40 up to +110°C connection coded plug thread probe ø6x14mm cable length 800m GFR2700/GRE2700		
<b>For models:</b>	GFR2700, GRE2700		





			
<b>GEV No.</b>	403910	<b>Ref. No.</b>	I0205805
<b>description</b>	temperature probe NTC 10kOhm cable PVC probe -40 up to +110°C connection 2-wire probe 5x20 cable length 1.475m		
<b>For models:</b>	GFR3600S, GRE3600, GRE3600S		

**sensors**

			
<b>GEV No.</b>	403155	<b>Ref. No.</b>	AD400009
<b>description</b>	sensor for induction device ø 25mm H 17mm cable length 130mm		
<b>For models:</b>	GIC3035		

**electronics**

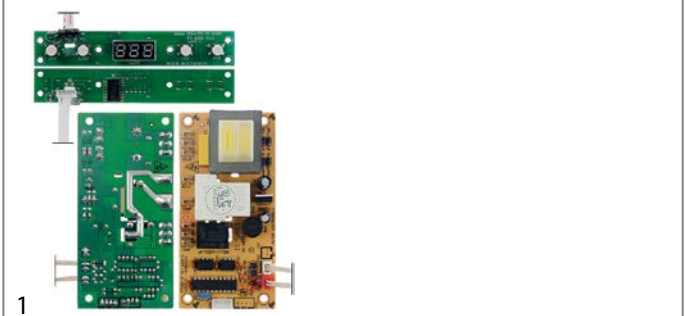

**PCBs**

			
<b>GEV No.</b>	361873	<b>Ref. No.</b>	1.1.A.A17.01.01 1.1.A.A17.04.06
<b>description</b>	control PCB refrigerated show case GGC 1270/2270 cable length 225mm 2-piece type KB3150		
<b>For models:</b>	GGC2270, GGC2270B		

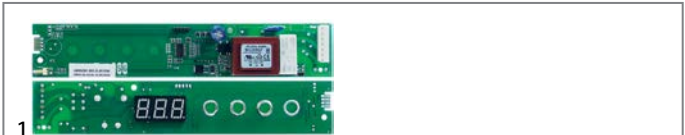

			
<b>GEV No.</b>	403954	<b>Ref. No.</b>	I9R00462
<b>description</b>	control PCB refrigeration IARP L 222mm W 40mm		
<b>For models:</b>	GFR3600S		

			
<b>GEV No.</b>	403736	<b>Ref. No.</b>	43845000
<b>description</b>	control PCB refrigeration IARP L 222mm W 40mm for fridge		
<b>For models:</b>	GRE3600, GRE3600S		

			
<b>GEV No.</b>	403529	<b>Ref. No.</b>	263019008956
<b>description</b>	display PCB microwave GMW1025 L 160mm W 85mm cable length 200mm for microwave		
<b>For models:</b>	GMW1025		

			
<b>GEV No.</b>	403154	<b>Ref. No.</b>	DQA020110R
<b>description</b>	keypad PCB induction device GIC3035 L 247mm W 53mm keypad connection 4 contact pins edition since 2012 buttons 8		
<b>For models:</b>	GIC3035		
<b>accessories for</b>	403154		
	<b>GEV No.</b>	403156	<b>Ref. No.</b> LAC5000003
	control panel induction device GIC3535 W 300mm H 58mm		
	<b>GEV No.</b>	403160	<b>Ref. No.</b> —
	control panel induction device GIC3535 W 300mm mounting pos. right H 58mm		

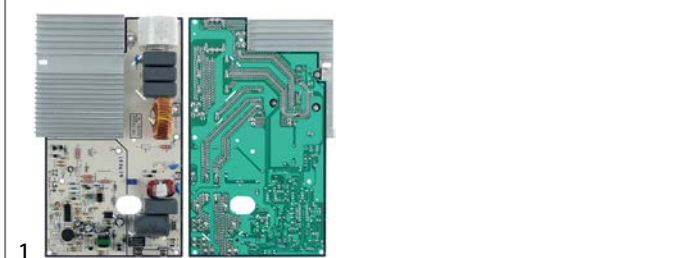
			
<b>GEV No.</b>	403188	<b>Ref. No.</b>	263029001088
<b>description</b>	line filter microwave for GMW1025 250V 50/60Hz conductor 2 PCB connection male faston 4.8mm L 80mm H 20mm W 40mm PCB Qty 1 pcs cable length 120mm type DNV-0818A-5		
<b>For models:</b>	GMW1025		

			
<b>GEV No.</b>	403153	<b>Ref. No.</b>	DQA010095R
<b>description</b>	main PCB induction device GIC3035 L 267mm W 160mm connection male faston 6.3mm vertical keypad connection 4 contact pins SZ-L5		
<b>For models:</b>	GIC3035		
<b>accessories for</b>	403153		
	<b>GEV No.</b>	403154	<b>Ref. No.</b> DQA020110R
	keypad PCB induction device GIC3035 L 247mm W 53mm keypad connection 4 contact pins edition since 2012 buttons 8		



1

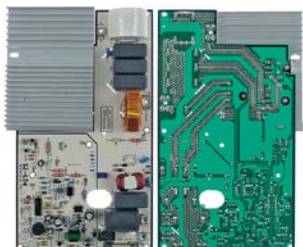

<b>GEV No.</b>	403680	<b>Ref. No.</b>	DQA010198R
<b>description</b>	main PCB induction device GIC3035 L 267mm W 160mm connection screw keypad connection 4 contact pins SZ-L5a		
<b>For models:</b>	GIC3035		

1



<b>GEV No.</b>	401855	<b>Ref. No.</b>	0000009240
<b>description</b>	control box with pressure switch double for slicer 230V		
<b>For models:</b>	GFS1030		

1





<b>GEV No.</b>	403165	<b>Ref. No.</b>	2852
<b>description</b>	PCB GSM1000 speed control		
<b>For models:</b>	GSM1000		
<b>spare parts for</b>	403165		
	<b>GEV No.</b>	696506	<b>Ref. No.</b>
			2858
	knob for PCB ø 26mm black Qty 1 pcs		

## keypads

### front foils

1



<b>GEV No.</b>	403156	<b>Ref. No.</b>	LAC5000003
<b>description</b>	control panel induction device GIC3535 W 300mm H 58mm		
<b>For models:</b>	GIC3035		
<b>accessories for</b>	403156		
	<b>GEV No.</b>	403154	<b>Ref. No.</b>
			DQA020110R
	keypad PCB induction device GIC3035 L 247mm W 53mm keypad connection 4 contact pins edition since 2012 buttons 8		

### central units

1



<b>GEV No.</b>	400788	<b>Ref. No.</b>	0000000297
<b>description</b>	control box for slicer 230V		
<b>For models:</b>	GFS1022, GFS1025, GFS1030, GFS2022, GFS2025		

1



<b>GEV No.</b>	403764	<b>Ref. No.</b>	49357000
<b>description</b>	front foil blast freezer L 165mm W 45mm		
<b>For models:</b>	GFR3600S, GRE3600, GRE3600S		

### membrane keypads

1



<b>GEV No.</b>	403682	<b>Ref. No.</b>	00000001752
<b>description</b>	control box for slicer 230V 50Hz edition since 04/2016		
<b>For models:</b>	GFS2019, GFS2030		

1



<b>GEV No.</b>	403187	<b>Ref. No.</b>	253069002692
<b>description</b>	membrane keypad microwave GMW1025 2-piece buttons 15 Qty 1 pcs L 164mm W 70mm		
<b>For models:</b>	GMW1025		

### control panel

1



<b>GEV No.</b>	506281	<b>Ref. No.</b>	909763
<b>description</b>	control panel for dishwasher L 250mm W 40mm black suitable for Silanos		
<b>For models:</b>	GDW2001		





















## solenoid valves

## solenoid valves (water)

TP



<b>GEV No.</b>	370017	<b>Ref. No.</b>	902390
<b>description</b>	solenoid valve single straight 230VAC inlet 3/4" outlet 11.5mm DN10 TP p max 10bar		
<b>For models:</b>	GDW2001		
<b>spare parts for</b>	370017		
	<b>GEV No.</b>	371013	<b>Ref. No.</b> —
solenoid coil TP 230VAC 50/60Hz			
<b>accessories for</b>	370017		
	<b>GEV No.</b>	371220	<b>Ref. No.</b> —
reducer TP flow rate 3l/min red tolerance ±15%			
	<b>GEV No.</b>	371221	<b>Ref. No.</b> —
reducer TP flow rate 5.5l/min yellow tolerance ±15%			
	<b>GEV No.</b>	371222	<b>Ref. No.</b> —
reducer TP flow rate 6l/min grey tolerance ±15%			
	<b>GEV No.</b>	371223	<b>Ref. No.</b> —
reducer TP flow rate 10l/min white tolerance ±15%			
	<b>GEV No.</b>	371224	<b>Ref. No.</b> —
reducer TP flow rate 12l/min bronze tolerance ±15%			
	<b>GEV No.</b>	371225	<b>Ref. No.</b> —
reducer TP flow rate 16l/min light brown tolerance ±15%			
	<b>GEV No.</b>	371226	<b>Ref. No.</b> —
reducer TP flow rate 20l/min red tolerance ±15%			
	<b>GEV No.</b>	371230	<b>Ref. No.</b> —
reducer TP flow rate 0.25l/min red tolerance ±25%			
	<b>GEV No.</b>	371231	<b>Ref. No.</b> —
reducer TP flow rate 0.35l/min violet tolerance ±25%			
	<b>GEV No.</b>	371232	<b>Ref. No.</b> —
reducer TP flow rate 0.5l/min orange tolerance ±25%			
	<b>GEV No.</b>	371233	<b>Ref. No.</b> —
reducer TP flow rate 0.8l/min white tolerance ±25%			
	<b>GEV No.</b>	371234	<b>Ref. No.</b> —
reducer TP flow rate 1l/min light blue tolerance ±25%			
	<b>GEV No.</b>	371235	<b>Ref. No.</b> —
reducer TP flow rate 1.2l/min brown tolerance ±25%			

<b>accessories for</b>	370017		
	<b>GEV No.</b>	371236	<b>Ref. No.</b> —
reducer TP flow rate 1.5l/min light brown tolerance ±25%			
	<b>GEV No.</b>	371237	<b>Ref. No.</b> —
reducer TP flow rate 2.5l/min yellow tolerance ±25%			
	<b>GEV No.</b>	371238	<b>Ref. No.</b> —
reducer TP flow rate 3.4l/min dark green tolerance ±25%			
	<b>GEV No.</b>	371239	<b>Ref. No.</b> —
reducer TP flow rate 5l/min black tolerance ±25%			
	<b>GEV No.</b>	371240	<b>Ref. No.</b> —
reducer TP flow rate 8l/min blue tolerance ±20%			

## solenoid valves (refrigeration)

SANHUA

valves



<b>GEV No.</b>	374110	<b>Ref. No.</b>	W0205011
<b>description</b>	solenoid valve type FDF2AT connection 6mm soldering connection L 143mm pipe connection ø 6mm 220-240V		
<b>For models:</b>	GFR2700		
<b>accessories for</b>	374110		
	<b>GEV No.</b>	696787	<b>Ref. No.</b> W0208009
T-piece copper ID ø 4.5mm ED ø 6mm refrigeration for GFR2700			

## pressure switches

## for warewashing

ø 58mm with male faston 6.3mm

with connection horizontal



<b>GEV No.</b>	541001	<b>Ref. No.</b>	905264
<b>description</b>	pressure control pressure range 35/17mbar connection 6mm ø 58mm pressure connection horizontal warewashing		
<b>For models:</b>	GDW2001		



compressors

ACC/ZEL

R600A

LBP monophase

Lower evaporation temperature below -20°C



1

<b>GEV No.</b>	605141	<b>Ref. No.</b>	DQYD0015 E27B6F1Z0001
<b>description</b>	compressor coolant R600a type HPY12AAa 220-240V 50Hz LBP 8.8kg 1/5HP cylinder capacity 12cm <sup>3</sup> RSIR H 200mmWWWWWWWWWW		
<b>For models:</b>	GBC1002, GBC1002S, GBC1002SS, GBC1003, GBC1003S, GBC1003SS, GBC1102, GDS2600, GPS2600, GSA2600, GSC2336, GSD2600, GSF2600		



1

<b>GEV No.</b>	605150	<b>Ref. No.</b>	1.1.A.A02.01
<b>description</b>	compressor coolant R600a type HVM10AA 220-240V 50Hz LBP 8.7kg 1/6HP cylinder capacity 10cm <sup>3</sup> RSIR H 180mmWWWWWWWWWW		
<b>For models:</b>	GCV1600		



1

<b>GEV No.</b>	650150	<b>Ref. No.</b>	VRX1560.01
<b>description</b>	compressor coolant R600a type HVM67AA 220-240V 50Hz LBP 7.5kg 1/8HP cylinder capacity 7cm <sup>3</sup> RSIR H 180mmWWWW		
<b>For models:</b>	GHS1600, GHS2600		



1

<b>GEV No.</b>	605142	<b>Ref. No.</b>	1.1.A.A02.04 DQYD0014
<b>description</b>	compressor coolant R600a type HVM86AA 220-240V 50Hz LBP fully hermetic 7.83kg 1/7HP cylinder capacity 8.6cm <sup>3</sup> RSIR H 174mmWWWW		
<b>For models:</b>	GBC1001, GBC1001S, GBC1001SS, GGC1078, GGC1078B		

EMBRACO / ASPERA

R290A

LBP monophase

Lower evaporation temperature below -20°C



1

<b>GEV No.</b>	605258	<b>Ref. No.</b>	I0210981 W0201133
<b>description</b>	compressor coolant R290 type EMTE2134U 220-240V 50Hz LBP 9kg 3/8HP cylinder capacity 9.5cm <sup>3</sup> CSIR H 187mm 250W 278W 305W 330W 366WWWWWW		
<b>For models:</b>	GFR2700, GFR3600S		





R600A

LBP monophase

Lower evaporation temperature below -20°C



1

<b>GEV No.</b>	605281	<b>Ref. No.</b>	W0201151
<b>description</b>	compressor coolant R600a type EMB40CLC 220-240V 50Hz LBP 8kg 1HP cylinder capacity 7.24cm <sup>3</sup> H 160mmWWWWW		
<b>For models:</b>	GRE2700		



1

<b>GEV No.</b>	605257	<b>Ref. No.</b>	45004031
<b>description</b>	compressor coolant R600a type EMD46CLT 220-240V 50Hz LBP 7.5kgHP cylinder capacity 7.96cm <sup>3</sup> RSCR H 210mm 88W 118W 154W 196W 246WWWWW		
<b>For models:</b>	GRE3600, GRE3600S		

miscellaneous

R134A



1

<b>GEV No.</b>	605140	<b>Ref. No.</b>	DQYA0087
<b>description</b>	compressor KONOR type GQR90AA coolant R134a 220-240V 50Hz 10.1kg 1/4HP cylinder capacity 9.1cm <sup>3</sup> RSIR H 186mmWWWWW		

R600A



1

<b>GEV No.</b>	605143	<b>Ref. No.</b>	1.1.A.A02.25
<b>description</b>	compressor DONPER type QD167YU coolant R600a 220-240V 50Hz fully hermetic 11.9kg 3/8HP cylinder capacity 16.7cm <sup>3</sup> RSCR H 220mm 169W 199W 236W 280W 334W 391WWWWW test method ASHRAE capacitor 6µF		
<b>For models:</b>	GGC2270, GGC2270B		

accessories

miscellaneous



1

<b>GEV No.</b>	699425	<b>Ref. No.</b>	1.1.C.C41.01
<b>description</b>	vibration damper ø 25mm H 10mm		
<b>For models:</b>	GGC1078, GGC1078B		

fans

axial fans

import



1

<b>GEV No.</b>	601131 <sup>1</sup>	<b>Ref. No.</b>	I0221151
<b>description</b>	axial fan L 119mm W 119mm H 25mm 230VAC 50/60Hz 19/18W bearing ball bearing connection male faston 2.8mm metal ADDA fan wheel ø 110mm temp.-resist. 70°C		
<b>For models:</b>	GFR3600S, GRE3600, GRE3600S		
<b>accessories for</b>	601131		
	<b>GEV No.</b>	550898	<b>Ref. No.</b> I0221181
	connecting cable cable length 2000mm connection F 2.8 connection distance 7.9mm for axial flow fan		

<sup>1</sup>with ball bearings







1

<b>GEV No.</b>	601909 <sup>1</sup>	<b>Ref. No.</b>	45003031
<b>description</b>	axial fan L 119mm W 119mm H 38mm 220-240 50/60Hz 31/29W bearing ball bearing connection male faston 2.8mm		
<b>For models:</b>	GFR3600S, GRE3600, GRE3600S		

<sup>1</sup>with ball bearings



1

<b>GEV No.</b>	601787 <sup>1</sup>	<b>Ref. No.</b>	DQFA1000 DQFD1000 DQFD1001
<b>description</b>	axial fan L 119mm W 119mm H 38mm 230VAC 50/60Hz 22/38.4W bearing slide bearing manuf. no. HT-A12038S220 connection plug cable length 300mm HUI TONG fan wheel ø 110mm input current 0.1/0.16A housing aluminium		
<b>For models:</b>	GBC1001, GBC1001S, GBC1001SS, GSC1100G, GSC2336		

<sup>1</sup>with slide bearings



1

<b>GEV No.</b>	601834 <sup>1</sup>	<b>Ref. No.</b>	1.1.A.A03.01.31
<b>description</b>	axial fan L 119mm W 119mm H 38mm 230VAC 50/60Hz 16/15W bearing ball bearing manuf. no. RAM1238B1 connection cable length 900mm XINRUILIAN fan wheel ø 110mm temp.-resist. -10 up to +70°C input current 0.16A		
<b>For models:</b>	GCV1600		

<sup>1</sup>with ball bearings



1

<b>GEV No.</b>	602136	<b>Ref. No.</b>	DQFD2003
<b>description</b>	axial fan L 119mm W 119mm H 38mm 230VAC 50/60Hz 22/38.4W bearing slide bearing manuf. no. HT-A12038S220 connection with cable 500mm cable length 300mm HUI TONG fan wheel ø 110mm input current 0.1/0.16A housing aluminium		
<b>For models:</b>	GBC1001, GBC1001S, GBC1001SS, GBC1002, GBC1002S, GBC1002SS, GBC1003, GBC1003S, GBC1003SS, GBC1102, GBC1103		



1

<b>GEV No.</b>	601604 <sup>1</sup>	<b>Ref. No.</b>	E17A1A010100 S900.34
<b>description</b>	axial fan L 119mm W 119mm H 38mm 230VAC 50/60Hz 17/15W bearing slide bearing manuf. no. AA1282HS-AT connection cable 300mm fan wheel ø 110mm temp.-resist. 70°C input current 0.1A airflow 130m <sup>3</sup> /h 2600rpm		
<b>For models:</b>	GDS2600, GHS1600, GHS2600, GPS2600, GSA2600, GSD2600, GSF2600		

<sup>1</sup>with slide bearings

accessories

fan guards



1

<b>GEV No.</b>	691104	<b>Ref. No.</b>	I0427017 WJFZ0007
<b>description</b>	guard ø 115mm mounting distance 105mm for axial fan 119mm		
<b>For models:</b>	GBC1001, GBC1001S, GBC1001SS, GBC1002, GBC1002S, GBC1002SS, GBC1003, GBC1003S, GBC1003SS, GBC1102, GBC1103, GRE3600, GRE3600S, GSC2336		



connecting cables



<b>GEV No.</b>	550898	<b>Ref. No.</b>	I0221181
<b>description</b>	connecting cable cable length 2000mm connection F 2.8 connection distance 7.9mm for axial flow fan		
<b>For models:</b>	GRE3600, GRE3600S		



refrigeration fans

refrigeration motors universal

ebm-papst

miscellaneous



<b>GEV No.</b>	601783	<b>Ref. No.</b>	E17A1A050500
<b>description</b>	fan motor 10W 230V 50/60Hz L3 87mm W 67mm cable length 400mm 1300rpm ebm-papst M4Q045-CA03-51/C18 3 mounting options bearing slide bearing for refrigerated counters		
<b>For models:</b>	GDS2600, GPS2600, GSA2600, GSD2600, GSF2600		
<b>spare parts for</b>	601783		
	<b>GEV No.</b>	601413	<b>Ref. No.</b> —
	fixing plate suitable for fanwheel ED ø 32mm shaft ø 7 mounting distance 26mm		
<b>accessories for</b>	601783		
	<b>GEV No.</b>	601385	<b>Ref. No.</b> E181A1723401
	fan wheel sucking ø 172mm fan wheel mounting 25.4mm blade angle 34° W 42mm aluminium		

IMPORT

multi fit fan motors WEIGUANG



<b>GEV No.</b>	601020	<b>Ref. No.</b>	W0301906 W0301911
<b>description</b>	fan motor 5W 230V 50-60Hz L1 44mm L2 48mm L3 79mm W 84mm cable length 500mm 1300rpm YZF5-13-18/26 5 mounting options bearing slide bearing		
<b>For models:</b>	GFR2700, GRE2700		

miscellaneous



<b>GEV No.</b>	601789	<b>Ref. No.</b>	1.1.A.A03.01.10
<b>description</b>	fan motor 10W 220-240V 50/60Hz L1 83mm L2 92mm W 84mm cable length 1000mm 1300/1550rpm WEIGUANG YZF10-20		
<b>For models:</b>	GGC2270, GGC2270B		
<b>spare parts for</b>	601789		
	<b>GEV No.</b>	601413	<b>Ref. No.</b> —
	fixing plate suitable for fanwheel ED ø 32mm shaft ø 7 mounting distance 26mm		

accessories

fan wheels

aluminium

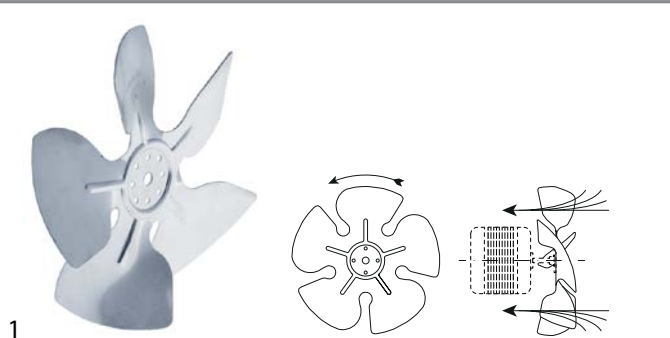

<b>GEV No.</b>	601553	<b>Ref. No.</b>	W0301078
<b>description</b>	fan wheel sucking ø 172mm fan wheel mounting 25.4mm blade angle 28° W 35mm aluminium		
<b>For models:</b>	GFR2700, GRE2700		

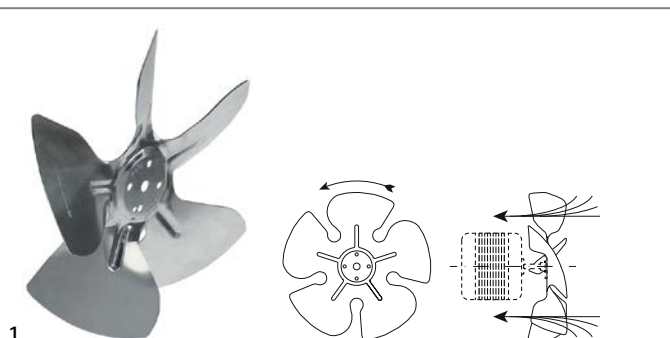

<b>GEV No.</b>	601385	<b>Ref. No.</b>	E181A1723401
<b>description</b>	fan wheel sucking ø 172mm fan wheel mounting 25.4mm blade angle 34° W 42mm aluminium		
<b>For models:</b>	GDS2600, GPS2600, GSA2600, GSD2600, GSF2600		

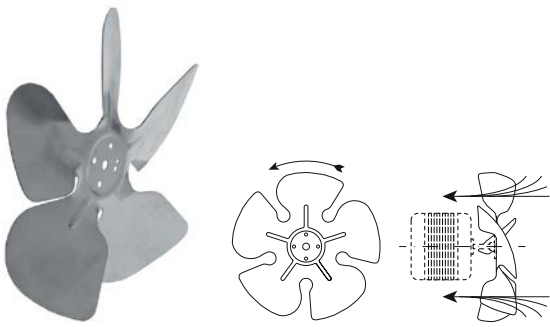

1

<b>GEV No.</b>	601070	<b>Ref. No.</b>	1.1.A.A03.03.05 W0301060
<b>description</b>	fan wheel sucking ø 200mm fan wheel mounting 25.4mm blade angle 28° W 38mm aluminium		
<b>For models:</b>	GFR2700, GGC2270, GGC2270B, GRE2700		

fan guards

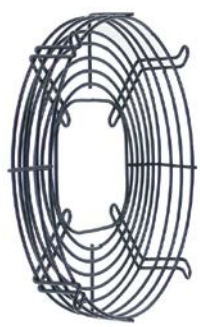

1

<b>GEV No.</b>	602101	<b>Ref. No.</b>	E192A1200300 E192A1723800
<b>description</b>	guard ø 210mm H 35mm mounting distance 1 230mm mounting distance 2 100mm		
<b>For models:</b>	GDS2600, GPS2600, GSA2600, GSD2600, GSF2600		

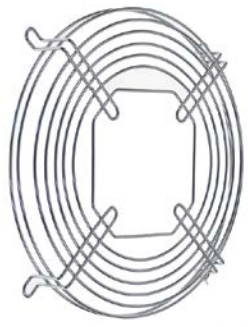

1

<b>GEV No.</b>	699432	<b>Ref. No.</b>	1.1.B.B10.36
<b>description</b>	guard ø 215mm mounting distance 230mm		
<b>For models:</b>	GGC2270, GGC2270B		

cooling motors (complete)



1

<b>GEV No.</b>	602174	<b>Ref. No.</b>	W0301913
<b>description</b>	fan 220-240V 7W 50/60Hz fan wheel ø 170mm connection cable 350mm 1300rpm GFR2700/GRE2700		
<b>For models:</b>	GFR2700, GRE2700		
<b>accessories for</b>	602174		
	<b>GEV No.</b>	699579	<b>Ref. No.</b> 80021501
	bracket for fan for evaporator L 130mm W 80mm hole distance 63mm for GFR2700/GRE2700		



1

<b>GEV No.</b>	601836	<b>Ref. No.</b>	DQJB2004
<b>description</b>	fan 220V 25/3W 50/60Hz fan wheel ø 172mm L 82mm W 82mm connection spate terminal M4 cable length 1000mm		
<b>For models:</b>	GBC1002, GBC1002S, GBC1002SS, GBC1003, GBC1003S, GBC1003SS, GBC1102, GBC1103		



1

<b>GEV No.</b>	601835	<b>Ref. No.</b>	DQJB2013
<b>description</b>	fan 220V 35/5W 50/60Hz L 82mm W 82mm connection spate terminal M4 cable length 1100mm		
<b>spare parts for</b>	601835		
	<b>GEV No.</b>	602184	<b>Ref. No.</b> —
	fixing plate suitable for fanwheel ED ø 33mm shaft ø 6 mounting distance 17mm		



1

<b>GEV No.</b>	601791	<b>Ref. No.</b>	1.1.A.A03.02.04
<b>description</b>	fan motor pair 220-240V 10W 50Hz fan wheel ø 110mm mounting distance 137mm cable length 800mm		
<b>For models:</b>	GGC2270, GGC2270B		

### cold air circulating fans

#### cold air circulating fans



1

<b>GEV No.</b>	601845	<b>Ref. No.</b>	1.1.A.A03.01.08
<b>description</b>	fan motor 220-240V 50Hz IN 22W / OUT 5W shaft ø 4mm shaft L 20/48mm L 65mm W 66mm H 73mm Qty 1 pcs		
<b>For models:</b>	GGC1078, GGC1078B		
<b>accessories for</b>	601845		
	<b>GEV No.</b>	601846	<b>Ref. No.</b> 1.1.C.C17.04
	fan wheel blowing ø 150mm shaft intake ø 4mm W 33mm plastic Qty 1 pcs		

#### accessories

#### fan wheels for cold air circulating fans



1

<b>GEV No.</b>	601846	<b>Ref. No.</b>	1.1.C.C17.04
<b>description</b>	fan wheel blowing ø 150mm shaft intake ø 4mm W 33mm plastic Qty 1 pcs		
<b>For models:</b>	GGC1078, GGC1078B		

### cross flow fans

#### EMMEVI - FERGAS

#### with standard coil



1

<b>GEV No.</b>	601018	<b>Ref. No.</b>	01202330
<b>description</b>	cross flow fan TG 180 roller ø 60mm roller length 180mm motor position right 230V/50Hz 25W universal bearing silicone connection male faston 6.3mm -10 up to +60°C 230V connections 1-2 1950U/min connections 1-4 1500U/min		
<b>For models:</b>	GCO2001		

#### accessories for cross flow fans

#### air ducts



1

<b>GEV No.</b>	701630	<b>Ref. No.</b>	00012330
<b>description</b>	air duct for cross flow fan for combi-steamer plastic grey		
<b>For models:</b>	GCO2001		



hot air fans

miscellaneous



1

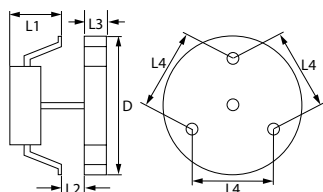

**GEV No.** 500902      **Ref. No.** MOT30029

**description** fan motor 220V 55W 50/60Hz L1 68mm FIME type L25R without fan wheel

**For models:** GCO500

**accessories for** 500902

**GEV No.** 550879      **Ref. No.** —



insulation ø 130mm thickness 3mm hole ø 18mm for hot air fan



1

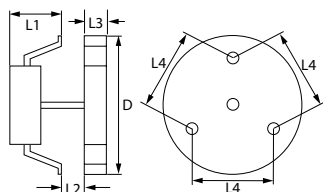

**GEV No.** 602100      **Ref. No.** 01203230

**description** hot air fan 240V 59W 50/60Hz L1 80mm L2 16mm fan wheel ø 150mm IMS type 138251

**For models:** GCO2001

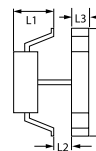

1

**GEV No.** 601838      **Ref. No.** 278009000033

**description** fan motor 220-240V 18W 2500rpm L1 33mm L2 12mm L3 15mm L4mm fan wheel ø 120mm shaft 2x2.5mm GALANZ type GAL6309E(30)-ZD Qty 1 pcs

**For models:** GMW1025



1

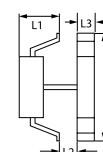

**GEV No.** 601827      **Ref. No.** DQB000019R

**description** hot air fan 18V 2750rpm L1 6mm L2mm L3 16mm L4mm fan wheel ø 85mm type YHWF-85

**For models:** GIC3035

accessories

fan wheels for hot air fans



1

**GEV No.** 601839      **Ref. No.** 223149000014

**description** fan wheel ø 120mm W 32mm shaft intake ø 2x2.5mm plastic blades 4 Qty 1 pcs

**For models:** GMW1025



1

**GEV No.** 601261      **Ref. No.** VEN30013

**description** fan wheel ø 154mm W 25mm shaft intake ø 6x5mm chrome-plated blades 7

**For models:** GCO500





miscellaneous



<b>1</b>			
<b>GEV No.</b>	601840	<b>Ref. No.</b>	22313900011
<b>description</b>	bracket $\varnothing$ 130mm L 135mm W 130mm for hot air fan Qty 1 pcs		
<b>For models:</b>	GMW1025		

motors

for slicers

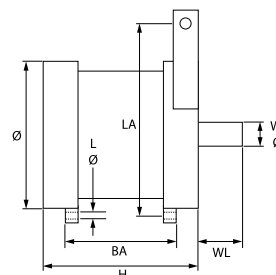

<b>1</b>			
<b>GEV No.</b>	501530	<b>Ref. No.</b>	0000001753
<b>description</b>	motor 230V 1 phase 50Hz 1380rpm shaft $\varnothing$ 15mm shaft length 25mm 195-220 edition since 04/2016		
<b>For models:</b>	GFS2019		

speed controllers

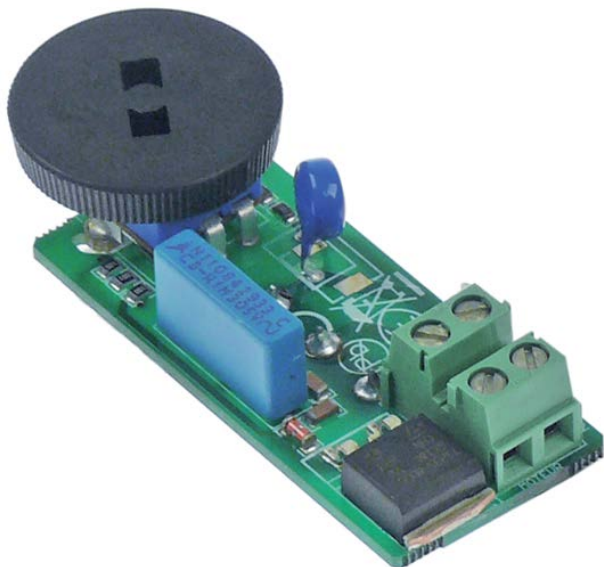

<b>1</b>			
<b>GEV No.</b>	403165	<b>Ref. No.</b>	2852
<b>description</b>	PCB GSM1000 speed control		
<b>For models:</b>	GSM1000		
<b>spare parts for</b>	403165		
	<b>GEV No.</b>	<b>Ref. No.</b>	<b>2858</b>
	knob for PCB $\varnothing$ 26mm black Qty 1 pcs		

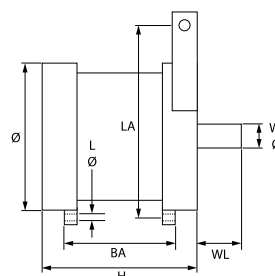

<b>1</b>			
<b>GEV No.</b>	501427	<b>Ref. No.</b>	00000700283
<b>description</b>	motor 230V 1 phase 50Hz 1380rpm shaft $\varnothing$ 15mm shaft length 25mm $\varnothing$ 115mm H 86mm mounting distance 44mm hole distance 145mm hole $\varnothing$ 6mm type H35-700283		
<b>For models:</b>	GFS1022, GFS2022		

motors

gear motors

for microwaves



<b>1</b>			
<b>GEV No.</b>	601867	<b>Ref. No.</b>	27801900017
<b>description</b>	gear motor GALANZ type GAL-33-30-TD(B) 4W 30V voltage AC 50/60Hz 33/40rpm shaft $\varnothing$ 6x3.5mm for microwave Qty 1 pcs		
<b>For models:</b>	GMW1025		

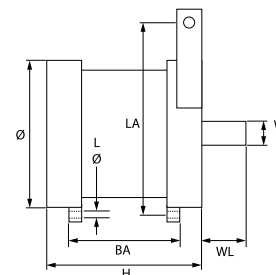

<b>1</b>			
<b>GEV No.</b>	501434	<b>Ref. No.</b>	0000000423
<b>description</b>	motor 230V 1 phase 50Hz 1380rpm shaft $\varnothing$ 15mm shaft length 33mm $\varnothing$ 113mm H 91mm mounting distance 49mm hole distance 150mm hole $\varnothing$ 6mm type H40-423 ELETTRMECANICA capacitor 8 $\mu$ F		
<b>For models:</b>	GFS1025, GFS2025		



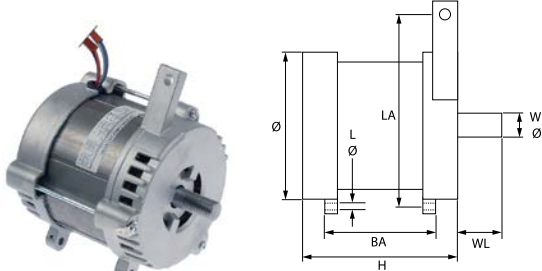



1

<b>GEV No.</b>	501433	<b>Ref. No.</b>	0000000681
<b>description</b>	motor 230V 1 phase 50Hz 1380rpm shaft $\varnothing$ 15mm shaft length 35mm $\varnothing$ 113mm H 121mm mounting distance 79mm hole distance 150mm hole $\varnothing$ 6mm type H70-681 ELETTRMECANICA capacitor 10 $\mu$ F		
<b>For models:</b>	GFS1030		

for hand blenders

motors



1

<b>GEV No.</b>	698378	<b>Ref. No.</b>	2847
<b>description</b>	motor for hand blender 230V 100W shaft $\varnothing$ 6.4mm GSM1000		
<b>For models:</b>	GSM1000		

for citrus juicers



1

<b>GEV No.</b>	501426	<b>Ref. No.</b>	900956
<b>description</b>	motor for citrus juicers 180W 230-240V 50Hz shaft $\varnothing$ 8mm shaft length 40mm type RCJ298252 0.18kW		
<b>For models:</b>	GJU1001		

## pumps

### wash and rinse pumps

#### LGB



<b>GEV No.</b>	500984	<b>Ref. No.</b>	902263
<b>description</b>	pump inlet $\varnothing$ 45mm outlet $\varnothing$ 39mm type ZF270VSX 230V 50Hz 1 phase 0.4kW L 209mm rotation direction right capacitor 10 $\mu$ F LGB		
<b>For models:</b>	GDW2001		

### drain pumps

#### HANNING



<b>GEV No.</b>	501596	<b>Ref. No.</b>	902332
<b>description</b>	drain pump 40W 220-240V inlet $\varnothing$ 30mm outlet $\varnothing$ 24mm 50Hz type DPS35-061 HANNING		
<b>For models:</b>	GDW2001		

### booster pumps II

#### accessories



<b>GEV No.</b>	365015	<b>Ref. No.</b>	0000000633
<b>description</b>	operating capacitor capacity 10 $\mu$ F 400V tolerance 5%Hz ambient temperature max. -25 to +85°C $\varnothing$ 35.5mm L 59mm M8 plastic connection male faston 6.3mm protection		
<b>For models:</b>	GFS1030, GFS2030		





1

<b>GEV No.</b>	365012	<b>Ref. No.</b>	00000000149
<b>description</b>	operating capacitor capacity 6.3µF 450V tolerance 5% 50Hz ambient temperature max. -25 to +85°C ø 30mm L 61mm M8 plastic connection male faston 6.3mm protection		
<b>For models:</b>	GFS1022		

filters

interference suppression filters



1

<b>GEV No.</b>	365168	<b>Ref. No.</b>	902107
<b>description</b>	interference suppression filter type FCP045000 250V 50/60Hz conductor 4 with E connection male faston 6.3mm L 56mm ø 38mm Hmm Wmm M8 plastic Qty 1 pcs		
<b>For models:</b>	GDW2001		

condensators & interference suppression filters

operating capacitors

plastic



1

<b>GEV No.</b>	365015	<b>Ref. No.</b>	00000000633
<b>description</b>	operating capacitor capacity 10µF 400V tolerance 5%Hz ambient temperature max. -25 to +85°C ø 35.5mm L 59mm M8 plastic connection male faston 6.3mm protection		
<b>For models:</b>	GFS1030, GFS2030		

line filters

without housing



1

<b>GEV No.</b>	403188	<b>Ref. No.</b>	263029001088
<b>description</b>	line filter microwave for GMW1025 250V 50/60Hz conductor 2 PCB connection male faston 4.8mm L 80mm H 20mm W 40mm PCB Qty 1 pcs cable length 120mm type DNV-0818A-5		
<b>For models:</b>	GMW1025		



1

<b>GEV No.</b>	365012	<b>Ref. No.</b>	00000000149
<b>description</b>	operating capacitor capacity 6.3µF 450V tolerance 5% 50Hz ambient temperature max. -25 to +85°C ø 30mm L 61mm M8 plastic connection male faston 6.3mm protection		
<b>For models:</b>	GFS1022		

HV capacitors



1

<b>GEV No.</b>	365159	<b>Ref. No.</b>	253059000142
<b>description</b>	HV capacitor for microwave 1.15µF type CH85-21115 2100V 50/60Hz double connection male faston 4.8mm L 105mm H 33mm W 52mm dependent on equipment aluminium Qty 1 pcs		
<b>For models:</b>	GMW1025		



1

<b>GEV No.</b>	365013	<b>Ref. No.</b>	00000000182
<b>description</b>	operating capacitor capacity 8µF 400V tolerance 5%Hz ambient temperature max. -25 to +85°C ø 31.5mm L 55mm M8 plastic connection male faston 6.3mm protection		
<b>For models:</b>	GFS1025, GFS2019, GFS2022, GFS2025		

fuses

fine fuses



1

<b>GEV No.</b>	358186	<b>Ref. No.</b>	DZJ020003
<b>description</b>	fuse size ø6.3x32 15A slow-acting rated 250V Qty 1 pcs		
<b>For models:</b>	GIC3035		





electric accessories

cables

power supply cables

			
1			
<b>GEV No.</b>	551085	<b>Ref. No.</b>	0000009171 C03013
<b>description</b>	cable CEE7/7 type E+F 3-pole contacts P+N+E 1.5mm <sup>2</sup> max. 16A max 230V 2m with plug H05VV-F 3G1.5		
<b>For models:</b>	GFS1022, GFS1025, GFS1030, GFS2019, GFS2022, GFS2025, GFS2030, GTO1001, GTO2001		

			
1			
<b>GEV No.</b>	698880	<b>Ref. No.</b>	E25EUB315300
<b>description</b>	connecting cable 3-pole contacts P+N+E 1.5mm <sup>2</sup> max. 16A max 250V 2.9m		
<b>For models:</b>	GDS2600, GPS2600, GSA2600, GSD2600, GSF2600		

			
1			
<b>GEV No.</b>	699317	<b>Ref. No.</b>	S900.47
<b>description</b>	connecting cable CEE7/7 type E+F 3-pole contacts P+N+E 1.5mm <sup>2</sup> max. 16A max 250V 2.95m H05VV-F black		
<b>For models:</b>	GHS1600, GHS2600		

			
1			
<b>GEV No.</b>	551203	<b>Ref. No.</b>	C03007 CAV30014
<b>description</b>	connecting cable CEE7/7 type E+F 3-pole contacts P+N+E 2.5mm <sup>2</sup> max. 16A max 230V 2m H07 RN-F with plug		
<b>For models:</b>	GCO500, GEG2001		

			
1			
<b>GEV No.</b>	551232	<b>Ref. No.</b>	253159002607
<b>description</b>	power lead CEE7/7 1mm <sup>2</sup> max 500V 1.5m Qty 1 pcs connection male faston 6.3mm black		
<b>For models:</b>	GMW1025		

			
1			
<b>GEV No.</b>	551217	<b>Ref. No.</b>	DQXA6002
<b>description</b>	power lead CEE7/7 type E+F 3-pole contacts P+N+E 0.75mm <sup>2</sup> max. 16A 2.2m with strain relief 16A Qty 1 pcs white		
<b>For models:</b>	GBC1001, GBC1001S, GBC1001SS, GBC1002, GBC1002S, GBC1002SS, GBC1003, GBC1003S, GBC1003SS, GBC1102, GBC1103, GSC1100G, GSC2336		

			
1			
<b>GEV No.</b>	551218	<b>Ref. No.</b>	1.1.A.A08.02.02 1.1.A.A08.02.79 1.1.A.A08.02.87
<b>description</b>	power lead CEE7/7 type E+F 3-pole contacts P+N+E 0.75mm <sup>2</sup> max. 16A max 230V 2m Qty 1 pcs grey		
<b>For models:</b>	GCV1600, GGC1078, GGC1078B, GGC2270, GGC2270B		

			
1			
<b>GEV No.</b>	551193	<b>Ref. No.</b>	900864
<b>description</b>	power lead CEE7/7 type E+F 3-pole contacts P+N+E 1.5mm <sup>2</sup> max. 16A max 230V 1.37m H07RN-F 3G1.50mm <sup>2</sup> countries A/B/D/F/I		

			
1			
<b>GEV No.</b>	552002	<b>Ref. No.</b>	I3306470
<b>description</b>	power lead CEE7/7 type E+F contacts P+N+E 1mm <sup>2</sup> max. 16A max 230V 2.5m		
<b>For models:</b>	GRE3600, GRE3600S		

			
1			
<b>GEV No.</b>	551325	<b>Ref. No.</b>	XC0000071R
<b>description</b>	power lead P+N+E 1mm <sup>2</sup> max 500V 1.5m Qty 1m connection screw		
<b>For models:</b>	GIC3035		



## accessories

## cable glands

## threaded cable glands

## screw connections



1

<b>GEV No.</b>	551379	<b>Ref. No.</b>	PPC30004
<b>description</b>	cable gland thread PG13.5 cable ø 12mm mounting ø 20mm WS 24 plastic Qty 1 pcs with nut		
<b>For models:</b>	GCO500		



1

<b>GEV No.</b>	551288 <sup>1</sup>	<b>Ref. No.</b>	A10032
<b>description</b>	cable gland thread PG16 cable ø 14mm mounting ø 22.5mm WS 27 plastic Qty 1 pcs		
<b>For models:</b>	GEG2001		

<sup>1</sup>incl. fastening nut

## strain reliefs



1

<b>GEV No.</b>	506235	<b>Ref. No.</b>	1.1.C.C24.03
<b>description</b>	strain relief L 28mm W 12mm H 8mm hole ø 3.5mm hole distance 16mm plastic Qty 1 pcs		
<b>For models:</b>	GGC1078, GGC1078B		

## cable harnesses



1

<b>GEV No.</b>	694615	<b>Ref. No.</b>	253169000472
<b>description</b>	cable harness for microwave L 800mm Qty 1 pcs		
<b>For models:</b>	GMW1025		

## connection cables

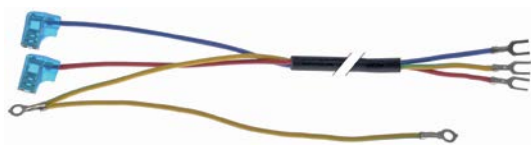

1

<b>GEV No.</b>	699304	<b>Ref. No.</b>	DQXB9019
<b>description</b>	connection cable L 360mm 3-pole		
<b>For models:</b>	GBC1001, GBC1001S, GBC1001SS, GBC1002, GBC1002S, GBC1002SS, GBC1003, GBC1003S, GBC1003SS, GBC1102, GBC1103		

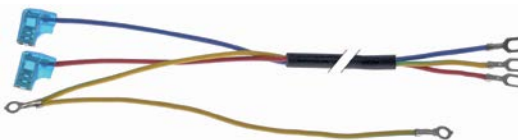

1

<b>GEV No.</b>	699305	<b>Ref. No.</b>	DQXB2003
<b>description</b>	connection cable L 650mm 3-pole		
<b>For models:</b>	GSC2336		



1

<b>GEV No.</b>	699306	<b>Ref. No.</b>	DQXB4003
<b>description</b>	connection cable L 665mm 3-pole		
<b>For models:</b>	GSC1100G		

## terminals

## connection terminals with screw/faston connections



1

<b>GEV No.</b>	551444	<b>Ref. No.</b>	01200720
<b>description</b>	power terminal block 3-pole max. 25A max 450V connection male faston 6.3mm temp.-resist. 150°C		
<b>For models:</b>	GCO2001		



1

<b>GEV No.</b>	550516	<b>Ref. No.</b>	MOR30005
<b>description</b>	power terminal block 3-pole max. 40A max 400V connection M6/ male faston 6.3mm temp.-resist. 150°C cross section 6mm <sup>2</sup> mounting distance 66.5mm		
<b>For models:</b>	GCO500		



1

<b>GEV No.</b>	550411	<b>Ref. No.</b>	904150 A16014
<b>description</b>	power terminal block 6-pole max. 40A max 450V connection ø6mm <sup>2</sup> / F6.3 temp.-resist. 150°C cross section 6mm <sup>2</sup>		
<b>For models:</b>	GDW2001, GEG2001		



connection terminals with faston connections



1			
<b>GEV No.</b>	519372	<b>Ref. No.</b>	904167
<b>description</b>	distribution terminal block 4-pole max. 17.5A max 450V connection F6.3 temp.-resist. 110°C 450V		
<b>For models:</b>	GDW2001		

connection boxes



1			
<b>GEV No.</b>	550300	<b>Ref. No.</b>	A10007
<b>description</b>	power terminal block 3-pole contacts P+N+E		
<b>For models:</b>	GTO1001, GTO2001		

terminal boxes



1			
<b>GEV No.</b>	551214	<b>Ref. No.</b>	S900.48
<b>description</b>	terminal box 4-pole L 90mm W 52mm H 28mm with strain relief Qty 1 pcs		
<b>For models:</b>	GHS1600, GHS2600		



1			
<b>GEV No.</b>	551216	<b>Ref. No.</b>	SLZB3001
<b>description</b>	terminal box 4-pole L 90mm W 52mm H 33mm with strain relief 250V 1mm <sup>2</sup> Qty 1 pcs		
<b>For models:</b>	GBC1001, GBC1001S, GBC1001SS, GBC1002, GBC1002S, GBC1002SS, GBC1003, GBC1003S, GBC1003SS, GBC1102, GBC1103, GSC2336		

equipmentspecific units

for slicers

covers



1			
<b>GEV No.</b>	696528	<b>Ref. No.</b>	00000000489
<b>description</b>	blade covering ø 180mm for knife ø 220mm mounting thread M6 fixing dimensions 12x12mm cast aluminium edition since year of construction 2010		
<b>For models:</b>	GFS1022, GFS2022		

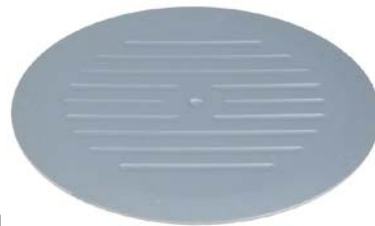

1			
<b>GEV No.</b>	697749	<b>Ref. No.</b>	00000000463 00000000490
<b>description</b>	blade covering ø 209mm for knife ø 250mm mounting thread M6 fixing dimensions 12x12mm aluminium		
<b>For models:</b>	GFS1025, GFS2025		



1			
<b>GEV No.</b>	697744	<b>Ref. No.</b>	00000000403
<b>description</b>	blade covering ø 248mm for knife ø 300mm mounting thread M6 fixing dimensions 12x12mm aluminium		
<b>For models:</b>	GFS1030, GFS2030		

locking screws

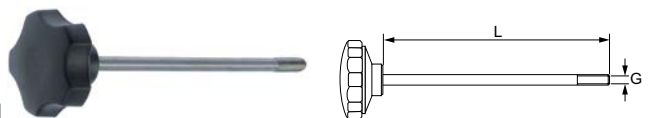

1			
<b>GEV No.</b>	698376	<b>Ref. No.</b>	00000001302 00000701302
<b>description</b>	locking screw thread M6 L 134mm black		
<b>For models:</b>	GFS1022, GFS2022		



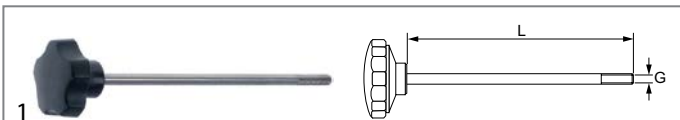

<b>GEV No.</b>	697439	<b>Ref. No.</b>	0000000777
<b>description</b>	locking screw thread M6 L 155mm handle ø 40mm		
<b>For models:</b>	GFS2025		

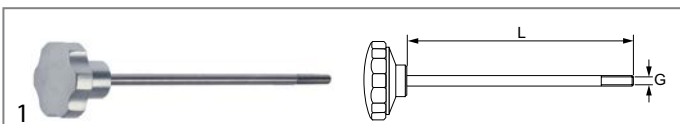

<b>GEV No.</b>	696602	<b>Ref. No.</b>	00000009958
<b>description</b>	locking screw thread M6 L 188mm handle ø 39mm for model 300/S-G,Dolly Verticale VS300		
<b>For models:</b>	GFS1030		

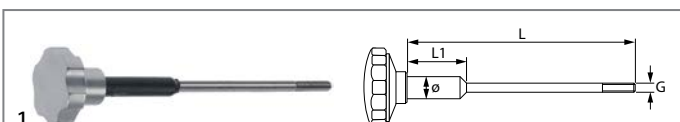

<b>GEV No.</b>	698629	<b>Ref. No.</b>	00000709956
<b>description</b>	locking screw thread M6 L 155mm ø 10mm L1 55mm handle ø 29mm		
<b>For models:</b>	GFS1025		

adjustment knobs



<b>GEV No.</b>	697419	<b>Ref. No.</b>	0000000130 00000700130
<b>description</b>	adjusting knob 0-15 ø 55mm shaft ø 12mm shaft L 28mm handle ø 42mm 250		
<b>For models:</b>	GFS1022, GFS2019, GFS2022, GFS2025, GFS2030		



<b>GEV No.</b>	696522	<b>Ref. No.</b>	00000009503
<b>description</b>	adjusting knob 0-22 ø 68mm shaft ø 18mm shaft L 50mm handle ø 68mm turn direction left		
<b>For models:</b>	GFS1030		

eccentric disc for slice thickness



<b>GEV No.</b>	697470	<b>Ref. No.</b>	00000000830
<b>description</b>	eccentrics for cutting thickness hole ø 12mm groove width 6mm ED ø 52mm thickness 21.5mm		
<b>For models:</b>	GFS2025		



<b>GEV No.</b>	697471	<b>Ref. No.</b>	00000000379
<b>description</b>	eccentrics for cutting thickness hole ø 12mm groove width 6mm ED ø 58mm thickness 21mm		
<b>For models:</b>	GFS1022, GFS1025, GFS2019, GFS2022, GFS2030		

spring washers



<b>GEV No.</b>	697478	<b>Ref. No.</b>	00000000671
<b>description</b>	spring washer ID ø 19mm ED ø 26mm Qty 1 pcs		
<b>For models:</b>	GFS1030		

guiding pieces  
for sliding plates





<b>GEV No.</b>	697483	<b>Ref. No.</b>	00000000117
<b>description</b>	guide 195		
<b>For models:</b>	GFS1022, GFS2019, GFS2022		



<b>GEV No.</b>	697448	<b>Ref. No.</b>	00000009177
<b>description</b>	guide 220-250		
<b>For models:</b>	GFS2025, GFS2030		



			
1			
<b>GEV No.</b>	696524	<b>Ref. No.</b>	00000000602 00000009691
<b>description</b>	guide L 117mm W 92mm H 51mm hole ø 18mm shaft intake ø 16mm aluminium		
<b>For models:</b>	GFS1030		

			
1			
<b>GEV No.</b>	697477	<b>Ref. No.</b>	00000000126
<b>description</b>	connection plate L 75mm W 15mm		
<b>For models:</b>	GFS2019, GFS2022, GFS2025, GFS2030		

for carriage			
			
1			
<b>GEV No.</b>	696510	<b>Ref. No.</b>	00000009466
<b>description</b>	guide 220		
<b>For models:</b>	GFS1022, GFS2019, GFS2022		

bushes			
			
1			
<b>GEV No.</b>	698626	<b>Ref. No.</b>	00000000119
<b>description</b>	bush ED ø 18mm ID ø 16mm H 15mm		
<b>For models:</b>	GFS1030, GFS2025, GFS2030		

			
1			
<b>GEV No.</b>	698627	<b>Ref. No.</b>	00000000611
<b>description</b>	bush ED ø 8mm ID ø 5mm H 10mm		
<b>For models:</b>	GFS1030		

spindles			
			
1			
<b>GEV No.</b>	697782	<b>Ref. No.</b>	00000000501
<b>description</b>	spindle for carriage ø 16mm L 390mm thread M8		
<b>For models:</b>	GFS1025		

housings			
bottom parts			
			
1			
<b>GEV No.</b>	696512	<b>Ref. No.</b>	00000000504
<b>description</b>	bottom plate 220		
<b>For models:</b>	GFS1022, GFS2019, GFS2022		

			
1			
<b>GEV No.</b>	696345	<b>Ref. No.</b>	00000000516
<b>description</b>	bottom plate L 390mm W 190mm plastic 300		
<b>For models:</b>	GFS1025		

			
1			
<b>GEV No.</b>	698393	<b>Ref. No.</b>	00000000701
<b>description</b>	bottom plate L 409mm W 174mm plastic		
<b>For models:</b>	GFS2025, GFS2030		

			
1			
<b>GEV No.</b>	698389	<b>Ref. No.</b>	00000000768
<b>description</b>	cover L 447mm W 180mm plastic		
<b>For models:</b>	GFS1030		

hand guard			
			
1			
<b>GEV No.</b>	697754	<b>Ref. No.</b>	00000000784
<b>description</b>	hand protection for knife ø 300mm H 125mm W 60mm thickness 1.2mm hole ø 6.5mm mounting distance 84mm stainless steel		
<b>For models:</b>	GFS1030		

			
1			
<b>GEV No.</b>	696511	<b>Ref. No.</b>	00000000197
<b>description</b>	wiper for knife ø 220/250mm stainless steel		
<b>For models:</b>	GFS1025, GFS2025		

			
1			
<b>GEV No.</b>	697481	<b>Ref. No.</b>	00000000623
<b>description</b>	Thumb screw thread M6 thread L 8mm ø 14mm H 6mm SS		
<b>For models:</b>	GFS1030, GFS2019, GFS2022, GFS2025		

			
1			
<b>GEV No.</b>	697755	<b>Ref. No.</b>	00000000162
<b>description</b>	hand protection for carriage 300 H 180mm W 152mm thickness 5mm hole ø 10mm mounting distance 110mm plastic		
<b>For models:</b>	GFS1030		

			
1			
<b>GEV No.</b>	698640	<b>Ref. No.</b>	00000009924
<b>description</b>	blade pulley complete with shaft shaft ø 14 shaft length 95mm mounting thread M5 3 hole fixing		
<b>For models:</b>	GFS1022, GFS2022		

			
1			
<b>GEV No.</b>	697826	<b>Ref. No.</b>	00000000924
<b>description</b>	hand protection for slicer		
<b>For models:</b>	GFS1025, GFS2025		



			
1			
<b>GEV No.</b>	697747	<b>Ref. No.</b>	00000009920
<b>description</b>	blade pulley with spindle D1 ø 40mm D2 ø 64.3mm D3 ø 67.5mm shaft ø 14 L 33mm shaft length 152mm mounting thread M5 mounting ø 3-hole		
<b>For models:</b>	GFS1025		

			
1			
<b>GEV No.</b>	698964	<b>Ref. No.</b>	00000000482
<b>description</b>	hand protection for slicer 195-220		
<b>For models:</b>	GFS2019, GFS2022		

			
1			
<b>GEV No.</b>	697746	<b>Ref. No.</b>	00000009469
<b>description</b>	blade pulley with spindle D1 ø 40mm D2 ø 76mm shaft ø 16 L 40mm shaft length 157mm mounting thread M5 mounting ø 3-hole		
<b>For models:</b>	GFS1030		

accessories

			
1			
<b>GEV No.</b>	697482	<b>Ref. No.</b>	00000000446
<b>description</b>	screw thread M5 ø 8mm L 15mm		
<b>For models:</b>	GFS1025, GFS1030, GFS2019, GFS2022, GFS2025		



<b>spare parts for</b> 697746			
	<b>GEV No.</b>	514030	<b>Ref. No.</b> —
retaining ring shaft ø 20mm thickness 1.3mm steel DIN 471			
	<b>GEV No.</b>	523512	<b>Ref. No.</b> 00000000632
deep-groove ball bearing type 6204-2RS shaft ø 20mm ED ø 47mm W 14mm with sealing discs deep-groove ball bearing DIN 625-1			
	<b>GEV No.</b>	692029	<b>Ref. No.</b> —
retaining ring bore ø 47mm thickness 1.8mm steel DIN 472			



food holders

handles

			
1			
<b>GEV No.</b>	698642	<b>Ref. No.</b>	00000001130
<b>description</b>	handle thread M10 ø 59mm L 100mm aluminium		
<b>For models:</b>	GFS1030		

			
1			
<b>GEV No.</b>	696515	<b>Ref. No.</b>	00000001242
<b>description</b>	handle thread M10x1.5 ø 34mm L 88mm food holder		
<b>For models:</b>	GFS1025		
<b>accessories for</b>	696515		
	<b>GEV No.</b>	696517	<b>Ref. No.</b> 00000800678
	 thread bolt for handle ø 12mm L 64mm thread M6/M10 stainless steel		

			
1			
<b>GEV No.</b>	697429	<b>Ref. No.</b>	00000000298
<b>description</b>	handle thread M6 ø 25mm L 126mm with hand guard D1 ø 70mm		
<b>For models:</b>	GFS2019, GFS2022, GFS2025, GFS2030		

food holders



			
1			
<b>GEV No.</b>	698644	<b>Ref. No.</b>	00000000608
<b>description</b>	food holder 300-350 L 290mm hole ø 12mm handle M10 CE		
<b>For models:</b>	GFS1030		
<b>accessories for</b>	698644		
	<b>GEV No.</b>	110703	<b>Ref. No.</b> —
	 cylindrical handle thread M10 ø 28mm L 87mm		

			
1			
<b>GEV No.</b>	698418	<b>Ref. No.</b>	00000009878
<b>description</b>	food holder L 240mm hole ø 12mm handle M6 with handle		
<b>For models:</b>	GFS1025, GFS2025, GFS2030		

accessories

			
1			
<b>GEV No.</b>	698630	<b>Ref. No.</b>	00000000827
<b>description</b>	spike food holder ø 3mm L 11.5mm		
<b>For models:</b>	GFS1025, GFS1030, GFS2019, GFS2022, GFS2025, GFS2030		

			
1			
<b>GEV No.</b>	697480	<b>Ref. No.</b>	00000000151
<b>description</b>	stop bolt food holder ø 7.5mm L 8mm plastic		
<b>For models:</b>	GFS1025, GFS1030, GFS2019, GFS2022, GFS2025, GFS2030		

			
1			
<b>GEV No.</b>	696517	<b>Ref. No.</b>	00000800678
<b>description</b>	thread bolt for handle ø 12mm L 64mm thread M6/M10 stainless steel		
<b>For models:</b>	GFS1025		
<b>accessories for</b>	696517		
	<b>GEV No.</b>	696515	<b>Ref. No.</b> 00000001242
	 handle thread M10x1.5 ø 34mm L 88mm food holder		

blades

standard

			
1			
<b>GEV No.</b>	697546	<b>Ref. No.</b>	00000000254
<b>description</b>	slicing machine blade ED ø 195mm seat ø 30mm 3-hole ID ø 155mm H 12.8mm C45 standard		
<b>For models:</b>	GFS2019		

			
1			
<b>GEV No.</b>	697436	<b>Ref. No.</b>	00000000855
<b>description</b>	slicing machine blade ED ø 220mm seat ø 40mm 3-hole ID ø 180mm H 15.5mm C45		
<b>For models:</b>	GFS1022, GFS2022		

			
1			
<b>GEV No.</b>	697365	<b>Ref. No.</b>	0000000142
<b>description</b>	slicing machine blade ED ø 250mm seat ø 40mm 3-hole ID ø 210mm H 17.5mm C45 standard		
<b>For models:</b>	GFS1025, GFS2025		

			
1			
<b>GEV No.</b>	697385	<b>Ref. No.</b>	00000000636
<b>description</b>	slicing machine blade ED ø 300mm seat ø 40mm 3-hole ID ø 250mm H 20mm C45 standard		
<b>For models:</b>	GFS1030, GFS2030		

### sharpener units

#### lids

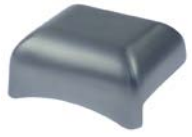
			
1			
<b>GEV No.</b>	696514	<b>Ref. No.</b>	00000000863
<b>description</b>	lid for sharpener units L 116mm W 100mm mounting distance 26mm		
<b>For models:</b>	GFS1025, GFS2022, GFS2025		

			
1			
<b>GEV No.</b>	698643	<b>Ref. No.</b>	00000000596
<b>description</b>	lid for sharpener units L 150mm W 120mm		
<b>For models:</b>	GFS1030, GFS2030		

#### holders

			
1			
<b>GEV No.</b>	696493	<b>Ref. No.</b>	00000000771
<b>description</b>	bracket for sharpener units L 60mm W 31mm H 78mm hole ø 12mm mounting thread M6 with fastening angle		
<b>For models:</b>	GFS1030		

<b>knobs</b>			
			
1			
<b>GEV No.</b>	697441	<b>Ref. No.</b>	00000000854
<b>description</b>	locking screw thread M5 handle ø 25mm black L 30mm		
<b>For models:</b>	GFS2022, GFS2025		

			
1			
<b>GEV No.</b>	696518	<b>Ref. No.</b>	00000009954
<b>description</b>	locking screw thread M5 L 47mm handle ø 25mm silver		
<b>For models:</b>	GFS1025		

			
1			
<b>GEV No.</b>	697428	<b>Ref. No.</b>	00000000138
<b>description</b>	locking screw thread M6 handle ø 25mm black L 15mm		
<b>For models:</b>	GFS2019		

			
1			
<b>GEV No.</b>	697384	<b>Ref. No.</b>	00000000734
<b>description</b>	locking screw thread M6 handle ø 25mm black L 54mm		
<b>For models:</b>	GFS2030		

			
1			
<b>GEV No.</b>	696523	<b>Ref. No.</b>	00000009510
<b>description</b>	locking screw thread M6 L 53mm handle ø 34mm silver		
<b>For models:</b>	GFS1030		

			
1			
<b>GEV No.</b>	697445	<b>Ref. No.</b>	00000000677
<b>description</b>	mushroom cap handle thread M6 handle ø 33mm L 26mm plastic black		
<b>For models:</b>	GFS2030		







sharpener units





1			
<b>GEV No.</b>	697397	<b>Ref. No.</b>	00000009864
<b>description</b>	blade sharpener 220/250/275		
<b>For models:</b>	GFS1022, GFS1025, GFS2022, GFS2025		



1			
<b>GEV No.</b>	697355	<b>Ref. No.</b>	00000009693
<b>description</b>	blade sharpener 350		
<b>For models:</b>	GFS1030		
<b>spare parts for</b>	697355		
	<b>GEV No.</b>	697377	<b>Ref. No.</b> 00000000720
	grindstone ø 51mm thickness 12mm bore ø 8mm grained coarse without bevel		
	<b>GEV No.</b>	697378	<b>Ref. No.</b> 00000000721
	grindstone ø 51mm thickness 7mm bore ø 8mm grained fine with bevel, without hub		



1			
<b>GEV No.</b>	697420	<b>Ref. No.</b>	00000009168
<b>description</b>	blade sharpener PARKER		
<b>For models:</b>	GFS2019		
<b>spare parts for</b>	697420		
	<b>GEV No.</b>	697423	<b>Ref. No.</b> 00000000816
	grindstone ø 40mm thickness 8mm bore ø 6mm grained fine with bevel, with hub		
	<b>GEV No.</b>	697424	<b>Ref. No.</b> 00000000871
	grindstone ø 40mm thickness 8mm bore ø 6mm grained coarse with bevel, with hub		
	<b>GEV No.</b>	697428	<b>Ref. No.</b> 00000000138
	locking screw thread M6 handle ø 25mm black L 15mm		

spindles



1			
<b>GEV No.</b>	698633	<b>Ref. No.</b>	00000000778
<b>description</b>	spindle for sharpener units ø 12mm L 95mm thread M5		
<b>For models:</b>	GFS1030		

grindstones



1			
<b>GEV No.</b>	697378	<b>Ref. No.</b>	00000000721
<b>description</b>	grindstone ø 51mm thickness 7mm bore ø 8mm grained fine with bevel, without hub		
<b>For models:</b>	GFS1030, GFS2030		

grindstones with hub



1			
<b>GEV No.</b>	697424	<b>Ref. No.</b>	00000000871
<b>description</b>	grindstone ø 40mm thickness 8mm bore ø 6mm grained coarse with bevel, with hub		
<b>For models:</b>	GFS2019		



1			
<b>GEV No.</b>	697423	<b>Ref. No.</b>	00000000816
<b>description</b>	grindstone ø 40mm thickness 8mm bore ø 6mm grained fine with bevel, with hub		
<b>For models:</b>	GFS2019		



1			
<b>GEV No.</b>	697421	<b>Ref. No.</b>	00000000641
<b>description</b>	grindstone ø 45mm thickness 8mm bore ø 6mm grained coarse with bevel, with hub		
<b>For models:</b>	GFS1025, GFS2022, GFS2025		



1			
<b>GEV No.</b>	697422	<b>Ref. No.</b>	00000000642
<b>description</b>	grindstone ø 45mm thickness 8mm bore ø 6mm grained fine with bevel, with hub		
<b>For models:</b>	GFS1025, GFS2022, GFS2025		

grindstones cup form



1			
<b>GEV No.</b>	697377	<b>Ref. No.</b>	00000000720
<b>description</b>	grindstone ø 51mm thickness 12mm bore ø 8mm grained coarse without bevel		
<b>For models:</b>	GFS1030, GFS2030		

carriages

handles



1			
<b>GEV No.</b>	697440	<b>Ref. No.</b>	00000000432
<b>description</b>	handle thread M10 handle ø 66mm H 51mm black		
<b>For models:</b>	GFS1022		

accessories



1			
<b>GEV No.</b>	696516	<b>Ref. No.</b>	00000000186
<b>description</b>	bracket for carriage L 56mm aluminium		
<b>For models:</b>	GFS2019, GFS2022		



1			
<b>GEV No.</b>	698631	<b>Ref. No.</b>	00000000895
<b>description</b>	spindle for carriage thread M6 L 170mm ø 12mm		
<b>For models:</b>	GFS2025		



1			
<b>GEV No.</b>	697827	<b>Ref. No.</b>	00000000678
<b>description</b>	spindle for slicer thread M10 L 95mm thread L 12/15mm total length 122mm ø 16mm stainless steel		
<b>For models:</b>	GFS1030		

miscellaneous



1			
<b>GEV No.</b>	697356	<b>Ref. No.</b>	00000000300
<b>description</b>	bracket thread M10x0.75 ø 30mm for microswitch ID ø 14.5mm thickness 13mm mounting thread M5		
<b>For models:</b>	GFS1025		



1			
<b>GEV No.</b>	697476	<b>Ref. No.</b>	00000000509
<b>description</b>	bush ø 14mm L 88mm ID ø 12mm		
<b>For models:</b>	GFS1025, GFS2019, GFS2022, GFS2025, GFS2030		



1			
<b>GEV No.</b>	698388	<b>Ref. No.</b>	00000000765
<b>description</b>	mounting flange ø 18mm L 128mm W 28mm		
<b>For models:</b>	GFS1030		



1			
<b>GEV No.</b>	698392	<b>Ref. No.</b>	00000000828
<b>description</b>	thread bolt thread M6 ø 6mm L 35mm for slicer		
<b>For models:</b>	GFS1025, GFS1030, GFS2019, GFS2022, GFS2025, GFS2030		



1			
<b>GEV No.</b>	698628	<b>Ref. No.</b>	00000000774
<b>description</b>	threaded shaft thread M6 L 37mm for slicer		
<b>For models:</b>	GFS1030		

for hand blenders

housings



1			
<b>GEV No.</b>	699708	<b>Ref. No.</b>	2840M
<b>description</b>	cover for handle blue GSM1000 L 80mm W 42mm		
<b>For models:</b>	GSM1000		



			
1			
<b>GEV No.</b>	696503	<b>Ref. No.</b>	2851
<b>description</b>	handle for hand blender plastic grey		
<b>For models:</b>	GSM1000		

			
1			
<b>GEV No.</b>	699134	<b>Ref. No.</b>	2849M
<b>description</b>	housing left blue GSM1000		
<b>For models:</b>	GSM1000		
<b>accessories for</b>	699134		
	<b>GEV No.</b>	<b>Ref. No.</b>	
	699133	2843M	
	housing right blue GSM1000		

			
1			
<b>GEV No.</b>	699133	<b>Ref. No.</b>	2843M
<b>description</b>	housing right blue GSM1000		
<b>For models:</b>	GSM1000		
<b>accessories for</b>	699133		
	<b>GEV No.</b>	<b>Ref. No.</b>	
	699134	2849M	
	housing left blue GSM1000		

			
1			
<b>GEV No.</b>	698386	<b>Ref. No.</b>	2848M
<b>description</b>	sticker for hand blender silver L 125mm W 25mm thickness 1mm ON-OFF		
<b>For models:</b>	GSM1000		

			
1			
<b>GEV No.</b>	698387	<b>Ref. No.</b>	2853M
<b>description</b>	sticker for lid silver L 50mm W 27mm		
<b>For models:</b>	GSM1000		

couplings

			
1			
<b>GEV No.</b>	696504	<b>Ref. No.</b>	2846
<b>description</b>	coupling for hand blender D1 ø 19mm int. ø 1 6.3mm L 29.5mm teeth 8 GSM1000		
<b>For models:</b>	GSM1000		

			
1			
<b>GEV No.</b>	696505	<b>Ref. No.</b>	2860
<b>description</b>	coupling with roll pin for hand blender D1 ø 19mm int. ø 1 8mm teeth 8 GSM1000		
<b>For models:</b>	GSM1000		

blender sticks

blades

blades with adaptor (complete)

			
1			
<b>GEV No.</b>	698262	<b>Ref. No.</b>	0551
<b>description</b>	knife ø 39mm hole ø 4mm H 12mm		
<b>For models:</b>	GSM1000		



1

<b>GEV No.</b>	698261	<b>Ref. No.</b>	0550
<b>description</b>	knife ø 39mm hole ø 4mm H 18mm		
<b>For models:</b>	GSM1000		



1

<b>GEV No.</b>	698381	<b>Ref. No.</b>	0552
<b>description</b>	mixer disc ø 36mm hole ø 4mm H 0.8mm GSM1000		
<b>For models:</b>	GSM1000		



1

<b>GEV No.</b>	698382	<b>Ref. No.</b>	0553
<b>description</b>	mixer disc ø 36mm hole ø 4mm H 3.4mm GSM1000		
<b>For models:</b>	GSM1000		

### blender sticks



1

<b>GEV No.</b>	698379	<b>Ref. No.</b>	2845M
<b>description</b>	blender stick GSM1000 L 234mm flange ø 66mm		
<b>For models:</b>	GSM1000		

### spindles



1

<b>GEV No.</b>	698380	<b>Ref. No.</b>	2844M
<b>description</b>	drive shaft for hand blender with coupling D1 ø 4mm D2 ø 8mm L 214mm SS		
<b>For models:</b>	GSM1000		
<b>spare parts for</b>	698380		
	<b>GEV No.</b>	696505	<b>Ref. No.</b> 2860
	coupling with roll pin for hand blender D1 ø 19mm int. ø 1.8mm teeth 8 GSM1000		

### miscellaneous



1

<b>GEV No.</b>	698385	<b>Ref. No.</b>	2841
<b>description</b>	bracket for grab handle L 40mm W 37mm thickness 1.5mm		
<b>For models:</b>	GSM1000		



1

<b>GEV No.</b>	696507	<b>Ref. No.</b>	2854
<b>description</b>	bracket for motor plastic black		
<b>For models:</b>	GSM1000		



1

<b>GEV No.</b>	696506	<b>Ref. No.</b>	2858
<b>description</b>	knob for PCB ø 26mm black Qty 1 pcs		
<b>For models:</b>	GSM1000		



1

<b>GEV No.</b>	532648	<b>Ref. No.</b>	2859
<b>description</b>	O-ring EPDM thickness 1.5mm ID ø 5mm Qty 1 pcs		
<b>For models:</b>	GSM1000		



1

<b>GEV No.</b>	698384	<b>Ref. No.</b>	45710
<b>description</b>	protection cap for grab handle plastic black		
<b>For models:</b>	GSM1000		



1

<b>GEV No.</b>	698383	<b>Ref. No.</b>	0632
<b>description</b>	shaft sealing ID ø 4mm ED ø 12mm for hand blender H 6.3mm		
<b>For models:</b>	GSM1000		



for citrus juicers

spillage trays



1

<b>GEV No.</b>	696502	<b>Ref. No.</b>	900963
<b>description</b>	drain tray for citrus juicers ø 175mm hole ø 42mm H 110mm SS		
<b>For models:</b>	GJU1001		

gaskets



1

<b>GEV No.</b>	532647	<b>Ref. No.</b>	900970
<b>description</b>	O-ring EPDM thickness 1.8mm ID ø 11.8mm Qty 1 pcs		
<b>For models:</b>	GJU1001		



1

<b>GEV No.</b>	511953	<b>Ref. No.</b>	900871
<b>description</b>	seal kit for citrus juicers		
<b>For models:</b>	GJU1001		

motors



1

<b>GEV No.</b>	501426	<b>Ref. No.</b>	900956
<b>description</b>	motor for citrus juicers 180W 230-240V 50Hz shaft ø 8mm shaft length 40mm type RCJ298252 0.18kW		
<b>For models:</b>	GJU1001		

juicer insert



1

<b>GEV No.</b>	650168	<b>Ref. No.</b>	900901
<b>description</b>	filter for citrus juicers ø 155mm H 23mm plastic		
<b>For models:</b>	GJU1001		



1

<b>GEV No.</b>	650167	<b>Ref. No.</b>	221266
<b>description</b>	juicer insert set for citrus juicers ø 57/62/79mm H 45/50/55mm plastic		
<b>For models:</b>	GJU1001		

spindles



1

<b>GEV No.</b>	650170	<b>Ref. No.</b>	900895
<b>description</b>	spindle L 48mm square thread M8x1.25 for citrus juicers WS 12		
<b>For models:</b>	GJU1001		

miscellaneous



1

<b>GEV No.</b>	650171	<b>Ref. No.</b>	900925
<b>description</b>	cover for spindle ø 44mm H 18mm aluminium		
<b>For models:</b>	GJU1001		



1

<b>GEV No.</b>	650169	<b>Ref. No.</b>	221242
<b>description</b>	drip tray for citrus juicers ø 79mm H 20mm plastic black		
<b>For models:</b>	GJU1001		

for fridges

drain systems

drain valves



1

<b>GEV No.</b>	699499	<b>Ref. No.</b>	W0409858
<b>description</b>	drain fitting connection A L 47mm hose ø 15mm for GFR2700/ GRE2700 plastic		
<b>For models:</b>	GFR2700, GRE2700		

<b>accessories for</b>	699499		
	<b>GEV No.</b>	699567	<b>Ref. No.</b>
			W0409859
	<b>description</b>	drain fitting connection B L 20mm for GFR2700/GRE2700 plastic	





1

<b>GEV No.</b>	699567	<b>Ref. No.</b>	W0409859
<b>description</b>	drain fitting connection B L 20mm for GFR2700/GRE2700 plastic		
<b>For models:</b>	GFR2700, GRE2700		
<b>accessories for</b>	699567		
	<b>GEV No.</b>	699499	<b>Ref. No.</b>
			W0409858
	drain fitting connection A L 47mm hose ø 15mm for GFR2700/GRE2700 plastic		

### drain pans



1

<b>GEV No.</b>	530916	<b>Ref. No.</b>	80012001
<b>description</b>	drain pan L 520mm W 233mm H 30mm for GFR2700/GRE2700 hole ø 24mm		
<b>For models:</b>	GFR2700, GRE2700		

### control parts



1

<b>GEV No.</b>	698848	<b>Ref. No.</b>	GPC1088-03
<b>description</b>	lamp with thermostat ø 140mm H 35mm		
<b>For models:</b>	GPC1088		

### spare parts and accessories



1

<b>GEV No.</b>	699568	<b>Ref. No.</b>	W0604038
<b>description</b>	base plate for door hinge mounting pos. lower L 35mm W 25mm for GFR2700/GRE2700		
<b>For models:</b>	GFR2700, GRE2700		



1

<b>GEV No.</b>	699569	<b>Ref. No.</b>	W0604030
<b>description</b>	base plate for door hinge mounting pos. right L 74mm W 42mm for GFR2700/GRE2700		
<b>For models:</b>	GFR2700, GRE2700		



1

<b>GEV No.</b>	694967	<b>Ref. No.</b>	SLCX0002
<b>description</b>	cover L 51mm W 44mm H 12mm plastic mounting distance 30mm		
<b>For models:</b>	GSC2336		



1

<b>GEV No.</b>	692867	<b>Ref. No.</b>	W04102051
<b>description</b>	cover ø 20mm L 400mm W 43mm plastic Qty 1 pcs for GFR2700/GRE2700		
<b>For models:</b>	GFR2700, GRE2700		



<b>accessories for</b>	692867		
	<b>GEV No.</b>	692870	<b>Ref. No.</b>
			W0413062

	<b>GEV No.</b>	696789	<b>Ref. No.</b>
			W0210413
	copper pipe with insulation pipe ø 6 for fridge GFR2700/GRE2700		







			
1			
<b>GEV No.</b>	698849	<b>Ref. No.</b>	GPC1046-03 GPC1088-04
<b>description</b>	cover cap L 96mm W 44mm H 13mm plastic		
<b>For models:</b>	GPC1046, GPC1088		



			
1			
<b>GEV No.</b>	698878	<b>Ref. No.</b>	WJQZ9001
<b>description</b>	guide counterweight for sliding door L 248mm W 20mm H 10mm		
<b>For models:</b>	GBC1102, GBC1103		

			
1			
<b>GEV No.</b>	692870	<b>Ref. No.</b>	W0413062
<b>description</b>	rubber pad L 40mm W 17mm H 30mm for GFR2700/GRE2700		
<b>For models:</b>	GFR2700, GRE2700		
<b>accessories for</b>	692870		
	<b>GEV No.</b>	692867	<b>Ref. No.</b> W04102051
	cover ø 20mm L 400mm W 43mm plastic Qty 1 pcs for GFR2700/GRE2700		
	<b>GEV No.</b>	696789	<b>Ref. No.</b> W0210413
	copper pipe with insulation pipe ø 6 for fridge GFR2700/GRE2700		



			
1			
<b>GEV No.</b>	699232	<b>Ref. No.</b>	I0535012
<b>description</b>	strain relief L 56mm W 14.5mm H 20mm		
<b>For models:</b>	GFR3600S		

<b>housing and bezels</b>			
<b>covers</b>			
			
1			
<b>GEV No.</b>	699586	<b>Ref. No.</b>	80010941 80011041
<b>description</b>	bracket for air baffle L 800mm W 38mm H 20mm for GFR2700/GRE2700 3 holes		
<b>For models:</b>	GFR2700, GRE2700		
<b>accessories for</b>	699586		
	<b>GEV No.</b>	699573	<b>Ref. No.</b> 80010942 80011042
	deflector rear L 1030mm W 363mm H 20mm for GFR2700/GRE2700		

			
1			
<b>GEV No.</b>	699576	<b>Ref. No.</b>	81131203
<b>description</b>	cover for drain pan L 598mm W 218mm H 42mm for GFR2700/GRE2700		
<b>For models:</b>	GFR2700, GRE2700		
<b>accessories for</b>	699576		
	<b>GEV No.</b>	696783	<b>Ref. No.</b> W0803011
	insulation Styropor for drain pan L 515mm W 213mm H 18mm Qty pcs for GFR2700/GRE2700		

			
1			
<b>GEV No.</b>	692879	<b>Ref. No.</b>	W0409863
<b>description</b>	cover for lamp L 185mm W 55mm H 40mm for GFR2700/GRE2700		
<b>For models:</b>	GFR2700, GRE2700		
<b>accessories for</b>	692879		
	<b>GEV No.</b>	357260	<b>Ref. No.</b> W0304086 W0304511
	LED bar L 130mm W 14mm H 8mm cable length 300mm GFR2700/GRE2700		

			
1			
<b>GEV No.</b>	998252	<b>Ref. No.</b>	44037000
<b>description</b>	cover for ventilation L 72mm W 62mm H 10mm Qty 1 pcs		
<b>For models:</b>	GFR3600S, GRE3600, GRE3600S		



			
1			
<b>GEV No.</b>	699574	<b>Ref. No.</b>	81131204
<b>description</b>	cover front for evaporator L 598mm W 295mm H 65mm for GFR2700/GRE2700		
<b>For models:</b>	GFR2700, GRE2700		
<b>accessories for</b>	699574		
	<b>GEV No.</b>	<b>Ref. No.</b>	
	699577	80021203	
<b>description</b>	cover left for evaporator L 255mm W 155mm H 15mm for GFR2700/GRE2700		
	<b>GEV No.</b>	<b>Ref. No.</b>	
	699578	80021204	
<b>description</b>	cover right for evaporator L 255mm W 155mm H 15mm for GFR2700/GRE2700		



<b>control panel</b>			
			
1			
<b>GEV No.</b>	699234	<b>Ref. No.</b>	44027000
<b>description</b>	bezel L 780mm W 67mm H 62mm mounting pos. upper		
<b>For models:</b>	GRE3600		



<b>lids</b>			
			
1			
<b>GEV No.</b>	698864	<b>Ref. No.</b>	GPC1046-05 GPC1088-06
<b>description</b>	cover black L 50mm W 42mm H 7mm		
<b>For models:</b>	GPC1046, GPC1088		

<b> housings</b>			
			
1			
<b>GEV No.</b>	699575	<b>Ref. No.</b>	81131401 81131403
<b>description</b>	front panel front-upper for fridge L 730mm W 300mm H 62mm for GFR2700/GRE2700		
<b>For models:</b>	GFR2700, GRE2700		

			
1			
<b>GEV No.</b>	699233	<b>Ref. No.</b>	I9500323
<b>description</b>	terminal box L 98mm W 74mm H 35mm kit		
<b>For models:</b>	GFR3600S, GRE3600, GRE3600S		

			
1			
<b>GEV No.</b>	699577	<b>Ref. No.</b>	80021203
<b>description</b>	cover left for evaporator L 255mm W 155mm H 15mm for GFR2700/GRE2700		
<b>For models:</b>	GFR2700, GRE2700		
<b>accessories for</b>	699577		
	<b>GEV No.</b>	<b>Ref. No.</b>	
	699574	81131204	
<b>description</b>	cover front for evaporator L 598mm W 295mm H 65mm for GFR2700/GRE2700		
	<b>GEV No.</b>	<b>Ref. No.</b>	
	699578	80021204	
<b>description</b>	cover right for evaporator L 255mm W 155mm H 15mm for GFR2700/GRE2700		

			
1			
<b>GEV No.</b>	699578	<b>Ref. No.</b>	80021204
<b>description</b>	cover right for evaporator L 255mm W 155mm H 15mm for GFR2700/GRE2700		
<b>For models:</b>	GFR2700, GRE2700		
<b>accessories for</b>	699578		
	<b>GEV No.</b>	<b>Ref. No.</b>	
	699574	81131204	
<b>description</b>	cover front for evaporator L 598mm W 295mm H 65mm for GFR2700/GRE2700		
	<b>GEV No.</b>	<b>Ref. No.</b>	
	699577	80021203	
<b>description</b>	cover left for evaporator L 255mm W 155mm H 15mm for GFR2700/GRE2700		

			
1			
<b>GEV No.</b>	699573	<b>Ref. No.</b>	80010942 80011042
<b>description</b>	deflector rear L 1030mm W 363mm H 20mm for GFR2700/GRE2700		
<b>For models:</b>	GFR2700, GRE2700		
<b>accessories for</b>	699573		
	<b>GEV No.</b>	<b>Ref. No.</b>	
	699586	80010941 80011041	
<b>description</b>	bracket for air baffle L 800mm W 38mm H 20mm for GFR2700/GRE2700 3 holes		



equipment feet



1

<b>GEV No.</b>	698865	<b>Ref. No.</b>	GPC1088-12
<b>description</b>	equipment foot M8 thread L 15mm ø 29mm		
<b>For models:</b>	GPC1088		

handles



1

<b>GEV No.</b>	692390	<b>Ref. No.</b>	LCCG0005
<b>description</b>	handle rod for door L 380mm W 40mm aluminium Qty 1 pcs		
<b>For models:</b>	GSC1100G		

caps



1

<b>GEV No.</b>	692372	<b>Ref. No.</b>	S900.03
<b>description</b>	cap grey ø 16.5mm mounting ø 12.5mm H 7mm Qty 1 pcs		
<b>For models:</b>	GHS1600, GHS2600		

frame

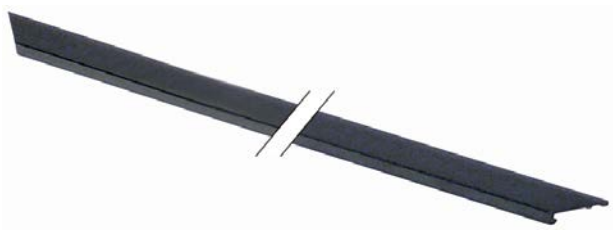

1

<b>GEV No.</b>	699583	<b>Ref. No.</b>	W04102045
<b>description</b>	frame rail for door mounting pos. left/right L 1530mm W 19mm H 7.5mm plastic for GFR2700/GRE2700		
<b>For models:</b>	GFR2700, GRE2700		
<b>accessories for</b>	699583		
	<b>GEV No.</b>	<b>Ref. No.</b>	W04102044
	699584		
	frame rail for door mounting pos. upper/lower L 650mm W 19mm H 7.5mm plastic for GFR2700/GRE2700		



1

<b>GEV No.</b>	699584	<b>Ref. No.</b>	W04102044
<b>description</b>	frame rail for door mounting pos. upper/lower L 650mm W 19mm H 7.5mm plastic for GFR2700/GRE2700		
<b>For models:</b>	GFR2700, GRE2700		
<b>accessories for</b>	699584		
	<b>GEV No.</b>	<b>Ref. No.</b>	W04102045
	699583		
	frame rail for door mounting pos. left/right L 1530mm W 19mm H 7.5mm plastic for GFR2700/GRE2700		

miscellaneous



1

<b>GEV No.</b>	692392	<b>Ref. No.</b>	SLSE4005
<b>description</b>	cover for lighting W 1170mm H 280mm thickness 1mm plastic Qty 1 pcs		
<b>For models:</b>	GSC1100G		



1

<b>GEV No.</b>	692391	<b>Ref. No.</b>	SLZE0027
<b>description</b>	housing for bulb socket L 150mm W 40mm H 20mm plastic Qty 1 pcs		
<b>For models:</b>	GSC1100G, GSC2336		

doors



1

<b>GEV No.</b>	699571	<b>Ref. No.</b>	81130201
<b>description</b>	door right suitable for GFR2700/GRE2700 W 730mm H 1610mm thickness 45mm stainless steel		
<b>For models:</b>	GFR2700, GRE2700		
<b>spare parts for</b>	699571		
	<b>GEV No.</b>	<b>Ref. No.</b>	W0604030
	699569		
	base plate for door hinge mounting pos. right L 74mm W 42mm for GFR2700/GRE2700		
	<b>GEV No.</b>	<b>Ref. No.</b>	W0409842
	701641		
	bush upper for door hinge ID ø 11mm ED ø 13mm L 29.5mm for GFR2700/GRE2700		
	<b>GEV No.</b>	<b>Ref. No.</b>	W0409843
	701642		
	bush lower for door hinge ID ø 11mm ED ø 13mm L 26mm for GFR2700/GRE2700		

Table continues overleaf

<b>spare parts for</b> 699571				
	GEV No.	902514	Ref. No.	W0404514
refrigeration gasket profile 9750 W 660mm L 1537mm plug size				



<b>1</b>	<b>GEV No.</b>	699381	<b>Ref. No.</b>	BLGM4010
<b>description</b> glass door left W 600mm H 1330mm D 40mm				
<b>For models:</b> GSC1100G				

<b>spare parts for</b> 699381				
	GEV No.	901662	Ref. No.	SLJP4007
door seal profile 9156 W 569mm L 1295mm plug size Qty 1 pcs				



<b>1</b>	<b>GEV No.</b>	699382	<b>Ref. No.</b>	BLGM4011
<b>description</b> glass door right W 600mm H 1330mm D 40mm				
<b>For models:</b> GSC1100G				

<b>spare parts for</b> 699382				
	GEV No.	901662	Ref. No.	SLJP4007
door seal profile 9156 W 569mm L 1295mm plug size Qty 1 pcs				

miscellaneous



<b>1</b>	<b>GEV No.</b>	692869	<b>Ref. No.</b>	81131801 W0409081
<b>description</b> cover for drain pipe L 145mm W 49mm H 44mm plastic for GFR2700				
<b>For models:</b> GFR2700, GRE2700				



<b>1</b>	<b>GEV No.</b>	698888	<b>Ref. No.</b>	SLZV0019
<b>description</b> cover transparent for lamp L 810mm W 40mm H 30mm Qty 1 pcs				
<b>For models:</b> GBC1003, GBC1003S, GBC1003SS, GBC1103				

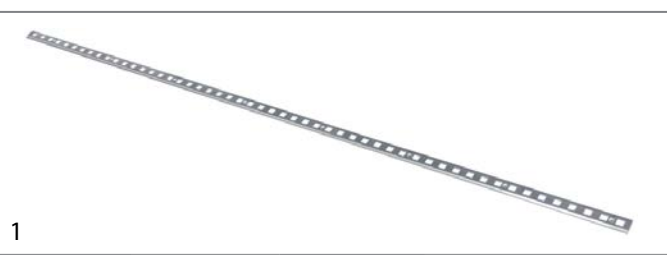

<b>1</b>	<b>GEV No.</b>	692426	<b>Ref. No.</b>	LCCJ2029
<b>description</b> guide for fridge L 1145mm W 26mm H 4.5mm Qty 1 pcs				
<b>For models:</b> GSC1100G, GSC2336				

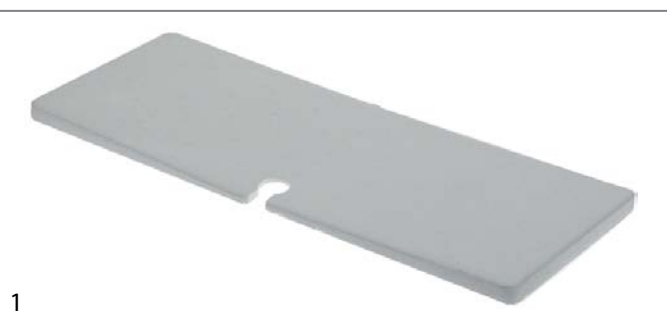

<b>1</b>	<b>GEV No.</b>	696783	<b>Ref. No.</b>	W0803011
<b>description</b> insulation Styropor for drain pan L 515mm W 213mm H 18mm Qty pcs for GFR2700/GRE2700				
<b>For models:</b> GFR2700, GRE2700				

<b>accessories for</b> 696783				
	GEV No.	699576	Ref. No.	81131203
cover for drain pan L 598mm W 218mm H 42mm for GFR2700/GRE2700				





			
1			
<b>GEV No.</b>	698877	<b>Ref. No.</b>	LCCCK0001
<b>description</b>	shelf support L 26.5mm W 8.5mm H 40mm aluminium		
<b>For models:</b>	GSC1100G, GSC2336		

for display coolers

control parts

			
1			
<b>GEV No.</b>	692700	<b>Ref. No.</b>	1.1.C.C12.07
<b>description</b>	door handle L 100mm W 32mm hole distance 68mm black Qty 1 pcs		
<b>For models:</b>	GGC2270B		

			
1			
<b>GEV No.</b>	692409	<b>Ref. No.</b>	1.1.C.C12.06
<b>description</b>	door handle L 100mm W 32mm hole distance 68mm white		
<b>For models:</b>	GGC2270		

			
1			
<b>GEV No.</b>	692402	<b>Ref. No.</b>	1.1.C.C12.14
<b>description</b>	handle grey for vitrine H 9.5mm L 85mm W 25mm mounting distance 70mm Qty 1 pcs		
<b>For models:</b>	GGC1078		

			
1			
<b>GEV No.</b>	692401	<b>Ref. No.</b>	1.1.C.C23.01
<b>description</b>	knob ø 27mm grey zero mark shaft ø 6x4.6mm shaft flat left for thermostat to clip Qty 1		
<b>For models:</b>	GGC1078, GGC1078B		

spare parts and accessories

			
1			
<b>GEV No.</b>	699422	<b>Ref. No.</b>	1.1.C.C63.61
<b>description</b>	clip for dryer L 90mm W 20mm H 52mm plastic Qty 1 pcs		
<b>For models:</b>	GCV1600		

housing and bezels

fascias

			
1			
<b>GEV No.</b>	692411	<b>Ref. No.</b>	1.1.C.C40.02
<b>description</b>	base plate for evaporator L 305mm W 241mm thickness 1.5mm plastic Qty 1 pcs		
<b>For models:</b>	GGC2270, GGC2270B		

			
1			
<b>GEV No.</b>	692405	<b>Ref. No.</b>	1.1.C.C22.08
<b>description</b>	control panel for vitrine temperature MIN/MAX W 130mm D 23mm H 145mm plastic Qty 1 pcs		
<b>For models:</b>	GGC1078, GGC1078B		

			
1			
<b>GEV No.</b>	699410	<b>Ref. No.</b>	1.1.C.C15.03.35
<b>description</b>	front panel mounting pos. front W 518mm D 35mm H 440mm black		
<b>For models:</b>	GGC2270B		



1

<b>GEV No.</b>	699409	<b>Ref. No.</b>	1.1.C.C15.03.03
<b>description</b>	front panel mounting pos. front W 518mm D 35mm H 440mm white		
<b>For models:</b>	GGC2270		



1

<b>GEV No.</b>	699401	<b>Ref. No.</b>	S24AC21A0001
<b>description</b>	front panel mounting pos. front W 865mm D 15mm H 248mm		
<b>For models:</b>	GDS2600, GPS2600, GSA2600, GSD2600, GSF2600		



1

<b>GEV No.</b>	698854	<b>Ref. No.</b>	1.1.C.C15.01.02
<b>description</b>	front panel mounting pos. in the front/at the back black W 427mm D 33mm H 190mm plastic Qty 1 pcs for vitrine		
<b>For models:</b>	GGC1078B		



1

<b>GEV No.</b>	692417	<b>Ref. No.</b>	1.1.C.C21.01
<b>description</b>	housing for control W 130mm D 75mm H 145mm plastic Qty 1 pcs		
<b>For models:</b>	GGC1078, GGC1078B		



1

<b>GEV No.</b>	699415	<b>Ref. No.</b>	1.1.C.C02.02
<b>description</b>	lamp cover W 310mm D 5mm H 172mm black		
<b>For models:</b>	GGC1078, GGC1078B, GGC2270B		



1

<b>GEV No.</b>	699414	<b>Ref. No.</b>	1.1.C.C02.01
<b>description</b>	lamp cover W 310mm D 5mm H 172mm white		
<b>For models:</b>	GGC2270		



1

<b>GEV No.</b>	699407	<b>Ref. No.</b>	S24AC20A0005
<b>description</b>	sheet mounting pos. upper for door W 890mm D 115mm H 10mm		
<b>For models:</b>	GDS2600, GPS2600, GSA2600, GSD2600, GSF2600		

lids



1

<b>GEV No.</b>	699403	<b>Ref. No.</b>	S24AC50A0003
<b>description</b>	top for display refrigerator W 910mm D 705mm H 125mm		
<b>For models:</b>	GSD2600		

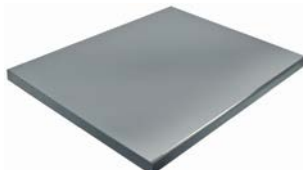

1

<b>GEV No.</b>	699404	<b>Ref. No.</b>	S24AC30A0003
<b>description</b>	top for display refrigerator W 910mm D 705mm H 55mm		
<b>For models:</b>	GDS2600, GSF2600		

housings



1

<b>GEV No.</b>	698851	<b>Ref. No.</b>	1.1.C.C15.01.06
<b>description</b>	back panel for vitrine W 515mm D 45mm H 410mm black		
<b>For models:</b>	GGC2270B		



1

<b>GEV No.</b>	692269	<b>Ref. No.</b>	1.1.C.C15.01.05
<b>description</b>	back panel for vitrine W 515mm D 45mm H 410mm white		
<b>For models:</b>	GGC2270		

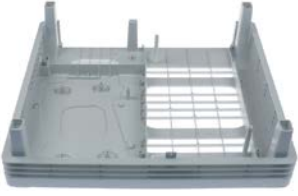



1

<b>GEV No.</b>	692416	<b>Ref. No.</b>	1.1.C.C25.15
<b>description</b>	bottom for vitrine W 378mm H 115mm L 425mm Qty 1 pcs		
<b>For models:</b>	GGC1078		



1

<b>GEV No.</b>	692419	<b>Ref. No.</b>	1.1.C.C01.15
<b>description</b>	casing cover for display refrigerator W 425mm L 380mm plastic Qty 1 pcs white		
<b>For models:</b>	GGC1078		
<b>accessories for</b>	692419		
	<b>GEV No.</b>	<b>Ref. No.</b>	—
	692414		
	lid L 313mm W 163mm for lighting Qty 1 pcs		



1

<b>GEV No.</b>	692437	<b>Ref. No.</b>	1.1.C.C22.07
<b>description</b>	casing cover W 130mm D 70mm H 6mm plastic Qty 1 pcs		
<b>For models:</b>	GGC2270, GGC2270B		



1

<b>GEV No.</b>	692420	<b>Ref. No.</b>	1.1.B.B05.02
<b>description</b>	cover for condenser W 365mm D 220mm H 130mm plate Qty 1 pcs		
<b>For models:</b>	GGC1078, GGC1078B		



1

<b>GEV No.</b>	692422	<b>Ref. No.</b>	1.1.C.C16.02
<b>description</b>	cover for evaporator W 280mm D 345mm H 35mm plastic Qty 1 pcs		
<b>For models:</b>	GGC1078, GGC1078B		



1

<b>GEV No.</b>	692403	<b>Ref. No.</b>	1.1.C.C15.01.01
<b>description</b>	front panel mounting pos. front for vitrine W 427mm D 33mm H 190mm plastic Qty 1 pcs white		
<b>For models:</b>	GGC1078		



1

<b>GEV No.</b>	698860	<b>Ref. No.</b>	1.1.C.C56.84
<b>description</b>	guide mounting pos. front for side part W 23mm D 30mm H 635mm Qty 1 pcs		
<b>For models:</b>	GGC1078B		



1

<b>GEV No.</b>	698861	<b>Ref. No.</b>	1.1.C.C56.85
<b>description</b>	guide mounting pos. rear for side part W 30mm D 30mm H 635mm Qty 1 pcs		
<b>For models:</b>	GGC1078B		



1

<b>GEV No.</b>	699175	<b>Ref. No.</b>	P04AC21A0003
<b>description</b>	housing for control part W 200mm D 115mm H 95mm		
<b>For models:</b>	GDS2600, GPS2600, GSA2600, GSD2600, GSF2600		



1

<b>GEV No.</b>	692415	<b>Ref. No.</b>	1.1.C.C18.04
<b>description</b>	housing for evaporator W 370mm H 175mm L 420mm Qty 1 pcs		
<b>For models:</b>	GGC1078, GGC1078B		



1

<b>GEV No.</b>	699323	<b>Ref. No.</b>	VRX1560.2
<b>description</b>	housing for switch W 114mm D 68mm H 100mm		
<b>For models:</b>	GHS1600, GHS2600		



1

<b>GEV No.</b>	692436	<b>Ref. No.</b>	1.1.C.C21.03
<b>description</b>	housing W 128mm D 65mm H 38mm plastic Qty 1 pcs		
<b>For models:</b>	GGC2270, GGC2270B		



1

<b>GEV No.</b>	692270	<b>Ref. No.</b>	1.1.C.C15.03.08 1.1.C.C15.03.09
<b>description</b>	side panel W 418mm H 410mm plastic white		
<b>For models:</b>	GGC2270		

ventilation grilles



1

<b>GEV No.</b>	698855	<b>Ref. No.</b>	1.1.C.C14.02
<b>description</b>	cover for fan W 425mm D 380mm H 36mm plastic Qty 1 pcs black		
<b>For models:</b>	GGC1078B		



1

<b>GEV No.</b>	699411	<b>Ref. No.</b>	1.1.C.C14.01
<b>description</b>	cover for fan W 425mm D 380mm H 36mm plastic Qty 1 pcs white		
<b>For models:</b>	GGC1078		



1

<b>GEV No.</b>	698853	<b>Ref. No.</b>	1.1.C.C26.02
<b>description</b>	grid mounting pos. lower for ventilation W 350mm D 12mm H 57mm plastic Qty 1 pcs black		
<b>For models:</b>	GGC1078B		



1

<b>GEV No.</b>	699417	<b>Ref. No.</b>	1.1.C.C26.01
<b>description</b>	grid mounting pos. lower for ventilation W 350mm D 12mm H 57mm plastic Qty 1 pcs white		
<b>For models:</b>	GGC1078		



1

<b>GEV No.</b>	701253	<b>Ref. No.</b>	1.1.C.C49.09
<b>description</b>	ventilation grille for air fan plastic black H 50mm L 620mm Qty 1 pcs		
<b>For models:</b>	GCV1600		



1

<b>GEV No.</b>	701254	<b>Ref. No.</b>	1.1.C.C49.10
<b>description</b>	ventilation grille for aspiration plastic black H 50mm L 260mm Qty 1 pcs		
<b>For models:</b>	GCV1600		

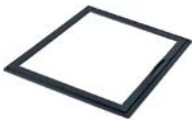

frame			
			
1			
<b>GEV No.</b>	699412	<b>Ref. No.</b>	1.1.C.C63.14
<b>description</b>	door frame inner W 378mm D 10mm H 385mm		
<b>For models:</b>	GCV1600		

			
1			
<b>GEV No.</b>	699413	<b>Ref. No.</b>	1.1.C.C63.13
<b>description</b>	door frame outer W 375mm D 10mm H 375mm		
<b>For models:</b>	GCV1600		

side parts			
			
1			
<b>GEV No.</b>	698862	<b>Ref. No.</b>	1.1.C.C38.19
<b>description</b>	side panel for door L 590mm thickness 17mm		
<b>For models:</b>	GGC1078B		

			
1			
<b>GEV No.</b>	698852	<b>Ref. No.</b>	1.1.C.C15.02.02
<b>description</b>	side panel mounting pos. left/right black W 316mm D 13.5mm H 190mm plastic Qty 1 pcs for vitrine		
<b>For models:</b>	GGC1078B		

			
1			
<b>GEV No.</b>	692404	<b>Ref. No.</b>	1.1.C.C15.02.01
<b>description</b>	side panel mounting pos. left/right white W 316mm D 13.5mm H 190mm plastic Qty 1 pcs for vitrine		
<b>For models:</b>	GGC1078		

			
1			
<b>GEV No.</b>	699444	<b>Ref. No.</b>	1.1.C.C56.06
<b>description</b>	side panel mounting pos. vertical W 40mm D 40mm H 1370mm black		
<b>For models:</b>	GGC2270B		

			
1			
<b>GEV No.</b>	699443	<b>Ref. No.</b>	1.1.C.C56.03
<b>description</b>	side panel mounting pos. vertical W 40mm D 40mm H 1370mm white		
<b>For models:</b>	GGC2270		

			
1			
<b>GEV No.</b>	699324	<b>Ref. No.</b>	VRX38.12
<b>description</b>	side panel W 390mm D 40mm H 222mm		
<b>For models:</b>	GHS1600, GHS2600		

			
1			
<b>GEV No.</b>	698850	<b>Ref. No.</b>	1.1.C.C15.03.10
<b>description</b>	side panel W 418mm H 410mm plastic black		
<b>For models:</b>	GGC2270B		

miscellaneous			
			
1			
<b>GEV No.</b>	699427	<b>Ref. No.</b>	1.1.C.C03.01
<b>description</b>	blank H 5mm ø 12mm		
<b>For models:</b>	GGC1078, GGC2270		

			
1			
<b>GEV No.</b>	699428	<b>Ref. No.</b>	1.1.C.C03.02
<b>description</b>	blank H 5mm ø 12mm		
<b>For models:</b>	GGC1078B, GGC2270B		

			
1			
<b>GEV No.</b>	692369	<b>Ref. No.</b>	1.1.C.C63.71
<b>description</b>	bracket for thermometer W 81mm H 41mm plastic Qty 1 pcs		
<b>For models:</b>	GCV1600		





<b>GEV No.</b>	692410	<b>Ref. No.</b>	1.1.C.C09.01
<b>description</b>	cover for lighting mounting pos. inner L 230mm W 84mm H 2.5mm plastic Qty 1 pcs		
<b>For models:</b>	GGC1078, GGC1078B, GGC2270, GGC2270B		



<b>GEV No.</b>	699315	<b>Ref. No.</b>	SLZE0042
<b>description</b>	fixing plate for evaporator L 55mm W 27mm H 6mm		
<b>For models:</b>	GBC1001, GBC1001S, GBC1001SS, GBC1002, GBC1002S, GBC1002SS, GBC1003, GBC1003S, GBC1003SS, GBC1102, GBC1103		



<b>GEV No.</b>	692370	<b>Ref. No.</b>	1.1.C.C63.70
<b>description</b>	rail for gasket L 740mm W 42mm H 19mm plastic Qty 1 pcs		
<b>For models:</b>	GCV1600		

glass panels

glass panels

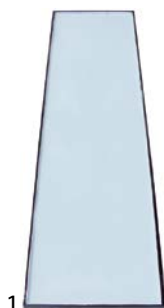

<b>GEV No.</b>	692293	<b>Ref. No.</b>	1.1.E.E2.02.44
<b>description</b>	glass panel L 1392mm W 376mm thickness 10mm flat mounting pos. lateral for display refrigerator		
<b>For models:</b>	GGC2270, GGC2270B		

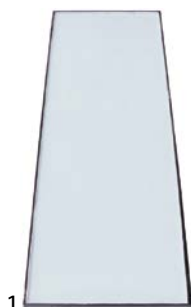

<b>GEV No.</b>	699328	<b>Ref. No.</b>	1.1.E.E2.02.45
<b>description</b>	glass panel L 1395mm W 464mm thickness 17.5mm mounting pos. rear refrigerated show case GGC2270		
<b>For models:</b>	GGC2270, GGC2270B		



<b>GEV No.</b>	699330	<b>Ref. No.</b>	1.1.E.E2.02.76
<b>description</b>	glass panel L 360mm W 357mm thickness 10.5mm for door GCV1600		
<b>For models:</b>	GCV1600		

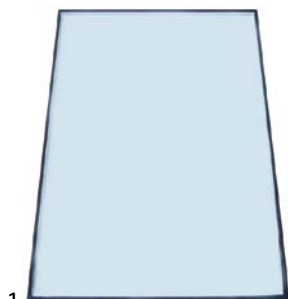

<b>GEV No.</b>	692291	<b>Ref. No.</b>	1.1.E.E2.02.64
<b>description</b>	glass panel L 635mm W 390mm thickness 10mm flat mounting pos. door for display refrigerator		
<b>For models:</b>	GGC1078, GGC1078B		



<b>GEV No.</b>	699326	<b>Ref. No.</b>	1.1.E.E2.02.74
<b>description</b>	glass panel L 645mm W 595mm H 16mm thickness 8mm mounting pos. left for display refrigerator GCV1600		
<b>For models:</b>	GCV1600		

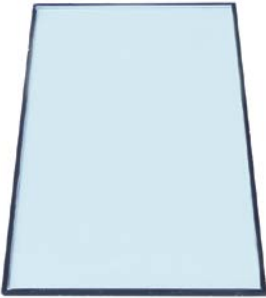

<b>GEV No.</b>	699327	<b>Ref. No.</b>	1.1.E.E2.02.75
<b>description</b>	glass panel L 645mm W 595mm H 16mm thickness 8mm mounting pos. right for display refrigerator GCV1600		
<b>For models:</b>	GCV1600		

1

<b>GEV No.</b>	692292	<b>Ref. No.</b>	1.1.E.E2.02.12
<b>description</b>	glass panel L 655mm W 390mm thickness 10mm flat mounting pos. rear for display refrigerator		
<b>For models:</b>	GGC1078, GGC1078B		

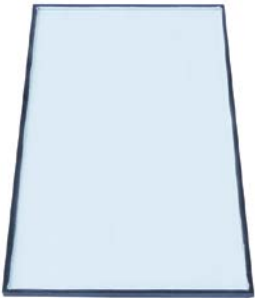

1

<b>GEV No.</b>	692290	<b>Ref. No.</b>	1.1.E.E2.02.11
<b>description</b>	glass panel L 660mm W 332mm thickness 10mm flat mounting pos. lateral for fridge		
<b>For models:</b>	GGC1078, GGC1078B		



1

<b>GEV No.</b>	699329	<b>Ref. No.</b>	1.1.E.E2.04.15.A0
<b>description</b>	glass panel L 773mm W 710mm thickness 12mm mounting pos. front-side for display refrigerator GCV1600		
<b>For models:</b>	GCV1600		

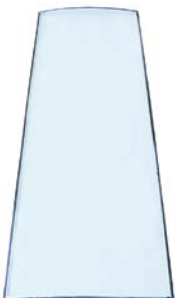

1

<b>GEV No.</b>	692289	<b>Ref. No.</b>	1.1.E.E2.02.65
<b>description</b>	glass panel W 460mm H 1360mm thickness 17mm curved for fridge		
<b>For models:</b>	GGC2270, GGC2270B		

accessories



1

<b>GEV No.</b>	699431	<b>Ref. No.</b>	1.1.B.B14.05
<b>description</b>	rail L 775mm		
<b>For models:</b>	GCV1600		

doors



1

<b>GEV No.</b>	699176	<b>Ref. No.</b>	S24AC22A0001-LEFT
<b>description</b>	door L 515mm W 425mm H 55mm mounting pos. left		
<b>For models:</b>	GPS2600, GSA2600, GSD2600, GSF2600		



1

<b>GEV No.</b>	699177	<b>Ref. No.</b>	S24AC22A0001-RIGHT
<b>description</b>	door L 515mm W 425mm H 55mm mounting pos. right		
<b>For models:</b>	GPS2600, GSA2600, GSD2600, GSF2600		



1

<b>GEV No.</b>	698859	<b>Ref. No.</b>	1.1.C.C11.02
<b>description</b>	door frame L 425mm W 15mm H 28mm mounting pos. upper/lower		
<b>For models:</b>	GGC1078B		

			
1			
<b>GEV No.</b>	699378	<b>Ref. No.</b>	BLGM9H02
<b>description</b>	glass door W 440mm H 770mm with catch mounting pos. right D 25mm		

			
1			
<b>GEV No.</b>	699379	<b>Ref. No.</b>	BLGM9H01
<b>description</b>	glass door W 440mm H 770mm with rollers D 25mm d 8mm delivery freight forwarding company only		

			
1			
<b>GEV No.</b>	699380	<b>Ref. No.</b>	BLGM9H00 GBC1001-44
<b>description</b>	glass door W 600mm H 800mm D 30mm		

			
1			
<b>GEV No.</b>	699405	<b>Ref. No.</b>	S24AC50A0004
<b>description</b>	shelf L 255mm W 890mm H 30mm stainless steel		
<b>For models:</b>	GSD2600		

door mechanics			
bolts			
			
1			
<b>GEV No.</b>	699424	<b>Ref. No.</b>	1.1.B.B09.03
<b>description</b>	door bolt H 7mm W 7mm L 20.5mm mounting pos. upper		
<b>For models:</b>	GGC1078, GGC1078B		

bushes			
			
1			
<b>GEV No.</b>	699430	<b>Ref. No.</b>	1.1.C.C13.02
<b>description</b>	bush H 15mm ø 10mm		
<b>For models:</b>	GGC1078B, GGC2270, GGC2270B		

miscellaneous			
			
1			
<b>GEV No.</b>	694928	<b>Ref. No.</b>	WJCX0000
<b>description</b>	door magnet L 46mm W 16mm H 14.5mm		
<b>For models:</b>	GBC1102, GBC1103		

			
1			
<b>GEV No.</b>	694929	<b>Ref. No.</b>	WJCXG000
<b>description</b>	plate for magnet L 45mm W 12mm H 1.5mm mounting distance 32mm		
<b>For models:</b>	GBC1102, GBC1103		



for pyroceram ranges

ceramic hobs

ceramic glass plates

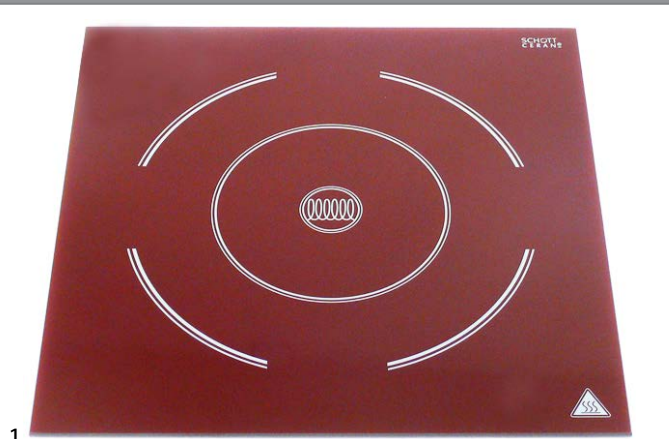

<b>GEV No.</b>	694579	<b>Ref. No.</b>	MBF000032R
<b>description</b>	ceramic plate L 300mm W 300mm thickness 4mm		
<b>For models:</b>	GIC3035		

for deep fryers

fasteners

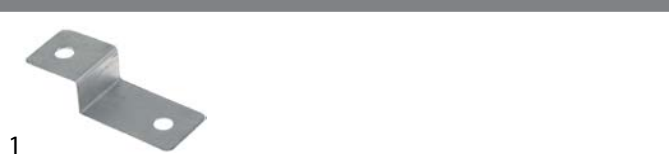

<b>GEV No.</b>	692544	<b>Ref. No.</b>	2.02HDF4260701
<b>description</b>	mounting strap L 63mm W 25mm H 15mm		
<b>For models:</b>	GDF3024, GDF3028, GDF5028		

lids



<b>GEV No.</b>	698544	<b>Ref. No.</b>	3.CP0603070100
<b>description</b>	mushroom cap handle handle ø 50mm ø 70mm L 36mm plastic black		
<b>For models:</b>	GDF3004, GDF3008, GDF3024, GDF3028, GDF5008, GDF5028		

miscellaneous



<b>GEV No.</b>	694737	<b>Ref. No.</b>	2.02HDF8A130001
<b>description</b>	bezel plate L 63mm H 15mm ID ø 26mm		
<b>For models:</b>	GDF5008, GDF5028		

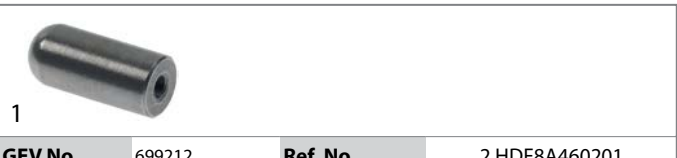

<b>GEV No.</b>	699212	<b>Ref. No.</b>	2.HDF8A460201
<b>description</b>	pipe stainless steel L 30mm W 13mm thread M5		
<b>For models:</b>	GDF5008, GDF5028		

for convection ovens/combi-steamers



<b>GEV No.</b>	692843	<b>Ref. No.</b>	00004380
<b>description</b>	spacer bush ID ø 7mm H 7.5mm ED ø 17.5mm for glass plate white Spacer		
<b>For models:</b>	GCO2001		

spare parts and accessories

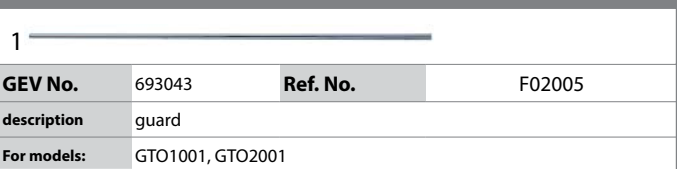

<b>GEV No.</b>	693043	<b>Ref. No.</b>	F02005
<b>description</b>	guard		
<b>For models:</b>	GTO1001, GTO2001		



glass panels



<b>GEV No.</b>	694950	<b>Ref. No.</b>	VET30017
<b>description</b>	door glass for combi-steamer L 485mm mounting pos. inner W 415mm thickness 4mm		
<b>For models:</b>	GCO500		



<b>GEV No.</b>	694951	<b>Ref. No.</b>	VET05021
<b>description</b>	door glass for combi-steamer L 555mm mounting pos. outer W 425mm thickness 4mm		
<b>For models:</b>	GCO500		

			
1			
<b>GEV No.</b>	692841	<b>Ref. No.</b>	21100870
<b>description</b>	glass panel L 447mm mounting pos. inner W 585mm		
<b>For models:</b>	GCO2001		
<b>accessories for</b>	692841		
	<b>GEV No.</b>	<b>Ref. No.</b>	
	692842	21100880	
	glass panel L 450mm mounting pos. outer W 590mm		
	<b>GEV No.</b>	<b>Ref. No.</b>	
	692843	00004380	
	spacer bush ID ø 7mm H 7.5mm ED ø 17.5mm for glass plate white Spacer		

			
1			
<b>GEV No.</b>	692842	<b>Ref. No.</b>	21100880
<b>description</b>	glass panel L 450mm mounting pos. outer W 590mm		
<b>For models:</b>	GCO2001		
<b>accessories for</b>	692842		
	<b>GEV No.</b>	<b>Ref. No.</b>	
	692841	21100870	
	glass panel L 447mm mounting pos. inner W 585mm		
	<b>GEV No.</b>	<b>Ref. No.</b>	
	692843	00004380	
	spacer bush ID ø 7mm H 7.5mm ED ø 17.5mm for glass plate white Spacer		
	<b>GEV No.</b>	<b>Ref. No.</b>	
	694993	00011680	
	door handle ø 18mm L 350mm stainless steel M5 black matt		

Fans - accessories

			
1			
<b>GEV No.</b>	701630	<b>Ref. No.</b>	00012330
<b>description</b>	air duct for cross flow fan for combi-steamer plastic grey		
<b>For models:</b>	GCO2001		

for hot dog machines

lids

			
1			
<b>GEV No.</b>	694450	<b>Ref. No.</b>	F05051
<b>description</b>	lid for hot dog machine ø 205mm		
<b>For models:</b>	GHM1001		

glass cylinders

			
1			
<b>GEV No.</b>	693002	<b>Ref. No.</b>	F05009
<b>description</b>	glass cylinder ø 200mm Pyrex glass H 240mm		
<b>For models:</b>	GHM1001		

skewers

			
1			
<b>GEV No.</b>	693018	<b>Ref. No.</b>	F05010
<b>description</b>	bun spikes for hot dog machine		
<b>For models:</b>	GHM1001		

water containers

			
1			
<b>GEV No.</b>	693005	<b>Ref. No.</b>	F05022
<b>description</b>	water container for hot dog machine PTFE/aluminium		
<b>For models:</b>	GHM1001		

for induction devices

			
1			
<b>GEV No.</b>	970790	<b>Ref. No.</b>	AB600022
<b>description</b>	grease filter W 323mm H 144mm thickness 8mm SS layers 2 outer grids 1 inner grids 1 for induction device		
<b>For models:</b>	GIC3035		





for tilting bratt pans

miscellaneous



1

<b>GEV No.</b>	523510	<b>Ref. No.</b>	00000000860
<b>description</b>	deep-groove ball bearing type 6202-2RS shaft ø 15mm ED ø 35mm W 11mm with sealing discs deep-groove ball bearing DIN 625-1		
<b>For models:</b>	GFS1025, GFS2019, GFS2022, GFS2025, GFS2030		

for microwaves

electric

line filters

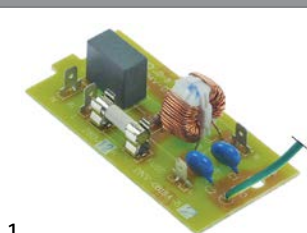

1

<b>GEV No.</b>	403188	<b>Ref. No.</b>	263029001088
<b>description</b>	line filter microwave for GMW1025 250V 50/60Hz conductor 2 PCB connection male faston 4.8mm L 80mm H 20mm W 40mm PCB Qty 1 pcs cable length 120mm type DNV-0818A-5		
<b>For models:</b>	GMW1025		

ceramic plates



1

<b>GEV No.</b>	692350	<b>Ref. No.</b>	243999000108	
<b>description</b>	ceramic plate L 330mm W 335mm for microwave thickness 3.5mm GMW1025 Qty 1 pcs			
<b>For models:</b>	GMW1025			
<b>accessories for</b>	692350			
	<b>GEV No.</b>	901698	<b>Ref. No.</b>	593219000016
	gasket L 330mm W 325mm silicone for ceramic plate Qty 1 pcs			

miscellaneous



1

<b>GEV No.</b>	601869	<b>Ref. No.</b>	213149000023
<b>description</b>	bracket L 78mm W 20mm H 50mm for condenser Qty 1 pcs		
<b>For models:</b>	GMW1025		

doors

films



1

<b>GEV No.</b>	692451	<b>Ref. No.</b>	515059000119
<b>description</b>	film L 287mm W 159mm for door inside thickness 0.1mm transparent suitable for GALANZ plastic Qty 1 pcs		
<b>For models:</b>	GMW1025		

for ovens

housing and bezels

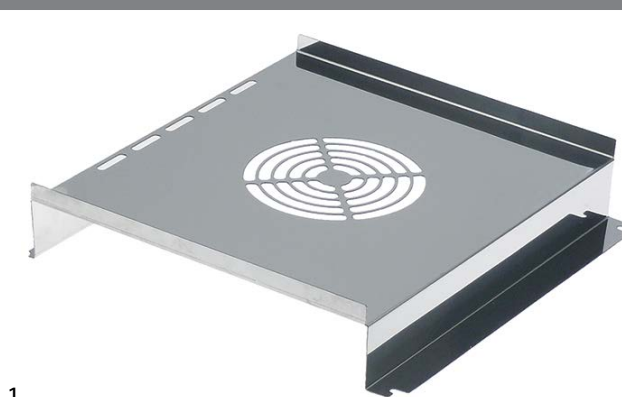

1

<b>GEV No.</b>	692763	<b>Ref. No.</b>	DEF30123
<b>description</b>	cover for hot air oven L 320mm W 325mm H 62mm		
<b>For models:</b>	GCO500		

for saladettes

housing and bezels



1

<b>GEV No.</b>	692692	<b>Ref. No.</b>	KITSR4AC2A00
<b>description</b>	bridge L 168/330/534mm 6 pieces		
<b>For models:</b>	GSA2600		



1

<b>GEV No.</b>	692691	<b>Ref. No.</b>	KITSR4AC4A00
<b>description</b>	bridge set 2-piece for saladette W 25mm D 184mm H 11mm		
<b>For models:</b>	GPS2600, GSD2600		



1

<b>GEV No.</b>	993263	<b>Ref. No.</b>	P04AC20A0006
<b>description</b>	cutting board L 950mm W 130mm H 20mm		
<b>For models:</b>	GSA2600		



1

<b>GEV No.</b>	692257	<b>Ref. No.</b>	VRX.01 VRX.02 VRX.04 VRX.05 VRX.06 VRX33-38
<b>description</b>	mounting set for glass plate for saladette 53-piece Qty 1 pcs 6x mounting clip 7x angle 12x flat-headed bolt 14x bush 14x screw connection		
<b>For models:</b>	GHS1600, GHS2600		

### doors



1

<b>GEV No.</b>	701546	<b>Ref. No.</b>	S24AC22A0006
<b>description</b>	door bolt L 28mm mounting pos. upper thread L 8mmmm		
<b>For models:</b>	GPS2600, GSA2600, GSD2600, GSF2600		

### for salamander grills



1

<b>GEV No.</b>	692240	<b>Ref. No.</b>	30045
<b>description</b>	drain tray for salamander grill L 350mm W 245mm		
<b>For models:</b>	GTO1001, GTO2001		

### for dishwashers

#### boilers

#### boilers for dishwashers



1

<b>GEV No.</b>	508429	<b>Ref. No.</b>	900384
<b>description</b>	boiler 3500W 230V ø 127mm L 400mm		
<b>For models:</b>	GDW2001		

#### air traps

#### air traps



1

<b>GEV No.</b>	519643	<b>Ref. No.</b>	905262
<b>description</b>	air trap L 91mm W 54mm H 41mm hose ø 4x7mm plastic		
<b>For models:</b>	GDW2001		

#### air trap accessories



1

<b>GEV No.</b>	519162	<b>Ref. No.</b>	904131
<b>description</b>	spring		
<b>For models:</b>	GDW2001		



backflow preventers

backflow preventers



1

<b>GEV No.</b>	516101	<b>Ref. No.</b>	TR2433
<b>description</b>	backflow preventer dishwasher hose ø 12mm		
<b>For models:</b>	GDW2001		
<b>spare parts for</b>	516101		
	<b>GEV No.</b>	506367	<b>Ref. No.</b> —
	flat gasket rubber ED ø 40mm ID ø 28mm thickness 1.8mm Qty 1 pcs		

door mechanics

linkage



1

<b>GEV No.</b>	519261	<b>Ref. No.</b>	902740
<b>description</b>	door pin tie bar		
<b>For models:</b>	GDW2001		

threaded shafts



1

<b>GEV No.</b>	519228	<b>Ref. No.</b>	905424
<b>description</b>	threaded part end stop		
<b>For models:</b>	GDW2001		

sliding plates



1

<b>GEV No.</b>	519208	<b>Ref. No.</b>	904952
<b>description</b>	sliding plate sliding plate		
<b>For models:</b>	GDW2001		

hinges



1

<b>GEV No.</b>	519035	<b>Ref. No.</b>	901245
<b>description</b>	door hinge bores 3 hinge		
<b>For models:</b>	GDW2001		

hinge pins



1

<b>GEV No.</b>	519204	<b>Ref. No.</b>	904795
<b>description</b>	hinge pin hinge pin		
<b>For models:</b>	GDW2001		

locks



1

<b>GEV No.</b>	519247	<b>Ref. No.</b>	906121
<b>description</b>	door catch door locking catch		
<b>For models:</b>	GDW2001		
<b>accessories for</b>	519247		
	<b>GEV No.</b>	519050	<b>Ref. No.</b> —
	nut thread M12x1.75 H 4mm WS 16 SS Qty 1 pcs for snap lock		

screw connections



1

<b>GEV No.</b>	519645	<b>Ref. No.</b>	902111
<b>description</b>	nut thread 3/8" H 14mm WS 24 plastic Qty 1 pcs		
<b>For models:</b>	GDW2001		

washing and rinsing systems





1

<b>GEV No.</b>	501351	<b>Ref. No.</b>	908154
<b>description</b>	flange mounting pos. upper ø 91mm H 11mm ID ø 45mm hole ø 5,5mm		
<b>For models:</b>	GDW2001		



1

<b>GEV No.</b>	519444	<b>Ref. No.</b>	905449
<b>description</b>	opposite support mounting pos. upper/lower for wash arm support suitable for Silanos		
<b>For models:</b>	GDW2001		
<b>accessories for</b>	519444		
	<b>GEV No.</b>	519445	<b>Ref. No.</b> 908141
	gasket D1 ø 80mm D2 ø 50mm thickness 3mm with 4 screw holes		

			
1			
<b>GEV No.</b>	519238	<b>Ref. No.</b>	906002
<b>description</b>	plain washer ID ø 15mm ED ø 33mm thickness 0.8mm SS Qty 1 pcs		
<b>For models:</b>	GDW2001		

			
1			
<b>GEV No.</b>	501349	<b>Ref. No.</b>	908456
<b>description</b>	reducer for rinse arm shaft		
<b>For models:</b>	GDW2001		

			
1			
<b>GEV No.</b>	517355	<b>Ref. No.</b>	908702
<b>description</b>	spacer piece for wash arm support ID ø 44mm ED ø 80mm thickness 18mm L 55mm plastic		
<b>For models:</b>	GDW2001		

			
1			
<b>GEV No.</b>	519085	<b>Ref. No.</b>	902880
<b>description</b>	Thumb screw ø 34mm thread M6		
<b>For models:</b>	GDW2001		

			
1			
<b>GEV No.</b>	519537	<b>Ref. No.</b>	908701
<b>description</b>	wash pipe ø 37mm L 720mm plastic suitable for Silanos		
<b>For models:</b>	GDW2001		

## for toasters

### spare parts and accessories

			
1			
<b>GEV No.</b>	693043	<b>Ref. No.</b>	F02005
<b>description</b>	guard		
<b>For models:</b>	GTO1001, GTO2001		

## miscellaneous

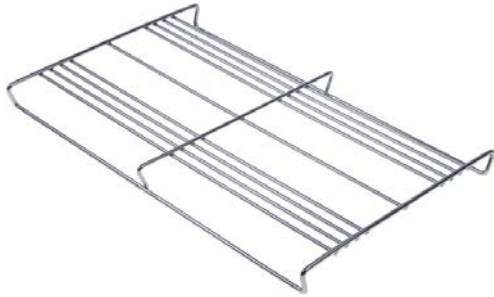
			
1			
<b>GEV No.</b>	694449	<b>Ref. No.</b>	F01069
<b>description</b>	guard L 315mm W 200mm for toaster H 24mm		
<b>For models:</b>	GTO1001, GTO2001		

## knobs

### universal knobs

			
1			
<b>GEV No.</b>	112733	<b>Ref. No.</b>	3ZCK165BT19010101MGB
<b>description</b>	knob zero mark t.max.°C ø 55mm shaft ø 6x4.6mm shaft flat upper black		
<b>For models:</b>	GDF3004, GDF3008, GDF3024, GDF3028, GDF5008, GDF5028		

## miscellaneous

			
1			
<b>GEV No.</b>	696506	<b>Ref. No.</b>	2858
<b>description</b>	knob for PCB ø 26mm black Qty 1 pcs		
<b>For models:</b>	GSM1000		

## accessories

### rosettes

			
1			
<b>GEV No.</b>	111806	<b>Ref. No.</b>	3.ZCK165BT20010101-1
<b>description</b>	rosette knob ø 16mm ø 55mm		
<b>For models:</b>	GDF3004, GDF3008, GDF3024, GDF3028, GDF5008, GDF5028		



## handles and hand wheels

### mushroom cap handles

 <p>1</p>			
<b>GEV No.</b>	697445	<b>Ref. No.</b>	0000000677
<b>description</b>	mushroom cap handle thread M6 handle ø 33mm L 26mm plastic black		
<b>For models:</b>	GFS2030		

 <p>1</p>			
<b>GEV No.</b>	698641	<b>Ref. No.</b>	0000001111
<b>description</b>	mushroom cap handle thread M6 handle ø 34mm L 25mm aluminium		
<b>For models:</b>	GFS1030		

### handle bars

#### producer-specific handle rails

##### TECNOEKA

 <p>1</p>			
<b>GEV No.</b>	694993	<b>Ref. No.</b>	00011680
<b>description</b>	door handle ø 18mm L 350mm stainless steel M5 black matt		
<b>For models:</b>	GCO2001		

### handle rails

#### handle rails

 <p>1</p>			
<b>GEV No.</b>	699449	<b>Ref. No.</b>	SLZB0020
<b>description</b>	handle rail for fridge L 220mm W 36mm H 23mm grey hole distance 120mm		
<b>For models:</b>	GSC2336		

### miscellaneous

 <p>1</p>			
<b>GEV No.</b>	692409	<b>Ref. No.</b>	1.1.C.C12.06
<b>description</b>	door handle L 100mm W 32mm hole distance 68mm white		
<b>For models:</b>	GGC2270		

 <p>1</p>			
<b>GEV No.</b>	698858	<b>Ref. No.</b>	1.1.C.C12.15
<b>description</b>	handle black for vitrine H 9.5mm L 85mm W 25mm mounting distance 70mm Qty 1 pcs		
<b>For models:</b>	GGC1078B		

 <p>1</p>			
<b>GEV No.</b>	692402	<b>Ref. No.</b>	1.1.C.C12.14
<b>description</b>	handle grey for vitrine H 9.5mm L 85mm W 25mm mounting distance 70mm Qty 1 pcs		
<b>For models:</b>	GGC1078		

 <p>1</p>			
<b>GEV No.</b>	691960	<b>Ref. No.</b>	A15015
<b>description</b>	handle L 100mm W 32mm hole distance 70mm for lid		
<b>For models:</b>	GTO1001, GTO2001		

 <p>1</p>			
<b>GEV No.</b>	110921	<b>Ref. No.</b>	A15016
<b>description</b>	handle L 130mm W 39mm hole distance 91mm Qty 1 pcs		
<b>For models:</b>	GHM1001		





1

<b>GEV No.</b>	692545	<b>Ref. No.</b>	3.HDF409010101
<b>description</b>	handle L 96mm W 64mm hole distance 73mm mounting pos. side panel black		
<b>For models:</b>	GDF3004, GDF3024		

## locks

### locking devices

#### producer-specific

##### WEIBO



1

<b>GEV No.</b>	692878	<b>Ref. No.</b>	W0604007
<b>description</b>	key cylinder rotation 90° cam length 45mm cam width 14mm for GFR2700/GRE2700 with 2 keys		
<b>For models:</b>	GFR2700, GRE2700		

### snap locks

#### producer-specific

##### METRO



1

<b>GEV No.</b>	692397	<b>Ref. No.</b>	WJLD1001
<b>description</b>	roller L 50mm mounting distance 32mm plastic Qty 1 pcs		

## hinges

### oven hinges



1

<b>GEV No.</b>	701631	<b>Ref. No.</b>	00014600	
<b>description</b>	opposite support mounting distance 119mm L 135mm W 12mm			
<b>For models:</b>	GCO2001			
<b>accessories for</b>	701631			
	<b>GEV No.</b>	701573	<b>Ref. No.</b>	00014610
	oven hinge mounting distance 142mm mounting distance 2mm lug mountingmm lever lengthmm groove distance 12mm spring thickness 3.3mm mounting ear position spring length 116mm L 170mm mounting pos. left/right W 22mm			



1

<b>GEV No.</b>	701573	<b>Ref. No.</b>	00014610	
<b>description</b>	oven hinge mounting distance 142mm mounting distance 2mm lug mountingmm lever lengthmm groove distance 12mm spring thickness 3.3mm mounting ear position spring length 116mm L 170mm mounting pos. left/right W 22mm			
<b>For models:</b>	GCO2001			
<b>accessories for</b>	701573			
	<b>GEV No.</b>	701631	<b>Ref. No.</b>	00014600
	opposite support mounting distance 119mm L 135mm W 12mm			





1

<b>GEV No.</b>	701592	<b>Ref. No.</b>	CER30021 STA00028
<b>description</b>	oven hinge set mounting distance 140mm lever length 42mm groove distance 15mm spring thickness 2.9mm L 170mm mounting pos. left/right with opposite support Qty 2 pcs		
<b>For models:</b>	GCO500		



door bearing

 <p>1</p>			
<b>GEV No.</b>	692406	<b>Ref. No.</b>	1.1.B.B10.17
<b>description</b>	bolt H 16.5mm ø 10/14mm ID ø 7mm brass for door hinge Qty 1 pcs		
<b>For models:</b>	GGC2270, GGC2270B		

 <p>1</p>			
<b>GEV No.</b>	701562	<b>Ref. No.</b>	44447000
<b>description</b>	bolt L 36mm W 22mm thread M6 bolt 12mm bolt ø 12mm		
<b>For models:</b>	GFR3600S, GRE3600, GRE3600S		

 <p>1</p>			
<b>GEV No.</b>	692421	<b>Ref. No.</b>	1.1.C.C13.01
<b>description</b>	bush H 15mm ø 10/13mm ID ø 7mm plastic for door hinge Qty 1 pcs		
<b>For models:</b>	GGC1078, GGC2270, GGC2270B		

 <p>1</p>			
<b>GEV No.</b>	701567	<b>Ref. No.</b>	41649000
<b>description</b>	bush L 11mm ø 11/15mm thickness 2mm		
<b>For models:</b>	GFR3600S, GRE3600, GRE3600S		

 <p>1</p>			
<b>GEV No.</b>	701572	<b>Ref. No.</b>	10534002
<b>description</b>	bush ø 18.5mm ID ø 12mm		
<b>For models:</b>	GFR3600S		

 <p>1</p>			
<b>GEV No.</b>	701280	<b>Ref. No.</b>	WJMA4002
<b>description</b>	door hinge L 42mm W 33mm H 82mm mounting pos. bottom right/left set Qty 1 pcs		
<b>For models:</b>	GSC1100G		

 <p>1</p>			
<b>GEV No.</b>	701281	<b>Ref. No.</b>	WJMA4005
<b>description</b>	door hinge L 43mm W 82mm H 71mm mounting pos. upper right/left set Qty 1 pcs		
<b>For models:</b>	GSC1100G		

 <p>1</p>			
<b>GEV No.</b>	698866	<b>Ref. No.</b>	GPC1046-12 GPC1088-13
<b>description</b>	door hinge L 90mm W 40mm H 19mm mounting pos. lower bolt 13mm bolt ø 10.5mm		
<b>For models:</b>	GPC1046, GPC1088		

 <p>1</p>			
<b>GEV No.</b>	698863	<b>Ref. No.</b>	GPC1046-04 GPC1088-05
<b>description</b>	door hinge L 90mm W 40mm H 19mm mounting pos. upper bolt 13mm bolt ø 10.5mm		
<b>For models:</b>	GPC1046, GPC1088		

 <p>1</p>			
<b>GEV No.</b>	701564	<b>Ref. No.</b>	46996000
<b>description</b>	hinge L 130mm W 85mm H 38mm mounting distance 48mm mounting distance 2 33mm thread M6 ø 8mm bolt 13mm bolt ø 8mm		
<b>For models:</b>	GRE3600		

 <p>1</p>			
<b>GEV No.</b>	692690	<b>Ref. No.</b>	S24AC22A0003
<b>description</b>	hinge L 40mm W 70mm H 22mm mounting distance 2 20mm		
<b>For models:</b>	GPS2600, GSA2600, GSD2600, GSF2600		





1

<b>GEV No.</b>	699587	<b>Ref. No.</b>	W0604033
<b>description</b>	hinge L 87mm W 46mm mounting pos. upper right thickness 3.6mm bolt 46mm bolt ø 10.5mm for GFR2700/GRE2700		
<b>For models:</b>	GFR2700, GRE2700		
<b>accessories for</b>	699587		
	<b>GEV No.</b>	699588	<b>Ref. No.</b>
			W0604037
	hinge L 88mm W 50mm mounting pos. bottom right thickness 3.6mm bolt 29mm bolt ø 11mm for GFR2700/GRE2700		



1

<b>GEV No.</b>	699588	<b>Ref. No.</b>	W0604037
<b>description</b>	hinge L 88mm W 50mm mounting pos. bottom right thickness 3.6mm bolt 29mm bolt ø 11mm for GFR2700/GRE2700		
<b>For models:</b>	GFR2700, GRE2700		
<b>spare parts for</b>	699588		
	<b>GEV No.</b>	699568	<b>Ref. No.</b>
			W0604038
	base plate for door hinge mounting pos. lower L 35mm W 25mm for GFR2700/GRE2700		
<b>accessories for</b>	699588		
	<b>GEV No.</b>	699587	<b>Ref. No.</b>
			W0604033
	hinge L 87mm W 46mm mounting pos. upper right thickness 3.6mm bolt 46mm bolt ø 10.5mm for GFR2700/GRE2700		



1

<b>GEV No.</b>	701563	<b>Ref. No.</b>	43870000
<b>description</b>	hinge L 98mm W 48mm H 38mm mounting distance 40mm mounting distance 2 20mm thread M6		
<b>For models:</b>	GFR3600S, GRE3600, GRE3600S		



1

<b>GEV No.</b>	694866	<b>Ref. No.</b>	WJMA2003
<b>description</b>	hinge mounting pos. lower L 82mm W 53mm H 43mm mounting distance 30mm mounting distance 2 56mm thickness 4mm bolt 20mm bolt ø 7mm		
<b>For models:</b>	GSC2336		



1

<b>GEV No.</b>	694865	<b>Ref. No.</b>	WJMA0004
<b>description</b>	hinge mounting pos. upper L 50mm W 33mm H 42mm mounting distance 27mm thickness 3mm bolt 32.5mm bolt ø 9mm Qty 1kg		
<b>For models:</b>	GSC2336		



1

<b>GEV No.</b>	699419	<b>Ref. No.</b>	1.1.B.B09.01
<b>description</b>	hinge bearing L 55mm W 15mm H 14mm mounting distance 26mm mounting pos. upper		
<b>For models:</b>	GGC1078, GGC1078B		



1

<b>GEV No.</b>	701565	<b>Ref. No.</b>	48205000
<b>description</b>	hinge bearing L 72mm W 39mm H 30mm mounting distance 25mm mounting distance 2 25mm mounting pos. left		
<b>For models:</b>	GRE3600		



1

<b>GEV No.</b>	701566	<b>Ref. No.</b>	46997000
<b>description</b>	hinge bearing L 72mm W 39mm H 30mm mounting distance 25mm mounting distance 2 25mm mounting pos. right		
<b>For models:</b>	GRE3600		



1

<b>GEV No.</b>	699423	<b>Ref. No.</b>	1.1.B.B09.17
<b>description</b>	hinge bearing L 85mm W 17mm H 17mm mounting distance 48mm mounting pos. upper		
<b>For models:</b>	GGC2270, GGC2270B		



accessories

bushes



1

<b>GEV No.</b>	701642	<b>Ref. No.</b>	W0409843
<b>description</b>	bush lower for door hinge ID ø 11mm ED ø 13mm L 26mm for GFR2700/GRE2700		
<b>For models:</b>	GFR2700, GRE2700		



1

<b>GEV No.</b>	701641	<b>Ref. No.</b>	W0409842
<b>description</b>	bush upper for door hinge ID ø 11mm ED ø 13mm L 29.5mm for GFR2700/GRE2700		
<b>For models:</b>	GFR2700, GRE2700		

base plate



1

<b>GEV No.</b>	699568	<b>Ref. No.</b>	W0604038
<b>description</b>	base plate for door hinge mounting pos. lower L 35mm W 25mm for GFR2700/GRE2700		
<b>For models:</b>	GFR2700, GRE2700		



1

<b>GEV No.</b>	699569	<b>Ref. No.</b>	W0604030
<b>description</b>	base plate for door hinge mounting pos. right L 74mm W 42mm for GFR2700/GRE2700		
<b>For models:</b>	GFR2700, GRE2700		

filters

accessories

fastening material



1

<b>GEV No.</b>	694581	<b>Ref. No.</b>	WJB000079R
<b>description</b>	frame L 317mm W 170mm H 9mm for filter		
<b>For models:</b>	GIC3035		

equipment feet and end caps

equipment feet

with screw mounting



1

<b>GEV No.</b>	701640	<b>Ref. No.</b>	W0409018
<b>description</b>	equipment foot tube ø 51mm plate size 70x70mm hole distance 50mm H 11,7-18mm Qty 1 pcs for GFR2700/GRE2700 adjustable		
<b>For models:</b>	GFR2700, GRE2700		

with fixing plate



1

<b>GEV No.</b>	701640	<b>Ref. No.</b>	W0409018
<b>description</b>	equipment foot tube ø 51mm plate size 70x70mm hole distance 50mm H 11,7-18mm Qty 1 pcs for GFR2700/GRE2700 adjustable		
<b>For models:</b>	GFR2700, GRE2700		

screw-in feet



1

<b>GEV No.</b>	701230	<b>Ref. No.</b>	900888
<b>description</b>	equipment feet kit thread M5 thread L 10mm ø 22mm H 12mm rubber WS Qty 4 pcs bore ø 5/10mm		
<b>For models:</b>	GJU1001		



1

<b>GEV No.</b>	700972	<b>Ref. No.</b>	S900.13
<b>description</b>	equipment foot thread M10 thread L 16mm ø 29mm H 11.5mm Qty 1 pcs for fridge		
<b>For models:</b>	GHS1600, GHS2600		



1

<b>GEV No.</b>	701593	<b>Ref. No.</b>	PIE30010
<b>description</b>	equipment foot thread M10 thread L 18.5mm ø 49mm H 35mm plastic Qty 4 pcs		
<b>For models:</b>	GCO500		



1

<b>GEV No.</b>	692235	<b>Ref. No.</b>	A13012
<b>description</b>	equipment foot thread M10 thread L 20mm ø 26mm H 6mm Qty 1 pcs		
<b>For models:</b>	GEG2001		



1

<b>GEV No.</b>	802156	<b>Ref. No.</b>	00002790
<b>description</b>	equipment foot thread M10 thread L 20mm ø 60mm H 50mm Qty 1 pcs		
<b>For models:</b>	GCO2001		



1

<b>GEV No.</b>	701112	<b>Ref. No.</b>	I0403014
<b>description</b>	equipment foot thread M10 thread L 43mm ø 29mm H 52mm plastic WS 35 Qty 1 pcs		
<b>For models:</b>	GRE3600, GRE3600S		



1

<b>GEV No.</b>	701451	<b>Ref. No.</b>	00000001240
<b>description</b>	equipment foot thread M5 thread L 13mm ø 37.5mm H 25mm conical aluminium WS Qty 1 pcs bore ø 6mm		
<b>For models:</b>	GFS1025		



1

<b>GEV No.</b>	701219	<b>Ref. No.</b>	AB300035
<b>description</b>	equipment foot thread M5 thread L 9mm ø 33mm H 34mm Qty 1 pcs		
<b>For models:</b>	GIC3035		



1

<b>GEV No.</b>	701220	<b>Ref. No.</b>	AB300055
<b>description</b>	equipment foot thread M6 thread L 20mm ø 33mm H 20mm WS 12 Qty 1 pcs		
<b>For models:</b>	GIC3035		



1

<b>GEV No.</b>	701279	<b>Ref. No.</b>	WJLB0008
<b>description</b>	equipment foot thread M8 thread L 22mm ø 35mm H 38mm Qty 1 pcs		



1

<b>GEV No.</b>	698495	<b>Ref. No.</b>	00000001251
<b>description</b>	equipment foot thread M8 thread L 9mm ø 48mm H 43mm conical aluminium WS Qty 1 pcs		
<b>For models:</b>	GFS1030		

## bolting feet





1

<b>GEV No.</b>	691814	<b>Ref. No.</b>	A13003
<b>description</b>	equipment foot ø 22mm H 20mm bore ø 4mm Qty 1 pcs		
<b>For models:</b>	GHM1001, GTO1001, GTO2001		





 <p>1</p>			
<b>GEV No.</b>	698546	<b>Ref. No.</b>	3.0000161
<b>description</b>	equipment foot ø 29mm H 16mm rubber bore ø 6mm Qty 1 pcs		
<b>For models:</b>	GDF3004, GDF3008, GDF3024, GDF3028, GDF5008, GDF5028		

 <p>1</p>			
<b>GEV No.</b>	697433	<b>Ref. No.</b>	00000000140 00000700140
<b>description</b>	equipment foot ø 35mm H 26mm bore ø 5mm Qty 1 pcs		
<b>For models:</b>	GFS1022, GFS2019, GFS2022, GFS2025, GFS2030		

equipment feet with stem

 <p>1</p>			
<b>GEV No.</b>	701251	<b>Ref. No.</b>	223189000015
<b>description</b>	equipment foot ø 20mm H 12mm mounting ø 8mm mounting measurements 19mm overall height 19mm plastic Qty 1 pcs		
<b>For models:</b>	GMW1025		

miscellaneous

with fixing plate

ø30mm

 <p>1</p>			
<b>GEV No.</b>	701277 <sup>1</sup>	<b>Ref. No.</b>	WJLA1001 WJLA1009
<b>description</b>	swivel castor 2 with & 2 without brake ø 30mm plate fixing housing zinc-plated sheet steel plate size 61x51mm hole distance mm capacity 60kg bearing slide bearing wheel body PVC tread PVC H 44mm wheel width 23.5mm		
<b>For models:</b>	GBC1001, GBC1001S, GBC1001SS, GBC1002, GBC1002S, GBC1002SS, GBC1003, GBC1003S, GBC1003SS, GBC1102, GBC1103, GSC2336		

<sup>1</sup>with swivel brake

ø75mm

 <p>1</p>			
<b>GEV No.</b>	701282	<b>Ref. No.</b>	WJLA1002
<b>description</b>	swivel castor set 2 with & 2 without brake ø 75mm plates fixing 102x83mm housing zinc-plated sheet steel hole distance 55/75mm bearing slide bearing H 112mm wheel width 31mm Qty 4 pcs		
<b>For models:</b>	GSC1100G		

with spigot

ø40mm

 <p>1</p>			
<b>GEV No.</b>	701120	<b>Ref. No.</b>	1.1.B.B10.95 1.1.B.B10.96
<b>description</b>	castor set 2 with & 2 without brake ø 40mm with thread bolt housing chrome-plated steel thread L 24mm thread ø M10x1.5mm capacity 60kg bearing ball bearing wheel body nylon tread nylon H 68mm wheel width 20mm Qty 4 pcs		
<b>For models:</b>	GGC2270, GGC2270B		

baskets

crumb screens

 <p>1</p>			
<b>GEV No.</b>	970869	<b>Ref. No.</b>	2.HDF405069510
<b>description</b>	crumb screen L 220mm W 160mm H 35mm 4 litre		
<b>For models:</b>	GDF3004, GDF3024		

 <p>1</p>			
<b>GEV No.</b>	970870	<b>Ref. No.</b>	2.HDF812020609510
<b>description</b>	crumb screen L 245mm W 200mm H 35mm 8 litre		
<b>For models:</b>	GDF3008, GDF3028, GDF5008, GDF5028		

wire baskets for hot dog machines



1	<b>GEV No.</b>	693004	<b>Ref. No.</b>	F04012
	<b>description</b>	grid basket for hot dog grill ø 180mm H 210mm		
	<b>For models:</b>	GHM1001		



1	<b>GEV No.</b>	970747	<b>Ref. No.</b>	F01070
	<b>description</b>	grate W 350mm D 240mm H 7mm SS for toaster wire gauge frame 4mm lengthwise wires gauge 3mm crossing wires ROLLER GRILL		
	<b>For models:</b>	GTO1001, GTO2001		

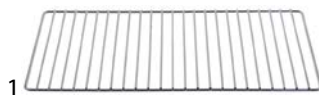

1	<b>GEV No.</b>	970905	<b>Ref. No.</b>	GPC1046-13 GPC1088-14-half size
	<b>description</b>	grate W 365mm D 165mm H 7mm wire gauge frame 4mm lengthwise wires gauge 3mm		
	<b>For models:</b>	GPC1046, GPC1088		



1	<b>GEV No.</b>	970906	<b>Ref. No.</b>	WJGA9005
	<b>description</b>	grate W 400mm D 345mm chrome-plated steel wire gauge frame 6mm crossing wires 4		
	<b>For models:</b>	GBC1002, GBC1002S, GBC1002SS, GBC1003, GBC1003S, GBC1102		

shelves and shelf rails

grates

universal

without upstand



1	<b>GEV No.</b>	970801	<b>Ref. No.</b>	WJGA9008
	<b>description</b>	grate W 345mm D 400mm chrome-plated steel wire gauge frame 6mm lengthwise wires gauge 2.5mm crossing wires 4 Qty 1 pcs		
	<b>For models:</b>	GBC1003, GBC1003S, GBC1003SS, GBC1103		



1	<b>GEV No.</b>	970800	<b>Ref. No.</b>	WJGA9002
	<b>description</b>	grate W 345mm D 500mm chrome-plated steel wire gauge frame 6mm lengthwise wires gauge 2.5mm crossing wires 4 Qty 1 pcs		
	<b>For models:</b>	GBC1001, GBC1001S, GBC1001SS		

with upstand



1	<b>GEV No.</b>	970925	<b>Ref. No.</b>	S14AC29A0001
	<b>description</b>	grate W 325mm D 570mm GN 1/1 H 55mm plastic-coated steel wire gauge frame 7.5mm lengthwise wires gauge 4mm crossing wires 3 grey		
	<b>For models:</b>	GPS2600, GSA2600, GSD2600, GSF2600		





1	<b>GEV No.</b>	970904	<b>Ref. No.</b>	GPC1088-14-full size
	<b>description</b>	grate W 350mm D 295mm H 30mm chrome-plated steel wire gauge frame 4mm lengthwise wires gauge 2mm crossing wires 1 Qty 2 pcs		
	<b>For models:</b>	GPC1088		





			
<b>GEV No.</b>	970795	<b>Ref. No.</b>	1.1.B.B25.15
<b>description</b>	grate W 735mm D 235mm H 37mm chrome-plated steel wire gauge frame 8mm lengthwise wires gauge 3mm crossing wires 1		
<b>For models:</b>	GCV1600		

			
<b>GEV No.</b>	970794	<b>Ref. No.</b>	1.1.B.B25.16
<b>description</b>	grate W 735mm D 365mm H 35mm chrome-plated steel wire gauge frame 8mm lengthwise wires gauge 3mm crossing wires 1		
<b>For models:</b>	GCV1600		

## producer-specific

			
<b>GEV No.</b>	698856	<b>Ref. No.</b>	1.1.B.B02.01.03
<b>description</b>	grate W 360mm D 305mm plastic-coated steel		
<b>For models:</b>	GGC1078B		
<b>accessories for</b>	698856		
	<b>GEV No.</b>	692400	<b>Ref. No.</b> 1.1.C.C10.07
	shelf support L 28.5mm W 14mm H 17.5mm plastic Qty 1 pcs		
	<b>GEV No.</b>	698857	<b>Ref. No.</b> 1.1.C.C10.08
	shelf support L 28.5mm W 14mm H 17.5mm plastic Qty 1 pcs		

			
<b>GEV No.</b>	970876	<b>Ref. No.</b>	1.1.B.B02.01.01
<b>description</b>	grate W 360mm D 305mm plastic-coated steel		
<b>For models:</b>	GGC1078		

			
<b>GEV No.</b>	692696	<b>Ref. No.</b>	1.1.B.B02.04.02
<b>description</b>	grate W 430mm D 390mm H 8mm plastic-coated steel refrigeration wire gauge frame 8mm lengthwise wires gauge 3.6mm crossing wires 5 black		
<b>For models:</b>	GGC2270B		

			
<b>GEV No.</b>	692339	<b>Ref. No.</b>	1.1.B.B02.04.01
<b>description</b>	grate W 430mm D 390mm H 8mm plastic-coated steel refrigeration wire gauge frame 8mm lengthwise wires gauge 3.6mm crossing wires 5 white		
<b>For models:</b>	GGC2270		

			
<b>GEV No.</b>	970910	<b>Ref. No.</b>	WJGA2023
<b>description</b>	grate W 530mm D 380mm H 40mm plastic-coated steel wire gauge frame 6mm lengthwise wires gauge 3mm crossing wires 23		

			
<b>GEV No.</b>	970981	<b>Ref. No.</b>	W0402369
<b>description</b>	grate W 530mm D 650mm plastic-coated steel crossing wires 2 suitable for GFR2700		
<b>For models:</b>	GFR2700		

			
<b>GEV No.</b>	970799	<b>Ref. No.</b>	WJGA4078
<b>description</b>	grate W 540mm D 505mm H 41mm plastic-coated steel wire gauge frame 6mm lengthwise wires gauge 3mm crossing wires 3 white Qty 1 pcs		
<b>For models:</b>	GSC1100G		

			
<b>GEV No.</b>	970982	<b>Ref. No.</b>	W0402040
<b>description</b>	grate W 620mm D 530mm plastic-coated steel with hinge camp crossing wires 2 suitable for GRE2700		
<b>For models:</b>	GRE2700		

			
<b>GEV No.</b>	970980	<b>Ref. No.</b>	W0402366
<b>description</b>	grate W 630mm D 602mm plastic-coated steel crossing wires 2 suitable for GFR2700/GRE2700		
<b>For models:</b>	GFR2700, GRE2700		

			
<b>GEV No.</b>	970930	<b>Ref. No.</b>	44714000
<b>description</b>	grate W 650mm D 330mm H 9mm wire gauge frame 7mm lengthwise wires gauge 3mm crossing wires 1		
<b>For models:</b>	GRE3600, GRE3600S		

			
<b>GEV No.</b>	970929	<b>Ref. No.</b>	44379000
<b>description</b>	grate W 665mm D 560mm H 30mm wire gauge frame 7mm lengthwise wires gauge 3mm crossing wires 2		
<b>For models:</b>	GFR3600S, GRE3600, GRE3600S		

accessories

			
<b>GEV No.</b>	691917	<b>Ref. No.</b>	F03006
<b>description</b>	grid handle L 204mm W 80mm		
<b>For models:</b>	GTO1001, GTO2001		

grid attachments

			
<b>GEV No.</b>	692368	<b>Ref. No.</b>	1.1.B.B25.27
<b>description</b>	rack support L 220mm H 83mm mounting pos. bottom right SS Qty 1 pcs		
<b>For models:</b>	GCV1600		

			
<b>GEV No.</b>	692365	<b>Ref. No.</b>	1.1.B.B25.28
<b>description</b>	rack support L 220mm H 83mm mounting pos. upper left SS Qty 1 pcs		
<b>For models:</b>	GCV1600		

			
<b>GEV No.</b>	692366	<b>Ref. No.</b>	1.1.B.B25.29
<b>description</b>	rack support L 220mm H 83mm mounting pos. upper right SS Qty 1 pcs		
<b>For models:</b>	GCV1600		



			
<b>GEV No.</b>	692367	<b>Ref. No.</b>	1.1.B.B25.26
<b>description</b>	rack support L 320mm H 83mm mounting pos. bottom left SS Qty 1 pcs		
<b>For models:</b>	GCV1600		

			
<b>GEV No.</b>	701252	<b>Ref. No.</b>	1.1.B.B25.35
<b>description</b>	rail for grid attachment L 405mm Hmm mounting pos. left/right W 19mm SS Qty 1 pcs		
<b>For models:</b>	GCV1600		

shelf rails and supports

producer-specific

			
<b>GEV No.</b>	698870	<b>Ref. No.</b>	LCCJ2001
<b>description</b>	guide L 390mm W 25mm mounting pos. left/right inner height 4mm		
<b>For models:</b>	GBC1001, GBC1001S, GBC1001SS, GBC1002, GBC1002S, GBC1002SS, GBC1003, GBC1003S, GBC1003SS, GBC1102, GBC1103		

			
<b>GEV No.</b>	701643	<b>Ref. No.</b>	80037407
<b>description</b>	guide U-shape L 620mm W 15mm H 20mm mounting pos. left for GFR2700/GRE2700		
<b>For models:</b>	GFR2700, GRE2700		
<b>accessories for</b>	701643		
	<b>GEV No.</b>	701644	<b>Ref. No.</b>
			80037408
	guide U-shape L 620mm W 15mm H 20mm mounting pos. right for GFR2700/GRE2700		





1



<b>GEV No.</b>	701644	<b>Ref. No.</b>	80037408
<b>description</b>	guide U-shape L 620mm W 15mm H 20mm mounting pos. right for GFR2700/GRE2700		
<b>For models:</b>	GFR2700, GRE2700		
<b>accessories for</b>	701644		
	<b>GEV No.</b>	<b>Ref. No.</b>	
	701643	80037407	
	guide U-shape L 620mm W 15mm H 20mm mounting pos. left for GFR2700/GRE2700		

1



<b>GEV No.</b>	701549	<b>Ref. No.</b>	S24AC29A0005
<b>description</b>	rack L 245mm W 40mm H 30mm mounting pos. right		
<b>For models:</b>	GPS2600, GSA2600, GSD2600, GSF2600		

1



<b>GEV No.</b>	699231	<b>Ref. No.</b>	I0402137
<b>description</b>	guide white L 1350mm W 20mm H 5mm Qty 1		
<b>For models:</b>	GRE3600, GRE3600S		

1



<b>GEV No.</b>	699585	<b>Ref. No.</b>	80037402
<b>description</b>	rack L 985mm W 57mm H 38mm mounting pos. left/right aperture 15x15mm hole distance 55mm 18 holes for GFR2700/GRE2700		
<b>For models:</b>	GFR2700, GRE2700		
<b>accessories for</b>	699585		
	<b>GEV No.</b>	<b>Ref. No.</b>	
	701643	80037407	
	guide U-shape L 620mm W 15mm H 20mm mounting pos. left for GFR2700/GRE2700		
	<b>GEV No.</b>	<b>Ref. No.</b>	
	701644	80037408	
	guide U-shape L 620mm W 15mm H 20mm mounting pos. right for GFR2700/GRE2700		

1



<b>GEV No.</b>	696443	<b>Ref. No.</b>	KITGD4AC2A00
<b>description</b>	pair of setting bar U-shape L 548mm W 20mm inner height 13mm mounting pos. left/right		
<b>For models:</b>	GPS2600, GSA2600, GSD2600, GSF2600		

1



<b>GEV No.</b>	692398	<b>Ref. No.</b>	LCCK0002
<b>description</b>	shelf support L 24mm W 9mm H 29mm aluminium for fridge Qty 1 pcs		
<b>For models:</b>	GBC1001, GBC1001S, GBC1001SS, GBC1002, GBC1002S, GBC1002SS, GBC1003, GBC1003S, GBC1003SS, GBC1102, GBC1103		

1



<b>GEV No.</b>	701550	<b>Ref. No.</b>	S24AC29A0002
<b>description</b>	rack L 244mm W 50mm H 8mm mounting pos. front		
<b>For models:</b>	GPS2600, GSA2600, GSD2600, GSF2600		

1



<b>GEV No.</b>	692400	<b>Ref. No.</b>	1.1.C.C10.07
<b>description</b>	shelf support L 28.5mm W 14mm H 17.5mm plastic Qty 1 pcs		
<b>For models:</b>	GGC1078		

1



<b>GEV No.</b>	701548	<b>Ref. No.</b>	S24AC29A0004
<b>description</b>	rack L 245mm W 40mm H 30mm mounting pos. left		
<b>For models:</b>	GPS2600, GSA2600, GSD2600, GSF2600		





<b>GEV No.</b>	698857	<b>Ref. No.</b>	1.1.C.C10.08
<b>description</b>	shelf support L 28.5mm W 14mm H 17.5mm plastic Qty 1 pcs		
<b>For models:</b>	GGC1078B		



<b>GEV No.</b>	692408	<b>Ref. No.</b>	1.1.C.C10.09
<b>description</b>	shelf support L 38.5mm W 14mm H 18mm plastic Qty 1 pcs		
<b>For models:</b>	GGC2270		



<b>GEV No.</b>	699416	<b>Ref. No.</b>	1.1.C.C10.10
<b>description</b>	shelf support L 38.5mm W 14mm H 18mm plastic Qty 1 pcs		
<b>For models:</b>	GGC2270B		

**profile 9058**

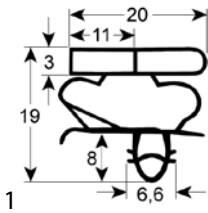

<b>GEV No.</b>	902395	<b>Ref. No.</b>	44404000
<b>description</b>	refrigeration gasket profile 9058 W 770mm L 1810mm plug size Qty 1		
<b>For models:</b>	GFR3600S, GRE3600, GRE3600S		

**profile 9750**

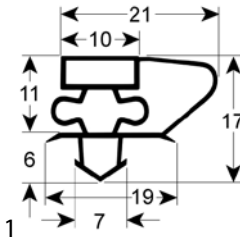

<b>GEV No.</b>	902514	<b>Ref. No.</b>	W0404514
<b>description</b>	refrigeration gasket profile 9750 W 660mm L 1537mm plug size		
<b>For models:</b>	GFR2700, GRE2700		

**profile 9156**

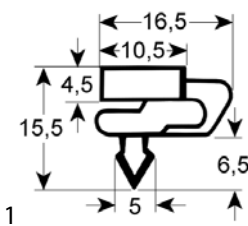

<b>GEV No.</b>	901662	<b>Ref. No.</b>	SLJP4007
<b>description</b>	door seal profile 9156 W 569mm L 1295mm plug size Qty 1 pcs		
<b>For models:</b>	GSC1100G		

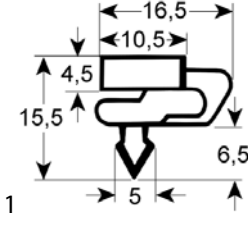

<b>GEV No.</b>	901674	<b>Ref. No.</b>	SLJP9002
<b>description</b>	refrigeration gasket profile 9156 W 415mm L 775mm plug size Qty 1 pcs		

**gaskets**

refrigeration gaskets

plug-in gaskets

profile 9149

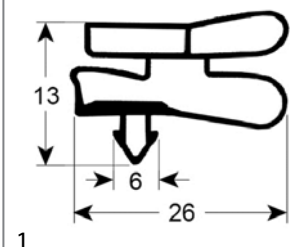

<b>GEV No.</b>	902216	<b>Ref. No.</b>	R04AC22A0002
<b>description</b>	refrigeration gasket profile 9149 W 385mm L 480mm plug size		
<b>For models:</b>	GPS2600, GSA2600, GSD2600, GSF2600		

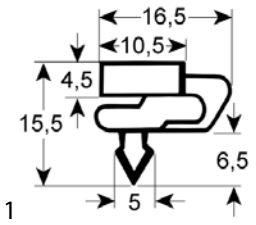

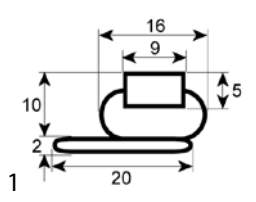

<b>GEV No.</b>	901648	<b>Ref. No.</b>	SLJP2010
<b>description</b>	refrigeration gasket profile 9156 W 595mm L 1340mm plug size Qty 1 pcs		
<b>For models:</b>	GSC2336		

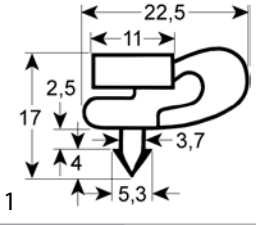

<b>GEV No.</b>	901650	<b>Ref. No.</b>	1.1.E.E1.25
<b>description</b>	refrigeration gasket profile 9968 W 515mm L 1390mm external size with metal reinforcement Qty 1 pcs		
<b>For models:</b>	GGC2270		

profile 9161



<b>GEV No.</b>	902208	<b>Ref. No.</b>	SLJP2025
<b>description</b>	refrigeration gasket profile 9161 W 590mm L 1540mm plug size		

profile 9910

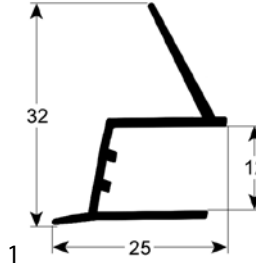

<b>GEV No.</b>	901651	<b>Ref. No.</b>	1.1.C.C63.67
<b>description</b>	refrigeration gasket profile 9910 Wmm L 735mm external size Qty 1 mounting pos. left		
<b>For models:</b>	GCV1600		

profile 9930

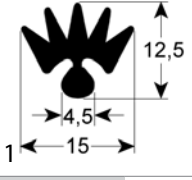

<b>GEV No.</b>	901645	<b>Ref. No.</b>	1.1.C.63.69
<b>description</b>	refrigeration gasket profile 9930 Wmm L 746mm plug size		
<b>For models:</b>	GCV1600		

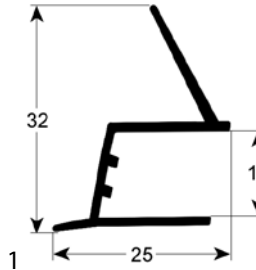

<b>GEV No.</b>	901646	<b>Ref. No.</b>	1.1.C.C63.76
<b>description</b>	refrigeration gasket profile 9910 Wmm L 735mm external size Qty 1 mounting pos. right		
<b>For models:</b>	GCV1600		

screw-in gaskets

profile 9968

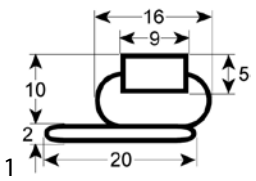

<b>GEV No.</b>	901649	<b>Ref. No.</b>	1.1.E.E1.35
<b>description</b>	refrigeration gasket profile 9968 W 418mm L 658mm external size with metal reinforcement Qty 1 pcs		
<b>For models:</b>	GGC1078B		

gaskets for heated units

door seals

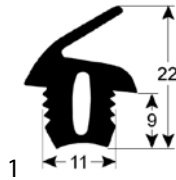

<b>GEV No.</b>	902446	<b>Ref. No.</b>	GUA30015
<b>description</b>	door seal profile 2718 L 5500mm		
<b>For models:</b>	GCO500		

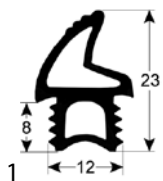

<b>GEV No.</b>	902497	<b>Ref. No.</b>	01000770
<b>description</b>	door seal profile 2764 L 1020mm suitable for TECNOEKA		
<b>For models:</b>	GCO2001		

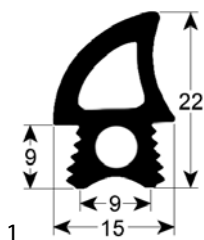

<b>GEV No.</b>	902419	<b>Ref. No.</b>	01000810
<b>description</b>	door seal profile 2767 L 1780mm suitable for TECNOEKA		
<b>For models:</b>	GCO2001		

### O-rings

#### EPDM

#### ø1.50mm

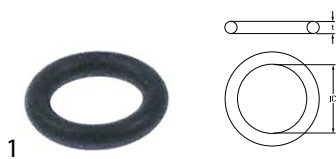

<b>GEV No.</b>	532648	<b>Ref. No.</b>	2859
<b>description</b>	O-ring EPDM thickness 1.5mm ID ø 5mm Qty 1 pcs		
<b>For models:</b>	GSM1000		

#### ø3.00mm



<b>GEV No.</b>	510955	<b>Ref. No.</b>	00002001
<b>description</b>	O-ring EPDM thickness 3mm ID ø 6mm Qty 1 pcs		
<b>For models:</b>	GCO2001		

#### ø5.34mm

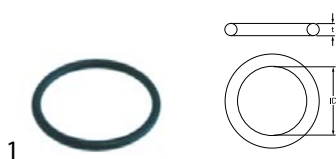

<b>GEV No.</b>	521120	<b>Ref. No.</b>	907981
<b>description</b>	O-ring EPDM thickness 5.34mm ID ø 37.47mm Qty 1 pcs		
<b>For models:</b>	GDW2001		

### miscellaneous



<b>GEV No.</b>	532647	<b>Ref. No.</b>	900970
<b>description</b>	O-ring EPDM thickness 1.8mm ID ø 11.8mm Qty 1 pcs		
<b>For models:</b>	GJU1001		

### sealing washers

#### rubber gaskets



<b>GEV No.</b>	519114	<b>Ref. No.</b>	903260
<b>description</b>	flat gasket rubber ED ø 25mm ID ø 16.5mm thickness 2mm Qty 1 pcs		
<b>For models:</b>	GDW2001		

### shaft gaskets

#### shaft gaskets



<b>GEV No.</b>	697475	<b>Ref. No.</b>	00000012671
<b>description</b>	shaft seal ID ø 20mm ED ø 30mm thickness 5mm		
<b>For models:</b>	GFS1025		



<b>GEV No.</b>	698383	<b>Ref. No.</b>	0632
<b>description</b>	shaft sealing ID ø 4mm ED ø 12mm for hand blender H 6.3mm		
<b>For models:</b>	GSM1000		

### miscellaneous



<b>GEV No.</b>	511953	<b>Ref. No.</b>	900871
<b>description</b>	seal kit for citrus juicers		
<b>For models:</b>	GJU1001		



special gaskets

for microwaves



1

<b>GEV No.</b>	901698	<b>Ref. No.</b>	593219000016
<b>description</b>	gasket L 330mm W 325mm silicone for ceramic plate Qty 1 pcs		
<b>For models:</b>	GMW1025		

miscellaneous



1

<b>GEV No.</b>	698545	<b>Ref. No.</b>	3.0000404
<b>description</b>	gasket ED ø 31mm ID ø 21mm		
<b>For models:</b>	GDF3008, GDF3028, GDF5008, GDF5028		



1

<b>GEV No.</b>	698543	<b>Ref. No.</b>	3.0000403
<b>description</b>	gasket external height 4mm ED ø 25mm ID ø 16mm		
<b>For models:</b>	GDF3008, GDF3028, GDF5008, GDF5028		

gaskets for wash arm support



1

<b>GEV No.</b>	519445	<b>Ref. No.</b>	908141
<b>description</b>	gasket D1 ø 80mm D2 ø 50mm thickness 3mm with 4 screw holes		
<b>For models:</b>	GDW2001		

refrigeration cycle components

valves

Schrader valves

Schrader valves (complete)



1

<b>GEV No.</b>	750636	<b>Ref. No.</b>	S900.42
<b>description</b>	Schrader valve complete connection 1/4"SAE ø 6mm L 120mm		
<b>For models:</b>	GHS1600, GHS2600		

filter driers

accessories

holders



1

<b>GEV No.</b>	699297	<b>Ref. No.</b>	SLJAC008
<b>description</b>	bracket L 40mm W 30mm H 31mm ID ø 18mm ED ø 22mm for dryer		
<b>For models:</b>	GBC1001, GBC1001S, GBC1001SS, GBC1002, GBC1002S, GBC1002SS, GBC1003, GBC1003S, GBC1003SS, GBC1102, GBC1103, GSC1100G, GSC2336		

miscellaneous



1

<b>GEV No.</b>	750381	<b>Ref. No.</b>	TCGV0002
<b>description</b>	dryer ø 18.5mm L 115.5mm connection 2,4/5,2mm Qty 1 pcs		
<b>For models:</b>	GBC1001, GBC1001S, GBC1001SS, GBC1002, GBC1002S, GBC1002SS, GBC1003, GBC1003S, GBC1003SS, GBC1102, GBC1103, GSC2336		



1

<b>GEV No.</b>	750693	<b>Ref. No.</b>	1.1.A.A04.01
<b>description</b>	dryer ø 19mm L 120.5mm connection 2/5mm Qty 1 pcs		
<b>For models:</b>	GCV1600, GGC1078, GGC1078B		

			
1			
<b>GEV No.</b>	750378	<b>Ref. No.</b>	C01AE66A0001 C04AC26A0001
<b>description</b>	dryer ø 19mm L 145mm connection 4,5/8mm type XH9 Qty 1 pcs		
<b>For models:</b>	GDS2600, GPS2600, GSA2600, GSD2600, GSF2600		

			
1			
<b>GEV No.</b>	750748	<b>Ref. No.</b>	W0204101
<b>description</b>	dryer ø 19mm L 166mm connection 2,7/5,2 for GFR2700/GRE2700		
<b>For models:</b>	GFR2700, GRE2700		

			
1			
<b>GEV No.</b>	750694	<b>Ref. No.</b>	1.1.A.A04.06
<b>description</b>	dryer ø 25mm L 144mm connection 6/8mm Qty 1 pcs		
<b>For models:</b>	GGC2270, GGC2270B		

			
1			
<b>GEV No.</b>	750324	<b>Ref. No.</b>	S900.44
<b>description</b>	dryer size 20g ø 23mm L 117mm connection 4,8/8,3mm		
<b>For models:</b>	GHS1600, GHS2600		

			
1			
<b>GEV No.</b>	750382	<b>Ref. No.</b>	TCGV0009
<b>description</b>	dryer ø 18.5mm L 120mm connection 4/7mm Qty 1 pcs		
<b>For models:</b>	GSC1100G		
<b>accessories for</b>	750382		
	<b>GEV No.</b>	694868	<b>Ref. No.</b> —
bracket for dryer L 40mm W 30mm H 31mm Qty 1 pcs			

## refrigeration pipes

### copper pipes uninsulated

			
1			
<b>GEV No.</b>	694931	<b>Ref. No.</b>	VRX.15
<b>description</b>	capillary pipe ID ø 0.8mm L 2340m ED ø 2mm		
<b>For models:</b>	GHS1600, GHS2600		

			
1			
<b>GEV No.</b>	692407	<b>Ref. No.</b>	1.1.B.B06.21
<b>description</b>	copper pipe copper ID ø 3.8mm L 0.1m ED ø 4.8mm Qty 1 pcs		
<b>For models:</b>	GGC2270, GGC2270B		

			
1			
<b>GEV No.</b>	692730	<b>Ref. No.</b>	TCGO3004
<b>description</b>	copper pipe ID ø 4mm L 0.095m ED ø 6mm		
<b>For models:</b>	GBC1002, GBC1002S, GBC1003, GBC1003S, GBC1102, GBC1103		

			
1			
<b>GEV No.</b>	692418	<b>Ref. No.</b>	1.1.B.B06.26
<b>description</b>	refrigeration pipe copper ID ø 5mm L 1m ED ø 6mm Qty 1		
<b>For models:</b>	GCV1600, GGC1078, GGC1078B, GGC2270, GGC2270B		

			
1			
<b>GEV No.</b>	692872	<b>Ref. No.</b>	W0210284
<b>description</b>	refrigeration pipe ID ø 2/3mm L 0.4m refrigeration ED ø 5mm GFR2700		
<b>For models:</b>	GFR2700		

			
1			
<b>GEV No.</b>	692871	<b>Ref. No.</b>	W0210452
<b>description</b>	refrigeration pipe ID ø 3/7mm L 0.38m refrigeration ED ø 6/8mm GFR2700		
<b>For models:</b>	GFR2700		



1

<b>GEV No.</b>	692874	<b>Ref. No.</b>	W0210412
<b>description</b>	refrigeration pipe ID ø 5.5mm L 0.3m refrigeration ED ø 6.5mm GFR2700		
<b>For models:</b>	GFR2700		



1

<b>GEV No.</b>	692876	<b>Ref. No.</b>	W0210411
<b>description</b>	refrigeration pipe ID ø 5mm L 0.28m refrigeration ED ø 6.5mm GFR2700		
<b>For models:</b>	GFR2700		





1

<b>GEV No.</b>	692875	<b>Ref. No.</b>	W0210416
<b>description</b>	refrigeration pipe ID ø 6,5/7,5mm L 0.38m refrigeration ED ø 7,5/8,5mm GRE2700		
<b>For models:</b>	GRE2700		



1

<b>GEV No.</b>	692873	<b>Ref. No.</b>	W0210282	
<b>description</b>	refrigeration pipe ID ø 6.5mm L 0.36m refrigeration ED ø 8mm GFR2700			
<b>For models:</b>	GFR2700			
<b>accessories for</b>	692873			
	<b>GEV No.</b>	696787	<b>Ref. No.</b>	W0208009
	T-piece copper ID ø 4.5mm ED ø 6mm refrigeration for GFR2700			





1

<b>GEV No.</b>	692877	<b>Ref. No.</b>	W0210417
<b>description</b>	refrigeration pipe ID ø 6/7mm L 0.41m refrigeration ED ø 7/8mm GRE2700		
<b>For models:</b>	GRE2700		

copper pipes insulated



1

<b>GEV No.</b>	696789	<b>Ref. No.</b>	W0210413	
<b>description</b>	copper pipe with insulation pipe ø 6 for fridge GFR2700/GRE2700			
<b>For models:</b>	GFR2700, GRE2700			
<b>accessories for</b>	696789			
	<b>GEV No.</b>	692867	<b>Ref. No.</b>	W04102051
	cover ø 20mm L 400mm W 43mm plastic Qty 1 pcs for GFR2700/GRE2700			
	<b>GEV No.</b>	692870	<b>Ref. No.</b>	W0413062
	rubber pad L 40mm W 17mm H 30mm for GFR2700/GRE2700			



1

<b>GEV No.</b>	699570	<b>Ref. No.</b>	W0210414
<b>description</b>	refrigeration pipe pipe ø 8 L 1700mm GFR2700		
<b>For models:</b>	GFR2700		



1

<b>GEV No.</b>	699572	<b>Ref. No.</b>	W0210418
<b>description</b>	refrigeration pipe pipe ø 8 L 1700mm GRE2700		
<b>For models:</b>	GRE2700		



connections



1

<b>GEV No.</b>	696787	<b>Ref. No.</b>	W0208009
<b>description</b>	T-piece copper ID ø 4.5mm ED ø 6mm refrigeration for GFR2700		
<b>For models:</b>	GFR2700		

**accessories for** 696787

	<b>GEV No.</b>	374110	<b>Ref. No.</b>	W0205011
	<b>description</b>	solenoid valve type FDF2AT connection 6mm soldering connection L 143mm pipe connection ø 6mm 220-240V		
	<b>GEV No.</b>	692873	<b>Ref. No.</b>	W0210282
	<b>description</b>	refrigeration pipe ID ø 6.5mm L 0.36m refrigeration ED ø 8mm GFR2700		

heating tubes



1

<b>GEV No.</b>	701583	<b>Ref. No.</b>	C04AC26A0002
<b>description</b>	heater ED ø 6mm ID ø 3mm L 260mm copper		
<b>For models:</b>	GPS2600, GSA2600, GSD2600, GSF2600		

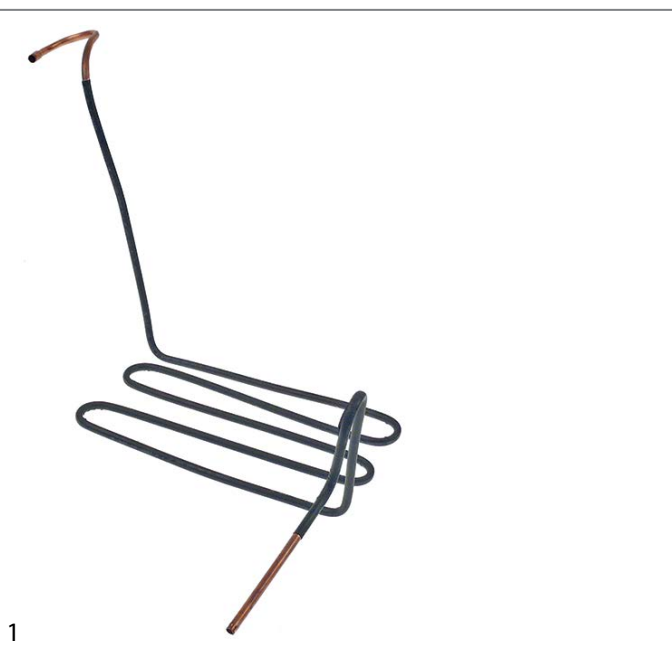

1

<b>GEV No.</b>	701495	<b>Ref. No.</b>	TCGD4010
<b>description</b>	heater ED ø 6mm ID ø 5mm Qty 1m for evaporator connection ø 6mm		
<b>For models:</b>	GSC1100G		

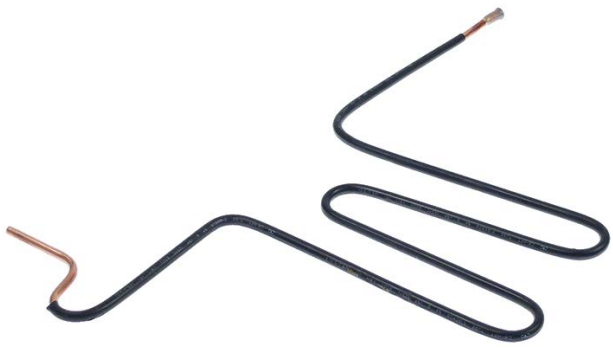
1

<b>GEV No.</b>	701582	<b>Ref. No.</b>	TCGD2001
<b>description</b>	heater pipe ED ø 5mm ID ø 3mm L 355mm H 250mm		
<b>For models:</b>	GBC1001, GBC1001S, GBC1001SS		

## evaporators for fridges

### producer-specific



1

<b>GEV No.</b>	750387	<b>Ref. No.</b>	TLZA9000
<b>description</b>	evaporator for fridge GBC1001 L 430mm W 500mm		
<b>For models:</b>	GBC1001, GBC1001S, GBC1001SS		



1

<b>GEV No.</b>	750376	<b>Ref. No.</b>	TLZD9001
<b>description</b>	evaporator for fridge GBC1002 L 760mm W 500mm		
<b>For models:</b>	GBC1002, GBC1002S, GBC1002SS, GBC1102		



1

<b>GEV No.</b>	750456	<b>Ref. No.</b>	TLZD2008
<b>description</b>	evaporator for fridge HSC360 L 780mm W 495mm		



1

<b>GEV No.</b>	750377	<b>Ref. No.</b>	TLZD9002
<b>description</b>	evaporator for fridge L 1000mm W 500mm		
<b>For models:</b>	GBC1003, GBC1003S, GBC1003SS, GBC1103		



1

<b>GEV No.</b>	750352	<b>Ref. No.</b>	1.1.A.A10.27
<b>description</b>	evaporator L 250mm W 50mm H 117mm		
<b>For models:</b>	GGC1078, GGC1078B		



1

<b>GEV No.</b>	750629	<b>Ref. No.</b>	GPC1088-02
<b>description</b>	evaporator L 320mm W 320mm H 5mm		
<b>For models:</b>	GPC1088		

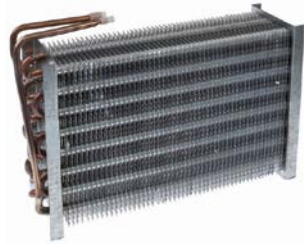

1

<b>GEV No.</b>	750350	<b>Ref. No.</b>	1.1.A.A10.40
<b>description</b>	evaporator L 345mm W 100mm H 215mm total length 345mm overall width 100mm overall height 240mm for fridge		
<b>For models:</b>	GGC2270, GGC2270B		



1

<b>GEV No.</b>	750744	<b>Ref. No.</b>	W0202112	
<b>description</b>	evaporator L 404mm W 175mm H 142mm GFR2700			
<b>For models:</b>	GFR2700			
<b>accessories for</b>	750744			
	<b>GEV No.</b>	699574	<b>Ref. No.</b>	81131204
	<b>GEV No.</b>	699577	<b>Ref. No.</b>	80021203
	<b>GEV No.</b>	699578	<b>Ref. No.</b>	80021204



1

<b>GEV No.</b>	750371	<b>Ref. No.</b>	1.1.A.A10.23
<b>description</b>	evaporator L 545mm W 50mm H 110mm total length 600mm overall width 50mm overall height 123mm		
<b>For models:</b>	GCV1600		



1

<b>GEV No.</b>	750660	<b>Ref. No.</b>	TLZA4003
<b>description</b>	evaporator L 620mm W 225mm H 160mm		



1

<b>GEV No.</b>	750375	<b>Ref. No.</b>	TLZA4004
<b>description</b>	evaporator L 760mm W 140mm H 225mm		



1

<b>GEV No.</b>	750743	<b>Ref. No.</b>	W0202117	
<b>description</b>	evaporator W 150mm H 135mm L 300mm GRE2700			
<b>For models:</b>	GRE2700			
<b>accessories for</b>	750743			
	<b>GEV No.</b>	699574	<b>Ref. No.</b>	81131204
	cover front for evaporator L 598mm W 295mm H 65mm for GFR2700/ GRE2700			
	<b>GEV No.</b>	699577	<b>Ref. No.</b>	80021203
	cover left for evaporator L 255mm W 155mm H 15mm for GFR2700/ GRE2700			
	<b>GEV No.</b>	699578	<b>Ref. No.</b>	80021204
	cover right for evaporator L 255mm W 155mm H 15mm for GFR2700/ GRE2700			

accessories

miscellaneous



1

<b>GEV No.</b>	692868	<b>Ref. No.</b>	W0409079
<b>description</b>	cover for evaporator plastic GFR2700/GRE2700		
<b>For models:</b>	GFR2700, GRE2700		

condensors

filters



1

<b>GEV No.</b>	699402	<b>Ref. No.</b>	P04AC28A0002
<b>description</b>	filter for condenser L 218mm W 230mm thickness 6mm Qty 1 pcs		
<b>For models:</b>	GDS2600, GPS2600, GSA2600, GSD2600, GSF2600		

condensors



1

<b>GEV No.</b>	750746	<b>Ref. No.</b>	W0203051
<b>description</b>	condenser Capacitor W 250mm H 100mm L 260mm for GRE2700		
<b>For models:</b>	GRE2700		





1

<b>GEV No.</b>	750742	<b>Ref. No.</b>	W0203052
<b>description</b>	condenser Capacitor W 250mm H 140mm L 260mm GFR2700		
<b>For models:</b>	GFR2700		



1

<b>GEV No.</b>	750372	<b>Ref. No.</b>	DTLA9000
<b>description</b>	condenser W 195mm D 80mm H 205mm Qty 1 pcs		
<b>For models:</b>	GBC1001, GBC1001S, GBC1001SS		



1

<b>GEV No.</b>	750319	<b>Ref. No.</b>	VRX.11
<b>description</b>	condenser for pizza table W 228mm D 77mm H 179mm		
<b>For models:</b>	GHS1600, GHS2600		



1

<b>GEV No.</b>	750347	<b>Ref. No.</b>	C04AC28A0001
<b>description</b>	condenser W 220mm D 100mm H 230mm L 270mm		
<b>For models:</b>	GDS2600, GPS2600, GSA2600, GSD2600, GSF2600		



1

<b>GEV No.</b>	750373	<b>Ref. No.</b>	DTLA9002
<b>description</b>	condenser W 190mm D 160mm H 205mm Qty 1 pcs		
<b>For models:</b>	GBC1003, GBC1003S, GBC1003SS, GBC1103		



1

<b>GEV No.</b>	750384	<b>Ref. No.</b>	1.1.A.A09.01
<b>description</b>	condenser W 220mm D 60mm H 280mm Qty 1 pcs		
<b>For models:</b>	GGC1078, GGC1078B		



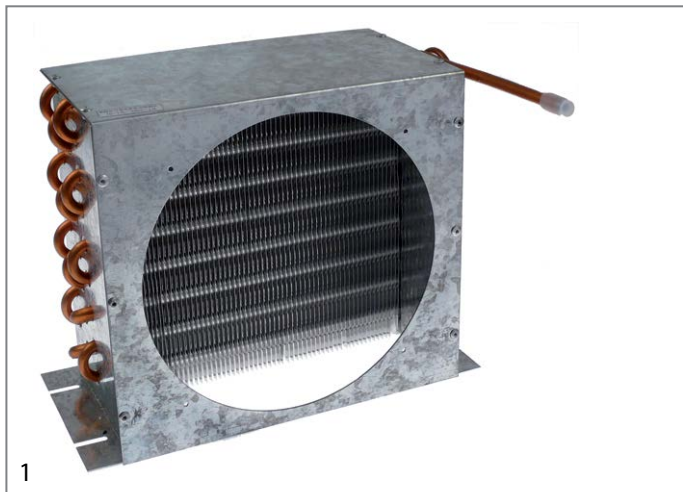

1

<b>GEV No.</b>	750351	<b>Ref. No.</b>	1.1.A.A09.09
<b>description</b>	condenser W 255mm D 130mm H 235mm		
<b>For models:</b>	GGC2270, GGC2270B		

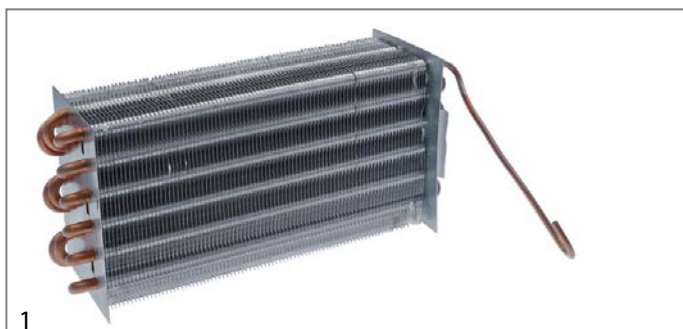

1

<b>GEV No.</b>	750370	<b>Ref. No.</b>	1.1.A.A09.21
<b>description</b>	condenser W 265mm D 93mm H 140mm Qty 1 pcs		
<b>For models:</b>	GCV1600		



1

<b>GEV No.</b>	750374	<b>Ref. No.</b>	DTLA4008
<b>description</b>	condenser W 555mm D 100mm H 275mm Qty 1 pcs		



1

<b>GEV No.</b>	750703	<b>Ref. No.</b>	44918000
<b>description</b>	condenser W 790mm D 10mm H 1360mm		
<b>For models:</b>	GFR3600S		

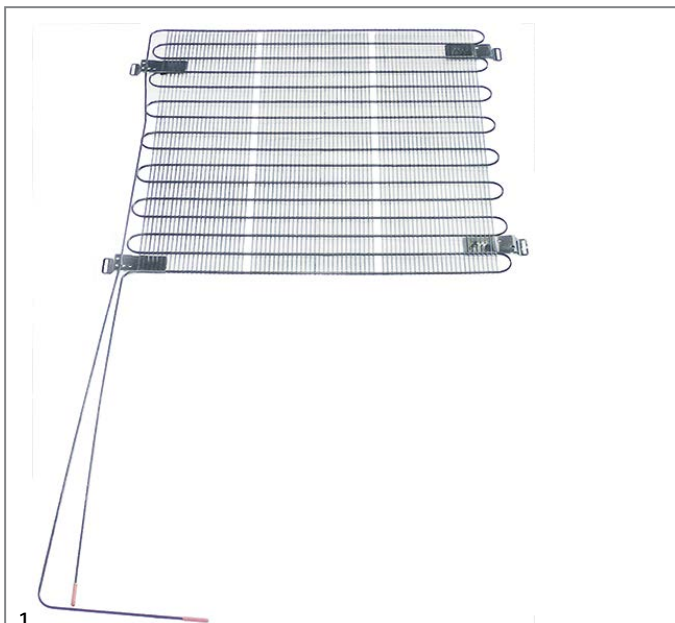

1

<b>GEV No.</b>	750699	<b>Ref. No.</b>	45034000
<b>description</b>	condenser W 790mm D 10mm H 750mm Qty 1 pcs		
<b>For models:</b>	GRE3600, GRE3600S		





## evaporation and condensing trays

### evaporation trays

			
1			
<b>GEV No.</b>	699302	<b>Ref. No.</b>	SLZJ0021
<b>description</b>	evaporation tray L 185mm W 130mm H 75mm		
<b>For models:</b>	GBC1001, GBC1001S, GBC1001SS		

			
1			
<b>GEV No.</b>	699299	<b>Ref. No.</b>	SLZJ0014
<b>description</b>	evaporation tray L 210mm W 105mm H 80mm		
<b>For models:</b>	GSC2336		

			
1			
<b>GEV No.</b>	699211	<b>Ref. No.</b>	I0425088
<b>description</b>	evaporation tray L 230mm W 144mm H 45mm		
<b>For models:</b>	GRE3600, GRE3600S		

				
1				
<b>GEV No.</b>	750745	<b>Ref. No.</b>	W0409071	
<b>description</b>	evaporation tray rear L 527mm W 238mm for fridge for GFR2700/ GRE2700			
<b>For models:</b>	GFR2700, GRE2700			
<b>accessories for</b>	750745			
	<b>GEV No.</b>	750747	<b>Ref. No.</b>	W0409078
	overflow plastic for GFR2700/GRE2700			

### unheated condensing trays



			
1			
<b>GEV No.</b>	750630	<b>Ref. No.</b>	GPC1088-08
<b>description</b>	condensing tray L 200mm W 135mm H 30mm plastic		
<b>For models:</b>	GPC1088		

			
1			
<b>GEV No.</b>	750632	<b>Ref. No.</b>	SLZJ0022
<b>description</b>	drip tray L 187mm W 128mm H 70mm plastic		
<b>For models:</b>	GBC1002, GBC1002S, GBC1002SS, GBC1003, GBC1003S, GBC1003SS, GBC1102, GBC1103		

			
1			
<b>GEV No.</b>	750631	<b>Ref. No.</b>	SLZJ0015
<b>description</b>	drip tray L 302mm W 204mm H 85mm plastic		
<b>For models:</b>	GSC1100G		

			
1			
<b>GEV No.</b>	699418	<b>Ref. No.</b>	1.1.C.C29.02
<b>description</b>	drip tray L 400mm W 144mm H 50mm plastic		
<b>For models:</b>	GGC2270, GGC2270B		

### miscellaneous

				
1				
<b>GEV No.</b>	750747	<b>Ref. No.</b>	W0409078	
<b>description</b>	overflow plastic for GFR2700/GRE2700			
<b>For models:</b>	GFR2700, GRE2700			
<b>accessories for</b>	750747			
	<b>GEV No.</b>	750745	<b>Ref. No.</b>	W0409071
	evaporation tray rear L 527mm W 238mm for fridge for GFR2700/ GRE2700			

## transmission technology and ball bearings

### ball bearings

#### deep-groove ball bearings 2RS



1

<b>GEV No.</b>	523501	<b>Ref. No.</b>	00000000637
<b>description</b>	deep-groove ball bearing type 608-2RS shaft $\varnothing$ 8mm ED $\varnothing$ 22mm W 7mm with sealing discs deep-groove ball bearing DIN 625-1		
<b>For models:</b>	GFS1030		



1

<b>GEV No.</b>	523510	<b>Ref. No.</b>	00000000860
<b>description</b>	deep-groove ball bearing type 6202-2RS shaft $\varnothing$ 15mm ED $\varnothing$ 35mm W 11mm with sealing discs deep-groove ball bearing DIN 625-1		
<b>For models:</b>	GFS1025, GFS2019, GFS2022, GFS2025, GFS2030		



1

<b>GEV No.</b>	523512	<b>Ref. No.</b>	00000000632
<b>description</b>	deep-groove ball bearing type 6204-2RS shaft $\varnothing$ 20mm ED $\varnothing$ 47mm W 14mm with sealing discs deep-groove ball bearing DIN 625-1		
<b>For models:</b>	GFS1030		



1

<b>GEV No.</b>	523504	<b>Ref. No.</b>	00000000862
<b>description</b>	deep-groove ball bearing type 626-2RS shaft $\varnothing$ 6mm ED $\varnothing$ 19mm W 6mm with sealing discs deep-groove ball bearing DIN 625-1		
<b>For models:</b>	GFS1025, GFS2019, GFS2022, GFS2025, GFS2030		

## drive belts

### poly-v belts

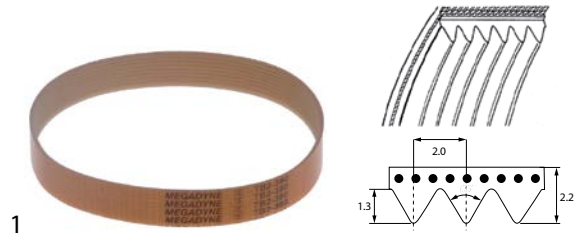

1

<b>GEV No.</b>	698215	<b>Ref. No.</b>	00000000635
<b>description</b>	poly-v belt grooves 10 W 20mm L 400mm profile TB2		
<b>For models:</b>	GFS1030		

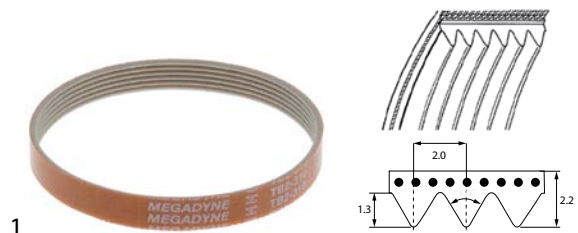

1

<b>GEV No.</b>	698963	<b>Ref. No.</b>	00000000492
<b>description</b>	poly-v belt grooves 5 W 10mm L 310mm profile TB2		
<b>For models:</b>	GFS2019, GFS2022		

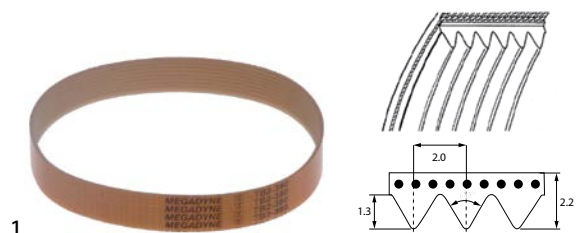

1

<b>GEV No.</b>	698217	<b>Ref. No.</b>	00000000861
<b>description</b>	poly-v belt grooves 7 W 14mm L 330mm profile TB2		
<b>For models:</b>	GFS1025, GFS2025		

## springs

### compression springs



1

<b>GEV No.</b>	519162	<b>Ref. No.</b>	904131
<b>description</b>	spring		
<b>For models:</b>	GDW2001		



1

<b>GEV No.</b>	692701	<b>Ref. No.</b>	1.1.B.B10.06
<b>description</b>	spring L 4mm wire gauge ø 1mm windings 5 D1 ø 9.5mm		
<b>For models:</b>	GGC1078, GGC1078B		

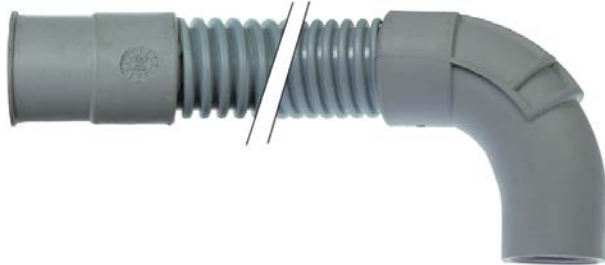

1

<b>GEV No.</b>	519456	<b>Ref. No.</b>	907439
<b>description</b>	drain hose L 1500mm D1 ø 21mm D2 ø 21mm		
<b>For models:</b>	GDW2001		

## dosing pumps

### membrane dosing pumps

#### self-priming

#### SEKO



1

<b>GEV No.</b>	362031	<b>Ref. No.</b>	902201
<b>description</b>	dosing pump type DIB E rinse aid pump rate 0-5cm <sup>3</sup> per stroke pressure connection ø 4x6mm suction connection ø 4x6mm suction connection SEKO supporting pressure closed		
<b>For models:</b>	GDW2001		

## accessories

### miscellaneous



1

<b>GEV No.</b>	513329	<b>Ref. No.</b>	906375
<b>description</b>	bracket for dosing pump L 70mm H 25mm W 40mm spring steel		
<b>For models:</b>	GDW2001		

## hoses

### drain hoses



1

<b>GEV No.</b>	530921	<b>Ref. No.</b>	907446
<b>description</b>	drain hose 3/4" L 1500mm A int. ø 29mm A ext. ø 34mm B int. ø 21mm B ext. ø 26mm outer hose ø 24mm		
<b>For models:</b>	GDW2001		

## industrial hoses

### PVC hoses

#### PVC hoses without fabric



1

<b>GEV No.</b>	570027	<b>Ref. No.</b>	902046
<b>description</b>	PVC hose ID ø 4mm ED ø 7mm L 100m thickness 1.5mm t.max. 60°C transparent		
<b>For models:</b>	GDW2001		

### silicone hoses

#### without fabric



1

<b>GEV No.</b>	530410	<b>Ref. No.</b>	907279
<b>description</b>	silicone hose ID ø 4mm ED ø 7mm L 2m thickness 1.5mm t.max. 200°C transparent		
<b>For models:</b>	GDW2001		

## formed hoses

### straight



1

<b>GEV No.</b>	519392	<b>Ref. No.</b>	903756
<b>description</b>	formed hose L 61mm dishwasher straight hose ext. ø 50mm hose int. ø 38mm		
<b>For models:</b>	GDW2001		





form L



1

<b>GEV No.</b>	503190	<b>Ref. No.</b>	903694
<b>description</b>	formed hose L 120mm supply EPDM warewashing 45 ED ø 56mm		
<b>For models:</b>	GDW2001		



1

<b>GEV No.</b>	506280	<b>Ref. No.</b>	909371
<b>description</b>	formed hose L 190mm EPDM warewashing black		
<b>For models:</b>	GDW2001		



1

<b>GEV No.</b>	505410	<b>Ref. No.</b>	903672
<b>description</b>	formed hose L 70mm warewashing ID ø 27mm ED ø 37mm		
<b>For models:</b>	GDW2001		

miscellaneous



1

<b>GEV No.</b>	699420	<b>Ref. No.</b>	1.1.C.C41.13
<b>description</b>	formed hose ID ø 19mm ED ø 24mm L 150mm		
<b>For models:</b>	GGC1078, GGC1078B		

for dishwashers

miscellaneous



1

<b>GEV No.</b>	503190	<b>Ref. No.</b>	903694
<b>description</b>	formed hose L 120mm supply EPDM warewashing 45 ED ø 56mm		
<b>For models:</b>	GDW2001		



1

<b>GEV No.</b>	506280	<b>Ref. No.</b>	909371
<b>description</b>	formed hose L 190mm EPDM warewashing black		
<b>For models:</b>	GDW2001		

fittings, hose and pipe connectors

hose connectors

without screw connection



1

<b>GEV No.</b>	519644	<b>Ref. No.</b>	905434
<b>description</b>	T-piece plastic connection ø12mm - ø5mm - ø12mm		
<b>For models:</b>	GDW2001		



1

<b>GEV No.</b>	519216	<b>Ref. No.</b>	905382
<b>description</b>	T-piece plastic hose ø 12-12-12mm 3-way		
<b>For models:</b>	GDW2001		

ancillary products

clamps

double wire clamps



1

<b>GEV No.</b>	513268	<b>Ref. No.</b>	902425
<b>description</b>	hose clamp ø 8-10mm wire gauge ø 1mm Qty 1 pcs		
<b>For models:</b>	GDW2001		



## fastening material

### screws

#### side bolts



1

<b>GEV No.</b>	560551	<b>Ref. No.</b>	00000000615
<b>description</b>	side bolts thread M10 L 15mm SS Qty 1 pcs intake slotted head ø 24.5mm		
<b>For models:</b>	GFS1030		

#### knurled screws



1

<b>GEV No.</b>	697481	<b>Ref. No.</b>	00000000623
<b>description</b>	Thumb screw thread M6 thread L 8mm ø 14mm H 6mm SS		
<b>For models:</b>	GFS1030, GFS2019, GFS2022, GFS2025		

### nuts

#### hexagonal nuts

##### DIN 985



1

<b>GEV No.</b>	560142	<b>Ref. No.</b>	902040
<b>description</b>	hexagonal nut thread M6 H 6mm SS WS 10 Qty 20 pcs DIN/ISO DIN 985 self-locking		
<b>For models:</b>	GDW2001		

#### miscellaneous



1

<b>GEV No.</b>	551380	<b>Ref. No.</b>	DAD30010
<b>description</b>	cage nut thread M10 Qty 4 pcs		
<b>For models:</b>	GCO500		

### washers

#### spring washers



1

<b>GEV No.</b>	697478	<b>Ref. No.</b>	00000000671
<b>description</b>	spring washer ID ø 19mm ED ø 26mm Qty 1 pcs		
<b>For models:</b>	GFS1030		

### washers

#### miscellaneous



1

<b>GEV No.</b>	519238	<b>Ref. No.</b>	906002
<b>description</b>	plain washer ID ø 15mm ED ø 33mm thickness 0.8mm SS Qty 1 pcs		
<b>For models:</b>	GDW2001		

### fasteners

#### mounting clips



1

<b>GEV No.</b>	692865	<b>Ref. No.</b>	00007750
<b>description</b>	mounting clip for bulb socket L 16mm H 19mm		
<b>For models:</b>	GCO2001		

### clamps

#### double wire clamps



1

<b>GEV No.</b>	513268	<b>Ref. No.</b>	902425
<b>description</b>	hose clamp ø 8-10mm wire gauge ø 1mm Qty 1 pcs		
<b>For models:</b>	GDW2001		



## roll pins



1

<b>GEV No.</b>	691637	<b>Ref. No.</b>	0744
<b>description</b>	roll pin ø 3mm L 20mm		
<b>For models:</b>	GSM1000		

<b>A</b>			
alarm devices	15		
axial fans	24		
<b>B</b>			
ballasts	13		
bi-metal thermostats	5, 6		
booster pumps II	31		
<b>C</b>			
cable glands	34		
cables	33		
cam switches	9		
castors and bumper angles	71		
clamps	90, 91		
cold air circulating fans	28		
compressors	23		
condensators & interference suppression filters	32		
connection cables	34		
contactors	15		
control thermostats	6, 7		
copper pipes insulated	81		
copper pipes uninsulated	80		
cross flow fans	28		
<b>D</b>			
defrost timers	15		
door seals	77		
dosing pumps	89		
double wire clamps	90, 91		
drain hoses	89		
drain pumps	31		
<b>E</b>			
electric accessories	33		
electronic controllers	17		
evaporators	83		
<b>F</b>			
fans	24		
fasteners	91		
fastening material	91		
filter driers	79		
filters	32		
fluorescent lamps	13, 13		
foil heating elements	5		
formed hoses	89		
fuses	32		
<b>G</b>			
gaskets for heated units	77		
gaskets for wash arm support	79		
		grates	72
<b>H</b>			
		heating cables	4
		heating elements	3
		heating elements for convection	5
		heating elements for fryers	3
		heating elements for griddles	3
		heating elements for ovens	3
		hexagonal nuts	91
		hose connectors	90
		hoses	89
		hot air fans	29
		HV capacitors	32
<b>I</b>			
		immersion heating elements	4
		indicator lights	10
		indicator lights (complete)	11
		induction coils	3
		industrial hoses	89
<b>K</b>			
		knurled screws	91
<b>L</b>			
		lamp accessories	14
		lamps	10
		LED	12
<b>M</b>			
		magnetic switches	10
		magnetrons	16
		mechanical timers	15
		microswitches	8
		microwave lamps	14
		motors	30
		mounting clips	91
<b>N</b>			
		nuts	91
<b>O</b>			
		operating capacitors	32
		O-rings	78
		oven hinges	66
		oven lamps	14
<b>P</b>			
		plug-in gaskets	76
		position switches	9
		power supply cables	33
		pressure switches	22

probes	19
pumps	31
push/momentary push switches	8
PVC hoses	89

**Q**

quartz heating elements	4
-------------------------	---

**R**

refrigeration cycle components	79
refrigeration fans	26
refrigeration gaskets	76
refrigeration motors universal	26
refrigeration pipes	80
refrigeration thermostats	7
relays	16
rocker/momentary rocker switches	8
roll pins	92

**S**

safety bi-metal thermostats	5
safety thermostats	6
Schrader valves	79
screw-in gaskets	77
screws	91
sealing washers	78
shaft gaskets	78
shelves and shelf rails	72
side bolts	91
silicone hoses	89
snap locks	66
solenoid valves	22
solid state relays	16
speed controllers	30
spring washers	91
starter	13
strain reliefs	34
switches and momentary switches	8
system switches (ROLD)	9

**T**

temperature probes	19
terminal boxes	35
terminals	34
thermostats	5
threaded cable glands	34
timers	15
transformers	16

**U**

universal probes	19
------------------	----

**W**

wash and rinse pumps	31
washers	91