



GAS COMPONENTS



ELECTRIC COMPONENTS



WATER TECHNOLOGY



MECHANICAL COMPONENTS



TOOLS

Spare parts suitable for

METALCARRELLI

Find the complete and up-to-date range of products in our GEV Webshop



Manufacturer catalogue

The most important spare parts and accessories arranged clearly for every manufacturer

- ✓ Complete product range and all appliance data always up to date in the GEV Webshop
- ✓ Alphabetical Index at the end of the catalogue

GEV Webshop

www.gev-online.co.uk

www.gev-online.com



- 🔍 Add to Favourites
- 🔍 Sign In with email address and usual password
- 🔍 Easy-order – place several items in your basket at the same time
- 🔍 Quick Item search – no login needed



heating elements

heating elements for bain maries

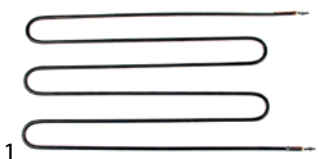
			
GEV No.	418334	Ref. No.	003001040005 R1515
description	heating element 1400W 230V heating circuits 1 L 555mm L1 45mm W 270mm connection M4 connection distance 262mm tube ø 8mm dry heating element L2 510mm H 20mm		

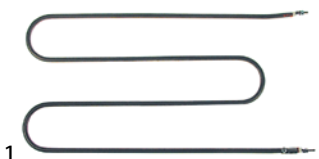
			
GEV No.	418335	Ref. No.	003001040010 R1545
description	heating element 500W 230V heating circuits 1 L 430mm L1 38mm W 280mm connection M4 connection distance 271mm tube ø 8.5mm dry heating element L2 392mm H 16mm		

heating cables

connection on both sides

with wire end ferrules

			
GEV No.	418336	Ref. No.	R1504
description	heating cable 230W 230V L 4000mm silicone impregnated glass fibre braiding ø 3mm connection terminal		

			
GEV No.	418337	Ref. No.	R1506
description	heating cable 313W 230V L 6600mm silicone impregnated glass fibre braiding ø 3mm connection terminal		

			
GEV No.	418338	Ref. No.	R1508
description	heating cable 384W 230V L 7900mm silicone impregnated glass fibre braiding ø 4mm connection terminal		

with male fastons

			
GEV No.	419108	Ref. No.	003001040011 003001040018
description	heating cable 250W 230V L 4000mm silicone ø 3mm connection female faston 6.3mm		

			
GEV No.	419107	Ref. No.	003001040012 003001040019
description	heating cable 300W 230V L 6000mm silicone ø 3mm		

			
GEV No.	419106	Ref. No.	003001040013 003001040020
description	heating cable 450W 230V L 8000mm silicone ø 3mm		

			
GEV No.	418339	Ref. No.	003001040014 003001040021 R1510
description	heating cable 600W 230V L 9900mm silicone ø 3mm connection male faston 6.3mm		

immersion heating elements

with compression flange 70 x 26mm

			
GEV No.	417278	Ref. No.	003001020002 R1535
description	heating element 1950W 230V heating circuits 3 L 230mm W 70mm washing		

thermostats

control and safety thermostats

IMIT / TEMPOMATIC / ARTHERMO

control thermostats

			
GEV No.	375404	Ref. No.	003201820001
description	thermostat t.max. 110°C temperature range 0-90°C 1-pole 1CO 15A probe ø 6mm probe L 104mm capillary pipe 1400mm capillary pipe isolated 1350mm gland nut shaft ø 6x4.6mm shaft L 18mm shaft position upper rotation 270° probe material copper 400V		

1 electric components



PRODIGY / FIRT

control thermostats



GEV No.	390723	Ref. No.	003201820002
description	thermostat PRODIGY temperature range -35 up to +35°C probe ø 6mm probe L 110mm capillary pipe 1500mm type TR/711-N		
accessories for	390723		
	GEV No.	110305	Ref. No.
	knob thermostat t.max. 35°C temperature range -35 up to +35°C ø 45mm shaft ø 6x4.6mm shaft flat inclined rotation 270° white		

various

control thermostats with operation switch



GEV No.	375762	Ref. No.	R0090
description	thermostat t.max. 120°C temperature range 30-120°C 1-pole 1CO 16A probe ø 6.5mm probe L 98mm capillary pipe 1450mm capillary pipe isolated 1350mm rotation 270°		

switches and momentary switches

rocker/momentary rocker switches

30x22mm

labelled



GEV No.	300125	Ref. No.	R0056
description	rocker switch mounting measurements 30x22mm green 2NO 230V 16A 0-I connection male faston 6.3mm ambient temperature max. 125/55°C protection IP65 with cover cap		
accessories for	300125		
	GEV No.	301036	Ref. No.
	protective cover internal size 30x22mm for rocker switch mounting measurementsmm		



GEV No.	301164	Ref. No.	R0056 R0096
description	rocker switch mounting measurements 30x22mm green 2NO 250V 16A illuminated connection male faston 6.3mm ambient temperature max. 85°C protection IP65 with cover cap		
accessories for	301164		
	GEV No.	301036	Ref. No.
	protective cover internal size 30x22mm for rocker switch mounting measurementsmm		

lamps

indicator lights

indicator lights (complete)

ø10mm

with plug-in socket



GEV No.	359866	Ref. No.	R0095
description	indicator light ø 10mm 230V red cable length 200mm		

hard-glass infrared lamps



GEV No.	359463	Ref. No.	003151620002 A9560
description	infrared lamp socket E27 240V 250W ø 125mm L 173mm type BR125 red hard glas		

electronic controllers

ELIWELL













universal controllers

built-in version



GEV No.	379994	Ref. No.	R0052
description	electronic controller ELIWELL mounting measurements 71x29mm 230V voltage AC NTC/PTC defr. funct. no		



 <p>71 x 29mm</p>			
1			
GEV No.	379690	Ref. No.	R0092
description	electronic controller ELIWELL type ICPlus902 model ICP16D0750000 mounting measurements 71x29mm 230V voltage AC NTC/PTC relay outputs 1 CO-15A(8) NTC/PTC built-in depth 60mm defr. funct. -50 up to +150°C display 3½ digits		
accessories for	379690		
	GEV No.	378194	Ref. No. —
	temperature probe NTC 10kOhm cable PVC probe -20 up to +80°C cable -10 up to 100°C probe ø7x24.5mm cable length 1.5m without screw connection 2-wire		
	GEV No.	379052	Ref. No. —
	temperature probe PTC 1kOhm cable silicone probe -50 up to +150°C cable -50 up to +180°C probe ø6x40mm cable length 1.5m without screw connection 2-wire		
	GEV No.	379053	Ref. No. —
	temperature probe PTC 1kOhm cable PVC probe -50 up to +150°C cable -10 up to 100°C probe ø6x30mm cable length 3m without screw connection 2-wire		
	GEV No.	379057	Ref. No. —
	temperature probe NTC 10kOhm cable PVC probe -20 up to +80°C cable -10 up to 100°C probe ø6x25mm cable length 3m 2-wire		
	GEV No.	379064	Ref. No. —
	temperature probe PTC 1kOhm cable silicone probe -50 up to +150°C cable -50 up to +180°C probe ø6x40mm cable length 3m without screw connection 2-wire		
	GEV No.	379142	Ref. No. —
	temperature probe PTC 1kOhm cable PVC probe -50 up to +150°C cable -10 up to 100°C probe ø6x30mm cable length 1.5m without screw connection 2-wire		
	GEV No.	379160	Ref. No. —
	temperature probe NTC 10kOhm cable thermoplastic probe -40 up to +110°C cable -40 up to +110°C probe ø6x14mm cable length 1.5m without screw connection 2-wire		
	GEV No.	379161	Ref. No. —
	temperature probe NTC 10kOhm cable thermoplastic probe -40 up to +110°C cable -40 up to +110°C probe ø6x14mm cable length 3m without screw connection 2-wire		
	GEV No.	379343	Ref. No. —
	temperature probe NTC 10kOhm cable silicone probe -40 up to +110°C cable -50 up to +180°C probe ø6x40mm cable length 3m 2-wire		
	GEV No.	379458	Ref. No. —
	temperature probe NTC 10kOhm cable silicone probe -40 up to +110°C cable -50 up to +180°C probe ø6x40mm cable length 1.5m without screw connection 2-wire		
	GEV No.	379781	Ref. No. —
	temperature probe PTC 1kOhm cable thermoplastic probe -50 up to +150°C cable -40 up to +110°C probe ø6x14mm cable length 1.5m without screw connection 2-wire		
	GEV No.	379782	Ref. No. —
	temperature probe PTC 1kOhm cable thermoplastic probe -50 up to +150°C cable -40 up to +110°C probe ø6x14mm cable length 3m 2-wire resistor 1kOhm		

fans



hot air fans

miscellaneous

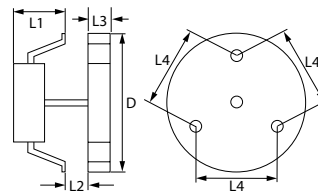

1



GEV No.	601011	Ref. No.	R1536
description	hot air fan 220-240V 40W 50/60Hz L1 65mm L2 15mm L3 25mm L4 87mm fan wheel ø 150mm FIME type C25R8023CLH		
accessories for	601011		
	GEV No.	550879	Ref. No. —
	insulation ø 130mm thickness 3mm hole ø 20mm for hot air fan		
	GEV No.	601260	Ref. No. —
	nut thread M6L IT for hot air fan		

electric accessories

cables

spiral cables



1

GEV No.	550101	Ref. No.	003553280001
description	spiral cable plug type CEE7/7 type E+F 1.5mm ² 3-pole with plug L 500mm expansion 5:1 countries A/B/D/F/I orange t.max. 70°C		



gas burners

hob burners

producer-specific hob burners

METALCARRELLI

universal



1

GEV No.	105927	Ref. No.	009540650002 A0135
description	burner unit L 350mm W 250mm number of burners: 1 complete 1.75kW LPG		



1

GEV No.	105928	Ref. No.	009540650003 A0136
description	burner unit L 470mm W 340mm number of burners: 2 complete		

equipment feet and end caps

bolting feet



1

GEV No.	693442	Ref. No.	001804340001
description	equipment foot \varnothing 29mm H 15mm rubber bore \varnothing 6mm Qty 1 pcs		

DERBY RUOTE

with bolt hole

plastic



1

GEV No.	701413	Ref. No.	005201250020
description	swivel castor \varnothing 125mm bolt hole bolt hole \varnothing 13mm housing polypropylene capacity 100kg bearing ball bearing wheel body polypropylene tread TPE tyres H 161mm wheel width 30mm Qty 1 pcs		

miscellaneous

with bolt hole

 \varnothing 125mm

1

GEV No.	700342 ¹	Ref. No.	005201250021 83022000 R3207F
description	swivel castor with swivel brake \varnothing 125mm plug fitting 21x21mm housing zinc-plated sheet steel bearing slide bearing H 157mm wheel width 27mm		

¹with swivel brake

with spigot

 \varnothing 100mm

1

GEV No.	700339	Ref. No.	005101000001 R3220
description	swivel castor \varnothing 100mm threaded shaft M10 housing chrome-plated steel bearing ball bearing H 140mm wheel width 25mm Qty 1 pcs		



1

GEV No.	700336	Ref. No.	005151250002 R3205F
description	swivel castor with swivel brake \varnothing 125mm plug fitting \varnothing 10x38mm housing chrome-plated steel bearing slide bearing wheel body polypropylene tread TPE tyres Qty 1 pcs		

 \varnothing 125mm

1

GEV No.	700341	Ref. No.	00520125000 005201250001 R3207
description	swivel castor \varnothing 125mm plug fitting 21x21mm housing zinc-plated sheet steel bearing slide bearing H 157mm wheel width 27mm		



 <p>1</p>			
GEV No.	700340	Ref. No.	005151250001 R3205
description	swivel castor \varnothing 125mm plug fitting \varnothing 10x38mm housing zinc-plated sheet steel bearing slide bearing tread thermoplastic rubber H 157mm wheel width 27mm		

bumper angles

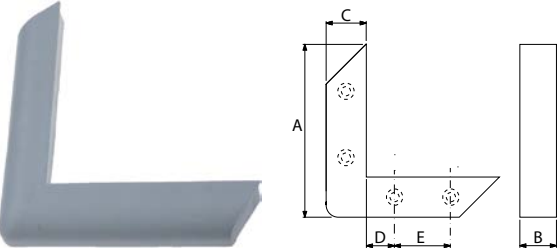
 <p>1</p>			
GEV No.	692112	Ref. No.	233004680002 A0034
description	bumper angle outer length 180mm inner length 145mm W 32mm H 30mm mounting distance 51mm hole distance 42mm hole \varnothing 3mm plastic grey		

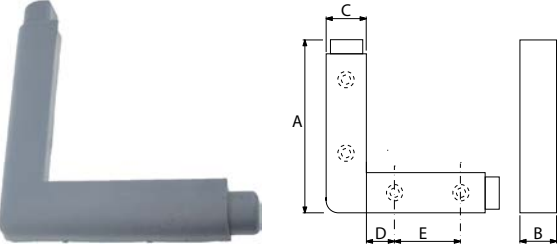
 <p>1</p>			
GEV No.	692113	Ref. No.	233004680001
description	bumper angle outer length 180mm inner length 148mm W 34mm H 22mm mounting distance 52mm hole distance 48mm hole \varnothing 3mm plastic grey		

valves and tank inlets

ball valves

universal

mini ball valves

 <p>1</p>			
GEV No.	520724	Ref. No.	M2001020001
description	ball valve connection 1/2" IT - 1/2" ET DN10 total length 45mm chrome-plated brass		

B

ball valves 7

C

cables 5

castors and bumper angles 6

control thermostats 3

E

electric accessories 5

electronic controllers 4

F

fans 5

G

gas burners 6

H

heating cables 3

heating elements 3

heating elements for bain maries 3

hob burners 6

hot air fans 5

I

immersion heating elements 3

indicator lights 4

indicator lights (complete) 4

L

lamps 4

R

rocker/momentary rocker switches 4

S

spiral cables 5

switches and momentary switches 4

T

thermostats 3

V

valves and tank inlets 7