



GAS COMPONENTS



ELECTRIC COMPONENTS



WATER TECHNOLOGY



MECHANICAL COMPONENTS



TOOLS

Spare parts suitable for

MERCATUS

Find the complete and up-to-date range of products in our GEV Webshop



Manufacturer catalogue

The most important spare parts and accessories arranged clearly for every manufacturer

- ✓ Complete product range and all appliance data always up to date in the GEV Webshop
- ✓ Alphabetical Index at the end of the catalogue

GEV Webshop

www.gev-online.co.uk

www.gev-online.com



- 🔍 Add to Favourites
- 🔍 Sign In with email address and usual password
- 🔍 Easy-order – place several items in your basket at the same time
- 🔍 Quick Item search – no login needed



switches and momentary switches

rocker/momentary rocker switches

30x22mm



1

| | | | |
|---|---|-----------------|-----------------|
| GEV No. | 301003 | Ref. No. | 43201004 |
| description | rocker switch mounting measurements 30x22mm green 2NO 250V 16A illuminated 0-I connection male faston 6.3mm ambient temperature max. 125/55°C protection IP65 | | |
| accessories for | 301003 | | |
|  | GEV No. | 301036 | Ref. No. |
| | protective cover internal size 30x22mm for rocker switch mounting measurementsmm | | |



1

| | | | |
|--------------------|--|-----------------|----------|
| GEV No. | 346474 | Ref. No. | 43201014 |
| description | dummy element external size 30x22mm suitable for rocker switch | | |



1

| | | | |
|--------------------|--|-----------------|----------|
| GEV No. | 346473 | Ref. No. | 43201005 |
| description | rocker switch mounting measurements 30x22mm orange 2NO 230V 16A illuminated fan connection male faston 6.3mm ambient temperature max. 100/55°C protection IP40 | | |

lamps

indicator lights

indicator lights (complete)

30x22mm



1

| | | | |
|---|---|-----------------|-----------------|
| GEV No. | 359177 | Ref. No. | 43201006 |
| description | indicator light mounting measurements 30x22mm 230V red connection male faston 6.3mm temp.-resist. 85°C type Marquardt 1667.. IP44 | | |
| accessories for | 359177 | | |
|  | GEV No. | 301036 | Ref. No. |
| | protective cover internal size 30x22mm for rocker switch mounting measurementsmm | | |

electronic controllers

CAREL

refrigeration controllers

built-in version



1

| | | | |
|--------------------|--|-----------------|----------|
| GEV No. | 378333 ¹ | Ref. No. | 41103010 |
| description | electronic controller CAREL IRMEC0HB011 mounting measurements 71x29mm built-in depth 94mm 115-230V voltage AC NTC/PTC relay outputs 4 CO-12A(2) CO-8A(4) CO-8A(4) CO-8A(4) NTC/PTC NTC/PTC DI DI IR/RS-485 protection IP65 -50 up to +99/+150°C display 3 digits | | |

¹with IR/RS-485 interface



1

| | | | |
|--------------------|---|-----------------|----------|
| GEV No. | 379586 | Ref. No. | 41103001 |
| description | electronic controller CAREL mounting measurements 71x29mm 12V voltage AC protection IP65 heating or cooling refrigeration type IR325E0001 | | |



1

| | | | |
|---|---|-----------------|-----------------|
| GEV No. | 378236 ¹ | Ref. No. | 41103006 |
| description | electronic controller CAREL PBMEH0HB111 mounting measurements 138.5x29mm built-in depth 75mm 115-230V voltage AC NTC/PTC relay outputs 5 NO-10A(10) CO-12A(2) NO-8A(4) NO-8A(4) CO-8A(4) NTC NTC DI DI yes IR/RS-485 yes protection IP54 -50 up to +150°C display 3½ digits | | |
| spare parts for | 378236 | | |
|  | GEV No. | 378255 | Ref. No. |
| | frame W 197mm H 50mm plastic black for CAREL | | |

¹with IR/RS-485 interface



1

| | | | |
|--------------------|---|-----------------|----------|
| GEV No. | 378326 | Ref. No. | 41103038 |
| description | electronic controller CAREL PYMT1Z054G mounting measurements 71x29mm built-in depth 59mm 230V voltage AC NTC relay outputs 1 CO-12A(2) NTC NTC DI yes protection IP54 -50 up to +90°C display 3½ digits | | |

built-in version 2-piece

CAREL 140 x 110mm



1

| | | | |
|--------------------|---|-----------------|------------------------|
| GEV No. | 378465 | Ref. No. | 41103005 PSB0001000 |
| description | electronic controller CAREL PSB0001000 mounting measurements 145x110mm built-in depth 30mm 230V voltage AC NTC relay outputs 4 NO-16A(12) CO-16A(12) NO-10A(4) NO-16A(12) NTC NTC DI DI yes yes installation kit inclusive yes protection IP44 DIN rail°C display | | |



71 x 29mm

1

| | | | |
|--------------------|--|-----------------|----------|
| GEV No. | 378251 | Ref. No. | 41201003 |
| description | keypad unit CAREL PST mounting measurements 71x29mm built-in depth 35mmV voltage relay outputs protection IP65°C display | | |

accessories



1

| | | | |
|--------------------|--|-----------------|----------|
| GEV No. | 378255 | Ref. No. | 41401011 |
| description | frame W 197mm H 50mm plastic black for CAREL | | |

DIXELL

refrigeration controllers

built-in version



71 x 29mm

1

| | | | |
|--------------------|--|-----------------|----------|
| GEV No. | 378488 | Ref. No. | 41103064 |
| description | electronic controller DIXELL XR20CH-5G0C3 mounting measurements 71x29mm built-in depth 61mm 230V voltage AC NTC/PTC relay outputs 1 NO-16A(5) NTC/PTC NTC/PTC/DI protection IP55°C display 3½ digits | | |



1

| | | | |
|--------------------|--|-----------------|----------|
| GEV No. | 378676 | Ref. No. | 41103087 |
| description | electronic controller DIXELL XW20LH mounting measurements 149x30mm built-in depth 65mm 230V NTC display 3 digits | | |



1

| | | | |
|--------------------|---|-----------------|----------------------|
| GEV No. | 378530 | Ref. No. | 41103042 41103075 |
| description | electronic controller DIXELL XW70LH-5N0W0-B mounting measurements 150x31mm built-in depth 76mm 230V voltage AC NTC relay outputs 5 NO-20A(8) CO-8A(3) NO-8A(3) NO-8A(3) NTC NTC DI DI yes yes IR/RS-485 yes protection IP65 -50 up to +150°C display 2½ digit | | |

accessories universal for electronic con-

electronic controller accessories

fitting parts



1

| | | | |
|--------------------|---|-----------------|----------|
| GEV No. | 692723 | Ref. No. | 41401005 |
| description | bracket plastic dimensions 51.5x198mm cut-out 28x70mm for electronic controller | | |



probes

universal probes

temperature probes

| | | | |
|--------------------|--|-----------------|----------|
| 1 |  | | |
| GEV No. | 379160 | Ref. No. | 41201006 |
| description | temperature probe NTC 10kOhm cable thermoplastic probe -40 up to +110°C cable -40 up to +110°C probe ø6x14mm cable length 1.5m without screw connection 2-wire | | |

| | | | |
|--------------------|--|-----------------|----------|
| 1 |  | | |
| GEV No. | 379161 | Ref. No. | 41201005 |
| description | temperature probe NTC 10kOhm cable thermoplastic probe -40 up to +110°C cable -40 up to +110°C probe ø6x14mm cable length 3m without screw connection 2-wire | | |

keypads

front foils

| | | | |
|--------------------|---|-----------------|---------|
| 1 |  | | |
| GEV No. | 403773 | Ref. No. | 5901326 |
| description | front foil refrigeration MERCATUS L 332mm W 65mm | | |

pressure switches

for refrigeration

DANFOSS

| | | | |
|--------------------|--|-----------------|----------|
| 1 |  | | |
| GEV No. | 541464 | Ref. No. | 41301001 |
| description | pressure control DANFOSS type KP1 60-1101 pressure connection vertical ND refrigeration reset automatic switching diff. 0.7 - 4.0bar pressure range -0.2 up to +7.5bar connection 7/16" UNF (1/4" SAE) | | |

compressors

ACC/ZEL

R134A

HMBP monophase

High/Medium evaporation temperature above -20/-15 °C

| | | | |
|--------------------|--|-----------------|----------|
| 1 |  | | |
| GEV No. | 605006 | Ref. No. | 40103007 |
| description | compressor coolant R134a type GD40MB 220-240V 50Hz HMBP fully hermetic 6.7kg 1/8HP power input 200W cylinder capacity 4.1cm ³ CSIR H 162.5mm 64W 87W 117W 153W 196W 245W 301W 363W test method ASHRAE | | |

| | | | |
|--------------------|--|-----------------|----------|
| 1 |  | | |
| GEV No. | 605012 | Ref. No. | 40103008 |
| description | compressor coolant R134a type GL45TB 220-240V 50Hz HMBP fully hermetic 8.4kg 1/6HP power input 342W cylinder capacity 4.5cm ³ CSIR H 175.5mmW 76W 101W 134W 175W 223W 278W 342W 413W test method ASHRAE ambient temperature max. 43°C | | |

| | | | |
|--------------------|---|-----------------|----------|
| 1 |  | | |
| GEV No. | 605007 | Ref. No. | 40103009 |
| description | compressor coolant R134a type GL60TB 220-240V 50Hz HMBP fully hermetic 9.5kg 1/5HP power input 437W cylinder capacity 5.7cm ³ CSIR H 175.5mm 95W 128W 170W 222W 284W 355W 437W 528W test method ASHRAE ambient temperature max. 43°C | | |



1

| | | | |
|--------------------|--|-----------------|----------|
| GEV No. | 605008 | Ref. No. | 40103001 |
| description | compressor coolant R134a type GL80TB 220-240V 50Hz HMBP fully hermetic 9.5kg 1/5HP power input 554W cylinder capacity 7.6cm ³ CSIR H 175.5mm 165W 215W 290W 390W 500W 615W 727W 840W test method ASHRAE ambient temperature max. 43°C | | |



1

| | | | |
|--------------------|--|-----------------|----------|
| GEV No. | 605009 | Ref. No. | 40103002 |
| description | compressor coolant R134a type GL90TB 220-240V 50Hz HMBP fully hermetic 10.8kg 1/4HP power input 293W cylinder capacity 8.8cm ³ CSIR H 175.5mmW 143W 194W 259W 339W 432W 539W 661W 796W test method ASHRAE | | |



1

| | | | |
|--------------------|---|-----------------|----------|
| GEV No. | 605010 | Ref. No. | 40103003 |
| description | compressor coolant R134a type GP12TB 220-240V 50Hz HMBP fully hermetic 11.2kg 3/8HP power input 661W cylinder capacity 12cm ³ CSIR H 203.6mmW 143W 194W 259W 339W 432W 539W 661W 796W test method ASHRAE ambient temperature max. 43°C | | |



1

| | | | |
|--------------------|---|-----------------|----------|
| GEV No. | 605011 | Ref. No. | 40103004 |
| description | compressor coolant R134a type GP14TB 220-240V 50Hz HMBP fully hermetic 11.5kg 3/8HP power input 566W cylinder capacity 14cm ³ CSIR H 203.6mm 191W 271W 373W 497W 643W 810W 999W 1209W test method ASHRAE ambient temperature max. 43°C | | |

fans

axial fans

ebm-papst



1

| | | | |
|---|--|-----------------|-------------------|
| GEV No. | 601038 ¹ | Ref. No. | 40701007 |
| description | axial fan L 80mm W 80mm H 38mm 230VAC 50/60Hz 12W bearing ball bearing manuf. no. 8556N metal connection cable 300mm ebm-papst fan wheel ø 75mm temp.-resist. 90°C airflow 50m ³ /h | | |
| accessories for | 601038 | | |
|  | GEV No. | 691102 | Ref. No. — |
| | guard ø 75mm mounting distance 71mm for axial fan 80mm | | |

¹with ball bearings

refrigeration fans

refrigeration motors universal

ebm-papst

IQ series

ebmpapst



1

| | | | |
|--------------------|--|-----------------|----------|
| GEV No. | 601893 | Ref. No. | 40701060 |
| description | fan motor 10W 230V 50/60Hz L1 43.5mm L3 82mm W 67mm cable length 1500mm 1300rpm ebm-papst IQ3612 5 mounting options bearing ball bearing | | |

standard motors



1

| | | | |
|------------------------|---|-----------------|-------------------|
| GEV No. | 601287 | Ref. No. | 40701002 |
| description | fan motor 10W 230V 50Hz L1 43mm L3 81mm W 83mm cable length 450mm | | |
| spare parts for | 601287 | | |
| | GEV No. | 601413 | Ref. No. — |
| | fixing plate suitable for fanwheel ED ø 32mm shaft ø 7 mounting distance 26mm | | |



1

| | | | |
|------------------------|---|-----------------|-------------------|
| GEV No. | 601286 | Ref. No. | 40701001 |
| description | fan motor M4Q045-CA01-01 7W 230V 50Hz L1 43mm L3 81mm W 83mm cable length 450mm | | |
| spare parts for | 601286 | | |
| | GEV No. | 601413 | Ref. No. — |
| | fixing plate suitable for fanwheel ED ø 32mm shaft ø 7 mounting distance 26mm | | |

multi fit fan motors



1

| | | | |
|------------------------|--|-----------------|-------------------|
| GEV No. | 601758 | Ref. No. | 40701012 |
| description | fan motor 16W 230V 50/60Hz L1 43.5mm L3 87mm W 72mm cable length 1500mm 1300/1550rpm ebm-papst M4Q045-CF01-75 5 mounting options bearing slide bearing | | |
| spare parts for | 601758 | | |
| | GEV No. | 601413 | Ref. No. — |
| | fixing plate suitable for fanwheel ED ø 32mm shaft ø 7 mounting distance 26mm | | |



1

| | | | |
|------------------------|--|-----------------|-------------------|
| GEV No. | 601759 | Ref. No. | 40701011 |
| description | fan motor 18W 230V 50/60Hz L1 43.5mm L3 93mm W 78mm cable length 1500mm 1300/1550rpm ebm-papst M4Q045-DA01-75 5 mounting options bearing slide bearing | | |
| spare parts for | 601759 | | |
| | GEV No. | 601413 | Ref. No. — |
| | fixing plate suitable for fanwheel ED ø 32mm shaft ø 7 mounting distance 26mm | | |

accessories

fan wheels

aluminium

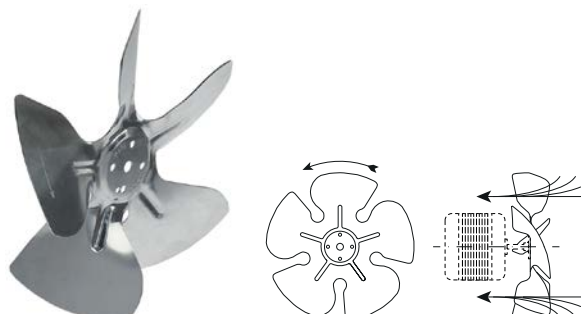

1

| | | | |
|--------------------|--|-----------------|----------|
| GEV No. | 601385 | Ref. No. | 40801005 |
| description | fan wheel sucking ø 172mm fan wheel mounting 25.4mm blade angle 34° W 42mm aluminium | | |

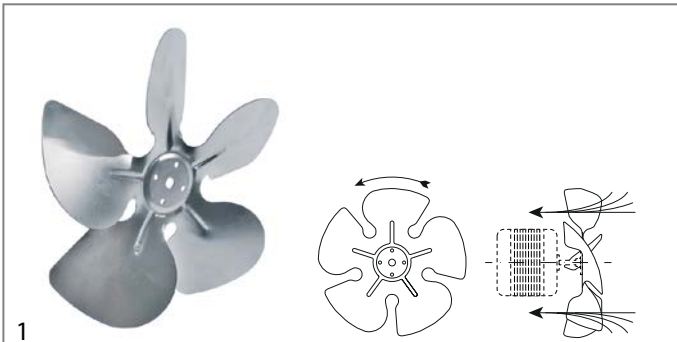

1

| | | | |
|--------------------|--|-----------------|----------|
| GEV No. | 601282 | Ref. No. | 40801001 |
| description | fan wheel sucking \varnothing 200mm fan wheel mounting 25.4mm blade angle 34° W 44mm aluminium | | |

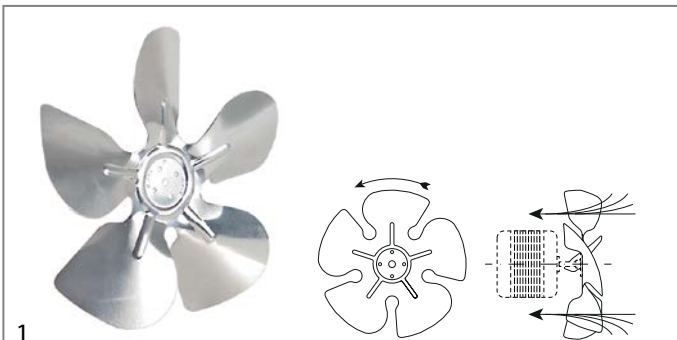

1

| | | | |
|--------------------|--|-----------------|----------|
| GEV No. | 601283 | Ref. No. | 40801002 |
| description | fan wheel sucking \varnothing 230mm fan wheel mounting 25.4mm blade angle 28° W 41mm aluminium | | |

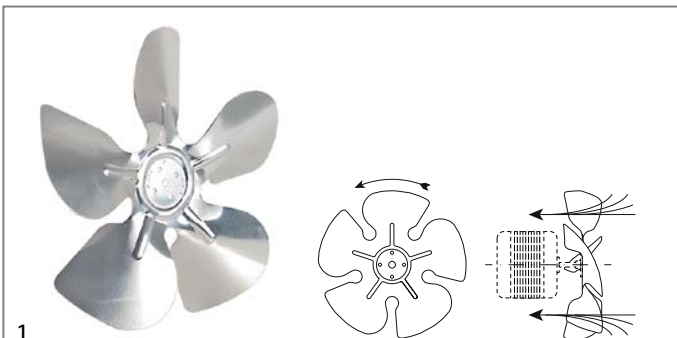

1

| | | | |
|--------------------|--|-----------------|----------|
| GEV No. | 601284 | Ref. No. | 40801003 |
| description | fan wheel sucking \varnothing 254mm fan wheel mounting 25.4mm blade angle 28° W 42mm aluminium | | |

cold air circulating fans (complete)



1

| | | | | |
|------------------------|---|-----------------|-----------------|---|
| GEV No. | 601964 | Ref. No. | 40701045 | |
| description | fan A2E250AM06-12 fan wheel \varnothing 250mm blades 9 230V 50/60Hz 115/150W \varnothing 250mm 2450rpm cable length 1400mm sucking suitable capacitor 3 μ F | | | |
| spare parts for | 601964 | | | |
| | GEV No. | 365137 | Ref. No. | — |
| | capacitor capacity 3 μ F 450V tolerance 5% 50/60Hz ambient temperature max. -25 to +85°C \varnothing 25mm L 56mm M8 plastic connection cable 250mm 416.17.77GF protection | | | |

cross flow fans

ebm-papst



1

| | | | | |
|------------------------|--|-----------------|-----------------|----------|
| GEV No. | 601291 | Ref. No. | 40701006 | |
| description | cross flow fan QLZ06/0018A335-2524L-74rk roller \varnothing 60mm roller length 180mm laminated core thickness 23mm motor position left 220-240V/50-60Hz 30W bearing silicone connection male faston 6.3mm airflow 150m ³ /h 0 up to +60°C 220-240V 50Hz | | | |
| accessories for | 601291 | | | |
| | GEV No. | 550782 | Ref. No. | 44303016 |
| | connecting cable L 3100mm | | | |

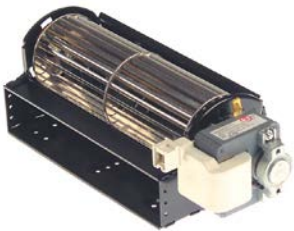
1

| | | | |
|------------------------|--|-----------------|----------|
| GEV No. | 601290 | Ref. No. | 40701008 |
| description | cross flow fan QZ06/1800A310-2524L-71rk roller ø 60mm roller length 180mm laminated core thickness 23mm motor position right 220-240V/50-60Hz 30W universal bearing silicone connection male faston 6.3mm airflow 170m ³ /h 0 up to +60°C 230V 50Hz | | |
| accessories for | 601290 | | |
| | GEV No. | Ref. No. | 44303016 |
| | connecting cable L 3100mm | | |

COPREL
with moulded coils



1

| | | | |
|--------------------|--|-----------------|----------|
| GEV No. | 602103 | Ref. No. | 40701051 |
| description | cross flow fan COPREL TFL roller ø 45mm roller length 240mm laminated core thickness 15mm motor position left 230V/50-60Hz 16W universal bearing silicone connection cable 3000mm airflow 110m ³ /h -10 up to +50°C | | |



1

| | | | |
|--------------------|---|-----------------|----------|
| GEV No. | 602105 | Ref. No. | 40701050 |
| description | cross flow fan COPREL TFR roller ø 45mm roller length 240mm laminated core thickness 15mm motor position right 230V/50-60Hz 16W universal bearing silicone connection cable 3000mm airflow 110m ³ /h -10 up to +50°C | | |

electric accessories

cables

connection cables



1

| | | | |
|--------------------|---------------------------|-----------------|----------|
| GEV No. | 550782 | Ref. No. | 44303016 |
| description | connecting cable L 3100mm | | |

equipment-specific units

for fridges

drawers

drawers



1

| | | | |
|--------------------|--------------------------------|-----------------|----------|
| GEV No. | 695269 | Ref. No. | 60602686 |
| description | drawer L 550mm W 320mm H 100mm | | |

for refrigerated counters

worktops



1

| | | | |
|--------------------|---------------------------------------|-----------------|----------|
| GEV No. | 695268 | Ref. No. | 45205014 |
| description | cutting board L 1295mm W 150mm H 25mm | | |



1

| | | | |
|--------------------|--------------------------------------|-----------------|----------|
| GEV No. | 695267 | Ref. No. | 45205013 |
| description | cutting board L 860mm W 150mm H 25mm | | |



1

| | | | |
|--------------------|--------------------------------------|-----------------|----------------------|
| GEV No. | 695266 | Ref. No. | 45205015 61001081 |
| description | cutting board L 880mm W 150mm H 25mm | | |



1

| | | | |
|--------------------|---|-----------------|----------|
| GEV No. | 693817 | Ref. No. | 44901021 |
| description | glass panel L 1460mm W 280mm thickness 10mm rectangular | | |

for freezer cabinets
spare parts and accessories



1

| | | | |
|--------------------|--------------|-----------------|----------|
| GEV No. | 692116 | Ref. No. | 60607149 |
| description | mounting set | | |



1

| | | | |
|--------------------|---|-----------------|----------|
| GEV No. | 693822 | Ref. No. | 44901058 |
| description | glass panel L 1460mm W 340mm thickness 10mm rectangular | | |

glass panels

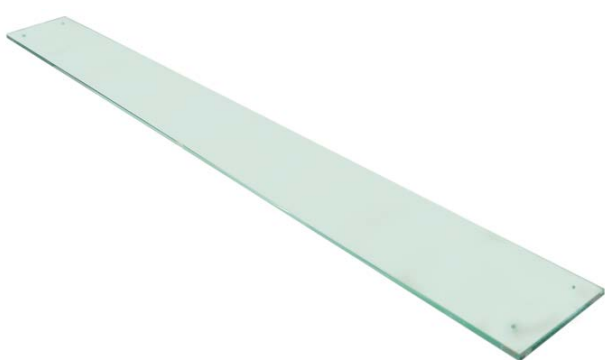

1

| | | | |
|--------------------|---|-----------------|----------|
| GEV No. | 693818 | Ref. No. | 44901016 |
| description | glass panel L 1440mm W 156mm thickness 10mm rectangular | | |

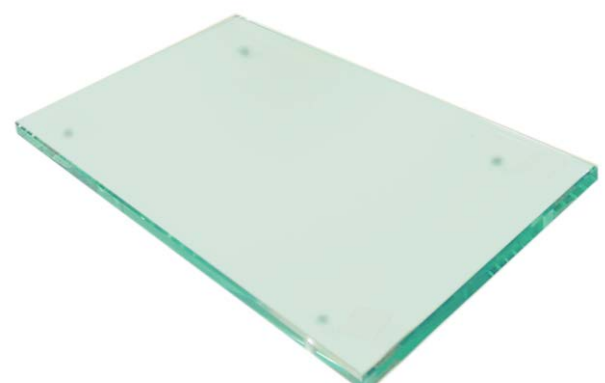

1

| | | | |
|--------------------|--|-----------------|----------|
| GEV No. | 693816 | Ref. No. | 44901015 |
| description | glass panel L 342/378mm W 165/185mm thickness 10mm trapezoidal Qty 2 pcs | | |



1

| | | | |
|--------------------|---|-----------------|----------|
| GEV No. | 693821 | Ref. No. | 44901056 |
| description | glass panel L 380mm W 183mm thickness 10mm dimensions 380(340)x183(163)mm | | |



1

| | | | |
|--------------------|---|-----------------|----------|
| GEV No. | 693811 | Ref. No. | 44901068 |
| description | glass panel L 571mm W 260mm thickness 8mm | | |

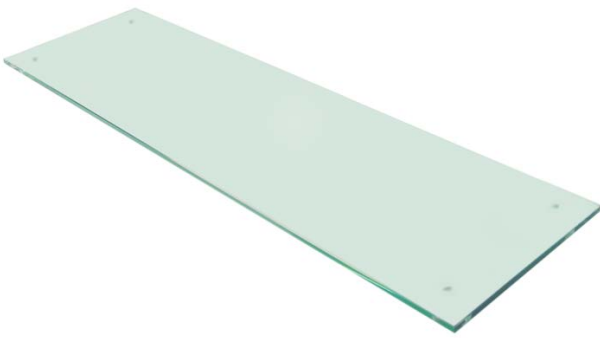

1

| | | | |
|--------------------|---|-----------------|----------|
| GEV No. | 693812 | Ref. No. | 44901067 |
| description | glass panel L 854mm W 260mm thickness 8mm rectangular | | |

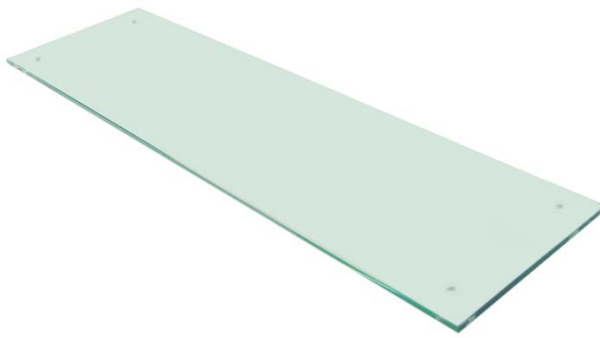

1

| | | | |
|--------------------|--|-----------------|----------|
| GEV No. | 693813 | Ref. No. | 44901066 |
| description | glass panel L 870mm W 250mm thickness 10mm rectangular | | |



Image not available

1

| | | | |
|--------------------|-------------------------|-----------------|----------|
| GEV No. | 693814 | Ref. No. | 61004004 |
| description | glass panel set 2-piece | | |



Image not available

1

| | | | |
|--------------------|-------------------------|-----------------|----------|
| GEV No. | 693819 | Ref. No. | 60607168 |
| description | glass panel set 2-piece | | |



Image not available

1

| | | | |
|--------------------|-------------------------|-----------------|----------|
| GEV No. | 693820 | Ref. No. | 60607167 |
| description | glass panel set 2-piece | | |



Image not available

1

| | | | |
|--------------------|-------------------------|-----------------|----------|
| GEV No. | 693823 | Ref. No. | 60607218 |
| description | glass panel set 2-piece | | |



1

| | | | |
|--------------------|-------------------------|-----------------|----------|
| GEV No. | 693825 | Ref. No. | 60607217 |
| description | glass panel set 2-piece | | |

for display coolers

glass panels

accessories



1

| | | | |
|--------------------|--------------------------------|-----------------|----------|
| GEV No. | 695264 | Ref. No. | 42001007 |
| description | bracket for glass plate double | | |



1

| | | | |
|--------------------|--------------------------------|-----------------|----------|
| GEV No. | 695265 | Ref. No. | 42001008 |
| description | bracket for glass plate triple | | |

for espresso machines

brewing units

shower screens

screws



1

| | | | |
|--------------------|--|-----------------|----------|
| GEV No. | 560300 | Ref. No. | 44404002 |
| description | countersunk screw thread M5 L 16mm SS DIN 963/ISO 2009 Qty 1 pcs intake slotted head ø 9mm | | |

for convection ovens/combi-steamers

doors



1

| | | | |
|--------------------|-------------------------|-----------------|----------|
| GEV No. | 695263 | Ref. No. | 42001005 |
| description | bracket for glass plate | | |

door mechanics

holders



1

| | | | |
|--------------------|-------------------------|-----------------|----------|
| GEV No. | 695263 | Ref. No. | 42001005 |
| description | bracket for glass plate | | |

handles and hand wheels

bracket handles



1

| | | | |
|--------------------|--|-----------------|----------|
| GEV No. | 690450 | Ref. No. | 42201011 |
| description | pull handle L 275mm H 43mm mounting distance 227mm | | |

recessed handles



1

| | | | |
|--------------------|-----------------|-----------------|----------|
| GEV No. | 695262 | Ref. No. | 42601036 |
| description | recessed handle | | |

hinges

piano hinges

producer-specific

MERCATUS

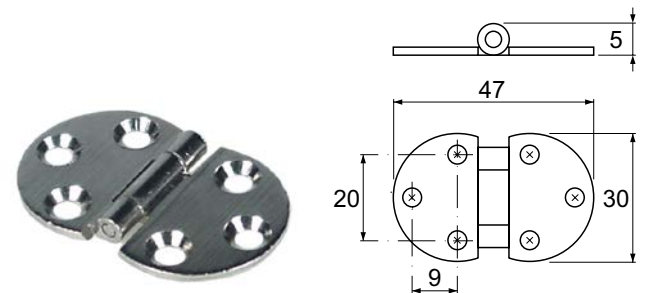

1



| | | | |
|--------------------|--|-----------------|----------|
| GEV No. | 690961 | Ref. No. | 42001001 |
| description | hinge L 47mm W 30mm H 5mm mounting distance 20mm mounting distance 19mm hole ø 4.5mm thickness 2mm | | |

spring assisted hinges

producer-specific

MERCATUS

| | | | |
|--|--------------------------|-----------------|---------------------------------|
|  <p>1</p> | | | |
| GEV No. | 690957 | Ref. No. | 42001059 + 42001026 60601201 |
| description | hinge mounting pos. left | | |

| | | | |
|---|---------------------------|-----------------|--|
|  <p>1</p> | | | |
| GEV No. | 690956 | Ref. No. | 42001025 42001025+42001058 60601202 |
| description | hinge mounting pos. right | | |
| spare parts for | 690956 | | |
|  <p>hinge bearing without bolt</p> | | | |
| GEV No. | 690958 | Ref. No. | 42001027 42001058 42001059 60601041 |

door bearing

| | | | |
|--|--------|-----------------|----------|
|  <p>1</p> | | | |
| GEV No. | 695260 | Ref. No. | 44601011 |
| description | bush | | |

| | | | |
|--|---|-----------------|----------|
|  <p>1</p> | | | |
| GEV No. | 700896 | Ref. No. | 60701220 |
| description | hinge L 175mm mounting pos. lower with bolt shaft ø 7mm | | |

| | | | |
|--|---|-----------------|----------|
|  <p>1</p> | | | |
| GEV No. | 690960 | Ref. No. | 60605086 |
| description | hinge bearing mounting pos. left without bolt | | |

| | | | |
|---|--|-----------------|----------|
|  <p>1</p> | | | |
| GEV No. | 690959 | Ref. No. | 60605085 |
| description | hinge bearing mounting pos. right without bolt | | |

| | | | |
|---|----------------------------|-----------------|--|
|  <p>1</p> | | | |
| GEV No. | 690958 | Ref. No. | 42001027 42001058 42001059 60601041 |
| description | hinge bearing without bolt | | |

miscellaneous

| | | | |
|---|------------|-----------------|----------|
|  <p>1</p> | | | |
| GEV No. | 690963 | Ref. No. | 42001004 |
| description | hinge left | | |

| | | | |
|---|-------------|-----------------|----------|
|  <p>1</p> | | | |
| GEV No. | 690962 | Ref. No. | 42001003 |
| description | hinge right | | |

pullouts

frame



1

| | | | |
|--------------------|--|-----------------|----------|
| GEV No. | 690797 | Ref. No. | 60602692 |
| description | frame for telescopic rail mounting pos. left | | |



1

| | | | |
|--------------------|---|-----------------|----------|
| GEV No. | 690796 | Ref. No. | 60602691 |
| description | frame for telescopic rail mounting pos. right | | |

equipment feet and end caps

equipment feet

with fixing plate



1

| | | | |
|--------------------|---|-----------------|----------|
| GEV No. | 700712 | Ref. No. | 42101001 |
| description | equipment foot tube ø 57mm plate size 80x100mm hole distance 60x78mm H 135-215mm SS size 2 1/4" Qty 1 pcs | | |



1

| | | | |
|--------------------|---|-----------------|----------|
| GEV No. | 700120 | Ref. No. | 42101004 |
| description | equipment foot tube ø 57mm plate size 90x100mm hole distance 60x78mm H 130-210mm SS size 2" Qty 1 pcs | | |

TENTE

with fixing plate

chrome-plated steel



1

| | | | |
|--------------------|--|-----------------|----------------------|
| GEV No. | 700344 | Ref. No. | 42701003 42701005 |
| description | swivel castor ø 100mm plate fixing housing zinc-plated sheet steel plate size 105x85mm hole distance 60x78mm capacity 80kg bearing slide bearing wheel body polypropylene tread TPE tyres H 128mm wheel width 32mm Qty 1 pcs | | |

miscellaneous

with fixing plate

ø100mm



1

| | | | |
|--------------------|--|-----------------|----------|
| GEV No. | 700345 | Ref. No. | 42701004 |
| description | swivel castor with swivel brake ø 100mm plates fixing 105x85mm | | |



diverse sets



| | | | |
|--------------------|---|-----------------|----------------|
| GEV No. | 700912 | Ref. No. | 10001009-0-0-0 |
| description | swivel castor set ø 100mm plates fixing 105x85mm bearing ball bearing H 127mm wheel width 38mm 2x with swivel brake 4-piece | | |

shelves and shelf rails

grates

universal

without upstand



| | | | | |
|------------------------|--|-----------------|-----------------|---|
| GEV No. | 970125 | Ref. No. | 46501009 | |
| description | grate W 325mm D 530mm GN 1/1 plastic-coated steel crossing wires 1 white suitable for refrigerator | | | |
| accessories for | 970125 | | | |
| | GEV No. | 690330 | Ref. No. | — |
| | rack L 1000mm W 22mm H 4mm aperture 3x8mm hole distance 12.5mm stainless steel | | | |
| | GEV No. | 694700 | Ref. No. | — |
| | shelf support L 31/28mm W 22mm H 18mm SS Qty 12 pcs | | | |
| | GEV No. | 694701 | Ref. No. | — |
| | shelf support L 31/28mm W 22mm H 17mm SS with hook Qty 12 pcs | | | |



| | | | |
|--------------------|---|-----------------|----------------------|
| GEV No. | 970468 | Ref. No. | 46501003 46502001 |
| description | grate W 400mm D 480mm plastic-coated steel crossing wires 1 suitable for refrigerator | | |

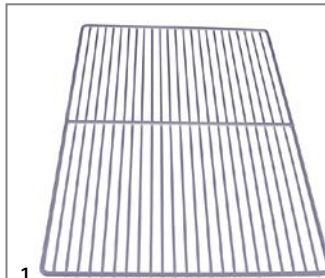

| | | | |
|--------------------|---|-----------------|----------------------|
| GEV No. | 970469 | Ref. No. | 46501002 46502007 |
| description | grate W 400mm D 600mm plastic-coated steel crossing wires 1 suitable for refrigerator | | |



| | | | |
|--------------------|-----------------------|-----------------|----------|
| GEV No. | 970660 | Ref. No. | 61404045 |
| description | grate W 835mm D 805mm | | |

with upstand



| | | | | |
|------------------------|--|-----------------|-----------------|---|
| GEV No. | 970556 | Ref. No. | 46502004 | |
| description | grate W 530mm D 650mm GN 2/1 plastic-coated steel with hinge camp wire gauge frame 9mm lengthwise wires gauge 5mm crossing wires 2 white suitable for refrigerator | | | |
| accessories for | 970556 | | | |
| | GEV No. | 690330 | Ref. No. | — |
| | rack L 1000mm W 22mm H 4mm aperture 3x8mm hole distance 12.5mm stainless steel | | | |
| | GEV No. | 690332 | Ref. No. | — |
| | shelf support L 31/28mm W 22mm H 17mm SS with hook Qty 1 pcs | | | |
| | GEV No. | 694700 | Ref. No. | — |
| | shelf support L 31/28mm W 22mm H 18mm SS Qty 12 pcs | | | |
| | GEV No. | 694701 | Ref. No. | — |
| | shelf support L 31/28mm W 22mm H 17mm SS with hook Qty 12 pcs | | | |

producer-specific

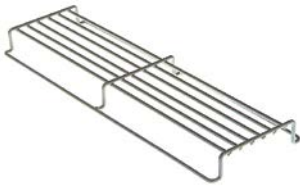

| | | | |
|--------------------|--|-----------------|----------|
| 1 | | | |
| GEV No. | 970467 | Ref. No. | 46501004 |
| description | grate W 125mm D 385mm H 30mm steel suitable for refrigerator | | |

shelf rails and supports

producer-specific



| | | | |
|--------------------|--------------------------------------|-----------------|----------|
| 1 | | | |
| GEV No. | 700889 | Ref. No. | 45907006 |
| description | bolt ø 7mm L 10mm M5 stainless steel | | |



| | | | |
|--------------------|--|-----------------|----------|
| 1 | | | |
| GEV No. | 695249 | Ref. No. | 60602677 |
| description | pair of setting bar E-shape L 560mm W 31mm H 14mm mounting pos. left/right | | |



| | | | |
|--------------------|--|-----------------|----------|
| 1 | | | |
| GEV No. | 695252 | Ref. No. | 61001070 |
| description | pair of setting bar E-shape L 568mm W 10mm H 30mm mounting pos. left/right | | |



| | | | |
|--------------------|--|-----------------|----------|
| 1 | | | |
| GEV No. | 695860 | Ref. No. | 60701431 |
| description | pair of setting bar E-shape L 635mm W 14mm H 15mm mounting pos. left/right | | |

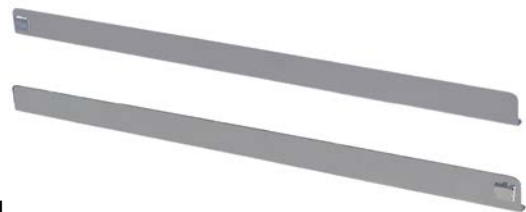

| | | | |
|--------------------|--|-----------------|----------|
| 1 | | | |
| GEV No. | 695250 | Ref. No. | 60603128 |
| description | pair of setting bar L-shape L 580mm W 31mm H 18mm mounting pos. left/right | | |
| For models: | PK20, PK25 | | |



| | | | |
|--------------------|--|-----------------|----------|
| 1 | | | |
| GEV No. | 695248 | Ref. No. | 60601785 |
| description | pair of setting bar U-shape L 460mm W 16mm H 29mm mounting pos. left/right | | |



| | | | |
|--------------------|--|-----------------|----------|
| 1 | | | |
| GEV No. | 695251 | Ref. No. | 60604292 |
| description | pair of setting bar U-shape L 473mm W 16mm H 29mm mounting pos. left/right | | |



| | | | |
|--------------------|---------------------|-----------------|----------|
| 1 | | | |
| GEV No. | 695253 | Ref. No. | 60601694 |
| description | rack L 285mm W 31mm | | |



| | | | |
|--------------------|---------------------|-----------------|----------|
| 1 | | | |
| GEV No. | 695258 | Ref. No. | 60601470 |
| description | rack L 338mm W 48mm | | |



1



| | | | |
|--------------------|---------------------|-----------------|----------|
| GEV No. | 695259 | Ref. No. | 61001028 |
| description | rack L 340mm W 31mm | | |

1

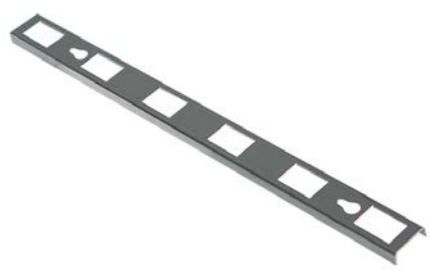

| | | | |
|--------------------|---------------------|-----------------|----------|
| GEV No. | 695256 | Ref. No. | 60604278 |
| description | rack L 410mm W 32mm | | |

1



| | | | |
|--------------------|--|-----------------|----------|
| GEV No. | 695255 | Ref. No. | 60602574 |
| description | rack L 483mm W 31mm mounting pos. rear | | |

1



| | | | |
|--------------------|---------------------|-----------------|----------|
| GEV No. | 695254 | Ref. No. | 60601693 |
| description | rack L 505mm W 31mm | | |

1

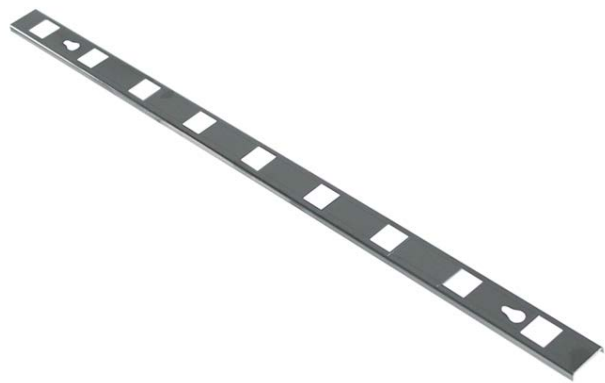

| | | | |
|--------------------|---------------------|-----------------|----------|
| GEV No. | 695257 | Ref. No. | 60604277 |
| description | rack L 650mm W 32mm | | |

1



| | | | |
|--------------------|---|-----------------|----------|
| GEV No. | 700888 | Ref. No. | 61503011 |
| description | rack L 990mm W 32mm mounting pos. left/right hole distance 225mm aperture 20x20mm | | |

gaskets

refrigeration gaskets

plug-in gaskets

profile 9048

We offer custom-made gaskets for this profile

1

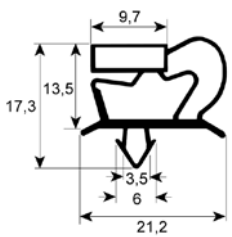

| | | | |
|--------------------|---|-----------------|----------|
| GEV No. | 900549 | Ref. No. | 41801031 |
| description | refrigeration gasket profile 9048 W 160mm L 395mm plug size | | |

1

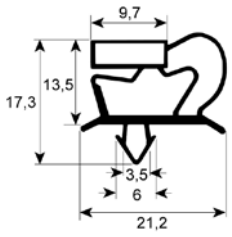

| | | | |
|--------------------|---|-----------------|----------|
| GEV No. | 901346 | Ref. No. | 41801023 |
| description | refrigeration gasket profile 9048 W 222mm L 400mm plug size | | |

1

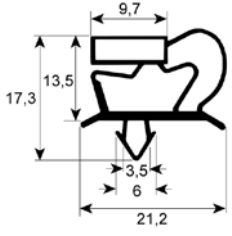

| | | | |
|--------------------|---|-----------------|----------|
| GEV No. | 900548 | Ref. No. | 41801030 |
| description | refrigeration gasket profile 9048 W 267mm L 394mm plug size | | |

| | | | |
|--------------------|---|-----------------|----------|
| GEV No. | 900546 | Ref. No. | 41801028 |
| description | refrigeration gasket profile 9048 W 267mm L 472mm plug size | | |

| | | | |
|--------------------|---|-----------------|----------|
| GEV No. | 900553 | Ref. No. | 41801021 |
| description | refrigeration gasket profile 9048 W 394mm L 484mm plug size | | |

| | | | |
|--------------------|---|-----------------|----------|
| GEV No. | 900557 | Ref. No. | 41801016 |
| description | refrigeration gasket profile 9048 W 285mm L 390mm plug size | | |

| | | | |
|--------------------|---|-----------------|----------|
| GEV No. | 900550 | Ref. No. | 41801029 |
| description | refrigeration gasket profile 9048 W 394mm L 600mm plug size | | |

| | | | |
|--------------------|---|-----------------|----------|
| GEV No. | 900555 | Ref. No. | 41801004 |
| description | refrigeration gasket profile 9048 W 285mm L 465mm plug size | | |

| | | | |
|--------------------|---|-----------------|----------|
| GEV No. | 900554 | Ref. No. | 41801002 |
| description | refrigeration gasket profile 9048 W 465mm L 618mm plug size | | |

| | | | |
|--------------------|---|-----------------|----------|
| GEV No. | 900551 | Ref. No. | 41801011 |
| description | refrigeration gasket profile 9048 W 363mm L 466mm plug size | | |

| | | | |
|--------------------|---|-----------------|----------|
| GEV No. | 900547 | Ref. No. | 41801027 |
| description | refrigeration gasket profile 9048 W 470mm L 600mm plug size | | |

| | | | |
|--------------------|---|-----------------|----------|
| GEV No. | 900556 | Ref. No. | 41801015 |
| description | refrigeration gasket profile 9048 W 390mm L 618mm plug size | | |

| | | | |
|--------------------|---|-----------------|----------|
| GEV No. | 900552 | Ref. No. | 41801007 |
| description | refrigeration gasket profile 9048 W 470mm L 770mm plug size | | |

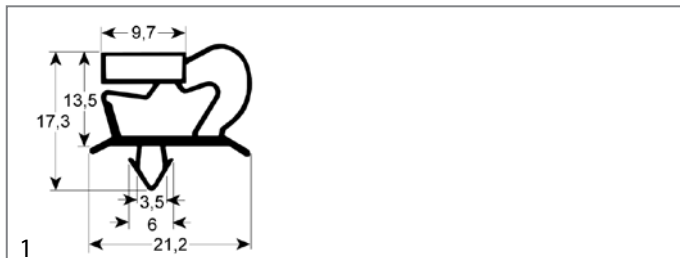

| | | | |
|--------------------|--|-----------------|-----|
| GEV No. | 902258 | Ref. No. | N/A |
| description | refrigeration gasket profile 9048 Wmm L 2500mm | | |

profile 9703

We offer custom-made gaskets for this profile

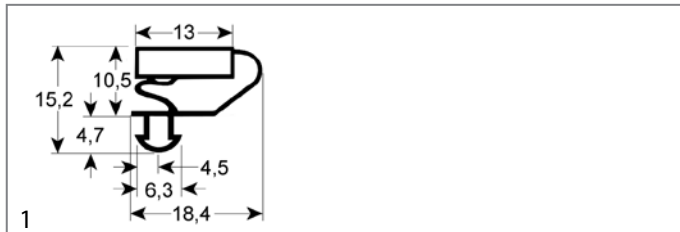

| | | | |
|--------------------|--|-----------------|----------|
| GEV No. | 901506 | Ref. No. | 41801056 |
| description | refrigeration gasket profile 9703 W 478mm L 632mm glass door | | |

profile 9194

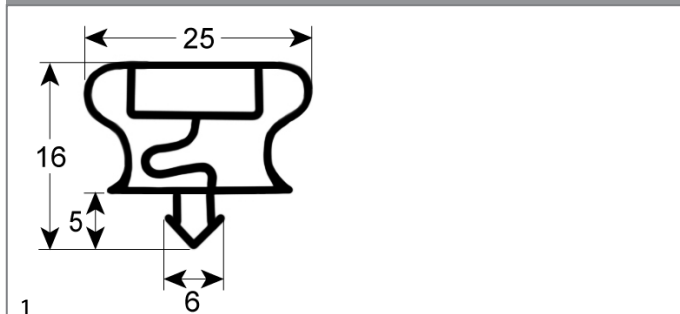

| | | | |
|--------------------|---|-----------------|----------|
| GEV No. | 902403 | Ref. No. | 41801037 |
| description | refrigeration gasket profile 9194 W 210mm L 395mm plug size | | |

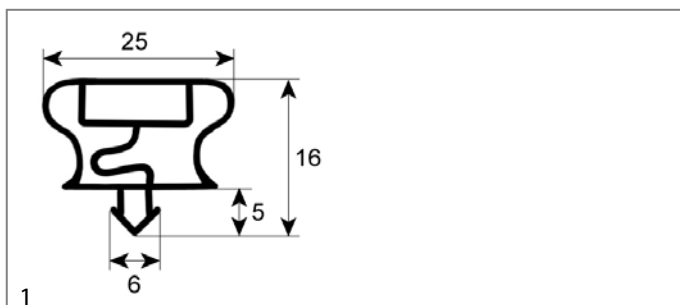

| | | | |
|--------------------|---|-----------------|----------|
| GEV No. | 901344 | Ref. No. | 41801022 |
| description | refrigeration gasket profile 9194 W 400mm L 174mm plug size Qty 1 | | |

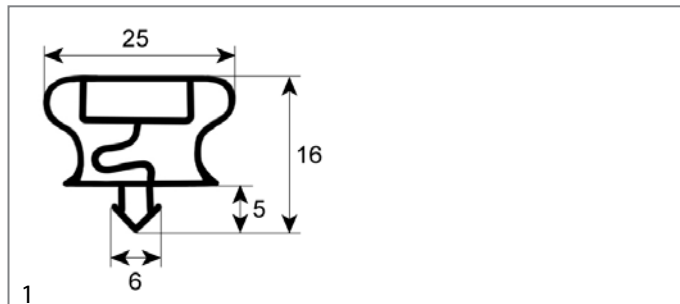

| | | | |
|--------------------|---|-----------------|----------|
| GEV No. | 901345 | Ref. No. | 41801024 |
| description | refrigeration gasket profile 9194 W 405mm L 400mm plug size Qty 1 | | |

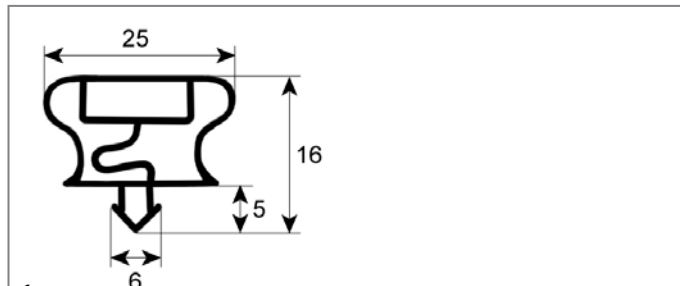

| | | | |
|--------------------|--|-----------------|----------|
| GEV No. | 901309 | Ref. No. | 41801025 |
| description | refrigeration gasket profile 9194 W 650mm L 1480mm plug size Qty 1 | | |

refrigeration cycle components

valves

expansion valves

DANFOSS

valves

type TUA/TUB/TUC



| | | | |
|--------------------|--|-----------------|----------|
| GEV No. | 750016 | Ref. No. | 41604006 |
| description | expansion valve DANFOSS type TUB coolant R134a angled 90° thermostatically controlled inlet 6mm ODF outlet 12mm ODF p max 34bar -40 up to +10°C capillary pipe 800mm | | |

shut-off valves

3-way



| | | | |
|--------------------|--|-----------------|----------|
| GEV No. | 750073 | Ref. No. | 41602002 |
| description | shut-off valve CASTEL type 6070/23M8 3-way connection 1: 7/16" UNF (1/4" SAE) connection 2: 5/8" UNF (3/8" SAE) connection 3: 8mm soldering connection throughput 1.29m ³ /h p max 30bar -60 up to +120°C | | |

filter driers

DANFOSS



| | | | |
|--------------------|---|-----------------|----------|
| GEV No. | 750037 | Ref. No. | 41002006 |
| description | dryer connection 7/16" UNF (1/4" SAE) 41cm ³ p max 46bar -40 up to +70°C 216g type DCL 032 size 3 cubic inches | | |

evaporators

for fridges

producer-specific



| | | | |
|--------------------|------------------------------------|-----------------|----------|
| GEV No. | 750157 | Ref. No. | 40209002 |
| description | evaporator L 1250mm W 75mm H 150mm | | |



| | | | |
|--------------------|------------------------------------|-----------------|----------|
| GEV No. | 750158 | Ref. No. | 40209003 |
| description | evaporator L 1750mm W 155mm H 80mm | | |



| | | | |
|--------------------|------------------------------------|-----------------|----------|
| GEV No. | 750159 | Ref. No. | 40209004 |
| description | evaporator L 2244mm W 153mm H 80mm | | |



| | | | |
|--------------------|--|-----------------|----------|
| GEV No. | 750163 | Ref. No. | 40211003 |
| description | evaporator L 370mm W 370mm complete with fan | | |

| | | | |
|------------------------|--|-----------------|---|
| spare parts for | 750163 | | |
| GEV No. | 601030 | Ref. No. | — |
| description | axial fan L 119mm W 119mm H 38mm 230VAC 50Hz 18W bearing ball bearing manuf. no. 4656Z metal connection male faston 2.8mm ebm-papst fan wheel ø 110mm temp.-resist. 75°C | | |



| | | | |
|--------------------|---|-----------------|----------|
| GEV No. | 750162 | Ref. No. | 40211001 |
| description | evaporator L 420mm W 85mm H 345mm complete with fan | | |

| | | | |
|------------------------|--|-----------------|---|
| spare parts for | 750162 | | |
| GEV No. | 601030 | Ref. No. | — |
| description | axial fan L 119mm W 119mm H 38mm 230VAC 50Hz 18W bearing ball bearing manuf. no. 4656Z metal connection male faston 2.8mm ebm-papst fan wheel ø 110mm temp.-resist. 75°C | | |



| | | | |
|--------------------|-----------------------------------|-----------------|----------|
| GEV No. | 750161 | Ref. No. | 40210001 |
| description | evaporator L 445mm W 355mm H 68mm | | |



| | | | |
|---|-----------------------------------|-----------------|----------|
|  | | | |
| 1 | | | |
| GEV No. | 750156 | Ref. No. | 40209001 |
| description | evaporator L 710mm W 80mm H 155mm | | |

evaporation and condensing trays

unheated condensing trays

| | | | |
|---|---|-----------------|----------|
|  | | | |
| 1 | | | |
| GEV No. | 750707 | Ref. No. | 42601063 |
| description | condensing tray L 545mm W 81mm H 25mm plastic | | |

fastening material

screws

countersunk screws

| | | | |
|--|--|-----------------|----------|
|  | | | |
| 1 | | | |
| GEV No. | 560300 | Ref. No. | 44404002 |
| description | countersunk screw thread M5 L 16mm SS DIN 963/ISO 2009 Qty 1 pcs intake slotted head ø 9mm | | |

hexagonal screws

| | | | |
|---|--|-----------------|----------|
|  | | | |
| 1 | | | |
| GEV No. | 560089 | Ref. No. | 44401003 |
| description | hexagonal screw thread M6 thread L 25mm SS WS 10 Qty 20 pcs DIN 933 / ISO 4017 | | |

| | | | |
|---|---|-----------------|----------|
|  | | | |
| 1 | | | |
| GEV No. | 695261 | Ref. No. | 44401050 |
| description | hexagonal screw thread M5 thread L 12mm | | |

nuts

cap nuts

| | | | |
|---|--|-----------------|----------|
|  | | | |
| 1 | | | |
| GEV No. | 560136 | Ref. No. | 44503007 |
| description | cap nuts thread M5 WS 8 SS Qty 20 pcs DIN/ISO DIN 1587 | | |

A

axial fans 6

C

cables 9

cap nuts 21

castors and bumper angles 14

cold air circulating fans (complete) 8

compressors 5

connection cables 9

countersunk screws 21

cross flow fans 8

E

electric accessories 9

electronic controllers 3

evaporators 20

expansion valves 19

F

fans 6

fastening material 21

filter driers 20

G

grates 15

H

hexagonal screws 21

I

indicator lights 3

indicator lights (complete) 3

L

lamps 3

N

nuts 21

P

piano hinges 12

plug-in gaskets 17

pressure switches 5

probes 5

R

refrigeration cycle components 19

refrigeration fans 7

refrigeration gaskets 17

refrigeration motors universal 7

rocker/momentary rocker switches 3

S

screws 21

shelves and shelf rails 15

shut-off valves 20

spring assisted hinges 13

switches and momentary switches 3

T

temperature probes 5

U

universal probes 5