



**GAS COMPONENTS**



**ELECTRIC COMPONENTS**



**WATER TECHNOLOGY**



**MECHANICAL COMPONENTS**



**TOOLS**

Spare parts suitable for

**MEIKO**

Find the complete and up-to-date range of products in our GEV Webshop



# Manufacturer catalogue

The most important spare parts and accessories arranged clearly for every manufacturer

- ✓ Complete product range and all appliance data always up to date in the GEV Webshop
- ✓ Alphabetical Index at the end of the catalogue

## GEV Webshop

[www.gev-online.co.uk](http://www.gev-online.co.uk)

[www.gev-online.com](http://www.gev-online.com)



- 🔍 Add to Favourites
- 🔍 Sign In with email address and usual password
- 🔍 Easy-order – place several items in your basket at the same time
- 🔍 Quick Item search – no login needed

## heating elements

### dry heating elements for dishwashers

			
<b>GEV No.</b>	419058	<b>Ref. No.</b>	0101082
<b>description</b>	heating element 1000W 240V heating circuits 1 L 424mm W 37mm connection length 37mm tube ø 8.5mm connection M4 dry heating element 2 hole fixing thread M14x1.5 mounting distance 29mm		

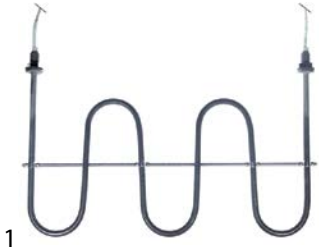
			
<b>GEV No.</b>	420052	<b>Ref. No.</b>	0101136
<b>description</b>	heating element 2000W 230V heating circuits 1 L 175mm W 295mm connection length 40mm tube ø 6.5mm cable length 230mm dry heating element dishwasher 2 hole fixing thread M10x1 INCOLOY-800 mounting distance 289mm		

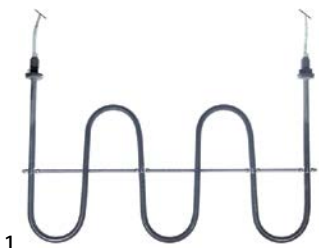
			
<b>GEV No.</b>	419059	<b>Ref. No.</b>	0101156
<b>description</b>	heating element 2000W 254V heating circuits 1 L 175mm W 298mm connection length 30mm tube ø 6.3mm cable length 230mm dry heating element 2 hole fixing thread M10x1 mounting distance 169mm		

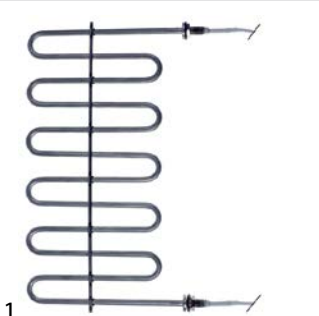

			
<b>GEV No.</b>	418852	<b>Ref. No.</b>	0101135
<b>description</b>	heating element 3000W 230V heating circuits 1 L 170mm W 295mm tube ø 6.5mm thread M10x1 cable length 220mm convection heating element mounting distance 290mm bridge length 310mm		

## immersion heating elements

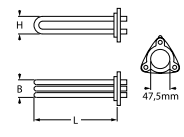
### 3 hole flange ø47.5mm

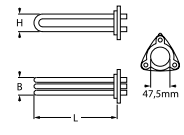
 			
<b>GEV No.</b>	420368	<b>Ref. No.</b>	9605102
<b>description</b>	heating element 10500W 230V mounting ø 47.5mm heating circuits 3 L 490mm W 42mm H 42mm number of thermostat sleeves 1 thermostat sleeves ø 7mm length thermostat sleeves 150mm thermostat sleeve centre tube ø 8.5mm hole distance 64mm hole ø 8/10mm connection length 22mm connection screw clamp 3 hole flange immersion heater INCOLOY		

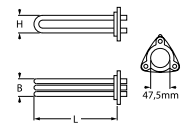
 			
<b>GEV No.</b>	420158	<b>Ref. No.</b>	0101195 0101195+0101197
<b>description</b>	heating element 3600W 230V mounting ø 47.5mm heating circuits 3 L 270mm W 28mm H 34mm number of thermostat sleeves 2 thermostat sleeves ø 7.5mm length thermostat sleeves 100mm thermostat sleeve eccentric, non clinging tube ø 6.1mm hole distance 62mm hole ø 10mm connection length 17mm connection male faston 6.3mm 3 hole flange immersion heater		

 			
<b>GEV No.</b>	420541	<b>Ref. No.</b>	9632938
<b>description</b>	heating element 4000W 380V mounting ø 47.5mm heating circuits 3 L 235mm W 34mm H 40mm number of thermostat sleeves 1 thermostat sleeves ø 85mm length thermostat sleeves 155mm tube ø 8.5mm connection F6.3		
<b>spare parts for</b>	420541		
			
<b>GEV No.</b>	510408	<b>Ref. No.</b>	0101176
O-ring EPDM thickness 5.34mm ID ø 47mm Qty 1 pcs			



<b>GEV No.</b>	418773	<b>Ref. No.</b>	9519587
<b>description</b>	heating element 4500W 240V mounting $\varnothing$ 47.5mm heating circuits 3 L 260mm W 33mm H 36mm number of thermostat sleeves 1 thermostat sleeves $\varnothing$ 7mm length thermostat sleeves 150mm thermostat sleeve centre not clinging tube $\varnothing$ 8.5mm connection screw with integrated fuse		
<b>For models:</b>	FV40.2, FV40.2 AB 2002, FV40.2 AB 2003, FV40.2M, FV40.2MIKE2, FV40.2M-MIKE2		
<b>accessories for</b>	418773		
	<b>GEV No.</b>	510408	<b>Ref. No.</b> 0101176
	O-ring EPDM thickness 5.34mm ID $\varnothing$ 47mm Qty 1 pcs		
	<b>GEV No.</b>	560395	<b>Ref. No.</b> —
	flat-headed bolt thread M4 thread L 8mm SS DIN 84/ISO 1207 Qty 1 pcs intake slotted head $\varnothing$ 7mm head thickness 2.5mm		

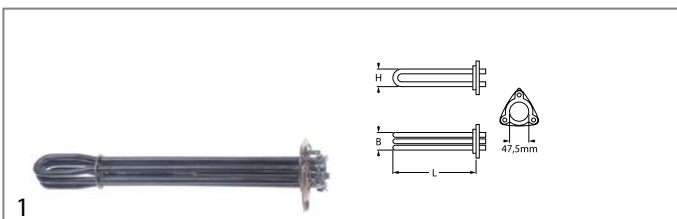

<b>GEV No.</b>	419041	<b>Ref. No.</b>	9519588
<b>description</b>	heating element 6000/6530W 230/240V mounting $\varnothing$ 47.5mm heating circuits 3 L 330mm W 42mm H 42mm number of thermostat sleeves 1 thermostat sleeves $\varnothing$ 7mm length thermostat sleeves 120mm thermostat sleeve centre tube $\varnothing$ 8.5mm hole $\varnothing$ 10x8mm connection screw 3 hole flange immersion heater		
<b>For models:</b>	FV40.2, FV40.2MIKE2, FV40.2M-MIKE2		
<b>accessories for</b>	419041		
	<b>GEV No.</b>	510408	<b>Ref. No.</b> 0101176
	O-ring EPDM thickness 5.34mm ID $\varnothing$ 47mm Qty 1 pcs		

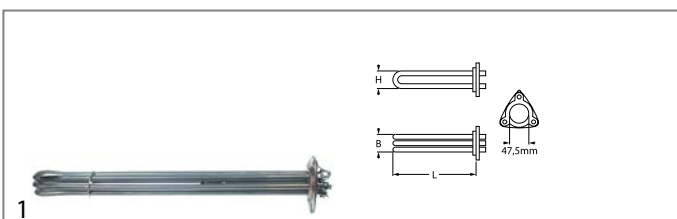

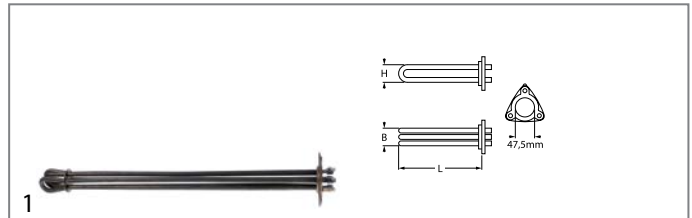

<b>GEV No.</b>	418772	<b>Ref. No.</b>	9519590
<b>description</b>	heating element 7500W 240V mounting $\varnothing$ 47.5mm heating circuits 3 L 405mm W 32mm H 37mm thermostat sleeves $\varnothing$ 7mm length thermostat sleeves 150mm thermostat sleeve centre tube $\varnothing$ 8.5mm hole distance 63mm hole $\varnothing$ 8mm connection screw		
<b>For models:</b>	FV40.2, FV40.2MIKE2, FV40.2M-MIKE2		
<b>accessories for</b>	418772		
	<b>GEV No.</b>	510408	<b>Ref. No.</b> 0101176
	O-ring EPDM thickness 5.34mm ID $\varnothing$ 47mm Qty 1 pcs		



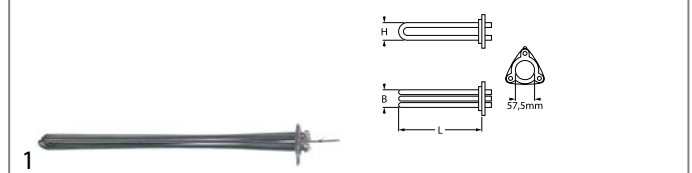

<b>GEV No.</b>	418877	<b>Ref. No.</b>	9519591
<b>description</b>	heating element 9000/9800W 230/240V mounting $\varnothing$ 47.5mm heating circuits 3 L 485mm W 30mm H 32mm number of thermostat sleeves 1 thermostat sleeves $\varnothing$ 7mm length thermostat sleeves 120mm thermostat sleeve centre not clinging tube $\varnothing$ 8.5mm hole distance 62mm hole $\varnothing$ 8mm connection length 20mm connection M4 immersion heater		
<b>spare parts for</b>	418877		
	<b>GEV No.</b>	510408	<b>Ref. No.</b> 0101176
	O-ring EPDM thickness 5.34mm ID $\varnothing$ 47mm Qty 1 pcs		

3 hole flange  $\varnothing$  57.5mm

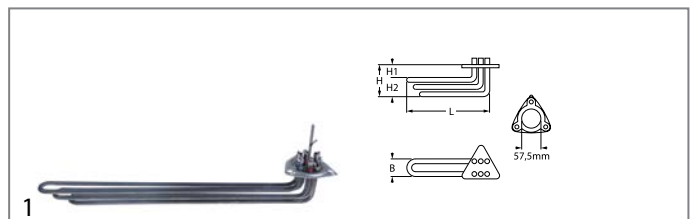

<b>GEV No.</b>	420369	<b>Ref. No.</b>	9615641
<b>description</b>	heating element 10500W 230V mounting $\varnothing$ 57.5mm heating circuits 3 L 650mm W 44mm H 37mm tube $\varnothing$ 8.5mm hole distance 72mm hole $\varnothing$ 8/10mm connection length 80mm connection screw clamp 3 hole flange immersion heater with threaded rod INCOLOY-800		
<b>spare parts for</b>	420369		
	<b>GEV No.</b>	532000	<b>Ref. No.</b> 0401048
	O-ring EPDM thickness 7mm ID $\varnothing$ 57mm Qty 1 pcs		



<b>GEV No.</b>	418769	<b>Ref. No.</b>	0101186 0101186+0401048
<b>description</b>	heating element 11000W 240V mounting $\varnothing$ 57.5mm heating circuits 3 L 502mm W 38mm H 73mm H1 38mm H2 35mm tube $\varnothing$ 8.5mm hole distance 73mm 3 hole flange immersion heater		
<b>accessories for</b>	418769		
	<b>GEV No.</b>	532000	<b>Ref. No.</b> 0401048
	O-ring EPDM thickness 7mm ID $\varnothing$ 57mm Qty 1 pcs		

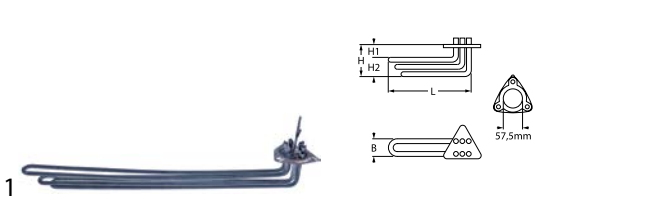



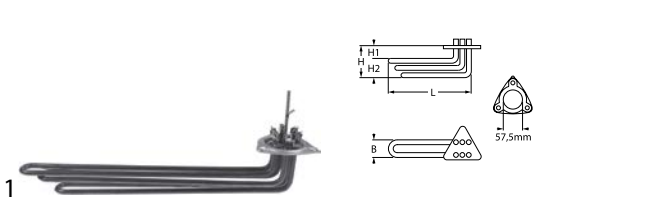

<b>GEV No.</b>	418770	<b>Ref. No.</b>	0101185 0101185+0401048
<b>description</b>	heating element 15000W 230V mounting $\varnothing$ 57.5mm heating circuits 3 L 580mm W 40mm H 73mm H1 39mm H2 34mm tube $\varnothing$ 8.5mm hole distance 72mm hole $\varnothing$ 8mm 3 hole flange immersion heater		





<b>GEV No.</b>	419057	<b>Ref. No.</b>	0101187 0101187 + 0401048
<b>description</b>	heating element 8000W 240V mounting $\varnothing$ 57.5mm heating circuits 3 L 414mm W 40mm H 75mm H1 40mm H2 35mm tube $\varnothing$ 8.5mm hole distance 72mm hole $\varnothing$ 8mm connection length 80mm connection screw clamp 3 hole flange immersion heater		
<b>accessories for</b>	419057		
		<b>GEV No.</b>	532000 <b>Ref. No.</b> 0401048
	O-ring EPDM thickness 7mm ID $\varnothing$ 57mm Qty 1 pcs		

with compression flange (miscellaneous)

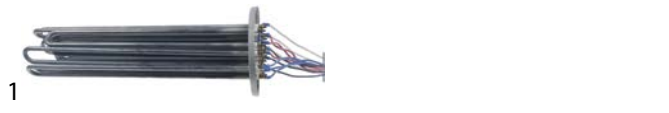

<b>GEV No.</b>	415507	<b>Ref. No.</b>	0101152 9708856
<b>description</b>	heating element 2000W 230V heating circuits 1 L 250mm W 35mm H 25mm connection male faston 6.3mm tube $\varnothing$ 8.5mm immersion heater special fixing mounting distance 21mm		
<b>For models:</b>	DV120T, DV40N, DV40T, DV40T FA, DV80T, ECO STAR 430F, ECO STAR 530F, ECO STAR 545D, FR30G, FR30G AB 1992, FR40G AB 1980, FR40G AB 1983, FR40GUS AB 1980, FR40GUS AB 1983, FV110G, FV20N, FV20T, FV25G AB 1986, FV25G AB 1992, FV28G AB 1994, FV28G AB 1997, FV28GFA, FV30GS, FV40.2, FV40.2 AB 2003, FV40N AB 1980, FV40N AB 1983, FV40N AB 1992, FV40T, FV40TFA, FV60E AB 1983, FV60E AB 1988, FV70T		
<b>spare parts for</b>	415507		
		<b>GEV No.</b>	510364 <b>Ref. No.</b> 0101175
	gasket Lmm Wmm $\varnothing$ 36mm for heating element thickness 3mm with 4 screw holes		
		<b>GEV No.</b>	510365 <b>Ref. No.</b> —
	counterflange $\varnothing$ 36mm Lmm Wmm		









<b>GEV No.</b>	419018	<b>Ref. No.</b>	0101184 0101184 + 0408229
<b>description</b>	heating element 36000W 415V heating circuits 12 L 420mm W 90mm H 90mm immersion heater		
<b>For models:</b>	DV221		
<b>accessories for</b>	419018		
		<b>GEV No.</b>	501383 <b>Ref. No.</b> 0408229
	flat gasket ID $\varnothing$ 102mm ED $\varnothing$ 144mm hole distance 33mm hole $\varnothing$ 6mm EPDM for heating element thickness 3mm		

with round flange  $\varnothing$ 47.5mm





<b>GEV No.</b>	419257	<b>Ref. No.</b>	9519586
<b>description</b>	heating element 3000/3265W 230/240V heating circuits 3 mounting $\varnothing$ 47.5mm L 185mm W 37mm H 30mm round flange connection screw cable lengthmm immersion heater tube $\varnothing$ 8.5mm thermostat sleeves $\varnothing$ 7mm number of thermostat sleeves 1 length thermostat sleeves 120mm thermostat sleeve centre not clinging		
<b>For models:</b>	FV40.2, FV40.2 AB 2002, FV40.2 AB 2003, FV40.2M, FV40.2MIKE2, FV40.2M-MIKE2		





<b>GEV No.</b>	415693	<b>Ref. No.</b>	0101150 9504228 9504228+0101176
<b>description</b>	heating element 3000W 230V heating circuits 3 mounting $\varnothing$ 47.5mm L 220mm W 30mm H 30mm round flange connection male faston 6.3mm immersion heater tube $\varnothing$ 6.5mm connection length 40mm thermostat sleeves $\varnothing$ 6.5mm number of thermostat sleeves 2 length thermostat sleeves 170mm thermostat sleeve centre		
<b>For models:</b>	DV120B, DV120T, DV40 AB 1992, DV40T, DV40T FA, DV80T, ECO STAR 430F, ECO STAR 530F, ECO STAR 545D, FR30G AB 1992, FV110G, FV130B, FV20N, FV20T, FV25G AB 1992, FV28G AB 1994, FV28G AB 1997, FV28GFA, FV30GS, FV40N AB 1992, FV40TFA, FV60E AB 1988, FV70TD		
<b>accessories for</b>	415693		
		<b>GEV No.</b>	510408 <b>Ref. No.</b> 0101176
	O-ring EPDM thickness 5.34mm ID $\varnothing$ 47mm Qty 1 pcs		
		<b>GEV No.</b>	510562 <b>Ref. No.</b> —
	O-ring silicone thickness 5.34mm ID $\varnothing$ 47mm Qty 1 pcs		
		<b>GEV No.</b>	520235 <b>Ref. No.</b> —
	3 hole flange hole distance 70.5mm perforation $\varnothing$ 6.5mm ID $\varnothing$ 53.5mm		
		<b>GEV No.</b>	520236 <b>Ref. No.</b> —
	flange for heating element ID $\varnothing$ 50mm ED $\varnothing$ 90mm hole $\varnothing$ 6.5mm 3 holes		
		<b>GEV No.</b>	550002 <b>Ref. No.</b> 0101183
	tension strap H 10mm L 21mm W 10mm hole $\varnothing$ 6.5mm for heating element		
		<b>GEV No.</b>	550362 <b>Ref. No.</b> —
	blind flange $\varnothing$ 64mm mounting $\varnothing$ 47.5mm		



<b>GEV No.</b>	415508	<b>Ref. No.</b>	0101151
<b>description</b>	heating element 3600W 230V heating circuits 3 mounting ø 47.5mm L 380mm W 125mm H 25mm tube ø 6.3mm round flange with thread bolt connection male faston 6.3mm immersion heater connection length 30mm H1 15mm		
<b>For models:</b>	DV100 AB 1980, DV100 AB 1983, DV120B, DV160 AB 1980, DV240B AB 1980, DV40 AB 1983, DV40 AB 1992, DV80, DV80 AB 1980, DV80 AB 1983, DV80 AB 1992		
<b>accessories for</b>	415508		
	<b>GEV No.</b>	510562	<b>Ref. No.</b> —
	O-ring silicone thickness 5.34mm ID ø 47mm Qty 1 pcs		
	<b>GEV No.</b>	521012	<b>Ref. No.</b> —
	gasket graphite ED ø 15mm ID ø 5mm thickness 1.2mm Qty 1 pcs		
	<b>GEV No.</b>	550002	<b>Ref. No.</b> 0101183
	tension strap H 10mm L 21mm W 10mm hole ø 6.5mm for heating element		





<b>GEV No.</b>	420365	<b>Ref. No.</b>	0101180
<b>description</b>	heating element 3600W 230V heating circuits 3 mounting ø 47.5mm L 270mm W 38mm H 29mm round flange connection male faston 6.3mm immersion heater tube ø 6.3mm thermostat sleeves ø 6.5mm number of thermostat sleeves 2 length thermostat sleeves 100mm thermostat sleeve eccentric, non clinging		
<b>accessories for</b>	420365		
	<b>GEV No.</b>	510408	<b>Ref. No.</b> 0101176
	O-ring EPDM thickness 5.34mm ID ø 47mm Qty 1 pcs		
	<b>GEV No.</b>	510562	<b>Ref. No.</b> —
	O-ring silicone thickness 5.34mm ID ø 47mm Qty 1 pcs		









<b>GEV No.</b>	417535	<b>Ref. No.</b>	0101163 9504234 9708867
<b>description</b>	heating element 4500W 230V heating circuits 3 mounting ø 47.5mm L 345mm W 33mm H 40mm thermostat sleeves ø 8.5mm number of thermostat sleeves 2 length thermostat sleeves 20.5mm thermostat sleeve eccentric, non clinging		
<b>For models:</b>	ECO STAR 430F, ECO STAR 530F, ECO STAR 545D, FV110G, FV20N, FV40N AB 1992, FV40T, FV40TFA, FV60E AB 1988, FV70TD		
<b>accessories for</b>	417535		
	<b>GEV No.</b>	510408	<b>Ref. No.</b> 0101176
	O-ring EPDM thickness 5.34mm ID ø 47mm Qty 1 pcs		

















<b>GEV No.</b>	415509	<b>Ref. No.</b>	0101158
<b>description</b>	heating element 6000W 230V heating circuits 3 mounting ø 47.5mm L 145mm W 374mm H 25mm H1 5mm H2 20mm tube ø 6.4mm round flange with thread bolt connection male faston 6.3mm immersion heater connection length 30mm		
<b>For models:</b>	DV160 AB 1983, DV160 AB 1996, DV240B AB 1983, DV240B AB 1996, DV260B, FV120B AB 1980, FV120B AB 1983, FV130B, FV240B AB 1980, FV240B AB 1983, FV70TD		
<b>accessories for</b>	415509		
	<b>GEV No.</b>	510408	<b>Ref. No.</b> 0101176
	O-ring EPDM thickness 5.34mm ID ø 47mm Qty 1 pcs		
	<b>GEV No.</b>	510562	<b>Ref. No.</b> —
	O-ring silicone thickness 5.34mm ID ø 47mm Qty 1 pcs		
	<b>GEV No.</b>	550002	<b>Ref. No.</b> 0101183
	tension strap H 10mm L 21mm W 10mm hole ø 6.5mm for heating element		



<b>GEV No.</b>	415663	<b>Ref. No.</b>	0101143 9504236
<b>description</b>	heating element 6000W 230V heating circuits 3 mounting ø 47.5mm L 400mm W 40mm H 28mm round flange connection M4 immersion heater tube ø 6.3mm thermostat sleeves ø 7mm number of thermostat sleeves 2 length thermostat sleeves 150mm thermostat sleeve not clinging		
<b>For models:</b>	DV120B, DV120T, DV40 AB 1992, DV40T, DV40T FA, DV80 AB 1992, DV80T, ECO STAR 545D, FV130B, FV40N AB 1992, FV40TFA, FV60E AB 1988, FV70TD		
<b>spare parts for</b>	415663		
	<b>GEV No.</b>	510408	<b>Ref. No.</b> 0101176
	O-ring EPDM thickness 5.34mm ID ø 47mm Qty 1 pcs		
<b>accessories for</b>	415663		
	<b>GEV No.</b>	510408	<b>Ref. No.</b> 0101176
	O-ring EPDM thickness 5.34mm ID ø 47mm Qty 1 pcs		
	<b>GEV No.</b>	510562	<b>Ref. No.</b> —
	O-ring silicone thickness 5.34mm ID ø 47mm Qty 1 pcs		
	<b>GEV No.</b>	520235	<b>Ref. No.</b> —
	3 hole flange hole distance 70.5mm perforation ø 6.5mm ID ø 53.5mm		
	<b>GEV No.</b>	520236	<b>Ref. No.</b> —
	flange for heating element ID ø 50mm ED ø 90mm hole ø 6.5mm 3 holes		
	<b>GEV No.</b>	550002	<b>Ref. No.</b> 0101183
	tension strap H 10mm L 21mm W 10mm hole ø 6.5mm for heating element		
	<b>GEV No.</b>	550362	<b>Ref. No.</b> —
	blind flange ø 64mm mounting ø 47.5mm		



			
<b>GEV No.</b>	415873	<b>Ref. No.</b>	0101167 9504237
<b>description</b>	heating element 7500W 230V heating circuits 3 mounting ø 47.5mm L 415mm W 30mm H 47mm round flange connection M4 immersion heater tube ø 6.5mm connection length 24mm thermostat sleeves ø 6.3mm number of thermostat sleeves 2 length thermostat sleeves 210mm thermostat sleeve not clinging		
<b>For models:</b>	DV120B, DV120T, DV40T, DV40T FA, DV80T, FV110G, FV130B, FV20N, FV40N AB 1992, FV40TFA, FV60E AB 1988, FV70T, FV70TD		
<b>spare parts for</b>	415873		
	<b>GEV No.</b>	510408	<b>Ref. No.</b> 0101176
	O-ring EPDM thickness 5.34mm ID ø 47mm Qty 1 pcs		
<b>accessories for</b>	415873		
	<b>GEV No.</b>	510408	<b>Ref. No.</b> 0101176
	O-ring EPDM thickness 5.34mm ID ø 47mm Qty 1 pcs		
	<b>GEV No.</b>	510562	<b>Ref. No.</b> —
	O-ring silicone thickness 5.34mm ID ø 47mm Qty 1 pcs		
	<b>GEV No.</b>	520235	<b>Ref. No.</b> —
	3 hole flange hole distance 70.5mm perforation ø 6.5mm ID ø 53.5mm		
	<b>GEV No.</b>	520236	<b>Ref. No.</b> —
	flange for heating element ID ø 50mm ED ø 90mm hole ø 6.5mm 3 holes		
	<b>GEV No.</b>	550002	<b>Ref. No.</b> 0101183
	tension strap H 10mm L 21mm W 10mm hole ø 6.5mm for heating element		
	<b>GEV No.</b>	550362	<b>Ref. No.</b> —
	blind flange ø 64mm mounting ø 47.5mm		

			
<b>GEV No.</b>	415692	<b>Ref. No.</b>	0101166 9504240
<b>description</b>	heating element 9000W 230V heating circuits 3 mounting ø 47.5mm L 485mm W 34mm H 24mm round flange connection M4 immersion heater tube ø 6.3mm thermostat sleeves ø 7mm number of thermostat sleeves 2 length thermostat sleeves 170mm thermostat sleeve not clinging		
<b>For models:</b>	DV120B, DV120T, DV40T, DV40T FA, DV80 AB 1992, DV80T, ECO STAR 545D, FV130B		
<b>spare parts for</b>	415692		
	<b>GEV No.</b>	510408	<b>Ref. No.</b> 0101176
	O-ring EPDM thickness 5.34mm ID ø 47mm Qty 1 pcs		
<b>accessories for</b>	415692		
	<b>GEV No.</b>	510562	<b>Ref. No.</b> —
	O-ring silicone thickness 5.34mm ID ø 47mm Qty 1 pcs		
	<b>GEV No.</b>	520235	<b>Ref. No.</b> —
	3 hole flange hole distance 70.5mm perforation ø 6.5mm ID ø 53.5mm		
	<b>GEV No.</b>	520236	<b>Ref. No.</b> —
	flange for heating element ID ø 50mm ED ø 90mm hole ø 6.5mm 3 holes		
	<b>GEV No.</b>	550002	<b>Ref. No.</b> 0101183
	tension strap H 10mm L 21mm W 10mm hole ø 6.5mm for heating element		

<b>accessories for</b>	415692		
	<b>GEV No.</b>	550362	<b>Ref. No.</b> —
	blind flange ø 64mm mounting ø 47.5mm		

<b>with round flange (miscellaneous)</b>			
			
<b>GEV No.</b>	420367	<b>Ref. No.</b>	9533178
<b>description</b>	heating element 2000W 440V heating circuits 1 mounting ø 33mm L 270mm W 38mm H 29mm round flange connection male faston 6.3mm immersion heater tube ø 8.5mm		

<b>1½"</b>			
			
<b>GEV No.</b>	415506	<b>Ref. No.</b>	0101140
<b>description</b>	heating element 3000W 230V heating circuits 3 thread 1½" L 230mm W 29mm H 25mm tube ø 6.3mm connection male faston 6.3mm immersion heater connection length 15mm flange with thread		
<b>For models:</b>	DV40 AB 1983, EE60, EE90, FR30G, FR40G AB 1983, FR40GUS AB 1983, FR60, FV25G AB 1986, FV40N AB 1983		
<b>accessories for</b>	415506		
	<b>GEV No.</b>	510406	<b>Ref. No.</b> 0408020
	flat gasket fibre ED ø 60mm ID ø 48mm thickness 3mm for thread 1½" Qty 1 pcs		
	<b>GEV No.</b>	510424	<b>Ref. No.</b> 0409008
	gasket copper ED ø 55mm ID ø 48mm thickness 2.2mm Centellen for thread 1½"		
	<b>GEV No.</b>	520211	<b>Ref. No.</b> —
	reducer thread 2" ET - 1½" IT brass		
	<b>GEV No.</b>	520212	<b>Ref. No.</b> —
	hexagonal nut thread 1½" brass WS 60 H 8mm		
	<b>GEV No.</b>	550361	<b>Ref. No.</b> —
	blind flange ø 58mm thread 1½"		













			
<b>GEV No.</b>	416221	<b>Ref. No.</b>	9502869
<b>description</b>	heating element 3000W 230V heating circuits 3 thread 1½" L 235mm W 33mm H 26mm thermostat sleeves ø 7mm length thermostat sleeves 202mm thermostat sleeve centre not clinging tube ø 6.3mm connection male faston immersion heater connection length 16mm flange with thread number of thermostat sleeves 1		
<b>accessories for</b>	416221		
	<b>GEV No.</b>	510406	<b>Ref. No.</b> 0408020
	flat gasket fibre ED ø 60mm ID ø 48mm thickness 3mm for thread 1½" Qty 1 pcs		
	<b>GEV No.</b>	510424	<b>Ref. No.</b> 0409008
	gasket copper ED ø 55mm ID ø 48mm thickness 2.2mm Centellen for thread 1½"		
	<b>GEV No.</b>	520211	<b>Ref. No.</b> —
	reducer thread 2" ET - 1½" IT brass		



Table continues overleaf



<b>accessories for</b>	416221			
	GEV No.	520212	Ref. No.	—
	hexagonal nut thread 1½" brass WS 60 H 8mm			
	GEV No.	550361	Ref. No.	—
	blind flange ø 58mm thread 1½"			

	1			
<b>GEV No.</b>	415502	<b>Ref. No.</b>	0101142	
<b>description</b>	heating element 4500W 230V heating circuits 3 thread 1½" L 370mm W 34mm H 26mm tube ø 6.5mm immersion heater flange with thread			
<b>For models:</b>	DR70, DR90E, DV100 AB 1983, DV111, DV111E, DV120B, DV80, DV80 AB 1975, DV80 AB 1980, EE60, EE90, FV30, FV40N AB 1983, FV50, FV60E AB 1983			
<b>accessories for</b>	415502			
	GEV No.	510406	Ref. No.	0408020
	flat gasket fibre ED ø 60mm ID ø 48mm thickness 3mm for thread 1½" Qty 1 pcs			
	GEV No.	510424	Ref. No.	0409008
	gasket copper ED ø 55mm ID ø 48mm thickness 2.2mm Centellen for thread 1½"			
	GEV No.	520211	Ref. No.	—
	reducer thread 2" ET - 1½" IT brass			
	GEV No.	520212	Ref. No.	—
	hexagonal nut thread 1½" brass WS 60 H 8mm			
	GEV No.	550361	Ref. No.	—
	blind flange ø 58mm thread 1½"			

	1			
<b>GEV No.</b>	416222	<b>Ref. No.</b>	9502870	
<b>description</b>	heating element 6000W 230V heating circuits 3 thread 1½" L 415mm W 33mm H 26mm thermostat sleeves ø 7mm length thermostat sleeves 230mm thermostat sleeve centre not clinging connection M4 immersion heater flange with thread number of thermostat sleeves 1			
<b>accessories for</b>	416222			
	GEV No.	510406	Ref. No.	0408020
	flat gasket fibre ED ø 60mm ID ø 48mm thickness 3mm for thread 1½" Qty 1 pcs			
	GEV No.	510424	Ref. No.	0409008
	gasket copper ED ø 55mm ID ø 48mm thickness 2.2mm Centellen for thread 1½"			
	GEV No.	520211	Ref. No.	—
	reducer thread 2" ET - 1½" IT brass			
	GEV No.	520212	Ref. No.	—
	hexagonal nut thread 1½" brass WS 60 H 8mm			
	GEV No.	550361	Ref. No.	—
	blind flange ø 58mm thread 1½"			

	1			
<b>GEV No.</b>	415503	<b>Ref. No.</b>	0101144	
<b>description</b>	heating element 6000W 230V heating circuits 3 thread 1½" L 415mm W 36mm H 26mm thermostat sleeves ømm length thermostat sleevesmm thermostat sleeve tube ø 6.3mm cable lengthmm connection M4 immersion heater connection lengthmm flange with thread WS 41			
<b>accessories for</b>	415503			
	GEV No.	510406	Ref. No.	0408020
	flat gasket fibre ED ø 60mm ID ø 48mm thickness 3mm for thread 1½" Qty 1 pcs			
	GEV No.	510424	Ref. No.	0409008
	gasket copper ED ø 55mm ID ø 48mm thickness 2.2mm Centellen for thread 1½"			
	GEV No.	520211	Ref. No.	—
	reducer thread 2" ET - 1½" IT brass			
	GEV No.	520212	Ref. No.	—
	hexagonal nut thread 1½" brass WS 60 H 8mm			
	GEV No.	550361	Ref. No.	—
	blind flange ø 58mm thread 1½"			

	1			
<b>GEV No.</b>	416220	<b>Ref. No.</b>	0101145	
<b>description</b>	heating element 6000W 230V heating circuits 3 thread 1½" L 415mm W 36mm H 75mm H1 48mm H2 27mm tube ø 6.3mm connection grip connection immersion heater flange with thread			
<b>accessories for</b>	416220			
	GEV No.	510406	Ref. No.	0408020
	flat gasket fibre ED ø 60mm ID ø 48mm thickness 3mm for thread 1½" Qty 1 pcs			
	GEV No.	510424	Ref. No.	0409008
	gasket copper ED ø 55mm ID ø 48mm thickness 2.2mm Centellen for thread 1½"			
	GEV No.	520211	Ref. No.	—
	reducer thread 2" ET - 1½" IT brass			
	GEV No.	520212	Ref. No.	—
	hexagonal nut thread 1½" brass WS 60 H 8mm			
	GEV No.	550361	Ref. No.	—
	blind flange ø 58mm thread 1½"			



	1			
<b>GEV No.</b>	415504	<b>Ref. No.</b>	0101146	
<b>description</b>	heating element 7500W 230V heating circuits 3 thread 1½" L 415mm W 26mm H 34mm connection M4 immersion heater flange with thread			
<b>For models:</b>	DR90E, DV111, DV111E, DV120B, DV240B AB 1983, DV260B, DV80, FV120B AB 1983, FV240B AB 1983, FV60E AB 1983			
<b>accessories for</b>	415504			
	GEV No.	510406	Ref. No.	0408020
	flat gasket fibre ED ø 60mm ID ø 48mm thickness 3mm for thread 1½" Qty 1 pcs			

Table continues overleaf









<b>accessories for</b>	415504		
	GEV No.	510424	Ref. No. 0409008
	gasket copper ED ø 55mm ID ø 48mm thickness 2.2mm Centellen for thread 1½"		
	GEV No.	520211	Ref. No. —
	reducer thread 2" ET - 1½" IT brass		
	GEV No.	520212	Ref. No. —
	hexagonal nut thread 1½" brass WS 60 H 8mm		
	GEV No.	550361	Ref. No. —
	blind flange ø 58mm thread 1½"		

	1		
<b>GEV No.</b>	415510	<b>Ref. No.</b>	0101149
<b>description</b>	heating element 9000W 230V heating circuits 3 thread 1½" L 420mm W 39mm H 65mm H1 40mm H2 25mm tube ø 6.3mm connection M4 immersion heater flange with thread		
<b>spare parts for</b>	415510		
	GEV No.	560080	Ref. No. —
	hexagonal screw thread M4 thread L 8mm SS WS 7 Qty 20 pcs DIN 933 / ISO 4017		
<b>accessories for</b>	415510		
	GEV No.	510406	Ref. No. 0408020
	flat gasket fibre ED ø 60mm ID ø 48mm thickness 3mm for thread 1½" Qty 1 pcs		
	GEV No.	510424	Ref. No. 0409008
	gasket copper ED ø 55mm ID ø 48mm thickness 2.2mm Centellen for thread 1½"		
	GEV No.	520211	Ref. No. —
	reducer thread 2" ET - 1½" IT brass		
	GEV No.	520212	Ref. No. —
	hexagonal nut thread 1½" brass WS 60 H 8mm		
	GEV No.	550361	Ref. No. —
	blind flange ø 58mm thread 1½"		

	1		
<b>GEV No.</b>	416223	<b>Ref. No.</b>	9502872
<b>description</b>	heating element 9000W 230V heating circuits 3 thread 1½" L 485mm W 26mm H 26mm thermostat sleeves ø 7mm length thermostat sleeves 200mm thermostat sleeve centre not clinging tube ø 6.3mm connection male faston 6.3mm immersion heater number of thermostat sleeves 1		
<b>accessories for</b>	416223		
	GEV No.	510406	Ref. No. 0408020
	flat gasket fibre ED ø 60mm ID ø 48mm thickness 3mm for thread 1½" Qty 1 pcs		
	GEV No.	510424	Ref. No. 0409008
	gasket copper ED ø 55mm ID ø 48mm thickness 2.2mm Centellen for thread 1½"		
	GEV No.	520211	Ref. No. —
	reducer thread 2" ET - 1½" IT brass		

<b>accessories for</b>	416223		
	GEV No.	520212	Ref. No. —
	hexagonal nut thread 1½" brass WS 60 H 8mm		
	GEV No.	550361	Ref. No. —
	blind flange ø 58mm thread 1½"		



	1		
<b>GEV No.</b>	420072	<b>Ref. No.</b>	9546104
<b>description</b>	heating element 1000/1500W 200/250V heating circuits 1 L 184mm W 130mm H 20mm L1 60mm L2 34mm L3 90mm thread M14x1.5 mounting distance 121.5mm tube ø 8.5mm immersion heater		
<b>For models:</b>	FV40.2M-MIKE2		

	1		
<b>GEV No.</b>	418878	<b>Ref. No.</b>	9546105
<b>description</b>	heating element 2000W 230V heating circuits 1 L 184mm W 131mm H 19mm L1 55mm L2 39mm L3 90mm thread M14x1.5 mounting distance 123mm tube ø 8.5mm connection length 40mm 2 hole fixing connection M4 immersion heater		
<b>For models:</b>	FV40.2M-MIKE2		

## thermostats

### bi-metal thermostats

#### safety bi-metal thermostats

	1		
<b>GEV No.</b>	390171	<b>Ref. No.</b>	0108043
<b>description</b>	bi-metal safety thermostat hole distancemm switch-off temp. 110°C 1NC 1-pole 16A connection F6.3		
<b>For models:</b>	DV120T, DV40N, DV40T, DV40T FA, ECO STAR 430F, ECO STAR 530F, ECO STAR 545D, FV20N, FV20T, FV28GFA, FV40.2, FV40.2 AB 2003, FV40N AB 1992, FV40T, FV40TFA, FV70T, FV70TD		
<b>accessories for</b>	390171		
	GEV No.	510362	Ref. No. 0108040
	gasket for thermostat ED ø 40mm ID ø 19mm suitable for COMENDA, MEIKO equiv. no. 630511/0108040		



1

<b>GEV No.</b>	390240	<b>Ref. No.</b>	0108038
<b>description</b>	bi-metal safety thermostat switch-off temp. 105°C 1-pole connection F6.3		
<b>For models:</b>	DV120B, DV120T, DV160 AB 1996, DV240B AB 1996, DV270B AB 1992, DV40 AB 1992, DV40T, DV40T FA, DV80 AB 1992, DV80T, ECO STAR 545D, FR30G AB 1992, FV110G, FV130B, FV20N, FV20T, FV250B AB 1992, FV25G AB 1992, FV28G AB 1994, FV28G AB 1997, FV28GFA, FV30GS, FV40N AB 1992, FV40T, FV40TFA, FV60E AB 1988, FV70T, FV70TD		

bi-metal thermostats



1

<b>GEV No.</b>	390170	<b>Ref. No.</b>	0108051
<b>description</b>	bi-metal thermostat 2-pole		
<b>For models:</b>	DV120T, DV40N, DV40T, DV80T, FR30G AB 1992, FV110G, FV130B, FV20N, FV20T, FV25G AB 1992, FV30GS, FV40N AB 1983, FV40N AB 1992, FV40T, FV60E AB 1988, FV70T		



1

<b>GEV No.</b>	390123	<b>Ref. No.</b>	0108053
<b>description</b>	bi-metal thermostat hole distance 23.8mm switch-off temp. 50°C 1NC 1-pole 16A 250V connection F6.3 2 hole fixing		
<b>For models:</b>	DV120T, DV160 AB 1996, DV240B AB 1996, DV40N, DV40T, DV80T, ECO STAR 430F, ECO STAR 530F, FV110G, FV130B, FV20N, FV20T, FV28GFA, FV40N AB 1983, FV40N AB 1992, FV40T, FV70T		



1

<b>GEV No.</b>	390103	<b>Ref. No.</b>	0108047
<b>description</b>	bi-metal thermostat hole distance mm switch-off temp. 59°C 1NC 1-pole 16A connection F6.3		
<b>For models:</b>	DV100 AB 1980, DV100 AB 1983, DV120B, DV120T, DV160 AB 1980, DV160 AB 1983, DV160 AB 1996, DV240B AB 1980, DV240B AB 1983, DV240B AB 1996, DV270B AB 1992, DV40 AB 1983, DV40 AB 1992, DV40N, DV40T, DV80, DV80 AB 1980, DV80 AB 1983, DV80 AB 1992, DV80T, ECO STAR 430F, ECO STAR 530F, FR30G, FR40G AB 1976, FR40G AB 1980, FR40G AB 1983, FR40GUS AB 1976, FR40GUS AB 1980, FR40GUS AB 1983, FV110G, FV130B, FV20N, FV20T, FV250B AB 1992, FV25G AB 1986, FV28G AB 1994, FV28G AB 1997, FV28GFA, FV30, FV40N AB 1980, FV40N AB 1983, FV40N AB 1992, FV40T, FV50, FV50 M, FV60E AB 1983, FV70T		
<b>accessories for</b>	390103		
	<b>GEV No.</b>	510362	<b>Ref. No.</b> 0108040
	gasket for thermostat ED ø 40mm ID ø 19mm suitable for COMENDA, MEIKO equiv. no. 630511/0108040		

control and safety thermostats

EGO

safety thermostats

55.32\_ series



1

<b>GEV No.</b>	390244	<b>Ref. No.</b>	9502526
<b>description</b>	safety thermostat switch-off temp. 120°C 3-pole 20A probe ø 6mm probe L 94mm capillary pipe 540mm capillary pipe isolated 500mm gland nut probe SS		
<b>For models:</b>	ECO STAR 430F, ECO STAR 530F, ECO STAR 545D, FV28GFA		



1

<b>GEV No.</b>	375861	<b>Ref. No.</b>	9500473
<b>description</b>	safety thermostat switch-off temp. 150°C 3-pole 16A probe ø 6mm probe L 98mm capillary pipe 480mm capillary pipe isolated mm gland nut probe		





1

<b>GEV No.</b>	390928	<b>Ref. No.</b>	9502027
<b>description</b>	thermostat switch-off temp. 196°C 3-pole 3NC 20A probe ø 6mm probe L 87mm capillary pipe 890mm capillary pipe isolated 350mm gland nut probe		

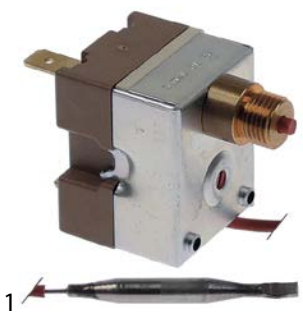

CAMPINI			
safety thermostats			
			
1			
<b>GEV No.</b>	381386	<b>Ref. No.</b>	0108085
<b>description</b>	safety thermostat switch-off temp. 176°C temperature range°C 1-pole 1NC 16A probe ø 5mm probe L 77mm capillary pipe 955mm capillary pipe isolated 350mm gland nut shaft ømm 250VACV		

RATHGEBER			
control thermostats			
			
1			
<b>GEV No.</b>	390243	<b>Ref. No.</b>	0108041
<b>description</b>	thermostat t.max. 90°C temperature range 0-90°C 1-pole 1CO 16A probe ø 6mm probe L 140mm capillary pipe 3000mm capillary pipe isolated 50mm gland nut shaft Lmm rotation 270°		

			
1			
<b>GEV No.</b>	390127	<b>Ref. No.</b>	0108030 0108036
<b>description</b>	thermostat t.max. 95°C temperature range 0-95°C 1-pole 1CO 16A probe ø 6mm probe L 145mm capillary pipe 480mm capillary pipe isolated 430mm gland nut shaft ø 6x4.6mm shaft L 17mm shaft position lower° rotation 270°		
<b>For models:</b>	DV270B AB 1988, DV40 AB 1983, FR30G, FR40G AB 1980, FR40G AB 1983, FR40GUS AB 1980, FR40GUS AB 1983, FV250B AB 1988, FV25G AB 1986, FV40N AB 1980, FV40N AB 1983, FV60E AB 1983		

			
1			
<b>GEV No.</b>	390242	<b>Ref. No.</b>	0108037
<b>description</b>	thermostat t.max. 95°C temperature range 0-95°C 1-pole 1CO 16A probe ø 6mm probe L 150mm capillary pipe 480mm capillary pipe isolated 420mm gland nut shaft Lmm rotation 270°		
<b>For models:</b>	DV120B, DV120T, DV160 AB 1996, DV240B AB 1996, DV270B AB 1992, DV40 AB 1992, DV40T, DV80 AB 1992, DV80T, ECO STAR 430F, ECO STAR 530F, FR30G AB 1992, FV110G, FV130B, FV20N, FV20T, FV250B AB 1992, FV25G AB 1992, FV28G AB 1994, FV28G AB 1997, FV28GFA, FV30GS, FV40N AB 1992, FV40T, FV60E AB 1988, FV70T		

various			
control thermostats			
			
1			
<b>GEV No.</b>	390245	<b>Ref. No.</b>	0108039
<b>description</b>	thermostat t.max. 90°C temperature range 0-70/20-90°C 2-pole 2CO 16A probe ø 6mm probe L 145mm capillary pipe 480mm capillary pipe isolated 250mm rotation 315°		
<b>For models:</b>	DV120T, DV40T, DV80T, FV130B		

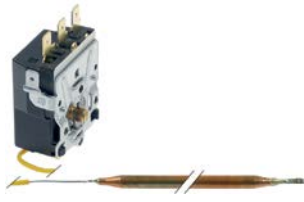
			
1			
<b>GEV No.</b>	390933	<b>Ref. No.</b>	9500086 9637704
<b>description</b>	thermostat t.max. 95°C temperature range 0-95°C 1CO probe ø 6mm probe L 145mm capillary pipe 470mm capillary pipe isolated 440mm shaft ø 6mm shaft L 3mm rotation 270° 24V contacts male faston 6.3mm Qty 1 pcs		

rod thermostats

rod thermostats			
			
1			
<b>GEV No.</b>	390108	<b>Ref. No.</b>	0108004 9539518
<b>description</b>	rod thermostat temperature range 0-100°C 1CO 1-pole 6A probe ø 1/2"mm probe L 200mm		
<b>For models:</b>	DR90, DR90E, DV100 AB 1980, DV100 AB 1983, DV111, DV111E, DV120B, DV160 AB 1980, DV160 AB 1983, DV221, DV240B AB 1980, DV240B AB 1983, DV250B, DV260B, DV80, DV80 AB 1983, DV80 AB 1992, EE60, EE90, FV120B AB 1980, FV120B AB 1983, FV200B, FV240B AB 1980		

			
1			
<b>GEV No.</b>	390986	<b>Ref. No.</b>	9521606
<b>description</b>	rod thermostat temperature range 0-120°C 1CO probe ø 1/2"mm probe L 90mm		



			
1			
<b>GEV No.</b>	390241	<b>Ref. No.</b>	9521606
<b>description</b>	rod thermostat temperature range 25-90°C 1CO 1-pole 16A probe ø 1/2"mm probe L 90mm		

## accessories

## gland nut accessories

## ducts

			
1			
<b>GEV No.</b>	550148	<b>Ref. No.</b>	9546760
<b>description</b>	gland duct ET M12x0.75 IT M9x1 probe ø max. 6.5mm WS 17 silicone		





## plunger sockets

			
1			
<b>GEV No.</b>	501213	<b>Ref. No.</b>	8000005 8400025
<b>description</b>	thermowell thread M14x1 L 147mm SS single ø 7mm		
<b>For models:</b>	DV40 AB 1983, FR30G, FV40N AB 1983, FV60E AB 1983		

## switches and momentary switches

## microswitches

## universal

				
1				
<b>GEV No.</b>	345043	<b>Ref. No.</b>	0122106	
<b>description</b>	lever set 5-piece			
<b>accessories for</b>	345043			
	<b>GEV No.</b>	345042	<b>Ref. No.</b>	0122103 0122105 0122108 9544800
	microswitch with plunger 250V 16A 1CO connection male faston 6.3mm L 28mm ambient temperature max. 125°C mounting distance 22mm type EF83161.3 actuating force: 75g blue/black			
	<b>GEV No.</b>	347217	<b>Ref. No.</b>	—
	microswitch with plunger 250V 4A 1CO connection male faston 6.3mm L 28mm ambient temperature max. 125°C mounting distance 22mm type EF83161.5 actuating force: 20g blue/black			



1				
<b>GEV No.</b>	345042	<b>Ref. No.</b>	0122103 0122105 0122108 9544800	
<b>description</b>	microswitch with plunger 250V 16A 1CO connection male faston 6.3mm L 28mm ambient temperature max. 125°C mounting distance 22mm type EF83161.3 actuating force: 75g blue/black			
<b>For models:</b>	DV120T, DV160 AB 1996, DV240B AB 1996, DV270B AB 1992, DV40N, DV40T, DV40T FA, DV80T, FR30G AB 1992, FV130B, FV20T, FV250B AB 1992, FV25G AB 1986, FV25G AB 1992, FV28GFA, FV40.2, FV40.2 AB 2003, FV40.2MIKE2, FV40.2M-MIKE2, FV40N AB 1992, FV40T, FV40TFA, FV70T, FV70TD			
<b>accessories for</b>	345042			
	<b>GEV No.</b>	345043	<b>Ref. No.</b>	0122106
	lever set 5-piece			

## lever actuated

			
1			
<b>GEV No.</b>	345257	<b>Ref. No.</b>	0122105 0122106
<b>description</b>	microswitch with lever 250V 16A 1CO connection male faston 6.3mm L 29mm L1 33mm ambient temperature max. 120°C mounting distance 22mm actuating force: 130g lever length 31.5mm		

## pin-plunger actuated



			
1			
<b>GEV No.</b>	345060	<b>Ref. No.</b>	0122007
<b>description</b>	microswitch with plunger 250V 16A 1NO connection male faston 6.3mm ambient temperature max. 85°C mounting distance 22mm type BS1010 actuating force: 350g red stroke 9mm		
<b>For models:</b>	DV120B, DV160 AB 1983, DV160 AB 1996, DV221, DV240B AB 1980, DV240B AB 1983, DV240B AB 1996, DV270B AB 1988, DV270B AB 1992, DV40 AB 1983, DV40 AB 1992, DV80, DV80 AB 1983, DV80 AB 1992, FR30G, FR40G AB 1976, FR40G AB 1980, FR40G AB 1983, FR40GUS AB 1976, FR40GUS AB 1980, FR40GUS AB 1983, FV110G, FV130B, FV250B AB 1992, FV25G AB 1986, FV30, FV40GE, FV40N AB 1980, FV40N AB 1983, FV50, FV50 M, FV60E AB 1983		







			
1			
<b>GEV No.</b>	345062	<b>Ref. No.</b>	0122017
<b>description</b>	microswitch with plunger 250V 16A 1NO/1NC connection male faston 6.3mm ambient temperature max. 85°C mounting distance 22mm type BS1012 actuating force: 350g red stroke 8mm		

			
1			
<b>GEV No.</b>	345247	<b>Ref. No.</b>	0122016
<b>description</b>	microswitch with plunger 250V 6A 2NO connection male faston 6.3mm ambient temperature max. 85°C mounting distance 22mm type 3SE4305 actuating force: 350g black		
<b>For models:</b>	DV100 AB 1980, DV120B, DV160 AB 1980, DV160 AB 1983, DV240B AB 1980, DV240B AB 1983, DV260B, DV40 AB 1992, DV80, DV80 AB 1980, DV80 AB 1983, DV80 AB 1992, FR40G AB 1980, FR40GUS AB 1980, FV120B AB 1980, FV120B AB 1983, FV240B AB 1980, FV240B AB 1983		

			
1			
<b>GEV No.</b>	347161	<b>Ref. No.</b>	9520085 9622932
<b>description</b>	microswitch with plunger 250V 0.1A 1NO connection male faston 6.3mm ambient temperature max. 125°C mounting distance 22mm white		
<b>For models:</b>	FV40.2, FV40.2MIKE2, FV40.2M-MIKE2		

			
1			
<b>GEV No.</b>	345042	<b>Ref. No.</b>	0122103 0122105 0122108 9544800
<b>description</b>	microswitch with plunger 250V 16A 1CO connection male faston 6.3mm L 28mm ambient temperature max. 125°C mounting distance 22mm type EF83161.3 actuating force: 75g blue/black		
<b>For models:</b>	DV120T, DV160 AB 1996, DV240B AB 1996, DV270B AB 1992, DV40N, DV40T, DV40T FA, DV80T, FR30G AB 1992, FV130B, FV20T, FV250B AB 1992, FV25G AB 1986, FV25G AB 1992, FV28GFA, FV40.2, FV40.2 AB 2003, FV40.2MIKE2, FV40.2M-MIKE2, FV40N AB 1992, FV40T, FV40TFA, FV70T, FV70TD		
<b>accessories for</b>	345042		
	<b>GEV No.</b>	345043	<b>Ref. No.</b> 0122106
	lever set 5-piece		

accessories			
			
1			
<b>GEV No.</b>	501282	<b>Ref. No.</b>	8000425
<b>description</b>	bush for door contact switch		
<b>For models:</b>	FV25G AB 1986		

			
1			
<b>GEV No.</b>	345043	<b>Ref. No.</b>	0122106
<b>description</b>	lever set 5-piece		
<b>accessories for</b>	345043		
	<b>GEV No.</b>	345042	<b>Ref. No.</b> 0122103 0122105 0122108 9544800
	microswitch with plunger 250V 16A 1CO connection male faston 6.3mm L 28mm ambient temperature max. 125°C mounting distance 22mm type EF83161.3 actuating force: 75g blue/black		
	<b>GEV No.</b>	347217	<b>Ref. No.</b> —
	microswitch with plunger 250V 4A 1CO connection male faston 6.3mm L 28mm ambient temperature max. 125°C mounting distance 22mm type EF83161.5 actuating force: 20g blue/black		

			
Image not available			
1			
<b>GEV No.</b>	501284	<b>Ref. No.</b>	8000422
<b>description</b>	pressure bolt for door contact switch		
<b>For models:</b>	FV25G AB 1986		

			
1			
<b>GEV No.</b>	501280	<b>Ref. No.</b>	8000421
<b>description</b>	pressure pin for door contact switch		
<b>For models:</b>	FV25G AB 1986		

position switches			
BERNSTEIN			
			
1			
<b>GEV No.</b>	347965	<b>Ref. No.</b>	9520115
<b>description</b>	position switch with handle with a switch 1NO/1NC 500V 10A L 108mm W 36mm H 33mm protection IP65 actuating force: 1000g screw connection M20 mounting distance 25mm		



TELEMECANIQUE (EFA)



<b>GEV No.</b>	346207	<b>Ref. No.</b>	9500490
<b>description</b>	position switch with plunger 2NC L 70mm W 30mm H 30mm protection IP65		

float switches



<b>GEV No.</b>	347959	<b>Ref. No.</b>	0130023
<b>description</b>	float switch thread 1/4" NPT 1NO $\phi$ 53mm L 90mm mounting $\phi$ 14mm 250V 0.4A cable cable length 600mm		

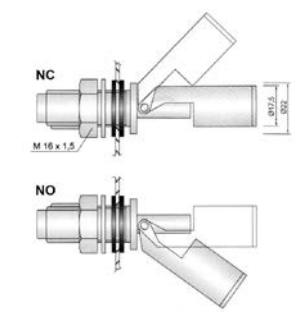

<b>GEV No.</b>	345484	<b>Ref. No.</b>	0130028 9503380 9526211
<b>description</b>	float switch thread M16x1.5 1NO or 1NC $\phi$ 17.5mm L 92mm mounting $\phi$ 16mm 250V 1A cable cable length 2000mm		
<b>For models:</b>	DV40T FA, FV28GFA		



<b>GEV No.</b>	346208	<b>Ref. No.</b>	9519580 9622935
<b>description</b>	float switch 1NC $\phi$ 85mm L 90mm mounting $\phi$ 8mm 240V 16A male faston 6.3mm cable lengthmm		
<b>For models:</b>	FV40.2, FV40.2MIKE2, FV40.2M-MIKE2		
<b>spare parts for</b>	346208		

	<b>GEV No.</b>	347161	<b>Ref. No.</b>	9520085 9622932
	microswitch with plunger 250V 0.1A 1NO connection male faston 6.3mm ambient temperature max. 125°C mounting distance 22mm white			

floats



<b>GEV No.</b>	347967	<b>Ref. No.</b>	9537131
<b>description</b>	float with magnet for float switch $\phi$ 42.5mm L 43mm Wmm Hmm SS		



<b>GEV No.</b>	347246	<b>Ref. No.</b>	0620351
<b>description</b>	float with magnet $\phi$ 40mm L 99mm Wmm Hmm PVC		



rotary switches

ENTRELEC

			
1			
<b>GEV No.</b>	345478	<b>Ref. No.</b>	0123001
<b>description</b>	rotary switch 4 0-1-2-3 sets of contacts 6 400V 12A connection screw		
<b>For models:</b>	DR90, DV100 AB 1980, DV100 AB 1983, DV111, DV111E, DV160 AB 1980, DV221, DV80 AB 1980, FR60, FV120B AB 1980, FV120B AB 1983, FV200B, FV240B AB 1980, FV240B AB 1983, FV60 AB 1973, FV60 AB 1976, FV60E AB 1983		

KRAUS & NAIMER

rotary switches

			
1			
<b>GEV No.</b>	345475	<b>Ref. No.</b>	0123260 0123271
<b>description</b>	rotary switch 2 0-1 sets of contacts 1 type CH6 A290-600 FS1 400V 20A shaft $\phi$ 6x4.6mm shaft L 21mm with knob connection screw		
<b>For models:</b>	DV120B, DV160 AB 1983, DV240B AB 1980, DV240B AB 1983, DV270B AB 1988, DV40 AB 1983, DV80, DV80 AB 1983, FV250B AB 1988, FV40N AB 1980		

			
1			
<b>GEV No.</b>	345476	<b>Ref. No.</b>	0123261 0123272
<b>description</b>	rotary switch 2 0-1 sets of contacts 2 type CH6-AT08F183 400V 20A shaft $\phi$ 6x4.6mm shaft L 21mm with knob connection screw code 26/000100 marking A291		
<b>For models:</b>	DV40 AB 1983, FV40N AB 1983		

			
1			
<b>GEV No.</b>	345474	<b>Ref. No.</b>	0123259 0123273
<b>description</b>	rotary switch 3 0-1-2 sets of contacts 3 type CH6-A230 400V 20A shaft $\phi$ 6x4.6mm shaft L 21mm with knob connection screw		
<b>For models:</b>	DV120B, DV240B AB 1980, DV240B AB 1983, DV80		

			
1			
<b>GEV No.</b>	345477	<b>Ref. No.</b>	0123270
<b>description</b>	rotary switch 3 0-1-2 sets of contacts 4 400V 20A shaft $\phi$ 6x4.6mm shaft L 21mm connection screw		

touch sensitive light switches

			
1			
<b>GEV No.</b>	401970	<b>Ref. No.</b>	0122170
<b>description</b>	light barrier 15/264V L 75mm W 25mm H 18mm		

			
1			
<b>GEV No.</b>	403109	<b>Ref. No.</b>	9612566+9616164
<b>description</b>	light barrier 15/264V L 75mm W 25mm H 18mm cable length 2000mm		

magnetic switches

29x19mm

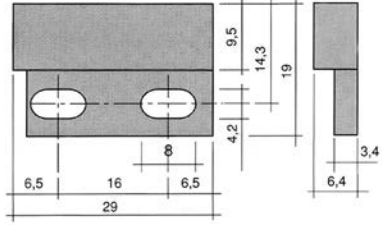
			
1			
			
<b>GEV No.</b>	347966	<b>Ref. No.</b>	9500385
<b>description</b>	magnetic switch L 29mm W 19mm 1CO 12V 0.05A P max. 0.6W connection cable cable length 5000mm		

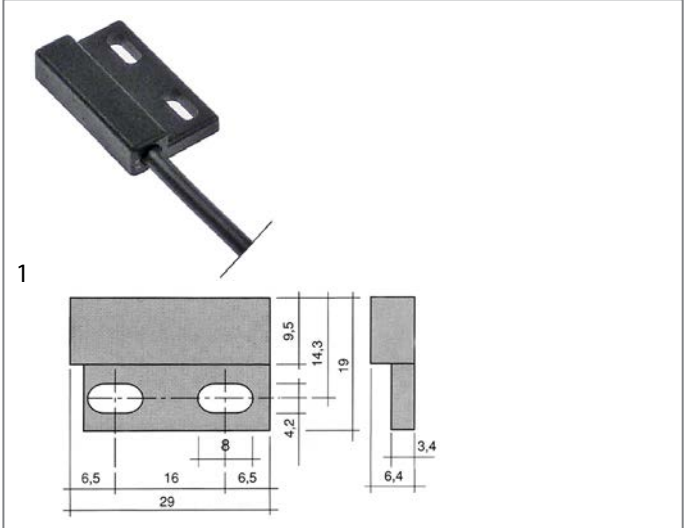

<b>GEV No.</b>	345808	<b>Ref. No.</b>	0122053
<b>description</b>	magnetic switch L 29mm W 19mm 1CO 150V 0.5A P max. 10W connection cable cable length 1000mm		

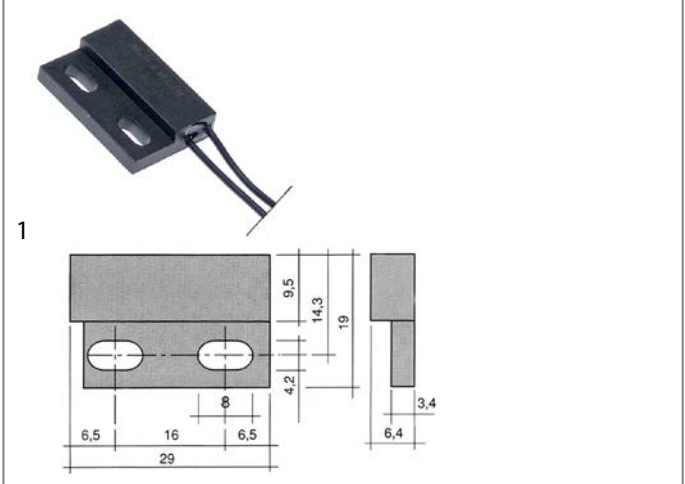

<b>GEV No.</b>	347960	<b>Ref. No.</b>	8302780
<b>description</b>	magnetic switch L 29mm W 19mm 1NO 12V 0.05A P max. 0.6W connection cable cable length 290mm		

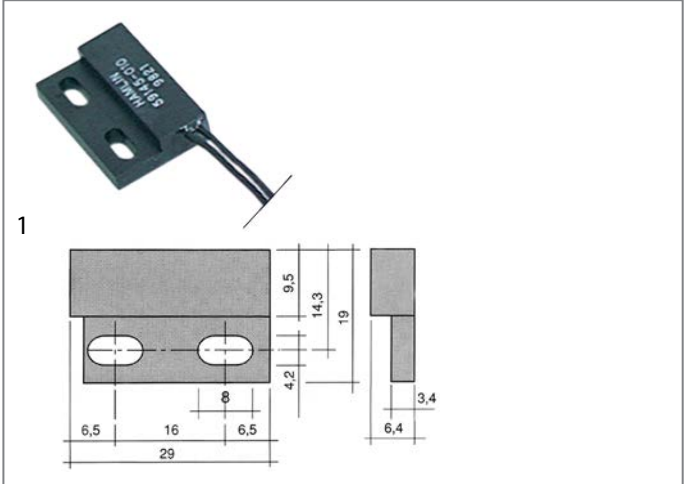

<b>GEV No.</b>	345248	<b>Ref. No.</b>	0122070
<b>description</b>	magnetic switch L 29mm W 19mm 1NO 24V 0.01A P max. 0.24W connection cable cable length 300mm		
<b>For models:</b>	DV120B, DV120T, DV160 AB 1996, DV240B AB 1996, DV270B AB 1992, DV40 AB 1992, DV40N, DV40T, DV40T FA, DV80 AB 1992, DV80T, ECO STAR 430F, ECO STAR 545D, FR30G AB 1992, FV110G, FV130B, FV20N, FV20T, FV250B AB 1992, FV25G AB 1992, FV28G AB 1994, FV28G AB 1997, FV28GFA, FV30GS, FV40.2, FV40.2 AB 2002, FV40.2MIKE2, FV40N AB 1992, FV40T, FV40TFA, FV60E AB 1988, FV70T, FV70TD		

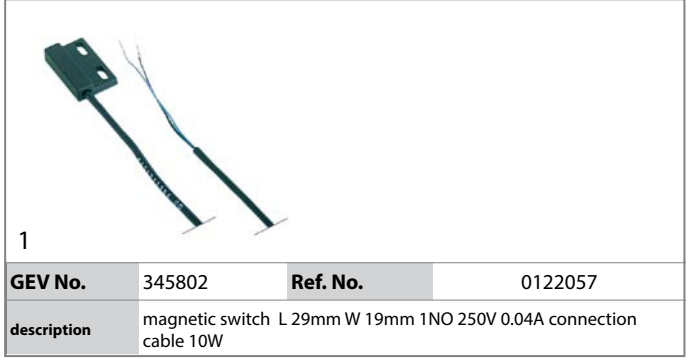

<b>GEV No.</b>	345802	<b>Ref. No.</b>	0122057
<b>description</b>	magnetic switch L 29mm W 19mm 1NO 250V 0.04A connection cable 10W		

46x26mm

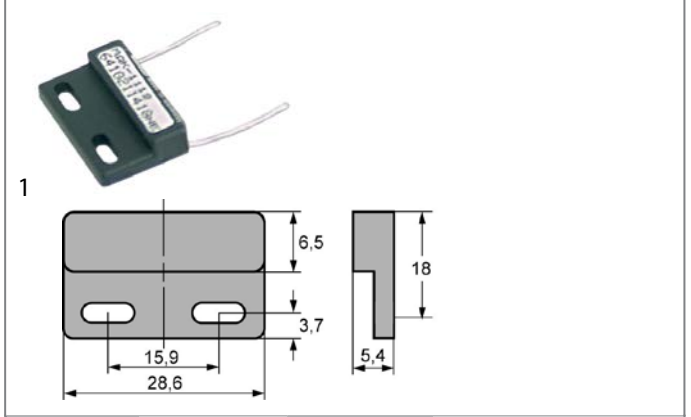

<b>GEV No.</b>	345807	<b>Ref. No.</b>	0122037
<b>description</b>	magnetic switch L 29mm W 18mm 24V		

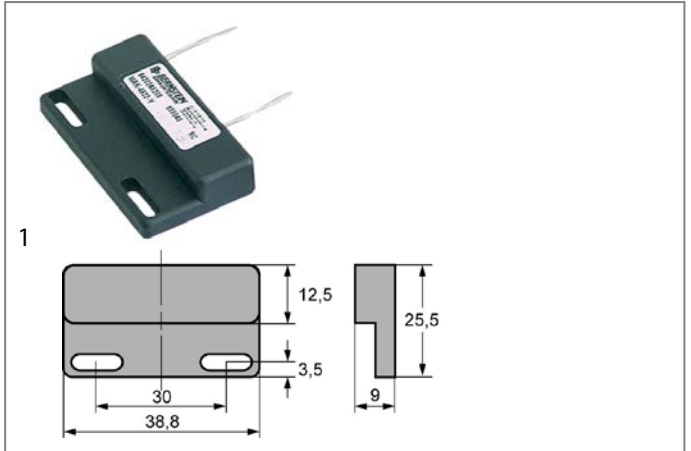

<b>GEV No.</b>	345804	<b>Ref. No.</b>	0122051
<b>description</b>	magnetic switch L 46mm W 26mm 1NO 24V 0.01A connection cable		





**80x20mm**

1

<b>GEV No.</b>	345803	<b>Ref. No.</b>	0122021
<b>description</b>	magnetic switch L 80mm W 20mm 1CO 250V 1A connection cable 80W		

2

<b>GEV No.</b>	345801	<b>Ref. No.</b>	0122024 0122056
<b>description</b>	magnetic switch L 80mm W 20mm 1NO 250V 3A P max. 100W connection cable cable length 5000mm		
<b>For models:</b>	DV270B AB 1988, FV250B AB 1988		

**80x30mm**

1

<b>GEV No.</b>	345806	<b>Ref. No.</b>	0122050
<b>description</b>	magnetic switch L 80mm W 30mm 1CO 250V 1A P max. 80W connection cable cable length 7500mm		

**ø 6mm**

1

<b>GEV No.</b>	347972	<b>Ref. No.</b>	9542983 MAK-3013-X-5
<b>description</b>	magnetic switch 100V 0.5A P max. 20W probe L 29mm 1CO connection cable cable length 5000mm		

**accessories**

**magnets**

1

<b>GEV No.</b>	347572	<b>Ref. No.</b>	9620695
<b>description</b>	magnet H 18mm ID ø 5.3mm ED ø 34mm plastic-coated		

1

<b>GEV No.</b>	365138	<b>Ref. No.</b>	0140206
<b>description</b>	magnet ID ø 5.3mm ED ø 31mm H 15mm		

1

<b>GEV No.</b>	699285	<b>Ref. No.</b>	0140200
<b>description</b>	magnet L 49mm H 8mm W 24mm		
<b>For models:</b>	FR40G AB 1976, FR40G AB 1980, FR40GUS AB 1976, FR40GUS AB 1980, FV240B AB 1980, FV250B AB 1992, FV30, FV50, FV50 M		

1

<b>GEV No.</b>	345486	<b>Ref. No.</b>	0122013
<b>description</b>	magnet ø 20mm Lmm H 6mm Wmm ID ø 3.25mm ED ø 20mm M3		
<b>For models:</b>	DV120T, DV40T, DV40T FA, DV80T, FV130B, FV20T, FV250B AB 1992, FV28GFA, FV40T, FV40TFA, FV70T, FV70TD		



## magnetic holders



1

<b>GEV No.</b>	699280	<b>Ref. No.</b>	0620420
<b>description</b>	magnet holder internal size 25x49mm H 11mm		

## control equipment

## SIEMENS

## 3SB series ø22mm old

## push buttons



1

<b>GEV No.</b>	345481	<b>Ref. No.</b>	0121033
<b>description</b>	push button mounting measurements ø22mm black		
<b>For models:</b>	FR30G, FR40G AB 1983, FR40GUS AB 1983, FV25G AB 1986, FV40N AB 1983		

## 3SB series ø22mm new

## push buttons



1

<b>GEV No.</b>	347570	<b>Ref. No.</b>	0150026 9604403
<b>description</b>	momentary push switch mounting measurements ø22mm white		



1

<b>GEV No.</b>	345671	<b>Ref. No.</b>	9555317
<b>description</b>	push button mounting measurements ø22mm black		



1

<b>GEV No.</b>	347569	<b>Ref. No.</b>	0121023 0121036
<b>description</b>	push button mounting measurements ø22mm EMERGENCY SHUT-DOWN red		
<b>accessories for</b>	347569		



<b>GEV No.</b>	347571	<b>Ref. No.</b>	0121037
<b>description</b>	sticker for emergency shut-down switch yellow ID ø 22.3mm ED ø 60mm		

## momentary mushroom switches



1

<b>GEV No.</b>	347478	<b>Ref. No.</b>	9604418
<b>description</b>	emergency stop switch mounting measurements ø22mm red series 3SB		

**accessories for** 347478

<b>GEV No.</b>	346630	<b>Ref. No.</b>	—
<b>description</b>	contact block SIEMENS 3SB3400-0B 1NO max 400V 10A black		



<b>GEV No.</b>	346631	<b>Ref. No.</b>	—
<b>description</b>	contact block SIEMENS 3SB3400-0C 1NC max 400V 10A black		

## accessories



1

<b>GEV No.</b>	347571	<b>Ref. No.</b>	0121037
<b>description</b>	sticker for emergency shut-down switch yellow ID ø 22.3mm ED ø 60mm		

**accessories for** 347571

<b>GEV No.</b>	347569	<b>Ref. No.</b>	0121023 0121036
<b>description</b>	push button mounting measurements ø22mm EMERGENCY SHUT-DOWN red		

## lamps

## indicator lights

## indicator lights 3-piece (housing, lens and bulb)

## lamps

## light bulbs



1

<b>GEV No.</b>	359656	<b>Ref. No.</b>	0150214
<b>description</b>	light bulb socket Ba9s 130V 2W ø 10mm L 28mm		



indicator lights (complete)			
ø13mm			
with plug-in socket			
			
1			
<b>GEV No.</b>	359141	<b>Ref. No.</b>	0150001
<b>description</b>	indicator light ø 13mm red 230V connection male faston 6.3mm temp.-resist. 120°C Qty 1 pcs		

			
1			
<b>GEV No.</b>	359143	<b>Ref. No.</b>	0150000
<b>description</b>	indicator light ø 13mm yellow 230V connection male faston 6.3mm temp.-resist. 120°C Qty 1 pcs		
<b>For models:</b>	DV100 AB 1980, DV100 AB 1983, DV120B, DV160 AB 1980, DV160 AB 1983, DV221, DV240B AB 1980, DV240B AB 1983, DV260B, DV270B AB 1988, DV40 AB 1983, DV80, DV80 AB 1980, DV80 AB 1983, DV80 AB 1992, FR30G, FR40G AB 1980, FR40G AB 1983, FR40GUS AB 1980, FR40GUS AB 1983, FV120B AB 1980, FV120B AB 1983, FV240B AB 1980, FV240B AB 1983, FV250B AB 1988, FV25G AB 1986, FV30, FV40N AB 1980, FV40N AB 1983, FV50, FV50 M, FV60E AB 1983		

screw-on/push-on fit

light bulbs			
for indicator lights			
			
1			
<b>GEV No.</b>	359656	<b>Ref. No.</b>	0150214
<b>description</b>	light bulb socket Ba9s 130V 2W ø 10mm L 28mm		

timers

programme timers

			
1			
<b>GEV No.</b>	360198	<b>Ref. No.</b>	0124036
<b>description</b>	timer chambers 3 operation time 162s		
<b>For models:</b>	DV40 AB 1983, FV40N AB 1980, FV40N AB 1983		

			
1			
<b>GEV No.</b>	360199	<b>Ref. No.</b>	0124040 0124090
<b>description</b>	timer chambers 3 operation time 85s		
<b>For models:</b>	DR70, DV100 AB 1980, DV160 AB 1980, DV160 AB 1983, DV80 AB 1975, DV80 AB 1980, DV80 AB 1983		

			
1			
<b>GEV No.</b>	360241	<b>Ref. No.</b>	0124045
<b>description</b>	timer chambers 4 operation time 8min		
<b>For models:</b>	DV260B, DV270B AB 1988, FV120B AB 1980, FV120B AB 1983, FV240B AB 1980, FV240B AB 1983, FV250B AB 1988		

			
1			
<b>GEV No.</b>	360240	<b>Ref. No.</b>	0124031
<b>description</b>	timer operation time 120s		
<b>For models:</b>	FR40G AB 1976, FR40G AB 1980, FR40G AB 1983, FR40GUS AB 1976, FR40GUS AB 1980, FR40GUS AB 1983		

			
1			
<b>GEV No.</b>	360064	<b>Ref. No.</b>	0124039
<b>description</b>	timer operation time 56s		
<b>For models:</b>	DV120B, DV240B AB 1980, DV240B AB 1983, DV80		

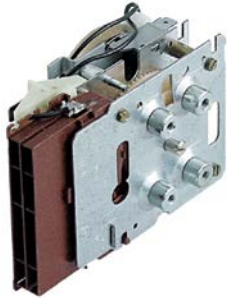
			
1			
<b>GEV No.</b>	360239	<b>Ref. No.</b>	0124080
<b>description</b>	timer run-time 120s		
<b>For models:</b>	FR30G, FV25G AB 1986		

			
1			
<b>GEV No.</b>	380224	<b>Ref. No.</b>	0135205 0135208 9518557 9518558 9520028 9520031
<b>description</b>	power contactor resistive load 25A 230VAC (AC3/400V) 17A/7.5kW main contacts 3NO auxiliary contacts 1NO connection screw connection type Fanal DSL16 10 type ISKRA KNL16 10		
<b>For models:</b>	DR70, DR90, DV111, DV111E, DV160 AB 1983, DV160 AB 1996, DV221, DV240B AB 1983, DV240B AB 1996, DV250B, DV260B, DV270B AB 1988, DV80 AB 1975, EE60, EE90, FR60, FV120B AB 1980, FV120B AB 1983, FV200B, FV240B AB 1980, FV240B AB 1983, FV250B AB 1988, FV30, FV50, FV50 M, FV60 AB 1973, FV60 AB 1976		

## contactors

### ISKRA (FANAL)

#### power contactors

			
1			
<b>GEV No.</b>	380212	<b>Ref. No.</b>	0135209
<b>description</b>	power contactor resistive load 20A 230VAC (AC3/400V) 8.5A/5.5kW main contacts 3NO auxiliary contacts 1NC connection screw connection type Fanal K07M 01 type ISKRA DSL7 01		
<b>For models:</b>	DV120B, DV120T, DV160 AB 1996, DV240B AB 1996, DV40 AB 1992, DV40N, DV40T, DV40T FA, DV80 AB 1983, DV80T, ECO STAR 430F, ECO STAR 545D, FR30G AB 1992, FV110G, FV130B, FV20N, FV20T, FV25G AB 1992, FV28GFA, FV30GS, FV40.2, FV40.2 AB 2003, FV40N AB 1992, FV40T, FV40TFA, FV60E AB 1988, FV70T, FV70TD		

			
1			
<b>GEV No.</b>	380203	<b>Ref. No.</b>	0135204 9520025
<b>description</b>	power contactor resistive load 25A 230VAC (AC3/400V) 9A/4kW main contacts 3NO auxiliary contacts 1NC connection screw connection type Fanal DSL9 01 type ISKRA KNL9 01 230V		
<b>For models:</b>	DV270B AB 1992, DV40T FA, ECO STAR 430F, ECO STAR 545D, FV250B AB 1992, FV28GFA, FV70TD		

			
1			
<b>GEV No.</b>	380219	<b>Ref. No.</b>	0135202 0135207 9520023 9520024
<b>description</b>	power contactor resistive load 25A 230VAC (AC3/400V) 17A/7.5kW main contacts 3NO auxiliary contacts 1NC connection screw connection type Fanal DSL16 01 type ISKRA KNL16 01		
<b>For models:</b>	DV120B, DV120T, DV160 AB 1983, DV160 AB 1996, DV240B AB 1983, DV240B AB 1996, DV270B AB 1988, DV40N, DV40T, DV40T FA, DV80 AB 1992, DV80T, ECO STAR 430F, ECO STAR 545D, FV120B AB 1983, FV130B, FV200B, FV240B AB 1983, FV250B AB 1988, FV28GFA, FV70TD		
<b>accessories for</b>	380219		
	<b>GEV No.</b>	381379	<b>Ref. No.</b> —
	overload switch connection screw setting range 11.3-16A for contactors KNL16 type BR16 11.3-16A		

			
1			
<b>GEV No.</b>	380204	<b>Ref. No.</b>	0135206 9518556 9520026
<b>description</b>	power contactor resistive load 25A 230VAC (AC3/400V) 9A/4kW main contacts 3NO auxiliary contacts 1NO connection screw connection type Fanal DSL9 10 type ISKRA KNL9 10		
<b>For models:</b>	DR90, DV111, DV111E, DV160 AB 1983, DV221, DV240B AB 1983, DV260B, DV270B AB 1992, EE60, EE90, FR60, FV120B AB 1983, FV240B AB 1983, FV250B AB 1992, FV50 M, FV60 AB 1973, FV60 AB 1976		

SIEMENS

power contactors



1

<b>GEV No.</b>	380389	<b>Ref. No.</b>	9521023
<b>description</b>	power contactor resistive load 22A 230VAC (AC3/400V) 9A/4kW main contacts 3NO auxiliary contacts 1NO connection screw connection type 3RT10-16-1AP01		



1

<b>GEV No.</b>	380880	<b>Ref. No.</b>	9542897
<b>description</b>	power contactor resistive load 40A 24VDC (AC3/400V) 9A/4kW main contacts 3NO auxiliary contacts connection screw connection type 3RT1023-1BB40 50Hz		

ABL SURSUM

motor protection circuit breakers



1

<b>GEV No.</b>	380303	<b>Ref. No.</b>	9540602
<b>description</b>	motor protection circuit breaker type Mbs25-063 setting range 4-6.3A (AC3/400V) 3kW		

TRIPUS (Eichhoff)

small relay switches

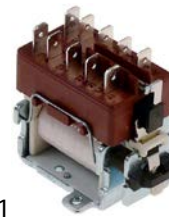

1

<b>GEV No.</b>	380119	<b>Ref. No.</b>	0135223 0135511 0135512
<b>description</b>	small relay switch 230V main contacts 2NO/2NC connection Faston 6.3mm resistive load 16A		
<b>For models:</b>	DR70, DV100 AB 1980, DV100 AB 1983, DV120B, DV160 AB 1980, DV160 AB 1996, DV240B AB 1980, DV240B AB 1996, DV80, DV80 AB 1975, DV80 AB 1980, DV80 AB 1983, FR30G, FR40G AB 1980, FR40G AB 1983, FR40GUS AB 1980, FR40GUS AB 1983, FV25G AB 1986, FV30, FV40N AB 1980, FV40N AB 1983, FV50, FV60E AB 1983		

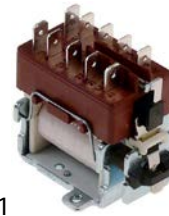

1

<b>GEV No.</b>	380121	<b>Ref. No.</b>	0135221
<b>description</b>	small relay switch 230V main contacts 3NO/1NC auxiliary contacts knob ø70mm (227-piece) connection Faston 6.3mm type E3250 resistive load 16A		
<b>For models:</b>	DV100 AB 1980, DV100 AB 1983, DV120B, DV160 AB 1980, DV240B AB 1980, DV80, DV80 AB 1980, DV80 AB 1983, FV40GE, FV60E AB 1983		

miscellaneous

RC circuits



1

<b>GEV No.</b>	381218	<b>Ref. No.</b>	0138214 0142006 0142010 9006825 9530873 9543320 9548739 9548957 9549559
<b>description</b>	RC circuit 275V cable length 200mm MKP class X2 voltage AC 100Ohm capacity 0.47µF		

power contactors



<b>GEV No.</b>	380635	<b>Ref. No.</b>	9540220
<b>description</b>	contactor 230V type B7-30-01		
<b>For models:</b>	FV40.2		



<b>GEV No.</b>	380280	<b>Ref. No.</b>	0125013 0125031 0125044 0125045
<b>description</b>	time relay WIELAND NGZ11 time range 1.5-30s 24-240V AC/DC 5A connection grip connection		

relays

time relays

time relays



<b>GEV No.</b>	381217	<b>Ref. No.</b>	0125004 0125041 0125111 9536506 9536544 9551647 9657575
<b>description</b>	time relay DOLD MK7850N.82/210/61 time range 0.02s-300h 12-240V AC/DC 5A mounting measurements 35mm multi-functional connection screw clamp ambient temperature max. 60°C with jumper wire X2-X3		

miscellaneous



<b>GEV No.</b>	381219	<b>Ref. No.</b>	9551020
<b>description</b>	power relays 1CO voltage AC/DC 1/3A connection screw clamp		

probes

universal probes

temperature probes



<b>GEV No.</b>	378275	<b>Ref. No.</b>	9660867
<b>description</b>	temperature probe PTC 1kOhm cable silicone probe -50 up to +150°C cable -50 up to +180°C probe ø6x50mm cable length 8.4m cable colours white/brown 2-wire		

producer-specific probes

probes



<b>GEV No.</b>	379696	<b>Ref. No.</b>	0180635
<b>description</b>	probe Pt1000 cable silicone probe -50 up to +250°C cable -50 up to +180°C connection 1-wire thread probe ø4.6x5mm cable length 8.5m		





<b>GEV No.</b>	379151	<b>Ref. No.</b>	0180681
<b>description</b>	temperature probe NTC 10kOhm cable PVC probe -40 up to +110°C cable -10 up to 100°C connection 2-wire thread probe ø4x30mm cable length 2m		





<b>GEV No.</b>	381199	<b>Ref. No.</b>	0125052
<b>description</b>	time relay WIELAND KZL91 time range 0.1s-120h 24-230V AC/DC 5A mounting measurements DIN railmm connection screw clamp		

			
1			
<b>GEV No.</b>	379551	<b>Ref. No.</b>	0180683
<b>description</b>	temperature probe NTC 2.2kOhm cable PVC probe -40 up to +110°C cable -10 up to 100°C connection 2-wire thread probe ø6x17mm cable length 3m		
<b>For models:</b>	DV40T FA, FV40TFA, FV70TD		

			
1			
<b>GEV No.</b>	378514	<b>Ref. No.</b>	9656863 9724904
<b>description</b>	temperature probe Pt1000 cable PTFE probe -50 up to +350°C cable -40 up to +250°C connection coded plug thread probe ø3x23mm cable length 0.4m		

			
1			
<b>GEV No.</b>	378512	<b>Ref. No.</b>	8303815
<b>description</b>	temperature probe Pt1000 cable PVC probe -50 up to +150°C cable -20 up to +80°C connection coded plug thread probe ø6x45mm cable length 0.75m		

			
1			
<b>GEV No.</b>	379822	<b>Ref. No.</b>	9640338
<b>description</b>	temperature probe Pt1000 cable PVC probe -50 up to +250°C cable -10 up to 100°C connection coded plug thread probe ø7x32mm cable length 0.5m		

			
1			
<b>GEV No.</b>	378513	<b>Ref. No.</b>	9656868 9697140
<b>description</b>	temperature probe Pt1000 cable PVC probe -50 up to +250°C cable -20 up to +80°C connection coded plug thread probe ø7x25mm cable length 0.5m		

			
1			
<b>GEV No.</b>	379152	<b>Ref. No.</b>	0180682
<b>description</b>	temperature probe PTC 1kOhm cable PVC probe -50 up to +150°C cable -10 up to 100°C connection 2-wire thread 1/4" probe ø6x35mm cable length 2.2m		
<b>For models:</b>	DV120T, DV40T, DV40T FA, DV80T, ECO STAR 545D, FV20T, FV28GFA, FV40T, FV40TFA, FV70T, FV70TD		

			
1			
<b>GEV No.</b>	379154	<b>Ref. No.</b>	0180684
<b>description</b>	temperature probe PTC 1kOhm cable PVC probe -50 up to +150°C cable -10 up to 100°C connection wire end ferrules thread probe ø4.5x5mm cable length 1.5m		

			
1			
<b>GEV No.</b>	379153	<b>Ref. No.</b>	9500236
<b>description</b>	temperature probe PTC 1kOhm cable silicone probe -50 up to +150°C cable -50 up to +180°C connection 2-wire thread probe ø6x35mm cable length 2.2m		
<b>For models:</b>	DV120T, DV40T, DV40T FA, DV80T, ECO STAR 545D, FV20T, FV28GFA, FV40T, FV40TFA, FV70T		

			
1			
<b>GEV No.</b>	378353	<b>Ref. No.</b>	8303881
<b>description</b>	temperature probe PTC 1kOhm cable silicone probe -50 up to +150°C cable -50 up to +180°C connection coded plug thread probe ø6x50mm cable length 1.7m		

			
1			
<b>GEV No.</b>	379795	<b>Ref. No.</b>	9548993 9614610 9614768 9640339 9642324
<b>description</b>	temperature probe PTC 1kOhm cable silicone probe -50 up to +150°C cable -50 up to +180°C connection coded plug thread probe ø7x32mm cable length 0.5m		
<b>For models:</b>	FV40.2MIKE2, FV40.2M-MIKE2		

			
1			
<b>GEV No.</b>	378356	<b>Ref. No.</b>	9605615
<b>description</b>	temperature probe PTC cable silicone probe -50 up to +150°C cable -50 up to +180°C connection coded plug thread probe ø3.5x13mm cable length 0.4m		
<b>For models:</b>	FV40.2M-MIKE2		

			
1			
<b>GEV No.</b>	379150	<b>Ref. No.</b>	0180680
<b>description</b>	temperature probe thermocouple K (NiCr-Ni) cable silicone probe -50 up to 1150°C cable -50 up to +180°C connection 2-wire thread probe ø4x50mm cable length 1.7m		

			
1			
<b>GEV No.</b>	378276	<b>Ref. No.</b>	9544007 9545533 9649173
<b>description</b>	upgrade kit PTC 1kOhm cable silicone probe -50 up to +150°C cable -50 up to +180°C connection 2-wire thread probe ø7x32mm cable length 0.5m		
<b>For models:</b>	FV40.2MIKE2, FV40.2M-MIKE2		



# electronics

## EPROMS

electric components



1

<b>GEV No.</b>	403785	<b>Ref. No.</b>	9537736 9615751
<b>description</b>	EEPROM type Mike2-EE1		



1

<b>GEV No.</b>	400243	<b>Ref. No.</b>	0124205
<b>description</b>	EPROM		
<b>For models:</b>	DV40 AB 1992, DV80 AB 1992, FR30G AB 1992, FV20N, FV25G AB 1992, FV30GS, FV40N AB 1992		



1

<b>GEV No.</b>	400720	<b>Ref. No.</b>	0124201
<b>description</b>	EPROM		
<b>For models:</b>	DV120B, FV20T, FV40T, FV60E AB 1988, FV70T		

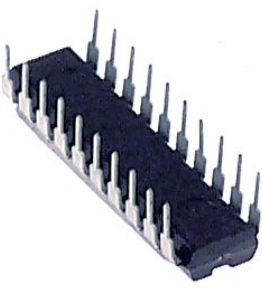

1

<b>GEV No.</b>	400722	<b>Ref. No.</b>	0124225
<b>description</b>	EPROM		
<b>For models:</b>	DV40N, FV20N, FV40T		

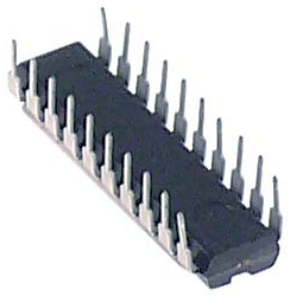

1

<b>GEV No.</b>	400723	<b>Ref. No.</b>	0124231
<b>description</b>	EPROM		
<b>For models:</b>	FV20N, FV20T, FV70T		



1

<b>GEV No.</b>	400822	<b>Ref. No.</b>	0124124
<b>description</b>	EPROM		
<b>For models:</b>	DV120T, DV40T, DV40T FA, DV80T, FV20T, FV28GFA, FV40T, FV40TFA, FV70T, FV70TD		

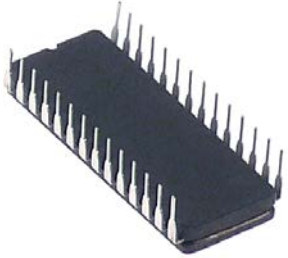

1

<b>GEV No.</b>	400824	<b>Ref. No.</b>	0124352
<b>description</b>	EPROM		
<b>For models:</b>	DV120T, DV40T, DV40T FA, DV80T, FV20T, FV28GFA, FV40T, FV40TFA, FV70T, FV70TD		



1

<b>GEV No.</b>	400826	<b>Ref. No.</b>	0124203
<b>description</b>	EPROM		

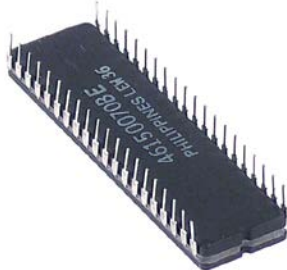

1

<b>GEV No.</b>	400827	<b>Ref. No.</b>	0124210
<b>description</b>	EPROM		
<b>For models:</b>	DV160 AB 1996, DV240B AB 1996, DV270B AB 1992, FV110G, FV130B, FV250B AB 1992		

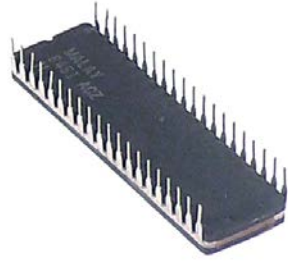

1

<b>GEV No.</b>	400831	<b>Ref. No.</b>	0124229
<b>description</b>	EPROM		
<b>For models:</b>	DV160 AB 1996, DV240B AB 1996, DV270B AB 1992, FV110G, FV130B, FV250B AB 1992, FV40T		

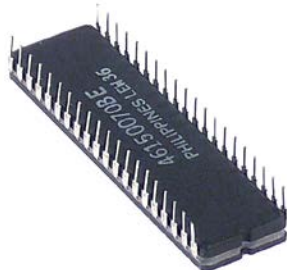

1

<b>GEV No.</b>	400828	<b>Ref. No.</b>	0124214
<b>description</b>	EPROM		
<b>For models:</b>	DV160 AB 1996, DV240B AB 1996, DV270B AB 1992, FV110G, FV130B, FV250B AB 1992		

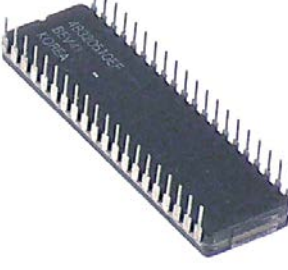

1

<b>GEV No.</b>	400832	<b>Ref. No.</b>	0124230
<b>description</b>	EPROM		
<b>For models:</b>	DV160 AB 1996, DV240B AB 1996, DV270B AB 1992, FV110G, FV130B, FV20T, FV250B AB 1992		

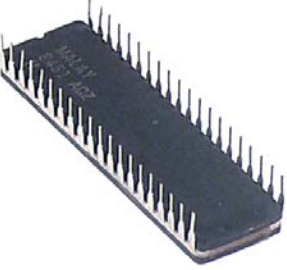

1

<b>GEV No.</b>	400829	<b>Ref. No.</b>	0124227
<b>description</b>	EPROM		
<b>For models:</b>	DV160 AB 1996, DV240B AB 1996, DV270B AB 1992, FV110G, FV130B, FV20T, FV250B AB 1992, FV40T, FV70T		

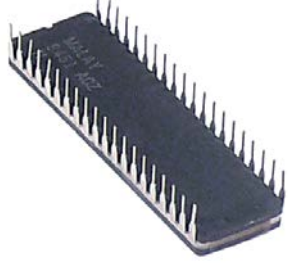

1

<b>GEV No.</b>	400833	<b>Ref. No.</b>	0124243
<b>description</b>	EPROM		
<b>For models:</b>	DV160 AB 1996, DV240B AB 1996, DV270B AB 1992, FV110G, FV130B, FV250B AB 1992		

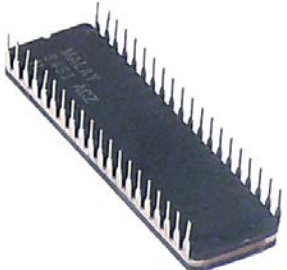

1

<b>GEV No.</b>	400830	<b>Ref. No.</b>	0124228
<b>description</b>	EPROM		
<b>For models:</b>	DV160 AB 1996, DV240B AB 1996, DV270B AB 1992, FV110G, FV130B, FV250B AB 1992, FV70T		



1

<b>GEV No.</b>	400834	<b>Ref. No.</b>	0124236
<b>description</b>	EPROM		
<b>For models:</b>	DV160 AB 1996, DV240B AB 1996, DV270B AB 1992, FV110G, FV130B, FV250B AB 1992		



1

<b>GEV No.</b>	400836	<b>Ref. No.</b>	0124237
<b>description</b>	EPROM		
<b>For models:</b>	DV160 AB 1996, DV240B AB 1996, DV270B AB 1992, FV110G, FV130B, FV250B AB 1992		

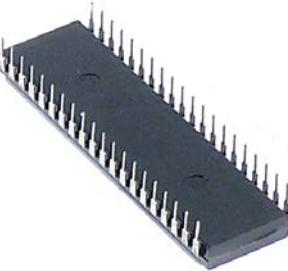

1

<b>GEV No.</b>	400837	<b>Ref. No.</b>	0124245
<b>description</b>	EPROM		
<b>For models:</b>	DV160 AB 1996, DV240B AB 1996, DV270B AB 1992, FV110G, FV130B, FV250B AB 1992		



1

<b>GEV No.</b>	400838	<b>Ref. No.</b>	0124223
<b>description</b>	EPROM		
<b>For models:</b>	DV160 AB 1996, DV240B AB 1996, DV270B AB 1992, DV40N, FV110G, FV130B, FV250B AB 1992		



1

<b>GEV No.</b>	400840	<b>Ref. No.</b>	0124246
<b>description</b>	EPROM		
<b>For models:</b>	FV28G AB 1994, FV28G AB 1997		

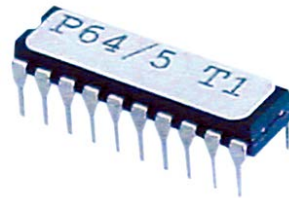

1

<b>GEV No.</b>	400847	<b>Ref. No.</b>	9505865
<b>description</b>	EPROM		
<b>For models:</b>	ECO STAR 430F		

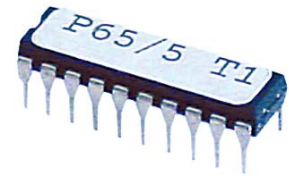

1

<b>GEV No.</b>	400848	<b>Ref. No.</b>	9505866
<b>description</b>	EPROM		
<b>For models:</b>	ECO STAR 430F		



1

<b>GEV No.</b>	400835	<b>Ref. No.</b>	0124239
<b>description</b>	EPROM CODE P59/5		
<b>For models:</b>	DV120B, DV160 AB 1996, DV240B AB 1996, DV270B AB 1992, DV40N, FV110G, FV130B, FV250B AB 1992		



1

<b>GEV No.</b>	400839	<b>Ref. No.</b>	0124222
<b>description</b>	EPROM CODE SPÜLS/4EW		
<b>For models:</b>	DV120T, DV40N, DV40T, DV80T		

1

<b>GEV No.</b>	403786	<b>Ref. No.</b>	9621015
<b>description</b>	EPROM type ECOSTAR GK V2.2B		



1

<b>GEV No.</b>	400825	<b>Ref. No.</b>	0124123 9534803
<b>description</b>	EPROM type M1-6-EE CODE 9534803		
<b>For models:</b>	DV120T, DV40T, DV40T FA, DV80T, ECO STAR 545D, FV20T, FV28GFA, FV40.2, FV40.2 AB 2003, FV40T, FV40TFA, FV70T, FV70TD		



1

<b>GEV No.</b>	401706	<b>Ref. No.</b>	9520591
<b>description</b>	EPROM type M1-6-FA2		
<b>For models:</b>	FV40.2		



1

<b>GEV No.</b>	400823	<b>Ref. No.</b>	0124351
<b>description</b>	EPROM type MSPL6-P-STD CODE 124351		
<b>For models:</b>	DV120T, DV40T, DV40T FA, DV80T, ECO STAR 545D, FV20T, FV28GFA, FV40T, FV40TFA, FV70T, FV70TD		



1

<b>GEV No.</b>	402112	<b>Ref. No.</b>	01241198
<b>description</b>	EPROM type P3/5		

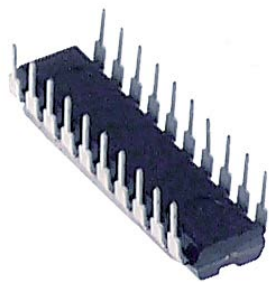

1

<b>GEV No.</b>	401707	<b>Ref. No.</b>	9511252
<b>description</b>	EPROM type SPÜL3 P67/5		

rectifiers



1

<b>GEV No.</b>	400851	<b>Ref. No.</b>	0140070
<b>description</b>	rectifier 420V 10A		

PCBs



1

<b>GEV No.</b>	400220	<b>Ref. No.</b>	0124185 0124187
<b>description</b>	control PCB		
<b>For models:</b>	DV40 AB 1992, DV40N, DV80 AB 1992, ECO STAR 430F, FV20N, FV20T, FV25G AB 1992, FV30GS, FV40N AB 1992, FV40T		

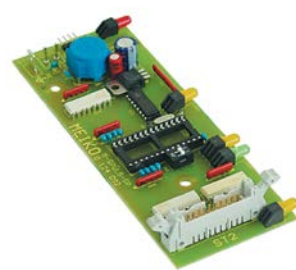

1

<b>GEV No.</b>	400811	<b>Ref. No.</b>	0124092
<b>description</b>	control PCB		
<b>For models:</b>	FV28G AB 1994, FV28G AB 1997		



1			
<b>GEV No.</b>	400221	<b>Ref. No.</b>	0124190
<b>description</b>	control PCB dishwasher DV40, DV80, DV120B		
<b>For models:</b>	DV120T, DV160 AB 1996, DV240B AB 1996, DV270B AB 1992, DV40N, DV40T, DV80T, FV110G, FV130B, FV20T, FV250B AB 1992, FV40T, FV70T		



1			
<b>GEV No.</b>	400211	<b>Ref. No.</b>	0124196
<b>description</b>	display PCB dishwasher DV40, DV80, DV120B		
<b>For models:</b>	DV120B, DV120T, DV160 AB 1996, DV240B AB 1996, DV270B AB 1992, DV40N, DV40T, DV80T, FV110G, FV130B, FV20T, FV250B AB 1992, FV40T, FV60E AB 1988, FV70T		



1			
<b>GEV No.</b>	400959	<b>Ref. No.</b>	0124091 9500250
<b>description</b>	control PCB dishwasher FV28G, ECOstar 430F 230V		
<b>For models:</b>	FV28G AB 1994, FV28G AB 1997		



1			
<b>GEV No.</b>	400799	<b>Ref. No.</b>	9532115
<b>description</b>	display PCB dishwasher ECO STAR		
<b>For models:</b>	ECO STAR 545D, FV130B, FV40.2		



1			
<b>GEV No.</b>	400960	<b>Ref. No.</b>	9500251
<b>description</b>	control PCB for dosing pump 230V 230V		
<b>For models:</b>	FV28G AB 1997		



1			
<b>GEV No.</b>	403114	<b>Ref. No.</b>	9617233
<b>description</b>	display PCB for dishwasher L 141mm W 55mm cable length 140mm with housing		

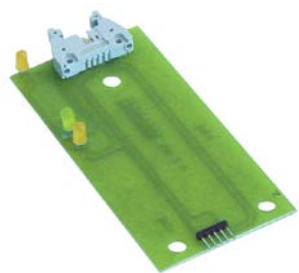

1			
<b>GEV No.</b>	400210	<b>Ref. No.</b>	0124186
<b>description</b>	display PCB		
<b>For models:</b>	DV40 AB 1992, DV40N, DV80 AB 1992, FR30G AB 1992, FV20N, FV20T, FV25G AB 1992, FV30GS, FV40N AB 1992, FV40T, FV70T		



1			
<b>GEV No.</b>	403115	<b>Ref. No.</b>	9542049
<b>description</b>	display PCB for dishwasher L 141mm W 55mm cable length 140mm with housing		
<b>For models:</b>	FV40.2MIKE2, FV40.2M-MIKE2		

1

<b>GEV No.</b>	403014	<b>Ref. No.</b>	9533502 9626264 9643652
<b>description</b>	net board dishwasher FV40.2/EcoStar530F L 81mm W 80mm 80W type MIKE-NET1		
<b>For models:</b>	FV40.2MIKE2, FV40.2M-MIKE2		



1

<b>GEV No.</b>	361273	<b>Ref. No.</b>	0124056 0124057
<b>description</b>	PCB		
<b>For models:</b>	DV100 AB 1980, DV120B, DV160 AB 1980, DV240B AB 1980, DV80, DV80 AB 1980, FR40G AB 1980, FR40GUS AB 1980, FV120B AB 1980, FV240B AB 1980, FV40N AB 1980		



1

<b>GEV No.</b>	400812	<b>Ref. No.</b>	0124120
<b>description</b>	PCB		
<b>For models:</b>	DV120T, DV40T, DV40T FA, DV80T, FV20T, FV28GFA, FV40.2, FV40.2 AB 2003, FV40T, FV40TFA, FV70T, FV70TD		



1

<b>GEV No.</b>	400813	<b>Ref. No.</b>	0124093
<b>description</b>	PCB		
<b>For models:</b>	FV28G AB 1994		



1

<b>GEV No.</b>	400821	<b>Ref. No.</b>	0124121 0124122 9519719
<b>description</b>	PCB		
<b>For models:</b>	DV120T, DV40T, DV40T FA, DV80T, ECO STAR 545D, FV20T, FV28GFA, FV40.2, FV40.2 AB 2003, FV40T, FV40TFA, FV70T, FV70TD		
<b>accessories for</b>	400821		
	<b>GEV No.</b>	<b>Ref. No.</b>	0124124
	EPROM		
	<b>GEV No.</b>	<b>Ref. No.</b>	0124351
	EPROM type MSPL6-P-STD CODE 124351		
	<b>GEV No.</b>	<b>Ref. No.</b>	0124352
	EPROM		



1

<b>GEV No.</b>	401710	<b>Ref. No.</b>	9520149
<b>description</b>	PCB		
<b>For models:</b>	FV40.2		



1

<b>GEV No.</b>	403228	<b>Ref. No.</b>	9533501 9617235 9645493 9678638 9735526
<b>description</b>	PCB dishwasher FV40.2/EcoStar530F L 150mm W 75mm type MIKE2-E/A1		
<b>For models:</b>	FV40.2M-MIKE2		

1

<b>GEV No.</b>	403227	<b>Ref. No.</b>	9533503 9541525 9608942
<b>description</b>	PCB dishwasher L 210mm W 55mm with housing type MIKE2-CPU1		
<b>For models:</b>	FV40.2MIKE2, FV40.2M-MIKE2		

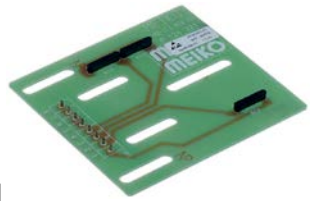

1

<b>GEV No.</b>	402944	<b>Ref. No.</b>	0124323 M2-III-CE3 NIV2 A
<b>description</b>	PCB dishwasher M2-III-CE3 NIV2 A L 97mm W 89mm level control		

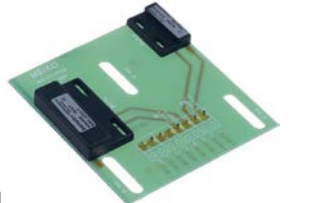

1

<b>GEV No.</b>	402921	<b>Ref. No.</b>	0124287 M2-III-NIV A
<b>description</b>	PCB for dishwasher type M2-III-NIV A		



1

<b>GEV No.</b>	400047	<b>Ref. No.</b>	0125035
<b>description</b>	PCB time delay 6-39s		
<b>For models:</b>	DV120B, DV240B AB 1980, DV240B AB 1983, DV80		



1

<b>GEV No.</b>	401571	<b>Ref. No.</b>	9552914
<b>description</b>	power PCB		

central units



1

<b>GEV No.</b>	400721	<b>Ref. No.</b>	0124217
<b>description</b>	PCB		
<b>For models:</b>	FV28G AB 1994, FV28G AB 1997		

keypads



1

<b>GEV No.</b>	402958	<b>Ref. No.</b>	9537365
<b>description</b>	keypad foil dishwasher FV130.2/250.2 DV270.2 suitable for MEIKO L 335mm W 60mm buttons 5		

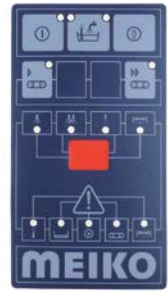

1

<b>GEV No.</b>	504366	<b>Ref. No.</b>	0467230
<b>description</b>	keypad foil for dishwasher with cable grey suitable for MEIKO L 217mm W 120mm buttons 14		



1

<b>GEV No.</b>	403229	<b>Ref. No.</b>	9542137
<b>description</b>	membrane keypad dishwasher FV46 suitable for MEIKO L 560mm W 54mm buttons 5 Qty 1 pcs		
<b>For models:</b>	FV40.2MIKE2, FV40.2M-MIKE2		

membrane keypads





1

<b>GEV No.</b>	403620	<b>Ref. No.</b>	0467226
<b>description</b>	keypad foil disinfection device TOPIC L 71mm W 52mm		

			
1			
<b>GEV No.</b>	400726	<b>Ref. No.</b>	0467225
<b>description</b>	membrane keypad		

			
1			
<b>GEV No.</b>	400727	<b>Ref. No.</b>	0467212
<b>description</b>	membrane keypad		

			
1			
<b>GEV No.</b>	400728	<b>Ref. No.</b>	0467220
<b>description</b>	membrane keypad		

			
1			
<b>GEV No.</b>	400729	<b>Ref. No.</b>	0467328
<b>description</b>	membrane keypad		
<b>For models:</b>	DV120T, DV40T, DV40T FA, DV80T, FV20T, FV28GFA, FV40T, FV40TFA, FV70T, FV70TD		

			
1			
<b>GEV No.</b>	400819	<b>Ref. No.</b>	0467208
<b>description</b>	membrane keypad		
<b>For models:</b>	FV28G AB 1994, FV28G AB 1997		

			
1			
<b>GEV No.</b>	400820	<b>Ref. No.</b>	0467207 9603662
<b>description</b>	membrane keypad		
<b>For models:</b>	FV28G AB 1994, FV28G AB 1997		

			
1			
<b>GEV No.</b>	400843	<b>Ref. No.</b>	9503065
<b>description</b>	membrane keypad 1. generation suitable for ECOSTAR 530F L 540mm W 50mm		
<b>For models:</b>	ECO STAR 430F		

			
1			
<b>GEV No.</b>	402896	<b>Ref. No.</b>	9542136
<b>description</b>	membrane keypad dishwasher buttons 7 suitable for MEIKO L 562mm W 54mm		
<b>For models:</b>	FV40.2MIKE2, FV40.2M-MIKE2		

			
1			
<b>GEV No.</b>	400195	<b>Ref. No.</b>	0467221
<b>description</b>	membrane keypad dishwasher DV40, DV80		
<b>For models:</b>	DV40 AB 1992, DV40N, DV80 AB 1992, FR30G AB 1992, FV20N, FV20T, FV25G AB 1992, FV30GS, FV40N AB 1992, FV40T, FV70T		

			
1			
<b>GEV No.</b>	403787	<b>Ref. No.</b>	9542078
<b>description</b>	membrane keypad dishwasher DV80.2 L 560mm W 53mm		

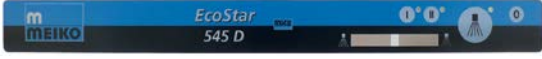
			
1			
<b>GEV No.</b>	403788	<b>Ref. No.</b>	9656782
<b>description</b>	membrane keypad dishwasher ECO545 / ECOStar545 L 560mm W 53mm		

			
1			
<b>GEV No.</b>	403617	<b>Ref. No.</b>	0467228
<b>description</b>	membrane keypad disinfection device KD10-40 buttons 2 suitable for MEIKO L 215mm W 71mm		

			
1			
<b>GEV No.</b>	403616	<b>Ref. No.</b>	0467227
<b>description</b>	membrane keypad disinfection device KD10-40 buttons 3 suitable for MEIKO L 215mm W 71mm		

			
1			
<b>GEV No.</b>	504367	<b>Ref. No.</b>	9537572
<b>description</b>	membrane keypad for dishwasher with cable buttons 1 suitable for MEIKO L 60mm W 30mm		

			
1			
<b>GEV No.</b>	400725	<b>Ref. No.</b>	0467222
<b>description</b>	membrane keypad warewashing		

			
1			
<b>GEV No.</b>	400196	<b>Ref. No.</b>	0467210
<b>description</b>	membrane keypad warewashing DV120		
<b>For models:</b>	DV120B, DV120T, DV270B AB 1988, DV40N, DV40T, DV40T FA, DV80T, FV20T, FV250B AB 1988, FV28GFA, FV40T, FV40TFA, FV60E AB 1988, FV70T, FV70TD		



solenoid valves

solenoid valves (water)

ELBI

straight



<b>GEV No.</b>	373018	<b>Ref. No.</b>	9505869
<b>description</b>	solenoid valve single straight 230VAC inlet 3/4" outlet 14mm DN10 ELBI		
<b>spare parts for</b>	373018		
	<b>GEV No.</b>	370467	<b>Ref. No.</b> 9506228
	solenoid valve filter suitable for ELBI		

MÜLLER

medium temperature: 90°C  
duty cycle: 100%











	<b>GEV No.</b>	370001	<b>Ref. No.</b>	0113001 0113200
<b>description</b>	solenoid valve single angled 230VAC inlet 3/4" outlet 14.5mm DN10 t.max. 90°C duty cycle 100% MÜLLER			
<b>For models:</b>	DV100 AB 1980, DV100 AB 1983, DV120B, DV160 AB 1980, DV221, DV240B AB 1980, DV40 AB 1983, DV40 AB 1992, DV80, DV80 AB 1975, DV80 AB 1980, DV80 AB 1983, DV80 AB 1992, FR30G, FR30G AB 1992, FR40G AB 1976, FR40G AB 1980, FR40G AB 1983, FR40GUS AB 1976, FR40GUS AB 1980, FR40GUS AB 1983, FR60, FV120B AB 1980, FV130B, FV240B AB 1980, FV25G AB 1986, FV25G AB 1992, FV28G AB 1994, FV28G AB 1997, FV30, FV30GS, FV40GE, FV40N AB 1980, FV40N AB 1983, FV40N AB 1992, FV50, FV50 M, FV60 AB 1976, FV60E AB 1983, FV60E AB 1988			
<b>spare parts for</b>	370001			
	<b>GEV No.</b>	370126	<b>Ref. No.</b>	9500402
	solenoid valve body single angled inlet 3/4" outlet 14.5mm DN10 t.max. 90°C duty cycle 100% MÜLLER plastic			
	<b>GEV No.</b>	371002	<b>Ref. No.</b>	—
	solenoid valve holder MÜLLER flange support			
	<b>GEV No.</b>	371009	<b>Ref. No.</b>	0113224
	compression spring for solenoid coil			
	<b>GEV No.</b>	371011	<b>Ref. No.</b>	—
	spare parts kit membrane with long star star hight 8mm MÜLLER			
	<b>GEV No.</b>	371017	<b>Ref. No.</b>	0113223
	solenoid coil MÜLLER 230VAC connection male faston 6.3mm			
	<b>GEV No.</b>	371122	<b>Ref. No.</b>	0113098
	solenoid valve filter ø 19mm H 10mm suitable for MÜLLER			

Table continues overleaf

	<b>GEV No.</b>	400197	<b>Ref. No.</b>	0467249
<b>description</b>	membrane keypad warewashing DV120			
<b>For models:</b>	DV120T, DV160 AB 1996, DV240B AB 1996, DV270B AB 1992, DV40T, DV40T FA, DV80T, FV110G, FV130B, FV20T, FV250B AB 1992, FV28GFA, FV40T, FV40TFA, FV70T, FV70TD			

	<b>GEV No.</b>	400724	<b>Ref. No.</b>	0467211
<b>description</b>	membrane keypad warewashing DV120T			
<b>For models:</b>	DV120T, DV40T, DV40T FA, DV80T, FV20T, FV28GFA, FV40T, FV40TFA, FV70T, FV70TD			





	<b>GEV No.</b>	400842	<b>Ref. No.</b>	9503064
<b>description</b>	membrane keypad warewashing ECO STAR 430 L 430mm W 46mm			
<b>For models:</b>	ECO STAR 430F			

	<b>GEV No.</b>	403618	<b>Ref. No.</b>	0467258
<b>description</b>	membrane keypad warewashing suitable for MEIKO L 198mm W 52mm			

	<b>GEV No.</b>	403619	<b>Ref. No.</b>	9639828
<b>description</b>	membrane keypad warewashing TOPIC suitable for MEIKO L 185mm W 155mm			











<b>spare parts for</b> 370001			
	<b>GEV No.</b> 501161	<b>Ref. No.</b>	0113207
tap head for solenoid valve holder for solenoid coils			
<b>accessories for</b> 370001			
	<b>GEV No.</b> 371010	<b>Ref. No.</b>	—
solenoid coil 230VAC connection with cable cable length 2000mm			
	<b>GEV No.</b> 371037	<b>Ref. No.</b>	0113128
solenoid coil 24VAC 50/60Hz connection male faston 6.3mm			
	<b>GEV No.</b> 371038	<b>Ref. No.</b>	0113256
solenoid coil 230VAC connection appliance plug			

spare parts and accessories

valve bodies

			
1			
<b>GEV No.</b>	374024	<b>Ref. No.</b>	0113127
<b>description</b>	solenoid valve body double straight inlet 3/4" outlet 14.5mm DN10 t.max. 90°C duty cycle 100%		
<b>accessories for</b> 374024			
	<b>GEV No.</b> 371037	<b>Ref. No.</b>	0113128
solenoid coil 24VAC 50/60Hz connection male faston 6.3mm			

			
1			
<b>GEV No.</b>	370129	<b>Ref. No.</b>	0113215
<b>description</b>	solenoid valve body double straight inlet 3/4" outlet 14.5mm DN10 t.max. 90°C duty cycle 100% MÜLLER 230V		

			
1			
<b>GEV No.</b>	370667	<b>Ref. No.</b>	0113220
<b>description</b>	solenoid valve body single straight inlet 3/4" outlet 3/4" DN10 t.max. 90°C duty cycle 100% plastic		
<b>accessories for</b> 370667			
	<b>GEV No.</b> 371009	<b>Ref. No.</b>	0113224
compression spring for solenoid coil			
	<b>GEV No.</b> 371017	<b>Ref. No.</b>	0113223
solenoid coil MÜLLER 230VAC connection male faston 6.3mm			

			
1			
<b>GEV No.</b>	370179	<b>Ref. No.</b>	0113222
<b>description</b>	solenoid valve body single straight inlet 3/4" outlet 3/4" DN17 t.max. 90°C duty cycle 100% MÜLLER 230V L 98mm		
<b>For models:</b>	DV160 AB 1983, DV160 AB 1996, DV240B AB 1983, DV240B AB 1996, DV260B, DV270B AB 1988, DV270B AB 1992, FV120B AB 1983, FV240B AB 1983, FV250B AB 1988, FV250B AB 1992		

			
1			
<b>GEV No.</b>	370131	<b>Ref. No.</b>	0113261
<b>description</b>	solenoid valve body triple straight inlet 3/4" outlet 14.5mm DN10 t.max. 90°C duty cycle 100% MÜLLER 230V		

			
1			
<b>GEV No.</b>	370812 <sup>1</sup>	<b>Ref. No.</b>	9519103
<b>description</b>	solenoid valve body double angled 90° inlet 3/4" outlet 20mm input/min output/min DN13 MÜLLER plasticV voltage		

<sup>1</sup>pressure max 0.2-3 bar

			
1			
<b>GEV No.</b>	370128	<b>Ref. No.</b>	0113125 0113210
<b>description</b>	solenoid valve body double angled inlet 3/4" outlet 14.5mm DN10 t.max. 90°C duty cycle 100% MÜLLER 230V double-ways		



			
1			
<b>GEV No.</b>	370126	<b>Ref. No.</b>	9500402
<b>description</b>	solenoid valve body single angled inlet 3/4" outlet 14.5mm DN10 t.max. 90°C duty cycle 100% MÜLLER plastic		

			
1			
<b>GEV No.</b>	370813 <sup>1</sup>	<b>Ref. No.</b>	9518635 MEI9518635
<b>description</b>	solenoid valve body single angled inlet 3/4" outlet 20mm DN13 t.max. 90°C duty cycle 100% MÜLLER plastic		

<sup>1</sup>pressure max 0.2-3 bar

			
1			
<b>GEV No.</b>	370130	<b>Ref. No.</b>	0113260
<b>description</b>	solenoid valve body triple angled inlet 3/4" outlet 14.5mm DN10 t.max. 90°C duty cycle 100% MÜLLER 230V triple-ways		

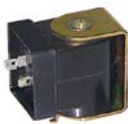
solenoid coils

			
1			
<b>GEV No.</b>	371038	<b>Ref. No.</b>	0113256
<b>description</b>	solenoid coil 230VAC connection appliance plug		
<b>For models:</b>	FV240B AB 1983		
<b>accessories for</b>	371038		
	<b>GEV No.</b>	371090	<b>Ref. No.</b> —
	power socket plug type DIN 43650A screw		

			
1			
<b>GEV No.</b>	371037	<b>Ref. No.</b>	0113128
<b>description</b>	solenoid coil 24VAC 50/60Hz connection male faston 6.3mm		

			
1			
<b>GEV No.</b>	370814	<b>Ref. No.</b>	9552884 9705364
<b>description</b>	solenoid coil 24VDC pressure range 0.3-10bar coil type 8466 connection F6.3		

			
1			
<b>GEV No.</b>	371017	<b>Ref. No.</b>	0113223
<b>description</b>	solenoid coil MÜLLER 230VAC connection male faston 6.3mm		
<b>For models:</b>	DV100 AB 1983, DV120B, DV120T, DV160 AB 1983, DV160 AB 1996, DV240B AB 1983, DV240B AB 1996, DV260B, DV270B AB 1988, DV270B AB 1992, DV40 AB 1983, DV40 AB 1992, DV40N, DV40T, DV40T FA, DV80, DV80 AB 1983, DV80 AB 1992, DV80T, FR30G, FR30G AB 1992, FR40G AB 1980, FR40G AB 1983, FR40GUS AB 1980, FR40GUS AB 1983, FV110G, FV120B AB 1983, FV130B, FV20N, FV20T, FV240B AB 1983, FV250B AB 1988, FV250B AB 1992, FV25G AB 1986, FV25G AB 1992, FV28G AB 1994, FV28G AB 1997, FV30, FV30GS, FV40N AB 1983, FV40N AB 1992, FV40T, FV40TFA, FV50, FV60E AB 1983, FV60E AB 1988, FV70T, FV70TD		

reducers

inlet side

			
1			
<b>GEV No.</b>	371207	<b>Ref. No.</b>	0113235
<b>description</b>	reducer MÜLLER type MR04 flow rate 18l/min mounting measurements 19mm nominal flow at 4bar pressure range 1-10bar approval KTW tolerance ±15% brown		

			
1			
<b>GEV No.</b>	371123	<b>Ref. No.</b>	0113236 9534217
<b>description</b>	reducer MÜLLER type MR19 flow rate 5l/min ø 19mm mounting measurements 19mm pressure range 1-10bar tolerance ±15%		
<b>For models:</b>	DV40T FA, FV40TFA, FV70TD		

filters

			
1			
<b>GEV No.</b>	370551	<b>Ref. No.</b>	0113218
<b>description</b>	screen for solenoid valve ø 12mm L 24mm		

			
1			
<b>GEV No.</b>	371122	<b>Ref. No.</b>	0113098
<b>description</b>	solenoid valve filter ø 19mm H 10mm suitable for MÜLLER		
<b>For models:</b>	DV100 AB 1980, DV100 AB 1983, DV120B, DV120T, DV160 AB 1980, DV160 AB 1983, DV160 AB 1996, DV240B AB 1980, DV240B AB 1983, DV240B AB 1996, DV260B, DV40 AB 1983, DV40 AB 1992, DV40N, DV40T, DV40T FA, DV80, DV80 AB 1983, DV80 AB 1992, DV80T, ECO STAR 430F, ECO STAR 530F, ECO STAR 545D, FR30G, FR30G AB 1992, FR40G AB 1980, FR40G AB 1983, FR40GUS AB 1980, FR40GUS AB 1983, FV110G, FV120B AB 1983, FV130B, FV20N, FV20T, FV240B AB 1983, FV250B AB 1992, FV25G AB 1992, FV28G AB 1994, FV28G AB 1997, FV30GS, FV40N AB 1983, FV40N AB 1992, FV40T, FV40TFA, FV60E AB 1983, FV60E AB 1988, FV70T, FV70TD		

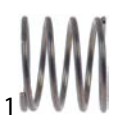

miscellaneous			
			
<b>GEV No.</b>	371309	<b>Ref. No.</b>	9519764
<b>description</b>	compression spring for membrane for DN10		

			
<b>GEV No.</b>	371009	<b>Ref. No.</b>	0113224
<b>description</b>	compression spring for solenoid coil		
<b>For models:</b>	DV100 AB 1983, DV120B, DV120T, DV160 AB 1983, DV160 AB 1996, DV240B AB 1983, DV240B AB 1996, DV260B, DV270B AB 1988, DV270B AB 1992, DV40 AB 1983, DV40 AB 1992, DV40N, DV40T, DV40T FA, DV80, DV80 AB 1983, DV80 AB 1992, DV80T, FR30G, FR30G AB 1992, FR40G AB 1980, FR40G AB 1983, FR40GUS AB 1980, FR40GUS AB 1983, FV110G, FV120B AB 1983, FV130B, FV20N, FV20T, FV240B AB 1983, FV250B AB 1988, FV250B AB 1992, FV25G AB 1986, FV25G AB 1992, FV28G AB 1994, FV28G AB 1997, FV30, FV30GS, FV40N AB 1983, FV40N AB 1992, FV40T, FV40TFA, FV50, FV60E AB 1983, FV60E AB 1988, FV70T, FV70TD		

			
<b>GEV No.</b>	501161	<b>Ref. No.</b>	0113207
<b>description</b>	tap head for solenoid valve holder for solenoid coils		
<b>For models:</b>	DV100 AB 1983, DV120B, DV160 AB 1983, DV260B, DV40 AB 1983, DV80, DV80 AB 1983, FR30G, FR40G AB 1983, FR40GUS AB 1983, FV120B AB 1983, FV240B AB 1983, FV25G AB 1986, FV40N AB 1983, FV60E AB 1983		



**ROBERTSHAW/INVENSYS**

*medium temperature:* 90°C 90°C 60°C  
*ambient temperature:* 60°C 25°C 60°C  
*duty cycle:* 40% 100% 100%

			
<b>GEV No.</b>	370753	<b>Ref. No.</b>	9544641 9727359
<b>description</b>	solenoid valve single straight 24VAC/DC inlet 3/4" outlet 6mm DN10 plastic		
<b>For models:</b>	FV40.2MIKE2, FV40.2M-MIKE2		







solenoid valves with reducers			
single			
			
<b>GEV No.</b>	371219	<b>Ref. No.</b>	9510710
<b>description</b>	solenoid valve single angled 230VAC inlet 3/4" outlet 14.5mm input 5l/min DN10 t.max. 90°C Invensys plastic flow regulating valve inlet black		



			
<b>GEV No.</b>	372027	<b>Ref. No.</b>	9625747 9686158
<b>description</b>	solenoid valve single angled 24VDC inlet 3/4" outlet 11.5mm input 10l/min output 0.25l/min flow regulating valve inlet brown		

			
<b>GEV No.</b>	372047	<b>Ref. No.</b>	0113202
<b>description</b>	solenoid valve single straight 230VAC inlet 3/4" outlet 14mm input 15l/min t.max. 90°C EATON (INVENSYS) plastic flow regulating valve inlet grey		
<b>For models:</b>	DV120T, DV40N, DV40T, DV40T FA, DV80T, FV110G, FV20N, FV20T, FV40T, FV40TFA, FV70T, FV70TD		
<b>spare parts for</b>	372047		
	<b>GEV No.</b>	370467	<b>Ref. No.</b> 9506228
	 solenoid valve filter suitable for ELBI		

2-fold			
			
<b>GEV No.</b>	370754	<b>Ref. No.</b>	9623793
<b>description</b>	solenoid valve double angled 24VAC/DC inlet 3/4" outlet 14.5mm Invensys plastic flow regulating valve inlet pink		



TP			
			
<b>GEV No.</b>	370018	<b>Ref. No.</b>	9005869
<b>description</b>	solenoid valve single straight 230VAC inlet 3/4" outlet 14mm DN10 TP		
<b>spare parts for</b>	370018		
	GEV No.	371013	Ref. No. —
solenoid coil TP 230VAC 50/60Hz			
<b>accessories for</b>	370018		
	GEV No.	371220	Ref. No. —
reducer TP flow rate 3l/min red tolerance ±15%			
	GEV No.	371221	Ref. No. —
reducer TP flow rate 5.5l/min yellow tolerance ±15%			
	GEV No.	371222	Ref. No. —
reducer TP flow rate 6l/min grey tolerance ±15%			
	GEV No.	371223	Ref. No. —
reducer TP flow rate 10l/min white tolerance ±15%			
	GEV No.	371224	Ref. No. —
reducer TP flow rate 12l/min bronze tolerance ±15%			
	GEV No.	371225	Ref. No. —
reducer TP flow rate 16l/min light brown tolerance ±15%			
	GEV No.	371226	Ref. No. —
reducer TP flow rate 20l/min red tolerance ±15%			
	GEV No.	371230	Ref. No. —
reducer TP flow rate 0.25l/min red tolerance ±25%			
	GEV No.	371231	Ref. No. —
reducer TP flow rate 0.35l/min violet tolerance ±25%			
	GEV No.	371232	Ref. No. —
reducer TP flow rate 0.5l/min orange tolerance ±25%			
	GEV No.	371233	Ref. No. —
reducer TP flow rate 0.8l/min white tolerance ±25%			
	GEV No.	371234	Ref. No. —
reducer TP flow rate 1l/min light blue tolerance ±25%			
	GEV No.	371235	Ref. No. —
reducer TP flow rate 1.2l/min brown tolerance ±25%			
	GEV No.	371236	Ref. No. —
reducer TP flow rate 1.5l/min light brown tolerance ±25%			
	GEV No.	371237	Ref. No. —
reducer TP flow rate 2.5l/min yellow tolerance ±25%			

accessories for 370018			
	GEV No.	371238	Ref. No. —
reducer TP flow rate 3.4l/min dark green tolerance ±25%			
	GEV No.	371239	Ref. No. —
reducer TP flow rate 5l/min black tolerance ±25%			
	GEV No.	371240	Ref. No. —
reducer TP flow rate 8l/min blue tolerance ±20%			































			
<b>GEV No.</b>	370029	<b>Ref. No.</b>	9623108 9686159
<b>description</b>	solenoid valve single straight 24VAC inlet 3/4" outlet 11.5mm DN10 TP flow regulating valve inlet white		
<b>spare parts for</b>	370029		
	GEV No.	371035	Ref. No. —
solenoid coil 24VAC			
<b>accessories for</b>	370029		
	GEV No.	371220	Ref. No. —
reducer TP flow rate 3l/min red tolerance ±15%			
	GEV No.	371221	Ref. No. —
reducer TP flow rate 5.5l/min yellow tolerance ±15%			
	GEV No.	371222	Ref. No. —
reducer TP flow rate 6l/min grey tolerance ±15%			
	GEV No.	371223	Ref. No. —
reducer TP flow rate 10l/min white tolerance ±15%			
	GEV No.	371224	Ref. No. —
reducer TP flow rate 12l/min bronze tolerance ±15%			
	GEV No.	371225	Ref. No. —
reducer TP flow rate 16l/min light brown tolerance ±15%			
	GEV No.	371226	Ref. No. —
reducer TP flow rate 20l/min red tolerance ±15%			
	GEV No.	371230	Ref. No. —
reducer TP flow rate 0.25l/min red tolerance ±25%			
	GEV No.	371231	Ref. No. —
reducer TP flow rate 0.35l/min violet tolerance ±25%			
	GEV No.	371232	Ref. No. —
reducer TP flow rate 0.5l/min orange tolerance ±25%			
	GEV No.	371233	Ref. No. —
reducer TP flow rate 0.8l/min white tolerance ±25%			

Table continues overleaf



accessories for		370029		
GEV No.	Ref. No.	Ref. No.	Ref. No.	—
	371234	Ref. No.	—	reducer TP flow rate 1l/min light blue tolerance ±25%
	371235	Ref. No.	—	reducer TP flow rate 1.2l/min brown tolerance ±25%
	371236	Ref. No.	—	reducer TP flow rate 1.5l/min light brown tolerance ±25%
	371237	Ref. No.	—	reducer TP flow rate 2.5l/min yellow tolerance ±25%
	371238	Ref. No.	—	reducer TP flow rate 3.4l/min dark green tolerance ±25%
	371239	Ref. No.	—	reducer TP flow rate 5l/min black tolerance ±25%
	371240	Ref. No.	—	reducer TP flow rate 8l/min blue tolerance ±20%

  <p>1</p>				
<b>GEV No.</b>	370016	<b>Ref. No.</b>	9000006	
<b>description</b>	solenoid valve single angled 230VAC inlet 3/4" outlet 14mm DN10 TP			
<b>For models:</b>	ECO STAR 430F, ECO STAR 530F, ECO STAR 545D			
<b>spare parts for</b>	370016			
	GEV No.	371013	Ref. No.	—
	solenoid coil TP 230VAC 50/60Hz			
<b>accessories for</b>	370016			
	GEV No.	371220	Ref. No.	—
	reducer TP flow rate 3l/min red tolerance ±15%			
	GEV No.	371221	Ref. No.	—
	reducer TP flow rate 5.5l/min yellow tolerance ±15%			
	GEV No.	371222	Ref. No.	—
	reducer TP flow rate 6l/min grey tolerance ±15%			
	GEV No.	371223	Ref. No.	—
	reducer TP flow rate 10l/min white tolerance ±15%			
	GEV No.	371224	Ref. No.	—
	reducer TP flow rate 12l/min bronze tolerance ±15%			
	GEV No.	371225	Ref. No.	—
	reducer TP flow rate 16l/min light brown tolerance ±15%			
	GEV No.	371226	Ref. No.	—
	reducer TP flow rate 20l/min red tolerance ±15%			

accessories for		370016		
GEV No.	Ref. No.	Ref. No.	Ref. No.	—
	371230	Ref. No.	—	reducer TP flow rate 0.25l/min red tolerance ±25%
	371231	Ref. No.	—	reducer TP flow rate 0.35l/min violet tolerance ±25%
	371232	Ref. No.	—	reducer TP flow rate 0.5l/min orange tolerance ±25%
	371233	Ref. No.	—	reducer TP flow rate 0.8l/min white tolerance ±25%
	371234	Ref. No.	—	reducer TP flow rate 1l/min light blue tolerance ±25%
	371235	Ref. No.	—	reducer TP flow rate 1.2l/min brown tolerance ±25%
	371236	Ref. No.	—	reducer TP flow rate 1.5l/min light brown tolerance ±25%
	371237	Ref. No.	—	reducer TP flow rate 2.5l/min yellow tolerance ±25%
	371238	Ref. No.	—	reducer TP flow rate 3.4l/min dark green tolerance ±25%
	371239	Ref. No.	—	reducer TP flow rate 5l/min black tolerance ±25%
	371240	Ref. No.	—	reducer TP flow rate 8l/min blue tolerance ±20%
	GEV No.	503139	Ref. No.	—
	solenoid valve filter ø 19.5mm H 16mm			





  <p>1</p>				
<b>GEV No.</b>	370031	<b>Ref. No.</b>	9623762	
<b>description</b>	solenoid valve single angled 24VAC inlet 3/4" outlet 14mm DN10 TP			
<b>spare parts for</b>	370031			
	GEV No.	371035	Ref. No.	—
	solenoid coil 24VAC			
<b>accessories for</b>	370031			
	GEV No.	371220	Ref. No.	—
	reducer TP flow rate 3l/min red tolerance ±15%			
	GEV No.	371221	Ref. No.	—
	reducer TP flow rate 5.5l/min yellow tolerance ±15%			

Table continues overleaf

accessories for		370031		
	GEV No.	371222	Ref. No.	—
reducer TP flow rate 6l/min grey tolerance ±15%				
	GEV No.	371223	Ref. No.	—
reducer TP flow rate 10l/min white tolerance ±15%				
	GEV No.	371224	Ref. No.	—
reducer TP flow rate 12l/min bronze tolerance ±15%				
	GEV No.	371225	Ref. No.	—
reducer TP flow rate 16l/min light brown tolerance ±15%				
	GEV No.	371226	Ref. No.	—
reducer TP flow rate 20l/min red tolerance ±15%				
	GEV No.	371230	Ref. No.	—
reducer TP flow rate 0.25l/min red tolerance ±25%				
	GEV No.	371231	Ref. No.	—
reducer TP flow rate 0.35l/min violet tolerance ±25%				
	GEV No.	371232	Ref. No.	—
reducer TP flow rate 0.5l/min orange tolerance ±25%				
	GEV No.	371233	Ref. No.	—
reducer TP flow rate 0.8l/min white tolerance ±25%				
	GEV No.	371234	Ref. No.	—
reducer TP flow rate 1l/min light blue tolerance ±25%				
	GEV No.	371235	Ref. No.	—
reducer TP flow rate 1.2l/min brown tolerance ±25%				
	GEV No.	371236	Ref. No.	—
reducer TP flow rate 1.5l/min light brown tolerance ±25%				
	GEV No.	371237	Ref. No.	—
reducer TP flow rate 2.5l/min yellow tolerance ±25%				
	GEV No.	371238	Ref. No.	—
reducer TP flow rate 3.4l/min dark green tolerance ±25%				
	GEV No.	371239	Ref. No.	—
reducer TP flow rate 5l/min black tolerance ±25%				
	GEV No.	371240	Ref. No.	—
reducer TP flow rate 8l/min blue tolerance ±20%				

various



1			
<b>GEV No.</b>	370668	<b>Ref. No.</b>	9545436
<b>description</b>	solenoid valve single 24V outlet 14mm 10 t.max. 60°C MÜLLER 19.010.278 plastic inlet 24mm		
<b>For models:</b>	FV40.2MIKE2, FV40.2M-MIKE2		



1			
<b>GEV No.</b>	370482	<b>Ref. No.</b>	9519728
<b>description</b>	solenoid valve single straight 230VAC outlet 6mm plastic inlet 3/4"mm		
<b>For models:</b>	FV40.2		

metal

ASCO

2-way





1			
<b>GEV No.</b>	370124	<b>Ref. No.</b>	0113246
<b>description</b>	solenoid valve 2-way-ways 230VAC inlet 1/2" outlet 1/2" L 69mm DN 16mm slide-on receptacle DIN -20° up to 85°C Asco coil type 400325-110 membranes NBR (water) p max 10bar p min 0.35bar valve set C 50/60Hz		
<b>spare parts for</b>	370124		
	<b>GEV No.</b>	371307	<b>Ref. No.</b> 0113249
solenoid coil Asco 230VAC pressure range 0.35-10bar connection DIN			



spare parts and accessories

solenoid coils

			
1			
<b>GEV No.</b>	371129	<b>Ref. No.</b>	0113251
<b>description</b>	solenoid coil Asco 230VAC coil type 400325-117		

			
1			
<b>GEV No.</b>	371307	<b>Ref. No.</b>	0113249
<b>description</b>	solenoid coil Asco 230VAC pressure range 0.35-10bar connection DIN		

solenoid valves (various)

			
1			
<b>GEV No.</b>	372040	<b>Ref. No.</b>	0113050
<b>description</b>	solenoid valve 2-ways 230VAC inlet 3/8" outlet 3/8" L 48mm body brass DN 6mm slide-on receptacle DIN type series SV04 coil type M20 p max 4bar 10W		

Solenoid valve - accessories

filters

			
1			
<b>GEV No.</b>	371122	<b>Ref. No.</b>	0113098
<b>description</b>	solenoid valve filter ø 19mm H 10mm suitable for MÜLLER		
<b>For models:</b>	DV100 AB 1980, DV100 AB 1983, DV120B, DV120T, DV160 AB 1980, DV160 AB 1983, DV160 AB 1996, DV240B AB 1980, DV240B AB 1983, DV240B AB 1996, DV260B, DV40 AB 1983, DV40 AB 1992, DV40N, DV40T, DV40T FA, DV80, DV80 AB 1983, DV80 AB 1992, DV80T, ECO STAR 430F, ECO STAR 530F, ECO STAR 545D, FR30G, FR30G AB 1992, FR40G AB 1980, FR40G AB 1983, FR40GUS AB 1980, FR40GUS AB 1983, FV110G, FV120B AB 1983, FV130B, FV20N, FV20T, FV240B AB 1983, FV250B AB 1992, FV25G AB 1992, FV28G AB 1994, FV28G AB 1997, FV30GS, FV40N AB 1983, FV40N AB 1992, FV40T, FV40TFA, FV60E AB 1983, FV60E AB 1988, FV70T, FV70TD		

			
1			
<b>GEV No.</b>	370467	<b>Ref. No.</b>	9506228
<b>description</b>	solenoid valve filter suitable for ELBI		

			
1			
<b>GEV No.</b>	370755	<b>Ref. No.</b>	8000009 8004068 9546133
<b>description</b>	reducer L 20mm ø 13.3mm		
<b>For models:</b>	ECO STAR 545D		

			
1			
<b>GEV No.</b>	370135	<b>Ref. No.</b>	0113250
<b>description</b>	spare parts kit size 1/2"		

			
1			
<b>GEV No.</b>	370136	<b>Ref. No.</b>	0113252
<b>description</b>	spare parts kit size 3/4"		

			
1			
<b>GEV No.</b>	501161	<b>Ref. No.</b>	0113207
<b>description</b>	tap head for solenoid valve holder for solenoid coils		
<b>For models:</b>	DV100 AB 1983, DV120B, DV160 AB 1983, DV260B, DV40 AB 1983, DV80, DV80 AB 1983, FR30G, FR40G AB 1983, FR40GUS AB 1983, FV120B AB 1983, FV240B AB 1983, FV25G AB 1986, FV40N AB 1983, FV60E AB 1983		



## pressure switches

### for warewashing

ø 58mm with male faston 6.3mm

with connection vertical



1

<b>GEV No.</b>	541163	<b>Ref. No.</b>	0130010 8002014
<b>description</b>	pressure control		
<b>For models:</b>	DV40 AB 1983, FV40N AB 1980, FV40N AB 1983, FV60E AB 1983		



1

<b>GEV No.</b>	541146	<b>Ref. No.</b>	0130026
<b>description</b>	pressure control pressure range 40/15mbar connection 6mm ø 58mm pressure connection vertical warewashing pressure connection ø 6mm		
<b>For models:</b>	DV120.2, ECO STAR 530F, FV110G, FV20N, FV28GFA, FV40.2, FV40.2 AB 2002, FV40.2M, FV40.2MIKE2, FV40.2M-MIKE2, FV40TFA, FV70TD		



1

<b>GEV No.</b>	541050	<b>Ref. No.</b>	0130009 0130019
<b>description</b>	pressure control pressure range 50/30mbar connection 6mm ø 58mm pressure connection vertical warewashing pressure connection ø 6mm		
<b>For models:</b>	FR30G, FR30G AB 1992, FR40G AB 1980, FR40G AB 1983, FR40GUS AB 1980, FR40GUS AB 1983, FV120B AB 1980, FV120B AB 1983, FV240B AB 1980, FV25G AB 1986, FV25G AB 1992, FV28G AB 1994, FV28G AB 1997, FV40T, FV60E AB 1983, FV60E AB 1988, FV70T		



1

<b>GEV No.</b>	541041	<b>Ref. No.</b>	0130008 0130014
<b>description</b>	pressure control pressure range 62/30mbar connection 6mm ø 58mm pressure connection vertical warewashing pressure connection ø 6mm		
<b>For models:</b>	DV100 AB 1980, DV100 AB 1983, DV120B, DV160 AB 1980, DV160 AB 1983, DV160 AB 1996, DV240B AB 1980, DV240B AB 1983, DV240B AB 1996, DV260B, DV270B AB 1988, DV270B AB 1992, DV40 AB 1992, DV80, DV80 AB 1980, DV80 AB 1983, DV80 AB 1992, FR30G AB 1992, FV130B, FV250B AB 1988, FV250B AB 1992, FV25G AB 1992, FV30GS, FV40N AB 1992		



1

<b>GEV No.</b>	541145	<b>Ref. No.</b>	0130027
<b>description</b>	pressure control pressure range 90/25mbar connection 6mm ø 58mm pressure connection vertical warewashing pressure connection ø 6mm		
<b>For models:</b>	DV120T, DV40N, DV40T, DV40T FA, DV80T, ECO STAR 545D		

### 73x43mm with coded plug



1

<b>GEV No.</b>	541869	<b>Ref. No.</b>	9622397
<b>description</b>	pressure control pressure range 40/15mbar connection 6mm size 73x43mm warewashing pressure connection ø 6mm		
<b>For models:</b>	FV40.2M-MIKE2		

### pressure transmitters





1

<b>GEV No.</b>	541149	<b>Ref. No.</b>	9537961
<b>description</b>	pressure transmitter pressure range 0-30mbar output voltage 0.5-3.5VDC input voltage 5VDC max 200mbar		
<b>For models:</b>	FV40.2MIKE2, FV40.2M-MIKE2		









miscellaneous			
			
1			
<b>GEV No.</b>	541983	<b>Ref. No.</b>	9520592 9547086
<b>description</b>	pressure control digital ø 58mm 5V voltage DC pressure connection ø 5.5mm pressure range 0.1-1bar		
<b>For models:</b>	FV40.2		

			
1			
<b>GEV No.</b>	541677	<b>Ref. No.</b>	9519033 9622898 9683764 9683764+0401014
<b>description</b>	pressure control pressure rangembar connection 15x20mm		
<b>For models:</b>	DV120.2, FV40.2, FV40.2 AB 2002, FV40.2 AB 2003, FV40.2M, FV40.2MIKE2, FV40.2M-MIKE2		
<b>accessories for</b>	541677		
	<b>GEV No.</b>	528928	<b>Ref. No.</b> 0401014
	O-ring EPDM ID ø 18mm thickness 2mm Qty 1 pcs		



electrodes

			
1			
<b>GEV No.</b>	361274	<b>Ref. No.</b>	8000014
<b>description</b>	conductivity probe mounting ø 17mm		
<b>For models:</b>	DR90, DV111, DV111E		

			
1			
<b>GEV No.</b>	361245	<b>Ref. No.</b>	0620437
<b>description</b>	conductivity probe with thread mounting ø 17mm		
<b>accessories for</b>	361245		
	<b>GEV No.</b>	501289	<b>Ref. No.</b> 0217432
	flat gasket rubber ED ø 24mm ID ø 14mm thickness 2mm Qty 1 pcs		
	<b>GEV No.</b>	501290	<b>Ref. No.</b> 0620162
	nut thread 3/8" H 8mm WS 24 plastic Qty 1 pcs		

			
1			
<b>GEV No.</b>	403314	<b>Ref. No.</b>	9500435
<b>description</b>	level electrode 1/2" total length 150mm probe L 125mm insulated probe length 110mm connection bullet connector		

fans

axial fans			
import			
			
1			
<b>GEV No.</b>	601080 <sup>1</sup>	<b>Ref. No.</b>	0190032
<b>description</b>	axial fan L 119mm W 119mm H 38mm 230VAC 50/60Hz 23/20W bearing ball bearing connection male faston 2.8mm metal ADDA fan wheel ø 110mm temp.-resist. 70°C		
<b>accessories for</b>	601080		
	<b>GEV No.</b>	550898	<b>Ref. No.</b> —
	connecting cable cable length 2000mm connection F 2.8 connection distance 7.9mm for axial flow fan		
	<b>GEV No.</b>	692519	<b>Ref. No.</b> —
	guard L 120mm W 120mm plastic		

<sup>1</sup>with ball bearings

			
1			
<b>GEV No.</b>	601809	<b>Ref. No.</b>	0550057 9615004
<b>description</b>	axial fan ø 365mm H 118mm 230/400VAC 50/60Hz 110/170W connection cable 1500mm manuf. no. FC031-4DH.2A.V6 ZIEHL-ABEGG fan wheel ø 308mm for drying		



## pumps

## wash and rinse pumps

FIR

pumps







1





<b>GEV No.</b>	500287	<b>Ref. No.</b>	0501135 9604594
<b>description</b>	pump for Meiko inlet $\varnothing$ 45mm outlet $\varnothing$ 40mm 230V type 2256.1420 50Hz 0.73kW 1HP L 200mm rotation direction right capacitor 16 $\mu$ F 1 phase FIR		
<b>spare parts for</b>	500287		
	<b>GEV No.</b>	365021	<b>Ref. No.</b> 0501136
	operating capacitor capacity 16 $\mu$ F 425V tolerance 5% 50/60Hz ambient temperature max. -25 to +85°C $\varnothing$ 35mm L 73mm single M8 plastic connection male faston 6.3mm 416.10.99 protection		
	<b>GEV No.</b>	501313	<b>Ref. No.</b> 0501138 9537022 9621793
	impellor $\varnothing$ 103mm H 28mm shaft intake $\varnothing$ 9/8mm		
	<b>GEV No.</b>	502007	<b>Ref. No.</b> —
	pump cover gasket		
	<b>GEV No.</b>	502014	<b>Ref. No.</b> —
	pump cover FIR inlet $\varnothing$ 45mm outlet $\varnothing$ 40mm		
	<b>GEV No.</b>	510692	<b>Ref. No.</b> 0501095 0501162
	mechanical shaft seal for shaft $\varnothing$ 11mm slide ring ext. $\varnothing$ 24mm slide ring H 13mm counter ring mounting $\varnothing$ 26mm height counter ring 8mm counter ring int. $\varnothing$ 14mm		





1

<b>GEV No.</b>	500561	<b>Ref. No.</b>	0501174 9534806
<b>description</b>	pump inlet $\varnothing$ 33mm outlet $\varnothing$ 30mm type B221A 230V 50Hz 1 phase 0.15kW 0.2HP L 195mm rotation direction left capacitor 6.3 $\mu$ F FIR		
<b>For models:</b>	FV28GFA		
<b>spare parts for</b>	500561		
	<b>GEV No.</b>	365012	<b>Ref. No.</b> 0501173
	operating capacitor capacity 6.3 $\mu$ F 450V tolerance 5% 50Hz ambient temperature max. -25 to +85°C $\varnothing$ 30mm L 61mm M8 plastic connection male faston 6.3mm protection		
	<b>GEV No.</b>	501309	<b>Ref. No.</b> 0501170
	impellor $\varnothing$ 80mm H 19mm M7R pump type type D1		
	<b>GEV No.</b>	501310	<b>Ref. No.</b> —
	pump cover		
	<b>GEV No.</b>	510693	<b>Ref. No.</b> —
	mechanical shaft seal for shaft $\varnothing$ 12mm slide ring ext. $\varnothing$ 24mm slide ring H 15.5mm slide ring int. $\varnothing$ 11mm counter ring mounting $\varnothing$ 24mm height counter ring 8mm counter ring int. $\varnothing$ 13.5mm		



1			
<b>GEV No.</b>	500274	<b>Ref. No.</b>	0501166 9534805
<b>description</b>	pump inlet ø 33mm outlet ø 30mm type B221A1500 230V 50Hz 1 phase 0.15kW 0.2HP L 195mm rotation direction left capacitor 6.3µF FIR		
<b>For models:</b>	DV40T FA, FV40TFA, FV70TD		
<b>spare parts for</b>	500274		
	<b>GEV No.</b>	365012	<b>Ref. No.</b> 0501173
	operating capacitor capacity 6.3µF 450V tolerance 5% 50Hz ambient temperature max. -25 to +85°C ø 30mm L 61mm M8 plastic connection male faston 6.3mm protection		
	<b>GEV No.</b>	501309	<b>Ref. No.</b> 0501170
	impellor ø 80mm H 19mm M7R pump type type D1		
	<b>GEV No.</b>	510693	<b>Ref. No.</b> —
	mechanical shaft seal for shaft ø 12mm slide ring ext. ø 24mm slide ring H 15.5mm slide ring int. ø 11mm counter ring mounting ø 24mm height counter ring 8mm counter ring int. ø 13.5mm		
	<b>GEV No.</b>	521500	<b>Ref. No.</b> 0501169
	pump cover		
	<b>GEV No.</b>	521700	<b>Ref. No.</b> 0501171
	pump cover gasket		



1			
<b>GEV No.</b>	500289	<b>Ref. No.</b>	0501088 0501147 0501163
<b>description</b>	pump inlet ø 45mm outlet ø 40mm type 1276.2530 230/400V 50Hz 3 phase 0.55kW 0.75HP L 270mm rotation direction right FIR		
<b>For models:</b>	DR70, DV80 AB 1975		
<b>spare parts for</b>	500289		
	<b>GEV No.</b>	501314	<b>Ref. No.</b> 0501081
	impellor ø 75mm		
	<b>GEV No.</b>	502007	<b>Ref. No.</b> —
	pump cover gasket		
	<b>GEV No.</b>	502014	<b>Ref. No.</b> —
	pump cover FIR inlet ø 45mm outlet ø 40mm		
	<b>GEV No.</b>	510692	<b>Ref. No.</b> 0501095 0501162
	mechanical shaft seal for shaft ø 11mm slide ring ext. ø 24mm slide ring H 13mm counter ring mounting ø 26mm height counter ring 8mm counter ring int. ø 14mm		







1

<b>GEV No.</b>	499216	<b>Ref. No.</b>	9621706
<b>description</b>	pump inlet ø 45mm outlet ø 40mm type 2256T2550 180-253V 50Hz 1 phase 0.75kW 1HP L 250mm rotation direction right capacitor 20µF FIR		
<b>spare parts for</b>	499216		
	<b>GEV No.</b>	365019	<b>Ref. No.</b> 9606122
	operating capacitor capacity 20µF 400V tolerance 5% 50/60Hz ambient temperature max. -25 to +85°C ø 39.5mm L 70mm M8 plastic connection male faston 6.3mm 16.10.25. protection		
	<b>GEV No.</b>	501313	<b>Ref. No.</b> 0501138 9537022 9621793
	impellor ø 103mm H 28mm shaft intake ø 9/8mm		
	<b>GEV No.</b>	502007	<b>Ref. No.</b> —
	pump cover gasket		
	<b>GEV No.</b>	502014	<b>Ref. No.</b> —
	pump cover FIR inlet ø 45mm outlet ø 40mm		
	<b>GEV No.</b>	510692	<b>Ref. No.</b> 0501095 0501162
	mechanical shaft seal for shaft ø 11mm slide ring ext. ø 24mm slide ring H 13mm counter ring mounting ø 26mm height counter ring 8mm counter ring int. ø 14mm		





1

<b>GEV No.</b>	499335	<b>Ref. No.</b>	0501125
<b>description</b>	pump inlet ø 45mm outlet ø 40mm type 3911K1513 230V 50Hz 1 phase 0.55kW 0.75HP L 205mm rotation direction right capacitor 12.5µF FIR		
<b>spare parts for</b>	499335		
	<b>GEV No.</b>	365014	<b>Ref. No.</b> 0501090
	operating capacitor capacity 12.5µF 450V tolerance 5%Hz ambient temperature max. -25 to +85°C ø 35mm L 70mm M8 plastic connection male faston 6.3mm 45S.C3DS.12.5 protection		
	<b>GEV No.</b>	510508	<b>Ref. No.</b> 0501091 9500311
	pump cover FIR inlet ø 45mm outlet ø 40mm pump type PU 0.5/3911 turn direction right ø 160mm ID ø 125mm inner height 25mm		
	<b>GEV No.</b>	510610	<b>Ref. No.</b> —
	impellor ø 95.5mm H 23mm shaft intake ø 9/8mm rotation direction right seat ø 16mm blades 6		
	<b>GEV No.</b>	510692	<b>Ref. No.</b> 0501095 0501162
	mechanical shaft seal for shaft ø 11mm slide ring ext. ø 24mm slide ring H 13mm counter ring mounting ø 26mm height counter ring 8mm counter ring int. ø 14mm		
	<b>GEV No.</b>	521702	<b>Ref. No.</b> —
	pump cover gasket thickness 3.5x4.5mm Qty 1 pcs		



1

<b>GEV No.</b>	501502	<b>Ref. No.</b>	0501126 9547992 9623417
<b>description</b>	pump inlet ø 45mm outlet ø 40mm type 3911K2530 180-253V 50Hz 1 phase 0.55kW 0.75HP L 205mm rotation direction right capacitor 10µF FIR		
<b>spare parts for</b>	501502		
	<b>GEV No.</b>	365014	<b>Ref. No.</b> 0501090
	operating capacitor capacity 12.5µF 450V tolerance 5%Hz ambient temperature max. -25 to +85°C ø 35mm L 70mm M8 plastic connection male faston 6.3mm 45S.C3DS.12.5 protection		
	<b>GEV No.</b>	501316	<b>Ref. No.</b> 0501092 0501137
	impellor ø 96mm H 23mm pump type pump 0.55kW shaft intake ø 9x8mm rotation direction right seat ø 16mm Spezial blades 6		
	<b>GEV No.</b>	510508	<b>Ref. No.</b> 0501091 9500311
	pump cover FIR inlet ø 45mm outlet ø 40mm pump type PU 0.5/3911 turn direction right ø 160mm ID ø 125mm inner height 25mm		
	<b>GEV No.</b>	510552	<b>Ref. No.</b> 0501094
	pump cover gasket pump type 1292-2/3942/3981/3911/3983		
	<b>GEV No.</b>	510692	<b>Ref. No.</b> 0501095 0501162
	mechanical shaft seal for shaft ø 11mm slide ring ext. ø 24mm slide ring H 13mm counter ring mounting ø 26mm height counter ring 8mm counter ring int. ø 14mm		









1

<b>GEV No.</b>	499207	<b>Ref. No.</b>	0501085 0501120 9623861
<b>description</b>	pump inlet ø 45mm outlet ø 40mm type 3911K2533 180-253V 50Hz 1 phase 0.55kW 0.75HP L 205mm rotation direction right capacitor 12.5µF FIR		
<b>For models:</b>	DV40 AB 1983, DV40 AB 1992, DV40N, DV40T, DV40T FA, ECO STAR 430F, ECO STAR 530F, FR30G, FR30G AB 1992, FR40G AB 1980, FR40G AB 1983, FR40GUS AB 1980, FR40GUS AB 1983, FV110G, FV20N, FV20T, FV25G AB 1986, FV25G AB 1992, FV28G AB 1994, FV28G AB 1997, FV28GFA, FV30GS, FV40N AB 1980, FV40N AB 1983, FV40N AB 1992, FV40T, FV40TFA, FV60E AB 1988, FV70T, FV70TD		
<b>spare parts for</b>	499207		
	<b>GEV No.</b>	365014	<b>Ref. No.</b> 0501090
	operating capacitor capacity 12.5µF 450V tolerance 5%Hz ambient temperature max. -25 to +85°C ø 35mm L 70mm M8 plastic connection male faston 6.3mm 45S.C3DS.12.5 protection		
	<b>GEV No.</b>	510508	<b>Ref. No.</b> 0501091 9500311
	pump cover FIR inlet ø 45mm outlet ø 40mm pump type PU 0.5/3911 turn direction right ø 160mm ID ø 125mm inner height 25mm		
	<b>GEV No.</b>	510610	<b>Ref. No.</b> —
	impellor ø 95.5mm H 23mm shaft intake ø 9/8mm rotation direction right seat ø 16mm blades 6		
	<b>GEV No.</b>	510692	<b>Ref. No.</b> 0501095 0501162
	mechanical shaft seal for shaft ø 11mm slide ring ext. ø 24mm slide ring H 13mm counter ring mounting ø 26mm height counter ring 8mm counter ring int. ø 14mm		
	<b>GEV No.</b>	521702	<b>Ref. No.</b> —
	pump cover gasket thickness 3.5x4.5mm Qty 1 pcs		





1

<b>GEV No.</b>	499128	<b>Ref. No.</b>	0501167
<b>description</b>	pump inlet ø 45mm outlet ø 40mm type 4228.1503 230V 50Hz 0.55kW L 207mm rotation direction right capacitor 12.5µF FIR		
<b>spare parts for</b>	499128		
	<b>GEV No.</b>	365014	<b>Ref. No.</b> 0501090
	operating capacitor capacity 12.5µF 450V tolerance 5%Hz ambient temperature max. -25 to +85°C ø 35mm L 70mm M8 plastic connection male faston 6.3mm 45S.C3D5.12.5 protection		
	<b>GEV No.</b>	510508	<b>Ref. No.</b> 0501091 9500311
	pump cover FIR inlet ø 45mm outlet ø 40mm pump type PU 0.5/3911 turn direction right ø 160mm ID ø 125mm inner height 25mm		
	<b>GEV No.</b>	510693	<b>Ref. No.</b> —
	mechanical shaft seal for shaft ø 12mm slide ring ext. ø 24mm slide ring H 15.5mm slide ring int. ø 11mm counter ring mounting ø 24mm height counter ring 8mm counter ring int. ø 13.5mm		
	<b>GEV No.</b>	521702	<b>Ref. No.</b> —
	pump cover gasket thickness 3.5x4.5mm Qty 1 pcs		
	<b>GEV No.</b>	524358	<b>Ref. No.</b> 9533822
	impeller ø 96mm H 23mm shaft intake ø M7Lmm rotation direction right suitable for MEIKO shaft ø 12mm shaft length 9mm blades 6		
<b>accessories for</b>	499128		
	<b>GEV No.</b>	551286	<b>Ref. No.</b> —
	adapter L 120mm 4-pole for Meiko pump suitable for 500038 plug type dependent on equipment		



1

<b>GEV No.</b>	500278	<b>Ref. No.</b>	0501032
<b>description</b>	pump inlet ø 57mm outlet ø 49mm type AF90L/2C-12 400V 50Hz 3 phase 2.7kW 3.7HP L 400mm rotation direction right FIR inlet ø 57mm outlet ø 49mm		
<b>For models:</b>	DV120B, DV240B AB 1980, DV240B AB 1983, DV260B, DV80, FV120B AB 1980, FV120B AB 1983, FV130B, FV240B AB 1980, FV240B AB 1983, FV30, FV50		
<b>spare parts for</b>	500278		
	<b>GEV No.</b>	507558	<b>Ref. No.</b> 9523844 9543778 9662632
	mechanical shaft seal for shaft ø 7mm height counter ring 5mm ID ø 6.75mm ED ø 20mm mounting ø counter ring 18.5/slide ring 20mm		
	<b>GEV No.</b>	510683	<b>Ref. No.</b> 9523260 9543781
	O-ring EPDM thickness 3mm ID ø 79mm Qty 1 pcs		

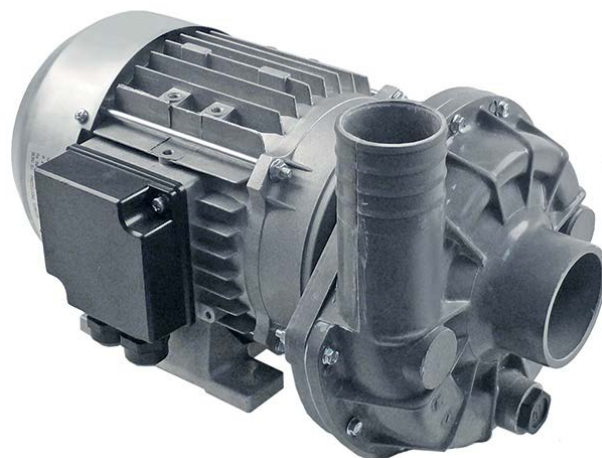

1





<b>GEV No.</b>	500029	<b>Ref. No.</b>	0501084 0501089 0501118
<b>description</b>	pump inlet ø 63mm outlet ø 47mm type 1295.2503 230/400V 50Hz 3 phase 0.88kW 1.2HP L 305mm rotation direction right FIR		
<b>For models:</b>	DV100 AB 1980, DV100 AB 1983, DV160 AB 1980, DV160 AB 1983, DV80 AB 1980, DV80 AB 1983, DV80 AB 1992, FV60E AB 1983		
<b>spare parts for</b>	500029		
	<b>GEV No.</b>	510693	<b>Ref. No.</b> —
	mechanical shaft seal for shaft ø 12mm slide ring ext. ø 24mm slide ring H 15.5mm slide ring int. ø 11mm counter ring mounting ø 24mm height counter ring 8mm counter ring int. ø 13.5mm		
	<b>GEV No.</b>	521213	<b>Ref. No.</b> —
	impeller ø 117mm H 24mm M8L		

Table continues overleaf

<b>spare parts for</b> 500029	
	GEV No. 521513 Ref. No. — pump cover FIR inlet ø 63mm outlet ø 47mm turn direction right ID ø 150mm inner height 32mm
	GEV No. 524416 Ref. No. — pump cover gasket thickness 4x4mm Qty 1 pcs



1

<b>GEV No.</b> 500031	<b>Ref. No.</b> 0501082 0501086
<b>description</b>	pump inlet ø 63mm outlet ø 53mm type 1205.2528 230/400V 50Hz 3 phase 2kW 2.7HP L 330mm rotation direction left FIR
<b>For models:</b>	DV120B, DV240B AB 1980, DV240B AB 1983, DV260B, DV80, FV120B AB 1980, FV120B AB 1983, FV130B, FV240B AB 1980, FV240B AB 1983, FV30, FV50
<b>spare parts for</b> 500031	
	GEV No. 510357 Ref. No. — impellor ø 124mm H 34/16mm thread M8R blades 6
	GEV No. 510523 Ref. No. — fan wheel ø 142mm shaft intake ø 15mm blades 12
	GEV No. 510531 Ref. No. 0501097 pump cover FIR inlet ø 63mm outlet ø 53mm auxiliary pressure connection M16x1.5mm supporting pressure open turn direction left ø 185mm ID ø 150mm inner height 37mm
	GEV No. 510693 Ref. No. — mechanical shaft seal for shaft ø 12mm slide ring ext. ø 24mm slide ring H 15.5mm slide ring int. ø 11mm counter ring mounting ø 24mm height counter ring 8mm counter ring int. ø 13.5mm
	GEV No. 524416 Ref. No. — pump cover gasket thickness 4x4mm Qty 1 pcs

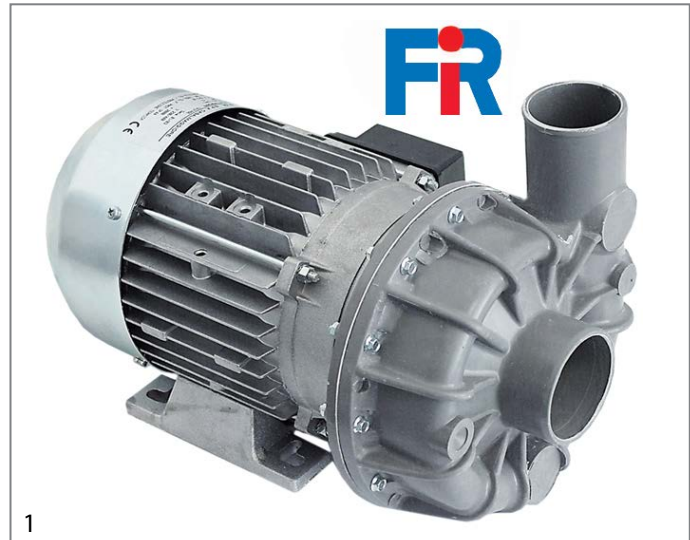







1

<b>GEV No.</b> 500111	<b>Ref. No.</b> 0501129 0501131 0501146
<b>description</b>	pump inlet ø 63mm outlet ø 53mm type 1241.2500 230/400V 50Hz 3 phase 1.1kW 1.5HP L 330mm rotation direction left FIR
<b>For models:</b>	DV120B, DV120T, DV240B AB 1996
<b>spare parts for</b> 500111	
	GEV No. 510531 Ref. No. 0501097 pump cover FIR inlet ø 63mm outlet ø 53mm auxiliary pressure connection M16x1.5mm supporting pressure open turn direction left ø 185mm ID ø 150mm inner height 37mm
	GEV No. 510612 Ref. No. — impellor ø 110mm H 34mm M8R
	GEV No. 510693 Ref. No. — mechanical shaft seal for shaft ø 12mm slide ring ext. ø 24mm slide ring H 15.5mm slide ring int. ø 11mm counter ring mounting ø 24mm height counter ring 8mm counter ring int. ø 13.5mm
	GEV No. 524416 Ref. No. — pump cover gasket thickness 4x4mm Qty 1 pcs





1

<b>GEV No.</b>	500244	<b>Ref. No.</b>	0501134
<b>description</b>	pump inlet $\varnothing$ 63mm outlet $\varnothing$ 54mm type 1241.2725 230/400V 3 phase 1.1kW 1.5HP rotation direction left FIR		
<b>For models:</b>	DV120T		
<b>spare parts for</b>	500244		
	<b>GEV No.</b>	510531	<b>Ref. No.</b> 0501097
	pump cover FIR inlet $\varnothing$ 63mm outlet $\varnothing$ 53mm auxiliary pressure connection M16x1.5mm supporting pressure open turn direction left $\varnothing$ 185mm ID $\varnothing$ 150mm inner height 37mm		
	<b>GEV No.</b>	510612	<b>Ref. No.</b> —
	impellor $\varnothing$ 110mm H 34mm M8R		
	<b>GEV No.</b>	510693	<b>Ref. No.</b> —
	mechanical shaft seal for shaft $\varnothing$ 12mm slide ring ext. $\varnothing$ 24mm slide ring H 15.5mm slide ring int. $\varnothing$ 11mm counter ring mounting $\varnothing$ 24mm height counter ring 8mm counter ring int. $\varnothing$ 13.5mm		
	<b>GEV No.</b>	524416	<b>Ref. No.</b> —
	pump cover gasket thickness 4x4mm Qty 1 pcs		

<b>spare parts for</b>	501454			
	<b>GEV No.</b>	521061	<b>Ref. No.</b>	9540713 9621796
	impellor $\varnothing$ 93mm H 27mm shaft intake $\varnothing$ 9x8mm rotation direction left blades 6			
<b>accessories for</b>	501454			
	<b>GEV No.</b>	501000	<b>Ref. No.</b>	9515339
	O-ring EPDM thickness 4mm ID $\varnothing$ 145mm Qty 1 pcs			



1

<b>GEV No.</b>	500698	<b>Ref. No.</b>	9519527
<b>description</b>	pump type 4273.2350 230V 50Hz 1 phase 0.55kW 0.75HP L 170mm rotation direction left capacitor 12.5 $\mu$ F FIR		
<b>For models:</b>	FV40.2		
<b>spare parts for</b>	500698		
	<b>GEV No.</b>	365014	<b>Ref. No.</b> 0501090
	operating capacitor capacity 12.5 $\mu$ F 450V tolerance 5%Hz ambient temperature max. -25 to +85°C $\varnothing$ 35mm L 70mm M8 plastic connection male faston 6.3mm 45S.C3DS.12.5 protection		
	<b>GEV No.</b>	510695	<b>Ref. No.</b> 9519539
	mechanical shaft seal height counter ring 5.5mm ID $\varnothing$ 11mm		
	<b>GEV No.</b>	512437	<b>Ref. No.</b> 9519529 9621794
	impellor $\varnothing$ 85mm H 27mm rotation direction right shaft $\varnothing$ 9mm blades 6		



1

<b>GEV No.</b>	501454	<b>Ref. No.</b>	4273P1850 9540609 9621709
<b>description</b>	pump inlet $\varnothing$ outlet $\varnothing$ type 4273P1850 180-253V 50Hz 1 phase 0.75kW L 190mm rotation direction right capacitor 16 $\mu$ F		
<b>spare parts for</b>	501454		
	<b>GEV No.</b>	510695	<b>Ref. No.</b> 9519539
	mechanical shaft seal height counter ring 5.5mm ID $\varnothing$ 11mm		



HANNING

pumps





1

<b>GEV No.</b>	500700	<b>Ref. No.</b>	9544228 9638029
<b>description</b>	pump inlet ø 28mm outlet ø 24mm type UP60-386 230V 50Hz 1 phase 0.19kW L 190mm capacitor 5µF HANNING		
<b>For models:</b>	DV120.2, FV40.2, FV40.2 AB 2002, FV40.2 AB 2003, FV40.2M, FV40.2MIKE2, FV40.2M-MIKE2		
<b>spare parts for</b>	500700		
	<b>GEV No.</b>	365131	<b>Ref. No.</b> 9520030
	capacitor capacity 5µF 450V tolerance 5% 50/60Hz ambient temperature max. -25 to +85°C ø 30mm L 60mm M8 aluminium connection male faston 6.3mm protection		
	<b>GEV No.</b>	507558	<b>Ref. No.</b> 9523844 9543778 9662632
	mechanical shaft seal for shaft ø 7mm height counter ring 5mm ID ø 6.75mm ED ø 20mm mounting ø counter ring 18.5/slide ring 20mm		
	<b>GEV No.</b>	524695	<b>Ref. No.</b> 9523267 9643336
	impellor ø 72mm H 24mm rotation direction left thread M6L suitable for HANNING blades 6		
	<b>GEV No.</b>	532644	<b>Ref. No.</b> —
	O-ring EPDM thickness 3mm ID ø 78mm Qty 1 pcs		



1

<b>GEV No.</b>	499066	<b>Ref. No.</b>	9517934 9638047
<b>description</b>	pump inlet ø 28mm outlet ø 24mm type UP60-393 200-240V 50Hz 1 phase 0.25kW L 190mm HANNING		
<b>For models:</b>	FV40.2, FV40.2MIKE2, FV40.2M-MIKE2		
<b>spare parts for</b>	499066		
	<b>GEV No.</b>	365017	<b>Ref. No.</b> —
	operating capacitor capacity 5µF 450V tolerance 5% 50/60Hz ambient temperature max. -25 to +85°C ø 28mm L 54mm M8 plastic connection male faston 6.3mm 16.10.08 protection		
	<b>GEV No.</b>	507558	<b>Ref. No.</b> 9523844 9543778 9662632
	mechanical shaft seal for shaft ø 7mm height counter ring 5mm ID ø 6.75mm ED ø 20mm mounting ø counter ring 18.5/slide ring 20mm		
	<b>GEV No.</b>	532644	<b>Ref. No.</b> —
	O-ring EPDM thickness 3mm ID ø 78mm Qty 1 pcs		



1

<b>GEV No.</b>	499164	<b>Ref. No.</b>	9638051
<b>description</b>	pump inlet ø 28mm outlet ø 24mm type UP60-397 400V 50Hz 1 phase L 190mm		





1

<b>GEV No.</b>	500982	<b>Ref. No.</b>	9535710 9638041
<b>description</b>	pump inlet ø 28mm outlet ø 26mm type UP60-388 200/240V 50Hz 1 phase 0.22kW L 190mm rotation direction left capacitor 5µF HANNING pump rate 160l/min with metal impellor discharge pressure 0.77bar		
<b>spare parts for</b>	500982		
	<b>GEV No.</b>	365131	<b>Ref. No.</b> 9520030
	capacitor capacity 5µF 450V tolerance 5% 50/60Hz ambient temperature max. -25 to +85°C ø 30mm L 60mm M8 aluminium connection male faston 6.3mm protection		



1

<b>GEV No.</b>	499129	<b>Ref. No.</b>	9532002 9607881 9638050
<b>description</b>	pump type UP60-396 240V 50Hz 1 phase 0.18kW L 166mm rotation direction left capacitor 5µF p max 0.75bar Qmax. 150l/min HANNING without lid		
<b>For models:</b>	FV40.2, FV40.2MIKE2, FV40.2M-MIKE2		
<b>spare parts for</b>	499129		
	<b>GEV No.</b>	524695	<b>Ref. No.</b> 9523267 9643336
	impellor ø 72mm H 24mm rotation direction left thread M6L suitable for HANNING blades 6		
	<b>GEV No.</b>	532644	<b>Ref. No.</b> —
	O-ring EPDM thickness 3mm ID ø 78mm Qty 1 pcs		

wash pump motors



1

<b>GEV No.</b>	500288	<b>Ref. No.</b>	0501040
<b>description</b>	pump motor ATB type PF112M/6/4P-11A 2200/4000W 400V 50/60Hz 3 phase L 390mm W 210mm H 270mm 1400/1700rpm shaft ø 20mm		
<b>For models:</b>	DV270B AB 1988, DV270B AB 1992, FV250B AB 1988, FV250B AB 1992		
<b>spare parts for</b>	500288		
	<b>GEV No.</b>	501071	<b>Ref. No.</b> 0403003 9721612
	mechanical shaft seal for shaft ø 25mm ED ø 41mm H 26mm Viton		
	<b>GEV No.</b>	501072	<b>Ref. No.</b> 0403009 9721613
	boot suitable for friction ring ID ø 30mm ED ø 40mm H 7mm		
	<b>GEV No.</b>	501073	<b>Ref. No.</b> 0403010
	slide ring H 8mm ED ø 38mm ID ø 25.7mm ceramic		
	<b>GEV No.</b>	501087	<b>Ref. No.</b> 0620333
	flange for motor		
	<b>GEV No.</b>	501117	<b>Ref. No.</b> 8100217
	nut for wash pump WS 32		
	<b>GEV No.</b>	501118	<b>Ref. No.</b> 8100218
	impellor		
	<b>GEV No.</b>	501119	<b>Ref. No.</b> 8101063
	flange with bolt		



1

<b>GEV No.</b>	500286	<b>Ref. No.</b>	0501024
<b>description</b>	pump motor ATB type RF0.75/4-7 750W 230/400V 50Hz 3 phase L 260mm W 200mm H 190mm 1380rpm shaft ø 19mm		
<b>For models:</b>	DV221		



booster pumps I



1

<b>GEV No.</b>	500060	<b>Ref. No.</b>	0535056
<b>description</b>	pump inlet ø 1" outlet ø 1" type PQM60 230V 50Hz 1 phase 0.37kW PEDRELLLO		
<b>accessories for</b>	500060		
	<b>GEV No.</b>	365015	<b>Ref. No.</b>
			—
	operating capacitor capacity 10µF 400V tolerance 5%Hz ambient temperature max. -25 to +85°C ø 35.5mm L 59mm M8 plastic connection male faston 6.3mm protection		



1

<b>GEV No.</b>	500699	<b>Ref. No.</b>	9515059 9544233
<b>description</b>	drain pump inlet ø 24mm outlet ø 24mm 230V 70W 50Hz HANNING type BE22B3-174		
<b>For models:</b>	DV120.2, FV40.2, FV40.2 AB 2002, FV40.2 AB 2003, FV40.2M, FV40.2M-MIKE2		
<b>spare parts for</b>	500699		
	<b>GEV No.</b>	510168	<b>Ref. No.</b>
			—
	fan wheel shaft intake ø 5mm ø 62mm H 14mm		

drain pumps

HANNING



1

<b>GEV No.</b>	501510	<b>Ref. No.</b>	9614202
<b>description</b>	drain pump 200-240V inlet ø 24mm outlet ø 24mm 50/60Hz HANNING type BE22B5-052 coded plug		



1

<b>GEV No.</b>	500042	<b>Ref. No.</b>	0535502 0535505 0535509 9624073
<b>description</b>	drain pump inlet ø 24mm outlet ø 24mm 230V 80W 50Hz HANNING type KD22B3-679		
<b>For models:</b>	DV40T FA, ECO STAR 530F, FR40G AB 1980, FR40GUS AB 1980, FV28G AB 1994, FV28G AB 1997, FV28GFA, FV40GE, FV40N AB 1980, FV40T-FA, FV70TD		
<b>spare parts for</b>	500042		
	<b>GEV No.</b>	510168	<b>Ref. No.</b>
			—
	fan wheel shaft intake ø 5mm ø 62mm H 14mm		



1

<b>GEV No.</b>	499307	<b>Ref. No.</b>	9626210
<b>description</b>	drain pump 90W 400V inlet ø 24mm outlet ø 24mm 50Hz HANNING type BE22B3-191 2600rpm input current 0.4A		
<b>spare parts for</b>	499307		
	<b>GEV No.</b>	510168	<b>Ref. No.</b>
			—
	fan wheel shaft intake ø 5mm ø 62mm H 14mm		



booster pumps II

accessories



1	<b>GEV No.</b>	365012	<b>Ref. No.</b>	0501173
<b>description</b> operating capacitor capacity 6.3µF 450V tolerance 5% 50Hz ambient temperature max. -25 to +85°C ø 30mm L 61mm M8 plastic connection male faston 6.3mm protection				
<b>For models:</b> DV40T FA, FV28GFA, FV40TFA, FV70TD				



1	<b>GEV No.</b>	365019	<b>Ref. No.</b>	9606122
<b>description</b> operating capacitor capacity 20µF 400V tolerance 5% 50/60Hz ambient temperature max. -25 to +85°C ø 39.5mm L 70mm M8 plastic connection male faston 6.3mm 16.10.25. protection				



1	<b>GEV No.</b>	365012	<b>Ref. No.</b>	0501173
<b>description</b> operating capacitor capacity 6.3µF 450V tolerance 5% 50Hz ambient temperature max. -25 to +85°C ø 30mm L 61mm M8 plastic connection male faston 6.3mm protection				
<b>For models:</b> DV40T FA, FV28GFA, FV40TFA, FV70TD				

condensators & interference suppression filters

operating capacitors

plastic



1	<b>GEV No.</b>	365014	<b>Ref. No.</b>	0501090
<b>description</b> operating capacitor capacity 12.5µF 450V tolerance 5% 50Hz ambient temperature max. -25 to +85°C ø 35mm L 70mm M8 plastic connection male faston 6.3mm 45S.C3DS.12.5 protection				
<b>For models:</b> DR70, DV40 AB 1983, DV40 AB 1992, DV40N, DV40T, DV40T FA, DV80 AB 1975, ECO STAR 430F, ECO STAR 530F, FR30G, FR30G AB 1992, FR40G AB 1980, FR40G AB 1983, FR40GUS AB 1980, FR40GUS AB 1983, FV110G, FV20N, FV20T, FV25G AB 1986, FV25G AB 1992, FV28G AB 1994, FV28G AB 1997, FV28GFA, FV40.2, FV40.2 AB 2002, FV40.2 AB 2003, FV40.2M, FV40.2MIKE2, FV40.2M-MIKE2, FV40N AB 1980, FV40N AB 1983, FV40T, FV40TFA, FV70T, FV70TD				

metal



1	<b>GEV No.</b>	365131	<b>Ref. No.</b>	9520030
<b>description</b> capacitor capacity 5µF 450V tolerance 5% 50/60Hz ambient temperature max. -25 to +85°C ø 30mm L 60mm M8 aluminium connection male faston 6.3mm protection				
<b>For models:</b> DV120.2, FV40.2, FV40.2 AB 2002, FV40.2 AB 2003, FV40.2M, FV40.2MIKE2, FV40.2M-MIKE2				



1	<b>GEV No.</b>	365021	<b>Ref. No.</b>	0501136
<b>description</b> operating capacitor capacity 16µF 425V tolerance 5% 50/60Hz ambient temperature max. -25 to +85°C ø 35mm L 73mm single M8 plastic connection male faston 6.3mm 416.10.99 protection				
<b>For models:</b> DV160 AB 1996, DV80 AB 1992, DV80T				

filters

RC circuits





1	<b>GEV No.</b>	381218	<b>Ref. No.</b>	0138214 0142006 0142010 9006825 9530873 9543320 9548739 9548957 9549559
<b>description</b> RC circuit 275V cable length 200mm MKP class X2 voltage AC 100Ohm capacity 0.47µF				

## fuses

### fine fuses

 <p>1</p>			
<b>GEV No.</b>	358699	<b>Ref. No.</b>	0145000
<b>description</b>	fine fuse size ø5x20mm 10A medium lag rated 250V Qty 10 pcs		
<b>For models:</b>	DV120B, DV120T, DV40 AB 1992, DV40N, DV40T, DV40T FA, DV80 AB 1992, DV80T, ECO STAR 430F, ECO STAR 545D, FR30G AB 1992, FV110G, FV20N, FV20T, FV25G AB 1992, FV28GFA, FV30GS, FV40.2, FV40.2 AB 2003, FV40N AB 1992, FV40T, FV40TFA, FV60E AB 1988, FV70T, FV70TD		

 <p>1</p>			
<b>GEV No.</b>	358696	<b>Ref. No.</b>	0145013
<b>description</b>	fine fuse size ø5x20mm 4A medium lag rated 250V Qty 10 pcs		
<b>For models:</b>	DV120B, DV120T, DV160 AB 1996, DV240B AB 1996, DV270B AB 1992, DV40N, DV40T, DV40T FA, DV80 AB 1992, DV80T, ECO STAR 430F, ECO STAR 545D, FV130B, FV250B AB 1992, FV28GFA, FV70TD		

 <p>1</p>			
<b>GEV No.</b>	358598	<b>Ref. No.</b>	0145049
<b>description</b>	fine fuse size ø5x20mm 0.63A slow-acting rated 250V Qty 10 pcs		
<b>For models:</b>	DR70, DV100 AB 1980, DV120B, DV160 AB 1980, DV240B AB 1980, DV80, DV80 AB 1975, DV80 AB 1980		

 <p>1</p>			
<b>GEV No.</b>	358601	<b>Ref. No.</b>	0145048
<b>description</b>	fine fuse size ø5x20mm 1.25A slow-acting rated 250V Qty 10 pcs		
<b>For models:</b>	DR70, DV80 AB 1975		

 <p>1</p>			
<b>GEV No.</b>	358602	<b>Ref. No.</b>	0145046
<b>description</b>	fine fuse size ø5x20mm 1.6A slow-acting rated 250V Qty 10 pcs		

 <p>1</p>			
<b>GEV No.</b>	358600	<b>Ref. No.</b>	0145045
<b>description</b>	fine fuse size ø5x20mm 1A slow-acting rated 250V Qty 10 pcs		
<b>For models:</b>	FV28G AB 1994, FV28G AB 1997		

 <p>1</p>			
<b>GEV No.</b>	358603	<b>Ref. No.</b>	0145047
<b>description</b>	fine fuse size ø5x20mm 2A slow-acting rated 250V Qty 10 pcs		
<b>For models:</b>	FV40.2M, FV40.2M-MIKE2		

 <p>1</p>			
<b>GEV No.</b>	358607	<b>Ref. No.</b>	0145001
<b>description</b>	fine fuse size ø5x20mm 6.3A slow-acting rated 250V Qty 10 pcs		
<b>For models:</b>	DV120B, FV30, FV50		

 <p>1</p>			
<b>GEV No.</b>	358704	<b>Ref. No.</b>	0145002
<b>description</b>	fine fuse size ø5x20mm 8A slow-acting rated 250V Qty 10 pcs		

### screw locks

#### D-system (DIAZED)

 <p>1</p>			
<b>GEV No.</b>	358082	<b>Ref. No.</b>	0145007
<b>description</b>	fuse size DII 16A rated 500V E27 ø 22mm L 50mm Qty 5 pcs		

 <p>1</p>			
<b>GEV No.</b>	358084	<b>Ref. No.</b>	0145009
<b>description</b>	fuse size DII 25A rated 500V E27 ø 22mm L 50mm Qty 5 pcs		

### line circuit breakers

#### ABL SURSUM

 <p>1</p>			
<b>GEV No.</b>	358214	<b>Ref. No.</b>	0145093
<b>description</b>	line circuit breaker 1-pole 10A tripping type K rated 240/415V		
<b>For models:</b>	DV160 AB 1996, DV240B AB 1996, FV130B		



## electric accessories

### cables

#### ribbon cables

##### group 1



<b>GEV No.</b>	400816	<b>Ref. No.</b>	0180502
<b>description</b>	ribbon cable 10-pole L 800mm plug type FC-10P raster size 2.54mm		
<b>For models:</b>	DV40 AB 1992, DV40N, DV80 AB 1992, FR30G AB 1992, FV20N, FV20T, FV25G AB 1992, FV30GS, FV40N AB 1992, FV40T, FV70T		



<b>GEV No.</b>	401708	<b>Ref. No.</b>	0180507 9519723
<b>description</b>	ribbon cable 14-pole L 2500mm plug type FC-14P raster size 2.54mm		
<b>For models:</b>	DV120T, DV40T, DV40T FA, DV80T, ECO STAR 545D, FV20T, FV28GFA, FV40T, FV40TFA, FV70T, FV70TD		



<b>GEV No.</b>	400818	<b>Ref. No.</b>	0180558
<b>description</b>	ribbon cable 20-pole L 1800mm plug type FC-20P raster size 2.54mm		
<b>For models:</b>	FV28G AB 1994, FV28G AB 1997		



<b>GEV No.</b>	400841	<b>Ref. No.</b>	0180503
<b>description</b>	ribbon cable 20-pole L 800mm plug type FC-20P raster size 2.54mm		
<b>For models:</b>	DV120B, DV120T, DV160 AB 1996, DV240B AB 1996, DV270B AB 1992, DV40N, DV40T, DV80T, FV110G, FV130B, FV20T, FV250B AB 1992, FV40T, FV60E AB 1988, FV70T		

##### group 4



<b>GEV No.</b>	400845	<b>Ref. No.</b>	9503172
<b>description</b>	ribbon cable 10-pole L 1800mm		
<b>For models:</b>	ECO STAR 430F		



<b>GEV No.</b>	400846	<b>Ref. No.</b>	9503170
<b>description</b>	ribbon cable 10-pole L 800mm		
<b>For models:</b>	ECO STAR 430F		



<b>GEV No.</b>	358104	<b>Ref. No.</b>	0145089
<b>description</b>	line circuit breaker 1-pole 16A tripping type B rated 240/415V nominal 16A		
<b>For models:</b>	DV160 AB 1996, DV240B AB 1996, FV130B		



<b>GEV No.</b>	358216	<b>Ref. No.</b>	0145074
<b>description</b>	line circuit breaker 1-pole 16A tripping type K rated 240/415V		



<b>GEV No.</b>	358105	<b>Ref. No.</b>	0145090
<b>description</b>	line circuit breaker 1-pole 20A tripping type B rated 240/415V		
<b>For models:</b>	DV160 AB 1996, DV240B AB 1996, DV270B AB 1992, FV250B AB 1992		



<b>GEV No.</b>	358217	<b>Ref. No.</b>	0145094
<b>description</b>	line circuit breaker 1-pole 20A tripping type K rated 240/415V		
<b>For models:</b>	DV270B AB 1992, FV250B AB 1992		



<b>GEV No.</b>	358106	<b>Ref. No.</b>	0145091
<b>description</b>	line circuit breaker 1-pole 25A tripping type B rated 240/415V nominal 25A		



<b>GEV No.</b>	358210	<b>Ref. No.</b>	0145092
<b>description</b>	line circuit breaker 1-pole 4A tripping type K rated 240/415V		



## electronic magnets



1

<b>GEV No.</b>	400850	<b>Ref. No.</b>	0140055
<b>description</b>	lifting magnet		



1

<b>GEV No.</b>	698676	<b>Ref. No.</b>	0457042
<b>description</b>	lifting magnet 24V voltage DC L 55mm W 26mm H 68mm		

## equipment-specific units

### for espresso machines

#### intake valves

#### accessories

#### miscellaneous



1

<b>GEV No.</b>	528422	<b>Ref. No.</b>	0420080
<b>description</b>	ball ø 8mm SS		

### for convection ovens/combi-steamers

#### hoses



1

<b>GEV No.</b>	697978	<b>Ref. No.</b>	8100538
<b>description</b>	hose ID ø 40mm ED ø 50mm L 52mm		

## for cleaning and disinfection machines

### connection pieces



1

<b>GEV No.</b>	698694	<b>Ref. No.</b>	0113129
<b>description</b>	connecting fitting ø 35mm 3/4" H 25mm L 35mm W 35mm		



1

<b>GEV No.</b>	698690	<b>Ref. No.</b>	0620367
<b>description</b>	connection angle ø 32mm hose ø 12mm 1/4" H 28mm L 62mm W 32mm		



1

<b>GEV No.</b>	698689	<b>Ref. No.</b>	0620464
<b>description</b>	connection angle ø 32mm hose ø 14mm 3/8" H 20mm L 50mm W 50mm		



1

<b>GEV No.</b>	698685	<b>Ref. No.</b>	0620463
<b>description</b>	connection angle ø 42mm hose ø 20mm 3/4" H 42mm L 70mm W 32mm		



1

<b>GEV No.</b>	698693	<b>Ref. No.</b>	0620313
<b>description</b>	filling pipe hose ø 13mm 1/2" H 25mm L 90mm W 25mm		



1

<b>GEV No.</b>	698687	<b>Ref. No.</b>	8301471
<b>description</b>	non-return valve ø 35mm hose ø 14mm 1/2" L 78mm		

### various





1

<b>GEV No.</b>	698725	<b>Ref. No.</b>	9520736
<b>description</b>	bearing ø 8.5mm L 11mm W 8mm H 8mm for reel		
<b>For models:</b>	FV40.2, FV40.2MIKE2, FV40.2M-MIKE2		

			
1			
<b>GEV No.</b>	504792	<b>Ref. No.</b>	9625221
<b>description</b>	cap ø 38mm ID ø 26mm H 22mm 3/4"		

			
1			
<b>GEV No.</b>	698695	<b>Ref. No.</b>	9602351 9705766
<b>description</b>	flap ø 42.4mm L 31mm W 42.4mm H 42.4mm		

			
1			
<b>GEV No.</b>	689005	<b>Ref. No.</b>	9603328 9621469
<b>description</b>	funnel ø 20mm L 56.2mm W 20mm H 30mm M6 content 2kg		

			
1			
<b>GEV No.</b>	698696	<b>Ref. No.</b>	8300670
<b>description</b>	pipe ø 40mm aperture 7mm L 55mm W 40mm H 40mm M6		

			
1			
<b>GEV No.</b>	698722	<b>Ref. No.</b>	0650065
<b>description</b>	rubber sleeve ø 50mm ID ø 40mm H 20mm EPDM for tank		

			
1			
<b>GEV No.</b>	698733	<b>Ref. No.</b>	9500307
<b>description</b>	sealing ring ø 25mm ID ø 11mm H 6.5mm		

			
1			
<b>GEV No.</b>	698724	<b>Ref. No.</b>	9679702
<b>description</b>	set ø 26mm ID ø 4.5mm for U-bend		

			
1			
<b>GEV No.</b>	698728	<b>Ref. No.</b>	0620232
<b>description</b>	spacer bush ø 12.5mm ID ø 8.5mm L 13mm W 12.5mm		

			
1			
<b>GEV No.</b>	698732	<b>Ref. No.</b>	8302477
<b>description</b>	spacer ring ø 19mm ID ø 5mm H 5.5mm		

<b>nozzles</b>			
			
1			
<b>GEV No.</b>	698734	<b>Ref. No.</b>	9600911
<b>description</b>	injection nozzle ø 26mm ID ø 1mm L 21mm W 22mm 1/8"		

			
1			
<b>GEV No.</b>	698686	<b>Ref. No.</b>	8303773
<b>description</b>	jet ø 30mm W 14mm steam stainless steel 1/2"		

			
1			
<b>GEV No.</b>	699281	<b>Ref. No.</b>	9550394
<b>description</b>	nozzle ø 12.5mm ID ø 6.5mm aperture 2x3.5mm L 69mm		

			
1			
<b>GEV No.</b>	698682	<b>Ref. No.</b>	8304572
<b>description</b>	nozzle ø 13mm ID ø 9.5mm aperture 14x1mm L 67mm W 18mm H 17mm 145° 1/4"		

			
1			
<b>GEV No.</b>	698681	<b>Ref. No.</b>	8304431
<b>description</b>	nozzle ø 13mm ID ø 9.5mm aperture 14x1mm L 73mm W 18mm H 17mm 150° 1/4"		







			
1			
<b>GEV No.</b>	698680	<b>Ref. No.</b>	0620469
<b>description</b>	nozzle ø 80mm ID ø 24mm aperture 6/8mm H 31mm grey		

nozzle holders

			
1			
<b>GEV No.</b>	698688	<b>Ref. No.</b>	0620467
<b>description</b>	nozzle holder ø 10mm ID ø 9mm aperture 4.5mm L 35mm W 29.2mm H 24mm 3/8"		

			
1			
<b>GEV No.</b>	698691	<b>Ref. No.</b>	9601608
<b>description</b>	nozzle holder ø 10mm ID ø 9mm aperture 4.5mm L 38mm W 24mm H 29.5mm 3/8"		

			
1			
<b>GEV No.</b>	698684	<b>Ref. No.</b>	0620470
<b>description</b>	nozzle holder ø 24mm ID ø 18mm L 40mm W 45mm H 36mm		

pipes

			
1			
<b>GEV No.</b>	698692	<b>Ref. No.</b>	8304006
<b>description</b>	overflow pipe ø 25mm L 433mm H 155mm		

			
1			
<b>GEV No.</b>	698726	<b>Ref. No.</b>	8300113
<b>description</b>	pipe ø 8mm ID ø 6mm L 40mm W 8mm for ventilation		

			
1			
<b>GEV No.</b>	698735	<b>Ref. No.</b>	8302895
<b>description</b>	retaining ring ø 32mm ID ø 28.5mm H 4mm		

			
1			
<b>GEV No.</b>	698727	<b>Ref. No.</b>	9613045
<b>description</b>	spacer ring ø 34mm ID ø 32mm L 24mm		

door mechanics

			
1			
<b>GEV No.</b>	698697	<b>Ref. No.</b>	8304585
<b>description</b>	catch L 98mm W 60mm H 23mm for door		

screw connections

			
1			
<b>GEV No.</b>	698729	<b>Ref. No.</b>	9643458
<b>description</b>	screw connection for wash jet L 14.5mm W 24mm H 30mm grey 3/8"-1/4"		

			
1			
<b>GEV No.</b>	698730	<b>Ref. No.</b>	9654017
<b>description</b>	screw connection L 14.5mm W 24mm H 30mm grey 3/8"		

for dishwashers

drain and intake components

MEIKO

drain /intake bodies

			
1			
<b>GEV No.</b>	501079	<b>Ref. No.</b>	0431051
<b>description</b>	clamping ring ø 125mm		
<b>For models:</b>	DV160 AB 1996, DV240B AB 1996, DV40 AB 1992, DV80 AB 1983, DV80 AB 1992, FR30G AB 1992, FV130B, FV25G AB 1986, FV25G AB 1992, FV30GS, FV40N AB 1992, FV60E AB 1988		



1

<b>GEV No.</b>	501164	<b>Ref. No.</b>	0237002
<b>description</b>	drain fitting		
<b>For models:</b>	DR90, DV111, DV111E, DV221, FR60, FV120B AB 1980, FV240B AB 1980, FV240B AB 1983, FV30, FV50, FV50 M, FV60 AB 1976		





2

<b>GEV No.</b>	501300	<b>Ref. No.</b>	8002887
<b>description</b>	drain fitting complete thread 1½" ED ø 69mm ID ø 40mm		
<b>For models:</b>	DV160 AB 1996, DV240B AB 1996, DV40 AB 1992, DV80 AB 1992, FR30G AB 1992, FV130B, FV25G AB 1992, FV30GS, FV40N AB 1992, FV60E AB 1988		





1

<b>GEV No.</b>	522000	<b>Ref. No.</b>	0620219
<b>description</b>	drain fitting thread 1½" ID ø 40mm		
<b>For models:</b>	DV100 AB 1980, DV100 AB 1983, DV120B, DV160 AB 1980, DV160 AB 1983, DV160 AB 1996, DV240B AB 1980, DV240B AB 1983, DV240B AB 1996, DV40 AB 1983, DV40 AB 1992, DV80, DV80 AB 1980, DV80 AB 1983, DV80 AB 1992, FR30G, FR30G AB 1992, FR40G AB 1983, FR40GUS AB 1983, FV130B, FV25G AB 1986, FV25G AB 1992, FV30GS, FV40N AB 1980, FV40N AB 1983, FV40N AB 1992, FV60E AB 1983, FV60E AB 1988		
<b>accessories for</b>	522000		
	<b>GEV No.</b>	501320	<b>Ref. No.</b> —
	flat gasket rubber ED ø 68mm ID ø 48mm thickness 2mm Qty 1 pcs		
	<b>GEV No.</b>	510406	<b>Ref. No.</b> 0408020
	flat gasket fibre ED ø 60mm ID ø 48mm thickness 3mm for thread 1½" Qty 1 pcs		
	<b>GEV No.</b>	522003	<b>Ref. No.</b> 0212005
	hexagonal nut thread 1½" brass		



1

<b>GEV No.</b>	501065	<b>Ref. No.</b>	0237003
<b>description</b>	drain fitting thread 2"		
<b>For models:</b>	DV270B AB 1992, FV120B AB 1980, FV200B, FV240B AB 1980		
<b>accessories for</b>	501065		
	<b>GEV No.</b>	501066	<b>Ref. No.</b> 0237009 0408224
	flat gasket rubber ED ø 85mm ID ø 59.5mm thickness 2mm Qty 1 pcs		
	<b>GEV No.</b>	501123	<b>Ref. No.</b> 8650064
	overflow pipe L 217mm ø 47mm		

<b>accessories for</b>	501065		
	<b>GEV No.</b>	501301	<b>Ref. No.</b> 0237008
	nut stand pipe thread 2" H 16.5mm		



1

<b>GEV No.</b>	501428	<b>Ref. No.</b>	0237100
<b>description</b>	drain fitting thread 2"		
<b>accessories for</b>	501428		
	<b>GEV No.</b>	501066	<b>Ref. No.</b> 0237009 0408224
	flat gasket rubber ED ø 85mm ID ø 59.5mm thickness 2mm Qty 1 pcs		



1

<b>GEV No.</b>	501165	<b>Ref. No.</b>	0237028
<b>description</b>	drain fitting with safety nut thread 2" ED ø 80mm ID ø 53mm		
<b>For models:</b>	DV260B, FV120B AB 1983, FV240B AB 1983		



1

<b>GEV No.</b>	510406	<b>Ref. No.</b>	0408020
<b>description</b>	flat gasket fibre ED ø 60mm ID ø 48mm thickness 3mm for thread 1½" Qty 1 pcs		
<b>For models:</b>	DV100 AB 1983, DV120B, DV160 AB 1983, DV160 AB 1996, DV240B AB 1983, DV240B AB 1996, DV40 AB 1983, DV40 AB 1992, DV80, DV80 AB 1983, DV80 AB 1992, FR30G, FR30G AB 1992, FR40G AB 1983, FR40GUS AB 1983, FV130B, FV25G AB 1986, FV25G AB 1992, FV30GS, FV40N AB 1983, FV40N AB 1992, FV60E AB 1983, FV60E AB 1988		





1

<b>GEV No.</b>	510875	<b>Ref. No.</b>	0408214
<b>description</b>	flat gasket rubber ED ø 68mm ID ø 48mm thickness 2mm Qty 1 pcs		
<b>For models:</b>	DV100 AB 1980, DV100 AB 1983, DV120B, DV160 AB 1980, DV160 AB 1983, DV160 AB 1996, DV240B AB 1980, DV240B AB 1983, DV240B AB 1996, DV40 AB 1983, DV40 AB 1992, DV80, DV80 AB 1980, DV80 AB 1983, DV80 AB 1992, FR30G, FR30G AB 1992, FR40G AB 1980, FR40G AB 1983, FR40GUS AB 1980, FR40GUS AB 1983, FV130B, FV25G AB 1986, FV25G AB 1992, FV30GS, FV40N AB 1980, FV40N AB 1983, FV40N AB 1992, FV60E AB 1983, FV60E AB 1988		





			
1			
<b>GEV No.</b>	501066	<b>Ref. No.</b>	0237009 0408224
<b>description</b>	flat gasket rubber ED ø 85mm ID ø 59.5mm thickness 2mm Qty 1 pcs		
<b>For models:</b>	DV270B AB 1992		

			
1			
<b>GEV No.</b>	504465	<b>Ref. No.</b>	9515234
<b>description</b>	gasket suitable for MEIKO for air valve ED ø 14mm ID ø 9mm EPDM thickness 1.6mm		
<b>For models:</b>	FV40.2, FV40.2M-MIKE2		

			
1			
<b>GEV No.</b>	501299	<b>Ref. No.</b>	8660464
<b>description</b>	hexagonal nut thread 1/2" H 5mm SS WS 27 Qty 1 pcs		
<b>For models:</b>	DV120T, DV40N, DV40T, DV40T FA, DV80T		

			
1			
<b>GEV No.</b>	522003	<b>Ref. No.</b>	0212005
<b>description</b>	hexagonal nut thread 1 1/2" brass		
<b>For models:</b>	DV100 AB 1980, DV100 AB 1983, DV120B, DV160 AB 1980, DV160 AB 1983, DV160 AB 1996, DV240B AB 1980, DV240B AB 1983, DV240B AB 1996, DV270B AB 1992, DV40 AB 1983, DV40 AB 1992, DV80, DV80 AB 1980, DV80 AB 1983, DV80 AB 1992, FR30G, FR30G AB 1992, FR40G AB 1980, FR40G AB 1983, FR40GUS AB 1980, FR40GUS AB 1983, FV130B, FV250B AB 1992, FV25G AB 1986, FV25G AB 1992, FV30GS, FV40N AB 1980, FV40N AB 1983, FV40N AB 1992, FV60E AB 1983, FV60E AB 1988		

			
1			
<b>GEV No.</b>	501054	<b>Ref. No.</b>	8000194 8001008
<b>description</b>	intake body		
<b>For models:</b>	FV25G AB 1986, FV25G AB 1992		

			
1			
<b>GEV No.</b>	501105	<b>Ref. No.</b>	8000095
<b>description</b>	intake body		
<b>For models:</b>	FR30G AB 1992, FV120B AB 1983, FV240B AB 1983		

			
1			
<b>GEV No.</b>	501146	<b>Ref. No.</b>	8002263
<b>description</b>	intake body		
<b>For models:</b>	ECO STAR 430F, ECO STAR 530F, FV28GFA		

			
1			
<b>GEV No.</b>	501147	<b>Ref. No.</b>	8002264
<b>description</b>	intake body		
<b>For models:</b>	ECO STAR 430F, ECO STAR 530F		

			
1			
<b>GEV No.</b>	501148 <sup>1</sup>	<b>Ref. No.</b>	8002534
<b>description</b>	intake body		
<b>For models:</b>	ECO STAR 430F, ECO STAR 530F, FV28G AB 1994		

<sup>1</sup>for drain pump

			
1			
<b>GEV No.</b>	501215	<b>Ref. No.</b>	8000021
<b>description</b>	intake body		
<b>For models:</b>	FR30G, FR30G AB 1992, FR40G AB 1983, FR40GUS AB 1983		

			
1			
<b>GEV No.</b>	501232	<b>Ref. No.</b>	8000056
<b>description</b>	intake body		



1

<b>GEV No.</b>	501233	<b>Ref. No.</b>	8000065
<b>description</b>	intake body		
<b>For models:</b>	DV160 AB 1996, DV240B AB 1996, DV40 AB 1983, DV40 AB 1992, DV80 AB 1983, DV80 AB 1992		



1

<b>GEV No.</b>	501245	<b>Ref. No.</b>	8000076
<b>description</b>	intake body		
<b>For models:</b>	DV100 AB 1983, DV160 AB 1983		



1

<b>GEV No.</b>	501254	<b>Ref. No.</b>	8002176
<b>description</b>	intake body		
<b>For models:</b>	FV30GS		



1

<b>GEV No.</b>	501152	<b>Ref. No.</b>	8003831
<b>description</b>	intake body angled		
<b>For models:</b>	ECO STAR 430F, ECO STAR 530F, FV28GFA, FV70TD		



1

<b>GEV No.</b>	501157	<b>Ref. No.</b>	8004985
<b>description</b>	intake body angled		
<b>For models:</b>	ECO STAR 430F, ECO STAR 530F, FV28GFA, FV40TFA, FV70TD		



1

<b>GEV No.</b>	501218	<b>Ref. No.</b>	8000032
<b>description</b>	intake body ED ø 128mm hose ø 40mm		
<b>For models:</b>	FV40N AB 1983, FV40N AB 1992, FV60E AB 1988		



1

<b>GEV No.</b>	501112	<b>Ref. No.</b>	8000855
<b>description</b>	intake body ED ø 130mm ID ø 55mm hose ø 55mm		
<b>For models:</b>	FV130B		



1

<b>GEV No.</b>	501058	<b>Ref. No.</b>	8003301
<b>description</b>	intake body inlet fitting equiv. no. 8003301		
<b>For models:</b>	DV40T FA, ECO STAR 430F, ECO STAR 530F		



1

<b>GEV No.</b>	501243	<b>Ref. No.</b>	8000082
<b>description</b>	intake body kit		
<b>For models:</b>	DV120B, DV240B AB 1983, DV80		





1

<b>GEV No.</b>	501155	<b>Ref. No.</b>	8004844
<b>description</b>	intake body pump sump		
<b>For models:</b>	ECO STAR 530F, FV20N, FV20T, FV40T, FV40TFA, FV70T, FV70TD		







			
1			
<b>GEV No.</b>	501199	<b>Ref. No.</b>	0620430
<b>description</b>	intake body pump sump ED ø 160mm ID ø 41mm hose ø 21mm		
<b>For models:</b>	ECO STAR 430F, FV28G AB 1994, FV28G AB 1997, FV28GFA		

			
1			
<b>GEV No.</b>	501149	<b>Ref. No.</b>	8003639
<b>description</b>	intake body pump sump with stand pipe		
<b>For models:</b>	FV110G, FV20N, FV20T, FV40T, FV70T, FV70TD		

			
1			
<b>GEV No.</b>	501150	<b>Ref. No.</b>	8003669
<b>description</b>	intake body pump sump with stand pipe		
<b>For models:</b>	DV40 AB 1992, DV80 AB 1992		

			
1			
<b>GEV No.</b>	501151	<b>Ref. No.</b>	8003787
<b>description</b>	intake body pump sump with stand pipe		
<b>For models:</b>	DV120B		

			
1			
<b>GEV No.</b>	501258	<b>Ref. No.</b>	8004721
<b>description</b>	intake body with electrodes thread 1½" ID ø 55mm hose ø 63mm		
<b>For models:</b>	DV120T		

			
1			
<b>GEV No.</b>	501063	<b>Ref. No.</b>	8004720
<b>description</b>	intake body without electrodes thread 1¼" ID ø 35mm hose ø 40mm		
<b>For models:</b>	DV40N, DV40T, DV40T FA, DV80T, ECO STAR 545D		
<b>accessories for</b>	501063		
	<b>GEV No.</b>	501009	<b>Ref. No.</b> 0401061
	O-ring EPDM thickness 3.53mm ID ø 206.5mm Qty 1 pcs		
	<b>GEV No.</b>	501037	<b>Ref. No.</b> 0620457
	overflow pipe L 255mm ø 33mm		

<b>accessories for</b>	501063		
	<b>GEV No.</b>	501205	<b>Ref. No.</b> 0620447 8070117
	overflow pipe L 214mm ø 33mm		

			
1			
<b>GEV No.</b>	501301	<b>Ref. No.</b>	0237008
<b>description</b>	nut stand pipe thread 2" H 16.5mm		
<b>For models:</b>	DV270B AB 1992		

			
1			
<b>GEV No.</b>	501321	<b>Ref. No.</b>	0212006
<b>description</b>	octagonal nut thread 1½"		

			
1			
<b>GEV No.</b>	501094	<b>Ref. No.</b>	8000022
<b>description</b>	opposite support ED ø 117mm ID ø 61mm thickness 1.4mm 9 holes hole ø 7mm		
<b>For models:</b>	DV100 AB 1983, DV120B, DV160 AB 1983, DV160 AB 1996, DV240B AB 1983, DV240B AB 1996, DV260B, DV40 AB 1983, DV40 AB 1992, DV80, DV80 AB 1983, DV80 AB 1992, FR30G, FR30G AB 1992, FR40G AB 1983, FR40GUS AB 1983, FV120B AB 1983, FV130B, FV240B AB 1983, FV25G AB 1986, FV25G AB 1992, FV30GS, FV40N AB 1983, FV40N AB 1992, FV60E AB 1983, FV60E AB 1988		

			
1			
<b>GEV No.</b>	100809	<b>Ref. No.</b>	0401016
<b>description</b>	O-ring EPDM thickness 2mm ID ø 21mm Qty 1 pcs		
<b>For models:</b>	DV120.2, DV120T, DV40N, DV40T, DV40T FA, DV80T, ECO STAR 545D, FV40.2, FV40.2 AB 2002, FV40.2M, FV40.2M-MIKE2		

			
1			
<b>GEV No.</b>	501009	<b>Ref. No.</b>	0401061
<b>description</b>	O-ring EPDM thickness 3.53mm ID ø 206.5mm Qty 1 pcs		
<b>For models:</b>	DV120.2, DV120B, DV120T, DV40 AB 1992, DV40N, DV40T, DV40T FA, DV80 AB 1992, DV80T, ECO STAR 530F, ECO STAR 545D, FV110G, FV20N, FV20T, FV40T, FV40TFA, FV70T, FV70TD		

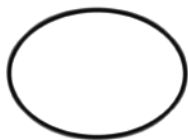

1

<b>GEV No.</b>	501173	<b>Ref. No.</b>	0401070
----------------	--------	-----------------	---------

<b>description</b>	O-ring EPDM thickness 3mm ID ø 122mm Qty 1 pcs		
--------------------	--	--	--

<b>For models:</b>	ECO STAR 430F, FV28G AB 1994, FV28G AB 1997, FV28GFA		
--------------------	--	--	--



1

<b>GEV No.</b>	501008	<b>Ref. No.</b>	0401045
----------------	--------	-----------------	---------

<b>description</b>	O-ring EPDM thickness 3mm ID ø 64mm Qty 1 pcs		
--------------------	---	--	--

<b>For models:</b>	DV100 AB 1983, DV120B, DV160 AB 1983, DV160 AB 1996, DV240B AB 1983, DV240B AB 1996, DV260B, DV40 AB 1983, DV40 AB 1992, DV80, DV80 AB 1983, DV80 AB 1992, FR30G, FR30G AB 1992, FR40G AB 1983, FR40GUS AB 1983, FV120B AB 1983, FV130B, FV240B AB 1983, FV25G AB 1986, FV25G AB 1992, FV30GS, FV40N AB 1983, FV40N AB 1992, FV60E AB 1983, FV60E AB 1988		
--------------------	---	--	--



1

<b>GEV No.</b>	532682	<b>Ref. No.</b>	9600791
----------------	--------	-----------------	---------

<b>description</b>	O-ring EPDM thickness 4mm ID ø 188mm Qty 1 pcs Shore 70°		
--------------------	--	--	--



1

<b>GEV No.</b>	501107	<b>Ref. No.</b>	8000471
----------------	--------	-----------------	---------

<b>description</b>	reinforcing ring ED ø 56mm ID ø 53mm L 20mm thickness 1.5mm stainless steel		
--------------------	---	--	--

<b>For models:</b>	DV120B, DV80, FV130B		
--------------------	----------------------	--	--

## filters



1

<b>GEV No.</b>	698625	<b>Ref. No.</b>	9607788
----------------	--------	-----------------	---------

<b>description</b>	cover cap for filter ø 74mm H 36mm		
--------------------	------------------------------------	--	--

<b>For models:</b>	FV40.2, FV40.2M-MIKE2		
--------------------	-----------------------	--	--



1

<b>GEV No.</b>	524338	<b>Ref. No.</b>	0620358
----------------	--------	-----------------	---------

<b>description</b>	drain filter for overflow pipe ø 61mm H 98mm		
--------------------	--	--	--



1

<b>GEV No.</b>	517770	<b>Ref. No.</b>	9540851
----------------	--------	-----------------	---------

<b>description</b>	flat filter for dishwasher H 11mm L 294mm W 300mm SS		
--------------------	--	--	--



1

<b>GEV No.</b>	517771	<b>Ref. No.</b>	9540865
----------------	--------	-----------------	---------

<b>description</b>	flat filter for dishwasher H 33mm L 300mm W 286mm SS		
--------------------	--	--	--



1

<b>GEV No.</b>	507559	<b>Ref. No.</b>	0251102
----------------	--------	-----------------	---------

			9547242
			9637803

<b>description</b>	flat filter L 298mm W 286mm		
--------------------	-----------------------------	--	--



1

<b>GEV No.</b>	501437	<b>Ref. No.</b>	9612003
----------------	--------	-----------------	---------

<b>description</b>	intake filter ø 195mm H 170mm		
--------------------	-------------------------------	--	--



1

<b>GEV No.</b>	501438	<b>Ref. No.</b>	9612087
----------------	--------	-----------------	---------

<b>description</b>	intake filter ø 230mm H 360mm		
--------------------	-------------------------------	--	--



1

<b>GEV No.</b>	501181	<b>Ref. No.</b>	9514944
----------------	--------	-----------------	---------

			961199
			9611991

<b>description</b>	round filters ø 125mm H 125mm		
--------------------	-------------------------------	--	--

<b>For models:</b>	FV40.2, FV40.2MIKE2, FV40.2M-MIKE2		
--------------------	------------------------------------	--	--



			
1			
<b>GEV No.</b>	517731	<b>Ref. No.</b>	8001109
<b>description</b>	round filters ø 135mm H 70mm		

			
1			
<b>GEV No.</b>	501200	<b>Ref. No.</b>	0620431
<b>description</b>	round filters ø 160mm H 56mm		
<b>For models:</b>	ECO STAR 430F, FV28G AB 1994, FV28G AB 1997, FV28GFA		

			
1			
<b>GEV No.</b>	517769	<b>Ref. No.</b>	9538626
<b>description</b>	round filters ø 190mm H 170mm plastic hole ø 26mm		

			
1			
<b>GEV No.</b>	501023	<b>Ref. No.</b>	0620346
<b>description</b>	round filters ø 200mm H 94mm		
<b>For models:</b>	DV120B, DV120T, DV40 AB 1992, DV40N, DV40T, DV40T FA, DV80 AB 1992, DV80T, ECO STAR 530F, ECO STAR 545D, FV110G, FV20N, FV20T, FV40T, FV40TFA, FV70T, FV70TD		

			
1			
<b>GEV No.</b>	507557 <sup>1</sup>	<b>Ref. No.</b>	9502656 9502657 9502667 9630597
<b>description</b>	round filters ø 80mm H 56mm		

<sup>1</sup>for drain pump

			
1			
<b>GEV No.</b>	501053	<b>Ref. No.</b>	8000193
<b>description</b>	round filters suction		
<b>For models:</b>	FV25G AB 1986		

			
1			
<b>GEV No.</b>	501207	<b>Ref. No.</b>	0620500
<b>description</b>	round filters suction ø 133mm H 45mm		
<b>For models:</b>	DV100 AB 1983, DV120B, DV160 AB 1983, DV160 AB 1996, DV240B AB 1983, DV240B AB 1996, DV40 AB 1983, DV40 AB 1992, DV80, DV80 AB 1983, DV80 AB 1992, FR30G, FR30G AB 1992, FR40G AB 1983, FR40GUS AB 1983, FV25G AB 1992, FV30GS, FV40N AB 1983, FV40N AB 1992, FV60E AB 1983, FV60E AB 1988		

			
1			
<b>GEV No.</b>	501091	<b>Ref. No.</b>	0620501
<b>description</b>	round filters suction ø 135mm H 100mm		
<b>For models:</b>	FV130B		

			
1			
<b>GEV No.</b>	501124	<b>Ref. No.</b>	8680031
<b>description</b>	round filters suction/ with locking ring H 101mm		
<b>For models:</b>	DV260B, FV120B AB 1983, FV240B AB 1983		

overflow pipes

			
1			
<b>GEV No.</b>	524815	<b>Ref. No.</b>	0620456
<b>description</b>	extension for overflow pipe ø 45mm ID ø 41mm L 132mm		



1

<b>GEV No.</b>	501114	<b>Ref. No.</b>	8000098
<b>description</b>	overflow pipe		



1

<b>GEV No.</b>	501115	<b>Ref. No.</b>	8650003
<b>description</b>	overflow pipe		



1

<b>GEV No.</b>	501038	<b>Ref. No.</b>	0620600
<b>description</b>	overflow pipe L 100mm ø 40mm		
<b>For models:</b>	FR30G, FR30G AB 1992, FR40G AB 1983, FR40GUS AB 1983, FV25G AB 1992		



1

<b>GEV No.</b>	501208	<b>Ref. No.</b>	0620601
<b>description</b>	overflow pipe L 120mm ø 40mm		
<b>For models:</b>	FR30G AB 1992, FV30GS, FV40N AB 1980, FV40N AB 1983, FV40N AB 1992, FV60E AB 1983, FV60E AB 1988		



1

<b>GEV No.</b>	501092	<b>Ref. No.</b>	0620602
<b>description</b>	overflow pipe L 130mm ø 40mm		
<b>For models:</b>	FR30G AB 1992, FR40G AB 1980, FR40GUS AB 1980		



1

<b>GEV No.</b>	501132	<b>Ref. No.</b>	0620347
<b>description</b>	overflow pipe L 140mm ø 30mm		
<b>For models:</b>	ECO STAR 430F, ECO STAR 530F, FV110G, FV20N, FV20T, FV28G AB 1994, FV28G AB 1997, FV28GFA, FV40T, FV40TFA, FV70T, FV70TD		



1

<b>GEV No.</b>	501209	<b>Ref. No.</b>	0620603
<b>description</b>	overflow pipe L 140mm ø 40mm		
<b>For models:</b>	DV100 AB 1983, DV120B, DV160 AB 1983, DV160 AB 1996, DV240B AB 1983, DV240B AB 1996, DV40 AB 1983, DV40 AB 1992, DV80, DV80 AB 1983, DV80 AB 1992, FR30G AB 1992		



1

<b>GEV No.</b>	501133	<b>Ref. No.</b>	0620348
<b>description</b>	overflow pipe L 175mm ø 30mm		
<b>For models:</b>	DV120B, DV40 AB 1992, DV80 AB 1992		



1

<b>GEV No.</b>	501122	<b>Ref. No.</b>	8650009
<b>description</b>	overflow pipe L 195mm ø 40mm		
<b>For models:</b>	DR90, DV111, DV111E, FR30G AB 1992, FV130B		





1

<b>GEV No.</b>	501205	<b>Ref. No.</b>	0620447 8070117
<b>description</b>	overflow pipe L 214mm ø 33mm		
<b>For models:</b>	DV40N, DV40T, DV40T FA		



			
1			
<b>GEV No.</b>	501123	<b>Ref. No.</b>	8650064
<b>description</b>	overflow pipe L 217mm ø 47mm		
<b>For models:</b>	DV270B AB 1992, FV250B AB 1992		

			
1			
<b>GEV No.</b>	501037	<b>Ref. No.</b>	0620457
<b>description</b>	overflow pipe L 255mm ø 33mm		
<b>For models:</b>	DV120T, DV40N, DV40T, DV40T FA, ECO STAR 545D		

			
1			
<b>GEV No.</b>	524375	<b>Ref. No.</b>	8101478
<b>description</b>	overflow pipe L 300mm ø 50mm		

			
1			
<b>GEV No.</b>	517732	<b>Ref. No.</b>	8258585
<b>description</b>	overflow pipe L 365mm ø 50mm		

			
1			
<b>GEV No.</b>	517772	<b>Ref. No.</b>	9514931
<b>description</b>	standpipe ø 50mm L 150mm		

containers

container lids

			
1			
<b>GEV No.</b>	501185	<b>Ref. No.</b>	0620127
<b>description</b>	cap		
<b>For models:</b>	DR90, DV111, DV111E, DV250B, FV60 AB 1973		

			
1			
<b>GEV No.</b>	501386	<b>Ref. No.</b>	9500040
<b>description</b>	cap ø 62.5mm suitable for MEIKO		

dosing containers

			
1			
<b>GEV No.</b>	501257	<b>Ref. No.</b>	8004424
<b>description</b>	cleaner container		
<b>For models:</b>	ECO STAR 545D, FV28G AB 1994, FV28G AB 1997, FV28GFA		



1

<b>GEV No.</b>	501067	<b>Ref. No.</b>	0260028
<b>description</b>	dosing container		
<b>For models:</b>	DV100 AB 1980, DV100 AB 1983, DV120B, DV160 AB 1980, DV240B AB 1980, DV260B, DV40 AB 1983, DV80, DV80 AB 1980, DV80 AB 1983, FR40G AB 1976, FR40G AB 1980, FR40G AB 1983, FR40GUS AB 1976, FR40GUS AB 1980, FR40GUS AB 1983, FV120B AB 1980, FV120B AB 1983, FV240B AB 1980, FV240B AB 1983, FV30, FV40N AB 1980, FV40N AB 1983, FV40N AB 1992, FV50, FV50 M, FV60E AB 1983, FV60E AB 1988		



1

<b>GEV No.</b>	501002	<b>Ref. No.</b>	0260040
<b>description</b>	rinse aid container		

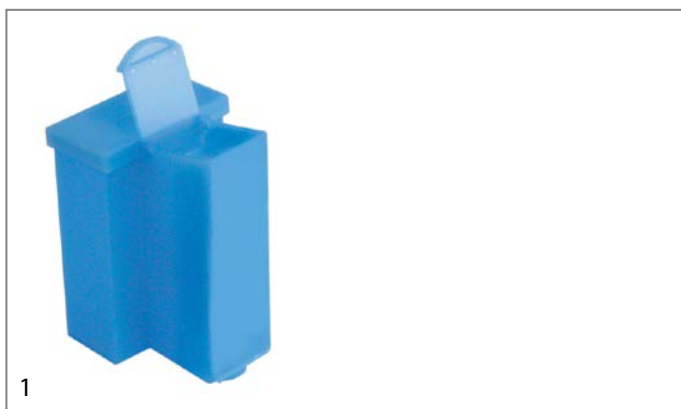

1

<b>GEV No.</b>	501059	<b>Ref. No.</b>	8003830
<b>description</b>	rinse aid container		
<b>For models:</b>	DV120T, DV160 AB 1996, DV240B AB 1996, DV40N, DV40T, DV40T FA, DV80T, ECO STAR 430F, ECO STAR 530F, ECO STAR 545D, FR30G AB 1992, FV110G, FV130B, FV20N, FV20T, FV250B AB 1992, FV28G AB 1994, FV28G AB 1997, FV28GFA, FV40T, FV40TFA, FV70T, FV70TD		



1

<b>GEV No.</b>	501166	<b>Ref. No.</b>	0260018
<b>description</b>	rinse aid container		

salt tanks



1

<b>GEV No.</b>	524177	<b>Ref. No.</b>	9532505	
<b>description</b>	lid ø 69mm H 20mm for salt tank ID ø 50mm			
<b>accessories for</b>	524177			
	<b>GEV No.</b>	524148	<b>Ref. No.</b>	—
	O-ring EPDM thickness 3.53mm ID ø 40.86mm Qty 1 pcs			



1









<b>GEV No.</b>	510929	<b>Ref. No.</b>	0270106	
<b>description</b>	salt tank ø 120mm H 117mm hose ø 10mm mounting ø 70mm overall height 157mm			
<b>For models:</b>	ECO STAR 545D			
<b>spare parts for</b>	510929			
	<b>GEV No.</b>	506015	<b>Ref. No.</b>	—
	O-ring EPDM thickness 3.53mm ID ø 39.69mm Qty 1 pcs			
	<b>GEV No.</b>	510018	<b>Ref. No.</b>	—
	nut ø 92mm H 10.5mm for salt tank ID ø 64mm			
	<b>GEV No.</b>	524177	<b>Ref. No.</b>	9532505
	lid ø 69mm H 20mm for salt tank ID ø 50mm			
<b>accessories for</b>	510929			
	<b>GEV No.</b>	510071	<b>Ref. No.</b>	—
	flat gasket rubber ED ø 81mm ID ø 68mm thickness 3mm for salt tank Qty 1 pcs			

Table continues overleaf





<b>accessories for</b> 510929				
	<b>GEV No.</b>	510654	<b>Ref. No.</b>	—
gasket H 6mm D1 ø 82mm D2 ø 68mm				
	<b>GEV No.</b>	510883	<b>Ref. No.</b>	9500825
gasket rubber ED ø 86mm ID ø 66mm thickness 2mm for salt tank Qty 1 pcs				

accessories				
				
1				
<b>GEV No.</b>	510883	<b>Ref. No.</b>	9500825	
<b>description</b>	gasket rubber ED ø 86mm ID ø 66mm thickness 2mm for salt tank Qty 1 pcs			
<b>For models:</b>	ECO STAR 545D			

boilers				
boilers for dishwashers				
				
Image not available				
1				
<b>GEV No.</b>	501158	<b>Ref. No.</b>	8400337	
<b>description</b>	boiler			

				
1				
<b>GEV No.</b>	501159	<b>Ref. No.</b>	8400304 8400328 8400338	
<b>description</b>	boiler			
<b>For models:</b>	FV40TFA, FV70TD			

				
Image not available				
1				
<b>GEV No.</b>	501229	<b>Ref. No.</b>	8000050	
<b>description</b>	boiler			
<b>For models:</b>	FV60E AB 1983			

				
1				
<b>GEV No.</b>	501260	<b>Ref. No.</b>	8400112	
<b>description</b>	boiler			
<b>For models:</b>	FV40N AB 1992, FV60E AB 1988			

				
1				
<b>GEV No.</b>	501261	<b>Ref. No.</b>	8400122	
<b>description</b>	boiler			
<b>For models:</b>	FR30G AB 1992, FV25G AB 1992, FV30GS			

				
Image not available				
1				
<b>GEV No.</b>	501263	<b>Ref. No.</b>	8400132	
<b>description</b>	boiler			

				
Image not available				
1				
<b>GEV No.</b>	501264	<b>Ref. No.</b>	8400162	
<b>description</b>	boiler			

				
1				
<b>GEV No.</b>	501265	<b>Ref. No.</b>	8400172 8400271 8400271/8004085/90	
<b>description</b>	boiler			

				
1				
<b>GEV No.</b>	501266	<b>Ref. No.</b>	8400208	
<b>description</b>	boiler			
<b>For models:</b>	DV40 AB 1992			



1

<b>GEV No.</b>	501267	<b>Ref. No.</b>	8400272
<b>description</b>	boiler		



1

<b>GEV No.</b>	501268	<b>Ref. No.</b>	8400280
<b>description</b>	boiler		
<b>For models:</b>	FV28G AB 1994, FV28G AB 1997		



1

<b>GEV No.</b>	501279	<b>Ref. No.</b>	8400267
<b>description</b>	boiler		
<b>For models:</b>	FV110G, FV20N, FV20T, FV40T, FV70T		



1

<b>GEV No.</b>	501285	<b>Ref. No.</b>	8400030 8400269
<b>description</b>	boiler		
<b>For models:</b>	DV120B, DV120T, DV80 AB 1983, DV80 AB 1992, DV80T, ECO STAR 545D, FV130B		



1

<b>GEV No.</b>	501304	<b>Ref. No.</b>	8400316 8400357
<b>description</b>	boiler		
<b>For models:</b>	DV40T FA		



1

<b>GEV No.</b>	501305	<b>Ref. No.</b>	9505183 9506370
<b>description</b>	boiler 3000W		
<b>For models:</b>	ECO STAR 430F, ECO STAR 530F		



1

<b>GEV No.</b>	501306	<b>Ref. No.</b>	9505184 9506365 9684165
<b>description</b>	boiler 4500W ø 150mm L 450mm		
<b>For models:</b>	ECO STAR 430F, ECO STAR 530F		

## accessories



1

<b>GEV No.</b>	501274	<b>Ref. No.</b>	8000078
<b>description</b>	boiler case		
<b>For models:</b>	DV100 AB 1983, DV260B		



1

<b>GEV No.</b>	501275	<b>Ref. No.</b>	8000081
<b>description</b>	boiler case		



1

<b>GEV No.</b>	501277	<b>Ref. No.</b>	8400032
<b>description</b>	boiler case		



1

<b>GEV No.</b>	508420	<b>Ref. No.</b>	9601016
<b>description</b>	flap for steam generator rubber ø 37mm ID ø 25mm thickness 5mm built-in version		



1

<b>GEV No.</b>	501113	<b>Ref. No.</b>	8000978
<b>description</b>	T-piece		

softener cartridges

softening columns



1

<b>GEV No.</b>	530006	<b>Ref. No.</b>	0270062
<b>description</b>	softener		



1

<b>GEV No.</b>	530000	<b>Ref. No.</b>	0270064
<b>description</b>	softener 4-fold L 380mm W 180mm		



1

<b>GEV No.</b>	501170	<b>Ref. No.</b>	0270063
<b>description</b>	softener 8 row L 385mm W 435mm		

housing and bezels

miscellaneous



1

<b>GEV No.</b>	524575	<b>Ref. No.</b>	0620455
<b>description</b>	spacer for cover plastic L 22mm ID ø 4.5mm ED ø 12mm		

hood mechanics for dishwashers

bolts



1

<b>GEV No.</b>	524774	<b>Ref. No.</b>	8000220
<b>description</b>	bolt ED ø 12mm L 51mm thread M8x1.25 for hood mechanics WS 17		



1

<b>GEV No.</b>	501238	<b>Ref. No.</b>	8000071
<b>description</b>	bolt hood mechanics		
<b>For models:</b>	DR70, DV100 AB 1983, DV120, DV120B, DV160 AB 1983, DV160 AB 1996, DV240B AB 1983, DV240B AB 1996, DV260B, DV40 AB 1983, DV40 AB 1992, DV80, DV80 AB 1975, DV80 AB 1980, DV80 AB 1983, DV80 AB 1992		



1

<b>GEV No.</b>	501055	<b>Ref. No.</b>	8000230
<b>description</b>	screw bolt for roller hood mechanics		
<b>For models:</b>	DR90, DV111, DV111E, DV120, DV120B, DV120T, DV160 AB 1996, DV240B AB 1996, DV250B, DV40 AB 1983, DV40 AB 1992, DV40N, DV40T, DV40T FA, DV80, DV80 AB 1980, DV80 AB 1983, DV80 AB 1992, DV80T		

spring holders



1

<b>GEV No.</b>	524818	<b>Ref. No.</b>	8004144
<b>description</b>	bracket for spring for hood mechanics		

springs



1

<b>GEV No.</b>	517736	<b>Ref. No.</b>	0431067
<b>description</b>	roller spring W 40mm ID ø 36mm lug length 26.75mm mounting distance 20mm		



1

<b>GEV No.</b>	517737	<b>Ref. No.</b>	0431069
<b>description</b>	roller spring W 40mm ID ø 41mm lug length 29mm mounting distance 20mm		
<b>For models:</b>	FV130B		

guide bars



1

<b>GEV No.</b>	501390	<b>Ref. No.</b>	8000161
<b>description</b>	guide bar L 506mm for hood for dishwasher		



1

<b>GEV No.</b>	524336	<b>Ref. No.</b>	0463053
<b>description</b>	guide bar L 627mm mounting pos. left for hood mechanics		



1

<b>GEV No.</b>	524337	<b>Ref. No.</b>	0463052
<b>description</b>	guide bar L 627mm mounting pos. right for hood mechanics		

linkage



1

<b>GEV No.</b>	501276	<b>Ref. No.</b>	0251103 8004146
<b>description</b>	linkage hood mechanics		
<b>For models:</b>	DV120.2, DV120T, DV40N, DV40T, DV40T FA, DV80T, ECO STAR 545D		



1

<b>GEV No.</b>	501239	<b>Ref. No.</b>	8000072
<b>description</b>	tie bar hood mechanics		
<b>For models:</b>	DR70, DR90, DV100 AB 1983, DV111, DV111E, DV120, DV120B, DV160 AB 1983, DV160 AB 1996, DV240B AB 1983, DV240B AB 1996, DV40 AB 1983, DV40 AB 1992, DV80, DV80 AB 1975, DV80 AB 1980, DV80 AB 1983, DV80 AB 1992		

hood handles



1

<b>GEV No.</b>	501237	<b>Ref. No.</b>	8000070
<b>description</b>	hood handle		
<b>For models:</b>	DR70, DR90, DV100 AB 1983, DV111, DV111E, DV80 AB 1975		

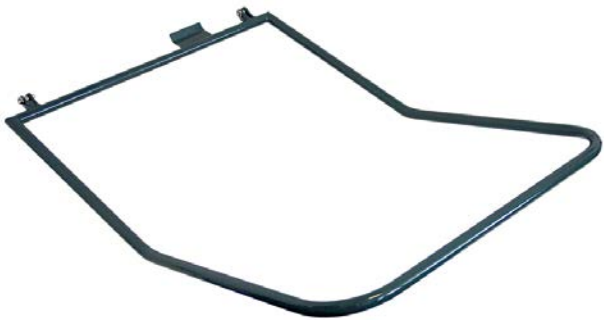

1

<b>GEV No.</b>	501250	<b>Ref. No.</b>	8000716
<b>description</b>	hood handle		
<b>For models:</b>	DV120, DV120B, DV40 AB 1983, DV40 AB 1992, DV80, DV80 AB 1980, DV80 AB 1983, DV80 AB 1992		

rollers



1

<b>GEV No.</b>	501036	<b>Ref. No.</b>	0620451
<b>description</b>	roller hood mechanics		
<b>For models:</b>	DV120.2, DV120T, DV40N, DV40T, DV40T FA, DV80T, ECO STAR 545D		



1

<b>GEV No.</b>	501188	<b>Ref. No.</b>	0620148
<b>description</b>	roller hood mechanics		
<b>For models:</b>	DR70, DR90, DV111, DV111E, DV120, DV120B, DV160 AB 1983, DV160 AB 1996, DV240B AB 1983, DV240B AB 1996, DV250B, DV260B, DV40 AB 1983, DV40 AB 1992, DV80, DV80 AB 1975, DV80 AB 1980, DV80 AB 1983, DV80 AB 1992		



1

<b>GEV No.</b>	511596	<b>Ref. No.</b>	0620149
<b>description</b>	roller ø 30mm H 16mm plastic cream hole ø 8.5mm		

miscellaneous



1

<b>GEV No.</b>	501035	<b>Ref. No.</b>	0620449
<b>description</b>	bearing for hood linkage		
<b>For models:</b>	DV120.2, DV120T, DV40N, DV40T, DV40T FA, DV80T, ECO STAR 545D		



1

<b>GEV No.</b>	524775	<b>Ref. No.</b>	8004480
<b>description</b>	lid for hood mechanics ED ø 32mm stainless steel H 1.7mm		



1

<b>GEV No.</b>	501034	<b>Ref. No.</b>	0620445
<b>description</b>	slide bearing hood mechanics		
<b>For models:</b>	DV120.2, DV120T, DV40N, DV40T, DV40T FA, DV80T, ECO STAR 545D		



1

<b>GEV No.</b>	501187	<b>Ref. No.</b>	0620146
<b>description</b>	slide bearing hood mechanics		
<b>For models:</b>	DR70, DR90, DV100 AB 1980, DV100 AB 1983, DV111, DV111E, DV120, DV120B, DV160 AB 1980, DV160 AB 1983, DV160 AB 1996, DV221, DV240B AB 1980, DV240B AB 1983, DV240B AB 1996, DV40 AB 1983, DV40 AB 1992, DV80, DV80 AB 1975, DV80 AB 1980, DV80 AB 1983, DV80 AB 1992		

basket guides

miscellaneous



1

<b>GEV No.</b>	699282	<b>Ref. No.</b>	9501104
<b>description</b>	guide for basket transport L 70mm W 30mm H 30mm		

## air traps

## air traps





1

<b>GEV No.</b>	501018	<b>Ref. No.</b>	0620244
<b>description</b>	air trap		
<b>For models:</b>	DV100 AB 1980, DV100 AB 1983, DV120B, DV120T, DV160 AB 1980, DV160 AB 1983, DV160 AB 1996, DV240B AB 1980, DV240B AB 1983, DV240B AB 1996, DV260B, DV270B AB 1988, DV270B AB 1992, DV40 AB 1983, DV40 AB 1992, DV40N, DV40T, DV40T FA, DV80, DV80 AB 1980, DV80 AB 1983, DV80 AB 1992, DV80T, ECO STAR 530F, FR30G, FR30G AB 1992, FR40G AB 1980, FR40G AB 1983, FR40GUS AB 1980, FR40GUS AB 1983, FV110G, FV120B AB 1980, FV120B AB 1983, FV130B, FV20N, FV20T, FV240B AB 1980, FV250B AB 1988, FV250B AB 1992, FV25G AB 1986, FV25G AB 1992, FV28G AB 1994, FV28G AB 1997, FV28GFA, FV30GS, FV40N AB 1980, FV40N AB 1983, FV40N AB 1992, FV40T, FV40TFA...(Other models you can see in the webshop)		
<b>accessories for</b>	501018		
	<b>GEV No.</b>	501043	<b>Ref. No.</b> 0650001
	rubber sleeve		



1

<b>GEV No.</b>	501179	<b>Ref. No.</b>	9515955
<b>description</b>	air trap L 52mm W 19mm H 56mm thread 3/8" hose ø 6mm plastic		
<b>For models:</b>	FV40.2, FV40.2MIKE2, FV40.2M-MIKE2		
<b>accessories for</b>	501179		
	<b>GEV No.</b>	501106	<b>Ref. No.</b> 9515964
	flat gasket rubber ED ø 26mm ID ø 18mm thickness 2mm Qty 1 pcs		
	<b>GEV No.</b>	503042	<b>Ref. No.</b> 9515957
	nut thread 3/8" H 6mm brass WS 22 Qty 1 pcs		

## air trap accessories



1

<b>GEV No.</b>	501043	<b>Ref. No.</b>	0650001
<b>description</b>	rubber sleeve		
<b>For models:</b>	DV100 AB 1980, DV100 AB 1983, DV120B, DV160 AB 1980, DV160 AB 1983, DV160 AB 1996, DV240B AB 1980, DV240B AB 1983, DV240B AB 1996, DV260B, DV270B AB 1988, DV270B AB 1992, DV40 AB 1983, DV40 AB 1992, DV40N, DV40T, DV40T FA, DV80, DV80 AB 1983, DV80 AB 1992, DV80T, ECO STAR 530F, FR30G, FR30G AB 1992, FR40G AB 1980, FR40G AB 1983, FR40GUS AB 1980, FR40GUS AB 1983, FV110G, FV120B AB 1980, FV120B AB 1983, FV130B, FV20N, FV20T, FV240B AB 1980, FV250B AB 1988, FV250B AB 1992, FV25G AB 1986, FV25G AB 1992, FV28G AB 1994, FV28G AB 1997, FV28GFA, FV30GS, FV40GE, FV40N AB 1980, FV40N AB 1983, FV40T, FV40TFA, FV60E AB 1983, FV60E AB 1988...(Other models you can see in the webshop)		

## mechanics for flight type dishwashers



1

<b>GEV No.</b>	524563	<b>Ref. No.</b>	9501778
<b>description</b>	bolt for transport system L 26mm ø 6mm suitable for MEIKO		
<b>accessories for</b>	524563		
	<b>GEV No.</b>	104447	<b>Ref. No.</b> 0341050
	clamping washer nominal-ø 5.7mm ED ø 11.7mm spring steel thickness 0.4mm		



1

<b>GEV No.</b>	511662	<b>Ref. No.</b>	8100868
<b>description</b>	bracket for roller spring L 95mm W 65mm H 60mm		



1

<b>GEV No.</b>	524554	<b>Ref. No.</b>	0620311 9500364
<b>description</b>	clip for round belt L 25mm W 25mm H 10mm suitable for MEIKO		



1

<b>GEV No.</b>	524551	<b>Ref. No.</b>	0620111
<b>description</b>	connector for tappet L 123mm W 20mm H 29mm hole ø 9mm suitable for COMENDA, MEIKO		



1

<b>GEV No.</b>	524339	<b>Ref. No.</b>	8132347
<b>description</b>	guide for transport system L 115mm W 30.6mm H 30.5mm hole ø 6mm suitable for MEIKO		



1

<b>GEV No.</b>	524559	<b>Ref. No.</b>	8231181
<b>description</b>	guide roller ID ø 20mm ED ø 33mm		





1

<b>GEV No.</b>	694464 <sup>1</sup>	<b>Ref. No.</b>	0440011
<b>description</b>	round belt ø 10mm Lmm Qty supplied by meter		

<sup>1</sup>by the meter







			
1			
<b>GEV No.</b>	501365	<b>Ref. No.</b>	0620223
<b>description</b>	tappet for dishwasher		

			
1			
<b>GEV No.</b>	524549	<b>Ref. No.</b>	0620271
<b>description</b>	tappet for dishwasher L 126mm W 51mm H 73mm hole ø 9mm suitable for MEIKO		

			
1			
<b>GEV No.</b>	524550	<b>Ref. No.</b>	0620270
<b>description</b>	tappet for dishwasher L 126mm W 52mm H 73mm hole ø 9mm suitable for MEIKO		

			
1			
<b>GEV No.</b>	524566	<b>Ref. No.</b>	8130077-02
<b>description</b>	tappet for dishwasher L 45mm W 38mm H 50mm hole ø 6mm suitable for MEIKO		

			
1			
<b>GEV No.</b>	524564	<b>Ref. No.</b>	8130035
<b>description</b>	tappet for dishwasher L 50mm W 32mm hole ø 6.5mm thickness 6mm suitable for MEIKO		
<b>accessories for</b>	524564		
	<b>GEV No.</b>	104447	<b>Ref. No.</b> 0341050
	clamping washer nominal-ø 5.7mm ED ø 11.7mm spring steel thickness 0.4mm		
	<b>GEV No.</b>	524563	<b>Ref. No.</b> 9501778
	bolt for transport system L 26mm ø 6mm suitable for MEIKO		

			
1			
<b>GEV No.</b>	524565	<b>Ref. No.</b>	9527672-03
<b>description</b>	tappet for dishwasher rotary L 84mm H 50mm thickness 11mm suitable for MEIKO		

<b>pulleys</b>			
			
1			
<b>GEV No.</b>	524560	<b>Ref. No.</b>	8230575 9647983
<b>description</b>	V-belt pulley single disc ø 170mm shaft intake ø 20mm groove depth 14mm disc width 29mm groove width 24mm overall width 60mm plastic for dishwasher		

<b>backflow preventers</b>			
<b>backflow preventers</b>			
			
1			
<b>GEV No.</b>	501135	<b>Ref. No.</b>	0620460 9001435
<b>description</b>	backflow preventer		
<b>For models:</b>	DV40T FA, FV28GFA, FV40TFA, FV70TD		
<b>accessories for</b>	501135		
	<b>GEV No.</b>	501137	<b>Ref. No.</b> 0650076
	sealing ring		

			
1			
<b>GEV No.</b>	524814	<b>Ref. No.</b>	9523195
<b>description</b>	backflow preventer		
<b>For models:</b>	FV40.2, FV40.2M-MIKE2		



1

<b>GEV No.</b>	501020	<b>Ref. No.</b>	0620334
<b>description</b>	backflow preventer connection 13 dishwasher		
<b>For models:</b>	DV120B, DV120T, DV160 AB 1996, DV240B AB 1996, DV40 AB 1992, DV40N, DV40T, DV80 AB 1992, DV80T, ECO STAR 430F, ECO STAR 530F, ECO STAR 545D, FR30G AB 1992, FV110G, FV130B, FV20N, FV20T, FV25G AB 1992, FV28G AB 1994, FV28G AB 1997, FV30GS, FV40N AB 1992, FV40T, FV60E AB 1988, FV70T		



1

<b>GEV No.</b>	501088	<b>Ref. No.</b>	0620349
<b>description</b>	backflow preventer connection 3/4" dishwasher		
<b>For models:</b>	DV270B AB 1992, FV250B AB 1992		



1

<b>GEV No.</b>	508411	<b>Ref. No.</b>	8002732
<b>description</b>	backflow preventer hose ø 12mm		



1

<b>GEV No.</b>	508412	<b>Ref. No.</b>	8002731
<b>description</b>	backflow preventer hose ø 13mm		

non-return valves



1

<b>GEV No.</b>	501585	<b>Ref. No.</b>	9541002
<b>description</b>	conversion kit FV40.2 hose ø 6mm		



1

<b>GEV No.</b>	501214	<b>Ref. No.</b>	9504799
<b>description</b>	non-return valve hose ø 6mm		

miscellaneous



1

<b>GEV No.</b>	524556	<b>Ref. No.</b>	9500892
<b>description</b>	bracket for guide plastic L 63mm W 25mm H 22mm for MEIKO		



1

<b>GEV No.</b>	501554	<b>Ref. No.</b>	8003003
<b>description</b>	brush for MEIKO		



1

<b>GEV No.</b>	501278	<b>Ref. No.</b>	8000423
<b>description</b>	gasket		



			
1			
<b>GEV No.</b>	501082	<b>Ref. No.</b>	0620287
<b>description</b>	hose connector plastic thread 3/8" Qty 1 pcs for hose ID 13-13mm angled		
<b>For models:</b>	DV120B, DV160 AB 1983, DV160 AB 1996, DV240B AB 1983, DV240B AB 1996, DV270B AB 1992, DV40 AB 1983, DV40 AB 1992, DV80, DV80 AB 1983, DV80 AB 1992, FV130B, FV250B AB 1992		

			
1			
<b>GEV No.</b>	524562	<b>Ref. No.</b>	0650066
<b>description</b>	sleeve for suction connection 8511EPDMspez H 20mm D1 ø 60mm D2 ø 45mm		

			
1			
<b>GEV No.</b>	524571	<b>Ref. No.</b>	9539613
<b>description</b>	terminal for bearing plastic L 38mm W 17mm H 10mm for MEIKO		

			
1			
<b>GEV No.</b>	524570	<b>Ref. No.</b>	9539607
<b>description</b>	tray for bearing plastic L 37.5mm W 35mm H 10mm for MEIKO		

door mechanics

springs

tension springs

			
1			
<b>GEV No.</b>	519555	<b>Ref. No.</b>	9547710
<b>description</b>	tension spring ø 15.5mm L1 30mm wire gauge ø 1.4mm L2 11.5mm L3 11.5mm total length 51mm		

			
1			
<b>GEV No.</b>	519554	<b>Ref. No.</b>	9614265
<b>description</b>	tension spring ø 20mm L1 140mm wire gauge ø 2.5mm L2 17mm L3 17mm total length 174mm for door mechanism		

			
1			
<b>GEV No.</b>	519497	<b>Ref. No.</b>	0124170 9521470 9521764
<b>description</b>	tension spring ø 21.6mm wire gauge ø 1.7mm total length 111mm for door mechanism with plate strap		
<b>For models:</b>	FV40.2, FV40.2MIKE2, FV40.2M-MIKE2		

			
1			
<b>GEV No.</b>	519553	<b>Ref. No.</b>	9601272
<b>description</b>	tension spring ø 30mm L1 200mm wire gauge ø 2.5mm L2 19mm L3 19mm total length 276mm for door mechanism with plate strap		

rollers

			
1			
<b>GEV No.</b>	501180	<b>Ref. No.</b>	9520672 9600964
<b>description</b>	roller ED ø 30mm ID ø 8.5mm H 10mm		
<b>For models:</b>	FV40.2, FV40.2MIKE2, FV40.2M-MIKE2		
<b>spare parts for</b>	501180		
		<b>GEV No.</b>	698725
		<b>Ref. No.</b>	9520736
	bearing ø 8.5mm L 11mm W 8mm H 8mm for reel		

			
1			
<b>GEV No.</b>	501358	<b>Ref. No.</b>	0620284
<b>description</b>	roller ED ø 36mm shaft diameter 8.8mm W 27mm		

 <p>Image not available</p>			
1			
<b>GEV No.</b>	501241	<b>Ref. No.</b>	8000747
<b>description</b>	roller for door		

			
1			
<b>GEV No.</b>	501329	<b>Ref. No.</b>	0620398
<b>description</b>	roller K397 for door mechanism		
<b>For models:</b>	ECO STAR 430F, FV28G AB 1994, FV28G AB 1997, FV28GFA		



1

<b>GEV No.</b>	501325	<b>Ref. No.</b>	0621085 8003675
<b>description</b>	roller long for door mechanism		
<b>For models:</b>	FV20N, FV20T, FV40N AB 1992, FV40T, FV40TFA, FV70T, FV70TD		



1

<b>GEV No.</b>	501324	<b>Ref. No.</b>	0621084 8003677
<b>description</b>	roller short for door mechanism		
<b>For models:</b>	FV20N, FV20T, FV40N AB 1992, FV40T, FV40TFA, FV70T, FV70TD		

hinges



1

<b>GEV No.</b>	501323	<b>Ref. No.</b>	8003681
<b>description</b>	door hinge door bearing, left mounting pos. left		
<b>For models:</b>	ECO STAR 530F, FV110G, FV20N, FV20T, FV40N AB 1992, FV40T, FV40TFA, FV70T, FV70TD		



1

<b>GEV No.</b>	501328	<b>Ref. No.</b>	8003985
<b>description</b>	door hinge door bearing, left mounting pos. left		
<b>For models:</b>	ECO STAR 430F, FV28G AB 1994, FV28G AB 1997, FV28GFA		



1

<b>GEV No.</b>	501322	<b>Ref. No.</b>	8003600
<b>description</b>	door hinge door bearing, right mounting pos. right		
<b>For models:</b>	ECO STAR 530F, FV110G, FV20N, FV20T, FV40N AB 1992, FV40T, FV40TFA, FV70T, FV70TD		



1

<b>GEV No.</b>	501327	<b>Ref. No.</b>	8004426
<b>description</b>	door hinge door bearing, right mounting pos. right		
<b>For models:</b>	ECO STAR 430F, FV28G AB 1994, FV28G AB 1997, FV28GFA		

door guides



1

<b>GEV No.</b>	699287	<b>Ref. No.</b>	9501665
<b>description</b>	guide bar L 690mm W 7mm H 30mm mounting pos. left/right		

miscellaneous



1

<b>GEV No.</b>	524817	<b>Ref. No.</b>	8002834 9661700
<b>description</b>	bearing for door left-hand thread ø 8.3mm L 40mm		



1

<b>GEV No.</b>	501217	<b>Ref. No.</b>	8000029
<b>description</b>	flange for membrane		
<b>For models:</b>	FR30G, FR40G AB 1983, FR40GUS AB 1983		





 <p>1</p>			
<b>GEV No.</b>	501331	<b>Ref. No.</b>	0435151
<b>description</b>	hauling cable polyamide ø 4mm L 310mm DIN 83331 hauling cable		
<b>For models:</b>	ECO STAR 430F, FV28G AB 1994, FV28G AB 1997, FV28GFA, FV40.2, FV40.2 AB 2002, FV40.2 AB 2003, FV40.2M, FV40.2MIKE2, FV40.2M-MIKE2		

 <p>1</p>			
<b>GEV No.</b>	501330	<b>Ref. No.</b>	0435150
<b>description</b>	hook for hauling cable rope hook		
<b>For models:</b>	ECO STAR 430F, FV28G AB 1994, FV28G AB 1997, FV28GFA, FV40.2, FV40.2 AB 2002, FV40.2 AB 2003, FV40.2M, FV40.2MIKE2, FV40.2M-MIKE2		

screw connections

 <p>1</p>			
<b>GEV No.</b>	501396	<b>Ref. No.</b>	0620422
<b>description</b>	cap H 16mm Qty 1 pcs		

 <p>1</p>			
<b>GEV No.</b>	524524	<b>Ref. No.</b>	0225050
<b>description</b>	cap thread 3/4" H 26mm plastic Qty 1 pcs with gasket		

 <p>1</p>			
<b>GEV No.</b>	501387	<b>Ref. No.</b>	9517398
<b>description</b>	nut thread 3/4" H 13mm WS 30 Qty 1 pcs		
<b>For models:</b>	DV120.2, FV40.2, FV40.2 AB 2002, FV40.2 AB 2003, FV40.2M, FV40.2M-MIKE2		

 <p>1</p>			
<b>GEV No.</b>	501290	<b>Ref. No.</b>	0620162
<b>description</b>	nut thread 3/8" H 8mm WS 24 plastic Qty 1 pcs		
<b>For models:</b>	DR90		

curtains

 <p>1</p>			
<b>GEV No.</b>	533010	<b>Ref. No.</b>	9502517
<b>description</b>	curtain W 610mm H 480mm complete PVC for dishwasher		

 <p>1</p>			
<b>GEV No.</b>	698623	<b>Ref. No.</b>	9608811
<b>description</b>	curtain W 620mm H 360mm plastic thickness 2mm		

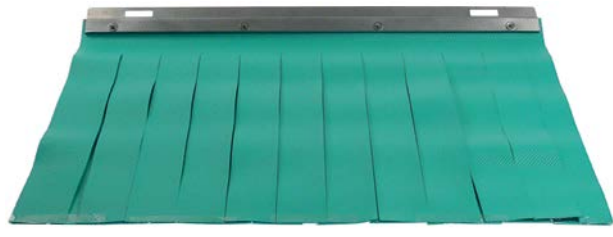
 <p>1</p>			
<b>GEV No.</b>	698615	<b>Ref. No.</b>	9502516
<b>description</b>	curtain W 650mm H 420mm plastic thickness 2mm		

 <p>1</p>			
<b>GEV No.</b>	533011	<b>Ref. No.</b>	8132550
<b>description</b>	curtain W 650mm H 445mm complete PVC for dishwasher		



1

<b>GEV No.</b>	533000	<b>Ref. No.</b>	9502513
<b>description</b>	curtain W 650mm H 475mm		

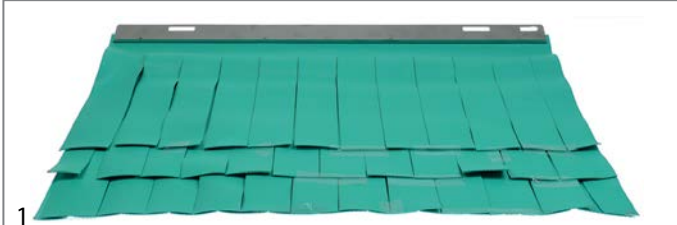

1

<b>GEV No.</b>	699288	<b>Ref. No.</b>	9510269
<b>description</b>	curtain W 650mm H 480mm mounting pos. front thickness 1.5mm		

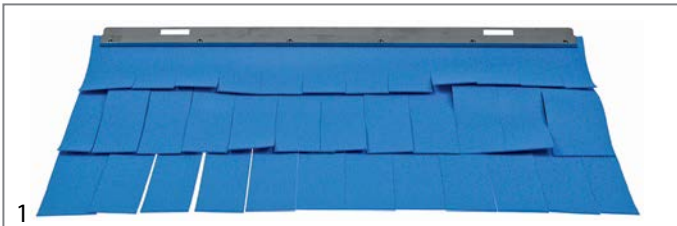

1

<b>GEV No.</b>	533170	<b>Ref. No.</b>	8102531
<b>description</b>	curtain W 660mm H 400mm warewashing for inlet		



1

<b>GEV No.</b>	533169	<b>Ref. No.</b>	8101676
<b>description</b>	curtain W 660mm H 400mm warewashing for inlet/drying W1 640mm		

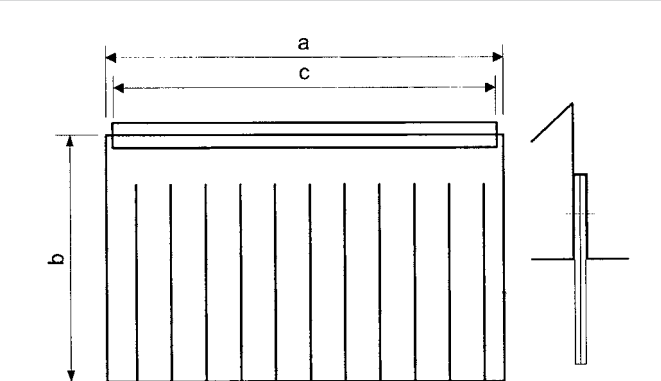

1

<b>GEV No.</b>	533164	<b>Ref. No.</b>	8100244
<b>description</b>	curtain W 660mm H 420mm warewashing for drying W1 640mm		



1

<b>GEV No.</b>	533171	<b>Ref. No.</b>	8101679
<b>description</b>	curtain W 700mm H 400mm warewashing for outlet W1 690mm		



1

<b>GEV No.</b>	533165	<b>Ref. No.</b>	8100245
<b>description</b>	curtain W 700mm H 420mm warewashing for outlet W1 690mm		



1

<b>GEV No.</b>	533172	<b>Ref. No.</b>	8101670
<b>description</b>	curtain W 730mm H 400mm warewashing for inlet W1 720mm		





1

<b>GEV No.</b>	533166	<b>Ref. No.</b>	8100242
<b>description</b>	curtain W 730mm H 420mm warewashing for inlet W1 720mm		



1			
<b>GEV No.</b>	533161	<b>Ref. No.</b>	0475013
<b>description</b>	curtain W 75mm H 250mm		

 Image not available 1			
<b>GEV No.</b>	533162	<b>Ref. No.</b>	0475012
<b>description</b>	curtain W 75mm H 330mm		

 Image not available 1			
<b>GEV No.</b>	533163	<b>Ref. No.</b>	0475011
<b>description</b>	curtain W 75mm H 380mm		

1			
<b>GEV No.</b>	533173	<b>Ref. No.</b>	8101682
<b>description</b>	curtain W 770mm H 325mm warewashing for wash area W1 760mm		

 Image not available 1			
<b>GEV No.</b>	533167	<b>Ref. No.</b>	8100414
<b>description</b>	curtain W 770mm H 370mm warewashing for rinsing W1 760mm		

1			
<b>GEV No.</b>	533174	<b>Ref. No.</b>	8101673
<b>description</b>	curtain W 770mm H 400mm warewashing for wash area W1 760mm		

1			
<b>GEV No.</b>	533168	<b>Ref. No.</b>	8100243
<b>description</b>	curtain W 770mm H 420mm warewashing for wash area W1 760mm		

washing and rinsing systems

1			
<b>GEV No.</b>	501204	<b>Ref. No.</b>	0620446
<b>description</b>	adapter for wash arm support		
<b>For models:</b>	ECO STAR 430F, FV28G AB 1994, FV28G AB 1997, FV28GFA		

1			
<b>GEV No.</b>	524558	<b>Ref. No.</b>	0620161
<b>description</b>	adapter for wash jet ID ø 21mm ED ø 28mm plastic		

1			
<b>GEV No.</b>	501389	<b>Ref. No.</b>	9522439
<b>description</b>	bearing for rinse arm ø 24mm H 6.5mm		
<b>For models:</b>	DV120.2, FV40.2, FV40.2 AB 2002, FV40.2 AB 2003, FV40.2M, FV40.2M-MIKE2		

1			
<b>GEV No.</b>	524816	<b>Ref. No.</b>	9600763
<b>description</b>	bush for wash arm ø 45mm thickness 2mm H 33mm ID ø 41.5mm		

			
1			
<b>GEV No.</b>	524773	<b>Ref. No.</b>	9550206
<b>description</b>	cap for wash pipe thread 1/2" L 25mm WS 27		

			
1			
<b>GEV No.</b>	501049	<b>Ref. No.</b>	8000189
<b>description</b>	centring star		
<b>For models:</b>	FV25G AB 1986		

			
1			
<b>GEV No.</b>	501126	<b>Ref. No.</b>	0620233
<b>description</b>	centring star		
<b>For models:</b>	DV120T, DV40N, DV40T, DV40T FA, DV80T, ECO STAR 545D, FV120B AB 1980, FV240B AB 1980		

			
1			
<b>GEV No.</b>	501127	<b>Ref. No.</b>	0620264
<b>description</b>	centring star		
<b>For models:</b>	DV100 AB 1983, DV120B, DV160 AB 1983, DV160 AB 1996, DV240B AB 1983, DV240B AB 1996, DV40 AB 1983, DV40 AB 1992, DV80, DV80 AB 1983, DV80 AB 1992		

			
1			
<b>GEV No.</b>	501144	<b>Ref. No.</b>	0620381 8001736
<b>description</b>	centring star		
<b>For models:</b>	DV40N, DV40T, DV40T FA, ECO STAR 530F, FV110G, FV28G AB 1994, FV28G AB 1997, FV70TD		

			
1			
<b>GEV No.</b>	501145	<b>Ref. No.</b>	8001738
<b>description</b>	centring star		

			
1			
<b>GEV No.</b>	501251	<b>Ref. No.</b>	0620382 8001737
<b>description</b>	centring star		
<b>For models:</b>	ECO STAR 430F		

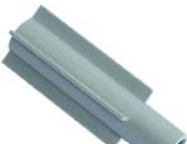
			
1			
<b>GEV No.</b>	501222	<b>Ref. No.</b>	8000039
<b>description</b>	centring star mounting pos. lower		
<b>For models:</b>	FV40N AB 1983, FV60E AB 1983		



			
1			
<b>GEV No.</b>	501221	<b>Ref. No.</b>	8000038
<b>description</b>	centring star mounting pos. upper		
<b>For models:</b>	FV40N AB 1983, FV60E AB 1983		

			
1			
<b>GEV No.</b>	501097	<b>Ref. No.</b>	8000086
<b>description</b>	centring star mounting pos. upper L 58mm		
<b>For models:</b>	FV120B AB 1983, FV240B AB 1983		







			
1			
<b>GEV No.</b>	524569	<b>Ref. No.</b>	9500043
<b>description</b>	coupling back part for rinse arm ø 55mm		

			
1			
<b>GEV No.</b>	524552	<b>Ref. No.</b>	9500042
<b>description</b>	coupling front part for rinse arm ø 56mm		
<b>accessories for</b>	524552		
	<b>GEV No.</b>	524553	<b>Ref. No.</b> 9500057
	gasket for rinse arm ø 25mm ID ø 10mm thickness 8mm		

			
1			
<b>GEV No.</b>	501194	<b>Ref. No.</b>	0620298
<b>description</b>	coupling piece for wash arm support		
<b>For models:</b>	FR30G, FR30G AB 1992, FR40G AB 1983, FR40GUS AB 1983		

			
1			
<b>GEV No.</b>	501044	<b>Ref. No.</b>	8000049
<b>description</b>	flange left-hand thread		
<b>For models:</b>	DR90, DV100 AB 1983, DV111, DV111E, DV120B, DV120T, DV160 AB 1983, DV160 AB 1996, DV221, DV240B AB 1983, DV240B AB 1996, DV260B, DV270B AB 1992, DV40 AB 1983, DV40N, DV40T, DV40T FA, DV80, DV80 AB 1983, DV80 AB 1992, DV80T, ECO STAR 545D, FV120B AB 1983, FV130B, FV240B AB 1983, FV250B AB 1992, FV40N AB 1983, FV60E AB 1983		

			
1			
<b>GEV No.</b>	501095	<b>Ref. No.</b>	8000048
<b>description</b>	flange right-hand thread		
<b>For models:</b>	DR90, DV100 AB 1983, DV111, DV111E, DV120B, DV120T, DV160 AB 1983, DV160 AB 1996, DV221, DV240B AB 1983, DV240B AB 1996, DV260B, DV270B AB 1992, DV40 AB 1983, DV40N, DV40T, DV40T FA, DV80, DV80 AB 1983, DV80 AB 1992, DV80T, ECO STAR 545D, FV120B AB 1983, FV130B, FV240B AB 1983, FV250B AB 1992, FV25G AB 1986, FV40N AB 1983, FV60E AB 1983		

			
1			
<b>GEV No.</b>	501191	<b>Ref. No.</b>	0620295
<b>description</b>	flow control valve		
<b>For models:</b>	FR30G, FR30G AB 1992, FR40G AB 1983, FR40GUS AB 1983		

			
1			
<b>GEV No.</b>	501206	<b>Ref. No.</b>	0620448
<b>description</b>	flow control valve		
<b>For models:</b>	ECO STAR 430F, FV20N, FV20T, FV28G AB 1994, FV28G AB 1997, FV28GFA, FV30GS, FV40N AB 1992, FV40T, FV40TFA, FV60E AB 1988, FV70T		

			
1			
<b>GEV No.</b>	524553	<b>Ref. No.</b>	9500057
<b>description</b>	gasket for rinse arm ø 25mm ID ø 10mm thickness 8mm		

			
1			
<b>GEV No.</b>	501047	<b>Ref. No.</b>	8000182
<b>description</b>	knurled nut		
<b>For models:</b>	FV25G AB 1986		

			
1			
<b>GEV No.</b>	698624	<b>Ref. No.</b>	9543879
<b>description</b>	pump hose D1 ø 85mm L 45mm int. ø 1 79mm		

			
1			
<b>GEV No.</b>	501016	<b>Ref. No.</b>	0620211
<b>description</b>	rinse arm support 1/2		
<b>For models:</b>	DV100 AB 1983, DV120B, DV120T, DV160 AB 1983, DV160 AB 1996, DV240B AB 1983, DV240B AB 1996, DV260B, DV270B AB 1992, DV40 AB 1983, DV40T, DV40T FA, DV80, DV80 AB 1983, DV80 AB 1992, DV80T, ECO STAR 545D, FV120B AB 1980, FV120B AB 1983, FV130B, FV240B AB 1980, FV240B AB 1983, FV250B AB 1992, FV25G AB 1986, FV30, FV40N AB 1980, FV40N AB 1983, FV50, FV50 M, FV60E AB 1983		

			
2			
<b>GEV No.</b>	501017	<b>Ref. No.</b>	0620235
<b>description</b>	rinse arm support mounting pos. upper		
<b>For models:</b>	DV120B, DV160 AB 1983, DV160 AB 1996, DV240B AB 1983, DV240B AB 1996, DV260B, DV270B AB 1992, DV40 AB 1983, DV40 AB 1992, DV80, DV80 AB 1983, DV80 AB 1992, ECO STAR 430F, FV110G, FV120B AB 1983, FV130B, FV240B AB 1983, FV250B AB 1992, FV28G AB 1994, FV28G AB 1997, FV28GFA		

			
1			
<b>GEV No.</b>	501046	<b>Ref. No.</b>	8000181
<b>description</b>	rinse arm support mounting pos. upper		
<b>For models:</b>	FV25G AB 1986		

			
1			
<b>GEV No.</b>	501142	<b>Ref. No.</b>	8000174
<b>description</b>	rinse pipe		
<b>For models:</b>	DV120T, DV40N, DV40T, DV40T FA, DV80T, ECO STAR 545D		

			
1			
<b>GEV No.</b>	501223	<b>Ref. No.</b>	8000040
<b>description</b>	rinse pipe		
<b>For models:</b>	FV40N AB 1983, FV60E AB 1983		

			
1			
<b>GEV No.</b>	501224	<b>Ref. No.</b>	8000041
<b>description</b>	rinse pipe		
<b>For models:</b>	FV40N AB 1983, FV60E AB 1983		

			
1			
<b>GEV No.</b>	501234	<b>Ref. No.</b>	8000066
<b>description</b>	rinse pipe		
<b>For models:</b>	DV100 AB 1983, DV120B, DV160 AB 1983, DV40 AB 1983, DV80, DV80 AB 1983		

			
1			
<b>GEV No.</b>	501235	<b>Ref. No.</b>	8000067
<b>description</b>	rinse pipe		
<b>For models:</b>	DV100 AB 1983, DV120B, DV160 AB 1983, DV240B AB 1983, DV40 AB 1983, DV80, DV80 AB 1983		

			
1			
<b>GEV No.</b>	501111	<b>Ref. No.</b>	8000681
<b>description</b>	rinse pipe mounting pos. lower		
<b>For models:</b>	DV270B AB 1992, FV130B, FV250B AB 1992		

			
1			
<b>GEV No.</b>	501048	<b>Ref. No.</b>	8000188
<b>description</b>	rinse pipe mounting pos. lower right-hand thread		
<b>For models:</b>	FV25G AB 1986		



			
1			
<b>GEV No.</b>	501247	<b>Ref. No.</b>	8000172
<b>description</b>	rinse pipe mounting pos. lower right-hand thread		
<b>For models:</b>	DV120B, DV160 AB 1983, DV160 AB 1996, DV240B AB 1983, DV240B AB 1996, DV40 AB 1983, DV80, DV80 AB 1983, DV80 AB 1992		

			
1			
<b>GEV No.</b>	501110	<b>Ref. No.</b>	8000680
<b>description</b>	rinse pipe mounting pos. upper		
<b>For models:</b>	DV270B AB 1992, FV130B, FV250B AB 1992		

			
1			
<b>GEV No.</b>	501098	<b>Ref. No.</b>	8000087
<b>description</b>	rinse pipe mounting pos. upper left-hand thread		
<b>For models:</b>	FV120B AB 1983, FV240B AB 1983		

			
1			
<b>GEV No.</b>	501248	<b>Ref. No.</b>	8000173
<b>description</b>	rinse pipe mounting pos. upper left-hand thread		
<b>For models:</b>	DV120B, DV160 AB 1983, DV160 AB 1996, DV240B AB 1983, DV240B AB 1996, DV40 AB 1983, DV80, DV80 AB 1983, DV80 AB 1992		

			
1			
<b>GEV No.</b>	524572	<b>Ref. No.</b>	0650010
<b>description</b>	rubber grommet for wash pipe ø 25mm		

			
1			
<b>GEV No.</b>	501027	<b>Ref. No.</b>	0620384
<b>description</b>	screw cap		
<b>For models:</b>	DV40 AB 1992, DV40N, DV40T, DV40T FA, ECO STAR 430F, ECO STAR 530F, FV110G, FV20N, FV20T, FV28G AB 1994, FV28G AB 1997, FV28GFA, FV30GS, FV40N AB 1992, FV40T, FV40TFA, FV60E AB 1988, FV70T, FV70TD		

			
1			
<b>GEV No.</b>	501061	<b>Ref. No.</b>	8004468
<b>description</b>	shim		
<b>For models:</b>	DV120.2, DV120T, DV40N, DV40T, DV40T FA, ECO STAR 545D		

			
1			
<b>GEV No.</b>	524574	<b>Ref. No.</b>	9517408 9604483
<b>description</b>	shim for rinse arm ø 30mm thread M12x1 WS 27		
<b>For models:</b>	DV120.2, FV40.2, FV40.2M, FV40.2M-MIKE2		

			
1			
<b>GEV No.</b>	524357	<b>Ref. No.</b>	9520931 9679658
<b>description</b>	slide ring for wash arm mounting pos. lower ED ø 50.6mm ID ø 42.3mm		
<b>For models:</b>	DV120.2, FV40.2, FV40.2 AB 2002, FV40.2 AB 2003, FV40.2M, FV40.2M-MIKE2		

			
1			
<b>GEV No.</b>	501074	<b>Ref. No.</b>	0403303
<b>description</b>	slide ring PTFE mounting measurements 17x26x1mm ø 13.3mm		
<b>For models:</b>	DR90, DV100 AB 1980, DV100 AB 1983, DV111, DV111E, DV120B, DV120T, DV160 AB 1980, DV160 AB 1983, DV160 AB 1996, DV221, DV240B AB 1980, DV240B AB 1983, DV240B AB 1996, DV260B, DV270B AB 1992, DV40 AB 1983, DV40 AB 1992, DV40N, DV40T, DV40T FA, DV80, DV80 AB 1975, DV80 AB 1980, DV80 AB 1983, DV80 AB 1992, DV80T, ECO STAR 545D, FV120B AB 1980, FV120B AB 1983, FV130B, FV200B, FV240B AB 1980, FV240B AB 1983, FV250B AB 1992, FV25G AB 1986, FV30, FV40N AB 1980, FV40N AB 1983, FV50, FV50 M, FV60 AB 1973, FV60 AB 1976		

			
1			
<b>GEV No.</b>	501256	<b>Ref. No.</b>	8004179
<b>description</b>	throttle disc		
<b>For models:</b>	ECO STAR 430F, FV28G AB 1994, FV28G AB 1997, FV28GFA		

			
1			
<b>GEV No.</b>	510112	<b>Ref. No.</b>	0310010
<b>description</b>	Thumb screw thread M10 thread L 10mm ø 22mm H 4.5mm SS		
<b>For models:</b>	DV40 AB 1992, DV40N, DV40T, DV40T FA, ECO STAR 430F, ECO STAR 530F, FV110G, FV20N, FV20T, FV28G AB 1994, FV28G AB 1997, FV28GFA, FV30GS, FV40N AB 1992, FV40T, FV40TFA, FV60E AB 1988, FV70T, FV70TD		

			
1			
<b>GEV No.</b>	501190	<b>Ref. No.</b>	0620294
<b>description</b>	wash arm support mounting pos. upper and bottom		
<b>For models:</b>	FR30G, FR30G AB 1992, FR40G AB 1983, FR40GUS AB 1983		





washing and rinsing systems (sorted by producer)

MEIKO

			
1			
<b>GEV No.</b>	501384	<b>Ref. No.</b>	9517399 9547257
<b>description</b>	rinse arm L 490mm nozzles 6 mounting ø 24.5mm mounting pos. upper/lower		
<b>For models:</b>	DV120.2, FV40.2, FV40.2M, FV40.2M-MIKE2		

			
1			
<b>GEV No.</b>	501141	<b>Ref. No.</b>	8000147
<b>description</b>	wash arm L 500mm nozzles 10 mounting ø 21/51mm mounting pos. lower		
<b>For models:</b>	DV120B, DV120T, DV160 AB 1983, DV160 AB 1996, DV240B AB 1983, DV240B AB 1996, DV40 AB 1983, DV40N, DV40T, DV40T FA, DV80, DV80 AB 1983, DV80 AB 1992, DV80T, ECO STAR 545D, FV40N AB 1983, FV60E AB 1983		



			
1			
<b>GEV No.</b>	501140	<b>Ref. No.</b>	8000146
<b>description</b>	wash arm L 500mm nozzles 10 mounting ø 21/51mm mounting pos. upper		
<b>For models:</b>	DV120B, DV120T, DV160 AB 1983, DV160 AB 1996, DV240B AB 1983, DV240B AB 1996, DV40 AB 1983, DV40N, DV40T, DV40T FA, DV80, DV80 AB 1983, DV80 AB 1992, DV80T, ECO STAR 545D, FV40N AB 1983, FV60E AB 1983		

				
1				
<b>GEV No.</b>	501385	<b>Ref. No.</b>	9517391 9517393	
<b>description</b>	wash arm L 500mm nozzles 11 mounting ø 16/42.5mm mounting pos. upper/lower			
<b>For models:</b>	DV120.2, FV40.2, FV40.2 AB 2003, FV40.2M, FV40.2M-MIKE2			
<b>spare parts for</b>	501385			
	<b>GEV No.</b>	501387	<b>Ref. No.</b>	9517398
	nut thread 3/4" H 13mm WS 30 Qty 1 pcs			
	<b>GEV No.</b>	501388	<b>Ref. No.</b>	9517397 9671628
	bearing for wash arm ø 22mm H 34.5mm			
	<b>GEV No.</b>	524357	<b>Ref. No.</b>	9520931 9679658
	slide ring for wash arm mounting pos. lower ED ø 50.6mm ID ø 42.3mm			

			
1			
<b>GEV No.</b>	501293	<b>Ref. No.</b>	8000187
<b>description</b>	wash arm L 200mm nozzles 15 mounting pos. lower complete/3-armed		
<b>For models:</b>	FV25G AB 1986		





			
1			
<b>GEV No.</b>	501015	<b>Ref. No.</b>	0620163
<b>description</b>	end cap		
<b>For models:</b>	DR90, DV100 AB 1980, DV100 AB 1983, DV111, DV111E, DV120B, DV160 AB 1980, DV160 AB 1983, DV221, DV240B AB 1980, DV240B AB 1983, DV260B, DV40 AB 1983, DV80, DV80 AB 1975, DV80 AB 1980, DV80 AB 1983, DV80 AB 1992, FR40G AB 1976, FR40G AB 1980, FR40GUS AB 1976, FR40GUS AB 1980, FV120B AB 1980, FV200B, FV240B AB 1980, FV25G AB 1986, FV30, FV40N AB 1980, FV40N AB 1983, FV50, FV50 M, FV60 AB 1976, FV60E AB 1983		

			
1			
<b>GEV No.</b>	501553	<b>Ref. No.</b>	8000321
<b>description</b>	wash arm		
<b>For models:</b>	FV25G AB 1986		
<b>accessories for</b>	501553		
	<b>GEV No.</b>	501083	<b>Ref. No.</b>
			0620292
	 end cap		

			
1			
<b>GEV No.</b>	501045	<b>Ref. No.</b>	8000093
<b>description</b>	wash arm boss mounting pos. lower ø 20.4mm		
<b>For models:</b>	DV260B, FV120B AB 1983, FV240B AB 1983, FV25G AB 1986		



			
1			
<b>GEV No.</b>	501051	<b>Ref. No.</b>	8000191
<b>description</b>	rinse arm L 365mm nozzles 3 mounting ø 16mm mounting pos. lower		
<b>For models:</b>	FV25G AB 1986		



			
1			
<b>GEV No.</b>	501052	<b>Ref. No.</b>	8000192
<b>description</b>	rinse arm L 367mm nozzles 3 mounting ø 12mm mounting pos. upper/lower		
<b>For models:</b>	FV25G AB 1986		

			
1			
<b>GEV No.</b>	501019	<b>Ref. No.</b>	0620286 8002880
<b>description</b>	rinse arm boss		
<b>For models:</b>	DV100 AB 1983, DV120B, DV120T, DV160 AB 1983, DV160 AB 1996, DV240B AB 1983, DV240B AB 1996, DV260B, DV270B AB 1992, DV40 AB 1983, DV40N, DV40T, DV40T FA, DV80, DV80 AB 1983, DV80T, ECO STAR 545D, FV120B AB 1983, FV130B, FV240B AB 1983, FV250B AB 1992, FV25G AB 1986, FV40N AB 1980, FV40N AB 1983, FV60E AB 1983		

			
1			
<b>GEV No.</b>	501249	<b>Ref. No.</b>	8000231
<b>description</b>	rinse arm boss		
<b>For models:</b>	FV25G AB 1986		

			
1			
<b>GEV No.</b>	501012	<b>Ref. No.</b>	0472031 8000124
<b>description</b>	rinse jet		
<b>For models:</b>	FR30G, FR30G AB 1992, FR40G AB 1983, FR40GUS AB 1983, FV120B AB 1983, FV240B AB 1983, FV25G AB 1986		

			
1			
<b>GEV No.</b>	501333	<b>Ref. No.</b>	9542559
<b>description</b>	rinse arm L 470mm nozzles 4 mounting ø 15.7mm mounting pos. lower complete		
<b>For models:</b>	ECO STAR 545D		
<b>spare parts for</b>	501333		
	<b>GEV No.</b>	501259	<b>Ref. No.</b>
			9517405 9517406
	 rinse jet		

			
1			
<b>GEV No.</b>	501332	<b>Ref. No.</b>	9542558
<b>description</b>	rinse arm L 475mm nozzles 4 mounting ø 15.5mm mounting pos. upper complete		
<b>For models:</b>	ECO STAR 545D		
<b>spare parts for</b>	501332		
	<b>GEV No.</b>	501259	<b>Ref. No.</b> 9517405 9517406
			rinse jet

			
1			
<b>GEV No.</b>	507556	<b>Ref. No.</b>	9601025
<b>description</b>	rinse arm L 620mm nozzles 6 mounting pos. lower		

			
1			
<b>GEV No.</b>	507572	<b>Ref. No.</b>	9600672
<b>description</b>	rinse arm L 716mm nozzles 8 mounting ø 19mm mounting pos. upper/lower complete		

			
1			
<b>GEV No.</b>	501019	<b>Ref. No.</b>	0620286 8002880
<b>description</b>	rinse arm boss		
<b>For models:</b>	DV100 AB 1983, DV120B, DV120T, DV160 AB 1983, DV160 AB 1996, DV240B AB 1983, DV240B AB 1996, DV260B, DV270B AB 1992, DV40 AB 1983, DV40N, DV40T, DV40T FA, DV80, DV80 AB 1983, DV80T, ECO STAR 545D, FV120B AB 1983, FV130B, FV240B AB 1983, FV250B AB 1992, FV25G AB 1986, FV40N AB 1980, FV40N AB 1983, FV60E AB 1983		



			
1			
<b>GEV No.</b>	501259	<b>Ref. No.</b>	9517405 9517406
<b>description</b>	rinse jet		
<b>For models:</b>	ECO STAR 545D, FV40.2, FV40.2 AB 2003		

			
1			
<b>GEV No.</b>	523051	<b>Ref. No.</b>	9600673
<b>description</b>	wash arm bearing 4 holes hole ø 19mm seat ø 10mm H 50mm		

			
1			
<b>GEV No.</b>	501138	<b>Ref. No.</b>	8000046
<b>description</b>	rinse arm		
<b>For models:</b>	DV100 AB 1983, DV120B, DV120T, DV160 AB 1983, DV160 AB 1996, DV240B AB 1983, DV240B AB 1996, DV40 AB 1983, DV40N, DV40T, DV40T FA, DV80, DV80 AB 1983, DV80 AB 1992, DV80T, FV40N AB 1983, FV60E AB 1983		

			
1			
<b>GEV No.</b>	501139	<b>Ref. No.</b>	8000047
<b>description</b>	rinse arm		
<b>For models:</b>	DV100 AB 1983, DV120B, DV120T, DV160 AB 1983, DV160 AB 1996, DV240B AB 1983, DV240B AB 1996, DV40 AB 1983, DV40N, DV40T, DV40T FA, DV80, DV80 AB 1983, DV80 AB 1992, DV80T, FV40N AB 1983, FV60E AB 1983		





			
1			
<b>GEV No.</b>	501292	<b>Ref. No.</b>	8000097 9542572
<b>description</b>	rinse arm L 530mm nozzles 4 mounting ø 15.7mm mounting pos. upper		
<b>For models:</b>	DR90, DV111, DV111E, DV260B, DV270B AB 1988, DV270B AB 1992, FV120B AB 1983, FV130B, FV240B AB 1983, FV250B AB 1988, FV250B AB 1992		
<b>spare parts for</b>	501292		
			
<b>GEV No.</b>	501259	<b>Ref. No.</b>	9517405 9517406
<b>description</b>	rinse jet		

			
1			
<b>GEV No.</b>	501291	<b>Ref. No.</b>	8000096 9542573
<b>description</b>	rinse arm L 535mm nozzles 4 mounting ø 15.7mm mounting pos. lower		
<b>For models:</b>	DR90, DV111, DV111E, DV260B, DV270B AB 1988, DV270B AB 1992, FV120B AB 1983, FV130B, FV240B AB 1983, FV250B AB 1988, FV250B AB 1992		

			
1			
<b>GEV No.</b>	501019	<b>Ref. No.</b>	0620286 8002880
<b>description</b>	rinse arm boss		
<b>For models:</b>	DV100 AB 1983, DV120B, DV120T, DV160 AB 1983, DV160 AB 1996, DV240B AB 1983, DV240B AB 1996, DV260B, DV270B AB 1992, DV40 AB 1983, DV40N, DV40T, DV40T FA, DV80, DV80 AB 1983, DV80T, ECO STAR 545D, FV120B AB 1983, FV130B, FV240B AB 1983, FV250B AB 1992, FV25G AB 1986, FV40N AB 1980, FV40N AB 1983, FV60E AB 1983		

			
1			
<b>GEV No.</b>	501014	<b>Ref. No.</b>	0620157
<b>description</b>	rinse jet		
<b>For models:</b>	DR70, DR90, DV100 AB 1980, DV100 AB 1983, DV111, DV111E, DV120B, DV120T, DV160 AB 1980, DV160 AB 1983, DV160 AB 1996, DV221, DV240B AB 1980, DV240B AB 1983, DV240B AB 1996, DV260B, DV270B AB 1988, DV270B AB 1992, DV40 AB 1983, DV40 AB 1992, DV40N, DV40T, DV40T FA, DV80, DV80 AB 1975, DV80 AB 1980, DV80 AB 1983, DV80 AB 1992, DV80T, ECO STAR 430F, ECO STAR 530F, EE60, EE90, FV110G, FV120B AB 1980, FV120B AB 1983, FV130B, FV200B, FV20N, FV20T, FV240B AB 1980, FV240B AB 1983, FV250B AB 1988, FV250B AB 1992, FV28G AB 1994, FV28G AB 1997, FV28GFA, FV30, FV30GS, FV40N AB 1980...(Other models you can see in the webshop)		

			
1			
<b>GEV No.</b>	501013	<b>Ref. No.</b>	0620121
<b>description</b>	swirl		
<b>For models:</b>	DR70, DR90, DV100 AB 1980, DV100 AB 1983, DV111, DV111E, DV120B, DV120T, DV160 AB 1980, DV160 AB 1983, DV160 AB 1996, DV221, DV240B AB 1980, DV240B AB 1983, DV240B AB 1996, DV260B, DV270B AB 1988, DV270B AB 1992, DV40 AB 1983, DV40 AB 1992, DV40N, DV40T, DV40T FA, DV80, DV80 AB 1975, DV80 AB 1980, DV80 AB 1983, DV80 AB 1992, DV80T, ECO STAR 430F, ECO STAR 530F, EE60, EE90, FV110G, FV120B AB 1980, FV120B AB 1983, FV130B, FV200B, FV20N, FV20T, FV240B AB 1980, FV240B AB 1983, FV250B AB 1988, FV250B AB 1992, FV28G AB 1994, FV28G AB 1997, FV28GFA, FV30, FV30GS, FV40N AB 1980...(Other models you can see in the webshop)		

			
1			
<b>GEV No.</b>	501015	<b>Ref. No.</b>	0620163
<b>description</b>	end cap		
<b>For models:</b>	DR90, DV100 AB 1980, DV100 AB 1983, DV111, DV111E, DV120B, DV160 AB 1980, DV160 AB 1983, DV221, DV240B AB 1980, DV240B AB 1983, DV260B, DV40 AB 1983, DV80, DV80 AB 1975, DV80 AB 1980, DV80 AB 1983, DV80 AB 1992, FR40G AB 1976, FR40G AB 1980, FR40GUS AB 1976, FR40GUS AB 1980, FV120B AB 1980, FV200B, FV240B AB 1980, FV25G AB 1986, FV30, FV40N AB 1980, FV40N AB 1983, FV50, FV50 M, FV60 AB 1976, FV60E AB 1983		

			
1			
<b>GEV No.</b>	501099	<b>Ref. No.</b>	8000088
<b>description</b>	wash arm mounting pos. lower number 1		
<b>For models:</b>	FV120B AB 1983, FV240B AB 1983		

			
1			
<b>GEV No.</b>	501100	<b>Ref. No.</b>	8000089
<b>description</b>	wash arm mounting pos. lower number 2		
<b>For models:</b>	FV120B AB 1983, FV240B AB 1983		

			
1			
<b>GEV No.</b>	501101	<b>Ref. No.</b>	8000090
<b>description</b>	wash arm mounting pos. lower number 3		
<b>For models:</b>	FV120B AB 1983, FV240B AB 1983		

			
1			
<b>GEV No.</b>	501102	<b>Ref. No.</b>	8000091
<b>description</b>	wash arm mounting pos. upper number 1+3		
<b>For models:</b>	FV120B AB 1983, FV240B AB 1983		

1			
<b>GEV No.</b>	501103	<b>Ref. No.</b>	8000092
<b>description</b>	wash arm mounting pos. upper number 2		
<b>For models:</b>	FV120B AB 1983, FV240B AB 1983		

1			
<b>GEV No.</b>	501045	<b>Ref. No.</b>	8000093
<b>description</b>	wash arm boss mounting pos. lower ø 20.4mm		
<b>For models:</b>	DV260B, FV120B AB 1983, FV240B AB 1983, FV25G AB 1986		

1			
<b>GEV No.</b>	501104	<b>Ref. No.</b>	8000094
<b>description</b>	wash arm boss mounting pos. upper		
<b>For models:</b>	DV260B, FV120B AB 1983, FV240B AB 1983		

1			
<b>GEV No.</b>	501015	<b>Ref. No.</b>	0620163
<b>description</b>	end cap		
<b>For models:</b>	DR90, DV100 AB 1980, DV100 AB 1983, DV111, DV111E, DV120B, DV160 AB 1980, DV160 AB 1983, DV221, DV240B AB 1980, DV240B AB 1983, DV260B, DV40 AB 1983, DV80, DV80 AB 1975, DV80 AB 1980, DV80 AB 1983, DV80 AB 1992, FR40G AB 1976, FR40G AB 1980, FR40GUS AB 1976, FR40GUS AB 1980, FV120B AB 1980, FV200B, FV240B AB 1980, FV25G AB 1986, FV30, FV40N AB 1980, FV40N AB 1983, FV50, FV50 M, FV60 AB 1976, FV60E AB 1983		

1			
<b>GEV No.</b>	501225	<b>Ref. No.</b>	8000042
<b>description</b>	wash arm		
<b>For models:</b>	DV40 AB 1983, DV80 AB 1983, FV30, FV40N AB 1983, FV50		

1			
<b>GEV No.</b>	501226	<b>Ref. No.</b>	8000043 800043
<b>description</b>	wash arm		
<b>For models:</b>	DV40 AB 1983, DV80 AB 1983, FV40N AB 1983		

1			
<b>GEV No.</b>	501230	<b>Ref. No.</b>	8000052
<b>description</b>	wash arm		
<b>For models:</b>	DV100 AB 1983, DV120B, DV160 AB 1983, DV240B AB 1983, DV80, FV60E AB 1983		

1			
<b>GEV No.</b>	501231	<b>Ref. No.</b>	8000053
<b>description</b>	wash arm		
<b>For models:</b>	DV100 AB 1983, DV120B, DV160 AB 1983, DV240B AB 1983, DV80, FV60E AB 1983		

1			
<b>GEV No.</b>	501227	<b>Ref. No.</b>	8000044
<b>description</b>	wash arm boss		
<b>For models:</b>	DV100 AB 1983, DV120B, DV160 AB 1983, DV240B AB 1983, DV40 AB 1983, DV80, DV80 AB 1983, FV40N AB 1983, FV60E AB 1983		

1			
<b>GEV No.</b>	501228	<b>Ref. No.</b>	8000045
<b>description</b>	wash arm boss		
<b>For models:</b>	DV100 AB 1983, DV120B, DV160 AB 1983, DV240B AB 1983, DV40 AB 1983, DV80, DV80 AB 1983, FV40N AB 1983, FV60E AB 1983		









1				
<b>GEV No.</b>	501272	<b>Ref. No.</b>	8001813	
<b>description</b>	wash and rinse arm wash arm L 395mm rinse arm L 320mm w. jets 5 r. jets 3 mounting ø 16/51mm mounting pos. upper/lower 2 wash arms/ 2 rinse arms			
<b>For models:</b>	FV30GS			
<b>spare parts for</b>	501272			
	<b>GEV No.</b>	501013	<b>Ref. No.</b>	0620121
<b>swirl</b>				
	<b>GEV No.</b>	501014	<b>Ref. No.</b>	0620157
<b>rinse jet</b>				
	<b>GEV No.</b>	501025	<b>Ref. No.</b>	0620380
<b>wash arm boss mounting pos. upper</b>				

Table continues overleaf





<b>spare parts for</b> 501272				
	<b>GEV No.</b>	501027	<b>Ref. No.</b>	0620384
	screw cap			
	<b>GEV No.</b>	501031	<b>Ref. No.</b>	0620390
	rinse arm L 155mm			
	<b>GEV No.</b>	501195	<b>Ref. No.</b>	0620387
	wash arm short			
	<b>GEV No.</b>	510112	<b>Ref. No.</b>	0310010
	Thumb screw thread M10 thread L 10mm ø 22mm H 4.5mm SS			









<b>GEV No.</b>	501307	<b>Ref. No.</b>	8004683
<b>description</b>	wash and rinse arm wash arm L 400mm rinse arm L 320mm w. jets 10 r. jets 3 mounting ø 16/51mm mounting pos. upper/lower 2 wash arms/ 2 rinse arms		
<b>For models:</b>	ECO STAR 430F, FV28G AB 1994, FV28G AB 1997		

<b>spare parts for</b> 501307				
	<b>GEV No.</b>	501004	<b>Ref. No.</b>	—
	Thumb screw thread M10 thread L 10mm ø 22mm H 4.5mm SS			
	<b>GEV No.</b>	501013	<b>Ref. No.</b>	0620121
	swirl			
	<b>GEV No.</b>	501014	<b>Ref. No.</b>	0620157
	rinse jet			
	<b>GEV No.</b>	501017	<b>Ref. No.</b>	0620235
	rinse arm support mounting pos. upper			
	<b>GEV No.</b>	501027	<b>Ref. No.</b>	0620384
	screw cap			
	<b>GEV No.</b>	501031	<b>Ref. No.</b>	0620390
	rinse arm L 155mm			
	<b>GEV No.</b>	501032	<b>Ref. No.</b>	0620394
	rinse arm boss			
	<b>GEV No.</b>	501153	<b>Ref. No.</b>	8004008
	rinse arm shaft			
	<b>GEV No.</b>	501196	<b>Ref. No.</b>	0620388
	wash arm short			
	<b>GEV No.</b>	501197	<b>Ref. No.</b>	0620391
	rinse arm L 111mm			
	<b>GEV No.</b>	501256	<b>Ref. No.</b>	8004179
	throttle disc			





<b>GEV No.</b>	501270	<b>Ref. No.</b>	8001814
<b>description</b>	wash and rinse arm wash arm L 495mm rinse arm L 415mm w. jets 10 r. jets 4 mounting ø 16/51mm mounting pos. upper/lower 2 wash arms/ 2 rinse arms		
<b>For models:</b>	DV40 AB 1992, DV40T, DV40T FA, ECO STAR 530F, FV110G, FV20N, FV20T, FV40N AB 1992, FV40T, FV40TFA, FV60E AB 1988, FV70T, FV70TD		

<b>spare parts for</b> 501270				
	<b>GEV No.</b>	501004	<b>Ref. No.</b>	—
	Thumb screw thread M10 thread L 10mm ø 22mm H 4.5mm SS			
	<b>GEV No.</b>	501013	<b>Ref. No.</b>	0620121
	swirl			
	<b>GEV No.</b>	501014	<b>Ref. No.</b>	0620157
	rinse jet			
	<b>GEV No.</b>	501025	<b>Ref. No.</b>	0620380
	wash arm boss mounting pos. upper			
	<b>GEV No.</b>	501027	<b>Ref. No.</b>	0620384
	screw cap			
	<b>GEV No.</b>	501029	<b>Ref. No.</b>	0620386
	wash arm L 225mm mounting ø 30mm			
	<b>GEV No.</b>	501031	<b>Ref. No.</b>	0620390
	rinse arm L 155mm			

<b>GEV No.</b>	501030	<b>Ref. No.</b>	0620389
<b>description</b>	rinse arm		
<b>For models:</b>	DV40 AB 1992, DV40N, DV40T, DV40T FA, ECO STAR 530F, FV110G, FV20N, FV20T, FV40N AB 1992, FV40T, FV40TFA, FV60E AB 1988, FV70T, FV70TD		

<b>GEV No.</b>	501197	<b>Ref. No.</b>	0620391
<b>description</b>	rinse arm L 111mm		
<b>For models:</b>	ECO STAR 430F, FV28G AB 1994, FV28G AB 1997, FV28GFA, FV30GS		

			
1			
<b>GEV No.</b>	501031	<b>Ref. No.</b>	0620390
<b>description</b>	rinse arm L 155mm		
<b>For models:</b>	DV40 AB 1992, DV40N, DV40T, DV40T FA, ECO STAR 430F, ECO STAR 530F, FV110G, FV20N, FV20T, FV28G AB 1994, FV28G AB 1997, FV28GFA, FV30GS, FV40N AB 1992, FV40T, FV40TFA, FV60E AB 1988, FV70T, FV70TD		

			
1			
<b>GEV No.</b>	501014	<b>Ref. No.</b>	0620157
<b>description</b>	rinse jet		
<b>For models:</b>	DR70, DR90, DV100 AB 1980, DV100 AB 1983, DV111, DV111E, DV120B, DV120T, DV160 AB 1980, DV160 AB 1983, DV160 AB 1996, DV221, DV240B AB 1980, DV240B AB 1983, DV240B AB 1996, DV260B, DV270B AB 1988, DV270B AB 1992, DV40 AB 1983, DV40 AB 1992, DV40N, DV40T, DV40T FA, DV80, DV80 AB 1975, DV80 AB 1980, DV80 AB 1983, DV80 AB 1992, DV80T, ECO STAR 430F, ECO STAR 530F, EE60, EE90, FV110G, FV120B AB 1980, FV120B AB 1983, FV130B, FV200B, FV20N, FV20T, FV240B AB 1980, FV240B AB 1983, FV250B AB 1988, FV250B AB 1992, FV28G AB 1994, FV28G AB 1997, FV28GFA, FV30, FV30GS, FV40N AB 1980...(Other models you can see in the webshop)		

			
1			
<b>GEV No.</b>	501013	<b>Ref. No.</b>	0620121
<b>description</b>	swirl		
<b>For models:</b>	DR70, DR90, DV100 AB 1980, DV100 AB 1983, DV111, DV111E, DV120B, DV120T, DV160 AB 1980, DV160 AB 1983, DV160 AB 1996, DV221, DV240B AB 1980, DV240B AB 1983, DV240B AB 1996, DV260B, DV270B AB 1988, DV270B AB 1992, DV40 AB 1983, DV40 AB 1992, DV40N, DV40T, DV40T FA, DV80, DV80 AB 1975, DV80 AB 1980, DV80 AB 1983, DV80 AB 1992, DV80T, ECO STAR 430F, ECO STAR 530F, EE60, EE90, FV110G, FV120B AB 1980, FV120B AB 1983, FV130B, FV200B, FV20N, FV20T, FV240B AB 1980, FV240B AB 1983, FV250B AB 1988, FV250B AB 1992, FV28G AB 1994, FV28G AB 1997, FV28GFA, FV30, FV30GS, FV40N AB 1980...(Other models you can see in the webshop)		

			
1			
<b>GEV No.</b>	501028	<b>Ref. No.</b>	0620385
<b>description</b>	wash arm L 225mm mounting ø 30mm		
<b>For models:</b>	DV40 AB 1992, DV40N, DV40T, DV40T FA, ECO STAR 530F, FV110G, FV20N, FV20T, FV40N AB 1992, FV40T, FV40TFA, FV60E AB 1988, FV70T, FV70TD		

			
1			
<b>GEV No.</b>	501029	<b>Ref. No.</b>	0620386
<b>description</b>	wash arm L 225mm mounting ø 30mm		
<b>For models:</b>	DV40 AB 1992, DV40N, DV40T, DV40T FA, ECO STAR 530F, FV110G, FV20N, FV20T, FV40N AB 1992, FV40T, FV40TFA, FV60E AB 1988, FV70T, FV70TD		

			
1			
<b>GEV No.</b>	501195	<b>Ref. No.</b>	0620387
<b>description</b>	wash arm short		
<b>For models:</b>	ECO STAR 430F, FV28G AB 1994, FV28G AB 1997, FV28GFA, FV30GS		

			
1			
<b>GEV No.</b>	501196	<b>Ref. No.</b>	0620388
<b>description</b>	wash arm short		
<b>For models:</b>	ECO STAR 430F, FV28G AB 1994, FV28G AB 1997, FV28GFA, FV30GS		

			
1			
<b>GEV No.</b>	501334	<b>Ref. No.</b>	8004635
<b>description</b>	wash arm boss mounting pos. lower		
<b>For models:</b>	ECO STAR 430F, FV28GFA		

			
1			
<b>GEV No.</b>	501025	<b>Ref. No.</b>	0620380
<b>description</b>	wash arm boss mounting pos. upper		
<b>For models:</b>	DV40 AB 1992, DV40T, DV40T FA, ECO STAR 530F, FV110G, FV20N, FV20T, FV28G AB 1994, FV28G AB 1997, FV30GS, FV40N AB 1992, FV40T, FV40TFA, FV60E AB 1988, FV70T, FV70TD		

			
1			
<b>GEV No.</b>	501295	<b>Ref. No.</b>	8000678 9525861
<b>description</b>	wash arm mounting pos. lower		
<b>For models:</b>	DV270B AB 1992, FV130B, FV250B AB 1992		





			
1			
<b>GEV No.</b>	501294	<b>Ref. No.</b>	8000677 9525862
<b>description</b>	wash arm mounting pos. upper		
<b>For models:</b>	DV270B AB 1992, FV130B, FV250B AB 1992		

			
1			
<b>GEV No.</b>	501286	<b>Ref. No.</b>	8003968
<b>description</b>	rinse arm L 395mm nozzles 4 mounting ø 16mm mounting pos. upper complete		
<b>For models:</b>	FV110G		

			
1			
<b>GEV No.</b>	501083	<b>Ref. No.</b>	0620292
<b>description</b>	end cap		
<b>For models:</b>	DV270B AB 1988, DV270B AB 1992, FV130B, FV250B AB 1988, FV250B AB 1992		

			
1			
<b>GEV No.</b>	501030	<b>Ref. No.</b>	0620389
<b>description</b>	rinse arm		
<b>For models:</b>	DV40 AB 1992, DV40N, DV40T, DV40T FA, ECO STAR 530F, FV110G, FV20N, FV20T, FV40N AB 1992, FV40T, FV40TFA, FV60E AB 1988, FV70T, FV70TD		

			
1			
<b>GEV No.</b>	501089	<b>Ref. No.</b>	0620392 9525702
<b>description</b>	wash arm boss mounting pos. lower		
<b>For models:</b>	DV270B AB 1992, FV130B, FV250B AB 1992		

			
1			
<b>GEV No.</b>	501197	<b>Ref. No.</b>	0620391
<b>description</b>	rinse arm L 111mm		
<b>For models:</b>	ECO STAR 430F, FV28G AB 1994, FV28G AB 1997, FV28GFA, FV30GS		

			
1			
<b>GEV No.</b>	501090	<b>Ref. No.</b>	0620393 9525703
<b>description</b>	wash arm boss mounting pos. upper		
<b>For models:</b>	DV270B AB 1992, FV130B, FV250B AB 1992		

			
1			
<b>GEV No.</b>	501031	<b>Ref. No.</b>	0620390
<b>description</b>	rinse arm L 155mm		
<b>For models:</b>	DV40 AB 1992, DV40N, DV40T, DV40T FA, ECO STAR 430F, ECO STAR 530F, FV110G, FV20N, FV20T, FV28G AB 1994, FV28G AB 1997, FV28GFA, FV30GS, FV40N AB 1992, FV40T, FV40TFA, FV60E AB 1988, FV70T, FV70TD		

			
1			
<b>GEV No.</b>	501271	<b>Ref. No.</b>	8003886
<b>description</b>	rinse arm L 290mm nozzles 3 mounting ø 16mm mounting pos. upper complete		
<b>For models:</b>	ECO STAR 430F, FV28G AB 1994, FV28G AB 1997		

			
1			
<b>GEV No.</b>	501032	<b>Ref. No.</b>	0620394
<b>description</b>	rinse arm boss		
<b>For models:</b>	ECO STAR 430F, FV110G, FV28G AB 1994, FV28G AB 1997, FV28GFA		



1

<b>GEV No.</b>	501014	<b>Ref. No.</b>	0620157
<b>description</b>	rinse jet		
<b>For models:</b>	DR70, DR90, DV100 AB 1980, DV100 AB 1983, DV111, DV111E, DV120B, DV120T, DV160 AB 1980, DV160 AB 1983, DV160 AB 1996, DV221, DV240B AB 1980, DV240B AB 1983, DV240B AB 1996, DV260B, DV270B AB 1988, DV270B AB 1992, DV40 AB 1983, DV40 AB 1992, DV40N, DV40T, DV40T FA, DV80, DV80 AB 1975, DV80 AB 1980, DV80 AB 1983, DV80 AB 1992, DV80T, ECO STAR 430F, ECO STAR 530F, EE60, EE90, FV110G, FV120B AB 1980, FV120B AB 1983, FV130B, FV200B, FV20N, FV20T, FV240B AB 1980, FV240B AB 1983, FV250B AB 1988, FV250B AB 1992, FV28G AB 1994, FV28G AB 1997, FV28GFA, FV30, FV30GS, FV40N AB 1980...(Other models you can see in the webshop)		



2

<b>GEV No.</b>	501013	<b>Ref. No.</b>	0620121
<b>description</b>	swirl		
<b>For models:</b>	DR70, DR90, DV100 AB 1980, DV100 AB 1983, DV111, DV111E, DV120B, DV120T, DV160 AB 1980, DV160 AB 1983, DV160 AB 1996, DV221, DV240B AB 1980, DV240B AB 1983, DV240B AB 1996, DV260B, DV270B AB 1988, DV270B AB 1992, DV40 AB 1983, DV40 AB 1992, DV40N, DV40T, DV40T FA, DV80, DV80 AB 1975, DV80 AB 1980, DV80 AB 1983, DV80 AB 1992, DV80T, ECO STAR 430F, ECO STAR 530F, EE60, EE90, FV110G, FV120B AB 1980, FV120B AB 1983, FV130B, FV200B, FV20N, FV20T, FV240B AB 1980, FV240B AB 1983, FV250B AB 1988, FV250B AB 1992, FV28G AB 1994, FV28G AB 1997, FV28GFA, FV30, FV30GS, FV40N AB 1980...(Other models you can see in the webshop)		



1

<b>GEV No.</b>	501366	<b>Ref. No.</b>	9510612
<b>description</b>	rinse arm L 490mm nozzles 6 mounting ø 16mm mounting pos. lower straight/short		



1

<b>GEV No.</b>	501367	<b>Ref. No.</b>	8133096
<b>description</b>	rinse arm L 555mm nozzles 3 mounting ø 16mm mounting pos. upper straight/long		



1

<b>GEV No.</b>	501368	<b>Ref. No.</b>	8133099
<b>description</b>	rinse arm L 590mm nozzles 6 mounting ø 16mm mounting pos. lower straight/long		



1

<b>GEV No.</b>	517775	<b>Ref. No.</b>	9520203
<b>description</b>	wash arm mounting pos. lower L 670mm nozzles 5		



1

<b>GEV No.</b>	501198	<b>Ref. No.</b>	0620429
<b>description</b>	wash arm		
<b>For models:</b>	ECO STAR 430F, FV28G AB 1994, FV28G AB 1997, FV28GFA		



1

<b>GEV No.</b>	501001	<b>Ref. No.</b>	0217433
<b>description</b>	flat gasket rubber ED ø 24mm ID ø 17mm thickness 2mm Qty 1 pcs		
<b>For models:</b>	DV120B, DV120T, DV160 AB 1983, DV160 AB 1996, DV240B AB 1983, DV240B AB 1996, DV260B, DV270B AB 1992, DV40 AB 1983, DV40 AB 1992, DV40N, DV40T, DV80, DV80 AB 1983, DV80 AB 1992, DV80T, ECO STAR 430F, ECO STAR 530F, ECO STAR 545D, FR30G AB 1992, FV110G, FV120B AB 1983, FV130B, FV20N, FV20T, FV240B AB 1983, FV250B AB 1992, FV25G AB 1992, FV28G AB 1994, FV28G AB 1997, FV28GFA, FV30GS, FV40N AB 1992, FV40T, FV60E AB 1988, FV70T		





1

<b>GEV No.</b>	501172	<b>Ref. No.</b>	0360211 8660239
<b>description</b>	nut thread M16x1.5 H 5mm WS 22 SS Qty 1 pcs		
<b>For models:</b>	ECO STAR 430F, ECO STAR 530F, ECO STAR 545D, FV28G AB 1994, FV28G AB 1997, FV28GFA		





			
1			
<b>GEV No.</b>	501203	<b>Ref. No.</b>	0620436
<b>description</b>	swirl H 13mm ø 14.5mm 4mm		
<b>For models:</b>	ECO STAR 430F, FV28G AB 1994, FV28G AB 1997, FV28GFA		

			
1			
<b>GEV No.</b>	501202	<b>Ref. No.</b>	0620435
<b>description</b>	wash jet		
<b>For models:</b>	ECO STAR 430F, FV28G AB 1994, FV28G AB 1997, FV28GFA		

			
1			
<b>GEV No.</b>	501192	<b>Ref. No.</b>	0620296
<b>description</b>	wash arm mounting pos. upper/lower L 230mm nozzles 6 mounting ø 25mm suitable for wash pipe no. 0620294		
<b>For models:</b>	FR30G, FR30G AB 1992, FR40G AB 1983, FR40GUS AB 1983		

			
1			
<b>GEV No.</b>	501193	<b>Ref. No.</b>	0620297
<b>description</b>	end cap		
<b>For models:</b>	FR30G, FR30G AB 1992, FR40G AB 1983, FR40GUS AB 1983		

			
1			
<b>GEV No.</b>	501216	<b>Ref. No.</b>	8000023
<b>description</b>	rinse arm H 490mm L 225mm nozzles 6 mounting pos. right		
<b>For models:</b>	FR30G, FR30G AB 1992, FR40G AB 1976, FR40G AB 1980, FR40G AB 1983, FR40GUS AB 1976, FR40GUS AB 1980, FR40GUS AB 1983		

			
1			
<b>GEV No.</b>	501012	<b>Ref. No.</b>	0472031 8000124
<b>description</b>	rinse jet		
<b>For models:</b>	FR30G, FR30G AB 1992, FR40G AB 1983, FR40GUS AB 1983, FV120B AB 1983, FV240B AB 1983, FV25G AB 1986		

miscellaneous			
			
1			
<b>GEV No.</b>	524568	<b>Ref. No.</b>	9600446
<b>description</b>	end cap for wash arm ø 45mm H 45mm		

			
1			
<b>GEV No.</b>	517739	<b>Ref. No.</b>	0620468
<b>description</b>	nozzle insert hole ø 10mm H 20mm ø 32.5mm		

			
1			
<b>GEV No.</b>	517733	<b>Ref. No.</b>	8103318
<b>description</b>	rinse arm mounting pos. lower L 710mm nozzles 4		



			
1			
<b>GEV No.</b>	517734	<b>Ref. No.</b>	8103317
<b>description</b>	rinse arm mounting pos. upper L 655mm nozzles 3		

			
1			
<b>GEV No.</b>	501182	<b>Ref. No.</b>	0472032
<b>description</b>	rinse jet		





			
1			
<b>GEV No.</b>	524573	<b>Ref. No.</b>	0472030
<b>description</b>	rinse jet ø 0.3mm H 9.5mm thread 1/16" NPT WS 10		

			
1			
<b>GEV No.</b>	524557	<b>Ref. No.</b>	0472035
<b>description</b>	rinse jet ø 11.5mm H 9.6mm thread 1/16" NPT WS 10 hole ø 2mm		

			
1			
<b>GEV No.</b>	517773	<b>Ref. No.</b>	9520201
<b>description</b>	wash arm L 670mm nozzles 5		

			
1			
<b>GEV No.</b>	524555	<b>Ref. No.</b>	0620205
<b>description</b>	wash jet H 23.5mm ø 27mm		
<b>accessories for</b>	524555		
	<b>GEV No.</b>	524558	<b>Ref. No.</b> 0620161
	adapter for wash jet ID ø 21mm ED ø 28mm plastic		

			
Image not available			
1			
<b>GEV No.</b>	501189	<b>Ref. No.</b>	0620166
<b>description</b>	wash arm support		
<b>For models:</b>	DR90, DV111, DV111E, DV221		

			
1			
<b>GEV No.</b>	501418	<b>Ref. No.</b>	8004451
<b>description</b>	wash arm support complete mounting pos. lower		
<b>spare parts for</b>	501418		
	<b>GEV No.</b>	501033	<b>Ref. No.</b> 0620443
	wash arm support mounting pos. lower		
	<b>GEV No.</b>	501126	<b>Ref. No.</b> 0620233
	centring star		
	<b>GEV No.</b>	501142	<b>Ref. No.</b> 8000174
	rinse pipe		
<b>accessories for</b>	501418		
	<b>GEV No.</b>	501007	<b>Ref. No.</b> 0401030
	O-ring EPDM thickness 1.5mm ID ø 50mm Qty 1 pcs		

			
1			
<b>GEV No.</b>	501033	<b>Ref. No.</b>	0620443
<b>description</b>	wash arm support mounting pos. lower		
<b>For models:</b>	DV120T, DV40N, DV40T, DV40T FA, DV80T, ECO STAR 545D		

			
1			
<b>GEV No.</b>	501050	<b>Ref. No.</b>	8000190
<b>description</b>	wash arm support mounting pos. lower		
<b>For models:</b>	FV25G AB 1986		

			
1			
<b>GEV No.</b>	501130	<b>Ref. No.</b>	0620285
<b>description</b>	wash arm support mounting pos. lower		
<b>For models:</b>	ECO STAR 530F, FV110G, FV20N, FV20T, FV30GS, FV40T, FV40TFA, FV60E AB 1988, FV70T, FV70TD		

			
1			
<b>GEV No.</b>	501201	<b>Ref. No.</b>	0620432
<b>description</b>	wash arm support mounting pos. lower		
<b>For models:</b>	ECO STAR 430F, FV28G AB 1994, FV28G AB 1997, FV28GFA		

			
Image not available			
1			
<b>GEV No.</b>	501219	<b>Ref. No.</b>	8002536
<b>description</b>	wash arm support mounting pos. lower		
<b>For models:</b>	FV30GS		

			
1			
<b>GEV No.</b>	501297	<b>Ref. No.</b>	8000034 8000036
<b>description</b>	wash arm support mounting pos. lower		
<b>For models:</b>	FV40N AB 1983, FV60E AB 1983		





 <p>1</p>			
<b>GEV No.</b>	501128	<b>Ref. No.</b>	0620281
<b>description</b>	wash arm support mounting pos. lower D1 ø 28mm H 26mm ID ø 20.5mm flange 54x54mm		
<b>For models:</b>	DV120B, DV120T, DV160 AB 1983, DV160 AB 1996, DV240B AB 1983, DV240B AB 1996, DV40 AB 1983, DV40N, DV40T, DV40T FA, DV80, DV80 AB 1983, DV80 AB 1992, DV80T, ECO STAR 545D, FV40N AB 1983, FV60E AB 1983		

 <p>2</p>			
<b>GEV No.</b>	506231	<b>Ref. No.</b>	9538625
<b>description</b>	wash arm support mounting pos. lower D1 ø 55mm D2 ø 70mm H 90mm		

 <p>1</p>			
<b>GEV No.</b>	501096	<b>Ref. No.</b>	8000085
<b>description</b>	wash arm support mounting pos. upper		
<b>For models:</b>	FV120B AB 1983, FV240B AB 1983		

 <p>1</p>			
<b>GEV No.</b>	501131	<b>Ref. No.</b>	0620288 8000037 8000968
<b>description</b>	wash arm support mounting pos. upper		
<b>For models:</b>	ECO STAR 530F, FV20N, FV20T, FV30GS, FV40N AB 1983, FV40N AB 1992, FV40T, FV40TFA, FV60E AB 1983, FV60E AB 1988, FV70TD		

 <p>Image not available</p> <p>1</p>			
<b>GEV No.</b>	501220	<b>Ref. No.</b>	8002537
<b>description</b>	wash arm support mounting pos. upper		
<b>For models:</b>	FV30GS		

 <p>1</p>			
<b>GEV No.</b>	501129	<b>Ref. No.</b>	0620282
<b>description</b>	wash arm support mounting pos. upper H 26mm D1 ø 28mm ID ø 21mm flange 54x54mm		
<b>For models:</b>	DV120B, DV120T, DV160 AB 1983, DV160 AB 1996, DV240B AB 1983, DV240B AB 1996, DV40 AB 1983, DV40N, DV40T, DV40T FA, DV80, DV80 AB 1983, DV80 AB 1992, DV80T, ECO STAR 545D, FV40N AB 1983		

 <p>1</p>			
<b>GEV No.</b>	501388	<b>Ref. No.</b>	9517397 9671628
<b>description</b>	bearing for wash arm ø 22mm H 34.5mm		
<b>For models:</b>	DV120.2, FV40.2, FV40.2 AB 2002, FV40.2 AB 2003, FV40.2M, FV40.2M-MIKE2		

rinse arm shafts			
 <p>1</p>			
<b>GEV No.</b>	501026	<b>Ref. No.</b>	8004195
<b>description</b>	rinse arm shaft		
<b>For models:</b>	ECO STAR 430F, FV28GFA		

 <p>1</p>				
<b>GEV No.</b>	501062	<b>Ref. No.</b>	0620505 8004475	
<b>description</b>	rinse arm shaft			
<b>accessories for</b>	501062			
	<b>GEV No.</b>	100809	<b>Ref. No.</b>	0401016
	O-ring EPDM thickness 2mm ID ø 21mm Qty 1 pcs			
	<b>GEV No.</b>	501061	<b>Ref. No.</b>	8004468
	shim			
	<b>GEV No.</b>	501299	<b>Ref. No.</b>	8660464
	hexagonal nut thread 1/2" H 5mm SS WS 27 Qty 1 pcs			

 <p>1</p>			
<b>GEV No.</b>	501153	<b>Ref. No.</b>	8004008
<b>description</b>	rinse arm shaft		
<b>For models:</b>	ECO STAR 430F, FV28G AB 1994, FV28G AB 1997, FV28GFA		



## knobs

### producer-specific knobs

#### MEIKO



1

<b>GEV No.</b>	501085	<b>Ref. No.</b>	0620320
<b>description</b>	knob black		
<b>For models:</b>	DV100 AB 1983, DV260B, DV270B AB 1988, FR40G AB 1983, FR40GUS AB 1983, FV120B AB 1983, FV240B AB 1983, FV60E AB 1983		



1

<b>GEV No.</b>	110151	<b>Ref. No.</b>	0108018 old
<b>description</b>	knob switch zero mark ø 40mm shaft ø 6x4.6mm shaft flat upper white		



1

<b>GEV No.</b>	112744	<b>Ref. No.</b>	0108018
<b>description</b>	knob zero mark ø 42mm shaft ø 6x4.6mm shaft flat upper black		
<b>For models:</b>	DV40 AB 1983, FR30G, FR40G AB 1976, FR40G AB 1980, FR40G AB 1983, FR40GUS AB 1976, FR40GUS AB 1980, FR40GUS AB 1983, FV25G AB 1986, FV40GE, FV40N AB 1980, FV40N AB 1983, FV60E AB 1983		

### accessories

#### rosettes





1

<b>GEV No.</b>	501086	<b>Ref. No.</b>	0620321
<b>description</b>	rosette black		
<b>For models:</b>	DV100 AB 1983, DV260B, FR40G AB 1983, FR40GUS AB 1983, FV60E AB 1983		

			
1			
<b>GEV No.</b>	501253	<b>Ref. No.</b>	8002125
<b>description</b>	rinse arm shaft		
<b>For models:</b>	DV40 AB 1992		

			
1			
<b>GEV No.</b>	501298	<b>Ref. No.</b>	8003957
<b>description</b>	rinse arm shaft		
<b>For models:</b>	FV110G		

			
1			
<b>GEV No.</b>	501134	<b>Ref. No.</b>	0620383
<b>description</b>	rinse arm shaft centring star mounting pos. upper		
<b>For models:</b>	ECO STAR 530F, FV20N, FV20T, FV30GS, FV40N AB 1992, FV40T, FV40T-FA, FV60E AB 1988, FV70T, FV70TD		

			
1			
<b>GEV No.</b>	501154	<b>Ref. No.</b>	0620506 8004469
<b>description</b>	rinse arm shaft centring star mounting pos. upper ø 26mm H 108mm		
<b>For models:</b>	DV120T, DV40N, DV40T, DV40T FA, DV80T, ECO STAR 545D		

			
1			
<b>GEV No.</b>	524567	<b>Ref. No.</b>	9517409
<b>description</b>	rinse arm shaft ø 24mm H 36.6mm thread M12x1		
<b>For models:</b>	DV120.2, FV40.2, FV40.2 AB 2002, FV40.2 AB 2003, FV40.2M, FV40.2M-MIKE2		





miscellaneous			
			
1			
<b>GEV No.</b>	501080	<b>Ref. No.</b>	0620138
<b>description</b>	octagonal nut thread 1½"		
<b>For models:</b>	DV100 AB 1980, DV100 AB 1983, DV160 AB 1980, DV221, DV260B, DV270B AB 1988, DV80 AB 1980, FR40G AB 1976, FR40G AB 1980, FR40G AB 1983, FR40GUS AB 1976, FR40GUS AB 1980, FR40GUS AB 1983, FR60, FV120B AB 1983, FV240B AB 1980, FV240B AB 1983, FV40N AB 1980, FV60 AB 1976, FV60E AB 1983		

## equipment feet and end caps

### bullet feet

plastic			
			
1			
<b>GEV No.</b>	700108	<b>Ref. No.</b>	0621003 9702221
<b>description</b>	equipment foot pipe type 40x40 thickness 1-1.2mm H 17-55mm plastic Qty 1 pcs		
<b>For models:</b>	DV100 AB 1980, DV120B, DV120T, DV160 AB 1980, DV160 AB 1983, DV160 AB 1996, DV240B AB 1980, DV240B AB 1983, DV240B AB 1996, DV260B, DV270B AB 1992, DV40 AB 1983, DV40 AB 1992, DV40N, DV40T, DV40T FA, DV80, DV80 AB 1980, DV80 AB 1992, DV80T, FV120B AB 1983, FV130B, FV240B AB 1983, FV250B AB 1992		
<b>spare parts for</b>	700108		
		<b>GEV No.</b>	511512
		<b>Ref. No.</b>	—
			O-ring EPDM thickness 2.62mm ID ø 18.72mm Qty 10 pcs

## gaskets

### O-rings

EPDM			
			
1			
<b>GEV No.</b>	532605	<b>Ref. No.</b>	0401011
<b>description</b>	O-ring EPDM thickness 1.5mm ID ø 12mm Qty 1 pcs		

			
1			
<b>GEV No.</b>	501007	<b>Ref. No.</b>	0401030
<b>description</b>	O-ring EPDM thickness 1.5mm ID ø 50mm Qty 1 pcs		
<b>For models:</b>	DV120T, DV40N, DV40T, DV40T FA, DV80T, ECO STAR 430F, ECO STAR 530F, ECO STAR 545D, FV110G, FV20N, FV20T, FV28G AB 1994, FV28G AB 1997, FV28GFA, FV30GS, FV40N AB 1992, FV40T, FV40TFA, FV60E AB 1988, FV70T, FV70TD		

			
1			
<b>GEV No.</b>	528815	<b>Ref. No.</b>	0401038
<b>description</b>	O-ring EPDM thickness 1.78mm ID ø 3.69mm Qty 1 pcs		
<b>For models:</b>	FV25G AB 1986		

			
1			
<b>GEV No.</b>	501398	<b>Ref. No.</b>	0401021
<b>description</b>	O-ring EPDM thickness 12mm ID ø 25mm Qty 1 pcs		

			
1			
<b>GEV No.</b>	532680	<b>Ref. No.</b>	9541791
<b>description</b>	O-ring EPDM thickness 2.5mm ID ø 12mm Qty 1 pcs		

			
1			
<b>GEV No.</b>	361080	<b>Ref. No.</b>	0260051
<b>description</b>	O-ring EPDM thickness 2mm ID ø 16mm Qty 1 pcs		
<b>For models:</b>	DV120B, DV120T, DV40 AB 1992, DV40N, DV40T, DV80 AB 1992, DV80T, ECO STAR 430F, ECO STAR 530F, FR30G, FR30G AB 1992, FV110G, FV130B, FV20N, FV20T, FV25G AB 1986, FV25G AB 1992, FV28G AB 1994, FV28G AB 1997, FV30GS, FV40N AB 1992, FV40T, FV60E AB 1988, FV70T		

			
1			
<b>GEV No.</b>	100809	<b>Ref. No.</b>	0401016
<b>description</b>	O-ring EPDM thickness 2mm ID ø 21mm Qty 1 pcs		
<b>For models:</b>	DV120.2, DV120T, DV40N, DV40T, DV40T FA, DV80T, ECO STAR 545D, FV40.2, FV40.2 AB 2002, FV40.2M, FV40.2M-MIKE2		

			
1			
<b>GEV No.</b>	361311	<b>Ref. No.</b>	9541531
<b>description</b>	O-ring EPDM thickness 2mm ID ø 6mm Qty 1 pcs for type N6		

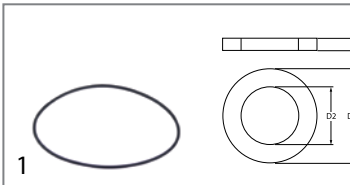

<b>GEV No.</b>	501419	<b>Ref. No.</b>	0401065
<b>description</b>	O-ring EPDM thickness 2mm ID ø 84mm Qty 1 pcs		

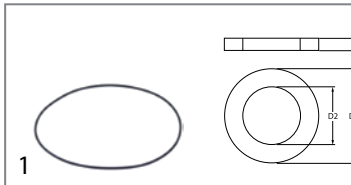

<b>GEV No.</b>	532636	<b>Ref. No.</b>	9500177
<b>description</b>	O-ring EPDM thickness 3mm ID ø 160mm Qty 1 pcs		



<b>GEV No.</b>	361085	<b>Ref. No.</b>	0260053
<b>description</b>	O-ring EPDM thickness 2mm ID ø 8mm Qty 1 pcs		
<b>For models:</b>	DV120B, DV120T, DV40 AB 1992, DV40N, DV40T, DV80 AB 1992, DV80T, ECO STAR 430F, ECO STAR 530F, FR30G AB 1992, FV110G, FV130B, FV20N, FV20T, FV25G AB 1992, FV28G AB 1994, FV28G AB 1997, FV30GS, FV40N AB 1992, FV40T, FV60E AB 1988, FV70T		

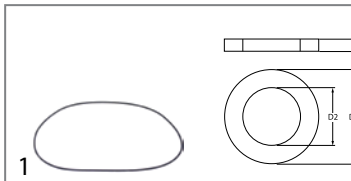

<b>GEV No.</b>	532637	<b>Ref. No.</b>	9500178
<b>description</b>	O-ring EPDM thickness 3mm ID ø 228mm Qty 1 pcs		

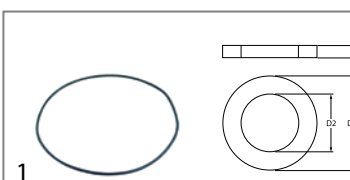

<b>GEV No.</b>	501009	<b>Ref. No.</b>	0401061
<b>description</b>	O-ring EPDM thickness 3.53mm ID ø 206.5mm Qty 1 pcs		
<b>For models:</b>	DV120.2, DV120B, DV120T, DV40 AB 1992, DV40N, DV40T, DV40T FA, DV80 AB 1992, DV80T, ECO STAR 530F, ECO STAR 545D, FV110G, FV20N, FV20T, FV40T, FV40TFA, FV70T, FV70TD		



<b>GEV No.</b>	527561	<b>Ref. No.</b>	0401066
<b>description</b>	O-ring EPDM thickness 3mm ID ø 22mm Qty 1 pcs		

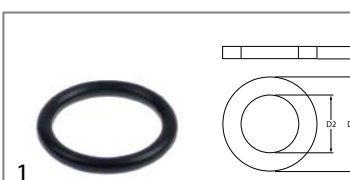

<b>GEV No.</b>	501352	<b>Ref. No.</b>	0401018
<b>description</b>	O-ring EPDM thickness 3.53mm ID ø 21.82mm Qty 1 pcs		

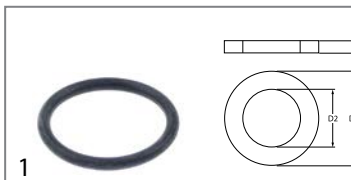

<b>GEV No.</b>	532675	<b>Ref. No.</b>	0401023
<b>description</b>	O-ring EPDM thickness 3mm ID ø 26mm Qty 1 pcs		



<b>GEV No.</b>	510895	<b>Ref. No.</b>	0401029 9659174
<b>description</b>	O-ring EPDM thickness 3.53mm ID ø 34.52mm Qty 1 pcs		

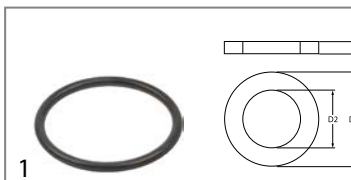

<b>GEV No.</b>	532676	<b>Ref. No.</b>	9515336
<b>description</b>	O-ring EPDM thickness 3mm ID ø 37.2mm Qty 1 pcs		
<b>For models:</b>	FV40.2, FV40.2M-MIKE2		

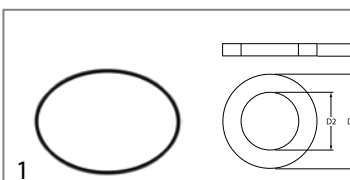

<b>GEV No.</b>	501173	<b>Ref. No.</b>	0401070
<b>description</b>	O-ring EPDM thickness 3mm ID ø 122mm Qty 1 pcs		
<b>For models:</b>	ECO STAR 430F, FV28G AB 1994, FV28G AB 1997, FV28GFA		



<b>GEV No.</b>	518113	<b>Ref. No.</b>	9541533
<b>description</b>	O-ring EPDM thickness 3mm ID ø 46mm Qty 1 pcs		
<b>For models:</b>	DV120.2		

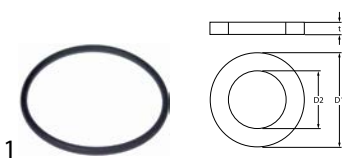

			
<b>GEV No.</b>	532677	<b>Ref. No.</b>	9541532
<b>description</b>	O-ring EPDM thickness 3mm ID ø 54.5mm Qty 1 pcs		
<b>For models:</b>	DV120.2		

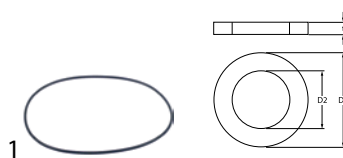
			
<b>GEV No.</b>	532682	<b>Ref. No.</b>	9600791
<b>description</b>	O-ring EPDM thickness 4mm ID ø 188mm Qty 1 pcs Shore 70°		

			
<b>GEV No.</b>	501008	<b>Ref. No.</b>	0401045
<b>description</b>	O-ring EPDM thickness 3mm ID ø 64mm Qty 1 pcs		
<b>For models:</b>	DV100 AB 1983, DV120B, DV160 AB 1983, DV160 AB 1996, DV240B AB 1983, DV240B AB 1996, DV260B, DV40 AB 1983, DV40 AB 1992, DV80, DV80 AB 1983, DV80 AB 1992, FR30G, FR30G AB 1992, FR40G AB 1983, FR40GUS AB 1983, FV120B AB 1983, FV130B, FV240B AB 1983, FV25G AB 1986, FV25G AB 1992, FV30GS, FV40N AB 1983, FV40N AB 1992, FV60E AB 1983, FV60E AB 1988		

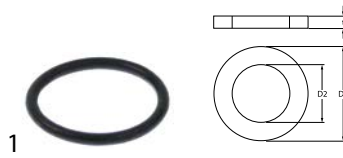
			
<b>GEV No.</b>	532634	<b>Ref. No.</b>	9601007
<b>description</b>	O-ring EPDM thickness 4mm ID ø 38mm Qty 1 pcs		

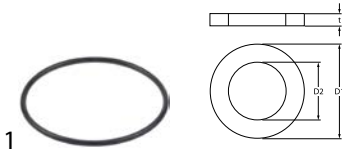
			
<b>GEV No.</b>	532678	<b>Ref. No.</b>	9533155
<b>description</b>	O-ring EPDM thickness 3mm ID ø 66mm Qty 1 pcs		
<b>For models:</b>	FV40.2, FV40.2MIKE2, FV40.2M-MIKE2		

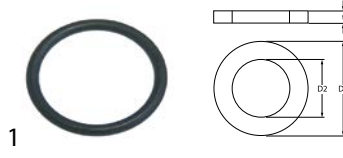
			
<b>GEV No.</b>	510408	<b>Ref. No.</b>	0101176
<b>description</b>	O-ring EPDM thickness 5.34mm ID ø 47mm Qty 1 pcs		
<b>For models:</b>	DV120.2, DV120B, DV120T, DV160 AB 1996, DV240B AB 1996, DV40 AB 1992, DV40T, DV40T FA, DV80 AB 1992, DV80T, ECO STAR 430F, ECO STAR 530F, ECO STAR 545D, FR30G AB 1992, FV110G, FV130B, FV20N, FV20T, FV25G AB 1992, FV28G AB 1994, FV28G AB 1997, FV28GFA, FV30GS, FV40.2, FV40.2 AB 2002, FV40.2 AB 2003, FV40.2M, FV40.2MIKE2, FV40.2M-MIKE2, FV40N AB 1992, FV40T, FV40TFA, FV60E AB 1988, FV70T, FV70TD		

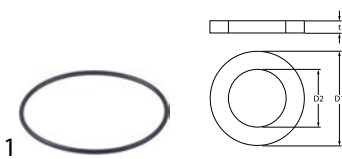
			
<b>GEV No.</b>	510683	<b>Ref. No.</b>	9523260 9543781
<b>description</b>	O-ring EPDM thickness 3mm ID ø 79mm Qty 1 pcs		
<b>For models:</b>	FV40.2, FV40.2MIKE2, FV40.2M-MIKE2		

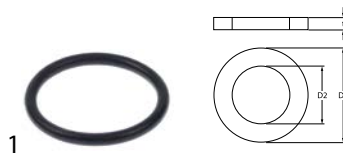
			
<b>GEV No.</b>	532632	<b>Ref. No.</b>	0401031
<b>description</b>	O-ring EPDM thickness 5mm ID ø 47mm Qty 1 pcs		

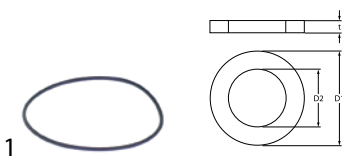
			
<b>GEV No.</b>	532496	<b>Ref. No.</b>	9515338
<b>description</b>	O-ring EPDM thickness 3mm ID ø 96mm Qty 1 pcs		
<b>For models:</b>	FV40.2, FV40.2MIKE2, FV40.2M-MIKE2		

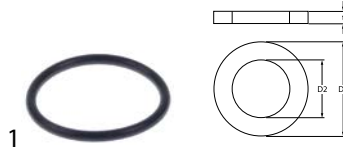
			
<b>GEV No.</b>	532633	<b>Ref. No.</b>	9532356
<b>description</b>	O-ring EPDM thickness 5mm ID ø 58mm Qty 1 pcs		

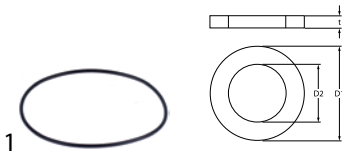
			
<b>GEV No.</b>	501000	<b>Ref. No.</b>	9515339
<b>description</b>	O-ring EPDM thickness 4mm ID ø 145mm Qty 1 pcs		
<b>For models:</b>	DV120.2, FV40.2, FV40.2 AB 2002, FV40.2 AB 2003, FV40.2M, FV40.2MIKE2, FV40.2M-MIKE2		

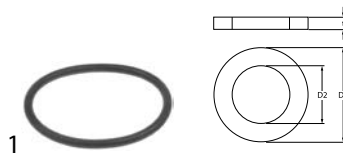
			
<b>GEV No.</b>	532679	<b>Ref. No.</b>	9500176
<b>description</b>	O-ring EPDM thickness 6mm ID ø 78mm Qty 1 pcs		

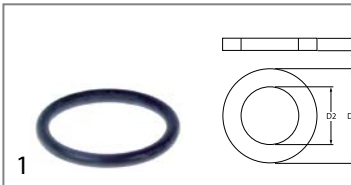

<b>GEV No.</b>	532000	<b>Ref. No.</b>	0401048
<b>description</b>	O-ring EPDM thickness 7mm ID ø 57mm Qty 1 pcs		

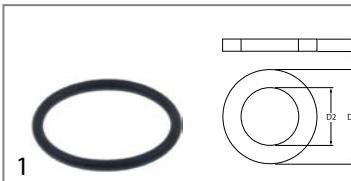

<b>GEV No.</b>	524145	<b>Ref. No.</b>	0401067
<b>description</b>	O-ring ID ø 32mm thickness 3mm Qty 1 pcs		



<b>GEV No.</b>	532714	<b>Ref. No.</b>	0401008
<b>description</b>	O-ring thickness 2.4mm ID ø 9.3mm Qty 1 pcs		

### silicone



<b>GEV No.</b>	532713	<b>Ref. No.</b>	9657016
<b>description</b>	O-ring silicone thickness 3mm ID ø 22mm Qty 1 pcs		

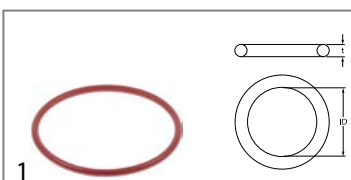

<b>GEV No.</b>	532712	<b>Ref. No.</b>	9657014
<b>description</b>	O-ring silicone thickness 4.5mm ID ø 80mm Qty 1 pcs		

### NBR

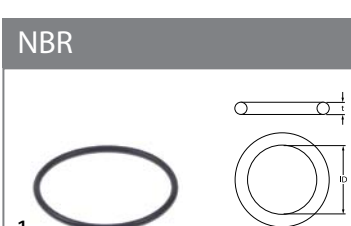

<b>GEV No.</b>	532635	<b>Ref. No.</b>	9523850
<b>description</b>	O-ring NBR thickness 3mm ID ø 48mm Qty 1 pcs		
<b>For models:</b>	FV40.2, FV40.2M-MIKE2		

## sealing washers

### fibre gaskets



<b>GEV No.</b>	501176	<b>Ref. No.</b>	0408003
<b>description</b>	flat gasket FIBER ED ø 24mm ID ø 17mm thickness 1.5mm Qty 1 pcs		
<b>For models:</b>	DR90, FR30G, FR30G AB 1992, FR40G AB 1983, FR40GUS AB 1983, FV110G		

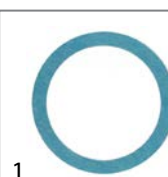

<b>GEV No.</b>	510406	<b>Ref. No.</b>	0408020
<b>description</b>	flat gasket fibre ED ø 60mm ID ø 48mm thickness 3mm for thread 1½" Qty 1 pcs		
<b>For models:</b>	DV100 AB 1983, DV120B, DV160 AB 1983, DV160 AB 1996, DV240B AB 1983, DV240B AB 1996, DV40 AB 1983, DV40 AB 1992, DV80, DV80 AB 1983, DV80 AB 1992, FR30G, FR30G AB 1992, FR40G AB 1983, FR40GUS AB 1983, FV130B, FV25G AB 1986, FV25G AB 1992, FV30GS, FV40N AB 1983, FV40N AB 1992, FV60E AB 1983, FV60E AB 1988		



<b>GEV No.</b>	501075	<b>Ref. No.</b>	0408006
<b>description</b>	sealing ring ED ø 30mm ID ø 21mm thickness 1.5mm Qty 1 pcs		
<b>For models:</b>	DR70, DR90E, DV111, DV111E, DV160 AB 1996, DV240B AB 1996, DV260B, DV270B AB 1992, DV80 AB 1975, DV80 AB 1980, FR40G AB 1980, FR40GUS AB 1980, FV120B AB 1983, FV240B AB 1983, FV250B AB 1992		

### rubber gaskets





<b>GEV No.</b>	511660	<b>Ref. No.</b>	0408226
<b>description</b>	flat gasket EPDM ED ø 37.2mm ID ø 28mm thickness 1.5mm Qty 1 pcs		





<b>GEV No.</b>	501010	<b>Ref. No.</b>	0408008
<b>description</b>	flat gasket FIBER ED ø 25mm ID ø 14mm thickness 1.5mm Qty 1 pcs		
<b>For models:</b>	DV120.2, DV120B, DV120T, DV40T, DV80T, ECO STAR 545D, FV110G, FV130B, FV20N, FV20T, FV28G AB 1994, FV28G AB 1997, FV40.2M, FV40.2M-MIKE2, FV40T, FV70T		





			
1			
<b>GEV No.</b>	501177	<b>Ref. No.</b>	0408227
<b>description</b>	flat gasket rubber ED ø 19mm ID ø 13mm thickness 1.5mm Qty 1 pcs		
<b>For models:</b>	DV40T FA, ECO STAR 545D, FV40TFA, FV70TD		

			
1			
<b>GEV No.</b>	510764	<b>Ref. No.</b>	0408225
<b>description</b>	flat gasket rubber ED ø 24mm ID ø 12mm thickness 2mm Qty 1 pcs		
<b>For models:</b>	FV40.2, FV40.2M-MIKE2		

			
1			
<b>GEV No.</b>	501289	<b>Ref. No.</b>	0217432
<b>description</b>	flat gasket rubber ED ø 24mm ID ø 14mm thickness 2mm Qty 1 pcs		
<b>For models:</b>	FV40.2, FV40.2 AB 2002, FV40.2 AB 2003, FV40.2MIKE2		

			
1			
<b>GEV No.</b>	505199	<b>Ref. No.</b>	9612484
<b>description</b>	flat gasket rubber ED ø 24mm ID ø 14mm thickness 3mm Qty 1 pcs		

			
1			
<b>GEV No.</b>	501001	<b>Ref. No.</b>	0217433
<b>description</b>	flat gasket rubber ED ø 24mm ID ø 17mm thickness 2mm Qty 1 pcs		
<b>For models:</b>	DV120B, DV120T, DV160 AB 1983, DV160 AB 1996, DV240B AB 1983, DV240B AB 1996, DV260B, DV270B AB 1992, DV40 AB 1983, DV40 AB 1992, DV40N, DV40T, DV80, DV80 AB 1983, DV80 AB 1992, DV80T, ECO STAR 430F, ECO STAR 530F, ECO STAR 545D, FR30G AB 1992, FV110G, FV120B AB 1983, FV130B, FV20N, FV20T, FV240B AB 1983, FV250B AB 1992, FV25G AB 1992, FV28G AB 1994, FV28G AB 1997, FV28GFA, FV30GS, FV40N AB 1992, FV40T, FV60E AB 1988, FV70T		

			
1			
<b>GEV No.</b>	501106	<b>Ref. No.</b>	9515964
<b>description</b>	flat gasket rubber ED ø 26mm ID ø 18mm thickness 2mm Qty 1 pcs		
<b>For models:</b>	FV40.2, FV40.2MIKE2, FV40.2M-MIKE2		

			
1			
<b>GEV No.</b>	510875	<b>Ref. No.</b>	0408214
<b>description</b>	flat gasket rubber ED ø 68mm ID ø 48mm thickness 2mm Qty 1 pcs		
<b>For models:</b>	DV100 AB 1980, DV100 AB 1983, DV120B, DV160 AB 1980, DV160 AB 1983, DV160 AB 1996, DV240B AB 1980, DV240B AB 1983, DV240B AB 1996, DV40 AB 1983, DV40 AB 1992, DV80, DV80 AB 1980, DV80 AB 1983, DV80 AB 1992, FR30G, FR30G AB 1992, FR40G AB 1980, FR40G AB 1983, FR40GUS AB 1980, FR40GUS AB 1983, FV130B, FV25G AB 1986, FV25G AB 1992, FV30GS, FV40N AB 1980, FV40N AB 1983, FV40N AB 1992, FV60E AB 1983, FV60E AB 1988		

			
1			
<b>GEV No.</b>	501066	<b>Ref. No.</b>	0237009 0408224
<b>description</b>	flat gasket rubber ED ø 85mm ID ø 59.5mm thickness 2mm Qty 1 pcs		
<b>For models:</b>	DV270B AB 1992		

			
1			
<b>GEV No.</b>	510883	<b>Ref. No.</b>	9500825
<b>description</b>	gasket rubber ED ø 86mm ID ø 66mm thickness 2mm for salt tank Qty 1 pcs		
<b>For models:</b>	ECO STAR 545D		

plastic gaskets

			
1			
<b>GEV No.</b>	501076	<b>Ref. No.</b>	0411005
<b>description</b>	gasket plastic ED ø 29.5mm ID ø 16mm thickness 6mm for thread M16 Qty 1 pcs		
<b>For models:</b>	DV260B, DV40 AB 1983, FV120B AB 1983, FV240B AB 1983		

copper gaskets

DIN-7603-A

			
1			
<b>GEV No.</b>	506247	<b>Ref. No.</b>	0409000
<b>description</b>	flat gasket copper ED ø 8mm ID ø 4mm thickness 1mm Qty 1 pcs		
<b>For models:</b>	DV120T, DV40N, DV40T, DV40T FA, DV80T, ECO STAR 430F, ECO STAR 545D, FV110G, FV20N, FV20T, FV25G AB 1986, FV28G AB 1994, FV28G AB 1997, FV28GFA, FV30GS, FV40N AB 1992, FV40T, FV40TFA, FV60E AB 1988, FV70T, FV70TD		

DIN-7603-C



1			
<b>GEV No.</b>	510420	<b>Ref. No.</b>	0108019
<b>description</b>	gasket copper ED ø 19.9mm ID ø 14.3mm thickness 2mm Qty 1 pcs		
<b>For models:</b>	DV40 AB 1983, FR30G, FR40G AB 1976, FR40G AB 1983, FR40GUS AB 1976, FR40GUS AB 1983, FR60, FV25G AB 1986, FV40N AB 1983, FV50, FV60 AB 1976, FV60E AB 1983		



1			
<b>GEV No.</b>	510424	<b>Ref. No.</b>	0409008
<b>description</b>	gasket copper ED ø 55mm ID ø 48mm thickness 2.2mm Centellen for thread 1½"		
<b>For models:</b>	DV100 AB 1980, DV100 AB 1983, DV120B, DV160 AB 1980, DV160 AB 1983, DV160 AB 1996, DV240B AB 1980, DV240B AB 1983, DV240B AB 1996, DV260B, DV270B AB 1992, DV40 AB 1983, DV80, DV80 AB 1983, DV80 AB 1992, EE60, EE90, FR30G, FR40G AB 1976, FR40G AB 1980, FR40G AB 1983, FR40GUS AB 1976, FR40GUS AB 1980, FR40GUS AB 1983, FR60, FV120B AB 1980, FV120B AB 1983, FV200B, FV240B AB 1980, FV240B AB 1983, FV250B AB 1992, FV25G AB 1986, FV30, FV40N AB 1980, FV40N AB 1983, FV50, FV50 M, FV60 AB 1973, FV60 AB 1976, FV60E AB 1983		

PTFE gaskets



1			
<b>GEV No.</b>	512401	<b>Ref. No.</b>	9603787
<b>description</b>	flat gasket PTFE ED ø 16mm ID ø 10mm thickness 2mm Qty 1 pcs		
<b>For models:</b>	FV40.2M-MIKE2		



1			
<b>GEV No.</b>	501175	<b>Ref. No.</b>	0403302
<b>description</b>	flat gasket PTFE ED ø 16mm ID ø 7mm thickness 1mm Qty 1 pcs		

shaft gaskets

shaft gaskets



1			
<b>GEV No.</b>	698455	<b>Ref. No.</b>	9541786
<b>description</b>	shaft sealing set ID ø 18mm ED ø 26mm thickness 10.5mm		

special gaskets

door seals for dishwashers

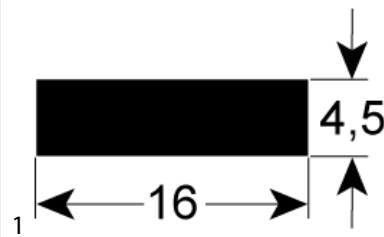

1			
<b>GEV No.</b>	504456	<b>Ref. No.</b>	0650080
<b>description</b>	door seal L 430mm W 16mm H 4.5mm rubber suitable for MEIKO		

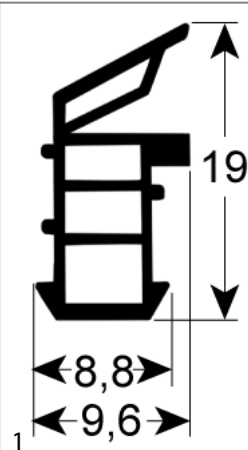

1			
<b>GEV No.</b>	902061	<b>Ref. No.</b>	0415028 9503848 9650780
<b>description</b>	door seal L 480mm black		

miscellaneous

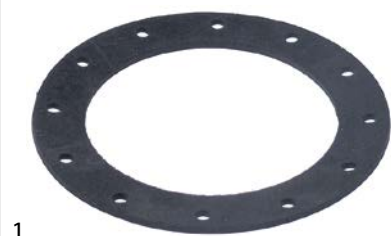

1			
<b>GEV No.</b>	501383	<b>Ref. No.</b>	0408229
<b>description</b>	flat gasket ID ø 102mm ED ø 144mm hole distance 33mm hole ø 6mm EPDM for heating element thickness 3mm		



1			
<b>GEV No.</b>	504465	<b>Ref. No.</b>	9515234
<b>description</b>	gasket suitable for MEIKO for air valve ED ø 14mm ID ø 9mm EPDM thickness 1.6mm		
<b>For models:</b>	FV40.2, FV40.2M-MIKE2		



thermostat gaskets

			
1			
<b>GEV No.</b>	510362	<b>Ref. No.</b>	0108040
<b>description</b>	gasket for thermostat ED ø 40mm ID ø 19mm suitable for COMENDA, MEIKO equiv. no. 630511/0108040		
<b>For models:</b>	DV100 AB 1980, DV100 AB 1983, DV120B, DV120T, DV160 AB 1980, DV160 AB 1983, DV160 AB 1996, DV240B AB 1980, DV240B AB 1983, DV240B AB 1996, DV270B AB 1992, DV40 AB 1983, DV40N, DV40T, DV40T FA, DV80, DV80 AB 1980, DV80 AB 1983, DV80 AB 1992, DV80T, ECO STAR 430F, ECO STAR 530F, ECO STAR 545D, FR30G, FR30G AB 1992, FR40G AB 1976, FR40G AB 1980, FR40G AB 1983, FR40GUS AB 1976, FR40GUS AB 1980, FR40GUS AB 1983, FV110G, FV130B, FV20N, FV20T, FV250B AB 1992, FV25G AB 1986, FV25G AB 1992, FV28G AB 1994, FV28G AB 1997, FV28GFA, FV30, FV30GS, FV40.2, FV40.2 AB 2003, FV40N AB 1980, FV40N AB 1983, FV40N AB 1992, FV40T, FV40T-FA...(Other models you can see in the webshop)		

			
1			
<b>GEV No.</b>	502215	<b>Ref. No.</b>	9501866
<b>description</b>	torsion spring ø 9mm wire gauge ø 1.6mm Qty 1 pcs for magnetic switch		

spring compressors

			
1			
<b>GEV No.</b>	501060	<b>Ref. No.</b>	8004425
<b>description</b>	spring compressor		
<b>For models:</b>	DV120.2, DV120T, DV40N, DV40T, DV40T FA, DV80T, ECO STAR 545D		

gaskets for wash arm support

			
1			
<b>GEV No.</b>	501070	<b>Ref. No.</b>	9515334
<b>description</b>	gasket D1 ø 58mm D2 ø 42mm thickness 2.5mm		
<b>For models:</b>	FV40.2, FV40.2M-MIKE2		

			
1			
<b>GEV No.</b>	501240	<b>Ref. No.</b>	8000073
<b>description</b>	spring compressor		
<b>For models:</b>	DR90, DV100 AB 1983, DV111, DV111E, DV120, DV120B, DV160 AB 1983, DV160 AB 1996, DV221, DV240B AB 1983, DV240B AB 1996, DV40 AB 1983, DV40 AB 1992, DV80, DV80 AB 1980, DV80 AB 1983, DV80 AB 1992		

transmission technology and ball bearings

drive belts

round belts

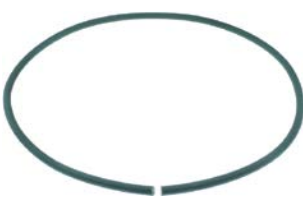
			
1			
<b>GEV No.</b>	694464 <sup>1</sup>	<b>Ref. No.</b>	0440011
<b>description</b>	round belt ø 10mm Lmm Qty supplied by meter		

<sup>1</sup>by the meter

springs

torsion springs

			
1			
<b>GEV No.</b>	524359	<b>Ref. No.</b>	0431211
<b>description</b>	torsion spring ø 8mm wire gauge ø 1.3mm Qty 1 pcs warewashing		

gas tension springs

gas tension springs

			
1			
<b>GEV No.</b>	501077	<b>Ref. No.</b>	0431040
<b>description</b>	gas tension spring 150N		
<b>For models:</b>	DV270B AB 1988, FV120B AB 1980, FV120B AB 1983, FV240B AB 1980, FV240B AB 1983, FV250B AB 1988, FV250B AB 1992		

			
1			
<b>GEV No.</b>	501078	<b>Ref. No.</b>	0431041
<b>description</b>	gas tension spring 75N		
<b>For models:</b>	FV120B AB 1980, FV120B AB 1983, FV130B, FV240B AB 1980, FV240B AB 1983, FV250B AB 1992		

accessories

			
1			
<b>GEV No.</b>	694469	<b>Ref. No.</b>	8003243
<b>description</b>	bearing for gas tension spring L 50mm W 16mm H 30mm hole ø 8mm		

roller springs

			
1			
<b>GEV No.</b>	501255	<b>Ref. No.</b>	0431070
<b>description</b>	roller spring type 5-1 L 870mm W 40mm ID ø 36mm		

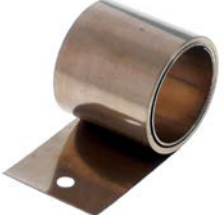
			
1			
<b>GEV No.</b>	501395	<b>Ref. No.</b>	0431073
<b>description</b>	roller spring type 5-2 L 970mm W 40mm ID ø 36mm lug length 72mm		

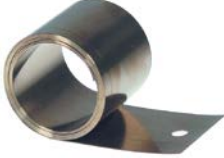
			
1			
<b>GEV No.</b>	501403	<b>Ref. No.</b>	0431071
<b>description</b>	roller spring type 7-1 L 870mm W 40mm ID ø 36mm lug length 52mm		

			
1			
<b>GEV No.</b>	501392	<b>Ref. No.</b>	9504018
<b>description</b>	roller spring type 7-1A L 920mm W 40mm ID ø 36mm lug length 52mm		

			
1			
<b>GEV No.</b>	501394	<b>Ref. No.</b>	0431074
<b>description</b>	roller spring type 7-2 L 970mm W 40mm ID ø 36mm lug length 72mm		

			
1			
<b>GEV No.</b>	501391	<b>Ref. No.</b>	9504017
<b>description</b>	roller spring W 40mm ID ø 35mm lug length 50mm		

			
1			
<b>GEV No.</b>	501406	<b>Ref. No.</b>	0431075
<b>description</b>	roller spring W 40mm ID ø 35mm lug length 50mm		

			
1			
<b>GEV No.</b>	517736	<b>Ref. No.</b>	0431067
<b>description</b>	roller spring W 40mm ID ø 36mm lug length 26.75mm mounting distance 20mm		

			
1			
<b>GEV No.</b>	517737	<b>Ref. No.</b>	0431069
<b>description</b>	roller spring W 40mm ID ø 41mm lug length 29mm mounting distance 20mm		
<b>For models:</b>	FV130B		







			
1			
<b>GEV No.</b>	518599	<b>Ref. No.</b>	0431081
<b>description</b>	roller spring with hole type 94		

accessories

bolts

			
1			
<b>GEV No.</b>	694468	<b>Ref. No.</b>	8100910
<b>description</b>	bearing bolt for roller spring ø 8mm L 79mm		

holders

			
1			
<b>GEV No.</b>	511662	<b>Ref. No.</b>	8100868
<b>description</b>	bracket for roller spring L 95mm W 65mm H 60mm		

tension springs

			
1			
<b>GEV No.</b>	519556	<b>Ref. No.</b>	9549548
<b>description</b>	tension spring ø 1.2mm total length 63mm wire gauge ø 1.6mm L1 63mm L2 8mm L3 8mm		

			
1			
<b>GEV No.</b>	501326	<b>Ref. No.</b>	0430025
<b>description</b>	tension spring ø 14mm total length 80mm wire gauge ø 1.1mm		
<b>For models:</b>	ECO STAR 430F, ECO STAR 530F, FV110G, FV20N, FV20T, FV28G AB 1994, FV28G AB 1997, FV28GFA, FV40N AB 1992, FV40T, FV40TFA, FV70T, FV70TD		

			
1			
<b>GEV No.</b>	701013	<b>Ref. No.</b>	9682387
<b>description</b>	tension spring ø 21.6mm total length 123mm wire gauge ø 1.6mm		

			
1			
<b>GEV No.</b>	700895	<b>Ref. No.</b>	9542938
<b>description</b>	tension spring ø 22mm wire gauge ø 1.6mm L1 110mm		

			
1			
<b>GEV No.</b>	699286	<b>Ref. No.</b>	9601445 9682398
<b>description</b>	tension spring ø 27mm total length 150mm wire gauge ø 2mm L1 4mm L2 142mm L3 4mm for door		

			
1			
<b>GEV No.</b>	501057	<b>Ref. No.</b>	0430006 8001613
<b>description</b>	tension spring total length 385mm D1 ø 45mm D2 ø 6.5mm		
<b>For models:</b>	DR70, DV100 AB 1980, DV100 AB 1983, DV111, DV111E, DV120, DV120.2, DV120B, DV120T, DV160 AB 1980, DV160 AB 1983, DV160 AB 1996, DV221, DV240B AB 1980, DV240B AB 1983, DV240B AB 1996, DV260B, DV270B AB 1992, DV40 AB 1983, DV40 AB 1992, DV40N, DV40T, DV40T FA, DV80, DV80 AB 1975, DV80 AB 1980, DV80 AB 1992, DV80T, ECO STAR 545D		

hose reels and spray guns

hose reels

spare parts and accessories

hoses

			
1			
<b>GEV No.</b>	520101	<b>Ref. No.</b>	0640026
<b>description</b>	hose ø 13x19mm connections length 20m approval LMBG temp.-resist. -20 up to +60°C operating p. 15bar burst p. 45bar suitable for drinking water for hose reel		



cleaning guns

spare parts and accessories

hoses

1 

<b>GEV No.</b>	520101	<b>Ref. No.</b>	0640026
<b>description</b>	hose ø 13x19mm connections length 20m approval LMBG temp.-resist. -20 up to +60°C operating p. 15bar burst p. 45bar suitable for drinking water for hose reel		

1 

<b>GEV No.</b>	361248	<b>Ref. No.</b>	0535624
<b>description</b>	dosing pump ASF/THOMAS without control 2l/h 230VAC detergent hose ø 4x7mm hose silicone type SR25 dimensions 63x124x101mm		
<b>spare parts for</b>	361248		
	<b>GEV No.</b>	361333	<b>Ref. No.</b> 0535676
	pump hose SR25 detergent hose ø 4x1.5mm hose type silicone		
	<b>GEV No.</b>	361335	<b>Ref. No.</b> 0535657
	hose guide SR25 for detergent hose type hose ø 6mm plastic 1-way/h		
	<b>GEV No.</b>	361336	<b>Ref. No.</b> 0535658
	closing clamp type SR25		
	<b>GEV No.</b>	361469	<b>Ref. No.</b> —
	roller assembly type SR25 2/4/6l/h		

dosing pumps

peristaltic dosing pumps

ASF/THOMAS

built-in version

without control

1 

<b>GEV No.</b>	361272	<b>Ref. No.</b>	0535620
<b>description</b>	dosing pump ASF/THOMAS without control 12l/h 230VAC detergent hose ø 4x7mm hose silicone type SR25 dimensions 63x124x101mm		
<b>spare parts for</b>	361272		
	<b>GEV No.</b>	361333	<b>Ref. No.</b> 0535676
	pump hose SR25 detergent hose ø 4x1.5mm hose type silicone		
	<b>GEV No.</b>	361335	<b>Ref. No.</b> 0535657
	hose guide SR25 for detergent hose type hose ø 6mm plastic 1-way/h		
	<b>GEV No.</b>	361336	<b>Ref. No.</b> 0535658
	closing clamp type SR25		
	<b>GEV No.</b>	361470	<b>Ref. No.</b> —
	roller assembly type SR25 12l/h		

1 

<b>GEV No.</b>	361324	<b>Ref. No.</b>	0535682
<b>description</b>	dosing pump ASF/THOMAS without control 4l/h 12VDC detergent hose ø 2x5.2mm hose Pharmed type SR10/50 for short duty cycle dimensions 63x124x101mm		
<b>For models:</b>	FV28G AB 1994		
<b>spare parts for</b>	361324		
	<b>GEV No.</b>	361296	<b>Ref. No.</b> 0535694
	pump hose SR10/50 detergent hose length 250mm hose ø 2x1.6mm hose type Pharmed		
	<b>GEV No.</b>	361327	<b>Ref. No.</b> 0535692
	pump head SR10/50 detergent hose type Pharmed 4l/h		







1

<b>GEV No.</b>	361968	<b>Ref. No.</b>	0535696
<b>description</b>	dosing pump ASF/THOMAS without control 4l/h 12VDC rinse aid hose ø 2.5x5.7mm hose silicone type SR10/50 for short duty cycle dimensions 63x124x101mm		







1

<b>GEV No.</b>	361330	<b>Ref. No.</b>	0535680	
<b>description</b>	dosing pump ASF/THOMAS without control 4l/h 12VDC rinse aid hose ø 2x5.2mm hose silicone type SR10/50 for short duty cycle dimensions 63x124x101mm			
<b>spare parts for</b>	361330			
	<b>GEV No.</b>	361292	<b>Ref. No.</b>	0535685 9520558
	pump head SR10/50 rinse aid hose type silicone 4l/h			
	<b>GEV No.</b>	361294	<b>Ref. No.</b>	0535688
	pump hose SR10/50 rinse aid hose length 190mm hose ø 2x5.2mm hose type silicone			



1

<b>GEV No.</b>	361249	<b>Ref. No.</b>	0535625	
<b>description</b>	dosing pump ASF/THOMAS without control 4l/h 230VAC detergent hose ø 4x7mm hose silicone type SR25 dimensions 63x124x101mm			
<b>For models:</b>	DV100 AB 1980, DV120B, DV160 AB 1980, DV240B AB 1980, DV80, DV80 AB 1980, FV120B AB 1980, FV240B AB 1980, FV40N AB 1980			
<b>spare parts for</b>	361249			
	<b>GEV No.</b>	361333	<b>Ref. No.</b>	0535676
	pump hose SR25 detergent hose ø 4x1.5mm hose type silicone			
	<b>GEV No.</b>	361335	<b>Ref. No.</b>	0535657
	hose guide SR25 for detergent hose type hose ø 6mm plastic 1-way/h			
	<b>GEV No.</b>	361336	<b>Ref. No.</b>	0535658
	closing clamp type SR25			
	<b>GEV No.</b>	361469	<b>Ref. No.</b>	—
	roller assembly type SR25 2/4/6l/h			



1

<b>GEV No.</b>	361325	<b>Ref. No.</b>	0535683	
<b>description</b>	dosing pump ASF/THOMAS without control 6l/h 12VDC detergent hose ø 2.4x5.6mm hose Pharmed type SR10/50 for short duty cycle dimensions 63x124x101mm 20500702			
<b>For models:</b>	FV28G AB 1994			
<b>spare parts for</b>	361325			
	<b>GEV No.</b>	361297	<b>Ref. No.</b>	0535695
	pump hose SR10/50 detergent hose length 190mm hose ø 2.4x1.6mm hose type Pharmed			
	<b>GEV No.</b>	361328	<b>Ref. No.</b>	0535693
	pump head SR10/50 detergent hose type Pharmed 6l/h			







1

<b>GEV No.</b>	361917	<b>Ref. No.</b>	0535697 9615179
<b>description</b>	dosing pump ASF/THOMAS without control 6l/h 12VDC rinse aid hose ø 2.5x1.6mm hose silicone type SR10/50 hose length 55/85mm		





1

<b>GEV No.</b>	361331	<b>Ref. No.</b>	0535681	
<b>description</b>	dosing pump ASF/THOMAS without control 6l/h 12VDC rinse aid hose ø 2.5x5.7mm hose silicone type SR10/50 for short duty cycle dimensions 63x124x101mm			
<b>spare parts for</b>	361331			
	<b>GEV No.</b>	361293	<b>Ref. No.</b>	0535686 9500290
	pump head SR10/50 rinse aid hose type silicone 6l/h			
	<b>GEV No.</b>	361295	<b>Ref. No.</b>	0535690
	pump hose SR10/50 rinse aid hose length 190mm hose ø 2.5x1.6mm hose type silicone			

			
1	GEV No.	361271	Ref. No. 0535613
	description	dosing pump ASF/THOMAS without control 6l/h 230VAC detergent hose ø 5x8mm hose silicone type SR25 dimensions 63x124x101mm	
	spare parts for	361271	
		GEV No.	361334 Ref. No. 0535664
	description	pump hose SR25 detergent hose ø 5x8mm hose type silicone	
		GEV No.	361335 Ref. No. 0535657
	description	hose guide SR25 for detergent hose type hose ø 6mm plastic 1-way/h	
		GEV No.	361336 Ref. No. 0535658
	description	closing clamp type SR25	
		GEV No.	361469 Ref. No. —
	description	roller assembly type SR25 2/4/6l/h	

spare parts

			
1	GEV No.	361297	Ref. No. 0535695
	description	pump hose SR10/50 detergent hose length 190mm hose ø 2.4x1.6mm hose type Pharmed	

			
1	GEV No.	361296	Ref. No. 0535694
	description	pump hose SR10/50 detergent hose length 250mm hose ø 2x1.6mm hose type Pharmed	

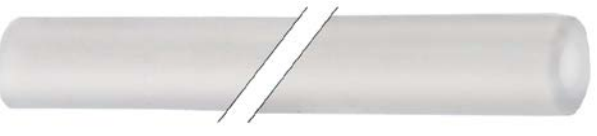
			
1	GEV No.	361295	Ref. No. 0535690
	description	pump hose SR10/50 rinse aid hose length 190mm hose ø 2.5x1.6mm hose type silicone	

			
1	GEV No.	361294	Ref. No. 0535688
	description	pump hose SR10/50 rinse aid hose length 190mm hose ø 2x5.2mm hose type silicone	

			
1	GEV No.	361333	Ref. No. 0535676
	description	pump hose SR25 detergent hose ø 4x1.5mm hose type silicone	

			
1	GEV No.	361334	Ref. No. 0535664
	description	pump hose SR25 detergent hose ø 5x8mm hose type silicone	

			
1	GEV No.	361335	Ref. No. 0535657
	description	hose guide SR25 for detergent hose type hose ø 6mm plastic 1-way/h	

			
1	GEV No.	361327	Ref. No. 0535692
	description	pump head SR10/50 detergent hose type Pharmed 4l/h	
	For models:	FV28G AB 1994	





			
1	GEV No.	361328	Ref. No. 0535693
	description	pump head SR10/50 detergent hose type Pharmed 6l/h	
	For models:	FV28G AB 1994	

			
1	GEV No.	361292	Ref. No. 0535685 9520558
	description	pump head SR10/50 rinse aid hose type silicone 4l/h	



			
1			
<b>GEV No.</b>	361293	<b>Ref. No.</b>	0535686 9500290
<b>description</b>	pump head SR10/50 rinse aid hose type silicone 6l/h		







**SAIER**  
built-in version  
without control

			
1			
<b>GEV No.</b>	361329	<b>Ref. No.</b>	9500049 9531928
<b>description</b>	dosing pump SAIER without control 10l/h 230VAC detergent hose ø 5x8mm type DSP9911E duty cycle 25%		
<b>For models:</b>	FV28G AB 1997		
<b>spare parts for</b>	361329		
	<b>GEV No.</b>	361332	<b>Ref. No.</b> 9500092
	pump hose detergent hose ø 4,8x8mm L 140mm		
	<b>GEV No.</b>	361671	<b>Ref. No.</b> —
	hose holder type 9911 hose ø 4.8mm		
	<b>GEV No.</b>	361672	<b>Ref. No.</b> —
	roller assembly type 8811		

spare parts

			
1			
<b>GEV No.</b>	361332	<b>Ref. No.</b>	9500092
<b>description</b>	pump hose detergent hose ø 4,8x8mm L 140mm		
<b>For models:</b>	FV28G AB 1997		

**SEKO**  
wall-mounted version  
with speed control

			
1			
<b>GEV No.</b>	361246	<b>Ref. No.</b>	9503331
<b>description</b>	dosing pump SEKO speed control 0.5-1l/h 230VAC rinse aid hose ø 6mm hose type C hose Sekobril suction level 1.5m type PR dimensions 103x82x92mm		
<b>For models:</b>	ECO STAR 545D, FV28GFA		
<b>spare parts for</b>	361246		
	<b>GEV No.</b>	361136	<b>Ref. No.</b> —
	roller assembly for dosing pump hole ø 4.8x4mm		
	<b>GEV No.</b>	361890	<b>Ref. No.</b> 9505652
	pump hose SEKO rinse aid hose ø 3x8mm hose length 128mm hose ø 6mm hose type C hose Sekobril		
<b>accessories for</b>	361246		
	<b>GEV No.</b>	361511	<b>Ref. No.</b> —
	mounting set detergent hose type 6x9mm hose length 2m PVC 2x hose/container filter/tank intake transparent		
	<b>GEV No.</b>	520252	<b>Ref. No.</b> —
	nylon hose ID ø 6mm ED ø 8mm L 5m thickness 1mm operating p. 10bar burst p. 50bar t.max. 100°C white		
	<b>GEV No.</b>	520278	<b>Ref. No.</b> —
	PVC hose ID ø 6mm ED ø 8mm L 2m thickness 1mm t.max. 60°C transparent		











			
1			
<b>GEV No.</b>	361247	<b>Ref. No.</b>	9504802 9511667 9533323
<b>description</b>	dosing pump SEKO speed control 1-7l/h 230VAC detergent hose ø 6mm hose type I hose Santoprene suction level 1.5m type PR dimensions 103x82x92mm		
<b>spare parts for</b>	361247		
	<b>GEV No.</b>	361136	<b>Ref. No.</b> —
	roller assembly for dosing pump hole ø 4.8x4mm		
	<b>GEV No.</b>	361238	<b>Ref. No.</b> 9505651 9511675
	pump hose SEKO detergent hose ø 6x10mm hose length 135mm hose ø 6mm hose type I hose Santoprene		

Table continues overleaf



<b>spare parts for</b> 361247			
	GEV No.	361562	Ref. No. —
pump cover for dosing pump yellow			
<b>accessories for</b> 361247			
	GEV No.	361511	Ref. No. —
mounting set detergent hose type 6x9mm hose length 2m PVC 2x hose/container filter/tank intake transparent			
	GEV No.	520252	Ref. No. —
nylon hose ID ø 6mm ED ø 8mm L 5m thickness 1mm operating p. 10bar burst p. 50bar t.max. 100°C white			
	GEV No.	520278	Ref. No. —
PVC hose ID ø 6mm ED ø 8mm L 2m thickness 1mm t.max. 60°C transparent			

**built-in version**







**without control**

			
1			
<b>GEV No.</b>	361772 <sup>1</sup>	<b>Ref. No.</b>	9518514
<b>description</b>	dosing pump SEKO without control 0.4l/h 230VAC rinse aid hose ø 4x6mm hose type D hose Sekobril suction level 1.5m type PG peristaltic pump		
<b>For models:</b>	FV40.2, FV40.2 AB 2003		
<b>spare parts for</b> 361772			
	GEV No.	361135	Ref. No. —
pump hose SEKO rinse aid hose ø 3x8mm hose ø 4x6mm hose type D hose Sekobril			
	GEV No.	361136	Ref. No. —
roller assembly for dosing pump hole ø 4.8x4mm			
	GEV No.	361562	Ref. No. —
pump cover for dosing pump yellow			



<sup>1</sup>with accessories

			
1			
<b>GEV No.</b>	361884 <sup>1</sup>	<b>Ref. No.</b>	9625978
<b>description</b>	dosing pump SEKO without control 1.25l/h 24VDC rinse aid hose ø 6mm hose type A hose Sekobril suction level 1.5m type PP 3.5W CODE PPP0001D2002		
<b>spare parts for</b> 361884			
	GEV No.	361239	Ref. No. —
pump hose rinse aid hose ø 3x7mm hose ø 6mm hose type A hose Sekobril			

<sup>1</sup>with accessories







			
1			
<b>GEV No.</b>	361322 <sup>1</sup>	<b>Ref. No.</b>	9544293
<b>description</b>	dosing pump SEKO without control 1l/h 24VDC rinse aid hose ø 6mm hose type B hose Sekobril suction level 1.5m horizontal/vertical type PP built-in version		
<b>For models:</b>	DV120.2, FV40.2 AB 2002, FV40.2M, FV40.2MIKE2, FV40.2M-MIKE2		
<b>spare parts for</b> 361322			
	GEV No.	361136	Ref. No. —
roller assembly for dosing pump hole ø 4.8x4mm			
	GEV No.	361882	Ref. No. 9544088
pump hose SEKO rinse aid hose ø 3x7.4mm hose length 135mm hose ø 6mm hose type B hose Sekobril			
<b>accessories for</b> 361322			
	GEV No.	361144	Ref. No. —
mounting set rinse aid hose type 4x6mm hose length 2m PVC/nylon hose container filter/non-return valve transparent			
	GEV No.	520090	Ref. No. —
PVC hose ID ø 4mm ED ø 6mm L 2m thickness 1mm t.max. 60°C transparent			
	GEV No.	520091	Ref. No. —
nylon hose ID ø 4mm ED ø 6mm L 2m thickness 1mm operating p. 10bar burst p. 50bar t.max. 100°C transparent			

<sup>1</sup>with accessories

			
1			
<b>GEV No.</b>	361771 <sup>1</sup>	<b>Ref. No.</b>	9518513
<b>description</b>	dosing pump SEKO without control 3l/h 230VAC detergent hose ø 6mm hose type K hose Santoprene suction level 1.5m type PG		
<b>For models:</b>	FV40.2, FV40.2 AB 2003		
<b>spare parts for</b> 361771			
	GEV No.	361815	Ref. No. —
pump hose detergent hose ø 6x10mm hose ø 4x6mm hose type K hose Santoprene type SEKO			



<sup>1</sup>with accessories





			
1			
<b>GEV No.</b>	361321 <sup>1</sup>	<b>Ref. No.</b>	9544292
<b>description</b>	dosing pump SEKO without control 7l/h 24VDC detergent hose ø 6mm hose type I hose Santoprene suction level 1.5m horizontal/vertical type PP built-in version		
<b>For models:</b>	DV120.2, FV40.2 AB 2002, FV40.2M, FV40.2MIKE2, FV40.2M-MIKE2		
<b>spare parts for</b>	361321		
	<b>GEV No.</b>	361136	<b>Ref. No.</b> —
	roller assembly for dosing pump hole ø 4.8x4mm		
	<b>GEV No.</b>	361238	<b>Ref. No.</b> 9505651 9511675
	pump hose SEKO detergent hose ø 6x10mm hose length 135mm hose ø 6mm hose type I hose Santoprene		
	<b>GEV No.</b>	361562	<b>Ref. No.</b> —
	pump cover for dosing pump yellow		
<b>accessories for</b>	361321		
	<b>GEV No.</b>	361142	<b>Ref. No.</b> —
	mounting set detergent hose type 4x6mm hose length 2m PVC 2x hose/container filter/tank intake transparent		
	<b>GEV No.</b>	520090	<b>Ref. No.</b> —
	PVC hose ID ø 4mm ED ø 6mm L 2m thickness 1mm t.max. 60°C transparent		
	<b>GEV No.</b>	520091	<b>Ref. No.</b> —
	nylon hose ID ø 4mm ED ø 6mm L 2m thickness 1mm operating p. 10bar burst p. 50bar t.max. 100°C transparent		

<sup>1</sup>with accessories

<b>spare parts</b>			
			
1			
<b>GEV No.</b>	361885	<b>Ref. No.</b>	9533450
<b>description</b>	roller assembly for dosing pump hole ø 4x3mm		

			
			
1			
<b>GEV No.</b>	361238	<b>Ref. No.</b>	9505651 9511675
<b>description</b>	pump hose SEKO detergent hose ø 6x10mm hose length 135mm hose ø 6mm hose type I hose Santoprene		
<b>For models:</b>	DV120.2, ECO STAR 545D, FV28GFA, FV40.2, FV40.2 AB 2002, FV40.2 AB 2003, FV40.2M, FV40.2MIKE2, FV40.2M-MIKE2		
<b>spare parts for</b>	361238		
	<b>GEV No.</b>	361639	<b>Ref. No.</b> —
	pump hose ED ø 10mm ID ø 6mm Shore 64° Santoprene dosing Qty 5m		

			
1			
<b>GEV No.</b>	361882	<b>Ref. No.</b>	9544088
<b>description</b>	pump hose SEKO rinse aid hose ø 3x7.4mm hose length 135mm hose ø 6mm hose type B hose Sekobril		
<b>For models:</b>	DV120.2, FV40.2, FV40.2 AB 2002, FV40.2 AB 2003, FV40.2M, FV40.2MIKE2, FV40.2M-MIKE2		

			
1			
<b>GEV No.</b>	361890	<b>Ref. No.</b>	9505652
<b>description</b>	pump hose SEKO rinse aid hose ø 3x8mm hose length 128mm hose ø 6mm hose type C hose Sekobril		
<b>For models:</b>	ECO STAR 545D, FV28GFA, FV40.2, FV40.2 AB 2003		





<b>various</b>			
<b>built-in version</b>			
			
1			
<b>GEV No.</b>	501407	<b>Ref. No.</b>	9609173 9665425
<b>description</b>	dosing pump 24VDC detergent hose ø 6mm		

**membrane dosing pumps**

**electric dosing pumps**

<b>Delta</b>			
			
1			
<b>GEV No.</b>	361023 <sup>1</sup>	<b>Ref. No.</b>	0260024
<b>description</b>	dosing pump ASF/THOMAS 230V rinse aid/detergent duty cycle 100% type DELTA valve lips/SS valve		
<b>For models:</b>	DR70, DV100 AB 1980, DV100 AB 1983, DV120B, DV160 AB 1980, DV160 AB 1996, DV221, DV240B AB 1980, DV240B AB 1996, DV260B, DV270B AB 1988, DV270B AB 1992, DV40 AB 1983, DV40T FA, DV80, DV80 AB 1975, DV80 AB 1980, DV80 AB 1983, DV80 AB 1992, FR40G AB 1976, FR40G AB 1983, FR40GUS AB 1976, FR40GUS AB 1983, FR60, FV120B AB 1980, FV120B AB 1983, FV200B, FV240B AB 1980, FV240B AB 1983, FV250B AB 1988, FV250B AB 1992, FV30, FV40N AB 1980, FV40TFA, FV50, FV50 M, FV60 AB 1976, FV60E AB 1983, FV70TD		
<b>spare parts for</b>	361023		
	<b>GEV No.</b>	361122	<b>Ref. No.</b> 0260016
	lip valve type DELTA		
	<b>GEV No.</b>	361123	<b>Ref. No.</b> —
	membrane type DELTA		

<sup>1</sup>lip valve SS  
Table continues overleaf



<b>spare parts for</b> 361023			
	<b>GEV No.</b>	361168	<b>Ref. No.</b> 0260027
valve type DELTA			
	<b>GEV No.</b>	361169	<b>Ref. No.</b> 0260021
hose connector type DELTA			
	<b>GEV No.</b>	361188	<b>Ref. No.</b> —
disc type DELTA			
	<b>GEV No.</b>	361319	<b>Ref. No.</b> 0260013
flat gasket rubber ID ø 9mm ED ø 14.5mm thickness 1mm type DELTA			

<b>spare parts</b>			
	<b>GEV No.</b>	361319	<b>Ref. No.</b> 0260013
flat gasket rubber ID ø 9mm ED ø 14.5mm thickness 1mm type DELTA			
<b>For models:</b>	DV100 AB 1980, DV100 AB 1983, DV120B, DV160 AB 1980, DV160 AB 1996, DV240B AB 1980, DV240B AB 1996, DV260B, DV270B AB 1992, DV40 AB 1983, DV40T FA, DV80, DV80 AB 1980, DV80 AB 1983, FR40G AB 1983, FR40GUS AB 1983, FV120B AB 1980, FV120B AB 1983, FV240B AB 1980, FV240B AB 1983, FV250B AB 1992, FV40N AB 1983, FV40TFA, FV60E AB 1983, FV70TD		

	<b>GEV No.</b>	361169	<b>Ref. No.</b> 0260021
hose connector type DELTA			
<b>For models:</b>	DR70, DV100 AB 1980, DV100 AB 1983, DV120B, DV160 AB 1980, DV160 AB 1996, DV221, DV240B AB 1980, DV240B AB 1996, DV260B, DV270B AB 1992, DV40 AB 1983, DV40T FA, DV80, DV80 AB 1975, DV80 AB 1980, DV80 AB 1983, DV80 AB 1992, FR40G AB 1976, FR40G AB 1980, FR40G AB 1983, FR40GUS AB 1976, FR40GUS AB 1980, FR40GUS AB 1983, FR60, FV120B AB 1980, FV120B AB 1983, FV200B, FV240B AB 1980, FV240B AB 1983, FV250B AB 1992, FV30, FV40N AB 1980, FV40N AB 1983, FV40TFA, FV50, FV50 M, FV60 AB 1976, FV60E AB 1983, FV70TD		

	<b>GEV No.</b>	361122	<b>Ref. No.</b> 0260016
lip valve type DELTA			
<b>For models:</b>	DR70, DV100 AB 1980, DV100 AB 1983, DV120B, DV160 AB 1980, DV160 AB 1996, DV221, DV240B AB 1980, DV240B AB 1996, DV260B, DV270B AB 1992, DV40 AB 1983, DV40T FA, DV80, DV80 AB 1975, DV80 AB 1980, DV80 AB 1983, DV80 AB 1992, FR40G AB 1976, FR40G AB 1980, FR40G AB 1983, FR40GUS AB 1976, FR40GUS AB 1980, FR40GUS AB 1983, FR60, FV120B AB 1980, FV120B AB 1983, FV200B, FV240B AB 1980, FV240B AB 1983, FV250B AB 1992, FV30, FV40N AB 1980, FV40TFA, FV50, FV50 M, FV60 AB 1976, FV60E AB 1983, FV70TD		

	<b>GEV No.</b>	361168	<b>Ref. No.</b>	0260027
1				
<b>description</b> valve type DELTA				
<b>For models:</b>	DV100 AB 1980, DV100 AB 1983, DV120B, DV160 AB 1980, DV160 AB 1996, DV240B AB 1980, DV240B AB 1996, DV260B, DV270B AB 1992, DV40 AB 1983, DV40T FA, DV80, DV80 AB 1980, DV80 AB 1983, FR40G AB 1980, FR40G AB 1983, FR40GUS AB 1980, FR40GUS AB 1983, FV120B AB 1980, FV120B AB 1983, FV240B AB 1980, FV240B AB 1983, FV250B AB 1992, FV40N AB 1980, FV40N AB 1983, FV40TFA, FV60E AB 1983, FV70TD			

<b>self-priming</b>				
<b>LANG</b>				
				
Image not available				
	<b>GEV No.</b>	501167	<b>Ref. No.</b>	0260022
1				
<b>description</b> dosing pump type N5				
<b>For models:</b> FV40GE				



	<b>GEV No.</b>	361032	<b>Ref. No.</b>	0260070
1				
<b>description</b> dosing pump type N6 membrane dosing pump rinse aid pressure connection ø angled, 4x6mm suction connection ø angled, 4x6mm				
<b>For models:</b>	DV120B, DV120T, DV40 AB 1992, DV40N, DV40T, DV80 AB 1992, DV80T, ECO STAR 430F, ECO STAR 530F, FR30G AB 1992, FV110G, FV130B, FV20N, FV20T, FV25G AB 1986, FV25G AB 1992, FV28G AB 1994, FV28G AB 1997, FV30GS, FV40N AB 1992, FV40T, FV60E AB 1988, FV70T			

<b>spare parts for</b> 361032				
	<b>GEV No.</b>	361079	<b>Ref. No.</b>	0260047
spring for type N5/N6 for ball				
	<b>GEV No.</b>	361080	<b>Ref. No.</b>	0260051
O-ring EPDM thickness 2mm ID ø 16mm Qty 1 pcs				
	<b>GEV No.</b>	361085	<b>Ref. No.</b>	0260053
O-ring EPDM thickness 2mm ID ø 8mm Qty 1 pcs				
	<b>GEV No.</b>	361309	<b>Ref. No.</b>	—
ball for type N5/N6				
	<b>GEV No.</b>	361310	<b>Ref. No.</b>	—
bracket for type N6 ball guide				
	<b>GEV No.</b>	361311	<b>Ref. No.</b>	9541531
O-ring EPDM thickness 2mm ID ø 6mm Qty 1 pcs for type N6				

Table continues overleaf







<b>spare parts for</b> 361032	
	GEV No. 361314 Ref. No. — valve ring for type N6 holder for O-ring
	GEV No. 361317 Ref. No. — sealing disc for type N6
	GEV No. 361886 Ref. No. — non-return valve inletmm outletmm outlet ø 12.4mm L 12.7mm

	
1	
<b>GEV No.</b> 361916	<b>Ref. No.</b> 9671455
<b>description</b>	dosing pump type N6 rinse aid pressure connection ø angled, 6mm suction connection ø angled, 6mm LANG

<b>spare parts</b>	
	
1	
<b>GEV No.</b> 361311	<b>Ref. No.</b> 9541531
<b>description</b>	O-ring EPDM thickness 2mm ID ø 6mm Qty 1 pcs for type N6

	
1	
<b>GEV No.</b> 361079	<b>Ref. No.</b> 0260047
<b>description</b>	spring for type N5/N6 for ball
<b>For models:</b>	FR30G

<b>accessories</b>	
	
1	
<b>GEV No.</b> 361086	<b>Ref. No.</b> 0260050
<b>description</b>	hose connector with union nut elbow connection
<b>For models:</b>	FR30G, FR30G AB 1992, FV25G AB 1986, FV25G AB 1992, FV30GS

	
1	
<b>GEV No.</b> 361313	<b>Ref. No.</b> 0260052
<b>description</b>	union nut spring adapter
<b>For models:</b>	DV120B, DV120T, DV40 AB 1992, DV40N, DV40T, DV80 AB 1992, DV80T, ECO STAR 430F, ECO STAR 530F, FR30G, FR30G AB 1992, FV110G, FV130B, FV20N, FV20T, FV25G AB 1986, FV25G AB 1992, FV28G AB 1994, FV28G AB 1997, FV30GS, FV40N AB 1992, FV40T, FV60E AB 1988, FV70T

<b>accessories</b>	
<b>container filters</b>	
	
1	
<b>GEV No.</b> 501003	<b>Ref. No.</b> 0260090 8001801
<b>description</b>	container filter
<b>For models:</b>	DV120B, DV120T, DV160 AB 1996, DV240B AB 1996, DV270B AB 1992, DV40 AB 1992, DV40N, DV40T, DV40T FA, DV80 AB 1992, DV80T, ECO STAR 430F, ECO STAR 530F, FV110G, FV130B, FV20N, FV250B AB 1992, FV28G AB 1994, FV40TFA, FV70TD

<b>electrodes for conductivity control</b>	
	
1	
<b>GEV No.</b> 361274	<b>Ref. No.</b> 8000014
<b>description</b>	conductivity probe mounting ø 17mm
<b>For models:</b>	DR90, DV111, DV111E

	
1	
<b>GEV No.</b> 361579	<b>Ref. No.</b> 0620437+0217432+0620162
<b>description</b>	conductivity probe mounting ø 17mm

<b>intake lances</b>	
	
1	
<b>GEV No.</b> 361790	<b>Ref. No.</b> 8005372
<b>description</b>	intake lance with filter L 430mm SS tube ø 6mm hose ømm cable lengthmm

hose couplings

plastic



<b>GEV No.</b>	361096	<b>Ref. No.</b>	0621206
<b>description</b>	hose connector hose ø 4x6-6x8mm straight		



Image not available

<b>GEV No.</b>	362029	<b>Ref. No.</b>	0621204
<b>description</b>	hose connector hose ø 5x8mm plastic connection 1/8"		

hoses

supply hoses

with aquastop



<b>GEV No.</b>	501125	<b>Ref. No.</b>	9517775
<b>description</b>	supply hose with Aquastop thread 3/4" ext. ø 25 L 1300mm 220-240V voltage AC 50/60Hz t.max. 60°C p max 10bar grey		
<b>For models:</b>	FV40.2		



<b>GEV No.</b>	524561	<b>Ref. No.</b>	9543975
<b>description</b>	supply hose with Aquastop thread 3/4" ext. ø 25 L 1300mm 24V voltage DC t.max. 60°C p max 10bar grey		
<b>For models:</b>	FV40.2MIKE2, FV40.2M-MIKE2		

drain hoses



<b>GEV No.</b>	501136	<b>Ref. No.</b>	0640037
<b>description</b>	drain hose DN19 L 2500mm A int. ø 19mm A ext. ø 24mm B int. ø 21mm B ext. ø 28mm outer hose ø 24mm		
<b>For models:</b>	DV40T FA, ECO STAR 430F, ECO STAR 530F, FV28G AB 1994, FV28G AB 1997, FV28GFA, FV40.2, FV40.2 AB 2002, FV40.2 AB 2003, FV40.2MIKE2, FV40TFA, FV70TD		

industrial hoses

PVC hoses

PVC hoses without fabric



<b>GEV No.</b>	520545	<b>Ref. No.</b>	0260006
<b>description</b>	PVC hose ID ø 5mm ED ø 8mm L 10m thickness 1.5mm t.max. 60°C transparent warewashing		
<b>For models:</b>	DR90, DV100 AB 1980, DV100 AB 1983, DV111, DV111E, DV120.2, DV120B, DV120T, DV160 AB 1980, DV160 AB 1983, DV160 AB 1996, DV240B AB 1980, DV240B AB 1983, DV240B AB 1996, DV260B, DV270B AB 1992, DV40 AB 1983, DV40 AB 1992, DV40N, DV40T, DV40T FA, DV80, DV80 AB 1980, DV80 AB 1983, DV80 AB 1992, DV80T, ECO STAR 530F, ECO STAR 545D, FR30G, FR30G AB 1992, FR40G AB 1980, FR40G AB 1983, FR40GUS AB 1980, FR40GUS AB 1983, FV110G, FV120B AB 1980, FV120B AB 1983, FV130B, FV20N, FV20T, FV240B AB 1980, FV250B AB 1992, FV25G AB 1986, FV25G AB 1992, FV28G AB 1994, FV28G AB 1997, FV28GFA, FV30GS, FV40.2, FV40.2 AB 2002... (Other models you can see in the webshop)		



<b>GEV No.</b>	520279	<b>Ref. No.</b>	0260007
<b>description</b>	PVC hose ID ø 6mm ED ø 9mm L 2m thickness 1.5mm t.max. 60°C transparent		
<b>For models:</b>	FV40.2, FV40.2MIKE2, FV40.2M-MIKE2		



<b>GEV No.</b>	570554	<b>Ref. No.</b>	9538712
<b>description</b>	PVC hose ID ø 6mm ED ø 9mm thickness 1.5mm blue		
<b>For models:</b>	FV40.2, FV40.2MIKE2, FV40.2M-MIKE2		



hoses wire reinforced

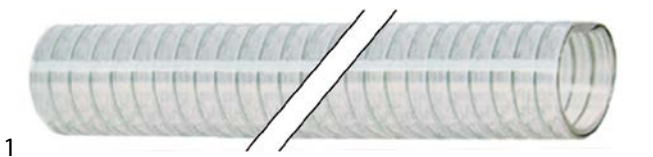

1

<b>GEV No.</b>	524356	<b>Ref. No.</b>	0640045
<b>description</b>	drain hose ID ø 22mm ED ø 28mm L 2m PVC wire reinforced		

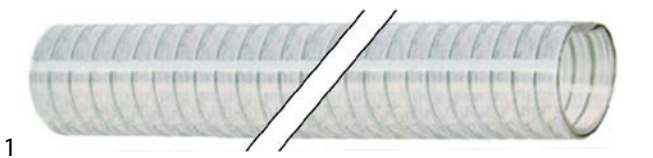

1

<b>GEV No.</b>	520920	<b>Ref. No.</b>	9641540
<b>description</b>	drain hose ID ø 22mm ED ø 28mm L 5m wire reinforced		

pressure hoses (other)

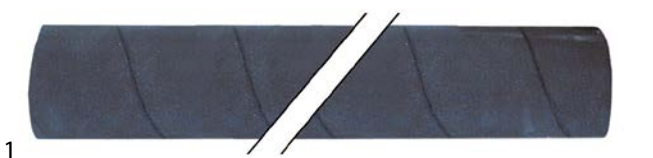

1

<b>GEV No.</b>	501042	<b>Ref. No.</b>	0640007
<b>description</b>	hose ID ø 40mm ED ø 49mm warewashing black Qty 1m		
<b>For models:</b>	DV160 AB 1996, DV40 AB 1983, DV40 AB 1992, DV40N, DV40T, DV40T FA, DV80 AB 1992, DV80T, ECO STAR 430F, ECO STAR 530F, ECO STAR 545D, FR30G AB 1992, FR40G AB 1980, FR40G AB 1983, FR40GUS AB 1980, FR40GUS AB 1983, FV110G, FV20N, FV20T, FV25G AB 1992, FV28G AB 1994, FV28G AB 1997, FV28GFA, FV30GS, FV40N AB 1983, FV40N AB 1992, FV40T, FV40TFA, FV60E AB 1988, FV70T, FV70TD		

drinking water hoses

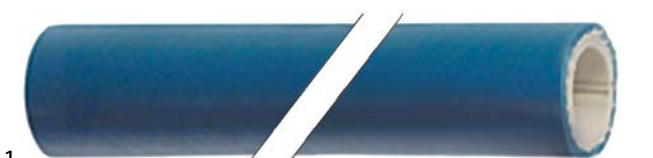

1

<b>GEV No.</b>	520101	<b>Ref. No.</b>	0640026
<b>description</b>	hose ø 13x19mm connections length 20m approval LMBG temp.-resist. -20 up to +60°C operating p. 15bar burst p. 45bar suitable for drinking water for hose reel		

formed hoses

straight



1

<b>GEV No.</b>	501041	<b>Ref. No.</b>	0630209
<b>description</b>	formed hose PVC dishwasher straight Qty 1m hose ext. ø 45mm hose int. ø 35mm		
<b>For models:</b>	DR70, DV40 AB 1983, DV80 AB 1975, FR30G, FR40G AB 1983, FR40GUS AB 1983, FV25G AB 1986, FV30, FV40N AB 1980, FV40N AB 1983, FV40N AB 1992, FV50, FV50 M, FV60 AB 1973, FV60 AB 1976, FV60E AB 1983		

form L



1

<b>GEV No.</b>	530530	<b>Ref. No.</b>	0650008
<b>description</b>	formed hose end piece A ext. ø 56mm end piece A int. ø 46mm AD2 ø 46mm ø end piece B 34mm L 135mm		

miscellaneous



1

<b>GEV No.</b>	524970	<b>Ref. No.</b>	9602750
<b>description</b>	formed hose ext. ø 27 D1 ø 37mm D2 ø 44mm L 720mm EPDM warewashing black		

for dishwashers

miscellaneous



1

<b>GEV No.</b>	501042	<b>Ref. No.</b>	0640007
<b>description</b>	hose ID ø 40mm ED ø 49mm warewashing black Qty 1m		
<b>For models:</b>	DV160 AB 1996, DV40 AB 1983, DV40 AB 1992, DV40N, DV40T, DV40T FA, DV80 AB 1992, DV80T, ECO STAR 430F, ECO STAR 530F, ECO STAR 545D, FR30G AB 1992, FR40G AB 1980, FR40G AB 1983, FR40GUS AB 1980, FR40GUS AB 1983, FV110G, FV20N, FV20T, FV25G AB 1992, FV28G AB 1994, FV28G AB 1997, FV28GFA, FV30GS, FV40N AB 1983, FV40N AB 1992, FV40T, FV40TFA, FV60E AB 1988, FV70T, FV70TD		

fittings, hose and pipe connectors

hose connectors

without screw connection



1

<b>GEV No.</b>	501212	<b>Ref. No.</b>	0621072
<b>description</b>	hose connector plastic hose ø 13-13mm 2-way		
<b>For models:</b>	FV28G AB 1994, FV28G AB 1997		

1

<b>GEV No.</b>	501210	<b>Ref. No.</b>	0621040
<b>description</b>	Y-piece plastic hose ø 10-10-10mm		
<b>For models:</b>	ECO STAR 545D		



1

<b>GEV No.</b>	501040	<b>Ref. No.</b>	0621036
<b>description</b>	Y-piece plastic hose ø 13-13-13mm 3-way		
<b>For models:</b>	DV120T, DV40T, DV40T FA, DV80T, ECO STAR 530F, ECO STAR 545D, FV40N AB 1983, FV40TFA, FV60E AB 1983, FV70TD		



1

<b>GEV No.</b>	501211	<b>Ref. No.</b>	0621070
<b>description</b>	Y-piece plastic hose ø 19-19-19mm 3-way		
<b>For models:</b>	ECO STAR 430F, FV28G AB 1994, FV28G AB 1997, FV28GFA		



1

<b>GEV No.</b>	510685	<b>Ref. No.</b>	9601255
<b>description</b>	T-piece plastic hose ø 14-23-14mm		
<b>For models:</b>	FV40.2MIKE2, FV40.2M-MIKE2		



1

<b>GEV No.</b>	501039	<b>Ref. No.</b>	0621035
<b>description</b>	T-piece with 3 connections		
<b>For models:</b>	DV120B, DV120T, DV221, DV40 AB 1983, DV40 AB 1992, DV40N, DV40T, DV40T FA, DV80 AB 1992, DV80T, ECO STAR 430F, ECO STAR 530F, ECO STAR 545D, FR30G AB 1992, FV110G, FV130B, FV20N, FV20T, FV25G AB 1992, FV28G AB 1994, FV28G AB 1997, FV28GFA, FV30GS, FV40N AB 1992, FV40T, FV40TFA, FV60E AB 1988, FV70T, FV70TD		

miscellaneous



1

<b>GEV No.</b>	501156	<b>Ref. No.</b>	8004877
<b>description</b>	hose connector		
<b>For models:</b>	DV40T FA, FV28GFA, FV40TFA, FV70TD		

fittings

reducers



1

<b>GEV No.</b>	501244	<b>Ref. No.</b>	8000077
<b>description</b>	reducer		
<b>For models:</b>	DV100 AB 1983, DV120B, DV240B AB 1983, DV80, DV80 AB 1983		

angle pieces



1

<b>GEV No.</b>	501162 <sup>1</sup>	<b>Ref. No.</b>	0206022
<b>description</b>	angle piece thread 1/4" ET - 1/4" ET nickel-plated brass pipe connection ø 10mm		
<b>For models:</b>	DV100 AB 1983, DV120B, DV160 AB 1983, DV240B AB 1983, DV80, DV80 AB 1983		

<sup>1</sup>incl. olive 10mm and union nut



hose connectors

plastic



1

<b>GEV No.</b>	528985 <sup>1</sup>	<b>Ref. No.</b>	0621026 9505201
<b>description</b>	hose connector plastic angled thread 3/4" hose ø 13mm Qty 1 pcs		

<sup>1</sup>incl. flat rubber gasket

stainless steel



1

<b>GEV No.</b>	501121	<b>Ref. No.</b>	8400250
<b>description</b>	hose connector thread 1/2" straight hose ø 19mm SS Qty 1 pcs		
<b>For models:</b>	DV160 AB 1996, DV240B AB 1996, FV250B AB 1992		



1

<b>GEV No.</b>	501005	<b>Ref. No.</b>	0360202
<b>description</b>	hose connector thread M14x1 straight hose ø 13mm SS Qty 1 pcs		
<b>For models:</b>	DV120B, DV120T, DV40T, DV80T, ECO STAR 545D, FV110G, FV130B, FV20N, FV20T, FV28G AB 1994, FV28G AB 1997, FV40T, FV70T		

producer-specific



1

<b>GEV No.</b>	501186	<b>Ref. No.</b>	0620129
<b>description</b>	connecting piece angled plastic ø 18mm		
<b>For models:</b>	ECO STAR 430F, ECO STAR 530F, FV28G AB 1994, FV28G AB 1997, FV28GFA		



1

<b>GEV No.</b>	501021	<b>Ref. No.</b>	0620342 1002.3557
<b>description</b>	hose connector		
<b>For models:</b>	DV120B, DV120T, DV160 AB 1996, DV240B AB 1996, DV270B AB 1992, DV40 AB 1992, DV40N, DV40T, DV80 AB 1992, DV80T, ECO STAR 430F, ECO STAR 530F, ECO STAR 545D, FR30G AB 1992, FV110G, FV130B, FV20N, FV20T, FV250B AB 1992, FV25G AB 1992, FV28G AB 1994, FV28G AB 1997, FV30GS, FV40N AB 1992, FV40T, FV60E AB 1988, FV70T		



1

<b>GEV No.</b>	501236	<b>Ref. No.</b>	8000069
<b>description</b>	hose connector		



1

<b>GEV No.</b>	501287	<b>Ref. No.</b>	0260049 8000346
<b>description</b>	hose connector angled ø M10x1mm		
<b>For models:</b>	DV120B, DV120T, DV40 AB 1992, DV40N, DV40T, DV80 AB 1992, DV80T, ECO STAR 430F, ECO STAR 530F, FR30G, FR30G AB 1992, FV110G, FV130B, FV20N, FV20T, FV25G AB 1986, FV25G AB 1992, FV28G AB 1994, FV28G AB 1997, FV30GS, FV40N AB 1992, FV40T, FV60E AB 1988, FV70T		



1

<b>GEV No.</b>	501024	<b>Ref. No.</b>	0620373
<b>description</b>	hose connector for hose ID 13-6-13mm plastic Qty 1 pcs		
<b>For models:</b>	DV111, DV111E, DV120T, DV40T, DV80T, ECO STAR 545D, FV110G, FV130B, FV20N, FV20T, FV28G AB 1994, FV28G AB 1997, FV40T, FV70T		



1

<b>GEV No.</b>	501093	<b>Ref. No.</b>	0621028
<b>description</b>	hose connector straight connection 3/4"x19mm		
<b>For models:</b>	DV160 AB 1996, DV240B AB 1996, DV270B AB 1992, FV250B AB 1992		



1

<b>GEV No.</b>	501022	<b>Ref. No.</b>	0620343
<b>description</b>	manifold double plastic		
<b>For models:</b>	DV120B, DV120T, DV160 AB 1996, DV240B AB 1996, DV40 AB 1992, DV40N, DV40T, DV80 AB 1992, DV80T, ECO STAR 430F, ECO STAR 530F, ECO STAR 545D, FR30G AB 1992, FV110G, FV130B, FV20N, FV20T, FV25G AB 1992, FV28G AB 1994, FV28G AB 1997, FV30GS, FV40N AB 1992, FV40T, FV60E AB 1988, FV70T		



1

<b>GEV No.</b>	501113	<b>Ref. No.</b>	8000978
<b>description</b>	T-piece		

## valves and tank inlets

### float valves

#### float valves



1

<b>GEV No.</b>	501397	<b>Ref. No.</b>	9507283
<b>description</b>	float valve inlet 3/4" outlet 13.5mm input 9l/min outputl/min pressure range 0.3-10bar MÜLLER type 21.010.115 for water container flow regulating valve inlet orange flow regulating valve outlet		

## water filters

### miscellaneous



1

<b>GEV No.</b>	530384	<b>Ref. No.</b>	9651178 9684118 9695683
<b>description</b>	filter insert MEIKO ø 64mm H 175mm		

## water cycle components

### supply filters



1

<b>GEV No.</b>	520129	<b>Ref. No.</b>	0113219
<b>description</b>	supply filter thread 3/4" ET - 3/4" IT total length 87mm plastic type 03		
<b>spare parts for</b>	520129		
	<b>GEV No.</b>	370545	<b>Ref. No.</b> —
	screen ø 11mm H 24mm suitable for supply filter Meiko 3/4"		

## ancillary products

### clamps

#### hose clamps

##### DIN 3017 - W2



1

<b>GEV No.</b>	520111	<b>Ref. No.</b>	0233036
<b>description</b>	hose clamp ø 10-16mm width 9mm Qty 10 pcs DIN 3017		
<b>For models:</b>	DV100 AB 1980, DV100 AB 1983, DV120.2, DV120B, DV120T, DV160 AB 1980, DV160 AB 1983, DV160 AB 1996, DV240B AB 1980, DV240B AB 1983, DV240B AB 1996, DV260B, DV270B AB 1992, DV40 AB 1983, DV40 AB 1992, DV40N, DV40T, DV40T FA, DV80, DV80 AB 1980, DV80 AB 1983, DV80 AB 1992, DV80T, ECO STAR 430F, ECO STAR 530F, ECO STAR 545D, FR30G, FR30G AB 1992, FR40G AB 1976, FR40G AB 1980, FR40G AB 1983, FR40GUS AB 1976, FR40GUS AB 1980, FR40GUS AB 1983, FV110G, FV120B AB 1980, FV120B AB 1983, FV130B, FV200B, FV20T, FV240B AB 1980, FV240B AB 1983, FV250B AB 1992, FV25G AB 1986, FV25G AB 1992, FV28G AB 1994, FV28G AB 1997, FV28GFA, FV30GS, FV40.2...(Other models you can see in the webshop)		



1

<b>GEV No.</b>	520112	<b>Ref. No.</b>	0233035 0233043
<b>description</b>	hose clamp ø 12-20mm width 9mm Qty 10 pcs DIN 3017		
<b>For models:</b>	DV120T, DV160 AB 1996, DV240B AB 1996, DV270B AB 1992, DV40N, DV40T, DV40T FA, DV80T, ECO STAR 430F, ECO STAR 530F, ECO STAR 545D, FV110G, FV20N, FV250B AB 1992, FV28G AB 1994, FV28G AB 1997, FV28GFA, FV40.2, FV40.2 AB 2002, FV40.2MIKE2, FV40TFA, FV70TD		



1

<b>GEV No.</b>	520113	<b>Ref. No.</b>	0233037
<b>description</b>	hose clamp ø 16-27mm width 9mm Qty 10 pcs DIN 3017		
<b>For models:</b>	DV100 AB 1980, DV100 AB 1983, DV120B, DV120T, DV160 AB 1980, DV240B AB 1980, DV260B, DV40 AB 1983, DV40 AB 1992, DV40T, DV40T FA, DV80, DV80 AB 1980, DV80 AB 1983, DV80 AB 1992, DV80T, ECO STAR 430F, ECO STAR 530F, ECO STAR 545D, FR30G, FR30G AB 1992, FR40G AB 1976, FR40G AB 1980, FR40G AB 1983, FR40GUS AB 1976, FR40GUS AB 1980, FR40GUS AB 1983, FV110G, FV120B AB 1980, FV120B AB 1983, FV130B, FV200B, FV20N, FV20T, FV240B AB 1980, FV240B AB 1983, FV25G AB 1986, FV25G AB 1992, FV28G AB 1994, FV28G AB 1997, FV28GFA, FV30, FV30GS, FV40N AB 1980, FV40N AB 1983, FV40N AB 1992, FV40T, FV40TFA, FV50, FV50 M...(Other models you can see in the webshop)		



 <p>1</p>			
<b>GEV No.</b>	520114	<b>Ref. No.</b>	0233045
<b>description</b>	hose clamp ø 20-32mm width 9mm Qty 10 pcs DIN 3017		
<b>For models:</b>	FV40.2, FV40.2MIKE2, FV40.2M-MIKE2		

 <p>1</p>			
<b>GEV No.</b>	520115	<b>Ref. No.</b>	0233039
<b>description</b>	hose clamp ø 25-40mm width 9mm Qty 10 pcs DIN 3017		
<b>For models:</b>	DV40T FA, FV200B, FV28GFA, FV40.2 AB 2003, FV40TFA, FV70TD		

 <p>1</p>			
<b>GEV No.</b>	520116	<b>Ref. No.</b>	0233046
<b>description</b>	hose clamp ø 32-50mm width 9mm Qty 5 pcs DIN 3017		
<b>For models:</b>	DR70, DV120B, DV120T, DV160 AB 1996, DV240B AB 1996, DV40 AB 1983, DV40 AB 1992, DV40N, DV40T, DV40T FA, DV80 AB 1975, DV80 AB 1992, DV80T, ECO STAR 430F, ECO STAR 530F, ECO STAR 545D, FR30G, FR30G AB 1992, FR40G AB 1980, FR40G AB 1983, FR40GUS AB 1980, FR40GUS AB 1983, FV110G, FV120B AB 1980, FV120B AB 1983, FV20N, FV20T, FV240B AB 1980, FV240B AB 1983, FV25G AB 1986, FV25G AB 1992, FV28G AB 1994, FV28G AB 1997, FV28GFA, FV30, FV30GS, FV40N AB 1980, FV40N AB 1983, FV40N AB 1992, FV40T, FV40TFA, FV50, FV50 M, FV60E AB 1983, FV60E AB 1988, FV70T, FV70TD		

 <p>1</p>			
<b>GEV No.</b>	520118	<b>Ref. No.</b>	0233047
<b>description</b>	hose clamp ø 50-70mm width 9mm Qty 5 pcs DIN 3017		
<b>For models:</b>	DV100 AB 1980, DV100 AB 1983, DV120B, DV120T, DV160 AB 1980, DV160 AB 1983, DV240B AB 1980, DV240B AB 1983, DV240B AB 1996, DV80, DV80 AB 1980, DV80 AB 1983, FR40G AB 1980, FR40GUS AB 1980, FV120B AB 1980, FV120B AB 1983, FV240B AB 1980, FV240B AB 1983, FV60E AB 1983		

 <p>1</p>			
<b>GEV No.</b>	520117	<b>Ref. No.</b>	0233041
<b>description</b>	hose clamp stainless steel ø 40-60mm width 9mm Qty 5 pcs DIN 3017		
<b>For models:</b>	DV120B, DV160 AB 1996, DV240B AB 1996, DV40 AB 1983, DV40 AB 1992, DV40N, DV40T, DV40T FA, DV80 AB 1975, DV80 AB 1992, DV80T, ECO STAR 430F, ECO STAR 530F, ECO STAR 545D, FR30G, FR30G AB 1992, FR40G AB 1983, FR40GUS AB 1983, FV110G, FV20N, FV20T, FV25G AB 1986, FV25G AB 1992, FV28G AB 1994, FV28G AB 1997, FV28GFA, FV30, FV30GS, FV40N AB 1980, FV40N AB 1983, FV40N AB 1992, FV40T, FV40TFA, FV50, FV50 M, FV60E AB 1988, FV70T, FV70TD		

double wire clamps

 <p>1</p>			
<b>GEV No.</b>	501163	<b>Ref. No.</b>	0233033
<b>description</b>	hose clamp		
<b>For models:</b>	FV28G AB 1994, FV28G AB 1997		

 <p>1</p>			
<b>GEV No.</b>	513268	<b>Ref. No.</b>	9500044 9500045
<b>description</b>	hose clamp ø 8-10mm wire gauge ø 1mm Qty 1 pcs		
<b>For models:</b>	FV40.2, FV40.2MIKE2, FV40.2M-MIKE2		

security hose clamps

<p>SS/brass</p>  <p>1</p>			
<b>GEV No.</b>	520065	<b>Ref. No.</b>	0233055
<b>description</b>	hose clamp SS/brass ø 5-10mm width 10mm Qty 5 pcs		
<b>For models:</b>	DV100 AB 1980, DV100 AB 1983, DV120B, DV160 AB 1980, DV160 AB 1983, DV240B AB 1980, DV240B AB 1983, DV260B, DV40 AB 1983, DV80, DV80 AB 1980, DV80 AB 1983, FR30G, FR40G AB 1980, FR40G AB 1983, FR40GUS AB 1980, FR40GUS AB 1983, FV120B AB 1980, FV120B AB 1983, FV200B, FV240B AB 1980, FV25G AB 1986, FV40N AB 1980, FV40N AB 1983, FV60E AB 1983		

one ear clamps

 <p>1</p>			
<b>GEV No.</b>	520774	<b>Ref. No.</b>	0233077 0233082
<b>description</b>	one ear clamp ø 16.6-19.8mm width 7mm strip thickness 0.6mm Qty 20 pcs SS W4		



			
1			
<b>GEV No.</b>	560487	<b>Ref. No.</b>	0233070 0233073
<b>description</b>	one ear clamp ø 19.4-22.6mm Qty 1 pcs zinc-coated steel		
<b>For models:</b>	DV120B, DV120T, DV160 AB 1996, DV240B AB 1996, DV270B AB 1992, DV40 AB 1992, DV40N, DV40T, DV40T FA, DV80 AB 1992, DV80T, ECO STAR 430F, ECO STAR 530F, ECO STAR 545D, FR30G AB 1992, FV110G, FV130B, FV20N, FV20T, FV250B AB 1992, FV25G AB 1992, FV28G AB 1994, FV28G AB 1997, FV30GS, FV40N AB 1992, FV40T, FV40TFA, FV60E AB 1988, FV70T, FV70TD		

			
1			
<b>GEV No.</b>	560324	<b>Ref. No.</b>	0233076 0233078
<b>description</b>	one ear clamp ø 8.5-10mm Qty 1 pcs stainless steel		
<b>For models:</b>	DV120B, DV120T, DV160 AB 1996, DV240B AB 1996, DV270B AB 1992, DV40 AB 1992, DV40N, DV40T, DV40T FA, DV80 AB 1992, DV80T, FR30G AB 1992, FV110G, FV130B, FV20N, FV20T, FV250B AB 1992, FV25G AB 1992, FV28G AB 1994, FV28G AB 1997, FV30GS, FV40N AB 1992, FV40T, FV40TFA, FV60E AB 1988, FV70T, FV70TD		

<b>pipe clamps</b>			
			
1			
<b>GEV No.</b>	501068	<b>Ref. No.</b>	0296002
<b>description</b>	tube connector ø 50mm SS Qty 1 pcs		
<b>For models:</b>	DV100 AB 1980, DV100 AB 1983, DV120B, DV120T, DV160 AB 1980, DV160 AB 1983, DV240B AB 1980, DV240B AB 1983, DV240B AB 1996, DV260B, DV80, DV80 AB 1980, DV80 AB 1983, DV80 AB 1992, FV120B AB 1980, FV120B AB 1983, FV130B, FV240B AB 1980, FV240B AB 1983, FV60E AB 1983		

<b>screws</b>			
<b>sheet metal screws</b>			
			
1			
<b>GEV No.</b>	560108	<b>Ref. No.</b>	0330020
<b>description</b>	sheet metal screws ø 4.2mm L 13mm SS Qty 20 pcs DIN 7981/ISO 7049 head ø 8.2mm oval head		
<b>For models:</b>	FV40.2, FV40.2MIKE2, FV40.2M-MIKE2		

<b>countersunk screws</b>			
			
1			
<b>GEV No.</b>	560075	<b>Ref. No.</b>	0306005
<b>description</b>	countersunk screw thread M4 L 6mm SS DIN 963/ISO 2009 Qty 20 pcs intake slotted head ø 7.5mm		
<b>For models:</b>	DR90, DV100 AB 1983, DV111, DV111E, DV120B, DV120T, DV160 AB 1983, DV160 AB 1996, DV240B AB 1983, DV240B AB 1996, DV260B, DV270B AB 1992, DV40 AB 1983, DV40N, DV40T, DV40T FA, DV80, DV80 AB 1975, DV80 AB 1983, DV80 AB 1992, DV80T, ECO STAR 545D, FV120B AB 1983, FV130B, FV200B, FV240B AB 1983, FV250B AB 1992, FV25G AB 1986, FV30, FV40N AB 1983, FV50, FV50 M, FV60 AB 1973, FV60 AB 1976, FV60E AB 1983		

			
1			
<b>GEV No.</b>	501069	<b>Ref. No.</b>	0306014
<b>description</b>	countersunk screw thread M5 L 8mm SS DIN 963/ISO 2009 Qty 100 pcs		
<b>For models:</b>	DV100 AB 1983, DV120B, DV160 AB 1983, DV240B AB 1983, DV260B, DV270B AB 1992, DV40 AB 1983, DV80, DV80 AB 1983, FV120B AB 1983, FV130B, FV240B AB 1983, FV250B AB 1992, FV25G AB 1986, FV40N AB 1983, FV60E AB 1983		

			
1			
<b>GEV No.</b>	560450	<b>Ref. No.</b>	0306006 0306115
<b>description</b>	countersunk screw thread M4 L 8mm SS DIN 965/ISO 7046 Qty 1 pcs intake Phillips head ø 7.3mm		
<b>For models:</b>	DV120B, DV120T, DV160 AB 1983, DV160 AB 1996, DV240B AB 1983, DV240B AB 1996, DV40 AB 1983, DV40N, DV40T, DV40T FA, DV80, DV80 AB 1983, DV80 AB 1992, DV80T, ECO STAR 545D, FV30, FV50, FV50 M		

**fastening material**

**rivets/rievt nuts**

**blind rivets DIN 7337 - stainless steel**

			
1			
<b>GEV No.</b>	560161	<b>Ref. No.</b>	9600832
<b>description</b>	blind rivet SS ø 3.9mm L 10mm Qty 50 pcs DIN 1700		







flat-headed bolts

			
1			
<b>GEV No.</b>	560478	<b>Ref. No.</b>	0308204
<b>description</b>	flat-headed bolt thread M4 thread L 30mm SS DIN 7985/ISO 7045 Qty 1 pcs intake Phillips head ø 8mm head thickness 3mm		

			
1			
<b>GEV No.</b>	560477	<b>Ref. No.</b>	0308203
<b>description</b>	flat-headed bolt thread M4 thread L 35mm SS DIN 7985 Qty 1 pcs intake Phillips head ø 8mm head thickness 3.5mm		

hexagonal screws

			
1			
<b>GEV No.</b>	560086	<b>Ref. No.</b>	0302000
<b>description</b>	hexagonal screw thread M6 thread L 10mm SS WS 10 Qty 20 pcs DIN 933 / ISO 4017		
<b>For models:</b>	DV40 AB 1983		

			
1			
<b>GEV No.</b>	560087	<b>Ref. No.</b>	0302001
<b>description</b>	hexagonal screw thread M6 thread L 16mm SS WS 10 Qty 20 pcs DIN 933 / ISO 4017		

grub screws

DIN 916/ISO 4029

			
1			
<b>GEV No.</b>	560366	<b>Ref. No.</b>	0322045
<b>description</b>	grub screw thread M6 L 20mm SS intake internal hexagon WS 3 Qty 1 pcs		

knurled screws

			
1			
<b>GEV No.</b>	510112	<b>Ref. No.</b>	0310010
<b>description</b>	Thumb screw thread M10 thread L 10mm ø 22mm H 4.5mm SS		
<b>For models:</b>	DV40 AB 1992, DV40N, DV40T, DV40T FA, ECO STAR 430F, ECO STAR 530F, FV110G, FV20N, FV20T, FV28G AB 1994, FV28G AB 1997, FV28GFA, FV30GS, FV40N AB 1992, FV40T, FV40TFA, FV60E AB 1988, FV70T, FV70TD		

nuts

cap nuts

			
1			
<b>GEV No.</b>	560135	<b>Ref. No.</b>	0336001
<b>description</b>	cap nuts thread M4 WS 7 SS Qty 20 pcs DIN/ISO DIN 1587		
<b>For models:</b>	DV120T, DV40N, DV40T, DV40T FA, DV80T, ECO STAR 430F, ECO STAR 530F, ECO STAR 545D, FV110G, FV120B AB 1983, FV20N, FV20T, FV240B AB 1983, FV25G AB 1986, FV28G AB 1994, FV28G AB 1997, FV28GFA, FV30GS, FV40N AB 1983, FV40N AB 1992, FV40T, FV40TFA, FV60E AB 1983, FV60E AB 1988, FV70T, FV70TD		

			
1			
<b>GEV No.</b>	560136	<b>Ref. No.</b>	0336050
<b>description</b>	cap nuts thread M5 WS 8 SS Qty 20 pcs DIN/ISO DIN 1587		

hexagonal nuts

DIN 934 / ISO 4032/8673

			
1			
<b>GEV No.</b>	560129	<b>Ref. No.</b>	0335008
<b>description</b>	hexagonal nut thread M5 H 4mm WS 8 SS DIN/ISO DIN 934 / ISO 4032/8673 Qty 1 pcs		
<b>For models:</b>	FV40.2, FV40.2MIKE2, FV40.2M-MIKE2		

			
1			
<b>GEV No.</b>	501303	<b>Ref. No.</b>	0335019
<b>description</b>	nut thread M10 H 8mm WS 17 brass DIN/ISO DIN 934 / ISO 4032/8673 Qty 1 pcs		
<b>For models:</b>	DV100 AB 1980, DV100 AB 1983, DV120.2, DV120B, DV160 AB 1980, DV240B AB 1980, DV260B, DV40 AB 1983, DV80, DV80 AB 1983, ECO STAR 545D, FR40G AB 1983, FR40GUS AB 1983, FV120B AB 1983, FV240B AB 1983, FV25G AB 1986, FV28GFA, FV40.2 AB 2002, FV40.2M, FV40.2MIKE2, FV40.2M-MIKE2, FV40N AB 1983, FV40N AB 1992, FV60E AB 1983, FV60E AB 1988		

DIN 985

			
1			
<b>GEV No.</b>	560142	<b>Ref. No.</b>	0337001
<b>description</b>	hexagonal nut thread M6 H 6mm SS WS 10 Qty 20 pcs DIN/ISO DIN 985 self-locking		

## hexagonal nuts metric (without norm)



1

<b>GEV No.</b>	501172	<b>Ref. No.</b>	0360211 8660239
<b>description</b>	nut thread M16x1.5 H 5mm WS 22 SS Qty 1 pcs		
<b>For models:</b>	ECO STAR 430F, ECO STAR 530F, ECO STAR 545D, FV28G AB 1994, FV28G AB 1997, FV28GFA		

## hexagonal nuts inch thread



1

<b>GEV No.</b>	501299	<b>Ref. No.</b>	8660464
<b>description</b>	hexagonal nut thread 1/2" H 5mm SS WS 27 Qty 1 pcs		
<b>For models:</b>	DV120T, DV40N, DV40T, DV40T FA, DV80T		



1

<b>GEV No.</b>	501319	<b>Ref. No.</b>	8000025
<b>description</b>	nut thread 1/2" H 8mm brass WS 27 Qty 1 pcs		
<b>For models:</b>	DV260B, FV120B AB 1983, FV240B AB 1983		



1

<b>GEV No.</b>	501318	<b>Ref. No.</b>	0212012
<b>description</b>	nut thread 1/4" H 6.5mm SS WS 22 Qty 1 pcs		
<b>For models:</b>	DV40T FA, ECO STAR 545D, FV40TFA, FV70TD		



1

<b>GEV No.</b>	503042	<b>Ref. No.</b>	9515957
<b>description</b>	nut thread 3/8" H 6mm brass WS 22 Qty 1 pcs		
<b>For models:</b>	FV40.2, FV40.2MIKE2, FV40.2M-MIKE2		



1

<b>GEV No.</b>	501288	<b>Ref. No.</b>	8000024 8660045
<b>description</b>	nut thread 3/8" H 8mm brass WS 22 Qty 1 pcs		
<b>For models:</b>	DV260B, FR30G, FR40G AB 1983, FR40GUS AB 1983, FV120B AB 1983, FV240B AB 1983		



1

<b>GEV No.</b>	501321	<b>Ref. No.</b>	0212006
<b>description</b>	octagonal nut thread 1/2"		



1

<b>GEV No.</b>	522003	<b>Ref. No.</b>	0212005
<b>description</b>	hexagonal nut thread 1 1/2" brass		
<b>For models:</b>	DV100 AB 1980, DV100 AB 1983, DV120B, DV160 AB 1980, DV160 AB 1983, DV160 AB 1996, DV240B AB 1980, DV240B AB 1983, DV240B AB 1996, DV270B AB 1992, DV40 AB 1983, DV40 AB 1992, DV80, DV80 AB 1980, DV80 AB 1983, DV80 AB 1992, FR30G, FR30G AB 1992, FR40G AB 1980, FR40G AB 1983, FR40GUS AB 1980, FR40GUS AB 1983, FV130B, FV250B AB 1992, FV25G AB 1986, FV25G AB 1992, FV30GS, FV40N AB 1980, FV40N AB 1983, FV40N AB 1992, FV60E AB 1983, FV60E AB 1988		

## washers

## spring washers



1

<b>GEV No.</b>	104447	<b>Ref. No.</b>	0341050
<b>description</b>	clamping washer nominal-ø 5.7mm ED ø 11.7mm spring steel thickness 0.4mm		

## washers

## DIN 125A



1

<b>GEV No.</b>	560312	<b>Ref. No.</b>	0340005
<b>description</b>	plain washer ID ø 10.5mm ED ø 20mm thickness 2mm SS Qty 1 pcs DIN 125A for thread M10		
<b>For models:</b>	FV40.2MIKE2		

## DIN 9021



1

<b>GEV No.</b>	560116	<b>Ref. No.</b>	0340020
<b>description</b>	plain washer ID ø 5.3mm ED ø 15mm thickness 1.5mm SS Qty 20 pcs DIN 9021 for thread M5		
<b>For models:</b>	FV40.2, FV40.2MIKE2, FV40.2M-MIKE2		



fasteners

slot nuts



<b>GEV No.</b>	560625	<b>Ref. No.</b>	9501109
<b>description</b>	slot nut W 35mm H 20mm L 50mm with hole		

clamps

hose clamps

DIN 3017 - W2



<b>GEV No.</b>	520111	<b>Ref. No.</b>	0233036
<b>description</b>	hose clamp ø 10-16mm width 9mm Qty 10 pcs DIN 3017		
<b>For models:</b>	DV100 AB 1980, DV100 AB 1983, DV120.2, DV120B, DV120T, DV160 AB 1980, DV160 AB 1983, DV160 AB 1996, DV240B AB 1980, DV240B AB 1983, DV240B AB 1996, DV260B, DV270B AB 1992, DV40 AB 1983, DV40 AB 1992, DV40N, DV40T, DV40T FA, DV80, DV80 AB 1980, DV80 AB 1983, DV80 AB 1992, DV80T, ECO STAR 430F, ECO STAR 530F, ECO STAR 545D, FR30G, FR30G AB 1992, FR40G AB 1976, FR40G AB 1980, FR40G AB 1983, FR40GUS AB 1976, FR40GUS AB 1980, FR40GUS AB 1983, FV110G, FV120B AB 1980, FV120B AB 1983, FV130B, FV200B, FV20T, FV240B AB 1980, FV240B AB 1983, FV250B AB 1992, FV25G AB 1986, FV25G AB 1992, FV28G AB 1994, FV28G AB 1997, FV28GFA, FV30GS, FV40.2...(Other models you can see in the webshop)		



<b>GEV No.</b>	520112	<b>Ref. No.</b>	0233035 0233043
<b>description</b>	hose clamp ø 12-20mm width 9mm Qty 10 pcs DIN 3017		
<b>For models:</b>	DV120T, DV160 AB 1996, DV240B AB 1996, DV270B AB 1992, DV40N, DV40T, DV40T FA, DV80T, ECO STAR 430F, ECO STAR 530F, ECO STAR 545D, FV110G, FV20N, FV250B AB 1992, FV28G AB 1994, FV28G AB 1997, FV28GFA, FV40.2, FV40.2 AB 2002, FV40.2MIKE2, FV40TFA, FV70TD		



<b>GEV No.</b>	520113	<b>Ref. No.</b>	0233037
<b>description</b>	hose clamp ø 16-27mm width 9mm Qty 10 pcs DIN 3017		
<b>For models:</b>	DV100 AB 1980, DV100 AB 1983, DV120B, DV120T, DV160 AB 1980, DV240B AB 1980, DV260B, DV40 AB 1983, DV40 AB 1992, DV40T, DV40T FA, DV80, DV80 AB 1980, DV80 AB 1983, DV80 AB 1992, DV80T, ECO STAR 430F, ECO STAR 530F, ECO STAR 545D, FR30G, FR30G AB 1992, FR40G AB 1976, FR40G AB 1980, FR40G AB 1983, FR40GUS AB 1976, FR40GUS AB 1980, FR40GUS AB 1983, FV110G, FV120B AB 1980, FV120B AB 1983, FV130B, FV200B, FV20N, FV20T, FV240B AB 1980, FV240B AB 1983, FV25G AB 1986, FV25G AB 1992, FV28G AB 1994, FV28G AB 1997, FV28GFA, FV30, FV30GS, FV40N AB 1980, FV40N AB 1983, FV40N AB 1992, FV40T, FV40TFA, FV50, FV50 M...(Other models you can see in the webshop)		



<b>GEV No.</b>	520114	<b>Ref. No.</b>	0233045
<b>description</b>	hose clamp ø 20-32mm width 9mm Qty 10 pcs DIN 3017		
<b>For models:</b>	FV40.2, FV40.2MIKE2, FV40.2M-MIKE2		



<b>GEV No.</b>	520115	<b>Ref. No.</b>	0233039
<b>description</b>	hose clamp ø 25-40mm width 9mm Qty 10 pcs DIN 3017		
<b>For models:</b>	DV40T FA, FV200B, FV28GFA, FV40.2 AB 2003, FV40TFA, FV70TD		



<b>GEV No.</b>	520116	<b>Ref. No.</b>	0233046
<b>description</b>	hose clamp ø 32-50mm width 9mm Qty 5 pcs DIN 3017		
<b>For models:</b>	DR70, DV120B, DV120T, DV160 AB 1996, DV240B AB 1996, DV40 AB 1983, DV40 AB 1992, DV40N, DV40T, DV40T FA, DV80 AB 1975, DV80 AB 1992, DV80T, ECO STAR 430F, ECO STAR 530F, ECO STAR 545D, FR30G, FR30G AB 1992, FR40G AB 1980, FR40G AB 1983, FR40GUS AB 1980, FR40GUS AB 1983, FV110G, FV120B AB 1980, FV120B AB 1983, FV20N, FV20T, FV240B AB 1980, FV240B AB 1983, FV25G AB 1986, FV25G AB 1992, FV28G AB 1994, FV28G AB 1997, FV28GFA, FV30, FV30GS, FV40N AB 1980, FV40N AB 1983, FV40N AB 1992, FV40T, FV40TFA, FV50, FV50 M, FV60E AB 1983, FV60E AB 1988, FV70T, FV70TD		



<b>GEV No.</b>	520118	<b>Ref. No.</b>	0233047
<b>description</b>	hose clamp ø 50-70mm width 9mm Qty 5 pcs DIN 3017		
<b>For models:</b>	DV100 AB 1980, DV100 AB 1983, DV120B, DV120T, DV160 AB 1980, DV160 AB 1983, DV240B AB 1980, DV240B AB 1983, DV240B AB 1996, DV80, DV80 AB 1980, DV80 AB 1983, FR40G AB 1980, FR40GUS AB 1980, FV120B AB 1980, FV120B AB 1983, FV240B AB 1980, FV240B AB 1983, FV60E AB 1983		



1

<b>GEV No.</b>	520117	<b>Ref. No.</b>	0233041
<b>description</b>	hose clamp stainless steel $\phi$ 40-60mm width 9mm Qty 5 pcs DIN 3017		
<b>For models:</b>	DV120B, DV160 AB 1996, DV240B AB 1996, DV40 AB 1983, DV40 AB 1992, DV40N, DV40T, DV40T FA, DV80 AB 1975, DV80 AB 1992, DV80T, ECO STAR 430F, ECO STAR 530F, ECO STAR 545D, FR30G, FR30G AB 1992, FR40G AB 1983, FR40GUS AB 1983, FV110G, FV20N, FV20T, FV25G AB 1986, FV25G AB 1992, FV28G AB 1994, FV28G AB 1997, FV28GFA, FV30, FV30GS, FV40N AB 1980, FV40N AB 1983, FV40N AB 1992, FV40T, FV40TFA, FV50, FV50 M, FV60E AB 1988, FV70T, FV70TD		

## security hose clamps

SS/brass



1

<b>GEV No.</b>	520065	<b>Ref. No.</b>	0233055
<b>description</b>	hose clamp SS/brass $\phi$ 5-10mm width 10mm Qty 5 pcs		
<b>For models:</b>	DV100 AB 1980, DV100 AB 1983, DV120B, DV160 AB 1980, DV160 AB 1983, DV240B AB 1980, DV240B AB 1983, DV260B, DV40 AB 1983, DV80, DV80 AB 1980, DV80 AB 1983, FR30G, FR40G AB 1980, FR40G AB 1983, FR40GUS AB 1980, FR40GUS AB 1983, FV120B AB 1980, FV120B AB 1983, FV200B, FV240B AB 1980, FV25G AB 1986, FV40N AB 1980, FV40N AB 1983, FV60E AB 1983		

## double wire clamps



1

<b>GEV No.</b>	501163	<b>Ref. No.</b>	0233033
<b>description</b>	hose clamp		
<b>For models:</b>	FV28G AB 1994, FV28G AB 1997		



1

<b>GEV No.</b>	513268	<b>Ref. No.</b>	9500044 9500045
<b>description</b>	hose clamp $\phi$ 8-10mm wire gauge $\phi$ 1mm Qty 1 pcs		
<b>For models:</b>	FV40.2, FV40.2MIKE2, FV40.2M-MIKE2		

## one ear clamps



1

<b>GEV No.</b>	520774	<b>Ref. No.</b>	0233077 0233082
<b>description</b>	one ear clamp $\phi$ 16.6-19.8mm width 7mm strip thickness 0.6mm Qty 20 pcs SS W4		



1

<b>GEV No.</b>	560487	<b>Ref. No.</b>	0233070 0233073
<b>description</b>	one ear clamp $\phi$ 19.4-22.6mm Qty 1 pcs zinc-coated steel		
<b>For models:</b>	DV120B, DV120T, DV160 AB 1996, DV240B AB 1996, DV270B AB 1992, DV40 AB 1992, DV40N, DV40T, DV40T FA, DV80 AB 1992, DV80T, ECO STAR 430F, ECO STAR 530F, ECO STAR 545D, FR30G AB 1992, FV110G, FV130B, FV20N, FV20T, FV250B AB 1992, FV25G AB 1992, FV28G AB 1994, FV28G AB 1997, FV30GS, FV40N AB 1992, FV40T, FV40TFA, FV60E AB 1988, FV70T, FV70TD		



1

<b>GEV No.</b>	560324	<b>Ref. No.</b>	0233076 0233078
<b>description</b>	one ear clamp $\phi$ 8.5-10mm Qty 1 pcs stainless steel		
<b>For models:</b>	DV120B, DV120T, DV160 AB 1996, DV240B AB 1996, DV270B AB 1992, DV40 AB 1992, DV40N, DV40T, DV40T FA, DV80 AB 1992, DV80T, FR30G AB 1992, FV110G, FV130B, FV20N, FV20T, FV250B AB 1992, FV25G AB 1992, FV28G AB 1994, FV28G AB 1997, FV30GS, FV40N AB 1992, FV40T, FV40TFA, FV60E AB 1988, FV70T, FV70TD		

## pipe clamps





1

<b>GEV No.</b>	501068	<b>Ref. No.</b>	0296002
<b>description</b>	tube connector $\phi$ 50mm SS Qty 1 pcs		
<b>For models:</b>	DV100 AB 1980, DV100 AB 1983, DV120B, DV120T, DV160 AB 1980, DV160 AB 1983, DV240B AB 1980, DV240B AB 1983, DV240B AB 1996, DV260B, DV80, DV80 AB 1980, DV80 AB 1983, DV80 AB 1992, FV120B AB 1980, FV120B AB 1983, FV130B, FV240B AB 1980, FV240B AB 1983, FV60E AB 1983		



retaining rings			
DIN 471			
			
1			
<b>GEV No.</b>	512260	<b>Ref. No.</b>	0341020
<b>description</b>	retaining ring shaft ø 14mm thickness 1.2mm steel DIN 471		

DIN 6799			
 			
1			
<b>GEV No.</b>	518557	<b>Ref. No.</b>	9655750
<b>description</b>	retaining ring E D1 ø 5mm D2 ø 11mm SS DIN 6799 thickness 0.7mm		

cotter pins			
			
1			
<b>GEV No.</b>	551304	<b>Ref. No.</b>	0351004
<b>description</b>	cotter pin ø 2mm L 20mm SS Qty 20 pcs		
<b>For models:</b>	DV100 AB 1983, DV120, DV120B, DV160 AB 1983, DV160 AB 1996, DV240B AB 1983, DV240B AB 1996, DV260B, DV270B AB 1992, DV40 AB 1983, DV40 AB 1992, DV80, DV80 AB 1980, DV80 AB 1983		

pins			
			
1			
<b>GEV No.</b>	694465	<b>Ref. No.</b>	0354000
<b>description</b>	grooved pin ø 2mm L 20mm SS		
<b>For models:</b>	DV100 AB 1983, DV120B, DV120T, DV160 AB 1983, DV160 AB 1996, DV240B AB 1983, DV240B AB 1996, DV260B, DV270B AB 1992, DV40 AB 1983, DV40N, DV40T, DV40T FA, DV80, DV80 AB 1983, DV80 AB 1992, DV80T, ECO STAR 545D, FV120B AB 1983, FV130B, FV240B AB 1983, FV250B AB 1992, FV40N AB 1983, FV60E AB 1983		

## consumables

### fuses

fine fuses			
			
1			
<b>GEV No.</b>	358699	<b>Ref. No.</b>	0145000
<b>description</b>	fine fuse size ø5x20mm 10A medium lag rated 250V Qty 10 pcs		
<b>For models:</b>	DV120B, DV120T, DV40 AB 1992, DV40N, DV40T, DV40T FA, DV80 AB 1992, DV80T, ECO STAR 430F, ECO STAR 545D, FR30G AB 1992, FV110G, FV20N, FV20T, FV25G AB 1992, FV28GFA, FV30GS, FV40.2, FV40.2 AB 2003, FV40N AB 1992, FV40T, FV40TFA, FV60E AB 1988, FV70T, FV70TD		

			
1			
<b>GEV No.</b>	358696	<b>Ref. No.</b>	0145013
<b>description</b>	fine fuse size ø5x20mm 4A medium lag rated 250V Qty 10 pcs		
<b>For models:</b>	DV120B, DV120T, DV160 AB 1996, DV240B AB 1996, DV270B AB 1992, DV40N, DV40T, DV40T FA, DV80 AB 1992, DV80T, ECO STAR 430F, ECO STAR 545D, FV130B, FV250B AB 1992, FV28GFA, FV70TD		

			
1			
<b>GEV No.</b>	358598	<b>Ref. No.</b>	0145049
<b>description</b>	fine fuse size ø5x20mm 0.63A slow-acting rated 250V Qty 10 pcs		
<b>For models:</b>	DR70, DV100 AB 1980, DV120B, DV160 AB 1980, DV240B AB 1980, DV80, DV80 AB 1975, DV80 AB 1980		

			
1			
<b>GEV No.</b>	358601	<b>Ref. No.</b>	0145048
<b>description</b>	fine fuse size ø5x20mm 1.25A slow-acting rated 250V Qty 10 pcs		
<b>For models:</b>	DR70, DV80 AB 1975		

			
1			
<b>GEV No.</b>	358602	<b>Ref. No.</b>	0145046
<b>description</b>	fine fuse size ø5x20mm 1.6A slow-acting rated 250V Qty 10 pcs		

			
1			
<b>GEV No.</b>	358600	<b>Ref. No.</b>	0145045
<b>description</b>	fine fuse size ø5x20mm 1A slow-acting rated 250V Qty 10 pcs		
<b>For models:</b>	FV28G AB 1994, FV28G AB 1997		

			
1			
<b>GEV No.</b>	358603	<b>Ref. No.</b>	0145047
<b>description</b>	fine fuse size ø5x20mm 2A slow-acting rated 250V Qty 10 pcs		
<b>For models:</b>	FV40.2M, FV40.2M-MIKE2		



1

<b>GEV No.</b>	358607	<b>Ref. No.</b>	0145001
<b>description</b>	fine fuse size ø5x20mm 6.3A slow-acting rated 250V Qty 10 pcs		
<b>For models:</b>	DV120B, FV30, FV50		



1

<b>GEV No.</b>	358704	<b>Ref. No.</b>	0145002
<b>description</b>	fine fuse size ø5x20mm 8A slow-acting rated 250V Qty 10 pcs		

screw locks

D-system (DIAZED)



1

<b>GEV No.</b>	358082	<b>Ref. No.</b>	0145007
<b>description</b>	fuse size DII 16A rated 500V E27 ø 22mm L 50mm Qty 5 pcs		



1

<b>GEV No.</b>	358084	<b>Ref. No.</b>	0145009
<b>description</b>	fuse size DII 25A rated 500V E27 ø 22mm L 50mm Qty 5 pcs		

<b>A</b>			
axial fans		41	
<b>B</b>			
bi-metal thermostats		9, 10	
booster pumps I		51	
booster pumps II		52	
<b>C</b>			
cables		54	
cap nuts		121	
clamps		118, 123	
cleaning guns		106	
condensators & interference suppression filters		52	
consumables		125	
contactors		20	
container filters		113	
control equipment		18	
cotter pins		125	
countersunk screws		120	
<b>D</b>			
door seals for dishwashers		102	
dosing pumps		106	
double wire clamps		119, 124	
drain hoses		114	
drain pumps		51	
drinking water hoses		115	
<b>E</b>			
electric accessories		54	
electrodes		41	
electronic magnets		55	
<b>F</b>			
fans		41	
fasteners		123	
fastening material		120	
filters		52	
fine fuses		125	
fittings		116	
flat-headed bolts		121	
float switches		14	
float valves		118	
formed hoses		115	
fuses		53, 125	
<b>G</b>			
gaskets for wash arm support		103	
grub screws		121	
<b>H</b>			
heating elements		3	
hexagonal nuts		121	
hexagonal screws		121	
hose clamps		118, 123	
hose connectors		115, 117	
hose couplings		114	
hose reels		105	
hoses		106, 114	
hoses wire reinforced		115	
<b>I</b>			
immersion heating elements		3	
indicator lights		18	
indicator lights (complete)		19	
industrial hoses		114	
intake lances		113	
<b>K</b>			
knurled screws		121	
<b>L</b>			
lamps		18	
light bulbs		19	
<b>M</b>			
magnetic switches		15	
microswitches		12	
<b>N</b>			
nuts		121	
<b>O</b>			
one ear clamps		119, 124	
operating capacitors		52	
O-rings		97	
<b>P</b>			
pins		125	
pipe clamps		120, 124	
plunger sockets		12	
position switches		13	
pressure switches		40	
probes		22	
programme timers		19	
pumps		42	
PVC hoses		114	
<b>R</b>			
reducers		116	
relays		22	
retaining rings		125	

ribbon cables	54
rivets/rivet nuts	120
rod thermostats	11, 11
rotary switches	15

**S**

safety bi-metal thermostats	9
safety thermostats	10
screw locks	126
screws	120
sealing washers	100
security hose clamps	119, 124
shaft gaskets	102
sheet metal screws	120
slot nuts	123
solenoid valves	32
spring washers	122
supply filters	118, 118
supply hoses	114
switches and momentary switches	12

**T**

temperature probes	22
thermostat gaskets	103
thermostats	9
time relays	22
timers	19
touch sensitive light switches	15

**U**

universal probes	22
------------------	----

**V**

valves and tank inlets	118
------------------------	-----

**W**

wash and rinse pumps	42
wash pump motors	50
washers	122
water cycle components	118
water filters	118