



GAS COMPONENTS



ELECTRIC COMPONENTS



WATER TECHNOLOGY



MECHANICAL COMPONENTS



TOOLS

Spare parts suitable for

MASTRO

Find the complete and up-to-date range of products in our GEV Webshop



Manufacturer catalogue

The most important spare parts and accessories arranged clearly for every manufacturer

- ✓ Complete product range and all appliance data always up to date in the GEV Webshop
- ✓ Alphabetical Index at the end of the catalogue

GEV Webshop

www.gev-online.co.uk

www.gev-online.com



- 🔍 Add to Favourites
- 🔍 Sign In with email address and usual password
- 🔍 Easy-order – place several items in your basket at the same time
- 🔍 Quick Item search – no login needed



heating elements

heating elements for ovens

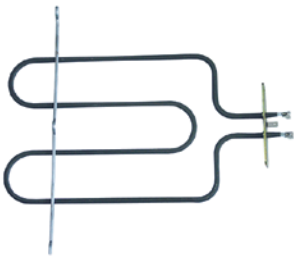

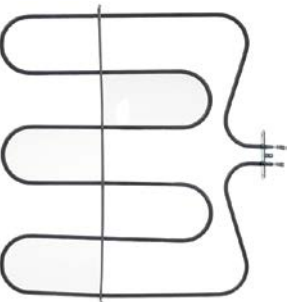

1

GEV No.	416533	Ref. No.	665.062.00
description	heating element 1400W 230V heating circuits 1 L 305mm W 180mm L1 52mm L2 250mm W1 75mm W2 30mm flange length 100mm flange width 22mm hole distance 79mm bridge length 300mm hole ø 4mm tube ø 6.3mm connection male faston 6.3mm rectangular flange grill setting oven		
For models:	6060CFE, 6060CFG		



1

GEV No.	416969	Ref. No.	09950327000
description	heating element 1400W 230V heating circuits 1 L 370mm W 400mm L1 45mm L2 325mm W1 184mm W2 30mm flange length 70mm flange width 22mm hole distance 46mm bridge length 420mm hole ø 5mm tube ø 6.3mm connection male faston 6.3mm windings 3 rectangular flange dry heating element		
For models:	AIB0017		
accessories for	416969		
	GEV No.	510368	Ref. No. —
	gasket L 70mm W 23.5mm hole ø 5mm hole distance 56mm FIBER thickness 2mm for heating element		



1

GEV No.	416042	Ref. No.	X68203
description	heating element 1500W 230V heating circuits 1 L 365mm W 500mm L1 45mm L2 315mm W1 240mm W2 30mm flange length 100mm flange width 22mm hole distance 86mm hole ø 5mm tube ø 6.3mm connection male faston 6.3mm mounting pos. lower rectangular flange dry heating element oven		
For models:	ACA2010, ACA206V, ACA210V		

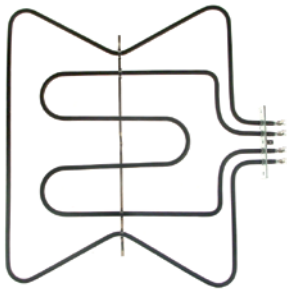

1

GEV No.	417441	Ref. No.	665.082.00
description	heating element 2300W 230V heating circuits 2 L 355mm W 393mm L1 38mm L2 317mm W1 165mm W2 67mm flange length 100mm flange width 22mm hole distance 86mm hole ø 4mm tube ø 6.3mm connection male faston 6.3mm rectangular flange dry heating element oven		
For models:	6060CFG		

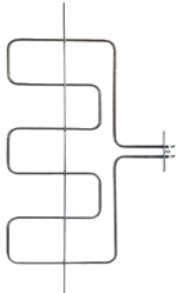

1

GEV No.	419251	Ref. No.	01951017000
description	heating element 2500W 230V heating circuits 1 L 360mm W 530mm L1 110mm L2 250mm W1 250mm W2 30mm flange length 100mm flange width 22mm hole distance 86mm bridge length 700mm hole ø 5mm tube ø 6.5mm connection male faston 6.3mm windings 3		
For models:	AAA2002		

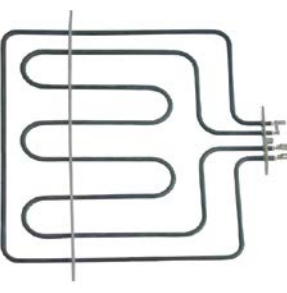

1

GEV No.	416041	Ref. No.	X68202
description	heating element 2600W 230V heating circuits 2 L 350mm W 355mm L1 36mm L2 314mm W1 147mm W2 60mm flange length 100mm flange width 22mm hole distance 80mm bridge length 480mm hole ø 5mm tube ø 6.3mm connection male faston 6.3mm mounting pos. upper rectangular flange dry heating element oven		
For models:	ACA2010, ACA206V, ACA210V		

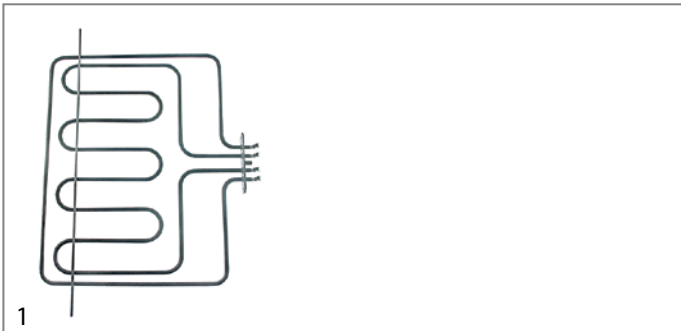

GEV No.	416970	Ref. No.	09950317000
description	heating element 2800W 230V heating circuits 2 L 323mm W 393mm L1 30mm L2 293mm W1 166mm W2 61mm flange length 100mm flange width 22mm hole distance 76mm bridge length 485mm hole ø 5mm tube ø 6.3mm connection male faston 6.3mm rectangular flange dry heating element		
For models:	AIB0017		
accessories for	416970		
	GEV No.	528090	Ref. No. 01980518000
	gasket L 100mm W 22mm thickness 1mm		

GEV No.	416043	Ref. No.	X47000
description	heating element 990W 230V L 475mm W 106mm H 24mm lug length 55mm lug width 18mm hole distance 138mm hole ø 5mm tube ø 6.3mm connection M4 heating circuits 1 bracket mounting oven		
For models:	ACA1004, ACA104V, ACA105V, ACA2007, ACA207V, ACA216, ACA216V, ADA104V, ADA106V, ADA205V, ADA208V, ADA210V, ADA212V		

heating elements for bain maries

GEV No.	416161	Ref. No.	071027
description	heating element 1000W 230V heating circuits 1 L 430mm W 95mm connection male faston 6.3mm connection distance 40mm connection length 10mm tube ø 6.3mm dry heating element W2 39mm H 36mm		
For models:	AXZ0003		

GEV No.	418344	Ref. No.	3710003
description	heating element 1200W 220V heating circuits 1 L 395mm W 220mm H 24mm connection M4 tube ø 8mm dry heating element L1 50mm L2 345mm connection distance 212mm		
For models:	IIA3006, IIA3007, IIA3008, IIA3010, IIA3011, IIA3012		

GEV No.	415927	Ref. No.	665.004.00
description	heating element 1200W 240V heating circuits 1 L 405mm W 88mm H 32mm lug length 40mm lug width 18mm dry heating element hole distance 44mm connection M5 bracket mounting mounting thread M5		
For models:	6570BME, 7070BME		

GEV No.	416536	Ref. No.	665.056.00
description	heating element 1500W 230V L 275mm W 80mm connection M4 tube ø 6.3mm 2 hole fixing thread 1/8" immersion heater H 22mm mounting distance 74mm		
For models:	6030BME		

GEV No.	415926	Ref. No.	665.003.00
description	heating element 1800W 240V heating circuits 1 L 403mm W 128mm H 32mm lug length 40mm lug width 18mm tube ø 8.5mm dry heating element hole distance 80mm bracket mounting mounting thread M5		
For models:	6540BME, 7040BME		

GEV No.	416537	Ref. No.	96500100
description	heating element 2200W 230V heating circuits 1 L 523mm W 134mm H 32mm lug length 40mm lug width 18mm tube ø 9mm dry heating element hole distance 79mm connection M5 bracket mounting connection length 30mm mounting thread M5 bain marie		
For models:	92BME, AFB0003		





GEV No.	417346	Ref. No.	665.058.00
description	heating element 3000W 230V heating circuits 1 L 278mm W 162mm connection M4 tube ø 6.5mm 2 hole fixing thread M10x1 immersion heater/dry heating element bain marie H 23mm mounting distance 156mm		
For models:	6060BME		
accessories for	417346		
	GEV No.	510416	Ref. No. —
	flat gasket fibre ED ø 19mm ID ø 10.5mm thickness 1.5mm for thread M10 Qty 1 pcs		
	GEV No.	510893	Ref. No. 456015
	O-ring EPDM thickness 2.62mm ID ø 9.92mm Qty 1 pcs		

Table continues overleaf



accessories for	417346			
	GEV No.	520231	Ref. No.	—
	nut thread M10x1 H 6mm WS 14 zinc-coated steel Qty 1 pcs			
	GEV No.	521129	Ref. No.	—
	nut thread M10 H 6mm SS WS 17 Qty 1 pcs DIN/ISO DIN 439			

	1		
GEV No.	418335	Ref. No.	003001040010
description	heating element 500W 230V heating circuits 1 L 430mm L1 38mm W 280mm connection M4 connection distance 271mm tube ø 8.5mm dry heating element L2 392mm H 16mm		
For models:	IFD0002-M		

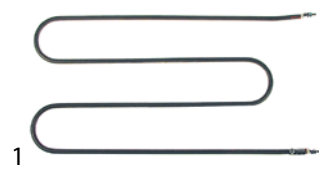
heating elements for crepes makers

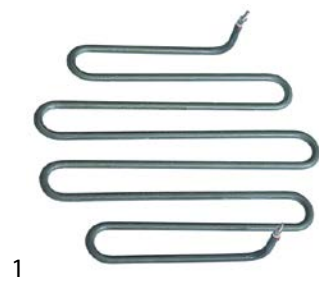
	1		
GEV No.	416157	Ref. No.	071066
description	heating element 2400W 230V L 305mm W 250mm H 60mm tube ø 8.5mm connection M4 connection length 16mm connection distance 225mm dry heating element heating circuits 1 crepes maker		
For models:	APZ0001, APZ0002, APZ0012		

heating elements for chip scuttles



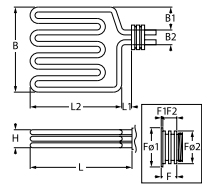

	1		
GEV No.	416082	Ref. No.	X48400
description	heating element 350W 230V heating circuits 8.5 L 172mm W 74mm flange length 110mm flange width 22mm hole distance 94mm connection length 20mm connection male faston 6.3mm tube ø 8.5mm rectangular flange hole ø 6mm dry heating element		
For models:	ACD001V, ACD002V		

heating elements for fryers

off-center connection with thread

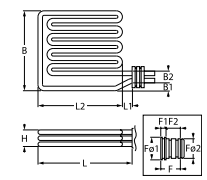
			
GEV No.	420560	Ref. No.	965.065.00
description	heating element 20000W 400V heating circuits 3 L 425mm W 255mm H 35mm flange length 19mm flange ø1 62mm flange ø2 57mm L1 21mm L2 408mm W2 34mm thread M54x1.5 tube ø 8.5mm cable length 510mm fryer		

with retaining rings

				
GEV No.	416408	Ref. No.	Y17000	
description	heating element 12000W 230/400V heating circuits 3 mounting pos. left L 280mm W 225mm H 32mm flange length 45mm flange length 1 9.6mm flange length 2 35.4mm flange ø1 44.5mm flange ø2 39.5mm thermostat sleeves ø 7mm length thermostat sleeves 280mm number of thermostat sleeves 1 thermostat sleeve eccentric, non clinging windings 5 L1 10mm L2 270mm W1 13mm W2 31mm tube ø 8.5mm cable length 600mm rotation flange fryer connection length 50mm			
For models:	ACC005V			
accessories for	416408			
	GEV No.	510899	Ref. No.	X05400
	O-ring EPDM thickness 3.53mm ID ø 37.69mm Qty 1 pcs			
	GEV No.	528155	Ref. No.	CGR4131NT X05300
	O-ring Viton thickness 3.53mm ID ø 32.93mm Qty 1 pcs			
	GEV No.	532545	Ref. No.	X05000
	O-ring Viton thickness 3.53mm ID ø 49.21mm Qty 1 pcs			
	GEV No.	691621	Ref. No.	M29600
	retaining ring shaft ø 40mm thickness 1.8mm steel DIN 471			

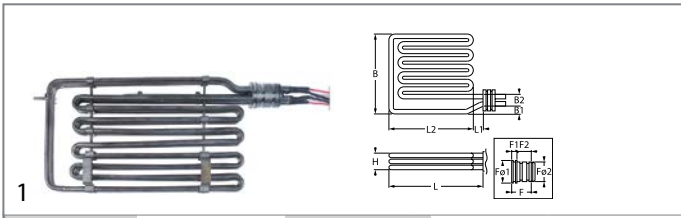

GEV No.	416407	Ref. No.	Y14400
description	heating element 15000W 230/400V heating circuits 3 mounting pos. left L 355mm W 190mm H 32mm flange length 45mm flange length 1 9.6mm flange length 2 35.4mm flange ø1 44.5mm flange ø2 39.5mm thermostat sleeves ø 7mm length thermostat sleeves 280mm number of thermostat sleeves 1 thermostat sleeve eccentric, clinging windings 4 L1 15mm L2 340mm W1 13mm W2 32mm tube ø 8.5mm cable length 570mm rotation flange connection length 60mm		
For models:	ADC006V		

accessories for	416407		
------------------------	--------	--	--

	GEV No.	510899	Ref. No.	X05400
	O-ring EPDM thickness 3.53mm ID ø 37.69mm Qty 1 pcs			
	GEV No.	528155	Ref. No.	CGR4131NT X05300
	O-ring Viton thickness 3.53mm ID ø 32.93mm Qty 1 pcs			
	GEV No.	532545	Ref. No.	X05000
	O-ring Viton thickness 3.53mm ID ø 49.21mm Qty 1 pcs			
	GEV No.	691621	Ref. No.	M29600
	retaining ring shaft ø 40mm thickness 1.8mm steel DIN 471			

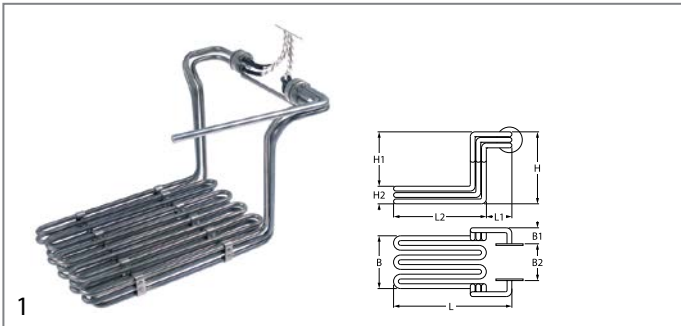

GEV No.	416409	Ref. No.	X57000
description	heating element 7500W 230/400V heating circuits 3 L 315mm W 170mm H 190mm L1 60mm L2 258mm W1 58mm W2 135mm W3 250mm H1 165mm H2 25mm windings 15 flange ø 30mm rotation flange cable length 980mm mounting ø 30mm tube ø 6.2mm connection length 21mm		
For models:	ACC0003, ACC003V, ACC008V, ACC010V, ADC004V		

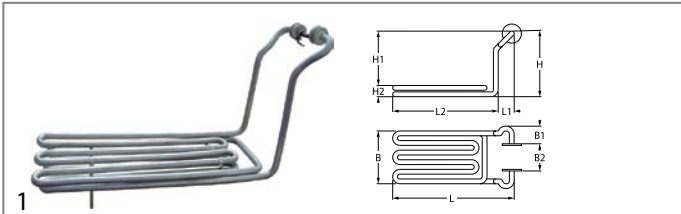

GEV No.	418870	Ref. No.	Y01100
description	heating element 3200W 230V		
For models:	ACC004V		

2 hole fixing

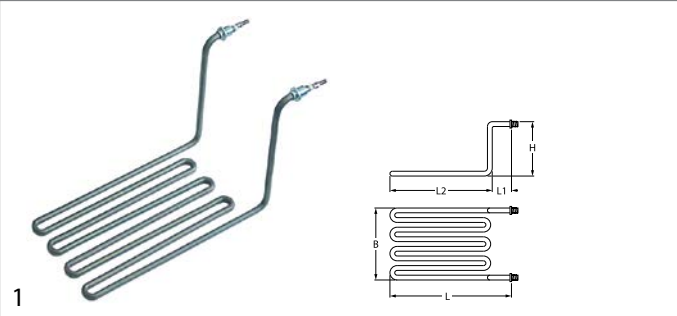

GEV No.	416169	Ref. No.	071052
description	heating element 3000W 230V heating circuits 1 L 290mm W 160mm H 185mm L1 18mm L2 272mm thread 1/4" mounting distance 144mm tube ø 8.5mm windings 4 2 hole fixing connection M5 fryer heaters		
For models:	AMZ0004, AMZ0005, AMZ0006, AMZ0007, IFA0004		

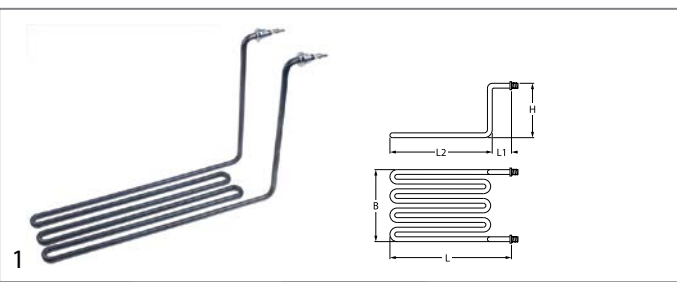

GEV No.	419100	Ref. No.	071109
description	heating element 3000W 230V heating circuits 1 L 355mm W 110mm H 225mm thread 1/4" mounting distance 100mm tube ø 8.5mm windings 3 2 hole fixing connection M5 fryer		
For models:	AMZ0008		

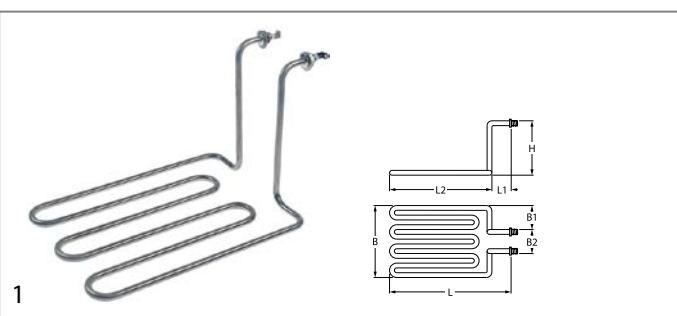

GEV No.	417567	Ref. No.	071001
description	heating element 3000W 230V heating circuits 1 L 290mm W 205mm H 195mm VNR/D1 connection screw immersion heater L1 35mm L2 270mm W1 60mm W2 75mm tube ø 8mm thread M12 windings 3		
For models:	AMZ0006, AMZ0007, IFA0004		



GEV No.	415929	Ref. No.	665.028.00
description	heating element 2500W 230V heating circuits 1 L 293mm W 40mm H 205mm L1 23mm L2 270mm H1 165mm H2 40mm thread M14x1.5 mounting distance 35mm tube ø 8.5mm 2 hole fixing connection M5 connection length 23mm immersion heater windings 4		
For models:	6030FRE, 6060FRE, 6540FRE, 6570FRE, 7040FRE10, 7070FRE10		
accessories for	415929		
	GEV No.	520228	Ref. No. —
tooth lock washer ID ø 15.3mm ED ø 24mm steel Qty 1 pcs for thread M14			
	GEV No.	520230	Ref. No. —
nut thread M14x1.5 H 5mm WS 19 zinc-coated steel Qty 1 pcs			
	GEV No.	521101	Ref. No. —
nut thread M14x1.5 H 5mm WS 19 SS Qty 1 pcs			
	GEV No.	550262	Ref. No. —
flat gasket copper ED ø 20mm ID ø 14mm thickness 2mm			
	GEV No.	560112	Ref. No. 12009944 Q232030000
plain washer ID ø 5.3mm ED ø 10mm thickness 1mm SS Qty 20 pcs DIN 125A for thread M5			
	GEV No.	560132	Ref. No. Q162030000
hexagonal nut thread M5 H 4mm WS 8 SS DIN/ISO DIN 934 / ISO 4032/8673 Qty 20 pcs			

GEV No.	419031	Ref. No.	965.009.00
description	heating element 3400/3700W 230/240V heating circuits 1 L 405mm W 44mm H 228mm L1 25mm L2 380mm H1 192mm H2 36mm thread M14x1.5 mounting distance 36mm tube ø 8.5mm 2 hole fixing connection M5 immersion heater windings 4 fryer		
For models:	AFC0003		

GEV No.	416172	Ref. No.	071005
description	heating element 3000W 230V heating circuits 1 L 300mm W 80mm H 255mm L1 43mm L2 257mm H1 215mm H2 40mm thread 1/4" mounting distance 67mm tube ø 8.5mm 2 hole fixing connection M5 connection length 12mm immersion heater windings 4		
For models:	AAC0001, AAC0002		
spare parts for	416172		
	GEV No.	510417	Ref. No. —
flat gasket fibre ED ø 20mm ID ø 14mm thickness 2mm Qty 1 pcs			
	GEV No.	528723	Ref. No. —
flat gasket FIBER ED ø 20mm ID ø 13mm thickness 1mm Qty 1 pcs			
accessories for	416172		
	GEV No.	361182	Ref. No. —
nut thread 1/4" H 5mm nickel-plated brass WS 17 Qty 1 pcs			
	GEV No.	520228	Ref. No. —
tooth lock washer ID ø 15.3mm ED ø 24mm steel Qty 1 pcs for thread M14			
	GEV No.	550262	Ref. No. —
flat gasket copper ED ø 20mm ID ø 14mm thickness 2mm			
	GEV No.	560112	Ref. No. 12009944 Q232030000
plain washer ID ø 5.3mm ED ø 10mm thickness 1mm SS Qty 20 pcs DIN 125A for thread M5			
	GEV No.	560132	Ref. No. Q162030000
hexagonal nut thread M5 H 4mm WS 8 SS DIN/ISO DIN 934 / ISO 4032/8673 Qty 20 pcs			

heating elements for griddles

GEV No.	416534	Ref. No.	665.057.00
description	heating element 1000W 230V heating circuits 1 L 422mm W 70mm H 66mm tube ø 8.5mm connection M5 connection distance 61mm dry heating element		
For models:	6030FTE, 6060FTE, 6060FTRE, 6060FTRRE		

GEV No.	416161	Ref. No.	071027
description	heating element 1000W 230V heating circuits 1 L 430mm W 95mm connection male faston 6.3mm connection distance 40mm connection length 10mm tube ø 6.3mm dry heating element W2 39mm H 36mm		
For models:	AXZ0003		



			
GEV No.	418498	Ref. No.	PD.411K
description	heating element 1000W 230V heating circuits 1 L 472mm W 76mm H 38mm tube ø 8.5mm connection M4 connection length 27mm dry heating element		
For models:	AHC0004, AHC0005		

			
GEV No.	420537	Ref. No.	Y15800
description	heating element 1750W 230V heating circuits 1 L 430mm W 60mm H 87mm tube ø 8.5mm		
For models:	ACH301V, ACH302V, ACH303V, ACH304V, ACH305V, ACH306V, ACH307V, ACH318V, ACH319V, ACH320V, ACK1002, ACK101V, ACK102V		

			
GEV No.	415928	Ref. No.	665.002.00
description	heating element 1800W 240V heating circuits 1 L 470mm W 90mm H 65mm tube ø 8.5mm connection M5 connection distance 82mm dry heating element		
For models:	6540FTE, 6540FTECR, 6540FTRE, 6540FTRECR, 6570FTE, 6570FTECR, 6570FTRE, 6570FTRECR, 6570FTRRE, 7040FTE, 7040FTECR, 7040FTES, 7040FTRE, 7070FTE, 7070FTECR, 7070FTRE, 7070FTRECR, 7070FTRRE		

			
GEV No.	420105	Ref. No.	665.102.00
description	heating element 2000W 230V heating circuits 1 L 480mm W 90mm H 42mm tube ø 8.5mm IRCA L1 50mm L2 430mm W1 49mm W2 20mm flange connection connection M5 hole distance 89mm flange length 100mm flange width 35mm hole ø 6mm windings 2 dry heating element		

			
GEV No.	416046	Ref. No.	Y10400
description	heating element 2350/2560W 220/240V heating circuits 1 L 590mm W 77mm H 80mm tube ø 8.5mm dry heating element		
For models:	ADH301V, ADH302V, ADH303V, ADH304V, ADH305V, ADH306V		

heating elements for gyros grills

			
GEV No.	416164	Ref. No.	071085
description	heating element 1500W 230V L 343mm W 74mm H 53mm connection male faston 6.3mm L1 125mm L2 110mm L3 108mm tube ø 6.3mm bracket mounting thread dry heating element		
For models:	AJE0002, AJE0003		

			
GEV No.	416163	Ref. No.	071067.1
description	heating element 2800W 230V L 327mm W 230mm H 68mm connection M6 thread 1/4" tube ø 8.5mm connection length 28mm 2 hole fixing dry heating element mounting distance 295mm		
For models:	AJE0001		

accessories for	416163			
	GEV No.	361182	Ref. No.	—
	nut thread 1/4" H 5mm nickel-plated brass WS 17 Qty 1 pcs			
	GEV No.	510417	Ref. No.	—
	flat gasket fibre ED ø 20mm ID ø 14mm thickness 2mm Qty 1 pcs			
	GEV No.	520228	Ref. No.	—
	tooth lock washer ID ø 15.3mm ED ø 24mm steel Qty 1 pcs for thread M14			
	GEV No.	550262	Ref. No.	—
	flat gasket copper ED ø 20mm ID ø 14mm thickness 2mm			

heating elements for hot dog machines

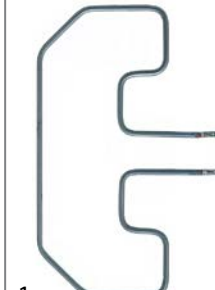
			
GEV No.	416159	Ref. No.	071015
description	heating element 750W 230V L 180mm W 327mm H 6.5mm tube ø 6.3mm W1 137mm W2 50mm connection male faston 6.3mm connection length 19mm dry heating element heating circuits 1		
For models:	ARZ0001		

heating elements for coffee machine

			
GEV No.	417467	Ref. No.	4.0.000.0214
description	heating element 1800W 230V heating circuits 2 mounting ø 38mm hole distance 57mm L 178mm W 28mm H 46mm H1 24mm H2 22mm hole ø 11mm tube ø 8.3mm connection M6 immersion heater 3 hole flange		
For models:	EFA0015		



1			
GEV No.	417503	Ref. No.	1601311
description	heating element 2200W 230V heating circuits 1 ø 56mm H 240mm W1 34mm H1 175mm H2 65mm mounting distance 28mm thread M10x1.5 windings 7 tube ø 6.5mm connection male faston 6.3mm suitable for COFFEE QUEEN		
For models:	EFB0017, EFB0018, EFC0003		

1			
GEV No.	417502	Ref. No.	1601312
description	heating element 3000W 230V heating circuits 1 L 600mm W 50mm H 35mm mounting distance 50mm tube ø 8mm thread M14x1.5 windings 3 connection M4 2 hole fixing suitable for COFFEE QUEEN		
For models:	EFB0014, EFB0019		

1				
GEV No.	417095	Ref. No.	5.0.000.0802	
description	heating element 3500W 230V heating circuits 2 mounting ø 39mm hole distance 57mm L 330mm W 34mm H 53mm L1 30mm L2 70mm L3 225mm H1 24mm H2 29mm windings 2 hole ø 11mm tube ø 8.3mm connection M6 immersion heater 3 hole flange			
For models:	EFA0016			
accessories for	417095			
	GEV No.	528013	Ref. No.	—
	gasket ID ø 40mm fibre thickness 4mm hole ø 11mm hole distance 57mm for heating element coffee machine parts			
	GEV No.	528740	Ref. No.	—
	gasket ID ø 44mm PTFE thickness 3.5mm hole ø 9.5mm hole distance 58mm suitable for ITALCREM, VISACREM for heating element coffee machine parts			

1			
GEV No.	417468	Ref. No.	4.0.000.0217
description	heating element 5000W 230V heating circuits 2 mounting ø 38mm hole distance 56mm L 438mm W 35mm H 52mm L1 40mm L2 68mm L3 330mm H1 23mm H2 29mm hole ø 11mm tube ø 8.3mm connection M6 immersion heater 3 hole flange		
For models:	EFA0023		

1			
GEV No.	417483	Ref. No.	120811
description	hot plate 95W 230V heating circuits 1 L 160mm W 150mm H 15mm connection plug connection cable length 200mm suitable for COFFEE QUEEN		
For models:	EFB0001, EFB0002, EFB0003, EFB0004		

heating elements for refrigeration

heating elements for defrosting

1			
GEV No.	419200	Ref. No.	B00REZ114
description	heating element 1080W 220V L 1065mm W 170mm L1 10mm L2 1060mm W1 70mm W2 60mm cable length 800mm tube ø 8.5mm		
For models:	BMA0099		

1			
GEV No.	419195	Ref. No.	B00REZ116
description	heating element 2x100W 2x115V L 380mm Wmm cable length 1500mm tube ø 8.5mm defrosting		
For models:	9925F, 9931F, 9932F, BNC0001BAR-F, BNC0001-F, BNC0002-F, BNC0007BAR-F, BNC0008-F, BNC0015BAR-F, BNC0015-F, BNC0016-F, BNC0030, BNC0030PI, BNC0032, BNC0033, BNC0034, BNC0034PI, BNC0035, CCZ0009-F, CCZ0018-F, CCZ0050, HAB0001-F, HAB0007-F, HAB0009-F, HAB0015-F, HAB0020, HAB0021, HCE2004-F, HCE2005-F, HCE2006-F, IEC0050, IEC0051, IEC0052, SALADBAR2, SALADBAR3, TIM3, TIM3PI, USN4, VAEN030-F, VAEN060-F, VAEN075-F		

1			
GEV No.	419197	Ref. No.	B00REZ111
description	heating element 2x200W 2x110V L 400mm Wmm cable length 1500mm tube ø 8.5mm defrosting		
For models:	BMB0002-FG, BMC0001-FG, HCE2007-F, HCE2008-F, HCE2009		





GEV No.	419196	Ref. No.	B00REZ100
description	heating element 55W 220V L 410mm W 50mm H 80mm cable length 1600mm tube ø 8.5mm defrosting		
For models:	BMB0002-FG, BNA0068, BNA0069, BNC0002-F, BNC0007-F, BNC0008-F, BNC0030, TIM3		

condensing trays heated



GEV No.	750516	Ref. No.	EV-V000016
description	condensing tray L 465mm W 178mm H 180mm 800W 230V		
For models:	BHZ0034, BHZ0035, BHZ0036, BHZ0037, BHZ0038, BHZ0039		



GEV No.	750517	Ref. No.	EV-V000017	
description	condensing tray L 468mm W 300mm H 120mm 800W 230V total length 525mm overall height 160mm			
For models:	BHZ0034, BHZ0035, BHZ0036, BHZ0037, BHZ0038, BHZ0039			
spare parts for	750517			
	GEV No.	417744	Ref. No.	R010-REU500
	heating element 400W 230V L 485mm W 70mm H 9.5mm heating circuits 1 cable length 500mm defrosting			

heating elements for tilting bratt pan



GEV No.	416539	Ref. No.	665.023.00
description	heating element 2100W 230V heating circuits 1 L 383mm W 170mm H 60mm W1 35mm W2 100mm connection M5 connection distance 92mm tube ø 8.5mm dry heating element tilting bratt pan		
For models:	6570BRE, 7070BRE, 7070BREM		



GEV No.	420556	Ref. No.	965.074.00
description	heating element for tilting bratt pan 6350W 230V L 550mm W 310mm H 30mm connection screw heating circuits 1 tube ø 8.5mm		

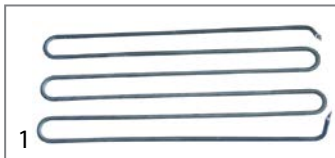

GEV No.	416540	Ref. No.	96500715
description	heating element tilting bratt pan 3330W 230V L 506mm W 200mm H 63mm dry heating element heating circuits 1 tube ø 8.5mm W1 30mm W2 140mm		
For models:	94BRE, 94BREM, 96BRE, 96BREM		



GEV No.	416045	Ref. No.	X48100
description	heating element tilting bratt pan 3400W 230V L 313mm W 195mm H 82mm connection M5 dry heating element heating circuits 1 tube ø 10mm W1 67mm W2 61mm		
For models:	ACK2003, ACK2004, ACK203V, ACK204V		

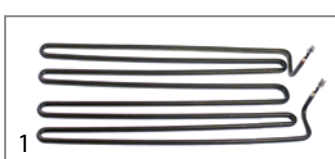

GEV No.	417344	Ref. No.	Y10500
description	heating element tilting bratt pan 4700W 230V L 540mm W 210mm H 60mm heating circuits 1 tube ø 8.5mm W1 70mm W2 70mm		
For models:	ADK201V, ADK202V, ADK203V, ADK204V		

heating elements for pasta cookers











GEV No.	416408	Ref. No.	Y17000	
description	heating element 12000W 230/400V heating circuits 3 mounting pos. left L 280mm W 225mm H 32mm flange length 45mm flange length 1 9.6mm flange length 2 35.4mm flange ø1 44.5mm flange ø2 39.5mm thermostat sleeves ø 7mm length thermostat sleeves 280mm number of thermostat sleeves 1 thermostat sleeve eccentric, non clinging windings 5 L1 10mm L2 270mm W1 13mm W2 31mm tube ø 8.5mm cable length 600mm rotation flange fryer connection length 50mm			
For models:	ACC005V			
accessories for	416408			
	GEV No.	510899	Ref. No.	X05400
	O-ring EPDM thickness 3.53mm ID ø 37.69mm Qty 1 pcs			

Table continues overleaf











accessories for	416408			
	GEV No.	528155	Ref. No.	CGR4131NT X05300
	O-ring Viton thickness 3.53mm ID ø 32.93mm Qty 1 pcs			
	GEV No.	532545	Ref. No.	X05000
	O-ring Viton thickness 3.53mm ID ø 49.21mm Qty 1 pcs			
	GEV No.	691621	Ref. No.	M29600
	retaining ring shaft ø 40mm thickness 1.8mm steel DIN 471			

	1			
GEV No.	416407	Ref. No.	Y14400	
description	heating element 15000W 230/400V heating circuits 3 mounting pos. left L 355mm W 190mm H 32mm flange length 45mm flange length 1 9.6mm flange length 2 35.4mm flange ø1 44.5mm flange ø2 39.5mm thermostat sleeves ø 7mm length thermostat sleeves 280mm number of thermostat sleeves 1 thermostat sleeve eccentric, clinging windings 4 L1 15mm L2 340mm W1 13mm W2 32mm tube ø 8.5mm cable length 570mm rotation flange connection length 60mm			
For models:	ADC006V			
accessories for	416407			
	GEV No.	510899	Ref. No.	X05400
	O-ring EPDM thickness 3.53mm ID ø 37.69mm Qty 1 pcs			
	GEV No.	528155	Ref. No.	CGR4131NT X05300
	O-ring Viton thickness 3.53mm ID ø 32.93mm Qty 1 pcs			
	GEV No.	532545	Ref. No.	X05000
	O-ring Viton thickness 3.53mm ID ø 49.21mm Qty 1 pcs			
	GEV No.	691621	Ref. No.	M29600
	retaining ring shaft ø 40mm thickness 1.8mm steel DIN 471			

	1			
GEV No.	418651	Ref. No.	Y19800	
description	heating element 1500W 230V heating circuits 1 L 300mm W 51mm 2 hole fixing connection male faston 6.3mm thread M14x1 tube ø 8.5mm mounting distance 43mm pasta cooker immersion heater			
For models:	ACE008V			
spare parts for	418651			
	GEV No.	507313	Ref. No.	12009837 Q307050000
	O-ring EPDM thickness 2.62mm ID ø 13.95mm Qty 1 pcs			
accessories for	418651			
	GEV No.	510417	Ref. No.	—
	flat gasket fibre ED ø 20mm ID ø 14mm thickness 2mm Qty 1 pcs			
	GEV No.	520228	Ref. No.	—
	tooth lock washer ID ø 15.3mm ED ø 24mm steel Qty 1 pcs for thread M14			
	GEV No.	521133	Ref. No.	—
	nut thread M14x1.5 H 6mm WS 19 zinc-coated steel Qty 1 pcs			
	GEV No.	550261	Ref. No.	—
	nut thread M14x1 H 4mm WS 19 SS Qty 1 pcs			

accessories for	418651			
	GEV No.	550262	Ref. No.	—
	flat gasket copper ED ø 20mm ID ø 14mm thickness 2mm			

	1			
GEV No.	415902	Ref. No.	Y19900	
description	heating element 2510W 230V L 295mm W 115mm Hmm 2 hole fixing connection male faston 6.3mm thread M14x1 tube ø 8.5mm			
For models:	ACE003V, ACE004V			
accessories for	415902			
	GEV No.	510417	Ref. No.	—
	flat gasket fibre ED ø 20mm ID ø 14mm thickness 2mm Qty 1 pcs			
	GEV No.	520228	Ref. No.	—
	tooth lock washer ID ø 15.3mm ED ø 24mm steel Qty 1 pcs for thread M14			
	GEV No.	521133	Ref. No.	—
	nut thread M14x1.5 H 6mm WS 19 zinc-coated steel Qty 1 pcs			
	GEV No.	550261	Ref. No.	—
	nut thread M14x1 H 4mm WS 19 SS Qty 1 pcs			
	GEV No.	550262	Ref. No.	—
	flat gasket copper ED ø 20mm ID ø 14mm thickness 2mm			

	1			
GEV No.	416535	Ref. No.	665.032.00	
description	heating element 3000W 230V heating circuits 1 L 303mm W 170mm Hmm 2 hole fixing connection M4 thread M10x1 tube ø 6.3mm mounting distance 164mm immersion heater			
For models:	6030CPE, 6060CPE, 6540CPE, 6570CPE			
spare parts for	416535			
	GEV No.	510893	Ref. No.	456015
	O-ring EPDM thickness 2.62mm ID ø 9.92mm Qty 1 pcs			





	1			
GEV No.	418046	Ref. No.	46500000 66507400	
description	heating element 3800W 230V heating circuits 3 L 250mm W 41mm H 34mm round flange connection male faston 6.3mm tube ø 6.3mm mounting ø 57.5mm immersion heater with gasket			
For models:	7040CPE, 7070CPE, AFE0002			
spare parts for	418046			
	GEV No.	510409	Ref. No.	835535651 F2680
	O-ring EPDM thickness 5.34mm ID ø 56.52mm Qty 1 pcs			

Table continues overleaf



accessories for	418046		
	GEV No.	550002	Ref. No. —
	tension strap H 10mm L 21mm W 10mm hole ø 6.5mm for heating element		

1			
GEV No.	419247	Ref. No.	665.103.00
description	heating element 4500W 230V heating circuits 3 L 350mm connection male faston 6.3mm tube ø 6.3mm flange ø 72mm thermostat sleeves ø 8.5mm length thermostat sleeves 200mm immersion heater		

1			
GEV No.	418907	Ref. No.	Y18400

description	heating element 7500W 230V heating circuits 3 L 422mm W 186mm H 25mm tube ø 6.3mm L1 32mm L2 390mm W1 170mm W2 28mm cable length 550mm flange length 1 9.6mm flange length 2 35.4mm flange length 45mm flange ø1 44.5mm flange ø2 40mm mounting pos. left		
For models:	ADE003V, ADE004V		

accessories for	418907		
------------------------	--------	--	--

	GEV No.	510899	Ref. No.	X05400
	O-ring EPDM thickness 3.53mm ID ø 37.69mm Qty 1 pcs			

	GEV No.	528155	Ref. No.	CGR4131NT X05300
	O-ring Viton thickness 3.53mm ID ø 32.93mm Qty 1 pcs			

	GEV No.	532545	Ref. No.	X05000
	O-ring Viton thickness 3.53mm ID ø 49.21mm Qty 1 pcs			

	GEV No.	691621	Ref. No.	M29600
	retaining ring shaft ø 40mm thickness 1.8mm steel DIN 471			

heating elements for pizza ovens

1			
GEV No.	418057	Ref. No.	91711041

description	heating element 1000W 230V L 1060mm W 205mm thread 1/4" mounting distance 196mm connection length 109mm connection M5 tube ø 8.6mm heating circuits 1 dry heating element 2 hole fixing		
For models:	CAB0007, CAB0008, CAB0009, CAB0010, CAB0011, CAB0012, CAB0013, CAB0014, CAB0015, CAB0016, CAB0017, CAB0018, CAB0024, CAB0025, CAB0026, CAB0027, CAB0039, CAB0040, CAB0041, CAB0042, CAB0043, CAB0044, CAB0045, CAB0046		

accessories for	418057		
------------------------	--------	--	--

	GEV No.	361182	Ref. No.	—
	nut thread 1/4" H 5mm nickel-plated brass WS 17 Qty 1 pcs			

	GEV No.	510417	Ref. No.	—
	flat gasket fibre ED ø 20mm ID ø 14mm thickness 2mm Qty 1 pcs			

	GEV No.	520228	Ref. No.	—
	tooth lock washer ID ø 15.3mm ED ø 24mm steel Qty 1 pcs for thread M14			

	GEV No.	550262	Ref. No.	—
	flat gasket copper ED ø 20mm ID ø 14mm thickness 2mm			

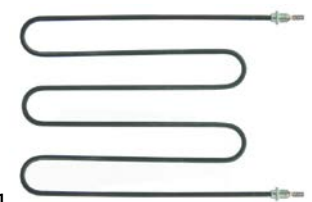
1			
GEV No.	416488	Ref. No.	IB5256400

description	heating element 1000W 230V L 320mm W 240mm thread M12x1.5 mounting distance 233mm connection length 33mm connection male faston 6.3mm tube ø 6.3mm heating circuits 1 dry heating element 2 hole fixing		
For models:	IBA0012, IBA0013		

accessories for	416488		
------------------------	--------	--	--

	GEV No.	560502	Ref. No.	—
	hexagonal nut thread M12x1.5 H 6mm WS 19 SS Qty 1 pcs zinc-plated			

1			
GEV No.	418880	Ref. No.	91711022

description	heating element 1000W 230V L 580mm W 235mm thread 1/4" mounting distance 227mm connection length 110mm connection M5 tube ø 8.5mm heating circuits 1 for pizza oven		
For models:	CAB0007, CAB0008, CAB0009, CAB0010, CAB0011, CAB0012, CAB0013, CAB0014, CAB0015, CAB0016, CAB0017, CAB0018, CAB0024, CAB0025, CAB0026, CAB0027, CAB0039, CAB0040, CAB0041, CAB0042, CAB0043, CAB0044, CAB0045, CAB0046		

1			
GEV No.	418054	Ref. No.	91711050

description	heating element 1000W 230V L 708mm W 198mm thread 1/4" mounting distance 178mm connection length 108mm connection M5 tube ø 8.5mm heating circuits 1 dry heating element 2 hole fixing		
For models:	CAB0007, CAB0008, CAB0009, CAB0010, CAB0011, CAB0012, CAB0013, CAB0014, CAB0015, CAB0016, CAB0017, CAB0018, CAB0024, CAB0025, CAB0026, CAB0027, CAB0039, CAB0040, CAB0041, CAB0042, CAB0043, CAB0044, CAB0045, CAB0046		

accessories for	418054		
------------------------	--------	--	--

	GEV No.	361182	Ref. No.	—
	nut thread 1/4" H 5mm nickel-plated brass WS 17 Qty 1 pcs			

	GEV No.	510417	Ref. No.	—
	flat gasket fibre ED ø 20mm ID ø 14mm thickness 2mm Qty 1 pcs			

	GEV No.	520228	Ref. No.	—
	tooth lock washer ID ø 15.3mm ED ø 24mm steel Qty 1 pcs for thread M14			

	GEV No.	550262	Ref. No.	—
	flat gasket copper ED ø 20mm ID ø 14mm thickness 2mm			









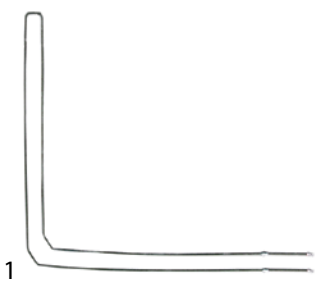

			
GEV No.	418059	Ref. No.	91711042
description	heating element 1000W 230V L 710mm W 300mm thread 1/4" mounting distance 290mm connection M5 tube ø 8.5mm heating circuits 1 dry heating element 2 hole fixing		
For models:	CAB0007, CAB0008, CAB0009, CAB0010, CAB0011, CAB0012, CAB0013, CAB0014, CAB0015, CAB0016, CAB0017, CAB0018, CAB0024, CAB0025, CAB0026, CAB0027, CAB0039, CAB0040, CAB0041, CAB0042, CAB0043, CAB0044, CAB0045, CAB0046		

			
GEV No.	416437	Ref. No.	91711021
description	heating element 1000W 230V L 895mm W 132mm thread 1/4" mounting distance 122mm connection length 110mm connection M4 tube ø 8.5mm heating circuits 1 dry heating element 2 hole fixing		
For models:	CAB0007, CAB0008, CAB0009, CAB0010, CAB0011, CAB0012, CAB0013, CAB0014, CAB0015, CAB0016, CAB0017, CAB0018, CAB0024, CAB0025, CAB0026, CAB0027, CAB0039, CAB0040, CAB0041, CAB0042, CAB0043, CAB0044, CAB0045, CAB0046		
accessories for	416437		
		GEV No.	361182 Ref. No. —
	nut thread 1/4" H 5mm nickel-plated brass WS 17 Qty 1 pcs		
		GEV No.	510417 Ref. No. —
	flat gasket fibre ED ø 20mm ID ø 14mm thickness 2mm Qty 1 pcs		
		GEV No.	520228 Ref. No. —
	tooth lock washer ID ø 15.3mm ED ø 24mm steel Qty 1 pcs for thread M14		
		GEV No.	550262 Ref. No. —
	flat gasket copper ED ø 20mm ID ø 14mm thickness 2mm		

			
GEV No.	418117	Ref. No.	RESI0057
description	heating element 1200W 230V heating circuits 1 mounting pos. upper L 147mm W 157mm L1 100mm ø 47mm thread M14x1.5 mounting distance 148mm cable length 970mm tube ø 8.5mm connection cable dry heating element 2 hole fixing		
For models:	CAD0004-ZN		

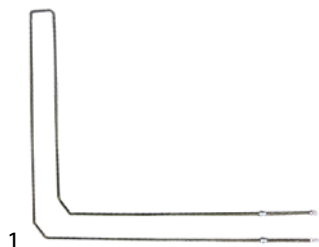
			
GEV No.	418221	Ref. No.	91711062
description	heating element 1400W 230V L 1144mm W 1090mm thread 1/4" mounting distance 100mm connection length 160mm connection M5 tube ø 8.5mm dry heating element mounting pos. bottom at the back 2 hole fixing		
For models:	CAB0019, CAB0020		





			
GEV No.	416438	Ref. No.	91711031
description	heating element 1400W 230V L 898mm W 132mm thread 1/4" mounting distance 123mm connection length 98mm connection M5 tube ø 8.5mm heating circuits 1 dry heating element 2 hole fixing		
For models:	CAB0007, CAB0008, CAB0009, CAB0010, CAB0011, CAB0012, CAB0013, CAB0014, CAB0015, CAB0016, CAB0017, CAB0018, CAB0024, CAB0025, CAB0026, CAB0027, CAB0039, CAB0040, CAB0041, CAB0042, CAB0043, CAB0044, CAB0045, CAB0046		
spare parts for	416438		
		GEV No.	510417 Ref. No. —
	flat gasket fibre ED ø 20mm ID ø 14mm thickness 2mm Qty 1 pcs		
accessories for	416438		
		GEV No.	361182 Ref. No. —
	nut thread 1/4" H 5mm nickel-plated brass WS 17 Qty 1 pcs		
		GEV No.	520228 Ref. No. —
	tooth lock washer ID ø 15.3mm ED ø 24mm steel Qty 1 pcs for thread M14		
		GEV No.	550262 Ref. No. —
	flat gasket copper ED ø 20mm ID ø 14mm thickness 2mm		

			
GEV No.	418220	Ref. No.	91711061
description	heating element 1400W 230V L 938mm W 880mm thread 1/4" mounting distance 97mm connection length 24mm connection M5 tube ø 8.7mm dry heating element mounting pos. bottom/centre 2 hole fixing		
For models:	CAB0019, CAB0020		
accessories for	418220		
		GEV No.	361182 Ref. No. —
	nut thread 1/4" H 5mm nickel-plated brass WS 17 Qty 1 pcs		
		GEV No.	510417 Ref. No. —
	flat gasket fibre ED ø 20mm ID ø 14mm thickness 2mm Qty 1 pcs		
		GEV No.	520228 Ref. No. —
	tooth lock washer ID ø 15.3mm ED ø 24mm steel Qty 1 pcs for thread M14		
		GEV No.	550262 Ref. No. —
	flat gasket copper ED ø 20mm ID ø 14mm thickness 2mm		

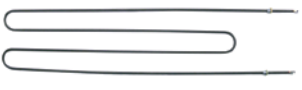

GEV No.	418119	Ref. No.	RESI0079
description	heating element 1500W 230V heating circuits 1 mounting pos. upper L 142mm W 158mm L1 95mm ø 49mm thread M14x1.5 mounting distance 150mm cable length 970mm tube ø 8.5mm dry heating element 2 hole fixing		
For models:	CAD0004, CAD0004-ZN		







GEV No.	418061	Ref. No.	91711043
description	heating element 1500W 230V L 1055mm W 280mm thread 1/4" mounting distance 272mm connection length 108mm connection M5 tube ø 8.5mm heating circuits 1 dry heating element 2 hole fixing		
For models:	CAB0007, CAB0008, CAB0009, CAB0010, CAB0011, CAB0012, CAB0013, CAB0014, CAB0015, CAB0016, CAB0017, CAB0018, CAB0024, CAB0025, CAB0026, CAB0027, CAB0039, CAB0040, CAB0041, CAB0042, CAB0043, CAB0044, CAB0045, CAB0046		
accessories for	418061		
	GEV No.	361182	Ref. No. —
	nut thread 1/4" H 5mm nickel-plated brass WS 17 Qty 1 pcs		
	GEV No.	510417	Ref. No. —
	flat gasket fibre ED ø 20mm ID ø 14mm thickness 2mm Qty 1 pcs		
	GEV No.	520228	Ref. No. —
	tooth lock washer ID ø 15.3mm ED ø 24mm steel Qty 1 pcs for thread M14		
	GEV No.	550262	Ref. No. —
	flat gasket copper ED ø 20mm ID ø 14mm thickness 2mm		

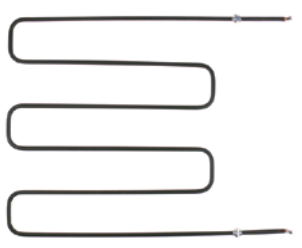





GEV No.	420501	Ref. No.	91711343
description	heating element 1500W 230V L 1060mm W 320mm thread 1/4" mounting distance 221mm connection length 110mm connection M5 tube ø 8.5mm heating circuits 1 dry heating element 2 hole fixing		
For models:	CAB0009-CD, CAB0058-DCG, CAB0062-DCG		



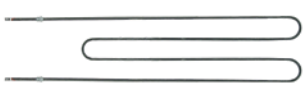



GEV No.	418673	Ref. No.	91711010
description	heating element 1500W 230V L 475mm W 445mm thread 1/4" mounting distance 436.5mm connection length 116mm connection male faston 6.3mm tube ø 8.5mm heating circuits 1 dry heating element 2 hole fixing		
For models:	CAB0029-CN, CAB0030-CN, CAB0032, CAB0033, CAB0035		
accessories for	418673		
	GEV No.	361182	Ref. No. —
	nut thread 1/4" H 5mm nickel-plated brass WS 17 Qty 1 pcs		

accessories for	418673		
	GEV No.	510417	Ref. No. —
	flat gasket fibre ED ø 20mm ID ø 14mm thickness 2mm Qty 1 pcs		
	GEV No.	520228	Ref. No. —
	tooth lock washer ID ø 15.3mm ED ø 24mm steel Qty 1 pcs for thread M14		
	GEV No.	550262	Ref. No. —
	flat gasket copper ED ø 20mm ID ø 14mm thickness 2mm		







GEV No.	416439	Ref. No.	91711023
description	heating element 1500W 230V L 900mm W 245mm thread 1/4" mounting distance 237mm connection length 110mm connection M5 tube ø 8.5mm heating circuits 1 dry heating element 2 hole fixing		
For models:	CAB0007, CAB0008, CAB0009, CAB0010, CAB0011, CAB0012, CAB0013, CAB0014, CAB0015, CAB0016, CAB0017, CAB0018, CAB0024, CAB0025, CAB0026, CAB0027, CAB0039, CAB0040, CAB0041, CAB0042, CAB0043, CAB0044, CAB0045, CAB0046		
accessories for	416439		
	GEV No.	361182	Ref. No. —
	nut thread 1/4" H 5mm nickel-plated brass WS 17 Qty 1 pcs		
	GEV No.	510417	Ref. No. —
	flat gasket fibre ED ø 20mm ID ø 14mm thickness 2mm Qty 1 pcs		
	GEV No.	520228	Ref. No. —
	tooth lock washer ID ø 15.3mm ED ø 24mm steel Qty 1 pcs for thread M14		
	GEV No.	550262	Ref. No. —
	flat gasket copper ED ø 20mm ID ø 14mm thickness 2mm		

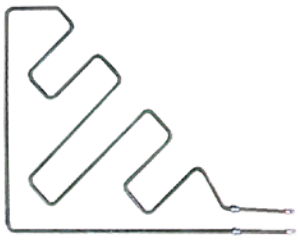

GEV No.	418056	Ref. No.	91711051
description	heating element 1600W 230V L 1060mm W 230mm thread 1/4" mounting distance 221mm connection length 110mm connection M5 tube ø 8.5mm heating circuits 1 dry heating element 2 hole fixing		
For models:	CAB0007, CAB0008, CAB0009, CAB0010, CAB0011, CAB0012, CAB0013, CAB0014, CAB0015, CAB0016, CAB0017, CAB0018, CAB0024, CAB0025, CAB0026, CAB0027, CAB0039, CAB0040, CAB0041, CAB0042, CAB0043, CAB0044, CAB0045, CAB0046		
accessories for	418056		
	GEV No.	361182	Ref. No. —
	nut thread 1/4" H 5mm nickel-plated brass WS 17 Qty 1 pcs		
	GEV No.	510417	Ref. No. —
	flat gasket fibre ED ø 20mm ID ø 14mm thickness 2mm Qty 1 pcs		
	GEV No.	520228	Ref. No. —
	tooth lock washer ID ø 15.3mm ED ø 24mm steel Qty 1 pcs for thread M14		
	GEV No.	550262	Ref. No. —
	flat gasket copper ED ø 20mm ID ø 14mm thickness 2mm		

GEV No.	418219	Ref. No.	91711060
description	heating element 1600W 230V L 710mm W 665mm thread 1/4" mounting distance 96mm connection length 148mm connection M5 tube ø 8.5mm heating circuits 1 dry heating element mounting pos. bottom in the front 2 hole fixing		
For models:	CAB0019, CAB0020		
accessories for	418219		
	GEV No.	361182	Ref. No. —
	nut thread 1/4" H 5mm nickel-plated brass WS 17 Qty 1 pcs		
	GEV No.	510417	Ref. No. —
	flat gasket fibre ED ø 20mm ID ø 14mm thickness 2mm Qty 1 pcs		
	GEV No.	520228	Ref. No. —
	tooth lock washer ID ø 15.3mm ED ø 24mm steel Qty 1 pcs for thread M14		
	GEV No.	550262	Ref. No. —
	flat gasket copper ED ø 20mm ID ø 14mm thickness 2mm		

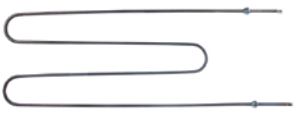

GEV No.	418058	Ref. No.	91711052
description	heating element 1600W 230V L 715mm W 275mm thread 1/4" mounting distance 275mm connection M4 tube ø 8.5mm heating circuits 1 dry heating element 2 hole fixing		
For models:	CAB0007, CAB0008, CAB0009, CAB0010, CAB0011, CAB0012, CAB0013, CAB0014, CAB0015, CAB0016, CAB0017, CAB0018, CAB0024, CAB0025, CAB0026, CAB0027, CAB0039, CAB0040, CAB0041, CAB0042, CAB0043, CAB0044, CAB0045, CAB0046		



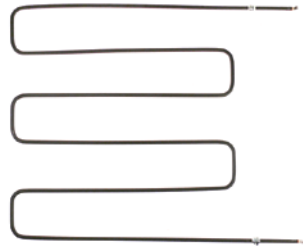

GEV No.	418118	Ref. No.	RESI0058
description	heating element 1800W 230V heating circuits 1 mounting pos. lower L 150mm W 155mm ø 55mm thread M14x1.5 mounting distance 150mm cable length 945mm tube ø 8.5mm connection cable dry heating element 2 hole fixing pizza oven		
For models:	CAD0004-ZN		
accessories for	418118		
	GEV No.	510417	Ref. No. —
	flat gasket fibre ED ø 20mm ID ø 14mm thickness 2mm Qty 1 pcs		
	GEV No.	520228	Ref. No. —
	tooth lock washer ID ø 15.3mm ED ø 24mm steel Qty 1 pcs for thread M14		
	GEV No.	520230	Ref. No. —
	nut thread M14x1.5 H 5mm WS 19 zinc-coated steel Qty 1 pcs		
	GEV No.	521101	Ref. No. —
	nut thread M14x1.5 H 5mm WS 19 SS Qty 1 pcs		

accessories for	418118		
	GEV No.	550262	Ref. No. —
	flat gasket copper ED ø 20mm ID ø 14mm thickness 2mm		





GEV No.	418675	Ref. No.	91711011
description	heating element 1800W 230V L 575mm W 550mm thread 1/4" mounting distance 541mm connection length 116mm connection male faston 6.3mm tube ø 8.5mm heating circuits 1 dry heating element 2 hole fixing		
For models:	CAB0029-CN, CAB0030-CN, CAB0032, CAB0033, CAB0035		

accessories for	418675		
	GEV No.	510417	Ref. No. —
	flat gasket fibre ED ø 20mm ID ø 14mm thickness 2mm Qty 1 pcs		



accessories for	418675		
	GEV No.	361182	Ref. No. —
	nut thread 1/4" H 5mm nickel-plated brass WS 17 Qty 1 pcs		
	GEV No.	520228	Ref. No. —
	tooth lock washer ID ø 15.3mm ED ø 24mm steel Qty 1 pcs for thread M14		

accessories for	418675		
	GEV No.	550262	Ref. No. —
	flat gasket copper ED ø 20mm ID ø 14mm thickness 2mm		

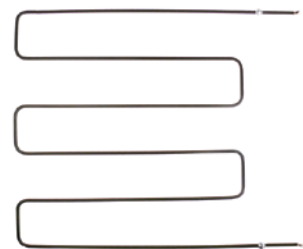
accessories for	418675		
	GEV No.	361182	Ref. No. —
	nut thread 1/4" H 5mm nickel-plated brass WS 17 Qty 1 pcs		
	GEV No.	520228	Ref. No. —
	tooth lock washer ID ø 15.3mm ED ø 24mm steel Qty 1 pcs for thread M14		



GEV No.	418677	Ref. No.	91711012
description	heating element 2000W 230V L 675mm W 650mm thread 1/4" mounting distance 651.5mm connection length 120mm connection male faston 6.3mm tube ø 8.5mm heating circuits 1 dry heating element 2 hole fixing		
For models:	CAB0029-CN, CAB0030-CN, CAB0032, CAB0032-CN, CAB0033, CAB0033-CN, CAB0035		

accessories for	418677		
	GEV No.	361182	Ref. No. —
	nut thread 1/4" H 5mm nickel-plated brass WS 17 Qty 1 pcs		
	GEV No.	510417	Ref. No. —
	flat gasket fibre ED ø 20mm ID ø 14mm thickness 2mm Qty 1 pcs		
	GEV No.	520228	Ref. No. —
	tooth lock washer ID ø 15.3mm ED ø 24mm steel Qty 1 pcs for thread M14		



accessories for	418677		
	GEV No.	520230	Ref. No. —
	nut thread M14x1.5 H 5mm WS 19 zinc-coated steel Qty 1 pcs		

Table continues overleaf





accessories for	418677		
	GEV No.	550262	Ref. No. —
flat gasket copper ED ø 20mm ID ø 14mm thickness 2mm			



GEV No.	416440	Ref. No.	91711033
description	heating element 2000W 230V L 892mm W 245mm thread 1/4" mounting distance 237mm connection length 97mm connection M5 tube ø 8.5mm heating circuits 1 dry heating element 2 hole fixing		
For models:	CAB0007, CAB0008, CAB0009, CAB0010, CAB0011, CAB0012, CAB0013, CAB0014, CAB0015, CAB0016, CAB0017, CAB0018, CAB0024, CAB0025, CAB0026, CAB0027, CAB0039, CAB0040, CAB0041, CAB0042, CAB0043, CAB0044, CAB0045, CAB0046		

spare parts for	416440		
	GEV No.	510417	Ref. No. —
flat gasket fibre ED ø 20mm ID ø 14mm thickness 2mm Qty 1 pcs			

accessories for	416440		
	GEV No.	361182	Ref. No. —
nut thread 1/4" H 5mm nickel-plated brass WS 17 Qty 1 pcs			

	GEV No.	520228	Ref. No. —
tooth lock washer ID ø 15.3mm ED ø 24mm steel Qty 1 pcs for thread M14			

	GEV No.	550262	Ref. No. —
flat gasket copper ED ø 20mm ID ø 14mm thickness 2mm			

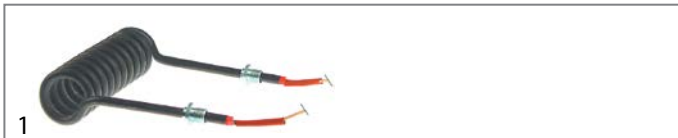



GEV No.	418120	Ref. No.	RESI0080
description	heating element 2200W 230V heating circuits 1 mounting pos. lower L 150mm W 155mm L1 95mm ø 49mm thread M14x1.5 mounting distance 146mm cable length 950mm tube ø 8.5mm connection cable dry heating element 2 hole fixing		
For models:	CAD0004, CAD0004-ZN		



GEV No.	418121	Ref. No.	RESI0060
description	heating element 2200W 230V heating circuits 1 mounting pos. upper L 230mm W 262mm L1 170mm ø 60mm thread M14x1.5 mounting distance 254mm cable length 1120mm tube ø 8.5mm connection cable dry heating element 2 hole fixing		
For models:	SY850VELED		

accessories for	418121		
	GEV No.	510417	Ref. No. —
flat gasket fibre ED ø 20mm ID ø 14mm thickness 2mm Qty 1 pcs			

	GEV No.	520228	Ref. No. —
tooth lock washer ID ø 15.3mm ED ø 24mm steel Qty 1 pcs for thread M14			

	GEV No.	520230	Ref. No. —
nut thread M14x1.5 H 5mm WS 19 zinc-coated steel Qty 1 pcs			

accessories for	418121		
	GEV No.	521101	Ref. No. —
nut thread M14x1.5 H 5mm WS 19 SS Qty 1 pcs			

	GEV No.	550262	Ref. No. —
flat gasket copper ED ø 20mm ID ø 14mm thickness 2mm			



GEV No.	418212	Ref. No.	91711072
description	heating element 2400W 230V L 1043mm W 1090mm thread 1/4" mounting distance 100mm connection length 160mm connection M5 tube ø 8.5mm dry heating element mounting pos. upper/lower 2 hole fixing pizza oven		
For models:	CAB0019, CAB0020		

accessories for	418212		
	GEV No.	361182	Ref. No. —
nut thread 1/4" H 5mm nickel-plated brass WS 17 Qty 1 pcs			

	GEV No.	510417	Ref. No. —
flat gasket fibre ED ø 20mm ID ø 14mm thickness 2mm Qty 1 pcs			

	GEV No.	520228	Ref. No. —
tooth lock washer ID ø 15.3mm ED ø 24mm steel Qty 1 pcs for thread M14			

	GEV No.	550262	Ref. No. —
flat gasket copper ED ø 20mm ID ø 14mm thickness 2mm			

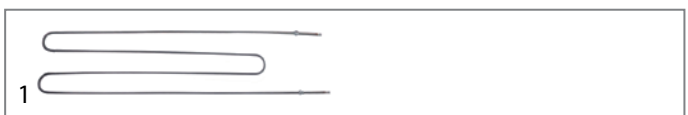

GEV No.	418060	Ref. No.	91711053
description	heating element 2400W 230V L 1060mm W 265mm thread 1/4" mounting distance 257mm connection length 108mm connection M5 tube ø 8.5mm heating circuits 1 dry heating element 2 hole fixing		
For models:	CAB0007, CAB0008, CAB0009, CAB0010, CAB0011, CAB0012, CAB0013, CAB0014, CAB0015, CAB0016, CAB0017, CAB0018, CAB0024, CAB0025, CAB0026, CAB0027, CAB0039, CAB0040, CAB0041, CAB0042, CAB0043, CAB0044, CAB0045, CAB0046		

accessories for	418060		
	GEV No.	361182	Ref. No. —
nut thread 1/4" H 5mm nickel-plated brass WS 17 Qty 1 pcs			

	GEV No.	510417	Ref. No. —
flat gasket fibre ED ø 20mm ID ø 14mm thickness 2mm Qty 1 pcs			





	GEV No.	520228	Ref. No. —
tooth lock washer ID ø 15.3mm ED ø 24mm steel Qty 1 pcs for thread M14			

	GEV No.	550262	Ref. No. —
flat gasket copper ED ø 20mm ID ø 14mm thickness 2mm			

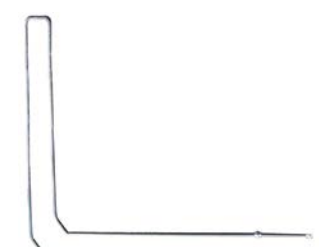







GEV No.	418674	Ref. No.	91711015
description	heating element 2400W 230V L 475mm W 445mm thread 1/4" mounting distance 436.5mm connection length 116mm connection male faston 6.3mm tube ø 8.5mm dry heating element 2 hole fixing		
For models:	CAB0029-CN, CAB0030-CN, CAB0032, CAB0033, CAB0035		
accessories for	418674		
	GEV No.	361182	Ref. No. —
	nut thread 1/4" H 5mm nickel-plated brass WS 17 Qty 1 pcs		
	GEV No.	510417	Ref. No. —
	flat gasket fibre ED ø 20mm ID ø 14mm thickness 2mm Qty 1 pcs		
	GEV No.	520228	Ref. No. —
	tooth lock washer ID ø 15.3mm ED ø 24mm steel Qty 1 pcs for thread M14		
	GEV No.	550262	Ref. No. —
	flat gasket copper ED ø 20mm ID ø 14mm thickness 2mm		



GEV No.	418213	Ref. No.	91711071
description	heating element 2400W 230V L 930mm W 883mm thread 1/4" mounting distance 109mm connection length 159mm connection M5 tube ø 8.5mm dry heating element 2 hole fixing		
For models:	CAB0019, CAB0020		
accessories for	418213		
	GEV No.	361182	Ref. No. —
	nut thread 1/4" H 5mm nickel-plated brass WS 17 Qty 1 pcs		
	GEV No.	510417	Ref. No. —
	flat gasket fibre ED ø 20mm ID ø 14mm thickness 2mm Qty 1 pcs		
	GEV No.	520228	Ref. No. —
	tooth lock washer ID ø 15.3mm ED ø 24mm steel Qty 1 pcs for thread M14		
	GEV No.	550262	Ref. No. —
	flat gasket copper ED ø 20mm ID ø 14mm thickness 2mm		



GEV No.	418214	Ref. No.	91711070
description	heating element 2600W 230V L 710mm W 665mm thread 1/4" mounting distance 93mm connection length 151mm connection M5 tube ø 8.5mm heating circuits 1 dry heating element 2 hole fixing W1 101mm W2 564mm		
For models:	CAB0019, CAB0020		
accessories for	418214		
	GEV No.	361182	Ref. No. —
	nut thread 1/4" H 5mm nickel-plated brass WS 17 Qty 1 pcs		
	GEV No.	510417	Ref. No. —
	flat gasket fibre ED ø 20mm ID ø 14mm thickness 2mm Qty 1 pcs		
	GEV No.	520228	Ref. No. —
	tooth lock washer ID ø 15.3mm ED ø 24mm steel Qty 1 pcs for thread M14		
	GEV No.	550262	Ref. No. —
	flat gasket copper ED ø 20mm ID ø 14mm thickness 2mm		



GEV No.	420502	Ref. No.	91711353
description	heating element 2690W 230V L 1060mm W 320mm thread 1/4" mounting distance 109mm connection length 159mm connection M5 tube ø 8.5mm heating circuits 1 mounting pos. upper threaded		
For models:	CAB0009-CD, CAB0058-DCG, CAB0062-DCG		







GEV No.	418123	Ref. No.	RESI0081
description	heating element 2800W 230V heating circuits 1 mounting pos. upper L 228mm W 260mm L1 168mm ø 60mm thread M14x1.5 mounting distance 251.5mm cable length 1170mm tube ø 8.5mm connection cable dry heating element 2 hole fixing		
For models:	CAD0005		

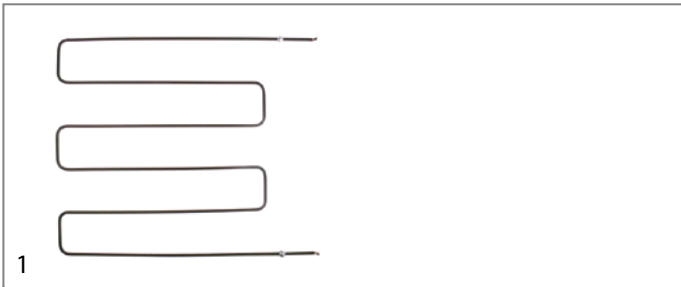





GEV No.	418676	Ref. No.	91711016
description	heating element 2800W 230V L 570mm W 520mm thread 1/4" mounting distance 511mm connection length 118mm connection male faston 6.3mm tube ø 8.5mm heating circuits 1		
For models:	CAB0029-CN, CAB0030-CN, CAB0032, CAB0033, CAB0035		



GEV No.	418678	Ref. No.	91711017
description	heating element 3200W 230V L 675mm W 650mm thread 1/4" mounting distance 641mm connection length 120mm connection male faston 6.3mm tube ø 8.5mm heating circuits 1 dry heating element 2 hole fixing		
For models:	CAB0029-CN, CAB0030-CN, CAB0032, CAB0032-CN, CAB0033, CAB0033-CN, CAB0035		
spare parts for	418678		
	GEV No.	510417	Ref. No. —
	flat gasket fibre ED ø 20mm ID ø 14mm thickness 2mm Qty 1 pcs		
accessories for	418678		
	GEV No.	361182	Ref. No. —
	nut thread 1/4" H 5mm nickel-plated brass WS 17 Qty 1 pcs		
	GEV No.	520228	Ref. No. —
	tooth lock washer ID ø 15.3mm ED ø 24mm steel Qty 1 pcs for thread M14		
	GEV No.	550262	Ref. No. —
	flat gasket copper ED ø 20mm ID ø 14mm thickness 2mm		



GEV No.	418122	Ref. No.	RESI0061
description	heating element 3300W 230V heating circuits 1 mounting pos. lower L 230mm W 263mm L1 168mm ø 60mm thread M14x1.5 mounting distance 254.5mm cable length 1140mm tube ø 8.5mm connection cable dry heating element 2 hole fixing		
For models:	SY850VELED		
spare parts for	418122		
	GEV No.	510417	Ref. No. —
	flat gasket fibre ED ø 20mm ID ø 14mm thickness 2mm Qty 1 pcs		
accessories for	418122		
	GEV No.	520228	Ref. No. —
	tooth lock washer ID ø 15.3mm ED ø 24mm steel Qty 1 pcs for thread M14		
	GEV No.	520230	Ref. No. —
	nut thread M14x1.5 H 5mm WS 19 zinc-coated steel Qty 1 pcs		
	GEV No.	521101	Ref. No. —
	nut thread M14x1.5 H 5mm WS 19 SS Qty 1 pcs		
	GEV No.	550262	Ref. No. —
	flat gasket copper ED ø 20mm ID ø 14mm thickness 2mm		

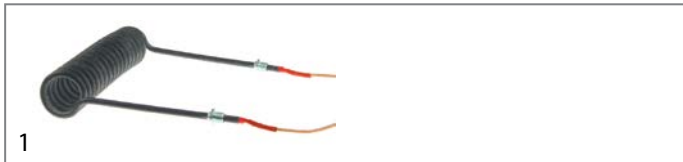





GEV No.	418124	Ref. No.	RESI0082
description	heating element 4100W 230V heating circuits 1 mounting pos. lower L 230mm W 248.5mm L1 175mm ø 65mm thread M14x1.5 mounting distance 240mm cable length 1200mm tube ø 8.5mm connection cable dry heating element 2 hole fixing		
For models:	CAD0005		







GEV No.	416435	Ref. No.	91711020
description	heating element 600W 230V L 605mm W 130mm thread 1/4" mounting distance 120mm connection length 110mm connection M4 tube ø 8.5mm heating circuits 1 dry heating element 2 hole fixing pizza oven		
For models:	CAB0007, CAB0008, CAB0009, CAB0010, CAB0011, CAB0012, CAB0013, CAB0014, CAB0015, CAB0016, CAB0017, CAB0018, CAB0024, CAB0025, CAB0026, CAB0027, CAB0039, CAB0040, CAB0041, CAB0042, CAB0043, CAB0044, CAB0045, CAB0046		
accessories for	416435		
	GEV No.	361182	Ref. No. —
	nut thread 1/4" H 5mm nickel-plated brass WS 17 Qty 1 pcs		
	GEV No.	510417	Ref. No. —
	flat gasket fibre ED ø 20mm ID ø 14mm thickness 2mm Qty 1 pcs		
	GEV No.	520228	Ref. No. —
	tooth lock washer ID ø 15.3mm ED ø 24mm steel Qty 1 pcs for thread M14		
	GEV No.	550262	Ref. No. —
	flat gasket copper ED ø 20mm ID ø 14mm thickness 2mm		





GEV No.	418055	Ref. No.	91711040
description	heating element 700W 230V L 711mm W 194mm thread 1/4" mounting distance 185mm connection length 121mm connection M5 tube ø 8.8mm heating circuits 1 dry heating element 2 hole fixing		
For models:	CAB0007, CAB0008, CAB0009, CAB0010, CAB0011, CAB0012, CAB0013, CAB0014, CAB0015, CAB0016, CAB0017, CAB0018, CAB0024, CAB0025, CAB0026, CAB0027, CAB0039, CAB0040, CAB0041, CAB0042, CAB0043, CAB0044, CAB0045, CAB0046		
accessories for	418055		
	GEV No.	361182	Ref. No. —
	nut thread 1/4" H 5mm nickel-plated brass WS 17 Qty 1 pcs		
	GEV No.	510417	Ref. No. —
	flat gasket fibre ED ø 20mm ID ø 14mm thickness 2mm Qty 1 pcs		
	GEV No.	520228	Ref. No. —
	tooth lock washer ID ø 15.3mm ED ø 24mm steel Qty 1 pcs for thread M14		
	GEV No.	550262	Ref. No. —
	flat gasket copper ED ø 20mm ID ø 14mm thickness 2mm		





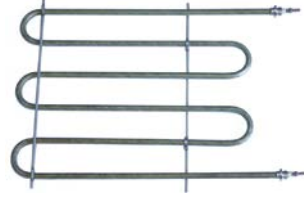

			
GEV No.	416436	Ref. No.	91711030
description	heating element 800W 230V L 605mm W 130mm thread 1/4" mounting distance 122mm connection length 110mm connection M4 tube ø 8.5mm heating circuits 1 dry heating element 2 hole fixing		
For models:	CAB0007, CAB0008, CAB0009, CAB0010, CAB0011, CAB0012, CAB0013, CAB0014, CAB0015, CAB0016, CAB0017, CAB0018, CAB0024, CAB0025, CAB0026, CAB0027, CAB0039, CAB0040, CAB0041, CAB0042, CAB0043, CAB0044, CAB0045, CAB0046		
spare parts for	416436		
	GEV No.	510417	Ref. No. —
flat gasket fibre ED ø 20mm ID ø 14mm thickness 2mm Qty 1 pcs			
accessories for	416436		
	GEV No.	361182	Ref. No. —
nut thread 1/4" H 5mm nickel-plated brass WS 17 Qty 1 pcs			
	GEV No.	520228	Ref. No. —
tooth lock washer ID ø 15.3mm ED ø 24mm steel Qty 1 pcs for thread M14			
	GEV No.	550262	Ref. No. —
flat gasket copper ED ø 20mm ID ø 14mm thickness 2mm			

heating elements for salamanders/toast-

			
GEV No.	416154	Ref. No.	071018
description	heating element 2500W 230V L 368mm W 255mm thread 1/4" mounting distance 246mm connection M5 dry heating element tube ø 8.5mm heating circuits 1 connection length 36mm H 8.5mm connection distance 247mm		
For models:	AJH0001		

			
GEV No.	416156	Ref. No.	071036
description	heating element 3000W 230V L 600mm W 265mm flange with thread thread 1/4" mounting distance 260mm connection M5 dry heating element tube ø 8.5mm connection length 34mm		
For models:	AJH0002		

heating elements for chargrills

			
GEV No.	416000	Ref. No.	Y00200
description	heating element 1500W 230V L 438mm W 80mm H 62mm thread 1/4" mounting distance 19mm tube ø 8.5mm connection male faston 6.3mm windings 2 heating circuits 1 connection length 23mm 2 hole fixing dry heating element		
For models:	ACK301V, ACK302V, ACK303V, ACK304V		
spare parts for	416000		
	GEV No.	510417	Ref. No. —
flat gasket fibre ED ø 20mm ID ø 14mm thickness 2mm Qty 1 pcs			
accessories for	416000		
	GEV No.	361182	Ref. No. —
nut thread 1/4" H 5mm nickel-plated brass WS 17 Qty 1 pcs			
	GEV No.	520228	Ref. No. —
tooth lock washer ID ø 15.3mm ED ø 24mm steel Qty 1 pcs for thread M14			
	GEV No.	550262	Ref. No. —
flat gasket copper ED ø 20mm ID ø 14mm thickness 2mm			

heating elements for heated cabinets

			
GEV No.	418344	Ref. No.	3710003
description	heating element 1200W 220V heating circuits 1 L 395mm W 220mm H 24mm connection M4 tube ø 8mm dry heating element L1 50mm L2 345mm connection distance 212mm		
For models:	IIA3006, IIA3007, IIA3008, IIA3010, IIA3011, IIA3012		

dry heating elements for dishwashers

			
GEV No.	420561	Ref. No.	12048965
description	heating element 2800W 230V heating circuits 1 L 325mm W 55mm H 40mm tube ø 6.5mm connection F6.3x0.8 dry heating element dishwasher		
For models:	GLB0061C-F, GLB0063C-F		

heating cables

drain heating cables

			
GEV No.	381244	Ref. No.	B00REZ104
description	drain heating cable 40W 220V 50Hz L 2000mm L1 (unheated) 1000mm L2 (heated) 1000mm cable ø 5mm connection 2-wire		
For models:	BMA0098, BMA0099		



connection on both sides

with wire end ferrules

1 

GEV No.	381402	Ref. No.	B00REZ112
description	heating cable 37W 220V 50Hz L 7000mm L1 (unheated) 300mm L2 (heated) 6700mm cable ø 3mm		
For models:	HCE2008-F, VAEK170-F, VAEK210-F, VAEK220-F		

1 

GEV No.	419220	Ref. No.	B00REZ113
description	heating cable 37W 220V L 9000mm L1 (unheated) 740mm L2 (heated) 8260mm silicone impregnated glass fibre braiding ø 3mm connection terminal		
For models:	HCE2009		

heating cartridges

1 

GEV No.	419212	Ref. No.	B00REZ106 BOOREZ106
description	heating cartridge 190W 230V ø 12mm L 180mm thread 3/8" cable length 1000mm		
For models:	BMA0098, BMA0099, BMC0001-F, BMC0003-F		

1 

GEV No.	417612	Ref. No.	R010-PTC/3
description	heating cartridge 400W 230V L 283mm ø 12.2mm thread 3/8" cable length 1500mm for tank		
For models:	BHZ0001, BHZ0002, BHZ0003, BHZ0004, BHZ0005, BHZ0006, BHZ0007, BHZ0008, BHZ0009, BHZ0010, BHZ0011, BHZ0012, BHZ0013, BHZ0034, BHZ0035, BHZ0036, BHZ0037, BHZ0038, BHZ0039		

1 

GEV No.	418346	Ref. No.	3710022
description	heating element 400W 230V ø 10mm L 380mm thread M14x1.25 cable length 110mm flange with thread		
For models:	Z/EI12, Z/EI15, Z/EI23, Z/EI8, Z/ER12, Z/ER15, Z/ER23, Z/ER8		

heating plates

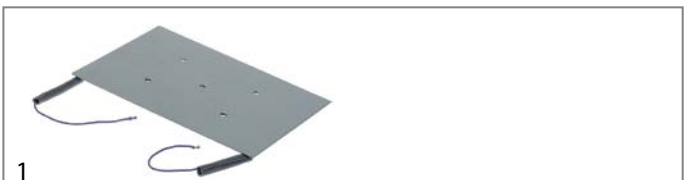
1 

GEV No.	418433	Ref. No.	PD.411R
description	hot plate 2700W 230V heating circuits 1 cable length 1650mm L 360mm W 250mm		
For models:	AHC0001, AHC0002		

ceramic heaters

245x60mm

1 

GEV No.	415104	Ref. No.	665.010.00
description	ceramic emitter 1000W 230V cable beaded cord L 245mm W 60mm H 35mm		
For models:	6030SPE, 6540SPE, 7040SPE		

spring clip

GEV No.	415109	Ref. No.	—
----------------	--------	-----------------	---

reflector L 245mm W 95mm H 31mm thickness 0.75mm hole ø 15x40mm

GEV No.	415110	Ref. No.	—
----------------	--------	-----------------	---

1 

GEV No.	415103	Ref. No.	071053 X48000
description	ceramic emitter 650W 230V cable beaded cord L 245mm W 60mm H 35mm		
For models:	AAD0001, ACD001V, ACD002V		

spring clip

GEV No.	415109	Ref. No.	—
----------------	--------	-----------------	---

reflector L 245mm W 95mm H 31mm thickness 0.75mm hole ø 15x40mm

GEV No.	415110	Ref. No.	—
----------------	--------	-----------------	---

contact heaters

1 

GEV No.	416237	Ref. No.	999206
description	contact heater 1400W 230V heating circuits 1 L 133mm W 120mm H 10mm dishwasher connection soldering connection connection distance 76mm connection length 37mm heat-conducting paste included hole ø 7mm dry heating element		
For models:	OPT1012		



quartz heating elements

1 			
GEV No.	416152	Ref. No.	071014.1
description	quartz heating element 500W 230V L 390mm ø 12mm connection male faston 6.3mm		
For models:	AJG0001, AJG0002		



1 			
GEV No.	418834	Ref. No.	071051
description	quartz heating element 600W 230V L 525mm ø 10mm connection male faston 6.3mm		
For models:	2158, AJG0004		





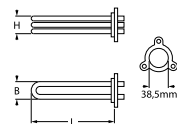

1 			
GEV No.	416153	Ref. No.	071051.1
description	quartz heating element 600W 230V L 530mm ø 12mm connection male faston 6.3mm		
For models:	2158, AJG0003, AJG0004, AJH0003		

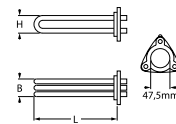

coil heating elements

1 			
GEV No.	420330	Ref. No.	927132
description	heating element 2000W 240V L 454mm W 210mm ø 27.5mm thread M14x1 connection M4 for drying warewashing heating circuits 1 2 hole fixing		
For models:	GLB0046		

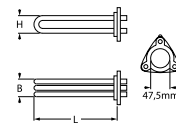

immersion heating elements

3 hole flange ø38.5mm			
1  			
GEV No.	418642	Ref. No.	230113
description	heating element 2600W 230V mounting ø 38.5mm heating circuits 1 L 260mm W 33mm H 24mm number of thermostat sleeves 1 thermostat sleeves ø 7mm length thermostat sleeves 175mm thermostat sleeve eccentric, non clinging tube ø 6.5mm hole distance 57mm 3 hole flange connection male faston 6.3mm immersion heater		
For models:	GLB0035, GLB0036, GLB0037, GLB0038, GLB0039, GLB0056, GLB0057, GLB0058, GLB0059, GLB0060		
accessories for	418642		
	GEV No.	532577	Ref. No. —
	O-ring EPDM thickness 5.34mm ID ø 40.65mm Qty 1 pcs		



3 hole flange ø47.5mm			
1  			
GEV No.	415001	Ref. No.	230081
description	heating element 4500W 230V mounting ø 47.5mm heating circuits 3 L 316mm W 35mm H 34mm number of thermostat sleeves 1 thermostat sleeves ø 7mm length thermostat sleeves 180mm thermostat sleeve eccentric, non clinging tube ø 6.3mm hole distance 62mm hole ø 8mm connection M4 3 hole flange immersion heater		
For models:	GLB0072		
spare parts for	415001		
	GEV No.	510408	Ref. No. 456002 E11700
	O-ring EPDM thickness 5.34mm ID ø 47mm Qty 1 pcs		
accessories for	415001		
	GEV No.	510562	Ref. No. —
	O-ring silicone thickness 5.34mm ID ø 47mm Qty 1 pcs		
	GEV No.	521103	Ref. No. —
	nut thread M4 H 3mm WS 7 brass Qty 20 pcs		
	GEV No.	521104	Ref. No. —
	washer ID ø 4.3mm ED ø 8mm thickness 0.5mm brass Qty 20 pcs for thread M4		
	GEV No.	560111	Ref. No. —
	plain washer ID ø 4.3mm ED ø 9mm thickness 0.8mm SS Qty 20 pcs DIN 125A for thread M4		
	GEV No.	560131	Ref. No. Q162020000
	hexagonal nut thread M4 H 3.2mm WS 7 SS DIN/ISO DIN 934 / ISO 4032/8673 Qty 20 pcs		

1  			
GEV No.	416240	Ref. No.	230083C
description	heating element 6545W 230/400V mounting ø 48mm heating circuits 3 L 355mm W 31mm H 37mm number of thermostat sleeves 1 thermostat sleeves ø 7mm length thermostat sleeves 175mm thermostat sleeve upper centre not clinging tube ø 6.5mm hole distance 63mm hole ø 10mm connection M4 3 hole flange immersion heater		
For models:	GLB0043, GLB0044, OPT1012, OPT1012C		
accessories for	416240		
	GEV No.	510408	Ref. No. 456002 E11700
	O-ring EPDM thickness 5.34mm ID ø 47mm Qty 1 pcs		
	GEV No.	510562	Ref. No. —
	O-ring silicone thickness 5.34mm ID ø 47mm Qty 1 pcs		







GEV No.	418439	Ref. No.	E11500
description	heating element 8000W 230V mounting \varnothing 47.5mm heating circuits 3 L 315mm W 37mm H 35mm number of thermostat sleeves 1 thermostat sleeves \varnothing 8.5mm length thermostat sleeves 215mm thermostat sleeve clinging tube \varnothing 8.5mm hole distance 62mm hole \varnothing 8mm connection M4 3 hole flange immersion heater		
For models:	ADL001V, ADL003V		
accessories for	418439		
	GEV No.	510408	Ref. No. 456002 E11700
	O-ring EPDM thickness 5.34mm ID \varnothing 47mm Qty 1 pcs		
	GEV No.	510562	Ref. No. —
	O-ring silicone thickness 5.34mm ID \varnothing 47mm Qty 1 pcs		



GEV No.	416410	Ref. No.	E11600
description	heating element 9000W 230V mounting \varnothing 47.5mm heating circuits 3 L 395mm W 33mm H 35mm number of thermostat sleeves 1 thermostat sleeves \varnothing 7mm length thermostat sleeves 210mm thermostat sleeve eccentric, clinging tube \varnothing 8.5mm hole distance 63mm hole \varnothing 8mm connection M4		
For models:	ACL0002, ACL002V, ADL002V, ADL004V, ADL005V		
accessories for	416410		
	GEV No.	510408	Ref. No. 456002 E11700
	O-ring EPDM thickness 5.34mm ID \varnothing 47mm Qty 1 pcs		
	GEV No.	510562	Ref. No. —
	O-ring silicone thickness 5.34mm ID \varnothing 47mm Qty 1 pcs		





GEV No.	416241	Ref. No.	230020C
description	heating element 8000W 230V mounting \varnothing 47.5mm heating circuits 3 L 355mm W 35mm H 35mm number of thermostat sleeves 1 thermostat sleeves \varnothing 7.5mm length thermostat sleeves 185mm thermostat sleeve not clinging tube \varnothing 6.3mm hole distance 64mm hole \varnothing 8mm connection M4 3 hole flange immersion heater		
For models:	GLB0043, GLB0046, GLB0070, GLB0071, GLB0073		
spare parts for	416241		
	GEV No.	510408	Ref. No. 456002 E11700
	O-ring EPDM thickness 5.34mm ID \varnothing 47mm Qty 1 pcs		
accessories for	416241		
	GEV No.	510093	Ref. No. 467002 69870
	protection cap		
	GEV No.	510408	Ref. No. 456002 E11700
	O-ring EPDM thickness 5.34mm ID \varnothing 47mm Qty 1 pcs		
	GEV No.	510562	Ref. No. —
	O-ring silicone thickness 5.34mm ID \varnothing 47mm Qty 1 pcs		





GEV No.	416242	Ref. No.	80398C
description	heating element 9500W 230V mounting \varnothing 47.5mm heating circuits 3 L 330mm W 35mm H 35mm number of thermostat sleeves 1 thermostat sleeves \varnothing 7mm length thermostat sleeves 175mm thermostat sleeve eccentric, non clinging tube \varnothing 8.5mm hole distance 72mm hole \varnothing 8/10mm connection M4 3 hole flange immersion heater		
For models:	GLB0044		
spare parts for	416242		
	GEV No.	510408	Ref. No. 456002 E11700
	O-ring EPDM thickness 5.34mm ID \varnothing 47mm Qty 1 pcs		

with compression flange 50 x 26mm



GEV No.	416234	Ref. No.	230098
description	heating element 600W 230V heating circuits 1 flange 50x26mm L 160mm W 45mm H 27mm tube \varnothing 8.8mm connection male faston 6.3mm connection length 40mm immersion heater compression flange		
For models:	GLB0035, GLB0036, GLB0037, GLB0038, GLB0039, GLB0056, GLB0057		
accessories for	416234		
	GEV No.	510387	Ref. No. 437086
	gasket L 46mm W 22mm \varnothing mm EPDM for heating element for flange 50x26mm		
	GEV No.	510388	Ref. No. —
	counterflange \varnothing mm hole distance \varnothing mm perforation \varnothing mm L 43mm W 21mm SS for heating element for flange 50x26mm		





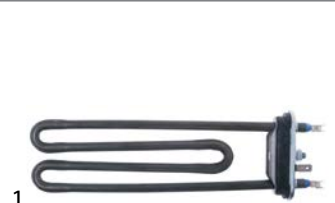
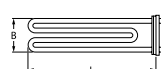

GEV No.	420331	Ref. No.	230112
description	heating element 1400W 230V compression flange flange 50x26mm L 160mm heating circuits 1 H 29mm W 190mm connection male faston 6.3mm immersion heater tube ø 8.4mm		
For models:	OPT1012C		
spare parts for	420331		
	GEV No.	510387	Ref. No. 437086
	gasket L 46mm W 22mm ømm EPDM for heating element for flange 50x26mm		
	GEV No.	510388	Ref. No. —
	counterflange ømm hole distancemm perforation ømm L 43mm W 21mm SS for heating element for flange 50x26mm		

with compression flange 70 x 26mm

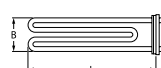
GEV No.	417278	Ref. No.	003001020002
description	heating element 1950W 230V heating circuits 3 L 230mm W 70mm washing		
For models:	IFD0001-MN		





GEV No.	415000	Ref. No.	230088
description	heating element 2900W 230V heating circuits 1 flange 70x26mm L 272mm W 51mm Hmm tube ø 6.3mm connection M4 immersion heater compression flange		
For models:	GLB0061, GLB0061C, GLB0062, GLB0063, GLB0064, GLB0064C, GLB0065, GLB0066		
spare parts for	415000		
	GEV No.	521128	Ref. No. 437048
	gasket L 66mm W 21mm ømm for heating element suitable for ELETTRORBAR, WOLK		
accessories for	415000		
	GEV No.	521128	Ref. No. 437048
	gasket L 66mm W 21mm ømm for heating element suitable for ELETTRORBAR, WOLK		

with expansion flange 70 x 18mm



GEV No.	416381	Ref. No.	12024951
description	heating element 2000W 230V heating circuits 1 flange 70x18mm L 280mm W 78mm H 22mm connection M4 immersion heater expansion flange tube ø 8.5mm		
For models:	GLB0035-FN, GLB0037-FN		
accessories for	416381		
	GEV No.	510429	Ref. No. —
	gasket L 76mm W 23mm hole distance 25mm 3 holes for heating element type DB 70 without thermostat sensor hole		



GEV No.	416239	Ref. No.	230100
description	heating element 2600W 230V heating circuits 1 flange 70x18mm L 270mm W 65mm connection male faston 6.3mm tube ø 8.5mm immersion heater expansion flange		
For models:	GLB0035, GLB0036, GLB0037, GLB0038, GLB0039		



GEV No.	416382	Ref. No.	12024645 Z203601000
description	heating element 2800W 230V heating circuits 1 flange 70x18mm L 370mm W 102mm H 27mm immersion heater tube ø 8.5mm		
For models:	GLB0061C-F, GLB0061C-FN, GLB0063C-F, GLB0063C-FN, OPT1012-CF		



GEV No.	418529	Ref. No.	12023778 Z743601000
description	heating element 4500W 230V heating circuits 3 flange 70x18mm L 365mm W 65mm H 27mm connection male faston 6.3mm immersion heater expansion flange tube ø 6.7mm		
For models:	OPT1012-CF, OPT1012-CFN		

with round flange ø57.5mm









GEV No.	416662	Ref. No.	66502200
description	heating element 6000W 230V heating circuits 3 L 405mm W 31mm H 46mm tube ø 6.3mm thermostat sleeves ø 7.5mm length thermostat sleeves 270mm number of thermostat sleeves 1 thermostat sleeve eccentric, clinging connection male faston 6.3mm immersion heater round flange mounting ø 57.5mm		
For models:	7070PEI		
spare parts for	416662		
	GEV No.	510409	Ref. No. 835535651 F2680
	O-ring EPDM thickness 5.34mm ID ø 56.52mm Qty 1 pcs		

Table continues overleaf



accessories for	416662		
	GEV No.	520235	Ref. No. 63501100
	3 hole flange hole distance 70.5mm perforation ø 6.5mm ID ø 53.5mm		
	GEV No.	550002	Ref. No. —
	tension strap H 10mm L 21mm W 10mm hole ø 6.5mm for heating element		



	1		
GEV No.	416663	Ref. No.	96502500
description	heating element 8000W 230V heating circuits 3 L 510mm W 43mm H 30mm tube ø 6.3mm thermostat sleeves ø 7.5mm length thermostat sleeves 275mm number of thermostat sleeves 1 thermostat sleeve eccentric, clinging connection male faston 6.3mm immersion heater round flange mounting ø 57.5mm		
For models:	94PE100I, 94PE100IA, 94PE100IAS, 94PE100IS, 94PE150I, 94PE150IA		
accessories for	416663		
	GEV No.	520235	Ref. No. 63501100
	3 hole flange hole distance 70.5mm perforation ø 6.5mm ID ø 53.5mm		
	GEV No.	550002	Ref. No. —
	tension strap H 10mm L 21mm W 10mm hole ø 6.5mm for heating element		



with round flange (miscellaneous)



	1		
GEV No.	419247	Ref. No.	665.103.00
description	heating element 4500W 230V heating circuits 3 L 350mm connection male faston 6.3mm tube ø 6.3mm flange ø 72mm thermostat sleeves ø 8.5mm length thermostat sleeves 200mm immersion heater		



miscellaneous

	1		
GEV No.	417575	Ref. No.	230118
description	heating element 2100W 230V W 165mm H 25mm L 270mm format angled		
For models:	OPT1012C		

	1		
GEV No.	416383	Ref. No.	12024559
description	heating element 2400W 230V heating circuits 1 mounting ø 42mm L 278mm W 39mm H 39mm hole distance 64mm hole ø 7mm connection M4 immersion heater 5 hole flange		
For models:	GLB0035-FN		
accessories for	416383		
	GEV No.	505092	Ref. No. 12010062
	O-ring EPDM thickness 5.34mm ID ø 43.82mm Qty 1 pcs		

	1		
GEV No.	416375	Ref. No.	12024907
description	heating element 2800W 230V heating circuits 1 mounting ø 42mm L 290mm W 37mm H 32mm tube ø 8mm hole distance 42mm hole ø 7mm connection M4 5 hole flange		
For models:	GLB0037-FN		
accessories for	416375		
	GEV No.	505092	Ref. No. 12010062
	O-ring EPDM thickness 5.34mm ID ø 43.82mm Qty 1 pcs		
	GEV No.	524478	Ref. No. —
	O-ring Viton thickness 5.7mm ID ø 44.2mm Qty 1 pcs		

	1		
GEV No.	416384	Ref. No.	12024683 Z201706000
description	heating element 2800W 230V mounting ø 63mm heating circuits 1 L 427mm W 44mm H 43mm thermostat sleeves ø 6.5mm length thermostat sleeves 190mm number of thermostat sleeves 1 thermostat sleeve not clinging hole distance 41mm hole ø 7.5mm connection M4 3 hole flange round flange		
For models:	GLB0061C-F, GLB0061C-FN, GLB0063C-F		
accessories for	416384		
	GEV No.	691033	Ref. No. 12010051 Q307035000
	O-ring EPDM thickness 5.34mm ID ø 62.87mm Qty 1 pcs		

	1		
GEV No.	416385	Ref. No.	12024732 Z241701000
description	heating element 6000W 230V mounting ø 63mm heating circuits 3 L 420mm W 39mm H 49mm thermostat sleeves ø 6.3mm length thermostat sleeves 190mm number of thermostat sleeves 1 thermostat sleeve not clinging tube ø 8mm hole distance 41mm hole ø 7mm connection M4 immersion heater 6 hole flange		
For models:	GLB0063C-FN, OPT1012-CF, OPT1012-CFN		
accessories for	416385		
	GEV No.	691033	Ref. No. 12010051 Q307035000
	O-ring EPDM thickness 5.34mm ID ø 62.87mm Qty 1 pcs		

















	1"		
GEV No.	420074	Ref. No.	965.066.00
description	heating element 260W 230V heating circuits 1 L 242mm W 18mm H 6.25mm tube ø 6.25mm thermostat sleeves ø 5mm length thermostat sleeves 230mm number of thermostat sleeves 1 thermostat sleeve centred, adjacent connection male faston 6.3mm connection length 35mm immersion heater flange with thread WS 32 thread 1"		
spare parts for	420074		
	GEV No.	503158	Ref. No. —
	flat gasket FIBER ED ø 44mm ID ø 33mm thickness 2mm Qty 1 pcs		





Table continues overleaf









accessories for	420074		
	GEV No.	507532	Ref. No. 12009831
	nut thread 1" H 10mm WS 40 brass Qty 1 pcs		



 <p>1</p>			
GEV No.	415664	Ref. No.	230085
description	heating element 2250W 230V heating circuits 1 L 300mm W 90mm H 25mm thread 1/8" mounting distance 64mm tube ø 6.3mm connection M4 immersion heater 2 hole fixing		
For models:	GLB0058, GLB0059, GLB0060		
accessories for	415664		
	GEV No.	510893	Ref. No. 456015
	O-ring EPDM thickness 2.62mm ID ø 9.92mm Qty 1 pcs		
	GEV No.	521103	Ref. No. —
	nut thread M4 H 3mm WS 7 brass Qty 20 pcs		
	GEV No.	521104	Ref. No. —
	washer ID ø 4.3mm ED ø 8mm thickness 0.5mm brass Qty 20 pcs for thread M4		
	GEV No.	521129	Ref. No. —
	nut thread M10 H 6mm SS WS 17 Qty 1 pcs DIN/ISO DIN 439		
	GEV No.	560111	Ref. No. —
	plain washer ID ø 4.3mm ED ø 9mm thickness 0.8mm SS Qty 20 pcs DIN 125A for thread M4		
	GEV No.	560131	Ref. No. Q162020000
	hexagonal nut thread M4 H 3.2mm WS 7 SS DIN/ISO DIN 934 / ISO 4032/8673 Qty 20 pcs		

 <p>1</p>			
GEV No.	415665	Ref. No.	230086
description	heating element 2750/3250W 220/240V heating circuits 1 L 380mm W 110mm H 30mm thread M10x1 mounting distance 75mm tube ø 6.5mm connection M4 immersion heater 2 hole fixing		
For models:	GLB0061, GLB0061C, GLB0062, GLB0063, GLB0064, GLB0064C, GLB0065, GLB0066, GLB0072		
spare parts for	415665		
	GEV No.	510893	Ref. No. 456015
	O-ring EPDM thickness 2.62mm ID ø 9.92mm Qty 1 pcs		
accessories for	415665		
	GEV No.	510416	Ref. No. —
	flat gasket fibre ED ø 19mm ID ø 10.5mm thickness 1.5mm for thread M10 Qty 1 pcs		
	GEV No.	520231	Ref. No. —
	nut thread M10x1 H 6mm WS 14 zinc-coated steel Qty 1 pcs		
	GEV No.	520876	Ref. No. 463007
	protection cap for heating element ø 11.5mm H 32mm W 25mm plastic		
	GEV No.	521103	Ref. No. —
	nut thread M4 H 3mm WS 7 brass Qty 20 pcs		

accessories for	415665		
	GEV No.	521104	Ref. No. —
	washer ID ø 4.3mm ED ø 8mm thickness 0.5mm brass Qty 20 pcs for thread M4		
	GEV No.	521129	Ref. No. —
	nut thread M10 H 6mm SS WS 17 Qty 1 pcs DIN/ISO DIN 439		
	GEV No.	560111	Ref. No. —
	plain washer ID ø 4.3mm ED ø 9mm thickness 0.8mm SS Qty 20 pcs DIN 125A for thread M4		
	GEV No.	560131	Ref. No. Q162020000
	hexagonal nut thread M4 H 3.2mm WS 7 SS DIN/ISO DIN 934 / ISO 4032/8673 Qty 20 pcs		

 <p>1</p>			
GEV No.	416235	Ref. No.	80360
description	heating element 3000W 230V heating circuits 1 L 320mm W 50mm H 40mm thread M10x1 mounting distance 44mm tube ø 6.3mm connection male faston 6.3mm 2 hole fixing L1 32mm L2 288mm		
For models:	GLB0070, GLB0071		
spare parts for	416235		
	GEV No.	510893	Ref. No. 456015
	O-ring EPDM thickness 2.62mm ID ø 9.92mm Qty 1 pcs		
accessories for	416235		
	GEV No.	510416	Ref. No. —
	flat gasket fibre ED ø 19mm ID ø 10.5mm thickness 1.5mm for thread M10 Qty 1 pcs		
	GEV No.	510893	Ref. No. 456015
	O-ring EPDM thickness 2.62mm ID ø 9.92mm Qty 1 pcs		
	GEV No.	521129	Ref. No. —
	nut thread M10 H 6mm SS WS 17 Qty 1 pcs DIN/ISO DIN 439		
	GEV No.	560192	Ref. No. —
	tooth lock washer ID ø 10.4mm ED ø 18mm SS DIN/ISO DIN 6798A Qty 1 pcs for thread M10		

heating elements for convection

 <p>1</p>			
GEV No.	418042	Ref. No.	01951147000
description	heating element 1200W 230V heating circuits 1 ID ø 180mm ED ø 194mm L 245mm H 34mm L1 44mm W1 31mm H1 15mm H2 18mm flange length 70mm flange width 22mm hole distance 56mm connection male faston 6.3mm tube ø 6.3mm convection heating element hole ø 5mm rectangular flange		
For models:	AAA2002		
spare parts for	418042		
	GEV No.	510368	Ref. No. —
	gasket L 70mm W 23.5mm hole ø 5mm hole distance 56mm FIBER thickness 2mm for heating element		





1

GEV No.	415925	Ref. No.	66500800
description	heating element 1260W 230V heating circuits 1 ID ø 180mm L 380mm H 19mm L1 188mm W1 32mm flange length 100mm flange width 22mm hole distance 86mm ED ø 192mm connection M5 connection length 30mm tube ø 6.3mm convection heating element hole ø 5mm rectangular flange		
For models:	65110CFGE, 6570CFE, 6570CFGE, 70110CFGE, 7070CFEQ, 7070CFGE, 7070CFVE		





1

GEV No.	418345	Ref. No.	3710004
description	heating element 1600W 230V heating circuits 1 ID ø 178mm ED ø 191mm L 250mm H 40mm L1 50mm W1 32mm H1 16mm H2 24mm flange length 70mm flange width 22mm hole distance 56mm connection male faston 6.3mm tube ø 6.3mm convection heating element hole ø 5mm rectangular flange		
For models:	IIA3006, IIA3007, IIA3008, IIA3010, IIA3011, IIA3012		
accessories for	418345		
	GEV No.	510368	Ref. No. —
	gasket L 70mm W 23.5mm hole ø 5mm hole distance 56mm FIBER thickness 2mm for heating element		



1

GEV No.	418043	Ref. No.	09950987000
description	heating element 1600W 230V heating circuits 1 ID ø 180mm ED ø 192mm L 245mm H 25mm L1 45mm W1 30mm H1 12mm H2 18mm flange length 70mm flange width 22mm hole distance 56mm connection male faston 6.3mm tube ø 6.3mm convection heating element hole ø 5mm rectangular flange		
For models:	AIB0014		
spare parts for	418043		
	GEV No.	510368	Ref. No. —
	gasket L 70mm W 23.5mm hole ø 5mm hole distance 56mm FIBER thickness 2mm for heating element		





1

GEV No.	416532	Ref. No.	665.061.00
description	heating element 2300W 230V heating circuits 1 ID ø 183mm ED ø 197mm L 212mm H 30mm L1 15mm W1 31mm H1 5mm H2 25mm flange length 70mm flange width 22mm hole distance 56mm connection male faston 6.3mm tube ø 6.5mm convection heating element hole ø 5mm rectangular flange		
For models:	6060CFE		
accessories for	416532		
	GEV No.	510368	Ref. No. —
	gasket L 70mm W 23.5mm hole ø 5mm hole distance 56mm FIBER thickness 2mm for heating element		



1

GEV No.	418044	Ref. No.	09950977000
description	heating element 2500W 230V heating circuits 1 ID ø 180mm ED ø 192mm L 245mm H 28mm L1 45mm W1 30mm H1 3mm H2 25mm flange length 70mm flange width 22mm hole distance 56mm connection male faston 6.3mm tube ø 6.3mm convection heating element hole ø 5mm rectangular flange		
For models:	AIB0012, AIB0013, AIB0015, AIB0017		
accessories for	418044		
	GEV No.	550937	Ref. No. 01960368000
	gasket L 71mm W 21mm hole ø 5mm hole distance 57mm fibre thickness 1mm for heating element		





1

GEV No.	416040	Ref. No.	X68002
description	heating element 2500W 230V heating circuits 1 ID ø 185mm ED ø 198mm L 212mm H 30mm L1 17mm W1 32mm H1 6mm H2 24mm flange length 70mm flange width 22mm hole distance 56mm connection male faston 6.3mm connection length 33mm tube ø 6.5mm dry heating element hole ø 5mm rectangular flange		
For models:	ACA2010, ACA206V, ACA210V		
accessories for	416040		
	GEV No.	510368	Ref. No. —
	gasket L 70mm W 23.5mm hole ø 5mm hole distance 56mm FIBER thickness 2mm for heating element		





			
1			
GEV No.	419016	Ref. No.	11950537000
description	heating element 3000W 230V heating circuits 1 ID ø 227mm ED ø 240mm L 265mm H 50mm L1 21mm W1 30mm H1 18mm H2 32mm flange length 70mm flange width 22mm hole distance 56mm connection male faston 6.3mm connection length 34mm tube ø 6.5mm convection heating element hole ø 5mm		
For models:	KF733, KF933U, KF965, KF981D		

			
1			
GEV No.	419024	Ref. No.	09950247000 RES30006
description	heating element 4000W 230V heating circuits 1 ID ø 217mm ED ø 233mm L 265mm H 50mm L1 25mm W1 33mm H1 5mm H2 45mm flange length 70mm flange width 22mm hole distance 56mm connection male faston 6.3mm connection length 29mm tube ø 8.5mm convection heating element hole ø 5mm rectangular flange oven		
For models:	KF981D, VG715RXS		
accessories for	419024		
	GEV No.	510368	Ref. No. —
	gasket L 70mm W 23.5mm hole ø 5mm hole distance 56mm FIBER thickness 2mm for heating element		

radiation heaters

			
1			
GEV No.	490151	Ref. No.	665.054.00
description	radiation heater octagonal 2100W 230V L 230mm W 230mm heating circuits 1 with heating coil energy regulation with temperature signalization connections 2+2 connection type cable AD		
For models:	7040PVE		

			
1			
GEV No.	490152	Ref. No.	Y17602
description	radiation heater octagonal 2500W 230V L 250mm W 250mm heating circuits 2 with heating coil energy regulation with temperature signalization connections 3+2 connection type cable AD		
For models:	ACA1010, ACA106V, ACA110V		

			
1			
GEV No.	490079	Ref. No.	96504100
description	radiation heater octagonal 3400W 230V L 300mm W 300mm heating circuits 2 H 30mm with heating coil energy regulation with temperature signalization connections 4+2 connection type cable AD		
For models:	92PCV, 94CFV, 94PCV		
spare parts for	490079		
	GEV No.	390931	Ref. No. —
	safety thermostat for radiation heater		

			
1			
GEV No.	419076	Ref. No.	97032038
description	heating element rectangular L 840mm W 190mm 2500W 230/400V H 40mm cable length 450mm chicken rotisserie		
For models:	53054-CN, 53304, AJD0002-CCN, AJD0003-CCN, AJD0014-C, AJD0019-C		

			
1			
GEV No.	418230	Ref. No.	071096
description	radiation heater rectangular 4000W 230V L 425mm W 265mm heating circuits 3 connections 3x 2 IRCA griddle		
For models:	AJA0017, AJA0018		



foil heating elements



1

GEV No.	490156	Ref. No.	965.037.00
description	radiation heater rectangular 7500W 400V L 280mm W 400mm heating circuits 3 connections 6 connection type cable AD		
For models:	7040CPE, 7070CPE, 92CPE, 92CPES, 94CPE, 94CPES		



1

GEV No.	416406	Ref. No.	Y15900
description	foil heating element L 400mm W 240mm 1000W 230V t.max. 150°C with temperature limiter silicone cable length 2000mm thickness 1mm		
For models:	ACB0004, ACB002V, ACB004V, ADB002V, ADB003V		

1-circuit



1

GEV No.	490042	Ref. No.	665.065.00 Y17702
description	radiation heater ø 200mm 1800W 230V heating circuits 1 energy regulation with temperature signalization with ribbon heater connections 2+2 connection type male faston 6.3mm EGO		
For models:	ACA1003, ACA1010, ACA103V, ACA106V, ACA110V, ACJ006V, VI6030PVED, VI6060PVED		

accessories

hexagonal nuts



1

GEV No.	560131	Ref. No.	Q162020000
description	hexagonal nut thread M4 H 3.2mm WS 7 SS DIN/ISO DIN 934 / ISO 4032/8673 Qty 20 pcs		
For models:	GLB0035-FN, GLB0037-FN, GLB0061C-F, GLB0063C-F, OPT1012-CF, OPT1012-CFN		

2-circuit



1

GEV No.	490118	Ref. No.	665.052.00 Y17802
description	radiation heater ø 250mm 2500W heating circuits 2 partial power 1000W		
For models:	7040PVE, ADA102V, ADA105V, VI6060PVED		



1

GEV No.	560132	Ref. No.	Q162030000
description	hexagonal nut thread M5 H 4mm WS 8 SS DIN/ISO DIN 934 / ISO 4032/8673 Qty 20 pcs		
For models:	GLB0035-FN, GLB0037-FN, GLB0061C-F, GLB0061C-FN, GLB0063C-F, GLB0063C-FN, OPT1012-CF, OPT1012-CFN		

flow heaters



1

GEV No.	417480	Ref. No.	1205101
description	flow heater 2200W 230V ø 68mm L 104mm Wmm connection male faston 6.3mm suitable for COFFEE QUEEN		
For models:	EFB0001, EFB0002, EFB0003, EFB0004, EFB0008, EFB0008-C, EFB0009, EFB0009-C		

washers



1

GEV No.	560112	Ref. No.	12009944 Q232030000
description	plain washer ID ø 5.3mm ED ø 10mm thickness 1mm SS Qty 20 pcs DIN 125A for thread M5		
For models:	GLB0035-FN, GLB0037-FN, GLB0061C-F, GLB0061C-FN, GLB0063C-F, GLB0063C-FN, OPT1012-CF, OPT1012-CFN		



1

GEV No.	560333	Ref. No.	0010026
description	plain washer ID ø 6.4mm ED ø 12mm thickness 1.6mm SS Qty 1 pcs DIN 125A for thread M6		
For models:	FGZ0009, FGZ0026, FGZ0027, FGZ0028		



			
1			
GEV No.	560113	Ref. No.	Q232040000
description	plain washer ID ϕ 6.4mm ED ϕ 12mm thickness 1.6mm SS Qty 20 pcs DIN 125A for thread M6		
For models:	GLB0035-FN, GLB0037-FN, GLB0061C-F, GLB0061C-FN, GLB0063C-F, GLB0063C-FN, OPT1012-CF, OPT1012-CFN		

tooth lock washers

			
1			
GEV No.	560125	Ref. No.	Q242020000
description	tooth lock washer ID ϕ 4.2mm ED ϕ 8mm SS DIN/ISO DIN 6798A Qty 20 pcs for thread M4		
For models:	OPT1012-CF, OPT1012-CFN		

retaining rings

			
1			
GEV No.	691621	Ref. No.	M29600
description	retaining ring shaft ϕ 40mm thickness 1.8mm steel DIN 471		
For models:	ACC005V, ADC006V, ADE003V, ADE004V		

sealing washers

fibre gaskets

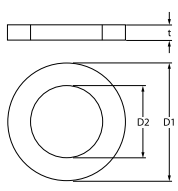
 			
1			
GEV No.	507332	Ref. No.	12010260 Q306024000
description	flat gasket fibre ED ϕ 18mm ID ϕ 12mm thickness 2mm Qty 1 pcs		
For models:	GLB0061C-F, GLB0061C-FN, GLB0063C-F, GLB0063C-FN, OPT1012-CF, OPT1012-CFN		

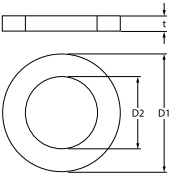
 			
1			
GEV No.	529484	Ref. No.	953.030.00
description	flat gasket fibre ED ϕ 58mm ID ϕ 50mm thickness 2mm Qty 1 pcs		

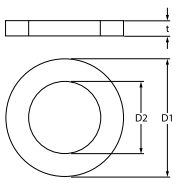
 			
1			
GEV No.	510406	Ref. No.	E50300
description	flat gasket fibre ED ϕ 60mm ID ϕ 48mm thickness 3mm for thread 1 1/2" Qty 1 pcs		
For models:	ADL001V, ADL002V, ADL003V, ADL004V, ADL005V, ADL006V, ADL007V, ADL008V, ADL009V, ADL010V, ADL011V, ADL012V, ADL013V, ADL014V, ADL015V		

PTFE gaskets

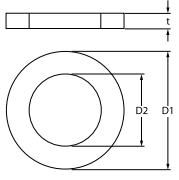
 			
1			
GEV No.	528021	Ref. No.	5.0.000.0307
description	flat gasket PTFE ED ϕ 53mm ID ϕ 42.5mm thickness 3mm Qty 1 pcs equiv. no. 12001/02286 suitable for Astoria/Aurora/Brasilia/Wega		
For models:	EFA0015, EFA0016, EFA0023		

O-rings

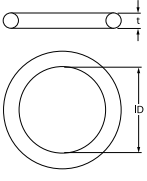
 			
1			
GEV No.	510893	Ref. No.	456015
description	O-ring EPDM thickness 2.62mm ID ϕ 9.92mm Qty 1 pcs		
For models:	GLB0058, GLB0059, GLB0060, GLB0061, GLB0061C, GLB0062, GLB0063, GLB0064, GLB0064C, GLB0065, GLB0066, GLB0072		

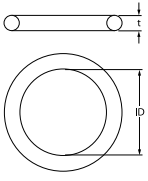
 			
1			
GEV No.	510072	Ref. No.	456016
description	O-ring EPDM thickness 3.53mm ID ϕ 32.93mm Qty 1 pcs		
For models:	GLB0070, GLB0071, GLB0072		

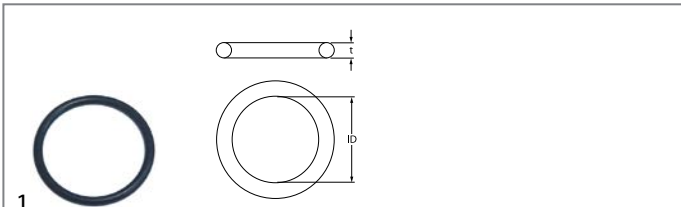

1

GEV No.	510899	Ref. No.	X05400
description	O-ring EPDM thickness 3.53mm ID ø 37.69mm Qty 1 pcs		
For models:	ACC005V, ACK1002, ACK101V, ACK102V, ADC006V, ADE003V, ADE004V		

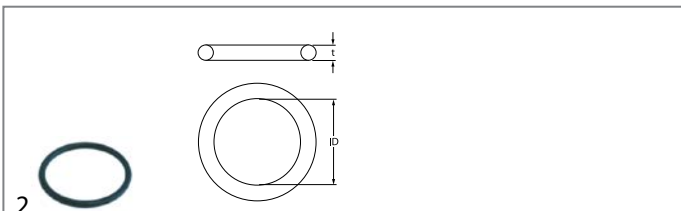

2

GEV No.	521120	Ref. No.	456075
description	O-ring EPDM thickness 5.34mm ID ø 37.47mm Qty 1 pcs		
For models:	GLB0035, GLB0036, GLB0037, GLB0038, GLB0039, GLB0056, GLB0057, GLB0058, GLB0059, GLB0060		

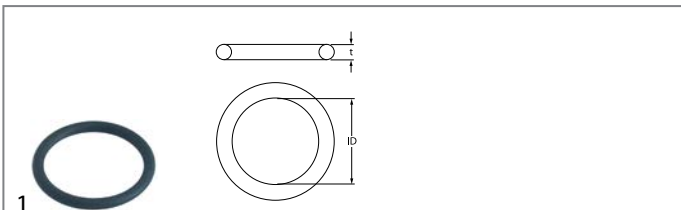

1

GEV No.	505092	Ref. No.	12010062
description	O-ring EPDM thickness 5.34mm ID ø 43.82mm Qty 1 pcs		
For models:	GLB0035-FN, GLB0037-FN		

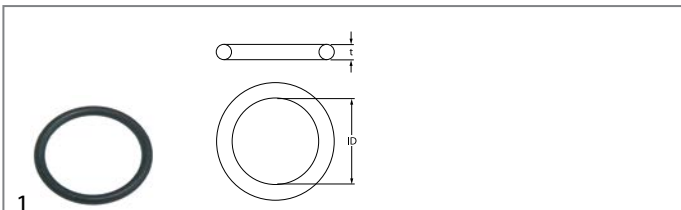

1

GEV No.	510408	Ref. No.	456002 E11700
description	O-ring EPDM thickness 5.34mm ID ø 47mm Qty 1 pcs		
For models:	ACL0002, ACL002V, ADL001V, ADL002V, ADL003V, ADL004V, ADL005V, GLB0043, GLB0044, GLB0070, GLB0071, GLB0072, GLB0073, OPT1012, OPT1012C		

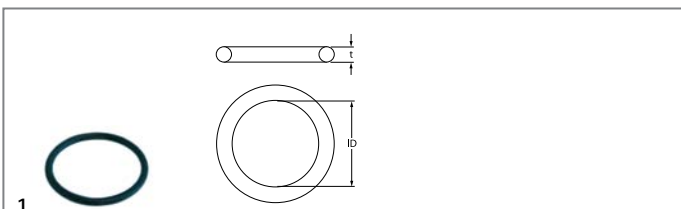

1

GEV No.	510409	Ref. No.	835535651 F2680
description	O-ring EPDM thickness 5.34mm ID ø 56.52mm Qty 1 pcs		
For models:	7040CPE, 7070PEI, FLC0001-F, FLC0003-F, FLC0012-F, FMD0001-F, FMD0002-F		

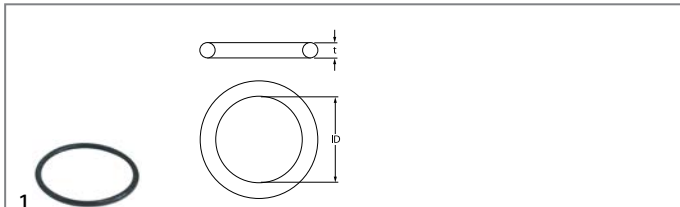

1

GEV No.	532545	Ref. No.	X05000
description	O-ring Viton thickness 3.53mm ID ø 49.21mm Qty 1 pcs		
For models:	ACC005V, ADC006V, ADE003V, ADE004V		

flange gaskets



1

GEV No.	528090	Ref. No.	01980518000
description	gasket L 100mm W 22mm thickness 1mm		
For models:	AAA2002, AIB0017		





1

GEV No.	550937	Ref. No.	01960368000
description	gasket L 71mm W 21mm hole ø 5mm hole distance 57mm fibre thickness 1mm for heating element		
For models:	AAA2002, AIB0012, AIB0013, AIB0014, AIB0015, AIB0017, KF630, KF733, KF933U, KF965, KF981D		



1

GEV No.	510387	Ref. No.	437086
description	gasket L 46mm W 22mm ømm EPDM for heating element for flange 50x26mm		
For models:	GLB0035, GLB0036, GLB0037, GLB0038, GLB0039, GLB0056, GLB0057, OPT1012C		
accessories for	510387		
	GEV No.	510388	Ref. No. —
	counterflange ømm hole distancemm perforation ømm L 43mm W 21mm SS for heating element for flange 50x26mm		





1

GEV No.	521128	Ref. No.	437048
description	gasket L 66mm W 21mm ømm for heating element suitable for ELETTRORBAR, WOLK		
For models:	GLB0061, GLB0061C, GLB0062, GLB0063, GLB0064, GLB0064C, GLB0065, GLB0066		





counterflanges			
			
1			
GEV No.	520235	Ref. No.	63501100
description	3 hole flange hole distance 70.5mm perforation ø 6.5mm ID ø 53.5mm		
For models:	7070PEI, 94PE100I, 94PE100IA, 94PE100IAS, 94PE100IS, 94PE150I, 94PE150IA		

capillary tube clips			
			
1			
GEV No.	551105	Ref. No.	M86800
description	capillary tube clip for pipe ø 6mm Qty 1 pcs		
For models:	ACC0003, ACC003V, ACC008V, ACC010V, ADC004V		

			
1			
GEV No.	550138	Ref. No.	063002
description	capillary tube clip for pipe ø 8.5mm for circular tube heating elements		
For models:	AAC0001, AAC0002, AMZ0004, AMZ0005, AMZ0006, AMZ0007, AMZ0008, AMZ0024, IFA0004		

			
1			
GEV No.	550980	Ref. No.	M86900
description	capillary tube clip for pipe ø 8.5mm Qty 1 pcs		
For models:	ACC004V		

spring clips			
			
1			
GEV No.	550041	Ref. No.	063001
description	probe clip for pipe ø 7mm for probe ø 6mm		
For models:	AAC0001, AAC0002, AMZ0004, AMZ0005, AMZ0006, AMZ0007, AMZ0008, AMZ0024, IFA0004		

			
1			
GEV No.	550419	Ref. No.	238.003.00
description	probe clip for pipe ø 8.5mm for probe ø 6mm Qty 1 pcs		
For models:	6030FRE, 6060FRE, 6540FRE, 6570FRE, 7040FRE10, 7070FRE10, AFC0003		

			
1			
GEV No.	550258	Ref. No.	M86500
description	probe clip for pipe ø 8mm for probe ø 6mm		
For models:	ACC0003, ACC003V, ACC004V, ACC008V, ACC010V, ADC004V		

			
1			
GEV No.	550795	Ref. No.	PIA30014
description	probe clip for pipe ø 6mm for probe ø 3.5mm Qty 1 pcs for oven		
For models:	VP800U, VP824RU, VP914RXS, VP920RXS		

protection caps			
			
1			
GEV No.	510093	Ref. No.	467002 69870
description	protection cap		
For models:	GLB0043, GLB0044, GLB0046, GLB0072, GLB0073, OPT1012, OPT1012C		

			
1			
GEV No.	520357	Ref. No.	12024282 Z101723000
description	protection cap for flange ø 57.5mm ø 62mm H 42mm		
For models:	GLB0061C-F, GLB0061C-FN, GLB0063C-F, GLB0063C-FN, OPT1012-CFN		

			
1			
GEV No.	520876	Ref. No.	463007
description	protection cap for heating element ø 11.5mm H 32mm W 25mm plastic		
For models:	GLB0035, GLB0036, GLB0037, GLB0038, GLB0039, GLB0058, GLB0059, GLB0060, GLB0061, GLB0061C, GLB0062, GLB0063, GLB0064, GLB0064C, GLB0065, GLB0066, GLB0072		

			
1			
GEV No.	510034	Ref. No.	12025258
description	protection cap for heating element ø 53mm mounting distance 74mm plastic L 35mm		
For models:	GLB0035-FN, GLB0037-FN		



			
1			
GEV No.	505208	Ref. No.	12022859 Z603602000
description	bracket for heating element		
For models:	GLB0035-FN, GLB0037-FN, GLB0061C-F, GLB0061C-FN, GLB0063C-F, GLB0063C-FN, OPT1012-CF		

			
1			
GEV No.	692776	Ref. No.	983.009.00
description	support bracket for heating element		
For models:	AFC0003		

hot plates

square & rectangular

with radiused edge

			
1			
GEV No.	490066 ¹	Ref. No.	X45500
description	hot plate dimensions 220x220mm 2600W 230V with spill ring connection 4 screw clamps protector yes square		
For models:	ACA1001, ACA1002, ACA1004, ACA101V, ACA102V, ACA104V, ACA105V		

¹incl. protector

			
1			
GEV No.	490056 ¹	Ref. No.	96500300
description	hot plate dimensions 300x300mm 3000W 230V with spill ring connection 4 screw clamps protector yes square		
For models:	92PCE, 94CFE, 94PCE, 96CFE, 96PCE		

¹incl. protector

			
1			
GEV No.	490071 ¹	Ref. No.	Y12100
description	hot plate dimensions 300x300mm 4000W 230V with spill ring connection 4 screw clamps protector yes square		
For models:	ADA101V, ADA103V, ADA104V, ADA106V		

¹incl. protector

tiltable

			
1			
GEV No.	490215	Ref. No.	965.083.00
description	hot plate dimensions 300x300mm 4000W 230V with cast edge tilt boiling plate connection 4 screw clamps H 45mm square		

round



with radiused edge

for domestic and commercial kitchens

			
1			
GEV No.	490014	Ref. No.	665.059.00
description	hot plate ø 180mm 1500W 230V connection 4 screw clamps with 8mm spill ring		
For models:	6030PCE, 6060CFE, 6060PCE		

			
1			
GEV No.	490018	Ref. No.	071009 X45400
description	hot plate ø 220mm 2000W 230V connection 4 screw clamps with 8mm spill ring		
For models:	ACJ005V, ACJ007V, ACJ008V, AOZ0001, AOZ0002		



			
1			
GEV No.	490020	Ref. No.	665.006.00 X45300
description	hot plate ø 220mm 2600W 230V connection 4 screw clamps with 8mm spill ring		
For models:	6540PCE, 6570CFE, 6570PCE, 7040PCE, ACJ005V, ACJ007V, ACJ008V		
accessories for	490020		
		GEV No.	550796
		Ref. No.	—
	fixing plate for hot plate ø220mm		

accessories

miscellaneous

			
1			
GEV No.	490111	Ref. No.	X44900
description	cover for hot plate ø 237mm		
For models:	ACJ005V, ACJ007V, ACJ008V		

energy regulators

EGO

1-circuit

			
1			
GEV No.	380034	Ref. No.	661.069.00
description	energy regulator 230V 13A 2-stage turn direction clockwise shaft ø 6x4.6mm shaft L 36mm power release 6-100%		
For models:	6570PVE, 7040PVE, 7070CFVE, 7070PVE		

			
1			
GEV No.	380015	Ref. No.	073010 11950017000 3700010 661.058.00 C5322489 TERM0014 TERM0050 X44400
description	energy regulator 230V 13A single-circuit turn direction right shaft ø 6x4.6mm shaft L 23mm mounting thread M4 power release 6-100% no. 50.57021.010		
For models:	2158, 53054-CN, 53304, 6030CPE, 7040PVE, AAD0001, ACA1010, ACA106V, ACA110V, ACK301V, ACK302V, ACK303V, ACK304V, AJD0002-CCN, AJD0003-CCN, AJD0014-C, AJD0019-C, AJE0001, AJE0002, AJE0003, AJG0003, AJG0004, AJH0001, AJH0002, AJH0003, AJH0007, AJH0008, AJH0009, ARZ0001, ARZ0002, ARZ0004, ARZ0005, ARZ0006, CAD0005, IIA4002, IIA4003, KF981D, SY850VELED, VI-6030PVED, VI6060PVED		

2-circuit

			
1			
GEV No.	381304	Ref. No.	Y17604
description	energy regulator EGO 230V 13A dual circuit turn direction right shaft ø 6x4.6mm shaft L 22mm mounting thread M4 no. 50.55071.100		
For models:	ACA1003, ACA1010, ACA103V, ACA106V, ACA110V, ACJ006V, ADA102V, ADA105V		

			
1			
GEV No.	380027	Ref. No.	661.068.00 661.102.00
description	energy regulator EGO 230V 13A dual circuit turn direction right shaft ø 6x4.6mm shaft L 23mm mounting thread M4 power release 6-70% no. 50.55021.100		
For models:	6570PVE, 7040PVE, 7070CFVE, 7070PVE, 92PCV, 94CFV, 94PCV, VI6030PVED, VI6060PVED		



ROBERTSHAW

MSA series

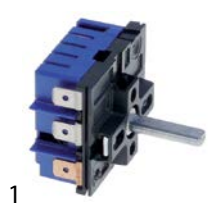

GEV No.	380858	Ref. No.	TER30004
description	energy regulator ROBERTSHAW 240V 15A turn direction right shaft ø 6x4.6mm shaft L 23mm mounting thread 8"-32UNC		
For models:	VG715RXS, VP914RXS, VP916RXS, VP920RXS		



GEV No.	390451	Ref. No.	R213004000	
description	bi-metal safety thermostat hole distance 23.5mm switch-off temp. 115°C 1NC 1-pole 16A connection F6.3			
For models:	OPT1012-CF			
accessories for	390451			
	GEV No.	505093	Ref. No.	12024049 N503017000
	gasket for thermostat ED ø 35mm ID ø 24mm thickness 7mm equiv. no. N503017			

thermostats

bi-metal thermostats

safety bi-metal thermostats



GEV No.	390233	Ref. No.	236039 926189
description	bi-metal safety thermostat hole distance 24mm switch-off temp. 110°C 1NC 1-pole 16A connection F6.3 2 hole fixing without holder		
For models:	GLB0035, GLB0036, GLB0037, GLB0038, GLB0039, GLB0043, GLB0044, GLB0046, GLB0056, GLB0057, GLB0058, GLB0059, GLB0060, GLB0061, GLB0061C, GLB0062, GLB0063, GLB0064, GLB0064C, GLB0065, GLB0066, GLB0070, GLB0071, GLB0072, GLB0073, OPT1012, OPT1012C		
accessories for	390233		



GEV No.	504736	Ref. No.	—
	bracket for contact thermostat		



GEV No.	550388	Ref. No.	—
	bracket for contact thermostat mounting distance 24.5mm mounting ø 3.8		



GEV No.	390367	Ref. No.	4.0.000.0250
description	bi-metal safety thermostat hole distance 39-44mm switch-off temp. 130°C 2NC 2-pole 16A connection F6.3 2 hole fixing		
For models:	EFA0015, EFA0016, EFA0023		



GEV No.	390459	Ref. No.	236053
description	bi-metal safety thermostat hole distance 23.5mm switch-off temp. 200°C 1NC 1-pole 16A connection F6.3 M4		
For models:	OPT1012		



GEV No.	390318	Ref. No.	236047
description	bi-metal safety thermostat switch-off temp. 95°C 1-pole 2 hole fixing		
For models:	GLB0035, GLB0036, GLB0037, GLB0038, GLB0039, GLB0056, GLB0057		

bi-metal thermostats





GEV No.	390634	Ref. No.	TER30002
description	bi-metal thermostat hole distance 23.5mm switch-off temp. 145°C 1NC 1-pole 16A 250V connection F6.3 2 hole fixing		
For models:	VP800U		





GEV No.	391045	Ref. No.	12095019
description	bi-metal thermostat hole distance 23.5mm switch-off temp. 51°C 1NC 1-pole 10A connection F6.3 threaded probe ø 16mm		
For models:	GLB0035-F, GLB0037-F		





			
1			
GEV No.	390301	Ref. No.	236035
description	bi-metal thermostat hole distance 23.8mm switch-off temp. 60°C 1NC 1-pole 16A connection F6.3 2 hole fixing		
For models:	GLB0035, GLB0036, GLB0037, GLB0038, GLB0039, GLB0056, GLB0057, OPT1012C		

			
1			
GEV No.	390319	Ref. No.	236048
description	bi-metal thermostat hole distance 23.8mm switch-off temp. 80°C 1NC 1-pole 16A connection F6.3 2 hole fixing		
For models:	GLB0035, GLB0036, GLB0037, GLB0038, GLB0039, GLB0056, GLB0057		

			
1			
GEV No.	390504	Ref. No.	236052
description	bi-metal thermostat hole distance 23.8mm switch-off temp. 90°C 1NO 1-pole 16A 250V connection F6.3 2 hole fixing probe ø 16mm		
For models:	OPT1012C		

			
1			
GEV No.	390129	Ref. No.	236056
description	bi-metal thermostat hole distance 23.8mm switch-off temp. 125°C 1NC 1-pole 16A connection F6.3 M4		
For models:	OPT1012		

			
1			
GEV No.	390450	Ref. No.	12023708 Z718405000
description	bi-metal thermostat hole distance 23.8mm switch-off temp. 66/57°C NC/NO 2-pole 16A connection F6.3		
For models:	GLB0035-FN, GLB0037-FN, GLB0061C-F, GLB0061C-FN, GLB0063C-F, GLB0063C-FN, OPT1012-CF, OPT1012-CFN		
accessories for	390450		
			
	GEV No.	505093	Ref. No. 12024049 N503017000
	gasket for thermostat ED ø 35mm ID ø 24mm thickness 7mm equiv. no. N503017		

			
1			
GEV No.	390158	Ref. No.	072011
description	bi-metal thermostat switch-off temp. 140°C connection M4		
For models:	ARZ0001, ARZ0002		

sets			
			
1			
GEV No.	390725	Ref. No.	160212-03
description	bi-metal safety thermostat NC 1+1-pole connection male faston 6.3mm vertical mounting ø 16mm set		
For models:	EFB0001, EFB0002, EFB0003, EFB0004, EFB0008, EFB0008-C, EFB0009, EFB0009-C		

control and safety thermostats

EGO

control thermostats

55.10/19_ series

			
1			
GEV No.	375001	Ref. No.	661.004.00
description	thermostat t.max. 112°C temperature range 30-110°C 1-pole 1NO 16A probe ø 6mm probe L 130mm capillary pipe 900mm capillary pipe isolated gland nut M9x1 shaft L 23mm shaft position upper rotation 270°		
For models:	6540BME, 7040BME, 92BME, AFB0003		

			
1			
GEV No.	375363	Ref. No.	E10600
description	thermostat t.max. 161°C temperature range 73-161°C 1-pole 1NO 16A probe ø 3mm probe L 144mm capillary pipe 1600mm capillary pipe isolated 1600mm gland nut shaft ø 6x4.6mm shaft L 23mm shaft position upper rotation 270°		
For models:	ACL0002, ACL002V, ADL001V, ADL002V		

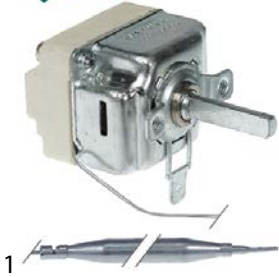

GEV No.	375720	Ref. No.	072051
description	thermostat t.max. 184°C temperature range 80-184°C 1-pole 1NO 16A probe ø 6mm probe L 87mm capillary pipe 570mm capillary pipe isolatedmm gland nut shaft ø 6x4.6mm shaft L 23mm shaft position upper rotation 270°		
For models:	AAC0001, AAC0002, AMZ0004, AMZ0005, AMZ0006, AMZ0007, AMZ0008, AMZ0024, IFA0004		

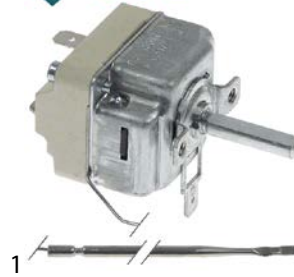

GEV No.	375463	Ref. No.	09953137000
description	thermostat t.max. 277°C 1-pole 1NO 16A probe ø 3.03mm probe L 139mm capillary pipe 870mm capillary pipe isolatedmm gland nut shaft ø 6x4.6mm shaft L 23mm		
For models:	KF733		

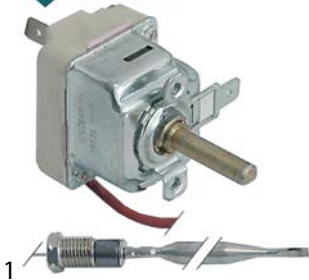

GEV No.	375237	Ref. No.	Y16000
description	thermostat t.max. 190°C temperature range 100-190°C 1-pole 1NO 16A probe ø 6mm probe L 130mm capillary pipe 1800mm capillary pipe isolated 1200mm gland nut M9x1 shaft L 23mm shaft position upper rotation 270°		
For models:	ACC004V, ACC005V, ADC006V		

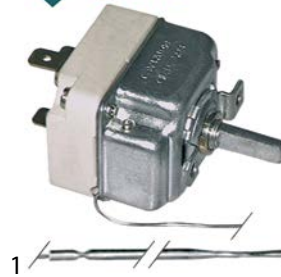

GEV No.	375216	Ref. No.	661.073.00
description	thermostat t.max. 280°C temperature range 50-280°C 1-pole 1NO 16A probe ø 3mm probe L 228mm capillary pipe 1300mm capillary pipe isolated 1150mm gland nut shaft L 23mm shaft position upper rotation 318°		
For models:	6060CFE		

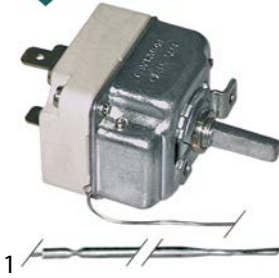

GEV No.	390068	Ref. No.	X43600
description	thermostat t.max. 269°C temperature range 55-269°C 1-pole 1CO 16A probe ø 3.1mm probe L 219mm capillary pipe 1280mm capillary pipe isolated 1270mm gland nut shaft ø 6x4.6mm shaft L 23mm shaft position upper° rotation 318°		
For models:	ACK1002, ACK101V, ACK102V		

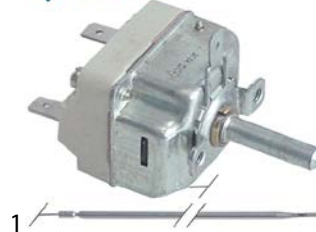

GEV No.	375327	Ref. No.	072005.1
description	thermostat t.max. 297°C temperature range 58-297°C 1-pole 1NO 16A probe ø 3.03mm probe L 219mm capillary pipe 870mm capillary pipe isolatedmm gland nut shaft L 23mm shaft position upper rotation 270°		
For models:	AJA0014, AJA0015, AJA0016, AJA0017, AJA0018, APZ0001, APZ0002, APZ0012		



GEV No.	375797	Ref. No.	Y19200
description	thermostat t.max. 300°C temperature range 50-300°C 1-pole 1NO 16A probe ø 6mm probe L 74mm capillary pipe 900mm capillary pipe isolatedmm gland nut shaft L 23mm shaft position upper rotation 270°		
For models:	ACK2003, ACK2004, ACK203V, ACK204V, ADK201V, ADK202V, ADK203V, ADK204V, ADK207V, ADK208V, ADK209V, ADK210V		



GEV No.	375594	Ref. No.	01951317000
description	thermostat t.max. 318°C temperature range 60-318°C 1-pole 1NO 16A probe ø 3.03mm probe L 139mm capillary pipe 870mm capillary pipe isolatedmm gland nut shaft ø 6x4.6mm shaft L 23mm shaft position upper rotation 270°		
For models:	AIB0012, AIB0013, KF630		



GEV No.	375595	Ref. No.	11950417000
description	thermostat t.max. 303°C temperature range 71-303°C 1-pole 1NO 16A probe ø 3mm probe L 114mm capillary pipe 1230mm capillary pipe isolatedmm gland nut shaft ø 6x4.6mm shaft L 23mm shaft position upper rotation 270° with 2 probes		
For models:	KF1001G		



GEV No.	375002	Ref. No.	X68205
description	thermostat t.max. 320°C temperature range 55-320°C 1-pole 1NO 16A probe ø 3.1mm probe L 226mm capillary pipe 870mm capillary pipe isolated 850mm gland nut shaft L 23mm shaft position upper rotation 270°		
For models:	ACA2010, ACA206V, ACA210V		



GEV No.	375800	Ref. No.	09952637000
description	thermostat t.max. 308°C temperature range 65-308°C 1-pole 1NO 16A probe ø 3.03mm probe L 120mm capillary pipe 600mm capillary pipe isolatedmm gland nut shaft ø 6x4.6mm shaft L 23mm shaft position upper rotation 270° with 2 probes		
For models:	AIB0014, AIB0017, KF933U, KF965, KF981D		



GEV No.	375499	Ref. No.	TERM0013
description	thermostat t.max. 320°C temperature range 60-320°C 1-pole 1NO 16A probe ø 3.1mm probe L 226mm capillary pipe 870mm capillary pipe isolatedmm gland nut shaft ø 6x4.6mm shaft L 23mm shaft position upper rotation 270°		
For models:	CAD0004		



GEV No.	375491	Ref. No.	G4210010
description	thermostat t.max. 346°C temperature range 63-346°C 1-pole 1NO probe ø 3mm probe L 144mm capillary pipe 900mm capillary pipe isolated 350mm gland nut shaft ø 6x4.6mm shaft L 23mm rotation 270°		
For models:	CAB0099		



GEV No.	375321	Ref. No.	661.070.00
description	thermostat t.max. 90°C temperature range 35-90°C 1-pole 1NO 16A probe ø 11mm probe L 24mm capillary pipe 900mm capillary pipe isolated 900mm gland nut shaft ø 6x4.6mm shaft L 23mm shaft position upper rotation 270° screw-in probe probe thread M14x1		
For models:	6030BME, 6060BME		



GEV No.	375253	Ref. No.	91310003
description	thermostat t.max. 455°C temperature range 85-455°C 1-pole 1NO 16A probe ø 3.9mm probe L 228mm capillary pipe 870mm capillary pipe isolated 660mm gland nut shaft ø 6x4.6mm shaft L 23mm shaft position upper rotation 270°		
For models:	CAB0013, CAB0014, CAB0015, CAB0024, CAB0025, CAB0029-CN, CAB0030-CN, CAB0032, CAB0032-CN, CAB0033, CAB0033-CN, CAB0035, CAB0039, CAB0040, CAB0041, CAB0042, CAB0043, CAB0044, CAB0045, CAB0046		

55.13_ series



GEV No.	375400	Ref. No.	12024096 Z393005000
description	thermostat t.max. 90°C temperature range 30-90°C 1-pole 1CO 16A probe ø 6mm probe L 98mm capillary pipe 2380mm capillary pipe isolated 1700mm gland nut M9x1 shaft ø 6x4.6mm shaft L 18mm shaft position upper rotation 270°		
For models:	GLB0035-FN, GLB0037-FN, OPT1012-CF		



GEV No.	375381	Ref. No.	3700002
description	thermostat t.max. 90°C temperature range 30-90°C 1-pole 1NO 16A probe ø 6mm probe L 130mm capillary pipe 2000mm capillary pipe isolated 2000mm gland nut shaft ø 6x4.6mm shaft L 23mm shaft position upper rotation 270°		
For models:	IIA3006, IIA3007, IIA3008, IIA3010, IIA3011, IIA3012, IIA4002, IIA4003		

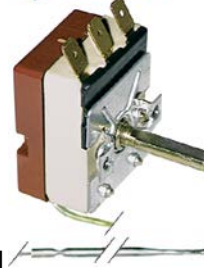

GEV No.	375130	Ref. No.	Z203014000
description	thermostat t.max. 90°C temperature range 32-90°C 1-pole 1CO 16A probe ø 6mm probe L 129mm capillary pipe 710mm capillary pipe isolated 500mm gland nut shaft ø 6x4.6mm shaft L 23mm shaft position upper rotation 270°		
For models:	GLB0061C-F, GLB0063C-F		



GEV No.	375426	Ref. No.	X57900
description	thermostat t.max. 93°C temperature range 30-93°C 1-pole 1CO 16A probe ø 6mm probe L 85mm capillary pipe 1230mm capillary pipe isolatedmm gland nut shaft position left rotation 270° probe material SS		
For models:	ACB0004, ACB002V, ACB004V		



GEV No.	375097	Ref. No.	661.041.00 X43800
description	thermostat t.max. 195°C temperature range 95-195°C 3-pole 3NO 16A probe ø 6mm probe L 117mm capillary pipe 1780mm capillary pipe isolated 1400mm gland nut M9x1 shaft ø 6x4.6mm shaft L 23mm shaft position upper rotation 270°		
For models:	6030FRE, 6060FRE, 6540FRE, 6570FRE, 7040FRE10, 7070FRE10, ACC0003, ACC003V, ACC008V, ACC010V, ACK301V, ACK302V, ACK303V, ACK304V, ADC004V, AFC0003		

55.17_series



GEV No.	390729	Ref. No.	SHELST01A100
description	thermostat t.max. 85°C 1-pole probe ø 6mm probe L 91mm capillary pipe 880mm capillary pipe isolatedmm gland nut shaft ø 6x4.6mm shaft L 16mm		
For models:	IEA0002-I, IEC0002-I		



GEV No.	375192	Ref. No.	66102700
description	thermostat t.max. 300°C temperature range 50-300°C 3-pole 3NO 16A probe ø 3mm probe L 219mm capillary pipe 900mm capillary pipe isolatedmm gland nut shaft ø 6x4.6mm shaft L 23mm shaft position upper rotation 270°		
For models:	65110CFGE, 6570CFE, 6570CFGE, 70110CFGE, 7070CFEQ, 7070CFGE, 7070CFVE, 94CFE, 94CFGE, 94CFV, 96CFE, 96CFGE		

55.34_series



GEV No.	375143	Ref. No.	661.005.00
description	thermostat t.max. 110°C temperature range 32-110°C 3-pole 3NO 16A probe ø 6mm probe L 138mm capillary pipe 1480mm capillary pipe isolated 1100mm gland nut M9x1 shaft ø 6x4.6mm shaft L 23mm shaft position upper rotation 270°		
For models:	6570BME, 7070BME		



GEV No.	375453	Ref. No.	X43900
description	thermostat t.max. 308°C temperature range 100-300°C 3-pole 3NO 16A probe ø 6mm probe L 75mm capillary pipe 1150mm capillary pipe isolatedmm gland nut shaft ø 6x4.6mm shaft L 23mm rotation 270° probe material SS		
For models:	ACA1004, ACA104V, ACA105V, ACA2007, ACA207V, ACA216, ACA216V, ACH301V, ACH302V, ACH303V, ACH304V, ACH305V, ACH306V, ACH307V, ACH318V, ACH319V, ACH320V, ADA104V, ADA106V, ADA205V, ADA208V, ADA210V, ADA212V, ADH301V, ADH302V, ADH303V, ADH304V, ADH305V, ADH306V		



GEV No.	375614	Ref. No.	661.007.00
description	thermostat t.max. 330°C temperature range 100-330°C 3-pole 3NO 16A probe ø 6mm probe L 75mm capillary pipe 870mm capillary pipe isolated 870mm gland nut shaft ø 6x4.6mm shaft L 23mm shaft position upper rotation 270°		
For models:	6030FTE, 6060FTE, 6060FTRE, 6060FTRRE, 6540FTE, 6540FTECR, 6540FTRE, 6540FTRECR, 6570BRE, 6570FTE, 6570FTECR, 6570FTRE, 6570FTRECR, 6570FTRRE, 7040FTE, 7040FTECR, 7040FTES, 7040FTRE, 7070BRE, 7070BREM, 7070FTE, 7070FTECR, 7070FTRE, 7070FTRECR, 7070FTRRE, 92FTEL, 92FTELC, 92FTER, 92FTECR, 94BRE, 94BREM, 94FTEL, 94FTELC, 94FTELR, 94FTELCR, 94FTER, 94FTECR, 96BRE, 96BREM		

safety thermostats
55.10/19_ series



GEV No.	375319	Ref. No.	66103400
description	safety thermostat switch-off temp. 230°C 1-pole 0.5A probe ø 11mm probe L 18mm capillary pipe 900mm capillary pipe isolatedmm gland nut probe screw-in probe thread M14x1		
For models:	7040FRG13, 7070FRG13, AFC0001		



GEV No.	375178	Ref. No.	X56700
description	safety thermostat switch-off temp. 230°C 1-pole 0.5A probe ø 4mm probe L 116mm capillary pipe 1500mm capillary pipe isolatedmm gland nut probe SS		
For models:	ADC003V, ADC008V, ADC009V, ADC010V		



GEV No.	375282	Ref. No.	0000X43400
description	safety thermostat switch-off temp. 230°C 1-pole 16A probe ø 11mm probe L 28mm capillary pipe 850mm capillary pipe isolated 830mm gland nut probe screw-in probe probe thread M14x1		
For models:	ACC0001, ACC0002, ACC001V, ACC002V, ACC006V, ACC007V, ADC001V, ADC002V		
accessories for	375282		
	GEV No.	507313	Ref. No. 12009837 Q307050000
	O-ring EPDM thickness 2.62mm ID ø 13.95mm Qty 1 pcs		
	GEV No.	510420	Ref. No. —
	gasket copper ED ø 19.9mm ID ø 14.3mm thickness 2mm Qty 1 pcs		
	GEV No.	521133	Ref. No. —
	nut thread M14x1.5 H 6mm WS 19 zinc-coated steel Qty 1 pcs		



GEV No.	390062	Ref. No.	661.021.00 X49500 Y16300
description	safety thermostat switch-off temp. 235°C 1-pole 0.5A probe ø 6mm probe L 130mm capillary pipe 1800mm capillary pipe isolated 1500mm gland nut M9x1 probe SS		
For models:	6030FRG, 6060FRG, 6540FRG, 6570FRG, 92FRG20, 92FRG20S, 94FRG20, 94FRG20S, ACC0003, ACC003V, ACC004V, ACC005V, ACC008V, ACC010V, ADC004V, ADC006V		
accessories for	390062		
	GEV No.	551083	Ref. No. 66103600
	cap for safety thermostat thread M8x1		

E·G·O

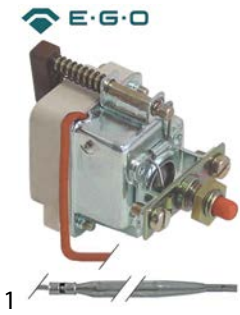

1

GEV No.	375353	Ref. No.	Y16500
description	safety thermostat switch-off temp. 355°C 1-pole 0.5A probe ø 4mm probe L 120mm capillary pipe 870mm capillary pipe isolated 870mm gland nut probe SS		
For models:	ACK2003, ACK2004, ACK203V, ACK204V, ADH307V, ADH308V, ADH309V, ADH310V, ADH311V, ADH312V, ADK201V, ADK202V, ADK203V, ADK204V, ADK207V, ADK208V, ADK209V, ADK210V, ADL011V, ADL012V		

55.13_series

E·G·O



1

GEV No.	375910	Ref. No.	220220
description	safety thermostat switch-off temp. 115°C 1-pole 1NC 16A probe ø 6mm probe L 78mm capillary pipe 350mm capillary pipe isolated 6mm gland nut M9x1 probe probe material SS		
For models:	EFB0014, EFB0019, EFC0003		

E·G·O



1

GEV No.	375191	Ref. No.	91310050
description	safety thermostat switch-off temp. 500°C 1-pole 16A probe ø 3.9mm probe L 230mm capillary pipe 870mm capillary pipe isolated 660mm gland nut probe		
For models:	CAA0003, CAA0004, CAA0005, CAB0007, CAB0008, CAB0009, CAB0010, CAB0011, CAB0012, CAB0016, CAB0017, CAB0018, CAB0019, CAB0020, CAB0026, CAB0027, CAB0029-CN, CAB0030-CN, CAB0055-DCG, CAB0056-DCG, CAB0057-DCG, CAB0058-DCG, CAB0059-DCG, CAB0060-DCG, CAB0061-DCG, CAB0062-DCG, GIOTTOD, GIOTTO		

55.14_series

E·G·O



1

GEV No.	375260	Ref. No.	PD.412H
description	safety thermostat switch-off temp. 240°C 1-pole 16A probe ø 6mm probe L 77mm capillary pipe 1280mm capillary pipe isolated 1050mm gland nut M10x1 probe SS		
For models:	AMZ0037-N		

55.11_series

E·G·O



1

GEV No.	375767	Ref. No.	3700014
description	safety thermostat switch-off temp. 170°C 1-pole 16A probe ø 3.1mm probe L 160mm capillary pipe 650mm capillary pipe isolated 600mm gland nut probe		
For models:	IIA3006, IIA3007, IIA3008, IIA3010, IIA3011, IIA3012, IIA4002, IIA4003		

55.32_series

E·G·O



1

GEV No.	375316	Ref. No.	66105100
description	safety thermostat switch-off temp. 140°C 3-pole 20A probe ø 6mm probe L 173mm capillary pipe 830mm capillary pipe isolated 800mm gland nut probe SS		
For models:	7070PEI, 94PE100I, 94PE100IA, 94PE100IAS, 94PE100IS, 94PE150I, 94PE150IA		

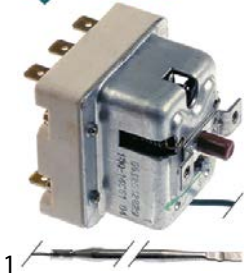

GEV No.	375364	Ref. No.	E10500
description	safety thermostat switch-off temp. 190°C 3-pole 20A probe ø 4mm probe L 120mm capillary pipe 3000mm capillary pipe isolated 3000mm gland nut probe		
For models:	ACL0001, ACL0002, ACL0003, ACL001V, ACL002V, ACL003V, ADL001V, ADL002V, ADL006V, ADL007V		



GEV No.	375290	Ref. No.	072027
description	safety thermostat switch-off temp. 240°C 3-pole 20A probe ø 6mm probe L 87mm capillary pipe 2000mm capillary pipe isolated 1800mm gland nut probe SS		
For models:	AAC0001, AAC0002, AMZ0006, AMZ0007, AMZ0008, IFA0004		

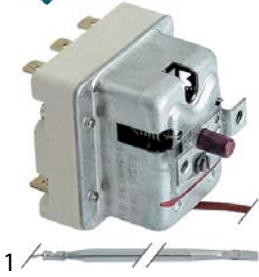

GEV No.	375312	Ref. No.	661.048.00
description	safety thermostat switch-off temp. 245°C 3-pole 3NC 20A probe ø 4mm probe L 120mm capillary pipe 1800mm capillary pipe isolated 1800mm gland nut probe SS		
For models:	6030FRE, 6060FRE, 6540FRE, 6570FRE, 7040FRE10, 7070FRE10, AFC0003		

accessories for	375312		
	GEV No.	550981	Ref. No. —
	probe clip for pipe ø 8.5mm for probe ø 6mm for heating elements spacing 0.4mm Qty 1 pcs		

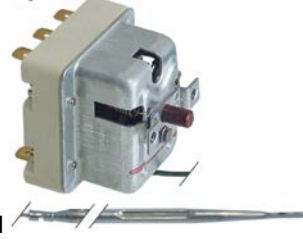

GEV No.	375262	Ref. No.	661.045.00
description	safety thermostat switch-off temp. 350°C 3-pole 20A probe ø 4mm probe L 120mm capillary pipe 900mm capillary pipe isolated 900mm gland nut probe		
For models:	6030FTE, 6060FTE, 6060FTRE, 6060FTRRE, 65110CFGE, 6540FTE, 6540FTECR, 6540FTRE, 6540FTRECR, 6570BRE, 6570CFE, 6570CFGE, 6570FTE, 6570FTECR, 6570FTRE, 6570FTRECR, 6570FTRRE, 70110CFGE, 7040FTE, 7040FTECR, 7040FTES, 7040FTRE, 7070BRE, 7070BREM, 7070CFEQ, 7070CFGE, 7070CFVE, 7070FTE, 7070FTECR, 7070FTRE, 7070FTRECR, 7070FTRRE, 92FTEL, 92FTELC, 92FTER, 92FTERC, 94BRE, 94BREM, 94CFE, 94CFGE, 94CFV, 94FTEL, 94FTELC, 94FTELR, 94FTELCR, 94FTER, 94FTERC, 96BRE, 96BREM, 96CFE... (Other models you can see in the webshop)		



GEV No.	375252	Ref. No.	X44800
description	safety thermostat switch-off temp. 350°C 3-pole 20A probe ø 6mm probe L 89mm capillary pipe 3000mm capillary pipe isolated 960mm gland nut probe		
For models:	ACA1004, ACA104V, ACA105V, ACA2007, ACA207V, ACA216, ACA216V, ACH301V, ACH302V, ACH303V, ACH304V, ACH305V, ACH306V, ACH307V, ACH318V, ACH319V, ACH320V, ACK1002, ACK101V, ACK102V, ADA104V, ADA106V, ADA205V, ADA208V, ADA210V, ADA212V, ADH301V, ADH302V, ADH303V, ADH304V, ADH305V, ADH306V		



GEV No.	390999	Ref. No.	TER30011
description	safety thermostat switch-off temp. 350°C temperature range°C 2-pole NC 20A probe ø 3mm probe L 187mm capillary pipe 690mm capillary pipe isolated 680mm gland nut shaft 6mm probe SS		
For models:	VP914RXS, VP920RXS		



GEV No.	375065	Ref. No.	TERM0005
description	safety thermostat switch-off temp. 500°C 3-pole 3NC 20A probe ø 4mm probe L 308mm capillary pipe 890mm capillary pipe isolated-mm gland nut probe SS		
For models:	CAD0004, CAD0004-ZN, CAD0005, CAD0007, CAD0009, CAD0010, SY12100VELED, SY12100VGASD, SY1280VE, SY1280VG, SY850VELED		



GEV No.	390610	Ref. No.	072028.1
description	safety thermostat switch-off temp. 235°C 1-pole 16A probe ø 3mm probe L 190mm capillary pipe 1000mm capillary pipe isolated 640mm gland nut probe SS		
For models:	AMZ0006, AMZ0007, IFA0004		



GEV No.	375190	Ref. No.	91310051
description	safety thermostat switch-off temp. 560°C 3-pole 20A probe ø 3.9mm probe L 228mm capillary pipe 870mm capillary pipe isolated 700mm gland nut probe		
For models:	CAB0007-CD, CAB0008-CD, CAB0009-CD, CAB0013, CAB0013-CD, CAB0014, CAB0014-CD, CAB0015, CAB0015-CD, CAB0024, CAB0024-CD, CAB0025, CAB0025-CD, CAB0029-CN, CAB0030-CN, CAB0032, CAB0032-CN, CAB0033, CAB0033-CN, CAB0035, CAB0039, CAB0040, CAB0041, CAB0042, CAB0043, CAB0044, CAB0045, CAB0046, CAB0055-DCG, CAB0056-DCG, CAB0057-DCG, CAB0058-DCG, CAB0059-DCG, CAB0060-DCG, CAB0061-DCG, CAB0062-DCG		

accessories



GEV No.	551083	Ref. No.	66103600
description	cap for safety thermostat thread M8x1		
For models:	7040FRG13, 7070FRG13		

56._series



GEV No.	375263	Ref. No.	072028
description	safety thermostat switch-off temp. 232°C 1-pole 16A probe ø 4mm probe L 91mm capillary pipe 510mm capillary pipe isolated 350mm gland nut		
For models:	AMZ0004, AMZ0005		

control thermostats with operation switch

55.10/19_ series





GEV No.	390039	Ref. No.	X57800	
description	thermostat t.max. 90°C temperature range 30-90°C 1-pole 1CO 16A probe ø 6mm probe L 173mm capillary pipe 980mm capillary pipe isolated 980mm gland nut shaft ø 6x4.6mm shaft L 23mm shaft position upper rotation 270° outer switch 2NO			
For models:	ADB002V, ADB003V			
accessories for	390039			
	GEV No.	111934	Ref. No.	3700057
	knob thermostat t.max. 90°C ø 50mm shaft ø 6x4.6mm shaft flat upper black temperature range 30-90°C rotation 270°			

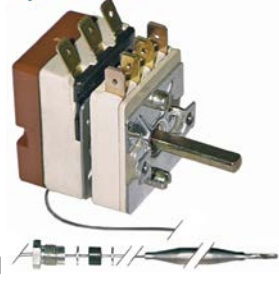

55.13_series



GEV No.	375406	Ref. No.	PD.412B
description	thermostat t.max. 110°C temperature range 30-110°C 1-pole 1CO 16A probe ø 6mm probe L 113mm capillary pipe 2380mm capillary pipe isolated 1700mm gland nut M9x1 shaft ø 6x4.6mm shaft L 18mm shaft position upper rotation 270° outer switch 2NO		
For models:	NGSB990CE, NGSCD990		
accessories for	375406		
	GEV No.	110545	Ref. No. —
	knob dial plate silver thermostat t.max. 110°C 30-110°C rotation 310° ED ø 59mm ID ø 45.5mm		
	GEV No.	112173	Ref. No. —
	knob universal ø 62mm black without adaptor/dial plate		
	GEV No.	112311	Ref. No. —
	knob adapter shaft ø 6x4.6mm L 0mm with spring		

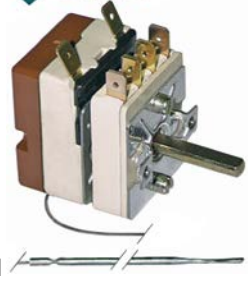

GEV No.	375408	Ref. No.	PD.412C
description	thermostat t.max. 320°C temperature range 50-320°C 1-pole 1NO 16A probe ø 3.03mm probe L 160mm capillary pipe 1150mm capillary pipe isolated gland nut shaft ø 6x4.6mm shaft L 23mm shaft position upper rotation 270° outer switch 2NO		
For models:	AHC0001, AHC0002, AHC0004, AHC0005, AHC0007, TP12EP, TP15EP		

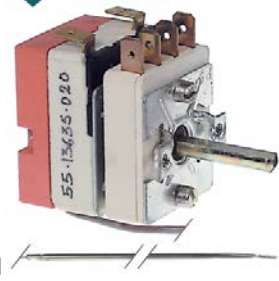

GEV No.	375780	Ref. No.	PD.412E
description	thermostat temperature range 120-190°C 1-pole 1NO 16A probe ø 3mm probe L 248mm capillary pipe 1730mm capillary pipe isolated 1660mm gland nut shaft ø 6x4.6mm shaft L 23mm shaft position upper rotation 270° outer switch 2NO		
For models:	AMZ0037-N		



IMIT / TEMPOMATIC / ARTHERMO

control thermostats



GEV No.	375404	Ref. No.	003201820001
description	thermostat t.max. 110°C temperature range 0-90°C 1-pole 1CO 15A probe ø 6mm probe L 104mm capillary pipe 1400mm capillary pipe isolated 1350mm gland nut shaft ø 6x4.6mm shaft L 18mm shaft position upper rotation 270° probe material copper 400V		
For models:	IFD0001-MN		



GEV No.	390006	Ref. No.	072029
description	thermostat t.max. 86°C temperature range 0-86°C 1-pole 1CO 16A probe ø 6.5mm probe L 95mm capillary pipe 1500mm capillary pipe isolated gland nut shaft ø 6x4.6mm shaft L 19mm rotation 270°		
For models:	AXZ0003		
accessories for	390006		
	GEV No.	110100	Ref. No. —
	knob thermostat t.max. 90°C 0-90°C ø 42mm shaft ø 6x4.6mm shaft flat -135° black		
	GEV No.	110105	Ref. No. —
	rosette knob ø 42mm ø 56mm zero mark		



CAEM

control thermostats



GEV No.	390672	Ref. No.	236042
description	thermostat t.max. 53°C temperature range fixed 53°C 1-pole 1CO 16A probe ø 9.5mm probe L 30mm capillary pipe 600mm capillary pipe isolated 540mm gland nut shaft Lmm screw-in probe probe thread M14x1		
For models:	GLB0058, GLB0059, GLB0060, GLB0061, GLB0061C, GLB0062, GLB0063, GLB0064, GLB0064C, GLB0065, GLB0066, GLB0072		
spare parts for	390672		
	GEV No.	510417	Ref. No. —
	flat gasket fibre ED ø 20mm ID ø 14mm thickness 2mm Qty 1 pcs		



GEV No.	390686	Ref. No.	236043
description	thermostat t.max. 83°C temperature range°C 1-pole 1CO 20A probe ø 6mm probe L 90mm capillary pipe 630mm capillary pipe isolated 550mm gland nut shaft ømm shaft Lmm shaft position rotation 270° probe material copper		
For models:	GLB0058, GLB0059, GLB0060, GLB0061, GLB0061C, GLB0062, GLB0063, GLB0064, GLB0064C, GLB0065, GLB0066, GLB0072		

safety thermostats



GEV No.	375597	Ref. No.	09952387000
description	safety thermostat switch-off temp. 335°C 1-pole 16A probe ø 5mm probe L 80mm capillary pipe 900mm capillary pipe isolatedmm gland nut probe SS		
For models:	AIB0014, KF933U, KF965, KF981D		



GEV No.	375456	Ref. No.	01951367000
description	safety thermostat switch-off temp. 335°C 2-pole 20A probe ø 3mm probe L 200mm capillary pipe 1050mm capillary pipe isolated 650mm gland nut probe SS at 250V 20A at 400V 10A		
For models:	KF630, KF733		

TECASA

safety thermostats



GEV No.	390452	Ref. No.	12023830 Z213014000
description	safety thermostat switch-off temp. 125°C 1-pole 16A probe ø 6mm probe L 73mm capillary pipe 870mm capillary pipe isolated 690mm gland nut M9x1 probe SS		
For models:	GLB0035-FN, GLB0037-FN, GLB0061C-F, GLB0061C-FN, GLB0063C-F, GLB0063C-FN, OPT1012-CF, OPT1012-CFN		

CAMPINI

safety thermostats



GEV No.	375892	Ref. No.	TER30013
description	safety thermostat switch-off temp. 318°C 1-pole 16A probe ø 3mm probe L 137mm capillary pipe 1260mm capillary pipe isolated 710mm gland nut probe SS type Ty 95-H		
For models:	VG715RXS, VP824RU, VP916RXS		

INVENSYS / ROBERTSHAW

safety thermostats

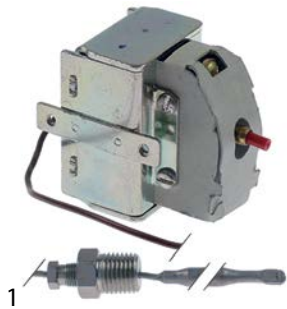

GEV No.	580045	Ref. No.	GS.2183
description	safety thermostat switch-off temp. 232°C 1-pole 1COA probe ø 6.4mm probe L 120mm capillary pipe 760mm capillary pipe isolatedmm gland nut 3/8" NPT shaft ømm probe SS screw connection 1/4" 450°F		
For models:	AMZ0001-NM		

various

control thermostats

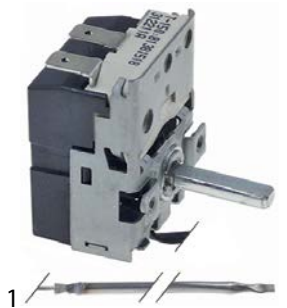

GEV No.	375914	Ref. No.	TER30003
description	thermostat t.max. 290°C temperature range 50-290°C 1-pole 1NOA probe ø 3mm probe L 165mm capillary pipe 1040mm capillary pipe isolated 600mm gland nut shaft ø 6x4.6mm shaft L 23mm shaft position upper rotation 270° probe material SS		
For models:	VG715RXS, VP800U, VP824RU, VP914RXS, VP916RXS, VP920RXS		



GEV No.	375904	Ref. No.	IB5866000
description	thermostat t.max. 90°C temperature range 0-90°C 1-pole 1NO 16A probe ø 6.5mm probe L 85mm capillary pipe 970mm capillary pipe isolatedmm gland nut shaft L 15mm shaft position upper rotation 270° probe material copper ambient temperature max. 150°C		
For models:	IBA0012, IBA0013		

refrigeration thermostats

RANCO

K22 series



GEV No.	390524	Ref. No.	NR23591
description	thermostat RANCO type K22L1082 probe ømm probe Lmm capillary pipe 2000mm temperature range -22 up to -3°C		
For models:	BAA0019, BAA0022, BAA0023, BAA0024, BAA0025, BAA0026, BAA0027, BAA0028, BAA0029, BAA0030, BAA0031, BAA0032, BAA0033, BAA0034, BAA0037, BAA0038, BAA0046, BAA0046W, BAA0051, BAA0053-A, BAA0055		



GEV No.	390589	Ref. No.	NR23597
description	thermostat RANCO type K22L1083 probe ø 2mm probe Lmm capillary pipe 2300mm		
For models:	BAA0040		

K50 series





GEV No.	390288	Ref. No.	N23034 NR23034
description	thermostat RANCO type K50L3163 probe ømm probe Lmm capillary pipe 2100mm temperature range -24 up to -14°C		
For models:	BAB0001, BAB0001-W, BAB0002, BAB0002-W, BAB0003, BAB0004		



GEV No.	390588	Ref. No.	NR23421
description	thermostat RANCO type K50L3274 probe ø 2mm probe Lmm capillary pipe 3000mm		
For models:	BAA0032, BAA0033, BAA0034, BAB0003, BAB0004, BAB0005, BAC0007, BAC0008		



 <p>1</p>			
GEV No.	390286	Ref. No.	NR23005
description	thermostat RANCO type K50L3383 probe ømm probe Lmm capillary pipe 1500mm temperature range +1 up to +3°C		
For models:	BAA0019, BAA0022, BAA0023, BAA0024, BAA0025, BAA0026, BAA0027, BAA0028, BAA0029, BAA0030, BAA0031, BAA0037, BAA0038, BAA0040, BAA0046, BAA0046W, BAA0051, BAA0053-A, BAA0055, BAB0001, BAB0001-W, BAB0002, BAB0002-W, BAC0009		

ATEA			
 <p>1</p>			
GEV No.	390522	Ref. No.	1025
description	thermostat ATEA type A01 0716 probe ø 2mm probe Lmm capillary pipe 1200mm		
For models:	EAA0002, EAA0003, EBZ0001-CN, EBZ0002-CN, EBZ0003-CN		

accessories

probe clips

spring clips

for thermostat

 <p>1</p>			
GEV No.	550041	Ref. No.	063001
description	probe clip for pipe ø 7mm for probe ø 6mm		
For models:	AAC0001, AAC0002, AMZ0004, AMZ0005, AMZ0006, AMZ0007, AMZ0008, AMZ0024, IFA0004		

 <p>1</p>			
GEV No.	550419	Ref. No.	238.003.00
description	probe clip for pipe ø 8.5mm for probe ø 6mm Qty 1 pcs		
For models:	6030FRE, 6060FRE, 6540FRE, 6570FRE, 7040FRE10, 7070FRE10, AFC0003		

 <p>1</p>			
GEV No.	550258	Ref. No.	M86500
description	probe clip for pipe ø 8mm for probe ø 6mm		
For models:	ACC0003, ACC003V, ACC004V, ACC008V, ACC010V, ADC004V		

for safety thermostat

 <p>1</p>			
GEV No.	550795	Ref. No.	PIA30014
description	probe clip for pipe ø 6mm for probe ø 3.5mm Qty 1 pcs for oven		
For models:	VP800U, VP824RU, VP914RXS, VP920RXS		

capillary tube clips

 <p>1</p>			
GEV No.	551105	Ref. No.	M86800
description	capillary tube clip for pipe ø 6mm Qty 1 pcs		
For models:	ACC0003, ACC003V, ACC008V, ACC010V, ADC004V		

 <p>1</p>			
GEV No.	550138	Ref. No.	063002
description	capillary tube clip for pipe ø 8.5mm for circular tube heating elements		
For models:	AAC0001, AAC0002, AMZ0004, AMZ0005, AMZ0006, AMZ0007, AMZ0008, AMZ0024, IFA0004		

 <p>1</p>			
GEV No.	550980	Ref. No.	M86900
description	capillary tube clip for pipe ø 8.5mm Qty 1 pcs		
For models:	ACC004V		

plunger sockets

 <p>1</p>			
GEV No.	513031	Ref. No.	929038
description	thermowell L 125mm SS single		
For models:	GLB0046		





			
1			
GEV No.	505207	Ref. No.	Z263002000
description	thermowell thread M12x1.75 IT ET M12x1.75 ID ø 8mm L 95mm SS/brass single ø 10mm		
For models:	GLB0061C-F, GLB0063C-F		

connecting bows			
			
1			
GEV No.	550060	Ref. No.	3700007 661.013.00 X44600
description	connecting bow long for thermostat Qty 1 pcs		
For models:	6030BME, 6030FRE, 6030FTE, 6060BME, 6060FRE, 6060FTE, 6060FTRE, 6060FTRRE, 65110CFGE, 6540BME, 6540FRE, 6540FTE, 6540FTECR, 6540FTRE, 6540FTRECR, 6570BME, 6570BRE, 6570CFE, 6570CFGE, 6570FRE, 6570FTE, 6570FTECR, 6570FTRE, 6570FTRECR, 6570FTRRE, 70110CFGE, 7040BME, 7040FRE10, 7040FTE, 7040FTECR, 7040FTES, 7040FTRE, 7070BME, 7070BRE, 7070BREM, 7070CFEQ, 7070CFGE, 7070CFVE, 7070FRE10, 7070FTE, 7070FTECR, 7070FTRE, 7070FTRECR, 7070FTRRE, 92BME, 92FRE18, 92FRE18S, 92FTEL, 92FTELC, 92FTER... (Other models you can see in the webshop)		

switches and momentary switches

rocker/momentary rocker switches

19x13mm			
			
1			
GEV No.	301066	Ref. No.	661.072.00
description	rocker switch mounting measurements 19x13mm black 2NO 250V 6A 0-I connection male faston 4.8mm ambient temperature max. 85°C protection IP40		
For models:	6060CFE		
accessories for	301066		
	GEV No.	301064	Ref. No.
			—
	protective cover for pressure switch external size 23.4x17.4mm internal size 19x13mm H 7.5mm clear mounting measurementsmm		



28x13.5mm			
			
1			
GEV No.	346957	Ref. No.	KODK005
description	rocker switch mounting measurements 28x13.5mm green 1NO 250V 6A illuminated ON-OFF connection male faston 6.3mm ambient temperature max. 85°C protection IP40		
For models:	FGZ0014		

30x11mm			
			
1			
GEV No.	345489	Ref. No.	Z403033000
description	momentary rocker switch mounting measurements 30x11mm orange 1NO 250V 16A connection male faston 6.3mm ambient temperature max. 90°C protection IP40		
For models:	GLB0061C-F, GLB0063C-F		

			
1			
GEV No.	301013	Ref. No.	F132
description	rocker switch mounting measurements 30x11mm black 1CO 250V 16A connection male faston 6.3mm ambient temperature max. 85/125°C protection IP40		
For models:	EBZ0001-CN, EBZ0002-CN, EBZ0003-CN, MISSOFTY		



			
1			
GEV No.	345575	Ref. No.	F133
description	rocker switch mounting measurements 30x11mm black 1CO 250V 16A I O II connection male faston 6.3mm ambient temperature max. 90°C protection IP40 with neutral position		
For models:	EBZ0001-CN, EBZ0002-CN, EBZ0003-CN		



			
1			
GEV No.	301038	Ref. No.	SHELSWAYA100
description	rocker switch mounting measurements 30x11mm green 1NO/indicator light 250V 16A connection male faston 6.3mm		
For models:	IEA0002-I, IEC0002-I		

30x22mm			
			
1			
GEV No.	301018	Ref. No.	3700102
description	momentary rocker switch mounting measurements 30x22mm orange 2NO 250V 16A illuminated 0-I connection male faston 6.3mm ambient temperature max. 125/55°C protection IP65		
For models:	IIA3006, IIA3007, IIA3008, IIA3010, IIA3011, IIA3012		
accessories for	301018		
	GEV No.	301036	Ref. No.
			—
	protective cover internal size 30x22mm for rocker switch mounting measurementsmm		







			
1			
GEV No.	301020	Ref. No.	91310090 INTE0012
description	momentary rocker switch mounting measurements 30x22mm red 2NO 250V 16A illuminated 0-I connection male faston 6.3mm ambient temperature max. 100/55°C protection IP65		
For models:	CAA0003, CAA0004, CAA0005, CAD0007		

			
1			
GEV No.	301003	Ref. No.	91310085 B00DU102 INTE0010
description	rocker switch mounting measurements 30x22mm green 2NO 250V 16A illuminated 0-I connection male faston 6.3mm ambient temperature max. 125/55°C protection IP65		
For models:	9925F, 9931F, 9932F, BMA0013-F, BMA0034-F, BMA0038-F, BMA0098, BMA0099, BMB0002-F, BMB0002-FG, BMB0004-F, BMB0014-F, BMB0014-FG, BMB0015-F, BMB0042-F, BMB0046-F, BMC0001-F, BMC0001-FG, BMC0003-F, BNA0068, BNA0069, BNC0001BAR-F, BNC0001-F, BNC0002-F, BNC0007BAR-F, BNC0007-F, BNC0008-F, BNC0015BAR-F, BNC0015-F, BNC0016-F, BNC0030, BNC0030PI, BNC0032, BNC0033, BNC0034, BNC0034PI, BNC0035, CAA0003, CAA0004, CAA0005, CAB0007, CAB0008, CAB0009, CAB0010, CAB0011, CAB0012, CAB0013, CAB0014, CAB0015, CAB0016...(Other models you can see in the webshop)		
accessories for	301003		
		GEV No.	301036 Ref. No. —
	protective cover internal size 30x22mm for rocker switch mounting measurementsmm		



			
1			
GEV No.	301002	Ref. No.	IB5806000 INTE0009
description	rocker switch mounting measurements 30x22mm orange 2NO 250V 16A illuminated 0-I connection male faston 6.3mm ambient temperature max. 85/125°C protection IP65		
For models:	CAD0004, CAD0005, CAD0007, IBA0012, IBA0013, SY850VELED		
accessories for	301002		
		GEV No.	301036 Ref. No. —
	protective cover internal size 30x22mm for rocker switch mounting measurementsmm		

			
1			
GEV No.	345512	Ref. No.	160801-04
description	rocker switch mounting measurements 30x22mm orange 2NO 400V 16A illuminated 0-I connection male faston 6.3mm ambient temperature max. 85/125°C protection IP40		
For models:	EFB0008, EFB0008-C, EFB0009, EFB0009-C, EFB0017, EFB0018, EFC0003		

			
1			
GEV No.	301001	Ref. No.	INTE0004 R042
description	rocker switch mounting measurements 30x22mm red 2NO 250V 16A illuminated 0-I connection male faston 6.3mm ambient temperature max. 125/55°C protection IP65		
For models:	BGB0001, BGB0002, BGB0003, BGB0004, BGB0005, BGB0006, BGB0007, BGB0008, BGB0009, BGB0010, BGB0011, BGB0012, BGB0013, BGB0014, BGB0015, BGB0016, BGB0017, BGB0018, BGB0019, BGB0022, BGB0023, BGB0024, BGB0025, BGB0026, BGB0027, BGB0028, BGB0029, BGB0044, BGB0050, BHZ0001, BHZ0002, BHZ0003, BHZ0004, BHZ0005, BHZ0006, BHZ0007, BHZ0008, BHZ0009, BHZ0010, BHZ0011, BHZ0012, BHZ0013, BHZ0034, BHZ0035, BHZ0036, BHZ0037, BHZ0038, BHZ0039, CAD0005, IFF0001...(Other models you can see in the webshop)		
accessories for	301001		
		GEV No.	301036 Ref. No. —
	protective cover internal size 30x22mm for rocker switch mounting measurementsmm		



			
1			
GEV No.	345491	Ref. No.	12039115 Z213033000
description	momentary rocker switch mounting measurements 30x22mm orange 1NO/indicator light 250V 16A connection male faston 6.3mm ambient temperature max. 100/55°C protection IP40		
For models:	GLB0035-FN, GLB0037-FN, GLB0061C-F, GLB0061C-FN, GLB0063C-F, GLB0063C-FN		
accessories for	345491		
		GEV No.	301036 Ref. No. —
	protective cover internal size 30x22mm for rocker switch mounting measurementsmm		



			
1			
GEV No.	346689	Ref. No.	Z203080000
description	momentary rocker switch mounting measurements 30x22mm orange 1NO/indicator light 230V 16A illuminated connection male faston 6.3mm ambient temperature max. 125°C protection IP40		
For models:	GLB0061C-F, GLB0063C-F		



			
1			
GEV No.	301062	Ref. No.	SHELSONA100
description	rocker switch mounting measurements 30x22mm green 2NO 250V 16A illuminated connection male faston 6.3mm ambient temperature max. 100/55°C protection IP40		
For models:	IEA0002-I, IEC0002-I		
accessories for	301062		
		GEV No.	301036 Ref. No. —
	protective cover internal size 30x22mm for rocker switch mounting measurementsmm		







 1			
GEV No.	301060	Ref. No.	073004
description	rocker switch mounting measurements 30x22mm red 2NO 250V 16A illuminated connection male faston 6.3mm ambient temperature max. 125/55°C protection IP40		
For models:	AJE0002, AJE0003, AJE0006, AJE0007, ARZ0004, ARZ0005, AXZ0003, IFB0001, IFB0002		



 1			
GEV No.	301004	Ref. No.	F131
description	rocker switch mounting measurements 30x22mm black 2CO 250V 16A connection male faston 6.3mm ambient temperature max. 125/55°C protection IP40		
For models:	EBZ0001-CN, EBZ0002-CN, EBZ0003-CN		
accessories for	301004		
	GEV No.	301036	Ref. No. —
	protective cover internal size 30x22mm for rocker switch mounting measurementsmm		

 1			
GEV No.	301188	Ref. No.	1350
description	rocker switch mounting measurements 30x22mm black 2NO/2NO 250V 16A I O II connection male faston 6.3mm ambient temperature max. 125/55°C protection IP40		
For models:	EBZ0001-CN, EBZ0002-CN, EBZ0003-CN, MISSOFTY		
accessories for	301188		
	GEV No.	301036	Ref. No. —
	protective cover internal size 30x22mm for rocker switch mounting measurementsmm		



 1			
GEV No.	346361	Ref. No.	INTE0011
description	rocker switch mounting measurements 30x22mm white 2CO 250V 16A I-II connection male faston 6.3mm ambient temperature max. 85°C protection IP40		
For models:	CAD0007		
accessories for	346361		
	GEV No.	301036	Ref. No. —
	protective cover internal size 30x22mm for rocker switch mounting measurementsmm		



blank			
 1			
GEV No.	346144	Ref. No.	210018
description	push switch mounting measurements 30x22mm white 2CO 250V 16A illuminated connection male faston 6.3mm ambient temperature max. 100/55°C protection IP65		
For models:	EEC0001, EED0010, EFF0002-Q		
accessories for	346144		
	GEV No.	301036	Ref. No. —
	protective cover internal size 30x22mm for rocker switch mounting measurementsmm		



labelled			
 1			
GEV No.	300125	Ref. No.	3700100 N23327 X50800
description	rocker switch mounting measurements 30x22mm green 2NO 230V 16A 0-I connection male faston 6.3mm ambient temperature max. 125/55°C protection IP65 with cover cap		
For models:	ACB0004, ACB002V, ACB004V, ACD001V, ACD002V, ACK301V, ACK302V, ACK303V, ACK304V, BAA0019, BAA0024, BAA0025, BAA0026, BAA0027, BAA0028, BAA0029, BAA0030, BAA0031, BAA0037, BAA0038, BAA0040, BAA0046, BAA0046W, BAA0051, BAB0001, BAB0001-W, BAB0002, BAB0002-W, BAB0003, BAB0004, BAB0005, IIA4002, IIA4003, IIA5005, IIA5006, IIA5010, IIA5011, IIA5012, IIA5013, IIA5014, IIA5015, Z/EI12, Z/EI15, Z/EI23, Z/EI8, Z/ER12, Z/ER15, Z/ER23, Z/ER8		
accessories for	300125		
	GEV No.	301036	Ref. No. —
	protective cover internal size 30x22mm for rocker switch mounting measurementsmm		

 1			
GEV No.	301006	Ref. No.	3700101
description	rocker switch mounting measurements 30x22mm orange 2NO 250V 16A illuminated connection male faston 6.3mm ambient temperature max. 125/55°C protection IP65 with cover cap		
For models:	IIA5005, IIA5006, IIA5010, IIA5011, IIA5012, IIA5013, IIA5014, IIA5015		
accessories for	301006		
	GEV No.	301036	Ref. No. —
	protective cover internal size 30x22mm for rocker switch mounting measurementsmm		



			
1			
GEV No.	346868	Ref. No.	19410102
description	rocker switch mounting measurements 30x22mm white 2NO 250V 16A illuminated 0-I connection male faston 6.3mm ambient temperature max. 125/55°C protection IP65 with cover cap		
For models:	AWZ0017		
accessories for	346868		
	GEV No.	301036	Ref. No. —
	protective cover internal size 30x22mm for rocker switch mounting measurementsmm		

			
1			
GEV No.	347412	Ref. No.	160802-04
description	rocker switch mounting measurements 30x22mm orange/orange 1NO/NO 250V 16A illuminated 0-I/0-II connection male faston 6.3mm ambient temperature max. 125/55°C protection IP40		
For models:	EFB0001, EFB0002, EFB0003, EFB0004		
accessories for	347412		
	GEV No.	301036	Ref. No. —
	protective cover internal size 30x22mm for rocker switch mounting measurementsmm		



			
1			
GEV No.	345747	Ref. No.	073009
description	rocker switch mounting measurements 30x22mm red/red 1NO/NO 250V 16A with LED 0-I/0-II connection male faston 6.3mm ambient temperature max. 125/55°C protection IP40		
For models:	AJG0001, AJG0002		
accessories for	345747		
	GEV No.	301036	Ref. No. —
	protective cover internal size 30x22mm for rocker switch mounting measurementsmm		

ø20mm			
			
1			
GEV No.	357074	Ref. No.	C5120729
description	rocker switch mounting measurements 20mm red 2NO 250V 10A I O connection male faston 4.8mm ambient temperature max. 85°C protection IP40		
For models:	53054-CN, 53304, AJD0002-CCN, AJD0003-CCN, AJD0014-C, AJD0019-C		

push/momentary push switches

28.5x28.5mm			
			
1			
GEV No.	346317	Ref. No.	09950067023
description	momentary push switch mounting measurements 28.5x28.5mm black 1NO 250V 16A connection male faston 6.3mm ambient temperature max. 150°C protection IP40		
For models:	AAA2001		



30x22mm			
			
1			
GEV No.	301086	Ref. No.	4.0.085.0018
description	push switch mounting measurements 30x22mm black 2NO 250V 12A 0-1 connection male faston 6.3mm ambient temperature max. 85/55°C protection IP54 with protective collar		
For models:	EHZ0001		

			
1			
GEV No.	345712	Ref. No.	00000000296
description	push switch mounting measurements 30x22mm red/green 2CO 250V 16A Stop / I connection male faston 6.3mm ambient temperature max. 85°C protection IP40 with indicator		
For models:	8921, 8922		
accessories for	345712		
	GEV No.	301127	Ref. No. 00000000285
	protective cover internal size 30x55mm transparent		

			
1			
GEV No.	345510	Ref. No.	00000000306
description	push switch mounting measurements 30x22mm red/green 2NO 250V 16A latching Stop / I connection male faston 6.3mm ambient temperature max. 85°C protection IP40 with indicator		
For models:	8920, 8922		

ø16mm			
			
1			
GEV No.	301100	Ref. No.	663.041.00
description	momentary push switch mounting ø 16mm red 1NO 250V 3A ignition connection male faston 6.3mm ambient temperature max. 85°C protection IP40		
For models:	6060CFG, 6060CFGE		



			
1			
GEV No.	346315	Ref. No.	11950427000
description	momentary push switch mounting \varnothing 16mm red 1NO/indicator light 250V 3A connection male faston 2.8mm ambient temperature max. 85°C protection IP40		
For models:	KF1001G		
accessories for	346315		
	GEV No.	346343	Ref. No. —
protective cover			
	GEV No.	346344	Ref. No. —
ring for protecting cover			

ø19.2mm

			
1			
GEV No.	346414	Ref. No.	LF1041001
description	momentary push switch mounting \varnothing 19.2mm silver 1NC/1NO 250V 5A SS connection soldering connection ambient temperature max. 85°C protection IP40		
For models:	FIF0014, FIG0002, FIG0009M, FIG0010, TC32BU		

			
1			
GEV No.	346415	Ref. No.	LF1041000
description	momentary push switch mounting \varnothing 19.2mm silver 1NO 50V 0.05A with LED connection soldering connection ambient temperature max. 85°C protection IP40		
For models:	FIF0014, FIG0002, FIG0009M, FIG0010, TC32BU		



ø22mm

			
1			
GEV No.	347425	Ref. No.	X56200 X69100
description	momentary push switch mounting measurements \varnothing 22mm black 1NC/1NO 250V 5A connection screw ambient temperature max. 85°C protection IP40		
For models:	ADK202V, ADK204V, ADK208V, ADK210V		

			
1			
GEV No.	347426 ¹	Ref. No.	X56300 X69000
description	momentary push switch mounting measurements \varnothing 22mm red 1NC/1NO 250V 5A connection screw ambient temperature max. 85°C protection IP40		
For models:	ADK202V, ADK204V, ADK208V, ADK210V		

¹incl. knob

			
1			
GEV No.	348220	Ref. No.	12115383
description	momentary push switch mounting \varnothing 22mm silver 1NO/1NC/indicator light 220V 5A connection male faston 2.8mm round		
For models:	GLB0035-F, GLB0037-F, GLB0061C-F, GLB0063C-F		

			
1			
GEV No.	401357	Ref. No.	F2138
description	momentary push switch mounting measurements \varnothing 22mm 1NO/1NC/indicator light 400V 4A indicator lamp 24V 0-1 connection screw ambient temperature max. 125/55°C protection IP40		
For models:	FHZ0003, FIF0001, FIF0002, FIF0003-22HP, FIF0004, FIF0005, FIG0003-F, FIG0011-F, TCG22E-F		
spare parts for	401357		
	GEV No.	346181	Ref. No. —
push button mounting \varnothing 21mm external size 30x55mm oval			
accessories for	401357		
	GEV No.	401709	Ref. No. —
protective cover external size 57x32mm internal size 47x22mm matt finish rubber H 27.5mm			

			
1			
GEV No.	699002	Ref. No.	SL0891
description	momentary push switch mounting \varnothing 22mm black/white 1NO/1NC/indicator light 230V 6A 0-1 connection screw ambient temperature max. 70°C protection IP40		
For models:	CBF0001		

			
1			
GEV No.	301058	Ref. No.	0000000653
description	protective cover internal size 30x55mm		
For models:	8921, 8922		

			
1			
GEV No.	301127	Ref. No.	0000000285
description	protective cover internal size 30x55mm transparent		
For models:	8922		





ø25mm			
			
1			
GEV No.	346312	Ref. No.	09951677000
description	momentary push switch mounting ø 25mm black 1NO 250V 16A water connection male faston 6.3mm ambient temperature max. 85°C protection IP40		
For models:	AIB0014, AIB0015, KF1001G, KF630, KF933U, KF965		



			
1			
GEV No.	347355	Ref. No.	PUL30003
description	momentary push switch mounting ø 25mm red 2NO 250V 16A connection male faston 6.3mm ambient temperature max. 85°C protection IP40		
For models:	VP800U		

			
1			
GEV No.	346316	Ref. No.	09951707000
description	push switch mounting ø 25mm black 2NO 250V 16A connection male faston 6.3mm ambient temperature max. 85°C protection IP40		
For models:	AIB0014, AIB0015, KF1001G, KF965, KF981D		

overload switches			
			
1			
GEV No.	347067	Ref. No.	19410152
description	push switch KJD17 mounting measurements 45x22mm black/white 2NO/A1 250V 10A IO connection male faston 4.8mm/6.3mm ambient temperature max. 85°C protection IP54 with cover cap		

miscellaneous			
			
1			
GEV No.	346955	Ref. No.	IB5804402
description	momentary push switch mounting measurements 29x29mm black 1NO 250V 6A connection screw VORTEX		
For models:	FJZ0010, FJZ0011, FJZ0012		
accessories for	346955		
	GEV No.	346960	Ref. No. IB4104002
	protection cap for push-button L 45mm W 21mm		

accessories			
protective covers			
			
1			
GEV No.	346960	Ref. No.	IB4104002
description	protection cap for push-button L 45mm W 21mm		
For models:	FJZ0010, FJZ0011, FJZ0012		
accessories for	346960		
	GEV No.	346955	Ref. No. IB5804402
	momentary push switch mounting measurements 29x29mm black 1NO 250V 6A connection screw VORTEX		

microswitches			
universal			
			
			
1			
GEV No.	345042	Ref. No.	IB5820800 N23196
description	microswitch with plunger 250V 16A 1CO connection male faston 6.3mm L 28mm ambient temperature max. 125°C mounting distance 22mm type EF83161.3 actuating force: 75g blue/black		
For models:	BAB0003, BAB0004, BAB0005, DRAGONEVV, MULTIPLO2S, MULTIPLO3S		
accessories for	345042		
	GEV No.	345043	Ref. No. —
	lever set 5-piece		

			
1			
GEV No.	348043	Ref. No.	MSC04N262
description	microswitch with plunger 250V 16A 1CO connection male faston 6.3mm Lmm L1 27.8mm ambient temperature max. 125°C mounting distance 22mm with lever set type MS1-16 actuating force: 100g white		
For models:	FLA0014, FLA0015, FLA0016		





lever actuated

			
1			
GEV No.	347035	Ref. No.	0900466
description	microswitch with lever 30V 1A 1CO connection with cable L 25mm ambient temperature max. 85°C type D2FW-G 271M actuating force: 80g lever length 21mm		
For models:	FGZ0009		

			
1			
GEV No.	347034	Ref. No.	0900465
description	microswitch with lever 30V 1A 1NO connection with cable L 18mm ambient temperature max. 85°C type D2FW-G 271M actuating force: 100g lever length 25mm		
For models:	FGZ0006, FGZ0007, FGZ0009, FGZ0012, FGZ0013, FGZ0025, FGZ0026, FGZ0027, FGZ0028		

			
1			
GEV No.	347010	Ref. No.	IB5820700
description	microswitch with lever 250V 16A 1CO connection male faston 4.8mm L 36mm ambient temperature max. 105°C mounting distance 22mm type D3V-16G443-1C25-K actuating force: 50g lever length 28mm		
For models:	MULTIPL02S, MULTIPL03S		

			
1			
GEV No.	346314	Ref. No.	09951147000 09951727000
description	microswitch with lever 250V 16A 1CO connection male faston 6.3mm L 56mm ambient temperature max. 125°C mounting distance 22mm type VRSR01DA1 actuating force: 50g		
For models:	AAA2002, AIB0014, AIB0015		

			
1			
GEV No.	345773	Ref. No.	761.004.00 X52800
description	microswitch with lever 250V 16A 1CO connection male faston 6.3mm L 60mm ambient temperature max. 125°C mounting distance 22mm actuating force: 65g lever length 51mm		
For models:	6060FRE, 6540FRE, 6570FRE, 7040FRE10, 7070FRE10, 92FRE18, 92FRE18S, 94FRE18, 94FRE18S, ACC0003, ACC003V, ACC004V, ACC005V, ACC008V, ACC010V, ADC004V, ADC006V		

			
1			
GEV No.	345125	Ref. No.	927246
description	microswitch with lever 250V 16A 1CO connection male faston 6.3mm ambient temperature max. 85°C mounting distance 25mm type C99ZP3 actuating force: 25g lever length 63.5mm		
For models:	GLB0046		

			
1			
GEV No.	346506	Ref. No.	661.019.00
description	microswitch with lever 1NO lever length 66mm		
For models:	6030FRE, 6060FRE, AFC0003		

			
1			
GEV No.	346865	Ref. No.	1061/UL
description	microswitch with lever 250V 5A connection male faston 6.3mm ambient temperature max. 125°C type 831540		
For models:	EBZ0001-CN, EBZ0002-CN, EBZ0003-CN		

roller-lever actuated

microswitches

			
1			
GEV No.	346893	Ref. No.	MSC04N292
description	microswitch with handle with a switch 250V 16A 1CO connection male faston 6.3mm ambient temperature max. 125°C mounting distance 22mm white		
For models:	FLA0014, FLA0015, FLA0016		

			
1			
GEV No.	345041	Ref. No.	SL0885
description	microswitch with handle with a switch 250V 16A 1CO connection male faston 6.3mm ambient temperature max. 85°C black lever length 20.5mm		
For models:	CBF0001, CBF0002, CBF0003		

1



GEV No.	345250	Ref. No.	661.052.00
description	microswitch with handle with a switch 250V 16A 1CO connection male faston 6.3mm L 27mm L1 36mm ambient temperature max. 125°C mounting distance 22mm type RL6-1-FGE-P12-5-L actuating force: 90g		
For models:	6570BRE, 7070BRE, 7070BREM, 7070BRGM		

pin-plunger actuated





1

GEV No.	347798	Ref. No.	A61424L0AG ANE61424L0AG
description	microswitch with plunger 250V 15A 1NO connection male faston 4.8mm L 20mm L2 22mm ambient temperature max. 105°C mounting distance 22mm type W-15-302C actuating force: 200g white		
For models:	NE1643, NE1653, NE1843, NE2140, NE3240		

1

GEV No.	345042	Ref. No.	IB5820800 N23196
description	microswitch with plunger 250V 16A 1CO connection male faston 6.3mm L 28mm ambient temperature max. 125°C mounting distance 22mm type EF83161.3 actuating force: 75g blue/black		
For models:	BAB0003, BAB0004, BAB0005, DRAGONEVV, MULTIPLO2S, MULTIPLO3S		
accessories for	345042		
	GEV No.	345043	Ref. No. —
	 lever set 5-piece		



1

GEV No.	347411	Ref. No.	160821
description	microswitch with plunger 250V 16A 1CO connection male faston 6.3mm L1 29.6mm ambient temperature max. 125°C mounting distance 22mm type V15T16-CZ100 actuating force: 46g grey		
For models:	EFB0001, EFB0002, EFB0003, EFB0004, EFB0008, EFB0008-C, EFB0009, EFB0009-C		

M10





1

GEV No.	347216	Ref. No.	09950437000 96102100
description	microswitch with plunger thread M10x0.75 thread L 14mm 250V 10A 1CO connection male faston 6.3mm stroke 7.5mm mounting distance 22mm L 28mm ambient temperature max. 125°C type NR6K5 actuating force: 260g		
For models:	94BRE, 94BREM, 94BRG, 94BRGM, 96BRE, 96BREM, 96BRG, 96BRGM, BGEU411, BGEU611, BGEU1011, GEU411, GEU411P, GEU611, GEU611P, GEV1011, GEV1011P, KF1001G, KF630, KF733, KF933U, KF965, KF981D		



1

GEV No.	345678	Ref. No.	073003 19410201
description	microswitch with plunger thread M10x0.75 thread L 16mm 250V 16A 1NO connection male faston 6.3mm stroke 2.5mm mounting distance 22mm ambient temperature max. 125°C actuating force: 290g		
For models:	AAC0001, AAC0002, AMZ0004, AMZ0005, AMZ0006, AMZ0007, AMZ0008, AMZ0024, FEB0031, FEB0033, FEB0034, FEB0035, IFA0004, MIRRA300, PALLADIO300AM, PALLADIO300T, PALLADIO330T, PALLADIO350AM		
accessories for	345678		
	GEV No.	100779	Ref. No. —
	 nut thread M10x0.75 H 3mm WS 14 SS Qty 2 pcs		



1

GEV No.	345032	Ref. No.	MSC04N276
description	microswitch with plunger thread M10x1 thread L 12mm 250V 16A 1CO connection male faston 6.3mm stroke 7mm mounting distance 22mm L 28mm ambient temperature max. 125°C type SP9603 actuating force: 180g		
For models:	FLA0014, FLA0015, FLA0016		

M12



1

GEV No.	345350	Ref. No.	R31600
description	microswitch with plunger mounting distance 22mm thread M12x0.75 thread L 16mm 250V 16A 1CO connection male faston 6.3mm stroke 4mm ambient temperature max. 125°C type EF83161.3 actuating force: 66g		
For models:	ACK301V, ACK302V, ACK303V, ACK304V		
accessories for	345350		
	GEV No.	345351	Ref. No. —
	 nut thread M12x0.75 H 1.6mm WS 14 chrome-plated brass Qty 1 pcs		



GEV No.	346176	Ref. No.	X54900
description	microswitch with plunger mounting distance 25mm thread M12x0.75 250V 1CO ambient temperature max. 125°C type MK V11D10		
For models:	ACK2003, ACK2004, ACK203V, ACK204V, ADK201V, ADK202V, ADK203V, ADK204V, ADK207V, ADK208V, ADK209V, ADK210V		

miscellaneous



GEV No.	347432	Ref. No.	160817
description	microswitch front fixing 250V 16A 1CO connection male faston 6.3mm ambient temperature max. 85°C thread M12x0.8		
For models:	EFB0014		

with push button

switches with snap-fit



GEV No.	348008	Ref. No.	B00DU103
description	microswitch with push button 250V 2.5A 1NO/1NC connection male faston 2.8mm/6.3mm L 27mm L1 22mm ambient temperature max. 104°C actuating force: 180g		
For models:	BMA0013-F, BMA0034-F, BMA0038-F, BMA0098, BMA0099, BMB0002-F, BMB0002-FG, BMB0004-F, BMB0014-F, BMB0014-FG, BMB0015-F, BMB0042-F, BMC0001-F, BMC0001-FG, BMC0003-F		

roller actuated

roller 0°



GEV No.	347155	Ref. No.	MIC00308
description	microswitch with roller plunger 15A 1CO connection screw thread M12x1 type Z15G1308		
For models:	CBG0010-M, CBG0011-M, CBG0013-M		

accessories



GEV No.	698204	Ref. No.	MSC04N264
description	bracket for microswitch C4-C6		
For models:	FLA0014, FLA0015, FLA0016		



GEV No.	346395	Ref. No.	F2163
description	cover for microswitch L 80mm W 60mm H 70mm		
For models:	FHZ0003, FIF0004, FIF0005, TCG22E-F		



GEV No.	347061	Ref. No.	MSC04N274
description	spacer ring for microswitch ID ø 10mm ED ø 14mm thickness 4mm		
For models:	FLA0014, FLA0015, FLA0016		

position switches

EMAS



GEV No.	348162	Ref. No.	B00DU106
description	position switch plastic 1NC/1NO 240V 3A L 93mm W 30mm H 30mm protection IP67 actuating force: 750g screw connection PG13.5 mounting distance 22mm		
For models:	VAEK170-F, VAEK210-F, VAEK220-F, VAEN030-F, VAEN060-F, VAEN075-F		

system switches (ROLD)





GEV No.	345721	Ref. No.	226102
description	blank cap holder		
For models:	OPT1012C		





			
1			
GEV No.	346848	Ref. No.	226111
description	element holder dimensions 25x25mm ID ø 21.4mm grey		
For models:	GLB0035, GLB0036, GLB0037, GLB0038, GLB0039, GLB0056, GLB0057, GLB0058, GLB0059, GLB0060, GLB0061, GLB0061C, GLB0062, GLB0063, GLB0064, GLB0064C, GLB0065, GLB0066, GLB0072, OPT1012C		

			
1			
GEV No.	347150	Ref. No.	226113
description	element holder mounting measurements 23.6x14.6mm grey arched for push buttons 11x21mm		
For models:	GLB0070		

			
1			
GEV No.	346201	Ref. No.	226080
description	element holder mounting measurements 28.5x77.5mm grey three-fold element holder		
For models:	OPT1012		

			
1			
GEV No.	345601	Ref. No.	299035
description	indicator lamp holder V ø 11mm		
For models:	GLB0035, GLB0036, GLB0037, GLB0038, GLB0039, GLB0056, GLB0057, GLB0058, GLB0059, GLB0060, GLB0061, GLB0061C, GLB0062, GLB0063, GLB0064, GLB0064C, GLB0065, GLB0066, GLB0072		

			
1			
GEV No.	345606	Ref. No.	226071
description	momentary switch unit 2CO 250V 16A connection male faston 6.3mm		
For models:	GLB0035, GLB0036, GLB0037, GLB0038, GLB0039, GLB0056, GLB0057, GLB0058, GLB0059, GLB0060, GLB0061, GLB0061C, GLB0062, GLB0063, GLB0064, GLB0064C, GLB0065, GLB0066, GLB0072		

			
1			
GEV No.	347842	Ref. No.	227064
description	push button ø 21mm grey edition		
For models:	GLB0035, GLB0036, GLB0037, GLB0038, GLB0039, GLB0056, GLB0057, GLB0058, GLB0059, GLB0060, GLB0061, GLB0061C, GLB0062, GLB0063, GLB0064, GLB0064C, GLB0065, GLB0066, GLB0072, OPT1012C		

			
1			
GEV No.	347470	Ref. No.	227065
description	push button ø 21mm grey with lens shaft 3.5x3.5mm suitable for ROLD		
For models:	GLB0035, GLB0036, GLB0037, GLB0038, GLB0039, GLB0056, GLB0057, GLB0058, GLB0059, GLB0060, GLB0061, GLB0061C, GLB0062, GLB0063, GLB0064, GLB0064C, GLB0065, GLB0066, GLB0072		

			
1			
GEV No.	346816	Ref. No.	227035
description	push button ø 23mm black		
For models:	OPT1012		

			
1			
GEV No.	347152	Ref. No.	227067
description	push button size 11x21mm blue		
For models:	GLB0070		

			
1			
GEV No.	346847	Ref. No.	409003
description	rotary disc green/black disc ø 18.7mm		
For models:	GLB0035, GLB0036, GLB0037, GLB0038, GLB0039, GLB0056, GLB0057, GLB0058, GLB0059, GLB0060, GLB0061, GLB0061C, GLB0062, GLB0063, GLB0064, GLB0064C, GLB0065, GLB0066, GLB0072		

1

GEV No.	345722	Ref. No.	4.0.000.0510
description	switch 1NO 250V 16A connection male faston 6.3mm		
For models:	EFA0016, EFA0023		



1

GEV No.	345605	Ref. No.	208010
description	switch 2CO 250V 16A connection male faston 6.3mm		
For models:	GLB0035, GLB0036, GLB0037, GLB0038, GLB0039, GLB0056, GLB0057, GLB0058, GLB0059, GLB0060, GLB0061, GLB0061C, GLB0062, GLB0063, GLB0064, GLB0064C, GLB0065, GLB0066, GLB0072, OPT1012C		



1

GEV No.	346851	Ref. No.	80804
description	switch 2CO 250V 16A connection male faston 6.3mm		
For models:	GLB0070, OPT1012		



1

GEV No.	345720	Ref. No.	4.0.000.0513
description	switch 2NO 250V 16A connection male faston 6.3mm		
For models:	EAB0009		

float switches

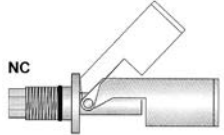
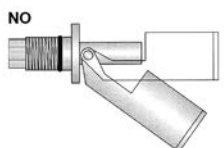
1

GEV No.	347494	Ref. No.	PD.404Q
description	float switch thread M16x1.5 1NO or 1NC ø 17mm L 88mm mounting ø 16mm 250V 1A cable cable length 520mm temp.-resist. -20 up to +105°C		
For models:	NGSB990CE, NGSCD990		

cam switches

on/off



1

GEV No.	301115	Ref. No.	073015.46
description	cam switch 2 operating positions 2NO sequence 0-1 16A shaft ø 6x4.6mm shaft L 23mm connection male faston 6.3mm		
For models:	AJA0014, AJA0015, AJA0017, AJA0018, AJG0011, AMZ0024		



1

GEV No.	300129	Ref. No.	073016
description	cam switch 2 operating positions 2NO sequence 0-1 16A shaft ø 6x4.6mm shaft L 23mm connection male faston 6.3mm ceramic		
For models:	2158, 2623, AAC0001, AAC0002, AJA0016, AJE0001, AJE0002, AJE0003, AJE0005, AJE0006, AJE0007, AJH0003, AJH0008, AJH0009, AMZ0004, AMZ0005, AMZ0006, AMZ0007, APZ0001, APZ0012, ARZ0004, ARZ0005, ARZ0006, IFA0004		

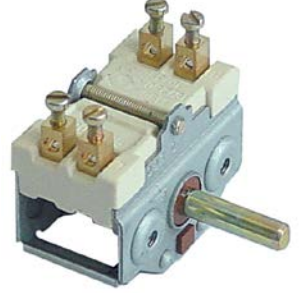

1

GEV No.	300151	Ref. No.	X51300
description	cam switch 2 operating positions 2NO sequence 0-1 16A shaft ø 6x4.6mm shaft L 23mm connection screw ceramic		
For models:	ACK1002, ACK101V, ACK102V, ADK201V, ADK202V, ADK203V, ADK204V, ADK207V, ADK208V, ADK209V, ADK210V		

1

GEV No.	300176	Ref. No.	073005
description	cam switch 2 operating positions 4NO sequence 0-1 16A shaft ø 6x4.6mm shaft L 23mm connection screw		
For models:	AMZ0008, APZ0002		

4-position



1

GEV No.	300023	Ref. No.	073055
description	cam switch 4 operating positions 1NO/2CO sequence 0-1-2-3 16A shaft ø 6x4.6mm shaft L 23mm connection screw 4-position ceramic		
For models:	AJA0015, AJG0011		

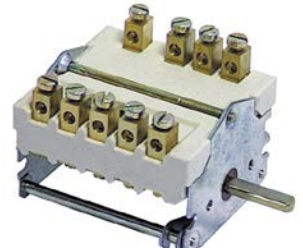

1

GEV No.	300104	Ref. No.	X44000
description	cam switch 4 operating positions 3NO/1CO sequence 0-1-2-3 32A shaft ø 6x4.6mm shaft L 23mm connection screw ceramic		
For models:	ACE003V, ACE004V, ACE008V, ADE003V, ADE004V		

7-position







1

GEV No.	300004	Ref. No.	X54100
description	cam switch 7 operating positions 1NO/2CO sequence 0-1-2-3-4-5-6 16A shaft ø 6x4.6mm shaft L 23mm connection male faston 6.3mm 7-position ceramic		
For models:	ACA1001, ACA1002, ACA1004, ACA101V, ACA102V, ACA104V, ACA105V, ACJ005V, ACJ007V, ACJ008V, ADA101V, ADA103V, ADA104V, ADA106V		



1

GEV No.	300025	Ref. No.	073007 661.002.00
description	cam switch 7 operating positions 1NO/2CO sequence 0-1-2-3-4-5-6 16A shaft ø 6x4.6mm shaft L 23mm connection screw 7-position ceramic		
For models:	6030PCE, 6060CFE, 6060PCE, 6540PCE, 6570CFE, 6570PCE, 7040PCE, 7040PCEQ, 7070CFEQ, 7070PCEQ, 92PCE, 94CFE, 94PCE, 96CFE, 96PCE, AOZ0001, AOZ0002		
accessories for	300025		
	GEV No.	112172	Ref. No. —
	knob universal ø 70mm black without adaptor/dial plate		
	GEV No.	112213	Ref. No. —
	knob dial plate silver switch 7-position t.max.°C ED ø 63mm ID ø 45.5mm		
	GEV No.	112311	Ref. No. —
	knob adapter shaft ø 6x4.6mm L 0mm with spring		



1

GEV No.	300106	Ref. No.	96100000
description	cam switch 7 operating positions 1NO/2CO sequence 0-1-2-3-4-5-6 32A shaft ø 6x4.6mm shaft L 23mm connection screw 7-position shaft flat upper		
For models:	92PCE, 94CFE, 94PCE, 96CFE, 96PCE		

3 operating positions



1

GEV No.	300167	Ref. No.	E11000
description	cam switch 3 operating positions 2NO/1CO sequence 0-1-2 16A shaft ø 6x4.6mm shaft L 23mm connection screw		
For models:	ACL0002, ACL002V, ADL001V, ADL002V, ADL003V, ADL004V, ADL005V		



1

GEV No.	345492	Ref. No.	Z213003000
description	cam switch 3 operating positions 3NO sequence 1-0-2 16A shaft ø 6x4.6mm shaft L 23mm connection male faston 6.3mm		
For models:	GLB0061C-F, GLB0063C-F		

4 operating positions





1

GEV No.	300229	Ref. No.	COM30001
description	cam switch 4 operating positions 4NO sequence 0-1-0-2 16A shaft ø 6x4.6mm shaft L 23mm connection male faston 6.3mm plastic		
For models:	VP914RXS, VP916RXS, VP920RXS		



1

GEV No.	300210	Ref. No.	661.037.00
description	cam switch 4 operating positions 4NO sequence 0-1-2-3 16A shaft ø 6x4.6mm shaft L 23mm connection screw ceramic		
For models:	6060CPE, 6540CPE, 6570CPE, 7040CPE, 7070CPE, 92CPE, 92CPES, 94CPE, 94CPES, AFE0002		
accessories for	300210		
	GEV No.	551456	Ref. No. —
gasket for switch ED ø 14mm ID ø 2.5mm thickness 3.5mm white			



1

GEV No.	300145	Ref. No.	66106200
description	cam switch 4 operating positions 4NO sequence 0-1-2-3 32A shaft ø 6x4.6mm shaft L 23mm connection screw ceramic		
For models:	7070PEI, 94PE100I, 94PE100IA, 94PE100IAS, 94PE100IS, 94PE150I, 94PE150IA		



1

GEV No.	347386	Ref. No.	Z273005000
description	cam switch 4 operating positions 6NO sequence 0-1-2-3 16A shaft ø 6x4.6mm shaft L 23mm connection male faston 6.3mm 7LA 840601		
For models:	OPT1012-CF		



1

GEV No.	347817	Ref. No.	12024445
description	cam switch 4 operating positions 8NO sequence 1-0-2-3 16A shaft ø 6x4.6mm shaft L 23mm connection male faston 6.3mm plastic		
For models:	GLB0061C-F, GLB0061C-FN, GLB0063C-F, GLB0063C-FN		

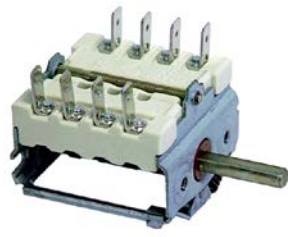

1

GEV No.	300184	Ref. No.	X44100
description	cam switch 4 operating positions sequence 0-3-2-1 shaft ø 6x4.6mm connection male faston 4-pole		
For models:	ACA1004, ACA104V, ACA105V, ACA2007, ACA207V, ACA216, ACA216V, ADA104V, ADA106V, ADA205V, ADA208V, ADA210V, ADA212V		



1

GEV No.	345493	Ref. No.	Z223001000
description	cam switch 4 operating positions sequence 1-0-2-3 shaft ø 6x4.6mm connection male faston 8-pole		
For models:	GLB0061C-F, GLB0063C-F		



5 operating positions



1

GEV No.	300114	Ref. No.	661.074.00
description	cam switch 5 operating positions 5NO sequence 0-1-2-3-4 16A shaft ø 6x4.6mm shaft L 23mm connection male faston 6.3mm		
For models:	6060CFE, 6060CFGE		

7 operating positions

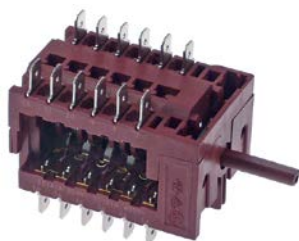

1

GEV No.	301298	Ref. No.	12024932
description	cam switch 7 operating positions 12NO sequence 0-1-2-3-4-5-6 16A shaft ø 6x4.6mm shaft L 23mm connection male faston 6.3mm plastic 12-pole		
For models:	OPT1012-CF		



1

GEV No.	300269	Ref. No.	661.125.00
description	cam switch 7 operating positions 16A sequence 0-1-2-3-4-5-6 shaft ø 6x4.6mm shaft L 23mm connection screw		

10 operating positions



1

GEV No.	301205	Ref. No.	01950037000
description	cam switch 10 operating positions 5NO/1CO sequence 0-1-2-3-4-5-6-7-8-9 16A shaft ø 6x4.6mm shaft L 23mm connection male faston 6.3mm ceramic		
For models:	AIB0017		



1

GEV No.	345666	Ref. No.	X68204
description	cam switch 10 operating positions 6NO/1CO sequence 0-1-2-3-4-5-6-7-8-9 8A shaft ø 6x4.6mm shaft L 23mm connection male faston 6.3mm plastic		
For models:	ACA2010, ACA206V, ACA210V		

operation switches



1

GEV No.	300080	Ref. No.	661.000.00
description	cam switch 2 operating positions 4NO 16A sequence 0-1 shaft ø 6x4.6mm shaft L 23mm connection screw operation switch ceramic ambient temperature max. 150°C		
For models:	6030BME, 6030FRE, 6030FTE, 6030SPE, 6060BME, 6060FRE, 6060FTE, 6060FTRE, 6060FTRRE, 65110CFGE, 6540BME, 6540FRE, 6540FTE, 6540FTECR, 6540FTRE, 6540FTRECR, 6540SPE, 6570BME, 6570BRE, 6570CFE, 6570CFGE, 6570FRE, 6570FTE, 6570FTECR, 6570FTRE, 6570FTRECR, 6570FTRRE, 70110CFGE, 7040BME, 7040FRE10, 7040FTE, 7040FTECR, 7040FTES, 7040FTRE, 7040SPE, 7070BME, 7070BRE, 7070BREM, 7070CFEQ, 7070CFGE, 7070CFVE, 7070FRE10, 7070FTE, 7070FTECR, 7070FTRE, 7070FTRECR, 7070FTRRE, 92BME, 92FRE18, 92FRE18S...(Other models you can see in the webshop)		
accessories for	300080		
		GEV No.	551456
		Ref. No.	—
	gasket for switch ED ø 14mm ID ø 2.5mm thickness 3.5mm white		

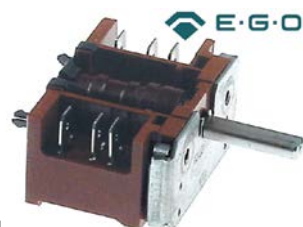

1

GEV No.	301214	Ref. No.	91310095
description	cam switch 2 operating positions operation switch 16A sequence 0-1 shaft ø 6x4.6mm shaft L 33mm connection male faston 6.3mm plastic ambient temperature max. 150°C		
For models:	CAB0029-CN, CAB0030-CN, CAB0032, CAB0032-CN, CAB0033, CAB0033-CN, CAB0035		

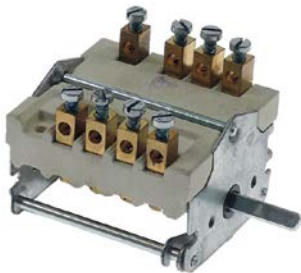

1

GEV No.	300180	Ref. No.	961.031.00
description	cam switch 2 operating positions operation switch 32A sequence 0-1 shaft \varnothing 6x4.6mm shaft L 23mm connection screw ceramic		



1

GEV No.	300269	Ref. No.	661.125.00
description	cam switch 7 operating positions 16A sequence 0-1-2-3-4-5-6 shaft \varnothing 6x4.6mm shaft L 23mm connection screw		



1

GEV No.	345668	Ref. No.	X49700
description	operation switch		
For models:	ACA1004, ACA104V, ACA105V, ACA2007, ACA207V, ACA216, ACA216V, ACH301V, ACH302V, ACH303V, ACH304V, ACH305V, ACH306V, ACH307V, ACH318V, ACH319V, ACH320V, ADA104V, ADA106V, ADA205V, ADA208V, ADA210V, ADA212V, ADH301V, ADH302V, ADH303V, ADH304V, ADH305V, ADH306V		



1

GEV No.	300183	Ref. No.	01950337400
description	operation switch 5 operating positions 5NO 16A sequence 0-1-2-3-4 shaft \varnothing 6x4.6mm shaft L 23mm connection male faston 6.3mm plastic ambient temperature max. 270°C		
For models:	AAA2002		



1

GEV No.	300091	Ref. No.	3700003 Y16200
description	operation switch EGO 2 operating positions 2NO 16A sequence 0-1 shaft \varnothing 6x4.6mm shaft L 23mm connection screw ceramic		
For models:	ACC0003, ACC003V, ACC004V, ACC005V, ACC008V, ACC010V, ACK2003, ACK2004, ACK203V, ACK204V, ADC004V, ADC006V, IIA3006, IIA3007, IIA3008, IIA3010, IIA3011, IIA3012, IIA4002, IIA4003		

rotary switches

BREMAS

A1600 series



1

GEV No.	347401	Ref. No.	205004
description	rotary switch 4 momentary switch-0-1-momentary switch sets of contacts 8 type CS0077762 600V 16A shaft \varnothing 5x5mm shaft L 22mm shaft square connection screw		
For models:	OPT1012		

A1700 series



1

GEV No.	346397	Ref. No.	5.0.000.0061
description	rotary switch 3 0-1-2 sets of contacts 6 type CA020V200 400V 20A shaft \varnothing 5x5mm shaft L 23mm shaft square connection screw		
For models:	EFA0015, EFA0016, EFA0023		
accessories for	346397		



GEV No.	110619	Ref. No.	—
description	knob switch zero mark t.max. °C \varnothing 48mm shaft \varnothing 5x5mm shaft flat black		

GOTTAK



1

GEV No.	347874	Ref. No.	12023965
description	rotary switch 5 0-1-2-3-4 sets of contacts 10 type 46RCTH 400V 16A shaft \varnothing 6x4.6mm shaft L 23mm shaft 6x4.6 connection male faston 6.3mm		
For models:	OPT1012-CFN		



producer-specific rotary switches

DIHR / KROMO			
			
1			
GEV No.	345896	Ref. No.	0065736
description	O-ring EPDM thickness 1.5mm ID ø 37mm Qty 1 pcs		
For models:	FGZ0009		

miscellaneous

			
1			
GEV No.	347040	Ref. No.	0220060
description	rotary switch sets of contacts 3 2 0-1 momentary type 400V 32A shaft ø 5x5mm shaft Lmm connection screw		
For models:	FGZ0007, FGZ0009, FGZ0027, FGZ0028		

accessories

levers

			
1			
GEV No.	347041	Ref. No.	0220065
description	knob 2 0-1 typeVA shaft ømm shaft Lmm connection for rotary switch		
For models:	FGZ0007, FGZ0009, FGZ0027, FGZ0028		

magnetic switches

36x13mm

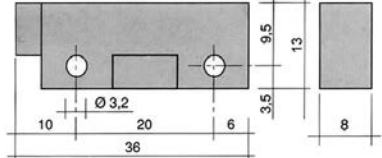
			
1			
			

GEV No.	345335	Ref. No.	IV5820000
description	magnetic switch L 36mm W 13mm 1NO 250V 0.04A P max. 10W connection cable cable length 960mm		
For models:	FLA0028		
accessories for	345335		
	GEV No.	519049	Ref. No.
			—
	 magnet ømm L 63mm H 10.7mm W 18.8mm hole distance 52mm M2 hole ø 2mm		

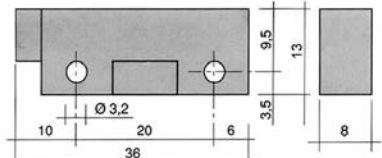
			
1			
			

GEV No.	345118 ¹	Ref. No.	211002 211002AG 80871 F2066 PD.424D
description	magnetic switch L 36mm W 13mm 1NO 250V 1A P max. 50W connection cable cable length 980mm		
For models:	AMZ0037-N, FHZ0001, FIF0023, GLB0035, GLB0036, GLB0037, GLB0038, GLB0039, GLB0046, GLB0056, GLB0057, GLB0058, GLB0059, GLB0060, GLB0061, GLB0061C, GLB0062, GLB0063, GLB0064, GLB0064C, GLB0065, GLB0066, GLB0070, GLB0071, GLB0072, GLB0073, OPT1012, OPT1012C		
accessories for	345118		
	GEV No.	345399	Ref. No.
			927088
	 magnet ø 3.3mm L 40mm H 8mm W 13mm hole distance 30mm M3		

¹with coded connector



40x13mm



1

GEV No.	300273	Ref. No.	LF1010005
description	magnetic switch L 40mm W 13mm 1NO 250V 1A P max. 50W connection cable length 1180mm		
For models:	FID0005, FID0006, FIF0014, TC32BU, TC32NEVADAT		

65x20mm



1

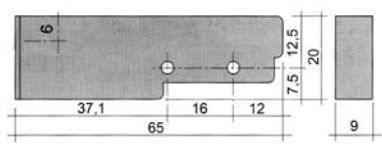

GEV No.	345116	Ref. No.	927017	
description	magnetic switch L 65mm W 20mm 1NO 250V 0.4A P max. 100W connection cable length 3000mm			
For models:	GLB0043, GLB0044, GLB0046			
accessories for	345116			
	GEV No.	345399	Ref. No.	927088
	magnet \varnothing 3.3mm L 40mm H 8mm W 13mm hole distance 30mm M3			

\varnothing 6mm



1

GEV No.	345202	Ref. No.	12024477 Z203009000
description	magnetic switch 250V 0.04A P max. 10W probe L 29mm 1NO connection plug cable length 1400mm		
For models:	GLB0035-F, GLB0035-FN, GLB0037-F, GLB0037-FN, GLB0061C-F, GLB0061C-FN, GLB0063C-F, GLB0063C-FN, OPT1012-CF, OPT1012-CFN		

accessories

magnets



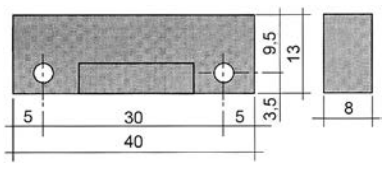

Image not available

1

GEV No.	346392	Ref. No.	F2063
description	magnet		
For models:	FHZ0001, FIF0023		

1

GEV No.	345399	Ref. No.	927088
description	magnet \varnothing 3.3mm L 40mm H 8mm W 13mm hole distance 30mm M3		
For models:	GLB0046, GLB0070, GLB0071, OPT1012, OPT1012C		

1

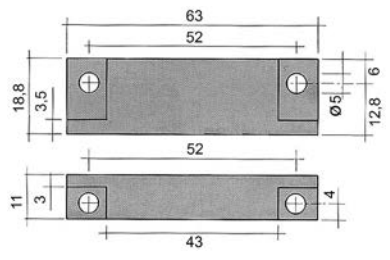
GEV No.	345336	Ref. No.	926014
description	magnet \varnothing 4.8mm L 63mm H 11mm W 18.8mm hole distance 51mm M4		
For models:	GLB0046		



1

GEV No.	347968	Ref. No.	F2925
description	magnet \varnothing 6mm L 20mm H mm W mm mounting \varnothing 6mm		
For models:	FLC0001-F, FLC0003-F, FLC0012-F, FMD0001-F, FMD0002-F		



1

GEV No.	505004	Ref. No.	12024303 Z200506000
description	magnet \varnothing mm L 17mm H 12mm W 14mm		
For models:	GLB0035-FN, GLB0037-FN, GLB0061C-F, GLB0061C-FN, GLB0063C-F, GLB0063C-FN, OPT1012-CF, OPT1012-CFN		



			
1			
GEV No.	346953	Ref. No.	999108
description	magnet ømm L 23mm H 17mm W 18mm M6 hole ø 6.5mm		
For models:	GLB0058, GLB0059, GLB0060, GLB0061, GLB0061C, GLB0062, GLB0063, GLB0064, GLB0064C, GLB0065, GLB0066, GLB0072		

			
1			
GEV No.	347810	Ref. No.	A61583030GP
description	switch for microwave right 1CO		
For models:	NE1880, NE2140, NE3240		

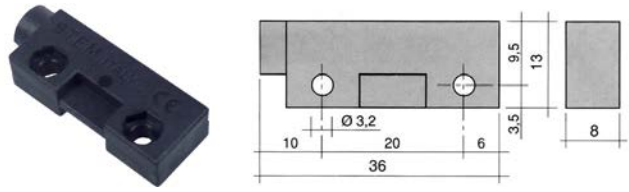
			
1			
GEV No.	345398	Ref. No.	217003
description	magnet ømm L 36mm H 8mm W 13mm hole distance 20mm M3 hole ø 3mm		
For models:	OPT1012		

control equipment

ABB

ø22mm

switches (complete)

			
1			
GEV No.	347425	Ref. No.	X56200 X69100
description	momentary push switch mounting measurements ø22mm black 1NC/1NO 250V 5A connection screw ambient temperature max. 85°C protection IP40		
For models:	ADK202V, ADK204V, ADK208V, ADK210V		

magnetic holders

			
1			
GEV No.	700816	Ref. No.	12024094 Z200507000
description	protection cap for magnet internal size 14x17mm H 17mm for dishwasher		
For models:	GLB0035-FN, GLB0037-FN, GLB0061C-F, GLB0061C-FN, GLB0063C-F, GLB0063C-FN, OPT1012-CF, OPT1012-CFN		

			
1			
GEV No.	347426 ¹	Ref. No.	X56300 X69000
description	momentary push switch mounting measurements ø22mm red 1NC/1NO 250V 5A connection screw ambient temperature max. 85°C protection IP40		
For models:	ADK202V, ADK204V, ADK208V, ADK210V		

¹incl. knob

miscellaneous

			
1			
GEV No.	347811	Ref. No.	A61583050GP
description	switch for microwave left 1CO		
For models:	NE1880, NE2140, NE3240		

			
1			
GEV No.	347153	Ref. No.	0220006
description	push switch mounting measurements ø22mm black 2NO 300V 5A connection screw ambient temperature max. 85°C protection IP40		
For models:	FGZ0005, FGZ0006, FGZ0007, FGZ0009, FGZ0012, FGZ0013, FGZ0025, FGZ0026, FGZ0027, FGZ0028		



BRETER

switches (complete)



1

GEV No.	345771	Ref. No.	66105600
description	momentary push switch yellow 1NC/1NO		
For models:	7070BREM, 7070BRGM		

ERSCE



1

GEV No.	345989	Ref. No.	X56500
description	contact block ERSCE C01B 1NC max 230V 10(4)A red		
For models:	ADK202V, ADK204V, ADK208V, ADK210V		

GENERAL ELECTRIC (AEG)



1



GEV No.	345779	Ref. No.	079003
description	contact block GENERAL ELECTRIC P9B10VN 1NO max 400V 10A brown		
For models:	2158, 2623		

GIOVENZANA

switches (complete)



1

GEV No.	401357	Ref. No.	F2138	
description	momentary push switch mounting measurements ø22mm 1NO/1NC/indicator light 400V 4A indicator lamp 24V 0-1 connection screw ambient temperature max. 125/55°C protection IP40			
For models:	FHZ0003, FIF0001, FIF0002, FIF0003-22HP, FIF0004, FIF0005, FIG0003-F, FIG0011-F, TCG22E-F			
spare parts for	401357			
	GEV No.	346181	Ref. No.	—
accessories for	push button mounting ø 21mm external size 30x55mm oval			
	GEV No.	401709	Ref. No.	—
accessories for	protective cover external size 57x32mm internal size 47x22mm matt finish rubber H 27.5mm			

LOVATO



1

GEV No.	301321	Ref. No.	961.051.00
description	contact block LOVATO LPX C10 1NO max 690V 10A light grey		

plastic series

rotary switches



1

GEV No.	301320	Ref. No.	961.050.00
description	rotary selector mounting measurements ø22mm black/silver sequence 1-0-2 latching		

TELEMECANIQUE (EFA)

XB4 series

switches (complete)



1

GEV No.	346934	Ref. No.	66105700
description	momentary push switch mounting measurements ø22mm blue 1NO/1NC		
For models:	7070BREM, 7070BRGM		

encoders and potentiometers



1

GEV No.	401953	Ref. No.	IB5944010
description	PCB hand blenders VORTEX with potentiometer 230V		
For models:	FJZ0010, FJZ0011, FJZ0012		





1



GEV No.	300189	Ref. No.	ELET0200
description	potentiometer		
For models:	CAD0004, CAD0005, CAD0007, SY850VELED		



			
1			
GEV No.	300362	Ref. No.	19414060N
description	potentiometer 0.1KOhm rotation 270° shaft ø 6mm confectioned shaft L 42mm thread M10 cable length 28mm Orione		
For models:	FLA0014, FLA0015		

			
1			
GEV No.	300227	Ref. No.	IB5940011
description	potentiometer 0.1KOhm rotation 270° shaft ø 6mm shaft L 42mm thread M10 cable length 600mm		
For models:	SIRIO1VVCAFFE, SIRIO2VVCAFFE		

accessories for	359818			
	GEV No.	359833	Ref. No.	—
	indicator light lens red Qty 1 pcs ø 8mm			
	GEV No.	359948	Ref. No.	—
	indicator light lens clear Qty 1 pcs ø 8mm			

				
1				
GEV No.	359817	Ref. No.	01951187000 09950377000	
description	indicator light 230V green connection male faston 6.3mm			
For models:	AAA2002, AIB0012, AIB0013, AIB0014, AIB0015, AIB0017, KF630, KF733, KF933U, KF965, KF981D			
accessories for	359817			
	GEV No.	359819	Ref. No.	09950388535
	indicator light lens green Qty 1 pcs ø 8mm			

lamps

indicator lights

indicator lights 2-piece (lens and indicator lamp)

indicator light lenses

ø 8mm (type RL-2)

			
1			
GEV No.	359819	Ref. No.	09950388535
description	indicator light lens green Qty 1 pcs ø 8mm		
For models:	AAA2002, AIB0012, AIB0013, AIB0014, AIB0015, AIB0017, KF630, KF733, KF933U, KF965, KF981D		

			
1			
GEV No.	359820	Ref. No.	09950368534
description	indicator light lens yellow Qty 1 pcs ø 8mm		
For models:	AAA2002, AIB0012, AIB0013, AIB0014, AIB0015, AIB0017, KF1001G, KF630, KF733, KF933U, KF965, KF981D		

indicator lamps for socket type RL

				
1				
GEV No.	359818	Ref. No.	01950377000 01951177000	
description	indicator light 230V clear connection male faston 6.3mm			
For models:	AAA2002, AIB0012, AIB0013, AIB0014, AIB0015, AIB0017, KF1001G, KF630, KF733, KF933U, KF965, KF981D			
accessories for	359818			
	GEV No.	359820	Ref. No.	09950368534
	indicator light lens yellow Qty 1 pcs ø 8mm			

indicator lamps for socket type SRZ / SDK / SDY / SFK

			
1			
GEV No.	359130	Ref. No.	216006
description	indicator lamp 230V clear connection male faston 6.3mm ø 8mm		
For models:	GLB0035, GLB0036, GLB0037, GLB0038, GLB0039, GLB0056, GLB0057, GLB0058, GLB0059, GLB0060, GLB0061, GLB0061C, GLB0062, GLB0063, GLB0064, GLB0064C, GLB0065, GLB0066, GLB0072		

indicator lights (complete)

ø 6mm

			
1			
GEV No.	359031	Ref. No.	IND30001
description	indicator light ø 6mm 230V green		
For models:	VP914RXS, VP916RXS, VP920RXS		

			
1			
GEV No.	359038	Ref. No.	91310116
description	indicator light ø 6mm 230V red		
For models:	CAB0029-CN, CAB0030-CN, CAB0032, CAB0032-CN, CAB0033, CAB0033-CN, CAB0035		

			
1			
GEV No.	359032	Ref. No.	IND30002
description	indicator light ø 6mm 230V yellow		
For models:	VG715RXS, VP800U, VP824RU, VP914RXS, VP916RXS, VP920RXS		



1			
GEV No.	357072	Ref. No.	C5120219
description	indicator light ø 6mm 220V red connection cable 300mm cable length 300mm metal		
For models:	53054-CN, 53304, AJD0002-CCN, AJD0003-CCN, AJD0014-C, AJD0019-C		



1			
GEV No.	359336	Ref. No.	91310115
description	indicator light ø 6mm 230V green		
For models:	CAB0029-CN, CAB0030-CN, CAB0032, CAB0032-CN, CAB0033, CAB0033-CN, CAB0035		

ø 8mm



1			
GEV No.	360742	Ref. No.	963.016.00
description	indicator light ø 8mm green 28V connection male faston 2.8mm		

ø 9mm



1			
GEV No.	359137	Ref. No.	Z203079000
description	indicator light ø 9mm 230V yellow connection male faston 6.3mm temp.-resist. 120°C with lens		
For models:	OPT1012-CF		

ø 10mm

with screw socket



1			
GEV No.	359791	Ref. No.	3760004
description	indicator light ø 10mm 230V green cable length 250mm		
For models:	IIA3006, IIA3007, IIA3008, IIA3010, IIA3011, IIA3012, IIA4002, IIA4003		



1			
GEV No.	360481	Ref. No.	SHELSTLYSA100
description	indicator light ø 10mm 250V green cable length 300mm socket screw base		
For models:	IEA0002-I, IEC0002-I		

with plug-in socket



1			
GEV No.	359139	Ref. No.	4.0.025.0130
description	indicator light ø 10mm green 230V connection male faston 6.3mm Qty 1 pcs		
For models:	EFA0015, EFA0016, EFA0023		



1			
GEV No.	359140	Ref. No.	4.0.025.0135 46301200 IB5846400
description	indicator light ø 10mm yellow 230V connection male faston 6.3mm Qty 1 pcs		
For models:	92BME, 92FRE18, 92FRE18S, 92FTEL, 92FTELC, 92FTER, 92FTERC, 94BRE, 94BREM, 94CFE, 94CFGE, 94CFV, 94FRE18, 94FRE18S, 94FTEL, 94FTELC, 94FTELR, 94FTELCR, 94FTELR, 94FTELR, 94FTELR, 96BRE, 96BREM, 96CFE, 96CFGE, EFA0015, EFA0016, EFA0023, IBA0012, IBA0013		

ø 12mm

with screw socket



1			
GEV No.	359048	Ref. No.	076006
description	indicator light ø 12mm 230V yellow connection male faston 6.3mm		
For models:	2158, AAC0001, AAC0002, AAD0001, AJA0014, AJA0015, AJA0017, AJA0018, AJE0001, AJG0003, AJG0004, AJH0001, AJH0002, AJH0003, AJH0007, AJH0008, AJH0009, AMZ0004, AMZ0005, AMZ0006, AMZ0007, AMZ0008, AMZ0024, AOZ0001, AOZ0002, APZ0001, APZ0002, APZ0012, ARZ0004, ARZ0005, ARZ0006, AXZ0003, IFA0004, IFB0001, IFB0002		





1			
GEV No.	359027	Ref. No.	076005 12025211 R693055000
description	indicator light ø 12mm 250V green connection male faston 6.3mm		
For models:	2158, 2623, AAC0001, AAC0002, AJA0014, AJA0015, AJA0017, AJA0018, AJE0001, AJE0005, AJG0003, AJG0004, AJG0011, AJH0003, AJH0008, AJH0009, AMZ0004, AMZ0005, AMZ0006, AMZ0007, AMZ0008, AMZ0024, APZ0001, APZ0002, APZ0012, ARZ0001, ARZ0002, ARZ0004, ARZ0005, ARZ0006, GLB0035-FN, GLB0037-FN, GLB0061C-F, GLB0061C-FN, GLB0063C-F, GLB0063C-FN, IFA0004, OPT1012-CF, OPT1012-CFN		





1			
GEV No.	359291	Ref. No.	663.043.00
description	indicator light ø 12mm 400V green connection male faston 6.3mm		
For models:	6030BME, 6030CPE, 6030FRE, 6030FTE, 6030PCE, 6030SPE, 6060BME, 6060CFE, 6060CFG, 6060CFGE, 6060CPE, 6060FRE, 6060FTE, 6060FTRE, 6060FTRRE, 6060PCE, 6570BME, 7040CPE, 7040PVE, 7070CPE, AFE0002, VI6030PVED, VI6060PVED		





			
1			
GEV No.	359290	Ref. No.	663.044.00
description	indicator light ø 12mm 400V yellow connection male faston 6.3mm		
For models:	6030BME, 6030CPE, 6030FRE, 6030FTE, 6060BME, 6060CFE, 6060CFGE, 6060CPE, 6060FRE, 6060FTE, 6060FTRE, 6060FTRRE, 6570BME		



with plug-in socket			
			
1			
GEV No.	359041	Ref. No.	X50900
description	indicator light ø 12mm green 230V connection male faston 6.3mm temp.-resist. 120°C Qty 1 pcs		
For models:	ACA1001, ACA1002, ACA1003, ACA1004, ACA1010, ACA101V, ACA102V, ACA103V, ACA104V, ACA105V, ACA106V, ACA110V, ACA2007, ACA2010, ACA204V, ACA206V, ACA207V, ACA208V, ACA210V, ACA216, ACA216V, ACC0003, ACC003V, ACC004V, ACC005V, ACC008V, ACC010V, ACE003V, ACE004V, ACE008V, ACH301V, ACH302V, ACH303V, ACH304V, ACH305V, ACH306V, ACH307V, ACH318V, ACH319V, ACH320V, ACJ005V, ACJ006V, ACJ007V, ACJ008V, ACK1002, ACK101V, ACK102V, ACK2003, ACK2004, ACK203V...(Other models you can see in the webshop)		



			
1			
GEV No.	359042	Ref. No.	X41200
description	indicator light ø 12mm yellow 230V connection male faston 6.3mm temp.-resist. 120°C Qty 1 pcs		
For models:	ACA1004, ACA104V, ACA105V, ACA2007, ACA2010, ACA206V, ACA207V, ACA210V, ACA216, ACA216V, ACB0004, ACB002V, ACB004V, ACC0003, ACC003V, ACC004V, ACC005V, ACC008V, ACC010V, ACH301V, ACH302V, ACH303V, ACH304V, ACH305V, ACH306V, ACH307V, ACH318V, ACH319V, ACH320V, ACK2003, ACK2004, ACK203V, ACK204V, ACK301V, ACK302V, ACK303V, ACK304V, ADA104V, ADA106V, ADA205V, ADA208V, ADA210V, ADA212V, ADB002V, ADB003V, ADC004V, ADC006V, ADH301V, ADH302V, ADH303V...(Other models you can see in the webshop)		



			
1			
GEV No.	505099	Ref. No.	12024254 R693056000
description	indicator light ø 12mm 230V yellow		
For models:	GLB0035-FN, GLB0037-FN, GLB0061C-F, GLB0061C-FN, GLB0063C-F, GLB0063C-FN, OPT1012-CF, OPT1012-CFN		



ø13mm			
with screw socket			
			
1			
GEV No.	359146	Ref. No.	963.013.00
description	indicator light ø 13mm 230V yellow		
For models:	GEU411, GEU611, GEV1011		
accessories for	359146		
	GEV No.	510302	Ref. No. —
O-ring EPDM ID ø 12.42mm thickness 1.78mm Qty 1 pcs			

accessories for	359146		
	GEV No.	511505	Ref. No. —
O-ring EPDM thickness 1.78mm ID ø 12.42mm Qty 10 pcs			



			
1			
GEV No.	359049	Ref. No.	66300000
description	indicator light ø 13mm 400V green		
For models:	65110CFGE, 6540BME, 6540CPE, 6540FRE, 6540FTE, 6540FTECR, 6540FTRE, 6540FTRECR, 6540PCE, 6540SPE, 6570BME, 6570BRE, 6570CFE, 6570CFGE, 6570CPE, 6570FRE, 6570FTE, 6570FTECR, 6570FTRE, 6570FTRECR, 6570FTRRE, 6570PCE, 6570PVE, 70110CFGE, 7040BME, 7040CPE, 7040FRE10, 7040FTE, 7040FTECR, 7040FTES, 7040FTRE, 7040PCE, 7040PCEQ, 7040PVE, 7040SPE, 7070BME, 7070BRE, 7070BREM, 7070CFEQ, 7070CFGE, 7070CFVE, 7070CPE, 7070FRE10, 7070FTE, 7070FTECR, 7070FTRE, 7070FTRECR, 7070FTRRE, 7070PCEQ, 7070PEI...(Other models you can see in the webshop)		
accessories for	359049		
	GEV No.	510302	Ref. No. —
O-ring EPDM ID ø 12.42mm thickness 1.78mm Qty 1 pcs			
	GEV No.	511505	Ref. No. —
O-ring EPDM thickness 1.78mm ID ø 12.42mm Qty 10 pcs			



			
1			
GEV No.	359050	Ref. No.	66300100
description	indicator light ø 13mm 400V yellow		
For models:	65110CFGE, 6540BME, 6540FRE, 6540FTE, 6540FTECR, 6540FTRE, 6540FTRECR, 6570BME, 6570BRE, 6570CFE, 6570CFGE, 6570FRE, 6570FTE, 6570FTECR, 6570FTRE, 6570FTRECR, 6570FTRRE, 70110CFGE, 7040BME, 7040FRE10, 7040FTE, 7040FTECR, 7040FTES, 7040FTRE, 7070BME, 7070BRE, 7070BREM, 7070CFEQ, 7070CFGE, 7070CFVE, 7070FRE10, 7070FTE, 7070FTECR, 7070FTRE, 7070FTRECR, 7070FTRRE, 94CFE, AFB0003, AFC0003		
accessories for	359050		
	GEV No.	510302	Ref. No. —
O-ring EPDM ID ø 12.42mm thickness 1.78mm Qty 1 pcs			
	GEV No.	511505	Ref. No. —
O-ring EPDM thickness 1.78mm ID ø 12.42mm Qty 10 pcs			

ø16mm			
with screw socket			
			
1			
GEV No.	359835	Ref. No.	PD.414K
description	indicator light ø 16mm 230V green connection male faston 6.3mm		
For models:	AHC0001, AHC0002, AHC0004, AHC0005		
accessories for	359835		
	GEV No.	550559	Ref. No. —
nut thread M16x1 H 5.5mm WS 19			

			
1			
GEV No.	359834	Ref. No.	PD.414J PD.414JB
description	indicator light ø 16mm 230V yellow connection male faston 6.3mm temp.-resist. 120°C		
For models:	AHC0001, AHC0002, AHC0004, AHC0005, AHC0007, AMZ0037-N, TP12EP, TP15EP		
accessories for	359834		
	GEV No.	550559	Ref. No. —
nut thread M16x1 H 5.5mm WS 19			

30x22mm			
			
1			
GEV No.	301303	Ref. No.	B00DU101
description	indicator lamp mounting measurements 30x22mm red indicator light 250V 16A connection male faston 6.3mm ambient temperature max. 125°C protection IP40		
For models:	9925F, 9931F, 9931VF, 9932F, 9953F, BMA0013-F, BMA0034-F, BMA0038-F, BMA0098, BMA0099, BMB0002-F, BMB0002-FG, BMB0004-F, BMB0014-F, BMB0014-FG, BMB0015-F, BMB0042-F, BMC0001-F, BMC0001-FG, BMC0003-F, BNA0068, BNA0069, BNC0001BAR-F, BNC0001-F, BNC0002-F, BNC0007BAR-F, BNC0007-F, BNC0008-F, BNC0015BAR-F, BNC0015-F, BNC0016-F, BNC0030, BNC0030PI, BNC0032, BNC0033, BNC0034, BNC0034PI, BNC0035, CCZ0009-F, CCZ0018-F, CCZ0050, HAB0001-F, HAB0007-F, HAB0009-F, HAB0015-F, HAB0020, HAB0021, HCE2004-F, HCE2005-F, HCE2006-F... (Other models you can see in the webshop)		

			
1			
GEV No.	359178	Ref. No.	LAMP0006
description	indicator light mounting measurements 30x22mm 230V green connection male faston 6.3mm temp.-resist. 85°C type Marquardt 1667.. IP44		
For models:	CAD0005, CAD0007, SY850VELED		
accessories for	359178		
	GEV No.	301036	Ref. No. —
protective cover internal size 30x22mm for rocker switch mounting measurementsmm			

			
1			
GEV No.	359180	Ref. No.	LAMP0002
description	indicator light mounting measurements 30x22mm 230V yellow connection male faston 6.3mm type Marquardt 1667..		
For models:	CAD0004, CAD0005, CAD0007, SY850VELED		
accessories for	359180		
	GEV No.	301036	Ref. No. —
protective cover internal size 30x22mm for rocker switch mounting measurementsmm			

			
1			
GEV No.	357022	Ref. No.	160804-04
description	indicator light mounting measurements 30x22mm 250V yellow connection male faston 6.3mm coffee		
For models:	EFB0002, EFB0003, EFB0008, EFB0008-C		

miscellaneous			
			
1			
GEV No.	359851	Ref. No.	KODK006
description	indicator light mounting measurements 32.5x8.5mm white 230V		
For models:	FGZ0014		

LED			
indicator lamps			
mounting diameter 6mm			
			
1			
GEV No.	359404	Ref. No.	216028
description	indicator light LED mounting ø 6mm 5VDC green connection cable 200mm 2mA		
For models:	GLB0070, OPT1012		

			
1			
GEV No.	358098	Ref. No.	216029
description	indicator light LED mounting ø 6mm 5VDC yellow connection cable 200mm 2mA		
For models:	GLB0070, OPT1012, OPT1012C		

LED bars			
			
1			
GEV No.	357216	Ref. No.	B00LA370
description	LED bar L 1200mm W 20mm H 20mm aluminium cable length 1000mm		
For models:	BNA0068, IEA0010, IEC0050		

1

GEV No.	357211	Ref. No.	B00LA110
description	LED bar L 1320mm W 20mm H 20mm aluminium cable length 1mm		
For models:	BMA0098, BMA0099		



1

GEV No.	357214	Ref. No.	B00LA270
description	LED bar L 690mm W 20mm H 20mm aluminium cable length 850mm		
For models:	BNA0069		



1

GEV No.	357217	Ref. No.	B00LA470
description	LED bar L 1600mm W 20mm H 20mm aluminium cable length 750mm		
For models:	IEA0011, IEA0012, IEC0051, IEC0052		



1

GEV No.	357212	Ref. No.	B00LA150
description	LED bar L 300mm W 20mm H 20mm aluminium cable length 1500mm		
For models:	BMB0046-F		



1

GEV No.	357215	Ref. No.	B00LA700
description	LED bar L 500mm W 19mm H 7mm aluminium cable length 900mm		
For models:	BMB0002-FG, BMC0001-FG		

screw-on/push-on fit

light bulbs

for ovens



1

GEV No.	359610	Ref. No.	01950108400 663.045.00 91310190 IB5946010
description	light bulb t.max. 300°C socket E14 15W 230V ø 22mm L 47mm lens L 20mm for oven lamp type Philips		
For models:	6060CFE, 6060CFG, 6060CFGE, AAA2002, AIB0012, AIB0013, AIB0014, AIB0015, AIB0017, CAB0029-CN, CAB0030-CN, CAB0032, CAB0032-CN, CAB0033, CAB0033-CN, CAB0035, IBA0012, IBA0013, KF1001G, KF630, KF733, KF933U		



1

GEV No.	359615	Ref. No.	91310191
description	light bulb t.max. 300°C socket E14 25W 230V ø 45mm L 76mm lens L 50mm for oven lamp IMPORT		
For models:	CAA0003, CAA0004, CAA0005, CAB0007, CAB0008, CAB0009, CAB0010, CAB0011, CAB0012, CAB0013, CAB0014, CAB0015, CAB0016, CAB0017, CAB0018, CAB0024, CAB0025, CAB0026, CAB0027, CAB0039, CAB0040, CAB0041, CAB0042, CAB0043, CAB0044, CAB0045, CAB0046		

halogen lamp

for socket E14 / E27



1

GEV No.	359728	Ref. No.	91310205
description	halogen lamp socket E14 230V 40W ø 25mm lens L 54mm L 80mm temp.-resist. 300°C Qty 1		
For models:	CAB0019, CAB0020		



for socket G4 / G6.35 / G9



GEV No.	359599	Ref. No.	91310196
description	halogen lamp socket G4 12V 20W temp.-resist. 500°C		
For models:	CAB0007-CD, CAB0008-CD, CAB0009-CD, CAB0013-CD, CAB0014-CD, CAB0015-CD, CAB0019, CAB0020, CAB0024-CD, CAB0025-CD, CAB0029-CN, CAB0030-CN, CAB0032-CN, CAB0033-CN, GIOTTOD, GIOTTO		



GEV No.	359074	Ref. No.	11950097000
description	halogen lamp socket G6.35 12V 35W temp.-resist. 500°C		
For models:	KF981D		



GEV No.	359946	Ref. No.	91310206 91310207
description	halogen lamp socket G9 230V 40W temp.-resist. 300°C		
For models:	CAA0003, CAA0004, CAA0005, GIOTTOD, GIOTTO		



GEV No.	357196	Ref. No.	5L020005
description	halogen lamp socket G9 230V 40W temp.-resist. 300°C OSRAM HALOPIN OVEN		
For models:	5771P, 5772P, 5773P, 5774P, 5778P, 5779P, 5782P, 5783P		

for socket GU5.3 / GU10 / GZ5.3



GEV No.	357054	Ref. No.	91310208
description	halogen lamp socket GU5.3 12V 20W ø 50mm H 38mm temp.-resist. 300°C AC/DC		
For models:	CAB0055-DCG, CAB0056-DCG, CAB0057-DCG, CAB0058-DCG, CAB0059-DCG, CAB0060-DCG, CAB0061-DCG, CAB0062-DCG		

hard-glass infrared lamps



GEV No.	359463	Ref. No.	003151620002
description	infrared lamp socket E27 240V 250W ø 125mm L 173mm type BR125 red hard glas		
For models:	9560T-MN, 9561T-MN, ICE0001, ICE0002		

fluorescent lamps

fluorescent lamps

G13



GEV No.	359386	Ref. No.	3760019 3760026
description	fluorescent lamp socket G13 L 1198mm 36W 230V Qty 1 pcs		
For models:	IIA5012, IIA5013, IIA5014, IIA5015, Z/EI12, Z/EI15, Z/EI23, Z/EI8, Z/ER12, Z/ER15, Z/ER23, Z/ER8		



GEV No.	359383	Ref. No.	3760025
description	fluorescent lamp socket G13 L 438mm 15W 230V Qty 1 pcs light colour 640		
For models:	Z/EI12, Z/EI15, Z/EI23, Z/EI8, Z/ER12, Z/ER15, Z/ER23, Z/ER8		



GEV No.	359372	Ref. No.	3760027
description	fluorescent lamp socket G13 L 895mm 30W 230V Qty 1 pcs		
For models:	Z/EI12, Z/EI15, Z/EI23, Z/EI8, Z/ER12, Z/ER15, Z/ER23, Z/ER8		

complete with holder



GEV No.	357115	Ref. No.	SHELAR36A100
description	fluorescent lamp L 1224mm W 23mm 28W 220/240V type TCH128 1xTL5-28W/830 HF		
For models:	IEA0002-I, IEC0002-I		

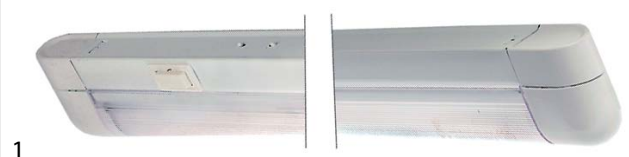

GEV No.	359391	Ref. No.	3760018
description	fluorescent lamp L 1245mm W 37mm 36W		
For models:	IIA5012, IIA5013, IIA5014, IIA5015		



accessories

sockets



1

GEV No.	359388	Ref. No.	3760024
description	lamp socket socket G13 for fluorescent lamps		
For models:	Z/EI12, Z/EI15, Z/EI23, Z/EI8, Z/ER12, Z/ER15, Z/ER23, Z/ER8		



1

GEV No.	359389	Ref. No.	3760023
description	lamp socket socket G13 for fluorescent lamps		
For models:	Z/EI12, Z/EI15, Z/EI23, Z/EI8, Z/ER12, Z/ER15, Z/ER23, Z/ER8		

starter



1

GEV No.	380464	Ref. No.	3760028
description	starter 4-65W		
For models:	Z/EI12, Z/EI15, Z/EI23, Z/EI8, Z/ER12, Z/ER15, Z/ER23, Z/ER8		

ballasts



1

GEV No.	401440	Ref. No.	3760020
description	electrical ballast 15W 230V for fluorescent lamps		
For models:	Z/EI12, Z/EI15, Z/EI23, Z/EI8, Z/ER12, Z/ER15, Z/ER23, Z/ER8		



1

GEV No.	401141	Ref. No.	3760021
description	electrical ballast 30W 230V for fluorescent lamps Qty 1 pcs		
For models:	Z/EI12, Z/EI15, Z/EI23, Z/EI8, Z/ER12, Z/ER15, Z/ER23, Z/ER8		



1

GEV No.	401441	Ref. No.	3760022
description	electrical ballast 36-40W for fluorescent lamps		
For models:	Z/EI12, Z/EI15, Z/EI23, Z/EI8, Z/ER12, Z/ER15, Z/ER23, Z/ER8		

fridge lamps

producer-specific fridge lamps

FRENOX



1

GEV No.	357242	Ref. No.	B00LA142
description	lamp with protective grid 42W 230V ømm L 225mm W 105mm H 110mm cable lengthmm		
For models:	VAEK170-F, VAEK210-F, VAEK220-F, VAEN030-F, VAEN060-F, VAEN075-F		

microwave lamps

light bulbs



1

GEV No.	359549	Ref. No.	ANE6030Q50GN
description	light bulb socket E14 220-240V 25W ø 25mm L 60mm Qty 1 pcs for microwave		
For models:	NE1880, NE2140, NE3240, NEC1475		



oven lamps

universal oven lamps

mounting diameter 35.5mm



1

GEV No.	359718	Ref. No.	663.047.00 IB5846000	
description	oven lamp mounting ø 35.5mm 230V 15W socket E14 temp.-resist. 300°C connection male faston 6.3mm hard glas			
For models:	6060CFE, 6060CFG, 6060CFGE, IBA0012, IBA0013			
spare parts for	359718			
	GEV No.	359701	Ref. No.	09950197400 91310185
	lamp socket socket E14 220-230V mounting ø 35.5mm connection male faston 6.3mm 15W			
	GEV No.	359740	Ref. No.	—
	light bulb t.max. 300°C socket E14 15W 230V ø 22mm L 48mm lens L 20mm for oven lamp IMPORT			





			
1			
GEV No.	357158	Ref. No.	LAM00003 LAM30003-A
description	oven lamp mounting ø 35.5mm 230V 40W socket G9 cable length 100mm connection male faston 6.3mm with gasket		
For models:	VG715RXS, VP800U, VP824RU, VP914RXS, VP916RXS, VP920RXS		
spare parts for	357158		
	GEV No.	357160	Ref. No. —
	lamp socket socket G9 220-230V mounting ø 35.5mm connection cable 100mm		
	GEV No.	358135	Ref. No. —
	gasket for oven lamp PTFE ID ø 44mm ED ø 53mm thickness 3mm with silicone O-ring		
	GEV No.	359705	Ref. No. —
	oven lamp glass thr.ø 33.5mm ø 52mm hard glas temp.-resist. 350°C		
	GEV No.	359946	Ref. No. 91310206 91310207
	halogen lamp socket G9 230V 40W temp.-resist. 300°C		

			
1			
GEV No.	359701	Ref. No.	09950197400 91310185
description	lamp socket socket E14 220-230V mounting ø 35.5mm connection male faston 6.3mm 15W		
For models:	AAA2002, AIB0014, AIB0015, CAB0029-CN, CAB0030-CN, CAB0032, CAB0032-CN, CAB0033, CAB0033-CN, CAB0035, KF1001G, KF630, KF733, KF933U		
accessories for	359701		
	GEV No.	359705	Ref. No. —
	oven lamp glass thr.ø 33.5mm ø 52mm hard glas temp.-resist. 350°C		
	GEV No.	359709	Ref. No. 09950208400 91610020
	oven lamp glass thr.ø 33.5mm ø 42mm hard glas temp.-resist. 350°C		
	GEV No.	359721	Ref. No. —
	gasket silicone ED ø 48mm ID ø 39.5mm thickness 5mm Qty 1 pcs		
	GEV No.	359942	Ref. No. —
	oven lamp glass thr.ø 33.5mm ø 41mm hard glas temp.-resist. 350°C		

			
1			
GEV No.	359709	Ref. No.	09950208400 91610020
description	oven lamp glass thr.ø 33.5mm ø 42mm hard glas temp.-resist. 350°C		
For models:	AAA2002, AIB0014, AIB0015, CAB0029-CN, CAB0030-CN, CAB0032, CAB0032-CN, CAB0033, CAB0033-CN, CAB0035, KF1001G, KF733, KF933U		

mounting diameter 65.5mm			
			
1			
GEV No.	359022	Ref. No.	91310186
description	lamp socket socket E14 mounting ø 65.5mm connection male faston 6.3mm		
For models:	CAA0003, CAA0004, CAA0005, CAB0007, CAB0008, CAB0009, CAB0010, CAB0011, CAB0012, CAB0013, CAB0014, CAB0015, CAB0016, CAB0017, CAB0018, CAB0019, CAB0020, CAB0024, CAB0025, CAB0026, CAB0027, CAB0039, CAB0040, CAB0041, CAB0042, CAB0043, CAB0044, CAB0045, CAB0046		



			
1			
GEV No.	357002	Ref. No.	91310187
description	lamp socket socket G9 mounting ø 65.5mm connection male faston 6.3mm		
For models:	CAA0003, CAA0004, CAA0005		

			
1			
GEV No.	359724	Ref. No.	91610021
description	oven lamp glass thread ø 62mm H 46mm ø 74mm hard glas temp.-resist. 350°C		
For models:	CAA0003, CAA0004, CAA0005, CAB0007, CAB0008, CAB0009, CAB0010, CAB0011, CAB0012, CAB0013, CAB0014, CAB0015, CAB0016, CAB0017, CAB0018, CAB0019, CAB0020, CAB0024, CAB0025, CAB0026, CAB0027, CAB0039, CAB0040, CAB0041, CAB0042, CAB0043, CAB0044, CAB0045, CAB0046		

			
1			
GEV No.	359729	Ref. No.	91410000
description	gasket glass fibre ID ø 57mm ED ø 67mm thickness 5mm ø 67mm		
For models:	CAA0003, CAA0004, CAA0005, CAB0007, CAB0008, CAB0009, CAB0010, CAB0011, CAB0012, CAB0013, CAB0014, CAB0015, CAB0016, CAB0017, CAB0018, CAB0019, CAB0020, CAB0024, CAB0025, CAB0026, CAB0027, CAB0039, CAB0040, CAB0041, CAB0042, CAB0043, CAB0044, CAB0045, CAB0046		

55x70mm

			
1			
GEV No.	358148	Ref. No.	91810185
description	lamp socket socket G4 12-250V mounting measurements 55x70mm connection cable 135mm		
For models:	CAB0007-CD, CAB0008-CD, CAB0009-CD, CAB0013-CD, CAB0014-CD, CAB0015-CD, CAB0024-CD, CAB0025-CD, CAB0030-CN, CAB0033-CN		

			
1			
GEV No.	358131	Ref. No.	5P110003
description	lamp socket socket G6.35 12-250V mounting measurements 55x70mm connection cable 300mm		
For models:	5771P, 5772P, 5773P, 5774P, 5778P, 5779P, 5782P, 5783P		
accessories for	358131		
	GEV No.	359937	Ref. No.
			5V010003 91610025
	lamp glass L 80mm W 65mm mounting measurements 52x67mm		

			
1			
GEV No.	359937	Ref. No.	5V010003 91610025
description	lamp glass L 80mm W 65mm mounting measurements 52x67mm		
For models:	5771P, 5772P, 5773P, 5774P, 5778P, 5779P, 5782P, 5783P, CAB0007-CD, CAB0008-CD, CAB0009-CD, CAB0013-CD, CAB0014-CD, CAB0015-CD, CAB0024-CD, CAB0025-CD, CAB0029-CN, CAB0030-CN, CAB0032-CN, CAB0033-CN		

			
1			
GEV No.	359937	Ref. No.	5V010003 91610025
description	lamp glass L 80mm W 65mm mounting measurements 52x67mm		
For models:	5771P, 5772P, 5773P, 5774P, 5778P, 5779P, 5782P, 5783P, CAB0007-CD, CAB0008-CD, CAB0009-CD, CAB0013-CD, CAB0014-CD, CAB0015-CD, CAB0024-CD, CAB0025-CD, CAB0029-CN, CAB0030-CN, CAB0032-CN, CAB0033-CN		

55x100mm

			
1			
GEV No.	101372	Ref. No.	C5125419
description	oven lamp complete L 100mm W 55mm 230V 25W socket E14 rectangular temp.-resist. 300°C connection male faston 6.3mm		
For models:	53054-CN, 5305-CN, 5330, 53304, AJD0002-CCN, AJD0003-CCN, AJD0005-CCN, AJD0006-CCN, AJD0014-C, AJD0015-C, AJD0017-C, AJD0018-C, AJD0019-C, AJD0023-C, AJD0030, AJD0031, AJD0032		
spare parts for	101372		
	GEV No.	359612	Ref. No.
			—
	light bulb t.max. 300°C socket E14 25W 230V ø 25mm L 56mm lens L 30mm for oven lamp type Philips		
	GEV No.	359698	Ref. No.
			—
	lamp socket L 100mm W 55mm socket E14 connection male faston 6.3mm		
	GEV No.	359714	Ref. No.
			—
	gasket for bulb socket		
	GEV No.	359715	Ref. No.
			—
	lamp glass L 110mm W 65mm thickness 5mm		
	GEV No.	359716	Ref. No.
			—
	frame for bulb socket		

lamps

light bulbs

			
1			
GEV No.	359610	Ref. No.	01950108400 663.045.00 91310190 IB5946010
description	light bulb t.max. 300°C socket E14 15W 230V ø 22mm L 47mm lens L 20mm for oven lamp type Philips		
For models:	6060CFE, 6060CFG, 6060CFG, AAA2002, AIB0012, AIB0013, AIB0014, AIB0015, AIB0017, CAB0029-CN, CAB0030-CN, CAB0032, CAB0033-CN, CAB0033, CAB0033-CN, CAB0035, IBA0012, IBA0013, KF1001G, KF630, KF733, KF933U		



			
1			
GEV No.	359615	Ref. No.	91310191
description	light bulb t.max. 300°C socket E14 25W 230V ø 45mm L 76mm lens L 50mm for oven lamp IMPORT		
For models:	CAA0003, CAA0004, CAA0005, CAB0007, CAB0008, CAB0009, CAB0010, CAB0011, CAB0012, CAB0013, CAB0014, CAB0015, CAB0016, CAB0017, CAB0018, CAB0024, CAB0025, CAB0026, CAB0027, CAB0039, CAB0040, CAB0041, CAB0042, CAB0043, CAB0044, CAB0045, CAB0046		

halogen lamps

for socket E14 / E27

			
1			
GEV No.	359728	Ref. No.	91310205
description	halogen lamp socket E14 230V 40W ø 25mm lens L 54mm L 80mm temp.-resist. 300°C Qty 1		
For models:	CAB0019, CAB0020		

for socket G4 / G6.35 / G9

 500°C			
1			
GEV No.	359599	Ref. No.	91310196
description	halogen lamp socket G4 12V 20W temp.-resist. 500°C		
For models:	CAB0007-CD, CAB0008-CD, CAB0009-CD, CAB0013-CD, CAB0014-CD, CAB0015-CD, CAB0019, CAB0020, CAB0024-CD, CAB0025-CD, CAB0029-CN, CAB0030-CN, CAB0032-CN, CAB0033-CN, GIOTTOD, GIOTTO		

 500°C			
1			
GEV No.	359074	Ref. No.	11950097000
description	halogen lamp socket G6.35 12V 35W temp.-resist. 500°C		
For models:	KF981D		

			
1			
GEV No.	359946	Ref. No.	91310206 91310207
description	halogen lamp socket G9 230V 40W temp.-resist. 300°C		
For models:	CAA0003, CAA0004, CAA0005, GIOTTOD, GIOTTO		

 OSRAM			
1			
GEV No.	357196	Ref. No.	5L020005
description	halogen lamp socket G9 230V 40W temp.-resist. 300°C OSRAM HALOPIN OVEN		
For models:	5771P, 5772P, 5773P, 5774P, 5778P, 5779P, 5782P, 5783P		

for socket GU5,3 / GU10

			
1			
GEV No.	357054	Ref. No.	91310208
description	halogen lamp socket GU5.3 12V 20W ø 50mm H 38mm temp.-resist. 300°C AC/DC		
For models:	CAB0055-DCG, CAB0056-DCG, CAB0057-DCG, CAB0058-DCG, CAB0059-DCG, CAB0060-DCG, CAB0061-DCG, CAB0062-DCG		

lamp accessories

lenses

glass panels

			
1			
GEV No.	357250	Ref. No.	91610013
description	lamp glass L 180mm W 84mm thickness 9.5mm for pizza oven		
For models:	CAB0019, CAB0020, CAB0055-DCG, CAB0056-DCG, CAB0057-DCG, CAB0058-DCG, CAB0059-DCG, CAB0060-DCG, CAB0061-DCG, CAB0062-DCG		

timers

programme timers

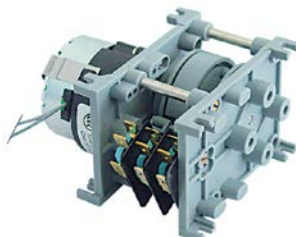
			
1			
GEV No.	361350	Ref. No.	Z613003000
description	timer 4803F1 engines 1 chambers 3 operation time 20min 230V shaft ømm shaft Lmm		
For models:	GLB0061C-F, GLB0063C-F		

			
1			
GEV No.	360005	Ref. No.	238052
description	timer BIGATTI D94 engines 1 chambers 1 operation time 20min 230V shaft ømm shaft Lmm manuf. no. WE006 motor type 82354021L		
For models:	GLB0035, GLB0036, GLB0037, GLB0038, GLB0039, GLB0056, GLB0057, GLB0059		



1

GEV No.	360349	Ref. No.	238053
description	timer CDC 11803 engines 1 chambers 3 operation time 150s 230V shaft ømm shaft Lmm manif. no. 11803F1BEE000.0010 motor type M48R ATS type 11803F1 / 238046		
For models:	GLB0035, GLB0036, GLB0037, GLB0038, GLB0039, GLB0056, GLB0057, GLB0058, GLB0059, GLB0060		
spare parts for	360349		
	GEV No.	360673	Ref. No. —
	motor kit pinion ø 6.8mm teeth 15 230V voltage AC 50/60Hz turn direction clockwise motor ø 48mm H 18.5mm motor type UDS-40NE1RNZ165 cable length 150mm with holder		





1

GEV No.	360743	Ref. No.	PRG30005
description	timer CDC 11902F1 engines 1 chambers 2 operation time 240s 230V 50/60Hz manif. no. 11902F1AGE000.0070 motor type M48R 230V		
For models:	VG715RXS, VP824RU, VP914RXS, VP916RXS, VP920RXS		



1

GEV No.	360329	Ref. No.	09951027000
description	timer CDC 11902F3 engines 1 chambers 2 operation time 240s 230V manif. no. PWE5J02H620 motor type M51B10R0000		
For models:	AIB0015, KF1001G, KF630, KF733, KF933U, KF965, KF981D		
spare parts for	360329		
	GEV No.	360118	Ref. No. —
	motor CDC pinion ø 4.9mm teeth 10 230V voltage AC 50/60Hz turn direction right motor ø 47mm H 19.3mm motor type M48R ATS for timer cable length 260mm 1.9/2.5W		





1

GEV No.	360528	Ref. No.	561.035.00
description	timer CDC 11902F3 engines 1 chambers 2 operation time 450s 230V motor type M48L ATS voltage AC		
For models:	GEU411, GEU611, GEV1011		



1

GEV No.	360525	Ref. No.	N23247
description	timer CDC 11904 engines 1 chambers 4 operation time 10min 230V shaft ømm shaft Lmm manif. no. 11904F1 / BCR000.0000 motor type M48R ATS		
For models:	BAA0019, BAA0022, BAA0023, BAA0024, BAA0025, BAA0026, BAA0027, BAA0028, BAA0029, BAA0030, BAA0031, BAA0032, BAA0033, BAA0034, BAA0037, BAA0038, BAA0046, BAA0046W, BAA0053-A, BAA0055		
spare parts for	360525		
	GEV No.	360118	Ref. No. —
	motor CDC pinion ø 4.9mm teeth 10 230V voltage AC 50/60Hz turn direction right motor ø 47mm H 19.3mm motor type M48R ATS for timer cable length 260mm 1.9/2.5W		



1

GEV No.	360524	Ref. No.	N23222
description	timer CDC 11904 engines 1 chambers 4 operation time 12min 230V shaft ømm shaft Lmm manif. no. 11904F1 / BDR000.0000 motor type M48R ATS		
For models:	BAA0024, BAA0025, BAA0026, BAA0027, BAA0028, BAA0029, BAA0030, BAA0031, BAA0032, BAA0033, BAA0034, BAA0037, BAA0038, BAA0046, BAA0046W		
spare parts for	360524		
	GEV No.	360118	Ref. No. —
	motor CDC pinion ø 4.9mm teeth 10 230V voltage AC 50/60Hz turn direction right motor ø 47mm H 19.3mm motor type M48R ATS for timer cable length 260mm 1.9/2.5W		



1

GEV No.	360566	Ref. No.	N23259
description	timer CDC 11904 engines 1 chambers 4 operation time 15min 115V 60Hz shaft ømm shaft Lmm manuf. no. 11904F1BEI000.0010 motor type M48R ATS voltage AC		
For models:	BAA0024, BAA0025, BAA0026, BAA0027, BAA0028, BAA0029, BAA0030, BAA0031, BAA0032, BAA0037, BAA0038, BAA0046, BAA0046W		





1

GEV No.	360565	Ref. No.	N23396 N23780
description	timer CDC 11904 engines 1 chambers 4 operation time 18min 230V 50/60Hz shaft ømm shaft Lmm manuf. no. 11904F1BFE000.0030 motor type M48R ATS voltage AC		
For models:	BAA0024, BAA0025, BAA0026, BAA0027, BAA0028, BAA0029, BAA0030, BAA0031, BAA0032, BAA0033, BAA0034, BAA0037, BAA0038, BAA0046, BAA0046W		



1

GEV No.	360549	Ref. No.	N23635
description	timer CDC 11904 engines 1 chambers 4 operation time 8min 230V 50/60Hz shaft ømm shaft Lmm manuf. no. 11904F1 / DER000.0010		
For models:	BAA0040, BAA0051		
spare parts for	360549		
	GEV No.	360118	Ref. No. —
	motor CDC pinion ø 4.9mm teeth 10 230V voltage AC 50/60Hz turn direction right motor ø 47mm H 19.3mm motor type M48R ATS for timer cable length 260mm 1.9/2.5W		





1

GEV No.	361357	Ref. No.	12024873
description	timer CDC 7803 engines 1 chambers 3 operation time 120s 230V shaft ømm shaft Lmm motor type M37LN		
For models:	GLB0035-F, GLB0035-FN, GLB0037-F, GLB0037-FN, GLB0061C-FN		



1

GEV No.	360133	Ref. No.	238066
description	timer CDC 7804DV engines 2 chambers 4 operation time 60s / 20min 230V shaft ømm shaft Lmm manuf. no. 7804DV / 360133 motor type M37RN/M37LN		
For models:	GLB0061, GLB0061C, GLB0062, GLB0063, GLB0064, GLB0064C, GLB0065, GLB0066		
spare parts for	360133		
	GEV No.	360119	Ref. No. —
	motor CDC pinion ø 5.4mm teeth 12 230V turn direction right motor ø 37mm motor type M37RN for timer		
	GEV No.	360131	Ref. No. —
	motor CDC pinion ø 5.4mm teeth 12 230V turn direction left motor ø 37mm motor type M37LN for timer		



1

GEV No.	361354	Ref. No.	Z213008000
description	timer CDC 7804DV engines 2 chambers 4 operation time 6s / 3min 230V shaft ømm shaft Lmm motor type M37RN/M37LN		
For models:	GLB0061C-F, GLB0063C-F		



1

GEV No.	361355	Ref. No.	12024177 Z243004000
description	timer CDC 7804DV engines 2 chambers 4 operation time 6s / 3min 230V shaft ømm shaft Lmm motor type M37RN/M37LN		
For models:	OPT1012-CF, OPT1012-CFN		



2

GEV No.	360440	Ref. No.	Z213002000
description	timer CDC 7805DV engines 2 chambers 5 operation time 6s / 3min 230V 50Hz shaft ømm shaft Lmm		
For models:	GLB0061C-F, GLB0063C-F		





1

GEV No.	360439	Ref. No.	12024204
description	timer CDC 7805DV engines 2 chambers 5 operation time 6s/180s 230V 50Hz shaft ømm shaft Lmm		
For models:	GLB0063C-FN		



1

GEV No.	360264	Ref. No.	238073	
description	timer CDC 7805DV engines 2 chambers 5 operation time 72s/20min 230V shaft ømm shaft Lmm manif. no. 7805DV / 238073 motor type M37RN/M37LN			
For models:	GLB0072			
spare parts for	360264			
	GEV No.	360119	Ref. No.	—
	motor CDC pinion ø 5.4mm teeth 12 230V turn direction right motor ø 37mm motor type M37RN for timer			
	GEV No.	360131	Ref. No.	—
	motor CDC pinion ø 5.4mm teeth 12 230V turn direction left motor ø 37mm motor type M37LN for timer			



1

GEV No.	360154	Ref. No.	N23248	
description	timer FIBER P20 engines 1 chambers 4 operation time 15min 230V shaft ømm shaft Lmm manif. no. P205J04J714 motor type M51B-J0R6400			
For models:	BAA0024, BAA0025, BAA0026, BAA0027, BAA0028, BAA0029, BAA0030, BAA0031, BAA0032, BAA0033, BAA0034, BAA0037, BAA0038, BAA0046, BAA0046W			
spare parts for	360154			
	GEV No.	360673	Ref. No.	—
	motor kit pinion ø 6.8mm teeth 15 230V voltage AC 50/60Hz turn direction clockwise motor ø 48mm H 18.5mm motor type UDS-40NE1RNZ165 cable length 150mm with holder			

electric timers



1

GEV No.	350072	Ref. No.	09950677000
description	timer MS65 with bell operation time 120min 2CO/1NO at 250V 16A impulse electric shaft ø 6x4.6mm shaft L 23mm with permanent position mounting distance 28mm connection lateral Invensys 3-pole 230V		
For models:	AAA2002		

with time spread



1

GEV No.	350142	Ref. No.	09952437000
description	timer MS65 with bell operation time 120min time spread 30min 1CO/1NC/2NO at 250V 16A permanent position yes time range 0-120min impulse electric 16A shaft ø 6x4.6mm shaft L 22mm connection male faston 6.3mm Invensys screw/F6.3 230V voltage AC 50Hz		
For models:	AIB0012, AIB0013, AIB0017, KF1001G, KF733, KF933U, KF965, KF981D		



1

GEV No.	350073	Ref. No.	09950507000
description	timer MS65 with buzzer board operation time 120min time spread 30min 1CO/1NC/2NO at 250V 16A permanent position yes impulse electric shaft ø 6x4.6mm shaft L 20mm with bell mounting distance 28mm connection lateral 3-pole		
For models:	AIB0013, AIB0014, AIB0015		

mechanical timers





1

GEV No.	350130	Ref. No.	PRG30001
description	timer M11 with bell 1-pole operation time 120min impulse mechanical 1NO at 250V 16A permanent position yes shaft ø 6x4.6mm shaft L 23mm mounting distance 28mm mounting thread M4 connection male faston 6.3mm 4 hole fixing shaft flat upper		
For models:	VG715RXS, VP800U, VP824RU, VP914RXS, VP920RXS		



1

GEV No.	350032	Ref. No.	073008
description	timer M2 2-pole operation time 15min impulse mechanical 2NO at 250V 16A permanent position no shaft ø 6x4.6mm shaft 6x4.6mm shaft L 18mm mounting distance 28mm connection rear		
For models:	AJG0001, AJG0002, AJG0003, AJG0004, AJH0007		
accessories for	350032		
	GEV No.	110366	Ref. No. —
	knob switch zero mark t.max.°C° 44mm shaft ø 6x4.6mm shaft flat upper black		
	GEV No.	110371	Ref. No. —
	dial plate graduation 15min permanent position no rotation 30-330° ø 60mm timers knob ø 45mm		

alarm devices

buzzer boards



1

GEV No.	403497	Ref. No.	A605S3030GP
description	buzzer board for microwave suitable for PANASONIC		
For models:	NE1880, NE2140, NE3240, NEC1475		

contactors

ABB

power contactors



1

GEV No.	380100	Ref. No.	210034
description	power contactor resistive load 20A 230VAC (AC3/400V) 12A/5.5kW main contacts 3NO auxiliary contacts 1NO connection screw connection type B6-30-10 / B7-30-10		
For models:	EFF0002-Q		



1

GEV No.	380110	Ref. No.	210035
description	power contactor resistive load 20A 400VAC (AC3/400V) 12A/5.5kW main contacts 3NO auxiliary contacts 1NO connection screw connection type B6-30-10 / B7-30-10		
For models:	EFF0002-Q		



GENERAL ELECTRIC (AEG)

power contactors



1

GEV No.	380237	Ref. No.	12024011
description	power contactor resistive load 16A 230VAC (AC3/400V) 6A/3kW main contacts 3NO auxiliary contacts 1NC connection male faston 6.3mm type AEG LS0701F		
For models:	GLB0035-F, GLB0035-FN, GLB0037-F, GLB0037-FN, GLB0061C-F, GLB0063C-F, GLB0063C-FN, OPT1012-CF		



1

GEV No.	380244	Ref. No.	Y10000
description	power contactor resistive load 25A 230VAC (AC3/400V) 9A/4kW main contacts 3NO auxiliary contacts 1NO connection screw connection type AEG LS4K 10A type GE CL00A 310		
For models:	ACC0003, ACC003V, ACC005V, ACC008V, ACC010V, ACK2003, ACK2004, ACK203V, ACK204V, ADC006V, ADK201V, ADK202V, ADK203V, ADK204V		



1

GEV No.	381191	Ref. No.	926282
description	power contactor resistive load 25A 400VAC (AC3/400V) 12A/5.5kW main contacts 3NO auxiliary contacts 1NO connection screw connection type AEG type GE CL01A310T6		
For models:	GLB0043, GLB0044		



1

GEV No.	380262	Ref. No.	Y11100
description	power contactor resistive load 32A 230VAC (AC3/400V) 17A/7.5kW main contacts 3NO auxiliary contacts 1NC connection screw connection type AEG LS7K01A type GE CL02A 301 H 85mm		
For models:	ACC005V, ACL0002, ACL002V, ADC006V, ADK201V, ADK202V, ADK203V, ADK204V, ADL001V, ADL002V		



1

GEV No.	380261	Ref. No.	ELET0002
description	power contactor resistive load 32A 230VAC (AC3/400V) 17A/7.5kW main contacts 3NO auxiliary contacts 1NO connection screw connection type AEG LS7K 10A type GE CL02A 310		
For models:	CAD0004, CAD0005, CAD0007, CAD0009, SY12100VELED, SY850VELED		

ISKRA (FANAL)

power contactors



1

GEV No.	380547	Ref. No.	461.021.00
description	power contactor resistive load 20A 230VAC (AC3/400V) 5A/2.2kW main contacts 3NO auxiliary contacts 1NC connection screw connection type Fanal DSL3 01 type ISKRA K03M 01		
For models:	BGEU411, GEU411		



1

GEV No.	380213	Ref. No.	073050 3700080
description	power contactor resistive load 20A 230VAC (AC3/400V) 8.5A/5.5kW main contacts 3NO auxiliary contacts 1NO connection screw connection type Fanal DSL7 10 type ISKRA K07M 10		
For models:	AAC0001, AAC0002, AMZ0006, AMZ0007, AMZ0008, IFA0004, IIA3006, IIA3007, IIA3008, IIA3010, IIA3011, IIA3012		



1

GEV No.	380964	Ref. No.	N23594
description	power contactor resistive load 20A 230VAC (AC3/400V) 9A/4kW main contacts 4NO auxiliary contacts connection screw connection type 11BG09T4A230		
For models:	BAA0033, BAB0005		

LOVATO

power contactors



1

GEV No.	380087	Ref. No.	66106600
description	power contactor resistive load 16A 230VAC (AC3/400V) 5A/2.2kW main contacts 3NO auxiliary contacts 1NO connection screw connection type 11BG0610A230		
For models:	7070BRE, 7070BREM		



1

GEV No.	381102	Ref. No.	0221005
description	power contactor resistive load 20A 24VAC (AC3/400V) 9A/4kW main contacts 4NO auxiliary contacts connection screw connection type 11BG09T4A24		
For models:	FGZ0006, FGZ0026		



1

GEV No.	380704	Ref. No.	66101700
description	power contactor resistive load 20A 230VAC (AC3/400V) 9A/4kW main contacts 3NO auxiliary contacts 1NC connection screw connection type 11BG0901A230		



1

GEV No.	380714	Ref. No.	91310136
description	power contactor resistive load 25A 230VAC (AC3/400V) 9A/4.2kW main contacts 3NO auxiliary contacts 1NO connection screw connection type BF0910A230		
For models:	CAB0007, CAB0007-CD, CAB0008, CAB0008-CD, CAB0009, CAB0009-CD, CAB0010, CAB0011, CAB0012, CAB0013, CAB0013-CD, CAB0014, CAB0014-CD, CAB0015, CAB0015-CD, CAB0016, CAB0017, CAB0018, CAB0019, CAB0020, CAB0024, CAB0024-CD, CAB0025, CAB0025-CD, CAB0026, CAB0027, CAB0029-CN, CAB0030-CN, CAB0032-CN, CAB0033-CN, CAB0039, CAB0040, CAB0041, CAB0042, CAB0043, CAB0044, CAB0045, CAB0046, CAB0055-DCG, CAB0056-DCG, CAB0057-DCG, CAB0058-DCG, CAB0059-DCG, CAB0060-DCG, CAB0061-DCG, CAB0062-DCG		



1

GEV No.	380712	Ref. No.	Z213007000
description	power contactor resistive load 20A 230VAC (AC3/400V) 9A/4kW main contacts 3NO auxiliary contacts 1NO connection male faston type 11BGF0910A230		
For models:	GLB0061C-F, GLB0063C-F		



1

GEV No.	381103	Ref. No.	0221106
description	power contactor resistive load 25A 24VAC (AC3/400V) 9A/4.2kW main contacts 4NO auxiliary contacts connection screw connection type BF09T4A024		
For models:	FGZ0007, FGZ0009, FGZ0027, FGZ0028		



1

GEV No.	380716	Ref. No.	96100200
description	power contactor resistive load 28A 230VAC (AC3/400V) 12A/5.7kW main contacts 3NO auxiliary contacts 1NO connection screw connection type BF1210A230		
For models:	92FRE18, 92FRE18S, 94BRE, 94BREM, 94FRE18, 94FRE18S, 96BRE, 96BREM, BGEU611, BGEU1011, GEU411P, GEU611, GEU611P, GEV1011, GEV1011P		



1

GEV No.	380788	Ref. No.	ELET0432
description	power contactor resistive load 32A 230VAC (AC3/400V) 18A/7.5kW main contacts 4NO connection screw connection type BF18T4A230		
For models:	CAD0009, SY12100VELED, SY850VELED		

overload switches



1

GEV No.	380754	Ref. No.	0221124
description	overload switch setting range 4-6.5A for contactors BF (09-38) series connection screw		
For models:	FGZ0007, FGZ0009, FGZ0027		

SIEMENS

power contactors



1

GEV No.	381387	Ref. No.	73350
description	power contactor resistive load 22A 230VAC (AC3/400V) 4kW main contacts 3NO auxiliary contacts 1NO connection screw connection type 3RT2016-1AP01		
For models:	OPT1012C		



1

GEV No.	380614	Ref. No.	1202404 12111795 Z203050000
description	power contactor resistive load 22A 230VAC (AC3/400V) 9A/4kW main contacts 3NO auxiliary contacts 1NO connection elastic terminals type 3RT2016-2AP01		
For models:	GLB0061C-F, GLB0061C-FN, GLB0063C-F, GLB0063C-FN, OPT1012-CF, OPT1012-CFN		



1

GEV No.	380389	Ref. No.	229037 Z743009000
description	power contactor resistive load 22A 230VAC (AC3/400V) 9A/4kW main contacts 3NO auxiliary contacts 1NO connection screw connection type 3RT10-16-1AP01		
For models:	GLB0043, GLB0044, GLB0061C-F, GLB0063C-F, GLB0070, GLB0071		

1

GEV No.	380390	Ref. No.	80351
description	power contactor resistive load 40A 230VAC (AC3/400V) 12A/5.5kW main contacts 3NO auxiliary contacts connection screw connection type 3RT10-24-1AL20 50/60Hz		
For models:	GLB0046		

small relay switches



1

GEV No.	380696	Ref. No.	12024012 Z683087000
description	small relay switch 230V (AC3/400V) 9A/4kW main contacts 3NO auxiliary contacts 1NC connection male faston 6.3mm resistive load 16A		
For models:	GLB0063C-FN, OPT1012-CF, OPT1012-CFN		

motor protection circuit breakers



1

GEV No.	380541	Ref. No.	927368
description	motor protection circuit breaker type 3RV1011-0JA10 setting range 0.7-1A (AC3/400V) 0.25kW		
For models:	GLB0046		

TELEMECANIQUE (Schneider Electric)

power contactors



1

GEV No.	380965	Ref. No.	Y10100
description	power contactor resistive load 20A 230VAC (AC3/400V) 6A/2.2kW main contacts 3NO auxiliary contacts 1NO connection screw connection type LC1K0610P7+		
For models:	ACC004V, ACK1002, ACK101V, ACK102V, ACK301V, ACK302V, ACK303V, ACK304V, ADC004V		



1

GEV No.	380090	Ref. No.	11950197000
description	power contactor resistive load 25A 230VAC (AC3/400V) 12A/5.5kW main contacts 4NO auxiliary contacts 1NO/1NC connection screw connection type LC1DT25P7		
For models:	AIB0014, AIB0015		

ALLEN BRADLEY

power contactors



1

GEV No.	380523	Ref. No.	1602231
description	power contactor resistive load 32A 230VAC (AC3/400V) 9A/4kW main contacts 3NO auxiliary contacts 1NO connection screw connection type 100-C09KF10		
For models:	EFB0014, EFB0019		

1

GEV No.	380469	Ref. No.	ELET0160
description	power contactor resistive load 32A 230VAC (AC3/400V) 9A/4kW main contacts 4NO connection screw connection type 100-C09KF400		
For models:	CAD0009, SY12100VELED, SY1280VE, SY850VELED		

lateral



1

GEV No.	380313	Ref. No.	229036
description	power relays FINDER 230VAC 16A 3CO connection male faston DIN rail manuf. no. 62.83.8.230.0008		
For models:	GLB0046, OPT1012		

solid state relays

accessories

diodes

high voltage diodes



1

GEV No.	358161	Ref. No.	A62024000AP
description	hv diode type 2X062+HVR-1X connection F6.3mm / lug M4 cable lengthmm for microwave		
For models:	NE1880		

relays

power relays

with DIN rail mounting

upper



1

GEV No.	380809	Ref. No.	12023706 Z203062000
description	power relays FINDER 230VAC 16A 2NO connection male faston 6.3mm bracket mounting manuf. no. 62.82.8.230.0307		
For models:	GLB0035-FN, GLB0037-FN, GLB0061C-F, GLB0061C-FN, GLB0063C-F, GLB0063C-FN		

with bracket mounting



1

GEV No.	380197	Ref. No.	09950287000
description	power relays 230VAC 16A 2CO connection male faston bracket mounting		
For models:	AIB0014, AIB0015		



1

GEV No.	380312	Ref. No.	229023 229024
description	power relays FINDER 230VAC 10A 3CO connection male faston 4.8mm bracket mounting dimensions 52x32.2x36.5mm manuf. no. 60.63.8.230.0000		
For models:	GLB0035, GLB0036, GLB0037, GLB0038, GLB0039, GLB0056, GLB0057, GLB0061, GLB0061C, GLB0062, GLB0063, GLB0064, GLB0064C, GLB0065, GLB0066, GLB0072		

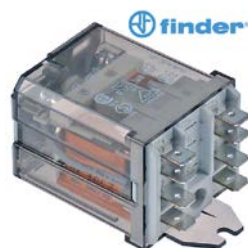

1

GEV No.	380139	Ref. No.	929115
description	power relays FINDER 230VAC 16A 2CO connection F6.3 bracket mounting dimensions 68x38.2x35.8mm manuf. no. 62.82.8.230.0000		
For models:	GLB0043, GLB0044, GLB0061, GLB0061C, GLB0062, GLB0063, GLB0064, GLB0064C, GLB0065, GLB0066, GLB0070, GLB0071, GLB0073		



1

GEV No.	380702	Ref. No.	229040
description	power relays FINDER 230VAC 16A 3NO connection male faston 6.3mm flange dimensions 36x38x68mm manuf. no. 62.83.8.230.0300 230V		
For models:	GLB0072		



1

GEV No.	380311	Ref. No.	229030
description	power relays Italiana Relè 230VAC 20A 1NC/1NO connection F6.3 bracket mounting manuf. no. A1B-230AC-FA		
For models:	GLB0058, GLB0059, GLB0060		



1

GEV No.	380185	Ref. No.	229029 DER111
description	power relays Italiana Relè 230VAC 30A 1NO connection F6.3 bracket mounting dimensions 36.5x32.2x51.8mm manuf. no. A1O-230AC-FA		
For models:	GLB0070, GLB0071, GLB0072, GLB0073, OPT1012		

with male contacts

female contact 2.0mm



1

GEV No.	380494	Ref. No.	3700053
description	power relays FINDER 230VAC 7A 4CO connection F2 plug-in connection manuf. no. 55.34.8.230.0054 94.74/ZMD4 250V connection 2mm		
For models:	IIA5005, IIA5006, IIA5010, IIA5011, IIA5012, IIA5013, IIA5014, IIA5015		
accessories for	380494		



GEV No.	380341	Ref. No.	—
relay socket 4-pole contacts 12 300V voltage AC 6A Italiana Relè manuf. no. ZMD4			

accessories for	380494		
GEV No.	380399	Ref. No.	—
relay socket 4-pole dimensions 76.2x27x86.1mm 250V voltage AC 1A FINDER manuf. no. 94.94.3			

plug-in/print relays



1

GEV No.	380941	Ref. No.	PD.2476
description	print relay 250VAC 2CO at 250V 8A connection pins raster size 5mm		
For models:	NGSB990CE, NGSCD990		

relay sockets



1

GEV No.	380393	Ref. No.	3700054
description	relay socket 4-pole		
For models:	IIA5005, IIA5006, IIA5010, IIA5011, IIA5012, IIA5013, IIA5014, IIA5015		

supervisory relays



1

GEV No.	401610	Ref. No.	N23633
description	supervisory relay revolutions		
For models:	BAB0003, BAB0004, BAB0005		

magnetrons

			
1			
GEV No.	402845	Ref. No.	2M244-M1GL
description	Magnetron PANASONIC type 2M244-M23		
For models:	NE3240		

transformers

open transformers

with clamp terminal

			
1			
GEV No.	401198	Ref. No.	ELET0094
description	transformer primary 0/230/400V secondary 12/0/12V 160VA		
For models:	CAD0004, CAD0005, CAD0007, SY850VELED		

			
1			
GEV No.	403683	Ref. No.	0223017
description	transformer primary 220 secondary 10 500VA Mini Jumbo/ Jumbo35 / Boxer35		
For models:	FGZ0005, FGZ0012		

			
1			
GEV No.	402080	Ref. No.	0223026
description	transformer primary 220/380VAC secondary 0-20VAC 600VA connection screw connection 50/60Hz		
For models:	FGZ0009, FGZ0027		

			
1			
GEV No.	402081	Ref. No.	0223032
description	transformer primary 220/380VAC secondary 0-21.4VAC 900VA connection screw connection 50/60Hz		
For models:	FGZ0007, FGZ0028		

			
1			
GEV No.	402086	Ref. No.	0223011
description	transformer primary 230/400VAC secondary 0-9/0-24VAC 64.5VA connection screw 50/60Hz		
For models:	FGZ0005, FGZ0006, FGZ0007, FGZ0009, FGZ0012, FGZ0013, FGZ0025, FGZ0026, FGZ0027, FGZ0028		

			
1			
GEV No.	403573	Ref. No.	ELET0003
description	transformer primary 230/400VAC secondary 115VAC 63VA secondary 0.5A H 78mm L 85mm W 77mm connection screw 50/60Hz type SFM00063CC15 open		
For models:	CAD0007, CAD0010, SY12100VGASD, SY1280VG		

			
1			
GEV No.	402084	Ref. No.	0223049
description	transformer primary 380/400VAC secondary 0-24VAC 1150VA connection screw connection 50/60Hz		
For models:	FGZ0027		



1			
GEV No.	402082	Ref. No.	0223035
description	transformer primary 380/400VAC secondary 0-33,1VAC 1150VA connection screw connection 50/60Hz		
For models:	FGZ0028		

encapsulated transformers

multiple connections



1			
GEV No.	402085	Ref. No.	0223004
description	transformer primary 230VAC secondary 24VAC 30VA secondary 1.25A connection male faston 6.3mm 50/60Hz type 65.16.230.323.224.05		
For models:	FGZ0005, FGZ0012, FGZ0013, FGZ0025		

PMA



1			
GEV No.	379054	Ref. No.	91310350
description	transformer primary 230VAC secondary 12VAC 3VA secondary 0.25A H 40mm L 45mm W 50mm connection screw 50/60Hz type 153/M		
For models:	CAA0003, CAA0004, CAA0005		

power supplies



1			
GEV No.	378410	Ref. No.	B00LA222
description	power supply primary 100-240VAC secondary 12VDC 15.6VA secondary 1.3A H 28.5mm L 91mm W 52mm connection screw 50/60Hz type NES-15-12 switched-mode power supply		
For models:	BMB0046-F, IEA0010, IEA0011, IEA0012, IEC0050, IEC0051, IEC0052		



1			
GEV No.	378362	Ref. No.	B00LA111
description	power supply primary 100-240VAC secondary 12VDC 50VA secondary 4.2A H 40mm L 130mm W 100mm connection screw 50-60Hz type NES-50-12		
For models:	BMA0098, BMA0099		



1			
GEV No.	378661	Ref. No.	B00LA106
description	power supply primary 100-240VAC secondary 12VDC H 31mm L 100mm W 83mm connection screw 50/60Hz type LRS-50-12 switched-mode power supply		
For models:	BMC0001-FG, CCZ0009-F, CCZ0050, IEA0010, IEA0011, IEA0012, IEC0050, IEC0051, IEC0052		

HV transformers



1			
GEV No.	403496	Ref. No.	A600B3580GP
description	HV transformer type NE1540/NE1840/NE1880 for microwave		
For models:	NE1880		



electronic controllers

CAREL

refrigeration controllers

built-in version



1

GEV No.	378030	Ref. No.	R055PJ32 R055PJEZSNH000K
description	electronic controller CAREL PJEZSNH000K mounting measurements 71x29mm built-in depth 31mm 230V voltage AC NTC relay outputs 1 CO-12A(2) NTC NTC yes protection IP54 incl. bezel°C display 2½ digit		
For models:	BGB0001, BGB0002, BGB0003, BGB0004, BGB0005, BGB0006, BGB0007, BGB0008, BGB0009, BGB0010, BGB0011, BGB0012, BGB0013, BGB0014, BGB0015, BGB0016, BGB0017, BGB0018, BGB0019, BGB0022, BGB0023, BGB0024, BGB0025, BGB0026, BGB0050, BHZ0001, BHZ0002, BHZ0003, BHZ0004, BHZ0005, BHZ0006, BHZ0009, BHZ0010, BHZ0011		
accessories for	378030		
	GEV No.	Ref. No.	—
	378261		
	temperature probe NTC 10kOhm cable thermoplastic probe -40 up to +110°C cable -40 up to +110°C probe ø6x35mm cable length 3m without screw connection 2-wire		
	GEV No.	Ref. No.	—
	379057		
	temperature probe NTC 10kOhm cable PVC probe -20 up to +80°C cable -10 up to 100°C probe ø6x25mm cable length 3m 2-wire		
	GEV No.	Ref. No.	A00DJ102
	379160		
	temperature probe NTC 10kOhm cable thermoplastic probe -40 up to +110°C cable -40 up to +110°C probe ø6x14mm cable length 1.5m without screw connection 2-wire		
	GEV No.	Ref. No.	—
	379161		
	temperature probe NTC 10kOhm cable thermoplastic probe -40 up to +110°C cable -40 up to +110°C probe ø6x14mm cable length 3m without screw connection 2-wire		
	GEV No.	Ref. No.	—
	379342		
	temperature probe NTC 10kOhm cable PVC probe -20 up to +80°C cable -10 up to 100°C probe ø6x25mm cable length 1.5m 2-wire protection IP67		
	GEV No.	Ref. No.	—
	379343		
	temperature probe NTC 10kOhm cable silicone probe -40 up to +110°C cable -50 up to +180°C probe ø6x40mm cable length 3m 2-wire		
	GEV No.	Ref. No.	—
	379458		
	temperature probe NTC 10kOhm cable silicone probe -40 up to +110°C cable -50 up to +180°C probe ø6x40mm cable length 1.5m without screw connection 2-wire		
	GEV No.	Ref. No.	—
	379784		
	temperature probe NTC 2kOhm cable thermoplastic probe -40 up to +110°C cable -40 up to +110°C probe ø6x35mm cable length 2m without screw connection 2-wire resistor 2kOhm		
	GEV No.	Ref. No.	—
	379860		
	temperature probe NTC 10kOhm cable PVC probe -20 up to +80°C cable -10 up to 100°C probe ø6x40mm cable length 1.5m without screw connection 2-wire		

DIXELL

universal controllers



1

GEV No.	403393	Ref. No.	A00DJ124
description	electronic controller DIXELL type XT110C-5H1AU mounting measurements 71x29mm 230V voltage AC mV/mA relay outputs 1 CO-8A(3) mV/mA DI DI yes defr. funct. no depend on probe°C display 3½ digits		
For models:	BMA0098, BMA0099		

refrigeration controllers

accessories



1

GEV No.	381247	Ref. No.	A00DJ108
description	data cable DIXELL		
For models:	BMA0013-F, BMA0034-F, BMA0038-F, BMB0002-F, BMB0004-F, BMB0014-F, BMB0014-FG, BMB0015-F, BMB0042-F, BMC0001-F, BMC0003-F, BNA0068, BNA0069, BNC0002-F, BNC0007-F, BNC0008-F, BNC0030, TIM3, VAEK170-F, VAEK210-F, VAEK220-F, VAEN030-F, VAEN060-F, VAEN075-F		
accessories for	381247		
	GEV No.	Ref. No.	—
	381245		
	display DIXELL DX60 mounting measurements 157x28mm built-in depth 20mmV voltage relay outputs protection IP00°C display 3½ digits		
	GEV No.	Ref. No.	—
	381246		
	refrigeration controller DIXELL XW60K-5L1CO mounting measurements 140x110mm built-in depth 60mm 230V voltage AC NTC relay outputs 4 NO-20A(8) NO-16A(5) NO-8A(3) NO-16A(5) NTC NTC DI DI yes protection -40 up to 110°C display DX60		







ELIWELL



universal controllers



built-in version



1	GEV No.	379605	Ref. No.	91310030
description	electronic controller ELIWELL type ICPlus915 model ICP22J135000 mounting measurements 71x29mm 12V voltage AC/DC Pt100/TC (J,K) relay outputs 2 NO-8A(4) NO-8A(4) Pt100/TC (J,K) cooking front measurements 78x37mm built-in depth 59mm mode of operation cooking protection IPx0 accuracy 1% built-in version defr. funct. no dependend on probe°C display 3½ digits			
For models:	CAA0003, CAA0004, CAA0005			
accessories for	379605			
	GEV No.	379050	Ref. No.	—
	temperature probe Pt100 cable Vetrotex probe -200 up to +600°C cable -50 up to +350°C probe ø6x100mm cable length 2.7m without screw connection 3-wire			
	GEV No.	379054	Ref. No.	91310350
	transformer primary 230VAC secondary 12VAC 3VA secondary 0.25A H 40mm L 45mm W 50mm connection screw 50/60Hz type 153/M			
	GEV No.	379785	Ref. No.	—
	temperature probe Pt100 cable silicone probe -100 up to 450°C cable -50 up to +180°C probe ø6x100mm cable length 1.5m without screw connection 2-wire resistor 0.1kOhm			
	GEV No.	379786	Ref. No.	—
	temperature probe Pt100 cable silicone probe -100 up to 450°C cable -50 up to +180°C probe ø6x100mm cable length 3m without screw connection 2-wire resistor 0.1kOhm			
	GEV No.	379787	Ref. No.	—
	temperature probe Pt100 cable Vetrotex probe -200 up to +600°C cable -50 up to +350°C probe ø6x100mm cable length 1.4m without screw connection 2-wire resistor 0.1kOhm			



1	GEV No.	379568	Ref. No.	TERM0012
description	electronic controller ELIWELL type ICPlus915 model ICP22J1750000 mounting measurements 71x29mm 230V voltage AC Pt100/TC (J,K) relay outputs 2 CO-8A(4) CO-8A(4) Pt100/TC (J,K,S) DI front measurements 78x37mm built-in depth 60mm mode of operation cooking protection IPx0 accuracy 1% built-in version defr. funct. no -150 to 1350°C display 3½ digits			
For models:	CAD0005, CAD0007, SY850VELED			
accessories for	379568			
	GEV No.	378065	Ref. No.	—
	alarm device AKO type AKO-520641 mounting measurements 214x214mm 230V voltage AC relay outputs 1 CO-8A(4) up to 4 front measurements 222x222mm yes yes			
	GEV No.	378074	Ref. No.	—
	temperature probe thermocouple J (Fe-CuNi) cable Vetrotex probe -50 up to +750°C cable -50 up to +350°C probe ø3x100mm cable length 3m without screw connection 2-wire			



accessories for	379568			
	GEV No.	378075	Ref. No.	—
	temperature probe thermocouple K (NiCr-Ni) cable Vetrotex probe -50 up to 1150°C cable -50 up to +350°C probe ø4.5x150mm cable length 3m without screw connection 2-wire			
	GEV No.	379050	Ref. No.	—
	temperature probe Pt100 cable Vetrotex probe -200 up to +600°C cable -50 up to +350°C probe ø6x100mm cable length 2.7m without screw connection 3-wire			
	GEV No.	379062	Ref. No.	—
	temperature probe thermocouple J (Fe-CuNi) cable Vetrotex probe -50 up to +750°C cable -50 up to +350°C probe ø6x50mm cable length 3m without screw connection 2-wire			

EVCO - EVERY CONTROL

universal controllers

built-in version



1	GEV No.	378134	Ref. No.	TERM0060
description	electronic controller EVERY CONTROL EVK411 mounting measurements 71x29mm built-in depth 59mm 230V voltage AC NTC/PTC/Pt100/Pt1000/TC(J,K)/mV/mA relay outputs 1 CO-16A(8) NTC/PTC/Pt100/Pt1000/TC(J,K)/mV/mA yes protection IP55 dependend on probe°C display 3½ digits			
For models:	SY850VELED			
accessories for	378134			
	GEV No.	378075	Ref. No.	—
	temperature probe thermocouple K (NiCr-Ni) cable Vetrotex probe -50 up to 1150°C cable -50 up to +350°C probe ø4.5x150mm cable length 3m without screw connection 2-wire			
	GEV No.	379051	Ref. No.	91310211
	temperature probe thermocouple J (Fe-CuNi) cable Vetrotex probe -50 up to +750°C cable -50 up to +350°C probe ø6x100mm cable length 3m without screw connection cable colours red/blue 2-wire			
	GEV No.	379062	Ref. No.	—
	temperature probe thermocouple J (Fe-CuNi) cable Vetrotex probe -50 up to +750°C cable -50 up to +350°C probe ø6x50mm cable length 3m without screw connection 2-wire			

refrigeration controllers

built-in version



1	GEV No.	379998	Ref. No.	3700041
description	electronic controller EVERY CONTROL type FK200XN7 mounting measurements 71x29mm 230V voltage AC NTC			
For models:	IIA5005, IIA5006, IIA5010, IIA5011, IIA5012, IIA5013, IIA5014, IIA5015			



built-in version 2-piece

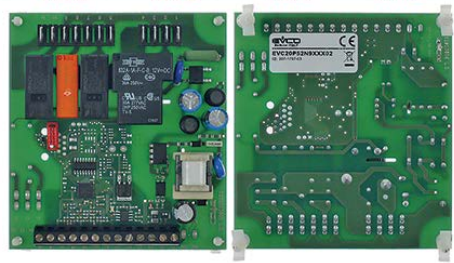

1

GEV No.	403412	Ref. No.	A00DJ120
description	keypad PCB refrigerated counter BGL2-VT incl. control panel mounting pos. horizontal buttons 6		
For models:	BNC0001BAR-F, BNC0007BAR-F, BNC0015BAR-F, HAB0001-F, HAB0007-F, HAB0009-F, HAB0015-F, HAB0020, HAB0021, IBC0055		
accessories for	403412		
	GEV No.	381249	Ref. No. A00DJ109
	temperature probe NTC 10kOhm cable PVC probe -40 up to +110°C cable -10 up to 100°C connection 2-wire thread probe ø6x14mm cable length 3m		

SHANGFANG

accessories



1

GEV No.	379054	Ref. No.	91310350
description	transformer primary 230VAC secondary 12VAC 3VA secondary 0.25A H 40mm L 45mm W 50mm connection screw 50/60Hz type 153/M		
For models:	CAA0003, CAA0004, CAA0005		

probes

universal probes

temperature probes

1



GEV No.	379160	Ref. No.	A00DJ102
description	temperature probe NTC 10kOhm cable thermoplastic probe -40 up to +110°C cable -40 up to +110°C probe ø6x14mm cable length 1.5m without screw connection 2-wire		
For models:	9925F, 9931F, 9932F, BMA0034-F, BMA0098, BMA0099, BMB0002-FG, BMB0014-FG, BMB0015-F, BMB0042-F, BMC0001-FG, BNC0001BAR-F, BNC0001-F, BNC0002-F, BNC0007BAR-F, BNC0008-F, BNC0015BAR-F, BNC0015-F, BNC0016-F, BNC0030, BNC0030PI, BNC0032, BNC0033, BNC0034, BNC0034PI, BNC0035, CCZ0009-F, CCZ0018-F, CCZ0050, HAB0001-F, HAB0007-F, HAB0009-F, HAB0015-F, HAB0020, HAB0021, HCE2004-F, HCE2005-F, HCE2006-F, HCE2007-F, HCE2008-F, HCE2009, IEC0050, IEC0051, IEC0052, SALADBAR2, SALADBAR3, TIM3, TIM3PI, USN4, VAEK170-F...(Other models you can see in the webshop)		

1



GEV No.	379051	Ref. No.	91310211
description	temperature probe thermocouple J (Fe-CuNi) cable Vetrotex probe -50 up to +750°C cable -50 up to +350°C probe ø6x100mm cable length 3m without screw connection cable colours red/blue 2-wire		
For models:	CAA0003, CAA0004, CAA0005, CAB0019, CAB0020, GIOTTOD, GIOTTOP		
accessories for	379051		
	GEV No.	379877	Ref. No. —
		electronic controller HONEYWELL type DC10N-400 mounting measurements 92x92mm 24/230V voltage AC TC (J) relay outputs 1 CO-10A(6) TC (J) universal built-in depth 55mm protection IP54 accuracy 1% built-in version defr. funct. no 0 up to +400°C display 3 digits	

humidity probes

1



GEV No.	403390	Ref. No.	A00DJ114
description	humidity probe humidity range 0-99% supply 9-28VDC outlet 4-20mA probe ø17.5x120mm cable lengthm 0 up to +70°C XH20P		
For models:	BMA0098, BMA0099		

producer-specific probes

probes

1

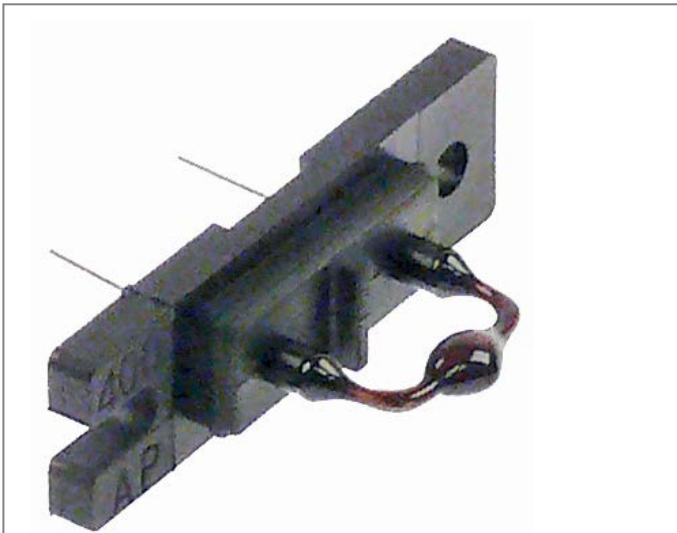
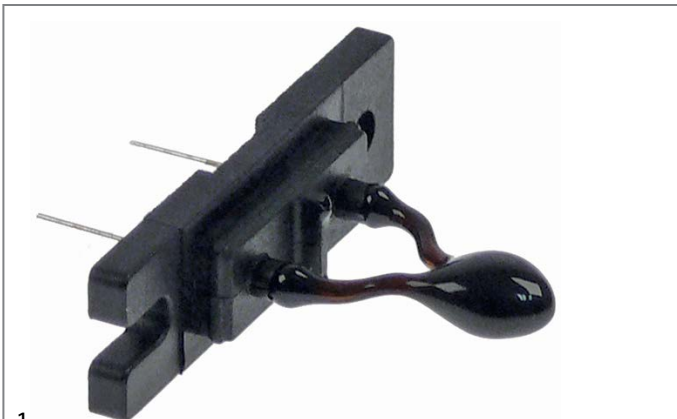

Image not available

GEV No.	403942	Ref. No.	231016
description	temperature probe		
For models:	GLB0071, GLB0073, OPT1012C		



GEV No.	403571	Ref. No.	A601L4000AP
description	temperature probe connection soldering connection for microwave PANASONIC		
For models:	NE1880, NE2140, NE3240		



GEV No.	403713	Ref. No.	A601L5150AP
description	temperature probe connection soldering connection for microwave PANASONIC		
For models:	NE1643, NE1653, NE1843		



GEV No.	381249	Ref. No.	A00DJ109
description	temperature probe NTC 10kOhm cable PVC probe -40 up to +110°C cable -10 up to 100°C connection 2-wire thread probe ø6x14mm cable length 3m		
For models:	9925F, 9931F, 9932F, BMA0034-F, BMA0098, BMA0099, BMB0002-F, BMB0002-FG, BMB0014-F, BMB0014-FG, BMB0015-F, BMB0042-F, BMB0046-F, BMC0001-F, BMC0001-FG, BMC0003-F, BNA0068, BNA0069, BNC0001BAR-F, BNC0001-F, BNC0002-F, BNC0007BAR-F, BNC0007-F, BNC0008-F, BNC0015BAR-F, BNC0015-F, BNC0016-F, BNC0030, BNC0030PI, BNC0032, BNC0033, BNC0034, BNC0034PI, BNC0035, CCZ0009-F, CCZ0018-F, CCZ0050, HAB0001-F, HAB0007-F, HAB0009-F, HAB0015-F, HAB0020, HAB0021, HCE2004-F, HCE2005-F, HCE2006-F, HCE2007-F, HCE2008-F, HCE2009, IEA0010...(Other models you can see in the webshop)		

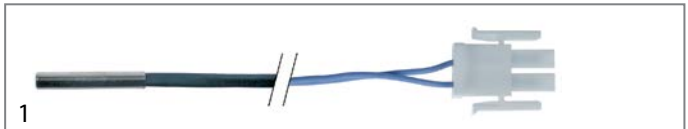

GEV No.	400910	Ref. No.	231014
description	temperature probe NTC 10kOhm cable silicone probe -40 up to +110°C cable -50 up to +180°C connection coded plug thread probe ø4.5x30mm cable length 0.35m		
For models:	GLB0043, GLB0044, GLB0046, GLB0070, GLB0071, OPT1012		



GEV No.	379519	Ref. No.	1604133 711000
description	temperature probe NTC cable silicone probe -40 up to +110°C cable -50 up to +180°C connection male faston thread probe ø10x30mm cable length 0.05m		
For models:	EFB0014, EFB0017, EFB0018, EFB0019, EFC0003		
accessories for	379519		

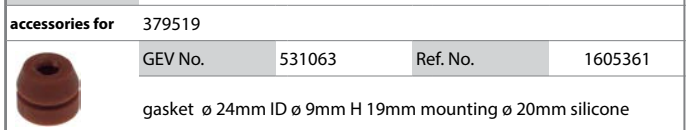

GEV No.	531063	Ref. No.	1605361
description	gasket ø 24mm ID ø 9mm H 19mm mounting ø 20mm silicone		



GEV No.	379944	Ref. No.	TERM0019 TERM0049
description	temperature probe Pt1000 cable Vetrotex probe -70 up to +500°C cable -50 up to +350°C connection 2-wire thread probe ø6x180mm cable length 1.7m		
For models:	CAD0004, CAD0004-ZN, CAD0005, CAD0007, CAD0009, CAD0010, SY12100VELED, SY12100VGASD, SY1280VE, SY1280VG, SY850VELED		



GEV No.	403694	Ref. No.	91310212
description	temperature probe thermocouple J (Fe-CuNi) cable Vetrotex probe -50 up to +750°C cable -50 up to +350°C connection 2-wire thread probe ø6x100mm cable length 0.45m		
For models:	CAB0007-CD, CAB0008-CD, CAB0009-CD, CAB0013-CD, CAB0014-CD, CAB0015-CD, CAB0019, CAB0020, CAB0024-CD, CAB0025-CD, CAB0055-DCG, CAB0056-DCG, CAB0057-DCG, CAB0058-DCG, CAB0059-DCG, CAB0060-DCG, CAB0061-DCG, CAB0062-DCG		



GEV No.	379941	Ref. No.	TERM0020
description	temperature probe thermocouple J (Fe-CuNi) cable Vetrotex probe -50 up to +750°C cable -50 up to +350°C connection 2-wire thread probe ø6x200mm cable length 1m		
For models:	CAD0005, CAD0007, SY850VELED		



GEV No.	379598	Ref. No.	91310215
description	temperature probe thermocouple K (NiCr-Ni) cable Vetrotex probe -50 up to 1150°C cable -50 up to +350°C connection 2-wire thread probe ø3x200mm cable length 1.5m		
For models:	CAB0007, CAB0008, CAB0009, CAB0010, CAB0011, CAB0012, CAB0016, CAB0017, CAB0018, CAB0026, CAB0027		



sensors



1

GEV No.	401611	Ref. No.	NR23676
description	sensor ø 18mm L 44mm thread M10x1 cable length 1450mm		
For models:	BAB0003, BAB0004, BAB0005		
accessories for	401611		
		GEV No.	521129
		Ref. No.	—
	nut thread M10 H 6mm SS WS 17 Qty 1 pcs DIN/ISO DIN 439		

accessories

miscellaneous



1

GEV No.	531063	Ref. No.	1605361
description	gasket ø 24mm ID ø 9mm H 19mm mounting ø 20mm silicone		
For models:	EFB0014, EFB0017, EFB0018, EFB0019, EFC0003		

electronics

EPROMS

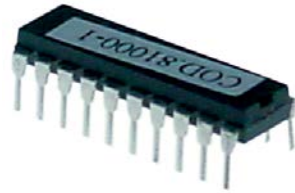

1

GEV No.	401558	Ref. No.	81000
description	EPROM CODE 81000-1		
For models:	GLB0071		



1

GEV No.	401559	Ref. No.	81021
description	EPROM CODE 81000-1		
For models:	GLB0070		



1

GEV No.	403246	Ref. No.	81006
description	EPROM for dishwasher CODE 81006-5		
For models:	OPT1012		



1

GEV No.	403244	Ref. No.	81008
description	EPROM for dishwasher CODE 81008		
For models:	GLB0046		



1

GEV No.	403241	Ref. No.	81001
description	EPROM type U61E for dishwasher CODE 81001-3		
For models:	GLB0043, GLB0044		

PCBs



1

GEV No.	403497	Ref. No.	A605S3030GP
description	buzzer board for microwave suitable for PANASONIC		
For models:	NE1880, NE2140, NE3240, NEC1475		

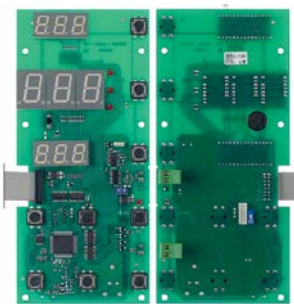

1

GEV No.	401149	Ref. No.	91310255
description	control PCB		
For models:	CAB0019, CAB0020		

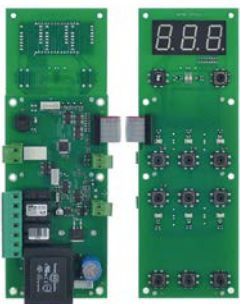

1

GEV No.	403693	Ref. No.	91310258
description	control PCB for pizza oven Michelangelo L 230mm W 80mm connection screw clamps		
For models:	CAB0007-CD, CAB0008-CD, CAB0009-CD, CAB0013-CD, CAB0014-CD, CAB0015-CD, CAB0024-CD, CAB0025-CD, CAB0055-DCG, CAB0056-DCG, CAB0057-DCG, CAB0058-DCG, CAB0059-DCG, CAB0060-DCG, CAB0061-DCG, CAB0062-DCG		



1

GEV No.	400859	Ref. No.	91310250
description	control PCB pizza oven TH4351DC		
For models:	CAB0007, CAB0008, CAB0009, CAB0010, CAB0011, CAB0012, CAB0016, CAB0017, CAB0018, CAB0026, CAB0027		



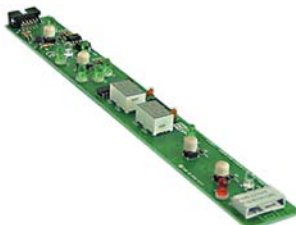

1

GEV No.	401204	Ref. No.	ELET0155
description	display PCB		
For models:	CAD0004, CAD0004-ZN, CAD0005, CAD0007, CAD0009, CAD0010, SY12100VELED, SY12100VGASD, SY1280VE, SY1280VG, SY850VELED		





1

GEV No.	400897	Ref. No.	227084	
description	display PCB dishwasher GS 60			
For models:	GLB0073			
accessories for	400897			
	GEV No.	403250	Ref. No.	80933
	ribbon cable 10-pole L 3000mm plug type coded 2 row plug: number of poles 10			



1

GEV No.	400898	Ref. No.	80889 80900	
description	keypad PCB dishwasher LP10/20/30 with display			
For models:	GLB0043, GLB0044, GLB0046, GLB0071			
accessories for	400898			
	GEV No.	402970	Ref. No.	41523
	ribbon cable 10-pole L 1200mm plug type 2 row coded Qty 1m			



1

GEV No.	401205	Ref. No.	ELET0212
description	main PCB		
For models:	CAD0004, CAD0004-ZN, CAD0005, CAD0007, CAD0009, CAD0010, SY12100VELED, SY12100VGASD, SY1280VE, SY1280VG, SY850VELED		



1

GEV No.	403725	Ref. No.	11950577000
description	main PCB combi-steamer L 262mm W 108mm		
For models:	KF981D		

1

GEV No.	402940	Ref. No.	4SCHS090
description	main PCB CSK 120 L 124mm W 100mm type MIR90		
For models:	VSFK170, VSFK200, VSFK203, VSFK400, VSFN075, VSFN122, VSFN200		

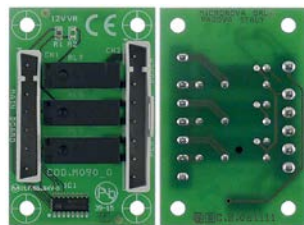

1

GEV No.	403621	Ref. No.	215036
description	PCB dishwasher 25/26/27-05 26/27-20 L 60mm W 40mm		
For models:	OPT1012C		



1

GEV No.	402771	Ref. No.	1031640
description	PCB coffee machine COFFEE QUEEN L 134mm W 48mm 230V with display		
For models:	EFB0001, EFB0004, EFB0009, EFB0009-C		



1

GEV No.	402880	Ref. No.	215027
description	PCB dishwasher L 152mm W 80mm		
For models:	GLB0071		



1

GEV No.	402834	Ref. No.	1031641
description	PCB coffee machine COFFEE QUEEN L 135mm W 48mm 230V with display		
For models:	EFC0003		

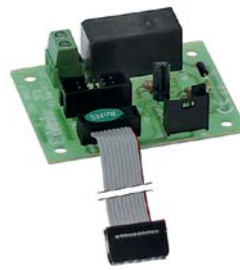

1

GEV No.	401049	Ref. No.	215022
description	PCB dishwasher LP10/20/30		
For models:	GLB0043, GLB0044, GLB0046		



1

GEV No.	401727	Ref. No.	19413007
description	PCB cutter C4-C6 230V		
For models:	FLA0014, FLA0015		



1

GEV No.	403518	Ref. No.	215034-5
description	PCB dishwasher R4258E1120T7S L 136mm W 85.5mm 230V		
For models:	OPT1012C		

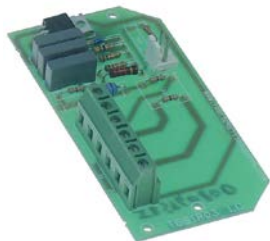

1			
GEV No.	401730	Ref. No.	IB5940800
description	PCB drink mixer Dragone 50/60Hz 230V		
For models:	DRAGONEVV		



1			
GEV No.	401729	Ref. No.	IB5940005
description	PCB drink mixer Sirio 50/60Hz 110-250V 1.5A		
For models:	SIRIO1VVCAFFE, SIRIO2VVCAFFE		



1			
GEV No.	401728	Ref. No.	IB5940000
description	PCB drink mixer Sirio 50/60Hz 120/240V 1.6A		
For models:	SIRIO1VVCAFFE, SIRIO2VVCAFFE		



1			
GEV No.	403692	Ref. No.	91310259
description	PCB for pizza oven Michelangelo L 80mm W 32mm connection coded plug for flues		
For models:	CAB0055-DCG, CAB0056-DCG, CAB0057-DCG, CAB0058-DCG, CAB0059-DCG, CAB0060-DCG, CAB0061-DCG, CAB0062-DCG		



1			
GEV No.	403515	Ref. No.	IB5940702
description	PCB fruit squeezer APOLLO L 111mm W 56mm 230V		
For models:	MULTIPL02S, MULTIPL03S		



1			
GEV No.	401953	Ref. No.	IB5944010
description	PCB hand blenders VORTEX with potentiometer 230V		
For models:	FJZ0010, FJZ0011, FJZ0012		



1			
GEV No.	402831	Ref. No.	1031646
description	PCB L 135mm W 48mm 230V with display for COFFEE QUEEN		
For models:	EFB0017, EFB0018		



1			
GEV No.	402835	Ref. No.	1031642
description	PCB L 135mm W 48mm 230V with display for COFFEE QUEEN		
For models:	EFB0014, EFB0019		



1			
GEV No.	403688	Ref. No.	F2140
description	PCB meat mincer/cheese grater T12 230V		
For models:	FHZ0003, FIF0001, FIF0002, FIF0003-22HP, FIF0004, FIF0005, FMC0001-F, TCG22E-F		

1

GEV No.	401385	Ref. No.	LF1033020
description	PCB Mod.12 230/400V type TGM7		
For models:	FID0005, FID0006, FID0007, FID0008, FIF0014, TC32BU, TC32NEVADAT		



1

GEV No.	401360	Ref. No.	F2141
description	PCB Mod.12 400V		
For models:	FHZ0003, FIF0001, FIF0002, FIF0003-22HP, FIF0004, FIF0005, FMC0001-F, TCG22E-F		



1

GEV No.	401358	Ref. No.	F2027
description	PCB Mod.8 230V		
For models:	FHZ0001, FIF0016-F		



1

GEV No.	401206	Ref. No.	ELET0203
description	PCB motor control		
For models:	CAD0004, CAD0005, CAD0007, SY850VELED		



1

GEV No.	401207	Ref. No.	ELET0213
description	PCB motor control		
For models:	CAD0004, CAD0004-ZN, CAD0005, CAD0007, CAD0009, CAD0010, SY12100VELED, SY12100VGASD, SY1280VE, SY1280VG, SY850VELED		



1

GEV No.	401150	Ref. No.	91310305 91310306
description	PCB pizza oven MAX 4/35		
For models:	CAB0007-CD, CAB0008-CD, CAB0009-CD, CAB0013-CD, CAB0014-CD, CAB0015-CD, CAB0019, CAB0020, CAB0024-CD, CAB0025-CD, CAB0055-DCG, CAB0056-DCG, CAB0057-DCG, CAB0058-DCG, CAB0059-DCG, CAB0060-DCG, CAB0061-DCG, CAB0062-DCG, GIOT-TOD, GIOTTOPT		



1

GEV No.	400814	Ref. No.	91310301
description	PCB pizza oven TH4351DC 2kW		
For models:	CAB0007, CAB0008, CAB0009, CAB0010, CAB0011, CAB0012, CAB0016, CAB0017, CAB0018, CAB0026, CAB0027		





1

GEV No.	401451	Ref. No.	66304800
description	PCB pyroceram range 110/920 series		
For models:	92PCV, 94CFV, 94PCV		





1

GEV No.	400955	Ref. No.	19411008
description	PCB slicer 230/400V		
For models:	FEB0031, FLA0016, FLA0028, MIRRA300		
accessories for	400955		
	GEV No.	401357	Ref. No. F2138
	momentary push switch mounting measurements ø22mm 1NO/1NC/indicator light 400V 4A indicator lamp 24V 0-1 connection screw ambient temperature max. 125/55°C protection IP40		
	GEV No.	401709	Ref. No. —
	protective cover external size 57x32mm internal size 47x22mm matt finish rubber H 27.5mm		



1

GEV No.	400785	Ref. No.	00000000359
description	PCB slicer 300SCEP 230V		
For models:	8921, 8922		
accessories for	400785		
	GEV No.	301058	Ref. No. 00000000653
	protective cover internal size 30x55mm		



1

GEV No.	403315	Ref. No.	19411000.06
description	PCB slicer CANOVA L 128mm W 42mm H 42mm		
For models:	PALLADIO300AM, PALLADIO350AM		



1

GEV No.	400954	Ref. No.	19411007
description	PCB slicer/cutter 50/60Hz 230V		
For models:	FEB0031, FLA0014, FLA0015, FLA0016, FLA0028, MIRRA300		





1

GEV No.	401965	Ref. No.	91310270
description	PCB suitable for EV385		
For models:	GIOTTOD, GIOTTOP, ZCKEV2AS, ZCKEVAS		



1

GEV No.	402093	Ref. No.	0230040
description	PCB vacuum packing machine B35 / B-M 42/42XL H_HD4		
For models:	FGZ0006, FGZ0007, FGZ0009, FGZ0026, FGZ0027, FGZ0028		
spare parts for	402093		
	GEV No.	358596	Ref. No. —
	fine fuse size ø5x20mm 0.25A slow-acting rated 250V Qty 10 pcs		



1

GEV No.	402095	Ref. No.	0230042
description	PCB vacuum packing machine B35 / B-M 42/42XL H_HD4 with sensor		
For models:	FGZ0006, FGZ0007, FGZ0009, FGZ0026, FGZ0027, FGZ0028		

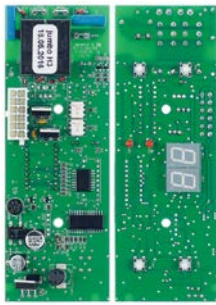







1

GEV No.	402092	Ref. No.	0230036
description	PCB vacuum packing machine JUMBO		
For models:	FGZ0005, FGZ0012, FGZ0013, FGZ0025		

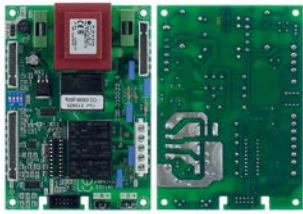

			
1			
GEV No.	403784	Ref. No.	215037
description	PCB warewashing ELETTOBAR / COLGED L 60mm W 30mm		
For models:	OPT1012C		

			
1			
GEV No.	403509	Ref. No.	999298
description	PCB warewashing NIAGARA/SILVER		
For models:	GLB0073		

			
1			
GEV No.	400899	Ref. No.	215023
description	power PCB dishwasher LP10/20/30 without EPROM		
For models:	GLB0043, GLB0044, GLB0046, GLB0070, GLB0071, OPT1012		
accessories for	400899		
	GEV No.	Ref. No.	
	400761	—	
plug connector 5-pole			
	400900	—	
EPROM CODE 225029-3			
	401558	81000	
EPROM CODE 81000-1			
	403241	81001	
EPROM type U61E for dishwasher CODE 81001-3			
	550048	—	
female bullet			

central units

			
1			
GEV No.	403703	Ref. No.	4.0.000.0953
description	central unit 240V 50/60Hz L 130mm W 120mm suitable for GICAR		
For models:	EFA0015, EFA0016, EFA0023		

			
1			
GEV No.	401092	Ref. No.	50PAA78246
description	control box 400V		
For models:	FIB0001		

			
1			
GEV No.	400788	Ref. No.	00000000297
description	control box for slicer 230V		
For models:	8921, 8922		

			
1			
GEV No.	402942	Ref. No.	074154
description	control box for vegetable slicer 230V for Star 10		
For models:	9654		

keypads

front foils

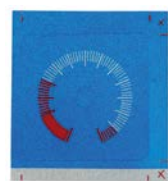
			
1			
GEV No.	696452	Ref. No.	MSC04V238
description	front foil cutter C9VV CE blue L 60mm W 60mm		
For models:	FLA0014, FLA0015, FLA0016		

			
1			
GEV No.	403238	Ref. No.	Z222903000
description	front foil dishwasher F148 grey model FI-48B suitable for FAGOR L 585mm W 62.5mm		
For models:	GLB0061C-F, GLB0063C-F		

1

GEV No.	401145	Ref. No.	91611080
description	keypad foil		
For models:	CAB0019, CAB0020		



1

GEV No.	401146	Ref. No.	91611090
description	keypad foil		
For models:	CAB0019, CAB0020		

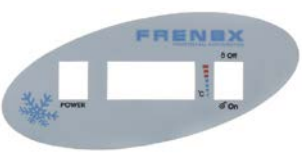

1

GEV No.	403710	Ref. No.	A00DJ105
description	keypad foil for fridge suitable for FRENEX		
For models:	9925F, 9931F, 9932F, BMA0013-F, BMA0034-F, BMA0038-F, BMB0002-F, BMB0002-FG, BMB0004-F, BMB0014-F, BMB0014-FG, BMB0015-F, BMB0042-F, BMC0001-F, BMC0001-FG, BMC0003-F, BNA0068, BNA0069, BNC0001BAR-F, BNC0001-F, BNC0002-F, BNC0007BAR-F, BNC0007-F, BNC0008-F, BNC0015BAR-F, BNC0015-F, BNC0016-F, BNC0030, BNC0030PI, BNC0032, BNC0033, BNC0034, BNC0034PI, BNC0035, CCZ0009-F, CCZ0018-F, CCZ0050, HAB0001-F, HAB0007-F, HAB0009-F, HAB0015-F, HAB0020, HAB0021, HCE2004-F, HCE2005-F, HCE2006-F, HCE2007-F, HCE2008-F, HCE2009, IEA0010...(Other models you can see in the webshop)		

membrane keypads



1

GEV No.	401356	Ref. No.	F2033
description	membrane keypad		
For models:	FHZ0001, FIF0016-F		



1

GEV No.	401202	Ref. No.	ELET0165
description	membrane keypad 6 buttons		
For models:	CAD0004, CAD0004-ZN, CAD0005, CAD0009, SY12100VELED, SY-1280VE, SY850VELED		



1

GEV No.	401203	Ref. No.	ELET0153
description	membrane keypad 6 buttons		
For models:	CAD0007, CAD0010, SY12100VELED, SY12100VGASD, SY1280VG		



1

GEV No.	402839	Ref. No.	1603853
description	membrane keypad buttons 2 suitable for COFFEE QUEEN L 67mm W 40mm		
For models:	EFC0003		





1

GEV No.	402773	Ref. No.	1603854
description	membrane keypad buttons 3 suitable for COFFEE QUEEN L 125mm W 41mm		
For models:	EFB0001, EFB0004, EFB0009, EFB0009-C		



 <p>1</p>			
GEV No.	402862	Ref. No.	1603859
description	membrane keypad buttons 3 suitable for COFFEE QUEEN L 333mm W 52mm		
For models:	EFB0019		

 <p>1</p>			
GEV No.	402838	Ref. No.	1603856
description	membrane keypad buttons 6 suitable for COFFEE QUEEN L 330mm W 50mm		
For models:	EFB0014		

 <p>1</p>			
GEV No.	402100	Ref. No.	0900105
description	membrane keypad vacuum packing machine with frame		
For models:	FGZ0007, FGZ0009, FGZ0027		

 <p>1</p>			
GEV No.	402096	Ref. No.	0900100
description	membrane keypad with frame		
For models:	FGZ0005, FGZ0012, FGZ0013, FGZ0025		

keypad units

 <p>1</p>			
GEV No.	403001	Ref. No.	LF1007001 LF1010027
description	keypad unit bone saw SO1650/SO2020 L 120mm W 49mm with cable		
For models:	FIG0002, FIG0009M		

 <p>1</p>			
GEV No.	401737	Ref. No.	19702021
description	keypad unit buttons 2 blue L 130mm W 41mm		
For models:	FEB0031, FLA0014, FLA0015, FLA0016, MIRRA300		



 <p>1</p>			
GEV No.	401736	Ref. No.	19702022
description	keypad unit buttons 2 white L 130mm W 41mm		
For models:	FEB0031, FLA0014, FLA0015, FLA0016, MIRRA300		



 <p>1</p>			
GEV No.	402667	Ref. No.	4.0.000.0955
description	keypad unit buttons 5 silver/black L 120mm W 50mm		
For models:	EFA0015, EFA0016, EFA0023		

 <p>1</p>			
GEV No.	401735	Ref. No.	LF1033021
description	keypad unit meat mincer TC12 buttons 3 cable length 90mm L 130mm W 41mm cable colours brown/yellow/grey/green/pink/white		
For models:	FID0005, FID0006, FID0007, FID0008, TC32NEVADAT		
accessories for	401735		
	GEV No.	Ref. No.	19563034
	 <p>gasket for keypad housing L 135mm W 50mm</p>		

			
1			
GEV No.	403006	Ref. No.	19702034
description	keypad unit slicer BAYONNE/CANOVA buttons 2 L 130mm W 41mm		
For models:	PALLADIO300AM, PALLADIO350AM		

			
1			
GEV No.	401694	Ref. No.	19702004
description	keypad unit slicer BAYONNE/CICLONE/SAN-DANIELE buttons 2 L 130mm W 41mm		
For models:	FEB0031, FLA0014, FLA0015, FLA0016, MIRRA300		
accessories for	401694		
		GEV No.	401373
		Ref. No.	19563034
	gasket for keypad housing L 135mm W 50mm		

			
1			
GEV No.	403002	Ref. No.	19702000
description	keypad unit slicer buttons 2 MIRRA/SAN-DANIELE/YORK L 120mm W 48mm		
For models:	FEB0031, FLA0014, FLA0015, FLA0028, MIRRA300		
accessories for	403002		
		GEV No.	403004
		Ref. No.	19563030
	gasket for keypad housing L 122mm W 52mm		

			
1			
GEV No.	403003	Ref. No.	19702002
description	keypad unit slicer GEMMA 300/350 buttons 2 L 150mm W 55mm		
For models:	FLA0016		
accessories for	403003		
		GEV No.	401380
		Ref. No.	19563032
	gasket for keypad housing L 150mm W 60mm		

			
1			
GEV No.	401356	Ref. No.	F2033
description	membrane keypad		
For models:	FHZ0001, FIF0016-F		

control panel

			
1			
GEV No.	692142	Ref. No.	0330120
description	housing vacuum packing machine 200/220		
For models:	FGZ0009, FGZ0028		

accessories

			
1			
GEV No.	403004	Ref. No.	19563030
description	gasket for keypad housing L 122mm W 52mm		
For models:	FEB0031, FIG0002, FIG0010, FLA0014, FLA0015, FLA0028, MIRRA300		



			
1			
GEV No.	401373	Ref. No.	19563034
description	gasket for keypad housing L 135mm W 50mm		
For models:	FEB0009-SNT, FEB0010-SNT, FEB0031, FEB0033, FEB0034, FEB0035, FIC0001, FIC0002, FID0006, FID0007, FID0008, FIG0002, FIG0009M, FIG0010, FLA0014, FLA0015, FLA0016, MIRRA300, PALLADIO300AM, PALLADIO300T, PALLADIO330T, PALLADIO350AM		

			
1			
GEV No.	401380	Ref. No.	19563032
description	gasket for keypad housing L 150mm W 60mm		
For models:	FLA0016		

solenoid valves

solenoid valves (water)

ELBI			
straight			

			
1			
GEV No.	373017	Ref. No.	240016
description	solenoide valve single straight 230VAC inlet 3/4" outlet 11.5mm DN10 ELBI		
For models:	GLB0070, GLB0071, GLB0073, OPT1012C		
spare parts for	373017		
		GEV No.	370467
		Ref. No.	—
	solenoide valve filter suitable for ELBI		



			
1			
GEV No.	370315	Ref. No.	929172
description	solenoid valve double straight 230VAC inlet 3/4" outlet 11.5mm input 16l/min t.max. 90°C ELBI plastic flow regulating valve inlet black		
For models:	GLB0043, GLB0044, GLB0046		

			
1			
GEV No.	370246	Ref. No.	240010
description	solenoid valve double straight 230VAC inlet 3/4" outlet 11.5mm t.max. 90°C ELBI plastic output B 0.5l/min flow regulating valve outlet B red		
For models:	GLB0035, GLB0036, GLB0037, GLB0038, GLB0039, GLB0056, GLB0057, GLB0059, GLB0061, GLB0061C, GLB0062, GLB0063, GLB0064, GLB0064C, GLB0065, GLB0066		

ROBERTSHAW/INVENSYS

medium temperature: 90°C 90°C 60°C
 ambient temperature: 60°C 25°C 60°C
 duty cycle: 40% 100% 100%

solenoid valves with reducers

single

			
1			
GEV No.	370613	Ref. No.	120624-01
description	solenoid valve single straight 230VAC inlet 3/4" outlet 11.5mm input 10l/min output 2.5l/min EATON (INVENSYS) plastic flow regulating valve outlet brown flow regulating valve inlet white		
For models:	EFC0003		

			
1			
GEV No.	370608	Ref. No.	120620-01
description	solenoid valve single straight 230VAC inlet 3/4" outlet 11.5mm input 9l/min output 0.95l/min EATON (INVENSYS) flow regulating valve outlet stainless steel flow regulating valve inlet blue		
For models:	EFB0001, EFB0009, EFB0009-C, EFB0017, EFB0018		

			
1			
GEV No.	370624	Ref. No.	120634
description	solenoid valve single straight 230VAC inlet 3/4" outlet 11.5mm input 9l/min output 5l/min EATON (INVENSYS) plastic flow regulating valve outlet black flow regulating valve inlet blue 6VA		
For models:	EFB0014, EFB0019		



2-fold

			
1			
GEV No.	370609	Ref. No.	120621-01
description	solenoid valve double straight 230VAC inlet 3/4" outlet 11.5mm input 9l/min flow regulating valve inlet blue output A 0.95l/min output B 0.95l/min flow regulating valve outlet A stainless steel flow regulating valve outlet B stainless steel		
For models:	EFB0004		

RPE











			
1			
GEV No.	374017	Ref. No.	3740017
description	solenoid valve single straight 230VAC inlet 3/4" outlet 10mm input 6l/min DN10 RPE polyamide flow regulating valve inlet white membranes NBR pressure range 0.2-10bar		
For models:	IIA3006, IIA3007, IIA3008, IIA3010, IIA3011, IIA3012		









JOHN GUEST

			
1			
GEV No.	370772	Ref. No.	ELE30005
description	solenoid valve double straight 230VAC inlet 3/4" outlet JG 8 DN10 t.max. 60°C duty cycle 100% RPE		
For models:	VP914RXS, VP916RXS		
accessories for	370772		
	GEV No.	371265	Ref. No.
			—
	GEV No.	371269	Ref. No.
			—



solenoid valves with reducers			
single			
			
GEV No.	374009	Ref. No.	ELE30004
description	solenoid valve single straight 220-240VAC inlet 3/4" outlet JG 8 input 10-12l/min output 0.07-0.14l/min t.max. 60°C duty cycle 100% RPE plastic flow regulating valve outlet brown flow regulating valve inlet white 1-ways medium temp max. 25°C		
For models:	VG715RXS, VP800U, VP824RU		

TP			
			
GEV No.	370021	Ref. No.	12023794 P255001000
description	solenoid valve double straight 230VAC inlet 3/4" outlet 11.5mm DN10 TP flow regulating valve inlet white		
For models:	GLB0037-FN, GLB0061C-F, GLB0063C-F		
spare parts for	370021		
	GEV No.	371013	Ref. No. —
solenoid coil TP 230VAC 50/60Hz			
accessories for	370021		
	GEV No.	371220	Ref. No. —
reducer TP flow rate 3l/min red tolerance ±15%			
	GEV No.	371221	Ref. No. —
reducer TP flow rate 5.5l/min yellow tolerance ±15%			
	GEV No.	371222	Ref. No. —
reducer TP flow rate 6l/min grey tolerance ±15%			
	GEV No.	371223	Ref. No. —
reducer TP flow rate 10l/min white tolerance ±15%			
	GEV No.	371224	Ref. No. —
reducer TP flow rate 12l/min bronze tolerance ±15%			
	GEV No.	371225	Ref. No. —
reducer TP flow rate 16l/min light brown tolerance ±15%			
	GEV No.	371226	Ref. No. —
reducer TP flow rate 20l/min red tolerance ±15%			
	GEV No.	371230	Ref. No. —
reducer TP flow rate 0.25l/min red tolerance ±25%			
	GEV No.	371231	Ref. No. —
reducer TP flow rate 0.35l/min violet tolerance ±25%			

accessories for	370021		
	GEV No.	371232	Ref. No. —
reducer TP flow rate 0.5l/min orange tolerance ±25%			
	GEV No.	371233	Ref. No. —
reducer TP flow rate 0.8l/min white tolerance ±25%			
	GEV No.	371234	Ref. No. P305013000
reducer TP flow rate 1l/min light blue tolerance ±25%			
	GEV No.	371235	Ref. No. —
reducer TP flow rate 1.2l/min brown tolerance ±25%			
	GEV No.	371236	Ref. No. —
reducer TP flow rate 1.5l/min light brown tolerance ±25%			
	GEV No.	371237	Ref. No. —
reducer TP flow rate 2.5l/min yellow tolerance ±25%			
	GEV No.	371238	Ref. No. —
reducer TP flow rate 3.4l/min dark green tolerance ±25%			
	GEV No.	371239	Ref. No. —
reducer TP flow rate 5l/min black tolerance ±25%			
	GEV No.	371240	Ref. No. —
reducer TP flow rate 8l/min blue tolerance ±20%			









			
GEV No.	370017	Ref. No.	11950277000 12025161 240011 Z701135000
description	solenoid valve single straight 230VAC inlet 3/4" outlet 11.5mm DN10 TP p max 10bar		
For models:	AIB0014, AIB0015, GLB0035, GLB0035-FN, GLB0036, GLB0037, GLB0038, GLB0039, GLB0056, GLB0057, GLB0058, GLB0059, GLB0060, GLB0061, GLB0061C, GLB0061C-F, GLB0061C-FN, GLB0062, GLB0063, GLB0063C-F, GLB0063C-FN, GLB0064, GLB0064C, GLB0065, GLB0066, GLB0072, OPT1012, OPT1012-CF, OPT1012-CFN		
spare parts for	370017		
	GEV No.	371013	Ref. No. —
solenoid coil TP 230VAC 50/60Hz			
accessories for	370017		
	GEV No.	371220	Ref. No. —
reducer TP flow rate 3l/min red tolerance ±15%			
	GEV No.	371221	Ref. No. —
reducer TP flow rate 5.5l/min yellow tolerance ±15%			
	GEV No.	371222	Ref. No. —
reducer TP flow rate 6l/min grey tolerance ±15%			

Table continues overleaf





accessories for		370017		
	GEV No.	371223	Ref. No.	—
reducer TP flow rate 10l/min white tolerance ±15%				
	GEV No.	371224	Ref. No.	—
reducer TP flow rate 12l/min bronze tolerance ±15%				
	GEV No.	371225	Ref. No.	—
reducer TP flow rate 16l/min light brown tolerance ±15%				
	GEV No.	371226	Ref. No.	—
reducer TP flow rate 20l/min red tolerance ±15%				
	GEV No.	371230	Ref. No.	—
reducer TP flow rate 0.25l/min red tolerance ±25%				
	GEV No.	371231	Ref. No.	—
reducer TP flow rate 0.35l/min violet tolerance ±25%				
	GEV No.	371232	Ref. No.	—
reducer TP flow rate 0.5l/min orange tolerance ±25%				
	GEV No.	371233	Ref. No.	—
reducer TP flow rate 0.8l/min white tolerance ±25%				
	GEV No.	371234	Ref. No.	P305013000
reducer TP flow rate 1l/min light blue tolerance ±25%				
	GEV No.	371235	Ref. No.	—
reducer TP flow rate 1.2l/min brown tolerance ±25%				
	GEV No.	371236	Ref. No.	—
reducer TP flow rate 1.5l/min light brown tolerance ±25%				
	GEV No.	371237	Ref. No.	—
reducer TP flow rate 2.5l/min yellow tolerance ±25%				
	GEV No.	371238	Ref. No.	—
reducer TP flow rate 3.4l/min dark green tolerance ±25%				
	GEV No.	371239	Ref. No.	—
reducer TP flow rate 5l/min black tolerance ±25%				
	GEV No.	371240	Ref. No.	—
reducer TP flow rate 8l/min blue tolerance ±20%				

solenoid valves with reducers

	1			
GEV No.	370437	Ref. No.	23010 N23010	
description	solenoid valve double angled 230VAC inlet 3/4" input 10l/min output 1.2/1.2l/min DN10 t.max. 90°C TP plastic flow regulating valve inlet white outlet 11.5mm output A 1.2l/min output B 1.2l/min flow regulating valve outlet A dark brown flow regulating valve outlet B dark brown			
For models:	BAA0029, BAA0031, BAA0032, BAA0038, BAB0002-W			

	1		
GEV No.	370436	Ref. No.	N23498
description	solenoid valve double angled 230VAC inlet 3/4" input 0.6/0.6l/min output DN10 t.max. 90°C TP plastic outlet 11.5mm output A 0.6l/min output B 0.6l/min flow regulating valve outlet A orange flow regulating valve outlet B orange		
For models:	BAA0023		

	1		
GEV No.	370395	Ref. No.	N23116
description	solenoid valve double angled 230VAC inlet 3/4" input 0.8/0.8l/min output DN10 t.max. 90°C TP plastic outlet 11.5mm output A 0.8l/min output B 0.8l/min flow regulating valve outlet A white flow regulating valve outlet B white		
For models:	BAA0027, BAA0053-A, BAB0001-W		

	1		
GEV No.	370434	Ref. No.	N23157
description	solenoid valve double angled 230VAC inlet 3/4" input 2.5/2.5l/min output DN10 t.max. 90°C TP plastic outlet 11.5mm output A 2.5l/min output B 2.5l/min flow regulating valve outlet A yellow flow regulating valve outlet B yellow		
For models:	BAA0034, BAA0046W		

	1		
GEV No.	370435	Ref. No.	N23542
description	solenoid valve double angled 230VAC inlet 3/4" t.max. 90°C TP plastic outlet 11.5mm output A 0.5l/min output B 0.8l/min flow regulating valve outlet A orange flow regulating valve outlet B white		
For models:	BAA0025		



1

GEV No.	370449	Ref. No.	N23220
description	solenoid valve single angled 230VAC inlet 3/4" outlet 11.5mm input 2.5l/min output/min DN10 t.max. 90°C TP plastic flow regulating valve inlet yellow		
For models:	BAA0032, BAA0033, BAA0037, BAA0046		



1

GEV No.	370451	Ref. No.	N23787 N23819
description	solenoid valve single angled 230VAC inlet 3/4" outlet 11.5mm input 3l/min t.max. 90°C TP plastic flow regulating valve inlet red		
For models:	BAA0033, BAA0046, BAA0051		



1

GEV No.	370450	Ref. No.	N23623
description	solenoid valve single angled 230VAC inlet 3/4" outlet 11.5mm input 5l/min t.max. 90°C TP plastic flow regulating valve outlet white flow regulating valve inlet pink		
For models:	BAA0040		



1

GEV No.	370426	Ref. No.	N23497
description	solenoid valve single angled 230VAC inlet 3/4" outlet 11.5mm input/min output 0.6l/min DN10 t.max. 90°C TP plastic flow regulating valve outlet orange		
For models:	BAA0022, BAA0024		



1

GEV No.	370399	Ref. No.	N23115
description	solenoid valve single angled 230VAC inlet 3/4" outlet 11.5mm input/min output 0.8l/min DN10 t.max. 90°C TP plastic		
For models:	BAA0026, BAA0053-A, BAB0001, BAB0002, BAB0003, BAB0004		



1

GEV No.	370427	Ref. No.	N23001
description	solenoid valve single angled 230VAC inlet 3/4" outlet 11.5mm input/min output 1.2l/min DN10 t.max. 90°C TP plastic flow regulating valve outlet dark brown		
For models:	BAA0028, BAA0030, BAA0032, BAA0037, BAA0055, BAB0005		

spare parts and accessories

reducers

outlet side



1

GEV No.	371234	Ref. No.	P305013000
description	reducer TP flow rate 1l/min light blue tolerance ±25%		
For models:	GLB0061C-F, GLB0063C-F		

various



1

GEV No.	370448	Ref. No.	N23537
description	solenoid valve single angled 230VAC cable length 600mm inlet 1/4"mm		
For models:	BAA0040, BAA0051		



			
1			
GEV No.	371141	Ref. No.	160230-05
description	solenoid valve single angled 240VAC outlet 11.5mm inlet 15mm		
For models:	EFB0014, EFB0019		

metal
ASCO
2-way

			
1			
GEV No.	370509	Ref. No.	0280042
description	solenoid valve 2-ways 24VAC inlet 1/2" outlet 1/2" connection 1/2" L 52mm DN 12.5mm slide-on receptacle DIN -20° up to 85°C membranes NBR (water) p max 7bar 1/2" brass		
For models:	FGZ0007, FGZ0009, FGZ0027, FGZ0028		







3-way

			
1			
GEV No.	370510	Ref. No.	0280052
description	solenoid valve brass 3-ways 24VAC connection 1/4" L 43mm DN 4.4mm -20 up to +90°C membranes NBR (water) p max 3bar p min 0bar 1/4"		
For models:	FGZ0009, FGZ0028		

LUCIFER

3-way

131F series

			
1			
GEV No.	370053	Ref. No.	5.0.000.0123
description	solenoid valve 3-ways 230VAC DN 2.5mm slide-on receptacle DIN -10 up to 140°C type series 131F coil type DZ06S6 membranes FKM (water/steam) p max 10bar flange 32x32mm		
For models:	EFA0015, EFA0016, EFA0023		
spare parts for	370053		
	GEV No.	370061	Ref. No. —
solenoid valve body LUCIFER-PARKER 3-ways outer cone			
	GEV No.	371031	Ref. No. —
solenoid coil LUCIFER-PARKER 230VAC 9VA coil type DZ06S6 seat ø 15mm			
accessories for	370053		
	GEV No.	371090	Ref. No. —
power socket plug type DIN 43650A screw			
	GEV No.	371095	Ref. No. —
O-ring Viton thickness 1.78mm ID ø 6.07mm Qty 1 pcs			
	GEV No.	371100	Ref. No. —
O-ring silicone thickness 1.78mm ID ø 6.07mm Qty 1 pcs			

solenoid valves (refrigeration)

CASTEL

valves

			
1			
GEV No.	370402	Ref. No.	A00SL100
description	solenoid valve CASTEL type 1028/2 230V p max 45bar 1/4" connection 1/4" -35 up to 110°C refrigeration copper/brass DN 6.35mm		
For models:	BMA0038-F, BMB0002-F, BMB0004-F, BMC0001-F, BMC0003-F, IBC0055, VAEN030-F, VAEN060-F, VAEN075-F		







valve bodies

STANDARD series

suitable for refrigerants R22, R134a, R404A, R407C, R410A, R507





1

GEV No.	370151	Ref. No.	N20410
description	solenoid valve body NC type 1028/2 S p max 45bar connection 1/4" soldering connection DN 2.2mm -35 up to +105°C L 125mm refrigeration straight CASTEL		
For models:	BAA0019, BAA0022, BAA0023, BAA0024, BAA0025, BAA0026, BAA0027, BAA0028, BAA0029, BAA0030, BAA0031, BAA0032, BAA0037, BAA0038, BAA0055		
accessories for	370151		
	GEV No.	371084	Ref. No. —
	solenoid coil CASTEL 230VAC 8VA 50/60Hz connection cable 1000mm type CM2		
	GEV No.	371090	Ref. No. —
	power socket plug type DIN 43650A screw		
	GEV No.	371301	Ref. No. —
	solenoid coil CASTEL 110VAC 8VA 50/60Hz seat ø 11.5mm connection DIN 43650A type HF2		
	GEV No.	371314	Ref. No. —
	solenoid coil CASTEL 240VAC 8VA 50/60Hz seat ø 11.5mm		
	GEV No.	371321	Ref. No. —
	solenoid coil CASTEL 12/24VAC 50/60Hz seat ø 11.5mm connection DIN 43650A type HF2		

spare parts and accessories



1

GEV No.	371041	Ref. No.	N23091
description	solenoid coil CASTEL 240VAC 8VA 50/60Hz seat ø 11.5mm connection DIN 43650A type HM2		
For models:	BAA0019, BAA0022, BAA0023, BAA0024, BAA0025, BAA0026, BAA0027, BAA0028, BAA0029, BAA0030, BAA0031, BAA0032, BAA0033, BAA0034, BAA0037, BAA0038, BAA0040, BAA0046, BAA0046W, BAA0051, BAA0055, BAC0007, BAC0009		
accessories for	371041		
	GEV No.	371090	Ref. No. —
	power socket plug type DIN 43650A screw		
	GEV No.	371092	Ref. No. —
	power socket plug type DIN large cable length 1000mm		

PARKER

valves



1

GEV No.	370366	Ref. No.	3740021
description	solenoid valve NC type YB09 with cable 230V pressure range 0-10bar connection 4mm soldering connection PARKER refrigeration straight		
For models:	IIA5005, IIA5006, IIA5010, IIA5011, IIA5012, IIA5013, IIA5014, IIA5015		
spare parts for	370366		
	GEV No.	371033	Ref. No. —
	solenoid coil PARKER 230VAC 9VA coil type YB09 with cable seat ø 14mm		

SANHUA

valves



1

GEV No.	370837	Ref. No.	A00SL101
description	solenoid valve SANHUA type MDF-A03-3H003 230V p max 45bar L 112mm -35 up to 110°C refrigeration copper/brass		
For models:	BMA0013-F, BMA0034-F, BMB0002-F, BMB0004-F, BMB0014-F, BMB0014-FG, BMB0015-F, BMB0042-F, BMB0046-F		

solenoid valves for vacuum machines



1

GEV No.	370507	Ref. No.	0280021
description	solenoid valve 2-ways 24VAC inlet 1/8" outlet 1/8"mm L 31mm DN 3.3mm 1/8" brass		
For models:	FGZ0006, FGZ0026		

1

GEV No.	370506	Ref. No.	0280010
description	solenoid valve 3-ways 24VAC inlet 1/8" outlet 1/8" mm L 35mm body inner cone DN 2.8mm 1/8" 24V brass		
For models:	FGZ0007, FGZ0027		



1

GEV No.	370816	Ref. No.	0280026
description	solenoid valve assembly 24VAC inlet 1/2" outlet 21mm 2 coils coil type VA12 24V thread 1/2" hose 21mm J35/J42/B35		
For models:	FGZ0013		



1

GEV No.	370511	Ref. No.	0280025
description	solenoid valve assembly 24VAC inlet 1/2" outlet 7.5mm 2 coils coil type VA12 thread 1/2" MJ		
For models:	FGZ0005		



1

GEV No.	541011	Ref. No.	224010
description	pressure control pressure range 110/70mbar connection 6mm 58mm pressure connection horizontal warewashing		
For models:	GLB0061, GLB0061C, GLB0062, GLB0063, GLB0064, GLB0064C, GLB0065, GLB0066		



1

GEV No.	541647	Ref. No.	224011
description	pressure control pressure range 115/85mbar connection 6mm 58mm pressure connection 6mm		
For models:	GLB0072		



1

GEV No.	541899	Ref. No.	224025
description	pressure control pressure range 125/105mbar connection 6mm 58mm pressure connection horizontal warewashing pressure connection 6mm		
For models:	OPT1012C		

pressure switches

for warewashing

ø 58mm with male faston 6.3mm

with connection horizontal



1

GEV No.	541002	Ref. No.	224002
description	pressure control pressure range 110/60mbar connection 6mm 58mm pressure connection horizontal warewashing pressure connection 6mm		
For models:	GLB0070, GLB0071		



1

GEV No.	541898	Ref. No.	224023
description	pressure control pressure range 165/140mbar connection 6mm 58mm pressure connection horizontal warewashing pressure connection 6mm		
For models:	OPT1012C		





1

GEV No.	541776	Ref. No.	12023804 Z713002000
description	pressure control pressure range 170/95mbar connection 6mm 58mm pressure connection horizontal warewashing		
For models:	OPT1012-CF, OPT1012-CFN		

			
1			
GEV No.	541105	Ref. No.	926049
description	pressure control pressure range 180/70mbar connection 6mm ø 58mm pressure connection horizontal warewashing		
For models:	GLB0043, GLB0044, GLB0046		

			
1			
GEV No.	541864	Ref. No.	12023803
description	pressure control pressure range 28/13mbar connection 6mm ø 58mm pressure connection horizontal warewashing suitable for FAGOR		
For models:	GLB0035-F, GLB0035-FN, GLB0037-F, GLB0037-FN		

			
1			
GEV No.	541001	Ref. No.	224004
description	pressure control pressure range 35/17mbar connection 6mm ø 58mm pressure connection horizontal warewashing		
For models:	GLB0035, GLB0036, GLB0037, GLB0038, GLB0039, GLB0043, GLB0044, GLB0056, GLB0057		

			
1			
GEV No.	541302	Ref. No.	12023802 Z203023000
description	pressure control pressure range 40/15mbar connection 6mm ø 58mm pressure connection horizontal warewashing		
For models:	GLB0061C-F, GLB0061C-FN, GLB0063C-F, GLB0063C-FN		

			
1			
GEV No.	541132	Ref. No.	224015
description	pressure control pressure range 40/18mbar connection 6mm ø 58mm pressure connection horizontal warewashing		
For models:	OPT1012		

			
1			
GEV No.	541003	Ref. No.	224003
description	pressure control pressure range 55/35mbar connection 6mm ø 58mm pressure connection horizontal warewashing pressure connection ø 6mm		
For models:	GLB0058, GLB0059, GLB0060, GLB0061, GLB0061C, GLB0062, GLB0063, GLB0064, GLB0064C, GLB0065, GLB0066, GLB0072		

			
1			
GEV No.	541299	Ref. No.	12023805 Z223005000
description	pressure control pressure range 95/75mbar connection 6mm ø 58mm pressure connection horizontal warewashing pressure connection ø 6mm		
For models:	GLB0061C-F, GLB0063C-F, GLB0063C-FN		

			
1			
GEV No.	541017	Ref. No.	69850
description	pressure control with mounting strap pressure range 40/20mbar connection 6mm ø 58mm pressure connection horizontal warewashing		
For models:	GLB0071, GLB0073		

<p>ø 84mm with coded plug</p> 			
1			
GEV No.	541296	Ref. No.	12024981
description	pressure control 2 pressure ranges pressure range 28/13 65/50mbar connection 6mm ø 84mm pressure connection horizontal warewashing pressure connection ø 5.5mm		
For models:	GLB0035-F, GLB0037-F		





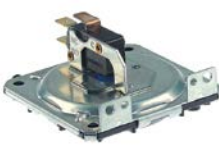

			
1			
GEV No.	541592	Ref. No.	12024269
description	pressure control 3 pressure ranges pressure range 40/15 120/60 150/95mbar connection 6mm ø 84mm pressure connection ø 6mm		
For models:	GLB0063C-FN		

accessories			
			
1			
GEV No.	541598	Ref. No.	12023163 Z602923000
description	bracket stainless steel H 37mm L 60mm W 12mm for pressure switch		
For models:	GLB0035-F, GLB0035-FN, GLB0037-F, GLB0037-FN, GLB0061C-F, GLB0061C-FN, GLB0063C-F, GLB0063C-FN, OPT1012-CF, OPT1012-CFN		

			
1			
GEV No.	541109	Ref. No.	035031 12023510 Z103077000
description	Y-piece plastic hose ø 8-6-8mm for pressure switch		
For models:	GLB0061, GLB0061C, GLB0061C-F, GLB0062, GLB0063, GLB0063C-F, GLB0063C-FN, GLB0064, GLB0064C, GLB0065, GLB0066, GLB0072		

for gas equipment			
			
1			
GEV No.	541348	Ref. No.	ELET0130
description	pressure control gas technology connection male faston 6.3mm suitable for ZANOLLI		
For models:	CAD0007, CAD0010, SY12100VGASD, SY1280VG		



			
1			
GEV No.	542115	Ref. No.	ELET0641
description	pressure control ø 65mm pressure range 0.17-0.75mbar connection 6.8mm pressure connection ø 6.8mm		
For models:	CAD0007, CAD0010, SY12100VGASD, SY1280VG		
accessories for	542115		
		GEV No.	542366
		Ref. No.	—
		bracket for pressure switches	
		GEV No.	542367
		Ref. No.	SUPP0414
		bracket for pressure switches	
		GEV No.	560521
		Ref. No.	—
		sheet-metal screw ø 4mm L 10mm SS Qty 1 pcs 14585 intake Phillips head ø 8mm	

for refrigeration

SAGI NO MIYA			
			
1			
GEV No.	541480	Ref. No.	N23342
description	pressure control HD reset manual p max 33bar refrigeration type FTB-3UC37 connection male faston 6.3mm switch-off pressure 30bar -20 to +70°C		
For models:	BAA0034, BAA0040, BAB0003, BAB0004, BAB0005, BAC0007, BAC0008, BAC0009		

			
1			
GEV No.	541479	Ref. No.	N23175
description	pressure control HD reset automatic refrigeration type HTB-X114 connection 2.4mm		
For models:	BAA0023, BAA0025, BAA0027, BAA0028, BAA0029, BAA0030, BAA0031, BAA0032, BAA0033, BAA0034, BAA0037, BAA0038, BAA0040, BAA0046, BAA0046W, BAA0051, BAB0001, BAB0001-W, BAB0002, BAB0002-W, BAB0003, BAB0004, BAB0005, BAC0007, BAC0008		

accessories

			
1			
GEV No.	542367	Ref. No.	SUPP0414
description	bracket for pressure switches		
For models:	CAD0007, CAD0010, SY12100VGASD, SY1280VG		
accessories for	542367		
	GEV No.	542115	Ref. No. ELET0641
	pressure control ø 65mm pressure range 0.17-0.75mbar connection 6.8mm pressure connection ø 6.8mm		

electrodes

			
1			
GEV No.	402832	Ref. No.	1205305
description	level electrode thread probe L 30mm ø 3mm thread M3 suitable for COFFEE QUEEN		
For models:	EFB0017, EFB0018		

			
1			
GEV No.	402863	Ref. No.	1205301
description	level electrode thread probe L 82mm ø 3mm thread M3 suitable for COFFEE QUEEN		
For models:	EFB0014, EFB0019		

			
1			
GEV No.	402837	Ref. No.	1205302
description	level electrode thread total length 55mm probe L 38mm insulated probe lengthmm connection ø 3mm thread M3 suitable for COFFEE QUEEN		
For models:	EFB0014, EFB0019, EFC0003		

accessories

gaskets

			
1			
GEV No.	531064	Ref. No.	1605362
description	gasket for electrode thread double ømm ID ø 3mm L 30mm silicone		
For models:	EFB0014, EFB0017, EFB0018, EFB0019, EFC0003		

flow meters and flow sensors

flow meters

GICAR

			
1			
GEV No.	400779	Ref. No.	000403.06.01
description	flow meter thread 1/4" stainless steel with LED		

cooling aggregates

GEV No.	379304***	Ref. No.	123456
description			
For models:			

GEV No.	379304***	Ref. No.	123456
description			
For models:			

compressors

EMBRACO / ASPERA

R134A

LBP monophase

Lower evaporation temperature below -20°C

			
1			
GEV No.	605017	Ref. No.	L8113/3
description	compressor coolant R134a type EMT36HLP 220-240V 50Hz LBP fully hermetic 7.52kg 1/10HP power input 108W cylinder capacity 3.97cm ³ RSIR 71W 94W 123W 160W 203W 253W test method ASHRAE		
For models:	EAA0002		



1

GEV No.	605129	Ref. No.	SHSGKM0104A2
description	compressor coolant R134a type FF 8.5HBK 220-240V 50Hz LMBP cylinder capacity 7.95cm ³		
For models:	IEC0002-I		

HBP monophase
High evaporation temperature above -15°C



1

GEV No.	605189	Ref. No.	A00KO110
description	compressor coolant R134a type EMT6160Z 220-240V 50Hz HBP 7.8kg 1/4HP cylinder capacity 6.76cm ³ CSIR H 166mmWWW 325W 412W 513W 630W 762W 910W ambient temperature max. 45°C		
For models:	BNC0001BAR-F, BNC0030PI, HAB0001-F, HAB0015-F		



1

GEV No.	605135	Ref. No.	A00KO101
description	compressor coolant R134a type EMT6170Z 220-240V 50Hz HBP fully hermetic 8.1kg 1/6HP cylinder capacity 7.69cm ³ CSIR H 166mmWWW 281W 358W 448W 550W 663W 982W		
For models:	9931F, 9932F, BMA0038-F, BMB0015-F, BMC0001-F, BMC0001-FG, BNC0007BAR-F, BNC0007-F, BNC0008-F, BNC0015-F, BNC0016-F, BNC0033, BNC0034, BNC0034PI, BNC0035, CCZ0009-F, CCZ0050, HAB0007-F, HAB0009-F, HCE2006-F, IEC0050, IEC0051, SALADBAR2, SALADBAR3, TIM3, TIM3PI, USN4		



1

GEV No.	605208	Ref. No.	A00KO109
description	compressor coolant R134a type NEK6210Z-A 220-240V 50Hz HBP 11kg 1/3HP cylinder capacity 12.1cm ³ CSIR H 200mmWWW 364W 485W 636W 818W 1030W 1273W test method EN 12900 ambient temperature max. 55°C		
For models:	BMC0003-F, BNC0015BAR-F, HAB0020, HAB0021, IBC0055, IEC0052		

HMBP monophase
High/Medium evaporation temperature above -20/-15 °C



1

GEV No.	605016	Ref. No.	A00KO100 L8116/2
description	compressor coolant R134a type EM65HHR 220-240V 50Hz HBP fully hermetic 7.62kg 1/6HP cylinder capacity 5.54cm ³ CSIRWWW 287W 389W 499W 617W 742W test method ASHRAE 842W		
For models:	9925F, 9931VF, 9953F, BMA0013-F, BMA0034-F, BNA0068, BNA0069, BNC0001-F, BNC0002-F, BNC0008-F, BNC0030, BNC0032, CCZ0018-F, EAA0003, HCE2004-F, HCE2005-F		



R404a/R507

LBP monophase

Lower evaporation temperature below -20°C



1			
GEV No.	605256	Ref. No.	A00KO105
description	compressor coolant R404A type NEU2140GK 220-240V 50Hz LBP 10.6kg 1/2HP cylinder capacity 8.77cm ³ CSR H 206mm 326W 421W 531W 658W 801WWWWWW test method EN 12900		
For models:	BMB0014-F, BMB0014-FG, BMB0046-F		



1			
GEV No.	605144	Ref. No.	A00KO102
description	compressor coolant R404a/R507 type NEK2168GK 220-240V 50Hz LBP 22.9kg 3/4HP cylinder capacity 14.28cm ³ CSR H 200mm 345W 454W 587W 742W 921W 1123WWWWWW		
For models:	BMA0098, BMB0002-F, BMB0002-FG, BMB0042-F		



1			
GEV No.	605174	Ref. No.	A00KO103
description	compressor coolant R404a/R507 type NJ2192GK 220-240V 50Hz LBP 20.4kg 1 1/4HP cylinder capacity 26.2cm ³ CSR H 265mm 685W 989W 1342W 1745W 2196W 2196WWWWWW		
For models:	BMA0099, BMB0004-F, HCE2007-F, HCE2008-F, HCE2009		



1			
GEV No.	605235	Ref. No.	A00KO114
description	compressor coolant R404a/R507 type NT2212GK 220-240V 50Hz LBP 18.3kg 1 1/4HP cylinder capacity 27.8cm ³ CSR H 250mm 876W 1125W 1421W 1770W 2174WWWWWW test method EN 12900		
For models:	VAEK170-F, VAEK210-F		



1			
GEV No.	605005	Ref. No.	3650048
description	compressor coolant R404a/R507 type T2155GK 230V 50Hz LBP fully hermetic 16.3kg power input 458W cylinder capacity 14.5cm ³ CSR H 221mm 368W 524W 717W 948W 1215W test method ASHRAE		
For models:	IIA5012, IIA5013, IIA5014, IIA5015		

HMBP monophase

High/Medium evaporation temperature above -20/-15 °C



1			
GEV No.	605133	Ref. No.	R093C-E9213GK
description	compressor coolant R404a/R507 type NE9213GK 220-240V 50Hz HMBP 12kg 1/2HP cylinder capacity 12.12cm ³ CSR H 205mmWWWW 862W 1080W 1327W 1602WW		
For models:	BGB0005, BGB0010, BGB0015, BGB0018, BGB0022, BGB0050, BHZ0002, BHZ0009, HDC0001		



1

GEV No.	605178	Ref. No.	A00KO113
description	compressor coolant R404a/R507 type NEK6217GK 220-240V 50Hz HMBP 11.6kg 5/8HP cylinder capacity 14.3cm ³ CSR H 206mmW 777W 954W 955W 1171W 1386W 1651W 1916W		
For models:	VAEN030-F, VAEN060-F		



1

GEV No.	605190	Ref. No.	N23438
description	compressor coolant R404a/R507 type NJ9232GK 220-240V 50Hz HMBP 22.1kg 1 1/4HP cylinder capacity 26.2cm ³ CSR H 277mmWW 1093W 1470W 1911W 2413W 2973W 3588W 4255W ambient temperature max. 45°C		
For models:	BAA0033		

accessories



1

GEV No.	380070	Ref. No.	L51
description	start relay 11F13 220-240V		
For models:	EAA0002, EAA0003		

SECOPI DANFOSS

R404a/R507

LBP 3-phase

Lower evaporation temperature below -20°C



1

GEV No.	605255	Ref. No.	A00KO112
description	compressor coolant R404a/R507 type NTZ048A4LR1A 380-415/380-460V 50/60Hz LBP 21kg 2HP cylinder capacity 48cm ³ H 333mm 1239W 1700W 2236W 2856W 3567W test method EN 12900		
For models:	VAEK220-F		

accessories

overload protector (klixon)



1

GEV No.	390575	Ref. No.	L39
description	overload protector for engine protective curcuit breaker T0221/26 150°C reset automatic suitable for Luke 2		
For models:	EAA0002, EAA0003		



1

GEV No.	390573	Ref. No.	L52
description	overload protector for engine protective curcuit breaker 734LFBYY 110°C/61°C reset automatic suitable for Luke 3-4/Fast Cold 2		
For models:	EAA0002, EAA0003		



fans

axial fans

import

electric components



GEV No.	602165	Ref. No.	764.055.00
description	axial fan L 119mm W 119mm H 38mm 230VAC 50/60Hz 15/14W manuf. no. 4715MS-23T-B5A connection male faston 2.8mm NMB fan wheel ø 110mm		



GEV No.	698721 ¹	Ref. No.	R030-FP-108-1-B
description	axial fan L 119mm W 119mm H 38mm 230VAC 50/60Hz 17/15W bearing ball bearing manuf. no. connection cable cable length 3000mm COMMONWEALTH fan wheel ø 110mm temp.-resist. 70°C input current 0.1A airflow 130m ³ /h 2600rpm		
For models:	BGB0027, BGB0028, BGB0029, BHZ0001, BHZ0002, BHZ0003, BHZ0004, BHZ0005, BHZ0006, BHZ0007, BHZ0008, BHZ0009, BHZ0010, BHZ0011, BHZ0012, BHZ0013, BHZ0034, BHZ0035, BHZ0036, BHZ0037, BHZ0038, BHZ0039		

¹with ball bearings



GEV No.	601080 ¹	Ref. No.	12023862 91310320 VENT0012 Z103066000
description	axial fan L 119mm W 119mm H 38mm 230VAC 50/60Hz 23/20W bearing ball bearing connection male faston 2.8mm metal ADDA fan wheel ø 110mm temp.-resist. 70°C		
For models:	CAB0007-CD, CAB0008-CD, CAB0009-CD, CAB0013-CD, CAB0014-CD, CAB0015-CD, CAB0019, CAB0020, CAB0024-CD, CAB0025-CD, CAB0055-DCG, CAB0056-DCG, CAB0057-DCG, CAB0058-DCG, CAB0059-DCG, CAB0060-DCG, CAB0061-DCG, CAB0062-DCG, CAD0005, CAD0007, CAD0009, CAD0010, OPT1012-CF, OPT1012-CFN, SY12100VELED, SY12100VGASD, SY1280VE, SY1280VG, SY850VELED		
accessories for	601080		
	GEV No.	550898	Ref. No. —
	connecting cable cable length 2000mm connection F 2.8 connection distance 7.9mm for axial flow fan		
	GEV No.	692519	Ref. No. 12025177 Z713015000
	guard L 120mm W 120mm plastic		

¹with ball bearings



GEV No.	601934	Ref. No.	A00FA100
description	axial fan L 120mm W 120mm H 40mm 220V 50-60Hz 21W bearing slide bearing manuf. no. DMX-G12038HA ³ BL connection cable cable length 200mm DEMEX input current 0.14A		
For models:	BMA0098, BMB0046-F		
accessories for	601934		
	GEV No.	601935	Ref. No. —
	fanwheel cover ø 120mm mounting distance 103mm for axial fan 119mm		



1

GEV No.	601130 ¹	Ref. No.	VENT0024
description	axial fan L 80mm W 80mm H 25mm 230VAC 50/60Hz 13/14W bearing ball bearing connection male faston 2.8mm metal ADDA fan wheel ø 75mm temp.-resist. 70°C airflow 30.6m ³ /h		
For models:	CAD0004-ZN, CAD0007		
accessories for	601130		
	GEV No.	550898	Ref. No. —
	connecting cable cable length 2000mm connection F 2.8 connection distance 7.9mm for axial flow fan		

¹with ball bearings



1



GEV No.	601388 ¹	Ref. No.	F067/4
description	axial fan L 172mm W 150mm H 38mm 230VAC 50/60Hz 38/35W bearing ball bearing connection male faston 2.8mm metal ADDA fan wheel ø 145mm mounting distance 162mm		
For models:	EBZ0001-CN, MISSOFTY		

¹with ball bearings



1

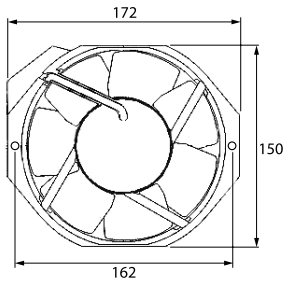

GEV No.	601932	Ref. No.	A00FA107
description	axial fan L 172mm W 150mm H 51mm 230 50/60Hz 23W bearing ball bearing manuf. no. AC17251CU7C1Y connection cable 1000mm MA-VIB airflow 336/390m ³ /h		
For models:	BMA0099, BMB0002-F, BMB0002-FG, BMB0004-F, BMC0001-F, BMC0001-FG, BMC0003-F		

accessories

fan guards



1

GEV No.	692519	Ref. No.	12025177 Z713015000
description	guard L 120mm W 120mm plastic		
For models:	OPT1012-CF, OPT1012-CFN		
accessories for	692519		
	GEV No.	601080	Ref. No. 12023862 91310320 VENT0012 Z103066000
	axial fan L 119mm W 119mm H 38mm 230VAC 50/60Hz 23/20W bearing ball bearing connection male faston 2.8mm metal ADDA fan wheel ø 110mm temp.-resist. 70°C		



1

GEV No.	691104	Ref. No.	A00FA101
description	guard ø 115mm mounting distance 105mm for axial fan 119mm		
For models:	9931VF, 9953F, BMA0098, BMB0046-F, BMC0001-F, BMC0003-F, BNC0008-F		



refrigeration fans

refrigeration motors universal



ELCO

N series - multi fit



GEV No.	601427	Ref. No.	5010
description	fan motor ELCO 10W 230V 50/60Hz bearing slide bearing L1 49mm L2 59mm L3 86.5mm W 83mm connection cable 500mm 1300/1550rpm 5 mounting options VNT10-20/028		
For models:	EAA0002, EAA0003		
spare parts for	601427		
	GEV No.	560140	Ref. No. —
	hexagonal nut thread M4 H 4.8mm SS WS 7 Qty 20 pcs DIN/ISO DIN 985 self-locking		
	GEV No.	560332	Ref. No. —
	plain washer ID ø 4.3mm ED ø 9mm thickness 0.8mm SS Qty 1 pcs		
	GEV No.	560340	Ref. No. —
	hexagonal nut thread M4 H 3.2mm WS 7 SS DIN/ISO DIN 934 / ISO 4032/8673 Qty 1 pcs		
	GEV No.	601413	Ref. No. —
	fixing plate suitable for fanwheel ED ø 32mm shaft ø 7 mounting distance 26mm		



GEV No.	601430	Ref. No.	5045
description	fan motor ELCO 5W 230V 50/60Hz bearing slide bearing L1 48mm L2 52mm L3 79.5mm W 83mm connection cable 500mm 1300/1550rpm 5 mounting options VNT5-13/027		
For models:	EAA0002, EAA0003		
spare parts for	601430		
	GEV No.	560140	Ref. No. —
	hexagonal nut thread M4 H 4.8mm SS WS 7 Qty 20 pcs DIN/ISO DIN 985 self-locking		
	GEV No.	560332	Ref. No. —
	plain washer ID ø 4.3mm ED ø 9mm thickness 0.8mm SS Qty 1 pcs		
	GEV No.	560340	Ref. No. —
	hexagonal nut thread M4 H 3.2mm WS 7 SS DIN/ISO DIN 934 / ISO 4032/8673 Qty 1 pcs		



spare parts for	601430		
	GEV No.	601413	Ref. No. —
	fixing plate suitable for fanwheel ED ø 32mm shaft ø 7 mounting distance 26mm		

N series - standard



GEV No.	601930	Ref. No.	A00FA109 A00KN100-A A00KN101-A A00KN700-A
description	fan motor ELCO 10W 230V 50/60Hz bearing slide bearing L1 55.5mm L2 91.5mm L3 119mm W 83mm cable length 2000mm 1300/1550rpm 5 mounting options VN10-20/929		
For models:	9925F, 9931F, 9932F, BMA0034-F, BMA0098, BMA0099, BMB0015-F, BMC0001-FG, BNC0001BAR-F, BNC0001-F, BNC0002-F, BNC0007BAR-F, BNC0008-F, BNC0015BAR-F, BNC0015-F, BNC0016-F, BNC0030, BNC0030PI, BNC0032, BNC0033, BNC0034, BNC0034PI, BNC0035, CCZ0009-F, CCZ0018-F, CCZ0050, HAB0001-F, HAB0007-F, HAB0009-F, HAB0015-F, HAB0020, HAB0021, HCE2004-F, HCE2005-F, HCE2006-F, HCE2007-F, IEC0050, IEC0051, IEC0052, SALADBAR2, SALADBAR3, TIM3, TIM3PI, USN4		
spare parts for	601930		
	GEV No.	601284	Ref. No. 1100 N20031
	fan wheel sucking ø 254mm fan wheel mounting 25.4mm blade angle 28° W 42mm aluminium		



GEV No.	601928	Ref. No.	A00FA104 A00KN102-A A00KN701-A
description	fan motor ELCO 16W 230V 50Hz bearing slide bearing L1 55.5mm L2 91.5mm L3 119mm W 83mm cable length 2000mm 1300/1550rpm 5 mounting options VNT16-25/1774		
For models:	BMA0098, BMA0099, BMB0002-FG, BMB0014-FG, BMB0042-F, HCE2008-F, HCE2009, IBC0055, VAEK170-F, VAEK210-F, VAEK220-F, VAEN030-F, VAEN060-F, VAEN075-F		
spare parts for	601928		
	GEV No.	601284	Ref. No. 1100 N20031
	fan wheel sucking ø 254mm fan wheel mounting 25.4mm blade angle 28° W 42mm aluminium		
	GEV No.	601413	Ref. No. —
	fixing plate suitable for fanwheel ED ø 32mm shaft ø 7 mounting distance 26mm		

BT series - capacitor motors



GEV No.	601420 ¹	Ref. No.	N23121
description	fan motor 45W 230V 50Hz L1 53mm L2 18mm L3 120mm W 103mm cable length 500mm 1300rpm ELCO 3FBT 50-40/15 3 mounting options bearing slide bearing		
For models:	BAA0033, BAA0034, BAA0040, BAB0003, BAB0004, BAC0007, BAC0008		

¹incl. capacitor

accessories

fan wheels

aluminium

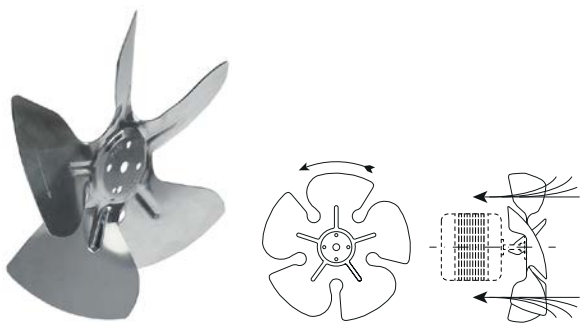

GEV No.	601385	Ref. No.	L8022
description	fan wheel sucking ø 172mm fan wheel mounting 25.4mm blade angle 34° W 42mm aluminium		
For models:	EAA0002, EAA0003		

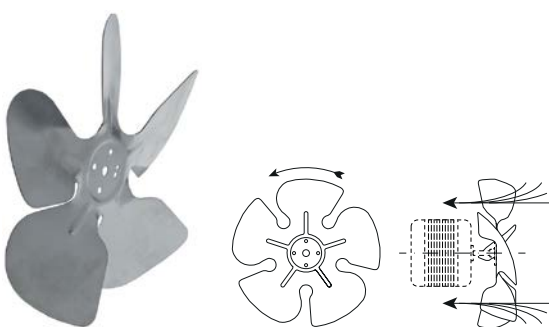

GEV No.	601070	Ref. No.	L8055
description	fan wheel sucking ø 200mm fan wheel mounting 25.4mm blade angle 28° W 38mm aluminium		
For models:	EAA0002, EAA0003		

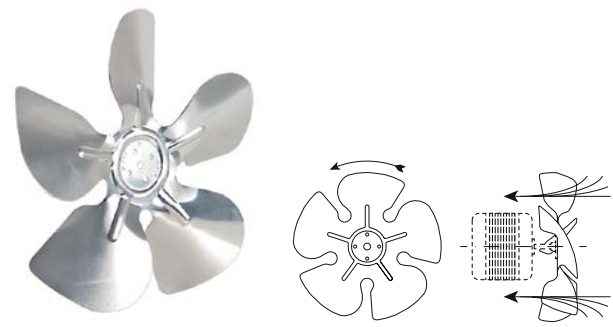

GEV No.	601284	Ref. No.	1100 N20031
description	fan wheel sucking ø 254mm fan wheel mounting 25.4mm blade angle 28° W 42mm aluminium		
For models:	BAA0030, BAA0031, BAA0032, BAA0033, BAA0034, BAA0037, BAA0046, BAB0002, EBZ0002-CN, EBZ0003-CN		



GEV No.	601387	Ref. No.	1112
description	fan wheel sucking ø 254mm fan wheel mounting 25.4mm blade angle 34° W 50mm aluminium		
For models:	EBZ0002-CN, EBZ0003-CN		

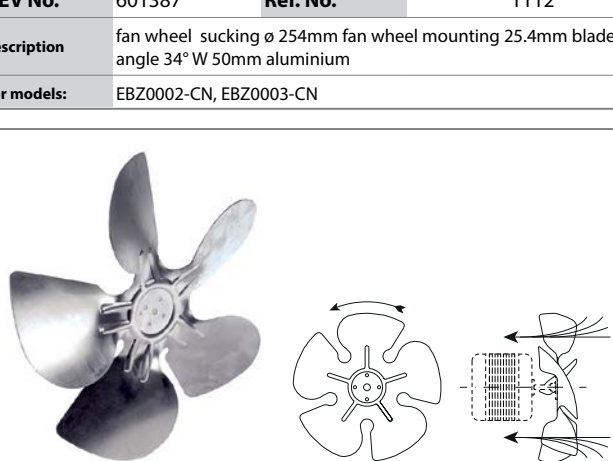

GEV No.	601410	Ref. No.	N20407
description	fan wheel sucking ø 300mm fan wheel mounting 25.4mm blade angle 28° W 45mm aluminium		
For models:	BAA0033, BAA0040, BAB0003, BAB0004, BAC0007, BAC0008		

plastic

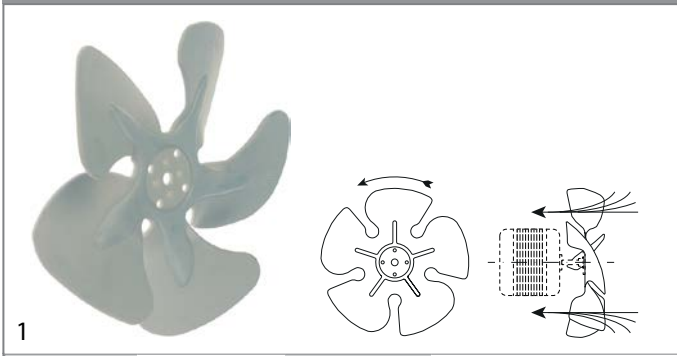

GEV No.	601412	Ref. No.	N10213
description	fan wheel sucking ø 154mm fan wheel mounting 25.4mm blade angle 28° W 34mm plastic		
For models:	BAA0023, BAA0024, BAA0025, BAA0026, BAA0027, BAA0029, BAA0030, BAA0031, BAA0032, BAA0033, BAA0034, BAA0038, BAA0046, BAA0046W, BAA0055, BAB0001-W, BAB0002-W		

aluminium

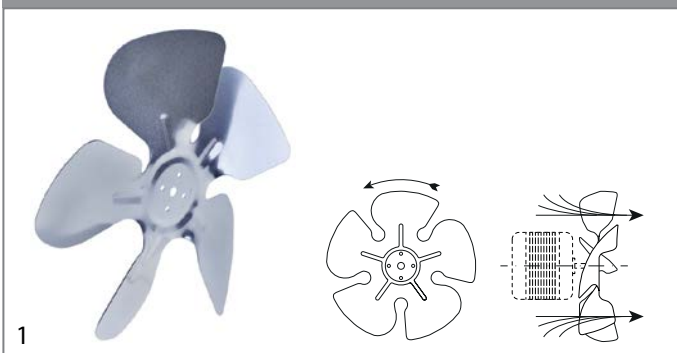

GEV No.	601571	Ref. No.	L8092
description	fan wheel blowing ø 230mm fan wheel mounting 25.4mm blade angle 28° W 43mm aluminium		
For models:	EAA0002, EAA0003		

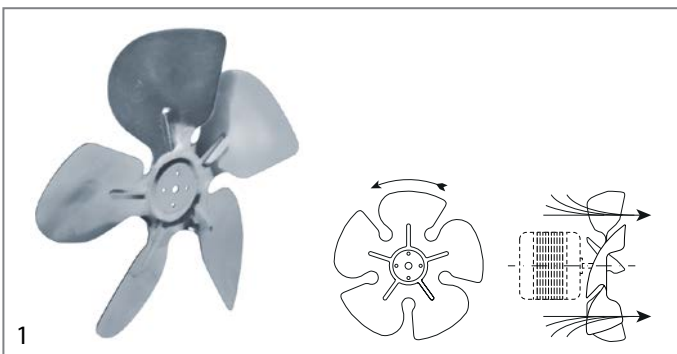

GEV No.	601573	Ref. No.	A00FA105
description	fan wheel blowing ø 254mm fan wheel mounting 25.4mm blade angle 28° W 44mm aluminium		
For models:	IBC0055, VAEK170-F, VAEK210-F, VAEK220-F, VAEN030-F, VAEN060-F, VAEN075-F		

cooling motors (complete)

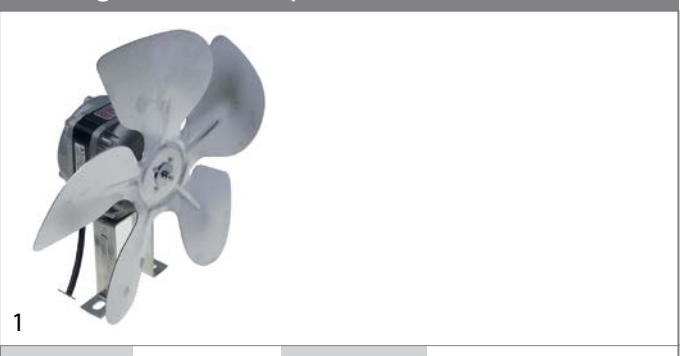

GEV No.	601702	Ref. No.	SHSGFM53A100
description	fan 230V 10W 50Hz fan wheel ø 254mm feet depth 84mm blade angle 28°		
For models:	IEC0002-I		

cooling motors (various)

refrigeration motors with foot



GEV No.	601418	Ref. No.	N23029
description	fan motor 10W 230V 50Hz L1 48mm L2 70mm L3 85mm W 83mm feet depth 72mm cable length 500mm connection with plug		
For models:	BAA0019, BAA0022, BAA0023, BAA0024, BAA0025, BAA0026, BAA0027, BAA0028, BAA0029, BAA0030, BAA0031, BAA0032, BAA0033, BAA0037, BAA0038, BAB0001, BAB0001-W, BAB0002, BAB0002-W		



GEV No.	601433	Ref. No.	1099
description	fan motor 16W 230V 50Hz L1 42mm L3 95mm W 83mm feet depth 84mm cable length 500mm connection with plug		
For models:	EBZ0002-CN		





1

GEV No.	601380	Ref. No.	1113
description	fan motor 25W 230V 50Hz L1 53mm L3 111.5mm W 83mm feet depth 84mm cable length 500mm connection with plug		
For models:	EBZ0003-CN		

cold air circulating fans (complete)

ebm-papst

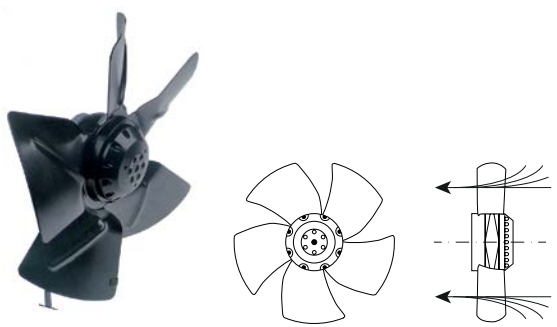
A4E series



1

GEV No.	601623	Ref. No.	4MTVZ004	
description	fan A4E315-AC08-19 fan wheel ø 315mm blades 5 230V 50Hz 95W 1370rpm cable length 450mm ebm-papst sucking suitable capacitor 3µF			
For models:	VSFK400, VSFN200			
accessories for	601623			
	GEV No.	365137	Ref. No.	—
	capacitor capacity 3µF 450V tolerance 5% 50/60Hz ambient temperature max. -25 to +85°C ø 25mm L 56mm M8 plastic connection cable 250mm 416.17.77GF protection			

cold air circulating fans

cold air circulating fans



1

GEV No.	601919	Ref. No.	A00FA102 A00SHP006-A A00SHP009-A
description	fan motor 220-230V 50-60Hz 5W shaft ø 6mm shaft L 14mm L 73mm W 62mm H 62mm cable length 2900mm input current 2A		
For models:	9925F, 9931F, 9932F, BMA0034-F, BMB0002-F, BMB0014-FG, BMC0003-F, BNA0068, BNA0069, BNC0001BAR-F, BNC0001-F, BNC0002-F, BNC0007BAR-F, BNC0007-F, BNC0008-F, BNC0015BAR-F, BNC0015-F, BNC0016-F, BNC0030, BNC0030PI, BNC0032, BNC0033, BNC0034, BNC0034PI, BNC0035, CCZ0009-F, CCZ0018-F, CCZ0050, HAB0001-F, HAB0007-F, HAB0009-F, HAB0015-F, HAB0020, HAB0021, HCE2004-F, HCE2005-F, HCE2006-F, HCE2007-F, HCE2008-F, HCE2009, IEC0050, IEC0051, IEC0052, SALADBAR2, SALADBAR3, TIM3, TIM3PI, USN4		

cooling fans



1

GEV No.	602086	Ref. No.	A490W3050GP
description	fan 220/240V 50Hz 25W W 140mm H 120mm D 150mm PANASONIC type J40013A6 cable length 145mm mounting pos. left		
For models:	NE1880, NE2140		

cross flow fans

ebm-papst



1

GEV No.	601936	Ref. No.	A00FA103
description	cross flow fan QLZ06/1800A265-2524 roller ø 60mm roller length 180mm laminated core thickness 28mm motor position right 230V/50Hz 31W refrigeration bearing rubber connection male faston 6.3mm airflow 160m³/h 0 up to +60°C 230V 150m³/h 50Hz		
For models:	BMA0013-F, BMA0038-F, BMB0004-F, BMB0014-F, BMB0015-F, IBC0055		



EMMEVI - FERGAS

with standard coil



1			
GEV No.	601018	Ref. No.	15950427000
description	cross flow fan TG 180 roller ø 60mm roller length 180mm motor position right 230V/50Hz 25W universal bearing silicone connection male faston 6.3mm -10 up to +60°C 230V connections 1-2 1950U/min connections 1-4 1500U/min		
For models:	AIB0014		

COPREL

with moulded coils



1			
GEV No.	601194	Ref. No.	09951057000
description	cross flow fan roller ø 60mm roller length 300mm laminated core thickness 20mm motor position right 230V/50Hz 43W universal bearing silicone connection male faston 6.3mm -30 up to +100°C 230V 50Hz		
For models:	AIB0015		

hot air motors

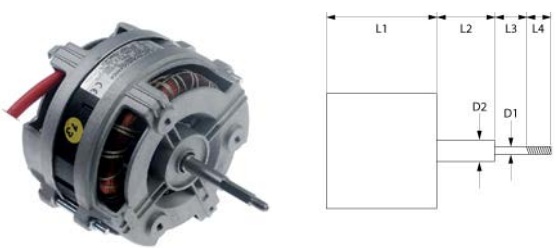

1			
GEV No.	601648	Ref. No.	09954527000
description	fan motor 220-240V 1 phase 50/60Hz 0.12kW 2800/3400rpm speeds 1 L1 95mm L2 32mm L3 23mm L4 12mm D1 ø 6x8mm D2 ø 10mm M6R ET 0.9A power input 0.12W at 50Hz 2800rpm at 60Hz 3400rpm suitable capacitor 6.3µF/450V		
For models:	KF733, KF933U, KF981D		
accessories for	601648		
	GEV No.	365012	Ref. No. 0000000149 206009
	operating capacitor capacity 6.3µF 450V tolerance 5% 50Hz ambient temperature max. -25 to +85°C ø 30mm L 61mm M8 plastic connection male faston 6.3mm protection		

1			
GEV No.	601195	Ref. No.	09951627000
description	fan motor 220-240V 1 phase 50/60Hz 0.12kW 2800/3400rpm speeds 1 L1 95mm L2 32mm L3 23mm L4 12mm D1 ø 7x8mm D2 ø 10mm M6R ET 0.9A at 50Hz 2800rpm at 60Hz 3400rpm suitable capacitor 6.3µF/450V type FIR1004		
For models:	AIB0015, KF1001G, KF630, KF965		

1			
GEV No.	500681	Ref. No.	MOTO0030
description	fan motor 220-240V 1 phase 50Hz 0.37kW 1400rpm speeds 1 L1 265mm L2 45mm L3 47mm D1 ø 24mm D2 ø 20mm M8L IT 2A suitable capacitor 12.5µF/400V at 50Hz 1400rpm type 1021S2252		
For models:	CAD0005, CAD0007, CAD0009, CAD0010, SY12100VELED, SY12100V-GASD, SY1280VE, SY1280VG, SY850VELED		
spare parts for	500681		
	GEV No.	521078	Ref. No. —
	fan wheel		
	GEV No.	601217	Ref. No. VENT0015
	fan wheel D1 ø 335mm H1 100mm blades 24 D2 ø 19.5mm D3 ø 23mm H2 45mm		
accessories for	500681		
	GEV No.	365014	Ref. No. 150064 F2028
	operating capacitor capacity 12.5µF 450V tolerance 5%Hz ambient temperature max. -25 to +85°C ø 35mm L 70mm M8 plastic connection male faston 6.3mm 45S.C3DS.12.5 protection		



1

GEV No.	601178	Ref. No.	66400000
description	fan motor 230V 1 phase 50Hz 0.12kW 1400rpm speeds 1 L1 120mm L2 77mm D1 ø 12mm 1.1A suitable capacitor at 50Hz 230V type MA71TYP01DX		
For models:	65110CFGE, 6570CFE, 6570CFGE, 70110CFGE, 7070CFEQ, 7070CFGE, 7070CFVE		
spare parts for	601178		
	GEV No.	Ref. No.	0000000182 150070 19410301 206001
	operating capacitor capacity 8µF 400V tolerance 5%Hz ambient temperature max. -25 to +85°C ø 31.5mm L 55mm M8 plastic connection male faston 6.3mm protection		



1

GEV No.	500964	Ref. No.	MOT30006
description	fan motor 230V 3 phase 50Hz 0.08kW 2700rpm speeds 1 L1 78mm L2 7mm L3 47mm L4 12mm D1 ø 8/6mm D2 ø 12mm M5R ET at 50Hz 2700rpm suitable capacitor 6.3µF/450V with capacitor 6,3µF/450V		
For models:	VG715RXS, VP824RU		



1

GEV No.	601993	Ref. No.	564.039.14
description	fan motor 230V 1 phase 50Hz 0.18/0.12kW 2800rpm speeds 1 L1 85mm L2 65mm L3 23mm D1 ø 8mm D2 ø 6mm M5x0.8 0.8A suitable capacitor 5µF/450V		
For models:	BGEU411, BGEU611, BGEU1011, GEU411P, GEU611P, GEV1011P		
accessories for	601993		
	GEV No.	Ref. No.	206010
	operating capacitor capacity 5µF 450V tolerance 5% 50/60Hz ambient temperature max. -25 to +85°C ø 28mm L 54mm M8 plastic connection male faston 6.3mm 16.10.08 protection		



1

GEV No.	602097	Ref. No.	11951439400
description	fan wheel blades 38 D1 ø 200mm D2 ø 6.5x8mm D3 ø 7mm H1 38mm H2 22mm H3 3mm		
For models:	KF933U, KF981D		



1

GEV No.	601819	Ref. No.	64400000
description	fan wheel D1 ø 160mm H1 60mm blades 36 D2 ø 12mm D3 ø 12mm H2 23mm		
For models:	65110CFGE, 6570CFE, 6570CFGE, 70110CFGE, 7070CFEQ, 7070CFGE, 7070CFVE		

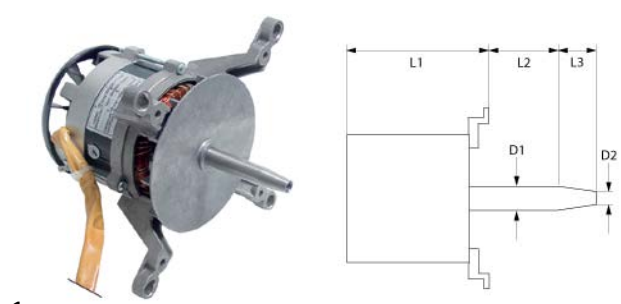

1

GEV No.	500664	Ref. No.	MOTO0034
description	fan motor 230V 1 phase 50Hz 0.37kW 1400rpm speeds 1 L1 170mm L2 50mm L3 28mm D1 ø 17mm D2 ø 12mm M8L IT 2.2A suitable capacitor 10µF/450V Cos(φ) 0.95 at 50Hz 1400rpm type 1020A2353		
For models:	CAD0004-ZN		



1

GEV No.	601778	Ref. No.	VEN30004
description	fan wheel D1 ø 197mm H1 43mm blades 45 D2 ø 8mm D3 ø 8x6.8mm H2 14mm H3 1.5mm		
For models:	VG715RXS		



1

GEV No.	601187	Ref. No.	11950389400
description	fan wheel D1 ø 200mm H1 40mm blades 38 D2 ø 8mm D3 ø 8mm H2 28mm		
For models:	KF965		



1

GEV No.	601186	Ref. No.	11950509400
description	fan wheel D1 ø 215mm H1 40mm blades 38 D2 ø 8mm D3 ø 8mm H2 26.5mm		
For models:	KF1001G		



1

GEV No.	601215	Ref. No.	VENT0001
description	fan wheel D1 ø 250mm H1 78mm blades 20 D2 ø 11.5mm D3 ø 16mm H2 30mm		
For models:	CAD0001-ZN, CAD0004, CAD0004-ZN		



1

GEV No.	601241	Ref. No.	VENT0018
description	fan wheel D1 ø 300mm H1 100mm blades 20 D2 ø 19.5mm D3 ø 23mm H2 46mm		
For models:	CAD0005, CAD0007, SY850VELED		



1

GEV No.	601217	Ref. No.	VENT0015
description	fan wheel D1 ø 335mm H1 100mm blades 24 D2 ø 19.5mm D3 ø 23mm H2 45mm		
For models:	CAD0009, CAD0010, SY12100VELED, SY12100VGASD		



hot air fans

miscellaneous



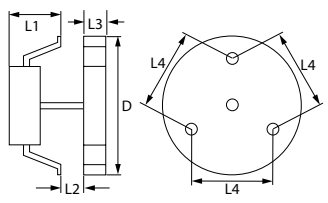

1

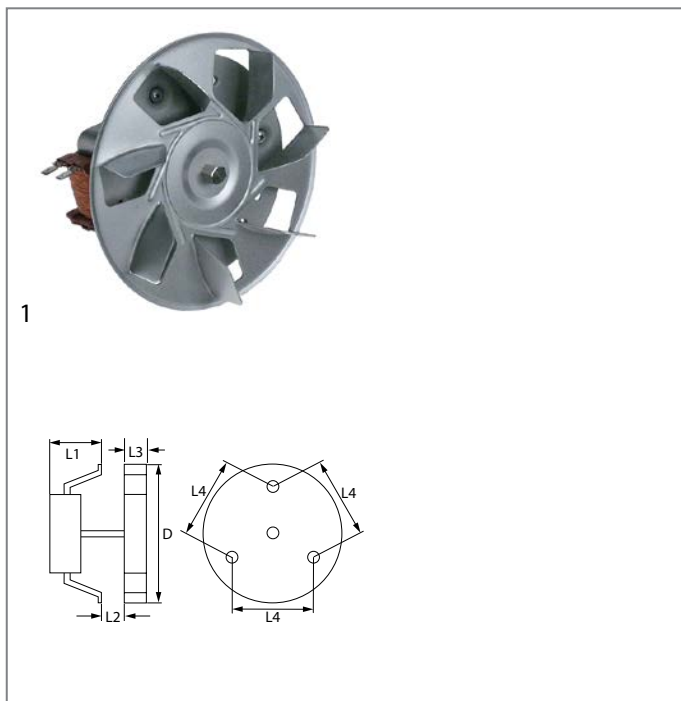

GEV No.	601699	Ref. No.	664.025.00	
description	hot air fan 220/240V 30W 50/60Hz L1 57mm L2 13mm L3 25mm L4 87mm fan wheel ø 150mm IMS type 7100VRD150H2023 fan wheel mounting 6x5mm			
For models:	6060CFE, 6060CFGE			
spare parts for	601699			
	GEV No.	601441	Ref. No.	—
	fan wheel ø 150mm W 25mm shaft intake ø 6x5mm stainless steel blades 7			
accessories for	601699			
	GEV No.	601441	Ref. No.	—
	fan wheel ø 150mm W 25mm shaft intake ø 6x5mm stainless steel blades 7			



GEV No.	601448	Ref. No.	V03000
description	hot air fan 220-240V 32W 50/60Hz L1 60mm L2 11mm L3 25mm L4 87mm fan wheel ø 155mm FIME type C20X0E01/11		
For models:	ACA2010, ACA204V, ACA206V, ACA208V, ACA210V		
spare parts for	601448		
	GEV No.	601261	Ref. No. —
	fan wheel ø 154mm W 25mm shaft intake ø 6x5mm chrome-plated blades 7		
accessories for	601448		
	GEV No.	550879	Ref. No. V05400
	insulation ø 130mm thickness 3mm hole ø 20mm for hot air fan		

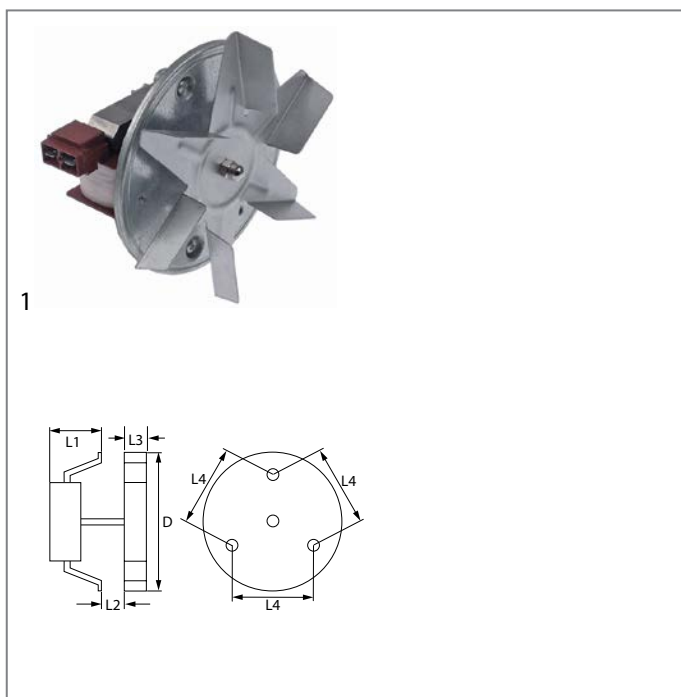

GEV No.	601694	Ref. No.	MOT30005
description	hot air fan 220-240V 33W 50/60Hz L1 57mm L2 13mm L3 21mm L4 87mm fan wheel ø 150mm IMS type VRB150H2022		
For models:	VP800U		

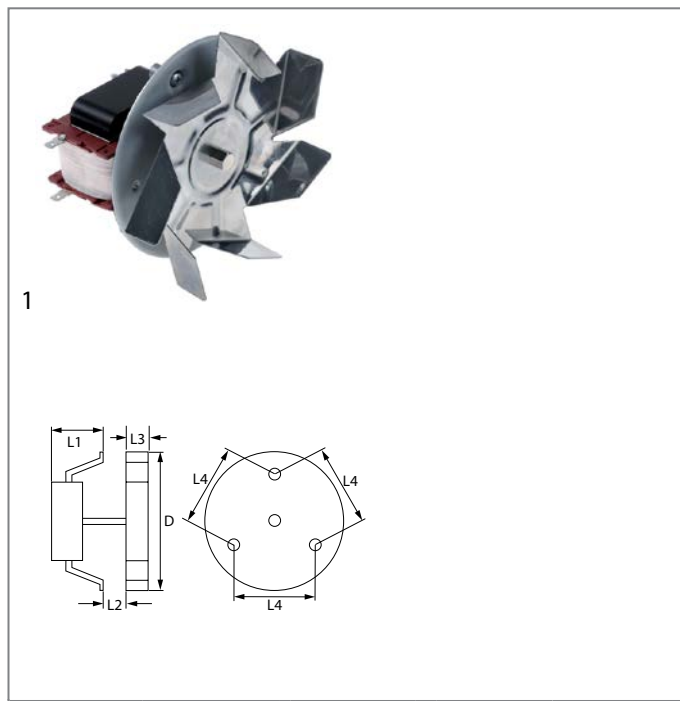

GEV No.	601125	Ref. No.	11950057000
description	hot air fan 220-240V 45W 50/60Hz L1 70mm L2 11mm L3 25mm L4 87mm fan wheel ø 150mm FIME type C30R0479CLF		
For models:	AAA2002, AIB0012, AIB0013, AIB0014, AIB0017		
accessories for	601125		
	GEV No.	550879	Ref. No. V05400
	insulation ø 130mm thickness 3mm hole ø 20mm for hot air fan		

accessories

miscellaneous

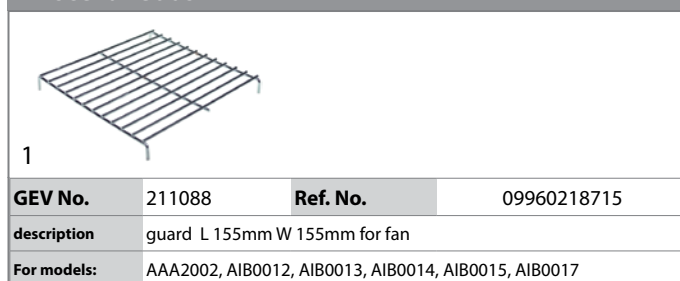

GEV No.	211088	Ref. No.	09960218715
description	guard L 155mm W 155mm for fan		
For models:	AAA2002, AIB0012, AIB0013, AIB0014, AIB0015, AIB0017		

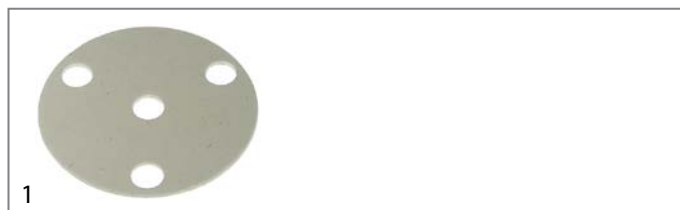

GEV No.	550879	Ref. No.	V05400
description	insulation ø 130mm thickness 3mm hole ø 20mm for hot air fan		
For models:	ACA2010, ACA204V, ACA206V, ACA208V, ACA210V		



accessories universal



GEV No.	521073	Ref. No.	A00EP101
description	fanwheel cover ø 290mm for evaporator fan hole distance 210mm plastic black H 50mm		
For models:	BMA0098, BMA0099, BNC0001BAR-F, BNC0007BAR-F, BNC0015BAR-F, BNC0030PI, BNC0034PI, CCZ0009-F, HAB0001-F, HAB0007-F, HAB0009-F, HAB0015-F, HAB0020, HAB0021, TIM3PI, USN4, VAEK170-F, VAEK210-F, VAEK220-F, VAEN030-F, VAEN060-F, VAEN075-F		



GEV No.	601933	Ref. No.	A00EP100
description	fanwheel cover W 180mm for fan wheel H 50mm mounting distance 160mm		
For models:	9925F, 9931F, 9932F, BNA0068, BNA0069, BNC0001BAR-F, BNC0001-F, BNC0002-F, BNC0007BAR-F, BNC0007-F, BNC0008-F, BNC0015BAR-F, BNC0015-F, BNC0016-F, BNC0030, BNC0030PI, BNC0032, BNC0033, BNC0034, BNC0034PI, BNC0035, CCZ0009-F, CCZ0018-F, CCZ0050, HAB0001-F, HAB0007-F, HAB0009-F, HAB0015-F, HAB0020, HAB0021, HCE2004-F, HCE2005-F, HCE2006-F, HCE2007-F, HCE2008-F, HCE2009, IBC0055, IEC0050, IEC0051, IEC0052, SALADBAR2, SALADBAR3, TIM3, TIM3PI, USN4		

for drink dispensers



GEV No.	500911	Ref. No.	L8102
description	gear motor FIBER type G025J0BAFSR 230V 50/60Hz 40rpm shaft ø 4mm L 66mm W 50mm H 34mm for drink dispenser motor type M51BJ0R0000 shaft length 19mm		
For models:	EAA0002, EAA0003		
spare parts for	500911		
	GEV No.	360673	Ref. No. —
	motor kit pinion ø 6.8mm teeth 15 230V voltage AC 50/60Hz turn direction clockwise motor ø 48mm H 18.5mm motor type UDS-40NE1RNZ165 cable length 150mm with holder		



GEV No.	501508	Ref. No.	P201
description	gear motor MECHTEX 230V 50/60Hz shaft ø 6mm L 66mm W 48mm H 36mm for drink dispenser		
For models:	EAA0002, EAA0003		



GEV No.	500909	Ref. No.	F033/1
description	gear motor KENTA type CD79F 60/68W 115/230V 50/60Hz 33/40rpm shaft ø 6x12mm L 220mm W 70mm H 105mm for drink dispenser		
For models:	EBZ0001-CN, EBZ0002-CN, EBZ0003-CN		

for grills



GEV No.	499111	Ref. No.	534027P
description	gear motor CEG type MM56A4-STD 90W 230V 50Hz 6500rpm L 705mm W 115mm H 550mm chicken rotisserie 0.12HP		
For models:	53054-CN, 5305-CN, 5330, 53304, AJD0002-CCN, AJD0003-CCN, AJD0005-CCN, AJD0006-CCN, AJD0014-C, AJD0015-C, AJD0017-C, AJD0018-C, AJD0019-C		

motors

gear motors

for ice-cube maker

miscellaneous



GEV No.	500675	Ref. No.	N23532
description	gear motor 220/240V 50Hz for flake ice maker		
For models:	BAB0001, BAB0001-W, BAB0002, BAB0002-W		



			
1			
GEV No.	500498	Ref. No.	079501
description	gear motor shaft ø 24mm L 180mm W 105mm H 95mm		
For models:	2158, 2623		

for gyros grills

			
1			
GEV No.	500868	Ref. No.	079515 664.026.00
description	gear motor BITRON type 323 4W 230V 50/60Hz 2.4rpm shaft ø 9mm shaft diameter 6x6mm L 81mm W 57mm H 31mm		
For models:	6060CFG, AJE0001, AJE0005		

			
1			
GEV No.	500869	Ref. No.	079513
description	gear motor KENTA type K9113077 21W 230V 50Hz 0.5rpm shaft ø 8.5mm L 152mm W 60mm H 110mm for gyro grill		
For models:	AJE0002, AJE0003, AJE0006, AJE0007		

for tilting bratt pans

			
1			
GEV No.	501582	Ref. No.	964.003.00
description	gear motor type AO-4/M 24V for tilting bratt pan		

			
1			
GEV No.	500349	Ref. No.	66401000
description	gear motor type MB564A 150W 230V 50Hz 1 phase shaft ø 14mm L 280mm W 105mm H 160mm for tilting bratt pan		
For models:	7070BREM, 7070BRGM		

for ovens
for conveyor belt

			
1			
GEV No.	500809	Ref. No.	MOTO0052
description	gear motor TRANSTECNO type MCB34480190G8 70W 48V 7.46rpm shaft ø 12mm L 220mm W 95mm H 175mm for conveyor belt		
For models:	CAD0004, CAD0004-ZN, CAD0005, CAD0007, CAD0009, CAD0010, SY12100VELED, SY12100VGASD, SY1280VG, SY850VELED		

for flues

			
1			
GEV No.	602083	Ref. No.	91310530
description	gear motor MOTEC type 04BUA1 230V 50Hz 500rpm shaft ø 6mm L 46mm W 48mm H 65mm		
For models:	CAB0019, CAB0020, CAB0055-DCG, CAB0056-DCG, CAB0057-DCG, CAB0058-DCG, CAB0059-DCG, CAB0060-DCG, CAB0061-DCG, CAB0062-DCG		

for dishwashers

			
1			
GEV No.	601861	Ref. No.	927105
description	gear motor FIR type 71-B5 180W 400V voltage AC 50/60Hz 3 phase 900/1100rpm shaft ø 14mm L 227mm for transport system without gearbox		
For models:	GLB0046		



miscellaneous



1			
GEV No.	500730	Ref. No.	IB9865132
description	gear motor CIARAMELLA 150W 230V voltage DC 50/60Hz shaft \varnothing 14mm L 205mm W 115mm H 80mm for citrus juicers		
For models:	MULTIPL02S, MULTIPL03S		



1			
GEV No.	500932	Ref. No.	IB5036000
description	gear motor CROUZET 3.5W 230V 50Hz shaft \varnothing 8mm L 80mm W 60mm H 40mm for pizza display		
For models:	IBA0012, IBA0013		

motors

for slicers

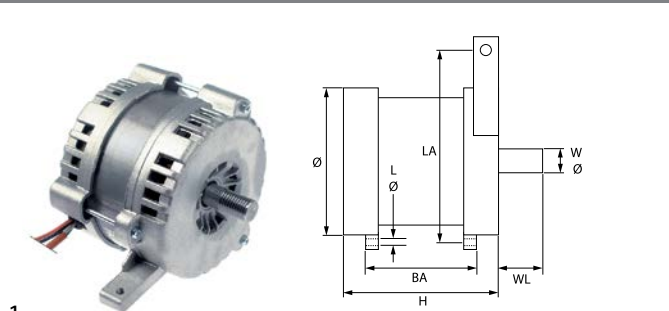

1			
GEV No.	500912	Ref. No.	00000000510
description	motor 230V 1 phase 50Hz 1380rpm shaft \varnothing 15mm shaft length 28mm \varnothing 115mm H 92mm mounting distance 49mm hole distance 145mm hole \varnothing 6mm type H40-510 250 ELETTRMECANICA		
For models:	8921		

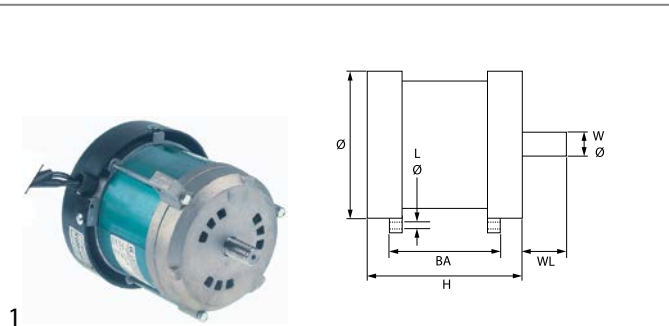

1			
GEV No.	500901	Ref. No.	19400107
description	motor 230V 275W 1 phase 50Hz 1400rpm shaft \varnothing 16.5mm shaft length 32mm \varnothing 130mm H 140mm mounting distance 108mm hole \varnothing 8mm 300-330-350		
For models:	FEB0033, FEB0034, FEB0035, PALLADIO300T, PALLADIO330T		

for bar blender



1			
GEV No.	500728	Ref. No.	IB5000800
description	motor for bar blender 220V 450W 50Hz 18000rpm thread M6L shaft \varnothing 8mm mounting distance 36mm H 60mm L 165mm W 80mm mounting thread M4 Dragone CIARAMELLA		
For models:	DRAGONEV, MULTIPL02S, MULTIPL03S		



1			
GEV No.	500729	Ref. No.	IB5000900
description	motor for bar blender 230V 750W 50Hz 14000/24000rpm thread M8L mounting distance 90mm Orione		
For models:	BARMASTER, ORIONEFIVE		



1			
GEV No.	500731	Ref. No.	IB9865200
description	motor for bar blender 230V 100W 50/60Hz 14000rpm shaft \varnothing 10mm shaft length 143mm H 83mm L 260mm W 83mm Sirio CIARAMELLA		
For models:	MULTIPL02S, MULTIPL03S, SIRIO1VVCAFFE, SIRIO2VVCAFFE		



1			
GEV No.	500732	Ref. No.	IB9865201
description	motor for bar blender 230V 100W 50/60Hz 14000rpm shaft \varnothing 18mm shaft length 143mm H 83mm L 260mm W 83mm Sirio CIARAMELLA		
For models:	SIRIO1VVCAFFE, SIRIO2VVCAFFE		



for cutters



1	GEV No.	500897	Ref. No.	MSC04N136
	description	motor 230V 50Hz 1 phase shaft ø 20mm shaft length 25mm mounting distance 64mm ø 100mm H 140mm C4-C6-C9		
	For models:	FLA0014, FLA0015, FLA0016		

for meat mincers

motors



1	GEV No.	500866	Ref. No.	LF1839701
	description	motor 3000W 230/400V 50Hz 3 phase shaft ø 19mm 1390rpm type M112 ø 175mm H 250mm CSM 3kW		
	For models:	TC32BU		



1	GEV No.	500861	Ref. No.	LF1838303
	description	motor for mincer 230V		
	For models:	FID0005		



1	GEV No.	500865	Ref. No.	LF1839703
	description	motor for mincer 230V		
	For models:	TC32BU		



1	GEV No.	500862	Ref. No.	LF1838301
	description	motor for mincer 400V		
	For models:	FID0005, FID0006		



1	GEV No.	500864	Ref. No.	LF1838601
	description	motor for mincer 400V		
	For models:	TC32BU		

rotors



1	GEV No.	500726	Ref. No.	F2095
	description	rotor 230V ø 89.2mm shaft ø 25mm shaft length 357mm Mod.12 meat mincer/cheese grater		
	For models:	FHZ0003, FIF0001, FIF0004		



1	GEV No.	500725	Ref. No.	F2202 F2233
	description	rotor 400V ø 89.2mm shaft ø 25mm shaft length 357mm Mod.22 meat mincer/cheese grater		
	For models:	FIF0002, FIF0005, TCG22E-F		

stators



1	GEV No.	500826	Ref. No.	F2008
	description	stator		
	For models:	FIF0016-F		



1	GEV No.	500824	Ref. No.	F2076
	description	stator 230V		
	For models:	FHZ0001, FIF0023		

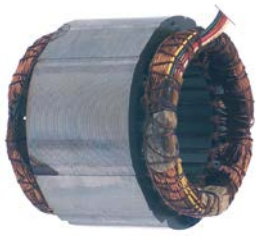

1

GEV No.	500825	Ref. No.	F2077
description	stator 230V 50Hz 4-pole 1400rpm 1 phase ø 110mm ID ø 66mm H 60mm with temperature protection Mod.8		
For models:	FHZ0001, FIF0023		



1

GEV No.	500828	Ref. No.	F2096
description	stator 230V 50Hz 4-pole 1400rpm 1 phase ø 150mm ID ø 90mm H 70mm with temperature protection Mod.12		
For models:	FHZ0003, FIF0001, FIF0004, FMC0001-F		



1

GEV No.	500827	Ref. No.	F2009
description	stator 230V 50Hz 4-pole 1400rpm 3 phase ø 110mm ID ø 62mm H 75mm with temperature protection Mod.8		
For models:	FIF0016-F		

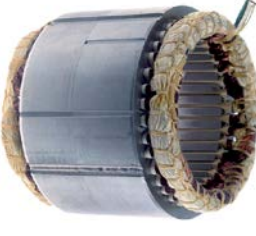

1

GEV No.	500830	Ref. No.	F2203
description	stator 230V 50Hz 6-pole 900rpm 1 phase ø 150mm ID ø 103mm H 90mm with temperature protection Mod.22		
For models:	FIF0002, FIF0005, TCG22E-F		



1

GEV No.	500829	Ref. No.	F2097
description	stator 400V 50Hz 4-pole 1400rpm 3 phase ø 150mm ID ø 83.6mm H 50mm with temperature protection Mod.12		
For models:	FHZ0003, FIF0001, FIF0004, FMC0001-F		



1

GEV No.	500831	Ref. No.	F2204
description	stator 400V 50Hz 6-pole 900rpm 3 phase ø 150mm ID ø 90mm H 70mm with temperature protection Mod.22		
For models:	FIF0002, FIF0005, TCG22E-F		

for vegetable slicers



1

GEV No.	500719	Ref. No.	IV5050002
description	motor 230V 515W 50Hz 1 phase shaft ø 14mm shaft length 37mm mounting distance 154mm TM		
For models:	FLA0028		

for coffee grinders

components





1

GEV No.	500238	Ref. No.	270003
description	motor 230V 50Hz 1 phase ø 110mm ID ø 65mm H 160mm shaft ø 14mm type T80		
For models:	EFF0002-Q		

 Image not available 1			
GEV No.	500861	Ref. No.	LF1838303
description	motor for mincer 230V		
For models:	FID0005		

 Image not available 1			
GEV No.	500865	Ref. No.	LF1839703
description	motor for mincer 230V		
For models:	TC32BU		

 Image not available 1			
GEV No.	500862	Ref. No.	LF1838301
description	motor for mincer 400V		
For models:	FID0005, FID0006		

 Image not available 1			
GEV No.	500864	Ref. No.	LF1838601
description	motor for mincer 400V		
For models:	TC32BU		

pumps



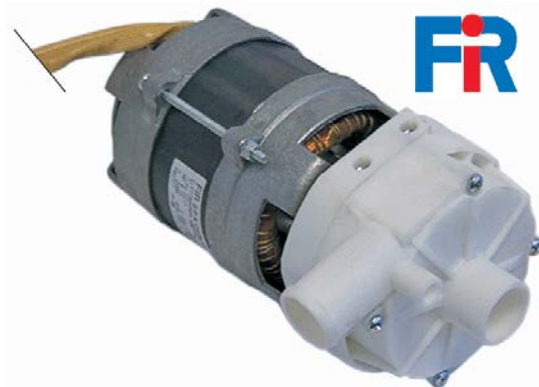

wash and rinse pumps

FIR

pumps



1

GEV No.	500037	Ref. No.	929167
description	pump inlet ø 28mm outlet ø 26mm type 2211.1410 230V 50Hz 1 phase 0.074kW 0.1HP L 190mm rotation direction left capacitor 5µF FIR		
For models:	GLB0044		
spare parts for	500037		
	GEV No.	365017	Ref. No. 206010
	operating capacitor capacity 5µF 450V tolerance 5% 50/60Hz ambient temperature max. -25 to +85°C ø 28mm L 54mm M8 plastic connection male faston 6.3mm 16.10.08 protection		
	GEV No.	510384	Ref. No. —
	pump cover inlet ø 28mm outlet ø 26mm ø 100mm ID ø 76mm		
	GEV No.	510695	Ref. No. —
	mechanical shaft seal height counter ring 5.5mm ID ø 11mm		
	GEV No.	521203	Ref. No. —
	impellor ø 72mm H 18mm thread M7 shaft ø 11mm shaft length 32mm blades 3		
	GEV No.	521703	Ref. No. 456038
	pump cover gasket EPDM thickness 2.5mm ID ø 75mm Qty 1 pcs		

accessories

vibration absorber



1

GEV No.	524000	Ref. No.	12025159 Z710316000
description	vibration damper H 15mm ø 20mm thread M6 thread L 14mm		
For models:	OPT1012-CF, OPT1012-CFN		







1

GEV No.	499336	Ref. No.	929175
description	pump inlet ø 62 outlet ø 62 type 2250.2732 230/400V 50Hz 2.95kW 4HP		
For models:	GLB0044		
spare parts for	499336		
	GEV No.	510687	Ref. No. 929179
	mechanical shaft seal for shaft ø 18mm height counter ring 8mm ID ø 17mm ED ø 39mm H 15mm mounting ø 42mm int. ø 1 21mm		
	GEV No.	521026	Ref. No. —
	pump cover gasket ID ø 182.5mm thickness 5x4.5mm		
	GEV No.	521028	Ref. No. —
	pump cover FIR inlet ø 62mm outlet ø 62mm turn direction right ø 215mm ID ø 175mm inner height 40mm		
	GEV No.	521277	Ref. No. 929181
	impellor ø 135mm H 39mm pump type Fir 2275 - 3.6HP thread M14L		



1

GEV No.	499334	Ref. No.	929174
description	pump inlet ø 62mm outlet ø 62mm type 2250.2731 230/400V 50Hz 1 phase 3kW FIR		
For models:	GLB0043, GLB0044		
spare parts for	499334		
	GEV No.	510687	Ref. No. 929179
	mechanical shaft seal for shaft ø 18mm height counter ring 8mm ID ø 17mm ED ø 39mm H 15mm mounting ø 42mm int. ø 1 21mm		
	GEV No.	512455	Ref. No. 929189
	fan wheel ø 155mm H 18mm shaft intake ø 18mm plastic blades 12		

spare parts for	499334		
	GEV No.	521026	Ref. No. —
	pump cover gasket ID ø 182.5mm thickness 5x4.5mm		
	GEV No.	521028	Ref. No. —
	pump cover FIR inlet ø 62mm outlet ø 62mm turn direction right ø 215mm ID ø 175mm inner height 40mm		
	GEV No.	521277	Ref. No. 929181
	impellor ø 135mm H 39mm pump type Fir 2275 - 3.6HP thread M14L		



1

GEV No.	500570	Ref. No.	75175
description	pump inlet ø 63mm outlet ø 47mm type 422512725 230/400V 50Hz 3 phase 1.1kW 1.5HP L 285mm rotation direction right FIR		
For models:	GLB0046		
spare parts for	500570		
	GEV No.	510693	Ref. No. 141002 Z201081000
	mechanical shaft seal for shaft ø 12mm slide ring ext. ø 24mm slide ring H 15.5mm slide ring int. ø 11mm counter ring mounting ø 24mm height counter ring 8mm counter ring int. ø 13.5mm		
	GEV No.	521082	Ref. No. 80881
	impellor ø 96mm H 32mm rotation direction right thread M8L		
	GEV No.	521513	Ref. No. —
	pump cover FIR inlet ø 63mm outlet ø 47mm turn direction right ID ø 150mm inner height 32mm		
	GEV No.	524416	Ref. No. —
	pump cover gasket thickness 4x4mm Qty 1 pcs		





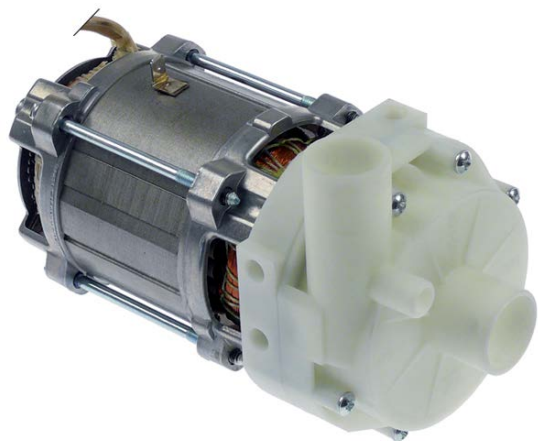

HANNING

pumps



1

GEV No.	499166	Ref. No.	12024233
description	pump inlet \varnothing 28mm outlet \varnothing 26mm type UP60-414 220-240V 50/60Hz 1 phase 0.25kW L 190mm rotation direction right capacitor 5 μ F HANNING p max 1bar Qmax. 150l/min		
For models:	GLB0063C-FN		
spare parts for	499166		
	GEV No.	365017	Ref. No. 206010
	operating capacitor capacity 5 μ F 450V tolerance 5% 50/60Hz ambient temperature max. -25 to +85°C \varnothing 28mm L 54mm M8 plastic connection male faston 6.3mm 16.10.08 protection		
	GEV No.	507558	Ref. No. —
	mechanical shaft seal for shaft \varnothing 7mm height counter ring 5mm ID \varnothing 6.75mm ED \varnothing 20mm mounting \varnothing counter ring 18.5/slide ring 20mm		
	GEV No.	532644	Ref. No. —
	O-ring EPDM thickness 3mm ID \varnothing 78mm Qty 1 pcs		

spare parts for	500321		
	GEV No.	650240	Ref. No. —
	impellor \varnothing 75mm H 27mm pump type 2/102FA10 shaft intake \varnothing 8mm rotation direction right thread M8L suitable for INSERTSTAR blades 6		
accessories for	500321		
	GEV No.	365093	Ref. No. 12024346
	operating capacitor capacity 6 μ F 400V tolerance 5% 50/60Hz ambient temperature max. -25 to +85°C \varnothing 31.5mm L 55mm M8 plastic connection male faston 6.3mm protection		



1

GEV No.	501562	Ref. No.	12043287
description	pump inlet \varnothing 38mm outlet \varnothing 38mm type 2/123 FA-22 230V 50Hz 1 phase 0.59kW 0.8HP rotation direction right capacitor 10 μ F INSERT-STAR		
For models:	GLB0061C-F, GLB0061C-FN, GLB0063C-F, GLB0063C-FN, OPT1012-CF, OPT1012-CFN		



1



GEV No.	499075	Ref. No.	12024270 Z203511000
description	pump inlet \varnothing 38mm outlet \varnothing 38mm type 2/123 FA31 230V 60Hz 1 phase 0.59kW L 240mm rotation direction right capacitor 10 μ F INSERTSTAR		
For models:	GLB0061C-F, GLB0061C-FN, GLB0063C-F, GLB0063C-FN, OPT1012-CF, OPT1012-CFN		

INSERT STAR

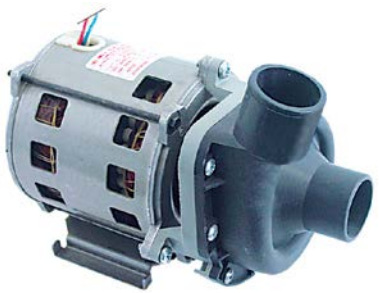
pumps



1

GEV No.	500321	Ref. No.	12023429
description	pump inlet \varnothing 38mm outlet \varnothing 38mm type 2/102FA10 230V 50/60Hz 1 phase 0.26kW 0.35HP L 195mm rotation direction right capacitor 6 μ F INSERTSTAR		
For models:	GLB0035-F, GLB0035-FN, GLB0037-F, GLB0037-FN		
spare parts for	500321		
	GEV No.	504578	Ref. No. —
	O-ring EPDM thickness 3.53mm ID \varnothing 94.84mm Qty 1 pcs		
	GEV No.	510693	Ref. No. 141002 Z201081000
	mechanical shaft seal for shaft \varnothing 12mm slide ring ext. \varnothing 24mm slide ring H 15.5mm slide ring int. \varnothing 11mm counter ring mounting \varnothing 24mm height counter ring 8mm counter ring int. \varnothing 13.5mm		





spare parts for	499075		
	GEV No.	510693	Ref. No. 141002 Z201081000
	mechanical shaft seal for shaft \varnothing 12mm slide ring ext. \varnothing 24mm slide ring H 15.5mm slide ring int. \varnothing 11mm counter ring mounting \varnothing 24mm height counter ring 8mm counter ring int. \varnothing 13.5mm		
	GEV No.	521000	Ref. No. —
	pump cover FAGOR inlet \varnothing 38mm outlet \varnothing 38mm		
	GEV No.	532491	Ref. No. —
	O-ring EPDM thickness 3.53mm ID \varnothing 120.2mm Qty 1 pcs		
	GEV No.	650238	Ref. No. —
	impellor \varnothing 77mm H 32mm pump type 2/123 FA31 shaft intake \varnothing 8mm rotation direction right thread M8L suitable for INSERTSTAR shaft \varnothing 12mm shaft length 26mm blades 6		

Table continues overleaf



accessories for 499075					
	<table border="1"> <tr> <td>GEV No.</td> <td>365015</td> <td>Ref. No.</td> <td>00000000633 12024376 19410307 206002 V321300000</td> </tr> </table> <p>operating capacitor capacity 10µF 400V tolerance 5%Hz ambient temperature max. -25 to +85°C ø 35.5mm L 59mm M8 plastic connection male faston 6.3mm protection</p>	GEV No.	365015	Ref. No.	00000000633 12024376 19410307 206002 V321300000
GEV No.	365015	Ref. No.	00000000633 12024376 19410307 206002 V321300000		



1	GEV No. 500320	Ref. No. 12024265 Z201011000			
description	pump inlet ø 38mm outlet ø 38mm type 2/123/FA30 230V 50Hz 1 phase 0.59kW 0.8HP L 235mm rotation direction right capacitor 10µF INSERTSTAR				
For models:	GLB0061C-F, GLB0061C-FN, GLB0063C-F, GLB0063C-FN, OPT1012-CF, OPT1012-CFN				
spare parts for 500320					
	<table border="1"> <tr> <td>GEV No.</td> <td>510693</td> <td>Ref. No.</td> <td>141002 Z201081000</td> </tr> </table> <p>mechanical shaft seal for shaft ø 12mm slide ring ext. ø 24mm slide ring H 15.5mm slide ring int. ø 11mm counter ring mounting ø 24mm height counter ring 8mm counter ring int. ø 13.5mm</p>	GEV No.	510693	Ref. No.	141002 Z201081000
GEV No.	510693	Ref. No.	141002 Z201081000		
	<table border="1"> <tr> <td>GEV No.</td> <td>521000</td> <td>Ref. No.</td> <td>—</td> </tr> </table> <p>pump cover FAGOR inlet ø 38mm outlet ø 38mm</p>	GEV No.	521000	Ref. No.	—
GEV No.	521000	Ref. No.	—		
	<table border="1"> <tr> <td>GEV No.</td> <td>521255</td> <td>Ref. No.</td> <td>Z201082000</td> </tr> </table> <p>impellor ø 88mm H 33mm M8L pump type 2/123/FA30 shaft ø 12mm</p>	GEV No.	521255	Ref. No.	Z201082000
GEV No.	521255	Ref. No.	Z201082000		
	<table border="1"> <tr> <td>GEV No.</td> <td>532491</td> <td>Ref. No.</td> <td>—</td> </tr> </table> <p>O-ring EPDM thickness 3.53mm ID ø 120.2mm Qty 1 pcs</p>	GEV No.	532491	Ref. No.	—
GEV No.	532491	Ref. No.	—		
accessories for 500320					
	<table border="1"> <tr> <td>GEV No.</td> <td>365015</td> <td>Ref. No.</td> <td>00000000633 12024376 19410307 206002 V321300000</td> </tr> </table> <p>operating capacitor capacity 10µF 400V tolerance 5%Hz ambient temperature max. -25 to +85°C ø 35.5mm L 59mm M8 plastic connection male faston 6.3mm protection</p>	GEV No.	365015	Ref. No.	00000000633 12024376 19410307 206002 V321300000
GEV No.	365015	Ref. No.	00000000633 12024376 19410307 206002 V321300000		
	<table border="1"> <tr> <td>GEV No.</td> <td>551227</td> <td>Ref. No.</td> <td>—</td> </tr> </table> <p>female faston size 6.3x0.8mm 1.0-2.5mm² straight CuZn gal Sn t.max. 110°C Qty 10 pcs</p>	GEV No.	551227	Ref. No.	—
GEV No.	551227	Ref. No.	—		

LGB



1	GEV No. 501484	Ref. No. 69122			
description	pump inlet ø 42mm outlet ø 37/24mm type LA50 230V 50Hz 1 phase 0.47kW L 220mm rotation direction right capacitor 10µF auxiliary pressure connection 8mm LGB				
For models:	OPT1012C				
spare parts for 501484					
	<table border="1"> <tr> <td>GEV No.</td> <td>365015</td> <td>Ref. No.</td> <td>00000000633 12024376 19410307 206002 V321300000</td> </tr> </table> <p>operating capacitor capacity 10µF 400V tolerance 5%Hz ambient temperature max. -25 to +85°C ø 35.5mm L 59mm M8 plastic connection male faston 6.3mm protection</p>	GEV No.	365015	Ref. No.	00000000633 12024376 19410307 206002 V321300000
GEV No.	365015	Ref. No.	00000000633 12024376 19410307 206002 V321300000		
	<table border="1"> <tr> <td>GEV No.</td> <td>510702</td> <td>Ref. No.</td> <td>—</td> </tr> </table> <p>mechanical shaft seal height counter ring 5.5mm ID ø 12mm</p>	GEV No.	510702	Ref. No.	—
GEV No.	510702	Ref. No.	—		
	<table border="1"> <tr> <td>GEV No.</td> <td>521024</td> <td>Ref. No.</td> <td>124057</td> </tr> </table> <p>impellor ø 88mm H 30mm rotation direction right thread M7L shaft ø 12mm blades 6</p>	GEV No.	521024	Ref. No.	124057
GEV No.	521024	Ref. No.	124057		
	<table border="1"> <tr> <td>GEV No.</td> <td>698767</td> <td>Ref. No.</td> <td>335015</td> </tr> </table> <p>fan blade ø 110mm H 18mm shaft intake ø 12mm plastic blades 6</p>	GEV No.	698767	Ref. No.	335015
GEV No.	698767	Ref. No.	335015		
	<table border="1"> <tr> <td>GEV No.</td> <td>698768</td> <td>Ref. No.</td> <td>480148</td> </tr> </table> <p>pump cover LGB inlet ø 42mm pump type LA50 AP ø 115mm ID ø 36mm</p>	GEV No.	698768	Ref. No.	480148
GEV No.	698768	Ref. No.	480148		
	<table border="1"> <tr> <td>GEV No.</td> <td>698769</td> <td>Ref. No.</td> <td>116032</td> </tr> </table> <p>pump casing ø 125mm outlet ø 24/37mm</p>	GEV No.	698769	Ref. No.	116032
GEV No.	698769	Ref. No.	116032		
	<table border="1"> <tr> <td>GEV No.</td> <td>698810</td> <td>Ref. No.</td> <td>456078</td> </tr> </table> <p>O-ring EPDM thickness 3.56mm ID ø 112mm Qty 1 pcs</p>	GEV No.	698810	Ref. No.	456078
GEV No.	698810	Ref. No.	456078		
	<table border="1"> <tr> <td>GEV No.</td> <td>698827</td> <td>Ref. No.</td> <td>429074</td> </tr> </table> <p>threaded ring LGB pump type LA50 ø 120mm ID ø 70mm</p>	GEV No.	698827	Ref. No.	429074
GEV No.	698827	Ref. No.	429074		



1

GEV No.	500156	Ref. No.	130109
description	pump inlet ø 50mm outlet ø 50mm type ZF400SX 230V 50Hz 1 phase 0.6kW 0.8HP L 210mm rotation direction right capacitor 16µF LGB		
For models:	GLB0061, GLB0061C, GLB0062, GLB0063, GLB0064, GLB0064C, GLB0065, GLB0066		
spare parts for	500156		
	GEV No.	509020	Ref. No. 124031
	impellor ø 104mm H 25mm M8L		
	GEV No.	510703	Ref. No. 141007 80843
	mechanical shaft seal for shaft ø 13mm slide ring H 13mm height counter ring 5.5mm ED ø 26mm		
	GEV No.	513713	Ref. No. 315017
	pump cover bottom part		
	GEV No.	521548	Ref. No. 116019
	pump cover LGB inlet ø 50mm outlet ø 50mm		
	GEV No.	521562	Ref. No. 116021
	pump cover		
	GEV No.	521734	Ref. No. 315022
	pump cover bottom part		
	GEV No.	523509	Ref. No. 314001
	deep-groove ball bearing type 6201-2RS shaft ø 12mm ED ø 32mm W 10mm with sealing discs deep-groove ball bearing DIN 625-1		
	GEV No.	532623	Ref. No. 80844
	O-ring EPDM thickness 2.62mm ID ø 120.32mm Qty 1 pcs		
accessories for	500156		
	GEV No.	365021	Ref. No. 206004 F2144
	operating capacitor capacity 16µF 425V tolerance 5% 50/60Hz ambient temperature max. -25 to +85°C ø 35mm L 73mm single M8 plastic connection male faston 6.3mm 416.10.99 protection		







1

GEV No.	500361	Ref. No.	80112
description	pump inlet ø 60mm outlet ø 49mm type ZF400SX 230V 50Hz 1 phase 0.8kW 1HP L 210mm rotation direction right capacitor 16µF LGB		
For models:	GLB0073		
spare parts for	500361		
	GEV No.	365021	Ref. No. 206004 F2144
	operating capacitor capacity 16µF 425V tolerance 5% 50/60Hz ambient temperature max. -25 to +85°C ø 35mm L 73mm single M8 plastic connection male faston 6.3mm 416.10.99 protection		
	GEV No.	509020	Ref. No. 124031
	impellor ø 104mm H 25mm M8L		
	GEV No.	510703	Ref. No. 141007 80843
	mechanical shaft seal for shaft ø 13mm slide ring H 13mm height counter ring 5.5mm ED ø 26mm		
	GEV No.	521547	Ref. No. 116013
	pump cover LGB inlet ø 60mm outlet ø 50mm supporting pressure M8 turn direction right ø 160mm ID ø 127mm inner height 36mm		
	GEV No.	521736	Ref. No. 315011
	pump cover bottom part bottom part		
	GEV No.	532623	Ref. No. 80844
	O-ring EPDM thickness 2.62mm ID ø 120.32mm Qty 1 pcs		
accessories for	500361		
	GEV No.	513264	Ref. No. 80545
	fastening angle for wash pump		







1

GEV No.	499126	Ref. No.	80113
description	pump inlet ø 60mm outlet ø 50mm type ZF400SX 230V 50Hz 1 phase 1.1kW L 215mm rotation direction right capacitor 16µF LGB		
For models:	GLB0070, GLB0071		
spare parts for	499126		
	GEV No.	365021	Ref. No. 206004 F2144
	operating capacitor capacity 16µF 425V tolerance 5% 50/60Hz ambient temperature max. -25 to +85°C ø 35mm L 73mm single M8 plastic connection male faston 6.3mm 416.10.99 protection		
	GEV No.	510703	Ref. No. 141007 80843
	mechanical shaft seal for shaft ø 13mm slide ring H 13mm height counter ring 5.5mm ED ø 26mm		
	GEV No.	521090	Ref. No. 80845
	impellor ø 101mm H 32mm thread M8L shaft ø 13mm shaft length 12mm		
	GEV No.	521547	Ref. No. 116013
	pump cover LGB inlet ø 60mm outlet ø 50mm supporting pressure M8 turn direction right ø 160mm ID ø 127mm inner height 36mm		
	GEV No.	532623	Ref. No. 80844
	O-ring EPDM thickness 2.62mm ID ø 120.32mm Qty 1 pcs		









1

GEV No.	500360	Ref. No.	80114
description	pump inlet ø 62mm outlet ø 50mm type ZF522SX 230V 50Hz 1 phase 1.1kW 1.5HP L 220mm rotation direction right capacitor 16µF LGB		
For models:	GLB0070, GLB0071		
spare parts for	500360		
	GEV No.	365021	Ref. No. 206004 F2144
	operating capacitor capacity 16µF 425V tolerance 5% 50/60Hz ambient temperature max. -25 to +85°C ø 35mm L 73mm single M8 plastic connection male faston 6.3mm 416.10.99 protection		
	GEV No.	510551	Ref. No. 456023 926084
	pump cover gasket ID ø 158.3mm pump type 1214/1293/1225/2243/1226/1204/3473/1241 thickness 3.53mm EPDM Qty 1 pcs		
	GEV No.	510693	Ref. No. 141002 Z201081000
	mechanical shaft seal for shaft ø 12mm slide ring ext. ø 24mm slide ring H 15.5mm slide ring int. ø 11mm counter ring mounting ø 24mm height counter ring 8mm counter ring int. ø 13.5mm		
	GEV No.	521280	Ref. No. —
	impellor ø 107mm H 26mm thread M8L shaft ø 20mm shaft length 15mm seat ø 8.2mm blades 6		
	GEV No.	521536	Ref. No. 926086
	pump cover ALBA / LGB inlet ø 62mm outlet ø 50mm auxiliary pressure connection 12mm supporting pressure closed turn direction right ø 180mm ID ø 150mm inner height 38mm		



1			
GEV No.	499101	Ref. No.	79056
description	pump inlet ø outlet ø 38mm type C600 230V 50Hz 1 phase 0.8kW L 220mm rotation direction right capacitor 16µF LGB with drain and flange		
For models:	OPT1012		
spare parts for	499101		
	GEV No.	365021	Ref. No. 206004 F2144
	operating capacitor capacity 16µF 425V tolerance 5% 50/60Hz ambient temperature max. -25 to +85°C ø 35mm L 73mm single M8 plastic connection male faston 6.3mm 416.10.99 protection		
	GEV No.	502280	Ref. No. —
	pump sump LGB auxiliary pressure connection 7mm supporting pressure closed pump type RV54		
	GEV No.	510703	Ref. No. 141007 80843
	mechanical shaft seal for shaft ø 13mm slide ring H 13mm height counter ring 5.5mm ED ø 26mm		
	GEV No.	521234	Ref. No. 124052
	impellor thread M8L ED ø 93mm W 16mm		
	GEV No.	523509	Ref. No. 314001
	deep-groove ball bearing type 6201-2RS shaft ø 12mm ED ø 32mm W 10mm with sealing discs deep-groove ball bearing DIN 625-1		
	GEV No.	532537	Ref. No. 456067
	O-ring EPDM thickness 3.53mm ID ø 113.9mm Qty 1 pcs		



1			
GEV No.	500153	Ref. No.	999134
description	pump inlet ø outlet ø type W180SX 230V 50Hz 1 phase 0.19kW 0.26HP L 220mm rotation direction right capacitor 5µF LGB		
For models:	GLB0035		
spare parts for	500153		
	GEV No.	365017	Ref. No. 206010
	operating capacitor capacity 5µF 450V tolerance 5% 50/60Hz ambient temperature max. -25 to +85°C ø 28mm L 54mm M8 plastic connection male faston 6.3mm 16.10.08 protection		
	GEV No.	510703	Ref. No. 141007 80843
	mechanical shaft seal for shaft ø 13mm slide ring H 13mm height counter ring 5.5mm ED ø 26mm		
	GEV No.	513267	Ref. No. 480054
	end cap for wash pump suitable for pump casing		
	GEV No.	513283	Ref. No. 437082
	gasket		
	GEV No.	518177	Ref. No. 111023
	drain unit thread 3/4" ID ø 35mm hose ø 24mm		
	GEV No.	518204	Ref. No. 429065
	screw connection for filter ø 67mm		
	GEV No.	518205	Ref. No. 437079 80182
	flat gasket rubber ED ø 61mm ID ø 47mm thickness 2mm Qty 1 pcs		
	GEV No.	521147	Ref. No. 315024
	flange		
	GEV No.	521221	Ref. No. 124048
	impellor ø 67mm H 16mm rotation direction right thread M7L shaft ø 13mm shaft length 12mm blades 8		
	GEV No.	528800	Ref. No. —
	O-ring EPDM thickness 2.62mm ID ø 75.87mm Qty 1 pcs		



1





GEV No.	500150	Ref. No.	999135
description	pump inlet \varnothing outlet \varnothing type W210SX 230V 50Hz 1 phase 0.24kW 0.33HP L 230mm rotation direction right capacitor 6.3 μ F LGB		
For models:	GLB0036, GLB0037, GLB0038, GLB0039, GLB0056, GLB0057		
spare parts for	500150		
	GEV No.	365012	Ref. No. 0000000149 206009
	operating capacitor capacity 6.3 μ F 450V tolerance 5% 50Hz ambient temperature max. -25 to +85°C \varnothing 30mm L 61mm M8 plastic connection male faston 6.3mm protection		
	GEV No.	509004	Ref. No. 124049
	impellor \varnothing 71mm H 16mm M7L rotation direction right shaft \varnothing 13mm shaft length 13mm blades 8		
	GEV No.	510703	Ref. No. 141007 80843
	mechanical shaft seal for shaft \varnothing 13mm slide ring H 13mm height counter ring 5.5mm ED \varnothing 26mm		
	GEV No.	513267	Ref. No. 480054
	end cap for wash pump suitable for pump casing		
	GEV No.	513275	Ref. No. 456074
	O-ring EPDM thickness 1.78mm ID \varnothing 82.27mm Qty 1 pcs		
	GEV No.	518177	Ref. No. 111023
	drain unit thread 3/4" ID \varnothing 35mm hose \varnothing 24mm		
	GEV No.	518204	Ref. No. 429065
	screw connection for filter \varnothing 67mm		
	GEV No.	518205	Ref. No. 437079 80182
	flat gasket rubber ED \varnothing 61mm ID \varnothing 47mm thickness 2mm Qty 1 pcs		
	GEV No.	521147	Ref. No. 315024
	flange		

OLYMPIA

pumps



1

GEV No.	500152	Ref. No.	130122
description	pump inlet \varnothing 44mm outlet \varnothing 30mm type T90 230V 50Hz 1 phase 0.33kW 0.45HP L 220mm rotation direction left capacitor 8 μ F OLYMPIA		
For models:	GLB0058, GLB0059, GLB0060		
spare parts for	500152		
	GEV No.	365013	Ref. No. 0000000182 150070 19410301 206001
	operating capacitor capacity 8 μ F 400V tolerance 5%Hz ambient temperature max. -25 to +85°C \varnothing 31.5mm L 55mm M8 plastic connection male faston 6.3mm protection		
	GEV No.	509007	Ref. No. 124043
	impellor \varnothing 85mm H 20mm rotation direction left thread M10R shaft \varnothing 12mm shaft length 7.5mm blades 12		
	GEV No.	510693	Ref. No. 141002 Z201081000
	mechanical shaft seal for shaft \varnothing 12mm slide ring ext. \varnothing 24mm slide ring H 15.5mm slide ring int. \varnothing 11mm counter ring mounting \varnothing 24mm height counter ring 8mm counter ring int. \varnothing 13.5mm		
	GEV No.	521703	Ref. No. 456038
	pump cover gasket EPDM thickness 2.5mm ID \varnothing 75mm Qty 1 pcs		

booster pumps I



1

GEV No.	499155	Ref. No.	Z209508000
description	pump inlet \varnothing 1" IT outlet \varnothing 1" IT type PRISMA15 230V 50Hz 0.6kW L 400mm capacitor 12 μ F		
For models:	GLB0061C-F, GLB0063C-F		









1

GEV No.	500359	Ref. No.	130143 DPE127
description	pump inlet ø 12 outlet ø 12 type PPL46DX 230V 50Hz 0.33kW capacitor 10µF LGB		
For models:	GLB0070, GLB0071		
spare parts for	500359		
	GEV No.	698663	Ref. No. —
	impellor ø 60mm H 12mm with flute shaft intake ø 12mm W 60mm suitable for LGB		
accessories for	500359		
	GEV No.	365015	Ref. No. 00000000633 12024376 19410307 206002 V321300000
	operating capacitor capacity 10µF 400V tolerance 5%Hz ambient temperature max. -25 to +85°C ø 35.5mm L 59mm M8 plastic connection male faston 6.3mm protection		



1

GEV No.	500358	Ref. No.	130120
description	pump inlet ø 3/8" outlet ø 3/8" type PS46 230V 50Hz 0.45kW ø 100mm L 200mm capacitor 10µF LGB		
For models:	GLB0043, GLB0044		
spare parts for	500358		
	GEV No.	510713	Ref. No. 141009
	slide ring for shaft ø 12mm ED ø 24mm H 16mm		
	GEV No.	510723	Ref. No. —
	counter ring H 8mm ED ø 26mm ID ø 13.5mm for mechanical shaft seal		
	GEV No.	698400	Ref. No. —
	pump cover gasket pump type PS46 thickness 2mm ID ø 66mm Qty 1 pcs		
accessories for	500358		
	GEV No.	365015	Ref. No. 00000000633 12024376 19410307 206002 V321300000
	operating capacitor capacity 10µF 400V tolerance 5%Hz ambient temperature max. -25 to +85°C ø 35.5mm L 59mm M8 plastic connection male faston 6.3mm protection		
	GEV No.	511279	Ref. No. —
	hose connector brass straight thread 3/8" hose ø 12mm Qty 1 pcs		
	GEV No.	520202	Ref. No. 927015
	hose connector nickel-plated brass straight thread 3/8" hose ø 12mm Qty 1 pcs		

accessories for 500358

	GEV No.	520677	Ref. No.	—
	hose connector brass straight thread 3/8" hose ø 13mm Qty 1 pcs			

drain pumps

ASKOLL



1

GEV No.	500210	Ref. No.	130123
description	drain pump 230V 40W		
For models:	GLB0035, GLB0036, GLB0037, GLB0038, GLB0039, GLB0056, GLB0057, GLB0060, GLB0072		



1

GEV No.	501541	Ref. No.	130177
description	drain pump 40W 220-240V inlet ø 30mm outlet ø 22mm 50Hz ASKOLL type M231 XP		
For models:	OPT1012C		



1

GEV No.	500214	Ref. No.	130105
description	drain pump inlet ø 30mm outlet ø 22mm 230/240V 30W 50Hz ASKOLL type R113		
For models:	GLB0061, GLB0061C, GLB0062, GLB0063, GLB0064, GLB0064C, GLB0065, GLB0066		

COPRECI



1			
GEV No.	500322	Ref. No.	Z220901000
description	drain pump inlet ø 25mm outlet ø 22mm 230V 30W 50Hz COPRECI		
For models:	GLB0061C-F, GLB0063C-F		

HANNING



1			
GEV No.	501561	Ref. No.	12094265
description	drain pump 38W 200-240V inlet ø 30mm outlet ø 24mm 50/60Hz type DP25R-396 HANNING		
For models:	GLB0063C-F, GLB0063C-FN		



1			
GEV No.	500363	Ref. No.	80117
description	drain pump 40W 230V		
For models:	GLB0070, GLB0071, GLB0073, OPT1012C		

accessories

holders



1			
GEV No.	500736	Ref. No.	Z220904000
description	fastening angle for drain pump		
For models:	GLB0061C-F, GLB0063C-F		



1			
GEV No.	513717	Ref. No.	035064
description	fastening angle for drain pump		
For models:	GLB0063, GLB0064, GLB0064C, GLB0065, GLB0066		

accessories for	513717		
	GEV No.	518171	Ref. No.
			—

booster pumps II

accessories







1			
GEV No.	365015	Ref. No.	0000000633 12024376 19410307 206002 V321300000
description	operating capacitor capacity 10µF 400V tolerance 5%Hz ambient temperature max. -25 to +85°C ø 35.5mm L 59mm M8 plastic connection male faston 6.3mm protection		
For models:	8922, FEB0033, FEB0034, FEB0035, GLB0043, GLB0044, GLB0061C-F, GLB0061C-FN, GLB0063C-F, GLB0063C-FN, OPT1012C, OPT1012-CF, OPT1012-CFN, PALLADIO300AM, PALLADIO300T, PALLADIO330T, PALLADIO350AM		







			
1			
GEV No.	365017	Ref. No.	206010
description	operating capacitor capacity 5µF 450V tolerance 5% 50/60Hz ambient temperature max. -25 to +85°C ø 28mm L 54mm M8 plastic connection male faston 6.3mm 16.10.08 protection		
For models:	GLB0035		

			
1			
GEV No.	365012	Ref. No.	0000000149 206009
description	operating capacitor capacity 6.3µF 450V tolerance 5% 50Hz ambient temperature max. -25 to +85°C ø 30mm L 61mm M8 plastic connection male faston 6.3mm protection		
For models:	8920, GLB0036, GLB0037, GLB0038, GLB0039, GLB0056, GLB0057		

			
1			
GEV No.	500166	Ref. No.	N23068
description	pump REBO type 63/45 150W 230V 50/60Hz inlet ø 28mm outlet ø 26mm L 200mm rotation direction right capacitor 5µF		
For models:	BAA0033, BAA0034		
spare parts for	500166		
	GEV No.	365017	Ref. No. 206010
	operating capacitor capacity 5µF 450V tolerance 5% 50/60Hz ambient temperature max. -25 to +85°C ø 28mm L 54mm M8 plastic connection male faston 6.3mm 16.10.08 protection		
	GEV No.	601412	Ref. No. N10213
	fan wheel sucking ø 154mm fan wheel mounting 25.4mm blade angle 28° W 34mm plastic		
	GEV No.	601413	Ref. No. —
	fixing plate suitable for fanwheel ED ø 32mm shaft ø 7 mounting distance 26mm		

pumps for ice machines

			
1			
GEV No.	500590	Ref. No.	N23377 NC23377
description	pump FIR type 4240.2300 120W 230V 50/60Hz inlet ø 22mm outlet ø 22mm L 240mm rotation direction right for ice-cube maker capacitor 5µF		
For models:	BAA0032, BAA0055		
spare parts for	500590		
	GEV No.	601412	Ref. No. N10213
	fan wheel sucking ø 154mm fan wheel mounting 25.4mm blade angle 28° W 34mm plastic		
	GEV No.	601413	Ref. No. —
	fixing plate suitable for fanwheel ED ø 32mm shaft ø 7 mounting distance 26mm		

			
1			
GEV No.	499232	Ref. No.	NC26557
description	pump REBO type NR40 55W 220/240V 50Hz inlet ø 19mm outlet ø 18mm L 110mm rotation direction left for ice-cube maker with filter		
For models:	BAC0007		
spare parts for	499232		
	GEV No.	500970	Ref. No. N23073
	pump motor 55W 230V 50Hz REBO L 205mm type outlet ømm suitable for for ice maker		
	GEV No.	695531	Ref. No. N10139
	supply filter thread 1" total length 100mm plastic with metal filter ø 18mm		
	GEV No.	695539	Ref. No. N10188
	intake valve with float		





1

GEV No.	500164	Ref. No.	NC23254
description	pump REBO type NR40 55W 220/240V 50Hz outlet ø 17mm L 113mm rotation direction left for ice-cube maker outlet upper		
For models:	BAA0024, BAA0025, BAA0026, BAA0027, BAA0028, BAA0029, BAA0030, BAA0031		



1

GEV No.	500161	Ref. No.	NC23076
description	pump REBO type NR40 55W 230V 50Hz outlet ø 17mm L 110mm rotation direction left for ice-cube maker		
For models:	BAA0019, BAA0022, BAA0023		
spare parts for	500161		
	GEV No.	500970	Ref. No. N23073
	pump motor 55W 230V 50Hz REBO L 205mm type outlet ømm suitable for for ice maker		



1

GEV No.	500596	Ref. No.	NC23626
description	pump REBO type NR50 60W 230V 50Hz outlet ø 17mm L 110mm rotation direction left for ice-cube maker		
For models:	BAA0040		



1

GEV No.	501408	Ref. No.	N23818
description	pump REBO type PV35 110W 220/240V 50Hz inlet ø 20mm outlet ø 26mm L 205mm for ice-cube maker capacitor 2µF with temperature protection		
For models:	BAA0051		



1

GEV No.	500970	Ref. No.	N23073
description	pump motor 55W 230V 50Hz REBO L 205mm type outlet ømm suitable for for ice maker		
For models:	BAA0022, BAA0023, BAA0024, BAA0025, BAA0026, BAA0027, BAA0028, BAA0029, BAA0030, BAA0031, BAC0007, BAC0008		

vacuum pumps

vacuum pumps





1

GEV No.	500990	Ref. No.	0431600
description	vacuum pump 16m³/h 230V 0.55kW 50Hz type KB 0016 E 3Z0		
For models:	FGZ0013		
spare parts for	500990		
	GEV No.	691537	Ref. No. 0939163
	oil separator filter flow rate 16m³/h ø 52mm L 120mm		



1

GEV No.	500987	Ref. No.	0430130
description	vacuum pump 4m³/h 230V 0.1kW 50Hz type PB 0004 B 000		
For models:	FGZ0005		
spare parts for	500987		
	GEV No.	500988	Ref. No. —
	level glass thread 1/2" plastic		



1

GEV No.	499006	Ref. No.	04313000
description	vacuum pump 8m³/h 220/240V 0.35kW 50/60Hz type PB0008		
For models:	FGZ0025		



1



GEV No.	499346	Ref. No.	0431300
description	vacuum pump 8m ³ /h 220-240V 0.55/0.66kW 50/60Hz type J21TV513		
For models:	FGZ0012		

1



GEV No.	524535	Ref. No.	929180
description	pump cover gasket thickness 4.5x4.5mm ID ø 182mm Qty 1 pcs		
For models:	GLB0043, GLB0044		

level glasses

1



GEV No.	691562	Ref. No.	0438005
description	level glass thread 3/4"		
For models:	FGZ0006, FGZ0007, FGZ0009, FGZ0013, FGZ0026, FGZ0027, FGZ0028		

accessories

pump covers

1



GEV No.	521563	Ref. No.	929191
description	pump cover		
For models:	GLB0043, GLB0044		

pump cover gaskets

1



GEV No.	513283	Ref. No.	437082
description	gasket		
For models:	GLB0035		

condensators & interference suppression filters

operating capacitors

plastic

1



GEV No.	365015	Ref. No.	0000000633 12024376 19410307 206002 V321300000
description	operating capacitor capacity 10µF 400V tolerance 5%Hz ambient temperature max. -25 to +85°C ø 35.5mm L 59mm M8 plastic connection male faston 6.3mm protection		
For models:	8922, FEB0033, FEB0034, FEB0035, GLB0043, GLB0044, GLB0061C-F, GLB0061C-FN, GLB0063C-F, GLB0063C-FN, OPT1012C, OPT1012-CF, OPT1012-CFN, PALLADIO300AM, PALLADIO300T, PALLADIO330T, PALLADIO350AM		

1





GEV No.	365014	Ref. No.	150064 F2028
description	operating capacitor capacity 12.5µF 450V tolerance 5%Hz ambient temperature max. -25 to +85°C ø 35mm L 70mm M8 plastic connection male faston 6.3mm 45S.C3DS.12.5 protection		
For models:	EFF0002-Q, FHZ0001, FIF0016-F, FIF0023		

1



GEV No.	365021	Ref. No.	206004 F2144
description	operating capacitor capacity 16µF 425V tolerance 5% 50/60Hz ambient temperature max. -25 to +85°C ø 35mm L 73mm single M8 plastic connection male faston 6.3mm 416.10.99 protection		
For models:	FHZ0003, FIF0001, FIF0004, FLC0001-F, FMC0001-F, FMD0001-F, FMD0002-F, GLB0061, GLB0061C, GLB0062, GLB0063, GLB0064, GLB0064C, GLB0065, GLB0066		

			
1			
GEV No.	365019	Ref. No.	206005 F2223 IV5820020
description	operating capacitor capacity 20µF 400V tolerance 5% 50/60Hz ambient temperature max. -25 to +85°C ø 39.5mm L 70mm M8 plastic connection male faston 6.3mm 16.10.25. protection		
For models:	FIF0002, FIF0005, FLA0004-F, FLA0028, GLB0070, GLB0071, GLB0072, GLB0073, TCG22E-F		

			
1			
GEV No.	365017	Ref. No.	206010
description	operating capacitor capacity 5µF 450V tolerance 5% 50/60Hz ambient temperature max. -25 to +85°C ø 28mm L 54mm M8 plastic connection male faston 6.3mm 16.10.08 protection		
For models:	GLB0035		

			
1			
GEV No.	365012	Ref. No.	00000000149 206009
description	operating capacitor capacity 6.3µF 450V tolerance 5% 50Hz ambient temperature max. -25 to +85°C ø 30mm L 61mm M8 plastic connection male faston 6.3mm protection		
For models:	8920, GLB0036, GLB0037, GLB0038, GLB0039, GLB0056, GLB0057		

			
1			
GEV No.	365093	Ref. No.	12024346
description	operating capacitor capacity 6µF 400V tolerance 5% 50/60Hz ambient temperature max. -25 to +85°C ø 31.5mm L 55mm M8 plastic connection male faston 6.3mm protection		
For models:	GLB0035-F, GLB0035-FN, GLB0037-F, GLB0037-FN		

			
1			
GEV No.	365013	Ref. No.	00000000182 150070 19410301 206001
description	operating capacitor capacity 8µF 400V tolerance 5%Hz ambient temperature max. -25 to +85°C ø 31.5mm L 55mm M8 plastic connection male faston 6.3mm protection		
For models:	8921, EEC0001, EED0010, FEB0031, GLB0058, GLB0059, GLB0060, MIRRA300		

filters

interference suppression filters

			
1			
GEV No.	365221	Ref. No.	661.120.00
description	interference suppression filter 250V 50/60Hz connection 5 male faston 6.3mm M8 plastic capacity 0,22µF(X2)+2x2mH+2X2,5nF(Y2)+1MOhmµF		

RC circuits

			
1			
GEV No.	365211	Ref. No.	N23457
description	interference suppression filter type XRY RC MKPX2 275V connection plug		
For models:	BAB0002, BAB0002-W		

fuses

fine fuses

			
1			
GEV No.	358530	Ref. No.	926284
description	fine fuse size ø5x20mm 0.8A fast-acting rated 250V Qty 10 pcs		
For models:	GLB0043, GLB0044, GLB0046, GLB0070, GLB0071, OPT1012		





			
1			
GEV No.	358675	Ref. No.	11950227000
description	fine fuse size ϕ 5x20mm 2.5A fast-acting rated 250V Qty 10 pcs		
For models:	AIB0014		

			
1			
GEV No.	358677	Ref. No.	228004 228010
description	fine fuse size ϕ 5x20mm 4A fast-acting rated 250V Qty 10 pcs		
For models:	GLB0043, GLB0044, GLB0070, GLB0071, GLB0073, OPT1012, OPT1012C		

			
1			
GEV No.	358074	Ref. No.	91310504
description	fine fuse size ϕ 5x20mm 5A fast-acting rated 250V Qty 10 pcs		
For models:	CAB0007-CD, CAB0008-CD, CAB0009-CD, CAB0013-CD, CAB0014-CD, CAB0015-CD, CAB0024-CD, CAB0025-CD, CAB0055-DCG, CAB0056-DCG, CAB0057-DCG, CAB0058-DCG, CAB0059-DCG, CAB0060-DCG, CAB0061-DCG, CAB0062-DCG		

			
1			
GEV No.	358760	Ref. No.	926283
description	fine fuse size ϕ 6.3x32mm 0.315A medium lag rated 250V Qty 10 pcs		
For models:	GLB0043, GLB0044, GLB0046, GLB0070, GLB0071, OPT1012		

various			
			
1			
GEV No.	358184	Ref. No.	A62304210BP
description	fine fuse size ϕ 6x30mm 10A slow-acting rated 250V Qty 1 pcs		
For models:	NE1643, NE1653, NE1843, NE1880		

fine fuse holders			
			
1			
GEV No.	550691	Ref. No.	ELET0058
description	fuse holder		
For models:	CAD0005, CAD0007, SY850VELED		

			
1			
GEV No.	550536	Ref. No.	12025158
description	fuse holder suitable fuse ϕ 10x38mm 30A rated 600V		
For models:	OPT1012-CF		

			
1			
GEV No.	550848	Ref. No.	ELET0440
description	fuse holder suitable fuse ϕ 5x20mm		
For models:	CAD0007, CAD0010, SY12100VGASD, SY1280VG, SY850VELED		

			
1			
GEV No.	550499	Ref. No.	H.228047
description	fuse holder suitable fuse ϕ 5x20mm 6.3A rated 500V		
For models:	GLB0043, GLB0044, GLB0070, GLB0071, GLB0073, OPT1012, OPT1012C		

			
1			
GEV No.	550105	Ref. No.	11950147000
description	rail-mounted terminal WIELAND type WK10/SIU 5X20 /V0 suitable fuse ϕ 5x20mm 1.0-16mm ² 10A rated 250V		
For models:	AIB0014, AIB0015		

			
1			
GEV No.	550519	Ref. No.	H.228048
description	cover plate suitable fuseA ratedV connection for fuse holder		
For models:	GLB0043, GLB0044, GLB0070, GLB0071, GLB0073, OPT1012, OPT1012C		

			
1			
GEV No.	551332	Ref. No.	91310511
description	fuse holder suitable fuse 5x20 10A rated 250V L 42mm W 16mm max. 10A		
For models:	CAB0007-CD, CAB0008-CD, CAB0009-CD, CAB0013-CD, CAB0014-CD, CAB0015-CD, CAB0019, CAB0020, CAB0024-CD, CAB0025-CD, CAB0055-DCG, CAB0056-DCG, CAB0057-DCG, CAB0058-DCG, CAB0059-DCG, CAB0060-DCG, CAB0061-DCG, CAB0062-DCG, GIOT-TOD, GIOTTOP		



line circuit breakers

miscellaneous



GEV No.	380927	Ref. No.	160429-02
description	power contactor nominal 6A 1-pole characteristic B		
For models:	EFB0014, EFB0019		



GEV No.	551116	Ref. No.	160565
description	low temperature appliance supply cable CEE7/7 - C13 3-pole contacts P+N+E 1.5mm ² max. 10A max 250V 1.4m H05VVf T70 2-pole + earthing insulation PVC		
For models:	EFB0001, EFB0002, EFB0003, EFB0004, EFB0008, EFB0008-C, EFB0009, EFB0009-C, EFB0017, EFB0018, EFC0003		

electric accessories

plugs - couplings - power sockets

appliance sockets/plugs

low temperature appliances 70°C



GEV No.	550704	Ref. No.	160570 IB5520000
description	low temperature appliance plug C14 male faston 6.3mm max 10A/250V T70 mounting distance 40mm hole ø 3.5mm thermoplastic		
For models:	BARMMASTER, EFB0001, EFB0002, EFB0003, EFB0004, EFB0008, EFB0008-C, EFB0009, EFB0009-C, EFB0017, EFB0018, EFC0003, ORIONEFIVE, SIRIO1VVCAFFE, SIRIO2VVCAFFE		



GEV No.	550726	Ref. No.	KODK008B
description	low temperature appliance supply cable CEE7/7 - C15 3-pole contacts P+N+E 1mm ² max. 10A max 250V 2.0m H05VVf T70 2-pole + earthing insulation PVC		
For models:	FGZ0014		



GEV No.	550962 ¹	Ref. No.	KODK008A
description	low temperature appliance plug C14 max 15A/250V T70 with cable		
For models:	FGZ0014		



GEV No.	550927	Ref. No.	19410530
description	low temperature appliance supply cable CEE7/7 3-pole 1mm ² 1.5m T70 with connector strip insulation PVC		
For models:	FEB0009-SNT, FEB0010-SNT, FEB0033, FEB0034, FEB0035, PALLADIO300AM, PALLADIO300T, PALLADIO330T, PALLADIO350AM		



GEV No.	550553	Ref. No.	IB5503010
description	medium temperature appliance supply cable CEE7/7 - C15 3-pole contacts P+N+E 1mm ² max. 10A max 250V 2.0m H05VVf T120 insulation PVC countries D/F/B/I black		
For models:	BARMMASTER, ORIONEFIVE, SIRIO1VVCAFFE, SIRIO2VVCAFFE		

cables

power supply cables



GEV No.	551085	Ref. No.	00000009171
description	cable CEE7/7 type E+F 3-pole contacts P+N+E 1.5mm ² max. 16A max 230V 2m with plug H05VV-F 3G1.5		
For models:	8920, 8921, 8922		





GEV No.	550767	Ref. No.	19410536
description	plug CEE 4-pole 3-pole+Nmm ² max. 16A max 415V 1.5m with cable		
For models:	PALLADIO300AM, PALLADIO300T, PALLADIO330T, PALLADIO350AM		

¹with cable





			
1			
GEV No.	551265	Ref. No.	B00FK100
description	supply cord CEE7/7 type E+F 3-pole contacts P+N+E 1.5mm ² max. 16A max 230V 2m H05VVf insulation PVC countries D/F/B/I black		
For models:	9925F, 9931F, 9931VF, 9932F, 9953F, BMA0013-F, BMA0034-F, BMA0038-F, BMA0098, BMA0099, BMB0002-F, BMB0002-FG, BMB0004-F, BMB0014-F, BMB0014-FG, BMB0015-F, BMB0042-F, BMB0046-F, BMC0001-F, BMC0001-FG, BMC0003-F, BNA0068, BNA0069, BNC0001BAR-F, BNC0001-F, BNC0002-F, BNC0007BAR-F, BNC0007-F, BNC0008-F, BNC0015BAR-F, BNC0015-F, BNC0016-F, BNC0030, BNC0030PI, BNC0032, BNC0033, BNC0034, BNC0034PI, BNC0035, CCZ0009-F, CCZ0018-F, CCZ0050, HAB0001-F, HAB0007-F, HAB0009-F, HAB0015-F, HAB0020, HAB0021, HCE2004-F, HCE2005-F... (Other models you can see in the webshop)		

<h3>spiral cables</h3>			
			
1			
GEV No.	550101	Ref. No.	003553280001
description	spiral cable plug type CEE7/7 type E+F 1.5mm ² 3-pole with plug L 500mm expansion 5:1 countries A/B/D/F/I orange t.max. 70°C		
For models:	IFD0002-M		

<h3>ribbon cables</h3>			
<h4>group 1</h4>			
			
1			
GEV No.	402970	Ref. No.	41523
description	ribbon cable 10-pole L 1200mm plug type 2 row coded Qty 1m		
For models:	GLB0043, GLB0044, GLB0046		

			
1			
GEV No.	403250	Ref. No.	80933
description	ribbon cable 10-pole L 3000mm plug type coded 2 row plug: number of poles 10		
For models:	GLB0073		

			
1			
GEV No.	400902	Ref. No.	80934
description	ribbon cable 10-pole L 750mm plug type FC-10P raster size 2.54mm		
For models:	GLB0071, OPT1012C		

<h3>terminals and connectors</h3>			
<h4>not insulated</h4>			
<h4>male fastons</h4>			
			
1			
GEV No.	699267	Ref. No.	0200090
description	male faston size 6.3mm with bore brass hole ø 4mmmm		
For models:	FGZ0005, FGZ0006, FGZ0007, FGZ0012, FGZ0013, FGZ0025, FGZ0026, FGZ0027		

<h3>terminals</h3>			
<h4>terminal blocks</h4>			
			
1			
GEV No.	550239	Ref. No.	Z743006000
description	lustre terminal 12-pole cross section 16mm ² max. 75A max 500V temp.-resist. 150°C		
For models:	OPT1012-CF		

			
1			
GEV No.	550232	Ref. No.	19410822
description	lustre terminal 12-pole cross section 2.5mm ² max. 32A max 450V temp.-resist. 150°C		
For models:	FEB0031, MIRRA300, SIRIO1VVCAFFE, SIRIO2VVCAFFE		

<h3>connection terminals with screw/faston connections</h3>			
			
1			
GEV No.	505212	Ref. No.	12024110
description	power terminal block 2-pole max. 20A max 600V connection ø2.5mm ² / F6.3 temp.-resist. 150°C cross section 4mm ²		
For models:	GLB0061C-F, GLB0063C-F		

			
1			
GEV No.	550278	Ref. No.	12024382
description	power terminal block 3-pole max. 40A max 400V connection ø6mm ² / F6.3 temp.-resist. 150°C cross section 6mm ²		
For models:	GLB0035-F, GLB0035-FN, GLB0037-F, GLB0037-FN		



1

GEV No.	550349	Ref. No.	220010
description	power terminal block 4-pole max. 40A max 400V connection ø6mm ² / F6.3 temp.-resist. 150°C cross section 6mm ²		
For models:	GLB0058, GLB0059, GLB0060		



1

GEV No.	550110	Ref. No.	PD.409B
description	power terminal block 5-pole max. 40A max 250V connection M6/ male faston 6.3mm temp.-resist. 130°C		
For models:	AHC0001, AHC0002, AHC0004, AHC0005, AMZ0037-N		



1

GEV No.	550411	Ref. No.	12025183 220011 R253044000 X59000
description	power terminal block 6-pole max. 40A max 450V connection ø6mm ² / F6.3 temp.-resist. 150°C cross section 6mm ²		
For models:	ACA1001, ACA1002, ACA101V, ACA102V, ACA2007, ACA207V, ACA216, ACA216V, ACC004V, ACE003V, ACE004V, ACE008V, ACH301V, ACH302V, ACH303V, ACH304V, ACH305V, ACH306V, ACH307V, ACH318V, ACH319V, ACH320V, ACJ005V, ACJ007V, ACJ008V, ACK2003, ACK2004, ACK203V, ACK204V, ACK301V, ACK302V, ACK303V, ACK304V, ACL0002, ACL002V, ADA101V, ADA103V, ADA205V, ADA208V, ADA210V, ADA212V, ADE003V, ADE004V, ADH301V, ADH302V, ADH303V, ADH304V, ADH305V, ADH306V, ADL001V...(Other models you can see in the webshop)		



1

GEV No.	550977 ¹	Ref. No.	160549
description	power terminal block 6-pole max. 40A max 450V connection ø6mm ² / F6.3 temp.-resist. 150°C cross section 6mm ² with ground lug		
For models:	EFB0014, EFB0019		

¹with ground lug

connection terminals with screw connection



1

GEV No.	550470	Ref. No.	X59200
description	power terminal block 3-pole max. 40A max 400V connection M6/M6 temp.-resist. 150°C cross section 6mm ²		
For models:	ACA2010, ACA204V, ACA206V, ACA208V, ACA210V, ACB0004, ACB002V, ACB004V, ACD001V, ACD002V, ADB002V, ADB003V, ADK207V, ADK208V, ADK209V, ADK210V		



1

GEV No.	551402	Ref. No.	463.026.00
description	power terminal block 3-pole max. 40A max 450V connection M5 temp.-resist. 150°C		



1

GEV No.	550507	Ref. No.	09950957300 66303600 X59100
description	power terminal block 4-pole max. 40A max 400V connection M6/M6 temp.-resist. 150°C		
For models:	65110CFGE, 6570CFE, 6570CFGE, 6570FRE, 6570PCE, 6570PVE, 70110CFGE, 7040PCEQ, 7040PVE, 7070BRE, 7070BREM, 7070CFEQ, 7070CFGE, 7070FRE10, 7070PCEQ, 7070PVE, 92CPE, 92FRE18, 92FRE18S, 92FTEL, 92FTELC, 92FTER, 92FTEFC, 92PCE, 92PCV, 94BRE, 94BREM, 94CFGE, 94CPE, 94CPES, 94FRE18, 94FRE18S, 94FTEL, 94FTELC, 94FTELR, 94FTELCR, 94FTEFC, 94FTEFCR, 94PCE, 94PCV, 94PE100I, 94PE100IA, 94PE100IAS, 94PE100IS, 94PE150I, 94PE150IA, 96BRE, 96BREM, 96CFGE, ACC0003...(Other models you can see in the webshop)		



1

GEV No.	550355	Ref. No.	5M100001 96300700
description	power terminal block 6-pole max. 40A max 400V connection M6/M6 temp.-resist. 150°C cross section 6mm ² hole distance 122mm		
For models:	5771P, 5772P, 5773P, 5774P, 5778P, 5779P, 5782P, 5783P, 94CFE, 94CFV, 96CFE, 96PCE, V16030PVED, V16060PVED		



connection terminals with strain relief

1 

GEV No.	550356	Ref. No.	MSC04N202A
description	power terminal block 2-pole max 450V max. 16A cable ø 15mm cross section 1.5mm ²		
For models:	FLA0014, FLA0015		

1 

GEV No.	550764	Ref. No.	MSC04N202
description	power terminal block 3-pole max 450V max. 16A cable ø 14.5mm cross section 1.5mm ² connection male faston 6.3mm mounting ø 28mm with strain relief		
For models:	FLA0014, FLA0015, FLA0016		

connection boxes

1 

GEV No.	550755 ¹	Ref. No.	09950047000
description	connecting cable 3-pole contacts P+N+E with strain relief black L 1600mm 2.5mm ²		
For models:	AIB0012, AIB0013, AIB0017, KF1001G, KF630, KF733		

¹with cable 1600mm

1 

GEV No.	550300	Ref. No.	459018
description	power terminal block 3-pole contacts P+N+E		
For models:	GLB0035, GLB0036, GLB0037, GLB0038, GLB0039, GLB0056, GLB0057		

1 

GEV No.	550671	Ref. No.	MOR30002
description	power terminal block 6-pole contacts 3P+N+E		
For models:	VP800U		

rail-mounted terminals

rail-mounted terminal blocks

1 

GEV No.	550407	Ref. No.	0000X53900
description	rail-mounted terminal block 5-pole cross section 16mm ² max 600V		
For models:	ACA1003, ACA1004, ACA1010, ACA103V, ACA104V, ACA105V, ACA106V, ACA110V, ACC0003, ACC003V, ACC005V, ACC008V, ACC010V, ACJ006V, ADA102V, ADA104V, ADA105V, ADA106V, ADC004V, ADC006V, ADK201V, ADK202V, ADK203V, ADK204V		

SIEMENS

feed-through terminals

1 

GEV No.	551431	Ref. No.	663.076.00
description	rail-mounted terminal SIEMENS 16mm ² blue H 46mm W 41mm L 10mm		

WEIDMÜLLER

accessories

1 

GEV No.	550789	Ref. No.	12024199
description	rail-mounted terminal grey for DIN rail 35mm		
For models:	OPT1012-CF		

WIELAND

rail-mounted terminals type 9700A

1 

GEV No.	550374	Ref. No.	12025191
description	rail-mounted terminal WIELAND type 9700A/10 S35 1.5-16mm ² top-hat rail 35mm blue W 10mm L 49mm		
For models:	OPT1012-CFN		



			
1			
GEV No.	550373	Ref. No.	12025214
description	rail-mounted terminal WIELAND type 9700A/10 S35 1.5-16mm ² top-hat rail 35mm grey W 10mm L 49mm		
For models:	OPT1012-CFN		

			
1			
GEV No.	550375	Ref. No.	12023727
description	rail-mounted terminal WIELAND type 9700A/10 SL2 S35 1.5-16mm ² top-hat rail 35mm yellow/green W 10mm L 53mm		
For models:	OPT1012-CFN		

			
1			
GEV No.	550381	Ref. No.	12023373
description	rail-mounted terminal WIELAND type 9700A/8 S35 1.0-10mm ² top-hat rail 35mm grey W 8mm L 46.6mm		
For models:	OPT1012-CF		

fuse terminal blocks			
			
1			
GEV No.	550105	Ref. No.	11950147000
description	rail-mounted terminal WIELAND type WK10/SIU 5X20 /V0 suitable fuse ø5x20mm 1.0-16mm ² 10A rated 250V		
For models:	AIB0014, AIB0015		

accessories			
			
1			
GEV No.	550370	Ref. No.	11950137000
description	terminal block end bracket clampsmm ²		
For models:	AIB0014, AIB0015		

accessories			
marking labels			
1	R	S	T
GEV No.	505000	Ref. No.	Z213005000
description	signboard R/S/T/N		
For models:	GLB0061C-F, GLB0063C-F		

holders			
			
1			
GEV No.	550766	Ref. No.	19410820
description	bracket for connector strip cross section 2.5mm ² 3-pole plastic L 51mm W 31mm		
For models:	FEB0031, MIRRA300		

various			
			
1			
GEV No.	550794	Ref. No.	MOR30001
description	terminal 1-pole cross section 6-16mm ² Qty 1 pcs		
For models:	VP800U, VP824RU, VP914RXS, VP920RXS		













gas taps			
PEL			
20S series			
			
1			
GEV No.	101094	Ref. No.	671.000.00
description	gas tap PEL type 20S gas inlet M16x1.5 (tube ø 10mm) bypass nozzle ø 0.35mm gas outlet M16x1.5 (tube ø 10/8mm) thermocouple connection M8x1 pilot connection shaft ø 8x6.5mm shaft L 22/15mm shaft flat lower		
For models:	65110CFG, 65110CFGE, 65110CFGG, 65110TPFG, 6540PCG, 6570CFG, 6570CFGE, 6570PCG, CEG110, CEG70		
spare parts for	101094		
	GEV No.	100408	Ref. No. —
	bypass nozzle type PEL20/21 bore ø 0.35mm thread M5x0.5		
	GEV No.	101060	Ref. No. GS.8036P
	magnet unit standard L 39mm D1 ø 15.4mm D2 ø 11mm suitable for PEL20-21/JUNKERS/EGA		
	GEV No.	101205	Ref. No. —
	gas tap front part shaft ø 8x6.5mm shaft L 22/15mm shaft flat upper/lower suitable for PEL20		

Table continues overleaf



spare parts for 101094				
	GEV No.	101230	Ref. No.	—
thermocouple nut T1: M8x1 T2: M18x1 aluminium				
accessories for 101094				
	GEV No.	101278	Ref. No.	673.001.00
olive for pipe ø 10mm Qty 1 pcs				
	GEV No.	101300	Ref. No.	—
union nut thread M16x1.5 tube ø 10mm				
	GEV No.	101450	Ref. No.	—
olive for pipe ø 8mm L 12.7mm Qty 1 pcs ED ø 10mm				
	GEV No.	101451	Ref. No.	—
union nut thread M16x1.5 tube ø 8mm				
	GEV No.	110081	Ref. No.	GS.3602
knob ø 70mm shaft ø 8x6.5mm shaft flat universal				
	GEV No.	110083	Ref. No.	—
knob dial plate gas tap without ignition flame silver				

				
1	GEV No.	101491	Ref. No.	X08000
description gas tap PEL type 20S gas inlet M16x1.5 (tube ø 10mm) bypass nozzle ø 0.35mm gas outlet M16x1.5 (tube ø 10/8mm) thermocouple connection M9x1 pilot connection shaft ø 8x6.5mm shaft L 22/15mm shaft flat lower				
For models: ACA2014, ACA214V				
spare parts for 101491				
	GEV No.	100408	Ref. No.	—
bypass nozzle type PEL20/21 bore ø 0.35mm thread M5x0.5				
	GEV No.	101060	Ref. No.	GS.8036P
magnet unit standard L 39mm D1 ø 15.4mm D2 ø 11mm suitable for PEL20-21/JUNKERS/EGA				
	GEV No.	101205	Ref. No.	—
gas tap front part shaft ø 8x6.5mm shaft L 22/15mm shaft flat upper/lower suitable for PEL20				
	GEV No.	101231	Ref. No.	—
thermocouple nut T1: M9x1 T2: M18x1				
accessories for 101491				
	GEV No.	101287	Ref. No.	—
olive for pipe ø 6mm Qty 1 pcs				
	GEV No.	101300	Ref. No.	—
union nut thread M16x1.5 tube ø 10mm				
	GEV No.	101450	Ref. No.	—
olive for pipe ø 8mm L 12.7mm Qty 1 pcs ED ø 10mm				
	GEV No.	101451	Ref. No.	—
union nut thread M16x1.5 tube ø 8mm				

accessories for 101491				
	GEV No.	110081	Ref. No.	GS.3602
knob ø 70mm shaft ø 8x6.5mm shaft flat universal				
	GEV No.	110083	Ref. No.	—
knob dial plate gas tap without ignition flame silver				

				
1	GEV No.	106840	Ref. No.	3780
description gas tap PEL type 20S gas inlet pipe flange ø21mm bypass nozzle ø 0mm gas outlet M16x1.5 (tube ø 10/8mm) thermocouple connection M8x1 pilot connection shaft ø 8x6.5mm shaft L 22/15mm shaft flat upper				
For models: 5305-CN, 5330, AJD0005-CCN, AJD0006-CCN, AJD0015-C, AJD0017-C, AJD0018-C				
spare parts for 106840				
	GEV No.	101060	Ref. No.	GS.8036P
magnet unit standard L 39mm D1 ø 15.4mm D2 ø 11mm suitable for PEL20-21/JUNKERS/EGA				
	GEV No.	101205	Ref. No.	—
gas tap front part shaft ø 8x6.5mm shaft L 22/15mm shaft flat upper/lower suitable for PEL20				
	GEV No.	101880	Ref. No.	—
gasket Viton ED ø 14mm ID ø 9mm thickness 7.7mm Qty 1 pcs				
	GEV No.	106202	Ref. No.	—
bypass nozzle type PEL20/21 bore ø 0mm thread M5x0.5				
accessories for 106840				
	GEV No.	101230	Ref. No.	—
thermocouple nut T1: M8x1 T2: M18x1 aluminium				
	GEV No.	101278	Ref. No.	673.001.00
olive for pipe ø 10mm Qty 1 pcs				
	GEV No.	101300	Ref. No.	—
union nut thread M16x1.5 tube ø 10mm				
	GEV No.	101450	Ref. No.	—
olive for pipe ø 8mm L 12.7mm Qty 1 pcs ED ø 10mm				
	GEV No.	101451	Ref. No.	—
union nut thread M16x1.5 tube ø 8mm				



21S series



1

GEV No.	101397	Ref. No.	671.001.00 GS.3875 X08100
description	gas tap PEL type 21S gas inlet M16x1.5 (tube ø 10mm) bypass nozzle ø 0.35mm gas outlet M16x1.5 (tube ø 10/8mm) thermocouple connection M9x1 pilot connection M10x1 shaft ø 8x6.5mm shaft L 22/15mm shaft flat lower		
For models:	110160PCG, 110170CFG, 6030FTG, 6060FTG, 6060FTRG, 6060FTRRG, 65110TPFG, 6540FTG, 6540FTRG, 6540GRG, 6540GRL, 6540PG40P, 6570FTG, 6570FTRG, 6570FTRRG, 6570GRG, 6570GRL, 6570TPFG, 6570TPG, 70110CFG, 70110CFGE, 70110PCG, 70110TPFG, 7040CPG, 7040FTG, 7040FTGS, 7040FTRG, 7040GRG, 7040GRL, 7040PCG, 7070CFG, 7070CFGE, 7070CPG, 7070FTG, 7070FTRG, 7070FTRRG, 7070GRG, 7070GRL, 7070PCG, 7070TPFG, 7070TPG, 92CPG, 92CPGS, 92PCG, 92PLG, 94CFG, 94CFGE, 94CPG, 94CPGS, 94PCG...(Other models you can see in the webshop)		
spare parts for	101397		
	GEV No.	100408	Ref. No. —
	bypass nozzle type PEL20/21 bore ø 0.35mm thread M5x0.5		
	GEV No.	101060	Ref. No. GS.8036P
	magnet unit standard L 39mm D1 ø 15.4mm D2 ø 11mm suitable for PEL20-21/JUNKERS/EGA		
	GEV No.	101206	Ref. No. —
	gas tap front part shaft ø 8x6.5mm shaft L 22/15mm shaft flat upper/lower suitable for PEL21		
	GEV No.	101231	Ref. No. —
	thermocouple nut T1: M9x1 T2: M18x1		
accessories for	101397		
	GEV No.	100908	Ref. No. 673.013.00 X13200
	union screw thread M10x1 for pipe ø 4mm Qty 1 pcs		
	GEV No.	100909	Ref. No. —
	union screw thread M10x1 for pipe ø 6mm Qty 1 pcs		
	GEV No.	101246	Ref. No. 673.004.00
	olive for pipe ø 4mm Qty 1 pcs		
	GEV No.	101278	Ref. No. 673.001.00
	olive for pipe ø 10mm Qty 1 pcs		
	GEV No.	101286	Ref. No. —
	olive ID ø 6mm Qty 1 pcs		
	GEV No.	101300	Ref. No. —
	union nut thread M16x1.5 tube ø 10mm		
	GEV No.	101450	Ref. No. —
	olive for pipe ø 8mm L 12.7mm Qty 1 pcs ED ø 10mm		
	GEV No.	101451	Ref. No. —
	union nut thread M16x1.5 tube ø 8mm		
	GEV No.	110081	Ref. No. GS.3602
	knob ø 70mm shaft ø 8x6.5mm shaft flat universal		

accessories for 101397



GEV No.	112206	Ref. No.	—
knob dial plate silver gas tap PEL21/22/23 t.max.°C ED ø 63mm ID ø 45.5mm			

22S/O series



1



















GEV No.	101086	Ref. No.	0000Y21400 67103100
description	gas tap PEL type 22S/O gas inlet M20x1.5 (tube ø 12mm) bypass nozzle ø 0.35mm gas outlet M20x1.5 (tube ø 12/10mm) thermocouple connection M9x1 pilot connection M10x1 shaft ø 10x8mm shaft L 25/17mm shaft flat lower		
For models:	7070PGI, ACE0001, ACE0002, ACE001V, ACE002V, ACL0001, ACL0003, ACL001V, ACL003V, ADE001V, ADE002V		
spare parts for	101086		
	GEV No.	100259	Ref. No. —
	bypass nozzle type PEL22 bore ø 0.35mm thread M6x0.5		
	GEV No.	101058	Ref. No. —
	magnet unit L 39mm D1 ø 15.4mm D2 ø 13.5mm suitable for PEL22/EGA24197 standard		
	GEV No.	101201	Ref. No. —
	gas tap front part shaft ø 10x8mm shaft L 25/17mm shaft flat upper/lower suitable for PEL22		
	GEV No.	101231	Ref. No. —
	thermocouple nut T1: M9x1 T2: M18x1		
	GEV No.	101240	Ref. No. —
	gas connection thread M20x1.5 tube ø 12/10mm for PEL gas taps with gasket and screws horizontal		
	GEV No.	101460	Ref. No. —
	O-ring ø 12.37mm D1 ø 2.62mm suitable for PEL22		
	GEV No.	101461	Ref. No. —
	screw kit suitable for PEL22 Qty 4 pcs		
accessories for	101086		
	GEV No.	100908	Ref. No. 673.013.00 X13200
	union screw thread M10x1 for pipe ø 4mm Qty 1 pcs		
	GEV No.	100909	Ref. No. —
	union screw thread M10x1 for pipe ø 6mm Qty 1 pcs		
	GEV No.	101241	Ref. No. —
	gas connection thread M20x1.5 tube ø 12/10mm for PEL gas taps vertical		
	GEV No.	101246	Ref. No. 673.004.00
	olive for pipe ø 4mm Qty 1 pcs		
	GEV No.	101248	Ref. No. —
	olive for pipe ø 12mm Qty 1 pcs suitable for PEL		
	GEV No.	101249	Ref. No. —
	olive for pipe ø 10mm Qty 1 pcs		

Table continues overleaf





accessories for		101086		
	GEV No.	101250	Ref. No.	—
	union nut thread M20x1.5 for pipe ø 10mm			
	GEV No.	101251	Ref. No.	—
	union nut thread M20x1.5 for pipe ø 12mm			
	GEV No.	101286	Ref. No.	—
	olive ID ø 6mm Qty 1 pcs			
	GEV No.	110080	Ref. No.	—
	knob ø 70mm shaft ø 10x8mm shaft flat universal			
	GEV No.	112206	Ref. No.	—
	knob dial plate silver gas tap PEL21/22/23 t.max.°C ED ø 63mm ID ø 45.5mm			

23S/O series



1

GEV No.	101092	Ref. No.	GS.3878	
description	gas tap PEL type 23S/O gas inlet M28x1.5 (tube ø 20mm) bypass nozzle ø 0.35mm gas outlet M24x1.5 (tube ø 16mm) thermocouple connection M10x1 pilot connection M10x1 shaft ø 10x8mm shaft L 25/17mm shaft flat upper			
For models:	NGPR6110			
spare parts for	101092			
	GEV No.	100455	Ref. No.	—
	bypass nozzle type PEL23/24 bore ø 0.35mm thread M8x0.5			
	GEV No.	101059	Ref. No.	—
	magnet unit T1: M10x1 T2: M22x1 L 46mm ø 18mm suitable for PEL23S M10x1			
	GEV No.	101204	Ref. No.	—
	gas tap front part shaft ø 10x8mm shaft L 25/17mm shaft flat upper/lower suitable for PEL23S			
	GEV No.	101244	Ref. No.	—
	gas connection thread M24x1.5 tube ø 12/16mm horizontal for PEL gas taps			
	GEV No.	101463	Ref. No.	—
	screw suitable for PEL23S Qty 4 pcs			
	GEV No.	528455	Ref. No.	—
	O-ring Viton thickness 2.62mm ID ø 18.72mm Qty 1 pcs			
accessories for	101092			
	GEV No.	100908	Ref. No.	673.013.00 X13200
	union screw thread M10x1 for pipe ø 4mm Qty 1 pcs			
	GEV No.	100909	Ref. No.	—
	union screw thread M10x1 for pipe ø 6mm Qty 1 pcs			
	GEV No.	101246	Ref. No.	673.004.00
	olive for pipe ø 4mm Qty 1 pcs			

accessories for		101092		
	GEV No.	101252	Ref. No.	—
	union nut thread M24x1.5 for pipe ø 12mm			
	GEV No.	101253	Ref. No.	67302800
	union nut thread M24x1.5 PEL for pipe ø 16mm			
	GEV No.	101254	Ref. No.	67303000
	union nut thread M28x1.5 tube ø 20mm			
	GEV No.	101255	Ref. No.	—
	olive for pipe ø 12mm Qty 1 pcs			
	GEV No.	101256	Ref. No.	67302700
	olive for pipe ø 16mm Qty 1 pcs			
	GEV No.	101257	Ref. No.	—
	olive for pipe ø 20mm Qty 1 pcs			
	GEV No.	101286	Ref. No.	—
	olive ID ø 6mm Qty 1 pcs			
	GEV No.	110080	Ref. No.	—
	knob ø 70mm shaft ø 10x8mm shaft flat universal			
	GEV No.	112206	Ref. No.	—
	knob dial plate silver gas tap PEL21/22/23 t.max.°C ED ø 63mm ID ø 45.5mm			

23S/V series



1













GEV No.	101093	Ref. No.	0000Y21300	
description	gas tap PEL type 23S/V gas inlet M28x1.5 (tube ø 20mm) bypass nozzle ø 0.35mm thermocouple connection M10x1 pilot connection M10x1 shaft ø 10x8mm shaft L 25/17mm shaft flat lower			
For models:	ADL014V, ADL015V			
spare parts for	101093			
	GEV No.	100455	Ref. No.	—
	bypass nozzle type PEL23/24 bore ø 0.35mm thread M8x0.5			
	GEV No.	101059	Ref. No.	—
	magnet unit T1: M10x1 T2: M22x1 L 46mm ø 18mm suitable for PEL23S M10x1			
	GEV No.	101204	Ref. No.	—
	gas tap front part shaft ø 10x8mm shaft L 25/17mm shaft flat upper/lower suitable for PEL23S			
	GEV No.	101245	Ref. No.	—
	gas connection thread M24x1.5 tube ø 12/16mm vertical for PEL gas taps			
	GEV No.	101463	Ref. No.	—
	screw suitable for PEL23S Qty 4 pcs			

Table continues overleaf

spare parts for 101093			
	GEV No.	528455	Ref. No. —
O-ring Viton thickness 2.62mm ID ø 18.72mm Qty 1 pcs			
accessories for 101093			
	GEV No.	100908	Ref. No. 673.013.00 X13200
union screw thread M10x1 for pipe ø 4mm Qty 1 pcs			
	GEV No.	100909	Ref. No. —
union screw thread M10x1 for pipe ø 6mm Qty 1 pcs			
	GEV No.	101246	Ref. No. 673.004.00
olive for pipe ø 4mm Qty 1 pcs			
	GEV No.	101252	Ref. No. —
union nut thread M24x1.5 for pipe ø 12mm			
	GEV No.	101253	Ref. No. 67302800
union nut thread M24x1.5 PEL for pipe ø 16mm			
	GEV No.	101254	Ref. No. 67303000
union nut thread M28x1.5 tube ø 20mm			
	GEV No.	101255	Ref. No. —
olive for pipe ø 12mm Qty 1 pcs			
	GEV No.	101256	Ref. No. 67302700
olive for pipe ø 16mm Qty 1 pcs			
	GEV No.	101257	Ref. No. —
olive for pipe ø 20mm Qty 1 pcs			
	GEV No.	101286	Ref. No. —
olive ID ø 6mm Qty 1 pcs			
	GEV No.	110080	Ref. No. —
knob ø 70mm shaft ø 10x8mm shaft flat universal			
	GEV No.	112206	Ref. No. —
knob dial plate silver gas tap PEL21/22/23 t.max.°C ED ø 63mm ID ø 45.5mm			







SABAF







			
1			
GEV No.	101747	Ref. No.	01991628700
description	gas tap SABAF type 10 gas inlet pipe flange ø14mm bypass nozzle ø 0.4mm gas outlet 1/4" (tube ø 8mm) front fixing M13x1 thermocouple connection M8x1 shaft ø 6x4.6mm shaft L 23.5/18.5mm shaft flat upper		
For models:	AAA2001, AAA2002		
spare parts for 101747			
	GEV No.	101376	Ref. No. —
gasket ID ø 8mm ED ø 12mm H 3/5mm			







spare parts for 101747			
	GEV No.	106724	Ref. No. —
magnet unit L 30mm D1 ø 12.5mm D2 ø 8.5mm suitable for SABAF			
accessories for 101747			
	GEV No.	101277	Ref. No. 673.005.00
olive ID ø 8mm Qty 1 pcs			
	GEV No.	101751	Ref. No. 01990279512 X07400
bracket			
	GEV No.	520656	Ref. No. —
union nut thread 1/4" tube ø 6/8mm			
	GEV No.	560082	Ref. No. —
hexagonal screw thread M4 thread L 16mm SS WS 7 Qty 20 pcs DIN 933 / ISO 4017			

			
1			
GEV No.	101748	Ref. No.	01991578700
description	gas tap SABAF type 10 gas inlet pipe flange ø14mm bypass nozzle ø 0.5mm gas outlet 1/4" (tube ø 8mm) front fixing M13x1 thermocouple connection M8x1 shaft ø 6x4.6mm shaft L 24/18mm shaft flat upper		
For models:	AAA2001, AAA2002		
spare parts for 101748			
	GEV No.	101376	Ref. No. —
gasket ID ø 8mm ED ø 12mm H 3/5mm			
	GEV No.	106724	Ref. No. —
magnet unit L 30mm D1 ø 12.5mm D2 ø 8.5mm suitable for SABAF			
accessories for 101748			
	GEV No.	101277	Ref. No. 673.005.00
olive ID ø 8mm Qty 1 pcs			
	GEV No.	101751	Ref. No. 01990279512 X07400
bracket			
	GEV No.	520656	Ref. No. —
union nut thread 1/4" tube ø 6/8mm			







			
1			
GEV No.	101749	Ref. No.	01991608700
description	gas tap SABAF type 10 gas inlet pipe flange ø14mm bypass nozzle ø 0.74mm gas outlet 1/4" (tube ø 8mm) front fixing thermocouple connection M8x1 shaft ø 6x4.6mm shaft L 23/17mm shaft flat upper		
For models:	AAA2001, AAA2002		
spare parts for	101749		
	GEV No.	101376	Ref. No. —
	gasket ID ø 8mm ED ø 12mm H 3/5mm		
	GEV No.	106724	Ref. No. —
	magnet unit L 30mm D1 ø 12.5mm D2 ø 8.5mm suitable for SABAF		
accessories for	101749		
	GEV No.	101277	Ref. No. 673.005.00
	olive ID ø 8mm Qty 1 pcs		
	GEV No.	101751	Ref. No. 01990279512 X07400
	bracket		
	GEV No.	520656	Ref. No. —
	union nut thread 1/4" tube ø 6/8mm		

			
1			
GEV No.	101994	Ref. No.	671.077.00
description	gas tap SABAF type 10 gas inlet pipe flange ø16mm bypass nozzle ø 0.65mm gas outlet 1/4" (tube ø 8mm) front fixing thermocouple connection plug-in connection shaft ø 8x6.5mm shaft L 26/12mm shaft flat lower		
For models:	6030PCG, 6060CFG, 6060CFGE, 6060PCG		
spare parts for	101994		
	GEV No.	101376	Ref. No. —
	gasket ID ø 8mm ED ø 12mm H 3/5mm		
	GEV No.	106725	Ref. No. —
	magnet unit L 35mm D1 ø 12.5mm D2 ø 8.5mm suitable for SABAF		
accessories for	101994		
	GEV No.	101277	Ref. No. 673.005.00
	olive ID ø 8mm Qty 1 pcs		
	GEV No.	101751	Ref. No. 01990279512 X07400
	bracket		
	GEV No.	520656	Ref. No. —
	union nut thread 1/4" tube ø 6/8mm		
	GEV No.	560082	Ref. No. —
	hexagonal screw thread M4 thread L 16mm SS WS 7 Qty 20 pcs DIN 933 / ISO 4017		

			
1			
GEV No.	106842	Ref. No.	C5816299
description	gas tap SABAF type 10 gas inlet pipe flange ø23mm bypass nozzle ø 0mm gas outlet 1/4" (tube ø 8mm) front fixing M13x1 thermocouple connection M8x1 shaft ø 8x6.5mm shaft L 32/12.5mm shaft flat right		
For models:	5305-CN		
spare parts for	106842		
	GEV No.	101051	Ref. No. —
	magnet unit L 27mm D1 ø 12.5mm D2 ø 8.5mm suitable for JUNKERS/EGA/MADEC/SABAF standard		
	GEV No.	101376	Ref. No. —
	gasket ID ø 8mm ED ø 12mm H 3/5mm		
accessories for	106842		
	GEV No.	101277	Ref. No. 673.005.00
	olive ID ø 8mm Qty 1 pcs		
	GEV No.	101751	Ref. No. 01990279512 X07400
	bracket		
	GEV No.	520656	Ref. No. —
	union nut thread 1/4" tube ø 6/8mm		

SIRAL

			
1			
GEV No.	101699	Ref. No.	062140
description	gas tap SIRAL gas inlet pipe flange ø16mm bypass nozzle ø 0.85mm gas outlet 1/4" (tube ø 8mm) front fixing thermocouple connection M8x1 shaft ø 8x6.5mm shaft L 23/12mm shaft flat upper		
For models:	AJE0005, AJE0006, AJE0007		
spare parts for	101699		
	GEV No.	101051	Ref. No. —
	magnet unit L 27mm D1 ø 12.5mm D2 ø 8.5mm suitable for JUNKERS/EGA/MADEC/SABAF standard		
accessories for	101699		
	GEV No.	101277	Ref. No. 673.005.00
	olive ID ø 8mm Qty 1 pcs		
	GEV No.	101351	Ref. No. —
	mounting strap for gas tap		
	GEV No.	520656	Ref. No. —
	union nut thread 1/4" tube ø 6/8mm		

gas thermostats

SIT

630 Eurosit series

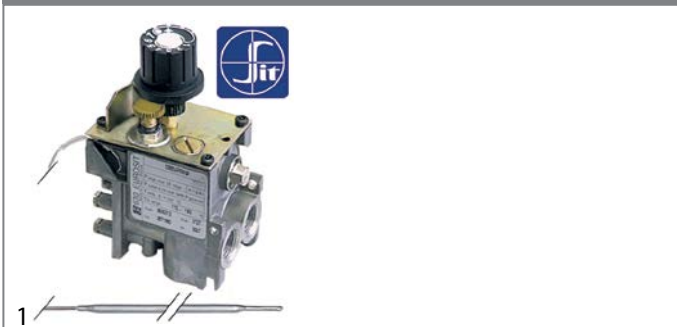

GEV No.	101413	Ref. No.	X16700
description	gas thermostat type 630 Eurosit series t.max. 100°C 30-100°C gas inlet 3/8" gas outlet 3/8" thermocouple connection M9x1 pilot connection M10x1 probe ø 5mm probe L 122mm capillary pipe 1050mm SIT		
For models:	ACB001V, ADB001V		
accessories for	101413		
	GEV No.	100904	Ref. No. —
locking screw M10x1 for pipe ø 4mm Qty 1 pcs			
	GEV No.	100905	Ref. No. SP385E
locking screw M10x1 for pipe ø 6mm Qty 1 pcs			
	GEV No.	101273	Ref. No. 673.006.00 67300800
olive for pipe ø 12mm L 9.5mm brass Qty 1 pcs suitable for universal			
	GEV No.	101276	Ref. No. —
union screw thread 3/8" tube ø 12mm Qty 1 pcs			
	GEV No.	101333	Ref. No. —
plug thread 3/8" with O-ring			

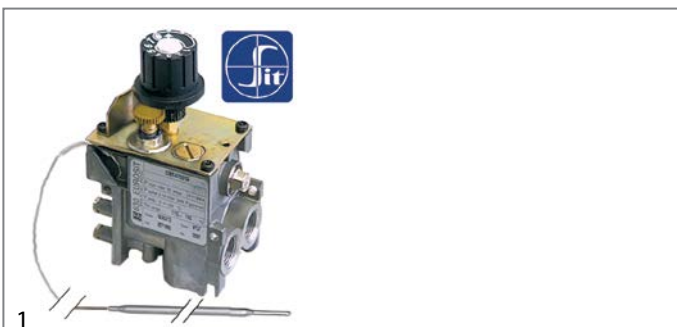

GEV No.	101188	Ref. No.	X12900
description	gas thermostat type 630 Eurosit series t.max. 190°C 110-190°C gas inlet 3/8" gas outlet 3/8" thermocouple connection M9x1 pilot connection M10x1 probe ø 4mm probe L 202mm capillary pipe 1050mm SIT		
For models:	ACC0001, ACC0002, ACC001V, ACC002V, ACC006V, ACC007V, ADC001V, ADC002V		
accessories for	101188		
	GEV No.	100904	Ref. No. —
locking screw M10x1 for pipe ø 4mm Qty 1 pcs			
	GEV No.	100905	Ref. No. SP385E
locking screw M10x1 for pipe ø 6mm Qty 1 pcs			

accessories for	101188			
	GEV No.	101273	Ref. No.	673.006.00 67300800
olive for pipe ø 12mm L 9.5mm brass Qty 1 pcs suitable for universal				
	GEV No.	101276	Ref. No.	—
union screw thread 3/8" tube ø 12mm Qty 1 pcs				
	GEV No.	101333	Ref. No.	—
plug thread 3/8" with O-ring				

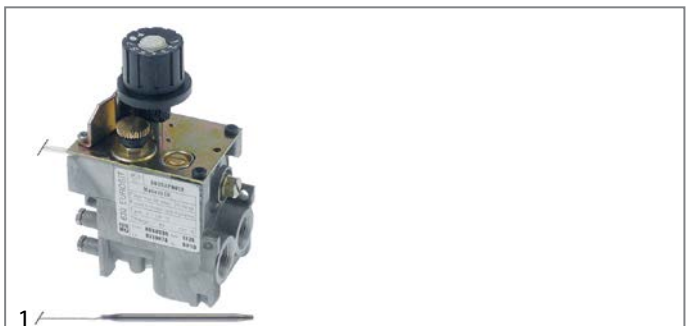

GEV No.	101915	Ref. No.	0000X13400
description	gas thermostat type 630 Eurosit series t.max. 320°C 80-320°C gas inlet 3/8" gas outlet 3/8" thermocouple connection M9x1 pilot connection M10x1 probe ø 4mm probe L 72mm capillary pipe 1050mm SIT		
For models:	ACA2012, ACA212V, ACH3016, ACH316V, ACK2001, ACK2002, ACK201V, ACK202V, ADA206V, ADA207V, ADA209V, ADA211V, ADA217V, ADH307V, ADH308V, ADH309V, ADH310V, ADH311V, ADH312V, AIE001V		
accessories for	101915		
	GEV No.	100825	Ref. No. —
gas tap spindle shaft ø 8x6.5mm shaft L 22/14mm suitable for EUROSIT			
	GEV No.	100904	Ref. No. —
locking screw M10x1 for pipe ø 4mm Qty 1 pcs			
	GEV No.	100905	Ref. No. SP385E
locking screw M10x1 for pipe ø 6mm Qty 1 pcs			
	GEV No.	100949	Ref. No. —
gasket suitable for 630 Eurosit series			
	GEV No.	101273	Ref. No. 673.006.00 67300800
olive for pipe ø 12mm L 9.5mm brass Qty 1 pcs suitable for universal			
	GEV No.	101276	Ref. No. —
union screw thread 3/8" tube ø 12mm Qty 1 pcs			
	GEV No.	101333	Ref. No. —
plug thread 3/8" with O-ring			
	GEV No.	101390	Ref. No. —
gas tap spindle shaft ø 6x4.6mm shaft L 32/15mm gas tap with ignition flame suitable for ZANUSSI, MARENO for gas thermostat EUROSIT			
	GEV No.	101392	Ref. No. —
adapter suitable for 630 Eurosit series			
	GEV No.	110357	Ref. No. —
gas tap spindle shaft ø 8x6.5mm shaft L 36/12mm suitable for 630 Eurosit series			

Table continues overleaf



accessories for 101915	
	GEV No. 110358 Ref. No. — adapter shaft ø 10x8mm shaft L 29/18mm suitable for 630 Eurosit series

710 Minisit series

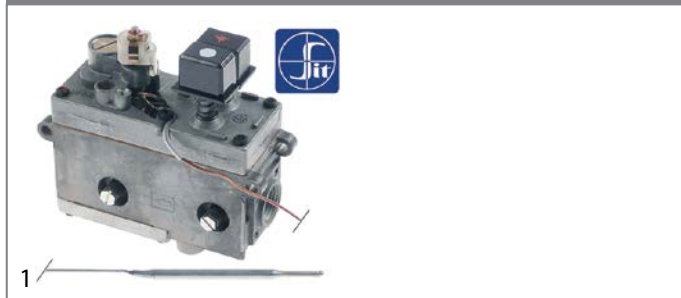



GEV No.	101135	Ref. No.	671.004.00 671.018.00 Y23000
----------------	--------	-----------------	------------------------------------

description gas thermostat SIT type MINISIT 710 t.max. 190°C 110-190°C gas inlet 1/2" gas outlet 3/8" thermocouple connection M9x1 pilot connection M10x1 probe ø 6mm probe L 102mm capillary pipe 1050mm probe type type A3 pressure controller no pressure regulator or bar gland nut

For models: 6030FRG, 6060FRG, 6540FRG, 6570FRG, 92FRG20, 92FRG20S, 94FRG20, 94FRG20S, ADC003V, ADC008V, ADC009V, ADC010V

spare parts for 101135

	GEV No. 101053 Ref. No. —
magnet unit T1: M9x1 T2: M24x1 L 45mm ø 17mm suitable for Minisit	

	GEV No. 102118 Ref. No. —
probe 110-190°C probe ø 6mm probe L 102mm capillary pipe 1050mm t.max. 190°C fryer probe type type A3 suitable for MINISIT 710	

accessories for 101135

	GEV No. 100809 Ref. No. —
O-ring EPDM thickness 2mm ID ø 21mm Qty 1 pcs	

	GEV No. 100820 Ref. No. —
gland duct ET M14x1.5 IT M10x0.75 probe ø max. 6.5mm WS 22	

	GEV No. 100904 Ref. No. —
locking screw M10x1 for pipe ø 4mm Qty 1 pcs	

	GEV No. 100905 Ref. No. SP.385E
locking screw M10x1 for pipe ø 6mm Qty 1 pcs	

	GEV No. 101054 Ref. No. —
magnet unit T1: M10x1 T2: M24x1 L 45mm ø 17mm suitable for Minisit	

	GEV No. 101136 Ref. No. —
piezoelectric igniter suitable for Minisit with cover cap ømm connection F6.3x0.8	

	GEV No. 101137 Ref. No. 671.005.00
cover cap without piezoelectric igniter	

	GEV No. 101267 Ref. No. —
reducer IT 3/8" ET 1/2" L 21mm	

	GEV No. 101268 Ref. No. —
gas connection thread 3/8" angled with O-ring MINISIT 710	

accessories for 101135	
	GEV No. 101269 Ref. No. —
gas connection thread 1/2" angled with O-ring MINISIT 710	
	GEV No. 101270 Ref. No. —
screw connection IT 3/8" ET 3/8" L 28mm	
	GEV No. 101272 Ref. No. —
screw connection IT 1/2" ET 3/8" L 57mm	
	GEV No. 101273 Ref. No. 673.006.00 67300800
olive for pipe ø 12mm L 9.5mm brass Qty 1 pcs suitable for universal	
	GEV No. 101274 Ref. No. —
olive for pipe ø 16mm Qty 1 pcs	
	GEV No. 101275 Ref. No. —
union screw thread 1/2" for pipe ø 16mm Qty 1 pcs	
	GEV No. 101276 Ref. No. —
union screw thread 3/8" tube ø 12mm Qty 1 pcs	
	GEV No. 110068 Ref. No. 671.006.00 Y23100
knob suitable for Minisit ø 37mm	

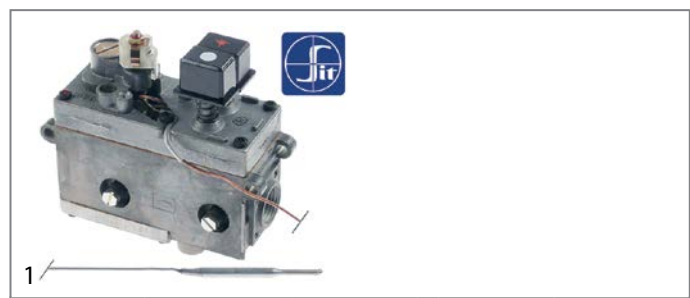



GEV No.	101132	Ref. No.	67102900 67103300
----------------	--------	-----------------	----------------------

description gas thermostat SIT type MINISIT 710 t.max. 340°C 100-340°C gas inlet 1/2" gas outlet 3/8" thermocouple connection M9x1 pilot connection M10x1 probe ø 5mm probe L 68mm capillary pipe 1050mm probe type type B1 pressure controller no pressure regulator or bar gland nut ignition gas no

For models: 7070BRG, 7070BRGM, 94BRG, 96BRG, 96BRGM

spare parts for 101132

	GEV No. 101053 Ref. No. —
magnet unit T1: M9x1 T2: M24x1 L 45mm ø 17mm suitable for Minisit	

	GEV No. 102102 Ref. No. —
probe 100-340°C probe ø 5mm probe L 68mm capillary pipe 1750mm t.max. 340°C oven/grill probe type type B1 suitable for MINISIT 710	

accessories for 101132

	GEV No. 100809 Ref. No. —
O-ring EPDM thickness 2mm ID ø 21mm Qty 1 pcs	

	GEV No. 100904 Ref. No. —
locking screw M10x1 for pipe ø 4mm Qty 1 pcs	









	GEV No. 100905 Ref. No. SP.385E
locking screw M10x1 for pipe ø 6mm Qty 1 pcs	

Table continues overleaf

accessories for		101132	
	GEV No.	101054	Ref. No. —
magnet unit T1: M10x1 T2: M24x1 L 45mm ø 17mm suitable for Minisit			
	GEV No.	101136	Ref. No. —
piezoelectric igniter suitable for Minisit with cover cap ømm connection F6.3x0.8			
	GEV No.	101137	Ref. No. 671.005.00
cover cap without piezoelectric igniter			
	GEV No.	101267	Ref. No. —
reducer IT 3/8" ET 1/2" L 21mm			
	GEV No.	101268	Ref. No. —
gas connection thread 3/8" angled with O-ring MINISIT 710			
	GEV No.	101269	Ref. No. —
gas connection thread 1/2" angled with O-ring MINISIT 710			
	GEV No.	101270	Ref. No. —
screw connection IT 3/8" ET 3/8" L 28mm			
	GEV No.	101272	Ref. No. —
screw connection IT 1/2" ET 3/8" L 57mm			
	GEV No.	101273	Ref. No. 673.006.00 67300800
olive for pipe ø 12mm L 9.5mm brass Qty 1 pcs suitable for universal			
	GEV No.	101274	Ref. No. —
olive for pipe ø 16mm Qty 1 pcs			
	GEV No.	101275	Ref. No. —
union screw thread 1/2" for pipe ø 16mm Qty 1 pcs			
	GEV No.	101276	Ref. No. —
union screw thread 3/8" tube ø 12mm Qty 1 pcs			
	GEV No.	110068	Ref. No. 671.006.00 Y23100
knob suitable for Minisit ø 37mm			

			
GEV No.	107352 ¹	Ref. No.	67102500
description	gas thermostat with threaded probe type MINISIT 710 t.max. 190°C 110-190°C gas inlet 1/2" gas outlet 3/8" thermocouple connection M9x1 pilot connection M10x1 probe ø 14.4mm probe L 26mm capillary pipe 1050mm probe type type F3 pressure controller no pressure regulator/mbar gland nut		
For models:	7040FRG13, 7070FRG13, AFC0001		
spare parts for	107352		
	GEV No.	107564	Ref. No. —
piezoelectric igniter body plastic blowing connection F6.3x0.8 ø 22mm			

¹probe thread 1/4"





PEL			
25ST series			
			
1	GEV No.	101172	Ref. No. 671.034.00
description	gas thermostat PEL type 25ST 100-300°C gas inlet M16x1.5 (tube ø 10mm) bypass nozzle ø 0.35mm gas outlet M16x1.5 (tube ø 10/8mm) thermocouple connection M9x1 pilot connection M10x1 capillary pipe 1200mm probe ø 6mm probe L 100mm shaft ø 8x6.5mm shaft L 21/15mm shaft flat upper		
For models:	110170CFG, 6540FTGCR, 6540FTRGCR, 6570FTGCR, 6570FTRGCR, 7040FTGCR, 7040FTRGCR, 7070FTGCR, 7070FTRGCR, AFA2003, AFA2004, AFA2006, AFH3005, AFH3006, AFH3007, AFH3008, AFH3019		
spare parts for	101172		
	GEV No.	100259	Ref. No. —
bypass nozzle type PEL22 bore ø 0.35mm thread M6x0.5			
	GEV No.	101060	Ref. No. GS.8036P
magnet unit standard L 39mm D1 ø 15.4mm D2 ø 11mm suitable for PEL20-21/JUNKERS/EGA			
	GEV No.	106200	Ref. No. —
nut thread M9x1 suitable for PEL 24/25S			
accessories for	101172		
	GEV No.	100908	Ref. No. 673.013.00 X13200
union screw thread M10x1 for pipe ø 4mm Qty 1 pcs			
	GEV No.	100909	Ref. No. —
union screw thread M10x1 for pipe ø 6mm Qty 1 pcs			
	GEV No.	101246	Ref. No. 673.004.00
olive for pipe ø 4mm Qty 1 pcs			
	GEV No.	101278	Ref. No. 673.001.00
olive for pipe ø 10mm Qty 1 pcs			
	GEV No.	101286	Ref. No. —
olive ID ø 6mm Qty 1 pcs			
	GEV No.	101300	Ref. No. —
union nut thread M16x1.5 tube ø 10mm			
	GEV No.	101450	Ref. No. —
olive for pipe ø 8mm L 12.7mm Qty 1 pcs ED ø 10mm			
	GEV No.	101451	Ref. No. —
union nut thread M16x1.5 tube ø 8mm			
	GEV No.	110079	Ref. No. —
knob dial plate gas thermostat 1-8 silver			
	GEV No.	110081	Ref. No. GS.3602
knob ø 70mm shaft ø 8x6.5mm shaft flat universal			



			
GEV No.	101441	Ref. No.	97100000
description	gas thermostat PEL type 25ST 30-90°C gas inlet M16x1.5 (tube ø 10mm) bypass nozzle ø 0.35mm gas outlet M16x1.5 (tube ø 10/8mm) thermocouple connection M9x1 pilot connection M10x1 capillary pipe 1200mm probe ø 6mm probe L 160mm shaft ø 8x6.5mm shaft L 21/15mm shaft flat upper		
For models:	92BMG, AFB0001, AFB0002		
spare parts for	101441		
	GEV No.	100259	Ref. No. —
	bypass nozzle type PEL22 bore ø 0.35mm thread M6x0.5		
	GEV No.	101060	Ref. No. GS.8036P
	magnet unit standard L 39mm D1 ø 15.4mm D2 ø 11mm suitable for PEL20-21/JUNKERS/EGA		
	GEV No.	106200	Ref. No. —
	nut thread M9x1 suitable for PEL 24/25S		
accessories for	101441		
	GEV No.	100908	Ref. No. 673.013.00 X13200
	union screw thread M10x1 for pipe ø 4mm Qty 1 pcs		
	GEV No.	100909	Ref. No. —
	union screw thread M10x1 for pipe ø 6mm Qty 1 pcs		
	GEV No.	101246	Ref. No. 673.004.00
	olive for pipe ø 4mm Qty 1 pcs		
	GEV No.	101278	Ref. No. 673.001.00
	olive for pipe ø 10mm Qty 1 pcs		
	GEV No.	101286	Ref. No. —
	olive ID ø 6mm Qty 1 pcs		
	GEV No.	101300	Ref. No. —
	union nut thread M16x1.5 tube ø 10mm		
	GEV No.	101450	Ref. No. —
	olive for pipe ø 8mm L 12.7mm Qty 1 pcs ED ø 10mm		
	GEV No.	101451	Ref. No. —
	union nut thread M16x1.5 tube ø 8mm		

SABAF

			
GEV No.	101692	Ref. No.	671.002.00
description	gas thermostat SABAF t.max. 300°C gas inlet M13x1 IT (tube ø 8mm) bypass nozzle ø 0.5mm gas outlet 3/8" ET (tube ø 10mm) gas outlet 2 thermocouple connection M8x1 pilot connection capillary pipe 850mm probe ø 4mm probe L 140mm shaft ø 8x6.5mm shaft L 34/14mm shaft flat upper		
For models:	65110CFG, 65110CFGG, 65110TPFG, 6570CFG, 6570TPFG, 70110CFG, 70110TPFG, 7070CFG, 7070TPFG		
spare parts for	101692		
	GEV No.	101060	Ref. No. GS.8036P
	magnet unit standard L 39mm D1 ø 15.4mm D2 ø 11mm suitable for PEL20-21/JUNKERS/EGA		
	GEV No.	106660	Ref. No. —
	bypass nozzle bore ø 0.85mm thread M4x0.5 SABAF		
accessories for	101692		
	GEV No.	101277	Ref. No. 673.005.00
	olive ID ø 8mm Qty 1 pcs		
	GEV No.	101278	Ref. No. 673.001.00
	olive for pipe ø 10mm Qty 1 pcs		
	GEV No.	101476	Ref. No. —
	union nut thread M13x1 for pipe ø 8mm		
	GEV No.	101478	Ref. No. —
	union nut thread 3/8" for pipe ø 10mm		

			
GEV No.	106310	Ref. No.	671.086.00
description	gas thermostat SABAF t.max. 300°C gas inlet pipe flange bypass nozzle ø 0.39mm gas outlet 3/8" (tube ø 8mm) thermocouple connection M8x1 capillary pipe 850mm probe ø 4mm probe L 140mm shaft ø 8x6.5mm edition since year of construction 09/2002		
For models:	6060CFG		
spare parts for	106310		
	GEV No.	101376	Ref. No. —
	gasket ID ø 8mm ED ø 12mm H 3/5mm		
accessories for	106310		
	GEV No.	101277	Ref. No. 673.005.00
	olive ID ø 8mm Qty 1 pcs		
	GEV No.	101477	Ref. No. 673.034.00
	union screw thread M13x1 tube ø 8mm Qty 1 pcs		



ROBERTSHAW



GEV No.	107562 ¹	Ref. No.	GS.2182
description	gas thermostat type GSE100301800 93-201°C 200-393°F gas inlet 1/4" CCT (tube ø 1/4") bypass nozzle ømm gas outlet 1/4" CCT (tube ø 1/4") thermocouple connection pilot connection capillary pipe 30" - 760mm probe ø 3/8" - 9.5mm probe L 5 3/8" - 135mm gland nut 1/4" NPT shaft ø 6.4x4.8mm shaft L 21/21mm shaft flat lower Invensys approval CE		
For models:	AMZ0001-NM		

¹with gland nut 1/4" NPT

gas valves and ignition boxes

gas control valves

ROBERTSHAW

gas controlled valves



GEV No.	580077	Ref. No.	GS.2181
description	gas valve supply Operator gas inlet 1/4" CCT outlet 1/4" CCT gas inlet 3/4" gas outlet 3/4" thermocouple connection 11/32" pilot connection 1/4" pressure regulatormbar type U7000BGOL pressure controller unregulated 0-70°C max 65mbar		
For models:	AMZ0001-NM		

SIT

NOVASIT



GEV No.	101162	Ref. No.	X11400
description	gas valve SIT series Novasit 820 230V 50Hz gas inlet 1/2" gas outlet 1/2" thermocouple connection M9x1 pilot connection M10x1 ignition pressure 3-5mbar pressure range 3-30mbar pressure regulator connection blind equiv. no. 0.820.010		
For models:	ADK207V, ADK208V, ADK209V, ADK210V		

spare parts for	101162		
------------------------	--------	--	--

	GEV No.	101065	Ref. No.	—
magnet unit with cable L 44mm D1 ø 30mm D2 ø 20mm suitable for NOVASIT				

	GEV No.	101313	Ref. No.	—
solenoid coil 230V 50Hz				

accessories for	101162			
------------------------	--------	--	--	--

	GEV No.	100006	Ref. No.	—
piezoelectric igniter suitable for ELETTROSIT body plastic blowing connection ø2.4mm ø 14mm				

	GEV No.	101305	Ref. No.	—
gas connection straight 1/2" flange 45x45mm ELETTROSIT/V4400/4600/4605 suitable for SIT/HONEYWELL hole distance 36x36mm				

	GEV No.	101306	Ref. No.	—
gas connection angled flange 45x45mm hole distance 36x36mm 1/2" ELETTROSIT/V4400/4600/4605 screw with O-ring suitable for SIT/HONEYWELL				

	GEV No.	101307	Ref. No.	—
gas connection straight flange 45x45mm hole distance 36x36mm 3/4" ELETTROSIT/V4400/4600/4605 screw with O-ring suitable for SIT/HONEYWELL				

	GEV No.	101308	Ref. No.	—
gas connection angled flange 45x45mm hole distance 36x36mm 3/4" ELETTROSIT/V4400/4600/4605 screw with O-ring suitable for SIT/HONEYWELL				

	GEV No.	101312	Ref. No.	X49000
microswitch				

	GEV No.	101314	Ref. No.	—
solenoid coil 24V 50Hz				



	GEV No.	101317	Ref. No.	—
plug with cable L 1000mm suitable for NOVASIT				









	GEV No.	101318	Ref. No.	—
cover cap for solenoid coil suitable for NOVASIT				

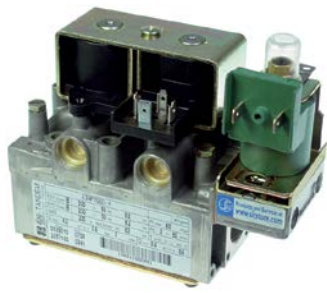

accessories			
			
1			
GEV No.	100905	Ref. No.	SP385E
description	locking screw M10x1 for pipe ø 6mm Qty 1 pcs		
For models:	AHA0001, AHA0002, AHA0003, AHB0001		

			
1			
GEV No.	101312	Ref. No.	X49000
description	microswitch		
For models:	ADK207V, ADK208V, ADK209V, ADK210V		

SIGMA			
			
1			
GEV No.	101989	Ref. No.	11950407000
description	gas valve 230V 50Hz gas inlet 3/4" gas outlet 3/4" SIT pressure range 2-50mbar equiv. no. 0.840.016		
For models:	KF1001G		
spare parts for	101989		
		GEV No.	106214 Ref. No. —
	solenoid coil 230V 50Hz Sigma		
accessories for	101989		
		GEV No.	107222 Ref. No. —
	plug for solenoid valve 3-pole cable length 1070mm		

TANDEM			
			
1			
GEV No.	101984	Ref. No.	GASI0007
description	gas valve 230V 50Hz gas inlet 1/2" gas outlet 1/2" pilot connection level slow ignition ignition times pressure range 2-50mbar power supply for modulator 230VAC rectified Tandem equiv. no. 0.836.010		
For models:	CAD0007, CAD0010, SY1280VG		
spare parts for	101984		
		GEV No.	101379 Ref. No. —
	solenoid coil 230V 50Hz suitable for Tandem		
accessories for	101984		
		GEV No.	101274 Ref. No. —
	olive for pipe ø 16mm Qty 1 pcs		
		GEV No.	101275 Ref. No. —
	union screw thread 1/2" for pipe ø 16mm Qty 1 pcs		
		GEV No.	101925 Ref. No. —
	plug with O-ring thread M10x1 for pilot burner suitable for NOVASIT		
		GEV No.	102845 Ref. No. —
	gas connection angled 1/2" flange 32x32mm hole distance 24x24mm Tandem		
		GEV No.	102846 Ref. No. —
	gas connection straight 1/2" flange 32x32mm hole distance 24x24mm suitable for Tandem		
		GEV No.	102847 Ref. No. —
	O-ring		







			
1			
GEV No.	101684	Ref. No.	91310340
description	gas valve 230V 50Hz gas inlet 1/2" gas outlet 1/2" pilot connection level slow ignition standard ignition time 3-7s pressure range 3-50mbar power supply for modulator type SIT equiv. no. 0.830.034		
For models:	CAA0003, CAA0004, CAA0005		
spare parts for	101684		
		GEV No.	101379 Ref. No. —
	solenoid coil 230V 50Hz suitable for Tandem		

Table continues overleaf

accessories for	101684		
	GEV No.	101274	Ref. No. —
	olive for pipe ø 16mm Qty 1 pcs		
	GEV No.	101275	Ref. No. —
	union screw thread 1/2" for pipe ø 16mm Qty 1 pcs		
	GEV No.	102845	Ref. No. —
	gas connection angled 1/2" flange 32x32mm hole distance 24x24mm Tandem		
	GEV No.	102846	Ref. No. —
	gas connection straight 1/2" flange 32x32mm hole distance 24x24mm suitable for Tandem		
	GEV No.	102847	Ref. No. —
	O-ring		

ignition boxes

BRAHMA



GEV No.	102338	Ref. No.	ELET0134
description	ignition box BRAHMA type SM11PMIX electrodes 2 waiting time 1.5s safety time 5s 230V 7VA 50-60Hz		
For models:	CAD0007, CAD0010, SY12100VGASD, SY1280VG		

SIT



GEV No.	101685	Ref. No.	91310280
description	ignition box SIT type 503EFD electrodes 2 waiting time 1.5s safety time 10s 220/240V 10VA 50-60Hz protection IP40		
For models:	CAA0003, CAA0004, CAA0005		



GEV No.	101990	Ref. No.	11950397000
description	ignition box SIT type 537ABC electrodes 3 waiting time 1.5s safety time 5s 230V 10VA 50-60Hz protection IP40		
For models:	KF1001G		

safety valves

SIT

400 series





GEV No.	101470	Ref. No.	Y21800
description	safety valve front fixing M12x1 pressure range 50mbar gas inlet 1/8" IT gas outlet 1/8" - M6x0.75 thermocouple connection M8x1 equiv. no. 0.400.088 suitable for SIT		
For models:	ADK209V, ADK210V		
spare parts for	101470		





	GEV No.	101052	Ref. No. —
	magnet unit L 43.5mm D1 ø 15.3mm D2 ø 10.5mm suitable for SIT M1		

accessories for	101470		
	GEV No.	101299	Ref. No. —
	nut thread M12x1		

	GEV No.	101499	Ref. No. —
	protection cap for safety valve thread M12x0.75 ID ø 18mm L 24mm aluminium		



440 series			
			
1			
GEV No.	101101	Ref. No.	GS.3713
description	gas valve pressure range 50mbar gas inlet 3/4" gas outlet 3/4" pilot connection M10x1 (tube ø 6mm) thermocouple connection M9x1 type SIT D3		
For models:	AHA0005-NN, AHA0008-NN, AHA0009, AHA0014-NN, AHA0021-NN, NGDR910		
accessories for	101101		
	GEV No.	100904	Ref. No. —
	locking screw M10x1 for pipe ø 4mm Qty 1 pcs		
	GEV No.	100905	Ref. No. SP.385E
	locking screw M10x1 for pipe ø 6mm Qty 1 pcs		

accessories for	106901		
	GEV No.	100905	Ref. No. SP.385E
	locking screw M10x1 for pipe ø 6mm Qty 1 pcs		
	GEV No.	102110	Ref. No. —
	pilot tube copper pipe ø 4mm thickness 1mm L 3000mm		
	GEV No.	102111	Ref. No. —
	pilot tube copper pipe ø 6mm thickness 1mm L 3000mm		
	GEV No.	102742	Ref. No. —
	pilot burner nozzle LPG code 25 bore ø 0.25mm Qty 1 pcs		

ignition parts

pilot burners

SIT			
100 series			
			
1			
GEV No.	106901	Ref. No.	672.080.00
description	pilot burner SIT type 100 series 1 flame nozzle ø 0.2mm gas connection 6mm		
For models:	110160PCG, 110170CFG, 6540PG40P, 70110CFG, 70110CFGE, 70110PCG, 70110TPFG, 7040PCG, 7070CFG, 7070CFGE, 7070PCG, AFA2001, AFA2002, AFA2003, AFA2004, AFA2008		
spare parts for	106901		
	GEV No.	100854	Ref. No. —
	pilot burner bracket double		
	GEV No.	100916	Ref. No. —
	compression spring for pilot burner Qty 1 pcs		
	GEV No.	100917	Ref. No. —
	gasket for pilot burner Qty 1 pcs aluminium		
	GEV No.	100918	Ref. No. —
	screw for pilot burner		
accessories for	106901		
	GEV No.	100904	Ref. No. —
	locking screw M10x1 for pipe ø 4mm Qty 1 pcs		



























			
1			
GEV No.	106904	Ref. No.	0000X19900
description	pilot burner SIT type 100 series 1 flame nozzle ø 0.2mm gas connection 6mm		
For models:	ACA2014, ACA2020, ACA214V, ACA220V, ADA206V, ADA207V, ADA209V, ADA211V, ADA213V		
spare parts for	106904		
	GEV No.	100245	Ref. No. GC.1001 SP.385F X19906
	pilot burner nozzle LPG code 20 bore ø 0.2mm Qty 1 pcs thread M8x0.75		
	GEV No.	100855	Ref. No. GS.8042P SP.385D
	pilot burner bracket triple		
	GEV No.	100885	Ref. No. 97203100 X19901
	air mixing sleeve for pilot burner Qty 1 pcs		
	GEV No.	100916	Ref. No. —
	compression spring for pilot burner Qty 1 pcs		
	GEV No.	100917	Ref. No. —
	gasket for pilot burner Qty 1 pcs aluminium		
	GEV No.	100918	Ref. No. —
	screw for pilot burner		
	GEV No.	107160	Ref. No. —
	pilot burner cap SIT 1 flame Hmm Lmm Qty 1 pcs		
	GEV No.	107166	Ref. No. 97203000
	pilot burner head SIT 1 flame Hmm Lmm Qty 1 pcs		
	GEV No.	107701	Ref. No. 672.094.00 97202900 GS.8040P SP.385B
	pilot burner bottom part SIT 100 series nozzle ø 0.2mm		

Table continues overleaf

accessories for		106904	
	GEV No.	100246	Ref. No.
			672.059.00 GS.3828 SP.385C X19907
	pilot burner nozzle natural gas bore ø 0.35mm Qty 1 pcs thread M8x0.75		
	GEV No.	100904	Ref. No.
			—
	locking screw M10x1 for pipe ø 4mm Qty 1 pcs		
	GEV No.	100905	Ref. No.
			SP.385E
	locking screw M10x1 for pipe ø 6mm Qty 1 pcs		
	GEV No.	102110	Ref. No.
			—
	pilot tube copper pipe ø 4mm thickness 1mm L 3000mm		
	GEV No.	102111	Ref. No.
			—
	pilot tube copper pipe ø 6mm thickness 1mm L 3000mm		
	GEV No.	107171	Ref. No.
			—
	pilot burner nozzle SIT natural/liquid gas bore ø 0.25mm Qty 1 pcs		
	GEV No.	107700	Ref. No.
			—
	pilot burner bottom part SIT 100 series nozzle ø 0.25mm		
	GEV No.	107702	Ref. No.
			—
	pilot burner bottom part SIT 100 series nozzle ø 0.35mm		

 <p>1</p>			
GEV No.	106902	Ref. No.	672.069.00
description	pilot burner SIT type 100 series 2 flames nozzle ø 0.2mm gas connection 6mm		
For models:	65110TPFG, 6570TPFG, 6570TPG, 70110TPFG, 7070TPFG, 7070TPG, AFA2005, AFA2006		
spare parts for	106902		
	GEV No.	100245	Ref. No.
			GC.1001 SP.385F X19906
	pilot burner nozzle LPG code 20 bore ø 0.2mm Qty 1 pcs thread M8x0.75		
	GEV No.	100842	Ref. No.
			—
	pilot burner cap 2 flames Qty 1 pcs		
	GEV No.	100885	Ref. No.
			97203100 X19901
	air mixing sleeve for pilot burner Qty 1 pcs		
	GEV No.	100916	Ref. No.
			—
	compression spring for pilot burner Qty 1 pcs		
	GEV No.	100917	Ref. No.
			—
	gasket for pilot burner Qty 1 pcs aluminium		
	GEV No.	100918	Ref. No.
			—
	screw for pilot burner		

spare parts for		106902	
	GEV No.	107161	Ref. No.
			GS.8041P SP.385A
	pilot burner cap SIT 2 flames Hmm Lmm Qty 1 pcs		
	GEV No.	107701	Ref. No.
			672.094.00 97202900 GS.8040P SP.385B
	pilot burner bottom part SIT 100 series nozzle ø 0.2mm		
accessories for		106902	
	GEV No.	100246	Ref. No.
			672.059.00 GS.3828 SP.385C X19907
	pilot burner nozzle natural gas bore ø 0.35mm Qty 1 pcs thread M8x0.75		
	GEV No.	100904	Ref. No.
			—
	locking screw M10x1 for pipe ø 4mm Qty 1 pcs		
	GEV No.	100905	Ref. No.
			SP.385E
	locking screw M10x1 for pipe ø 6mm Qty 1 pcs		
	GEV No.	102110	Ref. No.
			—
	pilot tube copper pipe ø 4mm thickness 1mm L 3000mm		
	GEV No.	102111	Ref. No.
			—
	pilot tube copper pipe ø 6mm thickness 1mm L 3000mm		
	GEV No.	107171	Ref. No.
			—
	pilot burner nozzle SIT natural/liquid gas bore ø 0.25mm Qty 1 pcs		
	GEV No.	107700	Ref. No.
			—
	pilot burner bottom part SIT 100 series nozzle ø 0.25mm		
	GEV No.	107702	Ref. No.
			—
	pilot burner bottom part SIT 100 series nozzle ø 0.35mm		

























 <p>1</p>			
GEV No.	106906	Ref. No.	GS.3851 X13500
description	pilot burner SIT type 100 series 3 flames nozzle ø 0.2mm gas connection 6mm		
For models:	ACA2013, ACA2020, ACA213V, ACA220V, ACB001V, ACE0001, ACE0002, ACE001V, ACE002V, ACH1003, ACH1004, ACH101V, ACH102V, ACH103V, ACH104V, ACJ0004, ACJ004V, ACK2001, ACK2002, ACK201V, ACK202V, ACL0001, ACL0003, ACL001V, ACL003V, ADA211V, ADA212V, ADB001V, ADE001V, ADE002V, ADH101V, ADH102V, ADL006V, ADL007V, ADL013V, AHA0001, AHA0002, AHA0003, AHA0005-NN, AHA0008-NN, AHA0009, AHA0011, AHA0013, AHA0014-NN, AHA0017, AHA0018, AHA0019, AHA0020, AHA0021-NN, AHB0001...(Other models you can see in the webshop)		
spare parts for	106906		
	GEV No.	100245	Ref. No.
			GC.1001 SP.385F X19906
	pilot burner nozzle LPG code 20 bore ø 0.2mm Qty 1 pcs thread M8x0.75		

Table continues overleaf



spare parts for 106906				
	GEV No.	100855	Ref. No.	GS.8042P SP.385D
pilot burner bracket triple				
	GEV No.	100885	Ref. No.	97203100 X19901
air mixing sleeve for pilot burner Qty 1 pcs				
	GEV No.	100916	Ref. No.	—
compression spring for pilot burner Qty 1 pcs				
	GEV No.	100917	Ref. No.	—
gasket for pilot burner Qty 1 pcs aluminium				
	GEV No.	100918	Ref. No.	—
screw for pilot burner				
	GEV No.	107162	Ref. No.	—
pilot burner cap SIT 3 flames Hmm Lmm Qty 1 pcs				
	GEV No.	107701	Ref. No.	672.094.00 97202900 GS.8040P SP.385B
pilot burner bottom part SIT 100 series nozzle ø 0.2mm				
accessories for 106906				
	GEV No.	100245	Ref. No.	GC.1001 SP.385F X19906
pilot burner nozzle LPG code 20 bore ø 0.2mm Qty 1 pcs thread M8x0.75				
	GEV No.	100246	Ref. No.	672.059.00 GS.3828 SP.385C X19907
pilot burner nozzle natural gas bore ø 0.35mm Qty 1 pcs thread M8x0.75				
	GEV No.	100904	Ref. No.	—
locking screw M10x1 for pipe ø 4mm Qty 1 pcs				
	GEV No.	100905	Ref. No.	SP.385E
locking screw M10x1 for pipe ø 6mm Qty 1 pcs				
	GEV No.	102110	Ref. No.	—
pilot tube copper pipe ø 4mm thickness 1mm L 3000mm				
	GEV No.	102111	Ref. No.	—
pilot tube copper pipe ø 6mm thickness 1mm L 3000mm				
	GEV No.	107171	Ref. No.	—
pilot burner nozzle SIT natural/liquid gas bore ø 0.25mm Qty 1 pcs				
	GEV No.	107700	Ref. No.	—
pilot burner bottom part SIT 100 series nozzle ø 0.25mm				
	GEV No.	107702	Ref. No.	—
pilot burner bottom part SIT 100 series nozzle ø 0.35mm				

				
1				
GEV No.	103344	Ref. No.	672.184.00	
description	pilot burner SIT type 100 series 3 flames nozzle ø 0.35mm gas connection 4mm			
spare parts for 103344				
	GEV No.	100246	Ref. No.	672.059.00 GS.3828 SP.385C X19907
pilot burner nozzle natural gas bore ø 0.35mm Qty 1 pcs thread M8x0.75				
	GEV No.	100855	Ref. No.	GS.8042P SP.385D
pilot burner bracket triple				
	GEV No.	100883	Ref. No.	—
pilot burner bottom part PRO-GAS 100 series nozzle ø 0.35mm				
	GEV No.	100885	Ref. No.	97203100 X19901
air mixing sleeve for pilot burner Qty 1 pcs				
	GEV No.	100904	Ref. No.	—
locking screw M10x1 for pipe ø 4mm Qty 1 pcs				
	GEV No.	102664	Ref. No.	—
pilot burner cap 3 flames suitable for 100 series H 29mm L 40mm				



















				
1				
GEV No.	106907	Ref. No.	672.057.00	
description	pilot burner SIT type 100 series 3 flames nozzle ø 0.35mm gas connection 6mm			
For models:	65110TPFG, 6570TPFG, 6570TPG, 70110TPFG, 7070TPFG, 7070TPG, 92FTGL, 92FTGLC, 92FTGR, 92FTGRC, 94FTGL, 94FTGLC, 94FTGLR, 94FTGLRC, 94FTGR, 94FTGRC, AFA2005, AFA2006			
spare parts for 106907				
	GEV No.	100246	Ref. No.	672.059.00 GS.3828 SP.385C X19907
pilot burner nozzle natural gas bore ø 0.35mm Qty 1 pcs thread M8x0.75				
	GEV No.	100855	Ref. No.	GS.8042P SP.385D
pilot burner bracket triple				
	GEV No.	100885	Ref. No.	97203100 X19901
air mixing sleeve for pilot burner Qty 1 pcs				
	GEV No.	100916	Ref. No.	—
compression spring for pilot burner Qty 1 pcs				

Table continues overleaf

spare parts for		106907	
	GEV No.	100917	Ref. No. —
gasket for pilot burner Qty 1 pcs aluminium			
	GEV No.	100918	Ref. No. —
screw for pilot burner			
	GEV No.	107162	Ref. No. —
pilot burner cap SIT 3 flames Hmm Lmm Qty 1 pcs			
	GEV No.	107702	Ref. No. —
pilot burner bottom part SIT 100 series nozzle ø 0.35mm			
accessories for		106907	
	GEV No.	100245	Ref. No. GC.1001 SP.385F X19906
pilot burner nozzle LPG code 20 bore ø 0.2mm Qty 1 pcs thread M8x0.75			
	GEV No.	100904	Ref. No. —
locking screw M10x1 for pipe ø 4mm Qty 1 pcs			
	GEV No.	100905	Ref. No. SP.385E
locking screw M10x1 for pipe ø 6mm Qty 1 pcs			
	GEV No.	102110	Ref. No. —
pilot tube copper pipe ø 4mm thickness 1mm L 3000mm			
	GEV No.	102111	Ref. No. —
pilot tube copper pipe ø 6mm thickness 1mm L 3000mm			
	GEV No.	107171	Ref. No. —
pilot burner nozzle SIT natural/liquid gas bore ø 0.25mm Qty 1 pcs			
	GEV No.	107700	Ref. No. —
pilot burner bottom part SIT 100 series nozzle ø 0.25mm			
	GEV No.	107701	Ref. No. 672.094.00 97202900 GS.8040P SP.385B
pilot burner bottom part SIT 100 series nozzle ø 0.2mm			

	1		
GEV No.	107881	Ref. No.	672.172.00
description	pilot burner SIT type 100 series 3 flames nozzle ø 0.35mm gas connection 6mm with igniter		











accessories			
pilot burner caps			
	1		
GEV No.	107790	Ref. No.	97300200 97300300
description	pilot burner cap 1 flame suitable for SIT H 60mm Qty 1 pcs		
For models:	92PCG, 94CFG, 94CFGE, 94PCG, 96CFG, 96CFGE, 96PCG, 96TPFG, 98PCG		





	1		
GEV No.	100835	Ref. No.	PD.2264
description	pilot burner cap 3 flames suitable for 100 series H 35mm L 48mm Qty 1 pcs W 52mm		
For models:	NGDR910		

	1		
GEV No.	107161	Ref. No.	GS.8041P SP.385A
description	pilot burner cap SIT 2 flames Hmm Lmm Qty 1 pcs		
For models:	AHA0001, AHA0002, AHA0003, AHA0011, AHB0001		

	1		
GEV No.	107166	Ref. No.	97203000
description	pilot burner head SIT 1 flame Hmm Lmm Qty 1 pcs		
For models:	92PCG, 94CFG, 94CFGE, 94PCG, 96CFG, 96CFGE, 96PCG, 96TPFG, 98PCG		



pilot burner bottom parts														
 <p>1</p>														
GEV No.	107701	Ref. No.	672.094.00 97202900 GS.8040P SP.385B											
description	pilot burner bottom part SIT 100 series nozzle \varnothing 0.2mm													
For models:	110160PCG, 110170CFG, 6540PG40P, 92PCG, 94CFG, 94CFGE, 94PCG, 96CFG, 96CFGE, 96PCG, 96TPFG, 98PCG, AFA2001, AFA2002, AFA2003, AFA2004, AFA2008, AHA0001, AHA0002, AHA0003, AHA0011, AHB0001													
spare parts for	107701													
 <table border="1"> <tr> <td>GEV No.</td> <td>100245</td> <td>Ref. No.</td> <td colspan="2">GC.1001 SP.385F X19906</td> </tr> <tr> <td>description</td> <td colspan="4">pilot burner nozzle LPG code 20 bore \varnothing 0.2mm Qty 1 pcs thread M8x0.75</td> </tr> </table>					GEV No.	100245	Ref. No.	GC.1001 SP.385F X19906		description	pilot burner nozzle LPG code 20 bore \varnothing 0.2mm Qty 1 pcs thread M8x0.75			
GEV No.	100245	Ref. No.	GC.1001 SP.385F X19906											
description	pilot burner nozzle LPG code 20 bore \varnothing 0.2mm Qty 1 pcs thread M8x0.75													
 <table border="1"> <tr> <td>GEV No.</td> <td>100916</td> <td>Ref. No.</td> <td colspan="2">—</td> </tr> <tr> <td>description</td> <td colspan="4">compression spring for pilot burner Qty 1 pcs</td> </tr> </table>					GEV No.	100916	Ref. No.	—		description	compression spring for pilot burner Qty 1 pcs			
GEV No.	100916	Ref. No.	—											
description	compression spring for pilot burner Qty 1 pcs													
 <table border="1"> <tr> <td>GEV No.</td> <td>100917</td> <td>Ref. No.</td> <td colspan="2">—</td> </tr> <tr> <td>description</td> <td colspan="4">gasket for pilot burner Qty 1 pcs aluminium</td> </tr> </table>					GEV No.	100917	Ref. No.	—		description	gasket for pilot burner Qty 1 pcs aluminium			
GEV No.	100917	Ref. No.	—											
description	gasket for pilot burner Qty 1 pcs aluminium													
 <table border="1"> <tr> <td>GEV No.</td> <td>100918</td> <td>Ref. No.</td> <td colspan="2">—</td> </tr> <tr> <td>description</td> <td colspan="4">screw for pilot burner</td> </tr> </table>					GEV No.	100918	Ref. No.	—		description	screw for pilot burner			
GEV No.	100918	Ref. No.	—											
description	screw for pilot burner													
accessories for	107701													
 <table border="1"> <tr> <td>GEV No.</td> <td>100246</td> <td>Ref. No.</td> <td colspan="2">672.059.00 GS.3828 SP.385C X19907</td> </tr> <tr> <td>description</td> <td colspan="4">pilot burner nozzle natural gas bore \varnothing 0.35mm Qty 1 pcs thread M8x0.75</td> </tr> </table>					GEV No.	100246	Ref. No.	672.059.00 GS.3828 SP.385C X19907		description	pilot burner nozzle natural gas bore \varnothing 0.35mm Qty 1 pcs thread M8x0.75			
GEV No.	100246	Ref. No.	672.059.00 GS.3828 SP.385C X19907											
description	pilot burner nozzle natural gas bore \varnothing 0.35mm Qty 1 pcs thread M8x0.75													
 <table border="1"> <tr> <td>GEV No.</td> <td>100904</td> <td>Ref. No.</td> <td colspan="2">—</td> </tr> <tr> <td>description</td> <td colspan="4">locking screw M10x1 for pipe \varnothing 4mm Qty 1 pcs</td> </tr> </table>					GEV No.	100904	Ref. No.	—		description	locking screw M10x1 for pipe \varnothing 4mm Qty 1 pcs			
GEV No.	100904	Ref. No.	—											
description	locking screw M10x1 for pipe \varnothing 4mm Qty 1 pcs													
 <table border="1"> <tr> <td>GEV No.</td> <td>100905</td> <td>Ref. No.</td> <td colspan="2">SP.385E</td> </tr> <tr> <td>description</td> <td colspan="4">locking screw M10x1 for pipe \varnothing 6mm Qty 1 pcs</td> </tr> </table>					GEV No.	100905	Ref. No.	SP.385E		description	locking screw M10x1 for pipe \varnothing 6mm Qty 1 pcs			
GEV No.	100905	Ref. No.	SP.385E											
description	locking screw M10x1 for pipe \varnothing 6mm Qty 1 pcs													
 <table border="1"> <tr> <td>GEV No.</td> <td>102110</td> <td>Ref. No.</td> <td colspan="2">—</td> </tr> <tr> <td>description</td> <td colspan="4">pilot tube copper pipe \varnothing 4mm thickness 1mm L 3000mm</td> </tr> </table>					GEV No.	102110	Ref. No.	—		description	pilot tube copper pipe \varnothing 4mm thickness 1mm L 3000mm			
GEV No.	102110	Ref. No.	—											
description	pilot tube copper pipe \varnothing 4mm thickness 1mm L 3000mm													
 <table border="1"> <tr> <td>GEV No.</td> <td>102111</td> <td>Ref. No.</td> <td colspan="2">—</td> </tr> <tr> <td>description</td> <td colspan="4">pilot tube copper pipe \varnothing 6mm thickness 1mm L 3000mm</td> </tr> </table>					GEV No.	102111	Ref. No.	—		description	pilot tube copper pipe \varnothing 6mm thickness 1mm L 3000mm			
GEV No.	102111	Ref. No.	—											
description	pilot tube copper pipe \varnothing 6mm thickness 1mm L 3000mm													
 <table border="1"> <tr> <td>GEV No.</td> <td>102742</td> <td>Ref. No.</td> <td colspan="2">—</td> </tr> <tr> <td>description</td> <td colspan="4">pilot burner nozzle LPG code 25 bore \varnothing 0.25mm Qty 1 pcs</td> </tr> </table>					GEV No.	102742	Ref. No.	—		description	pilot burner nozzle LPG code 25 bore \varnothing 0.25mm Qty 1 pcs			
GEV No.	102742	Ref. No.	—											
description	pilot burner nozzle LPG code 25 bore \varnothing 0.25mm Qty 1 pcs													

pilot burner brackets														
universal														
 <p>1</p>														
GEV No.	100855	Ref. No.	GS.8042P SP.385D											
description	pilot burner bracket triple													
For models:	AHA0001, AHA0002, AHA0003, AHA0011, AHB0001													
accessories for	100855													
 <table border="1"> <tr> <td>GEV No.</td> <td>100855</td> <td>Ref. No.</td> <td colspan="2">GS.8042P SP.385D</td> </tr> <tr> <td>description</td> <td colspan="4">pilot burner bracket triple</td> </tr> </table>					GEV No.	100855	Ref. No.	GS.8042P SP.385D		description	pilot burner bracket triple			
GEV No.	100855	Ref. No.	GS.8042P SP.385D											
description	pilot burner bracket triple													
 <table border="1"> <tr> <td>GEV No.</td> <td>100886</td> <td>Ref. No.</td> <td colspan="2">—</td> </tr> <tr> <td>description</td> <td colspan="4">pilot burner bracket suitable for 100 series 3-piece</td> </tr> </table>					GEV No.	100886	Ref. No.	—		description	pilot burner bracket suitable for 100 series 3-piece			
GEV No.	100886	Ref. No.	—											
description	pilot burner bracket suitable for 100 series 3-piece													
 <table border="1"> <tr> <td>GEV No.</td> <td>100888</td> <td>Ref. No.</td> <td colspan="2">—</td> </tr> <tr> <td>description</td> <td colspan="4">screw bolt for pilot burner</td> </tr> </table>					GEV No.	100888	Ref. No.	—		description	screw bolt for pilot burner			
GEV No.	100888	Ref. No.	—											
description	screw bolt for pilot burner													

pilot burner nozzles				
 <p>1</p>				
GEV No.	100245	Ref. No.	GC.1001 SP.385F X19906	
description	pilot burner nozzle LPG code 20 bore \varnothing 0.2mm Qty 1 pcs thread M8x0.75			
For models:	ACA2013, ACA2014, ACA2020, ACA213V, ACA214V, ACA220V, ACB001V, ACC0001, ACC0002, ACC001V, ACC002V, ACC006V, ACC007V, ACE0001, ACE0002, ACE001V, ACE002V, ACH1003, ACH1004, ACH101V, ACH102V, ACH103V, ACH104V, ACJ0004, ACJ004V, ACK2001, ACK2002, ACK201V, ACK202V, ACL0001, ACL0003, ACL001V, ACL003V, ADA206V, ADA207V, ADA209V, ADA211V, ADA212V, ADA213V, ADB001V, ADC001V, ADC002V, ADE001V, ADE002V, ADH101V, ADH102V, ADL006V, ADL007V, ADL013V, AHA0001...(Other models you can see in the webshop)			

 <p>1</p>				
GEV No.	100246	Ref. No.	672.059.00 GS.3828 SP.385C X19907	
description	pilot burner nozzle natural gas bore \varnothing 0.35mm Qty 1 pcs thread M8x0.75			
For models:	65110TPFG, 6570TPFG, 6570TPG, 70110CFG, 70110CFGE, 70110PCG, 70110TPFG, 7040PCG, 7070CFG, 7070CFGE, 7070PCG, 92PCG, 94CFG, 94CFGE, 94PCG, 96CFG, 96CFGE, 96PCG, 96TPFG, 98PCG, ACA2013, ACA2014, ACA2020, ACA213V, ACA214V, ACA220V, ACB001V, ACC0001, ACC0002, ACC001V, ACC002V, ACC006V, ACC007V, ACE0001, ACE0002, ACE001V, ACE002V, ACH1003, ACH1004, ACH101V, ACH102V, ACH103V, ACH104V, ACJ0004, ACJ004V, ACK2001, ACK2002, ACK201V, ACK202V, ACL0001...(Other models you can see in the webshop)			



ignition electrodes

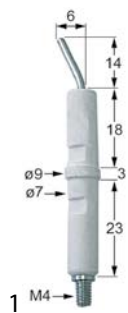

GEV No.	100706	Ref. No.	672.060.00 GS.3856 X14600
description	ignition electrode connection M4 Qty 1 pcs		
For models:	65110TPFG, 6570TPFG, 6570TPG, 70110TPFG, 7070TPFG, 7070TPG, 92FTGL, 92FTGLC, 92FTGR, 92FTGRC, 94FTGL, 94FTGLC, 94FTGLR, 94FTGLRC, 94FTGR, 94FTGRC, ACA2013, ACA2014, ACA2020, ACA204V, ACA208V, ACA213V, ACA214V, ACA220V, ACB001V, ACE0001, ACE0002, ACE001V, ACE002V, ACH1003, ACH1004, ACH101V, ACH102V, ACH103V, ACH104V, ACJ0004, ACJ004V, ACK2001, ACK2002, ACK201V, ACK202V, ACL0001, ACL0003, ACL001V, ACL003V, ADB001V, ADC003V, ADC008V, ADC009V, ADC010V...(Other models you can see in the webshop)		

miscellaneous









GEV No.	100885	Ref. No.	97203100 X19901
description	air mixing sleeve for pilot burner Qty 1 pcs		
For models:	92PCG, 94CFG, 94CFGE, 94PCG, 96CFG, 96CFGE, 96PCG, 96TPFG, 98PCG, ACA2014, ACA2020, ACA214V, ACA220V, ADA213V		

















GEV No.	100967	Ref. No.	623.241.00
description	pilot burner bracket		
For models:	110160PCG, 110170CFG, 6540PG40P, 70110CFG, 70110CFGE, 70110PCG, 70110TPFG, 7040PCG, 7070CFG, 7070CFGE, 7070PCG, AFA2001, AFA2002, AFA2003, AFA2004, AFA2008		

140 - 145 -150 series



GEV No.	107836	Ref. No.	672.013.00	
description	pilot burner SIT type 140 series 2 flames nozzle ø 0.40/0.38mm complete			
For models:	110170CFG, 6030FTG, 6060FTG, 6060FTRG, 6060FTRRG, 6540FTG, 6540FTGCR, 6540FTRG, 6540FTRGCR, 6540GRG, 6540GRL, 6570FTG, 6570FTGCR, 6570FTRG, 6570FTRGCR, 6570FTRRG, 6570GRG, 6570GRL, 7040CPG, 7040FTGCR, 7040FTGS, 7040FTRGCR, 7040GRG, 7040GRL, 7070BRG, 7070BRGM, 7070CPG, 7070FTG, 7070FTGCR, 7070FTRG, 7070FTRGCR, 7070FTRRG, 7070GRG, 7070GRL, 7070PGI, 92PLG, 94PG100I, 94PG100IA, 94PG150I, 94PG150IA, 94PLG, AFA2003, AFA2004, AFA2006, AFB0001, AFB0002, AFE0001, AFH3001, AFH3002, AFH3003...(Other models you can see in the webshop)			
spare parts for	107836			
	GEV No.	100207	Ref. No.	67409100 GS.3829 X30300
	pilot burner nozzle SIT natural gas code 27 bore ø 0.40/0.38mm suitable for SIT 140 series			
	GEV No.	100701	Ref. No.	672.015.00 GS.3857 X13001
	ignition electrode connection M4 Qty 1 pcs			
	GEV No.	100897	Ref. No.	673.003.00
	olive for pipe ø 4mm Qty 1 pcs for pilot burner			
	GEV No.	100906	Ref. No.	673.014.00
	screw connection thread M10x1 for ignition electrode brass Qty 1 pcs WS 10			
accessories for	107836			
	GEV No.	100801	Ref. No.	—
	gasket for pilot burner Qty 1 pcs			
	GEV No.	102110	Ref. No.	—
	pilot tube copper pipe ø 4mm thickness 1mm L 3000mm			
	GEV No.	102111	Ref. No.	—
	pilot tube copper pipe ø 6mm thickness 1mm L 3000mm			



			
GEV No.	107114 ¹	Ref. No.	672.014.00
description	pilot burner SIT type 140 series 2 flames nozzle 6mm gas connectionmm		
For models:	110170CFG, 6030FTG, 6060FTG, 6060FTRG, 6060FTRRG, 6540FTG, 6540FTGCR, 6540FTRG, 6540FTRGCR, 6540GRG, 6570FTG, 6570FTGCR, 6570FTRG, 6570FTRGCR, 6570FTRRG, 6570GRG, 7040CPG, 7040FTG, 7040FTGCR, 7040FTGS, 7040FTRG, 7040FTRGCR, 7040GRG, 7040GRL, 7070BRG, 7070BRGM, 7070CPG, 7070FTG, 7070FTGCR, 7070FTRG, 7070FTRGCR, 7070FTRRG, 7070GRG, 7070GRL, 7070PGI, 92BMG, 92CPG, 92CPGS, 94CFG, 94CPGS, 94TPFG, 96CFG, 96TPFG, AFA2003, AFA2004, AFA2006, AFB0001, AFB0002, AFE0001, AFH3001...(Other models you can see in the webshop)		
spare parts for	107114		
	GEV No.	100907	Ref. No. —
	screw connection thread M10x1 Qty 1 pcs type SEF 1 6mm for thermocouple		
accessories for	107114		
	GEV No.	100204	Ref. No. —
	pilot burner nozzle SIT LPG code 14 bore 0.18/0.20mm Qty 1 pcs suitable for 140 series		
	GEV No.	100205	Ref. No. 674.001.00 X30000
	pilot burner nozzle SIT LPG code 19 bore 0.23/0.26mm Qty 1 pcs suitable for SIT 150 series		
	GEV No.	100206	Ref. No. 674.000.00 X30100
	pilot burner nozzle SIT natural gas code 36 bore 0.60/0.55mm Qty 1 pcs suitable for SIT 150 series		
	GEV No.	100207	Ref. No. 67409100 GS.3829 X30300
	pilot burner nozzle SIT natural gas code 27 bore 0.40/0.38mm suitable for SIT 140 series		
	GEV No.	100216	Ref. No. —
	pilot burner nozzle SIT natural gas code 38 bore 0.45mm Qty 1 pcs suitable for SIT 150 series		
	GEV No.	100701	Ref. No. 672.015.00 GS.3857 X13001
	ignition electrode connection M4 Qty 1 pcs		
	GEV No.	100801	Ref. No. —
	gasket for pilot burner Qty 1 pcs		
	GEV No.	100897	Ref. No. 673.003.00
	olive for pipe 4mm Qty 1 pcs for pilot burner		
	GEV No.	100898	Ref. No. —
	olive for pipe 6mm Qty 1 pcs for pilot burner		
	GEV No.	100906	Ref. No. 673.014.00
	screw connection thread M10x1 for ignition electrode brass Qty 1 pcs WS 10		
	GEV No.	100907	Ref. No. —
	screw connection thread M10x1 Qty 1 pcs type SEF 1 6mm for thermocouple		
	GEV No.	100908	Ref. No. 673.013.00 X13200
	union screw thread M10x1 for pipe 4mm Qty 1 pcs		
	GEV No.	100909	Ref. No. —
	union screw thread M10x1 for pipe 6mm Qty 1 pcs		

¹incl. thermocouple fitting

accessories for	107114		
GEV No.	102110	Ref. No.	—
	pilot tube copper pipe 4mm thickness 1mm L 3000mm		
GEV No.	102111	Ref. No.	—
	pilot tube copper pipe 6mm thickness 1mm L 3000mm		





























			
GEV No.	102450	Ref. No.	X14400
description	pilot burner SIT type 150 series 1 flame nozzle 6mm gas connection		
For models:	ACA2010, ACA2012, ACA201V, ACA202V, ACA203V, ACA206V, ACA208V, ACA209V, ACA210V, ACA212V, ACA216, ACA216V, ACJ0001, ACJ0002, ACJ0003, ACJ001V, ACJ002V, ACJ003V, ADA201V, ADA202V, ADA203V, ADA204V, ADA205V, ADA206V, ADA207V, ADA208V, ADA209V, ADA210V, ADA217V, AIE001V		
spare parts for	102450		
	GEV No.	100204	Ref. No. —
	pilot burner nozzle SIT LPG code 14 bore 0.18/0.20mm Qty 1 pcs suitable for 140 series		
	GEV No.	100205	Ref. No. 674.001.00 X30000
	pilot burner nozzle SIT LPG code 19 bore 0.23/0.26mm Qty 1 pcs suitable for SIT 150 series		
	GEV No.	100206	Ref. No. 674.000.00 X30100
	pilot burner nozzle SIT natural gas code 36 bore 0.60/0.55mm Qty 1 pcs suitable for SIT 150 series		
	GEV No.	100207	Ref. No. 67409100 GS.3829 X30300
	pilot burner nozzle SIT natural gas code 27 bore 0.40/0.38mm suitable for SIT 140 series		
	GEV No.	100216	Ref. No. —
	pilot burner nozzle SIT natural gas code 38 bore 0.45mm Qty 1 pcs suitable for SIT 150 series		
	GEV No.	100765	Ref. No. —
	pilot burner nozzle SIT LPG code 20 bore 0.35mm Qty 1 pcs suitable for 150 series		
	GEV No.	100897	Ref. No. 673.003.00
	olive for pipe 4mm Qty 1 pcs for pilot burner		
	GEV No.	100898	Ref. No. —
	olive for pipe 6mm Qty 1 pcs for pilot burner		
	GEV No.	100906	Ref. No. 673.014.00
	screw connection thread M10x1 for ignition electrode brass Qty 1 pcs WS 10		
	GEV No.	100907	Ref. No. —
	screw connection thread M10x1 Qty 1 pcs type SEF 1 6mm for thermocouple		
	GEV No.	100908	Ref. No. 673.013.00 X13200
	union screw thread M10x1 for pipe 4mm Qty 1 pcs		
	GEV No.	100909	Ref. No. —
	union screw thread M10x1 for pipe 6mm Qty 1 pcs		

Table continues overleaf

















spare parts for	102450		
	GEV No.	101246	Ref. No. 673.004.00
	olive for pipe ø 4mm Qty 1 pcs		

1			
GEV No.	100170	Ref. No.	X13000
description	pilot burner SIT type 150 series 1 flame nozzle ømm gas connectionmm		
For models:	ACE005V, ACH3015, ACH3016, ACH308V, ACH309V, ACH310V, ACH311V, ACH312V, ACH313V, ACH314V, ACH315V, ACH316V, ACH317V, ADA213V, ADH307V, ADH308V, ADH309V, ADH310V, ADH311V, ADH312V, ADK207V, ADK208V, ADK209V, ADK210V		
spare parts for	100170		
	GEV No.	100907	Ref. No. —
	screw connection thread M10x1 Qty 1 pcs type SEF 1 ømm for thermocouple		
accessories for	100170		
	GEV No.	100204	Ref. No. —
	pilot burner nozzle SIT LPG code 14 bore ø 0.18/0.20mm Qty 1 pcs suitable for 140 series		
	GEV No.	100205	Ref. No. 674.001.00 X30000
	pilot burner nozzle SIT LPG code 19 bore ø 0.23/0.26mm Qty 1 pcs suitable for SIT 150 series		
	GEV No.	100206	Ref. No. 674.000.00 X30100
	pilot burner nozzle SIT natural gas code 36 bore ø 0.60/0.55mm Qty 1 pcs suitable for SIT 150 series		
	GEV No.	100207	Ref. No. 67409100 GS.3829 X30300
	pilot burner nozzle SIT natural gas code 27 bore ø 0.40/0.38mm suitable for SIT 140 series		
	GEV No.	100216	Ref. No. —
	pilot burner nozzle SIT natural gas code 38 bore ø 0.45mm Qty 1 pcs suitable for SIT 150 series		
	GEV No.	100701	Ref. No. 672.015.00 GS.3857 X13001
	ignition electrode connection M4 Qty 1 pcs		
	GEV No.	100801	Ref. No. —
	gasket for pilot burner Qty 1 pcs		
	GEV No.	100897	Ref. No. 673.003.00
	olive for pipe ø 4mm Qty 1 pcs for pilot burner		
	GEV No.	100898	Ref. No. —
	olive for pipe ø 6mm Qty 1 pcs for pilot burner		
	GEV No.	100906	Ref. No. 673.014.00
	screw connection thread M10x1 for ignition electrode brass Qty 1 pcs WS 10		
	GEV No.	100908	Ref. No. 673.013.00 X13200
	union screw thread M10x1 for pipe ø 4mm Qty 1 pcs		
	GEV No.	100909	Ref. No. —
	union screw thread M10x1 for pipe ø 6mm Qty 1 pcs		

160 series



1

	GEV No.	100056	Ref. No.	672.042.00
description	pilot burner SIT type 160 series 3 flames nozzle ømm gas connectionmm			
For models:	6030FRG, 6060FRG, 6540FRG, 6570FRG, 7040FRG13, 7070FRG13, 92FRG20, 92FRG20S, 94FRG20, 94FRG20S, AFC0001			
spare parts for	100056			
	GEV No.	100907	Ref. No.	—
	screw connection thread M10x1 Qty 1 pcs type SEF 1 ømm for thermocouple			
accessories for	100056			
	GEV No.	100202	Ref. No.	—
	pilot burner nozzle natural gas code 41 Qty 1 pcs nozzle ø 0.41mm			
	GEV No.	100203	Ref. No.	—
	pilot burner nozzle LPG code 25 Qty 1 pcs nozzle ø 0.25mm			
	GEV No.	100701	Ref. No.	672.015.00 GS.3857 X13001
	ignition electrode connection M4 Qty 1 pcs			
	GEV No.	100801	Ref. No.	—
	gasket for pilot burner Qty 1 pcs			
	GEV No.	100869	Ref. No.	—
	pilot burner nozzle natural gas code 51 Qty 1 pcs suitable for 160 series nozzle ø 0.51mm			
	GEV No.	100870	Ref. No.	673.007.00
	olive for pipe ø 4mm Qty 1 pcs suitable for 160 series for pilot burner			
	GEV No.	100906	Ref. No.	673.014.00
	screw connection thread M10x1 for ignition electrode brass Qty 1 pcs WS 10			
	GEV No.	100908	Ref. No.	673.013.00 X13200
	union screw thread M10x1 for pipe ø 4mm Qty 1 pcs			
	GEV No.	100909	Ref. No.	—
	union screw thread M10x1 for pipe ø 6mm Qty 1 pcs			
	GEV No.	101287	Ref. No.	—
	olive for pipe ø 6mm Qty 1 pcs			
	GEV No.	102110	Ref. No.	—
	pilot tube copper pipe ø 4mm thickness 1mm L 3000mm			
	GEV No.	102111	Ref. No.	—
	pilot tube copper pipe ø 6mm thickness 1mm L 3000mm			
	GEV No.	107650	Ref. No.	674.052.00
	pilot burner nozzle SIT LPG code 30 Qty 1 pcs			



accessories universal

covers



1

GEV No.	106572	Ref. No.	X23200
description	cover for pilot burner		
For models:	ACC0001, ACC0002, ACC001V, ACC002V, ACC006V, ACC007V, ADC001V, ADC002V		

electrodes



1

GEV No.	102496	Ref. No.	07991148000
description	gasket for ignition electrode		
For models:	AAA2002		



1

GEV No.	100701	Ref. No.	672.015.00 GS.3857 X13001
description	ignition electrode connection M4 Qty 1 pcs		
For models:	110170CFG, 6030FTG, 6060FTG, 6060FTRG, 6060FTRRG, 6540FTG, 6540FTGCR, 6540FTRG, 6540FTRGCR, 6540GRG, 6540GRL, 6570FTG, 6570FTGCR, 6570FTRG, 6570FTRGCR, 6570FTRRG, 6570GRG, 6570GRL, 7040CPG, 7040FTG, 7040FTGCR, 7040FTGS, 7040FTRG, 7040FTRGCR, 7040GRG, 7040GRL, 7070BRG, 7070BRGM, 7070CPG, 7070FTG, 7070FTGCR, 7070FTRG, 7070FTRGCR, 7070FTRRG, 7070GRG, 7070GRL, 7070PGI, 92BMG, 92CPG, 92CPGS, 92PLG, 94CFG, 94CPGS, 94PG100, 94PG100IA, 94PG150I, 94PG150IA, 94PLG, 94TPFG, 96CFG... (Other models you can see in the webshop)		
accessories for	100701		
		GEV No.	100906
		Ref. No.	673.014.00
	screw connection thread M10x1 for ignition electrode brass Qty 1 pcs WS 10		



1

GEV No.	100706	Ref. No.	672.060.00 GS.3856 X14600
description	ignition electrode connection M4 Qty 1 pcs		
For models:	65110TPFG, 6570TPFG, 6570TPG, 70110TPFG, 7070TPFG, 7070TPG, 92FTGL, 92FTGLC, 92FTGR, 92FTGRC, 94FTGL, 94FTGLC, 94FTGLR, 94FTGLRC, 94FTGR, 94FTGRC, ACA2013, ACA2014, ACA2020, ACA204V, ACA208V, ACA213V, ACA214V, ACA220V, ACB001V, ACE0001, ACE0002, ACE001V, ACE002V, ACH1003, ACH1004, ACH101V, ACH102V, ACH103V, ACH104V, ACJ0004, ACJ004V, ACK2001, ACK2002, ACK201V, ACK202V, ACL0001, ACL0003, ACL001V, ACL003V, ADB001V, ADC003V, ADC008V, ADC009V, ADC010V... (Other models you can see in the webshop)		

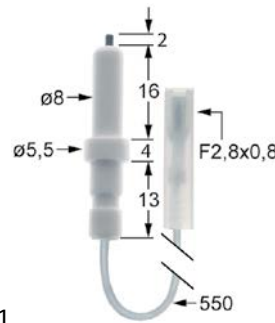

1

GEV No.	100808	Ref. No.	672.115.00
description	ignition electrode D1 ø 5.5mm cable length 550mm connection F 2.8x0.8mm D2 ø 8mm L1 2mm BL1 16mm BL2 4mm BL3 13mm		
For models:	6030PCG, 6060CFG, 6060CFGE, 6060PCG		



1

GEV No.	100817	Ref. No.	672.114.00
description	ignition electrode D1 ø 5mm cable length 700mm to clip		
For models:	6030PCG, 6060CFG, 6060CFGE, 6060PCG		



1

GEV No.	102494	Ref. No.	01992307000
description	ignition electrode D1 ø 6mm total length 710mm cable length 660mm connection male faston 2.8mm D2 ø 8mm L1 1mm BL1 17mm BL2 3.5mm BL3 13mm		
For models:	AAA2002		

GEV No.	100733	Ref. No.	X14500
description	ignition electrode D1 \varnothing 7mm D2 \varnothing 8.5mm cable length 600mm BL1 28mm BL2 3mm BL3 23mm to clip connection \varnothing 2.4mm		
For models:	ACA2013, ACA2014, ACA2020, ACA213V, ACA214V, ACA220V, ACJ0004, ACJ004V		

GEV No.	106583	Ref. No.	4.0.100.0075
description	ignition electrode flange length 22mm flange width 16mm D1 \varnothing 7mm L1 5mm L2 12mm BL1 26mm BL2 18mm connection \varnothing 2.4mm cable length 230mm fixing dimensions \varnothing 4.5mm		
For models:	BM11G		

GEV No.	100822	Ref. No.	X16800
description	ignition electrode D1 \varnothing 7mm D2 \varnothing 9mm connection M4 L1 16mm L2 25mm L3 8mm BL1 18mm BL2 3mm BL3 23mm to clip		
For models:	ACC0001, ACC0002, ACC001V, ACC002V, ACC006V, ACC007V, ADA206V, ADA207V, ADA209V, ADA211V, ADC001V, ADC002V		

GEV No.	101795	Ref. No.	11950447000
description	ignition electrode flange length 23mm flange width 15mm D1 \varnothing 6.5mm L1 12mm L2 27mm BL1 17mm BL2 17mm connection F 4.8x0.8mm cable length 970mm fixing dimensions \varnothing 5x4mm with flange		
For models:	KF1001G		

GEV No.	100815	Ref. No.	672.019.00
description	ignition electrode D1 \varnothing 7mm L1 12mm BL1 18mm BL2 17mm BL3 9mm connection M4 M11x1		
For models:	65110CFG, 65110CFGG, 65110TPFG, 6570CFG, 6570TPFG, 70110CFG, 70110TPFG, 7070CFG, 7070TPFG		



GEV No.	101794	Ref. No.	11950437000
description	ignition electrode flange length 23mm flange width 15mm D1 ø 6.5mm L1 9mm L2 16mm BL1 17mm BL2 17mm connection F 2.8x0.8mm cable length 960mm fixing dimensions ø5x4mm with flange		
For models:	KF1001G		

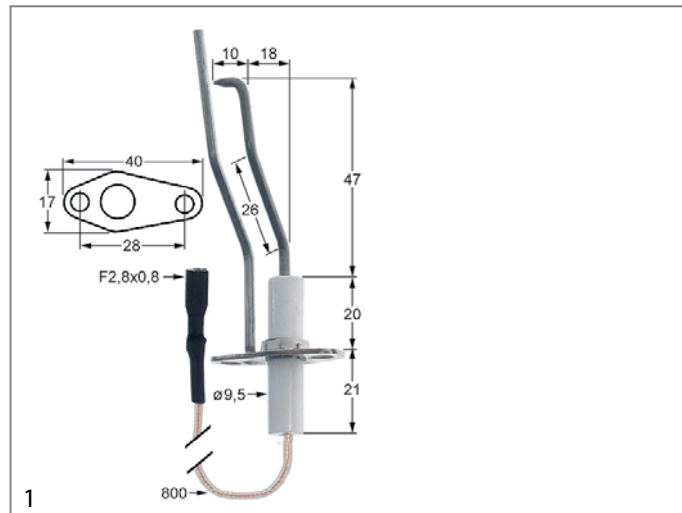

GEV No.	100769	Ref. No.	91310480
description	ignition electrode flange length 40mm flange width 17mm D1 ø 9.5mm L1 47mm L2 18mm L4 10mm L3 26mm BL1 20mm BL2 21mm connection F 2.8x0.8mm cable length 800mm fixing dimensions ø4.5mm mounting distance 28mm with flange with earthing contact		
For models:	CAA0003, CAA0004, CAA0005		

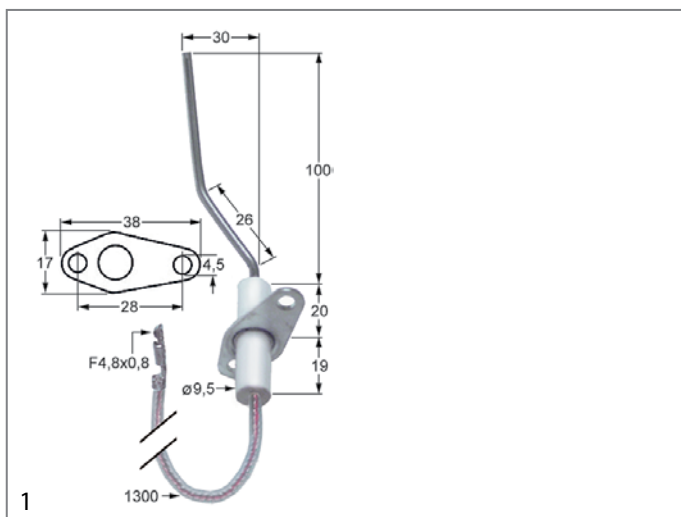

GEV No.	100780	Ref. No.	91310490
description	ignition electrode flange length 38mm flange width 17mm D1 ø 9.5mm L1 100mm L2 30mm L3 26mm BL1 20mm BL2 19mm connection F 4.8x0.8mm cable length 1300mm fixing dimensions ø4.5mm mounting distance 28mm with flange		
For models:	CAA0003, CAA0004, CAA0005		

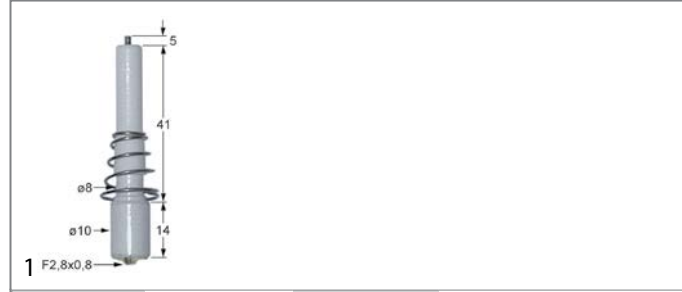

GEV No.	100729	Ref. No.	068032 672.005.00
description	ignition electrode L1 5mm D1 ø 8mm D2 ø 10mm BL1 41mm BL2 14mm connection F 2.8x0.8mm to clip with spring		
For models:	4567, 4568, 4569, 65110CFG, 65110CFGE, 65110TPFG, 6540PCG, 6570CFG, 6570CFGE, 6570PCG, APZ0003, APZ0004, APZ0013		



GEV No.	100906	Ref. No.	673.014.00
description	screw connection thread M10x1 for ignition electrode brass Qty 1 pcs WS 10		
For models:	110170CFG, 6030FRG, 6030FTG, 6060FRG, 6060FTG, 6060FTRG, 6060FTRRG, 6540FRG, 6540FTG, 6540FTGCR, 6540FTRG, 6540FTRGCR, 6540GRG, 6570FRG, 6570FTG, 6570FTGCR, 6570FTRG, 6570FTRGCR, 6570FTRRG, 6570GRG, 7040CPG, 7040FRG13, 7040FTG, 7040FTGCR, 7040FTGS, 7040FTRG, 7040FTRGCR, 7040GRG, 7040GRL, 7070BRG, 7070BRGM, 7070CPG, 7070FRG13, 7070FTG, 7070FTGCR, 7070FTRG, 7070FTRGCR, 7070FTRRG, 7070GRG, 7070GRL, 7070PGI, 92BMG, 92CPG, 92CPGS, 92FRG20, 92FRG20S, 92FTGL, 92FTGLC, 92FTGR, 92FTGRC...(Other models you can see in the webshop)		



GEV No.	102498	Ref. No.	07991159001
description	spring clip for ignition electrode		
For models:	AAA2002		

ignition cables

pre-assembled cables



GEV No.	100176	Ref. No.	X41000
description	ignition cable cable length 1000mm connection ø2.4mm / ø4mm permanent temperature 200°C		
For models:	ACA2013, ACA2014, ACA2020, ACA213V, ACA214V, ACA220V, ACE0001, ACE0002, ACE001V, ACE002V, ACL0001, ACL0003, ACL001V, ACL003V, ADC001V, ADC002V, ADC003V, ADC008V, ADE001V, ADE002V, ADL006V, ADL007V, ADL013V		



GEV No.	100026	Ref. No.	X40100
description	ignition cable cable length 1000mm connection ø4mm / F6.3mm		
For models:	ACB001V, ACC0001, ACC0002, ACC001V, ACC002V, ACC006V, ACC007V, ACE005V, ACH1003, ACH1004, ACH101V, ACH102V, ACH103V, ACH104V, ACH3015, ACH3016, ACH308V, ACH309V, ACH310V, ACH311V, ACH312V, ACH313V, ACH314V, ACH315V, ACH316V, ACH317V, ACK2001, ACK2002, ACK201V, ACK202V, ADB001V, ADC009V, ADC010V, ADH101V, ADH102V, ADH307V, ADH308V, ADH309V, ADH310V, ADH311V, ADH312V		



GEV No.	100193	Ref. No.	666.002.00
description	ignition cable cable length 1200mm connection ø2.4mm / ø4mm		
For models:	65110CFG, 65110TPFG, 6570CFG, 6570TPFG, 70110CFG, 70110TPFG, 7070CFG, 7070TPFG, 94CFG, 94CPGS, 94PG100I, 94PG100IA, 94PG150I, 94PG150IA, 94TPFG, 96CFG, 96TPFG		



GEV No.	100175	Ref. No.	X40300
description	ignition cable cable length 1750mm connection ø2.4mm / ø4mm		
For models:	ACA2012, ACA212V, ADA206V, ADA207V, ADA209V, ADA211V, ADA212V, ADA213V, ADA217V, AIE001V		



GEV No.	100194	Ref. No.	666.014.00
description	ignition cable cable length 1900mm connection ø2.4mm / ø4mm		
For models:	110170CFG, 65110CFG, AFA2003, AFA2004, AFA2006		



GEV No.	100036	Ref. No.	068033
description	ignition cable cable length 500mm connection F2.8mm / F2.8mm		
For models:	4567, 4568, APZ0003, APZ0004, APZ0013		



GEV No.	100197	Ref. No.	X40500
description	ignition cable cable length 600mm connection F2.8mm / ø2.4mm		
For models:	ADK207V, ADK208V, ADK209V, ADK210V		



GEV No.	100018	Ref. No.	666.001.00
description	ignition cable cable length 600mm connection ø2.4mm / ø4mm permanent temperature 200°C		
For models:	6030FRG, 6030FTG, 6060FRG, 6060FTG, 6060FTRG, 6060FTRRG, 65110TPFG, 6540FRG, 6540FTG, 6540FTGCR, 6540FTRG, 6540FTRGCR, 6540GRG, 6540GRL, 6570FRG, 6570FTG, 6570FTGCR, 6570FTRG, 6570FTRGCR, 6570FTRRG, 6570GRG, 6570GRL, 6570TPFG, 6570TPG, 70110TPFG, 7040CPG, 7040FTG, 7040FTGCR, 7040FTGS, 7040FTRG, 7040FTRGCR, 7040GRG, 7040GRL, 7070CPG, 7070FTG, 7070FTGCR, 7070FTRG, 7070FTRGCR, 7070FTRRG, 7070GRG, 7070GRL, 7070PGI, 7070TPFG, 7070TPG, 92BMG, 92FTGL, 92FTGLC, 92FTGR, 92FTGRC, 92PLG...(Other models you can see in the webshop)		



GEV No.	100199	Ref. No.	GS.3682
description	ignition cable cable length 600mm connection ø4mm / F2.8mm		
For models:	TP12JG, TP12JGP, TP15JG, TP15JGP		



GEV No.	100025	Ref. No.	66605100
description	ignition cable cable length 600mm connection ø4mm / F6.3mm		
For models:	7040FRG13, 7070BRG, 7070BRGM, 7070FRG13, 92FRG20, 92FRG20S, 94FRG20, 94FRG20S, AFC0001		



GEV No.	100178	Ref. No.	666.000.00
description	ignition cable cable length 900mm connection F2.8mm / ø2.4mm		
For models:	65110CFG, 65110CFGE, 65110TPFG, 6540PCG, 6570CFG, 6570CFGE, 6570PCG, 92CPG, 92CPGS		

piezoelectric igniters

mounting diameter 18mm



GEV No.	106782	Ref. No.	GS.3720A
description	piezoelectric igniter body metal blowing		
For models:	NGDR910, NGPR6110		





			
1			
GEV No.	100004	Ref. No.	M02100
description	piezoelectric igniter body plastic blowing mounting ø 18mm connection ø2.4mm		
For models:	ACA2012, ACA2013, ACA2014, ACA2020, ACA204V, ACA208V, ACA212V, ACA213V, ACA214V, ACA220V, ACB001V, ACC0001, ACC0002, ACC001V, ACC002V, ACC006V, ACC007V, ACE0001, ACE0002, ACE001V, ACE002V, ACH1003, ACH1004, ACH101V, ACH102V, ACH103V, ACH104V, ACH3015, ACH3016, ACH308V, ACH309V, ACH310V, ACH311V, ACH312V, ACH313V, ACH314V, ACH315V, ACH316V, ACH317V, ACK2001, ACK2002, ACK201V, ACK202V, ACL0001, ACL0003, ACL001V, ACL003V, ADA206V, ADA207V, ADA209V...(Other models you can see in the webshop)		

			
1			
GEV No.	100009	Ref. No.	4.0.100.0070 GS.3720
description	piezoelectric igniter body plastic blowing mounting ø 18mm connection ø2.4mm front measurements 26mm M18x1.5		
For models:	BM11G, TP12JG, TP12JGP, TP15JG, TP15JGP		
accessories for	100009		
	GEV No.	101339	Ref. No. —
cover cap for piezoelectric igniter			
	GEV No.	106869	Ref. No. —
cover cap for piezoelectric igniter ID ø 22mm ED ø 35mm H 25mm			
	GEV No.	107931	Ref. No. —
cover cap for piezoelectric igniter ID ø 21mm ED ø 36mm			

mounting diameter 22mm			
			
1			
GEV No.	100013	Ref. No.	672.006.00
description	piezoelectric igniter body plastic blowing mounting ø 22mm connection ø2.4mm cable lengthmm		
For models:	110170CFG, 6030FRG, 6030FTG, 6030PCG, 6060FRG, 6060FTG, 6060FTRG, 6060FTRRG, 6060PCG, 65110CFG, 65110CFGE, 65110CFGG, 65110TPFG, 6540FRG, 6540FTG, 6540FTGCR, 6540FTRG, 6540FTRGCR, 6540GRG, 6540GRL, 6540PCG, 6570CFG, 6570CFGE, 6570FRG, 6570FTG, 6570FTGCR, 6570FTRG, 6570FTRGCR, 6570FTRRG, 6570GRG, 6570GRL, 6570PCG, 6570TPFG, 6570TPG, 70110CFG, 70110TPFG, 7040CPG, 7040FTG, 7040FTGCR, 7040FTGS, 7040FTRG, 7040FTRGCR, 7040GRG, 7040GRL, 7070CFG, 7070CPG, 7070FTG, 7070FTGCR, 7070FTRG, 7070FTRGCR...(Other models you can see in the webshop)		
accessories for	100013		
	GEV No.	100023	Ref. No. —
female bullet size 2.3mm 0.5-1.5mm ² CuZn t.max. 125°C Qty 20 pcs			

ignition units

			
1			
GEV No.	101009	Ref. No.	068160
description	ignition unit outputs 2 1.5 V/DC dimensions 88x23x34mm mounting distance 73mm inlet F6.3x0.8 outlet F2.8x0.8 mounting ø 73mm		
For models:	2623, 4567, AJH0004, AJH0005, AJH0006, APZ0003, APZ0004, APZ0013		
accessories for	101009		
	GEV No.	301195	Ref. No. 068163
ignition switch for battery type AA 1.5V mounting ø 22mm built-in depth 42mm connection male faston 2.8mm/6.3mm red ignitionA protection IP40 ambient temperature max. 125/55°C			

			
1			
GEV No.	102485	Ref. No.	X50000
description	ignition unit outputs 2 220-240VAC 0.6VA 50-60Hz		
For models:	ADK207V, ADK208V, ADK209V, ADK210V		

			
1			
GEV No.	101017	Ref. No.	ELET0135
description	ignition unit outputs 2 230VAC dimensions 85x70x35mm mounting distance 60mm inlet cable outlet ø4mm type TC2STCAF 55VA 50/60Hz		
For models:	CAD0007, CAD0010, SY12100VGASD, SY1280VG		

			
1			
GEV No.	101031	Ref. No.	068161
description	ignition unit outputs 4 1.5 V/DC dimensions 111x23x34mm mounting distance 100mm inlet F6.3x0.8 outlet F2.8x0.8 mounting ø 100mm		
For models:	4568		



1

GEV No.	101023	Ref. No.	663.042.00
description	ignition unit outputs 4 230VAC dimensions 111x28x34mm mounting distance 98mm inlet F6.3x0.8 outlet F2.8x0.8 type ZAG4 0.3VA 50-60Hz		
For models:	6060CFG, 6060CFGE		
accessories for	101023		
	GEV No.	103257	Ref. No.
			—
accessories for	ignition unit outputs 4 230VAC dimensions 111x28x34mm mounting distance 98mm inlet F6.3x0.8 outlet F2.8x0.8 type FZ4 set 6-piece 0.3VA 50-60Hz		



1

GEV No.	101037	Ref. No.	07950017000
description	ignition unit outputs 6		
For models:	AAA2002		

ignition switches



1

GEV No.	301195	Ref. No.	068163
description	ignition switch for battery type AA 1.5V mounting \varnothing 22mm built-in depth 42mm connection male faston 2.8mm/6.3mm red ignitionA protection IP40 ambient temperature max. 125/55°C		
For models:	2623, 4567, 4568, AJH0004, AJH0005, AJH0006, APZ0003, APZ0004, APZ0013		
accessories for	301195		
	GEV No.	101009	Ref. No.
			068160
accessories for	ignition unit outputs 2 1.5 V/DC dimensions 88x23x34mm mounting distance 73mm inlet F6.3x0.8 outlet F2.8x0.8 mounting \varnothing 73mm		
	GEV No.	101031	Ref. No.
			068161
accessories for	ignition unit outputs 4 1.5 V/DC dimensions 111x23x34mm mounting distance 100mm inlet F6.3x0.8 outlet F2.8x0.8 mounting \varnothing 100mm		
	GEV No.	101032	Ref. No.
			—
accessories for	ignition unit outputs 6 1.5 V/DC dimensions 135x23x34mm mounting distance 123mm inlet F6.3x0.8 outlet F2.8x0.8 mounting \varnothing 122mm		

thermocouples

thermocouple sets universal



1

GEV No.	102281	Ref. No.	GS.2185
description	thermocouple set ROBERTSHAW 5-piece L 24" - 610mm		
For models:	AMZ0001-NM		

plug-in thermocouples

plug-in thermocouples standard

with barrel socket \varnothing 6mm

SIT

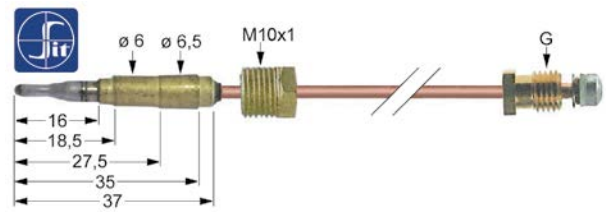

1

GEV No.	102438	Ref. No.	X13300
description	thermocouple M10x1 L 600mm plug connection \varnothing 6.0mm		
For models:	ACA2007, ACA2010, ACA201V, ACA202V, ACA203V, ACA204V, ACA206V, ACA207V, ACA208V, ACA209V, ACA210V, ACA216, ACA216V, ACJ0001, ACJ0002, ACJ0003, ACJ001V, ACJ002V, ACJ003V, ADA201V, ADA202V, ADA203V, ADA204V, ADA205V, ADA206V, ADA207V, ADA208V, ADA209V, ADA210V, ADA217V		

with barrel socket \varnothing 6(6.5)mm

thermocouples SIT

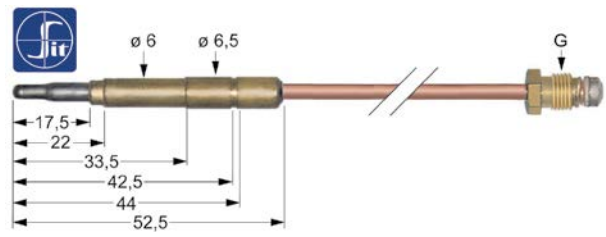

1

GEV No.	107601	Ref. No.	068159
description	thermocouple SIT M8x1 L 600mm plug connection \varnothing 6.0(6.5)mm		
For models:	AJE0006, AJE0007		

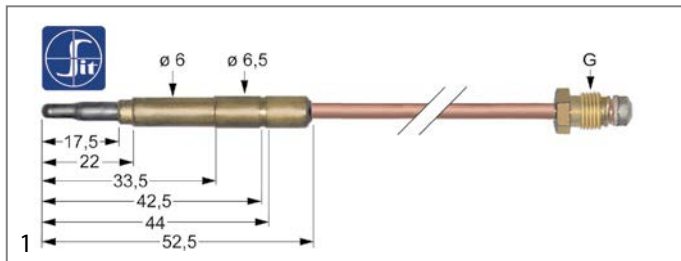

GEV No.	107612	Ref. No.	GS3890 X17600
description	thermocouple SIT M9x1 L 1000mm plug connection ø6.0(6.5)mm		
For models:	ADA213V, ADL013V, AHA0001, AHA0002, AHA0003, AHA0005-NN, AHA0008-NN, AHA0009, AHA0011, AHA0013, AHA0014-NN, AHA0017, AHA0018, AHA0019, AHA0020, AHA0021-NN, AHB0001, NGDR910, TP15JG		

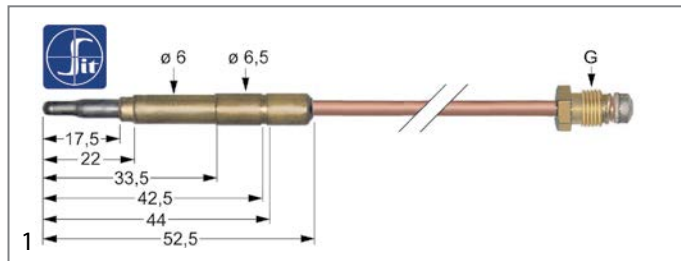

GEV No.	107609	Ref. No.	GS.3895 GS.3895B X14100 X14200
description	thermocouple SIT M9x1 L 600mm plug connection ø6.0(6.5)mm		
For models:	ACA2007, ACA2010, ACA2012, ACA2014, ACA201V, ACA202V, ACA203V, ACA204V, ACA206V, ACA207V, ACA208V, ACA209V, ACA210V, ACA212V, ACA214V, ACA216, ACA216V, ACE0001, ACE0002, ACE001V, ACE002V, ACE005V, ACH3015, ACH3016, ACH308V, ACH309V, ACH310V, ACH311V, ACH312V, ACH313V, ACH314V, ACH315V, ACH316V, ACH317V, ACJ0001, ACJ0002, ACJ0003, ACJ001V, ACJ002V, ACJ003V, ADA201V, ADA202V, ADA203V, ADA204V, ADA205V, ADA206V, ADA207V, ADA208V, ADA209V, ADA210V... (Other models you can see in the webshop)		

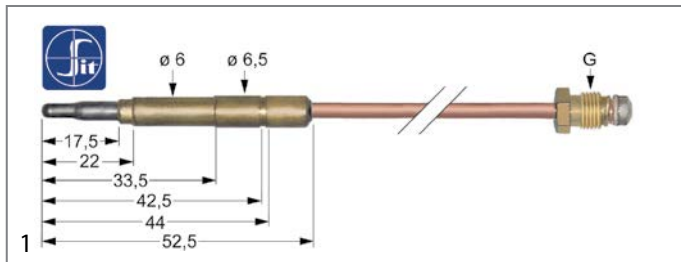

GEV No.	107614	Ref. No.	672.104.00
description	thermocouple SIT M9x1 L 1500mm plug connection ø6.0(6.5)mm		
For models:	110170CFG, 94CFG, 94TPFG, 96CFG, 96TPFG, AFA2003, AFA2004, AFA2006, AFA2008		

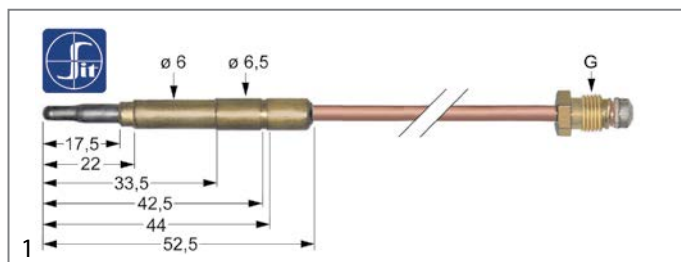

GEV No.	107611	Ref. No.	67208300 67209900
description	thermocouple SIT M9x1 L 850mm plug connection ø6.0(6.5)mm		
For models:	7070PGI, 92CPG, 92CPGS, 92PCG, 94CFG, 94CFGE, 94CPGS, 94PCG, 94PG100I, 94PG100IA, 94PG150I, 94PG150IA, 94TPFG, 94TPG, 96CFG, 96CFGE, 96PCG, 96TPFG, 98PCG		

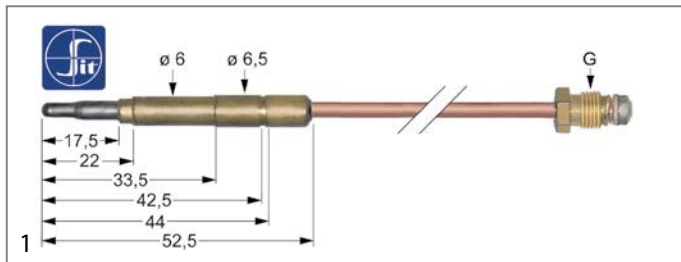

GEV No.	107608	Ref. No.	672.001.00 672.025.00 X13900
description	thermocouple SIT M9x1 L 500mm plug connection ø6.0(6.5)mm		
For models:	110160PCG, 110170CFG, 6030FRG, 6030FTG, 6060FRG, 6060FTG, 6060FTRG, 6060FTRRG, 65110TPFG, 6540FRG, 6540FTG, 6540FTGCR, 6540FTRG, 6540FTRGCR, 6540GRG, 6540GRL, 6540PG40P, 6570FRG, 6570FTG, 6570FTGCR, 6570FTRG, 6570FTRGCR, 6570FTRRG, 6570GRG, 6570GRL, 6570TPFG, 6570TPG, 70110CFG, 70110CFGE, 70110PCG, 70110TPFG, 7040CPG, 7040FRG13, 7040FTG, 7040FTGCR, 7040FTGS, 7040FTRG, 7040FTRGCR, 7040GRG, 7040GRL, 7040PCG, 7070BRG, 7070BRGM, 7070CFG, 7070CFGE, 7070CPG, 7070FRG13, 7070FTG, 7070FTGCR, 7070FTRG... (Other models you can see in the webshop)		

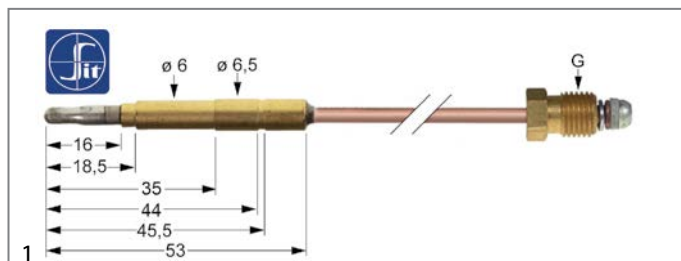

GEV No.	107876	Ref. No.	672.168.00
description	thermocouple SIT M9x1 L 850mm plug connection ø6.0(6.5)mm		

plug-in thermocouples with interruption

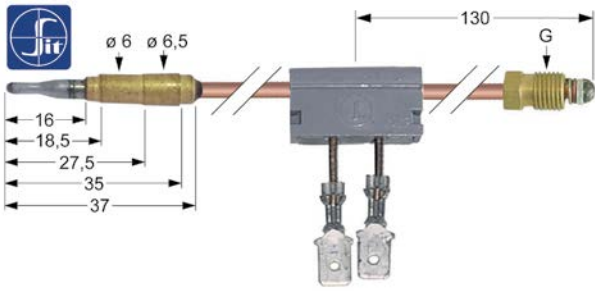

GEV No.	100172	Ref. No.	X14300
description	thermocouple SIT with interrupter ASA 11/32 L 400mm plug connection ϕ 6.0mm F 6.3mm		
For models:	ADH307V, ADH308V, ADH309V, ADH310V, ADH311V, ADH312V, ADK207V, ADK208V, ADK209V, ADK210V		

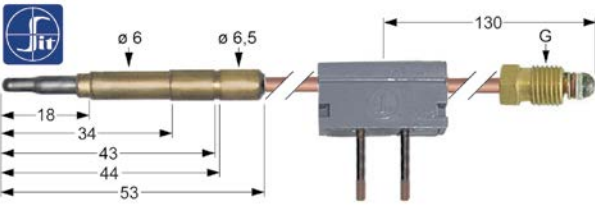

GEV No.	107164	Ref. No.	X14000
description	thermocouple SIT with interrupter M9x1 L 1000mm plug connection ϕ 6.0(6.5)mm soldering connection		
For models:	ACL0001, ACL0003, ACL001V, ACL003V, ADL006V, ADL007V		

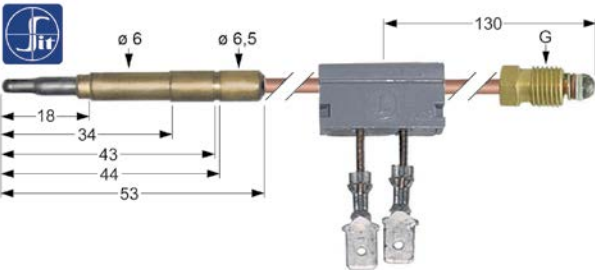

GEV No.	107177	Ref. No.	X19100
description	thermocouple SIT with interrupter M9x1 L 600mm plug connection ϕ 6.0mm F 6.3mm		
For models:	ACC0001, ACC0002, ACC001V, ACC002V, ACC006V, ACC007V, ADC001V, ADC002V, ADC003V, ADC008V, ADC009V, ADC010V		

threaded thermocouples

threaded thermocouples standard

with socket with thread M8x1

SIT

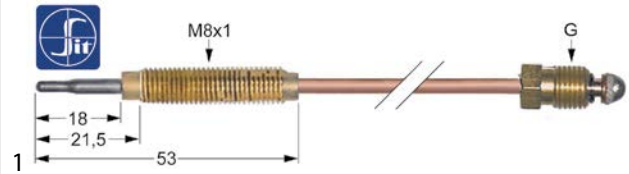

GEV No.	107633	Ref. No.	672.018.00
description	thermocouple SIT M8x1 L 1200mm M8x1		
For models:	65110CFG, 65110CFGG, 65110TPFG, 6570CFG, 6570TPFG, 70110CFG, 70110TPFG, 7070CFG, 7070TPFG		

accessories for	107633		
	GEV No.	102067	Ref. No. C5811029
	nut thread M8x1 H 3mm brass Qty 1 pcs type SEF 1		

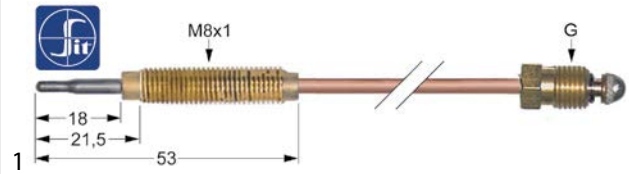

GEV No.	107634	Ref. No.	068138
description	thermocouple SIT M8x1 L 1500mm M8x1		
For models:	2623, 4568, 4570, AJH0004		

accessories for	107634		
	GEV No.	102067	Ref. No. C5811029
	nut thread M8x1 H 3mm brass Qty 1 pcs type SEF 1		

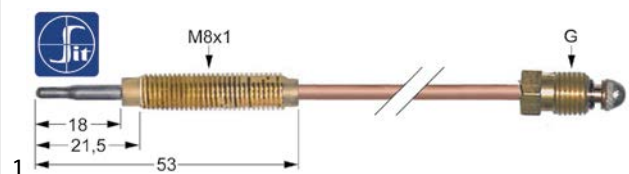

GEV No.	107627	Ref. No.	4.0.100.0055
description	thermocouple SIT M8x1 L 220mm M8x1		
For models:	BM11G		

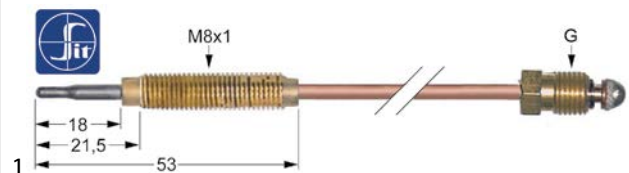

GEV No.	107629	Ref. No.	C5811039
description	thermocouple SIT M8x1 L 450mm M8x1		
For models:	53054-CN, 5305-CN, 5330, 53304, AJD0002-CCN, AJD0003-CCN, AJD0005-CCN, AJD0006-CCN, AJD0014-C, AJD0015-C, AJD0017-C, AJD0018-C, AJD0019-C		

accessories for	107629		
	GEV No.	102067	Ref. No. C5811029
	nut thread M8x1 H 3mm brass Qty 1 pcs type SEF 1		



GEV No.	107630	Ref. No.	672.000.00
description	thermocouple SIT M8x1 L 600mm M8x1		
For models:	65110CFG, 65110CFGE, 65110CFGG, 65110TPFG, 6540PCG, 6570CFG, 6570CFGE, 6570PCG, CEG110, CEG70		
accessories for	107630		
	GEV No.	Ref. No.	Qty
	102067	C5811029	1
	nut thread M8x1 H 3mm brass Qty 1 pcs type SEF 1		

GEV No.	107636	Ref. No.	X15700
description	thermocouple SIT M9x1 L 600mm M8x1		
For models:	ACA2014, ACA214V		
accessories for	107636		
	GEV No.	Ref. No.	Qty
	102067	C5811029	1
	nut thread M8x1 H 3mm brass Qty 1 pcs type SEF 1		

threaded thermocouples (miscellaneous)

GEV No.	102492	Ref. No.	01992278700
description	thermocouple M8x1 L 600mm M6x0.75		
For models:	AAA2002		

GEV No.	102257	Ref. No.	01990368700
description	thermocouple M8x1 L 600mm M8x1		
For models:	AAA2001		

GEV No.	102493	Ref. No.	01992288700
description	thermocouple M8x1 L 650mm M6x0.75		
For models:	AAA2002		

threaded thermocouples with cable link

GEV No.	102127	Ref. No.	672.134.00
description	thermocouple with two-conductors L 600mm M6x0.75 ø 2mm		
For models:	6030PCG, 6060CFG, 6060CFGE, 6060PCG		
accessories for	102127		
	GEV No.	Ref. No.	Qty
	102680	—	1
	nut thread M6x0.75 H 2.6mm WS 8 brass Qty 1 pcs type SEF 2		

GEV No.	102152	Ref. No.	672.135.00
description	thermocouple with two-conductors L 750mm M6x0.75 ø 2mm		
For models:	6030PCG, 6060CFG, 6060CFGE, 6060PCG		
accessories for	102152		
	GEV No.	Ref. No.	Qty
	102680	—	1
	nut thread M6x0.75 H 2.6mm WS 8 brass Qty 1 pcs type SEF 2		

extensions

GEV No.	102852	Ref. No.	X19400
description	thermocouple extension thread M9x1 L 1500mm		
For models:	ACA2012, ACA204V, ACA208V, ACA212V, ADA206V, ADA207V, ADA209V, ADA211V, ADA217V, AIE001V		
accessories for	102852		
	GEV No.	Ref. No.	Qty
	101261	—	1
	thermocouple fitting thread M9x1 Qty 1 pcs		

accessories

nuts

GEV No.	102497	Ref. No.	07991978700
description	nut thread M6x0.75 H 3mm WS 8 steel Qty 1 pcs		
For models:	AAA2002		



1			
GEV No.	102067	Ref. No.	C5811029
description	nut thread M8x1 H 3mm brass Qty 1 pcs type SEF 1		
For models:	53054-CN, 5305-CN, 5330, 53304, AJD0002-CCN, AJD0003-CCN, AJD0005-CCN, AJD0006-CCN, AJD0014-C, AJD0015-C, AJD0017-C, AJD0018-C, AJD0019-C, AJD0023-C, AJD0030, AJD0031, AJD0032		

screws

1			
GEV No.	102464	Ref. No.	X16500
description	thermocouple fitting thread M10x1 brass Qty 1 pcs		
For models:	ACA2014, ACA2020, ACA214V, ACA220V, ADA213V		

interrupters

1			
GEV No.	101265	Ref. No.	672.020.00
description	interrupter thread M9x1		
For models:	6030FRG, 6060FRG, 6540FRG, 6570FRG, 7040FRG13, 7070FRG13, 92FRG20, 92FRG20S, 94FRG20, 94FRG20S, AFC0001		

miscellaneous

1			
GEV No.	102649	Ref. No.	666.005.00
description	cable connection male faston 6.3mm cable length 900mm Qty 1m		
For models:	6540FRG, 6570FRG		

gas burners

hob burners

universal hob burners

SABAF

2 series - standard

1			
GEV No.	105993	Ref. No.	01992246610
description	burner cap 1.8kW ø 75mm bright finish		
For models:	AAA2002		





1			
GEV No.	105054	Ref. No.	07991196610 672.113.00
description	burner cap 3kW ø 100mm H 3.5mm bright finish		
For models:	6030PCG, 6060CFG, 6060CFGE, 6060PCG, AAA2002		
accessories for	105054		
	GEV No.	105058	Ref. No. 07991188901 672.112.00
	GEV No.	105059	Ref. No. 672.111.00



1			
GEV No.	104271	Ref. No.	01992238901
description	burner head 1.8kW for burner cap ø 75mm		
For models:	AAA2002		
accessories for	104271		
	GEV No.	107372	Ref. No. —
	GEV No.	107373	Ref. No. —

1			
GEV No.	105058	Ref. No.	07991188901 672.112.00
description	burner head 3kW for igniter ø 6mm for burner cap ø 100mm		
For models:	6030PCG, 6060CFG, 6060CFGE, 6060PCG, AAA2002		
accessories for	105058		
	GEV No.	105054	Ref. No. 07991196610 672.113.00
	GEV No.	105059	Ref. No. 672.111.00
	GEV No.	107374	Ref. No. —







			
1			
GEV No.	104272	Ref. No.	01992228900
description	burner lower part 1.8kW for igniter ø 6mm for thermocouple ø 6mm with nozzle ø0.97mm for burner cap ø 75mm		
For models:	AAA2002		

			
1			
GEV No.	105059	Ref. No.	672.111.00
description	burner lower part 3kW for igniter ø 6mm for thermocouple ø 6mm without nozzle for burner cap ø 100mm		
For models:	6030PCG, 6060CFG, 6060CFGE, 6060PCG		
accessories for	105059		
	GEV No.	105054	Ref. No. 07991196610 672.113.00
burner cap 3kW ø 100mm H 3.5mm bright finish			
	GEV No.	105058	Ref. No. 07991188901 672.112.00
burner head 3kW for igniter ø 6mm for burner cap ø 100mm			
	GEV No.	107374	Ref. No. —
burner cap 3kW ø 100mm H 3.5mm matt finish			

			
1			
GEV No.	105120	Ref. No.	07991698900
description	burner lower part 3kW for igniter ø 7mm for thermocouple ø 6mm with nozzle ø1.15mm for burner cap ø 100mm		
For models:	AAA2002		
accessories for	105120		
	GEV No.	105121	Ref. No. —
burner head 3kW for igniter ø 7.5mm for burner cap ø 100mm			
	GEV No.	105122	Ref. No. —
burner cap 3kW ø 100mm H 6mm matt finish			

2 series - flat skirt version



			
1			
GEV No.	105993	Ref. No.	01992246610
description	burner cap 1.8kW ø 75mm bright finish		
For models:	AAA2002		

			
1			
GEV No.	105054	Ref. No.	07991196610 672.113.00
description	burner cap 3kW ø 100mm H 3.5mm bright finish		
For models:	6030PCG, 6060CFG, 6060CFGE, 6060PCG, AAA2002		
accessories for	105054		
	GEV No.	105058	Ref. No. 07991188901 672.112.00
burner head 3kW for igniter ø 6mm for burner cap ø 100mm			
	GEV No.	105059	Ref. No. 672.111.00
burner lower part 3kW for igniter ø 6mm for thermocouple ø 6mm without nozzle for burner cap ø 100mm			

			
1			
GEV No.	104272	Ref. No.	01992228900
description	burner lower part 1.8kW for igniter ø 6mm for thermocouple ø 6mm with nozzle ø0.97mm for burner cap ø 75mm		
For models:	AAA2002		





			
1			
GEV No.	105059	Ref. No.	672.111.00
description	burner lower part 3kW for igniter ø 6mm for thermocouple ø 6mm without nozzle for burner cap ø 100mm		
For models:	6030PCG, 6060CFG, 6060CFGE, 6060PCG		
accessories for	105059		
	GEV No.	105054	Ref. No. 07991196610 672.113.00
burner cap 3kW ø 100mm H 3.5mm bright finish			
	GEV No.	105058	Ref. No. 07991188901 672.112.00
burner head 3kW for igniter ø 6mm for burner cap ø 100mm			
	GEV No.	107374	Ref. No. —
burner cap 3kW ø 100mm H 3.5mm matt finish			



			
1			
GEV No.	105120	Ref. No.	07991698900
description	burner lower part 3kW for igniter ø 7mm for thermocouple ø 6mm with nozzle ø1.15mm for burner cap ø 100mm		
For models:	AAA2002		
accessories for	105120		
	GEV No.	105121	Ref. No. —
burner head 3kW for igniter ø 7.5mm for burner cap ø 100mm			
	GEV No.	105122	Ref. No. —
burner cap 3kW ø 100mm H 6mm matt finish			



triple ring burner series - standard version



			
1			
GEV No.	105063	Ref. No.	07991126610 672.108.00
description	burner cap 3.6kW ø 131mm H 4mm mounting pos. outer		
For models:	6030PCG, 6060CFG, 6060CFGE, 6060PCG, AAA2002		
accessories for	105063		
	GEV No.	105064	Ref. No. 07991126610 672.109.00
burner cap 3.6kW ø 61mm H 6.5mm mounting pos. inner bright finish			
	GEV No.	105065	Ref. No. 672.107.00
burner head 3.6kW for burner cap ø 61/131mm			
	GEV No.	105717	Ref. No. 01992398900
burner lower part 3.6kW for igniter ø 6mm for thermocouple ø 6mm with nozzle ø1.35mm ID ø 64mm for burner cap ø 61/131mm			
	GEV No.	105922	Ref. No. —
burner lower part 3.6kW for igniter ø 6mm for thermocouple ø 6mm with nozzle ø1.35mm ID ø 75mm for burner cap ø 61/131mm			

			
1			
GEV No.	105064	Ref. No.	07991126610 672.109.00
description	burner cap 3.6kW ø 61mm H 6.5mm mounting pos. inner bright finish		
For models:	6030PCG, 6060CFG, 6060CFGE, 6060PCG, AAA2002		
accessories for	105064		
	GEV No.	105063	Ref. No. 07991126610 672.108.00
burner cap 3.6kW ø 131mm H 4mm mounting pos. outer			
	GEV No.	105065	Ref. No. 672.107.00
burner head 3.6kW for burner cap ø 61/131mm			
	GEV No.	105717	Ref. No. 01992398900
burner lower part 3.6kW for igniter ø 6mm for thermocouple ø 6mm with nozzle ø1.35mm ID ø 64mm for burner cap ø 61/131mm			

accessories for	105064		
	GEV No.	105922	Ref. No. —
burner lower part 3.6kW for igniter ø 6mm for thermocouple ø 6mm with nozzle ø1.35mm ID ø 75mm for burner cap ø 61/131mm			

			
1			
GEV No.	105065	Ref. No.	672.107.00
description	burner head 3.6kW for burner cap ø 61/131mm		
For models:	6030PCG, 6060CFG, 6060CFGE, 6060PCG		
accessories for	105065		
	GEV No.	105063	Ref. No. 07991126610 672.108.00
burner cap 3.6kW ø 131mm H 4mm mounting pos. outer			
	GEV No.	105064	Ref. No. 07991126610 672.109.00
burner cap 3.6kW ø 61mm H 6.5mm mounting pos. inner bright finish			
	GEV No.	105717	Ref. No. 01992398900
burner lower part 3.6kW for igniter ø 6mm for thermocouple ø 6mm with nozzle ø1.35mm ID ø 64mm for burner cap ø 61/131mm			

			
1			
GEV No.	105717	Ref. No.	01992398900
description	burner lower part 3.6kW for igniter ø 6mm for thermocouple ø 6mm with nozzle ø1.35mm ID ø 64mm for burner cap ø 61/131mm		
For models:	AAA2002		
accessories for	105717		
	GEV No.	101277	Ref. No. 673.005.00
olive ID ø 8mm Qty 1 pcs			
	GEV No.	101477	Ref. No. 673.034.00
union screw thread M13x1 tube ø 8mm Qty 1 pcs			

			
1			
GEV No.	105066	Ref. No.	672.106.00
description	burner lower part 3.6kW for igniter ø 6mm for thermocouple ø 6mm without nozzle ID ø 64mm for burner cap ø 61/131mm		
For models:	6030PCG, 6060CFG, 6060CFGE, 6060PCG		
accessories for	105066		
	GEV No.	101277	Ref. No. 673.005.00
olive ID ø 8mm Qty 1 pcs			
	GEV No.	101477	Ref. No. 673.034.00
union screw thread M13x1 tube ø 8mm Qty 1 pcs			





			
1			
GEV No.	104273	Ref. No.	01981558000
description	gasket for burner cap ø 61/131mm		
For models:	AAA2002		

triple ring burner series - flat skirt version

				
1				
GEV No.	105063	Ref. No.	07991126610 672.108.00	
description	burner cap 3.6kW ø 131mm H 4mm mounting pos. outer			
For models:	6030PCG, 6060CFG, 6060CFGE, 6060PCG, AAA2002			
accessories for	105063			
	GEV No.	105064	Ref. No.	07991126610 672.109.00
	burner cap 3.6kW ø 61mm H 6.5mm mounting pos. inner bright finish			
	GEV No.	105065	Ref. No.	672.107.00
	burner head 3.6kW for burner cap ø 61/131mm			
	GEV No.	105717	Ref. No.	01992398900
	burner lower part 3.6kW for igniter ø 6mm for thermocouple ø 6mm with nozzle ø1.35mm ID ø 64mm for burner cap ø 61/131mm			
	GEV No.	105922	Ref. No.	—
	burner lower part 3.6kW for igniter ø 6mm for thermocouple ø 6mm with nozzle ø1.35mm ID ø 75mm for burner cap ø 61/131mm			

				
1				
GEV No.	105064	Ref. No.	07991126610 672.109.00	
description	burner cap 3.6kW ø 61mm H 6.5mm mounting pos. inner bright finish			
For models:	6030PCG, 6060CFG, 6060CFGE, 6060PCG, AAA2002			
accessories for	105064			
	GEV No.	105063	Ref. No.	07991126610 672.108.00
	burner cap 3.6kW ø 131mm H 4mm mounting pos. outer			
	GEV No.	105065	Ref. No.	672.107.00
	burner head 3.6kW for burner cap ø 61/131mm			
	GEV No.	105717	Ref. No.	01992398900
	burner lower part 3.6kW for igniter ø 6mm for thermocouple ø 6mm with nozzle ø1.35mm ID ø 64mm for burner cap ø 61/131mm			
	GEV No.	105922	Ref. No.	—
	burner lower part 3.6kW for igniter ø 6mm for thermocouple ø 6mm with nozzle ø1.35mm ID ø 75mm for burner cap ø 61/131mm			

				
1				
GEV No.	105717	Ref. No.	01992398900	
description	burner lower part 3.6kW for igniter ø 6mm for thermocouple ø 6mm with nozzle ø1.35mm ID ø 64mm for burner cap ø 61/131mm			
For models:	AAA2002			
accessories for	105717			
	GEV No.	101277	Ref. No.	673.005.00
	olive ID ø 8mm Qty 1 pcs			
	GEV No.	101477	Ref. No.	673.034.00
	union screw thread M13x1 tube ø 8mm Qty 1 pcs			

				
1				
GEV No.	105066	Ref. No.	672.106.00	
description	burner lower part 3.6kW for igniter ø 6mm for thermocouple ø 6mm without nozzle ID ø 64mm for burner cap ø 61/131mm			
For models:	6030PCG, 6060CFG, 6060CFGE, 6060PCG			
accessories for	105066			
	GEV No.	101277	Ref. No.	673.005.00
	olive ID ø 8mm Qty 1 pcs			
	GEV No.	101477	Ref. No.	673.034.00
	union screw thread M13x1 tube ø 8mm Qty 1 pcs			

			
1			
GEV No.	104273	Ref. No.	01981558000
description	gasket for burner cap ø 61/131mm		
For models:	AAA2002		

accessories



pan supports

			
1			
GEV No.	210193	Ref. No.	GS.2720
description	pan support ø 275mm		
For models:	AHA0001, AHA0002, AHA0003, AHA0013, AHA0017, AHA0018, AHA0019, AHA0020		

			
1			
GEV No.	210203	Ref. No.	01960796610
description	pan support W 220mm L 530mm		
For models:	AAA2001, AAA2002		

			
1			
GEV No.	210173	Ref. No.	683.063.00
description	pan support W 265mm L 510mm		
For models:	6030PCG, 6060CFG, 6060CFGE, 6060PCG		

			
1			
GEV No.	210204	Ref. No.	01960806610
description	pan support W 290mm L 520mm		
For models:	AAA2001, AAA2002		

			
1			
GEV No.	210132	Ref. No.	681.008.00
description	pan support W 340mm L 570mm suitable for 700 series		
For models:	65110CFG, 65110CFGE, 65110CFGG, 65110TPFG, 6540PCG, 6570CFG, 6570CFGE, 6570PCG, 70110CFG, 70110CFGE, 70110PCG, 70110TPFG, 7040PCG, 7070CFG, 7070CFGE, 7070PCG, CEG110, CEG70		
accessories for	210132		
	GEV No.	210050	Ref. No. —
	reducer for pan support L 260mm W 260mm chrome-plated steel suitable for universal		

			
1			
GEV No.	210245	Ref. No.	1550Y63000
description	pan support W 370mm L 580mm		
For models:	ACA2007, ACA2010, ACA201V, ACA202V, ACA203V, ACA204V, ACA206V, ACA207V, ACA208V, ACA209V, ACA210V, ACA216, ACA216V, ACJ0001, ACJ0002, ACJ0003, ACJ001V, ACJ002V, ACJ003V		

			
1			
GEV No.	210060	Ref. No.	681.019.14
description	pan support W 400mm L 400mm enamelled		

			
1			
GEV No.	210137	Ref. No.	681.019.00
description	pan support W 400mm L 400mm suitable for 900 series		
For models:	110160PCG, 110170CFG, 6540PG40P, AFA2001, AFA2002, AFA2003, AFA2004, AFA2008		

			
1			
GEV No.	210196	Ref. No.	GS.4004
description	pan support W 500mm L 500mm		
For models:	AHB0001		

air mixers			
			
1			
GEV No.	105570	Ref. No.	GS.80005
description	air mixer complete		
For models:	AHA0001, AHA0002, AHA0003, AHA0009, AHA0011, AHB0001		





			
1			
GEV No.	104696	Ref. No.	923.271.00
description	air mixer ED ø 95mm thickness 0.75mm hole ø 10mm round burner		
For models:	94TPFG, 94TPG, 96TPFG		

			
1			
GEV No.	106282	Ref. No.	K98110
description	air mixer L 55mm W 45mm H 30mm		
For models:	ADC003V, ADC008V, ADC009V, ADC010V		

			
1			
GEV No.	106521	Ref. No.	0600V01500
description	air mixing sleeve L 30mm thread 3/8" IT		
For models:	ACA2007, ACA2010, ACA201V, ACA202V, ACA203V, ACA204V, ACA206V, ACA207V, ACA208V, ACA209V, ACA210V, ACA216, ACA216V, ACJ0001, ACJ0002, ACJ0003, ACJ001V, ACJ002V, ACJ003V, ADA201V, ADA202V, ADA203V, ADA204V, ADA205V, ADA206V, ADA207V, ADA208V, ADA209V, ADA210V, ADA217V		

			
1			
GEV No.	103127	Ref. No.	672.016.00
description	air mixing sleeve L 36mm ED ø 40mm ID ø 36mm aluminium		
For models:	110160PCG, 110170CFG, 65110CFG, 65110CFGE, 65110CFGG, 65110TPFG, 6540PCG, 6540PG40P, 6570CFG, 6570CFGE, 6570PCG, 70110CFG, 70110CFGE, 70110PCG, 70110TPFG, 7040PCG, 7070CFG, 7070CFGE, 7070PCG, AFA2001, AFA2002, AFA2003, AFA2004, AFA2008, CEG110, CEG70		

accessories for 103127			
	GEV No.	103118	Ref. No. 672.044.00
	burner cap ø 61mm		
	GEV No.	103119	Ref. No. 672.098.00
	burner ring for burner cap ø 61mm		
	GEV No.	103120	Ref. No. 672.050.00
	burner head for burner cap ø 61mm		
	GEV No.	103121	Ref. No. 672.010.00
	venturi		
	GEV No.	103122	Ref. No. 673.020.00
	burner holder ø 35mm H 82mm nozzle mounting M10x1 mounting distance 55mm connection M16x1.5mm with nozzle holder		
	GEV No.	103124	Ref. No. 672.101.00
	burner head E ø 150mm for burner cap ø 110mm 7.5kW code 672.077 A		
	GEV No.	103125	Ref. No. 672.079.00
	burner cap D ø 110mm 5.5kW bore ø 2.6mm with central hole		
	GEV No.	103126	Ref. No. 672.093.00
	burner cap E ø 110mm 7.5kW bore ø 3mm with central hole		

accessories for 103127			
	GEV No.	105067	Ref. No. 67207800
	burner cap C ø 84mm 3.5kW		
	GEV No.	105069	Ref. No. 67207600
	burner head C for burner cap ø 84mm 3.5kW		
	GEV No.	105070	Ref. No. 672.077.00
	burner head D ø 150mm for burner cap ø 110mm 5.5kW code 672.077 E		

			
1			
GEV No.	106066	Ref. No.	X20200
description	air mixing tube dimensions 18x42mm ED ø 24mm		
For models:	ACH3015, ACH3016, ACH308V, ACH309V, ACH310V, ACH311V, ACH312V, ACH313V, ACH314V, ACH315V, ACH316V, ACH317V		



			
1			
GEV No.	106765	Ref. No.	GS.3660
description	air mixing tube dimensions 18x42mm ED ø 26mm		
For models:	TP12JG, TP15JG		

			
1			
GEV No.	104741	Ref. No.	X20300
description	air mixing tube L 42mm ø 20mm		
For models:	ADA206V, ADA207V, ADA209V, ADA211V		

			
1			
GEV No.	106615	Ref. No.	X23500
description	air mixing tube L 42mm ø 22mm		
For models:	ADH307V, ADH308V, ADH309V, ADH310V, ADH311V, ADH312V		

bar burners

bar burners

			
1			
GEV No.	105102	Ref. No.	X68046
description	bar burner 1-row ø 27mm Wmm Hmm L 418mm oven		
For models:	ACB001V, ACE005V, ADB001V		
spare parts for 105102			
	GEV No.	104651	Ref. No. —
	mounting flange for igniter and thermocouple		





			
1			
GEV No.	105115	Ref. No.	Y22200
description	bar burner 1-row ø 40mm Wmm Hmm L 500mm flange width 43mm flange length 43mm tilting bratt pan		
For models:	ADK207V, ADK208V, ADK209V, ADK210V		

			
1			
GEV No.	104217	Ref. No.	X23900
description	bar burner 1-row ø 60mm Wmm Hmm L 505mm flange width 67mm flange length 67mm fryer		
For models:	ADE001V, ADE002V		

			
1			
GEV No.	105260	Ref. No.	X20100
description	bar burner 2 row L 450mm W 300mm ømm H 50mm 8.5kW griddle		
For models:	ACH3015, ACH3016, ACH315V, ACH316V, ACH317V		

			
1			
GEV No.	104174	Ref. No.	672.052.00
description	bar burner 2 row L 485mm W 240mm ømm H 170mm gril		
For models:	6540GRG, 6540GRL, 6570GRG, 6570GRL, 7040GRG, 7040GRL, 7070GRG, 7070GRL		

			
1			
GEV No.	105863	Ref. No.	GS.3652
description	bar burner 2 row L 525mm W 190mm ømm H 55mm gril		
For models:	TP12JG, TP12JGP, TP15JG, TP15JGP		

			
1			
GEV No.	105161	Ref. No.	97200600
description	bar burner 2 row L 585mm W 150mm ø 23mm Hmm bain marie		
For models:	92BMG, AFB0001		

			
1			
GEV No.	106846	Ref. No.	97201700
description	bar burner 2 row L 610mm W 220mm ømm H 47mm chargrill		
For models:	92PLG, 94PLG		

			
1			
GEV No.	105165	Ref. No.	67207400
description	bar burner 3 row L 390mm W 420mm ømm H 135mm tilting bratt pan		
For models:	7070BRG, 7070BRGM		

			
1			
GEV No.	105302	Ref. No.	Y22000
description	bar burner 3 row L 445mm W 280mm ømm H 40mm solid top		
For models:	ADA211V, ADA212V, ADA213V		

			
1			
GEV No.	105075	Ref. No.	672.122.00
description	bar burner 3 row L 455mm W 185mm ømm H 45mm griddle		
For models:	6030FTG, 6060FTG, 6060FTRG, 6060FTRRG		





			
1			
GEV No.	105340	Ref. No.	X24100
description	bar burner 3 row L 480mm W 305mm ømm H 60mm mounting distance 280mm chargrill		
For models:	ACH1003, ACH1004, ACH101V, ACH102V, ACH103V, ACH104V, ADH101V, ADH102V		

			
1			
GEV No.	104173	Ref. No.	672.029.00
description	bar burner 3 row L 507mm W 240mm ømm H 50mm griddle		
For models:	6540FTG, 6540FTGCR, 6540FTRG, 6540FTRGCR, 6570FTG, 6570FTGCR, 6570FTRG, 6570FTRGCR, 6570FTRRG, 7040FTG, 7040FTGCR, 7040FTGS, 7040FTRG, 7040FTRGCR, 7070FTG, 7070FTGCR, 7070FTRRG		

			
1			
GEV No.	105162	Ref. No.	97200700
description	bar burner 3 row L 585mm W 455mm ømm H 40mm bain marie		
For models:	AFB0002		

			
1			
GEV No.	105158	Ref. No.	97200000
description	bar burner 3 row L 625mm W 240mm ømm H 45mm griddle		
For models:	AFH3001, AFH3002, AFH3005, AFH3006		

			
1			
GEV No.	105303	Ref. No.	Y20100
description	bar burner 3 row L 630mm W 265mm ømm H 60mm griddle		
For models:	ADH307V, ADH308V, ADH309V, ADH310V, ADH311V, ADH312V		

			
1			
GEV No.	104171	Ref. No.	672.030.00
description	bar burner angled L 450mm W 185mm ømm Hmm oven		
For models:	65110CFG, 65110TPFG, 6570CFG, 6570TPFG, 70110CFG, 70110TPFG, 7070CFG, 7070TPFG		

			
1			
GEV No.	105105	Ref. No.	X20400
description	bar burner angled L 600mm W 305mm ømm Hmm oven		
For models:	ADA206V, ADA207V, ADA209V, ADA211V		

			
1			
GEV No.	105635	Ref. No.	11980137915
description	bar burner angled L 740mm W 355mm ømm Hmm convection oven		
For models:	KF1001G		

			
1			
GEV No.	104691	Ref. No.	672.153.00
description	bar burner L 520mm W 200mm ø 25mm H 60mm for tilting bratt pan		

			
1			
GEV No.	104690	Ref. No.	672.183.00
description	bar burner L 590mm W 585mm ø 25mm H 170mm tilting bratt pan for model 70/80 BRG		

			
1			
GEV No.	104797	Ref. No.	972.051.00
description	bar burner L 590mm W 585mm ø 25mm H 170mm tilting bratt pan for model 90/80 BRG		

			
1			
GEV No.	104694	Ref. No.	672.053.00
description	bar burner ø 29/32/29mm for gas oven		
For models:	65110CFG, 94CFG, 94TPFG, 96CFG, 96TPFG		

			
1			
GEV No.	105110	Ref. No.	X20600
description	bar burner ø 40mm Wmm Hmm L 323mm tilting bratt pan flange ø 61mm		
For models:	ACK2001, ACK2002, ACK201V, ACK202V, ACL0001, ACL0003, ACL001V, ACL003V		

			
1			
GEV No.	105718	Ref. No.	E30100
description	bar burner ø 40mm Wmm Hmm L 395mm flange ø 61mm tilting bratt pan		
For models:	ADL006V, ADL007V, ADL013V		

			
1			
GEV No.	105160	Ref. No.	672.072.15 67207200
description	bar burner ø 50mm Wmm Hmm L 428mm flange width 71mm kettle flange ø 75mm		
For models:	7040CPG, 7070CPG, 92CPG, 92CPGS, 94CPG, 94CPGS, 94PG100I, 94PG100IA, 94PG150I, 94PG150IA, AFE0001		
spare parts for	105160		
		GEV No.	105159
		Ref. No.	64104200
	end cap suitable for burner for pasta cooker		

			
1			
GEV No.	103343	Ref. No.	972.045.00
description	bar burner ø 52mm L 490mm flange width 24mm flange length 60mm fryer		

			
1			
GEV No.	109057	Ref. No.	Y23500
description	bar burner ø 60mm Wmm Hmm L 335mm pasta cooker		
For models:	ACE0001, ACE0002, ACE001V, ACE002V		

			
1			
GEV No.	105074	Ref. No.	872.005.00
description	bar burner T-shape L 740mm Wmm ø 41mm Hmm oven		
For models:	110170CFG, AFA2003, AFA2004, AFA2006		

			
1			
GEV No.	211019	Ref. No.	681.011.00
description	chargrill grid L 495mm W 160mm H 19mm		
For models:	6540GRG, 6540GRL, 6570GRG, 6570GRL, 7040GRG, 7040GRL, 7070GRG, 7070GRL		

			
1			
GEV No.	105159	Ref. No.	64104200
description	end cap suitable for burner for pasta cooker		
For models:	7040CPG		

			
1			
GEV No.	211020	Ref. No.	61152400 811.212.00
description	lava rock grid L 440mm W 295mm H 15mm		
For models:	6540GRL, 6570GRL, 7040GRL, 7070GRL		

			
1			
GEV No.	693070	Ref. No.	611.312.00
description	lever for grill grid		
For models:	6540GRL, 6570GRL		



chargrill grids



1

GEV No.	211019	Ref. No.	681.011.00
description	chargrill grid L 495mm W 160mm H 19mm		
For models:	6540GRG, 6540GRL, 6570GRG, 6570GRL, 7040GRG, 7040GRL, 7070GRG, 7070GRL		

lava rock grids



1

GEV No.	211020	Ref. No.	61152400 811.212.00
description	lava rock grid L 440mm W 295mm H 15mm		
For models:	6540GRL, 6570GRL, 7040GRL, 7070GRL		

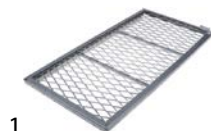

1

GEV No.	211053	Ref. No.	91106800
description	lava rock grid L 625mm W 325mm H 36mm stainless steel		
For models:	AFA2004, AFC0001, AFC0003		

tube burners



1

GEV No.	105164	Ref. No.	67207100
description	tubular burner L 190mm W 53mm H 64mm for fryer oval		
For models:	7040FRG13, 7070FRG13, AFC0001		



1

GEV No.	105866	Ref. No.	PD.2263
description	tubular burner L 265mm W 50mm H 71mm for fryer oval		
For models:	AMZ0001-NM		



1

GEV No.	104172	Ref. No.	672.031.00
description	tubular burner ø 74mm L 180mm H 60mm round for fryer		
For models:	6540FRG		



1

GEV No.	105163	Ref. No.	672.075.00
description	tubular burner ø 74mm L 180mm W 74mm H 60mm round for fryer		
For models:	6030FRG, 6060FRG, 6570FRG		



1

GEV No.	105261	Ref. No.	0900X23100
description	tubular burner ø 74mm L 180mm W 75mm H 60mm for fryer round		
For models:	ACC0001, ACC0002, ACC001V, ACC002V, ACC006V, ACC007V, ADC001V, ADC002V		

solid top burners



1

GEV No.	105168	Ref. No.	67209000
description	solid top burner ø 120mm H 77mm L 340mm for kettle		
For models:	7070PGI		



1

GEV No.	105485	Ref. No.	972.044.00
description	solid top burner ø 65mm H 102mm L 284mm		

surface burners

			
1			
GEV No.	105715	Ref. No.	GS.3043
description	surface burner L 245mm W 185mm H 80mm firing range 175x155mm burner rows 9 for rice cooker		
For models:	NGDR910		

ceramic burners

			
1			
GEV No.	101938	Ref. No.	530587M 534030P
description	ceramic burner L 845mm W 86mm firing range 61x801mm chicken rotisserie		
For models:	5330, AJD0005-CCN, AJD0006-CCN, AJD0015-C, AJD0017-C, AJD0018-C		

accessories

burner grids

			
1			
GEV No.	210153	Ref. No.	056452
description	burner grid L 500mm W 215mm for gyro grill		
For models:	AJE0006		

			
1			
GEV No.	210154	Ref. No.	056453
description	burner grid L 660mm W 215mm for gyro grill		
For models:	AJE0007		



accessories



nozzle holders

			
1			
GEV No.	104699	Ref. No.	675.511.00
description	nozzle holder L 153mm screw pipe fitting 1/2" ET M14x1		

			
1			
GEV No.	106283	Ref. No.	X68042
description	nozzle holder nozzle M6 M10x1 screw pipe fitting 1/4" tube ø 6mm		
For models:	ACB001V, ADB001V		

			
1			
GEV No.	104108	Ref. No.	0000X16100 673.023.00
description	nozzle holder nozzle mounting M10x1 tube ø 10mm gas inlet M16x1.5 gas outlet M14x1		
For models:	110170CFG, 6030FRG, 6030FTG, 6060FRG, 6060FTG, 6060FTRG, 6060FTRRG, 65110CFG, 65110CFGG, 65110TPFG, 6540FRG, 6540FTG, 6540FTGCR, 6540FTRG, 6540FTRGCR, 6540GRG, 6540GRL, 6570CFG, 6570FRG, 6570FTG, 6570FTGCR, 6570FTRG, 6570FTRGCR, 6570FTRRG, 6570GRG, 6570GRL, 6570TPFG, 6570TPG, 70110CFG, 70110TPFG, 7040CPG, 7040FTG, 7040FTGCR, 7040FTGS, 7040FTRG, 7040FTRGCR, 7040GRG, 7040GRL, 7070CFG, 7070FTG, 7070FTGCR, 7070FTRG, 7070FTRGCR, 7070FTRRG, 7070GRG, 7070GRL, 7070TPFG, 7070TPG, 92BMG, 92CPG...(Other models you can see in the webshop)		

accessories for	104108		
	GEV No.	102382	Ref. No. 673.024.00
	nut thread M14x1 H 3.5mm WS 18 brass Qty 1 pcs		
	GEV No.	104105	Ref. No. —
	burner lower part for burner cap ø 80mm 3.5kW		
	GEV No.	104107	Ref. No. —
	burner lower part for burner cap ø 100mm 6.4kW		

			
1			
GEV No.	106520	Ref. No.	0600V01100
description	nozzle holder thread 3/8" L 53mm IT M10x1 nozzle mounting M10x1		
For models:	ACA2007, ACA2010, ACA201V, ACA202V, ACA203V, ACA204V, ACA206V, ACA207V, ACA208V, ACA209V, ACA210V, ACA216, ACA216V, ACJ0001, ACJ0002, ACJ0003, ACJ001V, ACJ002V, ACJ003V, ADA201V, ADA202V, ADA203V, ADA204V, ADA205V, ADA206V, ADA207V, ADA208V, ADA209V, ADA210V, ADA217V		
accessories for	106520		
	GEV No.	106521	Ref. No. 0600V01500
	air mixing sleeve L 30mm thread 3/8" IT		



			
1			
GEV No.	106773	Ref. No.	GS.3867
description	nozzle holder thread M18x1.5 ET 3/8" IT M13x1		
For models:	TP12JG, TP15JG		

miscellaneous			
			
1			
GEV No.	105575	Ref. No.	GS.1456
description	compression spring ø 23mm L 35mm wire gauge ø 1.5mm for air mixers		
For models:	AHA0001, AHA0002, AHA0003, AHA0005-NN, AHA0008-NN, AHA0009, AHA0011, AHA0013, AHA0014-NN, AHA0017, AHA0018, AHA0019, AHA0020, AHA0021-NN, AHB0001		

			
1			
GEV No.	693070	Ref. No.	611.312.00
description	lever for grill grid		
For models:	6540GRL, 6570GRL		

			
1			
GEV No.	105576	Ref. No.	GS.2851
description	ring nut		
For models:	AHA0001, AHA0002, AHA0003, AHA0005-NN, AHA0008-NN, AHA0009, AHA0011, AHA0013, AHA0014-NN, AHA0017, AHA0018, AHA0019, AHA0020, AHA0021-NN, AHB0001		

gas nozzles

main nozzles

gas nozzles 3/8"			
			
1			
GEV No.	100989	Ref. No.	GS.282C
description	gas injector T1: 3/8" T2: M12x1.25 WS 19 bore ø 1.4mm LPG pressure range 50mbar 10kW		
For models:	AHA0001, AHA0002, AHA0003, AHA0009, AHA0011, AHA0017, AHA0018, AHA0019, AHA0020, AHB0001		

			
1			
GEV No.	100990	Ref. No.	GS.282D
description	gas injector T1: 3/8" T2: M12x1.25 WS 19 bore ø 1.5mm LPG pressure range 50mbar 11kW		
For models:	AHA0001, AHA0002, AHA0003, AHA0011, AHB0001		

			
1			
GEV No.	100992	Ref. No.	GS.282E
description	gas injector T1: 3/8" T2: M12x1.25 WS 19 bore ø 1.6mm LPG pressure range 28-30/37mbar 10kW		
For models:	AHA0001, AHA0002, AHA0003, AHA0009, AHA0011, AHA0017, AHA0018, AHA0019, AHA0020, AHB0001		

			
1			
GEV No.	100991	Ref. No.	GS282F
description	gas injector T1: 3/8" T2: M12x1.25 WS 19 bore ø 1.7mm LPG pressure range 50mbar 13kW		
For models:	AHA0001, AHA0002, AHA0003, AHA0011, AHA0013, AHA0017, AHA0018, AHA0019, AHA0020, AHB0001		

			
1			
GEV No.	100993	Ref. No.	GS.282G
description	gas injector T1: 3/8" T2: M12x1.25 WS 19 bore ø 1.95mm LPG pressure range 28-30/37mbar 13kW		
For models:	AHA0001, AHA0002, AHA0003, AHA0011, AHA0013, AHB0001		

			
1			
GEV No.	106836	Ref. No.	GS.2830
description	gas injector T1: 3/8" T2: M12x1.25 WS 19 bore ø 2.1mm pressure range 50mbar		
For models:	AHA0011, AHA0013, AHB0001		

			
1			
GEV No.	100994	Ref. No.	GS.282H
description	gas injector T1: 3/8" T2: M12x1.25 WS 19 bore ø 2.35mm natural gas pressure range 20/25mbar 9.3kW		
For models:	AHA0001, AHA0002, AHA0003, AHA0009, AHA0011, AHA0017, AHA0018, AHA0019, AHA0020, AHB0001		

			
1			
GEV No.	100996	Ref. No.	GS.282M
description	gas injector T1: 3/8" T2: M12x1.25 WS 19 bore ø 2.6mm natural gas pressure range 25mbar		
For models:	AHA0008-NN, AHA0014-NN, AHA0021-NN		

			
1			
GEV No.	100997	Ref. No.	GS.282I
description	gas injector T1: 3/8" T2: M12x1.25 WS 19 bore ø 3.2mm natural gas pressure range 20/25mbar 15kW		
For models:	AHA0001, AHA0002, AHA0003, AHA0011, AHA0013, AHB0001		

			
1			
GEV No.	100995	Ref. No.	GS.282N
description	gas injector T1: 3/8" T2: M12x1.25 WS 19 bore ø 3.5mm natural gas pressure range 20mbar		
For models:	AHA0001, AHA0002, AHA0003, AHB0001		

gas nozzles M6x0.75

			
1			
GEV No.	106591	Ref. No.	X25800
description	gas injector thread M6x0.75 WS 7 bore ø 1.15mm		
For models:	ACB001V, ADB001V		

gas nozzles M10x1

			
1			
GEV No.	100641	Ref. No.	Y08600
description	gas injector thread M10x1 WS 11 bore ø 1.35mm inner peaked		
For models:	ACK2001, ACK2002, ACK201V, ACK202V		

			
1			
GEV No.	106306	Ref. No.	X29600
description	gas injector thread M10x1 WS 11 bore ø 1.45mm code 145		
For models:	ACH1003, ACH1004, ACH101V, ACH102V, ACH103V, ACH104V, ADH101V, ADH102V		

			
1			
GEV No.	106286	Ref. No.	Y30700
description	gas injector thread M10x1 WS 11 bore ø 1.55mm inner peaked		
For models:	ACA204V, ACA208V, ADK207V, ADK208V		

			
1			
GEV No.	100643	Ref. No.	Y08700
description	gas injector thread M10x1 WS 11 bore ø 1.5mm inner peaked		
For models:	ACE0001, ACE0002, ACE001V, ACE002V, ACE005V		

			
1			
GEV No.	102867	Ref. No.	Y09100
description	gas injector thread M10x1 WS 11 bore ø 1.65mm		
For models:	ADH307V, ADH308V, ADH309V, ADH310V, ADH311V, ADH312V		

			
1			
GEV No.	100644	Ref. No.	Y30800
description	gas injector thread M10x1 WS 11 bore ø 1.6mm inner peaked		
For models:	ADE001V, ADE002V		

			
1			
GEV No.	103328	Ref. No.	Y30000
description	gas injector thread M10x1 WS 11 bore ø 1mm		
For models:	ACA204V, ACA208V		

			
1			
GEV No.	106287	Ref. No.	Y31200
description	gas injector thread M10x1 WS 11 bore ø 2.2mm inner peaked		
For models:	ACH1003, ACH1004, ACH101V, ACH102V, ACH103V, ACH104V, ADH101V, ADH102V		

			
1			
GEV No.	106500	Ref. No.	Y08800
description	gas injector thread M10x1 WS 11 bore ø 2.3mm inner peaked		
For models:	ACE0001, ACE0002, ACE001V, ACE002V, ADL006V, ADL007V, ADL013V		

			
1			
GEV No.	106289	Ref. No.	Y31500
description	gas injector thread M10x1 WS 11 bore ø 2.45mm inner peaked		
For models:	ADE001V, ADE002V		

			
1			
GEV No.	100154	Ref. No.	Y30100
description	gas injector thread M10x1 bore ø 1.05mm L 30mm WS 12		
For models:	ADK209V, ADK210V		

			
1			
GEV No.	106650	Ref. No.	674.065.00
description	gas injector thread M10x1 bore ø 1.2mm L 30mm WS 12		
For models:	6540GRL, 6570GRL		

			
1			
GEV No.	101975	Ref. No.	67407200
description	gas injector thread M10x1 bore ø 1.55mm L 30mm WS 12		
For models:	92PLG, 94PLG		





			
1			
GEV No.	100157	Ref. No.	67408900
description	gas injector thread M10x1 bore ø 2.4mm L 30mm WS 12		
For models:	94BRG, 94BRGM, 96BRG, 96BRGM		

			
1			
GEV No.	106466	Ref. No.	X34000
description	gas injector thread M10x1 WS 12 bore ø 1.15mm		
For models:	ACH308V, ACH309V, ACH310V, ACH311V, ACH312V, ACH313V, ACH314V		

			
1			
GEV No.	100420	Ref. No.	674.003.00 X33600
description	gas injector thread M10x1 WS 11 bore ø 0.95mm		
For models:	65110CFG, 65110CFGE, 65110CFGG, 6540PCG, 6570CFG, 6570CFGE, 6570PCG, ACC0001, ACC0002, ACC001V, ACC002V, ACC006V, ACC007V, ADC001V, ADC002V, AFC0001, CEG110, CEG70		

			
1			
GEV No.	106490	Ref. No.	N/A X34200
description	gas injector thread M10x1 WS 11 bore ø 1.25mm		
For models:	ACA2007, ACA2010, ACA201V, ACA202V, ACA203V, ACA204V, ACA206V, ACA207V, ACA208V, ACA209V, ACA210V, ACA216, ACA216V, ACJ0001, ACJ0002, ACJ0003, ACJ001V, ACJ002V, ACJ003V, ADA201V, ADA202V, ADA203V, ADA204V, ADA205V, ADA206V, ADA207V, ADA208V, ADA209V, ADA210V, ADA217V		

			
1			
GEV No.	102704	Ref. No.	674.005.00
description	gas injector thread M10x1 WS 11 bore ø 1.2mm		
For models:	65110CFG, 65110CFGE, 65110CFGG, 6540FTG, 6540FTGCR, 6540FTRG, 6540FTRGCR, 6540PCG, 6570CFG, 6570CFGE, 6570FTG, 6570FTGCR, 6570FTRG, 6570FTRGCR, 6570FTRRG, 6570PCG, 92FRG20, 92FRG20S, 92PCG, 94CFG, 94CFGE, 94FRG20, 94FRG20S, 94PCG, 96CFG, 96CFGE, 96PCG, 98PCG, CEG110, CEG70		

			
1			
GEV No.	102774	Ref. No.	X34600
description	gas injector thread M10x1 WS 11 bore ø 1.45mm		
For models:	ACC0001, ACC0002, ACC001V, ACC002V, ACC006V, ACC007V, ADC001V, ADC002V		

			
1			
GEV No.	101997	Ref. No.	X34500
description	gas injector thread M10x1 WS 11 bore ø 1.4mm		
For models:	ADA206V, ADA207V, ADA209V, ADA211V		

			
1			
GEV No.	100793	Ref. No.	X34700
description	gas injector thread M10x1 WS 11 bore ø 1.5mm		
For models:	ACA2014, ACA2020, ACA214V, ACA220V, ACH3015, ACH3016, ACH315V, ACH316V, ACH317V, ADA201V, ADA202V, ADA203V, ADA204V, ADA205V, ADA206V, ADA207V, ADA208V, ADA209V, ADA210V, ADA213V, ADA217V		

			
1			
GEV No.	106440	Ref. No.	674.032.00 X35400
description	gas injector thread M10x1 WS 11 bore ø 1.85mm		
For models:	6540FTG, 6540FTGCR, 6540FTRG, 6540FTRGCR, 6570FTG, 6570FTGCR, 6570FTRG, 6570FTRGCR, 6570FTRRG, 7040FTG, 7040FTGCR, 7040FTGS, 7040FTRG, 7040FTRGCR, 7070FTG, 7070FTGCR, 7070FTRG, 7070FTRGCR, 7070FTRRG, ACA2007, ACA2010, ACA201V, ACA202V, ACA203V, ACA204V, ACA206V, ACA207V, ACA208V, ACA209V, ACA210V, ACA216, ACA216V, ACJ0001, ACJ0002, ACJ0003, ACJ001V, ACJ002V, ACJ003V, ADA201V, ADA202V, ADA203V, ADA204V, ADA205V, ADA206V, ADA207V, ADA208V, ADA209V, ADA210V, ADA217V		

			
1			
GEV No.	102984	Ref. No.	X35300
description	gas injector thread M10x1 WS 11 bore ø 1.8mm		
For models:	ACA2014, ACA2020, ACA214V, ACA220V, ADA213V		

			
1			
GEV No.	109116	Ref. No.	X33700
description	gas injector thread M10x1 WS 11 bore ø 1mm code 100		
For models:	ACA2014, ACA2020, ACA214V, ACA220V, ADA213V		

			
1			
GEV No.	106284	Ref. No.	X32700
description	gas injector thread M10x1 WS 11 bore ø 2.15mm		
For models:	ADA206V, ADA207V, ADA209V, ADA211V		

			
1			
GEV No.	106495	Ref. No.	X36000
description	gas injector thread M10x1 WS 11 bore ø 2.25mm		
For models:	ACH3015, ACH3016, ACH315V, ACH316V, ACH317V, ADA201V, ADA202V, ADA203V, ADA204V, ADA205V, ADA206V, ADA207V, ADA208V, ADA209V, ADA210V, ADA217V		

			
1			
GEV No.	106695	Ref. No.	674.070.00
description	gas injector thread M10x1 WS 12 bore ø 1.45mm L 30mm		
For models:	6540FRG, 6570FRG		

			
1			
GEV No.	100067	Ref. No.	Y35000
description	gas injector thread M10x1 WS 12 bore ø 1.1mm G30 gas pressure 30mbar		
For models:	ADC009V, ADC010V		

			
1			
GEV No.	107343	Ref. No.	Y35200
description	gas injector thread M10x1 WS 12 bore ø 1.2mm LPG gas pressure 30mbar		
For models:	ADC003V, ADC008V		

			
1			
GEV No.	106290	Ref. No.	Y35900
description	gas injector thread M10x1 WS 12 bore ø 1.85mm inner peaked		
For models:	ADC003V, ADC008V		

			
1			
GEV No.	106318	Ref. No.	X34100
description	gas injector thread M10x1 WS 12 bore ø 1.2mm		
For models:	ACA2014, ACA2020, ACA214V, ACA220V, ADA213V		

			
1			
GEV No.	100404	Ref. No.	X34400
description	gas injector thread M10x1 WS 12 bore ø 1.35mm		
For models:	ACA2007, ACA2010, ACA201V, ACA202V, ACA203V, ACA204V, ACA206V, ACA207V, ACA208V, ACA209V, ACA210V, ACA216, ACA216V, ACJ0001, ACJ0002, ACJ0003, ACJ001V, ACJ002V, ACJ003V, ADA202V, ADA203V, ADA204V, ADA205V, ADA206V, ADA207V, ADA208V, ADA209V, ADA210V, ADA217V		

			
1			
GEV No.	106501	Ref. No.	674.024.00
description	gas injector thread M10x1 WS 12 bore ø 1.45mm		
For models:	65110CFG, 65110CFGE, 65110CFGG, 65110TPFG, 6540PCG, 6570CFG, 6570CFGE, 6570PCG, CEG110, CEG70		

			
1			
GEV No.	106502	Ref. No.	674.007.00
description	gas injector thread M10x1 WS 12 bore ø 1.8mm		
For models:	65110CFG, 65110CFGE, 65110CFGG, 65110TPFG, 6540PCG, 6570CFG, 6570CFGE, 6570PCG, 6570TPFG, 70110CFG, 70110TPFG, 7070CFG, 7070TPFG, 92FRG20, 92FRG20S, 94FRG20, 94FRG20S, 94TPFG, 94TPG, 96TPFG, CEG110, CEG70		



			
1			
GEV No.	100629	Ref. No.	X35700
description	gas injector thread M10x1 WS 12 bore ø 2mm		
For models:	ACA2007, ACA2010, ACA201V, ACA202V, ACA203V, ACA204V, ACA206V, ACA207V, ACA208V, ACA209V, ACA210V, ACA216, ACA216V, ACJ0001, ACJ0002, ACJ0003, ACJ001V, ACJ002V, ACJ003V, ADA202V, ADA203V, ADA204V, ADA205V, ADA206V, ADA207V, ADA208V, ADA209V, ADA210V, ADA217V		

			
1			
GEV No.	100108	Ref. No.	92210370
description	gas injector thread M13x1 bore ø 1.6mm WS 13		
For models:	CAA0003, CAA0004, CAA0005		

			
1			
GEV No.	102779	Ref. No.	GS.2869
description	gas injector thread M10x1 WS 13 bore ø 1.75mm		
For models:	TP12JG		

			
1			
GEV No.	102788	Ref. No.	PD.2267
description	gas injector thread M13x1 bore ø 1.75mm WS 13		
For models:	AMZ0001-NM		

			
1			
GEV No.	107828	Ref. No.	C5812680
description	gas injector thread M10x1 WS 12 bore ø 1.9mm GLP		
For models:	5305-CN, AJD0017-C, AJD0023-C, AJD0030, AJD0031, AJD0032		

			
1			
GEV No.	102783	Ref. No.	92210371
description	gas injector thread M13x1 bore ø 1.8mm WS 13		
For models:	CAA0003, CAA0004, CAA0005		

gas nozzles M13x1			
			
1			
GEV No.	102780	Ref. No.	GS.2870
description	gas injector thread M13x1 bore ø 1.15mm WS 13		
For models:	TP12JG, TP12JGP, TP15JG, TP15JGP		

			
1			
GEV No.	102781	Ref. No.	GS.2877
description	gas injector thread M13x1 bore ø 1.95mm WS 13		
For models:	TP15JG		

			
1			
GEV No.	102786	Ref. No.	PD.2265
description	gas injector thread M13x1 bore ø 1.2mm WS 13		
For models:	AMZ0001-NM		

			
1			
GEV No.	100389	Ref. No.	92210372
description	gas injector thread M13x1 bore ø 1.9mm WS 13		
For models:	CAA0003, CAA0004, CAA0005		

			
1			
GEV No.	102823	Ref. No.	GS.2868
description	gas injector thread M13x1 bore ø 1.35mm WS 13		
For models:	TP12JG, TP12JGP, TP15JG, TP15JGP		

			
1			
GEV No.	102824	Ref. No.	GS.2859
description	gas injector thread M13x1 bore ø 1mm WS 13		
For models:	TP15JG		



1

GEV No.	100417	Ref. No.	92210373
description	gas injector thread M13x1 bore ø 2.15mm WS 13		
For models:	CAA0003, CAA0004, CAA0005		



1

GEV No.	102789	Ref. No.	92210374
description	gas injector thread M13x1 bore ø 2.45mm WS 13		
For models:	CAA0003, CAA0004, CAA0005		



1

GEV No.	100710	Ref. No.	92210375
description	gas injector thread M13x1 bore ø 2.85mm WS 13		
For models:	CAA0003, CAA0004, CAA0005		



1

GEV No.	100722	Ref. No.	92210376
description	gas injector thread M13x1 bore ø 2.95mm WS 13		
For models:	CAA0003, CAA0004, CAA0005		



1

GEV No.	100866	Ref. No.	92210377
description	gas injector thread M13x1 bore ø 3.1mm WS 13		
For models:	CAA0003, CAA0004, CAA0005		



1

GEV No.	100923	Ref. No.	92210378
description	gas injector thread M13x1 bore ø 3.4mm WS 13		
For models:	CAA0003, CAA0004, CAA0005		



1

GEV No.	106272	Ref. No.	92210379
description	gas injector thread M13x1 bore ø 3.55mm WS 13		
For models:	CAA0003, CAA0004, CAA0005		



1

GEV No.	106274	Ref. No.	92210381
description	gas injector thread M13x1 bore ø 3.75mm WS 13		
For models:	CAA0003, CAA0004, CAA0005		



1

GEV No.	106273	Ref. No.	92210380
description	gas injector thread M13x1 bore ø 3.7mm WS 13		
For models:	CAA0003, CAA0004, CAA0005		



1

GEV No.	106275	Ref. No.	92210382
description	gas injector thread M13x1 bore ø 3.8mm WS 13		
For models:	CAA0003, CAA0004, CAA0005		



1

GEV No.	106276	Ref. No.	92210383
description	gas injector thread M13x1 bore ø 4.1mm WS 13		
For models:	CAA0003, CAA0004, CAA0005		

pilot burner nozzles

pilot burner nozzles ROBERTSHAW



1

GEV No.	106105	Ref. No.	GS.2187A
description	pilot burner nozzle LPG code 16 suitable for ROBERTSHAW		
For models:	AMZ0001-NM		





			
1			
GEV No.	100277	Ref. No.	GS.2187B
description	pilot burner nozzle natural gas code 26 suitable for ROBERTSHAW		
For models:	AMZ0001-NM		

pilot burner nozzles SIT

100 series

			
1			
GEV No.	100245	Ref. No.	GC.1001 SP.385F X19906
description	pilot burner nozzle LPG code 20 bore ø 0.2mm Qty 1 pcs thread M8x0.75		
For models:	ACA2013, ACA2014, ACA2020, ACA213V, ACA214V, ACA220V, ACB001V, ACC0001, ACC0002, ACC001V, ACC002V, ACC006V, ACC007V, ACE0001, ACE0002, ACE001V, ACE002V, ACH1003, ACH1004, ACH101V, ACH102V, ACH103V, ACH104V, ACJ0004, ACJ004V, ACK2001, ACK2002, ACK201V, ACK202V, ACL0001, ACL0003, ACL001V, ACL003V, ADA206V, ADA207V, ADA209V, ADA211V, ADA212V, ADA213V, ADB001V, ADC001V, ADC002V, ADE001V, ADE002V, ADH101V, ADH102V, ADL006V, ADL007V, ADL013V, AHA0001...(Other models you can see in the webshop)		

			
1			
GEV No.	100246	Ref. No.	672.059.00 GS.3828 SP.385C X19907
description	pilot burner nozzle natural gas bore ø 0.35mm Qty 1 pcs thread M8x0.75		
For models:	65110TPFG, 6570TPFG, 6570TPG, 70110CFG, 70110CFGE, 70110PCG, 70110TPFG, 7040PCG, 7070CFG, 7070CFGE, 7070PCG, 92PCG, 94CFG, 94CFGE, 94PCG, 96CFG, 96CFGE, 96PCG, 96TPFG, 98PCG, ACA2013, ACA2014, ACA2020, ACA213V, ACA214V, ACA220V, ACB001V, ACC0001, ACC0002, ACC001V, ACC002V, ACC006V, ACC007V, ACE0001, ACE0002, ACE001V, ACE002V, ACH1003, ACH1004, ACH101V, ACH102V, ACH103V, ACH104V, ACJ0004, ACJ004V, ACK2001, ACK2002, ACK201V, ACK202V, ACL0001...(Other models you can see in the webshop)		

			
1			
GEV No.	102973	Ref. No.	X19909
description	pilot burner nozzle natural gas bore ø 0.45mm Qty 1 pcs		
For models:	ADC003V, ADC008V, ADC009V, ADC010V		

140/150 series

			
1			
GEV No.	100205	Ref. No.	674.001.00 X30000
description	pilot burner nozzle SIT LPG code 19 bore ø 0.23/0.26mm Qty 1 pcs suitable for SIT 150 series		
For models:	110170CFG, 6030FTG, 6060FTG, 6060FTRG, 6060FTRR, 6540FTG, 6540FTGCR, 6540FTRG, 6540FTRGCR, 6540GRG, 6570FTG, 6570FTGCR, 6570FTRG, 6570FTRGCR, 6570FTRR, 6570GRG, 7040CPG, 7040FTG, 7040FTGCR, 7040FTGS, 7040FTRG, 7040FTRGCR, 7040GRG, 7040GRL, 7070FTG, 7070FTGCR, 7070FTRG, 7070FTRGCR, 7070FTRR, 7070GRG, 7070GRL, 7070PGI, 92BMG, 92CPG, 92CPGS, 92FTGL, 92FTGLC, 92FTGR, 92FTGRC, 92PLG, 94CPGS, 94FTGL, 94FTGLC, 94FTGLR, 94FTGLRC, 94FTGR, 94FTGRC, 94PG100I, 94PG100IA, 94PG150I...(Other models you can see in the webshop)		

			
1			
GEV No.	100207	Ref. No.	67409100 GS.3829 X30300
description	pilot burner nozzle SIT natural gas code 27 bore ø 0.40/0.38mm suitable for SIT 140 series		
For models:	7040GRG, 7040GRL, 7070BRG, 7070BRGM, 7070GRG, 7070GRL, 92FRG20, 92FRG20S, 94FRG20, 94FRG20S, ACA2007, ACA2010, ACA201V, ACA202V, ACA203V, ACA204V, ACA206V, ACA207V, ACA208V, ACA209V, ACA210V, ACA216, ACA216V, ACJ0001, ACJ0002, ACJ0003, ACJ001V, ACJ002V, ACJ003V, ADA201V, ADA202V, ADA203V, ADA204V, ADA205V, ADA206V, ADA207V, ADA208V, ADA209V, ADA210V, ADA217V, NYG1420		

			
1			
GEV No.	100206	Ref. No.	674.000.00 X30100
description	pilot burner nozzle SIT natural gas code 36 bore ø 0.60/0.55mm Qty 1 pcs suitable for SIT 150 series		
For models:	110170CFG, 6030FTG, 6060FTG, 6060FTRG, 6060FTRR, 6540FTG, 6540FTGCR, 6540FTRG, 6540FTRGCR, 6540GRG, 6570FTG, 6570FTGCR, 6570FTRG, 6570FTRGCR, 6570FTRR, 6570GRG, 7040CPG, 7040FTG, 7040FTGCR, 7040FTGS, 7040FTRG, 7040FTRGCR, 7070FTG, 7070FTGCR, 7070FTRG, 7070FTRGCR, 7070FTRR, 7070GRL, 92BMG, 92CPG, 92CPGS, 92FTGL, 92FTGLC, 92FTGR, 92FTGRC, 92PLG, 94CPGS, 94FTGL, 94FTGLC, 94FTGLR, 94FTGLRC, 94FTGR, 94FTGRC, 94PG100I, 94PG100IA, 94PG150I, 94PG150IA, 94PLG, ACA2012, ACA212V...(Other models you can see in the webshop)		

160 series

			
1			
GEV No.	107650	Ref. No.	674.052.00
description	pilot burner nozzle SIT LPG code 30 Qty 1 pcs		
For models:	6030FRG, 6060FRG, 6540FRG, 6570FRG, 7040FRG13, 7070FRG13, AFC0001		



1

GEV No.	107175	Ref. No.	674.051.00
description	pilot burner nozzle SIT natural gas code 51 Qty 1 pcs suitable for 160 series		
For models:	6030FRG, 6060FRG, 6540FRG, 6570FRG, 7040FRG13, 7070FRG13, AFC0001		

bypass nozzles

bypass nozzles PEL20/21



1

GEV No.	100554	Ref. No.	X11000
description	bypass nozzle type PEL20/21 bore ø 0.45mm thread M5x0.5		
For models:	ACA2014, ACA2020, ACA214V, ACA220V, ADA213V		



1

GEV No.	100550	Ref. No.	X11100
description	bypass nozzle type PEL20/21 bore ø 0.55mm thread M5x0.5		
For models:	ACA2020, ACA220V		



1

GEV No.	100278	Ref. No.	X04800
description	bypass nozzle type PEL20/21 bore ø 0.75mm thread M5x0.5		
For models:	ACA2007, ACA2010, ACA2014, ACA201V, ACA2020, ACA202V, ACA203V, ACA204V, ACA206V, ACA207V, ACA208V, ACA209V, ACA210V, ACA214V, ACA216, ACA216V, ACA220V, ACJ0001, ACJ0002, ACJ0003, ACJ001V, ACJ002V, ACJ003V, ADA201V, ADA202V, ADA203V, ADA204V, ADA205V, ADA206V, ADA207V, ADA208V, ADA209V, ADA210V, ADA213V, ADA217V		



1

GEV No.	100556	Ref. No.	GS.3687
description	bypass nozzle type PEL20/21 bore ø 0.95mm thread M5x0.5		
For models:	AHA0011		



1

GEV No.	100528	Ref. No.	X10600
description	bypass nozzle type PEL20/21 bore ø 0.9mm thread M5x0.5		
For models:	ACH308V, ACH309V, ACH310V, ACH311V, ACH312V, ACH313V, ACH314V		

auxiliary gas parts

screw connections

double nipples



1



GEV No.	106786	Ref. No.	GS.1071
description	double nipple T1: 3/4" T2: 3/4"		
For models:	AHA0009		

olives





1

GEV No.	101278	Ref. No.	673.001.00
description	olive for pipe ø 10mm Qty 1 pcs		
For models:	110160PCG, 110170CFG, 6030FTG, 6060FTG, 6060FTRG, 6060FTRRG, 65110CFG, 65110CFGE, 65110CFGG, 65110TPFG, 6540FRG, 6540FTG, 6540FTGCR, 6540FTRG, 6540FTRGCR, 6540GRG, 6540GRL, 6540PCG, 6540PG40P, 6570CFG, 6570CFGE, 6570FRG, 6570FTG, 6570FTGCR, 6570FTRG, 6570FTRGCR, 6570FTRRG, 6570GRG, 6570GRL, 6570PCG, 6570TPFG, 6570TPG, 70110CFG, 70110CFGE, 70110PCG, 70110TPFG, 7040CPE, 7040CPG, 7040FTG, 7040FTGCR, 7040FTGS, 7040FTRG, 7040FTRGCR, 7040GRG, 7040GRL, 7040PCG, 7070CFG, 7070CFGE, 7070CPE, 7070CPG...(Other models you can see in the webshop)		



accessories for	101278			
	GEV No.	100943	Ref. No.	—
	union nut thread M17x1 tube ø 10mm			
	GEV No.	101300	Ref. No.	—
	union nut thread M16x1.5 tube ø 10mm			
	GEV No.	101478	Ref. No.	—
	union nut thread 3/8" for pipe ø 10mm			





1

GEV No.	101273	Ref. No.	673.006.00 67300800	
description	olive for pipe ø 12mm L 9.5mm brass Qty 1 pcs suitable for universal			
For models:	6030FRG, 6060FRG, 6540FRG, 6570FRG, 7040FRG13, 7070BRG, 7070BRGM, 7070FRG13, 7070PGI, 92FRG20, 92FRG20S, 94BRG, 94FRG20, 94FRG20S, 96BRG, 96BRGM, AFC0001			
accessories for	101273			
	GEV No.	100944	Ref. No.	—
	union nut thread M18x1.5 for pipe ø 12mm			
	GEV No.	101276	Ref. No.	—
	union screw thread 3/8" tube ø 12mm Qty 1 pcs			





			
1			
GEV No.	101256	Ref. No.	67302700
description	olive for pipe ø 16mm Qty 1 pcs		
For models:	94PG100I, 94PG100IA, 94PG150I, 94PG150IA		
accessories for	101256		
	GEV No.	101253	Ref. No. 67302800
union nut thread M24x1.5 PEL for pipe ø 16mm			



			
1			
GEV No.	101246	Ref. No.	673.004.00
description	olive for pipe ø 4mm Qty 1 pcs		
For models:	110160PCG, 110170CFG, 6030FTG, 6060FTG, 6060FTRG, 6060FTRRG, 65110TPFG, 6540FTG, 6540FTGCR, 6540FTRG, 6540FTRGCR, 6540GRG, 6540GRL, 6540PG40P, 6570FTG, 6570FTGCR, 6570FTRG, 6570FTRGCR, 6570FTRRG, 6570GRG, 6570GRL, 6570TPFG, 6570TPG, 70110CFG, 70110CFGE, 70110PCG, 70110TPFG, 7040CPG, 7040FTG, 7040FTGCR, 7040FTGS, 7040FTRG, 7040FTRGCR, 7040GRG, 7040GRL, 7040PCG, 7070BRG, 7070BRGM, 7070CFG, 7070CFGE, 7070CPG, 7070FTG, 7070FTGCR, 7070FTRG, 7070FTRGCR, 7070FTRRG, 7070GRG, 7070GRL, 7070PCG, 7070PGI...(Other models you can see in the webshop)		
accessories for	101246		
	GEV No.	100908	Ref. No. 673.013.00 X13200
union screw thread M10x1 for pipe ø 4mm Qty 1 pcs			

			
1			
GEV No.	100897	Ref. No.	673.003.00
description	olive for pipe ø 4mm Qty 1 pcs for pilot burner		
For models:	110170CFG, 6030FTG, 6060FTG, 6060FTRG, 6060FTRRG, 6540FTG, 6540FTGCR, 6540FTRG, 6540FTRGCR, 6570FTG, 6570FTGCR, 6570FTRG, 6570FTRGCR, 6570FTRRG, 7040CPG, 7040FTG, 7040FTGCR, 7040FTGS, 7040FTRG, 7040FTRGCR, 7040GRG, 7040GRL, 7070BRG, 7070BRGM, 7070CPG, 7070FTG, 7070FTGCR, 7070FTRG, 7070FTRGCR, 7070FTRRG, 7070GRG, 7070GRL, 7070PGI, 92BMG, 92CPG, 92CPGS, 92FTGL, 92FTGLC, 92FTGR, 92FTGRC, 92PCG, 92PLG, 94CFG, 94CFGE, 94CPG, 94CPGS, 94FTGL, 94FTGLC, 94FTGLR, 94FTGLRC...(Other models you can see in the webshop)		

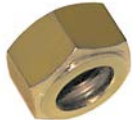
			
1			
GEV No.	100870	Ref. No.	673.007.00
description	olive for pipe ø 4mm Qty 1 pcs suitable for 160 series for pilot burner		
For models:	6030FRG, 6060FRG, 6540FRG, 6570FRG, 7040FRG13, 7070FRG13, 92FRG20, 92FRG20S, 94BRG, 94BRGM, 94FRG20, 94FRG20S, 94TPFG, 94TPG, 96BRG, 96BRGM, 96TPFG, AFC0001		

T-pieces			
			
1			
GEV No.	101833	Ref. No.	062155
description	T-piece		
For models:	AJE0006, AJE0007		

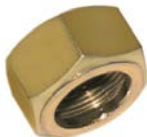
union nuts			
			
1			
GEV No.	101253	Ref. No.	67302800
description	union nut thread M24x1.5 PEL for pipe ø 16mm		
For models:	94PG100I, 94PG100IA, 94PG150I, 94PG150IA		
accessories for	101253		
	GEV No.	101256	Ref. No. 67302700
olive for pipe ø 16mm Qty 1 pcs			

			
1			
GEV No.	101254	Ref. No.	67303000
description	union nut thread M28x1.5 tube ø 20mm		
For models:	94PG100I, 94PG100IA, 94PG150I, 94PG150IA		
accessories for	101254		
	GEV No.	101257	Ref. No. —
olive for pipe ø 20mm Qty 1 pcs			

union screws			
			
1			
GEV No.	100905	Ref. No.	SP.385E
description	locking screw M10x1 for pipe ø 6mm Qty 1 pcs		
For models:	AHA0001, AHA0002, AHA0003, AHB0001		



1





GEV No.	100906	Ref. No.	673.014.00
description	screw connection thread M10x1 for ignition electrode brass Qty 1 pcs WS 10		
For models:	110170CFG, 6030FRG, 6030FTG, 6060FRG, 6060FTG, 6060FTRG, 6060FTRRG, 6540FRG, 6540FTG, 6540FTGCR, 6540FTRG, 6540FTRGCR, 6540GRG, 6570FRG, 6570FTG, 6570FTGCR, 6570FTRG, 6570FTRGCR, 6570FTRRG, 6570GRG, 7040CPG, 7040FRG13, 7040FTG, 7040FTGCR, 7040FTGS, 7040FTRG, 7040FTRGCR, 7040GRG, 7040GRL, 7070BRG, 7070BRGM, 7070CPG, 7070FRG13, 7070FTG, 7070FTGCR, 7070FTRG, 7070FTRGCR, 7070FTRRG, 7070GRG, 7070GRL, 7070PGI, 92BMG, 92CPG, 92CPGS, 92FRG20, 92FRG20S, 92FTGL, 92FTGLC, 92FTGR, 92FTGRC...(Other models you can see in the webshop)		



1

GEV No.	100908	Ref. No.	673.013.00 X13200
description	union screw thread M10x1 for pipe ø 4mm Qty 1 pcs		
For models:	110160PCG, 110170CFG, 6030FRG, 6030FTG, 6060FRG, 6060FTG, 6060FTRG, 6060FTRRG, 65110TPFG, 6540FRG, 6540FTG, 6540FTGCR, 6540FTRG, 6540FTRGCR, 6540GRG, 6540GRL, 6540PG40P, 6570FRG, 6570FTG, 6570FTGCR, 6570FTRG, 6570FTRGCR, 6570FTRRG, 6570GRG, 6570GRL, 6570TPFG, 6570TPG, 70110CFG, 70110CFGE, 70110PCG, 70110TPFG, 7040CPG, 7040FRG13, 7040FTG, 7040FTGCR, 7040FTGS, 7040FTRG, 7040FTRGCR, 7040GRG, 7040GRL, 7040PCG, 7070BRG, 7070BRGM, 7070CFG, 7070CFGE, 7070CPG, 7070FRG13, 7070FTG, 7070FTGCR, 7070FTRG...(Other models you can see in the webshop)		

accessories for 100908

	GEV No.	100897	Ref. No.	673.003.00
	olive for pipe ø 4mm Qty 1 pcs for pilot burner			
	GEV No.	101246	Ref. No.	673.004.00
	olive for pipe ø 4mm Qty 1 pcs			
	GEV No.	101280	Ref. No.	—
	olive for pipe ø 4mm Qty 1 pcs			
	GEV No.	101282	Ref. No.	—
	olive for pipe ø 4mm L 7.4mm Qty 1 pcs			



1

GEV No.	101477	Ref. No.	673.034.00
description	union screw thread M13x1 tube ø 8mm Qty 1 pcs		
For models:	6030PCG, 6060CFG, 6060CFGE, 6060PCG		

locking screws



1

GEV No.	105562	Ref. No.	GS.4232
description	blind screw connection 3/8"		
For models:	AHA0001, AHA0002, AHA0003, AHA0017, AHA0018, AHA0019, AHA0020		

angle pieces



1

GEV No.	106787	Ref. No.	GS.1161
description	angle piece T1: 3/4" T2: 3/4"		
For models:	AHA0009		



1

GEV No.	106776	Ref. No.	GS.4513
description	elbow screw joint T1: 1/4" T2: 1/8"		
For models:	AHA0009		



1

GEV No.	106283	Ref. No.	X68042
description	nozzle holder nozzle M6 M10x1 screw pipe fitting 1/4" tube ø 6mm		
For models:	ACB001V, ADB001V		

accessories



1

GEV No.	693439	Ref. No.	GS.4325
description	bush for wok		
For models:	AHA0009		



1

GEV No.	693434	Ref. No.	GS.4326
description	connecting piece for wok		
For models:	AHA0009		



gas lines

main gas lines

producer-specific



1

GEV No.	109204	Ref. No.	631.196.00
description	gas line tube ø 6mm L 255mm W 70mm connection with screw connection for kettle for pressure switch		

pressure switches

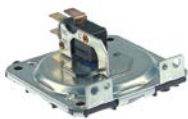

1



GEV No.	541348	Ref. No.	ELET0130
description	pressure control gas technology connection male faston 6.3mm suitable for ZANOLLI		
For models:	CAD0007, CAD0010, SY12100VGASD, SY1280VG		



1

GEV No.	542115	Ref. No.	ELET0641
description	pressure control ø 65mm pressure range 0.17-0.75mbar connection 6.8mm pressure connection ø 6.8mm		
For models:	CAD0007, CAD0010, SY12100VGASD, SY1280VG		

accessories for 542115

	GEV No.	542366	Ref. No.	—
bracket for pressure switches				
	GEV No.	542367	Ref. No.	SUPP0414
bracket for pressure switches				
	GEV No.	560521	Ref. No.	—
sheet-metal screw ø 4mm L 10mm SS Qty 1 pcs 14585 intake Phillips head ø 8mm				

consumables

lava rocks / ceramic briquettes



1

GEV No.	105342	Ref. No.	M30500
description	lava rocks content 9kg		
For models:	ACH1003, ACH1004, ACH101V, ACH102V, ACH103V, ACH104V, ADH101V, ADH102V		

equipment-specific units

for slicers

covers

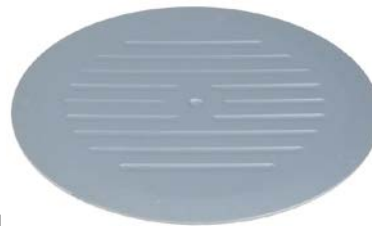

1

GEV No.	697749	Ref. No.	00000000490
description	blade covering ø 209mm for knife ø 250mm mounting thread M6 fixing dimensions 12x12mm aluminium		
For models:	8921		



1

GEV No.	697744	Ref. No.	00000000403
description	blade covering ø 248mm for knife ø 300mm mounting thread M6 fixing dimensions 12x12mm aluminium		
For models:	8922		



1

GEV No.	694826	Ref. No.	19510235
description	blade covering ø 255mm for knife ø 300mm mounting ø 17		
For models:	MIRRA300		
accessories for	694826		

	GEV No.	698242	Ref. No.	—
threaded bush L 18mm for slicer ET M12 IT M6				

handles



1

GEV No.	696267	Ref. No.	19021110
description	mushroom cap handle thread M4 ø 16mm L 18.5mm aluminium slicer		
For models:	FEB0009-SNT, FEB0010-SNT, FEB0031, FEB0033, FEB0034, FEB0035, PALLADIO300AM, PALLADIO300T, PALLADIO330T, PALLADIO350AM		

sliding plates

hand guard



1



GEV No.	696252	Ref. No.	19563002
description	protector ø 68mm ID ø 18mm thickness 10mm for sliding plate		
For models:	MIRRA300		

locking screws

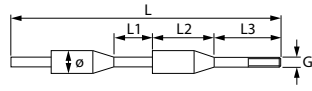

1



GEV No.	697740	Ref. No.	19530532	
description	locking screw thread M6 L 185mm ø 10mm D1 ø 10mm L2 18mm L3 18mm			
For models:	FEB0031			
accessories for	697740			
	GEV No.	111054	Ref. No.	—
	star handle thread M6 ø 40mm L 29mm blue			
	GEV No.	698200	Ref. No.	19562502
	star handle thread M6 ø 40mm L 29mm black			



1

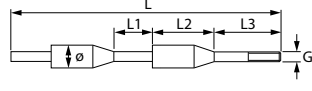

GEV No.	696230	Ref. No.	19530507
description	locking screw thread M8 L 235mm ø 10mm D1 ø 10mm without handle		
For models:	PALLADIO300AM, PALLADIO300T, PALLADIO350AM		

handles



1

GEV No.	698200	Ref. No.	19562502
description	star handle thread M6 ø 40mm L 29mm black		
For models:	MIRRA300, PALLADIO300AM, PALLADIO350AM		



1

GEV No.	697443	Ref. No.	19562504
description	star handle thread M8 ø 50mm L 29mm black		
For models:	FEB0031, MIRRA300		

adjustment knobs



1

GEV No.	697419	Ref. No.	0000000130
description	adjusting knob 0-15 ø 55mm shaft ø 12mm shaft L 28mm handle ø 42mm 250		
For models:	8920, 8921, 8922		



1

GEV No.	697510	Ref. No.	19562402
description	adjusting knob 0-15 ø 60mm shaft ø 12mm shaft L 32mm		
For models:	FEB0031, MIRRA300		

eccentric disc for slice thickness





1

GEV No.	697470	Ref. No.	0000000830
description	eccentrics for cutting thickness hole ø 12mm groove width 6mm ED ø 52mm thickness 21.5mm		
For models:	8920		



			
1			
GEV No.	697756	Ref. No.	19563505LG
description	eccentrics for cutting thickness hole ø 12mm groove width 6mm ED ø 56mm thickness 10mm		
For models:	FEB0031, MIRRA300		

			
1			
GEV No.	697471	Ref. No.	00000000379
description	eccentrics for cutting thickness hole ø 12mm groove width 6mm ED ø 58mm thickness 21mm		
For models:	8921, 8922		

springs			
			
1			
GEV No.	696209	Ref. No.	19390205
description	compression spring ø 13.5mm L 92mm wire gauge ø 1.4mm slicer		
For models:	PALLADIO300AM, PALLADIO350AM		

			
1			
GEV No.	696210	Ref. No.	19390600
description	compression spring ø 14mm L 16mm wire gauge ø 1.2mm slicer 220-250		
For models:	FEB0031, MIRRA300		

spring washers			
			
1			
GEV No.	696253	Ref. No.	19342005
description	spring washer ID ø 12mm ED ø 25mm Qty 1 pcs		
For models:	FEB0031, MIRRA300		

			
1			
GEV No.	696254	Ref. No.	19342006
description	spring washer ID ø 19mm ED ø 32mm Qty 1 pcs		
For models:	FEB0009-SNT, FEB0010-SNT, FEB0033, FEB0034, FEB0035, PALLADIO300AM, PALLADIO300T, PALLADIO330T, PALLADIO350AM		

guiding pieces

for sliding plates

			
1			
GEV No.	697483	Ref. No.	00000000117
description	guide 195		
For models:	8920		

			
1			
GEV No.	697448	Ref. No.	00000009177
description	guide 220-250		
For models:	8921, 8922		

			
1			
GEV No.	697477	Ref. No.	00000000126
description	connection plate L 75mm W 15mm		
For models:	8920, 8921, 8922		

for carriage

			
1			
GEV No.	696510	Ref. No.	00000009466
description	guide 220		
For models:	8920		

			
1			
GEV No.	696289	Ref. No.	19534029
description	knurled nut for carriage thread M22 ø 32mm chrome-plated 220-250 Qty 1 pcs WS H 7mm		
For models:	FEB0031, MIRRA300		

			
1			
GEV No.	696832	Ref. No.	19565001
description	pressure pin L 8mm ø 5mm Qty 5 pcs		
For models:	FEB0009-SNT, FEB0010-SNT, FEB0031, FEB0033, FEB0034, FEB0035, MIRRA300, PALLADIO300AM, PALLADIO300T, PALLADIO330T, PALLADIO350AM		

			
1			
GEV No.	696231	Ref. No.	19534034
description	spindle thread M8 L 32mm ø 10.5mm 220-250		
For models:	FEB0031, MIRRA300		

			
1			
GEV No.	696288	Ref. No.	19534024
description	threaded bush thread M22 L 20mm ID ø 11mm 220-250		
For models:	FEB0031, MIRRA300		

			
1			
GEV No.	696278	Ref. No.	19533200
description	threaded plate thread M6 L 36mm W 15mm hole distance 18mm thickness 4mm		
For models:	FEB0009-SNT, FEB0010-SNT, FEB0031, FEB0033, FEB0034, FEB0035, MIRRA300, PALLADIO300AM, PALLADIO300T, PALLADIO330T, PALLADIO350AM		

bushes

			
1			
GEV No.	696709	Ref. No.	19324102
description	bush ED ø 14mm ID ø 12mm H 12mm bronze		
For models:	FEB0009-SNT, FEB0010-SNT, FEB0031, MIRRA300, PALLADIO300AM, PALLADIO300T, PALLADIO330T, PALLADIO350AM		

			
1			
GEV No.	698626	Ref. No.	0000000119
description	bush ED ø 18mm ID ø 16mm H 15mm		
For models:	8921, 8922		

			
1			
GEV No.	696283	Ref. No.	19324108
description	bush for carriage ED ø 20mm ID ø 18mm H 20mm bronze		
For models:	FEB0009-SNT, FEB0010-SNT, FEB0033, FEB0034, FEB0035, PALLADIO300AM, PALLADIO300T, PALLADIO330T, PALLADIO350AM		

housings

bottom parts

			
1			
GEV No.	696512	Ref. No.	0000000504
description	bottom plate 220		
For models:	8920		

			
1			
GEV No.	698393	Ref. No.	0000000701
description	bottom plate L 409mm W 174mm plastic		
For models:	8921, 8922		

hand guard

			
1			
GEV No.	697446	Ref. No.	407
description	hand protection food holder 300 H 300mm W 163mm thickness 5.4mm mounting distance 110mm		



			
1			
GEV No.	698312	Ref. No.	19562336
description	hand protection for carriage 300-370 H 275mm W 297mm thickness 10mm mounting distance 248mm plexiglas		
For models:	FEB0033, FEB0034, FEB0035		

			
1			
GEV No.	697826	Ref. No.	00000000924
description	hand protection for slicer		
For models:	8921		

			
1			
GEV No.	698964	Ref. No.	00000000482
description	hand protection for slicer 195-220		
For models:	8920		

			
1			
GEV No.	698574	Ref. No.	19562342
description	hand protection for slicer H 280mm W 150mm thickness 5mm hole ø 10mm mounting distance 95mm plastic		
For models:	FEB0009-SNT, FEB0010-SNT, PALLADIO300AM, PALLADIO300T, PALLADIO330T, PALLADIO350AM		

accessories

			
1			
GEV No.	697482	Ref. No.	00000000446
description	screw thread M5 ø 8mm L 15mm		
For models:	8920, 8921		

			
1			
GEV No.	697481	Ref. No.	00000000623
description	Thumb screw thread M6 thread L 8mm ø 14mm H 6mm SS		
For models:	8920		

food holders

handles

			
1			
GEV No.	698195	Ref. No.	19562905
description	cone handle thread M10 ø 29mm L 82mm black		
For models:	FEB0031		

			
1			
GEV No.	697432	Ref. No.	00000000825
description	cone handle thread M6 ø 26mm plastic L 70mm thread L 6mm		
For models:	8921, 8922		

			
1			
GEV No.	111123	Ref. No.	19562904 19564021
description	handle thread M10 IT ø 30mm L 110mm D1 ø 65mm		
For models:	FEB0031, MIRRA300, PALLADIO300AM, PALLADIO350AM		

food holders

			
1			
GEV No.	698418	Ref. No.	00000009878
description	food holder L 240mm hole ø 12mm handle M6 with handle		
For models:	8922		

accessories

			
1			
GEV No.	698630	Ref. No.	00000000827
description	spike food holder ø 3mm L 11.5mm		
For models:	8921, 8922		

			
1			
GEV No.	697480	Ref. No.	00000000151
description	stop bolt food holder ø 7.5mm L 8mm plastic		
For models:	8921, 8922		

blades

pullers

			
1			
GEV No.	697531	Ref. No.	19702508
description	puller for knife ø 300mm hole distance 160mm thread M8		
For models:	FEB0009-SNT, FEB0033, FEB0034, FEB0035, MIRRA300, PALLADIO300AM, PALLADIO300T		

			
1			
GEV No.	697532	Ref. No.	19702512
description	puller for knife ø 357mm hole distance 160mm thread M8		
For models:	FEB0010-SNT, PALLADIO350AM		

PTFE

			
1			
GEV No.	697547	Ref. No.	18275403218TF
description	slicing machine blade ED ø 275mm seat ø 40mm 3-hole ID ø 218mm H 21.5mm PTFE 100Cr6		
For models:	FEB0031		

			
1			
GEV No.	698210	Ref. No.	1830057425422TF
description	slicing machine blade ED ø 300mm seat ø 57mm 4 hole ID ø 254mm H 22.5mm PTFE 100Cr6		
For models:	FEB0009-SNT, PALLADIO300AM, PALLADIO300T		

standard

			
1			
GEV No.	697436	Ref. No.	00000000855
description	slicing machine blade ED ø 220mm seat ø 40mm 3-hole ID ø 180mm H 15.5mm C45		
For models:	8920		

			
1			
GEV No.	697365	Ref. No.	00000000142
description	slicing machine blade ED ø 250mm seat ø 40mm 3-hole ID ø 210mm H 17.5mm C45 standard		
For models:	8921		

			
1			
GEV No.	697385	Ref. No.	00000000636
description	slicing machine blade ED ø 300mm seat ø 40mm 3-hole ID ø 250mm H 20mm C45 standard		
For models:	8922		

			
1			
GEV No.	697463	Ref. No.	18350574280F
description	slicing machine blade ED ø 350mm seat ø 57mm 4 hole ID ø 280mm H 22.5mm 100Cr6 standard		
For models:	FEB0010-SNT, PALLADIO350AM		

sharpener units

lids

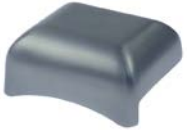

1

GEV No.	696514	Ref. No.	00000000863
description	lid for sharpener units L 116mm W 100mm mounting distance 26mm		
For models:	8921		



1

GEV No.	698643	Ref. No.	00000000596
description	lid for sharpener units L 150mm W 120mm		
For models:	8922		

knobs



1

GEV No.	697441	Ref. No.	00000000854
description	locking screw thread M5 handle ø 25mm black L 30mm		
For models:	8920, 8921		



1

GEV No.	697516	Ref. No.	19562700
description	locking screw thread M5 handle ø 25mm L 8mm		
For models:	FEB0031, MIRRA300		



1

GEV No.	697384	Ref. No.	00000000734
description	locking screw thread M6 handle ø 25mm black L 54mm		
For models:	8922		



1

GEV No.	697445	Ref. No.	00000000677
description	mushroom cap handle thread M6 handle ø 33mm L 26mm plastic black		
For models:	8922		

sharpener units



1

GEV No.	697397	Ref. No.	00000009864
description	blade sharpener 220/250/275		
For models:	8920, 8921		

grindstones



1

GEV No.	697565	Ref. No.	19300101
description	grindstone ø 40mm thickness 10mm bore ø 6mm grained fine with bevel, without hub		
For models:	FEB0031, MIRRA300		



1

GEV No.	697549	Ref. No.	19300201
description	grindstone ø 40mm thickness 7.8mm bore ø 6mm grained fine with bevel, without hub		
For models:	FEB0031, MIRRA300		



1

GEV No.	697393	Ref. No.	19300108C.10
description	grindstone ø 48mm thickness 15mm bore ø 8mm grained coarse with bevel, without hub		
For models:	FEB0009-SNT, FEB0010-SNT, FEB0030, FEB0033, FEB0034, FEB0035, PALLADIO300AM, PALLADIO300T, PALLADIO330T, PALLADIO350AM		



1

GEV No.	697392	Ref. No.	19300209
description	grindstone ø 50mm thickness 8mm bore ø 8mm grained fine with bevel, without hub		
For models:	FEB0009-SNT, FEB0010-SNT, FEB0030, FEB0033, FEB0034, FEB0035, PALLADIO300AM, PALLADIO300T, PALLADIO330T, PALLADIO350AM		



1

GEV No.	697378	Ref. No.	00000000721
description	grindstone ø 51mm thickness 7mm bore ø 8mm grained fine with bevel, without hub		
For models:	8922		

grindstones with hub



1

GEV No.	697421	Ref. No.	00000000641
description	grindstone ø 45mm thickness 8mm bore ø 6mm grained coarse with bevel, with hub		
For models:	8920, 8921		



1

GEV No.	697422	Ref. No.	00000000642
description	grindstone ø 45mm thickness 8mm bore ø 6mm grained fine with bevel, with hub		
For models:	8920, 8921		

grindstones cup form



1

GEV No.	697377	Ref. No.	00000000720
description	grindstone ø 51mm thickness 12mm bore ø 8mm grained coarse without bevel		
For models:	8922		

carriages

handles



1

GEV No.	697443	Ref. No.	19562504
description	star handle thread M8 ø 50mm L 29mm black		
For models:	FEB0031, MIRRA300		

accessories



1

GEV No.	696516	Ref. No.	00000000186
description	bracket for carriage L 56mm aluminium		
For models:	8920		

miscellaneous



1

GEV No.	696249	Ref. No.	19540905
description	bracket thread M10x0.75 ø 35mm for microswitch ID ø 20.2mm thickness 15mm mounting thread M8 250-300		
For models:	FEB0033, FEB0034, FEB0035, PALLADIO300AM, PALLADIO300T, PALLADIO330T, PALLADIO350AM		



1

GEV No.	697476	Ref. No.	00000000509
description	bush ø 14mm L 88mm ID ø 12mm		
For models:	8921, 8922		

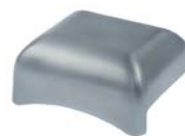

1

GEV No.	698419	Ref. No.	00000000867
description	cover L 115mm W 100mm for motor plastic		
For models:	8920		



1 

GEV No.	698392	Ref. No.	00000000828
description	thread bolt thread M6 ø 6mm L 35mm for slicer		
For models:	8920, 8921, 8922		

for bandsaws

wipers

1 

GEV No.	697772	Ref. No.	LF2001032
description	wiper L 45mm W 25mm thickness 3mm plastic SO1650/SO2020		
For models:	FIG0002		

miscellaneous

1 

GEV No.	699623	Ref. No.	LF2001014
description	insert lower L 31mm W 15mm H 15mm		
For models:	FIG0002, FIG0009M, FIG0010		

1 

GEV No.	699622	Ref. No.	LF2001028
description	plain washer chamfered ø 9-28mm H 5mm		
For models:	FIG0002, FIG0009M, FIG0010		

for meat mincers

gearboxes

1 

GEV No.	698164	Ref. No.	LF2043015
description	gearbox motor shaft ø 19mm flange ø 120mm transmission 1/49 drive shaft ø 25mm type FRS60		
For models:	FID0005, FID0006		

gear wheels

1 

GEV No.	698028	Ref. No.	F2106
description	gear wheel double ø 32/70mm shaft intake ø 15mm W 30mm teeth 18/41 splitting tooth width 14/11mm DIN/ISO Mod.12-22		
For models:	FIF0001, FIF0002, FIF0004, FIF0005, FMC0001-F, TCG22E-F		

1 

GEV No.	698027	Ref. No.	F2104
description	gear wheel ø 25mm shaft intake ø 10mm teeth 13 splitting tooth width 20mm DIN/ISO Mod.12-22		
For models:	FIF0001, FIF0002, FIF0004, FIF0005, FMC0001-F, TCG22E-F		

1 

GEV No.	698019	Ref. No.	F2020
description	gear wheel ø 34mm shaft intake ø 15mm teeth 19 splitting tooth width 19mm DIN/ISO Mod.8		
For models:	FIF0016-F, FIF0023		

1 

GEV No.	698029	Ref. No.	F2107
description	gear wheel ø 64mm shaft intake ø 16mm teeth 39 splitting tooth width 13mm DIN/ISO Mod.12-22		
For models:	FIF0001, FIF0002, FIF0004, FIF0005, FMC0001-F, TCG22E-F		

drive shafts

for blades



1

GEV No.	698038	Ref. No.	F2127
description	drive shaft ENTERPRISE model 12 ø 9.5mm L 53mm thread M12x1.75 D1 ø 20mm thread L 20mm		
For models:	FIF0001, FIF0004		



1

GEV No.	698056	Ref. No.	F2217
description	drive shaft ENTERPRISE model 22 ø 11mm L 53mm thread M12x1.75 D1 ø 22mm thread L 18mm		
For models:	FIF0002, FIF0005, TCG22E-F		



1

GEV No.	698023	Ref. No.	F2043
description	drive shaft ENTERPRISE model 8 ø 8.5mm L 37mm stainless steel thread M10x1.5 thread L 15mm		
For models:	FIF0016-F, FIF0023		



1

GEV No.	698135	Ref. No.	LF2033013
description	spindle ENTERPRISE model 32 ø 13mm L 87mm thread M20x1.5 D1 ø 29.5mm thread L 28mm		
For models:	TC32BU, TC32NEVADAT		



1

GEV No.	698146	Ref. No.	LF2034004
description	spindle ENTERPRISE model 42 ø 20mm L 113mm thread M20x1.5 D1 ø 34.5mm thread L 35mm		
For models:	FIF0014		



1

GEV No.	698045	Ref. No.	F2128
description	drive shaft model 12		
For models:	FIF0004		



1

GEV No.	698046	Ref. No.	F2129
description	drive shaft Unger model 12 ø 11.3mm L 43mm stainless steel thread M12x1.75 D1 ø 20mm thread L 20mm		
For models:	FIF0004		

for augers



1

GEV No.	698031	Ref. No.	F2109
description	drive shaft model 12-22 ø 17mm L 78mm D1 ø 25mm shaft diameter 10x23mm		
For models:	FIF0001, FIF0002, FIF0004, FIF0005, TCG22E-F		



1

GEV No.	698168	Ref. No.	LF2095010
description	drive shaft model 30 ø 25mm L 169mm D1 ø 30mm shaft diameter 10x30mm		
For models:	FID0005		



1

GEV No.	698167	Ref. No.	LF2039725
description	drive shaft model 30 ø 25mm L 205mm D1 ø 40mm shaft diameter 15x40mm		
For models:	TC32BU		



1

GEV No.	698020	Ref. No.	F2022
description	drive shaft model 8 ø 15mm L 124mm D1 ø 20mm shaft diameter 10x19mm		
For models:	FIF0016-F, FIF0023		



			
1			
GEV No.	698166	Ref. No.	LF2039412
description	drive shaft type 32 ø 25mm L 170mm D1 ø 40mm shaft diameter 15x40mm		
For models:	TC32NEVADAT		

			
1			
GEV No.	698030	Ref. No.	F2102
description	spindle ø 15mm L 31mm Mod.12-22 thread M14x1.5 total length 46mm		
For models:	FIF0001, FIF0004		

locking screws

locking levers



			
1			
GEV No.	698093	Ref. No.	F2189
description	locking lever thread M10 ø 28mm lever length 70mm thread L 30mm plastic total length 77mm		
For models:	FIF0003, FIF0003-22HP, FIF0005		

locking screws

			
1			
GEV No.	698092	Ref. No.	F2115
description	locking screw thread M10 thread L 30mm handle ø 60mm plastic		
For models:	FIF0001, FIF0002, FIF0004, FIF0005, TCG22E-F		

			
1			
GEV No.	698091	Ref. No.	F2040
description	locking screw thread M8 thread L 25mm handle ø 40mm		
For models:	FIF0016-F, FIF0023		

lids

			
1			
GEV No.	698017	Ref. No.	F2152
description	lid model 12-22 ø 100mm plastic mounting distance 85mm		
For models:	FHZ0003, FIF0004, FIF0005, TCG22E-F		
accessories for	698017		
	GEV No.	699592	Ref. No.
			—
	 plug for lid ø 75mm plastic for meat mincer/cheese grater		

			
1			
GEV No.	698010	Ref. No.	F2002
description	lid model 8 ø 78mm plastic mounting distance 70mm		
For models:	FHZ0001, FHZ0003, FIF0001, FIF0002, FIF0016-F, FIF0023		

gaskets

			
1			
GEV No.	698026	Ref. No.	F2206
description	gasket for gearbox for model 22 ø 132mm mounting distance 120mm rubber thickness 1mm		
For models:	FIF0002, FIF0005, TCG22E-F		

			
1			
GEV No.	698018	Ref. No.	F2012
description	gasket for gearbox for model 8 ø 110mm mounting distance 94x97mm rubber thickness 2mm		
For models:	FIF0016-F, FIF0023		

funnel trays

			
1			
GEV No.	698077	Ref. No.	F2038 F2113
description	hopper filling pipe central L 275mm W 200mm H 50mm tube ø 52mm		
For models:	FIF0001, FIF0004, FIF0016-F, FIF0023		

			
1			
GEV No.	698179	Ref. No.	IV2270500
description	hopper filling pipe central L 340mm W 250mm H 60mm tube ø 52mm		
For models:	FID0005		

funnels

			
1			
GEV No.	698085	Ref. No.	F2149
description	funnel model 12 ø 15mm		
For models:	FIF0001, FIF0004		

			
1			
GEV No.	698086	Ref. No.	F2150
description	funnel model 12 ø 20mm ED ø 65mm L 135mm		
For models:	FIF0001, FIF0004		

			
1			
GEV No.	698087	Ref. No.	F2151
description	funnel model 12 ø 25mm		
For models:	FIF0001, FIF0004		

			
1			
GEV No.	698088	Ref. No.	F2224
description	funnel model 22 ø 15mm		
For models:	FIF0002, FIF0005, TCG22E-F		

			
1			
GEV No.	698089	Ref. No.	F2225
description	funnel model 22 ø 20mm		
For models:	FIF0002, FIF0005, TCG22E-F		

			
1			
GEV No.	698090	Ref. No.	F2226
description	funnel model 22 ø 25mm		
For models:	FIF0002, FIF0005, TCG22E-F		

			
1			
GEV No.	698082	Ref. No.	F2050
description	funnel model 8 ø 15mm		
For models:	FIF0016-F, FIF0023		

			
1			
GEV No.	698083	Ref. No.	F2051
description	funnel model 8 ø 20mm		
For models:	FIF0016-F, FIF0023		

grinder plates			
ENTERPRISE			
with 2 notches			
flat			
			
1			
GEV No.	698295	Ref. No.	F2131
description	grinder plate type ENTERPRISE size 12 hole ø 6mm flat grooves 2 stainless steel ø 70mm		
For models:	FIF0001, FIF0004		

with hub			
			
1			
GEV No.	696140	Ref. No.	F0502
description	grinder plate type ENTERPRISE size 32 hole ø 4.5mm with hub grooves 2 stainless steel ø 100mm		
For models:	FIF0003, FIF0003-22HP		

blades			
ENTERPRISE			
			
1			
GEV No.	696022	Ref. No.	F2130
description	knife type ENTERPRISE size 12 ø 62mm internal size 12x12mm stainless steel		
For models:	FIF0001, FIF0004		

			
1			
GEV No.	696023	Ref. No.	F2218
description	knife type ENTERPRISE size 22 ø 73mm internal size 13x13mm stainless steel		
For models:	FIF0002, FIF0005, TCG22E-F		

			
1			
GEV No.	696033	Ref. No.	F0503
description	knife type ENTERPRISE size 32 ø 90mm internal size 15x15mm stainless steel		
For models:	FIF0003, FIF0003-22HP		

			
1			
GEV No.	696021	Ref. No.	F2044
description	knife type ENTERPRISE size 8 ø 55mm internal size 10x10mm stainless steel		
For models:	FIF0016-F, FIF0023		

ring nuts



1

GEV No.	698049	Ref. No.	F2134
description	ring nut Unger model 12 stainless steel		
For models:	FIF0004		



1

GEV No.	698024	Ref. No.	F2046
description	ring nut model 8 aluminium		
For models:	FIF0016-F, FIF0023		



1

GEV No.	698040	Ref. No.	F2133
description	ring nut Unger model 12 ED ø 89mm thickness 27mm ID ø 64mm stainless steel thread M82x2		
For models:	FIF0001, FIF0004		



1

GEV No.	698039	Ref. No.	F2132
description	ring nut Unger model 12 ID ø 78mm aluminium		
For models:	FIF0001, FIF0004		

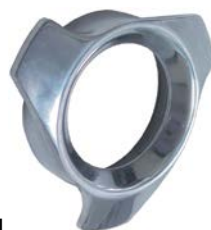

1

GEV No.	698057	Ref. No.	F2220
description	ring nut Unger model 22 ID ø 73mm aluminium		
For models:	FIF0002, FIF0005, TCG22E-F		

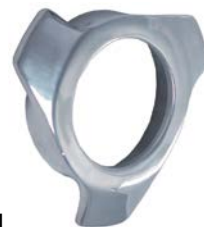

1

GEV No.	698058	Ref. No.	F2221
description	ring nut Unger model 22 ID ø 74mm stainless steel thread M94x2		
For models:	FIF0002, FIF0005, TCG22E-F		

augers

complete



1

GEV No.	698037	Ref. No.	F2124
description	auger model 12 ø 53mm L 135mm stainless steel with spindle ENTERPRISE		
For models:	FIF0001, FIF0004		



1

GEV No.	698035	Ref. No.	F2122
description	auger model 12 ø 53mm L 140mm aluminium with spindle ENTERPRISE		
For models:	FIF0001, FIF0004		

1

GEV No.	698043	Ref. No.	F2125
description	auger model 12 \varnothing 53mm L 145mm cast iron with spindle Unger		
For models:	FIF0004		



1

GEV No.	698055	Ref. No.	F2216
description	auger model 22 \varnothing 64mm L 150mm stainless steel with spindle ENTERPRISE		
For models:	FIF0002, FIF0005, TCG22E-F		



1

GEV No.	698044	Ref. No.	F2126
description	auger model 12 \varnothing 53mm L 145mm stainless steel with spindle Unger		
For models:	FIF0004		



1

GEV No.	698022	Ref. No.	F2042
description	auger model 8 \varnothing 44mm L 115mm stainless steel with spindle ENTERPRISE		
For models:	FIF0016-F, FIF0023		



1

GEV No.	698036	Ref. No.	F2123
description	auger model 12 \varnothing 53mm L 150mm cast iron with spindle ENTERPRISE		
For models:	FIF0001, FIF0004		



1

GEV No.	698021	Ref. No.	F2041
description	auger model 8 \varnothing 45mm L 117mm aluminium with spindle ENTERPRISE		
For models:	FIF0016-F, FIF0023		



1

GEV No.	698053	Ref. No.	F2214
description	auger model 22 \varnothing 63mm L 150mm aluminium with spindle ENTERPRISE		
For models:	FIF0002, FIF0005, TCG22E-F		

without bolt



1

GEV No.	698173	Ref. No.	LF2039703
description	auger model 32 stainless steel ENTERPRISE		
For models:	TC32BU		



1

GEV No.	698054	Ref. No.	F2215
description	auger model 22 \varnothing 63mm L 150mm cast iron with spindle ENTERPRISE		
For models:	FIF0002, FIF0005, TCG22E-F		

augers chambers

inner parts



1

GEV No.	698032	Ref. No.	F2117
description	auger chamber ENTERPRISE model 12 inlet \varnothing 56mm cast iron		
For models:	FIF0001, FIF0004		

			
1			
GEV No.	698294	Ref. No.	F2119
description	auger chamber ENTERPRISE model 12 inlet ø 60mm aluminium		
For models:	FIF0001, FIF0004		

			
1			
GEV No.	698041	Ref. No.	F2120
description	auger chamber Unger model 12 inlet ø 59mm cast iron		
For models:	FIF0004		

			
1			
GEV No.	698034	Ref. No.	F2118
description	auger chamber ENTERPRISE model 12 inlet ø 61mm stainless steel		
For models:	FIF0001, FIF0004		

			
1			
GEV No.	698042	Ref. No.	F2121
description	auger chamber Unger model 12 stainless steel		
For models:	FIF0004		

			
1			
GEV No.	698050	Ref. No.	F2212
description	auger chamber ENTERPRISE model 22 inlet ø 62mm aluminium		
For models:	FIF0002, FIF0005, TCG22E-F		

miscellaneous			
			
1			
GEV No.	698967	Ref. No.	LF1039710
description	magnet ø 32mm		
For models:	FID0005, FID0006, FID0007, FID0008, FIF0014, FIG0002, FIG0009M, FIG0010, TC32BU, TC32NEVADAT		

			
1			
GEV No.	698051	Ref. No.	F2210
description	auger chamber ENTERPRISE model 22 inlet ø 62mm cast iron		
For models:	FIF0002, FIF0005, TCG22E-F		

plungers			
			
1			
GEV No.	698080	Ref. No.	F2037 F2114 F2208
description	plunger ø 46mm L 120mm total length 240mm plastic hollow		
For models:	FIF0001, FIF0002, FIF0004, FIF0005, FIF0016-F, FIF0023, TCG22E-F		

			
1			
GEV No.	698052	Ref. No.	F2211
description	auger chamber ENTERPRISE model 22 inlet ø 62mm stainless steel thread M94x2		
For models:	FIF0002, FIF0005, TCG22E-F		
accessories for	698052		
	GEV No.	690058	Ref. No. —
	counter support for off-set 19mm mounting distance 14.25mm W 28mm L 52mm H 50mm type 6000/6004 no. 6000-020701		

			
1			
GEV No.	698371	Ref. No.	LF2035861
description	plunger ø 48mm L 165mm total length 320mm		
For models:	TC32NEVADAT		

for cutters

drive shafts



1

GEV No.	693940	Ref. No.	MSC04N104
description	drive shaft D1 ø 65mm ø 15mm L 170mm C4-C4VV		
For models:	FLA0014		



1

GEV No.	694348	Ref. No.	MSC06N104
description	drive shaft D1 ø 65mm ø 15mm L 233mm C6 CE/VT/VV		
For models:	FLA0015		
accessories for	694348		
	GEV No.	698305	Ref. No.
			—
	gasket for mincer thickness 0.9mm for gearbox		



1

GEV No.	694347	Ref. No.	MSC09V104
description	drive shaft D1 ø 85mm ø 20mm L 295mm C9VV CE		
For models:	FLA0016		

containers



1

GEV No.	697290	Ref. No.	MSC09V076
description	container C9VV edition since 10/2003		
For models:	FLA0016		



1

GEV No.	698976	Ref. No.	40750080
description	sump GN 1/3 H 200mm plastic		
For models:	FLA0028		

lids



1

GEV No.	691247	Ref. No.	MSC04N052
description	lid for cutter ø 225mm ID ø 204mm plastic C4-C6 edition until 08/2003		
For models:	FLA0014, FLA0015		



1

GEV No.	691664	Ref. No.	MSC04V052A
description	lid for cutter ø 225mm ID ø 204mm plastic with gasket C4-C6 edition since 08/2003		
For models:	FLA0014, FLA0015		



1

GEV No.	693943	Ref. No.	MSC09V052A
description	lid for cutter ø 265mm ID ø 240mm plastic with gasket C9VV edition since 10/2003		
For models:	FLA0016		

blades

spacer rings











Image not available

1

GEV No.	696035	Ref. No.	MSC04N068P
description	spacer ring ED ø 60mm int. ø 1 30mm H 12mm mounting distance 46mm 4 hole hole ø 4.2mm plastic C4-C4VV		
For models:	FLA0014		





1

GEV No.	696020	Ref. No.	MSC04N068	
description	spacer ring ED ø 60mm int. ø 1 30mm H 14mm mounting distance 46mm 4 hole hole ø 4.2mm plastic C4-C4VV			
For models:	FLA0014			
accessories for	696020			
	GEV No.	696037	Ref. No.	MSC04N062
	blade holder ED ø 60mm int. ø 1 15mm int. ø 2 30mm H 77mm mounting distance 46mm 4 hole hole ø 3mm plastic C4-C4VV			
	GEV No.	696174	Ref. No.	MSC04N064F
	mixer mounting pos. upper L 98mm seat ø 33mm mounting distance 46mm 4 hole hole ø 4.4mm thickness 2mm model C4-C6			
	GEV No.	696175	Ref. No.	MSC04N072F
	knife mounting pos. lower L 93mm seat ø 33mm mounting distance 46mm 4 hole hole ø 4.4mm thickness 2mm model C4-C6			
	GEV No.	696176	Ref. No.	MSC04N064
	knife mounting pos. upper L 98mm seat ø 33mm mounting distance 46mm 4 hole hole ø 4.4mm thickness 2mm model C4-C6			
	GEV No.	696177	Ref. No.	MSC04N072
	knife mounting pos. lower L 93mm seat ø 33mm mounting distance 46mm 4 hole hole ø 4.4mm thickness 2mm model C4-C6			
	GEV No.	696178	Ref. No.	MSC04N064Z
	knife mounting pos. upper L 98mm seat ø 42mm mounting distance 46mm 4 hole hole ø 4.4mm thickness 2mm model C4-C6			

accessories for	696020			
	GEV No.	696179	Ref. No.	MSC04N072Z
	knife mounting pos. lower L 93mm seat ø 33mm mounting distance 46mm 4 hole hole ø 4.4mm thickness 2mm model C4-C6			









1









GEV No.	696042	Ref. No.	MSC06N068P	
description	spacer ring ED ø 60mm int. ø 1 30mm H 18mm mounting distance 46mm 4 hole hole ø 4.2mm plastic C6-C6VV			
For models:	FLA0015			
accessories for	696042			
	GEV No.	696040	Ref. No.	MSC06N062P
	blade holder ED ø 60mm int. ø 1 15mm int. ø 2 30mm H 128mm mounting distance 46mm 4 hole hole ø 3mm plastic ø 60 C6-C6VV-mm			
	GEV No.	696180	Ref. No.	MSC04N064V
	knife mounting pos. upper L 98mm seat ø 33mm mounting distance 46mm 4 hole hole ø 4.4mm thickness 2mm model C4-C6			





1









GEV No.	696041	Ref. No.	MSC06N068	
description	spacer ring ED ø 60mm int. ø 1 30mm H 20mm mounting distance 46mm 4 hole hole ø 4.2mm plastic C6-C6VV			
For models:	FLA0015			
accessories for	696041			
	GEV No.	696039	Ref. No.	MSC06N062
	blade holder ED ø 60mm int. ø 1 15mm int. ø 2 30mm H 133mm mounting distance 46mm 4 hole hole ø 3mm plastic C6-C6VV			
	GEV No.	696174	Ref. No.	MSC04N064F
	mixer mounting pos. upper L 98mm seat ø 33mm mounting distance 46mm 4 hole hole ø 4.4mm thickness 2mm model C4-C6			
	GEV No.	696175	Ref. No.	MSC04N072F
	knife mounting pos. lower L 93mm seat ø 33mm mounting distance 46mm 4 hole hole ø 4.4mm thickness 2mm model C4-C6			
	GEV No.	696176	Ref. No.	MSC04N064
	knife mounting pos. upper L 98mm seat ø 33mm mounting distance 46mm 4 hole hole ø 4.4mm thickness 2mm model C4-C6			
	GEV No.	696177	Ref. No.	MSC04N072
	knife mounting pos. lower L 93mm seat ø 33mm mounting distance 46mm 4 hole hole ø 4.4mm thickness 2mm model C4-C6			
	GEV No.	696178	Ref. No.	MSC04N064Z
	knife mounting pos. upper L 98mm seat ø 42mm mounting distance 46mm 4 hole hole ø 4.4mm thickness 2mm model C4-C6			
	GEV No.	696179	Ref. No.	MSC04N072Z
	knife mounting pos. lower L 93mm seat ø 33mm mounting distance 46mm 4 hole hole ø 4.4mm thickness 2mm model C4-C6			



			
1			
GEV No.	696000	Ref. No.	MSC09V068
description	spacer ring ED ø 72mm int. ø 1 38mm H 24mm mounting distance 58mm 4 hole hole ø 5mm plastic C9VV		
For models:	FLA0016		
accessories for	696000		
	GEV No.	696036	Ref. No. MSC09V062
	blade holder ED ø 72mm int. ø 1 20mm int. ø 2 38mm H 165mm mounting distance 58mm 4 hole hole ø 3.5mm plastic C9VV		
	GEV No.	696182	Ref. No. MSC09V064F
	mixer mounting pos. upper L 119mm seat ø 42mm mounting distance 58mm 4 hole hole ø 4.4mm thickness 2.5mm model C9VV		
	GEV No.	696183	Ref. No. MSC09V072F
	mixer mounting pos. lower L 112mm seat ø 42mm mounting distance 58mm 4 hole hole ø 4.4mm thickness 2.5mm model C9VV		
	GEV No.	696184	Ref. No. MSC09V064
	knife mounting pos. upper L 119mm seat ø 42mm mounting distance 58mm 4 hole hole ø 4.4mm thickness 2.5mm model C9VV		
	GEV No.	696185	Ref. No. MSC09V072
	knife mounting pos. lower L 112mm seat ø 42mm mounting distance 58mm 4 hole hole ø 4.4mm thickness 2.5mm model C9VV		
	GEV No.	696186	Ref. No. MSC09V064Z
	knife mounting pos. upper L 119mm seat ø 42mm mounting distance 58mm 4 hole hole ø 4.4mm thickness 2.5mm model C9VV		
	GEV No.	696187	Ref. No. MSC09V072Z
	knife mounting pos. lower L 112mm seat ø 42mm mounting distance 58mm 4 hole hole ø 4.4mm thickness 2.5mm model C9VV		

holders

			
1			
GEV No.	696040	Ref. No.	MSC06N062P
description	blade holder ED ø 60mm int. ø 1 15mm int. ø 2 30mm H 128mm mounting distance 46mm 4 hole hole ø 3mm plastic ø 60 C6-C6VV-mm		
For models:	FLA0015		
accessories for	696040		
	GEV No.	696042	Ref. No. MSC06N068P
	spacer ring ED ø 60mm int. ø 1 30mm H 18mm mounting distance 46mm 4 hole hole ø 4.2mm plastic C6-C6VV		
	GEV No.	696180	Ref. No. MSC04N064V
	knife mounting pos. upper L 98mm seat ø 33mm mounting distance 46mm 4 hole hole ø 4.4mm thickness 2mm model C4-C6		

			
1			
GEV No.	696039	Ref. No.	MSC06N062
description	blade holder ED ø 60mm int. ø 1 15mm int. ø 2 30mm H 133mm mounting distance 46mm 4 hole hole ø 3mm plastic C6-C6VV		
For models:	FLA0015		
accessories for	696039		
	GEV No.	696041	Ref. No. MSC06N068
	spacer ring ED ø 60mm int. ø 1 30mm H 20mm mounting distance 46mm 4 hole hole ø 4.2mm plastic C6-C6VV		
	GEV No.	696174	Ref. No. MSC04N064F
	mixer mounting pos. upper L 98mm seat ø 33mm mounting distance 46mm 4 hole hole ø 4.4mm thickness 2mm model C4-C6		
	GEV No.	696175	Ref. No. MSC04N072F
	knife mounting pos. lower L 93mm seat ø 33mm mounting distance 46mm 4 hole hole ø 4.4mm thickness 2mm model C4-C6		
	GEV No.	696176	Ref. No. MSC04N064
	knife mounting pos. upper L 98mm seat ø 33mm mounting distance 46mm 4 hole hole ø 4.4mm thickness 2mm model C4-C6		
	GEV No.	696177	Ref. No. MSC04N072
	knife mounting pos. lower L 93mm seat ø 33mm mounting distance 46mm 4 hole hole ø 4.4mm thickness 2mm model C4-C6		
	GEV No.	696178	Ref. No. MSC04N064Z
	knife mounting pos. upper L 98mm seat ø 42mm mounting distance 46mm 4 hole hole ø 4.4mm thickness 2mm model C4-C6		
	GEV No.	696179	Ref. No. MSC04N072Z
	knife mounting pos. lower L 93mm seat ø 33mm mounting distance 46mm 4 hole hole ø 4.4mm thickness 2mm model C4-C6		





			
1			
GEV No.	696038	Ref. No.	MSC04N062P
description	blade holder ED ø 60mm int. ø 1 15mm int. ø 2 30mm H 72mm mounting distance 46mm 4 hole hole ø 3mm plastic C4-C4VV		
For models:	FLA0014		
accessories for	696038		
	GEV No.	696035	Ref. No. MSC04N068P
	spacer ring ED ø 60mm int. ø 1 30mm H 12mm mounting distance 46mm 4 hole hole ø 4.2mm plastic C4-C4VV		

Table continues overleaf

accessories for	696038		
	GEV No.	696180	Ref. No. MSC04N064V
knife mounting pos. upper L 98mm seat ø 33mm mounting distance 46mm 4 hole hole ø 4.4mm thickness 2mm model C4-C6			





GEV No.	696037	Ref. No.	MSC04N062
description	blade holder ED ø 60mm int. ø 1 15mm int. ø 2 30mm H 77mm mounting distance 46mm 4 hole hole ø 3mm plastic C4-C4VV		
For models:	FLA0014		

accessories for	696037		
	GEV No.	696020	Ref. No. MSC04N068
spacer ring ED ø 60mm int. ø 1 30mm H 14mm mounting distance 46mm 4 hole hole ø 4.2mm plastic C4-C4VV			

	GEV No.	696174	Ref. No. MSC04N064F
mixer mounting pos. upper L 98mm seat ø 33mm mounting distance 46mm 4 hole hole ø 4.4mm thickness 2mm model C4-C6			

	GEV No.	696175	Ref. No. MSC04N072F
knife mounting pos. lower L 93mm seat ø 33mm mounting distance 46mm 4 hole hole ø 4.4mm thickness 2mm model C4-C6			

	GEV No.	696176	Ref. No. MSC04N064
knife mounting pos. upper L 98mm seat ø 33mm mounting distance 46mm 4 hole hole ø 4.4mm thickness 2mm model C4-C6			

	GEV No.	696177	Ref. No. MSC04N072
knife mounting pos. lower L 93mm seat ø 33mm mounting distance 46mm 4 hole hole ø 4.4mm thickness 2mm model C4-C6			







	GEV No.	696178	Ref. No. MSC04N064Z
knife mounting pos. upper L 98mm seat ø 42mm mounting distance 46mm 4 hole hole ø 4.4mm thickness 2mm model C4-C6			

	GEV No.	696179	Ref. No. MSC04N072Z
knife mounting pos. lower L 93mm seat ø 33mm mounting distance 46mm 4 hole hole ø 4.4mm thickness 2mm model C4-C6			



GEV No.	696036	Ref. No.	MSC09V062
description	blade holder ED ø 72mm int. ø 1 20mm int. ø 2 38mm H 165mm mounting distance 58mm 4 hole hole ø 3.5mm plastic C9VV		
For models:	FLA0016		

accessories for	696036		
	GEV No.	696000	Ref. No. MSC09V068
spacer ring ED ø 72mm int. ø 1 38mm H 24mm mounting distance 58mm 4 hole hole ø 5mm plastic C9VV			

accessories for	696036		
	GEV No.	696182	Ref. No. MSC09V064F
mixer mounting pos. upper L 119mm seat ø 42mm mounting distance 58mm 4 hole hole ø 4.4mm thickness 2.5mm model C9VV			
	GEV No.	696183	Ref. No. MSC09V072F
mixer mounting pos. lower L 112mm seat ø 42mm mounting distance 58mm 4 hole hole ø 4.4mm thickness 2.5mm model C9VV			
	GEV No.	696184	Ref. No. MSC09V064
knife mounting pos. upper L 119mm seat ø 42mm mounting distance 58mm 4 hole hole ø 4.4mm thickness 2.5mm model C9VV			
	GEV No.	696185	Ref. No. MSC09V072
knife mounting pos. lower L 112mm seat ø 42mm mounting distance 58mm 4 hole hole ø 4.4mm thickness 2.5mm model C9VV			
	GEV No.	696186	Ref. No. MSC09V064Z
knife mounting pos. upper L 119mm seat ø 42mm mounting distance 58mm 4 hole hole ø 4.4mm thickness 2.5mm model C9VV			
	GEV No.	696187	Ref. No. MSC09V072Z
knife mounting pos. lower L 112mm seat ø 42mm mounting distance 58mm 4 hole hole ø 4.4mm thickness 2.5mm model C9VV			

blades

blades serrated



GEV No.	696187	Ref. No.	MSC09V072Z
description	knife mounting pos. lower L 112mm seat ø 42mm mounting distance 58mm 4 hole hole ø 4.4mm thickness 2.5mm model C9VV		
For models:	FLA0016		





GEV No.	696179	Ref. No.	MSC04N072Z
description	knife mounting pos. lower L 93mm seat ø 33mm mounting distance 46mm 4 hole hole ø 4.4mm thickness 2mm model C4-C6		
For models:	FLA0014, FLA0015		





GEV No.	696186	Ref. No.	MSC09V064Z
description	knife mounting pos. upper L 119mm seat ø 42mm mounting distance 58mm 4 hole hole ø 4.4mm thickness 2.5mm model C9VV		
For models:	FLA0016		





			
1			
GEV No.	696178	Ref. No.	MSC04N064Z
description	knife mounting pos. upper L 98mm seat ø 42mm mounting distance 46mm 4 hole hole ø 4.4mm thickness 2mm model C4-C6		
For models:	FLA0014, FLA0015		

			
1			
GEV No.	696180	Ref. No.	MSC04N064V
description	knife mounting pos. upper L 98mm seat ø 33mm mounting distance 46mm 4 hole hole ø 4.4mm thickness 2mm model C4-C6		
For models:	FLA0014, FLA0015		

blades smooth			
			
1			
GEV No.	696185	Ref. No.	MSC09V072
description	knife mounting pos. lower L 112mm seat ø 42mm mounting distance 58mm 4 hole hole ø 4.4mm thickness 2.5mm model C9VV		
For models:	FLA0016		

			
1			
GEV No.	696181	Ref. No.	MSC04N064P
description	knife mounting pos. upper L 98mm seat ø 33mm mounting distance 46mm 4 hole hole ø 4.4mm thickness 2mm model C4-C6		
For models:	FLA0014, FLA0015		

			
1			
GEV No.	696177	Ref. No.	MSC04N072
description	knife mounting pos. lower L 93mm seat ø 33mm mounting distance 46mm 4 hole hole ø 4.4mm thickness 2mm model C4-C6		
For models:	FLA0014, FLA0015		

mixers			
			
1			
GEV No.	696183	Ref. No.	MSC09V072F
description	mixer mounting pos. lower L 112mm seat ø 42mm mounting distance 58mm 4 hole hole ø 4.4mm thickness 2.5mm model C9VV		
For models:	FLA0016		

			
1			
GEV No.	696184	Ref. No.	MSC09V064
description	knife mounting pos. upper L 119mm seat ø 42mm mounting distance 58mm 4 hole hole ø 4.4mm thickness 2.5mm model C9VV		
For models:	FLA0016		

			
1			
GEV No.	696182	Ref. No.	MSC09V064F
description	mixer mounting pos. upper L 119mm seat ø 42mm mounting distance 58mm 4 hole hole ø 4.4mm thickness 2.5mm model C9VV		
For models:	FLA0016		

			
1			
GEV No.	696176	Ref. No.	MSC04N064
description	knife mounting pos. upper L 98mm seat ø 33mm mounting distance 46mm 4 hole hole ø 4.4mm thickness 2mm model C4-C6		
For models:	FLA0014, FLA0015		

			
1			
GEV No.	696174	Ref. No.	MSC04N064F
description	mixer mounting pos. upper L 98mm seat ø 33mm mounting distance 46mm 4 hole hole ø 4.4mm thickness 2mm model C4-C6		
For models:	FLA0014, FLA0015		

protective coverings



1

GEV No.	696189	Ref. No.	MSC04N075
description	protective covering for cutter blade mounting pos. lower model C4-C6		
For models:	FLA0014, FLA0015		



1

GEV No.	696188	Ref. No.	MSC04N073
description	protective covering for cutter blade mounting pos. upper model C4-C6		
For models:	FLA0014, FLA0015		

miscellaneous



1

GEV No.	696190	Ref. No.	MSC04N174
description	grindstone for knife L 60mm W 25mm thickness 12mm with handle		
For models:	FLA0014, FLA0015, FLA0016		



1

GEV No.	696378	Ref. No.	MSC04N028
description	guide for container plastic		
For models:	FLA0014, FLA0015		



1

GEV No.	696191	Ref. No.	MSC04N200
description	scraper L 121mm W 82mm plastic		
For models:	FLA0014, FLA0015, FLA0016		

for cheese graters

lids



1

GEV No.	698017	Ref. No.	F2152
description	lid model 12-22 ø 100mm plastic mounting distance 85mm		
For models:	FHZ0003, FIF0004, FIF0005, TCG22E-F		

accessories for	698017		
	GEV No.	699592	Ref. No.
			—
	plug for lid ø 75mm plastic for meat mincer/cheese grater		



1

GEV No.	698010	Ref. No.	F2002
description	lid model 8 ø 78mm plastic mounting distance 70mm		
For models:	FHZ0001, FHZ0003, FIF0001, FIF0002, FIF0016-F, FIF0023		

press levers



1

GEV No.	698012	Ref. No.	F2161
description	press lever Mod.12		
For models:	FHZ0003, FIF0004, FIF0005, TCG22E-F		



1	GEV No.	698236	Ref. No.	F2162
	description	press lever Mod.12-22		
	For models:	FHZ0003, FIF0004, FIF0005, TCG22E-F		

1

GEV No.	698009	Ref. No.	F2055
description	grating cylinder		
For models:	FHZ0001, FIF0023		

1

GEV No.	698016	Ref. No.	F2155
description	side panel ID ø 25mm ED ø 71mm W 24mm aluminium Mod.12-22		
For models:	FHZ0003, FIF0004, FIF0005, TCG22E-F		

rubbing cylinders

complete

1

GEV No.	698015	Ref. No.	F2158
description	grating cylinder ø 79mm L 155mm ID ø 25mm stainless steel Mod.12-22		
For models:	FHZ0003, FIF0004, FIF0005, TCG22E-F		

rubbing cylinders

1

GEV No.	698234	Ref. No.	F2156
description	grating cylinder ø 79mm L 142.2mm ID ø 71mm Mod.12-22		
For models:	FHZ0003, FIF0004, FIF0005, TCG22E-F		

side parts

1

GEV No.	698008	Ref. No.	F2057
description	grating cylinder		
For models:	FHZ0001, FIF0023		

grating cylinder housings

1

GEV No.	698013	Ref. No.	F2167
description	housing aluminium Mod.12		
For models:	FHZ0003, FIF0004, FIF0005, TCG22E-F		

gear wheels

1

GEV No.	698028	Ref. No.	F2106
description	gear wheel double ø 32/70mm shaft intake ø 15mm W 30mm teeth 18/41 splitting tooth width 14/11mm DIN/ISO Mod.12-22		
For models:	FIF0001, FIF0002, FIF0004, FIF0005, FMC0001-F, TCG22E-F		



1

GEV No.	698027	Ref. No.	F2104
description	gear wheel \varnothing 25mm shaft intake \varnothing 10mm teeth 13 splitting tooth width 20mm DIN/ISO Mod.12-22		
For models:	FIF0001, FIF0002, FIF0004, FIF0005, FMC0001-F, TCG22E-F		



1

GEV No.	698029	Ref. No.	F2107
description	gear wheel \varnothing 64mm shaft intake \varnothing 16mm teeth 39 splitting tooth width 13mm DIN/ISO Mod.12-22		
For models:	FIF0001, FIF0002, FIF0004, FIF0005, FMC0001-F, TCG22E-F		

miscellaneous



1

GEV No.	698011	Ref. No.	F2062 F2160
description	bolt for press lever \varnothing 8mm L 60mm		
For models:	FHZ0001, FHZ0003, FIF0004, FIF0005, FIF0023, TCG22E-F		



1

GEV No.	346394	Ref. No.	F2164
description	bush for microswitch \varnothing 8mm D1 \varnothing 22mm		
For models:	FHZ0003, FIF0004, FIF0005, TCG22E-F		



1

GEV No.	346395	Ref. No.	F2163
description	cover for microswitch L 80mm W 60mm H 70mm		
For models:	FHZ0003, FIF0004, FIF0005, TCG22E-F		

for mozzarella slicers

accessories



1

GEV No.	696374	Ref. No.	F2278
description	lid \varnothing 179mm H 80mm plastic grey for mozzarella cutter		
For models:	FMC0001-F		

for bar blender

blenders

jar components

jars



1

GEV No.	696761	Ref. No.	990035500
description	blender jar plastic 1250ml HBB908		
For models:	HBB908CE		



1

GEV No.	696081	Ref. No.	IB4050800
description	blender jar plastic 1500ml for mixer Dragone		
For models:	DRAGONEVV, MULTIPLO2S, MULTIPLO3S		



1

GEV No.	696083	Ref. No.	IB2260900A
description	blender jar stainless steel 2000ml for mixer Orione		
For models:	BARMASTER		



1

GEV No.	696082	Ref. No.	IB4050900
description	blender jar plastic 2000ml for mixer Orione		
For models:	BARMASTER		

complete



1

GEV No.	696084	Ref. No.	IB9865520
description	blender jar plastic 1500ml complete for mixer Dragone		
For models:	DRAGONEVV, MULTIPLO2S, MULTIPLO3S		



1

GEV No.	696085	Ref. No.	IB9865521
description	blender jar plastic 1500ml for mixing complete for mixer Dragone		
For models:	DRAGONEVV		



1

GEV No.	696086	Ref. No.	IB9865321.05
description	blender jar plastic 2000ml for mixing complete for mixer Orione		
For models:	BARMASTER		



1

GEV No.	696087	Ref. No.	IB9865320.04
description	blender jar plastic 2000ml complete for mixer Orione		
For models:	BARMASTER		



1

GEV No.	696089	Ref. No.	IB9865323.06
description	blender jar stainless steel 2000ml complete for mixer Orione		
For models:	BARMASTER		



1

GEV No.	696088	Ref. No.	IB9865324.04
description	blender jar stainless steel 2000ml for mixing complete for mixer Orione		
For models:	BARMASTER		



1

GEV No.	696768	Ref. No.	6126-650
description	container polycarbonate 1800ml		
For models:	HBB650, HBB850		

lids



1

GEV No.	651047	Ref. No.	990035400
description	lid ø 130mm rubber nominal-ø 120mm hole ø 54mm		
For models:	HBB908CE		



1

GEV No.	696072	Ref. No.	IB4000820
description	lid ø 148mm plastic nominal-ø 120mm hole ø 48mm Dragone		
For models:	DRAGONEVV, MULTIPLO2S, MULTIPLO3S		



1

GEV No.	696073	Ref. No.	IB4100920
description	lid ø 156mm rubber nominal-ø 136mm hole ø 48mm Orione		
For models:	BARMASTER		



1

GEV No.	696070	Ref. No.	IB4050905
description	lid lock ø 48mm H 50mm plastic		
For models:	BARMASTER, DRAGONEVV, MULTIPLO2S, MULTIPLO3S, ORIONEFIVE		

gaskets



1

GEV No.	581012	Ref. No.	990035600
description	gasket ED ø 67mm ID ø 47mm thickness 2.5mm Qty 1 pcs		
For models:	HBB908CE		



1

GEV No.	696076	Ref. No.	IB4100915
description	gasket silicone ED ø 68mm ID ø 48mm thickness 2mm Qty 1 pcs		
For models:	BARMASTER, ORIONEFIVE		



1

GEV No.	696071	Ref. No.	IB4104040
description	O-ring EPDM thickness 3.53mm ID ø 52.39mm Qty 1 pcs		
For models:	BARMASTER, ORIONEFIVE		



1

GEV No.	696075	Ref. No.	IB4104031
description	V-ring ID ø 8mm thickness 5mm		
For models:	DRAGONEV		

holders



1

GEV No.	696080	Ref. No.	IB4010910
description	bracket for jar ø 121mm nominal-ø 100mm hole ø 49mm plastic Orione		
For models:	BARMASTER, ORIONEFIVE		



1

GEV No.	651050	Ref. No.	990047900
description	bracket for jar ø 81mm nominal-ø 68mm hole ø 57.5mm plastic		
For models:	HBB908CE		

blades

spare blades



1

GEV No.	696065	Ref. No.	IB2680900
description	knife W 73mm H 47mm hole ø 6x8mm Orione		
For models:	BARMASTER		

couplings



1

GEV No.	696061	Ref. No.	IB2000801
description	coupling ø 20mm H 10mm stainless steel Dragonev		
For models:	DRAGONEV		



1

GEV No.	696062	Ref. No.	IB2000901
description	coupling ø 25mm H 17mm IT M5L stainless steel Orione		
For models:	BARMASTER, ORIONEFIVE		



1

GEV No.	696063	Ref. No.	IB2000903
description	coupling ø 28mm H 17mm IT M5L stainless steel Orione		
For models:	BARMASTER		

blades with adaptor (complete)



1

GEV No.	651058	Ref. No.	98650
description	knife kit stainless steel		
For models:	HBF600, HBB650, HBB850		



1

GEV No.	696403	Ref. No.	98250	
description	slicing unit complete HBB250/HBB250S			
For models:	HBB250SCE			
accessories for	696403			
	GEV No.	698370	Ref. No.	990036300
	mixer coupling ø 38mm H 11.5mm IT M6R teeth 6 rubber HBB250/HBB250S			



1

GEV No.	651000	Ref. No.	990079500
description	slicing unit ø 68mm plastic 1G908		
For models:	HBB908CE		



1

GEV No.	696074	Ref. No.	IB9865335.05
description	slicing unit plastic jar stainless steel Orione		
For models:	BARMASTER		



1

GEV No.	696077	Ref. No.	IB9865336.06
description	slicing unit stainless steel jar ø 70mm stainless steel Orione		
For models:	BARMASTER		



1

GEV No.	651046	Ref. No.	98908
description	slicing unit with gasket an acuator for bar blender ø 68mm plastic		
For models:	HBB908CE		

mixer discs



1

GEV No.	696060	Ref. No.	IB2100933
description	mixer disc ø 50mm hole ø 10mm H 6.5mm aluminium Orione		
For models:	BARMASTER		

			
1			
GEV No.	696290	Ref. No.	IB2100932
description	mixer disc ø 50mm hole ø 27mm H 8mm aluminium Orione		
For models:	BARMASTER		

mixer discs (complete)

			
1			
GEV No.	696057	Ref. No.	IB9865322.05
description	mixer disc complete plastic jar ø 70mm stainless steel Orione		
For models:	BARMASTER		

			
1			
GEV No.	696056	Ref. No.	IB98653220.04
description	mixer disc complete stainless steel jar ø 70mm stainless steel Orione		
For models:	BARMASTER		

spindles

			
1			
GEV No.	696291	Ref. No.	IB2100931
description	spindle ø 10mm L 60mm IT M5L Orione		
For models:	BARMASTER		

			
1			
GEV No.	696058	Ref. No.	IB2000902
description	spindle ø 10mm L 76.5mm D1 ø 23.5mm ID ø 21.5mm IT M5L aluminium Orione		
For models:	BARMASTER		

			
1			
GEV No.	695169	Ref. No.	IB2000806
description	spindle ø 8mm L 53mm T1: M5L T2: M6L steel Dragone		
For models:	DRAGONEVV, MULTIPLO2S, MULTIPLO3S		

miscellaneous

			
1			
GEV No.	695119	Ref. No.	IB2000910
description	cap nuts thread M5L WS 10 SS Qty 1 pcs		
For models:	BARMASTER, DRAGONEVV, MULTIPLO2S, MULTIPLO3S, ORIONEFIVE		

			
1			
GEV No.	696059	Ref. No.	IB2000926
description	union nut ø 70mm ID ø 46.8mm H 10.5mm stainless steel		
For models:	BARMASTER, ORIONEFIVE		



holders



1

GEV No.	696079	Ref. No.	IB4000810
description	bracket for jar ø 116mm int. ø 1 24mm int. ø 2 79mm Dragone		
For models:	DRAGONEVV, MULTIPLO2S, MULTIPLO3S		



1

GEV No.	696078	Ref. No.	IB4010900
description	bracket for jar ø 129mm int. ø 1 16mm int. ø 2 100mm Orione		
For models:	BARMASTER, ORIONEFIVE		

actuators

group 1



1

GEV No.	698203	Ref. No.	IB4100905
description	mixer coupling for jar ø 36mm H 14mm IT M6L teeth 6 rubber Dragone		
For models:	BARMASTER, DRAGONEVV, MULTIPLO2S, MULTIPLO3S		



1

GEV No.	698202	Ref. No.	IB4000815
description	mixer coupling for motor ø 36mm H 14mm IT M6L teeth 6 plastic Dragone		
For models:	DRAGONEVV, MULTIPLO2S, MULTIPLO3S		



1

GEV No.	696069	Ref. No.	IB4100900
description	mixer coupling motor ø 36mm H 14mm IT M8L teeth 6 plastic Orione		
For models:	BARMASTER		



1

GEV No.	698248	Ref. No.	990035800
description	mixer coupling ø 38.5mm H 12mm IT M6L teeth 6 rubber		
For models:	HBB908CE		



1

GEV No.	698370	Ref. No.	990036300
description	mixer coupling ø 38mm H 11.5mm IT M6R teeth 6 rubber HBB250/HBB250S		
For models:	HBB250SCE		

mixers

jars



1

GEV No.	698318	Ref. No.	IB4050100
description	blender jar plastic ø 105mm H 150mm		
For models:	EEA0006-S, EEA0007-S, MULTIPLO2S, MULTIPLO3S, SIRIO1VVCAFFE, SIRIO2VVCAFFE		



1

GEV No.	698564	Ref. No.	65010100
description	blender jar SS ø 104mm H 150mm DMB / DMB20		
For models:	EEA0006-S, EEA0007-S, MULTIPL02S, MULTIPL03S, SIRIO1VVCAFFE, SIRIO2VVCAFFE		



1

GEV No.	698249	Ref. No.	110E
description	blender jar stainless steel 500ml ø 105mm H 170mm 936-950		
For models:	HMD200CE		

holders

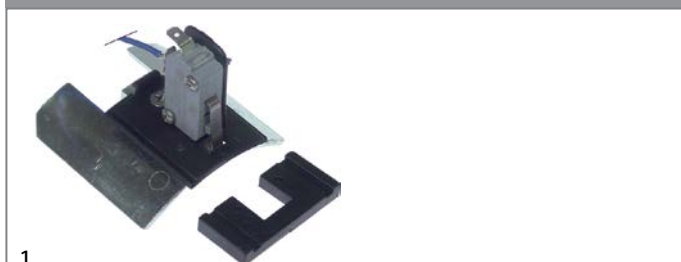

1

GEV No.	650100	Ref. No.	IB9866020
description	bracket with microswitch for jar W 62mm H 60mm		
For models:	EEA0006-S, EEA0007-S, SIRIO1VVCAFFE, SIRIO2VVCAFFE		

mixer discs



1

GEV No.	696091	Ref. No.	IB2100110
description	knife drink mixer ø 26mm IT M5 H 19mm Sirio		
For models:	EEA0006-S, EEA0007-S, SIRIO1VVCAFFE, SIRIO2VVCAFFE		



1

GEV No.	696066	Ref. No.	IB2200100
description	mixer disc drink mixer ø 25mm ID ø 5mm Sirio		
For models:	EEA0006-S, EEA0007-S, MULTIPL02S, MULTIPL03S, SIRIO1VVCAFFE, SIRIO2VVCAFFE		

accessories



1

GEV No.	696093	Ref. No.	IB2100100
description	spacer bush ø 8mm ID ø 5.3mm H 14mm Sirio		
For models:	EEA0006-S, EEA0007-S, MULTIPL02S, MULTIPL03S, SIRIO1VVCAFFE, SIRIO2VVCAFFE		

for hand blenders

spare parts and accessories



1

GEV No.	651051	Ref. No.	F2524
description	coupling male sitck side L 25mm teeth 8 int. ø 1.8x6mm		
For models:	FJZ0010-F, FJZ0011-F, FJZ0012-F		



1

GEV No.	696706	Ref. No.	IB4080110
description	cover ø 110mm H 135mm Sirio		
For models:	MULTIPL02S, MULTIPL03S, SIRIO1VVCAFFE, SIRIO2VVCAFFE		



couplings

 <p>1</p>			
GEV No.	651027	Ref. No.	IB4004043.04
description	coupling D1 ø 18mm D2 ø 21mm int. ø 1 12mm thread M8L L 36mm teeth 8 VORTEX edition since year of construction 10/2004		
For models:	FJZ0010, FJZ0011, FJZ0012		

beaters

<p>beaters</p>  <p>1</p>			
GEV No.	697763	Ref. No.	F2435
description	whisk ø 90mm L 270mm hole ø 8mm 350/450/650		
For models:	FJZ0010-F, FJZ0011-F, FJZ0012-F		

miscellaneous

 <p>1</p>			
GEV No.	550963	Ref. No.	IB5894000
description	bend relief ID ø 7mm		
For models:	FJZ0010, FJZ0011, FJZ0012		

 <p>1</p>			
GEV No.	346961	Ref. No.	IB4004042
description	push button ø 10mm L 62mm VORTEX		
For models:	FJZ0010, FJZ0011, FJZ0012		

for citrus juicers

<p>gaskets</p>  <p>1</p>			
GEV No.	696067	Ref. No.	IB4180700
description	gasket ø 26mm ID ø 11mm H 12mm for citrus juicers		
For models:	MULTIPL02S, MULTIPL03S		

 <p>1</p>			
GEV No.	696068	Ref. No.	IB4100110
description	gasket ø 85mm H 18mm drink mixer hole distance 55x75mm model Sirio		
For models:	EEA0006-S, EEA0007-S, MULTIPL02S, MULTIPL03S, SIRIO1VVCAFFE, SIRIO2VVCAFFE		

juicer insert

 <p>1</p>			
GEV No.	960107	Ref. No.	IB4000720
description	juicer insert		
For models:	MULTIPL02S, MULTIPL03S		

spindles

 <p>1</p>			
GEV No.	696090	Ref. No.	IB2080700
description	spindle L 66.5mm model APOLLO WS 14 IT M8L		
For models:	MULTIPL02S, MULTIPL03S		

 <p>1</p>			
GEV No.	696095	Ref. No.	IB2080710
description	spindle ø 8mm L 85mm motor model Sirio suitable for flange		
For models:	MULTIPL02S, MULTIPL03S		

miscellaneous

 <p>1</p>			
GEV No.	523000	Ref. No.	IB7300700
description	thrust ball bearing shaft ø 12mm ED ø 26mm W 9mm type 51101 DIN 711		
For models:	MULTIPL02S, MULTIPL03S		



for freezer cabinets

housing and bezels



1	GEV No.	692614	Ref. No.	C16014032
	description	front panel mounting pos. upper W 1415mm H 305mm thickness 63mm suitable for FRENOX stainless steel		
	For models:	BMB0004-F, BMC0003-F		

for display coolers

glass panels

accessories

1	GEV No.	694256	Ref. No.	R005R
	description	gasket for glass plate D1 ø 15mm D2 ø 4.5mm thickness 1mm PVC		
	For models:	BGB0001, BGB0002, BGB0003, BGB0004, BGB0005, BGB0006, BGB0007, BGB0008, BGB0009, BGB0010, BGB0011, BGB0012, BGB0013, BGB0014, BGB0015, BGB0022, BGB0023, BGB0024, BGB0025, BGB0026, BGB0050, HDC0001, HDC0002, HDC0003, HDC0004, HDC0005, IFF0001, IFF0002, IFF0003		

1	GEV No.	694255	Ref. No.	R005V
	description	Thumb screw for glass plate thread M4 L 18mm		
	For models:	BGB0001, BGB0002, BGB0003, BGB0004, BGB0005, BGB0006, BGB0007, BGB0008, BGB0009, BGB0010, BGB0011, BGB0012, BGB0013, BGB0014, BGB0015, BGB0022, BGB0023, BGB0024, BGB0025, BGB0026, BGB0027, BGB0028, BGB0029, BGB0050, HDC0001, HDC0002, HDC0003, HDC0004, HDC0005, IFF0001, IFF0002, IFF0003		

for ice-cube maker

drain systems

drain fittings



1	GEV No.	695620	Ref. No.	N10472
	description	drain fitting straight connection 24mm for ice maker		
	For models:	BAA0019, BAA0022, BAA0023, BAA0024, BAA0025, BAA0026, BAA0027, BAA0028, BAA0029, BAA0030, BAA0031, BAA0032, BAA0033, BAA0037, BAA0038, BAA0046, BAA0046W, BAA0051, BAA0055, BAB0001, BAB0001-W, BAB0002, BAB0002-W		

overflow pipes



1	GEV No.	695622	Ref. No.	N10305
	description	lid for overflow pipe tube ø 34mm		
	For models:	BAA0024, BAA0025, BAA0026, BAA0027, BAA0028, BAA0029, BAA0030, BAA0031, BAA0032, BAA0033, BAA0034, BAA0037, BAA0038, BAA0040, BAA0046, BAA0046W, BAA0051, BAA0055		

	accessories for	695622		
	GEV No.	695086	Ref. No.	N10133
	description	overflow pipe tube ø 20.5mm pipe length 88.6mm		



1	GEV No.	695083	Ref. No.	N13028
	description	overflow pipe ID ø 22mm D1 ø 27mm D2 ø 19mm L 144mm		
	For models:	BAA0019, BAA0022, BAA0023, BAA0053-A		



1	GEV No.	695086	Ref. No.	N10133
	description	overflow pipe tube ø 20.5mm pipe length 88.6mm		
	For models:	BAA0024, BAA0025, BAA0026, BAA0027, BAA0028, BAA0029, BAA0030, BAA0031, BAA0032, BAA0033, BAA0034, BAA0037, BAA0038, BAA0046, BAA0046W, BAA0055		

	accessories for	695086		
	GEV No.	532517	Ref. No.	—

	description	O-ring silicone thickness 1.78mm ID ø 17.17mm Qty 1 pcs		
--	--------------------	---	--	--

	GEV No.	695059	Ref. No.	N10007
--	----------------	--------	-----------------	--------

	description	hose connector for ice-cube maker		
--	--------------------	-----------------------------------	--	--

	GEV No.	695537	Ref. No.	N13006
--	----------------	--------	-----------------	--------

	description	gasket silicone ED ø 40mm ID ø 30mm thickness 2mm Qty 1 pcs		
--	--------------------	---	--	--

	GEV No.	695622	Ref. No.	N10305
--	----------------	--------	-----------------	--------

	description	lid for overflow pipe tube ø 34mm		
--	--------------------	-----------------------------------	--	--

reducing rings



1	GEV No.	699157	Ref. No.	N20785
	description	reduction ring ED ø 54mm int. ø 1 42mm int. ø 2 34mm H 30mm		
	For models:	BAB0001, BAB0001-W, BAB0002, BAB0002-W		

curtains

with holder



GEV No.	695506	Ref. No.	NC22034
description	curtain for ice maker W 328mm H 150mm with holder shaft length 325mm shaft ø 7.5mm		
For models:	BAA0024, BAA0025		



GEV No.	695507	Ref. No.	NC22035
description	curtain for ice maker W 433mm H 165mm with holder shaft length 438mm shaft ø 7.5mm		
For models:	BAA0026, BAA0027, BAA0028, BAA0029, BAA0030, BAA0031		



GEV No.	695508	Ref. No.	NC22059
description	curtain for ice maker W 660mm H 165mm with holder shaft length 665mm shaft ø 7.5mm		
For models:	BAA0037, BAA0038		



GEV No.	696594	Ref. No.	NC22106
description	curtain for ice-cube maker W 273mm H 160mm shaft length 280mm shaft ø 7.6mm holder length 316mm		
For models:	BAA0019, BAA0022, BAA0023		

without holder



GEV No.	695619	Ref. No.	NC10532
description	curtain for ice maker W 275mm H 80mm shaft length 280mm shaft ø 7.5mm		
For models:	BAA0019, BAA0022, BAA0023, BAA0053-A		

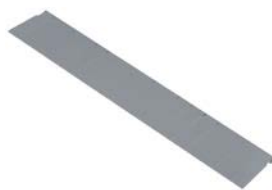

GEV No.	695117	Ref. No.	NC10534
description	curtain for ice-cube maker W 430mm H 80mm shaft length 440mm shaft ø 7.5mm complete with rod		
For models:	BAA0026, BAA0027, BAA0028, BAA0029, BAA0030, BAA0031, BAA0055		

suction system

intake filters



GEV No.	695532	Ref. No.	N20005
description	round filters ø 28mm H 60mm		
For models:	BAA0024, BAA0025, BAA0026, BAA0027, BAA0028, BAA0029, BAA0030, BAA0031, BAA0032, BAA0033, BAA0034, BAA0037, BAA0038, BAA0046, BAA0046W, BAA0055		

gaskets

miscellaneous



GEV No.	695537	Ref. No.	N13006
description	gasket silicone ED ø 40mm ID ø 30mm thickness 2mm Qty 1 pcs		
For models:	BAA0019, BAA0022, BAA0023, BAA0024, BAA0025, BAA0026, BAA0027, BAA0028, BAA0029, BAA0030, BAA0031, BAA0032, BAA0033, BAA0034, BAA0037, BAA0038, BAA0040, BAA0046, BAA0046W, BAA0051, BAA0055, BAB0001, BAB0001-W, BAB0002, BAB0002-W		

accessories for	695537		
GEV No.	695059	Ref. No.	N10007
description	hose connector for ice-cube maker		



flaps





GEV No.	696350	Ref. No.	NC26544
description	flap W 79mm H 86mm thickness 26mm		
For models:	BAA0019, BAA0055		





hoses			
formed hoses			
form L			
			
1			
GEV No.	695107	Ref. No.	N13005
description	formed hose L-shape for ice-cube maker ID ø 17mm ED ø 23.5mm L 70mm W 50mm		
For models:	BAA0040, BAA0051, BAA0053-A, BAA0055		

hose connectors				
with thread				
				
1				
GEV No.	695059	Ref. No.	N10007	
description	hose connector for ice-cube maker			
For models:	BAA0034			
accessories for	695059			
	GEV No.	695537	Ref. No.	N13006
	gasket silicone ED ø 40mm ID ø 30mm thickness 2mm Qty 1 pcs			

without thread			
			
1			
GEV No.	695058	Ref. No.	NC10006
description	hose connector 2-way for ice-cube maker		
For models:	BAA0022, BAA0032, BAA0033, BAA0046, BAA0055		

			
1			
GEV No.	695527	Ref. No.	NC26452
description	hose connector 3-way for hose for ice-cube maker		
For models:	BAA0023, BAA0032, BAA0046W		

floats			
float containers			
			
1			
GEV No.	695072	Ref. No.	NC10201
description	float container for ice maker with microswitch plastic		
For models:	BAB0003		

				
1				
GEV No.	402163	Ref. No.	N10145	
description	float container L 150mm 250V cable lengthmm ømm mounting ømm 2CO 12A male faston 6.3mm			
For models:	BAB0001, BAB0001-W, BAB0002, BAB0002-W, BAB0003, BAB0004, BAB0005			
spare parts for	402163			
	GEV No.	348044	Ref. No.	—
	microswitch with plunger 250V 16A 1CO connection male faston 4.8mm Lmm L1 27.8mm ambient temperature max. 125°C mounting distance 22mm with lever set type MS1-16 actuating force: 45g white			

miscellaneous			
			
1			
GEV No.	695536	Ref. No.	N10096
description	nut for drain assembly		
For models:	BAA0019, BAA0022, BAA0023, BAA0024, BAA0025, BAA0026, BAA0027, BAA0028, BAA0029, BAA0030, BAA0031, BAA0032, BAA0033, BAA0034, BAA0037, BAA0038, BAA0040, BAA0046, BAA0046W, BAA0051, BAA0055, BAB0001, BAB0001-W, BAB0002, BAB0002-W		

valves			
intake valves			
			
1			
GEV No.	695539	Ref. No.	N10188
description	intake valve with float		
For models:	BAC0007, BAC0008, BAC0009		

for espresso machines			
filter holders			
filter holders standard			
filter holders short			
			
1			
GEV No.	525845	Ref. No.	5.0.000.0657
description	filter holder mounting ø 83mm outlet 3/8" ID ø 62mm handle M12x1.75 wedge height 9mm wedge position horizontal number of wedges 2 lever inclined		
For models:	EFA0015, EFA0016, EFA0023		

filters

for 1 cup



1

GEV No.	526261	Ref. No.	5.0.000.0170
description	coffee filter ø 70mm mounting ø 60.5mm H 20.5mm cups 1 amount of coffee 6.5g		
For models:	EFA0015, EFA0016, EFA0023		

for 2 cups



1

GEV No.	529014	Ref. No.	5.0.000.0173
description	coffee filter ø 70mm mounting ø 60mm H 21mm cups 2 amount of coffee 12g perforation ø 0.3mm round		
For models:	EFA0015, EFA0016, EFA0023		

brewing units

shower screens

with upstand



1

GEV No.	525844	Ref. No.	5.0.025.0010
description	shower screen ø 55.3mm H 18.2mm		
For models:	EFA0015, EFA0016, EFA0023		

filter holder gaskets

flat

standard



1

GEV No.	526064	Ref. No.	5.0.025.0012
description	filter holder gasket D1 ø 73.3mm D2 ø 57.3mm H 8.5mm Qty 1 pcs		
For models:	EFA0015, EFA0016, EFA0023		

O-rings



1

GEV No.	510409	Ref. No.	835535651 F2680
description	O-ring EPDM thickness 5.34mm ID ø 56.52mm Qty 1 pcs		
For models:	7040CPE, 7070PEI, FLC0001-F, FLC0003-F, FLC0012-F, FMD0001-F, FMD0002-F		

brewing units with solenoid valve

components



1

GEV No.	525840	Ref. No.	5.0.016.0105
description	infusor 1/2" L 42mm WS 23		
For models:	EFA0015, EFA0016, EFA0023		

components

nozzles

with thread



1

GEV No.	528486	Ref. No.	5.0.016.0110
description	nozzle bore ø 0.7mm thread M6x0.75 L 9mm WS 7		
For models:	EFA0015, EFA0016, EFA0023		

water dispersions

water dispersions

group 2



1

GEV No.	525756	Ref. No.	5.0.025.0009
description	water distributor ø 30mm hole ø 1.5mm H 15mm ET M10x1 grooves 6 2.6mm brass 2 holes perforation ø 1mm		
For models:	EFA0015, EFA0016, EFA0023		



safety valves

safety valves

3/8"



1

GEV No.	529879	Ref. No.	4.0.000.0051
description	safety valve connection 3/8" triggering pressure 1.6bar approval CE 0036 sealed		
For models:	EFA0015, EFA0016, EFA0023		

expansion valves

with hose connection



1

GEV No.	526587	Ref. No.	5.0.016.0220
description	expansion valve T1: 1/4" ET hose ø 9,5mm L 42mm		
For models:	EFA0015, EFA0016, EFA0023		

gaskets



1

GEV No.	525822	Ref. No.	5.0.016.0223
description	gasket ED ø 15mm seat ø 6mm H 5.2mm overall height 10mm		
For models:	EFA0015, EFA0016, EFA0023		

drain pans

drain pans



1

GEV No.	525841	Ref. No.	4.0.000.0840
description	drain pan L 110mm W 85mm H 50mm hose ø 15mm		
For models:	EFA0015, EFA0016, EFA0023		

aerators and air bleeders



1

GEV No.	529304	Ref. No.	5.0.000.1002
description	aerator and air bleeder screw connection 1/4"		
For models:	EFA0015, EFA0016, EFA0023		

steam/water taps

steam/water taps

steam/water taps



1

GEV No.	531053	Ref. No.	5.0.016.0350
description	steam/water tap inlet 1/4" outlet 3/8" shaft 6mm shaft L 14mm		
For models:	EFA0015, EFA0016, EFA0023		

steam taps

steam taps (complete)



1

GEV No.	525835	Ref. No.	4.0.016.0020
description	steam tap inlet 1/4" thread Tr18x2		
For models:	EFA0015, EFA0016, EFA0023		

components

bushes



1

GEV No.	525827	Ref. No.	5.0.016.0305
description	bush for steam-/water-tap D1 ø 9mm D2 ø 10.4mm ID ø 6.2mm H 4.5mm brass		
For models:	EFA0015, EFA0016, EFA0023		

gaskets



1

GEV No.	526258	Ref. No.	5.0.016.0301
description	gasket D1 ø 12.5mm thickness 5.5mm silicone		
For models:	EFA0015, EFA0016, EFA0023		

water taps

water taps



1

GEV No.	525834	Ref. No.	4.0.016.0021
description	water tap inlet 1/4" thread Tr18x2		
For models:	EFA0015, EFA0016, EFA0023		

steam/water pipes

steam pipes



1

GEV No.	525838	Ref. No.	5.0.016.0320
description	steam pipe thread 3/8" H 180mm L 210mm ø 14.5mm tube ø 10mm stainless steel		
For models:	EFA0015, EFA0016, EFA0023		

water pipes



1

GEV No.	531054	Ref. No.	5.0.016.0330
description	water pipe ø 23.5mm L 96mm tube ø 8mm head ø 14.5mm		
For models:	EFA0015, EFA0016, EFA0023		

accessories

bushes



1

GEV No.	525826	Ref. No.	5.0.025.6508
description	bush D1 ø 9mm D2 ø 12mm int. ø 1 7mm H 5mm brass		
For models:	EFA0015, EFA0016, EFA0023		

gaskets



1

GEV No.	510893	Ref. No.	456015
description	O-ring EPDM thickness 2.62mm ID ø 9.92mm Qty 1 pcs		
For models:	GLB0058, GLB0059, GLB0060, GLB0061, GLB0061C, GLB0062, GLB0063, GLB0064, GLB0064C, GLB0065, GLB0066, GLB0072		

fine filters

fine filters



1

GEV No.	528357	Ref. No.	5.0.025.0023
description	fine filter ø 8.5mm H 22mm		
For models:	EFA0015, EFA0016, EFA0023		

intake valves

intake valves



1

GEV No.	525837	Ref. No.	4.0.016.0010
description	intake valve for FIAMMA		
For models:	EFA0015, EFA0016, EFA0023		

non-return valves

pistons



1

GEV No.	525830	Ref. No.	5.0.016.0231
description	piston for non-return valve triangular ø 12mm L 20.3mm		
For models:	EFA0015, EFA0016, EFA0023		

for coffee grinders

grinding burrs

grinding burrs straight

standard



1

GEV No.	527228	Ref. No.	260001
description	grinding burrs pair turn direction right D1 ø 83mm ID ø 45mm H 10mm tooth spacing 4mm hole ø 5.4mm bore ø 10mm mounting ø 64.5 straight suitable for FIORENZATO		
For models:	EFF0002-Q		

grinding burrs holders



1

GEV No.	527260	Ref. No.	170090
description	grinding burr holder D1 ø 63mm D2 ø 80mm H 31mm type T80 suitable for FIORENZATO		
For models:	EFF0002-Q		

dosing containers

dosing containers (complete)



1

GEV No.	527508	Ref. No.	RMT800003 RMUNI0007
description	dosing unit ø 120mm suitable for T80		
For models:	EFF0002-Q		

dosing container lids



1

GEV No.	527320	Ref. No.	160064
description	lid for dosing container mounting ø 114mm ø 122mm H 22mm suitable for M80		
For models:	EFF0002-Q		

dosing units



1

GEV No.	527529	Ref. No.	RMT800010
description	dosing unit		
For models:	EFF0002-Q		

springs

group 1



1

GEV No.	525075	Ref. No.	230027
description	tension spring ø 10mm total length 40mm wire gauge ø 1mm		
For models:	EFF0002-Q		

glass cylinders



1

GEV No.	525071	Ref. No.	160008
description	glass cylinder ø 115mm H 49mm plexiglas		
For models:	EFF0002-Q		



1

GEV No.	527322	Ref. No.	160083
description	glass cylinder ø 122mm H 10mm plexiglas		
For models:	EFF0002-Q		

levers

levers



1

GEV No.	525073	Ref. No.	160075
description	lever for dosing unit hole ø 18.8mm L 110mm plastic		
For models:	EFF0002-Q		

coffee presses

coffee presses



1

GEV No.	527506	Ref. No.	RMT800014
description	coffee press ø 57mm L 83mm H 41mm plastic		
For models:	EFF0002-Q		

bodies



1

GEV No.	525072	Ref. No.	170174
description	body for dosing container ø 120mm H 60mm aluminium		
For models:	EFF0002-Q		

automatic grinding

automatic grinding



1

GEV No.	525060	Ref. No.	RMT800002
description	housing with microswitch H 35mm plastic for model T80-M80-M1		
For models:	EFF0002-Q		

return spring



1

GEV No.	525081	Ref. No.	160074
description	cover plate mounting pos. lower ø 117mm plastic		
For models:	EFF0002-Q		

ratches

pins



1

GEV No.	525066	Ref. No.	130060
description	pin for stop ø 2.6mm D2 ø 4mm L 17mm		
For models:	EFF0002-Q		



1

GEV No.	525065	Ref. No.	130059
description	pressure pin for lever ø 4mm D2 ø 6mm L 16mm		
For models:	EFF0002-Q		

stars

central



1

GEV No.	525080	Ref. No.	160071
description	star mounting pos. centre ø 109mm hole ø 12mm H 31mm		
For models:	EFF0002-Q		

upper



1

GEV No.	527501	Ref. No.	160072
description	star mounting pos. upper ø 107mm hole ø 8mm H 39mm		
For models:	EFF0002-Q		

bottom



1

GEV No.	525079	Ref. No.	160070
description	star mounting pos. lower ø 109mm		
For models:	EFF0002-Q		

accessories



1

GEV No.	525078	Ref. No.	160065
description	spacer ring ø 42mm ID ø 25mm H 4mm plastic		
For models:	EFF0002-Q		

adjustment mechanism

lockable adjustment



1

GEV No.	525068	Ref. No.	160062
description	push button for setting ring L 36mm W 22mm shaft ø 6.2mm shaft length 23mm		
For models:	EFF0002-Q		

springs



1

GEV No.	525069	Ref. No.	230013
description	compression spring ø 5mm L 28mm wire gauge ø 0.5mm		
For models:	EFF0002-Q		

coffee beans containers

container lids



1

GEV No.	527313	Ref. No.	160149
description	lid for coffee beans container mounting ø 174mm ø 178mm		
For models:	EFF0002-Q		

coffee beans containers





1

GEV No.	525086	Ref. No.	RMT800015
description	coffee beans container complete ø 175mm H 220mm seat ø 68mm container capacity 1.2kg M80		
For models:	EFF0002-Q		



1

GEV No.	527314	Ref. No.	160080
description	coffee beans container ø 172mm H 222mm seat ø 67mm M80		
For models:	EFF0002-Q		

accessories for	527314			
	GEV No.	527313	Ref. No.	160149
	lid for coffee beans container mounting ø 174mm ø 178mm			
	GEV No.	527318	Ref. No.	160063
	catch L 86mm W 48mm thickness 2mm plastic			
	GEV No.	527319	Ref. No.	160067
	protection cap ø 60mm suitable for FIORENZATO plexiglas			

protection caps



1

GEV No.	527319	Ref. No.	160067
description	protection cap ø 60mm suitable for FIORENTATO plexiglas		
For models:	EFF0002-Q		

locks



1

GEV No.	527318	Ref. No.	160063
description	catch L 86mm W 48mm thickness 2mm plastic		
For models:	EFF0002-Q		

support for filter holder



1

GEV No.	527518	Ref. No.	170044
description	bracket for filter holder L 105mm W 57mm H 15mm aluminium		
For models:	EFF0002-Q		

counters

counters



1

GEV No.	527505	Ref. No.	210033
description	counter ø 20mm lever length 35mm for dosing unit		
For models:	EFF0002-Q		

for pour machines

coffee pots



1

GEV No.	960014	Ref. No.	110001
description	coffee pot 1.8l glas suitable for COFFEE QUEEN		
For models:	EFB0001, EFB0003, EFB0004		

filter pans

filter pans

COFFEE QUEEN



1

GEV No.	531086	Ref. No.	1102131
description	filter pan int. ø 1 255mm int. ø 2 145mm W 280mm D 340mm H 165mm filter no. 960017		
For models:	EFB0014, EFB0019		



1

GEV No.	525462	Ref. No.	1102016
description	filter pan stainless steel ED ø 193mm int. ø 1 153mm int. ø 2 90mm H 100mm filter no. 960100 suitable for COFFEE QUEEN		
For models:	EFB0001, EFB0002, EFB0003, EFB0004, EFB0008, EFB0008-C, EFB0009, EFB0009-C		



			
1			
GEV No.	531065	Ref. No.	1102011
description	filter pan stainless steel ED ø 193mm int. ø 1 175mm int. ø 2 125mm H 100mm filter no. 960015		
For models:	EFB0017, EFB0018		

drain taps

drain taps			
			
1			
GEV No.	527557	Ref. No.	120200-02
description	outlet tap complete pipe lengthmm thread 3/4" ET black/chrome suitable for COFFEE QUEEN		
For models:	EFB0014, EFB0019, EFC0003		

			
1			
GEV No.	531061	Ref. No.	1103363
description	outlet tap tube ømm pipe lengthmm thread 3/4" black/chrome suitable for COFFEE QUEEN		
For models:	EFB0008-C, EFB0009-C, EFB0014, EFB0017, EFB0018, EFB0019		

			
1			
GEV No.	531062	Ref. No.	1201924
description	outlet tap with nut tube ø 26mm pipe length 33mm thread M15x1 red suitable for COFFEE QUEEN		
For models:	EFB0017, EFB0018		

accessories

			
1			
GEV No.	531087	Ref. No.	1802120
description	extension for drain tap T1: 3/4" T2: 1/2" L 57mm suitable for COFFEE QUEEN		
For models:	EFB0014, EFB0019, EFC0003		

brew units

manifolds			
			
1			
GEV No.	525485	Ref. No.	1204016
description	manifold ø 35mm plastic suitable for COFFEE QUEEN		
For models:	EFB0001, EFB0002, EFB0003, EFB0004, EFB0008, EFB0008-C, EFB0009, EFB0009-C, EFB0014, EFB0019		

			
1			
GEV No.	531067	Ref. No.	1031801
description	water distributor ø 30mm thread M18x1.5 stainless steel suitable for COFFEE QUEEN		
For models:	EFB0014, EFB0017, EFB0018, EFB0019		

flow controllers

			
1			
GEV No.	525468	Ref. No.	160193
description	flow controller inlet 7/16" outlet M10mm suitable for COFFEE QUEEN		
For models:	EFB0017, EFB0018		

liquid level pipes

liquid level pipes			
			
1			
GEV No.	531066	Ref. No.	1103459
description	water level tube ED ø 8mm ID ø 6mm H 210mm for container		
For models:	EFB0008-C, EFB0009-C, EFB0017, EFB0018		



GEV No.	531092	Ref. No.	1103359
description	water level tube ED ø 8mm ID ø 6mm H 240mm with ball for COFFEE QUEEN		
For models:	EFB0014, EFB0019		

accessories

miscellaneous



GEV No.	531060	Ref. No.	1103461
description	cover for water level tube W 45mm H 205mm		
For models:	EFB0008-C, EFB0009-C, EFB0017, EFB0018		



GEV No.	531093	Ref. No.	1103361
description	cover for water level tube W 45mm H 235mm		
For models:	EFB0014, EFB0019		

non-return valves



GEV No.	525461	Ref. No.	1206123
description	non-return valve for hose ø 10.5mm H 14mm plastic		
For models:	EFB0017, EFB0018, EFB0019		

hoses



GEV No.	520609	Ref. No.	1505041
description	formed hose ED ø 14mm ID ø 10mm silicone coffee machine parts transparent Qty 1 U-shape		
For models:	EFB0001, EFB0002, EFB0003, EFB0004, EFB0008, EFB0008-C, EFB0009, EFB0009-C, EFB0014, EFB0019		

for bain marie

drain systems



GEV No.	515060	Ref. No.	3600077
description	drain fitting thread 3/4" H 18mm ID ø 20mm ED ø 38mm		
For models:	IIA3006, IIA3007, IIA3008, IIA3010, IIA3011, IIA3012		

spare parts and accessories



GEV No.	692889	Ref. No.	984.006.00
description	door magnet H 6mm ø 20mm M5 thread L 15mm		



GEV No.	691249	Ref. No.	623.027.00
description	lever		
For models:	6030BME, 6030CPE, 6060BME, 6060CPE, 6060FRE, 6060FRG, 6540BME, 6570BME, 6570FRE, 7040BME, 7070BME, 92BME, 92BMG, AFB0001, AFB0002, AFB0003		



GEV No.	692796	Ref. No.	256.431.00
description	mounting set hexagon L 31mm thread M5		

housing and bezels

1

GEV No.	691634	Ref. No.	623.002.00 623.002.15
description	fastening angle L 33mm W 14mm H 14mm SS		
For models:	110160PCG, 110170CFG, 6030BME, 6030CPE, 6030FRE, 6030FRG, 6030FTE, 6030FTG, 6030PCE, 6030PCG, 6030SPE, 6060BME, 6060CPE, 6060FRE, 6060FRG, 6060FTE, 6060FTG, 6060FTRE, 6060FTRG, 6060FTRRE, 6060FTRRG, 6060PCE, 6060PCG, 65110CFG, 65110CFGE, 65110CFGG, 65110TPFG, 6540BME, 6540CPE, 6540FRE, 6540FRG, 6540FTE, 6540FTECR, 6540FTG, 6540FTGCR, 6540FTRE, 6540FTRECR, 6540FTRG, 6540FTRGCR, 6540GRG, 6540GRL, 6540PCE, 6540PCG, 6540PG40P, 6540SPE, 6570BME, 6570BRE, 6570CFE, 6570CFG, 6570CFGE...(Other models you can see in the webshop)		



1

GEV No.	416529	Ref. No.	611.702.00
description	ceramic hob L 700mm W 650mm H 100mm complete		
For models:	6570PVE, 7070CFVE, 7070PVE		

for pyroceram ranges

ceramic hobs

ceramic hobs (complete)



1

GEV No.	416528	Ref. No.	61170100
description	ceramic hob complete		
For models:	7040PVE		

for conveyor oven

conveyor belts

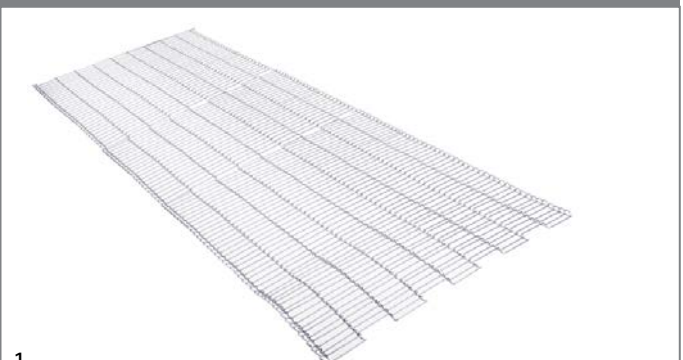

1

GEV No.	694278	Ref. No.	RETE0013
description	conveyor belt W 500mm for pizza oven Qty supplied by meter		
For models:	CAD0005, CAD0007, SY12100VELED, SY12100VGASD, SY850VELED		

for deep fryers

lids

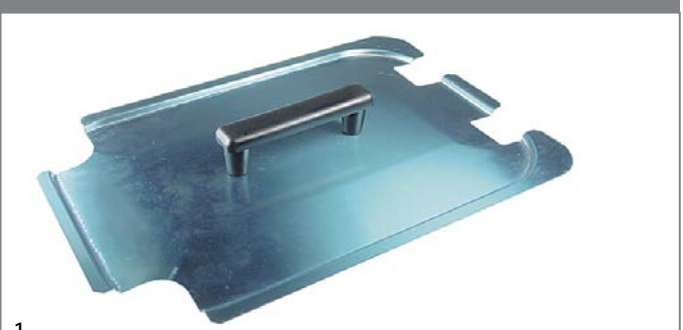

1

GEV No.	970369	Ref. No.	B65300
description	lid for fryer		
For models:	ACC0003, ACC003V, ACC008V, ACC010V, ADC004V		

spare parts and accessories



GEV No.	691633	Ref. No.	611.038.00
description	bracket fryer heaters		
For models:	6540FRE, 6570FRE, 7040FRE10, 7070FRE10		



GEV No.	692810	Ref. No.	256.420.00
description	cover for holder fryer heaters L 64mm W 56mm H 80mm mounting pos. left		



GEV No.	692778	Ref. No.	611.042.00
description	cover for holder fryer heaters L 64mm W 56mm H 80mm mounting pos. right		
For models:	6030FRE, 6060FRE, 6540FRE, 6570FRE, 7040FRE10, 7070FRE10, AFC0003		



GEV No.	692795	Ref. No.	941.130.00
description	fixing plate L 35mm W 10mm H 8mm M5 mounting distance 17mm		



GEV No.	691249	Ref. No.	623.027.00
description	lever		
For models:	6030BME, 6030CPE, 6060BME, 6060CPE, 6060FRE, 6060FRG, 6540BME, 6570BME, 6570FRE, 7040BME, 7070BME, 92BME, 92BMG, AFB0001, AFB0002, AFB0003		



GEV No.	514447	Ref. No.	623.201.00
description	lever L 42mm W 15mm thickness 2mm H 25mm		
For models:	6030FRE, 6060FRE, 6540FRE, 6570FRE, 7040FRE10, 7070FRE10, AFC0003		



GEV No.	692796	Ref. No.	256.431.00
description	mounting set hexagon L 31mm thread M5		



GEV No.	692886	Ref. No.	6211992.00 6211992.15
description	protective plate cover for fryer L 210mm W 60mm H 38mm mounting pos. heating element		

housing and bezels



GEV No.	691634	Ref. No.	623.002.00 623.002.15
description	fastening angle L 33mm W 14mm H 14mm SS		
For models:	110160PCG, 110170CFG, 6030BME, 6030CPE, 6030FRE, 6030FRG, 6030FTE, 6030FTG, 6030PCE, 6030PCG, 6030SPE, 6060BME, 6060CPE, 6060FRE, 6060FRG, 6060FTE, 6060FTG, 6060FTRE, 6060FTRG, 6060FTRR, 6060FTRRG, 6060PCE, 6060PCG, 65110CFG, 65110CFGE, 65110CFGG, 65110TPFG, 6540BME, 6540CPE, 6540FRE, 6540FRG, 6540FTE, 6540FTECR, 6540FTG, 6540FTGCR, 6540FTRE, 6540FTRECR, 6540FTRG, 6540FTRGCR, 6540GRG, 6540GRL, 6540PCE, 6540PCG, 6540PG40P, 6540SPE, 6570BME, 6570BRE, 6570CFE, 6570CFG, 6570CFGE...(Other models you can see in the webshop)		

door magnets



GEV No.	692889	Ref. No.	984.006.00
description	door magnet H 6mm ø 20mm M5 thread L 15mm		



sumps



1

GEV No.	695118	Ref. No.	058102
description	sump for fryer with hole L 320mm W 260mm H 200mm 8l		
For models:	AMZ0004, AMZ0005		

miscellaneous



1

GEV No.	692776	Ref. No.	983.009.00
description	support bracket for heating element		
For models:	AFC0003		

for drink dispensers

drain taps

control parts



1

GEV No.	650059	Ref. No.	L8017BLU
description	lever for drink dispenser blue		
For models:	EAA0002, EAA0003		

pistons



1

GEV No.	650035	Ref. No.	F015
description	piston D1 ø 22.4mm L 76mm for outlet tap		
For models:	EBZ0001-CN, EBZ0002-CN, EBZ0003-CN		

miscellaneous



1

GEV No.	650046	Ref. No.	7510
description	bush for lever		
For models:	EAA0002, EAA0003		



1

GEV No.	650049	Ref. No.	L8011
description	drain pipe L 102.5mm ø 14.5mm		
For models:	EAA0002, EAA0003		



1

GEV No.	650040	Ref. No.	F013
description	pin for lever		
For models:	EBZ0001-CN, EBZ0002-CN, EBZ0003-CN, MISSOFTY		

transmission technology and ball bearings

drive shafts



1

GEV No.	650034	Ref. No.	F303/1
description	drive shaft for drink dispenser ø 12mm L 330mm		
For models:	EBZ0001-CN, EBZ0002-CN, EBZ0003-CN		



1

GEV No.	650029	Ref. No.	L6124
description	drive shaft for paddle L 335mm suitable for 9 litres		
For models:	EAA0002, EAA0003		

containers

group 1



1	GEV No.	650101	Ref. No.	F009
	description	container for drink dispenser		
	For models:	EBZ0001-CN, EBZ0002-CN, EBZ0003-CN		

group 2



1	GEV No.	650017	Ref. No.	L8098
	description	container 9l		
	For models:	EAA0002, EAA0003		

bushes



1	GEV No.	650044	Ref. No.	F315/3
	description	bush for container ø 35mm L 16mm		
	For models:	EBZ0001-CN, EBZ0002-CN, EBZ0003-CN		



1	GEV No.	650043	Ref. No.	F317
	description	bush for drive shaft ø 16mm L 30mm		
	For models:	EBZ0001-CN, EBZ0002-CN, EBZ0003-CN		



1	GEV No.	650045	Ref. No.	F226
	description	bush for evaporator ø 19mm L 11mm		
	For models:	EBZ0001-CN, EBZ0002-CN, EBZ0003-CN		



1	GEV No.	650032	Ref. No.	1041
	description	bush for paddle		
	For models:	EAA0002, EAA0003		

lids



1	GEV No.	650053	Ref. No.	L8006B
	description	container lid grey		
	For models:	EAA0002, EAA0003		



1	GEV No.	650084	Ref. No.	F030/N
	description	lid for evaporator black		
	For models:	EBZ0001-CN, EBZ0002-CN, EBZ0003-CN		



1	GEV No.	650082	Ref. No.	F030BM
	description	lid for evaporator blue		
	For models:	EBZ0001-CN, EBZ0002-CN, EBZ0003-CN		



gaskets



1			
GEV No.	650039	Ref. No.	F026/2
description	bottom gasket for auger D1 ø 31mm D2 ø 24mm ID ø 12mm H 21mm rubber		
For models:	EBZ0001-CN, EBZ0002-CN, EBZ0003-CN		



1			
GEV No.	650026	Ref. No.	F019
description	gasket for evaporator H 14mm silicone		
For models:	EBZ0001-CN, EBZ0002-CN, EBZ0003-CN, MISSOFTY		



1			
GEV No.	650051	Ref. No.	F017
description	gasket for outlet tap mounting pos. lower		
For models:	EBZ0001-CN, EBZ0002-CN, EBZ0003-CN		



1			
GEV No.	650052	Ref. No.	F022/1
description	shaft sealing for drink dispenser D1 ø 12mm D2 ø 19mm		
For models:	EBZ0001-CN, EBZ0002-CN, EBZ0003-CN, MISSOFTY		

adjusting screws



1			
GEV No.	650050	Ref. No.	F034
description	adjusting screw thread M6		
For models:	EBZ0001-CN, EBZ0002-CN, EBZ0003-CN		

paddles



1			
GEV No.	650024	Ref. No.	L8099
description	paddle for drink dispenser		
For models:	EAA0002, EAA0003		

augers



1			
GEV No.	650054	Ref. No.	F304/1
description	auger for drink dispenser		
For models:	EBZ0001-CN, EBZ0002-CN, EBZ0003-CN		

drip grids



1			
GEV No.	650028	Ref. No.	L8034BLU
description	drip grid for drink dispenser		
For models:	EAA0002, EAA0003		

drip water trays



1			
GEV No.	650157	Ref. No.	GV2MODG
description	drip tray with drip grid grey		
For models:	EBZ0001-CN, EBZ0002-CN, EBZ0003-CN		

miscellaneous

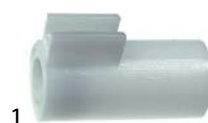

1			
GEV No.	650048	Ref. No.	F035
description	guide for spring		
For models:	EBZ0001-CN, EBZ0002-CN, EBZ0003-CN		

for griddles

spare parts and accessories



1

GEV No.	692889	Ref. No.	984.006.00
----------------	--------	-----------------	------------

description	door magnet H 6mm ø 20mm M5 thread L 15mm
--------------------	---



1

GEV No.	692779	Ref. No.	631.175.00
----------------	--------	-----------------	------------

description	drain connection for griddle ø 45mm L 60mm W 85mm mounting distance 65mm
--------------------	--



1

GEV No.	692795	Ref. No.	941.130.00
----------------	--------	-----------------	------------

description	fixing plate L 35mm W 10mm H 8mm M5 mounting distance 17mm
--------------------	--



1

GEV No.	692805	Ref. No.	683.028.00
----------------	--------	-----------------	------------

description	hook for solid top L 360mm
--------------------	----------------------------

For models:	65110TPFG, 6570TPFG, 6570TPG, 70110TPFG, 7070TPFG, 7070TPG, 94TPFG, 94TPG, 96TPFG, AFA2005, AFA2006
--------------------	---

housing and bezels



1

GEV No.	691634	Ref. No.	623.002.00
----------------	--------	-----------------	------------

description	fastening angle L 33mm W 14mm H 14mm SS
--------------------	---

For models:	110160PCG, 110170CFG, 6030BME, 6030CPE, 6030FRE, 6030FRG, 6030FTE, 6030FTG, 6030PCE, 6030PCG, 6030SPE, 6060BME, 6060CPE, 6060FRE, 6060FRG, 6060FTE, 6060FTG, 6060FTRE, 6060FTRG, 6060FTRRE, 6060FTRRG, 6060PCE, 6060PCG, 65110CFG, 65110CFGE, 65110CFGG, 65110TPFG, 6540BME, 6540CPE, 6540FRE, 6540FRG, 6540FTE, 6540FTECR, 6540FTG, 6540FTGCR, 6540FTRE, 6540FTRECR, 6540FTRG, 6540FTRGCR, 6540GRG, 6540GRL, 6540PCE, 6540PCG, 6540PG40P, 6540SPE, 6570BME, 6570BRE, 6570CFE, 6570CFG, 6570CFGE... (Other models you can see in the webshop)
--------------------	---

sumps



1

GEV No.	696805	Ref. No.	6111127.13
----------------	--------	-----------------	------------

description	grease collecting tray for griddle L 175mm W 185mm H 110mm
--------------------	--



1

GEV No.	696811	Ref. No.	6111249.00
----------------	--------	-----------------	------------

description	grease collecting tray for griddle L 270mm W 205mm H 110mm
--------------------	--

drain stoppers



1

GEV No.	691250	Ref. No.	641.023.00
----------------	--------	-----------------	------------

description	plug for griddle ø 30mm
--------------------	-------------------------

For models:	7040FTES, 7040FTGS
--------------------	--------------------

for gyros grills

skewers



1

GEV No.	693655	Ref. No.	059018
----------------	--------	-----------------	--------

description	skewer for gyro grill size 12x12mm L 615mm
--------------------	--

For models:	AJE0002, AJE0006
--------------------	------------------

1

GEV No.	693656	Ref. No.	059019
description	skewer for gyro grill size 12x12mm L 775mm		
For models:	AJE0003, AJE0007		

skewer plates



1

GEV No.	693649	Ref. No.	056422
description	skewer plate for gyro grill		
For models:	AJE0001, AJE0005		



1

GEV No.	693650	Ref. No.	098025
description	skewer plate for gyro grill		
For models:	AJE0007		

cotter pins



1

GEV No.	693457	Ref. No.	020102
description	retainer clip L 73mm wire gauge ø 3mm zinc-coated steel Qty 1 pcs		
For models:	AJE0001, AJE0002, AJE0003, AJE0005, AJE0006, AJE0007		

for chicken rotisserie

skewers



1

GEV No.	689000	Ref. No.	70290029
description	skewer square L 835mm thickness 12mm		
For models:	53054-CN, 5305-CN, 5330, 53304, AJD0002-CCN, AJD0003-CCN, AJD0005-CCN, AJD0006-CCN, AJD0014-C, AJD0015-C, AJD0017-C, AJD0018-C, AJD0019-C		

spit clamp



1

GEV No.	693143	Ref. No.	7024D001
description	skewer clamp crimping range 13x13mm ² double for skewer 12x12mm mounting pos. inner skewer 2x60mm skewer ø 4mm		
For models:	53054-CN, 5305-CN, 5330, 53304, AJD0002-CCN, AJD0003-CCN, AJD0005-CCN, AJD0006-CCN, AJD0014-C, AJD0015-C, AJD0017-C, AJD0018-C, AJD0019-C		



1

GEV No.	693142	Ref. No.	7024S001	
description	skewer clamp single for skewer 12x12mm mounting pos. outer skewer 75mm skewer ø 4mm			
For models:	53054-CN, 5305-CN, 5330, 53304, AJD0002-CCN, AJD0003-CCN, AJD0005-CCN, AJD0006-CCN, AJD0014-C, AJD0015-C, AJD0017-C, AJD0018-C, AJD0019-C			
accessories for	693142			
	GEV No.	697481	Ref. No.	00000000623
	Thumb screw thread M6 thread L 8mm ø 14mm H 6mm SS			

for convection ovens/combi-steamers



1

GEV No.	692843	Ref. No.	09980728000
description	spacer bush ID ø 7mm H 7.5mm ED ø 17.5mm for glass plate white Spacer		
For models:	AAA2002, AIB0014, AIB0015, KF1001G, KF630, KF733, KF933U, KF965, KF981D		

flow controllers



1

GEV No.	101752	Ref. No.	09980758900
description	flow controller for hot air oven		
For models:	AIB0014, AIB0015		

glass panels



1

GEV No.	693226	Ref. No.	09980438300
description	glass panel L 340mm W 280mm rectangular		
For models:	AIB0012		



1

GEV No.	693230	Ref. No.	01981248300
description	glass panel L 430mm W 345mm thickness 4mm rectangular		
For models:	AIB0013, AIB0017		



1

GEV No.	691811	Ref. No.	09982338418
description	glass panel L 583mm W 450mm mounting pos. outer		
For models:	AIB0013, AIB0017		

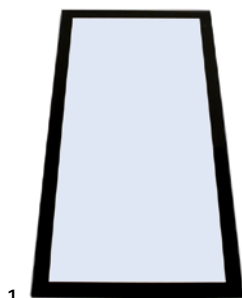

1

GEV No.	693224	Ref. No.	09980648418
description	glass panel L 645mm W 315mm thickness 5mm rectangular		
For models:	AAA2002, AIB0014, AIB0015		

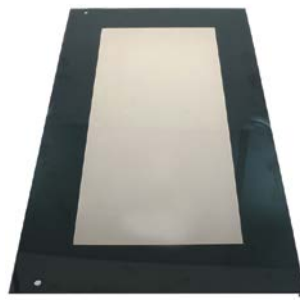

1

GEV No.	694338	Ref. No.	VET00070
description	glass panel L 750mm W 420mm thickness 4mm mounting pos. outer for oven		
For models:	VP800U		



1

GEV No.	694454	Ref. No.	09981219002 09981498418
description	glass panel L 770mm W 455mm thickness 4mm with frame		
For models:	AIB0014, AIB0015		

miscellaneous



1

GEV No.	696427	Ref. No.	12009970
description	rivet nut thread M5 DN 4mm L 12mm SS Qty 1 pcs ø 7mm WS 6		
For models:	GLB0063C-FN		

for hot dog machines

lids



1

GEV No.	693098	Ref. No.	058502
description	lid		
For models:	ARZ0001, ARZ0002		



glass cylinders

 <p>1</p>			
GEV No.	693002	Ref. No.	066006
description	glass cylinder ø 200mm Pyrex glass H 240mm		
For models:	ARZ0001, ARZ0002		

miscellaneous

 <p>1</p>			
GEV No.	693468	Ref. No.	057501
description	grid basket for hot dog grill ø 180mm H 210mm		
For models:	ARZ0001, ARZ0002		

skewers

 <p>1</p>			
GEV No.	693094	Ref. No.	055804
description	bun spikes		
For models:	ARZ0001		

for tilting bratt pans

spare parts and accessories

 <p>1</p>			
GEV No.	699598	Ref. No.	941.154.00
description	bolt L 24mm ø 14mm for tilting bratt pan		

 <p>1</p>			
GEV No.	699597	Ref. No.	256.461.00
description	mounting set for hinge for lid WS 13		

spindles

 <p>1</p>			
GEV No.	692887	Ref. No.	941.163.00
description	bearing block hinge for tilting bratt pan ø 20mm ID ø 15.5mm L 54mm		

 <p>1</p>			
GEV No.	693085	Ref. No.	64106700
description	bushing		
For models:	7070BRE, 7070BRG		

 <p>1</p>			
GEV No.	693083	Ref. No.	641.066.00
description	thread block		
For models:	6570BRE, 7070BRE, 7070BREM, 7070BRG, 7070BRGM		

 <p>1</p>			
GEV No.	690546	Ref. No.	K49100
description	thread block thread Tr24x5 right-hand thread W 38mm bolt ø 20mm D 40mm H 40mm		
For models:	ADK201V, ADK202V, ADK203V, ADK204V, ADK207V, ADK208V, ADK209V, ADK210V		

 <p>1</p>			
GEV No.	690543	Ref. No.	X65402
description	threaded rod		
For models:	ACK2001, ACK2002, ACK2003, ACK2004, ACK201V, ACK202V, ACK203V, ACK204V		

 <p>1</p>			
GEV No.	693084	Ref. No.	641.065.00
description	threaded rod		
For models:	6570BRE, 7070BRE, 7070BRG		



 <p>1</p>			
GEV No.	693087	Ref. No.	64107700
description	threaded rod		
For models:	7070BREM, 7070BRGM		



			
1			
GEV No.	692891	Ref. No.	910.732.00
description	threaded rod for tilting bratt pan ID ø 25mm ED ø 30mm L 670mm		

miscellaneous

			
1			
GEV No.	690545	Ref. No.	Y42100
description	ball bearing		
For models:	ADK202V, ADK204V, ADK208V, ADK210V		

			
1			
GEV No.	523510	Ref. No.	00000000860 260005 F2016 F2082
description	deep-groove ball bearing type 6202-2RS shaft ø 15mm ED ø 35mm W 11mm with sealing discs deep-groove ball bearing DIN 625-1		
For models:	8920, 8921, 8922, EEC0001, EED0010, EFF0002-Q, FHZ0001, FIF0016-F, FIF0023		

			
1			
GEV No.	692888	Ref. No.	941.181.00
description	fixing bolt L 35mm ø 12mm for tilting bratt pan WS 19		
accessories for	692888		
	GEV No.	692798	Ref. No. 256.471.00
	fixing bolt L 35mm ø 12mm with nut with disc tilting bratt pan WS 19		

			
1			
GEV No.	692798	Ref. No.	256.471.00
description	fixing bolt L 35mm ø 12mm with nut with disc tilting bratt pan WS 19		
spare parts for	692798		
	GEV No.	692888	Ref. No. 941.181.00
	fixing bolt L 35mm ø 12mm for tilting bratt pan WS 19		

			
1			
GEV No.	690967	Ref. No.	X65403
description	spindle L 400mm ø 20mm for hand wheel		
For models:	ACK2001, ACK2002, ACK2003, ACK2004, ACK201V, ACK202V, ACK203V, ACK204V		

			
1			
GEV No.	690542	Ref. No.	X65500
description	threaded bush		
For models:	ACK2001, ACK2002, ACK2003, ACK2004, ACK201V, ACK202V, ACK203V, ACK204V		

for boiling pans

spare parts and accessories

			
1			
GEV No.	692783	Ref. No.	941.139.15
description	adjusting bush for kettle ø 40/20mm L 80mm		

			
1			
GEV No.	514528	Ref. No.	941.137.00
description	bush for kettle lid ø 39mm ID ø 16mm H 12mm		

			
1			
GEV No.	692782	Ref. No.	641.150.00
description	spindle for kettle L 285mm ED ø 16mm		



1

GEV No.	692787	Ref. No.	631.195.00
description	threaded part brass L 160mm ID ø 34mm 1 1/2"		



1

GEV No.	542398	Ref. No.	678.082.00
description	water inlet for kettle fixed		

for lava stone grill

filters



1

GEV No.	514521	Ref. No.	611.373.00
description	drain filter for kettle L 145mm W 75mm		
For models:	7070PEI, 7070PGI		



1

GEV No.	692889	Ref. No.	984.006.00
description	door magnet H 6mm ø 20mm M5 thread L 15mm		



1

GEV No.	692892	Ref. No.	9221341.00
description	grease collecting tray L 750mm W 157mm H 22mm		

miscellaneous



1

GEV No.	514519	Ref. No.	678.087.00
description	closing clamp for kettle with locking schrew		



1

GEV No.	692809	Ref. No.	512.002.00
description	level glass size 35x35 2 bracket mounting for lava rock grill		
For models:	7070GRL, 94BRG, 96BRG, 96BRGM		

for microwaves

electric



1

GEV No.	347810	Ref. No.	A61583030GP
description	switch for microwave right 1CO		
For models:	NE1880, NE2140, NE3240		

housings

outer parts



1

GEV No.	403714	Ref. No.	ANE803X8Y0BP
description	start button for microwave NE-1446/NE-1646/NE-1846 PANASONIC		
For models:	NE1643, NE1843		

inner parts



1

GEV No.	691046	Ref. No.	A20113030GP	
description	roof liner L 483mm W 248mm for microwave			
For models:	NE1880, NE2140, NE3240			
accessories for	691046			
	GEV No.	692572	Ref. No.	ANE9082930AP
	mounting clip ø 8mm suitable for microwave			

miscellaneous



1

GEV No.	692572	Ref. No.	ANE9082930AP
description	mounting clip ø 8mm suitable for microwave		
For models:	NE1880, NE2140, NE3240		

for neutral elements

doors



1

GEV No.	692889	Ref. No.	984.006.00
description	door magnet H 6mm ø 20mm M5 thread L 15mm		

for pasta cookers

spare parts and accessories



1

GEV No.	692889	Ref. No.	984.006.00
description	door magnet H 6mm ø 20mm M5 thread L 15mm		



1

GEV No.	692795	Ref. No.	941.130.00
description	fixing plate L 35mm W 10mm H 8mm M5 mounting distance 17mm		



1

GEV No.	698471	Ref. No.	CO1356
description	lid for gearbox cast iron suitable for MPF1.5-2.5		
For models:	CBF0001		



1

GEV No.	692796	Ref. No.	256.431.00
description	mounting set hexagon L 31mm thread M5		



1

GEV No.	693080	Ref. No.	61157600
description	shaft extension		
For models:	7070CPE, 7070CPG		

for noodle machine



1

GEV No.	696455	Ref. No.	CO1342
description	lid for noodle machine L 190mm W 194mm H 18.5mm plastic transparent		
For models:	CBF0001		

for ovens

spare parts and accessories



1

GEV No.	692889	Ref. No.	984.006.00
description	door magnet H 6mm ø 20mm M5 thread L 15mm		



1

GEV No.	692795	Ref. No.	941.130.00
description	fixing plate L 35mm W 10mm H 8mm M5 mounting distance 17mm		



1

GEV No.	692805	Ref. No.	683.028.00
description	hook for solid top L 360mm		
For models:	65110TPFG, 6570TPFG, 6570TPG, 70110TPFG, 7070TPFG, 7070TPG, 94TPFG, 94TPG, 96TPFG, AFA2005, AFA2006		



1

GEV No.	692796	Ref. No.	256.431.00
description	mounting set hexagon L 31mm thread M5		

housing and bezels



1

GEV No.	691634	Ref. No.	623.002.00 623.002.15
description	fastening angle L 33mm W 14mm H 14mm SS		
For models:	110160PCG, 110170CFG, 6030BME, 6030CPE, 6030FRE, 6030FRG, 6030FTE, 6030FTG, 6030PCE, 6030PCG, 6030SPE, 6060BME, 6060CPE, 6060FRE, 6060FRG, 6060FTE, 6060FTG, 6060FTRE, 6060FTRG, 6060FTRRE, 6060FTRRG, 6060PCE, 6060PCG, 65110CFG, 65110CFGE, 65110CFGG, 65110TPFG, 6540BME, 6540CPE, 6540FRE, 6540FRG, 6540FTE, 6540FTECR, 6540FTG, 6540FTGCR, 6540FTRE, 6540FTRECR, 6540FTRG, 6540FTRGCR, 6540GRG, 6540GRL, 6540PCE, 6540PCG, 6540PG40P, 6540SPE, 6570BME, 6570BRE, 6570CFE, 6570CFG, 6570CFGE...(Other models you can see in the webshop)		

miscellaneous



1

GEV No.	699368	Ref. No.	935.045.13
description	bottom plate L 640mm W 425mm H 5mm SS		



1

GEV No.	696806	Ref. No.	256.425.00
description	support plate for heating element L 372mm W 180mm H 25mm		

for pizza ovens

drive shafts



1

GEV No.	693381	Ref. No.	MECC0417
description	drive shaft for pizza oven L 490mm		
For models:	CAD0004		



1

GEV No.	693382	Ref. No.	MECC0125
description	spindle for pizza oven L 595mm		
For models:	CAD0005, CAD0007, SY850VELED		

spare parts and accessories



1

GEV No.	693393	Ref. No.	MECC0114
description	coupling for pizza oven for drive shaft		
For models:	CAD0001-ZN, CAD0004, CAD0004-ZN, CAD0005, CAD0007, CAD0009, CAD0010, SY12100VELED, SY12100VGASD, SY1280VE, SY1280VG, SY850VELED		



1

GEV No.	693394	Ref. No.	MECC0419
description	spacer piece for drive shaft for pizza oven		
For models:	CAD0001-ZN, CAD0004, CAD0004-ZN		



1

GEV No.	693395	Ref. No.	MECC0036
description	spacer piece for drive shaft ID ø 20mm for pizza oven ø 38mm H 20mm		
For models:	CAD0005, CAD0007, SY850VELED		

glass panels



1

GEV No.	698992	Ref. No.	91610038
description	ceramic washer W 1120mm H 93mm thickness 4mm for pizza oven Qty 1 pcs		
For models:	CAB0057-DCG, CAB0058-DCG, CAB0061-DCG, CAB0062-DCG		

1

GEV No.	700205	Ref. No.	91610010
description	glass panel L 320mm W 100mm thickness 5mm rectangular		
For models:	CAA0003, CAA0004, CAA0005, CAB0029-CN, CAB0030-CN, CAB0032, CAB0033, CAB0035		



1

GEV No.	693377	Ref. No.	CRIS0026
description	glass panel L 325mm W 93mm thickness 6mm rectangular		
For models:	CAD0009, CAD0010		



1

GEV No.	693378	Ref. No.	CRIS0034
description	glass panel L 415mm W 105mm thickness 6mm rectangular		
For models:	CAD0005, CAD0007, SY850VELED		



1

GEV No.	693375	Ref. No.	CRIS0025
description	glass panel L 525mm W 93mm thickness 6mm rectangular		
For models:	SY12100VELED, SY12100VGASD, SY1280VE, SY1280VG		



1

GEV No.	700697	Ref. No.	91610001
description	glass panel L 626mm W 93mm thickness 4mm		
For models:	CAB0007, CAB0008, CAB0009, CAB0010, CAB0011, CAB0012, CAB0013, CAB0014, CAB0015, CAB0016, CAB0017, CAB0018, CAB0024, CAB0025, CAB0026, CAB0027, CAB0029-CN, CAB0030-CN, CAB0039, CAB0040, CAB0041, CAB0042, CAB0043, CAB0044, CAB0045, CAB0046		



1

GEV No.	693330	Ref. No.	91610002
description	glass panel L 713mm W 93mm rectangular		
For models:	CAB0019, CAB0020		

1



GEV No.	700703	Ref. No.	91610003
description	glass panel L 726mm W 93mm		
For models:	CAB0007, CAB0008, CAB0009, CAB0010, CAB0011, CAB0012, CAB0013, CAB0014, CAB0015, CAB0016, CAB0017, CAB0018, CAB0024, CAB0025, CAB0026, CAB0027, CAB0032-CN, CAB0033-CN, CAB0039, CAB0040, CAB0041, CAB0042, CAB0043, CAB0044, CAB0045, CAB0046		

2



GEV No.	691228	Ref. No.	91610004
description	glass panel L 926mm W 93mm rectangular		
For models:	CAB0007, CAB0008, CAB0009, CAB0010, CAB0011, CAB0012, CAB0013, CAB0014, CAB0015, CAB0016, CAB0017, CAB0018, CAB0024, CAB0025, CAB0026, CAB0027, CAB0039, CAB0040, CAB0041, CAB0042, CAB0043, CAB0044, CAB0045, CAB0046		

firebricks

1



GEV No.	850103	Ref. No.	91610056
description	firebrick L 1050mm W 350mm H 19mm delivery freight forwarding company only		
For models:	CAB0007, CAB0008, CAB0009, CAB0010, CAB0011, CAB0012, CAB0013, CAB0014, CAB0015, CAB0016, CAB0017, CAB0018, CAB0024, CAB0025, CAB0026, CAB0027, CAB0039, CAB0040, CAB0041, CAB0042, CAB0043, CAB0044, CAB0045, CAB0046		

1



GEV No.	850128	Ref. No.	91610141
description	firebrick L 1074mm W 358mm H 16mm delivery freight forwarding company only		
For models:	CAB0007-CD, CAB0009-CD, CAB0013-CD, CAB0056-DCG, CAB0058-DCG, CAB0060-DCG, CAB0062-DCG		

1

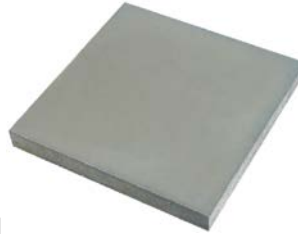

GEV No.	850056	Ref. No.	91610072
description	firebrick L 330mm W 330mm H 30mm delivery freight forwarding company only		
For models:	CAA0003, CAA0004, CAA0005		

1



GEV No.	850110	Ref. No.	91610110
description	firebrick L 588mm W 294mm H 19mm		
For models:	CAB0019, CAB0020		

1



GEV No.	850101	Ref. No.	91610050
description	firebrick L 600mm W 300mm H 20mm grooved delivery freight forwarding company only		
For models:	CAB0007, CAB0008, CAB0009, CAB0010, CAB0011, CAB0012, CAB0013, CAB0014, CAB0015, CAB0016, CAB0017, CAB0018, CAB0024, CAB0025, CAB0026, CAB0027, CAB0039, CAB0040, CAB0041, CAB0042, CAB0043, CAB0044, CAB0045, CAB0046		

1



GEV No.	850018	Ref. No.	91610101 91610130
description	firebrick L 616mm W 308mm H 19mm delivery freight forwarding company only		
For models:	CAB0029-CN, CAB0030-CN, CAB0032, CAB0033, CAB0035		



			
1			
GEV No.	850102	Ref. No.	91610055
description	firebrick L 700mm W 350mm H 19mm delivery freight forwarding company only		
For models:	CAB0007, CAB0008, CAB0009, CAB0010, CAB0011, CAB0012, CAB0013, CAB0014, CAB0015, CAB0016, CAB0017, CAB0018, CAB0024, CAB0025, CAB0026, CAB0027, CAB0039, CAB0040, CAB0041, CAB0042, CAB0043, CAB0044, CAB0045, CAB0046		

			
1			
GEV No.	850112	Ref. No.	91610102 91610140
description	firebrick L 715mm W 357mm H 20mm delivery freight forwarding company only		
For models:	CAB0008-CD, CAB0024-CD, CAB0025-CD, CAB0029-CN, CAB0030-CN, CAB0032, CAB0032-CN, CAB0033, CAB0033-CN, CAB0035, CAB0055-DCG, CAB0057-DCG, CAB0059-DCG, CAB0061-DCG		

			
1			
GEV No.	850105	Ref. No.	91610051
description	firebrick L 900mm W 300mm H 18mm delivery freight forwarding company only		
For models:	CAB0007, CAB0008, CAB0009, CAB0010, CAB0011, CAB0012, CAB0013, CAB0014, CAB0015, CAB0016, CAB0017, CAB0018, CAB0024, CAB0025, CAB0026, CAB0027, CAB0039, CAB0040, CAB0041, CAB0042, CAB0043, CAB0044, CAB0045, CAB0046		

			
1			
GEV No.	693392	Ref. No.	MECC0035
description	gear wheel teeth 10 shaft intake ø 20mm ø 44mm hub ømm stainless steel		
For models:	CAD0005, CAD0007, SY850VELED		

for salamander grills

			
1			
GEV No.	693054	Ref. No.	055813
description	mechanism for salamander grill		
For models:	2158, 2623		

for sliding doors

door guides

			
1			
GEV No.	693733	Ref. No.	PD.4748
description	guide sliding door L 54mm plastic 20		
For models:	TP12JG, TP15JG		

for dishwashers

containers

salt tanks

			
1			
GEV No.	505229	Ref. No.	Z471105000
description	filter L 71mm ø 10mm salt tank conical		
For models:	GLB0061C-F, GLB0063C-F		

			
1			
GEV No.	505220	Ref. No.	Z471107000
description	flat gasket for salt tank rubber thickness 3.9mm ID ø 68mm ED ø 86mm		
For models:	GLB0061C-F, GLB0063C-F		



1

GEV No.	524177	Ref. No.	480005 Z471108000
description	lid ø 69mm H 20mm for salt tank ID ø 50mm		
For models:	GLB0035, GLB0036, GLB0037, GLB0038, GLB0039, GLB0056, GLB0057, GLB0059, GLB0061, GLB0061C, GLB0061C-F, GLB0062, GLB0063, GLB0063C-F, GLB0064, GLB0064C, GLB0065, GLB0066		
accessories for	524177		
	GEV No.	524148	Ref. No. —
	O-ring EPDM thickness 3.53mm ID ø 40.86mm Qty 1 pcs		



1

GEV No.	517401	Ref. No.	Z471106000
description	nut ø 92mm H 10.5mm for salt tank ID ø 64.5mm		
For models:	GLB0061C-F, GLB0063C-F		







1

GEV No.	510018	Ref. No.	429011
description	nut ø 92mm H 10.5mm for salt tank ID ø 64mm		
For models:	GLB0035, GLB0036, GLB0037, GLB0038, GLB0039, GLB0056, GLB0057, GLB0059, GLB0061, GLB0061C, GLB0062, GLB0063, GLB0064, GLB0064C, GLB0065, GLB0066		







1

GEV No.	505101	Ref. No.	Z471102000
description	salt tank ø 90mm H 86mm		
For models:	GLB0061C-F, GLB0063C-F		
accessories for	505101		
	GEV No.	505220	Ref. No. Z471107000
	flat gasket for salt tank rubber thickness 3.9mm ID ø 68mm ED ø 86mm		
	GEV No.	506015	Ref. No. 456052 Z471109000
	O-ring EPDM thickness 3.53mm ID ø 39.69mm Qty 1 pcs		
	GEV No.	517401	Ref. No. Z471106000
	nut ø 92mm H 10.5mm for salt tank ID ø 64.5mm		
	GEV No.	524177	Ref. No. 480005 Z471108000
	lid ø 69mm H 20mm for salt tank ID ø 50mm		



1

GEV No.	510032	Ref. No.	406998
description	salt tank without gasket new model		
For models:	GLB0035, GLB0036, GLB0037, GLB0038, GLB0039, GLB0056, GLB0057, GLB0059, GLB0061, GLB0061C, GLB0062, GLB0063, GLB0064, GLB0064C, GLB0065, GLB0066		
spare parts for	510032		
	GEV No.	506015	Ref. No. 456052 Z471109000
	O-ring EPDM thickness 3.53mm ID ø 39.69mm Qty 1 pcs		
	GEV No.	510018	Ref. No. 429011
	nut ø 92mm H 10.5mm for salt tank ID ø 64mm		
	GEV No.	510071	Ref. No. 437034
	flat gasket rubber ED ø 81mm ID ø 68mm thickness 3mm for salt tank Qty 1 pcs		
	GEV No.	524177	Ref. No. 480005 Z471108000
	lid ø 69mm H 20mm for salt tank ID ø 50mm		



accessories



1			
GEV No.	510071	Ref. No.	437034
description	flat gasket rubber ED ø 81mm ID ø 68mm thickness 3mm for salt tank Qty 1 pcs		
For models:	GLB0035, GLB0036, GLB0037, GLB0038, GLB0039, GLB0056, GLB0057, GLB0059, GLB0061, GLB0061C, GLB0062, GLB0063, GLB0064, GLB0064C, GLB0065, GLB0066		

boilers

boilers for dishwashers



1			
GEV No.	513243	Ref. No.	80389
description	boiler		
For models:	GLB0070, GLB0071		



1			
GEV No.	518378	Ref. No.	104030
description	boiler		
For models:	GLB0072		



1			
GEV No.	518576	Ref. No.	104050
description	boiler		
For models:	OPT1012		



1			
GEV No.	513709	Ref. No.	104056
description	boiler ø 110mm L 295mm		
For models:	GLB0035, GLB0036, GLB0037, GLB0038, GLB0039, GLB0056, GLB0057		



1			
GEV No.	505209	Ref. No.	12022893
description	boiler ø 130mm L 310mm		
For models:	GLB0035-FN, GLB0037-FN		



1			
GEV No.	518235	Ref. No.	104060
description	boiler ø 145mm L 405mm flange 3 hole flange		
For models:	GLB0073, OPT1012C		



1			
GEV No.	518377	Ref. No.	104026
description	boiler ø 150mm L 360mm		
For models:	GLB0061, GLB0061C, GLB0062, GLB0063, GLB0064, GLB0064C, GLB0065, GLB0066		



1			
GEV No.	505210	Ref. No.	12022943 Z201710000
description	boiler ø 150mm L 460mm inlet ø 10		
For models:	GLB0061C-F, GLB0061C-FN, GLB0063C-F, OPT1012-CF, OPT1012-CFN		



1			
GEV No.	517455	Ref. No.	41230
description	boiler ø 210mm L 405mm		
For models:	GLB0044		

			
1			
GEV No.	518098	Ref. No.	104044.SO
description	boiler with safety thermostat 2600W 230V ø 110mm L 295mm W 110mm H 115mm connection 11mm hose ø 6mm with thermostat inlet ø 11mm		
For models:	GLB0035, GLB0036, GLB0037, GLB0038, GLB0039		
spare parts for	518098		
	GEV No.	390233	Ref. No. 236039 926189
	bi-metal safety thermostat hole distance 24mm switch-off temp. 110°C 1NC 1-pole 16A connection F6.3 2 hole fixing without holder		
	GEV No.	390319	Ref. No. 236048
	bi-metal thermostat hole distance 23.8mm switch-off temp. 80°C 1NC 1-pole 16A connection F6.3 2 hole fixing		
	GEV No.	418642	Ref. No. 230113
	heating element 2600W 230V mounting ø 38.5mm heating circuits 1 L 260mm W 33mm H 24mm number of thermostat sleeves 1 thermostat sleeves ø 7mm length thermostat sleeves 175mm thermostat sleeve eccentric, non clinging tube ø 6.5mm hole distance 57mm 3 hole flange connection male faston 6.3mm immersion heater		
	GEV No.	521120	Ref. No. 456075
	O-ring EPDM thickness 5.34mm ID ø 37.47mm Qty 1 pcs		

accessories

			
1			
GEV No.	518348	Ref. No.	468117
description	hose connector		
For models:	GLB0043, GLB0044, OPT1012		

			
1			
GEV No.	517799	Ref. No.	143228
description	pipe for boiler ø 9mm L 245mm		
For models:	GLB0035, GLB0036, GLB0037, GLB0038, GLB0039, GLB0056, GLB0057, GLB0058, GLB0059, GLB0060		

gaskets

			
1			
GEV No.	699343	Ref. No.	12048366
description	gasket L 118mm W 73mm H 9mm thickness 9mm		
For models:	OPT1012-CF		

			
1			
GEV No.	698802	Ref. No.	35510
description	gasket L 65mm W 10mm H 4mm thickness 4mm		
For models:	GLB0073		

softener cartridges

softening columns

			
1			
GEV No.	505102	Ref. No.	Z471101000
description	softener 4-fold L 380mm W 180mm		
For models:	GLB0061C-F, GLB0063C-F		

spare parts and accessories

			
1			
GEV No.	691767	Ref. No.	R722631000
description	bracket SS L 40mm W 30mm H 50mm		
For models:	GLB0061C-F, GLB0063C-F		

housing and bezels

flanges

			
1			
GEV No.	699252	Ref. No.	75057
description	flange H 40mm ø 130mm mounting pos. lower		
For models:	GLB0046		





			
1			
GEV No.	699251	Ref. No.	75141
description	flange H 65mm ø 130mm mounting pos. upper		
For models:	GLB0046		

miscellaneous			
			
1			
GEV No.	513000	Ref. No.	480057
description	lid rubber ED ø 27mm		
For models:	GLB0058, GLB0059, GLB0060, GLB0061, GLB0061C, GLB0062, GLB0063, GLB0064, GLB0064C, GLB0065, GLB0066		

			
1			
GEV No.	513708	Ref. No.	480058
description	lid rubber ø 17mm mounting ø 17mm		
For models:	GLB0061, GLB0061C, GLB0062, GLB0063, GLB0064, GLB0064C, GLB0065, GLB0066		

hood mechanics for dishwashers

bolts			
			
1			
GEV No.	513200	Ref. No.	80131
description	screw bolt hood mechanics		
For models:	GLB0071		

			
1			
GEV No.	505219	Ref. No.	12023966 Z710542000
description	shaft for roller		
For models:	OPT1012-CF, OPT1012-CFN		

bushes			
			
1			
GEV No.	505272	Ref. No.	12025255 Z710515000
description	bush ED ø 22mm ID ø 10mm L 7mm plastic		
For models:	OPT1012-CF, OPT1012-CFN		

springs			
			
1			
GEV No.	517448	Ref. No.	926108
description	tension spring ø 30mm total length 505mm wire gauge ø 5.5mm for hood mechanics Qty 1 pcs		
For models:	GLB0071		

guide bars			
			
1			
GEV No.	513724	Ref. No.	80068 80069
description	guide bar L 590mm hood mechanics		
For models:	GLB0070, GLB0071, OPT1012, OPT1012C		

			
1			
GEV No.	698803	Ref. No.	41038
description	sliding rail L 458mm mounting pos. rear W 21mm H 20mm		
For models:	GLB0043, GLB0044		

friction rings			
			
1			
GEV No.	505225	Ref. No.	12009922 Q308012000
description	slide ring PTFE ED ø 30mm ID ø 10mm thickness 3mm for hood joint Qty 1 pcs		
For models:	OPT1012-CF, OPT1012-CFN		

hood handles

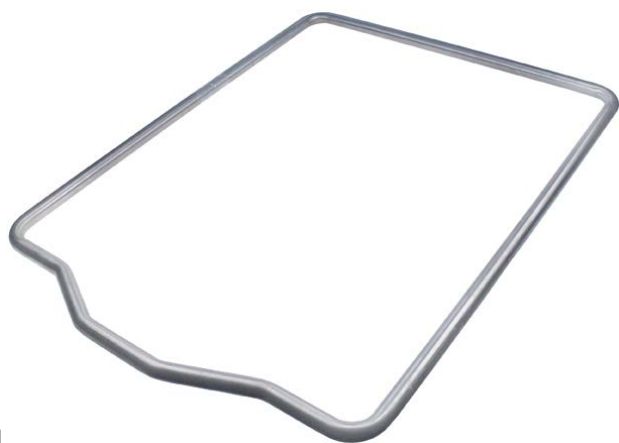

1

GEV No.	513719	Ref. No.	80027
description	hood handle		
For models:	GLB0070, GLB0071, OPT1012, OPT1012C		

hood handle supports



1

GEV No.	513202	Ref. No.	80190
description	bearing for hood handle plastic		
For models:	GLB0070, GLB0071, OPT1012, OPT1012C		



1

GEV No.	513192	Ref. No.	926243
description	guide for hood handle		
For models:	GLB0070, OPT1012, OPT1012C		

rollers



1

GEV No.	513201	Ref. No.	80132
description	roller \varnothing 36/42mm H 34mm hood mechanics plastic grey hole \varnothing 12mm		
For models:	GLB0071		



1

GEV No.	505218	Ref. No.	12025210 Z710546000
description	roller \varnothing 37mm H 12mm plastic hole \varnothing 12.1mm		
For models:	OPT1012-CF, OPT1012-CFN		

miscellaneous



1

GEV No.	513198	Ref. No.	80130
description	base for roller ED \varnothing 64mm ID \varnothing 8.5mm hood mechanics grey		
For models:	GLB0071		



1

GEV No.	508375	Ref. No.	80105
description	fixing support		
For models:	GLB0070, GLB0071, OPT1012, OPT1012C		



1

GEV No.	529240	Ref. No.	Q308000000
description	flat washer ED \varnothing 16.5mm ID \varnothing 8.2mm plastic thickness 4mm		
For models:	OPT1012-CF, OPT1012-CFN		



1

GEV No.	513274	Ref. No.	80998
description	hexagonal screw thread M4 plastic WS 7 thread L 6mm		
For models:	GLB0070, GLB0071, OPT1012, OPT1012C		



 <p>1</p>			
GEV No.	529241	Ref. No.	Q308002000
description	plain washer for dishwashers ED ø 13mm ID ø 6mm plastic thickness 3.5mm		
For models:	GLB0035-FN, GLB0037-FN, GLB0061C-F, GLB0061C-FN, GLB0063C-F, GLB0063C-FN, OPT1012-CF		

basket guides

guide bars

 <p>1</p>			
GEV No.	971056	Ref. No.	12021776 Z710326000
description	basket guide mounting pos. upper L 490mm H 36mm hole ø 6mm hole distance 400mm		
For models:	OPT1012-CF, OPT1012-CFN		

 <p>1</p>			
GEV No.	530558	Ref. No.	015039
description	guide bar mounting pos. left L 422mm W 43mm H 39mm		
For models:	GLB0036, GLB0037, GLB0038, GLB0039, GLB0056, GLB0057		





basket holders

 <p>1</p>			
GEV No.	699347	Ref. No.	75076
description	buffer for basket transport L 25m ø 17.5mm		
For models:	GLB0046		



 <p>1</p>			
GEV No.	699344	Ref. No.	75058
description	roller for basket H 35mm ø 45mm		
For models:	GLB0046		





air traps





air traps

 <p>1</p>			
GEV No.	505094	Ref. No.	12024350 Z203011000
description	air trap		
For models:	GLB0035-FN, GLB0037-FN, GLB0061C-F, GLB0061C-FN, GLB0063C-F, GLB0063C-FN, OPT1012-CF, OPT1012-CFN		
accessories for	505094		
	GEV No.	505096	Ref. No.
elbow			12024157 Z201312000 Z203012000
	GEV No.	505184	Ref. No.
eye bolt			12024222 Z203013000
	GEV No.	529412	Ref. No.
O-ring EPDM thickness 2.62mm ID ø 10.78mm Qty 1 pcs			000603.07.01 12009873 456006 Q307003000

 <p>1</p>			
GEV No.	518488	Ref. No.	107005
description	air trap		
For models:	GLB0035, GLB0036, GLB0037, GLB0038, GLB0039, GLB0056, GLB0057, GLB0058, GLB0059, GLB0060, GLB0061, GLB0061C, GLB0062, GLB0063, GLB0064, GLB0064C, GLB0065, GLB0066, GLB0072		
accessories for	518488		
	GEV No.	504618	Ref. No.
O-ring EPDM thickness 2.62mm ID ø 15.54mm Qty 1 pcs			—
	GEV No.	510075	Ref. No.
flat gasket rubber ED ø 22mm ID ø 13mm thickness 1.5mm Qty 1 pcs			437019
	GEV No.	510106	Ref. No.
hose connector for air trap			468029

			
1			
GEV No.	519499	Ref. No.	107012
description	air trap L 46mm W 35mm H 72mm thread 3/4" hose ø 5.5mm plastic		
For models:	GLB0071, GLB0073, OPT1012		
accessories for	519499		
	GEV No.	516261	Ref. No. 437098
	flat gasket rubber ED ø 33mm ID ø 25mm thickness 2.5mm for air trap Qty 1 pcs		
	GEV No.	519498	Ref. No. 417120
	nut thread 3/4" H 10mm WS 30 plastic Qty 1 pcs		

			
1			
GEV No.	510103	Ref. No.	12090549
description	air trap L 85mm W 20mm H 80mm hose ø 6mm plastic		
For models:	GLB0035-F, GLB0037-F		
spare parts for	510103		
	GEV No.	505045	Ref. No. 12009912 Q307036000
	O-ring EPDM thickness 1.78mm ID ø 5.28mm Qty 1 pcs		
	GEV No.	505094	Ref. No. 12024350 Z203011000
	air trap		
	GEV No.	510016	Ref. No. —
	eye bolt for rinse aid container connection		
	GEV No.	510105	Ref. No. —
	hose connector for air trap		

			
1			
GEV No.	518200	Ref. No.	984005
description	air trap ø 34mm H 78mm hose ø 6mm plastic		
For models:	GLB0035, GLB0036, GLB0037, GLB0038, GLB0039, GLB0044, GLB0046, GLB0056, GLB0057, GLB0058, GLB0059, GLB0060, GLB0061, GLB0061C, GLB0062, GLB0063, GLB0064, GLB0064C, GLB0065, GLB0066, GLB0070, GLB0071, GLB0072		
spare parts for	518200		
	GEV No.	504618	Ref. No. —
	O-ring EPDM thickness 2.62mm ID ø 15.54mm Qty 1 pcs		
	GEV No.	510075	Ref. No. 437019
	flat gasket rubber ED ø 22mm ID ø 13mm thickness 1.5mm Qty 1 pcs		
	GEV No.	510106	Ref. No. 468029
	hose connector for air trap		

			
1			
GEV No.	511959	Ref. No.	107014
description	air trap ø 42mm hose ø 6mm plastic		
For models:	OPT1012C		

			
1			
GEV No.	511993	Ref. No.	107013
description	air trap ø 43mm H 33mm hose ø 6mm plastic		
For models:	OPT1012C		

air trap accessories

			
1			
GEV No.	510075	Ref. No.	437019
description	flat gasket rubber ED ø 22mm ID ø 13mm thickness 1.5mm Qty 1 pcs		
For models:	GLB0035, GLB0036, GLB0037, GLB0038, GLB0039, GLB0056, GLB0057, GLB0058, GLB0059, GLB0060, GLB0061, GLB0061C, GLB0062, GLB0063, GLB0064, GLB0064C, GLB0065, GLB0066, GLB0072		

			
1			
GEV No.	510106	Ref. No.	468029
description	hose connector for air trap		
For models:	GLB0035, GLB0036, GLB0037, GLB0038, GLB0039, GLB0056, GLB0057, GLB0058, GLB0059, GLB0060, GLB0061, GLB0061C, GLB0062, GLB0063, GLB0064, GLB0064C, GLB0065, GLB0066, GLB0072		

mechanics for flight type dishwashers

			
1			
GEV No.	699351	Ref. No.	75231
description	cover for eccentrics plastic D1 ø 147mm D2 ø 32.6mm		
For models:	GLB0046		

			
1			
GEV No.	504423	Ref. No.	927048
description	protector L 230mm W 95mm H 16mm hole ø 25x7mm thickness 4mm		
For models:	GLB0046		



backflow preventers

backflow preventers



1

GEV No.	698703	Ref. No.	144995
description	air valve for drain hose D1 ø 21mm D2 ø 6mm ID ø 17mm		



1

GEV No.	518297	Ref. No.	144011
description	backflow preventer		
For models:	GLB0061, GLB0061C, GLB0062, GLB0063, GLB0064, GLB0064C, GLB0065, GLB0066		



1

GEV No.	518486	Ref. No.	144010 144010NT
description	backflow preventer connection 1/2" dishwasher hose ø 12mm		
For models:	GLB0035, GLB0036, GLB0037, GLB0038, GLB0039, GLB0046, GLB0056, GLB0057, GLB0058, GLB0059, GLB0060, GLB0070, GLB0071, GLB0072, GLB0073, OPT1012, OPT1012C		



1

GEV No.	516101	Ref. No.	12024568 Z231106000
description	backflow preventer dishwasher hose ø 12mm		
For models:	GLB0035-F, GLB0035-FN, GLB0037-F, GLB0037-FN, GLB0061C-F, GLB0061C-FN, GLB0063C-F, OPT1012-CF, OPT1012-CFN		
spare parts for	516101		



GEV No.	506367	Ref. No.	—
description	flat gasket rubber ED ø 40mm ID ø 28mm thickness 1.8mm Qty 1 pcs		

miscellaneous



1

GEV No.	519481	Ref. No.	927110
description	heater battery L 440mm W 260mm H 195mm		
For models:	GLB0046		



1

GEV No.	698716	Ref. No.	CWP2
description	PCB support L 34mm		
For models:	GLB0071, GLB0073, OPT1012C		

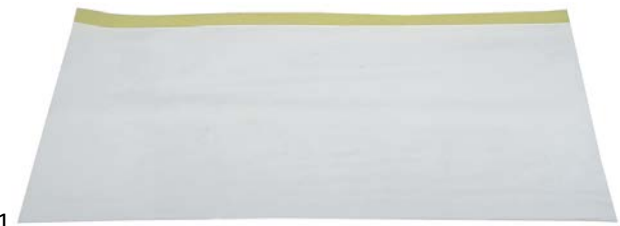

1

GEV No.	343006	Ref. No.	214086
description	protective film for dishwasher self-adhesive L 485mm W 360mm Qty 1 pcs		
For models:	GLB0061, GLB0061C, GLB0062, GLB0063, GLB0072, OPT1012C		



1

GEV No.	698871	Ref. No.	419036
description	spacer for PCB L 18mm W 6mm D1 ø 6mm D2 ø 3mm		
For models:	GLB0073		



1

GEV No.	698875	Ref. No.	461028
description	spacer for PCB L 19mm D1 ø 10mm		
For models:	OPT1012C		

door mechanics

spare parts and accessories



1

GEV No.	507580	Ref. No.	75226
description	catch hook for door		
For models:	GLB0046		

linkage



1

GEV No.	518355	Ref. No.	304021
description	door pin stop rod		
For models:	GLB0058, GLB0059, GLB0060, GLB0061, GLB0061C, GLB0062, GLB0063, GLB0064, GLB0064C, GLB0065, GLB0066, GLB0072		



1

GEV No.	519410	Ref. No.	Z200521000
description	linkage		
For models:	GLB0061C-F, GLB0063C-F		

sliding plates



1

GEV No.	517801	Ref. No.	307012
description	sliding plate L 75mm W 12mm H 10mm		
For models:	GLB0073		



1

GEV No.	505195	Ref. No.	12024180 Z200310000
description	sliding plate sliding plate		
For models:	GLB0061C-F, GLB0061C-FN, GLB0063C-F, GLB0063C-FN		



1

GEV No.	518356	Ref. No.	307003
description	sliding plate sliding plate		
For models:	GLB0058, GLB0059, GLB0060, GLB0061, GLB0061C, GLB0062, GLB0063, GLB0064, GLB0064C, GLB0065, GLB0066, GLB0072		



1

GEV No.	518353	Ref. No.	307005
description	stop plastic for door L 60mm W 12.5mm H 10mm		
For models:	GLB0036, GLB0037, GLB0038, GLB0039, GLB0056, GLB0057		

hinges



1

GEV No.	505005	Ref. No.	12022324 Z400514000
description	door hinge hinge left mounting pos. left		
For models:	GLB0035-FN, GLB0037-FN, GLB0061C-F, GLB0061C-FN, GLB0063C-F, GLB0063C-FN		

spare parts for	505005			
	GEV No.	700818	Ref. No.	12024071 Z400516000
hinge bolt L 32mm stainless steel D1 ø 7.8mm D2 ø 12mm				



1

GEV No.	505006	Ref. No.	12022325 Z400515000
description	door hinge hinge right mounting pos. right		
For models:	GLB0035-FN, GLB0037-FN, GLB0061C-F, GLB0061C-FN, GLB0063C-F, GLB0063C-FN		



1

GEV No.	504797	Ref. No.	35060
description	door hinge mounting pos. left ø 10mm L 70mm		
For models:	GLB0073		





1

GEV No.	518301	Ref. No.	311019
description	door hinge mounting pos. left/right		
For models:	GLB0058, GLB0059, GLB0060, GLB0061, GLB0061C, GLB0062, GLB0063, GLB0064, GLB0064C, GLB0065, GLB0066, GLB0072		



			
1			
GEV No.	510090	Ref. No.	449036
description	spring door lock spring mounting pos. door lock		
For models:	GLB0035, GLB0036, GLB0037, GLB0038, GLB0039, GLB0056, GLB0057		

hinge camps			
			
1			
GEV No.	518262	Ref. No.	311009
description	hinge camp mounting pos. left		
For models:	GLB0035, GLB0036, GLB0037, GLB0038, GLB0039, GLB0056, GLB0057		

			
1			
GEV No.	518261	Ref. No.	311008
description	hinge camp mounting pos. right		
For models:	GLB0035, GLB0036, GLB0037, GLB0038, GLB0039, GLB0056, GLB0057		

hinge pins			
			
1			
GEV No.	518264	Ref. No.	325034
description	hinge pin hinge pin		
For models:	GLB0036, GLB0037, GLB0038, GLB0039, GLB0056, GLB0057		

			
1			
GEV No.	518267	Ref. No.	325036
description	hinge pin hinge pin		
For models:	GLB0058, GLB0059, GLB0060, GLB0061, GLB0061C, GLB0062, GLB0063, GLB0064, GLB0064C, GLB0065, GLB0066, GLB0072		

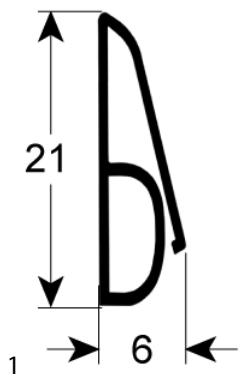
door seals			
			
1			
GEV No.	512472	Ref. No.	35017
description	door seal L 625mm W 21mm		
For models:	GLB0073		

doors			
			
1			
GEV No.	507442	Ref. No.	1200005030 Z200541000
description	door W 585mm H 430mm thickness 50mm complete FAGOR		
For models:	GLB0061C-F, GLB0063C-F		

door frames			
			
1			
GEV No.	504239	Ref. No.	12024295 Z200524000
description	door frame L 360mm W 15mm H 14mm plastic L-shape mounting distance 150mm		
For models:	GLB0061C-F, GLB0061C-FN, GLB0063C-F, GLB0063C-FN		

door bumpers



1

GEV No.	505149	Ref. No.	12024299 Z200522000
description	door bumper door bumper		
For models:	GLB0061C-F, GLB0061C-FN, GLB0063C-F, GLB0063C-FN		



1

GEV No.	518066	Ref. No.	417041
description	door bumper end stop		
For models:	GLB0058, GLB0059, GLB0060, GLB0061, GLB0061C, GLB0062, GLB0063, GLB0064, GLB0064C, GLB0065, GLB0066, GLB0072		



1

GEV No.	518354	Ref. No.	028078
description	door bumper slotted hole disc		
For models:	GLB0036, GLB0037, GLB0038, GLB0039, GLB0056, GLB0057		

door shafts



1

GEV No.	518263	Ref. No.	304017
description	door shaft		
For models:	GLB0035		

locks



1

GEV No.	505196	Ref. No.	12024235 Z200601000
description	door catch		
For models:	GLB0035-FN, GLB0037-FN, GLB0061C-F, GLB0061C-FN, GLB0063C-F, GLB0063C-FN		



1

GEV No.	518242	Ref. No.	329012
description	door catch		
For models:	GLB0035, GLB0036, GLB0037, GLB0038, GLB0039, GLB0056, GLB0057		



1

GEV No.	518244	Ref. No.	994011
description	door catch catch		
For models:	GLB0064, GLB0064C, GLB0065, GLB0066		



1

GEV No.	505007	Ref. No.	12003212 12003363 Z200607000
description	door catch door locking catch		
For models:	GLB0035-FN, GLB0037-FN, GLB0061C-F, GLB0061C-FN, GLB0063C-F, GLB0063C-FN		



1

GEV No.	513138	Ref. No.	994012
description	door catch with nut door locking catch		
For models:	GLB0058, GLB0059, GLB0060, GLB0072		



1

GEV No.	518245	Ref. No.	325030
description	spigot door catch		
For models:	GLB0058, GLB0059, GLB0060, GLB0061, GLB0061C, GLB0062, GLB0063, GLB0064, GLB0064C, GLB0065, GLB0066, GLB0072		

miscellaneous



1

GEV No.	513203	Ref. No.	80277
description	bracket for lever		
For models:	GLB0070, GLB0071, OPT1012, OPT1012C		



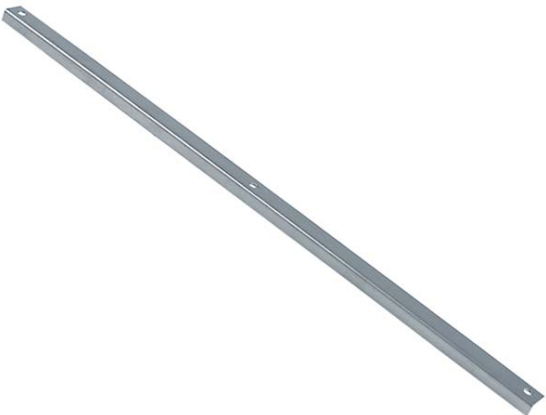

1

GEV No.	518247	Ref. No.	033291
description	fastening angle for door seal		
For models:	GLB0035		



1

GEV No.	518249	Ref. No.	033294
description	fastening angle for door seal		
For models:	GLB0036, GLB0037, GLB0038, GLB0039, GLB0056, GLB0057		



1

GEV No.	518526	Ref. No.	447137
description	grip shell		
For models:	GLB0035, GLB0036, GLB0037, GLB0038, GLB0039, GLB0056, GLB0057, GLB0058, GLB0059, GLB0060, GLB0061, GLB0061C, GLB0062, GLB0063, GLB0064, GLB0064C, GLB0065, GLB0066, GLB0072		



1

GEV No.	513204	Ref. No.	80275
description	opposite support for spring \varnothing 28mm L 100mm		
For models:	GLB0070, GLB0071, OPT1012, OPT1012C		



1

GEV No.	505010	Ref. No.	12023624 Z710544000
description	screw screw		
For models:	OPT1012-CF, OPT1012-CFN		



1

GEV No.	698748	Ref. No.	35013
description	side panel for door L 235mm W 100mm thickness 2mm		
For models:	GLB0073		



1

GEV No.	505008	Ref. No.	12025166 Z710529000
description	spring compressor spring compressor		
For models:	OPT1012-CF, OPT1012-CFN		



1

GEV No.	508396	Ref. No.	12021923 Z710543000
description	spring rod straight stainless steel L 140mm W 24mm		
For models:	OPT1012-CF, OPT1012-CFN		

screw connections



1

GEV No.	519498	Ref. No.	417120
description	nut thread 3/4" H 10mm WS 30 plastic Qty 1 pcs		
For models:	GLB0071, GLB0073, OPT1012		



1

GEV No.	504369	Ref. No.	12007871 Q223023000
description	nut thread 5/8" pipe (22.7mm) H 7.3mm WS 32 brass Qty 1 pcs		
For models:	OPT1012-CF, OPT1012-CFN		



1

GEV No.	698874	Ref. No.	417119
description	nut thread M3 H 3.5mm plastic Qty 1 pcs for PCB		
For models:	GLB0073		



1

GEV No.	698876	Ref. No.	486078
description	screw thread M6x30mm Qty 1 pcs SS		
For models:	GLB0046		

curtains

curtains



1

GEV No.	533008	Ref. No.	75120
description	curtain W 540mm H 405mm plastic thickness 1.3mm		
For models:	GLB0046		
accessories for	533008		
	GEV No.	Ref. No.	533009
	curtain rod L 545mm ø 8mm		



1

GEV No.	533007	Ref. No.	75123
description	curtain W 620mm H 250mm thickness 1.4mm		
For models:	GLB0046		

curtain rods



1

GEV No.	533009	Ref. No.	75121
description	curtain rod L 545mm ø 8mm		
For models:	GLB0046		



1

GEV No.	533019	Ref. No.	75124
description	curtain rod L 620mm ø 8mm		
For models:	GLB0046		

washing and rinsing systems



1

GEV No.	505040	Ref. No.	12110631 Z650704000
description	bush for wash arm		
For models:	GLB0061C-F, GLB0063C-F, OPT1012-CF		



1

GEV No.	513271	Ref. No.	412028
description	connector holder grey		
For models:	GLB0035, GLB0036, GLB0037, GLB0038, GLB0039, GLB0056, GLB0057		









1

GEV No.	517568	Ref. No.	41064
description	counterflange for wash arm support ø 69mm ID ø 63mm H 35mm mounting distance 64mm hole ø 7mm		
For models:	GLB0043, GLB0044		
accessories for	517568		
	GEV No.	Ref. No.	531605
	extension for rinsing shaft ø 16mm H 122mm thread L 12mm WS 19		

Table continues overleaf



accessories for	517568		
	GEV No.	532603	Ref. No. 926252
	O-ring EPDM thickness 3.53mm ID ø 69.85mm Qty 1 pcs		
	GEV No.	698750	Ref. No. 41185
	throttle disc ø 71.5mm hole ø 17/22mm		

	1		
GEV No.	517441	Ref. No.	41064CP
description	counterflange for wash arm support with throttle disc ø 70mm ID ø 63mm L 110mm W 89mm H 35mm		
For models:	GLB0043, GLB0044		
spare parts for	517441		
	GEV No.	698750	Ref. No. 41185
	throttle disc ø 71.5mm hole ø 17/22mm		
accessories for	517441		
	GEV No.	531605	Ref. No. 42053
	extension for rinsing shaft ø 16mm H 122mm thread L 12mm WS 19		
	GEV No.	532603	Ref. No. 926252
	O-ring EPDM thickness 3.53mm ID ø 69.85mm Qty 1 pcs		

	1		
GEV No.	505184	Ref. No.	12024222 Z203013000
description	eye bolt		
For models:	GLB0035-FN, GLB0037-FN, GLB0061C-F, GLB0061C-FN, GLB0063C-F, GLB0063C-FN, OPT1012-CF, OPT1012-CFN		

	1		
GEV No.	518461	Ref. No.	303029
description	flange for wash arm support		
For models:	GLB0061, GLB0061C, GLB0062, GLB0063, GLB0064, GLB0064C, GLB0065, GLB0066		

	1		
GEV No.	507545	Ref. No.	437091
description	flat gasket PTFE ED ø 13mm ID ø 7mm thickness 0.65mm Qty 1 pcs		
For models:	GLB0072		

	1		
GEV No.	518240	Ref. No.	437078
description	flat gasket rubber ED ø 33mm ID ø 17mm thickness 1.5mm Qty 1 pcs		
For models:	GLB0035, GLB0036, GLB0037, GLB0038, GLB0039, GLB0043, GLB0044, GLB0056, GLB0057		

	1		
GEV No.	507541	Ref. No.	437102
description	flat gasket rubber ED ø 74mm ID ø 57mm thickness 2mm Qty 1 pcs		
For models:	OPT1012C		

	1		
GEV No.	518444	Ref. No.	199051
description	flow control valve for wash arm ø 16mm H 20mm		
For models:	GLB0036, GLB0037, GLB0038, GLB0039, GLB0056, GLB0057		

	1		
GEV No.	513277	Ref. No.	437080
description	gasket		
For models:	GLB0036, GLB0037, GLB0038, GLB0039, GLB0056, GLB0057		

	1		
GEV No.	518594	Ref. No.	437037
description	gasket for rinse connection		
For models:	GLB0058, GLB0059, GLB0060		

	1		
GEV No.	518071	Ref. No.	80178
description	gasket for wash arm support L 109mm W 68mm		
For models:	GLB0070, GLB0071, OPT1012, OPT1012C		



1

GEV No.	518116	Ref. No.	H.172986-19
description	gasket for wash arm support rubber ø 60mm ID ø 47mm thickness 1mm		
For models:	GLB0072		



1

GEV No.	518595	Ref. No.	111001
description	hose connector double		
For models:	GLB0058, GLB0059, GLB0060		



1

GEV No.	513158	Ref. No.	80365
description	knurled nut		
For models:	GLB0043, GLB0044, GLB0071, GLB0073		



1

GEV No.	518286	Ref. No.	472068
description	knurled nut		
For models:	GLB0072		



1

GEV No.	517444	Ref. No.	80697
description	knurled nut thread M10x1 ø 25mm H 4mm SS		
For models:	OPT1012C		



1

GEV No.	505171	Ref. No.	12024375 Z200705000
description	knurled nut thread M14x1 ø 35mm H 5mm SS		
For models:	GLB0061C-F, GLB0061C-FN, GLB0063C-F, GLB0063C-FN, OPT1012-CF, OPT1012-CFN		



1

GEV No.	518238	Ref. No.	143173 143268
description	manifold ø 12mm L 98mm		
For models:	GLB0043, GLB0046, GLB0058, GLB0059, GLB0060, GLB0070, GLB0071, GLB0072, GLB0073, OPT1012, OPT1012C		



1

GEV No.	518593	Ref. No.	417039
description	nut for rinse pipe		
For models:	GLB0058, GLB0059, GLB0060		



1

GEV No.	517454	Ref. No.	308031
description	nut for wash arm ED ø 35mm thickness 11mm plastic		
For models:	GLB0064, GLB0064C, GLB0065, GLB0066		



1

GEV No.	518637	Ref. No.	429073
description	nut for wash arm support thread M5x2		
For models:	OPT1012C		





1

GEV No.	518080	Ref. No.	12023537 Z710708000
description	nut thread 1½" WS 50 duct thickness 15mm		
For models:	OPT1012-CF, OPT1012-CFN		
spare parts for	518080		
	GEV No.	507425	Ref. No. —
duct D1 ø 38mm D2 ø 45mm L 72mm int. ø 1 31mm int. ø 2 39mm			





			
1			
GEV No.	518596	Ref. No.	417038
description	nut wash pipe		
For models:	GLB0036, GLB0037, GLB0038, GLB0039, GLB0056, GLB0057, GLB0058, GLB0059, GLB0060		

			
1			
GEV No.	518434	Ref. No.	429050
description	rinse arm support mounting pos. upper		
For models:	GLB0035, GLB0036, GLB0037, GLB0038, GLB0039, GLB0043, GLB0044, GLB0056, GLB0057		

			
1			
GEV No.	518086	Ref. No.	80174
description	opposite support		
For models:	GLB0071, OPT1012, OPT1012C		

			
1			
GEV No.	518443	Ref. No.	468165
description	rinse arm support mounting pos. upper		
For models:	GLB0035, GLB0036, GLB0037, GLB0038, GLB0039, GLB0043, GLB0044, GLB0046, GLB0056, GLB0057		

			
1			
GEV No.	518089	Ref. No.	80184
description	retaining ring for wash arm ID ø 40mm ED ø 44mm thickness 3mm		
For models:	GLB0073, OPT1012, OPT1012C		

			
1			
GEV No.	518125	Ref. No.	143240
description	rinse hose ø 17.5mm		
For models:	GLB0061, GLB0061C, GLB0062, GLB0063, GLB0064, GLB0064C, GLB0065, GLB0066		

			
1			
GEV No.	524811	Ref. No.	303037
description	ring for wash arm ID ø 41mm ED ø 45mm thickness 3mm plastic		
For models:	GLB0070, OPT1012C		

			
1			
GEV No.	518003	Ref. No.	447128
description	screw cap		
For models:	GLB0058, GLB0059, GLB0060, GLB0061, GLB0061C, GLB0062, GLB0063, GLB0064, GLB0064C, GLB0065, GLB0066, OPT1012		

			
1			
GEV No.	524654	Ref. No.	441.041.00
description	rinse arm shaft mounting pos. upper ø 16mm H 61mm thread M12x1		

			
1			
GEV No.	513286	Ref. No.	80281
description	screw connection		
For models:	GLB0070, GLB0071, GLB0073, OPT1012		

			
1			
GEV No.	513259	Ref. No.	111026
description	rinse arm support mounting pos. upper		
For models:	GLB0036, GLB0037, GLB0038, GLB0039, GLB0056, GLB0057		

			
1			
GEV No.	518288	Ref. No.	429069
description	screw connection		
For models:	GLB0072		

			
1			
GEV No.	510011	Ref. No.	429008
description	screw connection plastic		
For models:	GLB0035, GLB0036, GLB0037, GLB0038, GLB0039, GLB0056, GLB0057, GLB0058, GLB0059, GLB0060		

			
1			
GEV No.	517443	Ref. No.	80623
description	slide ring for rinse arm mounting pos. upper/lower PTFE ED ø 22mm ID ø 9.5mm thickness 1mm		
For models:	GLB0071		

			
1			
GEV No.	518485	Ref. No.	419030
description	spacer rod		
For models:	GLB0058, GLB0059, GLB0060		

			
1			
GEV No.	513270	Ref. No.	80316
description	throttle disc		
For models:	GLB0070, GLB0071, GLB0073		

			
1			
GEV No.	518284	Ref. No.	199053
description	throttle disc		
For models:	OPT1012		

			
1			
GEV No.	518337	Ref. No.	199039
description	throttle disc		
For models:	GLB0061, GLB0061C, GLB0062, GLB0063		

			
1			
GEV No.	524653	Ref. No.	411.049.00
description	throttle disc ED ø 90mm ID ø 16mm		



			
1			
GEV No.	510112	Ref. No.	454002
description	Thumb screw thread M10 thread L 10mm ø 22mm H 4.5mm SS		
For models:	GLB0058, GLB0059, GLB0060, GLB0061, GLB0061C, GLB0062, GLB0063, GLB0064, GLB0064C, GLB0065, GLB0066, OPT1012		



			
1			
GEV No.	505034	Ref. No.	12009829 Q152016000
description	Thumb screw thread M5 thread L 7mm ø 20mm H 3mm SS		
For models:	GLB0035-F, GLB0035-FN, GLB0037-F, GLB0037-FN, GLB0061C-F, GLB0061C-FN, GLB0063C-F, GLB0063C-FN, OPT1012-CF, OPT1012-CFN		

			
1			
GEV No.	518484	Ref. No.	449045
description	wash arm support for stationary arms mounting pos. upper		
For models:	GLB0036, GLB0037, GLB0038, GLB0039, GLB0056, GLB0057, GLB0058, GLB0059, GLB0060		

			
1			
GEV No.	518580	Ref. No.	115129
description	wash arm support mounting pos. upper		
For models:	GLB0072		





			
1			
GEV No.	501546	Ref. No.	12048173
description	wash arm support mounting pos. upper ø 42mm H 78mm L1 340mm		
For models:	OPT1012-CF		
accessories for	501546		
	GEV No.	532103	Ref. No. 12049214
	O-ring EPDM thickness 3.53mm ID ø 13.87mm Qty 10 pcs		
	GEV No.	699343	Ref. No. 12048366
	gasket L 118mm W 73mm H 9mm thickness 9mm		

			
1			
GEV No.	513714	Ref. No.	80237
description	wash pipe		
For models:	GLB0070, GLB0071		
spare parts for	513714		
	GEV No.	518141	Ref. No. 80179
	wash arm support thread M46x2 ø 44mm ID ø 39mm L 112.5mm W 86mm hole ø 12mm		

			
1			
GEV No.	505181	Ref. No.	12024059
description	wash pipe L 530mm		
For models:	GLB0035-F, GLB0035-FN		

			
1			
GEV No.	505182	Ref. No.	12025154
description	wash pipe L 605mm		
For models:	GLB0037-F, GLB0037-FN		

			
1			
GEV No.	505169	Ref. No.	12023699 Z200706000
description	wash pipe L 681mm		
For models:	GLB0061C-F, GLB0061C-FN, GLB0063C-F, GLB0063C-FN		

			
1			
GEV No.	698718	Ref. No.	69017
description	wash pipe mounting pos. upper ø 72x120mm L 310mm plastic thread M6		
For models:	OPT1012C		

			
1			
GEV No.	511991	Ref. No.	12006587 Z710709000
description	wash pipe ø 38mm L 730mm SS		
For models:	OPT1012-CF, OPT1012-CFN		

			
1			
GEV No.	519493	Ref. No.	75165
description	wash pipe ø 48mm L 617mm plastic		
For models:	GLB0046		

for vacuum packers

lids

			
1			
GEV No.	692242	Ref. No.	0600100
description	lid L 378mm W 315mm H 20mm JUMBO		
For models:	FGZ0005, FGZ0012		

			
1			
GEV No.	692062	Ref. No.	0620010 0620011
description	lid with gasket L 475mm W 460mm H 75mm B42/J42/H-200		
For models:	FGZ0006		

air cylinders

air cylinders



1

GEV No.	691548	Ref. No.	0286017
description	air cylinder ø 110mm H 47mm shaft length 29mm		
For models:	FGZ0007		



1

GEV No.	691549	Ref. No.	0286020
description	air cylinder ø 110mm shaft length 47mm		
For models:	FGZ0027		



1

GEV No.	691545	Ref. No.	0286005
description	air cylinder ø 80mm H 30mm		
For models:	FGZ0005, FGZ0012		



1

GEV No.	691546	Ref. No.	0286010
description	air cylinder ø 80mm H 48mm		
For models:	FGZ0027		
spare parts for	691546		



GEV No.	691581	Ref. No.	—
description	membrane ø 80mm H 24mm		

accessories



1

GEV No.	699265	Ref. No.	0287050
description	nut ø 44mm H 10mm ID ø 22.5mm		
For models:	FGZ0005, FGZ0007, FGZ0013, FGZ0025, FGZ0026, FGZ0027		



1

GEV No.	699266	Ref. No.	0287030
description	valve support ø 58mm H 8mm ID ø 25mm		
For models:	FGZ0007, FGZ0027		

insert plates



1

GEV No.	692063	Ref. No.	0307050
description	insert plate L 740mm W 490mm thickness 20mm F80 KL		
For models:	FGZ0028		

oil separator filters

with thread



1

GEV No.	691534	Ref. No.	0939160
description	oil separator filter flow rate 4m ³ /h ø 35mm L 52mm thread 3/8"		
For models:	FGZ0005		



1

GEV No.	691954	Ref. No.	0939162
description	oil separator filter flow rate 8m ³ /h ø 35mm L 85mm thread 3/8"		
For models:	FGZ0012, FGZ0025		



without thread



1

GEV No.	691540	Ref. No.	0939170
description	oil separator filter flow rate 100m ³ /h ø 72mm L 248mm		
For models:	FGZ0007, FGZ0009, FGZ0027, FGZ0028		



1

GEV No.	691537	Ref. No.	0939163
description	oil separator filter flow rate 16m ³ /h ø 52mm L 120mm		
For models:	FGZ0013		



1

GEV No.	691538	Ref. No.	0939165
description	oil separator filter flow rate 21m ³ /h ø 72mm L 128mm		
For models:	FGZ0006, FGZ0026		



1

GEV No.	691539	Ref. No.	0939171
description	oil separator filter flow rate 63m ³ /h ø 72mm L 206mm		
For models:	FGZ0007, FGZ0009, FGZ0027		

air cushions



1

GEV No.	572004	Ref. No.	0301390
description	air cushion L 390mm W 85mm		
For models:	FGZ0009		



1

GEV No.	572005	Ref. No.	0301410
description	air cushion L 410mm W 85mm		
For models:	FGZ0028		



1

GEV No.	572007	Ref. No.	0301490
description	air cushion L 490mm W 85mm		
For models:	FGZ0009, FGZ0028		



1

GEV No.	572012	Ref. No.	0301740
description	air cushion L 740mm W 85mm		
For models:	FGZ0028		

oil filter



1

GEV No.	691542	Ref. No.	0939090
description	oil filter size 63-100 ø 78mm L 78mm		
For models:	FGZ0007, FGZ0009, FGZ0027, FGZ0028		

sealing bars



1

GEV No.	691587	Ref. No.	0380590
description	bracket for sealing bar L 365mm W 25mm H 50mm aluminium		
For models:	FGZ0009		



1

GEV No.	691997	Ref. No.	0300041
description	sealing bar L 280mm W 16mm H 34mm double		
For models:	FGZ0005, FGZ0012		



1

GEV No.	692207	Ref. No.	0300110
description	sealing bar L 323mm W 16mm H 34mm double		
For models:	FGZ0027		



1

GEV No.	692469	Ref. No.	0300116
description	sealing bar L 355mm W 15mm H 31mm double welding		
For models:	FGZ0013		

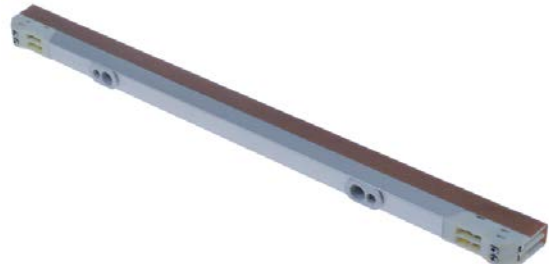

1

GEV No.	692103	Ref. No.	0300210
description	sealing bar L 420mm W 16mm H 34mm double		
For models:	FGZ0006, FGZ0026		



1

GEV No.	691998	Ref. No.	0300215
description	sealing bar L 425mm W 16mm H 34mm cut-off seal		
For models:	FGZ0006, FGZ0026		



1

GEV No.	698069	Ref. No.	KODK012
description	sealing bar L 460mm W 25mm H 70mm		
For models:	FGZ0014		

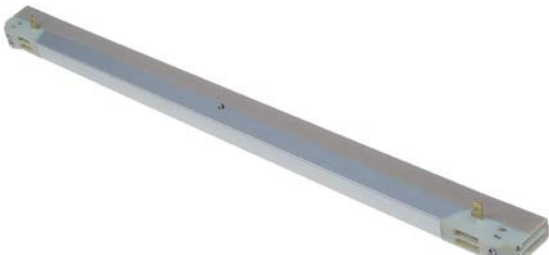

1

GEV No.	697922	Ref. No.	0300405
description	sealing bar L 466mm W 15mm H 30mm		
For models:	FGZ0009		



1

GEV No.	691816	Ref. No.	0300337
description	sealing bar L 500mm W 16mm H 34mm double		
For models:	FGZ0028		



1

GEV No.	692468	Ref. No.	0300320
description	sealing bar L 520mm W 15.5mm H 31mm		
For models:	FGZ0007		



1

GEV No.	691801	Ref. No.	0300510
description	sealing bar L 565mm W 15mm H 33mm double weld		
For models:	FGZ0009, FGZ0028		



1

GEV No.	692126	Ref. No.	0300310
description	sealing bar L 605mm W 15mm H 32mm		
For models:	FGZ0007		

heating wires



1

GEV No.	418506	Ref. No.	KODK001
description	heating wire L 454mm Qty 1		
For models:	FGZ0014		

locking screws



1

GEV No.	691566	Ref. No.	0939110
description	locking screw thread 1/2" plastic		
For models:	FGZ0007, FGZ0009, FGZ0013, FGZ0027, FGZ0028		



1

GEV No.	691567	Ref. No.	0939113
description	locking screw thread 3/4" plastic		
For models:	FGZ0006, FGZ0007, FGZ0009, FGZ0013, FGZ0026, FGZ0027, FGZ0028		

miscellaneous



1

GEV No.	692104	Ref. No.	0065225
description	connection head		
For models:	FGZ0005, FGZ0007, FGZ0012, FGZ0027		



1

GEV No.	692473	Ref. No.	0400730
description	flange ID ø 37mm L 60mm W 60mm H 14mm for pipe		
For models:	FGZ0009		



1

GEV No.	692470	Ref. No.	0380710
description	guide bar L 425mm W 25mm H 25mm for vacuum packing machine		
For models:	FGZ0006, FGZ0026		



1

GEV No.	697923	Ref. No.	0401020
description	intake body ID \varnothing 5mm ED \varnothing 27mm L 24mm for vacuum packing machine		
For models:	FGZ0005, FGZ0006, FGZ0012, FGZ0013, FGZ0025, FGZ0026		

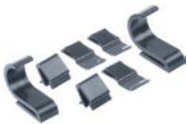

1

GEV No.	697921	Ref. No.	0330116
description	mounting clip set plastic for front panel		
For models:	FGZ0005, FGZ0006, FGZ0007, FGZ0009, FGZ0012, FGZ0013, FGZ0025, FGZ0026, FGZ0027, FGZ0028		



1

GEV No.	699263	Ref. No.	0810110
description	non-return valve ID \varnothing 5mm ED \varnothing 7mm L 39.5mm W 19.2mm		
For models:	FGZ0007, FGZ0009, FGZ0027, FGZ0028		



1

GEV No.	692471	Ref. No.	0810112
description	non-return valve ID \varnothing 8mm ED \varnothing 10mm L 39.5mm for vacuum packing machine		
For models:	FGZ0012		



1

GEV No.	696530	Ref. No.	0390614
description	nozzle ID \varnothing 5mm ED \varnothing 8mm L 28mm H 50mm for vacuum packing machine thread M8x0.75		
For models:	FGZ0009, FGZ0028		



1

GEV No.	690977	Ref. No.	0380702
description	rail for gasket L 280mm aluminium		
For models:	FGZ0005, FGZ0012		



1

GEV No.	692065	Ref. No.	0065250
description	retaining ring for vacuum packing machine shaft \varnothing 6mm thickness 0.7mm SS DIN 471		
For models:	FGZ0005, FGZ0006, FGZ0012, FGZ0013, FGZ0025, FGZ0026		



1

GEV No.	697925	Ref. No.	0065221
description	screw ED \varnothing 10mm W 22mm thread M4		
For models:	FGZ0009		



1

GEV No.	692066	Ref. No.	0390500
description	spindle ED \varnothing 6mm L 127mm		
For models:	FGZ0005, FGZ0012		

for heated display cases

miscellaneous



1

GEV No.	691105	Ref. No.	IB1926000
description	coupling for pizza display		
For models:	IBA0012, IBA0013		



1

GEV No.	691106	Ref. No.	IB7506000
description	door hinge kit for glass door mounting pos. upper/lower		
For models:	IBA0012, IBA0013		

for woks



1

GEV No.	541456	Ref. No.	GS.9392
description	spray arm		
For models:	AHA0001, AHA0002, AHA0003		



1

GEV No.	540666	Ref. No.	GS.3846 GS.3847
description	water nozzle thread 1/8"		
For models:	AHA0001, AHA0002, AHA0003, AHA0005-NN, AHA0008-NN, AHA0009, AHA0014-NN, AHA0021-NN, NGSB990CE		

for sausage fillers

funnels



1

GEV No.	698365	Ref. No.	LF2011015
description	funnel set ø 10/18/25mm L 190mm polyethylene seat ø 58mm		
For models:	FIC0004		

knobs

universal knobs





1

GEV No.	110253	Ref. No.	MANI0021
description	knob switch zero mark t.max.°C ø 50mm shaft ø 6x4.6mm shaft flat upper black		
For models:	CAD0004, CAD0005, SY850VELED		





1

GEV No.	110124	Ref. No.	G1790004
description	knob thermostat t.max. 350°C t.max.°F 100-350°F ø 50mm shaft ø 6x4.6mm shaft flat upper black temperature range 100-350°C rotation 270°		
For models:	CAB0099		
accessories for	110124		
	GEV No.	110135	Ref. No. —
	rosette knob up to ø 52mm		



1

GEV No.	111934	Ref. No.	3700057
description	knob thermostat t.max. 90°C ø 50mm shaft ø 6x4.6mm shaft flat upper black temperature range 30-90°C rotation 270°		
For models:	IIA3006, IIA3007, IIA3008, IIA3010, IIA3011, IIA3012, IIA4002, IIA4003		
accessories for	111934		
	GEV No.	110135	Ref. No. —
	rosette knob up to ø 52mm		



1

GEV No.	111492	Ref. No.	MAN30014
description	knob zero mark t.max.°C ø 47mm shaft ø 6x4.6mm shaft flat right nickel		
For models:	VP916RXS		

producer-specific knobs

VIRTUS



GEV No.	110081	Ref. No.	GS.3602
description	knob ø 70mm shaft ø 8x6.5mm shaft flat universal		
For models:	AHA0001, AHA0002, AHA0003, AHA0009, AHA0011, AHA0013, AHA0017, AHA0018, AHA0019, AHA0020, AHB0001		

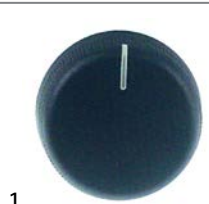

GEV No.	111586	Ref. No.	09960028500
description	knob switch zero mark ø 43mm shaft ø 6x4.6mm shaft flat lower black		
For models:	AIB0012, AIB0013, AIB0014, AIB0015, AIB0017, KF630, KF965, KF981D		



GEV No.	112916	Ref. No.	KODK003
description	knob switch zero mark t.max.°C temperature range°C ø 18mm shaft ø 5,5mm		
For models:	FGZ0014		



steam/water taps

steam/water taps



GEV No.	111272	Ref. No.	4.0.016.0023
description	turning handle ø 42.5mm L 53mm thread Tr18x2 black		
For models:	EFA0015, EFA0016, EFA0023		

accessories for 111272

	GEV No.	111269	Ref. No.	4.0.016.0028
	description	symbol water ø 28mm L 27mm black		
	GEV No.	111270	Ref. No.	4.0.016.0027
	description	symbol steam ø 28mm L 27mm black		
	GEV No.	111273	Ref. No.	4.0.016.0025
	description	cotter pin ø 1.3mm L 25mm		

knob dial plates



GEV No.	525829	Ref. No.	4.0.016.0024
description	plain washer with turning handle ø 21.5mm ID ø 6.5mm thickness 2mm brass		
For models:	EFA0015, EFA0016, EFA0023		



GEV No.	111270	Ref. No.	4.0.016.0027
description	symbol steam ø 28mm L 27mm black		
For models:	EFA0015, EFA0016, EFA0023		



GEV No.	111269	Ref. No.	4.0.016.0028
description	symbol water ø 28mm L 27mm black		
For models:	EFA0015, EFA0016, EFA0023		

accessories



GEV No.	111273	Ref. No.	4.0.016.0025
description	cotter pin ø 1.3mm L 25mm		
For models:	EFA0015, EFA0016, EFA0023		

miscellaneous



GEV No.	111390	Ref. No.	4.0.025.0015
description	knob ø 25.5mm L 38mm black		
For models:	EFA0015, EFA0016, EFA0023		



accessories

button springs

 <p>1</p>			
GEV No.	550132	Ref. No.	063009 PD.2451
description	knob spring ø 6x4.6mm Qty 10 pcs		
For models:	2158, 2623, 4567, 4568, 4569, AAC0001, AAC0002, AAD0001, AHC0001, AHC0002, AHC0004, AHC0005, AJA0014, AJA0015, AJA0016, AJA0017, AJA0018, AJE0001, AJE0002, AJE0003, AJE0005, AJE0006, AJE0007, AJG0001, AJG0002, AJG0003, AJG0004, AJG0011, AJH0001, AJH0002, AJH0003, AJH0004, AJH0005, AJH0006, AJH0007, AJH0008, AJH0009, AMZ0004, AMZ0005, AMZ0006, AMZ0007, AMZ0008, AMZ0024, AOZ0001, AOZ0002, AOZ0003, AOZ0004, APZ0001, APZ0002, APZ0003...(Other models you can see in the webshop)		

gaskets

 <p>1</p>			
GEV No.	691074	Ref. No.	12024516
description	gasket switch shaft		
For models:	GLB0035-F, GLB0037-F, GLB0061C-F, GLB0063C-F		

handles and hand wheels

hand wheels

hand wheels

 <p>1</p>			
GEV No.	691018	Ref. No.	65101800
description	hand wheel ø 150mm D1 ø 32mm bore ø 15mm depth of bore 22mm thread M6 hole distance 6mm groove widthmm L1 20mm L2 45mm handle length 82mm with folding handle		
For models:	7070BRE, 7070BRG		
spare parts for	691018		
	GEV No.	Ref. No.	—
		690855	
	folding handle ø 25mm seat ø 19mm shaft ø 8mm thread M6 with shaft and pin L 82mm		

 <p>1</p>			
GEV No.	693113	Ref. No.	0900X18500
description	hand wheel ø 150mm D1 ø 38mm bore ø 14mm thread groove width 5mm L1 38mm L2 40mm handle length 65mm with folding handle		
For models:	ACK2001, ACK2002, ACK2003, ACK2004, ACK201V, ACK202V, ACK203V, ACK204V		
spare parts for	693113		
	GEV No.	Ref. No.	—
		514255	
	folding handle ø 26mm total length 85mm seat ø 20mm shaft ømm thread M6 with pin L 85mm		
accessories for	693113		
	GEV No.	Ref. No.	—
		690968	
	roll pin ø 5mm L 20mm		

 <p>1</p>			
GEV No.	692431	Ref. No.	0900Y41900
description	hand wheel ø 200mm D1 ø 50mm bore ø 20mm thread groove width 8mm groove depth 12mm mounting distance 32mm L1 40mm L2 43mm handle length 65mm with folding handle		
For models:	ADK201V, ADK203V, ADK207V, ADK209V		

cylindrical handles

fixed

 <p>1</p>			
GEV No.	110804	Ref. No.	91510011
description	cylindrical handle thread M12 ø 29mm L 111mm		
For models:	CAA0003, CAA0004, CAA0005, CAB0007, CAB0007-CD, CAB0008, CAB0008-CD, CAB0009, CAB0009-CD, CAB0010, CAB0011, CAB0012, CAB0013, CAB0013-CD, CAB0014, CAB0014-CD, CAB0015, CAB0015-CD, CAB0016, CAB0017, CAB0018, CAB0024, CAB0024-CD, CAB0025, CAB0025-CD, CAB0026, CAB0027, CAB0039, CAB0040, CAB0041, CAB0042, CAB0043, CAB0044, CAB0045, CAB0046		

			
1			
GEV No.	110803	Ref. No.	91510010
description	cylindrical handle thread M12 ø 29mm L 87mm		
For models:	CAB0029-CN, CAB0030-CN, CAB0032, CAB0032-CN, CAB0033, CAB0033-CN, CAB0035		

			
1			
GEV No.	691314	Ref. No.	651.012.00
description	cylindrical handle thread M8 ø 28mm L 86mm		
For models:	6540GRL, 6570GRL, 7040GRL, 7070CPE, 7070GRL		

cone handles

			
1			
GEV No.	698195	Ref. No.	19562905
description	cone handle thread M10 ø 29mm L 82mm black		
For models:	FEB0031		

			
1			
GEV No.	693121	Ref. No.	065007
description	cone handle thread M8 ø 33mm L 82mm plastic black		
For models:	2158, 2623, AJH0001, AJH0002, AJH0003, AJH0004, AJH0005, AJH0006		

			
1			
GEV No.	697432	Ref. No.	0000000825
description	cone handle thread M6 ø 26mm plastic L 70mm thread L 6mm		
For models:	8921, 8922		

mushroom cap handles

			
1			
GEV No.	696267	Ref. No.	19021110
description	mushroom cap handle thread M4 ø 16mm L 18.5mm aluminium slicer		
For models:	FEB0009-SNT, FEB0010-SNT, FEB0031, FEB0033, FEB0034, FEB0035, PALLADIO300AM, PALLADIO300T, PALLADIO330T, PALLADIO350AM		

			
1			
GEV No.	111782	Ref. No.	061003
description	mushroom cap handle thread M6 handle ø 25mm L 17mm plastic black		
For models:	AJE0005, AMZ0024, ARZ0001, ARZ0002		

			
1			
GEV No.	697445	Ref. No.	0000000677
description	mushroom cap handle thread M6 handle ø 33mm L 26mm plastic black		
For models:	8922		

ball handles

			
1			
GEV No.	112694	Ref. No.	MSC04N018
description	ball handle thread M6 ø 20mm with metal bush black plastic		
For models:	FLA0014, FLA0015		

			
1			
GEV No.	101718	Ref. No.	GS.2014
description	ball handle thread M8 ø 25mm with metal bush black		
For models:	AHA0005-NN, AHA0008-NN, AHA0009, AHA0014-NN, AHA0021-NN, NGDR910		



star handles

			
1			
GEV No.	698200	Ref. No.	19562502
description	star handle thread M6 ø 40mm L 29mm black		
For models:	MIRRA300, PALLADIO300AM, PALLADIO350AM		

			
1			
GEV No.	697443	Ref. No.	19562504
description	star handle thread M8 ø 50mm L 29mm black		
For models:	FEB0031, MIRRA300		

bracket handles

			
1			
GEV No.	697944	Ref. No.	70491019
description	handle L 150mm H 38mm mounting distance 135mm thread M6 W 30mm black matt		
For models:	53054-CN, 5305-CN, 5330, 53304, AJD0002-CCN, AJD0003-CCN, AJD0005-CCN, AJD0006-CCN, AJD0014-C, AJD0015-C, AJD0017-C, AJD0018-C, AJD0019-C, AJD0023-C, AJD0030, AJD0031, AJD0032		

			
1			
GEV No.	390732	Ref. No.	Y65700
description	handle rod L 590mm H 60mm tube ø 30mm stainless steel		
For models:	ACA1004, ACA104V, ACA105V, ACA106V, ACA2007, ACA2010, ACA2012, ACA2013, ACA2014, ACA2020, ACA204V, ACA206V, ACA207V, ACA208V, ACA209V, ACA210V, ACA212V, ACA213V, ACA214V, ACA216, ACA216V, ACA220V, ACJ0004, ACJ004V, ADA104V, ADA106V, ADA205V, ADA206V, ADA207V, ADA208V, ADA209V, ADA210V, ADA211V, ADA212V, ADA213V, ADA217V, AIE001V		

 Image not available			
1			
GEV No.	505003	Ref. No.	Z650531000
description	pull handle		
For models:	OPT1012-CF		

			
1			
GEV No.	690083	Ref. No.	065005
description	pull handle L 110mm H 38mm mounting distance 94mm temp.-resist. 150°C		
For models:	AJE0002, AJE0003, AJE0006, AJE0007, ARZ0001, ARZ0002		

			
1			
GEV No.	502297	Ref. No.	9211711.00
description	pull handle L 230mm H 65mm mounting distance 180mm for oven right stainless steel		

			
1			
GEV No.	502292	Ref. No.	9211812.00
description	pull handle L 230mm H 65mm mounting distance 180mm for oven stainless steel		

			
1			
GEV No.	692802	Ref. No.	256.459.00
description	pull handle L 245mm mounting distance 224mm thread M6 for tilting bratt pan ø 20mm with fixing sheet silver		

			
1			
GEV No.	505002	Ref. No.	Z200512000
description	pull handle L 272mm H 42mm mounting distance 260mm thread M6 W 36mm		
For models:	OPT1012-CF		

			
1			
GEV No.	693229	Ref. No.	09960099002
description	pull handle L 296mm H 45mm mounting distance 280mm		
For models:	AIB0012		



1

GEV No.	691679	Ref. No.	Z400542000
description	pull handle L 310mm H 32mm mounting distance 260mm dishwasher since 2007 handle M6		
For models:	OPT1012-CF		



1

GEV No.	693225	Ref. No.	09960209002
description	pull handle L 515mm H 43mm mounting distance 497mm		
For models:	AIB0013, AIB0014, AIB0017, KF630, KF733, KF933U		

fasteners

locking levers



1

GEV No.	514519	Ref. No.	678.087.00
description	closing clamp for kettle with locking screw		

locking screws



1

GEV No.	697516	Ref. No.	19562700
description	locking screw thread M5 handle \varnothing 25mm L 8mm		
For models:	FEB0031, MIRRA300		

miscellaneous



1

GEV No.	693333	Ref. No.	91510000
description	handle		
For models:	CAB0019, CAB0020		

accessories

miscellaneous



1

GEV No.	693334	Ref. No.	91510050
description	hand protection for door handle		
For models:	CAB0019, CAB0020		



1

GEV No.	690026	Ref. No.	91510060
description	hand protection for door handle ED \varnothing 36mm ID \varnothing 12.3mm D1 \varnothing 22.6-23.5mm		
For models:	CAA0003, CAA0004, CAA0005, CAB0007, CAB0007-CD, CAB0008, CAB0008-CD, CAB0009, CAB0009-CD, CAB0010, CAB0011, CAB0012, CAB0013, CAB0013-CD, CAB0014, CAB0014-CD, CAB0015, CAB0015-CD, CAB0016, CAB0017, CAB0018, CAB0024, CAB0024-CD, CAB0025, CAB0025-CD, CAB0026, CAB0027, CAB0029-CN, CAB0030-CN, CAB0032, CAB0032-CN, CAB0033, CAB0033-CN, CAB0035, CAB0039, CAB0040, CAB0041, CAB0042, CAB0043, CAB0044, CAB0045, CAB0046		



1

GEV No.	693119	Ref. No.	055807
description	hand protection for griddle		
For models:	2158, 2623, AJH0001, AJH0002, AJH0003, AJH0004, AJH0005, AJH0006		



			
1			
GEV No.	693120	Ref. No.	055814
description	hand protection for griddle		
For models:	AJG0003, AJG0004		









locks

handle latches





universal

inside fixing

locks

			
1			
GEV No.	694054	Ref. No.	11961668500
description	door handle for headed units L 145mm W 40mm H 62mm spring length 33mm inner black		
For models:	KF965		
spare parts for	694054		
	GEV No.	514390	Ref. No. —
	spring for door handle ø 6mm L 54mm W 27.5mm		
	GEV No.	694675	Ref. No. —
	door catch L 88mm W 40mm H 37mm spring length 33mm mounting distance 60mm		
	GEV No.	694734	Ref. No. —
	door handle L 165mm W 40mm H 25mm black		
	GEV No.	694735	Ref. No. —
	cap ø 32mm black		
accessories for	694054		
	GEV No.	691123	Ref. No. —
	duct for door opener		
	GEV No.	694055	Ref. No. —
	door catch L 25mm W 14mm total length 54mm thread M8 thread L 29mm		
	GEV No.	694066	Ref. No. —
	door catch with spigot 2-stage L 28mm W 14mm H 15mm H1 16mm total length 51mm thread M8 thread L 23mm stainless steel		
	GEV No.	694067	Ref. No. —
	door catch with spigot 1-stage L 26mm total length 51mm thread M8		

			
1			
GEV No.	694234	Ref. No.	11960928500
description	door handle for headed units L 145mm W 40mm H 62mm spring length 40mm inner black		
For models:	KF981D		
spare parts for	694234		
	GEV No.	514450	Ref. No. —
	spring for door handle ø 6mm L 61mm W 27.5mm		
	GEV No.	694734	Ref. No. —
	door handle L 165mm W 40mm H 25mm black		
	GEV No.	694735	Ref. No. —
	cap ø 32mm black		

			
1			
GEV No.	694225	Ref. No.	MAG30019
description	door handle for headed units L 145mm W 40mm H 62mm spring length 55mm inner black		
For models:	VG715RXS, VP914RXS, VP916RXS, VP920RXS		
spare parts for	694225		
	GEV No.	514451	Ref. No. —
	spring for door handle ø 6mm L 76mm W 27.5mm		
	GEV No.	694734	Ref. No. —
	door handle L 165mm W 40mm H 25mm black		
	GEV No.	694735	Ref. No. —
	cap ø 32mm black		

edgmount latches

handle latches

miscellaneous



GEV No.	694003	Ref. No.	B00K1102
description	handle latch L 137mm mounting distance 118mm lockable refrigeration units I-01 H 31.5mm W 28mm type I-01 total length 190mm handle material plastic		
For models:	HAB0001-F, HAB0007-F, HAB0009-F, HAB0015-F, HAB0020, HAB0021		
accessories for	694003		
	GEV No.	700078	Ref. No. —
	door catch L 47mm W 14mm H 29mm mounting distance 21-33mm zinc die cast adjustable		

snap locks

universal



GEV No.	700410	Ref. No.	09980358700
description	snap lock L 57mm W 12mm H 15mm mounting distance 47/12.5mm complete with door catch brass		
For models:	AIB0012		

hinges

spring assisted hinges

producer-specific

FRENOX



GEV No.	701653	Ref. No.	P30090008
description	bracket for hinge L 180mm W 31mm lower mounting distance 58mm		
For models:	BMA0013-F, BMA0034-F, BMB0002-FG, BMB0014-F, BMB0014-FG, BMB0015-F, BMC0001-F, BMC0001-FG, BMC0003-F		
accessories for	701653		
	GEV No.	701416	Ref. No. B02ME100
	spring assisted hinge left/right L 114mm W 75mm mounting distance 25mm brass suitable for FRENOX		

	GEV No.	701651	Ref. No.	B02ME101
description	bush for door hinge 8 ED ø 11mm 19.5 H 11.5mm Qty 5 pcs			
For models:	BMA0013-F, BMA0034-F, BMA0038-F, BMA0098, BMA0099, BMB0002-F, BMB0002-FG, BMB0004-F, BMB0014-F, BMB0014-FG, BMB0015-F, BMB0042-F, BMC0001-F, BMC0001-FG, BMC0003-F			

	GEV No.	701388	Ref. No.	B02ME102
description	bush type for door hinge mounting pos. upper ED ø 31mm H 19mm plastic shaft diameter 14.3mm			
For models:	BMA0013-F, BMA0034-F, BMA0038-F, BMA0098, BMA0099, BMB0002-F, BMB0002-FG, BMB0004-F, BMB0014-F, BMB0014-FG, BMB0015-F, BMB0042-F, BMC0001-F, BMC0001-FG, BMC0003-F			
accessories for	701388			
	GEV No.	701416	Ref. No.	B02ME100
	spring assisted hinge left/right L 114mm W 75mm mounting distance 25mm brass suitable for FRENOX			
	GEV No.	701655	Ref. No.	—
	bush upper for door hinge ID ø 10mm ED ø 14mm L 36mm for aluminium			

	GEV No.	701416	Ref. No.	B02ME100
description	spring assisted hinge left/right L 114mm W 75mm mounting distance 25mm brass suitable for FRENOX			
For models:	9925F, 9931F, 9932F, BMA0013-F, BMA0034-F, BMA0038-F, BMA0098, BMA0099, BMB0002-F, BMB0002-FG, BMB0004-F, BMB0014-F, BMB0014-FG, BMB0015-F, BMB0042-F, BMC0001-F, BMC0001-FG, BMC0003-F, BNC0001BAR-F, BNC0001-F, BNC0002-F, BNC0007BAR-F, BNC0008-F, BNC0015BAR-F, BNC0015-F, BNC0016-F, BNC0030, BNC0030PI, BNC0032, BNC0033, BNC0034, BNC0034PI, BNC0035, CCZ0009-F, CCZ0018-F, CCZ0050, HAB0001-F, HAB0007-F, HAB0009-F, HAB0015-F, HAB0020, HAB0021, HCE2004-F, HCE2006-F, HCE2007-F, HCE2009, IBC0056, IBC0057, IBC0059, IBC0060...(Other models you can see in the webshop)			
accessories for	701416			
	GEV No.	701388	Ref. No.	B02ME102
	bush type for door hinge mounting pos. upper ED ø 31mm H 19mm plastic shaft diameter 14.3mm			
	GEV No.	701653	Ref. No.	P30090008
	bracket for hinge L 180mm W 31mm lower mounting distance 58mm			



oven hinges

GEV No.	700003	Ref. No.	684.023.00
description	opposite support L 110mm W 12mm mounting distance 94mm		
For models:	6060CFE, 6060CFG, 6060CFGE		

GEV No.	700001	Ref. No.	684.011.00
description	opposite support L 118mm W 17mm mounting distance 94mm		
For models:	65110CFG, 65110CFGE, 65110TPFG, 6570CFE, 6570CFG, 6570CFGE, 6570TPFG, 70110CFG, 70110CFGE, 70110TPFG, 7070CFEQ, 7070CFG, 7070CFGE, 7070CFVE, 7070TPFG, 94CFE, 94CFG, 94CFGE, 94CFV, 94TPFG, 96CFE, 96CFG, 96CFGE, 96TPFG		



GEV No.	700841	Ref. No.	09964139512 7424000002 CER30012
description	opposite support mounting distance 85mm L 107mm W 12.5mm for hinge		
For models:	KF630, VP800U, VP824RU		



GEV No.	700707	Ref. No.	01981589512
description	opposite support mounting distance 94mm L 140mm mounting pos. left W 13mm with welded metal sheet H 110mm for hinge		
For models:	AIB0014		
accessories for	700707		
	GEV No.	693045	Ref. No. —
	opposite support L 110mm W 12mm mounting distance 94mm		

GEV No.	700434	Ref. No.	01980869512
description	opposite support oven hinge		
For models:	AAA2002, AIB0013, AIB0014, AIB0015		

GEV No.	690030	Ref. No.	684.022.00
description	oven hinge mounting distance 118mm lug mounting 13mm lever length 117mm groove distance 10mm spring thickness 3.5mm mounting ear position left/right spring length 60mm L 155mm W 21mm		
For models:	6060CFE, 6060CFG, 6060CFGE		
accessories for	690030		
	GEV No.	700003	Ref. No. 684.023.00
	opposite support L 110mm W 12mm mounting distance 94mm		



GEV No.	700433	Ref. No.	09981619512
description	oven hinge mounting distance 142mm mounting distance 2mm lug mountingmm lever length 100mm groove distance 14mm spring thickness 4mm mounting ear position spring length 55mm L 155mm mounting pos. left/right		
For models:	AAA2002, AIB0014, AIB0015, KF1001G		
accessories for	700433		
	GEV No.	700434	Ref. No. 01980869512
	opposite support oven hinge		



GEV No.	700000	Ref. No.	01980859512
description	oven hinge mounting distance 142mm mounting distance 2mm lug mountingmm lever length 127mm groove distance 10mm spring thickness 3.7mm mounting ear position L 155mm mounting pos. left/right		
For models:	AIB0013, AIB0017, KF733		
accessories for	700000		
	GEV No.	693045	Ref. No. —
	opposite support L 110mm W 12mm mounting distance 94mm		
	GEV No.	700707	Ref. No. 01981589512
	opposite support mounting distance 94mm L 140mm mounting pos. left W 13mm with welded metal sheet H 110mm for hinge		

GEV No.	700627	Ref. No.	7424000001
description	oven hinge mounting distance 154mm mounting distance 2mm lug mountingmm lever length 79mm groove distance 14mm spring thickness 3.5mm mounting ear position spring length 54mm L 165mm mounting pos. left/right zinc-coated steel		
For models:	VP800U		
accessories for	700627		
	GEV No.	700628	Ref. No. —
	opposite support right oven hinge		
	GEV No.	700629	Ref. No. —
	opposite support mounting distance 75mm L 95mm W 26mm left H 46mm M5 cut-out 10X30mm oven hinge		
	GEV No.	700841	Ref. No. 09964139512 7424000002 CER30012
	opposite support mounting distance 85mm L 107mm W 12.5mm for hinge		

GEV No.	701621	Ref. No.	684.030.00
description	oven hinge mounting distance 173mm lug mounting 14mm lever length 115mm groove distance 7mm spring thickness 3.8mm mounting ear position left/right spring length 110mm L 207mm W 25mm		

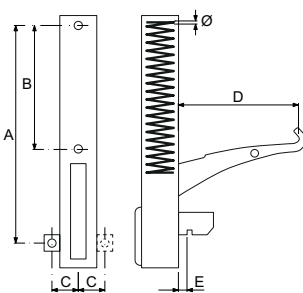

 <p>1</p>			
GEV No.	700006	Ref. No.	684.009.00 68402700 X66000
description	oven hinge mounting distance 173mm mounting distance 2 105mm lug mounting 14mm lever length 120mm groove distance 11mm spring thickness 3.5mm mounting ear position left spring length 112mm W 25mm		
For models:	110170CFG, 65110CFG, 65110CFGE, 65110TPFG, 6570CFE, 6570CFG, 6570CFGE, 6570TPFG, 70110CFG, 70110CFGE, 70110TPFG, 7070CFEQ, 7070CFG, 7070CFGE, 7070CFVE, 7070TPFG, 94CFE, 94CFG, 94CFGE, 94CFV, 94TPFG, 96CFE, 96CFG, 96CFGE, 96TPFG, ACA1004, ACA104V, ACA105V, ACA2007, ACA2010, ACA2012, ACA204V, ACA206V, ACA207V, ACA208V, ACA210V, ACA212V, ACA216, ACA216V, ADA104V, ADA106V, ADA205V, ADA206V, ADA207V, ADA208V, ADA209V, ADA210V, ADA211V, ADA212V, ADA217V...(Other models you can see in the webshop)		
accessories for	700006		
 <p>GEV No. 700001 Ref. No. 684.011.00</p> <p>opposite support L 118mm W 17mm mounting distance 94mm</p>			
 <p>GEV No. 700007 Ref. No. 684.010.00 68402600 X66100</p> <p>oven hinge mounting distance 173mm mounting distance 2 105mm lug mounting 14mm lever length 120mm groove distance 11mm spring thickness 3.5mm mounting ear position right spring length 112mm W 25mm</p>			

 <p>1</p>			
			
GEV No.	700007	Ref. No.	684.010.00 68402600 X66100
description	oven hinge mounting distance 173mm mounting distance 2 105mm lug mounting 14mm lever length 120mm groove distance 11mm spring thickness 3.5mm mounting ear position right spring length 112mm W 25mm		
For models:	110170CFG, 65110CFG, 65110CFGE, 65110TPFG, 6570CFE, 6570CFG, 6570CFGE, 6570TPFG, 70110CFG, 70110CFGE, 70110TPFG, 7070CFEQ, 7070CFG, 7070CFGE, 7070CFVE, 7070TPFG, 94CFE, 94CFG, 94CFGE, 94CFV, 94TPFG, 96CFE, 96CFG, 96CFGE, 96TPFG, ACA1004, ACA104V, ACA105V, ACA2007, ACA2010, ACA2012, ACA204V, ACA206V, ACA207V, ACA208V, ACA210V, ACA212V, ACA216, ACA216V, ADA104V, ADA106V, ADA205V, ADA206V, ADA207V, ADA208V, ADA209V, ADA210V, ADA211V, ADA212V, ADA217V...(Other models you can see in the webshop)		
accessories for	700007		
 <p>GEV No. 700001 Ref. No. 684.011.00</p> <p>opposite support L 118mm W 17mm mounting distance 94mm</p>			

accessories for	700007		
			
GEV No.	700006	Ref. No.	684.009.00 68402700 X66000
description	oven hinge mounting distance 173mm mounting distance 2 105mm lug mounting 14mm lever length 120mm groove distance 11mm spring thickness 3.5mm mounting ear position left spring length 112mm W 25mm		

 <p>1</p>			
GEV No.	701538	Ref. No.	09964199512
description	oven hinge set mounting distance 155mm mounting distance 2mm lug mountingmm lever length 77mm groove distance 14mm spring thickness 3.5mm mounting ear position spring length 53mm L 165mm mounting pos. left/right W 22mm pair		
For models:	KF630		

door bearing

 <p>1</p>			
GEV No.	700412	Ref. No.	09980309202
description	hinge bottom left		
For models:	AIB0012		

 <p>1</p>			
GEV No.	700411	Ref. No.	09980299202
description	hinge upper left		
For models:	AIB0012		

miscellaneous



GEV No.	691106	Ref. No.	IB7506000
description	door hinge kit for glass door mounting pos. upper/lower		
For models:	IBA0012, IBA0013		

accessories

shafts



GEV No.	700818	Ref. No.	12024071 Z400516000
description	hinge bolt L 32mm stainless steel D1 ø 7.8mm D2 ø 12mm		
For models:	GLB0035-FN, GLB0037-FN, GLB0061C-F, GLB0061C-FN, GLB0063C-F, GLB0063C-FN		
spare parts for	700818		



GEV No.	505005	Ref. No.	12022324 Z400514000
description	door hinge hinge left mounting pos. left		

bushes



GEV No.	694886	Ref. No.	11960918700
description	bush ID ø 7mm ED ø 12mm L 10mm		
For models:	KF965, KF981D		

pullouts

drawer slides

producer-specific



GEV No.	696701	Ref. No.	A00CK101
description	drawer slide L 450mm pull-out length 435mm Qty 1 pair mounting pos. right/left		
For models:	BNC0001BAR-F, BNC0007BAR-F, BNC0015BAR-F, BNC0030, BNC0030PI, BNC0032, BNC0033, BNC0034, BNC0034PI, BNC0035, HCE2004-F, HCE2005-F, HCE2006-F, HCE2007-F, HCE2008-F, HCE2009, TIM3, TIM3PI, USN4		

rollers

roller with holder



GEV No.	690955	Ref. No.	2330706
description	roller rollerø 28mm B1 6mm with holder SS/Nylon mounting pos. upper bearing slide bearing Qty 1 pcs H 5mm L 62mm mounting distance 25/45mm		
For models:	IIA3006, IIA3007, IIA3008, IIA3010, IIA3011, IIA3012, IIA4002, IIA4003		

accessories



GEV No.	693731	Ref. No.	SS.1602
description	bracket for roller mounting pos. left		
For models:	AHC0004, AHC0005, TP12JG, TP15JG		



GEV No.	693733	Ref. No.	PD.4748
description	guide sliding door L 54mm plastic 20		
For models:	TP12JG, TP15JG		

fittings for catering equipment

outlet taps

universal

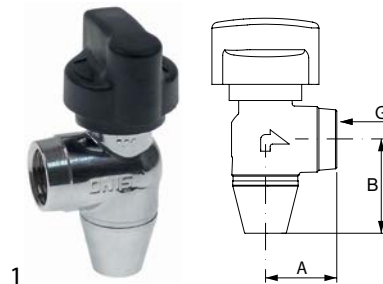

GEV No.	540747	Ref. No.	062001
description	outlet tap chrome-plated brass angled W 30mm H 40mm thread 1/2" IT		
For models:	AAC0001, AAC0002, AMZ0004, AMZ0005, AMZ0006, AMZ0007, AMZ0008, AXZ0003, IFA0004		



aerators and air bleeders



1

GEV No.	540827	Ref. No.	67802300 Y70200
description	aerator and air bleeder thread 3/4" ET chrome-plated L 45mm ø 36mm		
For models:	7070PEI, 7070PGI, 94PE100I, 94PE100IA, 94PE100IAS, 94PE100IS, 94PE150I, 94PE150IA, 94PG100I, 94PG100IA, 94PG150I, 94PG150IA, ADL003V, ADL004V, ADL005V, ADL008V, ADL009V, ADL010V, ADL011V, ADL012V		



1

GEV No.	542408	Ref. No.	256.334.00
description	aerator and air bleeder thread 3/8" ET WS 24 chrome-plated with adapter for kettle L 37mm		
spare parts for	542408		
	GEV No.	540825	Ref. No. —
	aerator and air bleeder thread 3/8" ET WS 24 chrome-plated L 37mm		

lid hinges

MODULAR

lid hinges



1

GEV No.	514520	Ref. No.	6111636.00
description	lid hinge L 250mm ID ø 40mm ED ø 42mm lid radius 215mm		

spare parts



1

GEV No.	692783	Ref. No.	941.139.15
description	adjusting bush for kettle ø 40/20mm L 80mm		

lid catches



1

GEV No.	514519	Ref. No.	678.087.00
description	closing clamp for kettle with locking schrew		

dispenser tap

complete



1

GEV No.	527557	Ref. No.	120200-02
description	outlet tap complete pipe lengthmm thread 3/4" ET black/chrome suitable for COFFEE QUEEN		
For models:	EFB0014, EFB0019, EFC0003		

drain taps



brass

drain taps





GEV No.	540132	Ref. No.	Y71100
description	drain tap 1 1/2" IT conical seal kettle A 90mm B 137mm B1 70mm chrome-plated brass		
For models:	ADL003V, ADL004V, ADL005V, ADL008V, ADL009V, ADL010V, ADL011V, ADL012V, ADL014V, ADL015V		
spare parts for	540132		
	GEV No.	540213	Ref. No. —
	handle ID ø 5mm L 117mm		
	GEV No.	540461	Ref. No. —
	shim for drain tap		
	GEV No.	540464	Ref. No. —
	nut for drain tap thread 1 1/2"		
accessories for	540132		
	GEV No.	510404	Ref. No. —
	flat gasket fibre ED ø 44mm ID ø 34mm thickness 2mm Qty 1 pcs		





GEV No.	540275	Ref. No.	67805100
description	drain tap 2" IT with union nut A 90mm B 151mm B1 80mm chrome-plated brass		
For models:	94PE100I, 94PE100IA, 94PE100IAS, 94PE100IS, 94PE150I, 94PE150IA, 94PG100I, 94PG100IA, 94PG150I, 94PG150IA		
spare parts for	540275		
	GEV No.	540214	Ref. No. —
	handle ID ø 6mm L 145mm		
accessories for	540275		
	GEV No.	529484	Ref. No. 953.030.00
	flat gasket fibre ED ø 58mm ID ø 50mm thickness 2mm Qty 1 pcs		
	GEV No.	542448	Ref. No. —
	gasket silicone 60x49x2 for drain tap 2"		



GEV No.	540276	Ref. No.	67805800
description	drain tap connection with union nut thread 1 1/2"		
For models:	7070PEI, 7070PGI		
spare parts for	540276		
	GEV No.	532374	Ref. No. —
	O-ring silicone thickness 5.34mm ID ø 43.82mm Qty 10 pcs		
accessories for	540276		
	GEV No.	514251	Ref. No. —
	gasket fibre ED ø 46mm ID ø 38mm thickness 2mm Qty 1 pcs		



GEV No.	540267	Ref. No.	E50200
description	drain tap connection with union nut thread 2"		
For models:	ADL001V, ADL002V, ADL006V, ADL007V, ADL013V		
spare parts for	540267		
	GEV No.	505517	Ref. No. —
	O-ring EPDM thickness 5.34mm ID ø 53.34mm Qty 1 pcs		
	GEV No.	540214	Ref. No. —
	handle ID ø 6mm L 145mm		



test taps

test taps

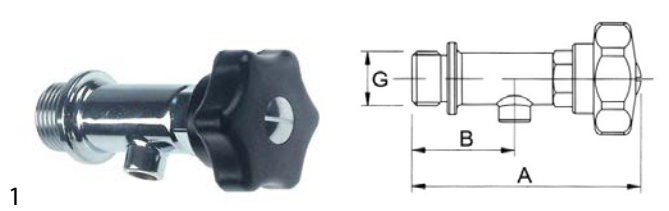

GEV No.	540818	Ref. No.	67803100 E50400 Y71300
description	test tap thread 1/2" ET W 88mm W1 38mm		
For models:	7070PEI, 7070PGI, 94PE100I, 94PE100IA, 94PE100IAS, 94PE100IS, 94PE150I, 94PE150IA, 94PG100I, 94PG100IA, 94PG150I, 94PG150IA, ACL0001, ACL0002, ACL0003, ACL001V, ACL002V, ACL003V, ADL001V, ADL002V, ADL003V, ADL004V, ADL005V, ADL006V, ADL007V, ADL008V, ADL009V, ADL010V, ADL011V, ADL012V		



GEV No.	542396	Ref. No.	678.079.00
description	test tap thread 3/8" IT W 78mm W1 22mm head ø 45mm head thickness 18mm		

safety fittings

accessories



GEV No.	540817	Ref. No.	67802700
description	fitting support thread 1/2" ET suitable for manometer		
For models:	94PE100I, 94PE100IA, 94PE100IAS, 94PE100IS, 94PE150I, 94PE150IA, 94PG100I, 94PG100IA, 94PG150I, 94PG150IA		





GEV No.	540821	Ref. No.	67804800
description	fitting support thread 1 1/4"		
For models:	94PE100I, 94PE100IA, 94PE100IAS, 94PE100IS, 94PE150I, 94PE150IA, 94PG100I, 94PG100IA, 94PG150I, 94PG150IA		



GEV No.	540822	Ref. No.	67804100
description	fitting support thread 3/4"		
For models:	7070PEI, 7070PGI		



GEV No.	540835	Ref. No.	67805400	
description	screw cap thread 3/4"			
For models:	94PE100I, 94PE100IA, 94PE100IAS, 94PE100IS, 94PE150I, 94PE150IA, 94PG100I, 94PG100IA, 94PG150I, 94PG150IA			
spare parts for	540835			
	GEV No.	513016	Ref. No.	—
		O-ring EPDM thickness 3.53mm ID ø 26.58mm Qty 1 pcs		
accessories for	540835			
	GEV No.	513016	Ref. No.	—
		O-ring EPDM thickness 3.53mm ID ø 26.58mm Qty 1 pcs		



GEV No.	540833	Ref. No.	67802800
description	screw cap thread 3/8"		
For models:	7070PEI, 7070PGI		



GEV No.	540828	Ref. No.	67802500
description	manometer siphon thread 3/8"		
For models:	94PE100I, 94PE100IA, 94PE100IAS, 94PE100IS, 94PE150I, 94PE150IA, 94PG100I, 94PG100IA, 94PG150I, 94PG150IA		

safety valves



GEV No.	514415	Ref. No.	678.052.00
description	safety valve for kettle thread M33		
For models:	94PE100I, 94PE100IA, 94PE100IAS, 94PE100IS, 94PE150I, 94PE150IA, 94PG100I, 94PG100IA, 94PG150I, 94PG150IA		



1

GEV No.	514121	Ref. No.	67904900
description	safety valve triggering pressure 0.5bar with CE approval M88 thread 1 1/4"		
For models:	94PE100I, 94PE100IA, 94PE100IAS, 94PE100IS, 94PE150I, 94PE150IA, 94PG100I, 94PG100IA, 94PG150I, 94PG150IA		



1

GEV No.	513287	Ref. No.	79028 926117
description	equipment foot tube ø 60mm thread M12 thread L 33mm H 155-235mm SS size 2" Qty 1 pcs		
For models:	GLB0046, GLB0070, GLB0071, GLB0072, OPT1012, OPT1012C		

filters

grease filters

grease filter



1

GEV No.	970962	Ref. No.	643.007.00
description	grease filter W 270mm L 270mm thickness 12mm for induction device		

with fixing plate



1

GEV No.	701100	Ref. No.	12009104 X260151000
description	equipment foot tube ø 64mm plate size 82x82mm hole distance 65x65mm H 135-200mm SS size 2 1/2" Qty 1 pcs		
For models:	OPT1012-CF, OPT1012-CFN		

equipment feet and end caps

equipment feet

with screw mounting

universal



1

GEV No.	700868	Ref. No.	73100
description	equipment foot tube ø 64mm thread M12 thread L 25mm H 155-235mm SS size 2 1/2" Qty 1 pcs		
For models:	OPT1012C		



1

GEV No.	701007	Ref. No.	B00AY100
description	equipment foot tube ø 64mm plate size 82x82mm hole distance 68x68mm H 100-150mm SS size 2 1/2" Qty 1 pcs		
For models:	9925F, 9931F, 9932F, BMA0013-F, BMA0034-F, BMB0002-F, BMB0002-FG, BMB0004-F, BMB0014-F, BMB0014-FG, BMB0015-F, BMC0001-F, BMC0001-FG, BMC0003-F, BNA0068, BNA0069, BNC0001BAR-F, BNC0001-F, BNC0002-F, BNC0007BAR-F, BNC0007-F, BNC0008-F, BNC0015BAR-F, BNC0015-F, BNC0016-F, BNC0030, BNC0030PI, BNC0032, BNC0033, BNC0034, BNC0034PI, BNC0035, CCZ0009-F, CCZ0018-F, CCZ0050, HCE2004-F, HCE2005-F, HCE2006-F, HCE2007-F, HCE2008-F, HCE2009, IEA0010, IEA0011, IEA0012, IEB0005, IEB0006, IEC0050, IEC0051, IEC0052, SALADBAR2...(Other models you can see in the webshop)		



1

GEV No.	700761	Ref. No.	N10406
description	equipment foot tube ø 50mm thread M10 thread L 12mm H 130-180mm SS size 2" Qty 1 pcs		
For models:	BAA0026, BAA0027, BAA0028, BAA0029, BAA0030, BAA0031, BAA0037, BAA0038, BAB0001, BAB0001-W, BAB0002, BAB0002-W		





bullet feet

plastic



1

GEV No.	700108	Ref. No.	SS.2016
description	equipment foot pipe type 40x40 thickness 1-1.2mm H 17-55mm plastic Qty 1 pcs		
For models:	AHC0004, AHC0005, TP12JG, TP15JG		
spare parts for	700108		
		GEV No.	511512
		Ref. No.	—
	O-ring EPDM thickness 2.62mm ID ø 18.72mm Qty 10 pcs		



1

GEV No.	695545	Ref. No.	PIE30001
description	equipment foot thread M10 thread L 32mm ø 40mm H 12mm Qty 1 pcs		
For models:	VP800U		



1

GEV No.	510115	Ref. No.	12024163 Z200107000
description	equipment foot thread M10 thread L 40mm ø 30mm H 10mm Qty 1 pcs		
For models:	GLB0035-F, GLB0035-FN, GLB0037-F, GLB0037-FN, GLB0061C-F, GLB0061C-FN, GLB0063C-F, GLB0063C-FN		

screw-in feet



1

GEV No.	695614	Ref. No.	M06400
description	equipment foot thread M10 ø 26mm H 30mm		
For models:	ACA1010, ACA110V, ACB0004, ACB004V, ACC006V, ACC007V, ACC008V, ACC010V, ACD002V, ACE004V, ACE005V, ACE008V, ACH1003, ACH1004, ACH103V, ACH104V, ACH3015, ACH3016, ACH315V, ACH316V, ACH317V, ACH318V, ACH319V, ACH320V, ACJ0001, ACJ0002, ACJ0003, ACJ0004, ACJ001V, ACJ002V, ACJ003V, ACJ004V, ACJ005V, ACJ006V, ACJ007V, ACJ008V, ACK1002, ACK102V, ACK303V, ACK304V		



1

GEV No.	695601	Ref. No.	461010
description	equipment foot thread M17 thread L 23mm ø 24mm H 11mm plastic WS 24 Qty 1 pcs		
For models:	GLB0035, GLB0036, GLB0037, GLB0038, GLB0039, GLB0056, GLB0057		



1

GEV No.	697901	Ref. No.	SS.2603
description	equipment foot thread M10 thread L 19.5mm ø 30mm H 34mm WS 13 Qty 1 pcs		
For models:	AHA0013, AHC0001, AHC0002		



1

GEV No.	696094	Ref. No.	IB4356015
description	equipment foot thread M4 thread L 10mm ø 15mm H 10mm Qty 1 pcs		
For models:	BARMASER, ORIONEFIVE		



1

GEV No.	802156	Ref. No.	09960058500
description	equipment foot thread M10 thread L 20mm ø 60mm H 50mm Qty 1 pcs		
For models:	AIB0012, AIB0013, AIB0014, AIB0015, AIB0017, KF1001G, KF630, KF733, KF933U, KF965		





1

GEV No.	693791	Ref. No.	19560201
description	equipment foot thread M5 thread L 10mm ø 36mm H 27mm Qty 1 pcs		
For models:	FEB0031, FLA0014, FLA0015, FLA0016		



			
1			
GEV No.	691264	Ref. No.	IB4356000
description	equipment foot thread M6 thread L 16mm ø 25mm H 6mm Qty 1 pcs		
For models:	IBA0012, IBA0013		

			
1			
GEV No.	697770	Ref. No.	19560202
description	equipment foot thread M8 thread L 12mm ø 47mm H 35mm Qty 1 pcs		
For models:	PALLADIO300AM, PALLADIO350AM		

			
1			
GEV No.	513284	Ref. No.	461019
description	equipment foot thread M8 thread L 20mm ø 30mm H 12mm Qty 1 pcs		
For models:	GLB0058, GLB0059, GLB0060, GLB0061, GLB0061C, GLB0062, GLB0063, GLB0064, GLB0064C, GLB0065, GLB0066		

			
1			
GEV No.	692781	Ref. No.	951.083.00
description	equipment foot thread M8 thread L 54mm ø 25mm H 11mm Qty 1 pcs		

bolting feet

			
1			
GEV No.	693442	Ref. No.	064001
description	equipment foot ø 29mm H 15mm rubber bore ø 6mm Qty 1 pcs		
For models:	AJA0014, AJA0015, AJA0016, AJE0001, AJE0005, AJG0001, AJG0002, AJG0003, AJG0004, AJH0002, AMZ0004, AMZ0005, AMZ0006, AMZ0007, AMZ0024, AOZ0001, AOZ0002, AOZ0003, AOZ0004, APZ0001, APZ0002, APZ0003, APZ0004, APZ0012, APZ0013, ARZ0001, ARZ0002, AXZ0003, IFA0004		

			
1			
GEV No.	697433	Ref. No.	00000000140
description	equipment foot ø 35mm H 26mm bore ø 5mm Qty 1 pcs		
For models:	8920, 8921, 8922		

TENTE

with fixing plate

chrome-plated steel

			
1			
GEV No.	700214	Ref. No.	B00AY101
description	swivel castor ø 100mm plate fixing housing zinc-plated sheet steel plate size 105x85mm hole distance 60x78mm capacity 80kg bearing slide bearing wheel body polypropylene tread TPE tyres H 128mm wheel width 32mm		
For models:	9925F, 9931F, 9932F, BMA0013-F, BMA0034-F, BMA0038-F, BMB0002-F, BMB0002-FG, BMB0004-F, BMB0014-F, BMB0014-FG, BMB0015-F, BMB0042-F, BMC0001-F, BMC0001-FG, BMC0003-F, BNA0068, BNA0069, BNC0001BAR-F, BNC0001-F, BNC0002-F, BNC0007BAR-F, BNC0007-F, BNC0008-F, BNC0015BAR-F, BNC0015-F, BNC0016-F, BNC0030, BNC0030PI, BNC0032, BNC0033, BNC0034, BNC0034PI, BNC0035, CCZ0009-F, CCZ0018-F, CCZ0050, HCE2004-F, HCE2005-F, HCE2006-F, HCE2007-F, HCE2008-F, HCE2009, IEA0010, IEA0011, IEA0012, IEB0005, IEB0006, IEC0050, IEC0051...(Other models you can see in the webshop)		

			
1			
GEV No.	700213 ¹	Ref. No.	B00AY102
description	swivel castor with swivel brake ø 100mm plate fixing housing zinc-plated sheet steel plate size 105x85mm hole distance 60x78mm capacity 80kg bearing slide bearing wheel body polypropylene tread TPE tyres H 128mm wheel width 32mm Qty 1 pcs		
For models:	9925F, 9931F, 9932F, BMA0034-F, BMB0002-FG, BMB0014-FG, BMB0015-F, BMB0042-F, BMC0001-FG, BNC0001BAR-F, BNC0001-F, BNC0002-F, BNC0007BAR-F, BNC0008-F, BNC0015BAR-F, BNC0015-F, BNC0016-F, BNC0030, BNC0030PI, BNC0032, BNC0033, BNC0034, BNC0034PI, BNC0035, CCZ0009-F, CCZ0018-F, CCZ0050, HCE2004-F, HCE2005-F, HCE2006-F, HCE2007-F, HCE2008-F, HCE2009, IEA0010, IEA0011, IEA0012, IEB0005, IEB0006, IEC0050, IEC0051, IEC0052, SALADBAR2, SALADBAR3, TIM3, TIM3PI, USN4		

¹with swivel brake



miscellaneous

with fixing plate

ø100mm



1

GEV No.	700978	Ref. No.	SHSMTKFR0100
description	swivel castor ø 100mm plates fixing 70x80mm hole distance 50/60mm bearing ball bearing H 135mm wheel width 31.5mm		
For models:	IEA0002-I, IEC0002-I		



1

GEV No.	700979	Ref. No.	SHSMTKFZ0100
description	swivel castor with swivel brake ø 100mm plates fixing 70x80mm hole distance 50/60mm bearing ball bearing H 135mm wheel width 31mm		
For models:	IEA0002-I, IEC0002-I		

with spigot

ø100mm



1

GEV No.	700336	Ref. No.	005151250002
description	swivel castor with swivel brake ø 125mm plug fitting ø10x38mm housing chrome-plated steel bearing slide bearing wheel body polypropylene tread TPE tyres Qty 1 pcs		
For models:	IFD0001-MN		

ø125mm



1

GEV No.	700341	Ref. No.	005201250001
description	swivel castor ø 125mm plug fitting 21x21mm housing zinc-plated sheet steel bearing slide bearing H 157mm wheel width 27mm		
For models:	IFD0002-M		



1

GEV No.	700340	Ref. No.	005151250001
description	swivel castor ø 125mm plug fitting ø10x38mm housing zinc-plated sheet steel bearing slide bearing tread thermoplastic rubber H 157mm wheel width 27mm		
For models:	IFD0001-MN		

bumper angles

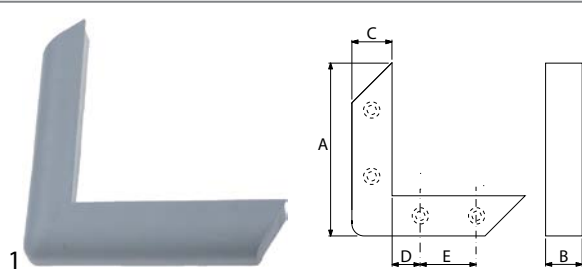

1

GEV No.	692112	Ref. No.	233004680002
description	bumper angle outer length 180mm inner length 145mm W 32mm H 30mm mounting distance 51mm hole distance 42mm hole ø 3mm plastic grey		
For models:	IFD0002-M		

baskets

crumb screens



1

GEV No.	970222	Ref. No.	Y47800
description	crumb screen L 303mm W 212mm suitable for fryer		
For models:	ACC0003, ACC003V, ACC008V, ACC010V, ADC004V		

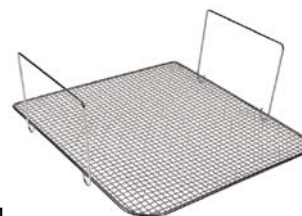

1

GEV No.	970605	Ref. No.	Y47000
description	crumb screen L 310mm W 295mm suitable for fryer		
For models:	ACC005V, ADC001V, ADC002V		

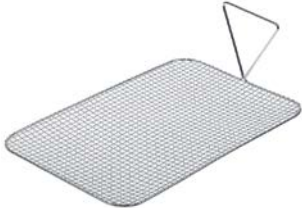
		
1		
GEV No.	970983	Ref. No. 683.096.00
description	crumb screen L 339mm W 220mm H 100mm chrome-plated steel suitable for for fryer 13 L	

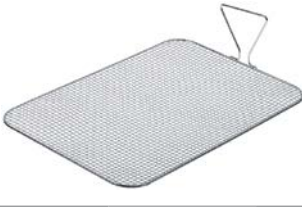
		
1		
GEV No.	970964	Ref. No. 983.045.00
description	crumb screen L 430mm W 297mm H 110mm	

		
1		
GEV No.	970545	Ref. No. 683.001.23
description	crumb screen L 330mm W 235mm suitable for fryer	
For models:	6030FRE, 6060FRE, 6540FRE, 7040FRE10, 7070FRE10	

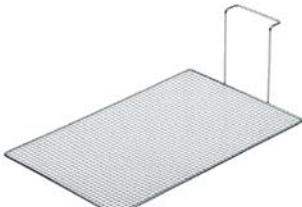
		
1		
GEV No.	970963	Ref. No. 983.010.00
description	crumb screen L 410mm W 260mm H 140mm for fryer	
For models:	AFC0003	

wire baskets for hot dog machines

		
1		
GEV No.	693468	Ref. No. 057501
description	grid basket for hot dog grill ø 180mm H 210mm	
For models:	ARZ0001, ARZ0002	

warewashing baskets

plastic baskets octagonal

mix baskets

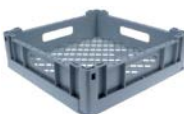
		
1		
GEV No.	971136	Ref. No. 12024550
description	mix basket L 352mm W 352mm H 105mm	
For models:	GLB0035-F, GLB0035-FN	

		
1		
GEV No.	976000	Ref. No. 12025069
description	mix basket L 395mm W 395mm H 145mm	
For models:	GLB0037-F, GLB0037-FN	



accessories

cutlery inserts



1	GEV No.	976010	Ref. No.	12025242
	description	cutlery insert Lmm Wmm ø 95mm H 105mm plastic		
	For models:	GLB0035-F, GLB0035-FN, GLB0037-F, GLB0037-FN		

sliding corners



1	GEV No.	970820	Ref. No.	75075
	description	sliding corner L 44mm W 44mm H 17mm		
	For models:	GLB0046		

basket holders



1	GEV No.	691910	Ref. No.	12038455 Z710325000
	description	basket support L 540mm W 630mm suitable for FI 80 - 120 stainless steel		
	For models:	OPT1012-CF, OPT1012-CFN		

plate inserts



1	GEV No.	976005	Ref. No.	12024286
	description	plate insert L 335mm W 195mm H 105mm plates 10 plastic-coated		
	For models:	GLB0035-F		



1	GEV No.	976014	Ref. No.	12025030
	description	plate insert L 370mm W 195mm H 105mm plates 11 plastic-coated		
	For models:	GLB0037-F, GLB0037-FN		

shelves and shelf rails

chargrill grids



1	GEV No.	211019	Ref. No.	681.011.00
	description	chargrill grid L 495mm W 160mm H 19mm		
	For models:	6540GRG, 6540GRL, 6570GRG, 6570GRL, 7040GRG, 7040GRL, 7070GRG, 7070GRL		

grates

universal

without upstand



1	GEV No.	970844	Ref. No.	B01RF101
	description	grate W 330mm D 430mm H 10mm plastic-coated steel wire gauge frame 6.9mm lengthwise wires gauge 3.5mm crossing wires 1 grey		
	For models:	BNC0030, BNC0030PI, BNC0032, BNC0033, BNC0034, BNC0034PI, BNC0035, HCE2004-F, HCE2005-F, HCE2006-F, HCE2007-F, HCE2008-F, HCE2009, TIM3, TIM3PI, USN4		



1	GEV No.	970834	Ref. No.	B01RF100
	description	grate W 330mm D 530mm H 10mm plastic-coated steel wire gauge frame 6.9mm lengthwise wires gauge 3.5mm crossing wires 1 grey		
	For models:	BNA0068, BNA0069, BNC0001-F, BNC0002-F, BNC0007-F, BNC0008-F, BNC0015-F, BNC0016-F, CCZ0009-F, CCZ0050, IEA0010, IEA0011, IEA0012, IEB0005, IEB0006, IEC0050, IEC0051, IEC0052, SALADBAR2, SALADBAR3		



1	GEV No.	970835	Ref. No.	B01RF115
	description	grate W 600mm D 400mm H 12mm plastic-coated steel wire gauge frame 7.5mm lengthwise wires gauge 5.5mm crossing wires 1 grey		
	For models:	9925F, 9931F, 9932F, CCZ0018-F		

with upstand



1

GEV No.	970471	Ref. No.	B01RF106
description	grate W 485mm D 460mm plastic-coated steel with hinge camp crossing wires 2 suitable for refrigerator for devices with Inox guide rails		
For models:	BMA0013-F, BMA0034-F, BMB0014-F, BMB0014-FG		



1

GEV No.	970833	Ref. No.	B01RF102
description	grate W 530mm D 650mm GN 2/1 H 29.5mm plastic-coated steel wire gauge frame 8mm lengthwise wires gauge 3.5mm crossing wires 2 grey		
For models:	BMB0002-F, BMB0002-FG, BMB0004-F, BMC0001-F, BMC0001-FG, BMC0003-F		

producer-specific



1

GEV No.	693930	Ref. No.	01960597915
description	grate W 435mm D 340mm chrome-plated steel suitable for refrigerator TECNOEKA		
For models:	AIB0013, AIB0017		

grid attachments



1

GEV No.	694963	Ref. No.	622.967.00
description	rack support L 630mm H 175mm mounting pos. left/right W 40mm mounting distance 603mm		
accessories for	694963		
	GEV No.	701650	Ref. No. 641.090.00
		bolt for grid attachment L 18mm head ø 15mm M6	



1

GEV No.	692890	Ref. No.	9111317.00
description	rack support L 630mm H 190mm mounting pos. left/right W 50mm mounting distance 608mm		

shelf rails and supports

producer-specific



1

GEV No.	701650	Ref. No.	641.090.00
description	bolt for grid attachment L 18mm head ø 15mm M6		



1

GEV No.	701327	Ref. No.	C17000126
description	guide SS L 435mm W 20mm mounting pos. right/left hook width 13mm inner height 17.3mm		
For models:	BNC0001BAR-F, BNC0007BAR-F, BNC0015BAR-F, BNC0030, BNC0030PI, BNC0032, BNC0033, BNC0034, BNC0034PI, BNC0035, TIM3, TIM3PI		



1

GEV No.	690760	Ref. No.	2330094
description	guide U-shape L 503mm W 24mm H 13mm mounting pos. left/right		
For models:	IIA5005, IIA5006, IIA5010, IIA5011, IIA5012, IIA5013, IIA5014, IIA5015		

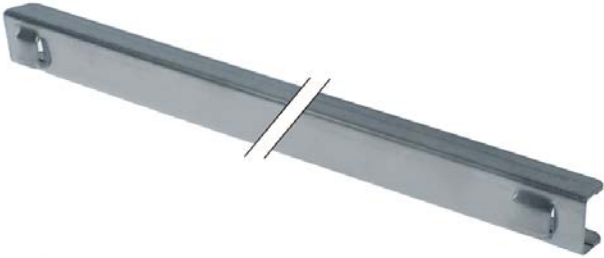
1

GEV No.	701329	Ref. No.	C11070025 P11070025
description	guide U-shape L 630mm W 19mm mounting pos. left/right hook width 13mm inner height 15mm		
For models:	BMB0002-F, BMB0002-FG, BMB0004-F, BMC0001-F, BMC0001-FG, BMC0003-F		



1

GEV No.	693481	Ref. No.	3380001
description	shelf support L 23mm W 20mm H 26mm		
For models:	IIA4002, IIA4003		



1

GEV No.	890033	Ref. No.	B00DI101
description	shelf support L 29mm W 22mm H 25mm SS for shelves		
For models:	BMA0034-F, BMA0098, BMA0099, BMB0014-FG, BMB0042-F, BMB0046-F		

gaskets

refrigeration gaskets

plug-in gaskets

profile 9703

We offer custom-made gaskets for this profile

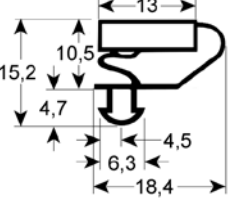

1

GEV No.	901128	Ref. No.	R053/1
description	refrigeration gasket profile 9703 W 295mm L 612mm plug size L1 600mm W1 285mm external size		
For models:	BGB0001, BGB0002, BGB0003, BGB0004, BGB0005, BGB0006, BGB0007, BGB0008, BGB0009, BGB0010, BGB0011, BGB0012, BGB0013, BGB0014, BGB0015, BGB0022		

profile 9753

We offer custom-made gaskets for this profile

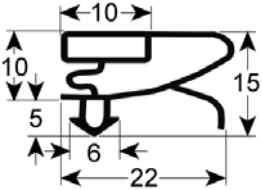

1

GEV No.	901725	Ref. No.	A00CO110
description	refrigeration gasket profile 9753 W 545mm L 1395mm plug size		
For models:	BMA0013-F, BMA0034-F, BMB0014-FG, BMB0015-F		

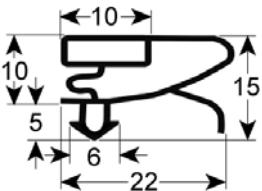

1

GEV No.	901739	Ref. No.	A00CO116
description	refrigeration gasket profile 9753 W 550mm L 750mm plug size		
For models:	BMB0046-F		

profile 9198

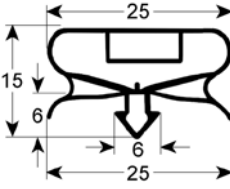

1

GEV No.	901727	Ref. No.	A00CO104
description	refrigeration gasket profile 9198 W 400mm L 410mm plug size		
For models:	HCE2004-F, HCE2005-F, HCE2006-F, HCE2007-F, HCE2008-F, HCE2009, USN4		

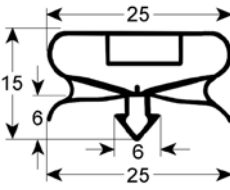

1

GEV No.	901737	Ref. No.	A00CO107
description	refrigeration gasket profile 9198 W 493mm L 618mm plug size		
For models:	9925F, 9931F, 9932F, CCZ0018-F		

GEV No.	901736	Ref. No.	A00CO101
description	refrigeration gasket profile 9198 W 610mm L 405mm plug size FRENEX		
For models:	BNA0068, BNA0069, BNC0001-F, BNC0002-F, BNC0007-F, BNC0008-F, BNC0015-F, BNC0016-F, BNC0030, BNC0030PI, BNC0032, BNC0033, BNC0034, BNC0034PI, BNC0035, CCZ0009-F, CCZ0050, IEA0010, IEA0011, IEA0012, IEB0005, IEB0006, IEC0050, IEC0051, IEC0052, SALADBAR2, SALADBAR3, TIM3, TIM3PI		

GEV No.	901724	Ref. No.	A00CO119
description	refrigeration gasket profile 9198 W 620mm L 1540mm plug size		
For models:	BMB0002-F, BMB0002-FG, BMB0004-F, BMC0001-F, BMC0001-FG, BMC0003-F		

GEV No.	901726	Ref. No.	A00CO117
description	refrigeration gasket profile 9198 W 640mm L 1440mm plug size		
For models:	BMA0038-F, BMA0098, BMA0099, BMB0042-F		

screw-in gaskets
profile 9030

We offer custom-made gaskets for this profile

GEV No.	900542	Ref. No.	3965045
description	refrigeration gasket profile 9030 W 410mm L 430mm external size		
For models:	IIA5005, IIA5006, IIA5010, IIA5011, IIA5012, IIA5013, IIA5014, IIA5015		

gaskets for heated units

window seals

GEV No.	902418	Ref. No.	09963468000
description	window gasket profile 1595 suitable for TECNOEKA Qty supplied by meter		
For models:	KF1001G, KF630, KF733, KF933U		

GEV No.	693228	Ref. No.	09980458000
description	window gasket profile 1882 L 2200mm Qty 1		
For models:	AIB0012		

door seals

GEV No.	900544	Ref. No.	0000X05600
description	door seal profile 2740 L 1350mm Qty 1		
For models:	ACA1004, ACA104V, ACA105V, ACA2007, ACA207V, ACA216, ACA216V, ADA104V, ADA106V, ADA205V, ADA206V, ADA207V, ADA208V, ADA209V, ADA210V, ADA211V, ADA212V		

GEV No.	900913	Ref. No.	GUA30002
description	door seal profile 2755 Qty supplied by meter		
For models:	VG715RXS, VP800U, VP824RU, VP914RXS, VP916RXS, VP920RXS		



GEV No.	902483	Ref. No.	FO4NEA0039
description	door seal profile 2763 L 1800mm suitable for TECNODOM		
For models:	5656TD		

GEV No.	902420	Ref. No.	09985548000
description	door seal profile 2767 L 2100mm suitable for TECNOEKA		
For models:	KF630, KF965, KF981D		

door seals with fixing hook

GEV No.	900599	Ref. No.	652.013.00
description	door seal W 550mm with mounting clip H 310mm		
For models:	110170CFG, 65110CFG, 6570CFG, 70110CFG, 70110TPFG, 7070CFG, 7070TPFG, AFA2003, AFA2004, AFA2006		

GEV No.	900735	Ref. No.	65201400
description	oven gasket L 310mm W 550mm 6 hooks external size		
For models:	65110CFGE, 6570CFE, 6570CFGE, 70110CFGE, 7070CFEQ, 7070CFGE, 7070CFVE		

GEV No.	900247	Ref. No.	652.009.00
description	oven gasket L 340mm W 460mm with 4 mounting clips external size		
For models:	6060CFE, 6060CFG, 6060CFGE		

GEV No.	900394	Ref. No.	09981148000 09988078000
description	oven gasket L 370mm W 640mm 6 hooks external size		
For models:	AIB0014, AIB0015, KF1001G, KF933U		

GEV No.	900396	Ref. No.	09980748000
description	oven gasket L 440mm W 370mm external size		
For models:	AIB0013, AIB0017		

GEV No.	900404	Ref. No.	652.010.00
description	oven gasket L 450mm W 330mm external size		
For models:	6060CFE, 6060CFG, 6060CFGE		

GEV No.	900395	Ref. No.	09980288000
description	oven gasket W 320mm with 4 mounting clips H 260mm		
For models:	AIB0012		

door gaskets (wire reinforced)



GEV No.	900248	Ref. No.	652.011.00
description	oven gasket wire reinforced L 295mm W 440mm		
For models:	6060CFE, 6060CFG, 6060CFGE		



GEV No.	693232	Ref. No.	09980928000
description	oven gasket wire reinforced L 425mm W 350mm		
For models:	AIB0013, AIB0017		

door seals with tension springs

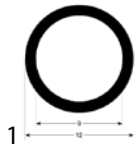

GEV No.	900249	Ref. No.	652.002.00
description	oven gasket profile 2965 L 305mm Qty 1 mounting pos. lateral		
For models:	65110TPFG, 6570TPFG, 7070TPFG		

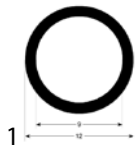

GEV No.	900250	Ref. No.	652.001.00
description	oven gasket profile 2965 L 615mm Qty 1 mounting pos. upper		
For models:	65110TPFG, 6570TPFG, 7070TPFG		



GEV No.	514003	Ref. No.	260.004.00
description	spring L 370mm for gasket mounting pos. lateral		
For models:	65110TPFG, 6570TPFG, 7070TPFG		

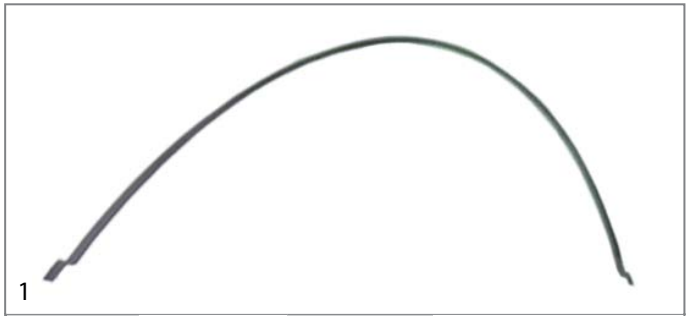

GEV No.	514001	Ref. No.	260.003.00
description	spring L 655mm for gasket mounting pos. upper		
For models:	65110TPFG, 6570TPFG, 7070TPFG		

boiling pan gaskets

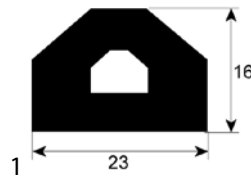

GEV No.	900510	Ref. No.	95200000
description	boiling pan gasket profile 3020 L 2000mm		
For models:	94PE100I, 94PE100IA, 94PE100IAS, 94PE100IS, 94PE150I, 94PE150IA, 94PG100I, 94PG100IA, 94PG150I, 94PG150IA		

O-rings

EPDM



GEV No.	361304	Ref. No.	456042
description	O-ring EPDM ID \varnothing 11.11mm thickness 1.78mm Qty 1 pcs for type DIB3E/DIB5E		
For models:	GLB0037, GLB0038, GLB0039		

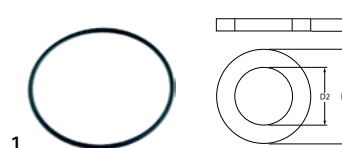

GEV No.	345896	Ref. No.	0065736
description	O-ring EPDM thickness 1.5mm ID \varnothing 37mm Qty 1 pcs		
For models:	FGZ0009		

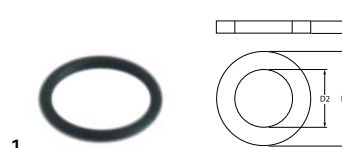

GEV No.	529545	Ref. No.	12009911
description	O-ring EPDM thickness 1.78mm ID \varnothing 10.82mm Qty 1 pcs		
For models:	GLB0035-F, GLB0035-FN, GLB0037-F, GLB0037-FN		



GEV No.	528815	Ref. No.	X05200
description	O-ring EPDM thickness 1.78mm ID ø 3.69mm Qty 1 pcs		
For models:	ACC0001, ACC0002, ACC001V, ACC002V, ACC006V, ACC007V, ADC001V, ADC002V		

GEV No.	525255	Ref. No.	5.0.000.0565
description	O-ring EPDM thickness 1.9mm ID ø 7.2mm Qty 1 pcs		
For models:	EFA0015, EFA0016, EFA0023		

GEV No.	505045	Ref. No.	12009912 Q307036000
description	O-ring EPDM thickness 1.78mm ID ø 5.28mm Qty 1 pcs		
For models:	GLB0035-FN, GLB0037-FN, GLB0061C-F, GLB0061C-FN, GLB0063C-F, GLB0063C-FN, OPT1012-CF		

GEV No.	529412	Ref. No.	000603.07.01 12009873 456006 Q307003000
description	O-ring EPDM thickness 2.62mm ID ø 10.78mm Qty 1 pcs		
For models:	GLB0035, GLB0035-F, GLB0035-FN, GLB0036, GLB0037-F, GLB0037-FN, GLB0056, GLB0057, GLB0061C-F, GLB0061C-FN, GLB0063C-F, GLB0063C-FN, OPT1012-CF, OPT1012-CFN		

GEV No.	528485	Ref. No.	456060
description	O-ring EPDM thickness 1.78mm ID ø 6.07mm Qty 1 pcs		
For models:	GLB0043, GLB0044, GLB0071		

GEV No.	528223	Ref. No.	5.0.025.0205
description	O-ring EPDM thickness 2.62mm ID ø 11.91mm Qty 1 pcs		
For models:	EFA0015, EFA0016, EFA0023		

GEV No.	510303	Ref. No.	456030
description	O-ring EPDM thickness 1.78mm ID ø 6.75mm Qty 1 pcs		
For models:	GLB0037, GLB0038, GLB0039, GLB0064, GLB0064C, GLB0065, GLB0066, GLB0072, GLB0073		

GEV No.	518227	Ref. No.	456020
description	O-ring EPDM thickness 2.62mm ID ø 12.37mm Qty 1 pcs		
For models:	GLB0035, GLB0036, GLB0037, GLB0038, GLB0039, GLB0056, GLB0057, GLB0058, GLB0059, GLB0060, GLB0061, GLB0061C, GLB0062, GLB0063, GLB0064, GLB0064C, GLB0065, GLB0066, GLB0072		

GEV No.	513275	Ref. No.	456074
description	O-ring EPDM thickness 1.78mm ID ø 82.27mm Qty 1 pcs		
For models:	GLB0035, GLB0036, GLB0056, GLB0057		

GEV No.	532623	Ref. No.	80844
description	O-ring EPDM thickness 2.62mm ID ø 120.32mm Qty 1 pcs		
For models:	GLB0070, GLB0071, GLB0073		

GEV No.	504574	Ref. No.	456019
description	O-ring EPDM thickness 1.78mm ID ø 9.25mm Qty 1 pcs		
For models:	GLB0035, GLB0036, GLB0037, GLB0038, GLB0039, GLB0056, GLB0057		



GEV No.	507313	Ref. No.	12009837 Q307050000
description	O-ring EPDM thickness 2.62mm ID ø 13.95mm Qty 1 pcs		
For models:	GLB0061C-F, GLB0061C-FN, GLB0063C-F, GLB0063C-FN, OPT1012-CF, OPT1012-CFN		



GEV No.	532494	Ref. No.	12010165 Q307051000
description	O-ring EPDM thickness 2.62mm ID ø 36.14mm Qty 1 pcs		
For models:	GLB0061C-F, GLB0061C-FN, GLB0063C-F, GLB0063C-FN, OPT1012-CF, OPT1012-CFN		



GEV No.	511510	Ref. No.	456070
description	O-ring EPDM thickness 2.62mm ID ø 15.54mm Qty 10 pcs		
For models:	GLB0070		



GEV No.	510893	Ref. No.	456015
description	O-ring EPDM thickness 2.62mm ID ø 9.92mm Qty 1 pcs		
For models:	GLB0058, GLB0059, GLB0060, GLB0061, GLB0061C, GLB0062, GLB0063, GLB0064, GLB0064C, GLB0065, GLB0066, GLB0072		



GEV No.	505073	Ref. No.	12010282
description	O-ring EPDM thickness 2.62mm ID ø 20.63mm Qty 1 pcs		
For models:	GLB0035-FN, GLB0037-FN		

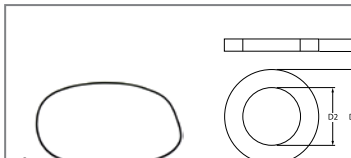

GEV No.	698025	Ref. No.	F2351
description	O-ring EPDM thickness 2mm ID ø 164.5mm Qty 1 pcs		
For models:	FIF0001, FIF0002, FIF0004, FIF0005, FMC0001-F, TCG22E-F		



GEV No.	532058	Ref. No.	456071
description	O-ring EPDM thickness 2.62mm ID ø 23.81mm Qty 10 pcs		
For models:	GLB0070		



GEV No.	528813	Ref. No.	5.0.016.0225
description	O-ring EPDM thickness 2mm ID ø 17mm Qty 1 pcs		
For models:	EFA0015, EFA0016, EFA0023		



GEV No.	504561	Ref. No.	456073
description	O-ring EPDM thickness 2.62mm ID ø 29.82mm Qty 1 pcs		
For models:	OPT1012C		



GEV No.	532672	Ref. No.	0065741
description	O-ring EPDM thickness 2mm ID ø 25mm Qty 1 pcs		
For models:	FGZ0009, FGZ0028		



GEV No.	517004	Ref. No.	0065730 N20429
description	O-ring EPDM thickness 2.62mm ID ø 34.6mm Qty 1 pcs		
For models:	BAB0001, BAB0001-W, BAB0002, BAB0002-W, FGZ0009		



GEV No.	361311	Ref. No.	5.0.016.0306
description	O-ring EPDM thickness 2mm ID ø 6mm Qty 1 pcs for type N6		
For models:	EFA0015, EFA0016, EFA0023		



1		
	GEV No. 532537	Ref. No. 456067
description O-ring EPDM thickness 3.53mm ID ø 113.9mm Qty 1 pcs		
For models: OPT1012		

1		
	GEV No. 506015	Ref. No. 456052 Z471109000
description O-ring EPDM thickness 3.53mm ID ø 39.69mm Qty 1 pcs		
For models: GLB0035, GLB0036, GLB0037, GLB0038, GLB0039, GLB0056, GLB0057, GLB0059, GLB0061, GLB0061C, GLB0061C-F, GLB0062, GLB0063, GLB0063C-F, GLB0064, GLB0064C, GLB0065, GLB0066		

1		
	GEV No. 532614	Ref. No. 19560103
description O-ring EPDM thickness 3.53mm ID ø 12.29mm Qty 1 pcs		
For models: PALLADIO300AM, PALLADIO350AM		

1		
	GEV No. 505180	Ref. No. 12010118 Q307057000
description O-ring EPDM thickness 3.53mm ID ø 47.22mm Qty 1 pcs		
For models: OPT1012-CF, OPT1012-CFN		

1		
	GEV No. 532103	Ref. No. 12049214
description O-ring EPDM thickness 3.53mm ID ø 13.87mm Qty 10 pcs		
For models: OPT1012-CF		

1		
	GEV No. 518175	Ref. No. 456061
description O-ring EPDM thickness 3.53mm ID ø 49.21mm Qty 1 pcs		
For models: GLB0035, GLB0036, GLB0037, GLB0038, GLB0039, GLB0056, GLB0057		

1		
	GEV No. 510072	Ref. No. 456016
description O-ring EPDM thickness 3.53mm ID ø 32.93mm Qty 1 pcs		
For models: GLB0070, GLB0071, GLB0072		

1		
	GEV No. 696071	Ref. No. IB4104040
description O-ring EPDM thickness 3.53mm ID ø 52.39mm Qty 1 pcs		
For models: BARMASER, ORIONEFIVE		

1		
	GEV No. 512511	Ref. No. 12115850
description O-ring EPDM thickness 3.53mm ID ø 32mm Qty 10 pcs		
For models: GLB0061C-F, GLB0063C-F		

1		
	GEV No. 532603	Ref. No. 926252
description O-ring EPDM thickness 3.53mm ID ø 69.85mm Qty 1 pcs		
For models: GLB0043, GLB0044		

1		
	GEV No. 510899	Ref. No. X05400
description O-ring EPDM thickness 3.53mm ID ø 37.69mm Qty 1 pcs		
For models: ACC005V, ACK1002, ACK101V, ACK102V, ADC006V, ADE003V, ADE004V		

1		
	GEV No. 532457	Ref. No. F2186
description O-ring EPDM thickness 3.53mm ID ø 85.32mm Qty 1 pcs		
For models: FIF0005, FMC0001-F		

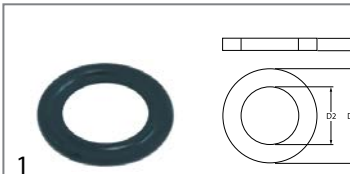

GEV No.	532498	Ref. No.	12010256 Q307048000
description	O-ring EPDM thickness 3.53mm ID ø 9.12mm Qty 1 pcs		
For models:	GLB0061C-F, GLB0061C-FN, GLB0063C-F, GLB0063C-FN, OPT1012-CF, OPT1012-CFN		

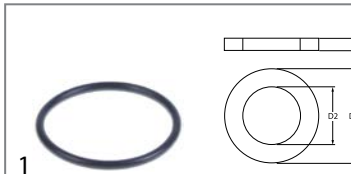

GEV No.	532718	Ref. No.	80816
description	O-ring EPDM thickness 4mm ID ø 80mm Qty 1 pcs		
For models:	GLB0044		

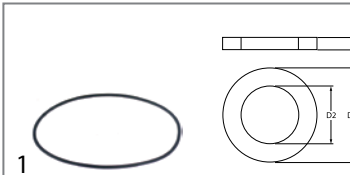

GEV No.	698810	Ref. No.	456078
description	O-ring EPDM thickness 3.56mm ID ø 112mm Qty 1 pcs		
For models:	OPT1012C		

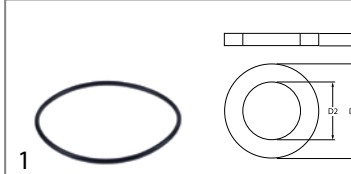

GEV No.	532543	Ref. No.	456076
description	O-ring EPDM thickness 5.34mm ID ø 136.5mm Qty 1 pcs		
For models:	OPT1012C		



GEV No.	527561	Ref. No.	0065740
description	O-ring EPDM thickness 3mm ID ø 22mm Qty 1 pcs		
For models:	FGZ0005, FGZ0006, FGZ0013, FGZ0025, FGZ0026		

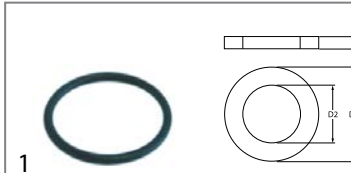

GEV No.	521120	Ref. No.	456075
description	O-ring EPDM thickness 5.34mm ID ø 37.47mm Qty 1 pcs		
For models:	GLB0035, GLB0036, GLB0037, GLB0038, GLB0039, GLB0056, GLB0057, GLB0058, GLB0059, GLB0060		

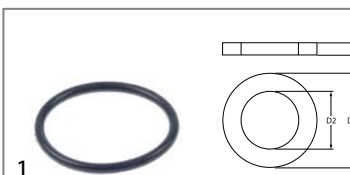

GEV No.	532671	Ref. No.	0065732
description	O-ring EPDM thickness 3mm ID ø 34mm Qty 1 pcs		
For models:	FGZ0007		

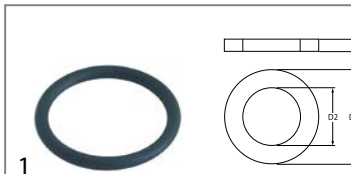

GEV No.	505092	Ref. No.	12010062
description	O-ring EPDM thickness 5.34mm ID ø 43.82mm Qty 1 pcs		
For models:	GLB0035-FN, GLB0037-FN		

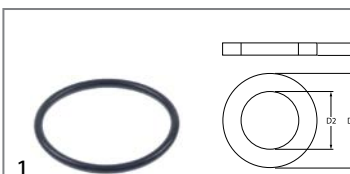

GEV No.	532670	Ref. No.	0287000
description	O-ring EPDM thickness 3mm ID ø 40mm Qty 1 pcs		
For models:	FGZ0007, FGZ0012, FGZ0027		

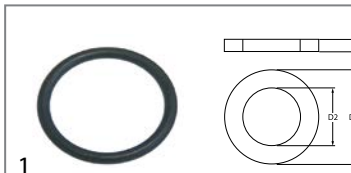

GEV No.	510408	Ref. No.	456002 E11700
description	O-ring EPDM thickness 5.34mm ID ø 47mm Qty 1 pcs		
For models:	ACL0002, ACL002V, ADL001V, ADL002V, ADL003V, ADL004V, ADL005V, GLB0043, GLB0044, GLB0070, GLB0071, GLB0072, GLB0073, OPT1012, OPT1012C		

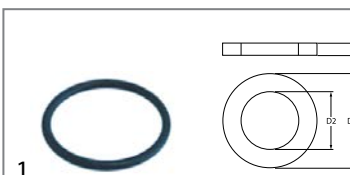



GEV No.	528192	Ref. No.	N20655
description	O-ring EPDM thickness 3mm ID ø 56mm Qty 1 pcs		
For models:	BAB0003		

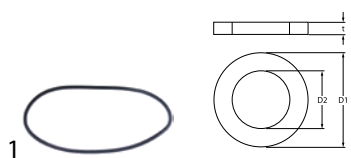

			
GEV No.	505175	Ref. No.	12010079 Q307052000
description	O-ring EPDM thickness 5.34mm ID ø 50.16mm Qty 1 pcs		
For models:	GLB0035-F, GLB0035-FN, GLB0037-F, GLB0037-FN, GLB0061C-F, GLB0061C-FN, GLB0063C-F, GLB0063C-FN		

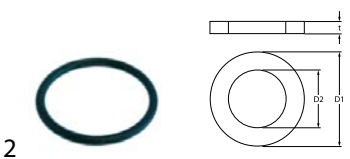
			
GEV No.	510551	Ref. No.	456023 926084
description	pump cover gasket ID ø 158.3mm pump type 1214/1293/1225/2243/1226/1204/3473/1241 thickness 3.53mm EPDM Qty 1 pcs		
For models:	GLB0046, GLB0070, GLB0071		

			
GEV No.	510409	Ref. No.	835535651 F2680
description	O-ring EPDM thickness 5.34mm ID ø 56.52mm Qty 1 pcs		
For models:	7040CPE, 7070PEI, FLC0001-F, FLC0003-F, FLC0012-F, FMD0001-F, FMD0002-F		

silicone			
			
GEV No.	532513	Ref. No.	F016
description	O-ring silicone thickness 2.62mm ID ø 15.88mm Qty 1 pcs food-safe white		
For models:	EBZ0001-CN, EBZ0002-CN, EBZ0003-CN		

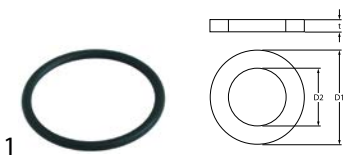
			
GEV No.	691033	Ref. No.	12010051 Q307035000
description	O-ring EPDM thickness 5.34mm ID ø 62.87mm Qty 1 pcs		
For models:	GLB0061C-F, GLB0061C-FN, GLB0063C-F, GLB0063C-FN, OPT1012-CF, OPT1012-CFN		

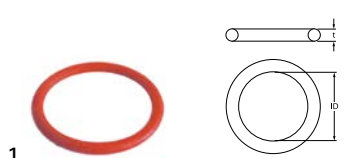
			
GEV No.	532255	Ref. No.	N20688
description	O-ring silicone thickness 2.62mm ID ø 21.89mm Qty 10 pcs		
For models:	BAB0001, BAB0001-W, BAB0002, BAB0002-W		

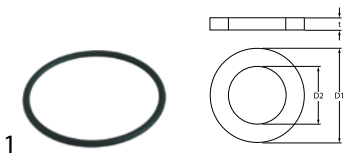
			
GEV No.	505178	Ref. No.	12009976 Q307049000
description	O-ring EPDM thickness 5.34mm ID ø 85.09mm Qty 1 pcs		
For models:	GLB0061C-F, GLB0061C-FN, GLB0063C-F, GLB0063C-FN		

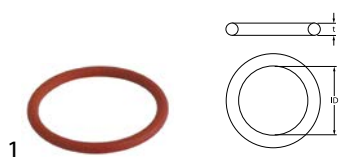
			
GEV No.	527123	Ref. No.	N20689
description	O-ring silicone thickness 3.53mm ID ø 34.52mm Qty 1 pcs		
For models:	BAB0003, BAB0004, BAB0005		

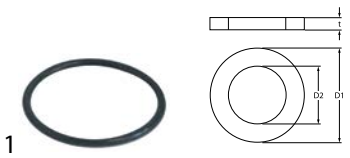
			
GEV No.	532545	Ref. No.	X05000
description	O-ring Viton thickness 3.53mm ID ø 49.21mm Qty 1 pcs		
For models:	ACC005V, ADC006V, ADE003V, ADE004V		

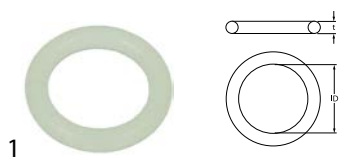
			
GEV No.	532514	Ref. No.	5034
description	O-ring silicone thickness 3mm ID ø 13mm Qty 1 pcs		
For models:	EAA0002, EAA0003		

Viton

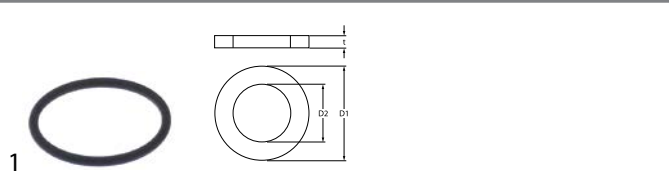

GEV No.	532625	Ref. No.	456081
description	O-ring Viton thickness 2.62mm ID ø 28.25mm Qty 1 pcs		
For models:	OPT1012C		

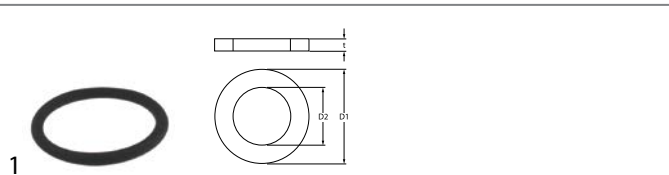

GEV No.	528155	Ref. No.	CGR4131NT X05300
description	O-ring Viton thickness 3.53mm ID ø 32.93mm Qty 1 pcs		
For models:	ACC005V, ADC006V, ADE003V, ADE004V, GLB0071, GLB0073		

miscellaneous

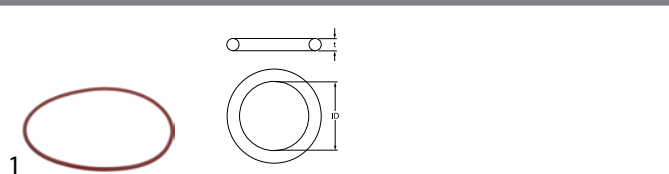

GEV No.	532600	Ref. No.	LF1211302
description	O-ring SILOPREN thickness 7mm ID ø 240.67mm Qty 1 pcs OR 08950		
For models:	FIC0002		

sealing washers

fibre gaskets



GEV No.	518541	Ref. No.	437021
description	flat gasket FIBER ED ø 12mm ID ø 8mm thickness 1.5mm Qty 1 pcs		
For models:	GLB0043, GLB0044, OPT1012		



GEV No.	529349	Ref. No.	437030
description	flat gasket FIBER ED ø 22mm ID ø 16.5mm thickness 2mm for thread 3/8" Qty 1 pcs		
For models:	GLB0058, GLB0059, GLB0060, GLB0061, GLB0061C, GLB0062, GLB0063, GLB0064, GLB0064C, GLB0065, GLB0066, GLB0072		



GEV No.	510074	Ref. No.	437025
description	flat gasket FIBER ED ø 35mm ID ø 27mm thickness 1.5mm Qty 1 pcs		
For models:	GLB0043, GLB0044		



GEV No.	510153	Ref. No.	Q306050000
description	flat gasket fibre ED ø 12mm ID ø 6.2mm thickness 1.5mm Qty 1 pcs		
For models:	GLB0061C-F, GLB0063C-F, OPT1012-CF, OPT1012-CFN		



GEV No.	507332	Ref. No.	12010260 Q306024000
description	flat gasket fibre ED ø 18mm ID ø 12mm thickness 2mm Qty 1 pcs		
For models:	GLB0061C-F, GLB0061C-FN, GLB0063C-F, GLB0063C-FN, OPT1012-CF, OPT1012-CFN		



GEV No.	529484	Ref. No.	953.030.00
description	flat gasket fibre ED ø 58mm ID ø 50mm thickness 2mm Qty 1 pcs		



GEV No.	510406	Ref. No.	E50300
description	flat gasket fibre ED ø 60mm ID ø 48mm thickness 3mm for thread 1½" Qty 1 pcs		
For models:	ADL001V, ADL002V, ADL003V, ADL004V, ADL005V, ADL006V, ADL007V, ADL008V, ADL009V, ADL010V, ADL011V, ADL012V, ADL013V, ADL014V, ADL015V		

rubber gaskets





GEV No.	510649	Ref. No.	LF1212201
description	boot Qty 1 pcs		
For models:	FIC0004		





			
1			
GEV No.	519547	Ref. No.	437041
description	flat gasket rubber ED ø 14.4mm ID ø 15.5mm thickness 2mm Qty 1 pcs size 3/4"		
For models:	GLB0035, GLB0036, GLB0037, GLB0038, GLB0039, GLB0056, GLB0057, GLB0058, GLB0059, GLB0060, GLB0061, GLB0061C, GLB0062, GLB0063, GLB0064, GLB0064C, GLB0065, GLB0066, GLB0072, GLB0073, OPT1012C		

			
1			
GEV No.	501302	Ref. No.	12023554
description	flat gasket rubber ED ø 57mm ID ø 30mm thickness 2mm Qty 1 pcs		
For models:	GLB0063C-FN		

			
1			
GEV No.	510075	Ref. No.	437019
description	flat gasket rubber ED ø 22mm ID ø 13mm thickness 1.5mm Qty 1 pcs		
For models:	GLB0035, GLB0036, GLB0037, GLB0038, GLB0039, GLB0056, GLB0057, GLB0058, GLB0059, GLB0060, GLB0061, GLB0061C, GLB0062, GLB0063, GLB0064, GLB0064C, GLB0065, GLB0066, GLB0072		

			
1			
GEV No.	505224	Ref. No.	12009960 Q307058000
description	flat gasket rubber ED ø 60mm ID ø 44mm thickness 2mm Qty 1 pcs		
For models:	OPT1012-CF, OPT1012-CFN		

			
1			
GEV No.	515018	Ref. No.	12009947 Q307032000
description	flat gasket rubber ED ø 32mm ID ø 21mm thickness 3mm Qty 1 pcs		
For models:	OPT1012-CF, OPT1012-CFN		

			
1			
GEV No.	518205	Ref. No.	437079 80182
description	flat gasket rubber ED ø 61mm ID ø 47mm thickness 2mm Qty 1 pcs		
For models:	GLB0035, GLB0036, GLB0037, GLB0038, GLB0039, GLB0056, GLB0057, GLB0070, GLB0071, GLB0073, OPT1012		

			
1			
GEV No.	518240	Ref. No.	437078
description	flat gasket rubber ED ø 33mm ID ø 17mm thickness 1.5mm Qty 1 pcs		
For models:	GLB0035, GLB0036, GLB0037, GLB0038, GLB0039, GLB0043, GLB0044, GLB0056, GLB0057		

			
1			
GEV No.	505194	Ref. No.	12009937 Q307059000
description	flat gasket rubber ED ø 72mm ID ø 57mm thickness 2mm Qty 1 pcs		
For models:	OPT1012-CF, OPT1012-CFN		

			
1			
GEV No.	516261	Ref. No.	437098
description	flat gasket rubber ED ø 33mm ID ø 25mm thickness 2.5mm for air trap Qty 1 pcs		
For models:	GLB0071, GLB0073, OPT1012		

			
1			
GEV No.	507541	Ref. No.	437102
description	flat gasket rubber ED ø 74mm ID ø 57mm thickness 2mm Qty 1 pcs		
For models:	OPT1012C		

			
1			
GEV No.	513059	Ref. No.	437063
description	flat gasket rubber ED ø 52mm ID ø 40mm thickness 3mm Qty 1 pcs		
For models:	GLB0058, GLB0059, GLB0060, GLB0061, GLB0061C, GLB0062, GLB0063, GLB0064, GLB0064C, GLB0065, GLB0066		

			
1			
GEV No.	510071	Ref. No.	437034
description	flat gasket rubber ED ø 81mm ID ø 68mm thickness 3mm for salt tank Qty 1 pcs		
For models:	GLB0035, GLB0036, GLB0037, GLB0038, GLB0039, GLB0056, GLB0057, GLB0059, GLB0061, GLB0061C, GLB0062, GLB0063, GLB0064, GLB0064C, GLB0065, GLB0066		



GEV No.	518294	Ref. No.	437087
description	flat gasket rubber ED ø 85mm ID ø 71mm thickness 2mm Qty 1 pcs		
For models:	OPT1012		



GEV No.	518060	Ref. No.	456040
description	gasket rubber ED ø 132mm ID ø 122mm thickness 5mm		
For models:	GLB0070, GLB0071, GLB0072, GLB0073		



GEV No.	696391	Ref. No.	0065600
description	rubber gasket rubber ED ø 25mm ID ø 5.5mm thickness 2.5mm Qty 1 pcs		
For models:	FGZ0005, FGZ0012		

plastic gaskets



GEV No.	695538	Ref. No.	N13007
description	gasket plastic ED ø 40mm ID ø 30mm thickness 2mm Qty 1 pcs		
For models:	BAA0019, BAA0022, BAA0023, BAA0024, BAA0025, BAA0026, BAA0027, BAA0028, BAA0029, BAA0030, BAA0031, BAA0032, BAA0033, BAA0034, BAA0037, BAA0038, BAA0040, BAA0046, BAA0046W, BAA0051, BAA0055, BAB0001, BAB0001-W, BAB0002, BAB0002-W		

copper gaskets

DIN-7603-A



GEV No.	526461	Ref. No.	5.0.016.0303
description	flat gasket copper ED ø 22mm ID ø 17mm thickness 2mm Qty 1 pcs		
For models:	EFA0015, EFA0016, EFA0023		

DIN-7603-C



GEV No.	691624	Ref. No.	K98800
description	gasket copper ED ø 17mm ID ø 12.5mm thickness 2.5mm		
For models:	ADC003V, ADC008V, ADC009V, ADC010V		



GEV No.	525819	Ref. No.	4.0.000.0013
description	gasket copper ED ø 17mm ID ø 13mm thickness 2mm for thread 1/4" Qty 1 pcs		
For models:	EFA0015, EFA0016, EFA0023		

PTFE gaskets



GEV No.	507545	Ref. No.	437091
description	flat gasket PTFE ED ø 13mm ID ø 7mm thickness 0.65mm Qty 1 pcs		
For models:	GLB0072		



GEV No.	510012	Ref. No.	437008
description	flat gasket PTFE ED ø 16.5mm ID ø 12.5mm thickness 1.5mm Qty 1 pcs equiv. no. 437008		
For models:	GLB0035, GLB0036, GLB0037, GLB0038, GLB0039, GLB0056, GLB0057, GLB0058, GLB0059, GLB0060		



GEV No.	525609	Ref. No.	5.0.000.0315
description	flat gasket PTFE ED ø 18mm ID ø 13.5mm thickness 2mm Qty 1 pcs		
For models:	EFA0015, EFA0016, EFA0023		





GEV No.	513725	Ref. No.	437100
description	flat gasket PTFE ED ø 21.2mm ID ø 19mm thickness 0.5mm Qty 1 pcs		
For models:	GLB0061, GLB0061C, GLB0062, GLB0063, GLB0064, GLB0064C, GLB0065, GLB0066		





GEV No.	359332	Ref. No.	5.0.025.1386
description	flat gasket PTFE ED ø 21mm ID ø 16.8mm thickness 1.7mm Qty 1 pcs		
For models:	EFA0015, EFA0016, EFA0023		





			
1			
GEV No.	525611	Ref. No.	5.0.025.0022
description	flat gasket PTFE ED ø 22mm ID ø 17mm thickness 2mm Qty 1 pcs		
For models:	EFA0015, EFA0016, EFA0023		

			
1			
GEV No.	518346	Ref. No.	437090
description	flat gasket PTFE ED ø 22mm ID ø 9.2mm thickness 1mm Qty 1 pcs equiv. no. 437090 suitable for COLGED		
For models:	GLB0072		

			
1			
GEV No.	526265	Ref. No.	5.0.016.0211
description	flat gasket PTFE ED ø 24mm ID ø 19mm thickness 2mm Qty 1 pcs		
For models:	EFA0015, EFA0016, EFA0023		

			
1			
GEV No.	528683	Ref. No.	5.0.016.0106
description	flat gasket PTFE ED ø 26mm ID ø 21mm thickness 2mm Qty 1 pcs suitable for GAGGIA, SPAZIALE		
For models:	EFA0015, EFA0016, EFA0023		

			
1			
GEV No.	526014	Ref. No.	5.0.025.0002
description	flat gasket PTFE ED ø 35mm ID ø 30mm thickness 2mm Qty 1 pcs		
For models:	EFA0015, EFA0016, EFA0023		



			
1			
GEV No.	518180	Ref. No.	303018
description	flat gasket PTFE ED ø 40mm ID ø 35mm thickness 3mm Qty 1 pcs equiv. no. 303018/371450-166 suitable for COLGED, HOBART		
For models:	GLB0035, GLB0036, GLB0037, GLB0038, GLB0039, GLB0056, GLB0057		

			
1			
GEV No.	528021	Ref. No.	5.0.000.0307
description	flat gasket PTFE ED ø 53mm ID ø 42.5mm thickness 3mm Qty 1 pcs equiv. no. 12001/02286 suitable for Astoria/Aurora/Brasilia/Wega		
For models:	EFA0015, EFA0016, EFA0023		

			
1			
GEV No.	505225	Ref. No.	12009922 Q308012000
description	slide ring PTFE ED ø 30mm ID ø 10mm thickness 3mm for hood joint Qty 1 pcs		
For models:	OPT1012-CF, OPT1012-CFN		

silicone gaskets

			
1			
GEV No.	581012	Ref. No.	990035600
description	gasket ED ø 67mm ID ø 47mm thickness 2.5mm Qty 1 pcs		
For models:	HBB908CE		

			
1			
GEV No.	695537	Ref. No.	N13006
description	gasket silicone ED ø 40mm ID ø 30mm thickness 2mm Qty 1 pcs		
For models:	BAA0019, BAA0022, BAA0023, BAA0024, BAA0025, BAA0026, BAA0027, BAA0028, BAA0029, BAA0030, BAA0031, BAA0032, BAA0033, BAA0034, BAA0037, BAA0038, BAA0040, BAA0046, BAA0046W, BAA0051, BAA0055, BAB0001, BAB0001-W, BAB0002, BAB0002-W		
accessories for	695537		
		GEV No.	695059
		Ref. No.	N10007
	hose connector for ice-cube maker		

			
1			
GEV No.	696076	Ref. No.	IB4100915
description	gasket silicone ED ø 68mm ID ø 48mm thickness 2mm Qty 1 pcs		
For models:	BARMASTER, ORIONEFIVE		

foam rubber gaskets

			
1			
GEV No.	505237	Ref. No.	12025277
description	foam rubber gasket W 8mm thickness 2mm self-adhesive Qty 450mm		
For models:	GLB0035-FN		



1

GEV No.	505264	Ref. No.	12024174 Z200313000
description	foam rubber gasket W 9mm thickness 2.5mm self-adhesive Qty 625mm		
For models:	GLB0061C-F, GLB0061C-FN, GLB0063C-F, GLB0063C-FN		



1

GEV No.	696390	Ref. No.	0320110
description	foam rubber gasket ø 3mm Qty supplied by meter		
For models:	FGZ0007, FGZ0009, FGZ0027, FGZ0028		



1

GEV No.	693787	Ref. No.	0320100
description	foam rubber gasket ø 6mm Qty supplied by meter		

sealing cords

flat



1

GEV No.	698994	Ref. No.	95311031
description	sealing cord flat size 20x2mm self-adhesive L 1124m t.max.°C for discs		
For models:	CAB0057-DCG, CAB0058-DCG, CAB0061-DCG, CAB0062-DCG		

square



1

GEV No.	694980	Ref. No.	953.004.00
description	sealing cord square size 12x12mm braided L 1.05m for hob		
For models:	92FTGL, 92FTGLC, 92FTGR, 92FTGRC, 94BRG, 94BRGM, 94FTGL, 94FTGLC, 94FTGLR, 94FTGLRC, 94FTGR, 94FTGRC, 94TPFG, 94TPG, 96BRG, 96BRGM, 96TPFG		



1

GEV No.	698993	Ref. No.	95311021
description	sealing cord square size 16x16mm braided L 1560mm t.max. 550°C for door		
For models:	CAB0057-DCG, CAB0058-DCG, CAB0061-DCG, CAB0062-DCG		



1

GEV No.	900505	Ref. No.	92013500
description	sealing cord square size 16x16mm t.max. 550°C braided L 0.69m for door		
For models:	CAB0019, CAB0020		



1

GEV No.	901176	Ref. No.	92210561
description	sealing cord square size 16x16mm t.max. 550°C braided L 1.2m for door		
For models:	CAA0003, CAA0004, CAA0005		

shaft gaskets

v-rings



1

GEV No.	696559	Ref. No.	0065063
description	V-ring for shaft ø 32mm ID ø 31mm ED ø 39mm thickness 7mm		
For models:	FGZ0009		



1

GEV No.	696075	Ref. No.	IB4104031
description	V-ring ID ø 8mm thickness 5mm		
For models:	DRAGONEV		

shaft gaskets



1

GEV No.	698118	Ref. No.	LF1234001
description	shaft seal		
For models:	FIF0014		





1

GEV No.	698001	Ref. No.	F2021
description	shaft seal ID ø 20mm ED ø 35mm thickness 7mm		
For models:	FIF0016-F, FIF0023		

 <p>Image not available</p>			
1			
GEV No.	698185	Ref. No.	F0544
description	shaft seal ID ø 20mm ED ø 35mm thickness 7mm		
For models:	FIF0003		

			
1			
GEV No.	698002	Ref. No.	F2101
description	shaft seal ID ø 25mm ED ø 40mm thickness 7mm		
For models:	FIF0001, FIF0002, FIF0004, FIF0005, FMC0001-F, TCG22E-F		

 <p>Image not available</p>			
1			
GEV No.	698123	Ref. No.	LF1243001
description	shaft seal ID ø 30mm ED ø 62mm thickness 7mm		
For models:	FID0005		

			
1			
GEV No.	698122	Ref. No.	LF1239401
description	shaft seal ID ø 40mm ED ø 62mm thickness 7mm		
For models:	TC32BU, TC32NEVADAT		

			
1			
GEV No.	650052	Ref. No.	F022/1
description	shaft sealing for drink dispenser D1 ø 12mm D2 ø 19mm		
For models:	EBZ0001-CN, EBZ0002-CN, EBZ0003-CN, MISSOFTY		

			
1			
GEV No.	698306	Ref. No.	MSC04N094
description	shaft sealing ID ø 15mm ED ø 20mm thickness 6mm		
For models:	FLA0014, FLA0015		

special gaskets

for vacuum packers

			
1			
GEV No.	693787	Ref. No.	0320100
description	foam rubber gasket ø 6mm Qty supplied by meter		

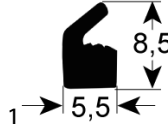
			
1			
GEV No.	900809	Ref. No.	0320215
description	lid gasket W 5.5mm H 9mm silicone Qty supplied by meter for vacuum packing machine		
For models:	FGZ0005, FGZ0006, FGZ0012, FGZ0013, FGZ0026		

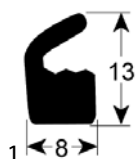
			
1			
GEV No.	900807	Ref. No.	0320210
description	lid gasket W 8mm H 13mm silicone Qty supplied by meter for vacuum packing machine		
For models:	FGZ0007, FGZ0009, FGZ0027, FGZ0028		

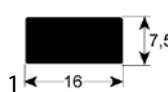
			
1			
GEV No.	900806	Ref. No.	0320200
description	gasket W 16mm H 7.5mm silicone Qty supplied by meter for vacuum packing machine		
For models:	FGZ0005, FGZ0006, FGZ0007, FGZ0009, FGZ0012, FGZ0013, FGZ0025, FGZ0026, FGZ0028		

door seals for dishwashers

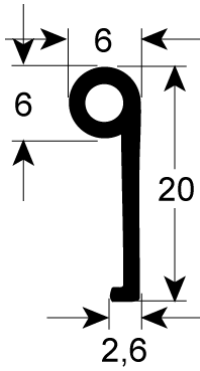
			
1			
GEV No.	518123	Ref. No.	41247
description	door seal L 1050mm W 6mm H 20mm Qty 1		
For models:	GLB0043, GLB0044		

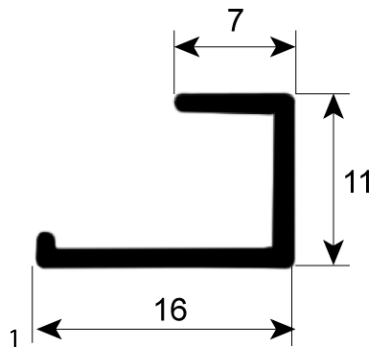

GEV No.	518246	Ref. No.	437057
description	door seal L 395mm dishwasher suitable for ELETTRORBAR, WOLK equiv. no. 437057		
For models:	GLB0035		

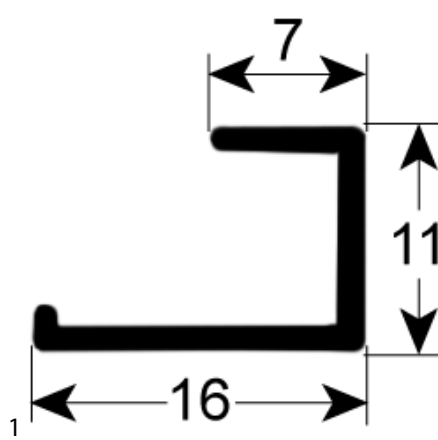

GEV No.	518248	Ref. No.	437058
description	door seal L 430mm dishwasher suitable for ELETTRORBAR, WOLK equiv. no. 437058		
For models:	GLB0036, GLB0037, GLB0038, GLB0039, GLB0056, GLB0057		



GEV No.	518215	Ref. No.	12024374 Z200315000
description	door seal L 590mm W 26mm H 26mm silicone FAGOR suitable for dishwasher		
For models:	GLB0061C-F, GLB0061C-FN, GLB0063C-F, GLB0063C-FN		

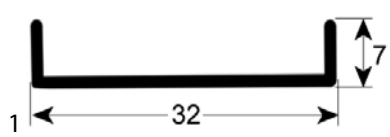

GEV No.	518536	Ref. No.	437052 437081
description	door seal L 590mm W 32mm dishwasher suitable for ELETTRORBAR, WOLK equiv. no. 437052		
For models:	GLB0061, GLB0061C, GLB0062, GLB0063, GLB0064, GLB0064C, GLB0065, GLB0066, GLB0072		



GEV No.	505237	Ref. No.	12025277
description	foam rubber gasket W 8mm thickness 2mm self-adhesive Qty 450mm		
For models:	GLB0035-FN		



GEV No.	505264	Ref. No.	12024174 Z200313000
description	foam rubber gasket W 9mm thickness 2.5mm self-adhesive Qty 625mm		
For models:	GLB0061C-F, GLB0061C-FN, GLB0063C-F, GLB0063C-FN		

miscellaneous



GEV No.	650039	Ref. No.	F026/2
description	bottom gasket for auger D1 ø 31mm D2 ø 24mm ID ø 12mm H 21mm rubber		
For models:	EBZ0001-CN, EBZ0002-CN, EBZ0003-CN		



GEV No.	505078	Ref. No.	12024556 Z200907000
description	gasket external height 23.5mm for sump ED ø 225mm ID ø 200mm		
For models:	GLB0061C-F, GLB0061C-FN, GLB0063C-F, GLB0063C-FN		





1

GEV No.	505077	Ref. No.	12024113
description	gasket external height 23mm for sump		
For models:	GLB0035-F, GLB0035-FN, GLB0037-F, GLB0037-FN		



1

GEV No.	650026	Ref. No.	F019
description	gasket for evaporator H 14mm silicone		
For models:	EBZ0001-CN, EBZ0002-CN, EBZ0003-CN, MISSOFTY		



1

GEV No.	511999	Ref. No.	75168
description	gasket for flange ED ø 123mm ID ø 46mm rubber thickness 3mm hole distance 53mm		
For models:	GLB0046		



1

GEV No.	650051	Ref. No.	F017
description	gasket for outlet tap mounting pos. lower		
For models:	EBZ0001-CN, EBZ0002-CN, EBZ0003-CN		



1

GEV No.	511992	Ref. No.	12023517 Z710547000
description	gasket suitable for FAGOR for hood mechanics L 100mm W 86mm thickness 2mm hole distance 30/45mm		
For models:	OPT1012-CF, OPT1012-CFN		

thermostat gaskets



1

GEV No.	505093	Ref. No.	12024049 N503017000
description	gasket for thermostat ED ø 35mm ID ø 24mm thickness 7mm equiv. no. N503017		
For models:	GLB0035-FN, GLB0037-FN, GLB0061C-F, GLB0061C-FN, GLB0063C-F, GLB0063C-FN, OPT1012-CF, OPT1012-CFN		

gaskets for wash arm support



1

GEV No.	518025	Ref. No.	437014
description	gasket D1 ø 50mm D2 ø 82mm thickness 2mm with 6 holes wash arm support equiv. no. 437014 suitable for COLGED		
For models:	GLB0058, GLB0059, GLB0060, GLB0061, GLB0061C, GLB0062, GLB0063, GLB0064, GLB0064C, GLB0065, GLB0066, GLB0072		



1

GEV No.	505167	Ref. No.	12023533
description	gasket D1 ø 68mm D2 ø 35mm thickness 3.5mm with 4 screw holes equiv. no. Z400703 suitable for FAGOR		
For models:	GLB0035-F, GLB0035-FN, GLB0037-F, GLB0037-FN		



1

GEV No.	505179	Ref. No.	12024227 Z710714000
description	gasket D1 ø 82.5mm D2 ø 44mm thickness 2.5mm with 4 screw holes wash arm support equiv. no. Z710714 suitable for FAGOR		
For models:	OPT1012-CF, OPT1012-CFN		



1

GEV No.	518339	Ref. No.	437064
description	gasket D2 ø 50mm thickness 2mm with 3 screw holes wash arm support equiv. no. 437064 suitable for COLGED hole ø 50mm hole distance 67mm		
For models:	GLB0061, GLB0061C, GLB0062, GLB0063, GLB0064, GLB0064C, GLB0065, GLB0066, GLB0073		



1

GEV No.	518402	Ref. No.	437050
description	gasket with 3 screw holes wash arm support hole distance 61mm D2 ø 34mm thickness 2.5mm hole ø 34mm		
For models:	GLB0046		

refrigeration cycle components

valves

Schrader valves

valve bodies



1

GEV No.	750097	Ref. No.	N14007
description	valve body for Schrader valve thread 1/4" SAE connection 6mm soldering connection		
For models:	BAA0019, BAA0022, BAA0023, BAA0024, BAA0025, BAA0026, BAA0027, BAA0028, BAA0029, BAA0030, BAA0031, BAA0032, BAA0033, BAA0034, BAA0037, BAA0038, BAA0040, BAA0046, BAA0046W, BAA0051, BAA0055, BAB0001, BAB0001-W, BAB0002, BAB0002-W, BAB0003, BAB0004, BAB0005, BAC0007, BAC0008		

valve inserts



1

GEV No.	750098	Ref. No.	N14005
description	Schrader valve CASTEL 8394/B R22		
For models:	BAA0019, BAA0022, BAA0023, BAA0024, BAA0025, BAA0026, BAA0027, BAA0028, BAA0029, BAA0030, BAA0031, BAA0032, BAA0033, BAA0034, BAA0037, BAA0038, BAA0040, BAA0046, BAA0046W, BAA0051, BAA0053-A, BAA0055, BAB0001, BAB0001-W, BAB0002, BAB0002-W, BAB0003, BAB0004, BAB0005, BAC0007, BAC0008		

filter driers

miscellaneous



1

GEV No.	750229	Ref. No.	1184
description	dryer size 20g ø 19mm L 138mm connection 6,2/6,2mm		
For models:	EAA0002, EAA0003, EBZ0002-CN, EBZ0003-CN, MISSOFTY		



1

GEV No.	750228	Ref. No.	F062
description	dryer size 20g ø 24mm L 109mm connection 2,6/6,2mm		
For models:	EBZ0001-CN		



1

GEV No.	750047	Ref. No.	A00DR100
description	dryer size 30g ø 24mm L 143mm connection 6,5/6,5mm type DP20-DP70,DP140		
For models:	9925F, 9931F, 9932F, BMA0013-F, BMA0034-F, BMA0038-F, BMA0098, BMA0099, BMB0002-F, BMB0002-FG, BMB0004-F, BMB0014-F, BMB0014-FG, BMB0015-F, BMB0042-F, BMB0046-F, BMC0001-F, BMC0001-FG, BMC0003-F, BNC0001BAR-F, BNC0001-F, BNC0002-F, BNC0007BAR-F, BNC0008-F, BNC0015BAR-F, BNC0015-F, BNC0016-F, BNC0030, BNC0030PI, BNC0032, BNC0033, BNC0034, BNC0034PI, BNC0035, CCZ0009-F, CCZ0018-F, CCZ0050, HAB0001-F, HAB0007-F, HAB0009-F, HAB0015-F, HAB0020, HAB0021, HCE2004-F, HCE2005-F, HCE2006-F, HCE2007-F, HCE2008-F, HCE2009, IBC0055...(Other models you can see in the webshop)		



evaporators

for walk-in fridges

producer-specific

FRENOX

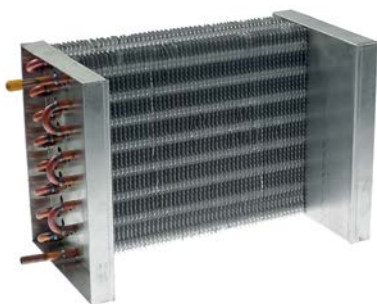

1

GEV No.	750643	Ref. No.	A00EV305
description	evaporator L 85mm W 320mm H 258mm total length 200mm overall width 380mm overall height 258mm		
For models:	VAEN030-F, VAEN060-F		

for fridges

producer-specific



1

GEV No.	750402	Ref. No.	01A01EV270
description	evaporator L 420mm H 455mm thickness 105mm FRENOX		
For models:	BNC0001BAR-F, BNC0001-F, BNC0002-F, BNC0030, BNC0030PI, BNC0032, HAB0001-F, HAB0015-F		

producer-specific



1

GEV No.	750213	Ref. No.	4EVPX101
description	evaporator		
For models:	VSFK170, VSFN075		



1

GEV No.	750408	Ref. No.	01A01EV273
description	evaporator for deep freezing FRENOX		
For models:	CCZ0009-F, HCE2006-F, HCE2008-F, HCE2009, IEC0051, IEC0052, SALADBAR3, USN4		



1

GEV No.	750514	Ref. No.	R096ESSHL150
description	evaporator L 1180mm W 175mm H 70mm total length 1240mm overall width 175mm mounting distance 1 158mm		
For models:	BGB0002, BGB0024		



1

GEV No.	750513	Ref. No.	R096ESSJJ200
description	evaporator L 1590mm W 175mm H 70mm total length 1650mm overall width 175mm mounting distance 1 158mm		
For models:	BGB0008, BGB0013, IFF0001, IFF0002, IFF0003		



1

GEV No.	750518	Ref. No.	R096ESSJJ250
description	evaporator L 2105mm W 175mm H 70mm total length 2145mm overall width 175mm overall height 100mm mounting distance 1 165mm refrigeration		
For models:	BGB0009, BGB0014		



1

GEV No.	750155	Ref. No.	3650025
description	evaporator L 320mm W 90mm H 150mm		
For models:	IIA5012, IIA5013, IIA5014, IIA5015		



1

GEV No.	750655	Ref. No.	A00EV701
description	evaporator L 389mm W 100mm H 200mm total length 505mm overall width 105mm overall height 200mm		
For models:	BMB0002-F, BMB0002-FG, BMB0004-F		



1

GEV No.	750546	Ref. No.	A00SHP009
description	evaporator L 395mm W 105mm H 367mm suitable for FRENEX complete with fan		
For models:	BMA0038-F, BMB0014-F, BMB0014-FG, BMC0001-F		

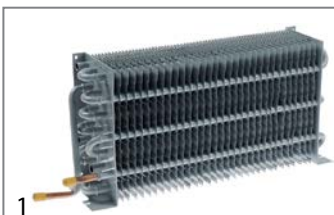

1

GEV No.	750654	Ref. No.	A00EV700
description	evaporator L 400mm W 96mm H 200mm total length 480mm overall width 103mm overall height 200mm		
For models:	BMC0001-F, BMC0001-FG		



1

GEV No.	750401	Ref. No.	A00EV140
description	evaporator L 410mm W 100mm H 200mm total length 480mm mounting distance 1 65mm suitable for FRENEX		
For models:	BMC0003-F		



1

GEV No.	750404	Ref. No.	01A01EV271
description	evaporator L 410mm W 110mm H 445mm for deep freezing FRENEX		
For models:	9925F, 9931F, 9932F, CCZ0018-F		



1

GEV No.	750407	Ref. No.	01A01EV272
description	evaporator L 410mm W 120mm H 350mm for refrigeration FRENEX		
For models:	CCZ0050, HCE2004-F, HCE2007-F, HCE2008-F, IEC0050, SALADBAR2, USN4		



1

GEV No.	750406	Ref. No.	01A01EV372
description	evaporator L 415mm W 105mm H 480mm double for refrigeration FRENEX		
For models:	BNC0007BAR-F, BNC0008-F, BNC0015BAR-F, BNC0015-F, BNC0016-F, BNC0033, BNC0034, BNC0034PI, BNC0035, HAB0007-F, HAB0009-F, HAB0020, HAB0021, TIM3, TIM3PI		

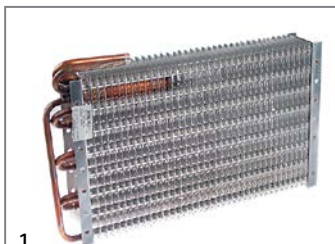

1

GEV No.	750154	Ref. No.	3650010
description	evaporator L 445mm W 75mm H 280mm total length 510mm		
For models:	IIA5005, IIA5006, IIA5010, IIA5011, IIA5012, IIA5013, IIA5014, IIA5015		



1

GEV No.	750515	Ref. No.	R096EISJJ200
description	evaporator L 985mm W 105mm H 70mm total length 1050mm overall width 105mm mounting distance 1 85mm		
For models:	BGB0003, BGB0008, BGB0013		

for saladettes



1

GEV No.	750652	Ref. No.	A00EV106
description	evaporator L 380mm W 85mm H 150mm total length 395mm overall width 95mm overall height 340mm		
For models:	BNA0068, BNA0069, CCZ0009-F, CCZ0050, HCE2004-F, HCE2005-F, HCE2006-F, HCE2007-F, HCE2008-F, HCE2009, IEC0050, IEC0051, IEC0052, SALADBAR2, SALADBAR3, USN4		

for refrigerated counters



1

GEV No.	750651	Ref. No.	A00EV101
description	evaporator L 390mm W 90mm H 200mm total length 400mm overall width 95mm overall height 430mm		
For models:	9925F, 9931F, 9932F, CCZ0018-F		

for ice-cube maker

for ice cube maker



1

GEV No.	750201	Ref. No.	ND10046
description	evaporator for ice-cube maker 36 cubes L 440mm W 190mm H 40mm		
For models:	BAA0026, BAA0027, BAA0028, BAA0029, BAA0030, BAA0031		

for display coolers



1

GEV No.	750704	Ref. No.	R096ESSHL250
description	evaporator L 2150mm W 175mm H 80mm		
For models:	BGB0004, BGB0026		



1

GEV No.	750202	Ref. No.	ND10047
description	evaporator for ice-cube maker 60 cubes L 665mm W 190mm H 40mm		
For models:	BAA0037, BAA0038		



1

GEV No.	750650	Ref. No.	A00EV100
description	evaporator L 390mm W 90mm H 150mm total length 400mm overall width 95mm overall height 430mm		
For models:	BNC0001BAR-F, BNC0001-F, BNC0002-F, BNC0007BAR-F, BNC0007-F, BNC0008-F, BNC0015BAR-F, BNC0015-F, BNC0016-F, BNC0030, BNC0030PI, BNC0032, BNC0033, BNC0034, BNC0034PI, BNC0035, HAB0001-F, HAB0007-F, HAB0009-F, HAB0015-F, HAB0020, HAB0021, TIM3, TIM3PI		

for drink dispensers



1

GEV No.	750184	Ref. No.	L6118
description	evaporator for drink dispenser NEW Faby 1-3 L 200mm W 180mm H 330mm		
For models:	EAA0002, EAA0003		

accessories

miscellaneous

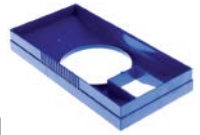

1

GEV No.	750252	Ref. No.	L8009BLU
description	bracket for evaporator		
For models:	EAA0002, EAA0003		

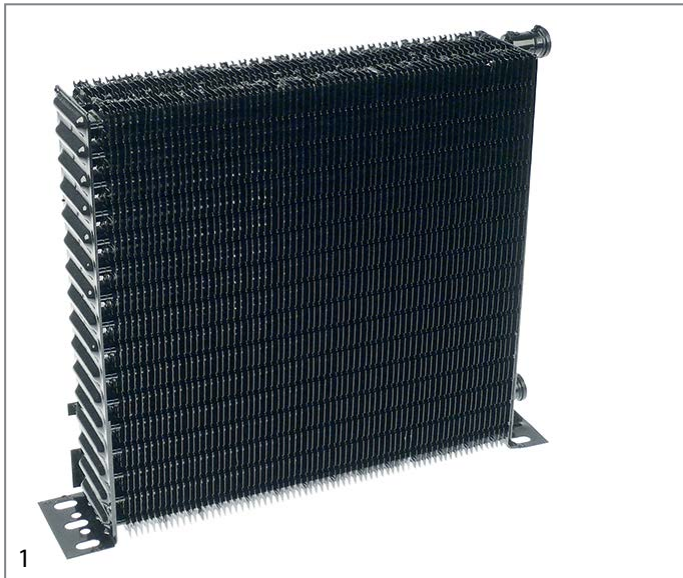

GEV No.	750409	Ref. No.	N20175
description	condenser W 260mm D 60mm H 250mm mounting distance 275mm connection ø 8mm		
For models:	BAB0002		

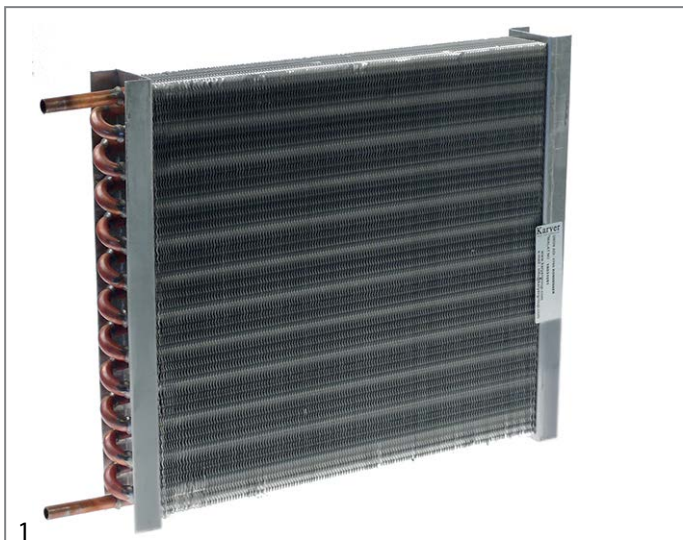

GEV No.	750656	Ref. No.	A00KN575
description	condenser W 310mm D 50mm H 425mm Qty 1 pcs suitable for FRENOX		
For models:	VAEK170-F, VAEK210-F, VAEN030-F, VAEN060-F, VAEN075-F		

condensers

condensers

1

GEV No.	750741	Ref. No.	A00KN103
description	condenser Capacitor W 290mm H 150mm L 670mm suitable for FRENOX		
For models:	BMA0099, BMB0004-F		

1

GEV No.	750297	Ref. No.	SHSGKD0103A1
description	condenser W 335mm D 100mm H 290mm		
For models:	IEC0002-I		

condensers water-cooled



1

GEV No.	750392	Ref. No.	N14034
description	condenser tube ø 15mm water-cooled ø 255mm mounting distance 128mm		
For models:	BAA0032, BAA0038, BAA0046W, BAC0008		

evaporation and condensing trays

evaporation trays



1

GEV No.	750524	Ref. No.	B01BH101
description	evaporation tray without heating element L 416mm W 103mm H 35mm		
For models:	9925F, 9931F, 9932F, BNA0068, BNA0069, BNC0001BAR-F, BNC0001-F, BNC0002-F, BNC0007BAR-F, BNC0007-F, BNC0008-F, BNC0015BAR-F, BNC0015-F, BNC0016-F, BNC0030, BNC0030PI, BNC0032, BNC0033, BNC0034, BNC0034PI, BNC0035, CCZ0009-F, CCZ0018-F, CCZ0050, HAB0001-F, HAB0007-F, HAB0009-F, HAB0015-F, HAB0020, HAB0021, HCE2004-F, HCE2005-F, HCE2006-F, HCE2007-F, HCE2008-F, HCE2009, IEC0050, IEC0051, IEC0052, SALADBAR2, SALADBAR3, TIM3, TIM3PI, USN4		

unheated condensing trays



1

GEV No.	750316	Ref. No.	NC10314
description	condensing tray L 160mm W 80mm H 85mm		
For models:	BAB0004		



1

GEV No.	750645	Ref. No.	B00BH102 B01BH102
description	evaporation tray L 298mm W 88mm H 50mm plastic		
For models:	9925F, 9931F, 9932F, BNA0068, BNA0069, BNC0001BAR-F, BNC0001-F, BNC0002-F, BNC0007BAR-F, BNC0007-F, BNC0008-F, BNC0015BAR-F, BNC0015-F, BNC0016-F, BNC0030, BNC0030PI, BNC0032, BNC0033, BNC0034, BNC0034PI, BNC0035, CCZ0009-F, CCZ0018-F, CCZ0050, HAB0001-F, HAB0007-F, HAB0009-F, HAB0015-F, HAB0020, HAB0021, HCE2004-F, HCE2005-F, HCE2006-F, HCE2007-F, HCE2008-F, HCE2009, IEC0050, IEC0051, IEC0052, SALADBAR2, SALADBAR3, TIM3, TIM3PI, USN4		



1

GEV No.	750644	Ref. No.	B01BH103
description	evaporation tray L 490mm W 55mm H 35mm plastic		
For models:	BMB0046-F		

transmission technology and ball bearings

ball bearings

deep-groove ball bearings 2RS



1

GEV No.	523073	Ref. No.	IV73060042RS
description	deep-groove ball bearing shaft \varnothing 20mm ED \varnothing 42mm W 12mm type 6004-2RS DIN 625-1		
For models:	FLA0028		



1

GEV No.	523534	Ref. No.	F0535
description	deep-groove ball bearing type 6001-2RS shaft \varnothing 12mm ED \varnothing 28mm W 8mm with sealing discs deep-groove ball bearing DIN 625-1		
For models:	FIF0003		



1

GEV No.	523551	Ref. No.	C6003-2RS SL2473
description	deep-groove ball bearing type 6003-2RS shaft \varnothing 17mm ED \varnothing 35mm W 10mm with sealing discs deep-groove ball bearing DIN 625-1		
For models:	CBF0001, CBG0013-M		



1

GEV No.	523522	Ref. No.	F0533 F0552 F2005 F2010 N20045 SL1799
description	deep-groove ball bearing type 6004-2RS shaft \varnothing 20mm ED \varnothing 42mm W 12mm with sealing discs deep-groove ball bearing DIN 625-1		
For models:	BAB0001, BAB0001-W, BAB0002, BAB0002-W, BAC0007, BAC0008, BAC0009, CBF0001, CBF0002, FHZ0001, FIF0003, FIF0016-F, FIF0023		



1

GEV No.	523541	Ref. No.	SL1312
description	deep-groove ball bearing type 6006-2RS shaft \varnothing 30mm ED \varnothing 55mm W 13mm with sealing discs deep-groove ball bearing DIN 625-1		
For models:	CBF0003		



1

GEV No.	523501	Ref. No.	314009
description	deep-groove ball bearing type 608-2RS shaft \varnothing 8mm ED \varnothing 22mm W 7mm with sealing discs deep-groove ball bearing DIN 625-1		
For models:	GLB0035, GLB0036, GLB0037, GLB0038, GLB0039, GLB0056, GLB0057		



1

GEV No.	505011	Ref. No.	12024032 Z710541000
description	deep-groove ball bearing type 6200-2RS shaft \varnothing 10mm ED \varnothing 30mm W 9mm DIN 625-1		
For models:	OPT1012-CF, OPT1012-CFN		



1

GEV No.	523509	Ref. No.	314001
description	deep-groove ball bearing type 6201-2RS shaft \varnothing 12mm ED \varnothing 32mm W 10mm with sealing discs deep-groove ball bearing DIN 625-1		
For models:	GLB0058, GLB0059, GLB0060, GLB0061, GLB0061C, GLB0062, GLB0063, GLB0064, GLB0064C, GLB0065, GLB0066, OPT1012		



1



GEV No.	523510	Ref. No.	00000000860 260005 F2016 F2082
description	deep-groove ball bearing type 6202-2RS shaft ø 15mm ED ø 35mm W 11mm with sealing discs deep-groove ball bearing DIN 625-1		
For models:	8920, 8921, 8922, EEC0001, EED0010, EFF0002-Q, FHZ0001, FIF0016-F, FIF0023		

1



GEV No.	523524	Ref. No.	SL2735
description	deep-groove ball bearing type 6206-2RS shaft ø 30mm ED ø 62mm W 16mm with sealing discs deep-groove ball bearing DIN 625-1		
For models:	CBF0003		

2



GEV No.	523511	Ref. No.	260006 F2103 N20433 SL0131
description	deep-groove ball bearing type 6203-2RS shaft ø 17mm ED ø 40mm W 12mm with sealing discs deep-groove ball bearing DIN 625-1		
For models:	BAB0001, BAB0001-W, CBF0002, EEC0001, EED0010, FIF0001, FIF0002, FIF0004, FIF0005, FLA0004-F, FMC0001-F, TCG22E-F		

1



GEV No.	523504	Ref. No.	00000000862 19320101
description	deep-groove ball bearing type 626-2RS shaft ø 6mm ED ø 19mm W 6mm with sealing discs deep-groove ball bearing DIN 625-1		
For models:	8920, 8921, 8922, PALLADIO300AM, PALLADIO350AM		

deep-groove ball bearings 2Z

1



GEV No.	523512	Ref. No.	SL2592 SL3125
description	deep-groove ball bearing type 6204-2RS shaft ø 20mm ED ø 47mm W 14mm with sealing discs deep-groove ball bearing DIN 625-1		
For models:	CBF0002		

1



GEV No.	523540	Ref. No.	SL0118
description	deep-groove ball bearing shaft ø 25mm ED ø 52mm W 15mm type 6205-2Z DIN 625-1		
For models:	CBF0003		

deep-groove ball bearings Z

1



GEV No.	523513	Ref. No.	F0545 F2171 N20112 SL0233
description	deep-groove ball bearing type 6205-2RS shaft ø 25mm ED ø 52mm W 15mm with sealing discs deep-groove ball bearing DIN 625-1		
For models:	BAB0003, CBF0003, FHZ0003, FIF0003, FIF0004, FIF0005, TCG22E-F		

1



GEV No.	697842	Ref. No.	19320203 F2093
description	deep-groove ball bearing type 6203-Z shaft ø 17mm ED ø 40mm W 12mm DIN 625-1		
For models:	FEB0009-SNT, FEB0010-SNT, FHZ0003, FIF0001, FIF0002, FIF0004, FIF0005, FMC0001-F, TCG22E-F		

deep-groove ball bearings open



1			
GEV No.	523535	Ref. No.	F0510
description	deep-groove ball bearing shaft \varnothing 20mm ED \varnothing 40mm W 14mm type 16005 DIN 625-1		
For models:	FIF0003		

thrust ball bearings



1			
GEV No.	523000	Ref. No.	IB7300700
description	thrust ball bearing shaft \varnothing 12mm ED \varnothing 26mm W 9mm type 51101 DIN 711		
For models:	MULTIPL02S, MULTIPL03S		



1			
GEV No.	523536	Ref. No.	F0511
description	thrust ball bearing shaft \varnothing 20mm ED \varnothing 40mm W 14mm type 51204 DIN 711		
For models:	FIF0003		



1			
GEV No.	523533	Ref. No.	LF1143001
description	thrust ball bearing shaft \varnothing 30mm ED \varnothing 47mm W 11mm type 51106 DIN 711		
For models:	FID0005, FID0006		



1			
GEV No.	523532	Ref. No.	LF1134001 SL2588
description	thrust ball bearing shaft \varnothing 30mm ED \varnothing 52mm W 16mm type 51206 DIN 711		
For models:	CBF0003, TC32BU, TC32NEVADAT		



1			
GEV No.	523052	Ref. No.	N20685
description	thrust ball bearing shaft \varnothing 30mm ED \varnothing 62mm W 42mm type 500-4251 DIN 711		
For models:	BAB0003, BAB0004, BAB0005		

flange bearings



1			
GEV No.	693388	Ref. No.	CUSC0022
description	flange bearing shaft \varnothing 12mm W 38mm 2 hole flange hole distance 48mm H 15mm		
For models:	CAD0001-ZN, CAD0004, CAD0004-ZN, CAD0005, CAD0007, CAD0009, CAD0010, SY12100VELED, SY12100VGASD, SY1280VE, SY1280VG, SY850VELED		

drive belts

poly-v belts

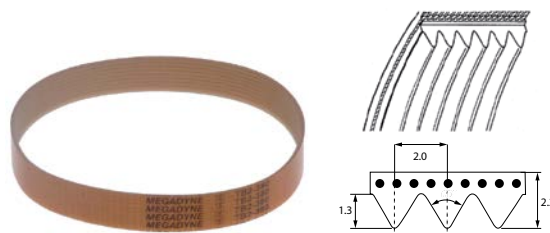

1			
GEV No.	698220	Ref. No.	19310207
description	poly-v belt grooves 10 W 20mm L 380mm profile TB2		
For models:	PALLADIO300AM, PALLADIO300T, PALLADIO330T, PALLADIO350AM		

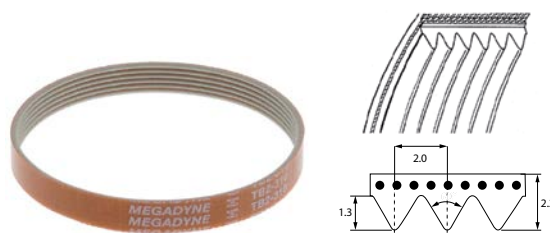

1			
GEV No.	698963	Ref. No.	00000000492
description	poly-v belt grooves 5 W 10mm L 310mm profile TB2		
For models:	8920		

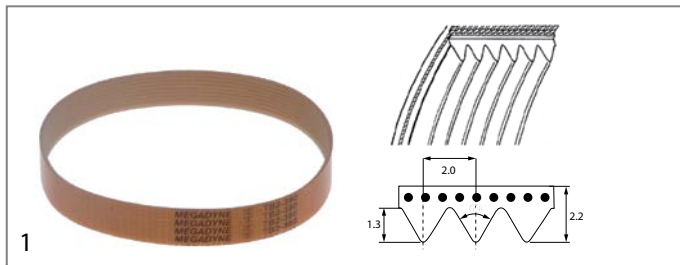
GEV No.	693939	Ref. No.	MSC04N112
description	poly-v belt grooves 6 W 12mm L 630mm profile TB2		
For models:	FLA0014, FLA0015		

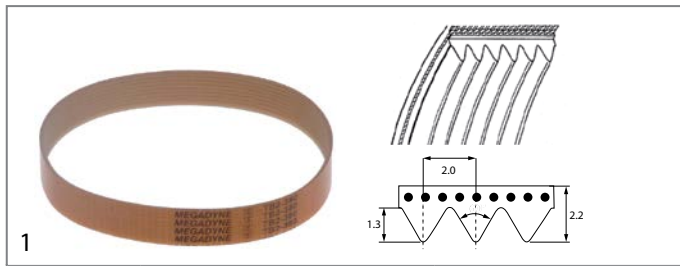

GEV No.	698223	Ref. No.	MSC04N112A
description	poly-v belt grooves 6 W 12mm L 660mm profile TB2		
For models:	FLA0014, FLA0015		

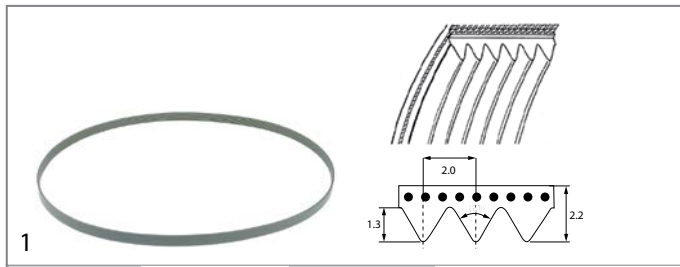

GEV No.	698224	Ref. No.	MSC09V112
description	poly-v belt grooves 7 W 14mm L 1186mm profile TB2		
For models:	FLA0016		

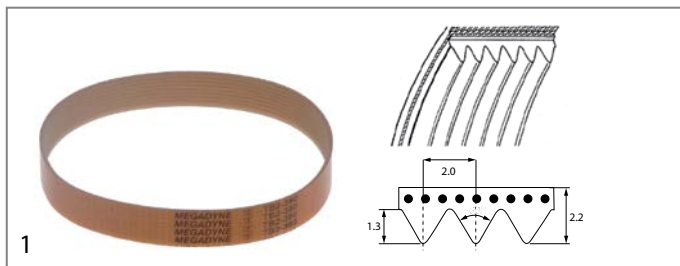

GEV No.	698217	Ref. No.	00000000861
description	poly-v belt grooves 7 W 14mm L 330mm profile TB2		
For models:	8921		

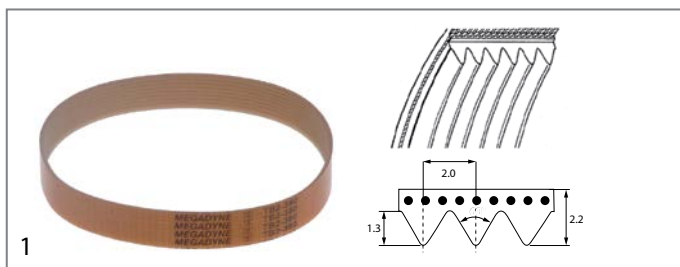

GEV No.	698219	Ref. No.	19310206
description	poly-v belt grooves 8 W 16mm L 360mm profile TB2		
For models:	MIRRA300		

springs

torsion springs



GEV No.	700177	Ref. No.	26001000
description	torsion spring for tilting bratt pan		
For models:	7070BRE, 7070BREM, 7070BRG, 7070BRGM, 7070PEI, 7070PGI		



GEV No.	700569	Ref. No.	002001
description	torsion spring ϕ 21.5mm L2 40mm wire gauge ϕ 3.3mm L1 100mm L3 45mm		
For models:	AJA0014, AJA0015, AJA0016		



GEV No.	693386	Ref. No.	SPRI0010
description	torsion spring ϕ 27.4mm L2 148mm wire gauge ϕ 3.4mm mounting pos. right L1 9mm		
For models:	SY12100VELED, SY12100VGASD		



GEV No.	693387	Ref. No.	SPRI0009
description	torsion spring ϕ 27.4mm L2 150mm wire gauge ϕ 3.6mm mounting pos. left L1 10mm		
For models:	SY12100VELED, SY12100VGASD		





GEV No.	514527	Ref. No.	260.119.00
description	torsion spring ϕ 32mm wire gauge ϕ 5.6mm L1 195mm L2 20mm L3 30mm mounting pos. lid Qty 1 pcs for kettle		



GEV No.	690548	Ref. No.	Y71500
description	torsion spring ϕ 39mm wire gauge ϕ 7mm L1 281mm L2 31mm L3 24mm mounting pos. left		
For models:	ADK201V, ADK202V, ADK203V, ADK204V, ADK207V, ADK208V, ADK209V, ADK210V		

			
1			
GEV No.	690549	Ref. No.	Y71800
description	torsion spring \varnothing 39mm wire gauge \varnothing 7mm L1 31mm L2 281mm L3 24mm mounting pos. left		
For models:	ADK203V, ADK204V, ADK209V, ADK210V		

			
1			
GEV No.	700179	Ref. No.	26001600
description	torsion spring \varnothing 52.4mm wire gauge \varnothing 4.1mm L1 27mm L2 97mm L3 27mm mounting pos. left		
For models:	94PE100I, 94PE100IA, 94PE100IAS, 94PE100IS, 94PE150I, 94PE150IA, 94PG100I, 94PG100IA, 94PG150I, 94PG150IA		

			
1			
GEV No.	700178	Ref. No.	26001500
description	torsion spring \varnothing 52.6mm wire gauge \varnothing 4.2mm L1 25mm L2 97mm L3 25mm mounting pos. right		
For models:	94PE100I, 94PE100IA, 94PE100IAS, 94PE100IS, 94PE150I, 94PE150IA, 94PG100I, 94PG100IA, 94PG150I, 94PG150IA		

compression springs

			
1			
GEV No.	526260	Ref. No.	5.0.016.0302
description	compression spring \varnothing 10.3mm L 31.5mm wire gauge \varnothing 1.2mm		
For models:	EFA0015, EFA0016, EFA0023		

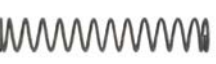
			
1			
GEV No.	527504	Ref. No.	230023
description	compression spring \varnothing 10.3mm L 60mm wire gauge \varnothing 1.3mm		
For models:	EFF0002-Q		

			
1			
GEV No.	691111	Ref. No.	F036
description	compression spring \varnothing 10mm L 70mm wire gauge \varnothing 1mm		
For models:	EBZ0001-CN, EBZ0002-CN, EBZ0003-CN		

			
1			
GEV No.	696209	Ref. No.	19390205
description	compression spring \varnothing 13.5mm L 92mm wire gauge \varnothing 1.4mm slicer		
For models:	PALLADIO300AM, PALLADIO350AM		

			
1			
GEV No.	696210	Ref. No.	19390600
description	compression spring \varnothing 14mm L 16mm wire gauge \varnothing 1.2mm slicer 220-250		
For models:	FEB0031, MIRRA300		

			
1			
GEV No.	691531	Ref. No.	0080020
description	compression spring \varnothing 15.2mm L 52mm wire gauge \varnothing 2mm for vacuum packing machine		
For models:	FGZ0009		

			
1			
GEV No.	696750	Ref. No.	927244
description	compression spring \varnothing 20mm L 89.5mm wire gauge \varnothing 2mm windings 14 zinc-coated steel		
For models:	GLB0046		

			
1			
GEV No.	691113	Ref. No.	F014
description	compression spring \varnothing 21.5mm L 80mm wire gauge \varnothing 1.5mm		
For models:	EBZ0001-CN, EBZ0002-CN, EBZ0003-CN, MISSOFTY		

			
1			
GEV No.	691112	Ref. No.	L8014
description	compression spring \varnothing 22.5mm L 50mm wire gauge \varnothing 1.4mm		
For models:	EAA0002, EAA0003		

			
1			
GEV No.	105575	Ref. No.	GS.1456
description	compression spring \varnothing 23mm L 35mm wire gauge \varnothing 1.5mm for air mixers		
For models:	AHA0001, AHA0002, AHA0003, AHA0005-NN, AHA0008-NN, AHA0009, AHA0011, AHA0013, AHA0014-NN, AHA0017, AHA0018, AHA0019, AHA0020, AHA0021-NN, AHB0001		

			
GEV No.	525069	Ref. No.	230013
description	compression spring ϕ 5mm L 28mm wire gauge ϕ 0.5mm		
For models:	EFF0002-Q		

			
GEV No.	691262	Ref. No.	IB76M4000
description	compression spring ϕ 6mm L 13mm wire gauge ϕ 0.8mm		
For models:	FJZ0010, FJZ0011, FJZ0012		

			
GEV No.	525825	Ref. No.	5.0.025.7060
description	spring ϕ 12mm L 14.5mm wire gauge ϕ 1.5mm windings 2		
For models:	EFA0015, EFA0016, EFA0023		

			
GEV No.	525823	Ref. No.	5.0.016.0214
description	spring ϕ 14.5mm L 27.5mm wire gauge ϕ 2mm windings 4		
For models:	EFA0015, EFA0016, EFA0023		

			
GEV No.	525824	Ref. No.	5.0.016.0234
description	spring ϕ 8mm L 33mm wire gauge ϕ 0.4mm windings 11.5		
For models:	EFA0015, EFA0016, EFA0023		

spring compressors

			
GEV No.	513119	Ref. No.	926009
description	spring compressor		
For models:	GLB0070, GLB0071, OPT1012, OPT1012C		

gas tension springs

gas tension springs

			
GEV No.	701299	Ref. No.	35070
description	gas tension spring 50N hub 150mm D1 ϕ 15mm D2 ϕ 6mm hole distance 365.5mm hole ϕ 6.5mm L 380mm		
For models:	GLB0073		

			
GEV No.	691528	Ref. No.	0810200
description	gas tension spring for vacuum packing machine 370N hub 40mm D1 ϕ 18mm D2 ϕ 8mm hole distance 145mm hole ϕ 6.2mm L 155mm		
For models:	FGZ0005, FGZ0006, FGZ0012, FGZ0013, FGZ0025		

			
GEV No.	691529	Ref. No.	0810215
description	gas tension spring for vacuum packing machine 500N hub 65mm D1 ϕ 18mm D2 ϕ 8mm hole distance 225mm hole ϕ 6.3mm L 235mm		
For models:	FGZ0007, FGZ0026, FGZ0027		

roller springs

roller springs

			
GEV No.	517449	Ref. No.	75271
description	roller spring L 95mm W 66mm		
For models:	GLB0046		

tension springs

			
GEV No.	525075	Ref. No.	230027
description	tension spring ϕ 10mm total length 40mm wire gauge ϕ 1mm		
For models:	EFF0002-Q		

			
GEV No.	698991	Ref. No.	92410560
description	tension spring ϕ 15.5mm total length 100mm wire gauge ϕ 1.5mm L1 15mm L2 70mm L3 15mm for dough mixer Qty 1 pcs		
For models:	GIOTTOD, GIOTTOP		

			
GEV No.	513206	Ref. No.	926007
description	tension spring ϕ 29.8mm total length 513mm wire gauge ϕ 5.8mm		
For models:	GLB0070, GLB0071, OPT1012, OPT1012C		

			
GEV No.	501581	Ref. No.	260.122.00
description	tension spring ϕ 30mm total length 210mm wire gauge ϕ 4mm L2 137mm for lid tilting bratt pan		

1 

GEV No.	517448	Ref. No.	926108
description	tension spring ø 30mm total length 505mm wire gauge ø 5.5mm for hood mechanics Qty 1 pcs		
For models:	GLB0071		

1 

GEV No.	505009	Ref. No.	12024948 Z710528000
description	tension spring ø 35mm total length 420mm wire gauge ø 5mm		
For models:	OPT1012-CF, OPT1012-CFN		

1 

GEV No.	701625	Ref. No.	260.123.00
description	tension spring ø 44mm total length 350mm wire gauge ø 5.8mm for tilting bratt pan		

1 

GEV No.	701617	Ref. No.	260.121.00
description	tension spring ø 65mm total length 420mm wire gauge ø 8.5mm for tilting bratt pan		

1 

GEV No.	517451	Ref. No.	35020
description	tension spring ø 8mm total length 150mm wire gauge ø 1mm Qty 1 pcs		
For models:	GLB0073		

1 

GEV No.	514073	Ref. No.	92012240
description	tension spring with thread ø 29.8mm total length 125 extendable max. 280mm wire gauge ø 5.2mm		
For models:	CAB0019, CAB0020		

bridges

1 

GEV No.	693484	Ref. No.	2300306
description	bridge for Gastronorm container L1 530mm L2 510mm SS W 22mm H 19.5mm Qty 1 pcs thickness 0.75mm		
For models:	IIA3006, IIA3007, IIA3008, IIA3010, IIA3011, IIA3012		

spillage trays

1 

GEV No.	698112	Ref. No.	F2047
description	meat collecting tray L 255mm W 195mm H 50mm		
For models:	FIF0001, FIF0004, FIF0016-F, FIF0023, FMC0001-F		

1 

GEV No.	698074	Ref. No.	F2222
description	meat collecting tray L 310mm W 240mm H 50mm		
For models:	FIF0002, FIF0003, FIF0003-22HP, FIF0005, TCG22E-F		

1 

GEV No.	698071	Ref. No.	F2069
description	meat collecting tray ø 160mm Lmm Wmm H 60mm		
For models:	FHZ0001, FIF0023		

1 

GEV No.	698073	Ref. No.	F2169
description	meat collecting tray ø 220mm Lmm Wmm H 90mm		
For models:	FHZ0003, FIF0004, FIF0005, TCG22E-F		

kitchen accessories

gastronorm

gastronorm plates

1 

GEV No.	695246	Ref. No.	3400202
description	gastronorm plate size GN 1/1 W 325mm L 530mm		
For models:	IIA5005, IIA5006, IIA5010, IIA5011, IIA5012, IIA5013, IIA5014, IIA5015		





baking sheets

			
1			
GEV No.	694531	Ref. No.	09960148801
description	baking sheet W 258mm L 324mm H 10mm aluminium		
For models:	AIB0012		

manometers



			
1			
GEV No.	541767	Ref. No.	5.0.000.0391
description	manometer ø 39mm pressure range 0-16bar thread 1/8" marking 7-9 connection on the backside FIAMMA		
For models:	EFA0015, EFA0016, EFA0023		

			
1			
GEV No.	541768	Ref. No.	5.0.000.0392
description	manometer ø 39mm pressure range 0-3bar FIAMMA thread 1/8" marking 1.5 connection on the backside		
For models:	EFA0015, EFA0016, EFA0023		

			
1			
GEV No.	541528	Ref. No.	0810101
description	manometer ø 40mm pressure range 0 up to 1bar connection angled connection ø 5mm		
For models:	FGZ0005, FGZ0006, FGZ0007, FGZ0012, FGZ0013, FGZ0025, FGZ0026, FGZ0027		

			
1			
GEV No.	541579	Ref. No.	E51000
description	manometer ø 52mm pressure range 0 up to 1bar connection marking 0.5 thread 1/4"		
For models:	ACL0001, ACL0002, ACL001V, ACL002V, ADL001V, ADL002V, ADL006V, ADL007V		

			
1			
GEV No.	542405	Ref. No.	678.083.00
description	manometer ø 63mm pressure range 0 up to 1bar 0 up to 14.5PSI filled with glycerin thread 1/4" for kettle connection on the backside		

			
1			
GEV No.	541062	Ref. No.	67803000
description	manometer ø 63mm pressure range 0 up to 1bar connection marking adjustable kettle thread 1/4"		
For models:	94PE100I, 94PE100IA, 94PE100IAS, 94PE100IS, 94PE150I, 94PE150IA, 94PG100I, 94PG100IA, 94PG150I, 94PG150IA		
spare parts for	541062		
	GEV No.	541130	Ref. No.
			—
	 glass panel ø 58mm thickness 2mm		

water taps

miscellaneous

water taps

accessories

tap heads

ceramic tap heads

without plunger bush intake

			
1			
GEV No.	548333	Ref. No.	M4500/53
description	ceramic tap head without plunger bush bearing thread 1/2" cold water T2: M24x1 D1 ø 18.5mm D2 ø 24mm H1 21mm H2 31mm H3 10mm shaft intake ø 8mm suitable for RIVER		

spare parts of other producers

suitable for MONOLITH



GEV No.	540452	Ref. No.	540452
description	ceramic cartridge D1 ø 40mm D2 ø 25.5mm H1 30mm H2 40.5mm H3 62mm suitable for KLARCO/ RIVER/ PROGASTRO with 2 locking pins shaft ø 10x10.5mm at 3bar 28l/min type N40D		
For models:	GDZ0005-G		

suitable for RUBINETTERIE DEL FRIULI



GEV No.	540452	Ref. No.	540452
description	ceramic cartridge D1 ø 40mm D2 ø 25.5mm H1 30mm H2 40.5mm H3 62mm suitable for KLARCO/ RIVER/ PROGASTRO with 2 locking pins shaft ø 10x10.5mm at 3bar 28l/min type N40D		
For models:	GDZ0005-G		

hose reels

wall-mounted hose reels



GEV No.	542040	Ref. No.	GDZ0019
description	hose reel closed for wall mounting hose length 10m hose type food-safe connection 3/4" complete with spray gun SS ø DN13mm		
spare parts for	542040		
	GEV No.	540553	Ref. No.
			—
	cleaning spray gun connection coupling DN13 brass controllable		
	GEV No.	542156	Ref. No.
			—
	hose connections 3/4" ø 13x20mm length 10m t.max. 70°C temp.-resist. -40 up to +90°C approval DVGW burst p. 10bar		

hose reels and spray guns

spray guns



GEV No.	548304	Ref. No.	River 800/2010
description	spray gun 1/2" ET L 245mm type Active grey		
spare parts for	548304		
	GEV No.	549247	Ref. No.
			—
	shower head angled white		
	GEV No.	549970	Ref. No.
			—
	pressure pin ø 10mm D1 ø 18mm L 50.2mm with spring for spray gun		

dosing pumps

peristaltic dosing pumps

GERMAC

built-in version



with frequency control





GEV No.	361795 ¹	Ref. No.	120000132 19022347
description	dosing pump GERMAC frequency control 3l/h 230VAC detergent hose ø 4x6mm hose thermoplastic type G300 3.5W 230V code 82334968 installation kit inclusive		
For models:	GLB0061C-F, GLB0063C-F, OPT1012-CF		
spare parts for	361795		
	GEV No.	361142	Ref. No.
			—
	mounting set detergent hose type 4x6mm hose length 2m PVC 2x hose/container filter/tank intake transparent		
	GEV No.	361268	Ref. No.
			—
	dosing pump GERMAC frequency control 3l/h 230VAC detergent hose ø 4x6mm hose thermoplastic type G300 built-in version dimensions 67x72x101mm		
	GEV No.	361467	Ref. No.
			—
	pump hose GERMAC detergent hose type thermoplastic hose ø 6x10mm for model G43/G45/G53/G54/G55/G300/G305		

¹with accessories



SEKO			
built-in version			
with frequency control			
 <p>1</p>			
GEV No.	361767 ¹	Ref. No.	209021
description	dosing pump SEKO 3l/h 230VAC detergent hose ø 4x6mm hose type K hose Santoprene suction level 1.5m type NBR 3 8W built-in version peristaltic pump		
For models:	GLB0035, GLB0036, GLB0037, GLB0038, GLB0039, GLB0056, GLB0057, GLB0058, GLB0059, GLB0060, GLB0061, GLB0061C, GLB0062, GLB0063, GLB0064, GLB0064C, GLB0065, GLB0066, GLB0071, GLB0072, GLB0073		
spare parts for	361767		
	GEV No.	361815	Ref. No.
		pump hose detergent hose ø 6x10mm hose ø 4x6mm hose type K hose Santoprene type SEKO	
¹ incl. inlet and conveyor hose			
 <p>1</p>			
GEV No.	361215	Ref. No.	209016
description	dosing pump SEKO frequency control 0.3-3.0l/h 230VAC detergent hose ø 4x6mm hose type K hose Santoprene suction level 1.5m type PBR protection IP55 dimensions 100x67x68mm power input 3.5W		
For models:	GLB0035, GLB0036, GLB0037, GLB0038, GLB0039, GLB0043, GLB0070, GLB0071, OPT1012		
spare parts for	361215		
	GEV No.	361136	Ref. No.
		roller assembly for dosing pump hole ø 4.8x4mm	
	GEV No.	361226	Ref. No.
		PCB L 59mm W 26mm electronic control	
	GEV No.	361815	Ref. No.
		pump hose detergent hose ø 6x10mm hose ø 4x6mm hose type K hose Santoprene type SEKO	
accessories for	361215		
	GEV No.	361142	Ref. No.
		mounting set detergent hose type 4x6mm hose length 2m PVC 2x hose/container filter/tank intake transparent	
	GEV No.	520090	Ref. No.
		PVC hose ID ø 4mm ED ø 6mm L 2m thickness 1mm t.max. 60°C transparent	
	GEV No.	520091	Ref. No.
		nylon hose ID ø 4mm ED ø 6mm L 2m thickness 1mm operating p. 10bar burst p. 50bar t.max. 100°C transparent	

 <p>1</p>			
GEV No.	361948	Ref. No.	209038
description	dosing pump SEKO frequency control 3l/h 230VAC detergent hose ø 4x6mm hose type L hose Santoprene suction level 1.5m type NBR 3		
For models:	OPT1012C		
spare parts for	361948		
	GEV No.	362004	Ref. No.
		dosing hose SEKO detergent hose ø 6x9mm hose length 138mm hose ø 4x6mm hose type L hose Santoprene	

spare parts			
 <p>1</p>			
GEV No.	698712	Ref. No.	143219
description	dosing hose SEKO detergent hose ø 4x8.6mm hose ø 4x6mm hose type H hose Santoprene		
For models:	GLB0035, GLB0036, GLB0037, GLB0038, GLB0039, GLB0056, GLB0057, GLB0058, GLB0059, GLB0060, GLB0061, GLB0061C, GLB0062, GLB0063, GLB0064, GLB0064C, GLB0065, GLB0066, GLB0072, GLB0073		

 <p>1</p>			
GEV No.	362004	Ref. No.	143267
description	dosing hose SEKO detergent hose ø 6x9mm hose length 138mm hose ø 4x6mm hose type L hose Santoprene		
For models:	OPT1012C		









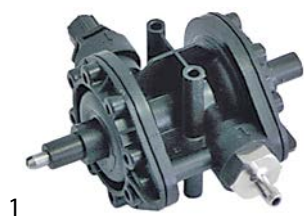

piston pumps			
spare parts			
 <p>1</p>			
GEV No.	510298	Ref. No.	144012
description	lip valve dosing pump suitable for DB2/DS5		
For models:	GLB0035, GLB0036, GLB0037, GLB0038, GLB0039		

membrane dosing pumps

self-priming

LANG



GEV No.	361221	Ref. No.	Z211109000 Z651123000
description	dosing pump type N6 rinse aid pressure connection ø 4x6mm suction connection ø 6x8mm LANG		
For models:	GLB0061C-F, GLB0063C-F, OPT1012-CF		
spare parts for	361221		
	GEV No.	361079	Ref. No. —
spring for type N5/N6 for ball			
	GEV No.	361080	Ref. No. —
O-ring EPDM thickness 2mm ID ø 16mm Qty 1 pcs			
	GEV No.	361085	Ref. No. —
O-ring EPDM thickness 2mm ID ø 8mm Qty 1 pcs			
	GEV No.	361309	Ref. No. —
ball for type N5/N6			
	GEV No.	361310	Ref. No. —
bracket for type N6 ball guide			
	GEV No.	361311	Ref. No. 5.0.016.0306
O-ring EPDM thickness 2mm ID ø 6mm Qty 1 pcs for type N6			
	GEV No.	361314	Ref. No. —
valve ring for type N6 holder for O-ring			
	GEV No.	361317	Ref. No. —
sealing disc for type N6			
	GEV No.	361886	Ref. No. —
non-return valve inletmm outletmm outlet ø 12.4mm L 12.7mm			
	GEV No.	505228	Ref. No. 12024067 Z203007000
spacer bush ID ø 4.5mm ED ø 10mm L 16mm for dosing pump			











spare parts



GEV No.	361311	Ref. No.	5.0.016.0306
description	O-ring EPDM thickness 2mm ID ø 6mm Qty 1 pcs for type N6		
For models:	EFA0015, EFA0016, EFA0023		

SEKO



GEV No.	361364 ¹	Ref. No.	926278 DWD3
description	dosing pump type DIB5E self-sucking rinse aid pump rate 0-5cm ³ per stroke pressure connection ø 4x6mm suction connection ø 4x6mm SEKO supporting pressure closed		
For models:	GLB0058, GLB0059, GLB0060, GLB0070, GLB0071, GLB0073, OPT1012C		
spare parts for	361364		
	GEV No.	361301	Ref. No. —
hose connector for type DIB3E/DIB5E			
	GEV No.	361302	Ref. No. —
valve bush for type DIB3E/DIB5E			
	GEV No.	361304	Ref. No. 456042
O-ring EPDM ID ø 11.11mm thickness 1.78mm Qty 1 pcs for type DIB3E/DIB5E			
	GEV No.	361305	Ref. No. —
valve disc for type DIB3E/DIB5E DIB3P/DIB5P			
	GEV No.	361306	Ref. No. —
membrane for type DIB3E/DIB5E ø 49mm hole ø 5mm			
	GEV No.	361307	Ref. No. —
membrane dosing pump ø 68mm hole ø 6mm for type DIB3P/DIB5P			
	GEV No.	361459	Ref. No. —
hose connector ø 6mm for dosing pump			
	GEV No.	361481	Ref. No. —
lip valve for type DIB3P/DIB5P DIB3E/DIB5E			
accessories for	361364		
	GEV No.	361240	Ref. No. —
hose connector 1-way hose ø 6mm plastic connection M10x1			
	GEV No.	361241	Ref. No. —
hose connector 1-way hose ø 9mm plastic connection M10x1			



¹auxiliary pressure connection closed





spare parts			
			
1			
GEV No.	361304	Ref. No.	456042
description	O-ring EPDM ID ø 11.1mm thickness 1.78mm Qty 1 pcs for type DIB3E/DIB5E		
For models:	GLB0037, GLB0038, GLB0039		

various			
			
1			
GEV No.	361015	Ref. No.	12045206
description	dosing pump membrane dosing pump rinse aid inlet 6x8mm outlet 4x6mm pressure connection ø 4x6mm suction connection ø 6x8mm		
For models:	GLB0035-F, GLB0035-FN, GLB0037-F, GLB0037-FN, GLB0061C-F, GLB0061C-FN, GLB0063C-F, OPT1012-CF, OPT1012-CFN		
spare parts for	361015		
		GEV No.	361132
		Ref. No.	—
		GEV No.	510298
		Ref. No.	144012

spare parts			
			
1			
GEV No.	510298	Ref. No.	144012
description	lip valve dosing pump suitable for DB2/DS5		
For models:	GLB0035, GLB0036, GLB0037, GLB0038, GLB0039		

self-priming with supporting pressure			
ELETTROBAR			
			
1			
GEV No.	361362	Ref. No.	987023
description	dosing pump rinse aid pressure connection ø 6mm pressure connection 6		
For models:	GLB0035, GLB0036, GLB0037, GLB0038, GLB0039, GLB0056, GLB0057, GLB0061, GLB0061C, GLB0062, GLB0063, GLB0064, GLB0064C, GLB0065, GLB0066, GLB0072, OPT1012		
spare parts for	361362		
		GEV No.	361363
		Ref. No.	199012
		GEV No.	510298
		Ref. No.	144012

			
1			
GEV No.	510298	Ref. No.	144012
description	lip valve dosing pump suitable for DB2/DS5		
For models:	GLB0035, GLB0036, GLB0037, GLB0038, GLB0039		

			
1			
GEV No.	361363	Ref. No.	199012
description	membrane		
For models:	GLB0035, GLB0036, GLB0037, GLB0038, GLB0039, GLB0056, GLB0057, GLB0061, GLB0061C, GLB0062, GLB0063, GLB0064, GLB0064C, GLB0065, GLB0066, GLB0072		

GERMAC			
spare parts			
			
1			
GEV No.	510298	Ref. No.	144012
description	lip valve dosing pump suitable for DB2/DS5		
For models:	GLB0035, GLB0036, GLB0037, GLB0038, GLB0039		

SEKO



1			
GEV No.	362013	Ref. No.	929198
description	dosing pump type DIB P with auxiliary pressure connection for dishwashers pump rate 0-3cm ³ per stroke pressure connection ø 4x6mm suction connection ø 4x6mm auxiliary pressure connection 10mm SEKO		
For models:	GLB0043		



1			
GEV No.	361304	Ref. No.	456042
description	O-ring EPDM ID ø 11.11mm thickness 1.78mm Qty 1 pcs for type DIB3E/DIB5E		
For models:	GLB0037, GLB0038, GLB0039		

accessories

container filters



1			
GEV No.	361062	Ref. No.	12011355
description	container filter hose ø 4mm		
For models:	OPT1012-CF		



1			
GEV No.	513043	Ref. No.	121017
description	container filter hose ø 4mm		
For models:	GLB0035, GLB0036, GLB0037, GLB0038, GLB0039, GLB0056, GLB0057, GLB0058, GLB0059, GLB0060, GLB0061, GLB0061C, GLB0062, GLB0063, GLB0064, GLB0064C, GLB0065, GLB0066, GLB0072		



1			
GEV No.	361141	Ref. No.	121075
description	container filter with weight ceramic hose ø 4mm		
For models:	GLB0035, GLB0036, GLB0037, GLB0038, GLB0039, GLB0043, GLB0044, GLB0056, GLB0057, GLB0058, GLB0059, GLB0060, GLB0061, GLB0061C, GLB0062, GLB0063, GLB0064, GLB0064C, GLB0065, GLB0066, GLB0072, GLB0073		



1			
GEV No.	361462	Ref. No.	121993
description	container filter with weight SS hose ø 4x6mm		
For models:	OPT1012C		

filter weights



1			
GEV No.	505409	Ref. No.	12024353
description	filter weight ID ø 7.6mm ext. ø 20 L 6mm 12g SS		
For models:	GLB0035-FN, GLB0037-FN, GLB0061C-F, GLB0061C-FN, GLB0063C-F, GLB0063C-FN, OPT1012-CF, OPT1012-CFN		



1			
GEV No.	505197	Ref. No.	Z701152000
description	filter weight ID ø 8x9mm ext. ø 14 L 20mm 17g brass		
For models:	GLB0061C-F, GLB0063C-F, OPT1012-CF		

hoses

PVC hoses



1			
GEV No.	520090	Ref. No.	143194
description	PVC hose ID ø 4mm ED ø 6mm L 2m thickness 1mm t.max. 60°C transparent		
For models:	GLB0035, GLB0036, GLB0037, GLB0038, GLB0039, GLB0056, GLB0057, GLB0058, GLB0059, GLB0060, GLB0061, GLB0061C, GLB0062, GLB0063, GLB0064, GLB0064C, GLB0065, GLB0066, GLB0072, GLB0073, OPT1012C		

accessories for	520090		
	GEV No.	361058	Ref. No.
			—
	container filter with non-return valve SS hose ø 4x6mm ø 20mm L 56mm		

Table continues overleaf



accessories for		520090		
	GEV No.	361066	Ref. No.	—
container filter straight SS hose ø 4x6mm L 37mm non return valve ball valve				
	GEV No.	361106	Ref. No.	—
container filter with weight and non-return valve SS hose ø 4x6mm ø 21mm L 51mm non return valve lip valve				
	GEV No.	361141	Ref. No.	121075
container filter with weight ceramic hose ø 4mm				
	GEV No.	361230	Ref. No.	—
container filter with weight stainless steel hose ø 4x6mm				
	GEV No.	361462	Ref. No.	121993
container filter with weight SS hose ø 4x6mm				
	GEV No.	361728	Ref. No.	—
container filter with 4m 4x6 hose SS hose ø 4x6mm hose length 4000mm				

T-pieces

without non-return valve

	1			
GEV No.	505086	Ref. No.	12025288 Z601157000	
description	T-piece connection 1: 10mm connection 2: 4mm			
For models:	GLB0035-FN, GLB0037-FN, GLB0061C-F, GLB0061C-FN, GLB0063C-F, OPT1012-CF, OPT1012-CFN			



tank inlets

	1			
GEV No.	361270	Ref. No.	468151	
description	tank inlet SS M12 hose ø 4mm			
For models:	GLB0035, GLB0036, GLB0037, GLB0038, GLB0039, GLB0043, GLB0044, GLB0056, GLB0057, GLB0058, GLB0059, GLB0060, GLB0061, GLB0061C, GLB0062, GLB0063, GLB0064, GLB0064C, GLB0065, GLB0066, GLB0070, GLB0071, GLB0072, GLB0073, OPT1012, OPT1012C			



	1			
GEV No.	508427	Ref. No.	12024531	
description	tank inlet stainless steel M10 hose ø 4mm			
For models:	GLB0061C-F, GLB0061C-FN, GLB0063C-F, GLB0063C-FN, OPT1012-CF, OPT1012-CFN			

miscellaneous

	1			
GEV No.	505228	Ref. No.	12024067 Z203007000	
description	spacer bush ID ø 4.5mm ED ø 10mm L 16mm for dosing pump			
For models:	GLB0035-FN, GLB0037-FN, GLB0061C-F, GLB0061C-FN, GLB0063C-F, GLB0063C-FN			
spare parts for	505228			
	GEV No.	361221	Ref. No.	Z211109000 Z651123000
dosing pump type N6 rinse aid pressure connection ø 4x6mm suction connection ø 6x8mm LANG				

	1			
GEV No.	521735	Ref. No.	466005	
description	spacer piece for rinse aid pump			
For models:	GLB0035, GLB0036, GLB0037, GLB0038, GLB0039, GLB0056, GLB0057, OPT1012			

hoses

supply hoses

stainless steel flexi hoses

tap tubes

	1			
GEV No.	520733	Ref. No.	9RV8001019 River 800/1019	
description	flex hose SS braid DN10 connections 1/2" - 1/2" L 400mm operating p. 10bar test pressure 32bar burst p. 95bar approval DVGW			

	1			
GEV No.	520102	Ref. No.	520102	
description	flex hose SS braid DN8 connections 1/2" - M10x1 L 500mm operating p. 10bar test pressure 32bar burst p. 95bar approval DVGW			
For models:	GDZ0005-G			

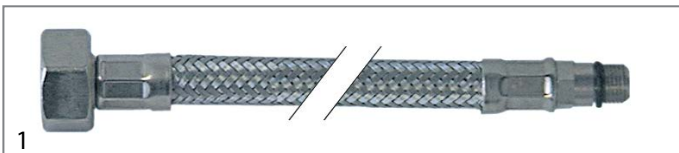

GEV No.	520103	Ref. No.	520103
description	flex hose SS braid DN8 connections 1/2" - M10x1 L 500mm operating p. 10bar test pressure 32bar burst p. 95bar approval DVGW		
For models:	GDZ0005-G		

PVC supply hoses



GEV No.	520010	Ref. No.	12024115 143170 Z602121000
description	supply hose PVC straight-curved DN13 connections 3/4" L 1500mm operating p. 10bar burst p. 32bar t.max. 90°C blue approval VDE flat seal		
For models:	GLB0035, GLB0036, GLB0037, GLB0038, GLB0039, GLB0056, GLB0057, GLB0061, GLB0061C, GLB0061C-F, GLB0061C-FN, GLB0062, GLB0063, GLB0063C-F, GLB0063C-FN, GLB0064, GLB0064C, GLB0065, GLB0066, GLB0072, OPT1012, OPT1012-CF, OPT1012-CFN		
accessories for	520010		
	GEV No.	520053	Ref. No. —
	screen connection 3/4" D1 ø 26mm D2 ø 15mm Qty 10 pcs rubber thickness 8mm		
	GEV No.	520054	Ref. No. —
	flat gasket rubber ED ø 23.5mm ID ø 14mm thickness 2.3mm Qty 10 pcs		



GEV No.	520011	Ref. No.	929169
description	supply hose PVC straight-curved DN13 connections 3/4" L 2000mm operating p. 10bar burst p. 32bar t.max. 90°C approval VDE flat seal		
For models:	GLB0043, GLB0044, GLB0058, GLB0059, GLB0060, GLB0073, OPT1012C		

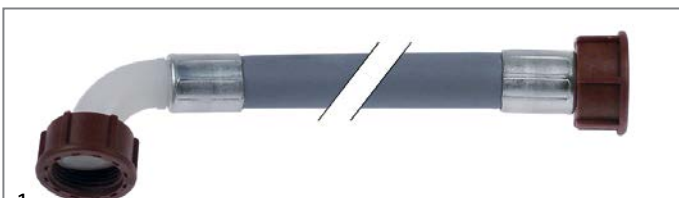

GEV No.	520012	Ref. No.	12025198
description	supply hose PVC straight-curved DN13 connections 3/4" L 2500mm operating p. 10bar burst p. 32bar t.max. 90°C approval VDE flat seal		
For models:	GLB0035-FN, GLB0037-FN		

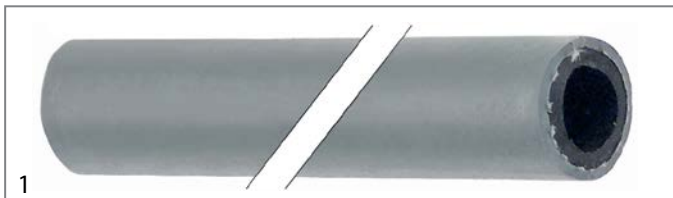

GEV No.	520015	Ref. No.	143004
description	supply hose ID ø 10mm ED ø 17mm L 5m operating p. 20bar burst p. 60bar t.max. 95°C grey Qty 5m		
For models:	GLB0058, GLB0059, GLB0060, GLB0061, GLB0061C, GLB0062, GLB0063, GLB0064, GLB0064C, GLB0065, GLB0066, GLB0072		
accessories for	520015		
	GEV No.	504377	Ref. No. —
	hose connector grommet ø 23mm grommet length 25mm total length 55mm for water filling		

pre-rinse hoses

PVC braided hoses



GEV No.	548306	Ref. No.	River 800/1009
description	shower hose connections 1/2" L 1100mm PVC operating p. 10bar burst p. 90bar t.max. 90°C for pre-rinse units suitable for drinking water rotary with fabric		

drain hoses



GEV No.	513718	Ref. No.	143120
description	drain hose DN19 L 1500mm straight ø inside 24mm straight ext. ø 28mm outer hose ø 23mm		
For models:	GLB0035, GLB0036, GLB0037, GLB0038, GLB0039, GLB0056, GLB0057		

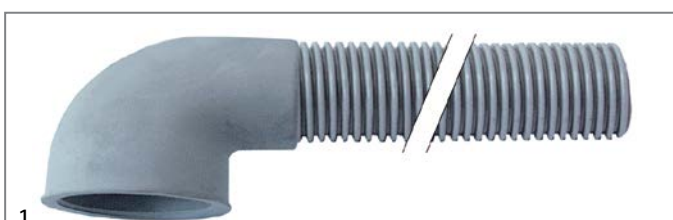

GEV No.	505082	Ref. No.	12024473 Z200910000
description	drain hose DN25 L 1500mm elbow ø inside 48mm elbow ext. ø 58mm outer hose ø 31mm		
For models:	GLB0061C-F, GLB0061C-FN, OPT1012-CF, OPT1012-CFN		





			
1			
GEV No.	505081	Ref. No.	12024114
description	drain hose DN25 L 1600mm elbow ø inside 31mm elbow ext. ø 40mm outer hose ø 30mm		
For models:	GLB0035-F, GLB0035-FN, GLB0037-F, GLB0037-FN		

			
1			
GEV No.	505402	Ref. No.	12115471
description	drain hose DN25 L 2000mm elbow ø inside 27mm elbow ext. ø 35mm inner hose ø 25mm outer hose ø 30mm plastic		
For models:	GLB0061C-F, GLB0063C-F		

			
1			
GEV No.	518068	Ref. No.	143136
description	drain hose DN34 L 2000mm elbow ø inside 50mm elbow ext. ø 59mm inner hose ø 35mm outer hose ø 42mm PVC		
For models:	GLB0070, GLB0071, GLB0072, GLB0073		

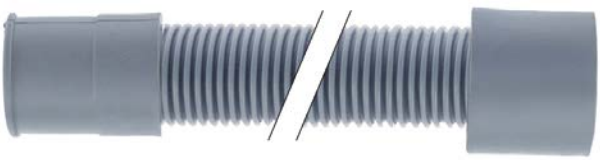
			
1			
GEV No.	513258	Ref. No.	127044
description	drain hose DN19 L 270mm A int. ø 22mm A ext. ø 28mm B int. ø 24mm B ext. ø 28mm outer hose ø 22mm		
For models:	GLB0061, GLB0061C, GLB0062, GLB0063, GLB0064, GLB0064C, GLB0065, GLB0066		

			
1			
GEV No.	518219	Ref. No.	127037
description	drain hose DN19 L 630mm A int. ø 20mm A ext. ø 27mm B int. ø 21mm B ext. ø 28mm outer hose ø 24mm		
For models:	GLB0061, GLB0061C, GLB0062, GLB0063, GLB0064, GLB0064C, GLB0065, GLB0066, GLB0072		

			
1			
GEV No.	530616	Ref. No.	DZS151
description	drain hose L 1500mm A int. ø 25mm B int. ø 25mm outer hose ø 32mm		
For models:	GLB0073, OPT1012C		

			
1			
GEV No.	505084	Ref. No.	12023666 Z220903000
description	drain hose DN19 L 2000mm straight ø inside 21mm straight ext. ø 26mm elbow ø inside 21mm elbow ext. ø 27mm outer hose ø 27mm		
For models:	GLB0061C-F, GLB0063C-F, GLB0063C-FN		

			
1			
GEV No.	530819	Ref. No.	143137
description	drain hose DN20 L 2500mm straight ø inside 19mm straight ext. ø 24mm elbow ø inside 22mm elbow ext. ø 27mm outer hose ø 24mm		
For models:	GLB0035, GLB0036, GLB0037, GLB0038, GLB0039, GLB0056, GLB0057, GLB0060		

			
1			
GEV No.	518638	Ref. No.	143252
description	drain hose DN24 L 1700mm straight ø inside 28mm straight ext. ø 34mm elbow ø inside 28mm elbow ext. ø 34mm outer hose ø 30mm		
For models:	OPT1012C		

			
1			
GEV No.	518652	Ref. No.	70097
description	drain hose DN24 L 600mm straight ø inside 30mm straight ext. ø 34mm elbow ø inside 29mm elbow ext. ø 33mm outer hose ø 29mm		
For models:	OPT1012C		

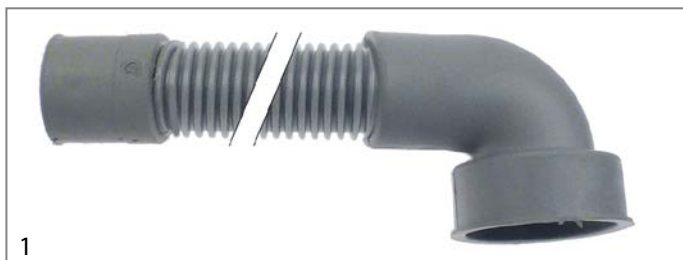

GEV No.	518654	Ref. No.	127056
description	drain hose DN34 L 600mm straight ø inside 30mm straight ext. ø 40mm elbow ø inside 51mm elbow ext. ø 61mm outer hose ø 34mm		
For models:	GLB0073		

industrial hoses

Niplaflex hoses



GEV No.	570561	Ref. No.	143182
description	pressure hose ID ø 10mm ED ø 17mm L 40m thickness 3.5mm operating p. 10bar burst p. 30bar t.max. 110°C		
For models:	GLB0058, GLB0059, GLB0060, GLB0061, GLB0061C, GLB0062, GLB0063, GLB0064, GLB0064C, GLB0065, GLB0066, GLB0072		



GEV No.	530561	Ref. No.	11000083 3676900000
description	pressure hose ID ø 10mm ED ø 17mm L 5m thickness 3.5mm operating p. 10bar burst p. 30bar t.max. 110°C		
For models:	GLB0035-F, GLB0035-FN, GLB0037-F, GLB0037-FN, GLB0061C-F, GLB0061C-FN, GLB0063C-F, GLB0063C-FN, OPT1012-CF, OPT1012-CFN		



GEV No.	530562	Ref. No.	143010
description	pressure hose ID ø 13mm ED ø 21mm L 5m operating p. 10bar burst p. 30bar t.max. 110°C		
For models:	GLB0043, GLB0044, GLB0046, GLB0070, GLB0071, GLB0073, OPT1012, OPT1012C		

pressure control hoses



GEV No.	530560	Ref. No.	11000066 143005 143131 3702400000
description	pressure control hose ID ø 5mm ED ø 9mm L 5m operating p. 30bar burst p. 90bar temp.-resist. 60°C		
For models:	GLB0035, GLB0035-F, GLB0035-FN, GLB0036, GLB0037, GLB0037-F, GLB0037-FN, GLB0038, GLB0039, GLB0043, GLB0044, GLB0046, GLB0056, GLB0057, GLB0058, GLB0059, GLB0060, GLB0061, GLB0061C, GLB0061C-F, GLB0061C-FN, GLB0062, GLB0063, GLB0063C-F, GLB0063C-FN, GLB0064, GLB0064C, GLB0065, GLB0066, GLB0071, GLB0072, GLB0073, OPT1012C, OPT1012-CF, OPT1012-CFN		

PVC hoses

PVC hoses without fabric





GEV No.	520383	Ref. No.	H.775601
description	PVC hose ID ø 4mm ED ø 6mm L 2m thickness 1mm t.max. 60°C blue		
For models:	GLB0058, GLB0059, GLB0060, GLB0073, OPT1012C		

accessories for	520383			
	GEV No.	361058	Ref. No.	—
	container filter with non-return valve SS hose ø 4x6mm ø 20mm L 56mm			
	GEV No.	361066	Ref. No.	—
	container filter straight SS hose ø 4x6mm L 37mm non return valve ball valve			
	GEV No.	361106	Ref. No.	—
	container filter with weight and non-return valve SS hose ø 4x6mm ø 21mm L 51mm non return valve lip valve			
	GEV No.	361141	Ref. No.	121075
	container filter with weight ceramic hose ø 4mm			
	GEV No.	361230	Ref. No.	—
	container filter with weight stainless steel hose ø 4x6mm			
	GEV No.	361462	Ref. No.	121993
	container filter with weight SS hose ø 4x6mm			
	GEV No.	361728	Ref. No.	—
	container filter with 4m 4x6 hose SS hose ø 4x6mm hose length 4000mm			



			
GEV No.	520090	Ref. No.	143194
description	PVC hose ID ø 4mm ED ø 6mm L 2m thickness 1mm t.max. 60°C transparent		
For models:	GLB0035, GLB0036, GLB0037, GLB0038, GLB0039, GLB0056, GLB0057, GLB0058, GLB0059, GLB0060, GLB0061, GLB0061C, GLB0062, GLB0063, GLB0064, GLB0064C, GLB0065, GLB0066, GLB0072, GLB0073, OPT1012C		
accessories for	520090		
	GEV No.	361058	Ref. No. —
	container filter with non-return valve SS hose ø 4x6mm ø 20mm L 56mm		
	GEV No.	361066	Ref. No. —
	container filter straight SS hose ø 4x6mm L 37mm non return valve ball valve		
	GEV No.	361106	Ref. No. —
	container filter with weight and non-return valve SS hose ø 4x6mm ø 21mm L 51mm non return valve lip valve		
	GEV No.	361141	Ref. No. 121075
	container filter with weight ceramic hose ø 4mm		
	GEV No.	361230	Ref. No. —
	container filter with weight stainless steel hose ø 4x6mm		
	GEV No.	361462	Ref. No. 121993
	container filter with weight SS hose ø 4x6mm		
	GEV No.	361728	Ref. No. —
	container filter with 4m 4x6 hose SS hose ø 4x6mm hose length 4000mm		

			
GEV No.	520027	Ref. No.	143013
description	PVC hose ID ø 4mm ED ø 7mm L 10m thickness 1.5mm t.max. 60°C transparent		
For models:	GLB0035, GLB0036, GLB0037, GLB0038, GLB0039, GLB0056, GLB0057, GLB0061, GLB0061C, GLB0062, GLB0063, GLB0064, GLB0064C, GLB0065, GLB0066, GLB0072		

<p>extraction and pressure hoses</p> 			
GEV No.	570202 ¹	Ref. No.	0322052
description	pressure hose ID ø 7mm ED ø 13mm Lm operating p. 10bar burst p. 30bar temp.-resist. -30 up to +80°C		
For models:	FGZ0005, FGZ0006, FGZ0007, FGZ0009, FGZ0026, FGZ0027, FGZ0028		

¹by the meter

formed hoses

straight

			
GEV No.	505026	Ref. No.	12023607
description	formed hose dishwasher straight		
For models:	GLB0035-F, GLB0035-FN, GLB0037-F, GLB0037-FN		

			
GEV No.	518519	Ref. No.	127054
description	formed hose dishwasher straight equiv. no. 127054		
For models:	GLB0035, GLB0036, GLB0037, GLB0038, GLB0039, GLB0056, GLB0057		

			
GEV No.	518213	Ref. No.	143009
description	formed hose dishwasher straight equiv. no. 143009		
For models:	GLB0060		

			
GEV No.	518223	Ref. No.	127022
description	formed hose dishwasher straight mounting pos. lower equiv. no. 127022		
For models:	GLB0058, GLB0059, GLB0060		

			
GEV No.	518070	Ref. No.	127026
description	formed hose dishwasher straight mounting pos. upper equiv. no. 127026		
For models:	GLB0061, GLB0061C, GLB0062, GLB0063, GLB0064, GLB0064C, GLB0065, GLB0066, GLB0072		

1

GEV No.	518380	Ref. No.	127036 80189
description	formed hose ext. ø 53 ID ø 43mm L 65mm dishwasher straight mounting pos. upper equiv. no. 127036		
For models:	GLB0061, GLB0061C, GLB0062, GLB0063, GLB0064, GLB0064C, GLB0065, GLB0066, GLB0070, GLB0071, GLB0073		



1

GEV No.	513294	Ref. No.	43149
description	formed hose hose ext. ø 20mm ID ø 13mm hose int. ø 25mm L 1350mm		
For models:	GLB0044		



1

GEV No.	503150	Ref. No.	12023567 Z740902000
description	formed hose hose ext. ø 54mm hose int. ø 38mm L 55mm		
For models:	OPT1012-CF, OPT1012-CFN		



1

GEV No.	530880	Ref. No.	12024437
description	formed hose hose int. ø 30.5mm D1 ø 39mm D2 ø 44.5mm L 45mm Qty 1		
For models:	GLB0063C-FN		

form L



1

GEV No.	518302	Ref. No.	127064
description	formed hose		
For models:	OPT1012		



1

GEV No.	524028	Ref. No.	12023698 Z740901000
description	formed hose 90° L2 120mm L1 190mm ID ø 38mm ED ø 54mm		
For models:	OPT1012-CF, OPT1012-CFN		



1

GEV No.	518639	Ref. No.	143237
description	formed hose end piece A ext. ø 18mm end piece A int. ø 11mm AD2 ø 18mm ø end piece B 11mm L 460mm		
For models:	GLB0036, GLB0037, GLB0038, GLB0039, GLB0056, GLB0057		



1

GEV No.	513305	Ref. No.	35603
description	formed hose end piece A ext. ø 51mm end piece A int. ø 44mm AD2 ø 42mm ø end piece B 33mm L 300mm		
For models:	GLB0073		



1

GEV No.	513251	Ref. No.	80187
description	formed hose end piece A ext. ø 59mm end piece A int. ø 47mm AD2 ø 58mm ø end piece B 46mm warewashing L-shape equiv. no. 80187 mounting pos. upper		
For models:	GLB0046		



 <p>1</p>			
GEV No.	505028	Ref. No.	12023689 Z200905000
description	formed hose end piece A int. ø 50mm ø end piece B 38mm L 250mm warewashing L-shape equiv. no. Z200905		
For models:	GLB0061C-F, GLB0061C-FN, GLB0063C-F, GLB0063C-FN		

 <p>1</p>			
GEV No.	518225	Ref. No.	127041
description	formed hose warewashing L-shape equiv. no. 127041		
For models:	GLB0061, GLB0061C, GLB0062, GLB0063, GLB0064, GLB0064C, GLB0065, GLB0066		

 <p>1</p>			
GEV No.	513250	Ref. No.	80188
description	formed hose ID ø 48mm ED ø 60mm thickness 6mm L1 235mm L2 140mm L-shape		
For models:	GLB0070, GLB0071, GLB0073		

 <p>1</p>			
GEV No.	518224	Ref. No.	127042
description	formed hose warewashing L-shape equiv. no. 127042		
For models:	GLB0058, GLB0059, GLB0060		

 <p>1</p>			
GEV No.	513254	Ref. No.	80186
description	formed hose L 340mm warewashing L-shape equiv. no. 80186 ID ø 60mm		
For models:	GLB0070, GLB0071, GLB0073		

 <p>1</p>			
GEV No.	513135	Ref. No.	926056
description	formed hose warewashing L-shape equiv. no. 926056, DZG461		
For models:	GLB0043, GLB0044, GLB0046		

 <p>1</p>			
GEV No.	518216	Ref. No.	127001
description	formed hose warewashing L-shape equiv. no. 127001 mounting pos. upper		
For models:	GLB0058, GLB0059, GLB0060		

 <p>1</p>			
GEV No.	513075	Ref. No.	929164
description	formed hose warewashing L-shape equiv. no. DZG60, 929164		
For models:	GLB0043, GLB0044, GLB0046		



1

GEV No.	505024	Ref. No.	12023683 Z200904000
description	formed hose warewashing L-shape equiv. no. Z200904		
For models:	GLB0061C-F, GLB0061C-FN, GLB0063C-F, GLB0063C-FN		



1

GEV No.	505023	Ref. No.	12023670
description	formed hose warewashing L-shape equiv. no. Z400905		
For models:	GLB0035-F, GLB0035-FN, GLB0037-F, GLB0037-FN		



1

GEV No.	505027	Ref. No.	12023625 Z710904000
description	formed hose warewashing L-shape equiv. no. Z740901		
For models:	OPT1012-CF, OPT1012-CFN		



1

GEV No.	505032	Ref. No.	12023779 Z740903000
description	formed hose warewashing L-shape equiv. no. Z740903 mounting pos. lower		
For models:	OPT1012-CF, OPT1012-CFN		

with branch



1

GEV No.	511929	Ref. No.	143239
description	formed hose ext. ø 17 L 430mm plastic black Qty 1		
For models:	GLB0036, GLB0037, GLB0038, GLB0039, GLB0056, GLB0057		

form U



1

GEV No.	520609	Ref. No.	1505041
description	formed hose ED ø 14mm ID ø 10mm silicone coffee machine parts transparent Qty 1 U-shape		
For models:	EFB0001, EFB0002, EFB0003, EFB0004, EFB0008, EFB0008-C, EFB0009, EFB0009-C, EFB0014, EFB0019		



1

GEV No.	518517	Ref. No.	127050
description	formed hose for drain pump D1 ø 28mm D2 ø 21mm warewashing U-shape		
For models:	GLB0061, GLB0061C, GLB0062, GLB0063, GLB0064, GLB0064C, GLB0065, GLB0066		



1

GEV No.	513260	Ref. No.	143242
description	formed hose warewashing		
For models:	GLB0035, GLB0036, GLB0037, GLB0038, GLB0039, GLB0056, GLB0057		



miscellaneous



1

GEV No.	513293	Ref. No.	143236
description	formed hose ext. ø 18 ID ø 11mm L 535mm dishwasher		
For models:	GLB0036, GLB0037, GLB0038, GLB0039, GLB0056, GLB0057		



1

GEV No.	513306	Ref. No.	127085
description	formed hose ext. ø 43 ID ø 34mm ED ø 23mm D1 ø 32mm L 140mm		
For models:	OPT1012C		



1

GEV No.	698841	Ref. No.	69020
description	formed hose ext. ø 44.5 ID ø 34.5mm ED ø 53mm D1 ø 43mm		
For models:	OPT1012C		



1

GEV No.	513307	Ref. No.	127082
description	formed hose ext. ø 47 ID ø 39mm ED ø 47mm D1 ø 39mm L 82mm		
For models:	OPT1012C		



1

GEV No.	513716	Ref. No.	127053
description	pressure hose warewashing		
For models:	GLB0036, GLB0037, GLB0038, GLB0039, GLB0056, GLB0057		

for dishwashers

pressure hoses



1

GEV No.	513136	Ref. No.	11000070 3704000000
description	pressure hose ext. ø 10 ID ø 4.5mm L 1000mm dosage black Qty 1 rinse aid		
For models:	GLB0035-F, GLB0035-FN, GLB0037-F, GLB0037-FN, GLB0061C-F, GLB0061C-FN, GLB0063C-F, OPT1012-CF, OPT1012-CFN		

ventilation hoses



1

GEV No.	513265	Ref. No.	143189
description	ventilation hose ext. ø 17 ID ø 14mm L 75mm warewashing back-flow restrictor		
For models:	GLB0061, GLB0061C, GLB0062, GLB0063, GLB0064, GLB0064C, GLB0065, GLB0066		

miscellaneous



1

GEV No.	530770	Ref. No.	929171
description	hose ED ø 30mm ID ø 20mm L 1050mm rubber black Qty 1		
For models:	GLB0043, GLB0044		



fittings, hose and pipe connectors

hose connectors

without screw connection



1

GEV No.	505088	Ref. No.	12023511 Z201106000
description	Y-piece plastic hose ø 12-12-12mm L 75mm		
For models:	GLB0035-F, GLB0035-FN, GLB0037-F, GLB0061C-F, GLB0061C-FN, GLB0063C-F, GLB0063C-FN, OPT1012-CF, OPT1012-CFN		



1

GEV No.	541109	Ref. No.	035031 12023510 Z103077000
description	Y-piece plastic hose ø 8-6-8mm for pressure switch		
For models:	GLB0061, GLB0061C, GLB0061C-F, GLB0062, GLB0063, GLB0063C-F, GLB0063C-FN, GLB0064, GLB0064C, GLB0065, GLB0066, GLB0072		



1

GEV No.	505086	Ref. No.	12025288 Z601157000
description	T-piece connection 1: 10mm connection 2: 4mm		
For models:	GLB0035-FN, GLB0037-FN, GLB0061C-F, GLB0061C-FN, GLB0063C-F, OPT1012-CF, OPT1012-CFN		



1

GEV No.	505087	Ref. No.	12024192
description	cross fitting		
For models:	GLB0037-FN		

fittings

double nipples



1

GEV No.	520169	Ref. No.	Z209509000
description	double nipple brass thread 3/4" - 3/4" Qty 1 pcs		
For models:	GLB0061C-F, GLB0063C-F		

sleeves



1

GEV No.	520175	Ref. No.	63103800
description	sleeve thread 1/2" - 1/2" nickel-plated brass WS 26 total length 30mm		
For models:	7070PEI, 7070PGI, 94PE100I, 94PE100IA, 94PE100IAS, 94PE100IS, 94PE150I, 94PE150IA, 94PG100I, 94PG100IA, 94PG150I, 94PG150IA		

hose connectors

plastic





1

GEV No.	361696	Ref. No.	0260255
description	hose connector plastic straight thread 3/8" hose ø 8mm Qty 1 pcs		
For models:	FGZ0007, FGZ0009		





			
1			
GEV No.	361752	Ref. No.	0260005
description	hose connector plastic angled thread 1/8" hose ø 4mm Qty 1 pcs		
For models:	FGZ0005, FGZ0006, FGZ0007, FGZ0012, FGZ0013, FGZ0025, FGZ0026, FGZ0027, FGZ0028		

brass			
			
1			
GEV No.	513253	Ref. No.	108006
description	hose connector brass angled thread 1/4" hose ø 12mm Qty 1 pcs		
For models:	GLB0072		

nickel-plated brass			
			
1			
GEV No.	520202	Ref. No.	927015
description	hose connector nickel-plated brass straight thread 3/8" hose ø 12mm Qty 1 pcs		
For models:	GLB0043, GLB0044, GLB0046		

producer-specific			
			
1			
GEV No.	505262	Ref. No.	Z230902000 Z230905000
description	duct thread M12x1.75 for hose ID 4mm SS		
For models:	GLB0061C-F, GLB0063C-F, OPT1012-CF		

			
1			
GEV No.	361840	Ref. No.	12024395 Z711904000
description	hose connector thread M20x2.5 5/8" pipe (22.7mm) grommet ø 11.5mm ID ø chrome-plated brassmm grommet length 20mm total length 52mm thread L 31mm T2: 5/8" pipe (22.7mm)		
For models:	OPT1012-CF, OPT1012-CFN		
accessories for	361840		
	GEV No.	507534	Ref. No.
			12009819 Q223107000
	nut thread M20x2.5 WS 24 SS Qty 1 pcs H 13mm for pipe ø 12mm		

			
1			
GEV No.	507534	Ref. No.	12009819 Q223107000
description	nut thread M20x2.5 WS 24 SS Qty 1 pcs H 13mm for pipe ø 12mm		
For models:	OPT1012-CF, OPT1012-CFN		

push-in fittings

JOHN GUEST

			
1			
GEV No.	520497	Ref. No.	RAC30001
description	push-in fitting John Guest straight pipe connection ø8mm - ø8mm		
For models:	VP914RXS, VP920RXS		

			
1			
GEV No.	520585	Ref. No.	RAC30003
description	plug connector John Guest angled pipe connection ø8mm - ø8mm approval NSF, SK		
For models:	VP800U, VP824RU, VP914RXS, VP920RXS		

valves and tank inlets

ball valves

universal

ball valves with butterfly handle

			
1			
GEV No.	540775	Ref. No.	67801400
description	ball valve connection 1" IT - 1" IT DN25 total length 68mm		
For models:	7040CPE, 7040CPG, 7070CPE, 7070CPG, 92CPE, 92CPES, 92CPG, 92CPGS, 92FRE18, 92FRE18S, 94CPE, 94CPES, 94CPG, 94CPGS, 94FRE18, 94FRE18S, AFE0001, AFE0002		
accessories for	540775		
	GEV No.	514529	Ref. No.
			—
	lever handle plastic/metal L 150mm for valve W 120mm H 25mm handle ø 28mm		



1

GEV No.	101895	Ref. No.	GS.2004
description	ball valve connection 1/4" IT - 1/4" IT DN10 total length 45mm		
For models:	AHA0005-NN, AHA0008-NN, AHA0009, AHA0014-NN, AHA0021-NN, NGDR910		



1

GEV No.	520281	Ref. No.	SHGMVN0304A1
description	ball valve connection 3/4" IT - 3/4" IT DN20 total length 56mm with lever handle handle length 87mm		
For models:	IEA0002-I, IEC0002-I		

ball valves with lever handle



1

GEV No.	520282	Ref. No.	AVA015ZR10
description	ball valve connection 1" IT - 1" IT DN25 total length 67mm with lever handle		
For models:	ACE0001, ACE0002, ACE001V, ACE002V, ADC001V, ADC002V, ADC003V, ADC008V, ADC009V, ADC010V, ADE001V, ADE002V, ADE003V, ADE004V		



1

GEV No.	540730	Ref. No.	M75500
description	ball valve connection 3/4" IT - 3/4" IT DN20 total length 70mm with lever handle handle length 95mm		
For models:	ACE003V, ACE004V, ACE008V, ADB001V, ADB002V, ADB003V		



1

GEV No.	514325	Ref. No.	M75400
description	ball valve connection 1" IT - 1" IT DN25 total length 83mm with lever handle		
For models:	ACC0001, ACC0002, ACC001V, ACC002V, ACE0001, ACE0002, ACE001V, ACE002V, ADC001V, ADC002V, ADC003V, ADC008V, ADC009V, ADC010V, ADE001V, ADE002V, ADE003V, ADE004V		

shut-off valves

universal



1

GEV No.	514360	Ref. No.	3600259
description	ball valve connection 1/2" IT - 1/2" IT DN15 total length 49mm		
For models:	IIA3006, IIA3007, IIA3008, IIA3010, IIA3011, IIA3012		





1

GEV No.	514370	Ref. No.	X18000	
description	shut-off valve connection 1/2" 1/2" hot total length 54mm shaft ø M5x0.8mm			
For models:	ACE0001, ACE0002, ACE001V, ACE002V, ACE003V, ACE004V, ACE005V, ACE008V, ACK2001, ACK2002, ACK2003, ACK2004, ACK201V, ACK202V, ACK203V, ACK204V, ADB001V, ADB002V, ADB003V, ADE001V, ADE002V, ADE003V, ADE004V, ADK201V, ADK202V, ADK203V, ADK204V, ADK207V, ADK208V, ADK209V, ADK210V			
spare parts for	514370			
	GEV No.	514085	Ref. No.	—
	rosette connection 26x19G chrome-plated total lengthmm mounting pos.			
	GEV No.	514086	Ref. No.	—
	hexagonal nut connection 26x19G brass total lengthmm mounting pos. H 6mm WS 34 Qty 1 pcs			
	GEV No.	540414	Ref. No.	—
	star handle connection hot total lengthmm mounting pos. shaft diameter 7x7mm ø 55mm 35 built-in depth 22mm			
	GEV No.	540415	Ref. No.	—
	star handle connection cold total lengthmm mounting pos. shaft diameter 7x7mm ø 55mm 35 built-in depth 22mm			

Table continues overleaf



spare parts for	514370		
	GEV No.	540672	Ref. No.
			—
gasket suitable for tap head			

			
1			
GEV No.	540660	Ref. No.	GS.2305
description	shut-off valve total length 105mm pipe connection ø 15mm		
For models:	AHA0001, AHA0002, AHA0003, AHA0009		

			
1			
GEV No.	520548	Ref. No.	678.065.00 678.065.25
description	ball valve complete with star handle H 84mm L 101mm W 26mm shaft ø 7.5mm intake tap ET 3/8"		
For models:	7040CPE, 7040CPG, 7070CPE, AFE0002		

tank inlets

			
1			
GEV No.	693483	Ref. No.	3600032
description	tank inlet connection 1/2" WS 27 L1 12mm L2 20mm		
For models:	IIA3006, IIA3007, IIA3008, IIA3010, IIA3011, IIA3012		

water softeners

softener cartridges

BILT

accessories

			
1			
GEV No.	520585	Ref. No.	RAC30003
description	plug connector John Guest angled pipe connection ø8mm - ø8mm approval NSF, SK		
For models:	VP800U, VP824RU, VP914RXS, VP920RXS		

water cycle components

pressure reduction valves

pressure reduction valves

universal

			
1			
GEV No.	520868	Ref. No.	927150
description	pressure reduction valve OR series PN40 connection 1/2" setting range 1-7bar p max 40bar t.max. 80°C brass		
For models:	GLB0046		

supply filters

			
1			
GEV No.	695531	Ref. No.	N10139
description	supply filter thread 1" total length 100mm plastic with metal filter ø 18mm		
For models:	BAA0019, BAA0022, BAA0023, BAA0040, BAA0053-A		

ancillary products

clamps

hose clamps

DIN 3017 - W2

			
1			
GEV No.	520114	Ref. No.	12010023
description	hose clamp ø 20-32mm width 9mm Qty 10 pcs DIN 3017		
For models:	GLB0063C-F		

			
1			
GEV No.	520115	Ref. No.	12009997 Q881305000
description	hose clamp ø 25-40mm width 9mm Qty 10 pcs DIN 3017		
For models:	GLB0061C-F, GLB0061C-FN, GLB0063C-F, GLB0063C-FN		

			
1			
GEV No.	520118	Ref. No.	12009933 Q881324000
description	hose clamp ø 50-70mm width 9mm Qty 5 pcs DIN 3017		
For models:	GLB0061C-F, GLB0061C-FN, GLB0063C-F, GLB0063C-FN		

			
1			
GEV No.	520110	Ref. No.	12010047 Q881308000
description	hose clamp ø 8-12mm width 9mm Qty 10 pcs DIN 3017		
For models:	GLB0035-F, GLB0035-FN, GLB0037-F, GLB0037-FN, GLB0061C-F, GLB0061C-FN, GLB0063C-F, OPT1012-CF, OPT1012-CFN		

			
1			
GEV No.	520117	Ref. No.	12009962 CFS1A Q881307000
description	hose clamp stainless steel ø 40-60mm width 9mm Qty 5 pcs DIN 3017		
For models:	GLB0035-F, GLB0035-FN, GLB0037-F, GLB0037-FN, GLB0061C-F, GLB0061C-FN, GLB0063C-F, GLB0063C-FN, GLB0071, GLB0073, OPT1012C, OPT1012-CF, OPT1012-CFN		

DIN 3017 - W4			
			
1			
GEV No.	520120	Ref. No.	12010036 927322 Q881302000
description	hose clamp SS W4 ø 12-20mm width 9mm Qty 1 pcs DIN 3017		
For models:	GLB0035-F, GLB0035-FN, GLB0037-F, GLB0037-FN, GLB0061C-F, GLB0061C-FN, GLB0063C-F, GLB0063C-FN, GLB0073, OPT1012C, OPT1012-CF, OPT1012-CFN		

double wire clamps			
			
1			
GEV No.	505190	Ref. No.	Q901307000
description	hose clamp ø 36-42mm wire gauge ø 3mm zinc-coated steel Qty 1 pcs		
For models:	GLB0035-FN, GLB0037-FN		

			
1			
GEV No.	505191	Ref. No.	12007966 Q901308000
description	hose clamp ø 52-59mm wire gauge ø 3.5mm Qty 1 pcs		
For models:	GLB0061C-F, GLB0061C-FN, GLB0063C-F, GLB0063C-FN		

			
1			
GEV No.	513268	Ref. No.	423011
description	hose clamp ø 8-10mm wire gauge ø 1mm Qty 1 pcs		
For models:	GLB0061, GLB0061C, GLB0062, GLB0063, GLB0064, GLB0064C, GLB0065, GLB0066, GLB0072		

double wire clamps with screw			
			
1			
GEV No.	505079	Ref. No.	12025195 Z400903000
description	hose clamp ø 186-172mm Qty 1 pcs		
For models:	GLB0035-F, GLB0035-FN, GLB0037-F, GLB0037-FN		

			
1			
GEV No.	505080	Ref. No.	12023841 Z200908000
description	hose clamp ø 235-215mm Qty 1 pcs		
For models:	GLB0061C-F, GLB0061C-FN, GLB0063C-F, GLB0063C-FN		



tools

hand tools

pliers

riveting pliers

rivet nut pliers

1 

GEV No.	802002	Ref. No.	GS.1329
description	grub screw thread M5 L 5mm DIN 913/ISO 4026 intake internal hexagon WS 3 Qty 1 pcs		
For models:	AHA0009		

cleaning tools

brushes

pipe brushes

nylon

1 

GEV No.	801464	Ref. No.	1103360
description	pipe brush nylon ø 10mm total length 300mm brush length 100mm		
For models:	EFB0008-C, EFB0009-C, EFB0014, EFB0017, EFB0018, EFB0019		

measuring equipment

thermometers

built-in thermometers

ø52mm

1 

GEV No.	541413	Ref. No.	3700039
description	thermometer mounting ø 52mm t.max. 120°C 0 up to +120°C probe ø 6mm probe L 36mm capillary pipe 1500mm		
For models:	IIA3006, IIA3007, IIA3008, IIA3010, IIA3011, IIA3012		

ø60mm

1 

GEV No.	541054	Ref. No.	91410020
description	thermometer mounting ø 60mm t.max. 500°C 0 up to +500°C probe ø 10mm probe L 80mm capillary pipe 700mm		
For models:	CAB0013, CAB0014, CAB0015, CAB0024, CAB0025, CAB0029-CN, CAB0030-CN, CAB0032, CAB0033, CAB0035, CAB0039, CAB0040, CAB0041, CAB0042, CAB0043, CAB0044, CAB0045, CAB0046		

battery powered

1 

GEV No.	378494	Ref. No.	R041E000
description	thermometer mounting measurements 45x26mm front measurements 48x28.5mm battery comp. rear cable length 2000mm probe ø 5mm probe L 19mm		
For models:	BGB0027, BGB0028, BGB0029		

fastening material

rivets/rivet nuts

blind rivets DIN 7337 - aluminium

1 

GEV No.	560048	Ref. No.	Q419005000
description	blind rivet aluminium ø 4mm L 8mm Qty 1 pcs		
For models:	OPT1012-CF		

blind rivets DIN 7337 - zinc-coated steel

1 

GEV No.	560047	Ref. No.	Q411304000
description	blind rivet steel ø 4.8mm L 11.3mm Qty 1 pcs		
For models:	GLB0061C-F, GLB0061C-FN, GLB0063C-F, GLB0063C-FN, OPT1012-CF, OPT1012-CFN		

blind rivet nuts hexagonal



1

GEV No.	550777	Ref. No.	Q221345000
description	rivet nut thread M10 DN 13mm L 22mm Qty 1 pcs		
For models:	GLB0061C-FN, GLB0063C-FN		



1

GEV No.	696427	Ref. No.	12009970
description	rivet nut thread M5 DN 4mm L 12mm SS Qty 1 pcs ø 7mm WS 6		
For models:	GLB0063C-FN		



1

GEV No.	551034	Ref. No.	12010163 Q221342000
description	rivet nut thread M5 DN 7mm L 12mm Qty 10 pcs		
For models:	GLB0061C-F, GLB0061C-FN, GLB0063C-F, GLB0063C-FN		

plastic rivets



1

GEV No.	692572	Ref. No.	ANE9082930AP
description	mounting clip ø 8mm suitable for microwave		
For models:	NE1880, NE2140, NE3240		

screws

sheet metal screws



1

GEV No.	560098	Ref. No.	Q082032000
description	sheet metal screws ø 3.5mm L 9.5mm SS Qty 20 pcs DIN 7981/ISO 7049 head ø 6.9mm oval head		
For models:	GLB0035-FN, GLB0037-FN, GLB0061C-F, GLB0061C-FN, GLB0063C-F, GLB0063C-FN, OPT1012-CF, OPT1012-CFN		

countersunk screws



1

GEV No.	560076	Ref. No.	0042115 Q042021000 Q152024000
description	countersunk screw thread M4 L 10mm SS DIN 963/ISO 2009 Qty 20 pcs intake slotted head ø 7.5mm		
For models:	FGZ0006, FGZ0027, GLB0035-FN, GLB0037-FN, GLB0061C-F, GLB0061C-FN, GLB0063C-F, GLB0063C-FN, OPT1012-CF, OPT1012-CFN		



1

GEV No.	560211	Ref. No.	Q042022000
description	countersunk screw thread M4 L 14mm SS DIN 963/ISO 2009 Qty 20 pcs intake slotted head ø 7.5mm		
For models:	OPT1012-CF, OPT1012-CFN		





1

GEV No.	560263	Ref. No.	0042118 12010287 Q041324000
description	countersunk screw thread M4 L 25mm SS DIN 963/ISO 2009 Qty 20 pcs intake slotted head ø 7.5mm		
For models:	FGZ0005, FGZ0007, FGZ0012, GLB0061C-F, GLB0061C-FN, GLB0063C-F, GLB0063C-FN, OPT1012-CF		





flat-headed bolts

			
1			
GEV No.	560021	Ref. No.	Q032011000
description	flat-headed bolt thread M3 thread L 10mm SS DIN 7985/ISO 7045 Qty 20 pcs head ø 6mm head thickness 2mm Phillips		
For models:	OPT1012-CFN		

			
1			
GEV No.	560019	Ref. No.	Q152015000
description	flat-headed bolt thread M3 thread L 6mm SS DIN 7985/ISO 7045 Qty 20 pcs head ø 6mm head thickness 2mm Phillips		
For models:	GLB0061C-F, GLB0061C-FN, GLB0063C-F, GLB0063C-FN		

			
1			
GEV No.	560062	Ref. No.	Q032021000
description	flat-headed bolt thread M4 thread L 10mm SS DIN 7985/ISO 7045 Qty 20 pcs intake Phillips head ø 8mm head thickness 2mm		
For models:	GLB0035-FN, GLB0037-FN, GLB0061C-F, GLB0063C-F		

			
1			
GEV No.	560061	Ref. No.	0041100
description	flat-headed bolt thread M4 thread L 6mm SS DIN 7985/ISO 7045 Qty 20 pcs intake Phillips head ø 8mm head thickness 2mm		
For models:	FGZ0007, FGZ0009		

			
1			
GEV No.	560068	Ref. No.	Q032032000
description	flat-headed bolt thread M5 thread L 16mm SS DIN 7985/ISO 7045 Qty 20 pcs intake Phillips head ø 10mm head thickness 2mm		
For models:	GLB0035-FN, GLB0037-FN		

			
1			
GEV No.	560018	Ref. No.	Q032041000
description	flat-headed bolt thread M6 thread L 10mm SS DIN 7985/ISO 7045 Qty 20 pcs head ø 12mm head thickness 5mm Phillips		
For models:	GLB0035-FN, GLB0037-FN, GLB0061C-F, GLB0061C-FN, GLB0063C-F, GLB0063C-FN, OPT1012-CF		

oval head screws

			
1			
GEV No.	560057	Ref. No.	12010242 Q152004000
description	oval head screw thread M5 L 13mm stainless steel intake Phillips Qty 10 pcs		
For models:	GLB0035-FN, GLB0037-FN, GLB0061C-F, GLB0061C-FN, GLB0063C-F, GLB0063C-FN, OPT1012-CF, OPT1012-CFN		

hexagonal screws

			
1			
GEV No.	560311	Ref. No.	Q012063000
description	hexagonal screw thread M10 thread L 20mm SS WS 17 Qty 1 pcs DIN 933 / ISO 4017		
For models:	GLB0061C-F, GLB0061C-FN, GLB0063C-F, OPT1012-CF, OPT1012-CFN		

			
1			
GEV No.	560083	Ref. No.	12010238 Q012031000
description	hexagonal screw thread M5 thread L 10mm SS WS 8 Qty 20 pcs DIN 933 / ISO 4017		
For models:	GLB0035-FN, GLB0061C-F, GLB0061C-FN, GLB0063C-F, GLB0063C-FN, OPT1012-CF, OPT1012-CFN		

			
1			
GEV No.	560086	Ref. No.	Q012041000
description	hexagonal screw thread M6 thread L 10mm SS WS 10 Qty 20 pcs DIN 933 / ISO 4017		
For models:	OPT1012-CF, OPT1012-CFN		

			
1			
GEV No.	524118	Ref. No.	Q012042000
description	hexagonal screw thread M6 thread L 16mm SS WS 10 Qty 1 pcs DIN 933 / ISO 4017		
For models:	GLB0035-FN, GLB0037-FN, GLB0061C-F, GLB0061C-FN, GLB0063C-F, GLB0063C-FN, OPT1012-CF, OPT1012-CFN		

			
1			
GEV No.	560089	Ref. No.	Q012044000
description	hexagonal screw thread M6 thread L 25mm SS WS 10 Qty 20 pcs DIN 933 / ISO 4017		
For models:	OPT1012-CF, OPT1012-CFN		

			
1			
GEV No.	560090	Ref. No.	0031259
description	hexagonal screw thread M6 thread L 30mm SS WS 10 Qty 20 pcs DIN 933 / ISO 4017		
For models:	FGZ0007, FGZ0009, FGZ0027		

			
1			
GEV No.	560252	Ref. No.	Q012046000
description	hexagonal screw thread M6 thread L 40mm SS WS 10 Qty 20 pcs DIN 933 / ISO 4017		
For models:	GLB0061C-F, GLB0061C-FN, GLB0063C-F, GLB0063C-FN		

			
1			
GEV No.	550682	Ref. No.	Q012053000
description	hexagonal screw thread M8 thread L 20mm SS WS 13 Qty 1 pcs DIN 933 / ISO 4017		
For models:	OPT1012-CF, OPT1012-CFN		

side bolts

			
1			
GEV No.	560298	Ref. No.	0065016
description	flat-headed bolt thread M6 L 20mm SS Qty 1 pcs intake hexagonal 4mm		
For models:	FGZ0006, FGZ0009, FGZ0013, FGZ0025, FGZ0026		

grub screws

DIN 913/ISO 4026

			
1			
GEV No.	802002	Ref. No.	GS.1329
description	grub screw thread M5 L 5mm DIN 913/ISO 4026 intake internal hexagon WS 3 Qty 1 pcs		
For models:	AHA0009		

knurled screws

			
1			
GEV No.	505034	Ref. No.	12009829 Q152016000
description	Thumb screw thread M5 thread L 7mm ø 20mm H 3mm SS		
For models:	GLB0035-F, GLB0035-FN, GLB0037-F, GLB0037-FN, GLB0061C-F, GLB0061C-FN, GLB0063C-F, GLB0063C-FN, OPT1012-CF, OPT1012-CFN		

			
1			
GEV No.	697481	Ref. No.	00000000623
description	Thumb screw thread M6 thread L 8mm ø 14mm H 6mm SS		
For models:	8920		

			
1			
GEV No.	510112	Ref. No.	454002
description	Thumb screw thread M10 thread L 10mm ø 22mm H 4.5mm SS		
For models:	GLB0058, GLB0059, GLB0060, GLB0061, GLB0061C, GLB0062, GLB0063, GLB0064, GLB0064C, GLB0065, GLB0066, OPT1012		

nuts

plate nuts

			
1			
GEV No.	560046	Ref. No.	Q221012000
description	plate nut hole ø M5mm L 16mm W 10mm		
For models:	GLB0035-FN, GLB0037-FN, GLB0061C-F, GLB0061C-FN, GLB0063C-F, GLB0063C-FN		

cap nuts

			
1			
GEV No.	695119	Ref. No.	IB2000910
description	cap nuts thread M5L WS 10 SS Qty 1 pcs		
For models:	BARMMASTER, DRAGONEVV, MULTIPLO2S, MULTIPLO3S, ORIONEFIVE		





			
1			
GEV No.	560137	Ref. No.	0020096
description	cap nuts thread M6 WS 10 SS Qty 20 pcs DIN/ISO DIN 1587		
For models:	FGZ0009		

			
1			
GEV No.	560132	Ref. No.	Q162030000
description	hexagonal nut thread M5 H 4mm WS 8 SS DIN/ISO DIN 934 / ISO 4032/8673 Qty 20 pcs		
For models:	GLB0035-FN, GLB0037-FN, GLB0061C-F, GLB0061C-FN, GLB0063C-F, GLB0063C-FN, OPT1012-CF, OPT1012-CFN		

knurled nuts			
			
1			
GEV No.	517444	Ref. No.	80697
description	knurled nut thread M10x1 ø 25mm H 4mm SS		
For models:	OPT1012C		

			
1			
GEV No.	511212	Ref. No.	0020030 Q162040000 Q163140000
description	hexagonal nut thread M6 H 5mm WS 10 SS DIN/ISO DIN 934 / ISO 4032/8673 Qty 1 pcs		
For models:	FGZ0005, FGZ0006, FGZ0007, FGZ0009, FGZ0012, FGZ0013, FGZ0025, FGZ0026, FGZ0027, FGZ0028, GLB0035-FN, GLB0037-FN, GLB0061C-F, GLB0061C-FN, GLB0063C-F, GLB0063C-FN, OPT1012-CF, OPT1012-CFN		

			
1			
GEV No.	505171	Ref. No.	12024375 Z200705000
description	knurled nut thread M14x1 ø 35mm H 5mm SS		
For models:	GLB0061C-F, GLB0061C-FN, GLB0063C-F, GLB0063C-FN, OPT1012-CF, OPT1012-CFN		

			
1			
GEV No.	560134	Ref. No.	Q162050000
description	hexagonal nut thread M8 H 6.5mm WS 13 SS DIN/ISO DIN 934 / ISO 4032/8673 Qty 20 pcs		
For models:	GLB0061C-F, GLB0061C-FN, GLB0063C-F, GLB0063C-FN, OPT1012-CF, OPT1012-CFN		

			
1			
GEV No.	518028	Ref. No.	454004
description	knurled nut thread M5 ø 25mm H 4mm SS		
For models:	GLB0035, GLB0036, GLB0037, GLB0038, GLB0039, GLB0056, GLB0057		

			
1			
GEV No.	505200	Ref. No.	Q162070000
description	nut thread M12x1.75 H 10mm WS 19 SS DIN/ISO DIN 934 / ISO 4032/8673 Qty 1 pcs		
For models:	GLB0061C-F, GLB0061C-FN, GLB0063C-F, GLB0063C-FN, OPT1012-CF, OPT1012-CFN		

hexagonal nuts			
DIN 934 / ISO 4032/8673			
			
1			
GEV No.	560131	Ref. No.	Q162020000
description	hexagonal nut thread M4 H 3.2mm WS 7 SS DIN/ISO DIN 934 / ISO 4032/8673 Qty 20 pcs		
For models:	GLB0035-FN, GLB0037-FN, GLB0061C-F, GLB0063C-F, OPT1012-CF, OPT1012-CFN		

DIN 985			
			
1			
GEV No.	560142	Ref. No.	0020035 Q222012000
description	hexagonal nut thread M6 H 6mm SS WS 10 Qty 20 pcs DIN/ISO DIN 985 self-locking		
For models:	FGZ0005, FGZ0006, FGZ0009, FGZ0012, FGZ0013, FGZ0025, FGZ0027, FGZ0028, GLB0035-FN, GLB0037-FN, GLB0061C-F, GLB0061C-FN, GLB0063C-F, GLB0063C-FN, OPT1012-CF, OPT1012-CFN		

DIN 439 / ISO 4035/8675



1

GEV No.	507533	Ref. No.	12009948 Q222016000
description	nut thread M20 H 9.5mm SS WS 29.5 Qty 1 pcs DIN/ISO DIN 439		
For models:	OPT1012-CF, OPT1012-CFN		

hexagonal nuts metric (without norm)



1

GEV No.	521134	Ref. No.	417017
description	hexagonal nut thread M14x1 SS		
For models:	GLB0058, GLB0059, GLB0060, GLB0061, GLB0061C, GLB0062, GLB0063, GLB0064, GLB0064C, GLB0065, GLB0066, GLB0072		



1

GEV No.	513266	Ref. No.	417104
description	nut		
For models:	GLB0035, GLB0036, GLB0037, GLB0038, GLB0039, GLB0056, GLB0057		



1

GEV No.	102382	Ref. No.	673.024.00
description	nut thread M14x1 H 3.5mm WS 18 brass Qty 1 pcs		
For models:	110170CFG, 6030FTG, 6060FTG, 6060FTRG, 6060FTRRG, 65110CFG, 65110CFGG, 65110TPFG, 6540FRG, 6540FTG, 6540FTGCR, 6540FTRG, 6540FTRGCR, 6540GRG, 6540GRL, 6570CFG, 6570FRG, 6570FTG, 6570FTGCR, 6570FTRG, 6570FTRGCR, 6570FTRRG, 6570GRG, 6570GRL, 6570TPFG, 6570TPG, 70110CFG, 70110TPFG, 7040FRG13, 7040FTG, 7040FTGCR, 7040FTGS, 7040FTRG, 7040FTRGCR, 7040GRG, 7040GRL, 7070BRG, 7070BRGM, 7070CFG, 7070FRG13, 7070FTG, 7070FTGCR, 7070FTRG, 7070FTRGCR, 7070FTRRG, 7070GRG, 7070GRL, 7070TPFG, 7070TPG, 92BMG...(Other models you can see in the webshop)		



1

GEV No.	102497	Ref. No.	07991978700
description	nut thread M6x0.75 H 3mm WS 8 steel Qty 1 pcs		
For models:	AAA2002		



1

GEV No.	102067	Ref. No.	C5811029
description	nut thread M8x1 H 3mm brass Qty 1 pcs type SEF 1		
For models:	53054-CN, 5305-CN, 5330, 53304, AJD0002-CCN, AJD0003-CCN, AJD0005-CCN, AJD0006-CCN, AJD0014-C, AJD0015-C, AJD0017-C, AJD0018-C, AJD0019-C, AJD0023-C, AJD0030, AJD0031, AJD0032		

hexagonal nuts inch thread



1

GEV No.	507532	Ref. No.	12009831
description	nut thread 1" H 10mm WS 40 brass Qty 1 pcs		
For models:	GLB0063C-FN		

miscellaneous



1

GEV No.	551380	Ref. No.	DAD30010
description	cage nut thread M10 Qty 4 pcs		
For models:	VG715RXS, VP824RU		

washers

spring rings



1

GEV No.	560122	Ref. No.	Q262030000
description	lock washer ID ø 5.2mm ED ø 9mm SS DIN127 Qty 20 pcs for thread M5		
For models:	GLB0035-FN, GLB0037-FN, GLB0061C-F, GLB0061C-FN, GLB0063C-F, GLB0063C-FN		



1

GEV No.	560123	Ref. No.	Q262040000
description	lock washer ID ø 6.3mm ED ø 11mm SS DIN127 Qty 20 pcs for thread M6		
For models:	GLB0035-FN, GLB0037-FN, GLB0061C-F, GLB0061C-FN, GLB0063C-F, GLB0063C-FN, OPT1012-CF, OPT1012-CFN		



			
1			
GEV No.	560124	Ref. No.	Q262050000
description	lock washer ID \varnothing 8.3mm ED \varnothing 15mm SS DIN127 Qty 20 pcs for thread M8		
For models:	OPT1012-CF, OPT1012-CFN		

			
1			
GEV No.	560114	Ref. No.	Q232050000
description	plain washer ID \varnothing 8.4mm ED \varnothing 16mm thickness 1.6mm SS Qty 20 pcs DIN 125A for thread M8		
For models:	OPT1012-CF, OPT1012-CFN		

spring washers

			
1			
GEV No.	696253	Ref. No.	19342005
description	spring washer ID \varnothing 12mm ED \varnothing 25mm Qty 1 pcs		
For models:	FEB0031, MIRRA300		

			
1			
GEV No.	696254	Ref. No.	19342006
description	spring washer ID \varnothing 19mm ED \varnothing 32mm Qty 1 pcs		
For models:	FEB0009-SNT, FEB0010-SNT, FEB0033, FEB0034, FEB0035, PALLADIO300AM, PALLADIO300T, PALLADIO330T, PALLADIO350AM		

washers

DIN 125A

			
1			
GEV No.	560112	Ref. No.	12009944 Q232030000
description	plain washer ID \varnothing 5.3mm ED \varnothing 10mm thickness 1mm SS Qty 20 pcs DIN 125A for thread M5		
For models:	GLB0035-FN, GLB0037-FN, GLB0061C-F, GLB0061C-FN, GLB0063C-F, GLB0063C-FN, OPT1012-CF, OPT1012-CFN		

			
1			
GEV No.	560333	Ref. No.	0010026
description	plain washer ID \varnothing 6.4mm ED \varnothing 12mm thickness 1.6mm SS Qty 1 pcs DIN 125A for thread M6		
For models:	FGZ0009, FGZ0026, FGZ0027, FGZ0028		

			
1			
GEV No.	560113	Ref. No.	Q232040000
description	plain washer ID \varnothing 6.4mm ED \varnothing 12mm thickness 1.6mm SS Qty 20 pcs DIN 125A for thread M6		
For models:	GLB0035-FN, GLB0037-FN, GLB0061C-F, GLB0061C-FN, GLB0063C-F, GLB0063C-FN, OPT1012-CF, OPT1012-CFN		

DIN 9021

			
1			
GEV No.	560117	Ref. No.	IV77R06X18 Q302022000
description	plain washer ID \varnothing 6.4mm ED \varnothing 18mm thickness 1.5mm SS Qty 20 pcs DIN 9021 for thread M6		
For models:	FLA0028, GLB0035-FN, GLB0037-FN, GLB0061C-F, GLB0061C-FN, GLB0063C-F, GLB0063C-FN, OPT1012-CF, OPT1012-CFN		

tooth lock washers

DIN 6798A

			
1			
GEV No.	560036	Ref. No.	Q242010000
description	tooth lock washer ID \varnothing 3.1mm ED \varnothing 5.7mm SS Qty 10 pcs		
For models:	GLB0061C-F, GLB0061C-FN, GLB0063C-F, GLB0063C-FN, OPT1012-CFN		

			
1			
GEV No.	560125	Ref. No.	Q242020000
description	tooth lock washer ID \varnothing 4.2mm ED \varnothing 8mm SS DIN/ISO DIN 6798A Qty 20 pcs for thread M4		
For models:	OPT1012-CF, OPT1012-CFN		

			
1			
GEV No.	560126	Ref. No.	Q242030000
description	tooth lock washer ID \varnothing 5.2mm ED \varnothing 10mm SS DIN/ISO DIN 6798A Qty 20 pcs for thread M5		
For models:	GLB0035-FN, GLB0037-FN, GLB0061C-F, GLB0063C-F, OPT1012-CF, OPT1012-CFN		

			
1			
GEV No.	560342	Ref. No.	Q242040000
description	tooth lock washer ID ø 6.5mm ED ø 11mm SS Qty 1 pcs for thread M6		
For models:	OPT1012-CF, OPT1012-CFN		

fasteners

slot nuts

			
1			
GEV No.	560456	Ref. No.	19365010
description	slot nut W 5mm H 5mm L 45mm		
For models:	PALLADIO300AM, PALLADIO350AM		

clamps

hose clamps

DIN 3017 - W2

			
1			
GEV No.	520114	Ref. No.	12010023
description	hose clamp ø 20-32mm width 9mm Qty 10 pcs DIN 3017		
For models:	GLB0063C-F		

			
1			
GEV No.	520115	Ref. No.	12009997 Q881305000
description	hose clamp ø 25-40mm width 9mm Qty 10 pcs DIN 3017		
For models:	GLB0061C-F, GLB0061C-FN, GLB0063C-F, GLB0063C-FN		

			
1			
GEV No.	520118	Ref. No.	12009933 Q881324000
description	hose clamp ø 50-70mm width 9mm Qty 5 pcs DIN 3017		
For models:	GLB0061C-F, GLB0061C-FN, GLB0063C-F, GLB0063C-FN		

			
1			
GEV No.	520110	Ref. No.	12010047 Q881308000
description	hose clamp ø 8-12mm width 9mm Qty 10 pcs DIN 3017		
For models:	GLB0035-F, GLB0035-FN, GLB0037-F, GLB0037-FN, GLB0061C-F, GLB0061C-FN, GLB0063C-F, OPT1012-CF, OPT1012-CFN		

			
1			
GEV No.	520117	Ref. No.	12009962 CFS1A Q881307000
description	hose clamp stainless steel ø 40-60mm width 9mm Qty 5 pcs DIN 3017		
For models:	GLB0035-F, GLB0035-FN, GLB0037-F, GLB0037-FN, GLB0061C-F, GLB0061C-FN, GLB0063C-F, GLB0063C-FN, GLB0071, GLB0073, OPT1012C, OPT1012-CF, OPT1012-CFN		

DIN 3017 - W4

			
1			
GEV No.	520120	Ref. No.	12010036 927322 Q881302000
description	hose clamp SS W4 ø 12-20mm width 9mm Qty 1 pcs DIN 3017		
For models:	GLB0035-F, GLB0035-FN, GLB0037-F, GLB0037-FN, GLB0061C-F, GLB0061C-FN, GLB0063C-F, GLB0063C-FN, GLB0073, OPT1012C, OPT1012-CF, OPT1012-CFN		

double wire clamps

			
1			
GEV No.	505190	Ref. No.	Q901307000
description	hose clamp ø 36-42mm wire gauge ø 3mm zinc-coated steel Qty 1 pcs		
For models:	GLB0035-FN, GLB0037-FN		





 <p>1</p>			
GEV No.	505191	Ref. No.	12007966 Q901308000
description	hose clamp ø 52-59mm wire gauge ø 3.5mm Qty 1 pcs		
For models:	GLB0061C-F, GLB0061C-FN, GLB0063C-F, GLB0063C-FN		

 <p>1</p>			
GEV No.	513268	Ref. No.	423011
description	hose clamp ø 8-10mm wire gauge ø 1mm Qty 1 pcs		
For models:	GLB0061, GLB0061C, GLB0062, GLB0063, GLB0064, GLB0064C, GLB0065, GLB0066, GLB0072		

<p>double wire clamps with screw</p>  <p>1</p>			
GEV No.	505079	Ref. No.	12025195 Z400903000
description	hose clamp ø 186-172mm Qty 1 pcs		
For models:	GLB0035-F, GLB0035-FN, GLB0037-F, GLB0037-FN		

 <p>1</p>			
GEV No.	505080	Ref. No.	12023841 Z200908000
description	hose clamp ø 235-215mm Qty 1 pcs		
For models:	GLB0061C-F, GLB0061C-FN, GLB0063C-F, GLB0063C-FN		

<p>retainer clips</p>  <p>1</p>			
GEV No.	693457	Ref. No.	020102
description	retainer clip L 73mm wire gauge ø 3mm zinc-coated steel Qty 1 pcs		
For models:	AJE0001, AJE0002, AJE0003, AJE0005, AJE0006, AJE0007		

<p>retaining rings</p> <p>DIN 471</p>  <p>1</p>			
GEV No.	692065	Ref. No.	0065250
description	retaining ring for vacuum packing machine shaft ø 6mm thickness 0.7mm SS DIN 471		
For models:	FGZ0005, FGZ0006, FGZ0012, FGZ0013, FGZ0025, FGZ0026		

 <p>1</p>			
GEV No.	516222	Ref. No.	F021
description	retaining ring shaft ø 12mm thickness 1mm SS DIN 471		
For models:	EBZ0001-CN, EBZ0002-CN, EBZ0003-CN		

 <p>1</p>			
GEV No.	691621	Ref. No.	M29600
description	retaining ring shaft ø 40mm thickness 1.8mm steel DIN 471		
For models:	ACC005V, ADC006V, ADE003V, ADE004V		

 <p>1</p>			
GEV No.	560302	Ref. No.	0065251
description	retaining ring shaft ø 8mm thickness 0.8mm SS DIN 471		
For models:	FGZ0006, FGZ0013, FGZ0025		

 <p>1</p>			
GEV No.	523104	Ref. No.	LF1513006
description	retaining ring thickness 1.6mm stainless steel DIN 471 bore ø 30mm		
For models:	FIC0002		

<p>DIN 472</p>  <p>1</p>			
GEV No.	698003	Ref. No.	F2015
description	retaining ring bore ø 35mm thickness 1.5mm steel DIN 472		
For models:	FIF0016-F, FIF0023		

			
1			
GEV No.	698004	Ref. No.	F2108
description	retaining ring bore ø 40mm thickness 1.9mm steel DIN 472		
For models:	FIF0001, FIF0002, FIF0004, FIF0005, TCG22E-F		

DIN 6799			
			
1			
GEV No.	518557	Ref. No.	0552.05065.4 238.000.00
description	retaining ring E D1 ø 5mm D2 ø 11mm SS DIN 6799 thickness 0.7mm		
For models:	6030FRE, 6060FRE, 6540FRE, 6570FRE		

			
1			
GEV No.	691470	Ref. No.	12010014 Q271006000
description	retaining ring E D1 ø 8mm D2 ø 16mm SS DIN 6799 thickness 1mm for shaft ø 9-12mm		
For models:	OPT1012-CF, OPT1012-CFN		

DIN 7993			
			
1			
GEV No.	518308	Ref. No.	303019
description	retaining ring DIN 7993 for drain assembly thickness 3mm ED ø 57mm		
For models:	GLB0060, GLB0061, GLB0061C, GLB0062, GLB0063, GLB0064, GLB0064C, GLB0065, GLB0066		

cotter pins			
			
1			
GEV No.	111273	Ref. No.	4.0.016.0025
description	cotter pin ø 1.3mm L 25mm		
For models:	EFA0015, EFA0016, EFA0023		

consumables

lubricants

silicone fats

			
1			
GEV No.	890101	Ref. No.	F139
description	silicone grease FERMIT GLISSA tube 60g -40 to +200°C approval		
description	<p>Fermit GLISSA - tube 60g</p> <p>Non-drip lubricating grease for drinking water valves and fittings Glissa silicone grease is suitable as a lubricant and sealant for drinking water valves and fittings (e.g. cartridges of single-lever mixers, switching valves and swivel spouts). Water-repellent, physiologically safe, sealing and has a high temperature resistance up to 200°C. Complies with the guidelines of the UBA for sanitary lubricants, tested by TZW for suitability for drinking water and approved in accordance with DIN ISO 21469. Temperature range: -40°C to +200°C</p>		
For models:	MISSOFTY		

lava rocks / ceramic briquets

			
1			
GEV No.	105342	Ref. No.	M30500
description	lava rocks content 9kg		
For models:	ACH1003, ACH1004, ACH101V, ACH102V, ACH103V, ACH104V, ADH101V, ADH102V		

fuses

fine fuses

			
1			
GEV No.	358530	Ref. No.	926284
description	fine fuse size ø5x20mm 0.8A fast-acting rated 250V Qty 10 pcs		
For models:	GLB0043, GLB0044, GLB0046, GLB0070, GLB0071, OPT1012		

			
1			
GEV No.	358675	Ref. No.	11950227000
description	fine fuse size ø5x20mm 2.5A fast-acting rated 250V Qty 10 pcs		
For models:	AIB0014		





 <p>1</p>			
GEV No.	358677	Ref. No.	228004 228010
description	fine fuse size ø5x20mm 4A fast-acting rated 250V Qty 10 pcs		
For models:	GLB0043, GLB0044, GLB0070, GLB0071, GLB0073, OPT1012, OPT1012C		

 <p>1</p>			
GEV No.	358074	Ref. No.	91310504
description	fine fuse size ø5x20mm 5A fast-acting rated 250V Qty 10 pcs		
For models:	CAB0007-CD, CAB0008-CD, CAB0009-CD, CAB0013-CD, CAB0014-CD, CAB0015-CD, CAB0024-CD, CAB0025-CD, CAB0055-DCG, CAB0056-DCG, CAB0057-DCG, CAB0058-DCG, CAB0059-DCG, CAB0060-DCG, CAB0061-DCG, CAB0062-DCG		

<p>ø6.3x32mm 250V</p>  <p>1</p>			
GEV No.	358760	Ref. No.	926283
description	fine fuse size ø6.3x32mm 0.315A medium lag rated 250V Qty 10 pcs		
For models:	GLB0043, GLB0044, GLB0046, GLB0070, GLB0071, OPT1012		

 <p>1</p>			
GEV No.	358184	Ref. No.	A62304210BP
description	fine fuse size ø6x30mmmm 10A slow-acting rated 250V Qty 1 pcs		
For models:	NE1643, NE1653, NE1843, NE1880		

<p>fine fuse holders</p>  <p>1</p>			
GEV No.	550691	Ref. No.	ELET0058
description	fuse holder		
For models:	CAD0005, CAD0007, SY850VELED		

 <p>1</p>			
GEV No.	550848	Ref. No.	ELET0440
description	fuse holder suitable fuse ø5x20mm		
For models:	CAD0007, CAD0010, SY12100VGASD, SY1280VG, SY850VELED		

 <p>1</p>			
GEV No.	550519	Ref. No.	H.228048
description	cover plate suitable fuseA ratedV connection for fuse holder		
For models:	GLB0043, GLB0044, GLB0070, GLB0071, GLB0073, OPT1012, OPT1012C		

A			
alarm devices	80	drain hoses	346
appliance sockets/plugs	146	drain pumps	139
axial fans	116		
B		E	
ball valves	355	edgemount latches	294
ballasts	73	electric accessories	146
bar burners	185	electric timers	79
bi-metal thermostats	34, 34	electrodes	112
boiling pan gaskets	312	electronic controllers	89
booster pumps I	138	energy regulators	33
booster pumps II	140	evaporators	327
brushes	359	extraction and pressure hoses	349
C		F	
cables	146	fans	116
cam switches	58	fasteners	366
cap nuts	362	fastening material	359
capillary tube clips	47	filter driers	326
castors and bumper angles	304	filter weights	344
ceramic burners	190	filters	144
ceramic heaters	20	fine fuses	368
clamps	357, 366	fittings	354
cleaning tools	359	flat-headed bolts	361
coil heating elements	21	float switches	58
cold air circulating fans	121	flow heaters	28
cold air circulating fans (complete)	121	flow meters	112
compressors	112	fluorescent lamps	72, 72
condensators & interference suppression filters	143	foam rubber gaskets	321
consumables	368	foil heating elements	28
contact heaters	20	formed hoses	349
contactors	80	fridge lamps	73
container filters	344	funnel trays	212
control equipment	65	fuses	144, 368
control thermostats	35, 44		
cooling aggregates	112	G	
cooling fans	121	gas burners	180
cotter pins	368	gas control valves	160
countersunk screws	360	gas lines	201
cross flow fans	121	gas nozzles	191
D		gas taps	150
door gaskets (wire reinforced)	312	gas thermostats	156
door seals	310	gaskets for heated units	310
door seals for dishwashers	323	gaskets for wash arm support	325
door seals with fixing hook	311	gastronorm	338
door seals with tension springs	312	grates	307
dosing pumps	340	grub screws	362
double nipples	354		
double wire clamps	358, 366	H	
double wire clamps with screw	358, 367	halogen lamp	71
		hand tools	359
		handle latches	294
		heating cables	19
		heating cartridges	20

heating elements	3
heating elements for bain maries	4
heating elements for charrills	19
heating elements for chip scuttles	5
heating elements for coffee machine	8
heating elements for convection	25
heating elements for defrosting	9
heating elements for fryers	5
heating elements for griddles	7
heating elements for gyros grills	8
heating elements for heated cabinets	19
heating elements for ovens	3
heating elements for pasta cookers	10
heating elements for pizza ovens	12
heating elements for refrigeration	9
heating elements for salamanders/toasters	19
heating elements for tilting bratt pan	10
heating plates	20
hexagonal nuts	363
hexagonal screws	361
hob burners	180
hose clamps	357, 366
hose connectors	354, 354
hose reels	340
hoses	345
hot air fans	124
hot air motors	122
hot plates	32
humidity probes	91
I	
ignition boxes	162
ignition cables	174
ignition switches	176
ignition units	175
immersion heating elements	21
indicator lights	67
indicator lights (complete)	67
industrial hoses	348
K	
knurled nuts	363
knurled screws	362
L	
lamp accessories	76
lamps	67
lava rocks / ceramic briquettes	201, 368
LED	70
light bulbs	71
lubricants	368
M	
magnetic switches	63
magnetrons	87
male fastons	147
measuring equipment	359
mechanical timers	80
microswitches	53
microwave lamps	73
motors	126
N	
Niplaflex hoses	348
nuts	362
O	
operating capacitors	143
O-rings	312
oval head screws	361
oven hinges	295
oven lamps	73
P	
piezoelectric igniters	174
pilot burners	163
pipe brushes	359
plate nuts	362
pliers	359
plug-in gaskets	309
plugs - couplings - power sockets	146
plunger sockets	47
position switches	56
power supply cables	146
pre-rinse hoses	346
pressure control hoses	348
pressure hoses	353
pressure reduction valves	357, 357
pressure switches	109, 201
probe clips	47
probes	91
programme timers	76
pumps	131
pumps for ice machines	141
push/momentary push switches	51
push-in fittings	355
PVC braided hoses	346
PVC hoses	348
PVC supply hoses	346
Q	
quartz heating elements	21

R

radiation heaters	27
refrigeration cycle components	326
refrigeration fans	118
refrigeration gaskets	309
refrigeration motors universal	118
refrigeration thermostats	46
relays	85
retainer clips	367
retaining rings	367
ribbon cables	147
riveting pliers	359
rivets/rivet nuts	359
rocker/momentary rocker switches	48
rotary switches	62

S

safety bi-metal thermostats	34
safety thermostats	40
safety valves	162
Schrader valves	326
screw-in gaskets	310
screws	360
sealing cords	322
sealing washers	318
shaft gaskets	322
sheet metal screws	360
shelves and shelf rails	307
shut-off valves	356
side bolts	362
silicone fats	368
sleeves	354
slot nuts	366
snap locks	294
softener cartridges	357
solenoid valves	102
solid state relays	85
solid top burners	189
spillage trays	338
spiral cables	147
spray guns	340
spray guns with external thread	340
spring assisted hinges	294
spring clips	47
spring rings	364
spring washers	365
stainless steel flexi hoses	345
starter	73
supply filters	357, 357
supply hoses	345
surface burners	190

switches and momentary switches	48
system switches (ROLD)	56

T

tank inlets	345, 357
tap tubes	345
temperature probes	91
terminals	147
terminals and connectors	147
thermocouples	176
thermostat gaskets	325
thermostats	34
timers	76
tools	359
tooth lock washers	365
transformers	87
tube burners	189

U

universal probes	91
------------------	----

V

vacuum pumps	142
valves and tank inlets	355
ventilation hoses	353

W

wall-mounted hose reels	340
wash and rinse pumps	131
washers	365
water cycle components	357
water softeners	357
water taps	339
window seals	310