



GAS COMPONENTS



ELECTRIC COMPONENTS



WATER TECHNOLOGY



MECHANICAL COMPONENTS



TOOLS

Spare parts suitable for

MASBAGA

Find the complete and up-to-date range of products in our GEV Webshop



Manufacturer catalogue

The most important spare parts and accessories arranged clearly for every manufacturer

- ✓ Complete product range and all appliance data always up to date in the GEV Webshop
- ✓ Alphabetical Index at the end of the catalogue

GEV Webshop

www.gev-online.co.uk

www.gev-online.com



- 🔍 Add to Favourites
- 🔍 Sign In with email address and usual password
- 🔍 Easy-order – place several items in your basket at the same time
- 🔍 Quick Item search – no login needed



heating elements

heating elements for ovens

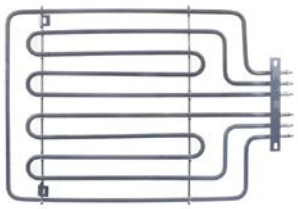
			
1			
GEV No.	419068	Ref. No.	2127
description	heating element 2400W 230V heating circuits 3 L 505mm W 355mm L1 55mm L2 450mm W1 114mm W2 127mm flange length 170mm flange width 45mm hole distance 138mm bridge length 368mm hole ø 12/7mm tube ø 8mm connection M4 connection length 30mm windings 4 rectangular flange dry heating element oven		
For models:	HA11E, S41E		

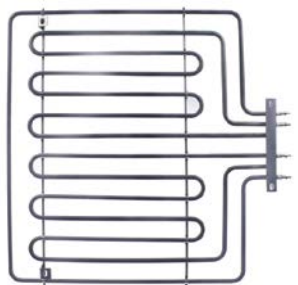
			
1			
GEV No.	419069	Ref. No.	2131
description	heating element 4000W 230V heating circuits 3 L 505mm W 510mm L1 55mm L2 450mm W1 191.5mm W2 127mm flange length 170mm flange width 45mm hole distance 138mm bridge length 520mm hole ø 12/7mm tube ø 8mm connection M4 connection length 30mm windings 6 rectangular flange dry heating element oven		
For models:	41E		

heating elements for fryers

2 hole fixing

group 2



			
1			
GEV No.	419070	Ref. No.	2180
description	heating element 2200W 230V heating circuits 1 L 300mm W 110mm H 170mm L1 35mm L2 15mm L3 250mm thread M12x1.25 mounting distance 102mm tube ø 8mm windings 3 2 hole fixing connection M4 connection length 35mm fryer cover		
For models:	BFE10, BFE5		

group 5

			
1			
GEV No.	419067	Ref. No.	65720019
description	heating element 3000W 220V heating circuits 1 L 300mm W 205mm H 180mm 2 hole fixing connection M4 fryer heaters L1 35mm L2 15mm L3 250mm W1 42.5mm W2 120mm tube ø 8.5mm thread M12x1 mounting distance 112mm connection length 38mm windings 5		
For models:	BFE10, BFE16, BFE24, BFE8		

ceramic heaters

245x60mm

			
1			
GEV No.	415102	Ref. No.	2088
description	ceramic emitter 400W 230V cable beaded cord L 245mm W 60mm H 35mm		
For models:	SFE		
spare parts for	415102		
	GEV No.	415109	Ref. No.
			—
	spring clip		
accessories for	415102		
	GEV No.	415110	Ref. No.
			—
	reflector L 245mm W 95mm H 31mm thickness 0.75mm hole ø 15x40mm		

coil heating elements

			
1			
GEV No.	419071	Ref. No.	2264
description	heating element 1000W 230V L 370mm W 50mm H 25mm tube ø 8mm thread M12x1.25 connection M4 connection length 30mm dry heating element heating circuits 1 2 hole fixing		
For models:	SFE		



radiation heaters



1

GEV No.	419076	Ref. No.	97032038
description	heating element rectangular L 840mm W 190mm 2500W 230/400V H 40mm cable length 450mm chicken rotisserie		
For models:	AP10E, AP10G, AP15E, AP15G, AP20E, AP20G, AP30E, AP30G, AP40E, AP40G, AP5E, AP5G, AP60E, AP60G, AP80E, AP80G		

foil heating elements



1

GEV No.	419075	Ref. No.	C5421210
description	foil heating element L 400mm W 290mm 1000W 230V t.max. 150°C silicone cable length 2000mm thickness 1mm bain marie		
For models:	3016, BM3RE, BM47E, BM49E, BM87E, BM89E		

accessories

capillary tube clips



1

GEV No.	550138	Ref. No.	68560069
description	capillary tube clip for pipe ø 8.5mm for circular tube heating elements		
For models:	BFE10, BFE12, BFE16, BFE24, BFE5, BFE8		

spring clips



1

GEV No.	551078	Ref. No.	69340099
description	probe spring for pipe ø 8mm for probe ø 5mm L 30mm W 10mm wire gauge ø 1mm		
For models:	BFE10, BFE12, BFE16, BFE24, BFE5, BFE8		

hot plates

round

with radiused edge

for domestic and commercial kitchens



1

GEV No.	490018	Ref. No.	3216
description	hot plate ø 220mm 2000W 230V connection 4 screw clamps with 8mm spill ring		
For models:	S40E, S41E		



1

GEV No.	490020	Ref. No.	3235	
description	hot plate ø 220mm 2600W 230V connection 4 screw clamps with 8mm spill ring			
For models:	S40E, S41E			
accessories for	490020			
	GEV No.	550796	Ref. No.	—
	fixing plate for hot plate ø220mm			

energy regulators

EGO

1-circuit



1

GEV No.	380015	Ref. No.	C5322489
description	energy regulator 230V 13A single-circuit turn direction right shaft ø 6x4.6mm shaft L 23mm mounting thread M4 power release 6-100% no. 50.57021.010		
For models:	AP10E, AP10G, AP15E, AP15G, AP20E, AP20G, AP30E, AP30G, AP40E, AP40G, AP55G, AP5E, AP5G, AP60E, AP60G, AP75G, AP80E, AP80G		



thermostats

control and safety thermostats

EGO

control thermostats

55.13_series



1

GEV No.	375505	Ref. No.	2221
description	thermostat t.max. 320°C temperature range 50-320°C 1-pole 1NO 16A probe ø 3mm probe L 160mm capillary pipe 870mm capillary pipe isolatedmm gland nut shaft ø 6x4.6mm shaft L 23mm shaft position upper rotation 270°		
For models:	41E, 82E, FT87CE, FT89E, HA11E, HA21E, HAD21E, S41E, SFCGE, SFCME, SFCPE		

IMIT / TEMPOMATIC / ARTHERMO

control thermostats



1

GEV No.	375939	Ref. No.	C5322059
description	thermostat t.max. 200°C temperature range 0-200°C 1-pole 1CO 16A probe ø 5mm probe L 98mm capillary pipe 1040mm capillary pipe isolatedmm gland nut shaft ø 6x4.6mm shaft L 20mm		
For models:	BFE10, BFE12, BFE16, BFE24, BFE5, BFE8		

safety thermostats



1

GEV No.	375941	Ref. No.	C5322209
description	safety thermostat switch-off temp. 238°C 1-pole 1NC 16A probe ø 5mm probe L 100mm capillary pipe 1050mm capillary pipe isolated-mm gland nut 250V		
For models:	BFE10, BFE12, BFE16, BFE24, BFE5, BFE8		

various

control thermostats



1

GEV No.	375940	Ref. No.	C5322579
description	thermostat temperature range 30-90°C 1-pole 1CO 16A probe ø 6mm probe L 108mm capillary pipe 1530mm shaft ø 6x4.6mm shaft L 12mm rotation 270° 400V		
For models:	3016, BM47E, BM49E, BM87E, BM89E, SFE		

safety thermostats



1

GEV No.	390754	Ref. No.	92011140
description	safety thermostat switch-off temp. 240°C 1-pole 0.5A probe ø 6mm probe L 79mm capillary pipe 860mm capillary pipe isolated 750mm probe thread M10x1 connection with cable cable length 600mm		
For models:	SF10MG, SF20MG		
spare parts for	390754		
	GEV No.	375783	Ref. No.
			—
	safety thermostat switch-off temp. 240°C 1-pole 0.5A probe ø 6mm probe L 77mm capillary pipe 860mm capillary pipe isolated 750mm gland nut M10x1 probe SS		

accessories

capillary tube clips



1

GEV No.	550138	Ref. No.	68560069
description	capillary tube clip for pipe ø 8.5mm for circular tube heating elements		
For models:	BFE10, BFE12, BFE16, BFE24, BFE5, BFE8		



switches and momentary switches

rocker/momentary rocker switches

ø20mm



1

GEV No.	357074	Ref. No.	C5120729
description	rocker switch mounting measurements 20mm red 2NO 250V 10A I O connection male faston 4.8mm ambient temperature max. 85°C protection IP40		
For models:	41E, 82E, AP10E, AP10G, AP15E, AP15G, AP20E, AP20G, AP30E, AP30G, AP40E, AP40G, AP55G, AP5E, AP5G, AP60E, AP60G, AP75G, AP80E, AP80G, AR02P, AR04, AR04P, AR12P, ARC10, ARM20, GA2, HA11E, HA21E, HAD21E, MR20, MR30, S41E, SFE		

cam switches

4-position



1

GEV No.	300007	Ref. No.	3218
description	cam switch 4 operating positions 1NO/2CO sequence 0-1-2-3 16A shaft ø 6x4.6mm shaft L 23mm connection male faston 6.3mm 4-position ceramic		
For models:	41E, 82E, S20E, S40E, S41E		

lamps

indicator lights

indicator lights (complete)

ø 6mm



1

GEV No.	357072	Ref. No.	C5120219
description	indicator light ø 6mm 220V red connection cable 300mm cable length 300mm metal		
For models:	3016, 41E, 82E, AP10E, AP10G, AP15E, AP15G, AP20E, AP20G, AP30E, AP30G, AP40E, AP40G, AP55G, AP5E, AP5G, AP60E, AP60G, AP75G, AP80E, AP80G, BFE10, BFE12, BFE16, BFE24, BFE5, BFE8, BM47E, BM49E, BM87E, BM89E, FT87CE, FT89E, HA11E, HA21E, HAD21E, MBM15E, S20E, S40E, S40V, S41E, SFCGE, SFCME, SFCPE, SFE		

ø20mm



1

GEV No.	357073	Ref. No.	C5120719
description	indicator light ø 20mm 250V red connection male faston 4.8mm temp.-resist. 105°C		
For models:	AR02P, AR04, AR04P, AR12P, ARC10, ARM20, GA2, MR20, MR30		

oven lamps

universal oven lamps

55x100mm



1

GEV No.	101372	Ref. No.	C5125419	
description	oven lamp complete L 100mm W 55mm 230V 25W socket E14 rectangular temp.-resist. 300°C connection male faston 6.3mm			
For models:	AP10E, AP10G, AP15E, AP15G, AP20E, AP20G, AP30E, AP30G, AP40E, AP40G, AP55G, AP5E, AP5G, AP60E, AP60G, AP75G, AP80E, AP80G, APP6G, APP8G, APV			
spare parts for	101372			
	GEV No.	359612	Ref. No.	—
	light bulb t.max. 300°C socket E14 25W 230V ø 25mm L 56mm lens L 30mm for oven lamp type Philips			
	GEV No.	359698	Ref. No.	—
	lamp socket L 100mm W 55mm socket E14 connection male faston 6.3mm			
	GEV No.	359714	Ref. No.	—
	gasket for bulb socket			
	GEV No.	359715	Ref. No.	—
	lamp glass L 110mm W 65mm thickness 5mm			
	GEV No.	359716	Ref. No.	—
	frame for bulb socket			



contactors

LS Industrial Systems

power contactors



1

GEV No.	380944	Ref. No.	C5123179
description	power contactor resistive load 20A 230VAC (AC3/400V) 12A/5.5kW main contacts 3NO auxiliary contacts 1NO/1NC connection screw connection type GMC-12		
For models:	FT87CE, FT89E, HA21E, HAD21E		

electronic controllers

miscellaneous

refrigeration controllers



1

GEV No.	378271	Ref. No.	C5322529
description	electronic controller OSAKA type T2001 AN /HSH5 mounting measurements 71x29mm 100-240V voltage AC NTC display 4 digits NTC/PTC		
For models:	AR02P, AR04, AR04P, AR12P, ARC10, ARM20, BM3RE, GA2, MC16E, MC20E, MM16E, MM20E, MR20, MR30		

motors

gear motors

for grills



1

GEV No.	499110	Ref. No.	C5020039
description	gear motor CROUZET 230V 50Hz 4rpm shaft ø 6x5mm L 91mm W 64mm H 58mm		
For models:	AP10G, AP15G, AP20G, AP30G, AP40G, AP5E, AP5G, AP60G, AP80G		



1

GEV No.	499111	Ref. No.	534027P
description	gear motor CEG type MM56A4-STD 90W 230V 50Hz 6500rpm L 705mm W 115mm H 550mm chicken rotisserie 0.12HP		
For models:	AP10E, AP10G, AP15E, AP15G, AP30E, AP30G, AP40E, AP40G, AP55G, AP60E, AP60G, AP75G, AP80E, AP80G		









gas taps

PEL

20S series



1













GEV No.	106840	Ref. No.	3780	
description	gas tap PEL type 20S gas inlet pipe flange ø21mm bypass nozzle ø 0mm gas outlet M16x1.5 (tube ø 10/8mm) thermocouple connection M8x1 pilot connection shaft ø 8x6.5mm shaft L 22/15mm shaft flat upper			
For models:	AP10E, AP10G, AP15E, AP15G, AP20E, AP20G, AP30E, AP30G, AP40E, AP40G, AP55G, AP5E, AP5G, AP60E, AP60G, AP75G, AP80E, AP80G			
spare parts for	106840			
	GEV No.	101060	Ref. No.	—
		magnet unit standard L 39mm D1 ø 15.4mm D2 ø 11mm suitable for PEL20-21/JUNKERS/EGA		
	GEV No.	101205	Ref. No.	—
		gas tap front part shaft ø 8x6.5mm shaft L 22/15mm shaft flat upper/lower suitable for PEL20		
	GEV No.	101880	Ref. No.	—
		gasket Viton ED ø 14mm ID ø 9mm thickness 7.7mm Qty 1 pcs		
	GEV No.	106202	Ref. No.	—
		bypass nozzle type PEL20/21 bore ø 0mm thread M5x0.5		
accessories for	106840			
	GEV No.	101230	Ref. No.	—
		thermocouple nut T1: M8x1 T2: M18x1 aluminium		
	GEV No.	101278	Ref. No.	3781
		olive for pipe ø 10mm Qty 1 pcs		
	GEV No.	101300	Ref. No.	3782
		union nut thread M16x1.5 tube ø 10mm		
	GEV No.	101450	Ref. No.	—
		olive for pipe ø 8mm L 12.7mm Qty 1 pcs ED ø 10mm		
	GEV No.	101451	Ref. No.	—
		union nut thread M16x1.5 tube ø 8mm		



21S series







1

GEV No.	106841	Ref. No.	C5811429
description	gas tap PEL type 21S gas inlet pipe flange ø21mm bypass nozzle ø 0mm gas outlet M16x1.5 (tube ø 10mm) thermocouple connection M9x1 pilot connection M10x1 shaft ø 8x6.5mm shaft L 22/15mm shaft flat right pipe input ø 9mm		
For models:	11G, 4101G, 41G, 61G, 720G, 741G, 761GG, 820M, CP7G, CP9G, H3, H4, M10G, M15G, M770G, MBM10G, MBM15G, PG47, PG87, PG89, S20G, S20PG, S21G, S40G, S41G, SPGG, SPPG		
spare parts for	106841		
	GEV No.	101060	Ref. No. —
	magnet unit standard L 39mm D1 ø 15.4mm D2 ø 11mm suitable for PEL20-21/JUNKERS/EGA		
	GEV No.	101231	Ref. No. —
	thermocouple nut T1: M9x1 T2: M18x1		
	GEV No.	106202	Ref. No. —
	bypass nozzle type PEL20/21 bore ø 0mm thread M5x0.5		
accessories for	106841		
	GEV No.	100908	Ref. No. —
	union screw thread M10x1 for pipe ø 4mm Qty 1 pcs		
	GEV No.	100909	Ref. No. A1018997
	union screw thread M10x1 for pipe ø 6mm Qty 1 pcs		
	GEV No.	101246	Ref. No. —
	olive for pipe ø 4mm Qty 1 pcs		
	GEV No.	101278	Ref. No. 3781
	olive for pipe ø 10mm Qty 1 pcs		
	GEV No.	101286	Ref. No. —
	olive ID ø 6mm Qty 1 pcs		
	GEV No.	101300	Ref. No. 3782
	union nut thread M16x1.5 tube ø 10mm		
	GEV No.	101450	Ref. No. —
	olive for pipe ø 8mm L 12.7mm Qty 1 pcs ED ø 10mm		
	GEV No.	101451	Ref. No. —
	union nut thread M16x1.5 tube ø 8mm		
	GEV No.	110081	Ref. No. —
	knob ø 70mm shaft ø 8x6.5mm shaft flat universal		
	GEV No.	112206	Ref. No. —
	knob dial plate silver gas tap PEL21/22/23 t.max.°C ED ø 63mm ID ø 45.5mm		

SABAF



1

GEV No.	106842	Ref. No.	C5816299
description	gas tap SABAF type 10 gas inlet pipe flange ø23mm bypass nozzle ø 0mm gas outlet 1/4" (tube ø 8mm) front fixing M13x1 thermocouple connection M8x1 shaft ø 8x6.5mm shaft L 32/12.5mm shaft flat right		
For models:	AP15G, AP20G, AP30G, AP40G, AP55G, AP75G, APP6G, APP8G, B1G, B2G, B3G, BC1G, BC2G, BC3G, BF1G, BF2G, BF3G, BP1G, BP2G, BP3G		
spare parts for	106842		
	GEV No.	101051	Ref. No. —
	magnet unit L 27mm D1 ø 12.5mm D2 ø 8.5mm suitable for JUNKERS/EGA/MADEC/SABAF standard		
	GEV No.	101376	Ref. No. —
	gasket ID ø 8mm ED ø 12mm H 3/5mm		
accessories for	106842		
	GEV No.	101277	Ref. No. C5815549
	olive ID ø 8mm Qty 1 pcs		
	GEV No.	101751	Ref. No. —
	bracket		
	GEV No.	520656	Ref. No. —
	union nut thread 1/4" tube ø 6/8mm		



1

GEV No.	106843	Ref. No.	C5816289
description	gas tap SABAF type 10 gas inlet pipe flange ø23mm bypass nozzle ø 0mm gas outlet 1/4" (tube ø 8mm) front fixing thermocouple connection M8x1 shaft ø 8x6.5mm shaft L 47/12.5mm shaft flat right		
For models:	S31G		
spare parts for	106843		
	GEV No.	101051	Ref. No. —
	magnet unit L 27mm D1 ø 12.5mm D2 ø 8.5mm suitable for JUNKERS/EGA/MADEC/SABAF standard		
	GEV No.	101376	Ref. No. —
	gasket ID ø 8mm ED ø 12mm H 3/5mm		
accessories for	106843		
	GEV No.	101277	Ref. No. C5815549
	olive ID ø 8mm Qty 1 pcs		
	GEV No.	101751	Ref. No. —
	bracket		
	GEV No.	520656	Ref. No. —
	union nut thread 1/4" tube ø 6/8mm		





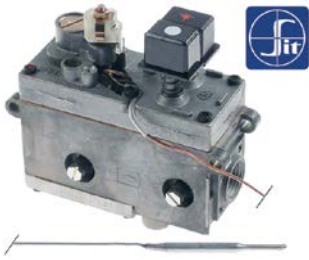

gas thermostats

SIT

710 Minisit series



GEV No.	101132	Ref. No.	3103
description	gas thermostat SIT type MINISIT 710 t.max. 340°C 100-340°C gas inlet 1/2" gas outlet 3/8" thermocouple connection M9x1 pilot connection M10x1 probe ø 5mm probe L 68mm capillary pipe 1050mm probe type type B1 pressure controller no pressure regulator mbar gland nut ignition gas no		
For models:	4101G, 41G, 61G, 741G, 761GG, 820M, FG20, FT87CG, FT87G, HA21G, HAD21G, HAG, SFCGG, SFCMG, SFPCG, ST120G, ST80G		
spare parts for	101132		
	GEV No.	101053	Ref. No. —
	magnet unit T1: M9x1 T2: M24x1 L 45mm ø 17mm suitable for Minisit		
	GEV No.	102102	Ref. No. —
	probe 100-340°C probe ø 5mm probe L 68mm capillary pipe 1750mm t.max. 340°C oven/grill probe type type B1 suitable for MINISIT 710		
accessories for	101132		
	GEV No.	100809	Ref. No. 3785
	O-ring EPDM thickness 2mm ID ø 21mm Qty 1 pcs		
	GEV No.	100904	Ref. No. —
	locking screw M10x1 for pipe ø 4mm Qty 1 pcs		
	GEV No.	100905	Ref. No. C5815359
	locking screw M10x1 for pipe ø 6mm Qty 1 pcs		
	GEV No.	101054	Ref. No. —
	magnet unit T1: M10x1 T2: M24x1 L 45mm ø 17mm suitable for Minisit		
	GEV No.	101136	Ref. No. —
	piezoelectric igniter suitable for Minisit with cover cap ømm connection F6.3x0.8		
	GEV No.	101137	Ref. No. —
	cover cap without piezoelectric igniter		
	GEV No.	101267	Ref. No. —
	reducer IT 3/8" ET 1/2" L 21mm		
	GEV No.	101268	Ref. No. —
	gas connection thread 3/8" angled with O-ring MINISIT 710		
	GEV No.	101269	Ref. No. —
	gas connection thread 1/2" angled with O-ring MINISIT 710		
	GEV No.	101270	Ref. No. —
	screw connection IT 3/8" ET 3/8" L 28mm		
	GEV No.	101272	Ref. No. —
	screw connection IT 1/2" ET 3/8" L 57mm		

accessories for	101132		
	GEV No.	101273	Ref. No. —
	olive for pipe ø 12mm L 9.5mm brass Qty 1 pcs suitable for universal		
	GEV No.	101274	Ref. No. —
	olive for pipe ø 16mm Qty 1 pcs		
	GEV No.	101275	Ref. No. —
	union screw thread 1/2" for pipe ø 16mm Qty 1 pcs		
	GEV No.	101276	Ref. No. —
	union screw thread 3/8" tube ø 12mm Qty 1 pcs		
	GEV No.	110068	Ref. No. —
	knob suitable for Minisit ø 37mm		

gas valves and ignition boxes

gas control valves

SIT

NOVASIT

accessories

			
GEV No.	100905	Ref. No.	C5815359
description	locking screw M10x1 for pipe ø 6mm Qty 1 pcs		
For models:	11G, 4101G, 41G, 61G, 720G, 741G, 761GG, CP7G, CP9G, FG20, FG220, FT87CG, FT87G, H3, H4, HA21G, HAD21G, HAG, M10G, M15G, M770G, MBM10G, MBM15G, PG47, PG87, PG89, S20G, S20PG, S21G, S40G, S41G, SF10MG, SF20MG, SFCGG, SFCMG, SFPCG, SPGG, SPPG, ST120G, ST80G		

ignition parts

pilot burners

SIT

100 series

accessories

pilot burner brackets

universal

			
GEV No.	100894	Ref. No.	3705
description	opposite support for pilot burner suitable for 100 series		
For models:	HA11G, S31G, S41G		



1

GEV No.	100893	Ref. No.	3786
description	pilot burner bracket suitable for 100 series 2-piece		
For models:	HA11G, S31G, S41G		



1

GEV No.	100888	Ref. No.	3704
description	screw bolt for pilot burner		
For models:	HA11G, S31G		

miscellaneous



1

GEV No.	100885	Ref. No.	C5815189
description	air mixing sleeve for pilot burner Qty 1 pcs		
For models:	11G, 41G, 61G, 720G, 741G, 761GG, 820M, H3, H4, S20G, S20PG, S21G, S40G, S41G		

POLIDORO

pilot burners



1

GEV No.	106837	Ref. No.	C5810129
description	pilot burner POLIDORO 3 flames natural gas code 27.2		
For models:	4101G, 41G, 61G, 741G, 761GG, 820M, CP7G, CP9G, FG20, FG220, FT-87CG, FT87G, HA21G, HAD21G, HAG, M10G, M15G, M770G, MBM10G, MBM15G, PG47, PG87, PG89, SF10MG, SF20MG, SFCGG, SFCMG, SFCPG, SPGG, SPPG, ST120G, ST80G		

producer-specific pilot burners

MAS-BAGA





1

GEV No.	107485	Ref. No.	C5815249M	
description	pilot burner LPG code 20			
For models:	11G, 41G, 61G, 741G, H3, H4, S20G, S20PG, S21G, S40G, S41G			
spare parts for	107485			
	GEV No.	100245	Ref. No.	—
	description	pilot burner nozzle LPG code 20 bore ø 0.2mm Qty 1 pcs thread M8x0.75		
	GEV No.	100885	Ref. No.	C5815189
	description	air mixing sleeve for pilot burner Qty 1 pcs		
	GEV No.	100904	Ref. No.	—
	description	locking screw M10x1 for pipe ø 4mm Qty 1 pcs		
	GEV No.	100905	Ref. No.	C5815359
	description	locking screw M10x1 for pipe ø 6mm Qty 1 pcs		
	GEV No.	106844	Ref. No.	C5815249 C5815309
	description	pilot burner 1 flame		
	GEV No.	106845	Ref. No.	C5815099
	description	pilot burner centre part ø 8mm		
	GEV No.	107483	Ref. No.	C5815169
	description	pilot burner bottom part LPG code 20		
	GEV No.	697942	Ref. No.	C5815279
	description	gasket for pilot burner ø 35.5mm thickness 1mm		

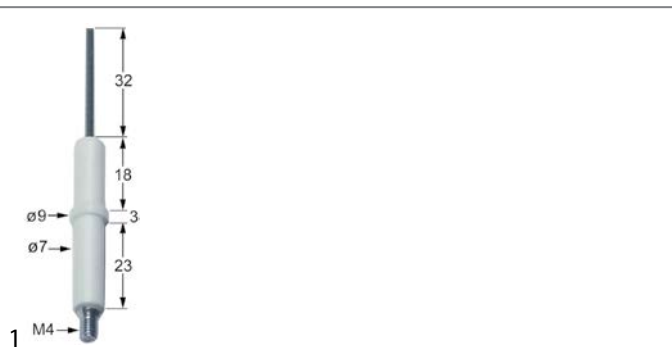

electrodes



GEV No.	100701	Ref. No.	C5810139
description	ignition electrode connection M4 Qty 1 pcs		
For models:	4101G, 41G, 61G, 741G, 761GG, 820M, CP7G, CP9G, FG20, FG220, FT-87CG, FT87G, HA21G, HAD21G, HAG, M10G, M15G, M770G, MBM10G, MBM15G, PG47, PG87, PG89, SF10MG, SF20MG, SFCGG, SFCMG, SFCPG, SPGG, SPPG, ST120G, ST80G		
accessories for	100701		
		GEV No.	100906
		Ref. No.	A1018998
	screw connection thread M10x1 for ignition electrode brass Qty 1 pcs WS 10		



GEV No.	102314	Ref. No.	96010061
description	ignition electrode D1 ø 7mm D2 ø 9mm connection M4 L1 2mm BL1 28mm BL2 3mm BL3 23mm to clip		
For models:	CP7G, CP9G		

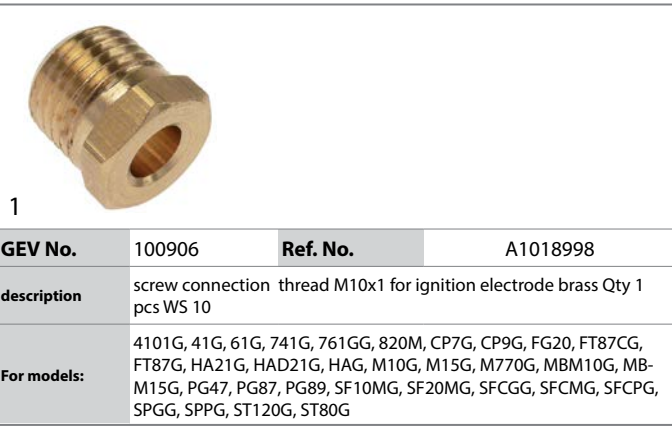

GEV No.	100906	Ref. No.	A1018998
description	screw connection thread M10x1 for ignition electrode brass Qty 1 pcs WS 10		
For models:	4101G, 41G, 61G, 741G, 761GG, 820M, CP7G, CP9G, FG20, FT87CG, FT87G, HA21G, HAD21G, HAG, M10G, M15G, M770G, MBM10G, MBM15G, PG47, PG87, PG89, SF10MG, SF20MG, SFCGG, SFCMG, SFCPG, SPGG, SPPG, ST120G, ST80G		

ignition cables

pre-assembled cables

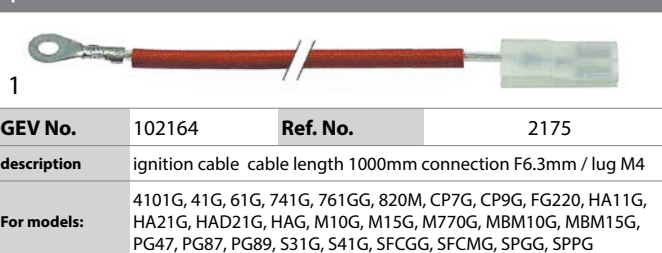

GEV No.	102164	Ref. No.	2175
description	ignition cable cable length 1000mm connection F6.3mm / lug M4		
For models:	4101G, 41G, 61G, 741G, 761GG, 820M, CP7G, CP9G, FG220, HA11G, HA21G, HAD21G, HAG, M10G, M15G, M770G, MBM10G, MBM15G, PG47, PG87, PG89, S31G, S41G, SFCGG, SFCMG, SPGG, SPPG		

piezoelectric igniters

miscellaneous

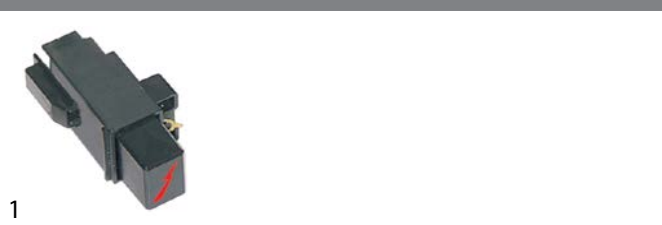

GEV No.	nla ¹	Ref. No.	3747
description	piezoelectric igniter suitable for Minisit connection F6.3x0.8 ømm		
For models:	4101G, 41G, 61G, 741G, 761GG, 820M, FT87CG, HAG, M15G, PG89, S31G, SF20MG, SFCGG, SFCMG, SFCPG, SPGG, SPPG, ST120G, ST80G		

¹no longer available

thermocouples

plug-in thermocouples



plug-in thermocouples standard

with barrel socket ø6(6.5)mm

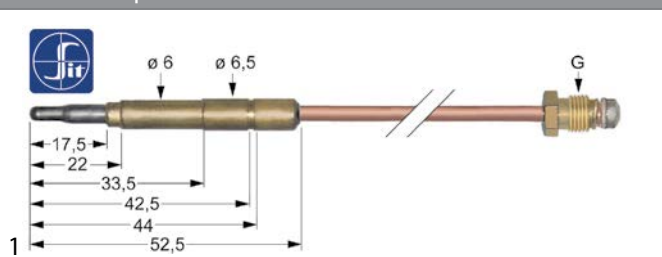
thermocouples SIT



GEV No.	107602	Ref. No.	C5811809
description	thermocouple SIT M8x1 L 850mm plug connection ø6.0(6.5)mm		
For models:	HA11G, S31G, S41G		
accessories for	107602		

		GEV No.	100920	Ref. No.	—
	thermocouple fitting thread M8x1 / M9x1 Qty 1 pcs				
		GEV No.	100922	Ref. No.	—
	thermocouple fitting thread M10x1 / ASA 11/32 Qty 1 pcs				

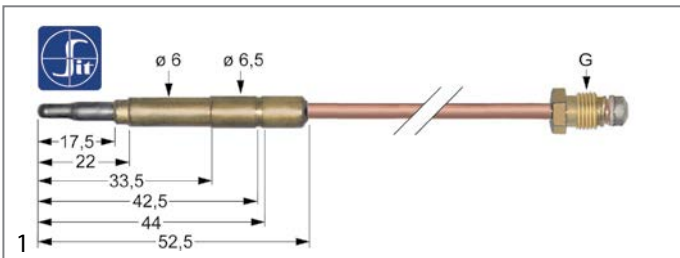

GEV No.	107612	Ref. No.	C5811009
description	thermocouple SIT M9x1 L 1000mm plug connection $\phi 6.0(6.5)$ mm		
For models:	4101G		

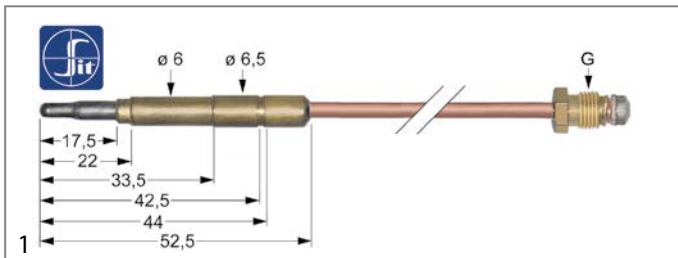

GEV No.	107611	Ref. No.	C5811679
description	thermocouple SIT M9x1 L 850mm plug connection $\phi 6.0(6.5)$ mm		
For models:	41G, HA21G, HAD21G, HAG		

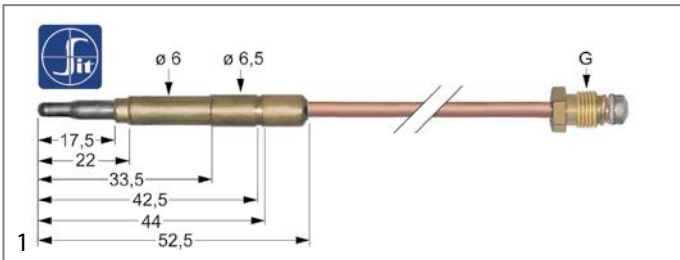

GEV No.	107614	Ref. No.	C5811059
description	thermocouple SIT M9x1 L 1500mm plug connection $\phi 6.0(6.5)$ mm		
For models:	741G, M10G, M15G, M770G, MBM10G, MBM15G		

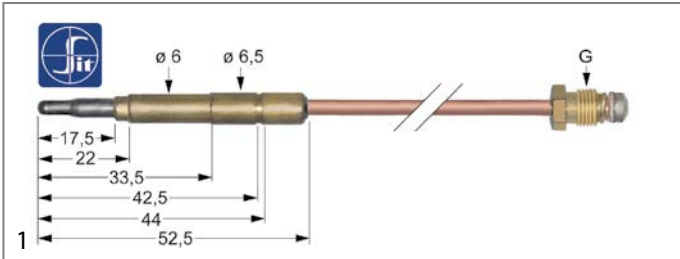

GEV No.	107606	Ref. No.	C5820049
description	thermocouple SIT M9x1 L 320mm plug connection $\phi 6.0(6.5)$ mm		
For models:	AP10G, AP15G, AP20G, AP30G, AP40G, AP5G, AP60G, AP80G, FT87CG, FT87G, PG89, SF10MG, SF20MG, SFCGG, SFCMG, SFCPG, ST120G, ST80G		

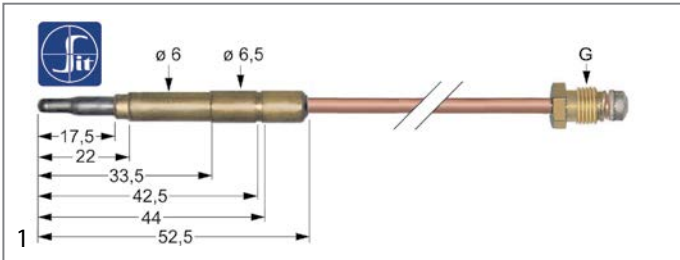

GEV No.	107609	Ref. No.	C5811829
description	thermocouple SIT M9x1 L 600mm plug connection $\phi 6.0(6.5)$ mm		
For models:	4101G, 41G, 61G, 741G, 761GG, 820M, CP7G, CP9G, HA11G, HAG, M15G, PG47, PG87, PG89, S41G, SF20MG, SFCGG, SFCMG, SPGG, SPPG		

threaded thermocouples
threaded thermocouples standard
with socket with thread M8x1
SIT

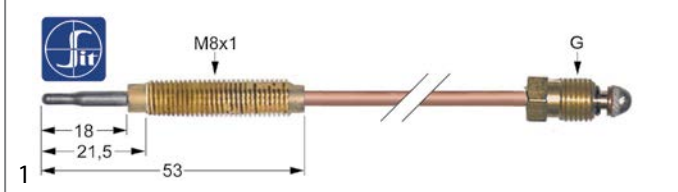

GEV No.	107628	Ref. No.	C5811019
description	thermocouple SIT M8x1 L 320mm M8x1		
For models:	41G, 61G, 741G, B1G, B2G, B3G, BC1G, BC2G, BC3G, BF1G, BF2G, BF3G, BP1G, BP2G, BP3G, S20G, S20PG, S21G, S31G, S40G, S41G		

accessories for	107628		
	GEV No.	102067	Ref. No.
			C5811029
	nut thread M8x1 H 3mm brass Qty 1 pcs type SEF 1		

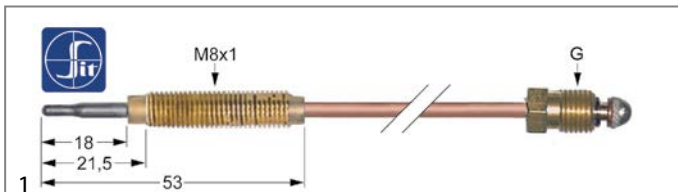

GEV No.	107629	Ref. No.	C5811039
description	thermocouple SIT M8x1 L 450mm M8x1		
For models:	AP10E, AP10G, AP15E, AP15G, AP20E, AP20G, AP30E, AP30G, AP40E, AP40G, AP55G, AP5E, AP5G, AP60E, AP60G, AP75G, AP80E, AP80G		

accessories for	107629		
	GEV No.	102067	Ref. No.
			C5811029
	nut thread M8x1 H 3mm brass Qty 1 pcs type SEF 1		

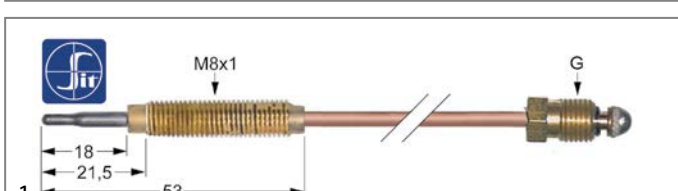

GEV No.	107638	Ref. No.	C5811049
description	thermocouple SIT M9x1 L 1000mm M8x1		
For models:	41G, 741G, 820M		



GEV No.	107635	Ref. No.	C5811739
description	thermocouple SIT M9x1 L 320mm M8x1		
For models:	H3		
accessories for	107635		
	GEV No.	102067	Ref. No. C5811029
	nut thread M8x1 H 3mm brass Qty 1 pcs type SEF 1		

GEV No.	107636	Ref. No.	C5811849
description	thermocouple SIT M9x1 L 600mm M8x1		
For models:	H4		
accessories for	107636		
	GEV No.	102067	Ref. No. C5811029
	nut thread M8x1 H 3mm brass Qty 1 pcs type SEF 1		

type Junkers with aluminised tip

GEV No.	102233	Ref. No.	C5811129
description	thermocouple M8x1 L 750mm M8x1		
For models:	41G, 61G		
accessories for	102233		
	GEV No.	102067	Ref. No. C5811029
	nut thread M8x1 H 3mm brass Qty 1 pcs type SEF 1		

accessories

nuts

GEV No.	102067	Ref. No.	C5811029
description	nut thread M8x1 H 3mm brass Qty 1 pcs type SEF 1		
For models:	AP10E, AP10G, AP15E, AP15G, AP20E, AP20G, AP30E, AP30G, AP40E, AP40G, AP55G, AP5E, AP5G, AP60E, AP60G, AP75G, AP80E, AP80G, APP6G, APP8G, B1G, B2G, B3G, BC1G, BC2G, BC3G, BF1G, BF2G, BF3G, BP1G, BP2G, BP3G, S31G		

gas burners

hob burners

universal hob burners

ARC

65 series

GEV No.	104328	Ref. No.	C5815139
description	burner pipe 4.5kW L 93mm total length 108mm air mixer ø 18.2mm ED ø 32.9mm ID ø 22.7mm		
For models:	41G, 61G, 720G, 741G, 761GG, 820M, S20G, S20PG, S21G, S40G, S41G		

SABAF









1 series

GEV No.	104288	Ref. No.	C5815589
description	burner cap 3.6kW ø 120mm		
For models:	B1G, B2G, B3G		
accessories for	104288		
	GEV No.	104289	Ref. No. C5815609
	burner lower part 3/3.6kW for burner cap ø 90/120mm		
	GEV No.	105086	Ref. No. C5815579
	burner ring 3.6kW for burner cap ø 120mm		
	GEV No.	105087	Ref. No. C5815599
	burner head 3.6kW for burner cap ø 120mm		

GEV No.	105087	Ref. No.	C5815599
description	burner head 3.6kW for burner cap ø 120mm		
For models:	B1G, B2G, B3G		
accessories for	105087		
	GEV No.	104288	Ref. No. C5815589
	burner cap 3.6kW ø 120mm		
	GEV No.	105085	Ref. No. —
	burner cap ø 120mm		
	GEV No.	105086	Ref. No. C5815579
	burner ring 3.6kW for burner cap ø 120mm		
	GEV No.	105088	Ref. No. —
	burner cap A ø 110mm with central hole		
	GEV No.	105089	Ref. No. —
	burner ring 3kW for burner cap ø 90mm		

1 gas components



			
1			
GEV No.	104289	Ref. No.	C5815609
description	burner lower part 3/3.6kW for burner cap ø 90/120mm		
For models:	B1G, B2G, B3G		
accessories for	104289		
	GEV No.	104286	Ref. No. —
	burner cap 3kW ø 90mm		
	GEV No.	104288	Ref. No. C5815589
	burner cap 3.6kW ø 120mm		
	GEV No.	105086	Ref. No. C5815579
	burner ring 3.6kW for burner cap ø 120mm		
	GEV No.	105087	Ref. No. C5815599
	burner head 3.6kW for burner cap ø 120mm		
	GEV No.	105089	Ref. No. —
	burner ring 3kW for burner cap ø 90mm		
	GEV No.	105090	Ref. No. —
	burner head 3kW for burner cap ø 90mm		
	GEV No.	106482	Ref. No. —
	gas injector thread M6x0.75 WS 7 bore ø 1.1mm		
	GEV No.	106485	Ref. No. —
	gas injector thread M6x0.75 WS 7 bore ø 1.6mm		

			
1			
GEV No.	105086	Ref. No.	C5815579
description	burner ring 3.6kW for burner cap ø 120mm		
For models:	B1G, B2G, B3G		
accessories for	105086		
	GEV No.	105085	Ref. No. —
	burner cap ø 120mm		
	GEV No.	105087	Ref. No. C5815599
	burner head 3.6kW for burner cap ø 120mm		
	GEV No.	105088	Ref. No. —
	burner cap A ø 110mm with central hole		
	GEV No.	105089	Ref. No. —
	burner ring 3kW for burner cap ø 90mm		

tube burners

			
1			
GEV No.	104414	Ref. No.	C5815399
description	tubular burner ø 74mm L 180mm thread 3/8" H 52mm ID ø 25mm W 74mm		
For models:	SF10MG, SF20MG		

ceramic burners

			
1			
GEV No.	101938	Ref. No.	530587M 534030P
description	ceramic burner L 845mm W 86mm firing range 61x801mm chicken rotisserie		
For models:	AP10E, AP10G, AP15E, AP15G, AP20E, AP20G, AP30E, AP30G, AP40E, AP40G, AP55G, AP5E, AP5G, AP60E, AP60G, AP75G, AP80E, AP80G		

gas nozzles

main nozzles

gas nozzles M10x1

			
1			
GEV No.	107827	Ref. No.	C5812660
description	gas injector thread M10x1 WS 12 bore ø 1.45mm GN		
For models:	11G, 4101G, H3, H4		

			
1			
GEV No.	107828	Ref. No.	C5812680
description	gas injector thread M10x1 WS 12 bore ø 1.9mm GLP		
For models:	11G, 4101G, AP15G, AP20G, AP30G, AP40G, AP55G, AP75G, APP6G, APP8G, H3, H4		





 <p>1</p>			
GEV No.	107826	Ref. No.	C5812640
description	gas injector thread M10x1 WS 12 bore ø 1mm GLP		
For models:	11G, 4101G, H3, H4		

 <p>1</p>			
GEV No.	107829	Ref. No.	C5812689
description	gas injector thread M10x1 WS 12 bore ø 2.2mm GN		
For models:	11G, H4		

pilot burner nozzles

pilot burner nozzles POLIDORO



 <p>1</p>			
GEV No.	100000	Ref. No.	C5810169
description	pilot burner nozzle POLIDORO LPG code 22 bore ø 0.22mm Qty 1 pcs		
For models:	4101G, 41G, 61G, 741G, 761GG, 820M, CP7G, CP9G, FG20, FG220, FT-87CG, FT87G, HA21G, HAD21G, HAG, M10G, M15G, M770G, MBM10G, MBM15G, PG47, PG87, PG89, SF10MG, SF20MG, SFCGG, SFCMG, SFCPG, SPGG, SPPG, ST120G, ST80G		

 <p>1</p>			
GEV No.	106703	Ref. No.	C5810159
description	pilot burner nozzle POLIDORO natural gas code 27.2 bore ø 2x0.27mm Qty 1 pcs		
For models:	4101G, 41G, 61G, 741G, 761GG, 820M, CP7G, CP9G, FG20, FG220, FT-87CG, FT87G, HA21G, HAD21G, HAG, M10G, M15G, M770G, MBM10G, MBM15G, PG47, PG87, PG89, SF10MG, SF20MG, SFCGG, SFCMG, SFCPG, SPGG, SPPG, ST120G, ST80G		

auxiliary gas parts

screw connections

olives

 <p>1</p>			
GEV No.	101278	Ref. No.	3781
description	olive for pipe ø 10mm Qty 1 pcs		
For models:	11G, 4101G, 41G, 61G, 720G, 741G, 761GG, 820M, BC2G, BC3G, BF2G, BF3G, BP2G, BP3G, CP7G, CP9G, FG20, FG220, FT87CG, FT87G, H3, H4, HA21G, HAD21G, HAG, M10G, M15G, M770G, MBM10G, MBM15G, PG47, PG87, PG89, S20G, S20PG, S21G, S40G, S41G, SF10MG, SF20MG, SFCGG, SFCMG, SFCPG, SPGG, SPPG, ST120G, ST80G		
accessories for	101278		
	GEV No.	100943	Ref. No.
			—
	 <p>union nut thread M17x1 tube ø 10mm</p>		

accessories for	101278		
	GEV No.	101300	Ref. No.
			3782
	union nut thread M16x1.5 tube ø 10mm		
	GEV No.	101478	Ref. No.
			—
	union nut thread 3/8" for pipe ø 10mm		

 <p>1</p>			
GEV No.	102797	Ref. No.	A1018999
description	olive for pipe ø 6mm Qty 1 pcs		
For models:	4101G, 41G, 61G, 741G, 761GG, 820M, CP7G, CP9G, FG20, FG220, FT-87CG, FT87G, HA21G, HAD21G, HAG, M10G, M15G, M770G, MBM10G, MBM15G, PG47, PG87, PG89, SF10MG, SF20MG, SFCGG, SFCMG, SFCPG, SPGG, SPPG, ST120G, ST80G		

union nuts

 <p>1</p>			
GEV No.	101296	Ref. No.	C5815539
description	union nut thread M12x1 for pipe ø 8mm		
For models:	S31G		
accessories for	101296		
	GEV No.	101277	Ref. No.
			C5815549
	olive ID ø 8mm Qty 1 pcs		

 <p>1</p>			
GEV No.	101300	Ref. No.	3782
description	union nut thread M16x1.5 tube ø 10mm		
For models:	11G, 4101G, 41G, 61G, 720G, 741G, 761GG, 820M, BC2G, BC3G, BF2G, BF3G, BP2G, BP3G, CP7G, CP9G, FG20, FG220, FT87CG, FT87G, H3, H4, HA21G, HAD21G, HAG, M10G, M15G, M770G, MBM10G, MBM15G, PG47, PG87, PG89, S20G, S20PG, S21G, S40G, S41G, SF10MG, SF20MG, SFCGG, SFCMG, SFCPG, SPGG, SPPG, ST120G, ST80G		
accessories for	101300		
	GEV No.	101278	Ref. No.
			3781
	olive for pipe ø 10mm Qty 1 pcs		

union screws



GEV No.	100905	Ref. No.	C5815359
description	locking screw M10x1 for pipe ø 6mm Qty 1 pcs		
For models:	11G, 4101G, 41G, 61G, 720G, 741G, 761GG, CP7G, CP9G, FG20, FG220, FT87CG, FT87G, H3, H4, HA21G, HAD21G, HAG, M10G, M15G, M770G, MBM10G, MBM15G, PG47, PG87, PG89, S20G, S20PG, S21G, S40G, S41G, SF10MG, SF20MG, SFCGG, SFCMG, SFPCPG, SPGG, SPPG, ST120G, ST80G		



GEV No.	100906	Ref. No.	A1018998
description	screw connection thread M10x1 for ignition electrode brass Qty 1 pcs WS 10		
For models:	4101G, 41G, 61G, 741G, 761GG, 820M, CP7G, CP9G, FG20, FT87CG, FT87G, HA21G, HAD21G, HAG, M10G, M15G, M770G, MBM10G, MBM15G, PG47, PG87, PG89, SF10MG, SF20MG, SFCGG, SFCMG, SFPCPG, SPGG, SPPG, ST120G, ST80G		



GEV No.	100907	Ref. No.	A1018996
description	screw connection thread M10x1 Qty 1 pcs type SEF 1 ømm for thermocouple		
For models:	4101G, 41G, 61G, 741G, 761GG, 820M, CP7G, CP9G, FG20, FG220, FT87CG, FT87G, HA21G, HAD21G, HAG, M10G, M15G, M770G, MBM10G, MBM15G, PG47, PG87, PG89, SF10MG, SF20MG, SFCGG, SFCMG, SFPCPG, SPGG, SPPG, ST120G, ST80G		



GEV No.	100909	Ref. No.	A1018997
description	union screw thread M10x1 for pipe ø 6mm Qty 1 pcs		
For models:	4101G, 41G, 61G, 741G, 761GG, 820M, CP7G, CP9G, FG20, FG220, FT87CG, FT87G, HA21G, HAD21G, HAG, M10G, M15G, M770G, MBM10G, MBM15G, PG47, PG87, PG89, SF10MG, SF20MG, SFCGG, SFCMG, SFPCPG, SPGG, SPPG, ST120G, ST80G		

accessories for	100909			
	GEV No.	100898	Ref. No.	—
	olive for pipe ø 6mm Qty 1 pcs for pilot burner			
	GEV No.	101286	Ref. No.	—
	olive ID ø 6mm Qty 1 pcs			
	GEV No.	101287	Ref. No.	—
	olive for pipe ø 6mm Qty 1 pcs			

accessories for	100909			
	GEV No.	101288	Ref. No.	—
	olive for pipe ø 6mm L 6mm aluminium Qty 1 pcs ED ø 8.5mm			

equipment-specific units for chicken rotisserie

skewers



GEV No.	689000	Ref. No.	70290029
description	skewer square L 835mm thickness 12mm		
For models:	AP10E, AP10G, AP15E, AP15G, AP20E, AP20G, AP30E, AP30G, AP40E, AP40G, AP55G, AP5E, AP5G, AP60E, AP60G, AP75G, AP80E, AP80G		

spit clamp



GEV No.	693143	Ref. No.	7024D001
description	skewer clamp crimping range 13x13mm ² double for skewer 12x12mm mounting pos. inner skewer 2x60mm skewer ø 4mm		
For models:	AP10E, AP10G, AP15E, AP15G, AP20E, AP20G, AP30E, AP30G, AP40E, AP40G, AP55G, AP5E, AP5G, AP60E, AP60G, AP75G, AP80E, AP80G		



GEV No.	693142	Ref. No.	7024S001
description	skewer clamp single for skewer 12x12mm mounting pos. outer skewer 75mm skewer ø 4mm		
For models:	AP10E, AP10G, AP15E, AP15G, AP20E, AP20G, AP30E, AP30G, AP40E, AP40G, AP55G, AP5E, AP5G, AP60E, AP60G, AP75G, AP80E, AP80G		

accessories for	693142			
	GEV No.	697481	Ref. No.	—
	Thumb screw thread M6 thread L 8mm ø 14mm H 6mm SS			



knobs

producer-specific knobs

MAS-BAGA



1

GEV No.	111417	Ref. No.	348373PM
description	knob zero mark ø 71.5mm shaft ø 6x4.6mm shaft flat upper yellow/black		
For models:	AP10E, AP10G, AP15E, AP15G, AP20E, AP20G, AP30E, AP30G, AP40E, AP40G, AP55G, AP5E, AP5G, AP60E, AP60G, AP75G, AP80E, AP80G		



1

GEV No.	111416	Ref. No.	340373PM
description	knob zero mark ø 71.5mm shaft ø 8x6.5mm shaft flat upper yellow/black		
For models:	AP10E, AP10G, AP15E, AP15G, AP20E, AP20G, AP30E, AP30G, AP40E, AP40G, AP55G, AP5E, AP5G, AP60E, AP60G, AP75G, AP80E, AP80G		

handles and hand wheels

hand wheels

hand wheels



1

GEV No.	694357	Ref. No.	C6262619
description	hand wheel ø 200mm D1 ø 50mm bore ø 15mm hole ø 7.2mm thread groove widthmm L1 46mm L2 50mm handle length 90mm with folding handle		
For models:	ST120G, ST80G		

bracket handles



1

GEV No.	697944	Ref. No.	70491019
description	handle L 150mm H 38mm mounting distance 135mm thread M6 W 30mm black matt		
For models:	AP10E, AP10G, AP15E, AP15G, AP20E, AP20G, AP30E, AP30G, AP40E, AP40G, AP55G, AP5E, AP5G, AP60E, AP60G, AP75G, AP80E, AP80G, APP6G, APP8G, APV		

hinges

spring assisted hinges

producer-specific

CORECO



1

GEV No.	700830	Ref. No.	C6262001	
description	spring assisted hinge right/left L 75mm W 26mm H 102mm refrigeration units mounting distance 25mm			
For models:	AR02P, AR04, AR04P, AR12P, ARC10, ARM20			
accessories for	700830			
	GEV No.	700854	Ref. No.	—
	hinge camp type TRB/L1 36mm mounting pos. bottom right L 100mm W 48mm H 17mm zinc die cast, chrome-plated hole distance 6.5x51x28mm shaft diameter torx 12x12mmmm			

FAGOR



1

GEV No.	700830	Ref. No.	C6262001	
description	spring assisted hinge right/left L 75mm W 26mm H 102mm refrigeration units mounting distance 25mm			
For models:	AR02P, AR04, AR04P, AR12P, ARC10, ARM20			
accessories for	700830			
	GEV No.	700854	Ref. No.	—
	hinge camp type TRB/L1 36mm mounting pos. bottom right L 100mm W 48mm H 17mm zinc die cast, chrome-plated hole distance 6.5x51x28mm shaft diameter torx 12x12mmmm			

oven hinges

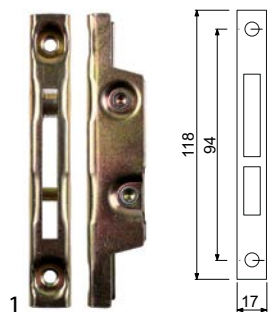

GEV No.	700001	Ref. No.	61980
description	opposite support L 118mm W 17mm mounting distance 94mm		
For models:	4101G, 41E, 41G, 61G, 741G, 761GG, 820M, 82E, HA11E, HA11G, HA21E, HA21G, HAD21E, HAD21G, HAG, S31G, S41E, S41G		



GEV No.	694359	Ref. No.	6160 C6262599
description	oven hinge mounting distance 105mm lever length 129.5mm spring thickness 4mm mounting ear position right L 206mm W 25mm Qty 1 pcs		
For models:	4101G, 41E, 41G, 61G, 741G, 761GG, 820M, 82E, HA11E, HA11G, HA21E, HA21G, HAD21E, HAD21G, HAG, S41E, S41G		



GEV No.	694360	Ref. No.	6163 C6262609
description	oven hinge mounting distance 173mm mounting distance 2 105mm lug mounting 14mm lever length 119mm groove distance 11mm spring thickness 4mm mounting ear position left spring length 111mm L 206mm W 25mm		
For models:	4101G, 41E, 41G, 61G, 741G, 761GG, 820M, 82E, HA11E, HA11G, HA21E, HA21G, HAD21E, HAD21G, HAG, S41E, S41G		

door bearing



GEV No.	694358	Ref. No.	C6262002
description	bolt L 25mm W 25mm H 19mm ID ø 7mm for hinge		
For models:	AR02P, AR04, AR04P, AR12P, ARC10		



GEV No.	694361	Ref. No.	706203P
description	hinge L 100mm W 48mm mounting pos. centre left/right		
For models:	AR02P, AR04, AR04P, AR12P, ARC10		



GEV No.	694034	Ref. No.	705003P
description	hinge right/left mounting pos. lower for fridge L 130mm W 80mm		
For models:	AR02P, AR04, AR04P, AR12P, ARC10, ARM20		



GEV No.	694033	Ref. No.	706003P
description	hinge right/left mounting pos. upper for fridge L 130mm W 80mm		
For models:	AR02P, AR04, AR04P, AR12P, ARC10, ARM20		

fittings for catering equipment

lid hinges

type RUBINETTERIE DEL FRIULI

for square and rectangular lids

spare parts



GEV No.	540848	Ref. No.	C6260349
description	torsion spring ø 43mm wire gauge ø 5mm L1 25mm L2 90mm L3 25mm mounting pos. left		
For models:	M10G, M15G, M770G, MBM10G, MBM15E, MBM15G, ST120G, ST80G		



			
1			
GEV No.	540849	Ref. No.	C6260339
description	torsion spring ϕ 43mm wire gauge ϕ 5mm L1 25mm L2 90mm L3 25mm mounting pos. right		
For models:	M10G, M15G, M770G, MBM10G, MBM15E, MBM15G, ST120G, ST80G		

miscellaneous
spare parts

			
1			
GEV No.	514418	Ref. No.	C6260239
description	adjusting bush ID ϕ 47mm ED ϕ 50mm L 63.5mm		
For models:	M10G, M15G, M770G, MBM10G, MBM15E, MBM15G, ST120G, ST80G		

			
1			
GEV No.	514194	Ref. No.	481240P
description	bracket for lid hinge ID ϕ 50mm H 89mm		
For models:	ST120G, ST80G		

			
1			
GEV No.	514193	Ref. No.	480340P
description	bracket for lid hinge ID ϕ 51mm H 185mm		
For models:	M10G, M15G, M770G, MBM10G, MBM15E, MBM15G		

gaskets

refrigeration gaskets

plug-in gaskets

profile 9798

We offer custom-made gaskets for this profile

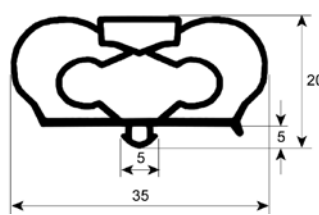
			
1			
GEV No.	901349	Ref. No.	705226P
description	refrigeration gasket profile 9798 W 602mm L 704mm plug size		
For models:	AR02P, AR04, AR04P, AR12P, ARC10		

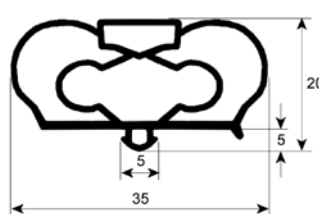
			
1			
GEV No.	901350	Ref. No.	746226P
description	refrigeration gasket profile 9798 W 604mm L 1492mm plug size		
For models:	AR12P, ARC10, ARM20		

gaskets for heated units

door seals

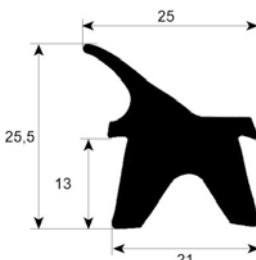
			
1			
GEV No.	901347	Ref. No.	490326P
description	door seal profile 2402 W 350mm L 575mm external size Qty 1		
For models:	4101G, 41E, 41G, 61G, 741G, 82E, HA11E, HA11G, HA21E, HA21G, HAD21E, HAD21G, S31G, S41E, S41G		

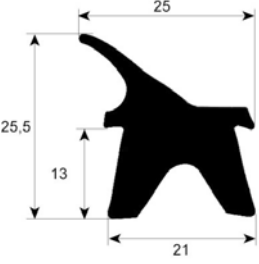

GEV No.	901348	Ref. No.	499926P
description	door seal profile 2402 W 350mm L 985mm external size Qty 1		
For models:	61G, 761GG, HAG		

O-rings

EPDM

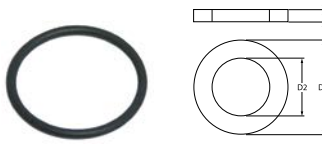

GEV No.	100809	Ref. No.	3785
description	O-ring EPDM thickness 2mm ID ø 21mm Qty 1 pcs		
For models:	4101G, 41G, 61G, 741G, 761GG, FG20, FG220, FT87CG, FT87G, HA21G, HAD21G, HAG, SF10MG, SF20MG, SFCGG, SFCMG, SFCPG, ST120G, ST80G		

springs

torsion springs



GEV No.	540848	Ref. No.	C6260349
description	torsion spring ø 43mm wire gauge ø 5mm L1 25mm L2 90mm L3 25mm mounting pos. left		
For models:	M10G, M15G, M770G, MBM10G, MBM15E, MBM15G, ST120G, ST80G		



GEV No.	540849	Ref. No.	C6260339
description	torsion spring ø 43mm wire gauge ø 5mm L1 25mm L2 90mm L3 25mm mounting pos. right		
For models:	M10G, M15G, M770G, MBM10G, MBM15E, MBM15G, ST120G, ST80G		

fastening material

screws

flat-headed bolts



GEV No.	101516	Ref. No.	1051
description	flat-headed bolt thread M4 thread L 16mm SS DIN 7985/ISO 7045 Qty 1 pcs		
For models:	4101G, 41G, 61G, 741G, 761GG, FG20, FG220, FT87CG, FT87G, HA21G, HAD21G, HAG, SF10MG, SF20MG, SFCGG, SFCMG, SFCPG, ST120G, ST80G		

nuts

hexagonal nuts

hexagonal nuts metric (without norm)



GEV No.	102680	Ref. No.	C5815299
description	nut thread M6x0.75 H 2.6mm WS 8 brass Qty 1 pcs type SEF 2		
For models:	41G, 61G, 720G, 741G, 761GG, 820M		



GEV No.	102067	Ref. No.	C5811029
description	nut thread M8x1 H 3mm brass Qty 1 pcs type SEF 1		
For models:	AP10E, AP10G, AP15E, AP15G, AP20E, AP20G, AP30E, AP30G, AP40E, AP40G, AP55G, AP5E, AP5G, AP60E, AP60G, AP75G, AP80E, AP80G, APP6G, APP8G, B1G, B2G, B3G, BC1G, BC2G, BC3G, BF1G, BF2G, BF3G, BP1G, BP2G, BP3G, S31G		

C			
cam switches	6		
capillary tube clips	5		
ceramic burners	14		
ceramic heaters	3		
coil heating elements	3		
contactors	7		
control thermostats	5, 5		
D			
door seals	19		
E			
electronic controllers	7		
energy regulators	4		
F			
fastening material	20		
flat-headed bolts	20		
foil heating elements	4		
G			
gas burners	13		
gas control valves	9		
gas nozzles	14		
gas taps	7		
gas thermostats	9		
gaskets for heated units	19		
H			
heating elements	3		
heating elements for fryers	3		
heating elements for ovens	3		
hexagonal nuts	20		
hob burners	13		
hot plates	4		
I			
ignition cables	11		
indicator lights	6		
indicator lights (complete)	6		
L			
lamps	6		
M			
motors	7		
N			
nuts	20		
O			
O-rings	20		
oven hinges	18		
oven lamps	6		
P			
piezoelectric igniters	11		
pilot burners	9		
plug-in gaskets	19		
R			
radiation heaters	4		
refrigeration gaskets	19		
rocker/momentary rocker switches	6		
S			
safety thermostats	5		
screws	20		
spring assisted hinges	17		
switches and momentary switches	6		
T			
thermocouples	11		
thermostats	5		
tube burners	14		