



GAS COMPONENTS



ELECTRIC COMPONENTS



WATER TECHNOLOGY



MECHANICAL COMPONENTS



TOOLS

Spare parts suitable for

MARENO

Find the complete and up-to-date range of products in our GEV Webshop



Manufacturer catalogue

The most important spare parts and accessories arranged clearly for every manufacturer

- ✓ Complete product range and all appliance data always up to date in the GEV Webshop
- ✓ Alphabetical Index at the end of the catalogue

GEV Webshop

www.gev-online.co.uk

www.gev-online.com




- 🔍 Add to Favourites
- 🔍 Sign In with email address and usual password
- 🔍 Easy-order – place several items in your basket at the same time
- 🔍 Quick item search – no login needed




heating elements


heating elements for ovens



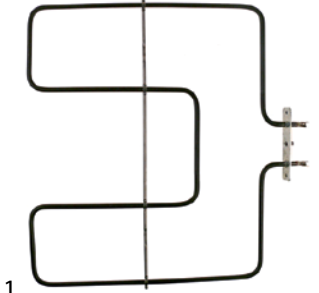
| | | | |
|--------------------|--|-----------------|--------------------------------|
| GEV No. | 415088 | Ref. No. | 1890500 213443 MA1890500 |
| description | heating element 1000W 220V L 557mm W 132mm flange length 175mm flange width 32mm hole distance 160mm tube ø 8.5mm connection length 33mm heating circuits 1 hole ø 6mm connection M5 dry heating element | | |
| For models: | C9F4E, C9F6E, C9FE6GS, C9V2E, C9V4E, NXBV7FC4, NXBV7FC8, V9F4E, V9FP4E, V9V2E, V9V4E, V9VP2E, V9VP4E, XBV7FC4, XBV7FC8, XBV9FC4, XBV9FC8 | | |




| | | | |
|--------------------|--|-----------------|------------------------|
| GEV No. | 416808 | Ref. No. | CM018102 MACM018102 |
| description | heating element 1000W 230V L 555mm W 63mm flange length 100mm flange width 22mm hole distance 86mm tube ø 8.5mm connection length 55mm heating circuits 1 hole ø 5.5mm connection male faston 6.3mm rectangular flange dry heating element | | |
| For models: | BF78E, BF98E, C7FE12G, C7FE8E, C7FE8EC, C7FE8G, C9FE12G, C9FE8E, C9FE8EC, C9FE8G | | |



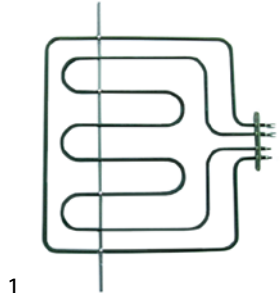
| | | | |
|--------------------|--|-----------------|----------------------------|
| GEV No. | 415968 | Ref. No. | 1037302400 MA1037302400 |
| description | heating element 1200W 230V heating circuits 1 L 346mm W 342mm L1 36mm L2 310mm W1 141mm W2 60mm flange length 100mm flange width 22mm hole distance 86mm hole ø 5mm tube ø 6.5mm connection male faston 6.3mm mounting pos. lower rectangular flange dry heating element | | |
| For models: | FOE60M, OFOE60M | | |




| | | | |
|--------------------|---|-----------------|----------------------------------|
| GEV No. | 418696 | Ref. No. | 0410150 CR0410150 CR410150 |
| description | heating element 1300W 230V heating circuits 1 L 350mm W 380mm L1 35mm L2 315mm W1 160mm W2 60mm flange length 100mm flange width 22mm hole distance 86mm bridge length 400mm hole ø 3.2mm tube ø 6mm connection male faston 6.3mm connection length 10mm windings 2 | | |
| For models: | CFE60, CFE60P, CFGE61, CFGE61D, CFGE61L, CFGE61P, CFVE60, OCFE60, OCFGE61 | | |



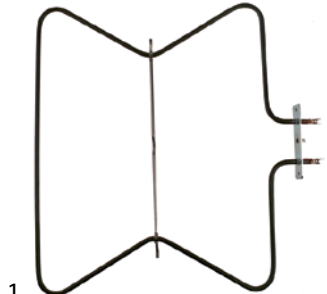
| | | | |
|--------------------|--|-----------------|-----------|
| GEV No. | 420111 | Ref. No. | CR0681390 |
| description | heating element 1500W 230V heating circuits 1 L 555mm W 210mm L1 70mm L2 485mm W1 88mm W2 33mm flange length 70mm flange width 22mm hole distance 56mm hole ø 5mm tube ø 8.5mm connection male faston 6.3mm connection length 17mm windings 3 flange connection dry heating element for oven | | |
| For models: | NC7FE12G36, NC7FE8E, NC7FE8EQ, NC7FE8G24, NC9FE12G44, NC9FE12G52, NC9FE8E, NC9FE8E2, NC9FE8G28, NC9FE8G36, NC9FE8G48 | | |



| | | | |
|--------------------|--|-----------------|----------------------------|
| GEV No. | 415967 | Ref. No. | 1037302300 MA1037302300 |
| description | heating element 2600W 230/400V heating circuits 2 L 355mm W 360mm L1 40mm L2 315mm W1 140mm W2 60mm flange length 100mm flange width 22mm hole distance 76mm bridge length 485mm hole ø 5mm tube ø 6.3mm connection male faston 6.3mm mounting pos. upper rectangular flange dry heating element | | |
| For models: | FOE60M, OFOE60M | | |



| | | | |
|--------------------|--|-----------------|----------------------|
| GEV No. | 415972 | Ref. No. | 1890600 MA1890600 |
| description | heating element 750W 230V L 483mm W 64mm H 21mm flange length 100mm flange width 22mm hole distance 85mm connection M5 tube ø 8.5mm heating circuits 1 rectangular flange hole ø 5mm dry heating element | | |
| For models: | C7011EFE, C7011EFEQ, C707EFE, C707EFEQ, CFE70, EC74EVG, EC78EVG, EC7FE8E | | |



| | | | |
|--------------------|---|-----------------|-----------|
| GEV No. | 418695 | Ref. No. | CR0410140 |
| description | heating element 900W 230V heating circuits 1 L 350mm W 390mm L1 40mm L2 310mm W1 165mm W2 60mm flange length 100mm flange width 22mm hole distance 86mm bridge length 300mm hole ø 3.2mm tube ø 6mm connection male faston 6.3mm connection length 10mm windings 4 oven | | |
| For models: | CFE60, CFE60P, CFGE61, CFGE61D, CFGE61L, CFGE61P, CFVE60, OCFE60, OCFGE61 | | |

1 electric components



heating elements for bain maries



| | | | |
|------------------------|--|-----------------|--------------------------------------|
| GEV No. | 415091 | Ref. No. | 1037039513 892600 MA1037039513 |
| description | heating element 1000W 230V heating circuits 1 L 295mm W 85mm connection length 20mm connection M3 tube ø 6.5mm 2 hole fixing thread M14x1 immersion heater/dry heating element bain marie/chip scuttle L1 145mm L2 150mm H 18mm mounting distance 79mm | | |
| For models: | BME40DM, BME40DMB, BME40M, BME60, BME602, BME60DM, BME60DMB, BME60M, BME80M, BSE40M, BSE140M, CSP6220, CSP6230, NSP74E, NSP94E, OBSE140M, SP74E, SP94E | | |
| spare parts for | 415091 | | |



| | | | |
|--------------------|---|-----------------|---|
| GEV No. | 510417 | Ref. No. | — |
| description | flat gasket fibre ED ø 20mm ID ø 14mm thickness 2mm Qty 1 pcs | | |

| | | | | |
|---|--|--------|-----------------|---|
| accessories for | 415091 | | | |
|  | GEV No. | 520228 | Ref. No. | — |
| description | tooth lock washer ID ø 15.3mm ED ø 24mm steel Qty 1 pcs for thread M14 | | | |



| | | | |
|--------------------|--|-----------------|----------------------|
| GEV No. | 521133 | Ref. No. | 1325313 MA1325313 |
| description | nut thread M14x1.5 H 6mm WS 19 zinc-coated steel Qty 1 pcs | | |



| | | | |
|--------------------|--|-----------------|---|
| GEV No. | 527169 | Ref. No. | — |
| description | hexagonal nut thread M3 H 2.8mm WS 5.5 brass Qty 1 pcs | | |



| | | | |
|--------------------|---|-----------------|---|
| GEV No. | 550261 | Ref. No. | — |
| description | nut thread M14x1 H 4mm WS 19 SS Qty 1 pcs | | |



| | | | |
|--------------------|--|-----------------|---|
| GEV No. | 550262 | Ref. No. | — |
| description | flat gasket copper ED ø 20mm ID ø 14mm thickness 2mm | | |




| | | | |
|--------------------|---|-----------------|---|
| GEV No. | 560110 | Ref. No. | — |
| description | plain washer ID ø 3.2mm ED ø 7mm thickness 0.5mm SS Qty 20 pcs DIN 125A for thread M3 | | |



| | | | |
|--------------------|--|-----------------|---|
| GEV No. | 560130 | Ref. No. | — |
| description | hexagonal nut thread M3 H 2.4mm WS 5.5 SS DIN/ISO DIN 934 / ISO 4032/8673 Qty 20 pcs | | |



| | | | |
|--------------------|--|-----------------|----------------------------|
| GEV No. | 415092 | Ref. No. | 1037039613 MA1037039613 |
| description | heating element 1300W 230V L 290mm W 130mm connection M4 tube ø 6.3mm 2 hole fixing thread M14x1.5 immersion heater L1 140mm L2 150mm H 18mm mounting distance 127mm | | |
| For models: | BME40M, BME60, BME602, BME60M, BME80M | | |







| | | | | |
|---|---|--------|-----------------|---|
| accessories for | 415092 | | | |
|  | GEV No. | 510417 | Ref. No. | — |
| description | flat gasket fibre ED ø 20mm ID ø 14mm thickness 2mm Qty 1 pcs | | | |



| | | | |
|--------------------|--|-----------------|---|
| GEV No. | 520228 | Ref. No. | — |
| description | tooth lock washer ID ø 15.3mm ED ø 24mm steel Qty 1 pcs for thread M14 | | |



| | | | |
|--------------------|--|-----------------|---|
| GEV No. | 520230 | Ref. No. | — |
| description | nut thread M14x1.5 H 5mm WS 19 zinc-coated steel Qty 1 pcs | | |

| | | | | |
|---|---|--------|-----------------|---|
| accessories for | 415092 | | | |
|  | GEV No. | 521101 | Ref. No. | — |
| description | nut thread M14x1.5 H 5mm WS 19 SS Qty 1 pcs | | | |
|  | GEV No. | 521103 | Ref. No. | — |
| description | nut thread M4 H 3mm WS 7 brass Qty 20 pcs | | | |
|  | GEV No. | 521104 | Ref. No. | — |
| description | washer ID ø 4.3mm ED ø 8mm thickness 0.5mm brass Qty 20 pcs for thread M4 | | | |
|  | GEV No. | 550262 | Ref. No. | — |
| description | flat gasket copper ED ø 20mm ID ø 14mm thickness 2mm | | | |
|  | GEV No. | 560111 | Ref. No. | — |
| description | plain washer ID ø 4.3mm ED ø 9mm thickness 0.8mm SS Qty 20 pcs DIN 125A for thread M4 | | | |
|  | GEV No. | 560131 | Ref. No. | — |
| description | hexagonal nut thread M4 H 3.2mm WS 7 SS DIN/ISO DIN 934 / ISO 4032/8673 Qty 20 pcs | | | |



| | | | |
|--------------------|--|-----------------|----------------------|
| GEV No. | 415979 | Ref. No. | 1634100 MA1634100 |
| description | heating element 1500W 230V heating circuits 1 L 497mm W 90mm flange length 124mm flange width 30mm hole distance 108mm connection length 33mm connection M5 tube ø 10mm rectangular flange hole ø 4mm dry heating element bain marie suitable for 700 series | | |
| For models: | BM74E, BM77E | | |



| | | | |
|--------------------|--|-----------------|----------------------|
| GEV No. | 415992 | Ref. No. | 1634200 MA1634200 |
| description | heating element 1800W 230V heating circuits 1 L 495mm W 90mm flange length 124mm flange width 30mm hole distance 108mm connection length 33mm connection M5 tube ø 10mm rectangular flange hole ø 4mm dry heating element bain marie | | |
| For models: | B74E, B78E, B94E, B98E, B9SB2E, B9SB4E, B9V2E, B9V4E, NB74E, NB78E, NB94E, NB98E | | |





| | | | |
|--------------------|--|-----------------|--------------------|
| GEV No. | 415081 | Ref. No. | 627510 MA627510 |
| description | heating element 1800W 240V heating circuits 1 L 500mm W 34mm connection M5 tube ø 8.5mm expansion flange bain marie flange 40x16mm | | |




| | | | |
|--------------------|--|-----------------|---------------------------------|
| GEV No. | 415083 | Ref. No. | 1368400 1634300 MA1634300 |
| description | heating element 2100W 220V heating circuits 1 L 500mm W 90mm flange length 124mm flange width 30mm hole distance 108mm connection length 33mm connection M5 tube ø 10mm rectangular flange hole ø 5mm bain marie suitable for 900 series | | |
| For models: | B9SB2E, B9SB4E, B9V2E, B9V4E, B9VP2E, B9VP4E, BM74E, BM77E | | |



| | | | |
|---|---|-----------------|-------|
|  | | | |
| GEV No. | 415082 | Ref. No. | 33610 |
| description | heating element 2200W 230V L 410mm W 34mm connection M5 tube ø 8.5mm expansion flange immersion heater flange 40x16mm | | |



| | | | |
|---|---|-----------------|-----------|
|  | | | |
| GEV No. | 418694 | Ref. No. | CR0502320 |
| description | heating element 750W 230V heating circuits 1 L 410mm W 63mm flange length 100mm flange width 22mm hole distance 86mm connection length 27mm connection male faston 6.3mm tube ø 8.5mm rectangular flange hole ø 5.5mm dry heating element | | |

heating elements for frying pans

| | | | |
|---|---|-----------------|----------------------------|
|  | | | |
| GEV No. | 416698 | Ref. No. | 1037317700 MA1037317700 |
| description | heating element 1350W 230V L 460mm W 95mm connection M4 tube ø 6.3mm dry heating element multi purpose roasting pan H 40mm connection distance 89mm | | |
| For models: | NVB74E, NVB74E2, NVB76E, NVB76E2, NVB96E, OVBE40, OVBE60, VB12C9E, VB74E, VB76E, VB96E, VBE40, VBE402, VBE40D, VBE40DB, VBE60, VBE602, VBE60D, VBE60DDB | | |

heating elements for chip scuttles

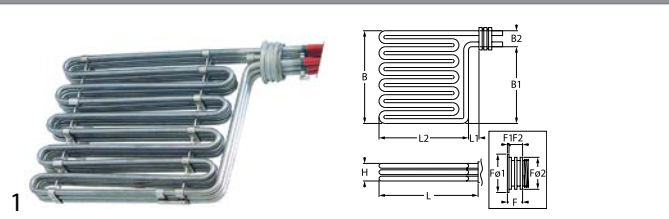
| | | | |
|---|---|-----------------|--------------------------------------|
|  | | | |
| GEV No. | 415091 | Ref. No. | 1037039513 892600 MA1037039513 |
| description | heating element 1000W 230V heating circuits 1 L 295mm W 85mm connection length 20mm connection M3 tube ø 6.5mm 2 hole fixing thread M14x1 immersion heater/dry heating element bain marie/ chip scuttle L1 145mm L2 150mm H 18mm mounting distance 79mm | | |
| For models: | BME40DM, BME40DMB, BME40M, BME60, BME602, BME60DM, BME60DMB, BME60M, BME80M, BSE40M, BSEI40M, CSP6220, CSP6230, NSP74E, NSP94E, OBSEI40M, SP74E, SP94E | | |
| spare parts for | 415091 | | |
|  | GEV No. | 510417 | Ref. No. — |
| | flat gasket fibre ED ø 20mm ID ø 14mm thickness 2mm Qty 1 pcs | | |
| accessories for | 415091 | | |
|  | GEV No. | 520228 | Ref. No. — |
| | tooth lock washer ID ø 15.3mm ED ø 24mm steel Qty 1 pcs for thread M14 | | |
|  | GEV No. | 521133 | Ref. No. 1325313 MA1325313 |
| | nut thread M14x1.5 H 6mm WS 19 zinc-coated steel Qty 1 pcs | | |
|  | GEV No. | 527169 | Ref. No. — |
| | hexagonal nut thread M3 H 2.8mm WS 5.5 brass Qty 1 pcs | | |
|  | GEV No. | 550261 | Ref. No. — |
| | nut thread M14x1 H 4mm WS 19 SS Qty 1 pcs | | |
|  | GEV No. | 550262 | Ref. No. — |
| | flat gasket copper ED ø 20mm ID ø 14mm thickness 2mm | | |




| | | | |
|---|---|--------|-------------------|
| accessories for | 415091 | | |
|  | GEV No. | 560110 | Ref. No. — |
| | plain washer ID ø 3.2mm ED ø 7mm thickness 0.5mm SS Qty 20 pcs DIN 125A for thread M3 | | |
|  | GEV No. | 560130 | Ref. No. — |
| | hexagonal nut thread M3 H 2.4mm WS 5.5 SS DIN/ISO DIN 934 / ISO 4032/8673 Qty 20 pcs | | |

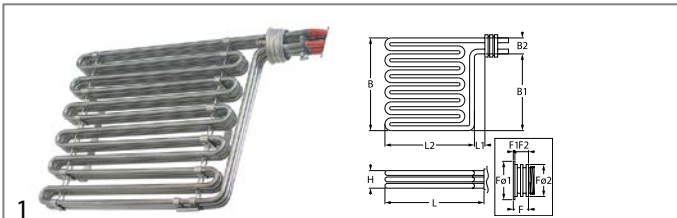
heating elements for fryers

side connection

with thread



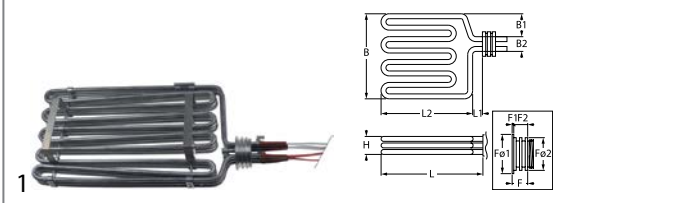
| | | | |
|---|---|-----------------|--|
| GEV No. | 416813 | Ref. No. | CM032101 CM032101R MACM032101 MACM032101R |
| description | heating element 10500W 230/400V heating circuits 3 mounting pos. right L 320mm W 240mm H 32mm flange length 21mm flange length 1 2mm flange length 2 19mm flange ø1 63mm flange ø2 57.5mm sensor screw connection 2x M10x1 thermostat sleeve upper/lower L1 20mm L2 300mm W1 204mm W2 33mm thread M54x1.5 windings 5 tube ø 8.5mm cable length 460mm rotation flange fryer fryer connection length 90mm 2 | | |
| For models: | EF74E12, F12C4E12, F74E10, F74E12, F76E10, F78E12, F94E10, F94E12, F94E18, F94E18K, F96E10, F98E12, F98E18, F98E18K, F9S4E12, F9S4E18, F9S4E18K, F9S8E12, F9S8E18, F9S8E18K | | |
| accessories for | 416813 | | |
|  | GEV No. | 550449 | Ref. No. — |
| | special wrench for ring nut | | |
|  | GEV No. | 550496 | Ref. No. CM099200 MACM099200 |
| | O-ring Viton thickness 3.53mm ID ø 50.39mm Qty 1 pcs | | |
|  | GEV No. | 550662 | Ref. No. CM021600 MACM021600 |
| | ring nut thread M54x1.5 H 7mm | | |



| | | | |
|--------------------|--|-----------------|--|
| GEV No. | 416814 | Ref. No. | CM032401 CM032401R MACM032401 MACM032401R |
| description | heating element 16500W 230/400V heating circuits 3 mounting pos. right L 400mm W 315mm H 36mm flange length 23mm flange length 1 2mm flange length 2 21mm flange ø1 63mm flange ø2 57.5mm sensor screw connection 2x M10x1 thermostat sleeve eccentric L1 15mm L2 378mm W1 282mm W2 33mm thread M54x1.5 windings 6 for o-ring ø 50.39mm tube ø 8.5mm cable length 280mm connection cable rotation flange immersion heater fryer connection length 75mm 2 | | |
| For models: | F74E10, F74E12, F76E10, F78E12, F94E10, F94E12, F94E18, F94E18K, F96E10, F98E12, F98E18, F98E18K, F954E12, F954E18, F954E18K, F958E12, F958E18, F958E18K | | |

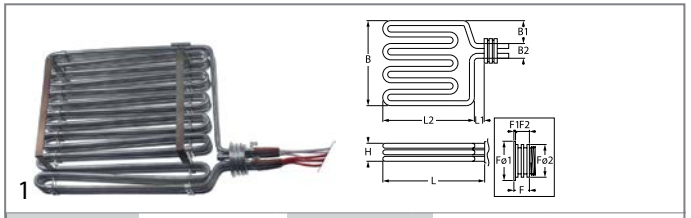
| | | | | |
|------------------------|--|--------|-----------------|------------------------|
| accessories for | 416814 | | | |
| | GEV No. | 106605 | Ref. No. | CM012401 MACM012401 |
| | union screw thread M10x1 probe ø max. 4.5mm | | | |
| | GEV No. | 528687 | Ref. No. | CM097900 MACM097900 |
| | O-ring Viton thickness 1.78mm ID ø 3.69mm Qty 1 pcs | | | |
| | GEV No. | 550496 | Ref. No. | CM099200 MACM099200 |
| | O-ring Viton thickness 3.53mm ID ø 50.39mm Qty 1 pcs | | | |
| | GEV No. | 550662 | Ref. No. | CM021600 MACM021600 |
| | ring nut thread M54x1.5 H 7mm | | | |

off-center connection
with thread

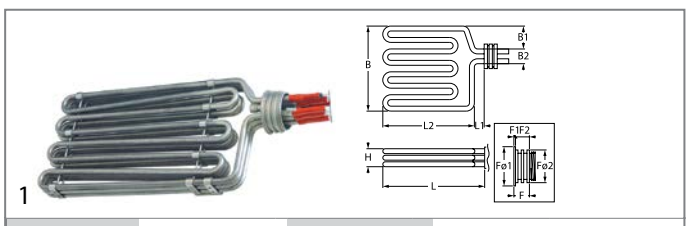


| | | | |
|--------------------|---|-----------------|-------------------------|
| GEV No. | 420113 | Ref. No. | CR0583860 CR0583860R |
| description | heating element 12000W 230V heating circuits 3 L 385mm W 205mm H 32mm flange length 21mm flange length 1 2mm flange length 2 19mm flange ø1 63mm flange ø2 54mm sensor screw connection 2x M10x1 thermostat sleeve upper/lower L1 20mm L2 365mm W1 45mm W2 32mm thread M54x1.5 tube ø 8.5mm cable length 300mm rotation flange immersion heater with probe intake ø 4mm for fryer | | |
| For models: | NF74E15, NF78E15, NF94E15, NF98E15 | | |

| | | | | |
|------------------------|--|--------|-----------------|------------------------|
| accessories for | 420113 | | | |
| | GEV No. | 532681 | Ref. No. | CR0582140 |
| | O-ring Viton thickness 3.53mm ID ø 66.27mm Qty 1 pcs | | | |
| | GEV No. | 550496 | Ref. No. | CM099200 MACM099200 |
| | O-ring Viton thickness 3.53mm ID ø 50.39mm Qty 1 pcs | | | |
| | GEV No. | 550662 | Ref. No. | CM021600 MACM021600 |
| | ring nut thread M54x1.5 H 7mm | | | |



| | | | | |
|------------------------|---|-----------------|-------------------------|------------------------|
| GEV No. | 420112 | Ref. No. | CR0583740 CR0583740R | |
| description | heating element 18000W 400V heating circuits 3 L 387mm W 305mm H 34mm flange length 21mm flange length 1 2.5mm flange length 2 18.5mm flange ø1 63mm flange ø2 54mm sensor screw connection 2x M10x1 thermostat sleeve upper/lower L1 25mm L2 362mm W1 45mm W2 32mm thread M54x1.5 tube ø 8.5mm cable length 350mm rotation flange immersion heater with probe intake ø 4mm for fryer | | | |
| For models: | NF94E22, NF94E222, NF94E222K, NF94E22K, NF98E22, NF98E222, NF98E222K, NF98E22K | | | |
| accessories for | 420112 | | | |
| | GEV No. | 550496 | Ref. No. | CM099200 MACM099200 |
| | O-ring Viton thickness 3.53mm ID ø 50.39mm Qty 1 pcs | | | |



| | | | |
|--------------------|---|-----------------|--|
| GEV No. | 416812 | Ref. No. | 1037316601 1037316601R MA1037316601 MA1037316601R |
| description | heating element 9000W 230/400V heating circuits 3 mounting pos. right L 360mm W 170mm H 35mm flange length 21mm flange length 1 2mm flange length 2 19mm flange ø1 63mm flange ø2 57.5mm thermostat sleeves ø 6.5mm sensor screw connection 2x M10x1 thermostat sleeve upper/lower L1 25mm L2 335mm W1 40mm W2 33mm thread M54x1.5 tube ø 8.7mm cable length 250mm rotation flange immersion heater with probe intake ø 4mm fryer code 3000 2 | | |
| For models: | EF74E10VG, F74E10, F74E6, F76E10, F94E10, F94E6, F96E10, FQE41R, FQE41RL, FQE41RL2, FQE61R, FQE61RL, NF74E10, NF76E10, NF94E10, NF96E10 | | |

| | | | | |
|------------------------|--|--------|-----------------|------------------------|
| accessories for | 416812 | | | |
| | GEV No. | 550496 | Ref. No. | CM099200 MACM099200 |
| | O-ring Viton thickness 3.53mm ID ø 50.39mm Qty 1 pcs | | | |
| | GEV No. | 550662 | Ref. No. | CM021600 MACM021600 |
| | ring nut thread M54x1.5 H 7mm | | | |

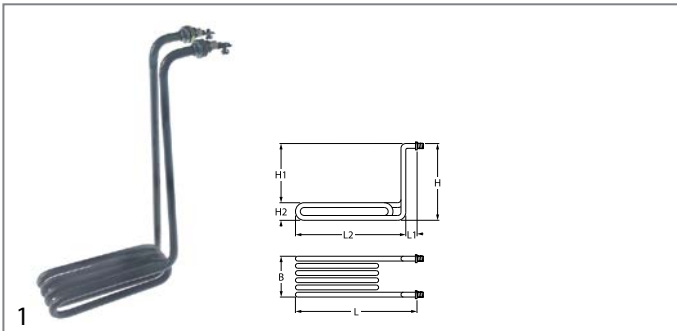




| | | | |
|------------------------|--|-----------------|--|
| | | | |
| GEV No. | 415090 | Ref. No. | 1037039900 1037039915 892900 MA1037039915 |
| description | heating element 5500W 230/400V heating circuits 3 L 325mm W 200mm H 210mm L1 15mm L2 310mm W1 67mm W2 66mm H1 183mm H2 25mm windings 12 flange length 115mm flange width 30mm hole distance 95mm hole ø 7mm connection M4 rectangular flange fryer heaters | | |
| For models: | FQE40, FQE40D, FQE40DSP, FQE60, FQE60D, FQE60DSP | | |
| accessories for | 415090 | | |
| | GEV No. | 521103 | Ref. No. — |
| | nut thread M4 H 3mm WS 7 brass Qty 20 pcs | | |
| | GEV No. | 521104 | Ref. No. — |
| | washer ID ø 4.3mm ED ø 8mm thickness 0.5mm brass Qty 20 pcs for thread M4 | | |
| | GEV No. | 560111 | Ref. No. — |
| | plain washer ID ø 4.3mm ED ø 9mm thickness 0.8mm SS Qty 20 pcs DIN 125A for thread M4 | | |
| | GEV No. | 560131 | Ref. No. — |
| | hexagonal nut thread M4 H 3.2mm WS 7 SS DIN/ISO DIN 934 / ISO 4032/8673 Qty 20 pcs | | |

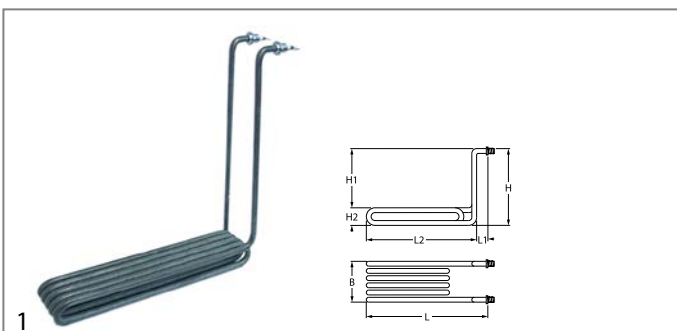
| | | | |
|--------------------|--|-----------------|--|
| | | | |
| GEV No. | 415963 | Ref. No. | 1037301600 1037301615 MA1037301615 |
| description | heating element 7500W 230/400V heating circuits 3 L 330mm W 194mm H 212mm L1 20mm L2 310mm W1 63mm W2 68mm H1 177mm H2 35mm windings 12 flange length 115mm flange width 30mm hole distance 95mm hole ø 6.5mm connection clamp tube ø 8.5mm rectangular flange fryer | | |
| For models: | FQE40, FQE40D, FQE40DSP, FQE60, FQE60D, FQE60DSP, FR74E10, FR77E10, FR92E10, FR94E10, FR9P2E10, FR9P4E10 | | |



| | | | |
|------------------------|--|-----------------|-------------------|
| <p>2 hole fixing</p> | | | |
| GEV No. | 415962 | Ref. No. | 1037314944 |
| description | heating element 2000W 230V heating circuits 1 L 318mm W 58mm H 200mm W1 8mm W2 40mm H1 155mm H2 45mm mounting distance 33mm thread M12x1 tube ø 8.5mm connection length 30mm connection male faston 6.3mm 2 hole fixing immersion heater | | |
| For models: | FQE41, FQE41L, FQE41L2, FQE61, FQE61L, FQE61L2, FR74E10, FR74E10L, FR74E10L2, FR77E10, FR77E10L, FR77E10L2, FR92E10, FR92E10L, FR92E10L2, FR94E10, FR94E10L, FR94E10L2 | | |
| accessories for | 415962 | | |
| | GEV No. | 361182 | Ref. No. — |
| | nut thread 1/4" H 5mm nickel-plated brass WS 17 Qty 1 pcs | | |
| | GEV No. | 510417 | Ref. No. — |
| | flat gasket fibre ED ø 20mm ID ø 14mm thickness 2mm Qty 1 pcs | | |
| | GEV No. | 520228 | Ref. No. — |
| | tooth lock washer ID ø 15.3mm ED ø 24mm steel Qty 1 pcs for thread M14 | | |
| | GEV No. | 550262 | Ref. No. — |
| | flat gasket copper ED ø 20mm ID ø 14mm thickness 2mm | | |

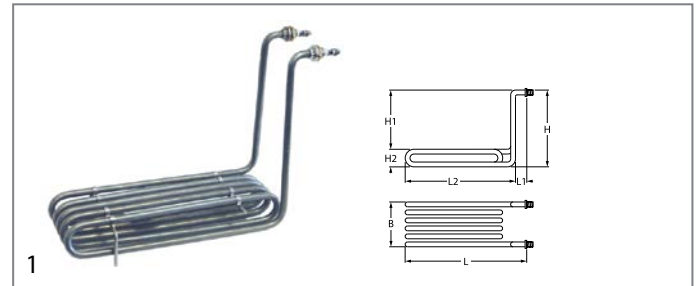
| | | | |
|------------------------|---|-----------------|-------------------|
| | | | |
| GEV No. | 415961 | Ref. No. | 1037313044 |
| description | heating element 3000W 230V heating circuits 1 L 325mm W 54mm H 206mm W1 9mm W2 37mm H1 167mm H2 42mm mounting distance 25mm thread M12x1 tube ø 8.5mm connection male faston 6.3mm 2 hole fixing immersion heater | | |
| For models: | FQE41, FQE41L, FQE41L2, FQE61, FQE61L, FQE61L2, FR74E10, FR74E10L, FR74E10L2, FR77E10, FR77E10L, FR77E10L2, FR92E10, FR92E10L, FR92E10L2, FR94E10, FR94E10L, FR94E10L2 | | |
| accessories for | 415961 | | |
| | GEV No. | 520229 | Ref. No. — |
| | nut thread M12x1 H 4mm WS 16 zinc-coated steel Qty 1 pcs | | |
| | GEV No. | 521110 | Ref. No. — |
| | flat gasket fibre ED ø 20mm ID ø 13mm thickness 2mm Qty 1 pcs | | |
| | GEV No. | 521131 | Ref. No. — |
| | nut thread M12x1 H 3.5mm WS 17 SS Qty 1 pcs | | |
| | GEV No. | 528110 | Ref. No. — |
| | O-ring EPDM thickness 2.62mm ID ø 12.37mm Qty 1 pcs | | |











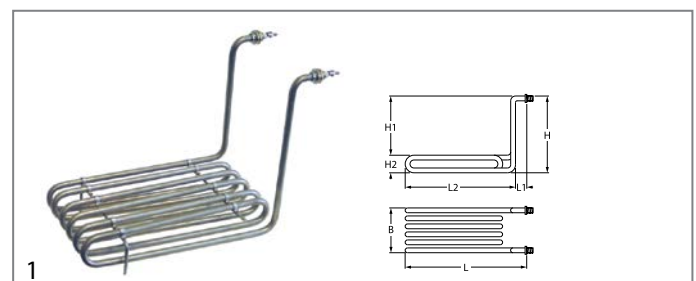
| | | | |
|---|--|-----------------|--|
| GEV No. | 415976 | Ref. No. | 1750000 MA1750000 |
| description | heating element 2300W 230V heating circuits 1 L 210mm W 66mm H 315mm L1 40mm L2 170mm H1 270mm H2 45mm thread M14x1.5 tube ø 10mm 2 hole fixing connection M5 windings 4 suitable for 700 series | | |
| For models: | FR74E, FR77E | | |
| accessories for | 415976 | | |
|  | GEV No. | 560112 | Ref. No. 15830499 MA15830499 |
| | plain washer ID ø 5.3mm ED ø 10mm thickness 1mm SS Qty 20 pcs DIN 125A for thread M5 | | |
|  | GEV No. | 560132 | Ref. No. — |
| | hexagonal nut thread M5 H 4mm WS 8 SS DIN/ISO DIN 934 / ISO 4032/8673 Qty 20 pcs | | |



| | | | |
|---|---|-----------------|--|
| GEV No. | 415986 | Ref. No. | 1464000 1466200 MA1464000 MA1466200 |
| description | heating element 5000W 220V heating circuits 1 L 346mm W 58mm H 330mm L1 26mm L2 320mm H1 288mm H2 42mm thread M14x1.25 tube ø 10mm 2 hole fixing connection M5 fryer windings 5 suitable for 900 series | | |
| For models: | FR92E13, FR92E132, FR92E13T, FR92E13T2, FR92E22, FR92E22T, FR94E13, FR94E132, FR94E13T, FR94E13T2, FR94E22, FR94E22T | | |
| accessories for | 415986 | | |
|  | GEV No. | 560112 | Ref. No. 15830499 MA15830499 |
| | plain washer ID ø 5.3mm ED ø 10mm thickness 1mm SS Qty 20 pcs DIN 125A for thread M5 | | |
|  | GEV No. | 560132 | Ref. No. — |
| | hexagonal nut thread M5 H 4mm WS 8 SS DIN/ISO DIN 934 / ISO 4032/8673 Qty 20 pcs | | |



| | | | |
|---|--|-----------------|----------------------------|
| GEV No. | 416576 | Ref. No. | 1037305600 MA1037305600 |
| description | heating element 2500W 220V heating circuits 1 L 285mm W 98mm H 214mm L1 20mm L2 265mm H1 174mm H2 40mm thread M12x1 tube ø 8.5mm 2 hole fixing connection M4 connection length 77mm fryer heaters windings 5 | | |
| For models: | FQE4 | | |
| accessories for | 416576 | | |
|  | GEV No. | 520229 | Ref. No. — |
| | nut thread M12x1 H 4mm WS 16 zinc-coated steel Qty 1 pcs | | |
|  | GEV No. | 521103 | Ref. No. — |
| | nut thread M4 H 3mm WS 7 brass Qty 20 pcs | | |
|  | GEV No. | 521104 | Ref. No. — |
| | washer ID ø 4.3mm ED ø 8mm thickness 0.5mm brass Qty 20 pcs for thread M4 | | |
|  | GEV No. | 521110 | Ref. No. — |
| | flat gasket fibre ED ø 20mm ID ø 13mm thickness 2mm Qty 1 pcs | | |
|  | GEV No. | 521131 | Ref. No. — |
| | nut thread M12x1 H 3.5mm WS 17 SS Qty 1 pcs | | |
|  | GEV No. | 528110 | Ref. No. — |
| | O-ring EPDM thickness 2.62mm ID ø 12.37mm Qty 1 pcs | | |
|  | GEV No. | 560111 | Ref. No. — |
| | plain washer ID ø 4.3mm ED ø 9mm thickness 0.8mm SS Qty 20 pcs DIN 125A for thread M4 | | |
|  | GEV No. | 560131 | Ref. No. — |
| | hexagonal nut thread M4 H 3.2mm WS 7 SS DIN/ISO DIN 934 / ISO 4032/8673 Qty 20 pcs | | |





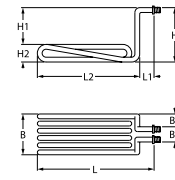




| | | | |
|---|---|-----------------|----------------------------|
| GEV No. | 416577 | Ref. No. | 1037305700 MA1037305700 |
| description | heating element 3500W 230V heating circuits 1 L 288mm W 146mm H 210mm L1 23mm L2 265mm H1 165mm H2 45mm thread 1/4" mounting distance 138mm tube ø 8.5mm 2 hole fixing connection M4 fryer heaters windings 6 | | |
| For models: | FQE6, FQE6+6 | | |
| accessories for | 416577 | | |
|  | GEV No. | 361182 | Ref. No. — |
| | nut thread 1/4" H 5mm nickel-plated brass WS 17 Qty 1 pcs | | |


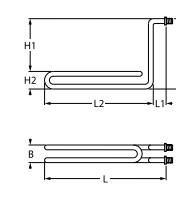




Table continues overleaf

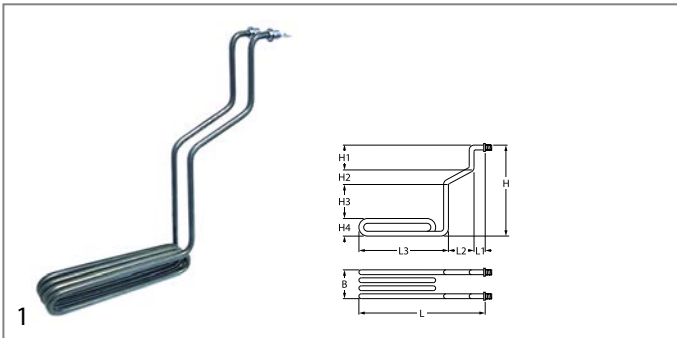


| | |
|---|--|
| accessories for 416577 | |
|  | GEV No. 510417 Ref. No. — flat gasket fibre ED ø 20mm ID ø 14mm thickness 2mm Qty 1 pcs |
|  | GEV No. 520228 Ref. No. — tooth lock washer ID ø 15.3mm ED ø 24mm steel Qty 1 pcs for thread M14 |
|  | GEV No. 521103 Ref. No. — nut thread M4 H 3mm WS 7 brass Qty 20 pcs |
|  | GEV No. 521104 Ref. No. — washer ID ø 4.3mm ED ø 8mm thickness 0.5mm brass Qty 20 pcs for thread M4 |
|  | GEV No. 550262 Ref. No. — flat gasket copper ED ø 20mm ID ø 14mm thickness 2mm |
|  | GEV No. 560111 Ref. No. — plain washer ID ø 4.3mm ED ø 9mm thickness 0.8mm SS Qty 20 pcs DIN 125A for thread M4 |
|  | GEV No. 560131 Ref. No. — hexagonal nut thread M4 H 3.2mm WS 7 SS DIN/ISO DIN 934 / ISO 4032/8673 Qty 20 pcs |

| | |
|---|---|
|   | |
| GEV No. 415969 | Ref. No. 1982700 MA1982700 |
| description | heating element 2400W 230V heating circuits 1 L 212mm W 74mm H 310mm L1 42mm L2 170mm W1 12mm W2 50mm H1 263mm H2 47mm tube ø 10mm connection M5 thread M14x1.25 2 hole fixing windings 5 mounting distance 54mm fryer connection length 22mm suitable for 700 series |
| For models: | FR74E, FR74E2, FR77E, FR77E2 |
| accessories for 415969 | |
|  | GEV No. 560112 Ref. No. 15830499 MA15830499 plain washer ID ø 5.3mm ED ø 10mm thickness 1mm SS Qty 20 pcs DIN 125A for thread M5 |
|  | GEV No. 560132 Ref. No. — hexagonal nut thread M5 H 4mm WS 8 SS DIN/ISO DIN 934 / ISO 4032/8673 Qty 20 pcs |

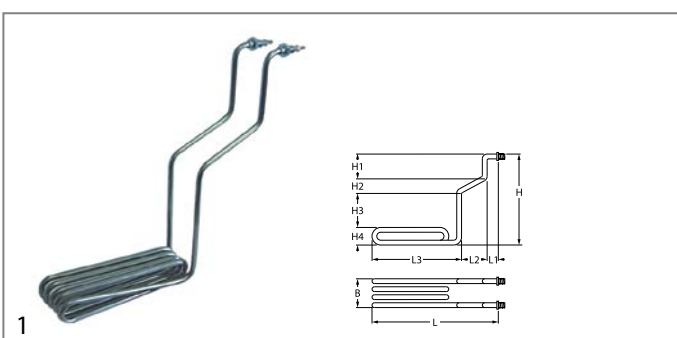
| | |
|--|--|
|   | |
| GEV No. 415990 | Ref. No. 1982900 MA1982900 |
| description | heating element 5800W 230V heating circuits 1 L 343mm W 110mm H 328mm L1 28mm L2 315mm W1 28mm W2 55mm H1 283mm H2 45mm tube ø 10mm connection M5 thread M14x1.25 2 hole fixing windings 7 mounting distance 96mm fryer connection length 35mm suitable for 900 series |
| For models: | FR92E13, FR92E132, FR92E13T, FR92E13T2, FR92E22, FR92E22T, FR94E13, FR94E132, FR94E13T, FR94E13T2, FR94E22, FR94E22T |
| accessories for 415990 | |
|  | GEV No. 560112 Ref. No. 15830499 MA15830499 plain washer ID ø 5.3mm ED ø 10mm thickness 1mm SS Qty 20 pcs DIN 125A for thread M5 |
|  | GEV No. 560132 Ref. No. — hexagonal nut thread M5 H 4mm WS 8 SS DIN/ISO DIN 934 / ISO 4032/8673 Qty 20 pcs |

| | |
|---|---|
|   | |
| GEV No. 415089 | Ref. No. 132522 |
| description | heating element 1850W 240V heating circuits 1 L 355mm W 38mm H 287mm L1 21mm L2 334mm H1 240mm H2 47mm thread 1/4" mounting distance 25mm tube ø 8.5mm 2 hole fixing connection male faston 6.3mm connection length 32mm fryer heaters windings 2 |
| accessories for 415089 | |
|  | GEV No. 361182 Ref. No. — nut thread 1/4" H 5mm nickel-plated brass WS 17 Qty 1 pcs |
|  | GEV No. 510417 Ref. No. — flat gasket fibre ED ø 20mm ID ø 14mm thickness 2mm Qty 1 pcs |
|  | GEV No. 520228 Ref. No. — tooth lock washer ID ø 15.3mm ED ø 24mm steel Qty 1 pcs for thread M14 |
|  | GEV No. 550262 Ref. No. — flat gasket copper ED ø 20mm ID ø 14mm thickness 2mm |



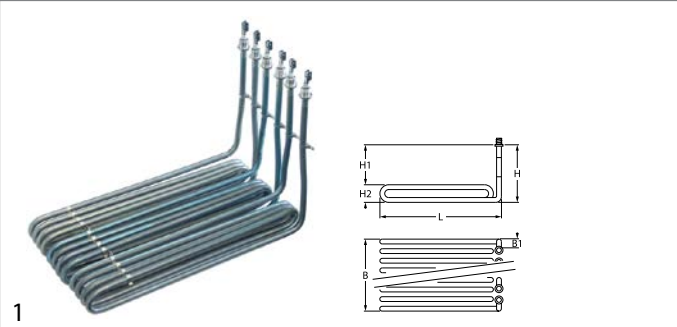
| | | | |
|--------------------|---|-----------------|--|
| GEV No. | 415985 | Ref. No. | 1463900 1466100 MA1463900 MA1466100 |
| description | heating element 3000W 220V L 350mm W 55mm H 330mm 2 hole fixing connection M5 heating circuits 1 fryer heaters L1 32mm L2 100mm L3 218mm H1 95mm H2 70mm H3 125mm H4 40mm tube ø 10mm thread M14x1.5 mounting distance 45mm connection length 10mm windings 3 | | |
| For models: | FR92E13, FR92E132, FR92E13T, FR92E13T2, FR92E22, FR92E22T, FR94E13, FR94E132, FR94E13T, FR94E13T2, FR94E22, FR94E22T | | |

| | | | |
|---|--|--------|--|
| accessories for | 415985 | | |
|  | GEV No. | 510417 | Ref. No. — |
| | flat gasket fibre ED ø 20mm ID ø 14mm thickness 2mm Qty 1 pcs | | |
|  | GEV No. | 520228 | Ref. No. — |
| | tooth lock washer ID ø 15.3mm ED ø 24mm steel Qty 1 pcs for thread M14 | | |
|  | GEV No. | 520230 | Ref. No. — |
| | nut thread M14x1.5 H 5mm WS 19 zinc-coated steel Qty 1 pcs | | |
|  | GEV No. | 521101 | Ref. No. — |
| | nut thread M14x1.5 H 5mm WS 19 SS Qty 1 pcs | | |
|  | GEV No. | 550262 | Ref. No. — |
| | flat gasket copper ED ø 20mm ID ø 14mm thickness 2mm | | |
|  | GEV No. | 560112 | Ref. No. 15830499 MA15830499 |
| | plain washer ID ø 5.3mm ED ø 10mm thickness 1mm SS Qty 20 pcs DIN 125A for thread M5 | | |
|  | GEV No. | 560132 | Ref. No. — |
| | hexagonal nut thread M5 H 4mm WS 8 SS DIN/ISO DIN 934 / ISO 4032/8673 Qty 20 pcs | | |

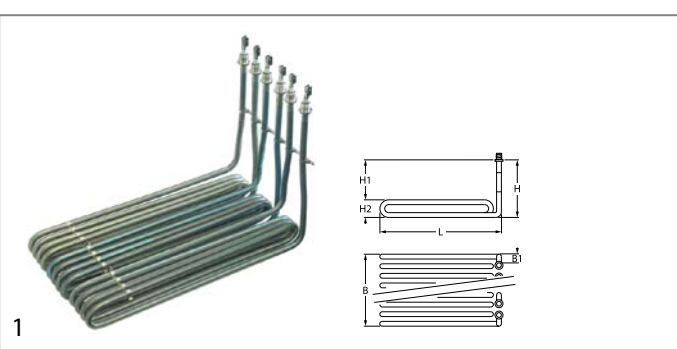


| | | | |
|--------------------|---|-----------------|----------------------|
| GEV No. | 415989 | Ref. No. | 1982800 MA1982800 |
| description | heating element 3000W 230V L 345mm W 65mm H 325mm 2 hole fixing connection grip connection heating circuits 1 immersion heater L1 30mm L2 95mm L3 220mm H1 96mm H2 55mm H3 130mm H4 44mm tube ø 10mm thread M14x1.25 mounting distance 58mm connection length 35mm windings 5 suitable for 900 series | | |
| For models: | FR92E13, FR92E132, FR92E13T, FR92E13T2, FR92E22, FR92E22T, FR94E13, FR94E132, FR94E13T, FR94E13T2, FR94E22, FR94E22T | | |





6 hole fixing



| | | | |
|--------------------|---|-----------------|----------------------------|
| GEV No. | 416810 | Ref. No. | 1037317100 MA1037317100 |
| description | heating element 6000W 230/400V heating circuits 3 L 320mm W 175mm H 205mm W1 5mm H1 165mm H2 40mm thread M12x1 tube ø 8.5mm connection male faston 6.3mm immersion heater 6 hole fixing | | |
| For models: | FQE41, FQE41L, FQE41L2, FQE61, FQE61L, FQE61L2, FR74E10, FR74E10L, FR74E10L2, FR77E10, FR77E10L, FR77E10L2, OFQE41, OFQE61 | | |




| | | | |
|--------------------|---|-----------------|----------------------------|
| GEV No. | 416811 | Ref. No. | 1037317200 MA1037317200 |
| description | heating element 9000W 230V heating circuits 3 L 320mm W 175mm H 205mm W1 5mm H1 165mm H2 40mm thread M12x1 tube ø 8.5mm connection male faston 6.3mm immersion heater 6 hole fixing | | |
| For models: | FQE41, FQE41L, FQE41L2, FQE61, FQE61L, FQE61L2, FR74E10, FR74E10L, FR74E10L2, FR77E10, FR77E10L, FR77E10L2, OFQE41, OFQE61 | | |


| | | | |
|---|---|--------|-------------------|
| spare parts for | 416811 | | |
|  | GEV No. | 521110 | Ref. No. — |
| | flat gasket fibre ED ø 20mm ID ø 13mm thickness 2mm Qty 1 pcs | | |
| accessories for | 416811 | | |
|  | GEV No. | 520229 | Ref. No. — |
| | nut thread M12x1 H 4mm WS 16 zinc-coated steel Qty 1 pcs | | |
|  | GEV No. | 521131 | Ref. No. — |
| | nut thread M12x1 H 3.5mm WS 17 SS Qty 1 pcs | | |
|  | GEV No. | 528110 | Ref. No. — |
| | O-ring EPDM thickness 2.62mm ID ø 12.37mm Qty 1 pcs | | |




heating elements for griddles







| | | | |
|--------------------|--|-----------------|--------|
| GEV No. | 415087 | Ref. No. | 892800 |
| description | heating element 1300W 220V heating circuits 1 L 428mm W 80mm H 66mm tube ø 6.3mm W1 13mm W2 43mm connection M4 dry heating element | | |




| | | | |
|--------------------|---|-----------------|----------------------|
| GEV No. | 415982 | Ref. No. | 1941800 MA1941800 |
| description | heating element 1300W 230V heating circuits 1 L 405mm W 85mm H 100mm tube ø 6.3mm W1 16mm W2 53mm connection clamp connection distance 40mm for grill | | |
| For models: | FT74E, FT74E2, FT74ER, FT74ER2, FT77E, FT77E2, FT77EC, FT77EC2, FT77ECRL, FT77ECRL2, FT77ERL, FT77ERL2 | | |




| | | | |
|--------------------|--|-----------------|--|
| GEV No. | 415076 | Ref. No. | 1037300700 1037300713 MA1037300713 |
| description | heating element 1300W 230V heating circuits 1 L 490mm W 78mm H 70mm tube ø 6.3mm W1 17mm W2 44mm connection M4 connection length 20mm dry heating element | | |
| For models: | BIE40, BIE40B, BIE60, BIE60B, EFT74ELVG, EFT74ERVG, EFT78ELVG, EFT78EMVG, FTE100B, FTE100BR, FTE100C, FTE100CRL, FTE40B, FTE40BR, FTE40C, FTE40D, FTE40DC, FTE60B, FTE60BR, FTE60BRR, FTE60C, FTE60D, FTE60DC, FTE60DCRL, FTE60DR, OFTE100CRL, OFTE40B, OFTE40BR, OFTE40C, OFTE60B, OFTE60BR, OFTE60BRR, OFTE60C | | |

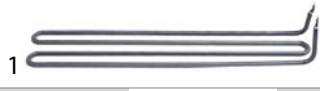
| | | | |
|---|---|--------|-------------------|
| accessories for | 415076 | | |
|  | GEV No. | 521103 | Ref. No. — |
| | nut thread M4 H 3mm WS 7 brass Qty 20 pcs | | |
|  | GEV No. | 521104 | Ref. No. — |
| | washer ID ø 4.3mm ED ø 8mm thickness 0.5mm brass Qty 20 pcs for thread M4 | | |
|  | GEV No. | 560111 | Ref. No. — |
| | plain washer ID ø 4.3mm ED ø 9mm thickness 0.8mm SS Qty 20 pcs DIN 125A for thread M4 | | |
|  | GEV No. | 560131 | Ref. No. — |
| | hexagonal nut thread M4 H 3.2mm WS 7 SS DIN/ISO DIN 934 / ISO 4032/8673 Qty 20 pcs | | |




| | | | |
|--------------------|---|-----------------|--------|
| GEV No. | 415085 | Ref. No. | 167622 |
| description | heating element 1400W 240V heating circuits 1 L 583mm W 50mm H 36mm tube ø 10mm connection M5 griddle dry heating element | | |




| | | | |
|--------------------|---|-----------------|------------------------|
| GEV No. | 416175 | Ref. No. | CM164800 MACM164800 |
| description | heating element 1600W 230V heating circuits 1 L 417mm W 87mm H 90mm tube ø 8.5mm L1 32mm L2 385mm connection M5 griddle connection distance 79mm dry heating element | | |
| For models: | FT129ELC, FT129EM, FT12C9EL, FT12C9ELC, FT12C9EM, FT12C9EMC, FT74EL, FT74ELC, FT74ER, FT76EL, FT76ELC, FT76EM, FT76EMC, FT78EL, FT78ELC, FT78EM, FT78EMC, FT94EL, FT94ELC, FT94ER, FT96EL, FT96ELC, FT96EM, FT96EMC, FT98EL, FT98ELC, FT98EM, FT98EMC, PM129E | | |







| | | | |
|--------------------|---|-----------------|----------------------|
| GEV No. | 415975 | Ref. No. | 1730000 MA1730000 |
| description | heating element 1800W 240V heating circuits 1 L 488mm W 84mm H 63mm tube ø 8.5mm W2 47mm connection M5 connection distance 35mm suitable for 700 series for grill | | |
| For models: | FT74E, FT74ER, FT74ERL, FT77E, FT77EC, FT77ERL | | |





| | | | |
|--------------------|---|-----------------|----------------------|
| GEV No. | 415958 | Ref. No. | 1941900 MA1941900 |
| description | heating element 1900W 230V heating circuits 1 L 585mm W 90mm H 80mm tube ø 6.3mm L1 585mm W2 50mm connection grip connection length 20mm connection distance 70mm suitable for 900 series for grill | | |
| For models: | F9V2E, F9V2E2, F9V2ER, F9V2ER2, F9V4E, F9V4E2, F9V4EC, F9V4EC2, F9V4ECRL, F9V4ECRL2, F9V4ER, F9V4ER2, F9V4ERL, F9V4ERL2 | | |





| | | | |
|---|---|-----------------|----------------------|
| GEV No. | 415086 | Ref. No. | 1029200 MA1029200 |
| description | heating element 2000W 220V heating circuits 1 L 600mm W 80mm H 70mm tube ø 6.3mm W1 10mm W2 58mm connection M4 griddle connection distance 45mm dry heating element | | |
| For models: | F9V2E, F9V2ER, F9V4E, F9V4EC, F9V4ECR, F9V4ER, F9V4ERL | | |
| accessories for | 415086 | | |
|  | GEV No. | 521103 | Ref. No. — |
| | nut thread M4 H 3mm WS 7 brass Qty 20 pcs | | |
|  | GEV No. | 521104 | Ref. No. — |
| | washer ID ø 4.3mm ED ø 8mm thickness 0.5mm brass Qty 20 pcs for thread M4 | | |
|  | GEV No. | 560111 | Ref. No. — |
| | plain washer ID ø 4.3mm ED ø 9mm thickness 0.8mm SS Qty 20 pcs DIN 125A for thread M4 | | |
|  | GEV No. | 560131 | Ref. No. — |
| | hexagonal nut thread M4 H 3.2mm WS 7 SS DIN/ISO DIN 934 / ISO 4032/8673 Qty 20 pcs | | |





| | | | |
|---|---|-----------------|-----------|
|  | | | |
| GEV No. | 420105 | Ref. No. | CR0731580 |
| description | heating element 2000W 230V heating circuits 1 L 480mm W 90mm H 42mm tube ø 8.5mm IRCA L1 50mm L2 430mm W1 49mm W2 20mm flange connection connection M5 hole distance 89mm flange length 100mm flange width 35mm hole ø 6mm windings 2 dry heating element | | |
| For models: | NG74E, NG74E2, NG78E, NG78E2 | | |

| | | | |
|---|--|-----------------|------------------------|
|  | | | |
| GEV No. | 416180 | Ref. No. | CM165100 MACM165100 |
| description | heating element 2200W 230V heating circuits 1 L 420mm W 130mm H 92mm tube ø 8.5mm L1 24mm L2 396mm connection M5 connection distance 122mm dry heating element | | |
| For models: | FT74EL, FT74ELC, FT74ER, FT76EL, FT76ELC, FT76EM, FT76EMC, FT78EL, FT78ELC, FT78EM, FT78EMC, FT94EL, FT94ELC, FT94ER, FT96EL, FT96ELC, FT96EM, FT96EMC, FT98EL, FT98ELC, FT98EM, FT98EMC | | |

| | | | |
|---|--|-----------------|------------------------|
|  | | | |
| GEV No. | 416694 | Ref. No. | CM164900 MACM164900 |
| description | heating element 2200W 230V heating circuits 1 L 570mm W 110mm H 90mm tube ø 8.5mm L1 20mm L2 550mm connection M5 griddle connection distance 102mm suitable for 900 series dry heating element | | |
| For models: | FT74EL, FT74ELC, FT74ER, FT76EL, FT76ELC, FT76EM, FT76EMC, FT78EL, FT78ELC, FT78EM, FT78EMC, FT94EL, FT94ELC, FT94ER, FT96EL, FT96ELC, FT96EM, FT96EMC, FT98EL, FT98ELC, FT98EM, FT98EMC | | |


| | | | |
|---|--|-----------------|-----------|
|  | | | |
| GEV No. | 420109 | Ref. No. | CR0582840 |
| description | heating element 2500W 230V heating circuits 1 L 635mm W 90mm H 80mm L1 30mm connection M5 connection distance 81.5mm tube ø 8.5mm connection length 18mm dry heating element for griddle | | |
| For models: | NFT94EL, NFT94ELC, NFT94ELO, NFT94ER, NFT96EL, NFT96ELC, NFT96EM, NFT96EMC, NFT98EL, NFT98ELC, NFT98ELO, NFT98EM, NFT98EMC | | |


| | | | |
|---|--|-----------------|-----------|
|  | | | |
| GEV No. | 420415 | Ref. No. | CR0937830 |
| description | heating element 2600W 230V heating circuits 1 L 480mm W 90mm H 42mm tube ø 8.5mm L1 50mm L2 430mm W1 49mm W2 20mm flange connection connection M5 hole distance 89mm flange length 100mm flange width 35mm hole ø 6mm windings 2 dry heating element | | |

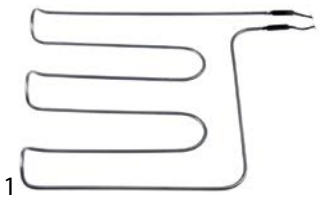
| | | | |
|--|--|-----------------|------------------------|
|  | | | |
| GEV No. | 416695 | Ref. No. | CM165200 MACM165200 |
| description | heating element 3300W 230V heating circuits 1 L 570mm W 130mm H 90mm tube ø 8.5mm L1 20mm L2 550mm griddle dry heating element | | |
| For models: | FT74EL, FT74ELC, FT74ER, FT76EL, FT76ELC, FT76EM, FT76EMC, FT78EL, FT78ELC, FT78EM, FT78EMC, FT94EL, FT94ELC, FT94ER, FT96EL, FT96ELC, FT96EM, FT96EMC, FT98EL, FT98ELC, FT98EM, FT98EMC | | |

heating elements for refrigeration

heating elements for defrosting


| | | | |
|--|--|-----------------|-----------------------|
|  | | | |
| GEV No. | 416325 | Ref. No. | 24769.35 MA2476935 |
| description | heating element 105W 230V L 410mm W 295mm H 6.5mm L1 93mm L2 317mm W1 257mm W2 38mm cable length 2500mm tube ø 6.3mm immersion heater defrosting | | |
| For models: | AF140B, AF140C, AF140F, AF140I, AF140MB, AF140MC, AF140MF, AF140MI, AF140MN, AF140MP, AF140N, AF140P, AF14F, AF14G, AF14N, AF70B, AF70C, AF70F, AF70I, AF70MB, AF70MC, AF70MF, AF70MI, AF70MN, AF70MP, AF70N, AF70P, AF72B, AF72C, AF72F, AF72I, AF72N, AF72P, AF7C, AF7F, AF7G, EF140DF, EF140DN, EF140DP, EF140MB, EF140MC, EF140MF, EF140MI, EF140MN, EF140MP, EF70DF, EF70DN, EF70DP, EF70MB, EF70MC...(Other models you can see in the webshop) | | |





| | | | |
|--|--|-----------------|-----------------------------------|
|  | | | |
| GEV No. | 416326 | Ref. No. | 24752.00 24752.15 MA2475215 |
| description | heating element 365W 230V L 435mm W 133mm H 50mm cable length 1200mm tube ø 6.5mm connection length 55mm defrosting | | |
| For models: | AF140B, AF140C, AF140F, AF140I, AF140MB, AF140MC, AF140MF, AF140MI, AF140MN, AF140MP, AF140N, AF140P, AF14F, AF14G, AF14N, AF70B, AF70C, AF70F, AF70I, AF70MB, AF70MC, AF70MF, AF70MI, AF70MN, AF70MP, AF70N, AF70P, AF72B, AF72C, AF72F, AF72I, AF72N, AF72P, AF7C, AF7F, AF7G, EF140DF, EF140DN, EF140DP, EF140MB, EF140MC, EF140MF, EF140MI, EF140MN, EF140MP, EF143MNI, EF70DF, EF70DN, EF70DP, EF70MB...(Other models you can see in the webshop) | | |





| | | | |
|--------------------|--|-----------------|---------|
| GEV No. | 418744 | Ref. No. | 2315200 |
| description | heating element 450W 220V L 400mm W 400mm L1 70mm L2 330mm W1 50mm W2 350mm defrosting | | |
| For models: | AFC14, AFC14V, AFC7, AFC7V, AFPC214, AFPC214P, AFPC214V, AFR1143P, AFR14, AFR14V, AFR214P, AFR214PV, AFR7, AFR7P, AFR7PV, AFR7V, AFRC214, AFRC214V | | |


heating elements for tilting bratt pan







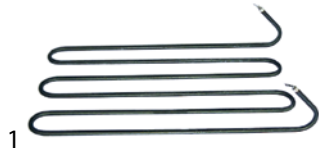
| | | | |
|---|--|-----------------|--|
| GEV No. | 415076 | Ref. No. | 1037300700 1037300713 MA1037300713 |
| description | heating element 1300W 230V heating circuits 1 L 490mm W 78mm H 70mm tube ø 6.3mm W1 17mm W2 44mm connection M4 connection length 20mm dry heating element | | |
| For models: | BIE40, BIE40B, BIE60, BIE60B, EFT74ELVG, EFT74ERVG, EFT78ELVG, EFT78EMVG, FTE100B, FTE100BR, FTE100C, FTE100CRL, FTE40B, FTE40BR, FTE40C, FTE40D, FTE40DC, FTE60B, FTE60BR, FTE60BRR, FTE60C, FTE60D, FTE60DC, FTE60DCRL, FTE60DR, OFTE100CRL, OFTE40B, OFTE40BR, OFTE40C, OFTE60B, OFTE60BR, OFTE60BRR, OFTE60C | | |
| accessories for | 415076 | | |
|  | GEV No. | 521103 | Ref. No. — |
| | nut thread M4 H 3mm WS 7 brass Qty 20 pcs | | |
|  | GEV No. | 521104 | Ref. No. — |
| | washer ID ø 4.3mm ED ø 8mm thickness 0.5mm brass Qty 20 pcs for thread M4 | | |
|  | GEV No. | 560111 | Ref. No. — |
| | plain washer ID ø 4.3mm ED ø 9mm thickness 0.8mm SS Qty 20 pcs DIN 125A for thread M4 | | |
|  | GEV No. | 560131 | Ref. No. — |
| | hexagonal nut thread M4 H 3.2mm WS 7 SS DIN/ISO DIN 934 / ISO 4032/8673 Qty 20 pcs | | |




| | | | |
|--------------------|--|-----------------|---------------------------------|
| GEV No. | 415973 | Ref. No. | 1685100 1686900 MA1686900 |
| description | heating element 2700W 240V heating circuits 1 L 360mm W 141mm H 85mm L1 55mm connection M4 connection distance 133mm tube ø 10mm connection length 25mm tilting bratt pan L2 305mm suitable for 700 series | | |
| For models: | BR707E, BR707EI, BR78EF, BR78EI, BR912EFM, BR912EIM, BR98EF, BR98EFM, BR98EI, BR98EIM, BR9S8EF, BR9S8EI | | |



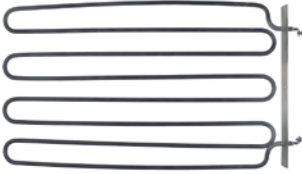
| | | | |
|---|--|-----------------|---------------------------------|
| GEV No. | 415084 | Ref. No. | 1475600 1878700 MA1878700 |
| description | heating element 3900W 240V L 520mm W 170mm H 94mm connection M4 tilting bratt pan heating circuits 1 tube ø 10mm L1 58mm L2 200mm connection length 25mm connection distance 160mm | | |
| For models: | BR78EF, BR78EI, BR912EFM, BR912EIM, BR94E, BR94EI, BR98EF, BR98EFM, BR98EI, BR98EIM, BR9M4E, BR9M4EI, BR9M4GI, BR9M6E, BR9M6EI, BR9S8EF, BR9S8EI, BR9SB4E, BR9SB4EI | | |
| accessories for | 415084 | | |
|  | GEV No. | 521103 | Ref. No. — |
| | nut thread M4 H 3mm WS 7 brass Qty 20 pcs | | |
|  | GEV No. | 521104 | Ref. No. — |
| | washer ID ø 4.3mm ED ø 8mm thickness 0.5mm brass Qty 20 pcs for thread M4 | | |
|  | GEV No. | 560111 | Ref. No. — |
| | plain washer ID ø 4.3mm ED ø 9mm thickness 0.8mm SS Qty 20 pcs DIN 125A for thread M4 | | |
|  | GEV No. | 560131 | Ref. No. — |
| | hexagonal nut thread M4 H 3.2mm WS 7 SS DIN/ISO DIN 934 / ISO 4032/8673 Qty 20 pcs | | |




| | | | |
|--------------------|--|-----------------|---------------------------------|
| GEV No. | 415987 | Ref. No. | 1493800 1878800 MA1878800 |
| description | heating element 5850W 230V L 530mm W 295mm H 90mm connection male faston for grill heating circuits 1 tube ø 10mm L1 80mm connection distance 275mm | | |
| For models: | BR78EF, BR78EI, BR912EFM, BR912EIM, BR94E, BR94EI, BR96E, BR96EI, BR98EF, BR98EFM, BR98EI, BR98EIM, BR9M4E, BR9M4EI, BR9M4GI, BR9M6E, BR9M6EI, BR9S8EF, BR9S8EI, BR9SB4E, BR9SB4EI | | |



| | | | |
|--------------------|--|-----------------|-----------|
| GEV No. | 420104 | Ref. No. | CR0683221 |
| description | heating element for tilting bratt pan 5000W 230V L 555mm W 180mm H 30mm connection M5 dry heating element heating circuits 1 tube ø 8.5mm L1 25mm L2 530mm W1 45mm W2 90mm flange connection flange length 170mm flange width 30mm hole ø 6.3mm windings 3 | | |
| For models: | NBR912EFM, NBR912EIM, NBR98EF, NBR98EFM, NBR98EI, NBR98EIM | | |




| | | | |
|--------------------|---|-----------------|-----------|
| GEV No. | 420106 | Ref. No. | CR0684240 |
| description | heating element for tilting bratt pan 6350W 230V L 550mm W 320mm H 24mm connection M5 dry heating element heating circuits 1 tube ø 8.5mm L1 45mm L2 505mm W1 48mm W2 225mm flange connection flange length 305mm flange width 30mm hole ø 6mm windings 4 | | |
| For models: | NBR912EFM, NBR912EIM, NBR98EF, NBR98EFM, NBR98EI, NBR98EIM | | |




| | | | |
|--------------------|---|-----------------|--|
| GEV No. | 415077 | Ref. No. | 1037301700 1037301713 MA1037301713 |
| description | heating element stock pot 1300W 230V L 280mm W 150mm H 40mm connection male faston 6.3mm tilting bratt pan heating circuits 1 tube ø 8.5mm bracket mounting hole distance 142mm hole ø 5mm lug length 25mm lug width 15mm | | |
| For models: | BRE40, BRE40D, BRE40DB, BRE40DG, BRE40DGB, BRE40G, OBRE40 | | |


heating elements for pasta cookers













| | | | |
|--------------------|--|-----------------|--------|
| GEV No. | 415020 | Ref. No. | 110331 |
| description | heating element 4500W 230V mounting ø 57.5mm heating circuits 3 L 355mm W 35mm H 47mm number of thermostat sleeves 1 thermostat sleeves ø 7mm length thermostat sleeves 295mm thermostat sleeve upper tube ø 8.5mm hole distance 70mm hole ø 10mm connection length 25mm connection male faston 6.3mm 3 hole flange immersion heater | | |






| | | | |
|--------------------|---|-----------------|-------------------------|
| GEV No. | 420096 | Ref. No. | CR0731030 CR0731030R |
| description | heating element 5600W 230V heating circuits 3 L 255mm W 210mm H 32mm rotation flange thread M54x1.5 tube ø 8.4mm L1 60mm L2 195mm W1 180mm W2 30mm cable length 1200mm windings 2 flange length 1 2mm flange length 2 20mm flange length 21mm flange ø1 63mm flange ø2 54mm for pasta cooker immersion heater | | |
| For models: | NPC74E, NPC78E | | |



| | | | | |
|---|--|-----------------|--|---|
| GEV No. | 415977 | Ref. No. | 1870000 1870000R MA1870000 MA1870000R | |
| description | heating element 5670W 230V heating circuits 3 L 292mm W 225mm H 26mm rotation flange tube ø 6.3mm thermostat sleeves ø 9mm length thermostat sleeves 185mm L1 42mm L2 250mm W1 197mm W2 28mm cable length 460mm number of thermostat sleeves 1 connection length 50mm flange length 1 9mm flange length 2 15.5mm flange length 24.5mm flange ø1 43.8mm flange ø2 39.7mm thermostat sleeve centred, adjacent pasta cooker sensor screw connection M10x1 | | | |
| For models: | CP704E, EPC74E, PC12C4E, PC12C9E, PC74E, PC76E, PC78E, PC94E, PC96E, PC98E, PC9S4E, PC9S6E, PC9S8E | | | |
| accessories for | 415977 | | | |
|  | GEV No. | 514016 | Ref. No. | 1036500400 1814500 MA1814500 |
| | flat gasket PTFE ED ø 45mm ID ø 40mm thickness 4mm Qty 1 pcs equiv. no. 1036500400/1814500 suitable for MARENO | | | |
|  | GEV No. | 514017 | Ref. No. | 0105246 1036500200 1814400 MA1814400 R0105246 SIR0105246 |
| | O-ring silicone thickness 3.53mm ID ø 32.93mm Qty 1 pcs | | | |
|  | GEV No. | 514018 | Ref. No. | 1033703500 1814600 MA1814600 |
| | bush | | | |
|  | GEV No. | 514020 | Ref. No. | 1036500100 1815000 1815014 MA1815014 |
| | bush | | | |
|  | GEV No. | 514021 | Ref. No. | 1036500300 1814700 MA1814700 |
| | O-ring silicone thickness 3.53mm ID ø 49.21mm Qty 1 pcs | | | |
|  | GEV No. | 514022 | Ref. No. | 1032300100 14044599 MA14044599 |
| | nut thread 1½" H 12mm SS WS 59 Qty 1 pcs | | | |
|  | GEV No. | 540435 | Ref. No. | 1869600 MA1869600 |
| | threaded rod thread M10 hollow | | | |
|  | GEV No. | 540436 | Ref. No. | 1033514900 MA1033514900 |
| | hexagonal nut thread M10x1.25 H 4mm WS 13 brass Qty 1 pcs | | | |
|  | GEV No. | 540438 | Ref. No. | 1868700 MA1868700 |
| | long nut thread M10 L 25mm WS 13 brass Qty 1 pcs | | | |
|  | GEV No. | 540439 | Ref. No. | 1869500 MA1869500 |
| | distance washer | | | |



| | | | |
|---|---|-----------------|--|
|  | | | |
| GEV No. | 415991 | Ref. No. | 1814213 1869900 1869900R MA1869900 MA1869900R |
| description | heating element 8499W 230V heating circuits 3 L 405mm W 225mm H 25mm rotation flange tube ø 6.3mm thermostat sleeves ø 9mm length thermostat sleeves 223mm L1 40mm L2 365mm W1 196mm W2 29mm cable length 1250mm number of thermostat sleeves 1 connection length 48mm flange length 1 9mm flange length 2 15.5mm flange length 24.5mm flange ø1 43.8mm flange ø2 39.7mm suitable for 900 series thermostat sleeve centred, adjacent pasta cooker sensor screw connection M10x1 | | |
| For models: | CP92E, CP92E2, CP94E, CP94E2, CP95B2E, CP95B2E2, CP95B4E, CP95-B4E2, DE92142, DE94242, PC12C9E, PC74E, PC76E, PC78E, PC94E, PC96E, PC98E, PC954E, PC956E, PC958E | | |
| accessories for | 415991 | | |
|  | GEV No. | 514016 | Ref. No. 1036500400 1814500 MA1814500 |
| | flat gasket PTFE ED ø 45mm ID ø 40mm thickness 4mm Qty 1 pcs equiv. no. 1036500400/1814500 suitable for MARENO | | |
|  | GEV No. | 514017 | Ref. No. 0105246 1036500200 1814400 MA1814400 R0105246 SIR0105246 |
| | O-ring silicone thickness 3.53mm ID ø 32.93mm Qty 1 pcs | | |
|  | GEV No. | 514018 | Ref. No. 1033703500 1814600 MA1814600 |
| | bush | | |
|  | GEV No. | 514019 | Ref. No. 1033202200 1033709000 MA1033202200 |
| | threaded rod thread M8 L 45mm brass | | |
|  | GEV No. | 514020 | Ref. No. 1036500100 1815000 1815014 MA1815014 |
| | bush | | |
|  | GEV No. | 514021 | Ref. No. 1036500300 1814700 MA1814700 |
| | O-ring silicone thickness 3.53mm ID ø 49.21mm Qty 1 pcs | | |
|  | GEV No. | 514022 | Ref. No. 1032300100 14044599 MA14044599 |
| | nut thread 1½" H 12mm SS WS 59 Qty 1 pcs | | |
|  | GEV No. | 540435 | Ref. No. 1869600 MA1869600 |
| | threaded rod thread M10 hollow | | |
|  | GEV No. | 540436 | Ref. No. 1033514900 MA1033514900 |
| | hexagonal nut thread M10x1.25 H 4mm WS 13 brass Qty 1 pcs | | |
|  | GEV No. | 540438 | Ref. No. 1868700 MA1868700 |
| | long nut thread M10 L 25mm WS 13 brass Qty 1 pcs | | |
|  | GEV No. | 540439 | Ref. No. 1869500 MA1869500 |
| | distance washer | | |

| | | | |
|--|---|-----------------|---|
|  | | | |
| GEV No. | 420098 | Ref. No. | CR0582040 CR0582040R |
| description | heating element 8500W 230V heating circuits 3 L 378mm W 210mm H 32mm rotation flange thread M54x1.5 tube ø 8.4mm L1 68mm L2 310mm W1 178mm W2 32mm cable length 1250mm windings 3 flange length 1 2mm flange length 2 19mm flange length 21mm flange ø1 63mm flange ø2 54mm for pasta cooker immersion heater | | |
| For models: | NPC94E, NPC98E | | |
| accessories for | 420098 | | |
|  | GEV No. | 514419 | Ref. No. — |
| | bracket for heating element L 68mm W 20mm H 28mm | | |
|  | GEV No. | 550496 | Ref. No. CM099200 MACM099200 |
| | O-ring Viton thickness 3.53mm ID ø 50.39mm Qty 1 pcs | | |






| | | | |
|---|---|-----------------|--|
|  | | | |
| GEV No. | 415971 | Ref. No. | 1037305810 1870100 1870100R MA1870100 MA1870100R |
| description | heating element 9000W 230/415V heating circuits 3 L 245mm W 320mm H 25mm rotation flange tube ø 6.3mm thermostat sleeves ø 7mm length thermostat sleeves 210mm L1 55mm L2 190mm W1 28mm W2 292mm cable length 600mm number of thermostat sleeves 1 connection length 35mm flange length 1 9mm flange length 2 15.5mm flange length 24.5mm flange ø1 43.8mm flange ø2 39.7mm mounting pos. left suitable for 600 series thermostat sleeve centred, adjacent pasta cooker sensor screw connection M10x1 | | |
| For models: | CPE60, CPE602, CPE60DB, OCPE6, OCPE60, PC12C4E, PC12C9E, PC74E, PC76E, PC78E, PC94E, PC96E, PC98E, PC954E, PC956E, PC958E | | |
| accessories for | 415971 | | |
|  | GEV No. | 514016 | Ref. No. 1036500400 1814500 MA1814500 |
| | flat gasket PTFE ED ø 45mm ID ø 40mm thickness 4mm Qty 1 pcs equiv. no. 1036500400/1814500 suitable for MARENO | | |
|  | GEV No. | 514017 | Ref. No. 0105246 1036500200 1814400 MA1814400 R0105246 SIR0105246 |
| | O-ring silicone thickness 3.53mm ID ø 32.93mm Qty 1 pcs | | |
|  | GEV No. | 514018 | Ref. No. 1033703500 1814600 MA1814600 |
| | bush | | |
|  | GEV No. | 514019 | Ref. No. 1033202200 1033709000 MA1033202200 |
| | threaded rod thread M8 L 45mm brass | | |




Table continues overleaf




| accessories for | | 415971 | |
|---|---------|--------|--|
|  | GEV No. | 514020 | Ref. No. 1036500100 1815000 1815014 MA1815014 |
| bush | | | |
|  | GEV No. | 514021 | Ref. No. 1036500300 1814700 MA1814700 |
| O-ring silicone thickness 3.53mm ID ø 49.21mm Qty 1 pcs | | | |
|  | GEV No. | 514022 | Ref. No. 1032300100 14044599 MA14044599 |
| nut thread 1½" H 12mm SS WS 59 Qty 1 pcs | | | |
|  | GEV No. | 540435 | Ref. No. 1869600 MA1869600 |
| threaded rod thread M10 hollow | | | |
|  | GEV No. | 540436 | Ref. No. 1033514900 MA1033514900 |
| hexagonal nut thread M10x1.25 H 4mm WS 13 brass Qty 1 pcs | | | |
|  | GEV No. | 540438 | Ref. No. 1868700 MA1868700 |
| long nut thread M10 L 25mm WS 13 brass Qty 1 pcs | | | |
|  | GEV No. | 540439 | Ref. No. 1869500 MA1869500 |
| distance washer | | | |



| | | | |
|--------------------|---|-----------------|-----------|
| GEV No. | 420097 | Ref. No. | CR0688330 |
| description | heating element 9000W 230V heating circuits 3 L 250mm W 325mm H 32mm rotation flange thread M54x1.5 tube ø 8.3mm L1 200mm L2 50mm W1 293mm W2 32mm cable length 1200mm windings 2 flange length 1 2mm flange length 2 19mm flange length 21mm flange ø1 63mm flange ø2 54mm for pasta cooker immersion heater | | |
| For models: | NPC76E, NPC96E | | |

| accessories for | | 420097 | |
|---|---------|--------|---------------------------------|
|  | GEV No. | 504230 | Ref. No. 15119299 MA15119299 |
| grub screw thread M5 L 8mm A2-A2L DIN 914/ISO 4027 WS 2.5 Qty 1 pcs | | | |
|  | GEV No. | 550496 | Ref. No. CM099200 MACM099200 |
| O-ring Viton thickness 3.53mm ID ø 50.39mm Qty 1 pcs | | | |
|  | GEV No. | 550662 | Ref. No. CM021600 MACM021600 |
| ring nut thread M54x1.5 H 7mm | | | |




| | | | |
|--|---|-----------------|---|
| GEV No. | 415094 | Ref. No. | 1037305800 |
| description | heating element 9000W 230V heating circuits 3 rotation flange pasta cooker immersion heater | | |
| accessories for | 415094 | | |
|  | GEV No. | 514016 | Ref. No. 1036500400 1814500 MA1814500 |
| flat gasket PTFE ED ø 45mm ID ø 40mm thickness 4mm Qty 1 pcs equiv. no. 1036500400/1814500 suitable for MARENO | | | |

| accessories for | | 415094 | |
|---|---------|--------|--|
|  | GEV No. | 514017 | Ref. No. 0105246 1036500200 1814400 MA1814400 R0105246 SIR0105246 |
| O-ring silicone thickness 3.53mm ID ø 32.93mm Qty 1 pcs | | | |
|  | GEV No. | 514018 | Ref. No. 1033703500 1814600 MA1814600 |
| bush | | | |
|  | GEV No. | 514019 | Ref. No. 1033202200 1033709000 MA1033202200 |
| threaded rod thread M8 L 45mm brass | | | |
|  | GEV No. | 514020 | Ref. No. 1036500100 1815000 1815014 MA1815014 |
| bush | | | |
|  | GEV No. | 514021 | Ref. No. 1036500300 1814700 MA1814700 |
| O-ring silicone thickness 3.53mm ID ø 49.21mm Qty 1 pcs | | | |
|  | GEV No. | 514022 | Ref. No. 1032300100 14044599 MA14044599 |
| nut thread 1½" H 12mm SS WS 59 Qty 1 pcs | | | |
|  | GEV No. | 540435 | Ref. No. 1869600 MA1869600 |
| threaded rod thread M10 hollow | | | |
|  | GEV No. | 540436 | Ref. No. 1033514900 MA1033514900 |
| hexagonal nut thread M10x1.25 H 4mm WS 13 brass Qty 1 pcs | | | |
|  | GEV No. | 540438 | Ref. No. 1868700 MA1868700 |
| long nut thread M10 L 25mm WS 13 brass Qty 1 pcs | | | |
|  | GEV No. | 540439 | Ref. No. 1869500 MA1869500 |
| distance washer | | | |

heating elements for pizza ovens




| | | | |
|--------------------|--|-----------------|----------------------------|
| GEV No. | 416573 | Ref. No. | 1037316400 MA1037316400 |
| description | heating element 1000W 230V L 428mm W 162mm flange length 100mm flange width 22mm connection length 20mm connection male faston 6.3mm L3 360mm W1 50mm W2 50mm tube ø 6.3mm heating circuits 1 rectangular flange dry heating element | | |
| For models: | SPE60M | | |









| | | | |
|--------------------|--|-----------------|------------------|
| GEV No. | 415164 | Ref. No. | 59741 MA59741 |
| description | heating element 900W 240V L 295mm W 88mm flange length 34mm flange width 24mm connection length 26mm connection M5 L3 200mm W1 30mm W2 28mm tube ø 6.3mm heating circuits 1 rectangular flange hole ø 5mm dry heating element bain marie | | |
| For models: | SBA, SBAC, SVAC, SVAC12, SVAC16, SVAC20, SVCG, SVCG08, SVCG12, SVCG16, SVCG20 | | |


heating elements for charrills







| | | | |
|--------------------|---|-----------------|------------------------|
| GEV No. | 420467 | Ref. No. | CR0681360 CR0842340 |
| description | heating element 3300W 230V L 620mm W 95mm H 40mm W1 20mm W2 48mm L1 15mm L2 30mm L3 575mm flange length 100mm flange width 35mm hole distance 88mm connection M5 heating circuits 1 tube ø 8.5mm connection length 45mm hole ø 6.5mm rectangular flange dry heating element | | |
| For models: | NG912E, NG912E2, NG94E, NG94E2, NG98E, NG98E2 | | |




| | | | |
|---|--|-----------------|----------------------------|
| GEV No. | 415095 | Ref. No. | 1037300000 MA1037300000 |
| description | heating element 1500W 220V L 465mm W 75mm H 55mm 2 hole fixing thread 1/4" mounting distance 70mm connection M4 L1 25mm L2 440mm tube ø 6.3mm dry heating element heating circuits 1 | | |
| accessories for | 415095 | | |
|  | GEV No. | 521103 | Ref. No. — |
| | nut thread M4 H 3mm WS 7 brass Qty 20 pcs | | |
|  | GEV No. | 521104 | Ref. No. — |
| | washer ID ø 4.3mm ED ø 8mm thickness 0.5mm brass Qty 20 pcs for thread M4 | | |
|  | GEV No. | 560111 | Ref. No. — |
| | plain washer ID ø 4.3mm ED ø 9mm thickness 0.8mm SS Qty 20 pcs DIN 125A for thread M4 | | |
|  | GEV No. | 560131 | Ref. No. — |
| | hexagonal nut thread M4 H 3.2mm WS 7 SS DIN/ISO DIN 934 / ISO 4032/8673 Qty 20 pcs | | |




| | | | |
|---|--|-----------------|----------------------------|
| GEV No. | 415965 | Ref. No. | 1037311315 MA1037311315 |
| description | heating element 1800W 230V L 486mm W 83mm H 30mm 2 hole fixing mounting distance 72mm connection M4 L1 38mm L2 448mm heating circuits 1 tube ø 6.3mm dry heating element thread M12x1 for sausage warmer | | |
| For models: | CWE42, CWE422, CWE62, CWE622, OCWE42, OCWE422, OCWE62, OCWE622 | | |
| accessories for | 415965 | | |
|  | GEV No. | 520229 | Ref. No. — |
| | nut thread M12x1 H 4mm WS 16 zinc-coated steel Qty 1 pcs | | |

| | | | |
|---|---|--------|-------------------|
| accessories for | 415965 | | |
|  | GEV No. | 521110 | Ref. No. — |
| | flat gasket fibre ED ø 20mm ID ø 13mm thickness 2mm Qty 1 pcs | | |
|  | GEV No. | 521131 | Ref. No. — |
| | nut thread M12x1 H 3.5mm WS 17 SS Qty 1 pcs | | |
|  | GEV No. | 528110 | Ref. No. — |
| | O-ring EPDM thickness 2.62mm ID ø 12.37mm Qty 1 pcs | | |


heating elements for salamanders/toast-



| | | | |
|--------------------|---|-----------------|----------------------------|
| GEV No. | 416572 | Ref. No. | 1037316500 MA1037316500 |
| description | heating element 1000W 230V heating circuits 1 L 425mm W 62mm flange length 100mm flange width 22mm hole distance 86mm connection male faston 6.3mm tube ø 6.3mm rectangular flange hole ø 5mm dry heating element | | |
| For models: | TSE60M | | |




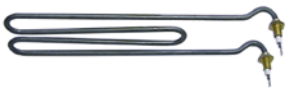




| | | | |
|--------------------|---|-----------------|--|
| GEV No. | 415140 | Ref. No. | 1037041200 1037316100 MA1037041200 MA1037316100 |
| description | heating element 2000W 230V heating circuits 1 L 435mm W 170mm L1 20mm L2 60mm L3 355mm W1 52mm W2 61mm flange length 100mm flange width 22mm hole distance 86mm tube ø 6.3mm connection length 54mm for salamander grill connection male faston 6.3mm rectangular flange hole ø 5mm H 6.3mm | | |
| For models: | SME62M, SME63M, SME70M | | |




| | | | |
|--------------------|---|-----------------|--|
| GEV No. | 415141 | Ref. No. | 1037042200 1037316200 MA1037316200 |
| description | heating element 2900W 230V heating circuits 1 L 425mm W 165mm L1 25mm L2 50mm L3 350mm W1 52mm W2 60mm flange length 100mm flange width 22mm hole distance 88mm tube ø 8.5mm connection length 17mm dry heating element rectangular flange hole ø 5mm H 8.5mm | | |
| For models: | SME62M, SME63M, SME70M | | |




| | | | |
|---|---|-----------------|--|
|  | | | |
| GEV No. | 415142 | Ref. No. | 1037042300 1037316300 MA1037316300 |
| description | heating element 3500W 230V heating circuits 1 L 525mm W 167mm L1 15mm L2 50mm L3 460mm W1 63mm W2 50mm flange length 100mm flange width 22mm hole distance 31mm tube ø 9mm connection length 54mm dry heating element connection male faston 6.3mm rectangular flange hole ø 10mm H 9mm | | |
| For models: | SME62M, SME63M, SME70M | | |

| | | | |
|---|--|-----------------|------------------------|
|  | | | |
| GEV No. | 415938 | Ref. No. | 1037303813 |
| description | heating element 1800W 230V heating circuits 1 L 330mm W 82mm H 25mm thread M10x1 mounting distance 72mm tube ø 6.3mm 2 hole fixing connection length 20mm immersion heater | | |
| For models: | DLS30, DLS303, DLS30P, DLS30P3, DLS31, DLS313, DLS31P3, MLS30, MLS303, MLS30P, MLS30P3, MLS31, MLS313, MLS31P3, MLS35, MLS353, MPLS30P | | |
| accessories for | 415938 | | |
|  | GEV No. | 510416 | Ref. No. — |
| | flat gasket fibre ED ø 19mm ID ø 10.5mm thickness 1.5mm for thread M10 Qty 1 pcs | | |
|  | GEV No. | 510893 | Ref. No. 200810 |
| | O-ring EPDM thickness 2.62mm ID ø 9.92mm Qty 1 pcs | | |
|  | GEV No. | 520231 | Ref. No. — |
| | nut thread M10x1 H 6mm WS 14 zinc-coated steel Qty 1 pcs | | |
|  | GEV No. | 521129 | Ref. No. — |
| | nut thread M10 H 6mm SS WS 17 Qty 1 pcs DIN/ISO DIN 439 | | |

heating elements for heating bridges


| | | | |
|---|---|-----------------|--|
|  | | | |
| GEV No. | 416665 | Ref. No. | 1037041600 1037041613 MA1037041613 |
| description | heating element 1000W 230V heating circuits 1 L 427mm W 60mm hole distance 87mm connection length 30mm connection M4 tube ø 6.3mm rectangular flange hole ø 5mm dry heating element flange length 100mm flange width 22mm | | |
| For models: | RIE40M, RIEP40M, TSE60M | | |


heating elements for heated cabinets


| | | | |
|---|--|-----------------|----------------------|
|  | | | |
| GEV No. | 416575 | Ref. No. | 1215400 MA1215400 |
| description | heating element 770W 240V heating circuits 1 L 462mm W 33mm flange length 70mm flange width 22mm hole distance 56mm connection length 32mm connection M5 tube ø 8.5mm rectangular flange hole ø 5mm for heated trolley | | |
| For models: | TP13E, TP17E, TP213E, TP217E, TP21E, TP221E | | |

heating cables


connection on both sides (metal braided)

| | | | |
|--|---|-----------------|---------|
|  | | | |
| GEV No. | 416323 | Ref. No. | 5576.12 |
| description | heating cable 42.7W 230V L1 (unheated) 1530mm L2 (heated) 2960mm door frame heating ø 4mm L 6020mm connection cable | | |

| | | | |
|--|---|-----------------|--|
|  | | | |
| GEV No. | 416324 | Ref. No. | 5576.22 5577.12 MA557622 MA557712 |
| description | heating cable 43W 230V L1 (unheated) 2x1500mm L2 (heated) 3000mm door frame heating ø 4mm L 6000mm connection cable | | |
| For models: | AF140B, AF140C, AF140F, AF140I, AF140MB, AF140MC, AF140MF, AF140MI, AF140MN, AF140MP, AF140N, AF140P, AF70B, AF70C, AF70F, AF70I, AF70MB, AF70MC, AF70MF, AF70MI, AF70MN, AF70MP, AF70N, AF70P, EF140DF, EF140DN, EF140DP, EF140MB, EF140MC, EF140MF, EF140MI, EF140MN, EF140MP, EF143DNF, EF143MNI, EF70DF, EF70DN, EF70DP, EF70MB, EF70MC, EF70MF, EF70MI, EF70MN, EF70MP, EF72DNF, EF72MNF, F140DF, F140DI, F140DN, F140DP...(Other models you can see in the webshop) | | |

| | | | |
|--|---|-----------------|--|
|  | | | |
| GEV No. | 416321 | Ref. No. | 2524612 4653500 MA2524612 MA4653500 |
| description | heating cable 49W 230V L1 (unheated) 830mm L2 (heated) 7600mm door frame heating ø 4mm L 9230mm connection cable | | |
| For models: | IR13C, IR13CC, IR13CV, IR13M, IR13MC, IR13MV, IR13V, IR17C, IR17CC, IR17CV, IR17M, IR17MC, IR17MV, IR17V, TR13C2P, TR13I4C, TR13I4CC, TR13I4CV, TR13N2C1P, TR13N2C1PC, TR13N2C1PV, TR13N2P, TR13N2PC, TR13N2PV, TR13N4C, TR13N4CC, TR13N4CV, TR17C3P, TR17I6C, TR17I6CC, TR17I6CV, TR17N2C2P, TR17N2C2PC, TR17N2C2PV, TR17N2P, TR17N3P, TR17N3PC, TR17N3PV, TR17N4C1P, TR17N4C1PC, TR17N4C1PV, TR17N6C, TR17N6CC, TR17N6CV, TR21N2C3P, TR21N2C3PC, TR21N2C3PV, TR21N2P, TR21N4C2P, TR21N4C2PC...(Other models you can see in the webshop) | | |

heating cartridges


| | | | |
|--|--|-----------------|----------------------|
|  | | | |
| GEV No. | 420223 | Ref. No. | 4646700 MA4646700 |
| description | heating cartridge 240W 230V ø 12mm L 240mm thread 3/8" cable length 3000mm connection cable flange with thread immersion heater | | |
| For models: | FB110F, FB110N, FB110P, FB140F, FB140FN, FB140N, FB140NN, FB140P, FB140PF, FB140PN, FB140PP, FB143NI, FB55F, FB55N, FB55P, FB70F, FB70N, FB70P, FB72F, FB72N, FB72NF, FB72P, FS140F, FS140FI, FS140FN, FS140I, FS140N, FS140NG, FS140NI, FS140NN, FS140P, FS140PN, FS140PP, FS143F, FS143FI, FS143N, FS143NF, FS143NI, FS143NN, FS143NP, FS143P, FS70F, FS70FG, FS70I, FS70N, FS70NG, FS70P, FS72F, FS72FI, FS72IN...(Other models you can see in the webshop) | | |





ceramic heaters

245x60mm

1


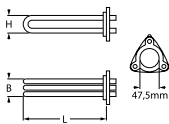




| | | | |
|---|--|-----------------|--|
| GEV No. | 415104 | Ref. No. | 1037039600 1037317601 MA1037317601 |
| description | ceramic emitter 1000W 230V cable beaded cord L 245mm W 60mm H 35mm | | |
| For models: | BSEI40M, NSP74E, NSP94E, OBSEI40M, SP74E, SP94E | | |
| spare parts for | 415104 | | |
|  | GEV No. | 415109 | Ref. No. — |
| | spring clip | | |
| accessories for | 415104 | | |
|  | GEV No. | 415110 | Ref. No. — |
| | reflector L 245mm W 95mm H 31mm thickness 0.75mm hole ø 15x40mm | | |

immersion heating elements

3 hole flange ø47.5mm


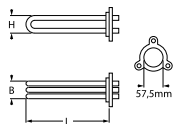
1





| | | | |
|---|---|-----------------|--|
| GEV No. | 415935 | Ref. No. | 1037305400 |
| description | heating element 4500W 230V mounting ø 47.5mm heating circuits 3 L 320mm W 34mm H 30mm number of thermostat sleeves 1 thermostat sleeves ø 7mm length thermostat sleeves 300mm thermostat sleeve eccentric, clinging tube ø 6.3mm hole distance 63mm hole ø 10mm connection male faston 6.3mm 3 hole flange immersion heater | | |
| For models: | DLS30, DLS303, DLS30P, DLS30P3, DLS31, DLS313, DLS31P3, MLC65, MLC653, MLS30, MLS303, MLS30P, MLS30P3, MLS31, MLS313, MLS31P3, MPLS30P | | |
| spare parts for | 415935 | | |
|  | GEV No. | 510408 | Ref. No. 200820 BN0118462630 |
| | O-ring EPDM thickness 5.34mm ID ø 47mm Qty 1 pcs | | |
| accessories for | 415935 | | |
|  | GEV No. | 510562 | Ref. No. — |
| | O-ring silicone thickness 5.34mm ID ø 47mm Qty 1 pcs | | |


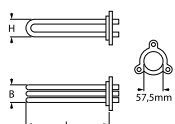
3 hole flange ø57.5mm

1


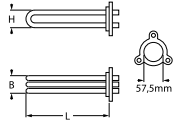
| | | | |
|---|---|-----------------|--|
| GEV No. | 420101 | Ref. No. | 0589130R CR0589130 CR0589130R |
| description | heating element 10500W 400V heating circuits 3 L 580mm W 36mm H 42mm tube ø 8.4mm number of thermostat sleeves 0 cable length 700mm immersion heater 3 hole flange hole distance 73mm mounting ø 57.5mm hole ø 10mm | | |
| For models: | NPI98E10, NPI98E15 | | |
| accessories for | 420101 | | |
|  | GEV No. | 521146 | Ref. No. CM046200 MACM046200 |
| | O-ring Viton thickness 5.34mm ID ø 56.52mm Qty 1 pcs | | |

1


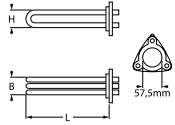
| | | | |
|--------------------|---|-----------------|------------------------|
| GEV No. | 416818 | Ref. No. | CM183900 MACM183900 |
| description | heating element 3400W 230V heating circuits 3 L 437mm W 45mm H 40mm tube ø 10mm connection cable cable length 1270mm connection length 10mm kettle 3 hole flange hole distance 72mm mounting ø 57.5mm hole ø 8/10mm suitable for 700 series | | |
| For models: | PI76E5, PI96E5 | | |

1

| | | | |
|--------------------|---|-----------------|------------------------|
| GEV No. | 416819 | Ref. No. | CM182300 MACM182300 |
| description | heating element 7600W 230V heating circuits 3 L 590mm W 48mm H 65mm tube ø 8.5mm cable length 1170mm connection length 26mm immersion heater 3 hole flange hole distance 72mm mounting ø 57.5mm hole ø 8x10mm | | |
| For models: | PI98E10, PI98E15, PI9S8E10 | | |

1

| | | | |
|--------------------|--|-----------------|--------|
| GEV No. | 415060 | Ref. No. | 110363 |
| description | heating element 3000W 230V mounting ø 57.5mm heating circuits 1 L 330mm W 45mm H 29mm number of thermostat sleeves 1 thermostat sleeves ø 7mm length thermostat sleeves 295mm thermostat sleeve not clinging tube ø 6.25mm hole distance 73mm hole ø 8mm connection male faston 6.3mm 3 hole flange immersion heater | | |



| | | | |
|--------------------|--|-----------------|------------|
| | | | |
| GEV No. | 415934 | Ref. No. | 1037312600 |
| description | heating element 3500W 230V mounting \varnothing 57.5mm heating circuits 3 L 192mm W 38mm H 50mm number of thermostat sleeves 1 thermostat sleeves \varnothing 7.5mm length thermostat sleeves 180mm thermostat sleeve eccentric, clinging tube \varnothing 8.5mm hole distance 72mm hole \varnothing 8mm connection male faston 6.3mm 3 hole flange immersion heater | | |
| For models: | MLC50, MLC503, MLC65, MLC653 | | |

| | | | |
|--------------------|--|-----------------|--------|
| | | | |
| GEV No. | 415020 | Ref. No. | 110331 |
| description | heating element 4500W 230V mounting \varnothing 57.5mm heating circuits 3 L 355mm W 35mm H 47mm number of thermostat sleeves 1 thermostat sleeves \varnothing 7mm length thermostat sleeves 295mm thermostat sleeve upper tube \varnothing 8.5mm hole distance 70mm hole \varnothing 10mm connection length 25mm connection male faston 6.3mm 3 hole flange immersion heater | | |

| | | | | |
|------------------------|---|-----------------|--------------------------------------|--|
| | | | | |
| GEV No. | 415021 | Ref. No. | 1037305500 110349 MA1037305500 | |
| description | heating element 6000W 230V mounting \varnothing 57.5mm heating circuits 3 L 343mm W 37mm H 50mm number of thermostat sleeves 1 thermostat sleeves \varnothing 7mm length thermostat sleeves 294mm thermostat sleeve not clinging tube \varnothing 8.5mm hole distance 72mm hole \varnothing 8mm connection M5 3 hole flange | | | |
| For models: | DLS30, DLS303, DLS30P, DLS30P3, DLS31, DLS313, DLS31P3, MLC50, MLC503, MLS30, MLS303, MLS30P, MLS30P3, MLS31, MLS313, MLS31P3, MLS35, MLS353, MPLS30P | | | |
| spare parts for | 415021 | | | |
| | GEV No. | 510409 | Ref. No. | 1036504200 LA70045010 LAR70045010 R70045010 |
| | O-ring EPDM thickness 5.34mm ID \varnothing 56.52mm Qty 1 pcs | | | |
| accessories for | 415021 | | | |
| | GEV No. | 550002 | Ref. No. | — |
| | tension strap H 10mm L 21mm W 10mm hole \varnothing 6.5mm for heating element | | | |


| | | | | |
|------------------------|--|-----------------|-----------------|--|
| | | | | |
| GEV No. | 415937 | Ref. No. | 1037312700 | |
| description | heating element 9000W 230V mounting \varnothing 57.5mm heating circuits 3 L 340mm W 37mm H 52mm number of thermostat sleeves 1 thermostat sleeves \varnothing 7mm length thermostat sleeves 300mm thermostat sleeve clinging tube \varnothing 8.5mm hole distance 72mm hole \varnothing 8mm connection M5 3 hole flange immersion heater | | | |
| For models: | MLC65, MLC653 | | | |
| spare parts for | 415937 | | | |
| | GEV No. | 510409 | Ref. No. | 1036504200 LA70045010 LAR70045010 R70045010 |
| | O-ring EPDM thickness 5.34mm ID \varnothing 56.52mm Qty 1 pcs | | | |

| | | | |
|--|--|-----------------|--------|
| with expansion flange 70 x 18mm | | | |
| | | | |
| GEV No. | 415016 | Ref. No. | 110227 |
| description | heating element 3000W 230V heating circuits 3 flange 70x18mm L 398mm W 60mm H 24mm connection male faston 6.3mm immersion heater expansion flange tube \varnothing 6.3mm | | |



| | | | | |
|---|---|-----------------|-----------------|------------------------|
| with round flange \varnothing47.5mm | | | | |
| | | | | |
| GEV No. | 416272 | Ref. No. | 110262 | |
| description | heating element 2400W 230V heating circuits 1 mounting \varnothing 47.5mm L 220mm W 35mm H 37mm round flange connection male faston 6.3mm immersion heater tube \varnothing 6.5mm thermostat sleeves \varnothing 7mm number of thermostat sleeves 1 length thermostat sleeves 195mm | | | |
| spare parts for | 416272 | | | |
| | GEV No. | 510408 | Ref. No. | 200820 BN0118462630 |
| | O-ring EPDM thickness 5.34mm ID \varnothing 47mm Qty 1 pcs | | | |
| accessories for | 416272 | | | |
| | GEV No. | 510408 | Ref. No. | 200820 BN0118462630 |
| | O-ring EPDM thickness 5.34mm ID \varnothing 47mm Qty 1 pcs | | | |
| | GEV No. | 510562 | Ref. No. | — |
| | O-ring silicone thickness 5.34mm ID \varnothing 47mm Qty 1 pcs | | | |
| | GEV No. | 520235 | Ref. No. | — |
| | 3 hole flange hole distance 70.5mm perforation \varnothing 6.5mm ID \varnothing 53.5mm | | | |
| | GEV No. | 520236 | Ref. No. | — |
| | flange for heating element ID \varnothing 50mm ED \varnothing 90mm hole \varnothing 6.5mm 3 holes | | | |
| | GEV No. | 550002 | Ref. No. | — |
| | tension strap H 10mm L 21mm W 10mm hole \varnothing 6.5mm for heating element | | | |




Table continues overleaf







| | |
|---|--|
| accessories for 416272 | |
|  | GEV No. 550362 Ref. No. — blind flange ø 64mm mounting ø 47.5mm |



with round flange ø57.5mm


| | | | |
|---|---|-----------------|------------------------|
| 1  | | | |
| GEV No. | 415849 | Ref. No. | R65020420 R65020421 |
| description | heating element 1500W 230V heating circuits 3 mounting ø 57.5mm L 530mm W 45mm H 30mm round flange connection M4 immersion heater tube ø 8.5mm connection length 15mm thermostat sleeves ø 7mm number of thermostat sleeves 1 length thermostat sleeves 272mm thermostat sleeve eccentric, clinging | | |
| For models: | ME102D, ME102M, ME102P, ME102T, ME201D, ME201M, ME201P, ME201T, ME202D, ME202M, ME202P, ME202T, ME220M, ME220P, ME220X, MEC40M, MEMT20D, MEMT20P, MEMT21D, MEMT21P, MEMT40D, MEMT40P | | |
| accessories for 415849 | | | |
|  | GEV No. 550002 | Ref. No. | — |
| tension strap H 10mm L 21mm W 10mm hole ø 6.5mm for heating element | | | |

| | | | |
|---|--|-----------------|--|
| 1  | | | |
| GEV No. | 415848 | Ref. No. | R65020350 |
| description | heating element 7500W 230V heating circuits 3 mounting ø 57.5mm L 365mm W 36mm H 50mm round flange connection M4 immersion heater tube ø 8.5mm thermostat sleeves ø 7.5mm number of thermostat sleeves 1 length thermostat sleeves 270mm thermostat sleeve eccentric, clinging | | |
| For models: | EM010M+SC, EM106H, EM106M, EM106M+SC, EM106P, EM110H, EM110M, EM110M+SC, EM110P, EM210H, EM210M, EM210M+SC, EM210P, ME061D, ME061P, ME061T, ME101D, ME101M, ME101P, ME101T, ME106M, ME106P, ME106X, ME110M, ME110P, ME110X, ME120M, ME120P, ME120X, ME210M, ME210P, ME210X, MEC24H, MEMT06D, MEMT06P, MEMT10D, MEMT10P | | |
| spare parts for 415848 | | | |
|  | GEV No. 510409 | Ref. No. | 1036504200 LA70045010 LAR70045010 R70045010 |
| O-ring EPDM thickness 5.34mm ID ø 56.52mm Qty 1 pcs | | | |
| accessories for 415848 | | | |
|  | GEV No. 550002 | Ref. No. | — |
| tension strap H 10mm L 21mm W 10mm hole ø 6.5mm for heating element | | | |

| | | | |
|---|---|-----------------|----------------------|
| 1  | | | |
| GEV No. | 415957 | Ref. No. | 5152300 MA5152300 |
| description | heating element 9000W 400V heating circuits 3 mounting ø 57.5mm L 402mm W 33mm H 43mm round flange cable length 1270mm immersion heater tube ø 8.5mm thermostat sleeves ø 7mm number of thermostat sleeves 1 length thermostat sleeves 270mm thermostat sleeve clinging | | |
| For models: | CSM102E, CSM102EP, CSM10E, CSM10EP, CSM201E, CSM201EP, CSM202E, CSM202EP, CSM6E, CSM6EP | | |
| accessories for 415957 | | | |
|  | GEV No. 550002 | Ref. No. | — |
| tension strap H 10mm L 21mm W 10mm hole ø 6.5mm for heating element | | | |

| | | | |
|--|---|-----------------|--------------------------------------|
| miscellaneous | | | |
| 1  | | | |
| GEV No. | 415994 | Ref. No. | 1677000 1878100 MA1878100 |
| description | heating element 3400W 230V heating circuits 3 L 430mm W 38mm H 46mm tube ø 10mm hole distance 58mm hole ø 10mm cable length 1300mm 4 hole flange kettle | | |
| For models: | P915E, PI707E | | |
| accessories for 415994 | | | |
|  | GEV No. 505092 | Ref. No. | 2604100 BN0119472130 MA2604100 |
| O-ring EPDM thickness 5.34mm ID ø 43.82mm Qty 1 pcs | | | |

| | | | |
|--|---|-----------------|---------------------------------|
| 1  | | | |
| GEV No. | 415984 | Ref. No. | 1414300 1878200 MA1878200 |
| description | heating element 6000W 240-415V heating circuits 3 L 584mm W 70mm H 65mm tube ø 8.5mm hole distance 96mm hole ø 6.5mm cable length 1300mm connection length 38mm 8 hole flange immersion heater flange width 116mm flange length 116mm | | |
| For models: | P9D10E, P9D15E, P9DA10E, P9DA15E, P9I10E, P9I15E, P9IA10E, P9IA15E | | |
| accessories for 415984 | | | |
|  | GEV No. 521116 | Ref. No. | 1422200 MA1422200 |
| O-ring Viton thickness 3.53mm ID ø 78.97mm Qty 1 pcs | | | |

| | | | |
|--|--|-----------------|----------------------|
| 1  | | | |
| GEV No. | 416815 | Ref. No. | 1878300 MA1878300 |
| description | heating element 7500W 230V heating circuits 3 L 580mm W 66mm H 64mm tube ø 8.5mm cable length 1290mm immersion heater hole distance 37mm flange length 110mm flange width 110mm hole ø 6mm | | |
| For models: | P9I10E, P9I15E, P9IA10E | | |





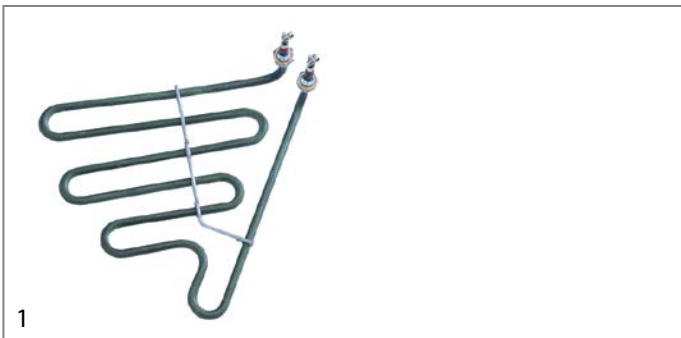




| | | | |
|---|--|-----------------|-------------------------|
| 1"  | | | |
| 1  | | | |
| GEV No. | 420074 | Ref. No. | CR0682160 CR0682160R |
| description | heating element 260W 230V heating circuits 1 L 242mm W 18mm H 6.25mm tube ø 6.25mm thermostat sleeves ø 5mm length thermostat sleeves 230mm number of thermostat sleeves 1 thermostat sleeve centred, adjacent connection male faston 6.3mm connection length 35mm immersion heater flange with thread WS 32 thread 1" | | |
| For models: | NPI76E5, NPI76G5, NPI78E8, NPI78G8, NPI96E5, NPI96G5, NPI98E10, NPI98E15, NPI98G10, NPI98G14, NPI98G14A | | |
| spare parts for 420074 | | | |
|  | GEV No. 503158 | Ref. No. | — |
| flat gasket FIBER ED ø 44mm ID ø 33mm thickness 2mm Qty 1 pcs | | | |

Table continues overleaf

| | | | |
|---|--|--------|-------------------|
| accessories for | 420074 | | |
|  | GEV No. | 507532 | Ref. No. — |
| | nut thread 1" H 10mm WS 40 brass Qty 1 pcs | | |



| | | | |
|--------------------|---|-----------------|---------------------------------|
| GEV No. | 416816 | Ref. No. | 1414400 1879000 MA1879000 |
| description | heating element 2000W 230V heating circuits 1 L 270mm W 242mm H 44mm tube ø 8.5mm connection M5 connection length 38mm kettle 2 hole fixing kettle W2 43mm thread 1/4" mounting distance 43mm | | |
| For models: | P9D10E, P9D15E, P9DA10E, P9DA15E, P9DSB10E, P9I10E, P9IA10E, PDASB10E | | |

| | | | |
|---|--|--------|-------------------|
| accessories for | 416816 | | |
|  | GEV No. | 361182 | Ref. No. — |
| | nut thread 1/4" H 5mm nickel-plated brass WS 17 Qty 1 pcs | | |
|  | GEV No. | 510417 | Ref. No. — |
| | flat gasket fibre ED ø 20mm ID ø 14mm thickness 2mm Qty 1 pcs | | |
|  | GEV No. | 520228 | Ref. No. — |
| | tooth lock washer ID ø 15.3mm ED ø 24mm steel Qty 1 pcs for thread M14 | | |
|  | GEV No. | 550262 | Ref. No. — |
| | flat gasket copper ED ø 20mm ID ø 14mm thickness 2mm | | |

2 connections

straight



| | | | |
|--------------------|---|-----------------|---|
| GEV No. | 416817 | Ref. No. | CM096300 CM096301 CR0682150 MACM096301 |
| description | heating element 4000W 230V heating circuits 1 L 619mm W 150mm Hmm tube ø 8.5mm cable length 790mm connection length 18mm kettle suitable for 900 series | | |
| For models: | NPD98E10, NPD98E15, PD98E10, PD98E15, PD9S8E10 | | |


heating elements for convection



| | | | |
|--------------------|--|-----------------|-----------|
| GEV No. | 415828 | Ref. No. | R65011310 |
| description | heating element 15000W 230V heating circuits 3 ID ø 388mm ED ø 408mm L 428mm H 132mm L1 20mm W1 105mm H1 114mm H2 18mm flange length 140mm flange width 25mm hole distance 126mm connection M4 connection length 65mm tube ø 8.5mm convection heating element hole ø 6.3mm rectangular flange | | |
| For models: | EC110M, EC210M, EM010M+SC, EM110H, EM110M, EM110M+SC, EM110P, EM210H, EM210M, EM210M+SC, EM210P, EV110H, EV110M, EV110M+SC, EV110P, EV210H, EV210M, EV210M+SC, EV210P, MACE10M, ME101D, ME101M, ME101P, ME101T, ME102D, ME102M, ME102P, ME102T, ME110M, ME110P, ME110X, ME120M, ME120P, ME120X, ME201D, ME201M, ME201P, ME201T, ME202D, ME202M, ME202P, ME202T, ME210M, ME210P, ME210X, ME220M, ME220P, ME220X, MEC24H, MEC40M...(Other models you can see in the webshop) | | |




| | | | |
|--------------------|---|-----------------|-----------|
| GEV No. | 418197 | Ref. No. | R65011250 |
| description | heating element 15000W 230V heating circuits 3 ID ø 512mm ED ø 530mm L 545mm H 130mm L1 15mm W1 105mm H1 25mm H2 105mm flange length 142mm flange width 25mm hole distance 126mm connection M4 connection length 68mm tube ø 8.5mm convection heating element hole ø 6mm rectangular flange | | |
| For models: | EC210M, EM210H, EM210M, EM210M+SC, EM210P, EV210H, EV210M, EV210M+SC, EV210P, ME102D, ME102M, ME102P, ME102T, ME202D, ME202M, ME202P, ME202T, MEC24H, MEC40M, MEMENT20D, MEMENT20P, MEMENT40D, MEMENT40P, MEVT20D, MEVT20P, MEVT40D, MEVT40P | | |


1

| | | | |
|---|--|-----------------|--|
| GEV No. | 415966 | Ref. No. | 1037300200 1037300400 4330700 MA1037300200 MA4330700 |
| description | heating element 2500W 230V heating circuits 1 ID ø 176mm ED ø 188mm L 210mm H 28mm L1 22mm W1 30mm H1 3mm H2 25mm flange length 70mm flange width 22mm hole distance 56mm connection male faston 6.3mm tube ø 6.3mm convection heating element hole ø 5mm rectangular flange | | |
| For models: | CFE60, CFE60P, CFGE60, CFGE61, CFGE61D, CFGE61L, CFGE61P, CFVE60, FOE60M, OFOE60M, SNA12, SNA16, SNA20, SNAC12, SNAC16, SNAC20, SNG08, SNG12, SNG16, SNG20, SVAC16, SVAC20, SVCG08, SVCG12, SVCG16, SVCG20, SVCG8 | | |
| accessories for | 415966 | | |
|  | GEV No. | 510368 | Ref. No. — |
| | gasket L 70mm W 23.5mm hole ø 5mm hole distance 56mm FIBER thickness 2mm for heating element | | |




1

| | | | |
|--------------------|---|-----------------|-----------|
| GEV No. | 415845 | Ref. No. | R65010320 |
| description | heating element 3150W 230V heating circuits 3 ID ø 201mm ED ø 215mm L 272mm H 35mm L1 57mm W1 60mm H1 8mm H2 27mm flange length 95mm flange width 22mm hole distance 77mm connection male faston 6.3mm connection length 20mm tube ø 6.5mm convection heating element hole ø 6mm rectangular flange | | |
| For models: | CVE004H, CVE004M, MACE04M, MVE042P, VE004M, VE004X | | |




1

| | | | |
|--------------------|--|-----------------|-----------|
| GEV No. | 415855 | Ref. No. | R65010450 |
| description | heating element 3900W 230V heating circuits 3 ID ø 176mm ED ø 244mm L 282mm H 43mm L1 38mm W1 61mm H1 13mm H2 30mm flange length 92mm flange width 22mm hole distance 78mm connection male faston 6.3mm connection length 60mm tube ø 6.3mm convection heating element hole ø 6.3mm rectangular flange | | |
| For models: | CVE104H, CVE104M, VE104M, VE104X | | |



1

| | | | |
|---|--|-----------------|---|
| GEV No. | 415251 | Ref. No. | 65010200 7800400 LA65010200 LAR65010200 MA7800400 |
| description | heating element 2500W 230V heating circuits 1 ID ø 178mm ED ø 190mm L 242mm H 35mm L1 46mm W1 31mm H1 10mm H2 25mm flange length 70mm flange width 22mm hole distance 56mm connection male faston 6.3mm horizontal tube ø 6.3mm convection heating element hole ø 5mm rectangular flange | | |
| For models: | AC, AR712PA, AR712PP, AR712PS, AR713PA, AR713PP, AR713PS, AR714PA, AR714PP, AR714PS, AR715PA, AR715PP, AR715PS, AR716PA, AR716PP, AR716PS, AR717PA, AR717PP, AR717PS, AR718PA, AR718PP, AR718PS, AR719PA, AR719PP, AR719PS, AR720PA, AR720PP, AR720PS, AU04, AU05, AU08, AU10, AU20, EAR612PA, EAR612PP, EAR612PS, EAR613PA, EAR613PP, EAR613PS, EAR614PA, EAR614PP, EAR614PS, EAR615PA, EAR615PP, EAR615PS, EAR616PA, EAR616PP, EAR616PS, EAR617PA, EAR617PP..(Other models you can see in the webshop) | | |
| spare parts for | 415251 | | |
|  | GEV No. | 510368 | Ref. No. — |
| | gasket L 70mm W 23.5mm hole ø 5mm hole distance 56mm FIBER thickness 2mm for heating element | | |




1



| | | | |
|--------------------|---|-----------------|-----------|
| GEV No. | 418196 | Ref. No. | R65011530 |
| description | heating element 6000W 230V heating circuits 3 ID ø 215mm ED ø 228mm L 266mm H 78mm L1 38mm W1 102mm H1 10mm H2 68mm flange length 142mm flange width 25mm hole distance 57mm connection M4 connection length 66mm tube ø 6.3mm convection heating element hole ø 6mm rectangular flange | | |
| For models: | MACE05M, MVE051P | | |





1


| | | | |
|--------------------|---|-----------------|-----------|
| GEV No. | 415871 | Ref. No. | R65011520 |
| description | heating element 6000W 230V heating circuits 3 ID ø 217mm ED ø 230mm L 267mm H 75mm L1 38mm W1 103mm H1 65mm H2 10mm flange length 140mm flange width 23mm hole distance 67mm connection M4 connection length 25mm tube ø 6.5mm convection heating element hole ø 5mm rectangular flange | | |
| For models: | CVE105H, CVE105M, MVE042P, VE105M, VE105X | | |


| | | | |
|---|---|-----------------|-----------|
|  | | | |
| 1 | | | |
| GEV No. | 415993 | Ref. No. | R65010680 |
| description | heating element 7200W 230V heating circuits 3 ID ϕ 215mm ED ϕ 230mm L 270mm H 78mm L1 30mm W1 102mm H1 10mm H2 68mm flange length 140mm flange width 22mm hole distance 63mm connection M4 connection length 65mm tube ϕ 6.3mm convection heating element hole ϕ 5mm rectangular flange | | |
| For models: | FE105M, FE105X, PE040M, PE040X | | |

| | | | | | | | |
|---|---|--|----------------|--------|-----------------|---|--|
|  | | | | | | | |
| 1 | | | | | | | |
| GEV No. | 415829 | Ref. No. | R65011540 | | | | |
| description | heating element 7500W 230V heating circuits 3 ID ϕ 248mm ED ϕ 260mm L 287mm H 88mm L1 20mm W1 105mm H1 23mm H2 65mm flange length 142mm flange width 25mm hole distance 64mm connection M4 connection length 78mm convection heating element hole ϕ 5mm rectangular flange | | | | | | |
| For models: | EC106M, EM106H, EM106M, EM106M+SC, EM106P, EV006M, EV106H, EV106M, EV106M+SC, EV106P, MACE07M, ME061D, ME061P, ME061T, ME106M, ME106P, ME106X, MEMT06D, MEMT06P, MEVT06D, MEVT06P, VE106M, VE106P, VE106X | | | | | | |
| accessories for | 415829 | | | | | | |
| |  | <table border="1"> <tr> <td>GEV No.</td> <td>531270</td> <td>Ref. No.</td> <td>—</td> </tr> </table> | GEV No. | 531270 | Ref. No. | — | |
| GEV No. | 531270 | Ref. No. | — | | | | |
| | gasket L 141mm W 22mm D1 ϕ 10mm D2 ϕ 9mm 9 holes graphite thickness 1mm suitable for UNOX | | | | | | |


| | | | |
|---|---|-----------------|-----------|
|  | | | |
| 1 | | | |
| GEV No. | 415827 | Ref. No. | R65011210 |
| description | heating element 9000W 230V heating circuits 3 ID ϕ 508mm ED ϕ 526mm L 550mm H 122mm L1 24mm W1 105mm H1 26mm H2 96mm flange length 140mm flange width 25mm hole distance 126mm connection M4 connection length 68mm tube ϕ 9mm convection heating element hole ϕ 6.3mm rectangular flange | | |
| For models: | ME210M, ME210P, ME210X, ME220M, ME220P, ME220X, VE210M, VE210P, VE210X, VE220M, VE220P, VE220X | | |

| | | | |
|--|---|-----------------|-----------|
|  | | | |
| 1 | | | |
| GEV No. | 415737 | Ref. No. | R65010180 |
| description | heating element 2500W 230V heating circuits 1 L 655mm W 120mm L1 30mm L2 625mm W2 90mm flange length 70mm flange width 22mm hole distance 56mm connection length 100mm connection M4 tube ϕ 6.3mm hole ϕ 5.5mm W1 30mm rectangular flange convection heating element windings 2 | | |
| For models: | FE110M, FE110X, PE080M, PE080X | | |


| | | | |
|--|--|-----------------|----------------------|
|  | | | |
| 1 | | | |
| GEV No. | 415998 | Ref. No. | 5152100 MA5152100 |
| description | heating element 3000W 400V heating circuits 1 L 513mm W 120mm L1 33mm L2 480mm W2 100mm flange length 50mm flange width 26mm connection M4 tube ϕ 8.5mm hole ϕ 6mm W1 20mm compression flange convection heating element | | |
| For models: | CON10E, CON10EP, CON201E, CON201EP, CSM102E, CSM102EP, CSM10E, CSM10EP, CSM201E, CSM201EP | | |

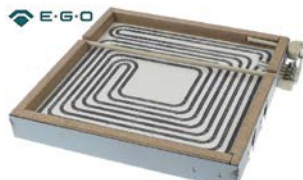
| | | | |
|---|--|-----------------|-----------|
|  | | | |
| 1 | | | |
| GEV No. | 415736 | Ref. No. | R65010390 |
| description | heating element 3500W 230V heating circuits 1 L 655mm W 125mm L1 30mm L2 625mm W2 88mm flange length 70mm flange width 22mm hole distance 56mm connection length 97mm connection M4 tube ϕ 6.25mm hole ϕ 5mm W1 30mm rectangular flange convection heating element windings 2 mounting distance 58mm | | |
| For models: | FE210M | | |



radiation heaters


| | | | |
|--|--|-----------------|---|
|  | | | |
| 1 | | | |
| GEV No. | 416963 | Ref. No. | 1037308900 1037308913 CR0419950 MA1037308913 |
| description | radiation heater octagonal 2400W 230V L 230mm W 230mm heating circuits 1 with heating coil energy regulation with temperature signalization connections 2+2 connection type cable AD | | |
| For models: | CFVE60, CT78EC, CT7FE8EC, PCVE40, PCVE40D, PCVE40DB, PCVE60, PCVE60D, PCVE60DB, V74EC, V76EC | | |





| | | | |
|---|--|-----------------|-----------|
|  | | | |
| 1 | | | |
| GEV No. | 490200 | Ref. No. | CR0509610 |
| description | radiation heater octagonal 3400W 230V L 300mm W 300mm heating circuits 2 H 30mm with heating coil energy regulation with temperature signalization connections 2+2 connection type cable cable length 800mm AD | | |
| For models: | CT98EC, CT9FE8EC | | |


| | | | |
|--|---|-----------------|-----------|
|  | | | |
| 1 | | | |
| GEV No. | 490195 | Ref. No. | CR0688660 |
| description | radiation heater L 300mm W 300mm 4000W 400V heating circuits 2 H 40mm connection type screw without pan detection EGO | | |
| For models: | NCT98E, NCT98E2, NCT9FE8E, NCT9FE8E2, NV94E, NV98E, NV9FE8E | | |

| | | | |
|--|---|-----------------|-----------------|
|  | | | |
| 1 | | | |
| GEV No. | 490079 | Ref. No. | CR0509620 |
| description | radiation heater octagonal 3400W 230V L 300mm W 300mm heating circuits 2 H 30mm with heating coil energy regulation with temperature signalization connections 4+2 connection type cable AD | | |
| For models: | V94E, V98E | | |
| spare parts for | 490079 | | |
|  | GEV No. | 390931 | Ref. No. |
| | safety thermostat for radiation heater | | |


| | | | |
|--|---|-----------------|----------------------------|
|  | | | |
| 1 | | | |
| GEV No. | 418029 | Ref. No. | 1037311013 MA1037311013 |
| description | radiation heater rectangular 1500W 230V L 450mm W 190mm heating circuits 1 connections 2 IRCA | | |
| For models: | FTVE100, FTVE40, FTVE40D, FTVE60, FTVE60D | | |

| | | | |
|---|--|-----------------|------------------------|
|  | | | |
| 1 | | | |
| GEV No. | 490153 | Ref. No. | CM189500 MACM189500 |
| description | radiation heater octagonal 3400W 230V L 300mm W 300mm heating circuits 2 H 30mm with heating coil energy regulation with temperature signalization connections 4+2 connection type cable cable length 900mm AD | | |
| For models: | CT98EC, CT9FE8EC, V94E, V98E | | |

| | | | |
|---|---|-----------------|----------------------------|
|  | | | |
| 1 | | | |
| GEV No. | 418030 | Ref. No. | 1037311213 MA1037311213 |
| description | radiation heater rectangular 2500W 230V L 450mm W 295mm heating circuits 1 connections 2 IRCA | | |
| For models: | FTVE100, FTVE40, FTVE40D, FTVE60, FTVE60D | | |

| | | | |
|---|---|-----------------|-----------|
| <p>square</p>  | | | |
| 1 | | | |
| GEV No. | 490202 | Ref. No. | CR0735680 |
| description | radiation heater L 300mm W 300mm 4000W 400V H 40mm connection type screw with pan detection | | |

| | | | |
|---|--|-----------------|--|
| <p>1-circuit</p>  | | | |
| 1 | | | |
| GEV No. | 490116 | Ref. No. | 1037309600 1037309613 MA1037309613 |
| description | radiation heater ø 165mm 1200W 230V heating circuits 1 H 33mm 7-position control with temperature signalization with ribbon heater connections 2+2 connection type male faston 6.3mm CERAMASPEED | | |
| For models: | CFVE60, PCVE40, PCVE40D, PCVE40DB, PCVE60, PCVE60D, PCVE60DB, V74EC, V76EC | | |



| | | | |
|--------------------|--|-----------------|--------------------------|
| GEV No. | 490113 | Ref. No. | 1037309000 1037309013 |
| description | radiation heater ø 200mm 1800W 230V heating circuits 1 energy regulation with temperature signalization with ribbon heater connections 2+2 connection type male faston 6.3mm CERAMASPEED | | |
| For models: | CFVE60, PCVE40, PCVE40D, PCVE40DB, PCVE60, PCVE60D, PCVE60DB, V74EC, V76EC | | |




| | | | |
|--------------------|---|-----------------|-----------|
| GEV No. | 490150 | Ref. No. | CR0791310 |
| description | radiation heater ø 250mm 2500W 230V heating circuits 1 energy regulation with temperature signalization with heating coil connections 2+2 connection type male faston 6.3mm EGO | | |
| For models: | NCT78E, NCT7FE8E, NV74EC, NV78EC, NV7FE8E | | |

2-circuit



| | | | |
|--------------------|--|-----------------|-----------|
| GEV No. | 490139 | Ref. No. | CR0511560 |
| description | radiation heater ø 250mm 2500W 230V heating circuits 2 energy regulation with temperature signalization partial power 1000W with ribbon heater connections 3+2 connection type male faston 6.3mm EGO | | |
| For models: | CFVE60, PCVE40, PCVE40D, PCVE40DB, PCVE60, PCVE60D, PCVE60DB, V74EC, V76EC | | |

foil heating elements




| | | | |
|--------------------|--|-----------------|----------------------|
| GEV No. | 420439 | Ref. No. | 4330600 MA4330600 |
| description | foil heating element L 460mm W 270mm 700W 220V t.max. 150°C thickness 1.5mm | | |
| For models: | SNA12, SNA16, SNA20, SNAC12, SNAC16, SNAC20, SNG08, SNG12, SNG16, SNG20, SVAC16, SVAC20, SVCG08, SVCG12, SVCG16, SVCG20, SVCG8 | | |




| | | | |
|--------------------|--|-----------------|-----------|
| GEV No. | 417701 | Ref. No. | BN1666273 |
| description | heater mat L 430mm W 120mm 30W 230V cable length 1200mm connection male faston 6.3mm | | |

accessories


hexagonal nuts



| | | | |
|--------------------|--|-----------------|----------------------------|
| GEV No. | 540436 | Ref. No. | 1033514900 MA1033514900 |
| description | hexagonal nut thread M10x1.25 H 4mm WS 13 brass Qty 1 pcs | | |
| For models: | C74GS, C78GS, C79G, C7FE12GS, C7FE8GS, C7FG12GS, C7FG8GS, C7FG9G, CFGE61, CFGE61D, CFGE61L, CFGE61P, CP704E, CP92E, CP92E2, CP94E, CP94E2, CP9SB2E, CP9SB2E2, CP9SB4E, CP9SB4E2, CPE40, CPE402, CPE60, CPE602, CPE60DB, DE92142, DE94242, EC74GVG, EC78GVG, EC7FG8G, EPC74E, OCFGE61, OCPE6, OCPE60, OPCG41, OPCG61, PC12C4E, PC12C9E, PC74E, PC76E, PC78E, PC94E, PC96E, PC98E, PC9S4E, PC9S6E, PC9S8E, PCG41, PCG41L...(Other models you can see in the webshop) | | |




| | | | |
|--------------------|--|-----------------|--------------------------------------|
| GEV No. | 514022 | Ref. No. | 1032300100 14044599 MA14044599 |
| description | nut thread 1½" H 12mm SS WS 59 Qty 1 pcs | | |
| For models: | CP704E, CP92E, CP92E2, CP94E, CP94E2, CP9SB2E, CP9SB2E2, CP9SB4E, CP9SB4E2, CPE40, CPE402, CPE60, CPE602, CPE60DB, DE92142, DE94242, EPC74E, OCPE6, OCPE60, PC12C4E, PC12C9E, PC74E, PC76E, PC78E, PC94E, PC96E, PC98E, PC9S4E, PC9S6E, PC9S8E | | |




| | | | |
|--------------------|---|-----------------|----------------------|
| GEV No. | 521133 | Ref. No. | 1325313 MA1325313 |
| description | nut thread M14x1.5 H 6mm WS 19 zinc-coated steel Qty 1 pcs | | |
| For models: | B9SB2G, B9SB4G, B9V2G, B9V4G, B9VP4G, BM74G, BM77G, C124G, C129G, C12C2G9, C12C9G, C12FG9G, C7011G, C7011GFE, C7011GFG, C704G, C707G, C707GFE, C707GFG, C712G, C74G, C78G, C7FE12G, C7FE8G, C7FG12G, C7FG8G, C7FGM12G, C912G, C912GS, C94G, C94GP, C94GS, C98G, C98GP, C98GS, C9F4E, C9F4GS, C9F6E, C9F6GS, C9F8GS, C9FE12G, C9FE12GS, C9FE4GS, C9FE6GS, C9FE8G, C9FE8GS, C9FEP4GS, C9FEP6GS, C9FEP8GS, C9FG12G...(Other models you can see in the webshop) | | |





| washers | | | |
|--|---|-----------------|------------------------|
|  <p>1</p> | | | |
| GEV No. | 560112 | Ref. No. | 15830499 MA15830499 |
| description | plain washer ID \varnothing 5.3mm ED \varnothing 10mm thickness 1mm SS Qty 20 pcs DIN 125A for thread M5 | | |
| For models: | BR707E, BR707EI, BR707G, BR707GI, BR94E, BR94EI, BR94G, BR94GI, BR96E, BR96EI, BR96G, BR96GI, BR9M4E, BR9M4EI, BR9M4G, BR9M4GI, BR9M6E, BR9M6EI, BR9M6G, BR9M6GI, BR9SB4E, BR9SB4EI, BR9SB4G, BR9SB4GI, EPC74E, EPC74G, PC12C4E, PC12C4G, PC12C9E, PC12C9G, PC74E, PC74G, PC76E, PC76G, PC78E, PC78G, PC94E, PC94G, PC96E, PC96G, PC98E, PC98G, PD707G, PI707E, PI707G, SER15, SER15A, SER18, SER18A, SER21 | | |


| ring nuts | | | |
|--|---|-----------------|------------------------|
|  <p>1</p> | | | |
| GEV No. | 550662 | Ref. No. | CM021600 MACM021600 |
| description | ring nut thread M54x1.5 H 7mm | | |
| For models: | EF74E10VG, EF74E12, F12C4E12, F74E10, F74E12, F74E6, F76E10, F78E12, F94E10, F94E12, F94E18, F94E18K, F94E6, F96E10, F98E12, F98E18, F98E18K, F9S4E18K, F9S8E18K, FQE41R, FQE41RL, FQE41RL2, FQE61R, FQE61RL, NF74E10, NF74E15, NF76E10, NF78E15, NF94E10, NF94E15, NF94E22, NF94E222, NF94E22K, NF94E22K, NF96E10, NF98E15, NF98E22, NF98E222, NF98E222K, NF98E22K, NPC74E, NPC76E, NPC78E, NPC94E, NPC96E, NPC98E | | |
| accessories for | 550662 | | |
| | GEV No. | 550449 | Ref. No. — |
| |  <p>special wrench for ring nut</p> | | |

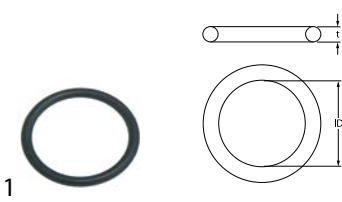
| sealing washers | | | |
|--|---|-----------------|-----------|
| fibre gaskets | | | |
|  <p>1</p> | | | |
| GEV No. | 510404 | Ref. No. | CR0682770 |
| description | flat gasket fibre ED \varnothing 44mm ID \varnothing 34mm thickness 2mm Qty 1 pcs | | |
| For models: | NPI76E5, NPI76G5, NPI78E8, NPI78G8, NPI96E5, NPI96G5, NPI98E10, NPI98E15, NPI98G10, NPI98G14, NPI98G14A | | |

| PTFE gaskets | | | |
|--|--|-----------------|------------------------------------|
|  <p>1</p> | | | |
| GEV No. | 514016 | Ref. No. | 1036500400 1814500 MA1814500 |
| description | flat gasket PTFE ED \varnothing 45mm ID \varnothing 40mm thickness 4mm Qty 1 pcs equiv. no. 1036500400/1814500 suitable for MARENO | | |
| For models: | CP704E, CP92E, CP92E2, CP94E, CP94E2, CP9SB2E, CP9SB2E2, CP9SB4E, CP9SB4E2, CPE40, CPE402, CPE60, CPE602, CPE60DB, DE92142, DE94242, EPC74E, OCPE6, OCPE60, PC12C4E, PC12C9E, PC74E, PC76E, PC78E, PC94E, PC96E, PC98E, PC9S4E, PC9S6E, PC9S8E | | |

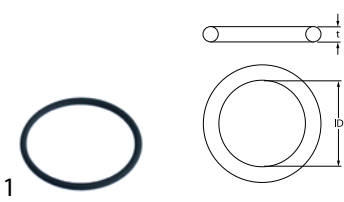
| O-rings | | | |
|--|--|-----------------|--------|
|  <p>1</p> | | | |
| GEV No. | 510893 | Ref. No. | 200810 |
| description | O-ring EPDM thickness 2.62mm ID \varnothing 9.92mm Qty 1 pcs | | |

| | | | |
|--|---|-----------------|--------|
|  <p>1</p> | | | |
| GEV No. | 510901 | Ref. No. | 200843 |
| description | O-ring EPDM thickness 2mm ID \varnothing 13mm Qty 1 pcs | | |

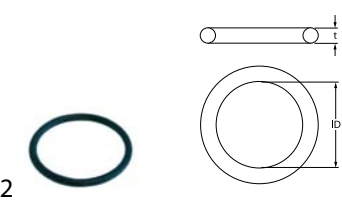
| | | | |
|--|---|-----------------|--------------------------------------|
|  <p>1</p> | | | |
| GEV No. | 505092 | Ref. No. | 2604100 BN0119472130 MA2604100 |
| description | O-ring EPDM thickness 5.34mm ID \varnothing 43.82mm Qty 1 pcs | | |
| For models: | CS102E, CS102EP, CS10E, CS10EP, CS6E, CS6EP, FV4E, FV4E1, P915E, PI707E, PI76E5, PI96E5, PI98E10, PI98E15, PI9S8E10 | | |



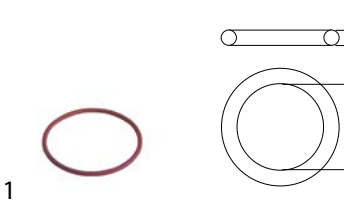
| | | | |
|--------------------|--|-----------------|------------------------|
| GEV No. | 510408 | Ref. No. | 200820 BN0118462630 |
| description | O-ring EPDM thickness 5.34mm ID ø 47mm Qty 1 pcs | | |



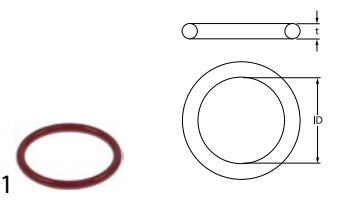
| | | | |
|--------------------|--|-----------------|------------------------|
| GEV No. | 550496 | Ref. No. | CM099200 MACM099200 |
| description | O-ring Viton thickness 3.53mm ID ø 50.39mm Qty 1 pcs | | |
| For models: | EF74E10VG, EF74E12, F12C4E12, F74E10, F74E12, F74E6, F76E10, F78E12, F94E10, F94E12, F94E18, F94E18K, F94E6, F96E10, F98E12, F98E18, F98E18K, F9S4E12, F9S4E18, F9S4E18K, F9S8E12, F9S8E18, F9S8E18K, FQE41R, FQE41RL, FQE41RL2, FQE61R, FQE61RL, NF74E10, NF74E15, NF76E10, NF78E15, NF94E10, NF94E15, NF94E22, NF94E222, NF94E222K, NF94E22K, NF96E10, NF98E15, NF98E22, NF98E222, NF98E222K, NF98E22K, NPC74E, NPC76E, NPC78E, NPC94E, NPC96E, NPC98E | | |



| | | | |
|--------------------|--|-----------------|---|
| GEV No. | 510409 | Ref. No. | 1036504200 LA70045010 LAR70045010 |
| description | O-ring EPDM thickness 5.34mm ID ø 56.52mm Qty 1 pcs | | |
| For models: | DLS30, DLS303, DLS30P, DLS30P3, DLS31, DLS313, DLS31P3, ME101M, ME101P, ME101T, ME102D, ME102M, ME102P, ME102T, ME201D, ME201M, ME201P, ME201T, ME202D, ME202M, ME202P, ME202T, MEMT06D, MEMT06P, MEMT10D, MEMT10P, MEMT20D, MEMT20P, MEMT21D, MEMT21P, MEMT40D, MEMT40P, MLC50, MLC503, MLC65, MLC653, MLS30, MLS303, MLS30P, MLS30P3, MLS31, MLS313, MLS31P3, MLS35, MLS353, MPLS30P | | |




| | | | |
|--------------------|--|-----------------|----------------------|
| GEV No. | 521116 | Ref. No. | 1422200 MA1422200 |
| description | O-ring Viton thickness 3.53mm ID ø 78.97mm Qty 1 pcs | | |
| For models: | P9D10E, P9D15E, P9DA10E, P9DA15E, P9I10E, P9I15E, P9IA10E, P9IA15E | | |

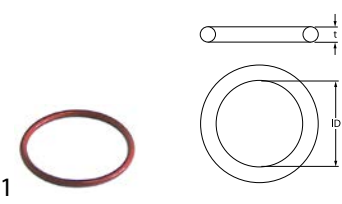


| | | | |
|--------------------|---|-----------------|---|
| GEV No. | 514017 | Ref. No. | 0105246 1036500200 1814400 MA1814400 R0105246 SIR0105246 |
| description | O-ring silicone thickness 3.53mm ID ø 32.93mm Qty 1 pcs | | |
| For models: | CP704E, CP92E, CP92E2, CP94E, CP94E2, CP9S82E, CP9S82E2, CP9S-B4E, CP9S84E2, CPE40, CPE402, CPE60, CPE602, CPE60DB, DE92142, DE94242, EPC74E, OCPE6, OCPE60, PC12C4E, PC12C9E, PC74E, PC76E, PC78E, PC94E, PC96E, PC98E, PC9S4E, PC9S6E, PC9S8E | | |

capillary tube clips




| | | | |
|--------------------|--|-----------------|----------------------------|
| GEV No. | 550970 | Ref. No. | 1033709500 MA1033709500 |
| description | capillary tube clip for pipe ø 8.5mm | | |
| For models: | FQE41, FQE41L, FQE41L2, FQE61, FQE61L, FQE61L2, FR74E10, FR74E10L, FR74E10L2, FR77E10, FR77E10L, FR77E10L2, FR92E10, FR92E10L, FR92E10L2, FR94E10, FR94E10L, FR94E10L2, OFQE41, OFQE61 | | |




| | | | |
|--------------------|---|-----------------|------------------------------------|
| GEV No. | 514021 | Ref. No. | 1036500300 1814700 MA1814700 |
| description | O-ring silicone thickness 3.53mm ID ø 49.21mm Qty 1 pcs | | |
| For models: | CP704E, CP92E, CP92E2, CP94E, CP94E2, CP9S82E, CP9S82E2, CP9S-B4E, CP9S84E2, CPE40, CPE402, CPE60, CPE602, CPE60DB, EPC74E, OCPE6, OCPE60, PC12C4E, PC12C9E, PC74E, PC76E, PC78E, PC94E, PC96E, PC98E, PC9S4E, PC9S6E, PC9S8E | | |


spring clips




| | | | |
|--------------------|--|-----------------|----------------------|
| GEV No. | 550419 | Ref. No. | 1567200 MA1567200 |
| description | probe clip for pipe ø 8.5mm for probe ø 6mm Qty 1 pcs | | |
| For models: | FR74E, FR74E2, FR77E, FR77E2, FR92E13, FR92E132, FR92E13T, FR92E13T2, FR92E22, FR92E22T, FR94E13, FR94E132, FR94E13T, FR94E13T2, FR94E22, FR94E22T | | |





| | | | |
|---|--|-----------------|----------------------------|
|  | | | |
| 1 | | | |
| GEV No. | 550417 | Ref. No. | 1033515200 MA1033515200 |
| description | probe clip for pipe ø 2x8.5mm for probe ø 6mm for heating elements spacing 15-19mm Qty 1 pcs | | |
| For models: | FQE41, FQE41L, FQE41L2, FQE61, FQE61L, FQE61L2, FR74E10, FR74E10L, FR74E10L2, FR77E10, FR77E10L, FR77E10L2, FR92E10, FR92E10L, FR92E10L2, FR94E10, FR94E10L, FR94E10L2, OFQE41, OFQE61 | | |


| | | | |
|--|--|-----------------|----------------------------|
|  | | | |
| 1 | | | |
| GEV No. | 691354 | Ref. No. | 1041304334 MA1041304334 |
| description | lever for tilting element | | |
| For models: | FQE41, FQE41L, FQE41L2, FQE61, FQE61L, FQE61L2, FR74E10, FR74E10L, FR74E10L2, FR77E10, FR77E10L, FR77E10L2, OFQE41, OFQE61 | | |

protection caps

| | | | |
|---|---|-----------------|--------|
|  | | | |
| 1 | | | |
| GEV No. | 510490 | Ref. No. | 161102 |
| description | protection cap for heating element ø 62mm H 54mm mounting distance 70mm | | |

| | | | |
|---|--|-----------------|------------------------------------|
|  | | | |
| 1 | | | |
| GEV No. | 514018 | Ref. No. | 1033703500 1814600 MA1814600 |
| description | bush | | |
| For models: | CP704E, CP92E, CP92E2, CP94E, CP94E2, CP95B2E, CP95B2E2, CP95B4E, CP95B4E2, CPE40, CPE402, CPE60, CPE602, CPE60DB, DE92142, DE94242, EPC74E, OCPE6, OCPE60, PC12C4E, PC12C9E, PC74E, PC76E, PC78E, PC94E, PC96E, PC98E, PC954E, PC956E, PC958E | | |

| | | | |
|---|--|-----------------|---|
|  | | | |
| 1 | | | |
| GEV No. | 514020 | Ref. No. | 1036500100 1815000 1815014 MA1815014 |
| description | bush | | |
| For models: | CP704E, CP92E, CP92E2, CP94E, CP94E2, CP95B2E, CP95B2E2, CP95B4E, CP95B4E2, CPE40, CPE402, CPE60, CPE602, CPE60DB, DE92142, DE94242, EPC74E, OCPE6, OCPE60, PC12C4E, PC12C9E, PC74E, PC76E, PC78E, PC94E, PC96E, PC98E, PC954E, PC956E, PC958E | | |

| | | | |
|---|--|-----------------|----------------------------|
|  | | | |
| 1 | | | |
| GEV No. | 691335 | Ref. No. | 1033715314 MA1033715314 |
| description | lever for tilting element | | |
| For models: | FQE41, FQE41L, FQE41L2, FQE61, FQE61L, FQE61L2, FR74E10, FR74E10L, FR74E10L2, FR77E10, FR77E10L, FR77E10L2, OFQE41, OFQE61 | | |

hot plates

square & rectangular

with radiused edge

| | | | |
|--|---|-----------------|------------------------------------|
|  | | | |
| 1 | | | |
| GEV No. | 490066 ¹ | Ref. No. | 1712913 CR1078117R MA1712913 |
| description | hot plate dimensions 220x220mm 2600W 230V with spill ring connection 4 screw clamps protector yes square | | |
| For models: | C7011EFE, C7011EFEQ, C707EFE, C707EFEQ, C74EC, C78EC, C78EQC, C7FE8E, C7FE8EC, C7FE8EQ, C94E, C94EC, C98E, C98EC, C9FE8E, C9FE8EC, NC74E2, NC74EQC, NC78E2, NC78EQC, NC7FE8E2, NC7FE8EQ | | |

¹incl. protector

| | | | |
|--|--|-----------------|--|
|  | | | |
| 1 | | | |
| GEV No. | 490056 ¹ | Ref. No. | 1340800 1937100 MA1340800 MA1937100 |
| description | hot plate dimensions 300x300mm 3000W 230V with spill ring connection 4 screw clamps protector yes square | | |
| For models: | C9F4E, C9F6E, C9V2E, C9V4E | | |

¹incl. protector



1

| | | | |
|--------------------|---|-----------------|----------------------|
| GEV No. | 490073 | Ref. No. | 1937200 MA1937200 |
| description | hot plate dimensions 300x300mm 3000W 400V with spill ring connection 4 screw clamps protector no square | | |
| For models: | C9F4E, C9F6E, C9V2E, C9V4E | | |



1

| | | | |
|--------------------|---|-----------------|---|
| GEV No. | 490071 ¹ | Ref. No. | 1340900 1937300 MA1937300 MA1937300R |
| description | hot plate dimensions 300x300mm 4000W 230V with spill ring connection 4 screw clamps protector yes square | | |
| For models: | C74EC, C78EC, C78EQC, C7FE8E, C7FE8EC, C7FE8EQ, C7FG12G, C7FG8G, C94E, C94EC, C98E, C98EC, C9F4E, C9F6E, C9FE8E, C9FE8EC, C9V2E, C9V4E, NC94E, NC94E2, NC98E, NC98E2, NC9FE8E, NC9FE8E2 | | |

¹incl. protector

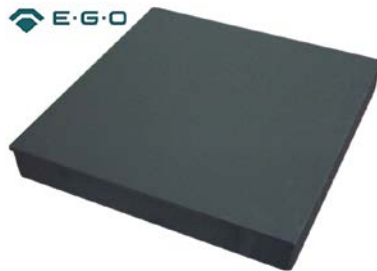


1

| | | | |
|--------------------|---|-----------------|----------------------|
| GEV No. | 490074 ¹ | Ref. No. | 1937400 MA1937400 |
| description | hot plate dimensions 300x300mm 4000W 400V with spill ring connection 4 screw clamps protector yes square | | |
| For models: | C74EC, C78EC, C78EQC, C7FE8E, C7FE8EC, C7FE8EQ, C7FG12G, C7FG8G, C94E, C94EC, C98E, C98EC, C9F4E, C9F6E, C9FE8E, C9FE8EC, C9V2E, C9V4E, NC94E, NC94E2, NC98E, NC98E2, NC9FE8E, NC9FE8E2 | | |

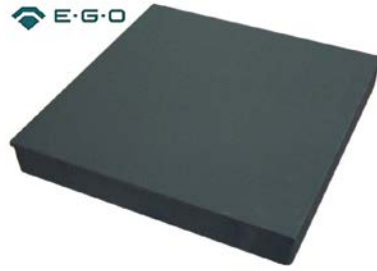
¹incl. protector

tiltable



1

| | | | |
|--------------------|---|-----------------|--------|
| GEV No. | 490088 | Ref. No. | 279111 |
| description | hot plate dimensions 300x300mm 2500W 400V with cast edge tilt boiling plate connection 4 screw clamps H 43mm square | | |



1

| | | | |
|--------------------|---|-----------------|--------------------|
| GEV No. | 490089 | Ref. No. | 783700 MA783700 |
| description | hot plate dimensions 300x300mm 4000W 230V with cast edge tilt boiling plate connection 4 screw clamps H 43mm square | | |

round

with radiused edge

for domestic and commercial kitchens



1


| | | | |
|--------------------|--|-----------------|-------------------------------------|
| GEV No. | 490014 | Ref. No. | 1037040900 1037044000 1641600 |
| description | hot plate ø 180mm 1500W 230V connection 4 screw clamps with 8mm spill ring | | |





1



| | | | |
|--------------------|---|-----------------|----------------------|
| GEV No. | 490129 | Ref. No. | 1839813 MA1839813 |
| description | hot plate ø 180mm 1500W 230V connection 4 screw clamps with 8mm spill ring | | |
| For models: | C7011E, C7011EFE, C7011GFE, C704E, C707E, C707EFE, C707GFE, CFE60, CFE60P, CFE70, EC74EVG, EC78EVG, EC7FE8E, OCFE60, OPCE40, OPCE60, PCE40, PCE40D, PCE40DB, PCE60, PCE60D, PCE60DB | | |




| | | | |
|---|--|-----------------|------------------------|
|  | | | |
| GEV No. | 490016 | Ref. No. | CM059900 MACM059900 |
| description | hot plate ø 180mm 2000W 230V connection 4 screw clamps with 8mm spill ring | | |
| For models: | C74EC, C78EC, C78EQC, C7FE8E, C7FE8EC, C7FE8EQ, C7FG12G, C7FG8G, C94E, C94EC, C98E, C98EC, C9FE8E, C9FE8EC | | |

| | | | |
|---|--|-----------------|-------------------------------------|
|  | | | |
| GEV No. | 490018 | Ref. No. | 1037043900 1037079100 1641500 |
| description | hot plate ø 220mm 2000W 230V connection 4 screw clamps with 8mm spill ring | | |


| | | | |
|---|---|-----------------|----------------------|
|  | | | |
| GEV No. | 490130 | Ref. No. | 1647013 MA1647013 |
| description | hot plate ø 220mm 2000W 230V connection 4 screw clamps with 8mm spill ring | | |
| For models: | C7011E, C7011EFE, C7011GFE, C704E, C707E, C707EFE, C707GFE, CFE60, CFE60P, OCFE60, PCE100, PCE40, PCE40M, PCE60 | | |


| | | | |
|---|--|-----------------|----------------------|
|  | | | |
| GEV No. | 490020 | Ref. No. | 1832313 MA1832313 |
| description | hot plate ø 220mm 2600W 230V connection 4 screw clamps with 8mm spill ring | | |
| For models: | C7011E, C7011EFE, C7011GFE, C704E, C707E, C707EFE, C707GFE, C74EC, C78EC, C78EQC, C7FE8E, C7FE8EC, C7FE8EQ, C7FG12G, C7FG8G, C94E, C94EC, C98E, C98EC, C9FE8E, C9FE8EC, CFE60, CFE60P, CFE70, EC74EVG, EC78EVG, EC7FE8E, NC74E2, NC74EC, NC78E2, NC78EC, NC7FE8E, NC7FE8E2, OCFE60, OPCE40, OPCE60, PCE40, PCE40D, PCE40DB, PCE60, PCE60D, PCE60DB | | |
| accessories for | 490020 | | |
| | GEV No. | 550796 | Ref. No. — |
| |  fixing plate for hot plate ø220mm | | |

| | | | |
|--|--|-----------------|--------|
| with cast brim | | | |
| with screw connection | | | |
|  | | | |
| GEV No. | 490106 | Ref. No. | 779111 |
| description | hot plate ø 400mm 5000W 400V connection 2x 3 screw clamps with cast edge screw bolt H 42mm | | |
| For models: | FP1E | | |

energy regulators

EGO

| | | | |
|--|---|-----------------|--|
| 1-circuit | | | |
|  | | | |
| GEV No. | 380015 | Ref. No. | 1037035310 1037110113 426710 MA1037110113 |
| description | energy regulator 230V 13A single-circuit turn direction right shaft ø 6x4.6mm shaft L 23mm mounting thread M4 power release 6-100% no. 50.57021.010 | | |
| For models: | CFVE60, CON102E, CON102EP, CON102G, CON102GP, CON10E, CON10EP, CON10G, CON10GP, CON201E, CON201EP, CON201G, CON201GP, CON202E, CON202EP, CON202G, CON202GP, CON6E, CON6EP, CON6G, CON6GP, CP704E, CP92E, CP92E2, CP94E, CP94E2, CP95B2E, CP95B2E2, CP95B4E, CP95B4E2, CPE60, CRE6220, CRE6230, CRE6320, CRE6330, CS102E, CS102EP, CS102G, CS102GP, CS10E, CS10EP, CS10G, CS6E, CS6EP, CS6G, CWE42, CWE62, FC10E, FC10G, FC20E...(Other models you can see in the webshop) | | |

| | | | |
|--|--|-----------------|----------------------------|
| 2-circuit | | | |
|  | | | |
| GEV No. | 380024 | Ref. No. | 1037108713 MA1037108713 |
| description | energy regulator 240V 13A turn direction right shaft ø 6x4.6mm shaft L 36mm mounting thread M4 no. 50.67079.601 with operation switch 1-pole | | |
| For models: | CFVE60, PCVE40, PCVE40D, PCVE40DB, PCVE60, PCVE60D, PCVE60DB, V74EC, V76EC, V94E, V98E | | |



1

| | | | |
|--------------------|---|-----------------|--|
| GEV No. | 380027 | Ref. No. | CM189600 CM293900 MACM189600 MACM293900 |
| description | energy regulator EGO 230V 13A dual circuit turn direction right shaft ø 6x4.6mm shaft L 23mm mounting thread M4 power release 6-70% no. 50.55021.100 | | |
| For models: | CFVE60, CP704E, CP92E, CP92E2, CP94E, CP94E2, CPE60, CPE602, CPE60DB, DE92142, DE94242, EPC74E, ERA10, ERA12, ERA14, ERA16, ERA18, ERA20, ERA210, ERA212, ERA214, ERA216, ERA218, ERA220, FTVE100, FTVE40, FTVE40D, FTVE60, FTVE60D, NPC74E, NPC74G, NPC76E, NPC76G, NPC78E, NPC78G, NPC94E, NPC94G, NPC96E, NPC96G, NPC98E, NPC98G, NPD76G5, NPD78G8, NPD96G5, NPD98E10, NPD98E15, NPD98G10, NPD98G15, NPD98G15A, NPI76E5...(Other models you can see in the webshop) | | |

control and safety thermostats

EGO

control thermostats

55.10/19_ series



1

| | | | |
|--------------------|--|-----------------|----------------------|
| GEV No. | 390265 | Ref. No. | 4644600 MA4644600 |
| description | thermostat t.max. 100°C temperature range fixed 100°C 1-pole 1NO 16A probe ø 6mm probe L 130mm capillary pipe 3000mm capillary pipe isolatedmm gland nut | | |
| For models: | F140DF, F140DI, F140DN, F140DP, F14DFG, F14DNG, F70DF, F70DI, F70DN, F70DP, F7DFG, F7DNG | | |

thermostats

bi-metal thermostats

bi-metal thermostats




1

| | | | |
|--------------------|--|-----------------|---------------------------------|
| GEV No. | 390293 | Ref. No. | 2430400 2578300 MA2578300 |
| description | bi-metal thermostat 1NO 1-pole probe L 21mm probe ø 21mm | | |



1

| | | | |
|---|--|-----------------|------------------------|
| GEV No. | 390025 | Ref. No. | 120524 |
| description | bi-metal thermostat hole distance 40mm switch-off temp. 55/42°C NC/NO 2-pole 16A 250V connection F6.3 2 hole fixing | | |
| accessories for | 390025 | | |
|  | GEV No. | 512154 | Ref. No. 200494 |
| gasket for thermostat ID ø 20mm equiv. no. 200494/H200494 hole distance 41mm suitable for COMENDA, HOONVED | | | |



1

| | | | |
|--------------------|--|-----------------|------------|
| GEV No. | 390232 | Ref. No. | 1037304000 |
| description | bi-metal thermostat switch-off temp. 55°C 1-pole | | |
| For models: | DLS30, DLS303, DLS30P, DLS30P3, DLS31, DLS313, DLS31P3, MLC50, MLC503, MLC65, MLC653, MLS30, MLS303, MLS30P, MLS30P3, MLS31, MLS313, MLS31P3, MLS35, MLS353, MPLS30P | | |



1


| | | | |
|--------------------|---|-----------------|-----------|
| GEV No. | 375548 | Ref. No. | CR0682740 |
| description | thermostat t.max. 142°C temperature range fixed 142°C 1-pole 1CO 16A probe ø 4mm probe L 157mm capillary pipe 870mm capillary pipe isolated 870mm gland nut shaft ø 6x4.6mm shaft Lmm shaft position | | |
| For models: | NPD78G8, NPI76E5, NPI76G5, NPI78E8, NPI78G8, NPI96E5, NPI96G5, NPI98E10, NPI98E15, NPI98G10, NPI98G14, NPI98G14A | | |



| | | | |
|--------------------|---|-----------------|--|
| GEV No. | 375198 | Ref. No. | 1568600 1873500 1981900 MA1568600 MA1873500 MA1981900 |
| description | thermostat t.max. 190°C temperature range 100-190°C 1-pole 1NO 16A probe ø 6mm probe L 130mm capillary pipe 3000mm capillary pipe isolated 2650mm gland nut M9x1 shaft L 23mm shaft position upper rotation 270° probe material SS | | |
| For models: | F74E10, F74E12, F76E10, F78E12, F94E10, F94E12, F94E18, F94E18K, F96E10, F98E12, F98E18, F98E18K, F954E12, F954E18, F954E18K, F958E12, F958E18, F958E18K, FQE40, FQE40D, FQE40DSP, FQE41, FQE41L, FQE41L2, FQE60, FQE60D, FQE60DSP, FQE61, FQE61L, FQE61L2, FR74E, FR74E10, FR74E10L, FR74E10L2, FR74E2, FR77E, FR77E10, FR77E10L, FR77E10L2, FR77E2, FR92E10, FR92E10L, FR92E10L2, FR92E13, FR92E132, FR92E22, FR94E10, FR94E10L, FR94E10L2, FR94E13...(Other models you can see in the webshop) | | |



| | | | |
|--------------------|--|-----------------|----------------------|
| GEV No. | 375201 | Ref. No. | 2992900 MA2992900 |
| description | thermostat t.max. 270°C temperature range 50-270°C 1-pole 1CO 16A probe ø 3mm probe L 219mm capillary pipe 3000mm capillary pipe isolated 2500mm gland nut M10x1 shaft L 23mm shaft position upper rotation 270° probe material SS | | |
| For models: | CON102E, CON102EP, CON102G, CON102GP, CON10E, CON10EP, CON10G, CON10GP, CON201E, CON201EP, CON201G, CON201GP, CON202E, CON202EP, CON202G, CON202GP, CON6E, CON6EP, CON6G, CON6GP, CSM102E, CSM102EP, CSM102G, CSM102GP, CSM10E, CSM10EP, CSM10G, CSM10GP, CSM201, CSM201E, CSM201EP, CSM201G, CSM201GP, CSM202, CSM202E, CSM202EP, CSM202G, CSM202GP, CSM6E, CSM6EP, CSM6G, CSM6GP | | |



| | | | |
|--------------------|---|-----------------|--|
| GEV No. | 390046 | Ref. No. | 1037035800 1450200 1450900 1450914 MA1037035800 MA1450200 |
| description | thermostat t.max. 190°C temperature range 104-190°C 1-pole 1NO 16A probe ø 6mm probe L 133mm capillary pipe 870mm capillary pipe isolatedmm gland nut M9x1 shaft ø 6x4.6mm shaft L 23mm shaft position lower rotation 270° probe material SS | | |
| For models: | FQE4, FQE6, FQE6+6, FR74E, FR74E10, FR77E, FR77E10, FR92E10, FR92E13, FR92E22, FR92G22, FR94E10, FR94E13, FR94E22, FR94G22, FR94G23, FR9P2E10, FR9P4E10, P9D10E, P9D15E, P9DA10E, P9DA15E, P9I10E, P9I10G, P9I15E, P9I5E, P9IA10E, P9IA10G, P9IA15E | | |



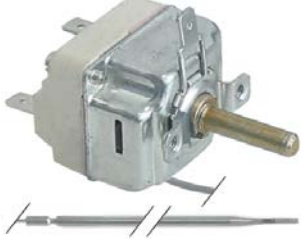
| | | | |
|--------------------|---|-----------------|---------------------------|
| GEV No. | 375216 | Ref. No. | LA65070210 LAR65070210 |
| description | thermostat t.max. 280°C temperature range 50-280°C 1-pole 1NO 16A probe ø 3mm probe L 228mm capillary pipe 1300mm capillary pipe isolated 1150mm gland nut shaft L 23mm shaft position upper rotation 318° | | |
| For models: | CVE004M, CVE104M, CVE105M, CVG105M, EC106M, EC110M, EC210M, EM010M+SC, EM106M, EM106M+SC, EM110M, EM110M+SC, EM210M, EM210M+SC, EV006M, EV106M, EV106M+SC, EV110M, EV110M+SC, EV210M, EV210M+SC, FE105M, FE105X, FE110M, FE110X, FE210M, FG105M, FG105X, FG110M, FG110X, FG210M, FG210X, GC106M, GC110M, GC210M, GM106M, GM106M+SC, GM110M, GM110M+SC, GM210M, GM210M+SC, GV106M, GV106M+SC, GV110M, GV110M+SC, GV210M, GV210M+SC, ME106M, ME106X, ME110M...(Other models you can see in the webshop) | | |



| | | | |
|--------------------|---|-----------------|----------------------------|
| GEV No. | 375322 | Ref. No. | 1037103500 MA1037103500 |
| description | thermostat t.max. 295°C temperature range fixed 295°C 1-pole 1NO 15A probe ø 3mm probe L 219mm capillary pipe 900mm capillary pipe isolatedmm gland nut | | |
| For models: | SPE60M, SPW60M | | |



| | | | |
|--------------------|---|-----------------|----------------------------|
| GEV No. | 375184 | Ref. No. | 1037102300 MA1037102300 |
| description | thermostat t.max. 298°C temperature range 55-294°C 1-pole 1NO 16A probe ø 3.1mm probe L 226mm capillary pipe 870mm capillary pipe isolated 350mm gland nut shaft L 23mm shaft position upper probe material SS | | |
| For models: | BR707E, BR707EI, BR78EF, BR78EI, BR912EFM, BR912EIM, BR912GFM, BR912GIM, BR94E, BR94EI, BR94G, BR94GI, BR98EF, BR98EFM, BR98EI, BR98EIM, BR98GF, BR98GFM, BR98GI, BR98GIM, BR9M4E, BR9M4EI, BR9M4G, BR9M4GI, BR9M6E, BR9M6EI, BR9M6G, BR9M6GI, BR9S8EF, BR9S8EI, BR9S8GF, BR9S8GI, BR9SB4E, BR9SB4EI, BR9SB4G, BR9SB4GI, CFE60, CFE60P, CFGE60, CFGE61, CFGE61D, CFGE61L, CFGE61P, CFVE60, FOE60M, MS10AG, MS10IG, MS70AG, MS70IG, MS70IGS... (Other models you can see in the webshop) | | |



| | | | |
|--------------------|--|-----------------|-----------|
| GEV No. | 375667 | Ref. No. | R65070360 |
| description | thermostat t.max. 300°C temperature range 68-300°C 1-pole 1NO 16A probe ø 3.1mm probe L 226mm capillary pipe 980mm capillary pipe isolated 980mm gland nut shaft ø 6x4.6mm shaft L 23mm shaft position upper rotation 318° | | |
| For models: | MACE04M, MACE05M, MACE07M, MACE10M, MACE20M, MACG05M, MACG07M, MACG10M, MACG20M, ME061M, ME101M, ME102M, ME201M, ME202M, MG061M, MG101M, MG102M, MG201M, MG202M | | |



| | | | |
|------------------------|--|-----------------|------------------------------------|
| GEV No. | 375884 | Ref. No. | CM293800 CM293801 MACM293801 |
| description | thermostat t.max. 400°C temperature range 65-400°C 1-pole 1NO probe ø 3.9mm probe L 163mm capillary pipe 870mm capillary pipe isolated 600mm gland nut shaft ø 6x4.6mm shaft L 23mm shaft position upper rotation 270° | | |
| For models: | CT78EC, CT7FE8EC, CT98EC, CT9FE8EC | | |
| accessories for | 375884 | | |
| | GEV No. | 112172 | Ref. No. — |
| | knob universal ø 70mm black without adaptor/dial plate | | |
| | GEV No. | 112311 | Ref. No. — |
| | knob adapter shaft ø 6x4.6mm L 0mm with spring | | |

| | | | |
|------------------------|--|--------|-------------------|
| accessories for | 375884 | | |
| | GEV No. | 112405 | Ref. No. — |
| | knob dial plate silver thermostat t.max. 350°C 100-350°C rotation 270° ED ø 63mm ID ø 45.5mm | | |



| | | | |
|--------------------|--|-----------------|-----------|
| GEV No. | 375945 | Ref. No. | CR0734520 |
| description | thermostat t.max. 470°C temperature range 90-470°C 1-pole 1NO 16A probe ø 3.9mm probe L 163mm capillary pipe 870mm capillary pipe isolated 600mm shaft ø 4.5x6mm shaft L 23mm shaft position upper rotation 270° | | |
| For models: | NCT78E, NCT7FE8E, NCT98E, NCT98E2, NCT9FE8E, NCT9FE8E2 | | |



| | | | |
|------------------------|---|-----------------|-------------------|
| GEV No. | 375219 | Ref. No. | R65070100 |
| description | thermostat t.max. 55°C temperature range fixed 55°C 1-pole 1NO 16A probe ø 6mm probe L 130mm capillary pipe 900mm capillary pipe isolated 850mm gland nut shaft Lmm shaft position probe material SS | | |
| For models: | EM010M+SC, EM106M, EM106M+SC, EM110M, EM110M+SC, EM210M, EM210M+SC, GM106M, GM106M+SC, GM110M, GM110M+SC, GM210M, GM210M+SC, ME061M, ME101M, ME102D, ME102M, ME106M, ME106X, ME110M, ME110X, ME120M, ME120X, ME201M, ME202M, ME210M, ME210X, ME220M, ME220X, MEC40M, MG061M, MG101M, MG102M, MG106M, MG106X, MG110M, MG110X, MG120M, MG120X, MG201M, MG202M, MG210M, MG210X, MG220M, MG220X, MGC20X | | |
| accessories for | 375219 | | |
| | GEV No. | 550148 | Ref. No. — |
| | gland duct ET M12x0.75 IT M9x1 probe ø max. 6.5mm WS 17 silicone | | |




| | | | |
|--------------------|---|-----------------|-----------|
| GEV No. | 375215 | Ref. No. | R65070165 |
| description | thermostat t.max. 65°C temperature range fixed 65°C 1-pole 1CO 16A probe ø 6mm probe L 130mm capillary pipe 900mm capillary pipe isolated 900mm gland nut shaft Lmm shaft position | | |
| For models: | CVE004M, CVE104M, CVE105M, CVG105M, EM010M+SC, EM106M, EM106M+SC, EM110M, EM110M+SC, EM210M, EM210M+SC, EV006M, EV106M, EV106M+SC, EV110M, EV110M+SC, EV210M, EV210M+SC, GM106M, GM106M+SC, GM110M, GM110M+SC, GM210M, GM210M+SC, GV106M, GV106M+SC, GV110M, GV110M+SC, GV210M, GV210M+SC, ME061M, ME101M, ME102D, ME102M, ME106M, ME106X, ME110M, ME110X, ME120M, ME120X, ME201M, ME202M, ME210M, ME210X, ME220M, ME220X, MEC40M, MG061M, MG101M, MG102M...(Other models you can see in the webshop) | | |




| | | | |
|--------------------|---|-----------------|----------------------|
| GEV No. | 390040 | Ref. No. | 7800300 MA7800300 |
| description | thermostat t.max. 90°C temperature range 30-90°C 1-pole 1CO 16A probe ø 6mm probe L 130mm capillary pipe 2040mm capillary pipe isolated 1940mm gland nut shaft ø 6x4.6mm shaft L 23mm shaft position upper rotation 270° probe material SS | | |
| For models: | AR712PA, AR712PP, AR712PS, AR713PA, AR713PP, AR713PS, AR714PA, AR714PP, AR714PS, AR715PA, AR715PP, AR715PS, AR716PA, AR716PP, AR716PS, AR717PA, AR717PP, AR717PS, AR718PA, AR718PP, AR718PS, AR719PA, AR719PP, AR719PS, AR720PA, AR720PP, AR720PS, EAR612PA, EAR612PP, EAR612PS, EAR613PA, EAR613PP, EAR613PS, EAR614PA, EAR614PP, EAR614PS, EAR615PA, EAR615PP, EAR615PS, EAR616PA, EAR616PP, EAR616PS, EAR617PA, EAR617PP, EAR617PS, EAR618PA, EAR618PP, EAR618PS, EAR619PA, EAR619PP...(Other models you can see in the webshop) | | |



| | | | |
|--------------------|---|-----------------|-----------|
| GEV No. | 375217 | Ref. No. | R65070240 |
| description | thermostat t.max. 70°C temperature range fixed 70°C 1-pole 1CO 16A probe ø 6mm probe L 130mm capillary pipe 900mm capillary pipe isolated 900mm gland nut shaft Lmm shaft position probe material SS | | |
| For models: | CVE004M, CVE104M, CVE105M, CVG105M, EM010M+SC, EM106M, EM106M+SC, EM110M, EM110M+SC, EM210M, EM210M+SC, EV006M, EV106M, EV106M+SC, EV110M, EV110M+SC, EV210M, EV210M+SC, GM106M, GM106M+SC, GM110M, GM110M+SC, GM210M, GM210M+SC, GV106M, GV106M+SC, GV110M, GV110M+SC, GV210M, GV210M+SC, ME061M, ME101M, ME102D, ME102M, ME106M, ME106X, ME110M, ME110X, ME120M, ME120X, ME201M, ME202M, ME210M, ME210X, ME220M, ME220X, MEC40M, MG061M, MG101M, MG102M...(Other models you can see in the webshop) | | |

55.13_series



| | | | |
|--------------------|--|-----------------|--------------------|
| GEV No. | 375505 | Ref. No. | 643800 MA643800 |
| description | thermostat t.max. 320°C temperature range 50-320°C 1-pole 1NO 16A probe ø 3mm probe L 160mm capillary pipe 870mm capillary pipe isolatedmm gland nut shaft ø 6x4.6mm shaft L 23mm shaft position upper rotation 270° | | |
| For models: | BR94E, BR94EI, BR94G, BR94GI, BR96G, BR96GI, BR9M4E, BR9M4EI, BR9M4G, BR9M4GI, BR9M6E, BR9M6EI, BR9M6G, BR9M6GI, BR9SB4E, BR9SB4EI | | |



| | | | |
|--------------------|--|-----------------|------------|
| GEV No. | 375211 | Ref. No. | 1037314600 |
| description | thermostat t.max. 85°C temperature range 30-85°C 1-pole 1CO 16A probe ø 6mm probe L 130mm capillary pipe 900mm capillary pipe isolated 900mm gland nut shaft L 23mm shaft position upper rotation 270° probe material SS | | |
| For models: | MLC50, MLC503, MLC65, MLC653, MLS35, MLS353 | | |



55.14_series



| | | | |
|--------------------|---|-----------------|----------------------------|
| GEV No. | 375874 | Ref. No. | 1037117700 MA1037117700 |
| description | thermostat t.max. 90°C temperature range 30-90°C 1-pole 1NO 16A probe ø 6mm probe L 74mm capillary pipe 900mm capillary pipe isolated 800mm gland nut M10x1 shaft ø 6x4.6mm shaft L 23mm shaft position 180° shaft position rotation 270° | | |
| For models: | BME40DM, BME40DMB, BME40M, BME60DM, BME60DMB, BME60M, BME80M, BSEI40M, CSP6220, CSP6230, NSP74E, NSP94E, OBSEI40M, SP74E, SP94E | | |

55.34_series



| | | | |
|--------------------|---|-----------------|-----------|
| GEV No. | 375188 | Ref. No. | CR0500540 |
| description | thermostat t.max. 110°C temperature range 30-110°C 3-pole 3NO 16A probe ø 6mm probe L 131mm capillary pipe 1160mm capillary pipe isolatedmm gland nut shaft ø 6x4.6mm shaft L 23mm shaft position upper rotation 310° | | |



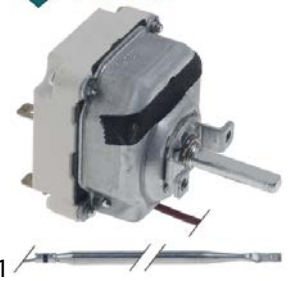
| | | | |
|--------------------|---|-----------------|----------------------|
| GEV No. | 375385 | Ref. No. | 8219601 BN8219601 |
| description | thermostat t.max. 180°C temperature range 100-180°C 3-pole 3NO 16A probe ø 6mm probe L 131mm capillary pipe 2000mm capillary pipe isolated 1800mm gland nut shaft ø 6x4.6mm shaft L 23mm shaft position upper rotation 270° | | |



| | | | |
|--------------------|--|-----------------|---------------------------------------|
| GEV No. | 375410 | Ref. No. | 1037101400 1616000 MA1037101400 |
| description | thermostat t.max. 180°C temperature range 95-180°C 3-pole 3NO 16A probe ø 6mm probe L 133mm capillary pipe 1780mm capillary pipe isolated 1400mm gland nut M10x1 shaft ø 6x4.6mm shaft L 23mm shaft position upper rotation 270° | | |
| For models: | PI707E | | |



| | | | |
|--------------------|---|-----------------|--------|
| GEV No. | 390135 | Ref. No. | 426011 |
| description | thermostat t.max. 220°C temperature range 90-220°C 3-pole capillary pipe isolatedmm gland nut | | |



| | | | |
|--------------------|--|-----------------|-----------|
| GEV No. | 375559 | Ref. No. | CR0686120 |
| description | thermostat t.max. 230°C temperature range 95-230°C 3-pole 3NO 16A probe ø 4mm probe L 128mm capillary pipe 1250mm capillary pipe isolated 1000mm gland nut shaft ø 6x4.6mm shaft L 23mm shaft position upper rotation 270° | | |
| For models: | NG74E, NG74E2, NG78E, NG78E2, NG912E, NG912E2, NG94E, NG94E2, NG98E, NG98E2 | | |




| | | | |
|--------------------|--|-----------------|----------------------------|
| GEV No. | 375183 | Ref. No. | 1037100600 MA1037100600 |
| description | thermostat t.max. 298°C temperature range 50-298°C 3-pole 3NO 16A probe ø 3mm probe L 219mm capillary pipe 900mm capillary pipe isolatedmm gland nut shaft ø 6x4.6mm shaft L 23mm shaft position upper rotation 318° | | |
| For models: | FTE100B, FTE100BR, FTE100CRL, FTE40B, FTE40C, FTE60B, FTE60BR, FTE60C | | |




| | | | |
|--------------------|--|-----------------|---|
| GEV No. | 375412 | Ref. No. | 1037035200 1732000 BN6A044600 MA1037035200 MA1732000 No More Available |
| description | thermostat t.max. 320°C temperature range 50-320°C 3-pole 3NO 16A probe ø 3.1mm probe L 226mm capillary pipe 1480mm capillary pipe isolated 1400mm gland nut shaft ø 6x4.6mm shaft L 23mm shaft position upper rotation 318° | | |
| For models: | BIE40, BIE60, BRE40, BRE40G, FT74E, FT74ER, FT74ERL, FT77E, FT77EC, FT77ERL, FTE100B, FTE100BR, FTE100CRL, FTE40B, FTE40C, FTE60B, FTE60BR, FTE60C | | |



| | | | |
|--------------------|--|-----------------|---------------------------------|
| GEV No. | 375192 | Ref. No. | 1309100 1309115 MA1309115 |
| description | thermostat t.max. 300°C temperature range 50-300°C 3-pole 3NO 16A probe ø 3mm probe L 219mm capillary pipe 900mm capillary pipe isolatedmm gland nut shaft ø 6x4.6mm shaft L 23mm shaft position upper rotation 270° | | |
| For models: | BF78E, BF98E, BIE40, BIE40B, BIE60, BIE60B, BR707E, BR707EI, BR94E, BR94EI, BR96E, BR96EI, BR9M4E, BR9M4EI, BR9M6E, BR9M6EI, BRE40, BRE40D, BRE40DB, BRE40DG, BRE40DGB, BRE40G, C12FEP9G, C7011EFE, C7011EFEQ, C707EFE, C707EFEQ, C7FE12G, C7FE8E, C7FE8EC, C7FE8G, C9F4E, C9F6E, C9FE12G, C9FE6GS, C9FE8E, C9FE8EC, C9FE8G, C9V2E, C9V4E, CFE70, CWE42, CWE422, CWE62, CWE622, EC74EVG, EC78EVG, EC7FE8E, EFT74ELVG, EFT74ERVG... (Other models you can see in the webshop) | | |



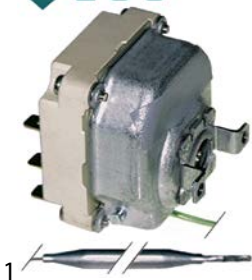
| | | | |
|--------------------|--|-----------------|-----------|
| GEV No. | 375944 | Ref. No. | CR0582770 |
| description | thermostat t.max. 350°C temperature range 100-350°C 3-pole 3NOA probe ø 3mm probe L 147mm capillary pipe 900mm capillary pipe isolatedmm gland nut shaft ø 6x4.6mm shaft L 26mm shaft position upper rotation 270° probe material SS | | |
| For models: | NFT74EL, NFT74ELC, NFT74ELCO, NFT74ELO, NFT74ER, NFT74ERC, NFT76EL, NFT76ELC, NFT76EM, NFT76EMC, NFT76ER, NFT78EL, NFT78ELC, NFT78ELCO, NFT78ELO, NFT78EM, NFT78EMC, NFT78ER, NFT78ERC, NFT94EL, NFT94ELC, NFT94ELO, NFT94ER, NFT96EL, NFT96ELC, NFT96EM, NFT96EMC, NFT98EL, NFT98ELC, NFT98ELO, NFT98EM, NFT98EMC | | |



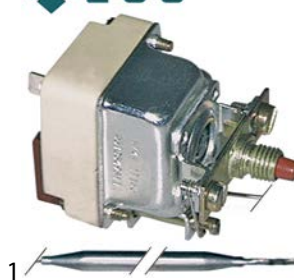
| | | | |
|--------------------|---|-----------------|--------|
| GEV No. | 390020 | Ref. No. | 425900 |
| description | thermostat t.max. 300°C temperature range 50-300°C 3-pole capillary pipe isolatedmm gland nut | | |



| | | | |
|--------------------|---|-----------------|------------|
| GEV No. | 375092 | Ref. No. | 1037035000 |
| description | thermostat t.max. 90°C temperature range 30-90°C 3-pole capillary pipe isolatedmm gland nut | | |
| For models: | BME40M, BME60, BME60M, BME80M, BSE40M | | |



| | | | |
|--------------------|--|-----------------|------------|
| GEV No. | 375210 | Ref. No. | 1037304900 |
| description | thermostat t.max. 90°C temperature range 38-90°C 3-pole 3CO 16A probe ø 6mm probe L 215mm capillary pipe 900mm capillary pipe isolated 900mm gland nut shaft Lmm rotation 270° | | |
| For models: | DLS30, DLS303, DLS30P, DLS30P3, DLS31, DLS313, DLS31P3, MLS30, MLS303, MLS30P, MLS30P3, MLS31, MLS313, MLS31P3, MPLS30P | | |



| | | | |
|--------------------|---|-----------------|----------------------|
| GEV No. | 375197 | Ref. No. | 1568700 MA1568700 |
| description | safety thermostat switch-off temp. 220°C 1-pole 16A probe ø 6mm probe L 142mm capillary pipe 2970mm capillary pipe isolated 2600mm gland nut probe SS | | |
| For models: | FR92E13, FR92E132, FR92E13T, FR92E13T2, FR92E22, FR92E22T, FR94E13, FR94E132, FR94E13T, FR94E13T2, FR94E22, FR94E22T | | |



| | | | |
|--------------------|---|-----------------|--|
| GEV No. | 375411 | Ref. No. | 1037035015 1230200 MA1037035015 MA1230200 |
| description | thermostat t.max. 93°C temperature range 30-93°C 3-pole 3NO 16A probe ø 6mm probe L 129mm capillary pipe 1480mm capillary pipe isolated 1100mm gland nut M10x1 shaft ø 6x4.6mm shaft L 23mm shaft position upper rotation 270° | | |
| For models: | B124E, B74E, B78E, B94E, B98E, BM74E, BM77E, BME40DM, BME40DMB, BME40M, BME60, BME602, BME60DM, BME60DMB, BME60M, BME80M, BSE40M, NB74E, NB78E, NB94E, NB98E, SNA12, SNA16, SNA20, SNAC12, SNAC16, SNAC20, SNG08, SNG12, SNG16, SNG20, SVAC16, SVAC20, SVCG08, SVCG12, SVCG16, SVCG20, SVCG8, TP13E, TP17E, TP213E, TP217E, TP21E, TP221E | | |

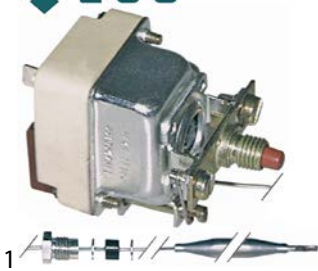
55.31_ series



| | | | |
|--------------------|--|-----------------|--------------------|
| GEV No. | 390066 | Ref. No. | 893100 MA893100 |
| description | safety thermostat switch-off temp. 220°C 3-pole 20A probe ø 14mm probe L 105mm capillary pipe 820mm capillary pipe isolated 660mm gland nut probe with half round bulb | | |

safety thermostats

55.10/19_ series



| | | | |
|--------------------|--|-----------------|----------------------------------|
| GEV No. | 390061 | Ref. No. | 732913 BN6A049401 MA732913 |
| description | safety thermostat switch-off temp. 220°C 1-pole 0.5A probe ø 6mm probe L 140mm capillary pipe 900mm capillary pipe isolatedmm gland nut probe M9x1 | | |
| For models: | FR74E, FR74E10, FR74G, FR77E, FR77E10, FR77G, FR92E10, FR92E13, FR92E22, FR92G22, FR94E10, FR94E13, FR94E22, FR94G23, FR9P2E10, FR9P4E10, P9D10E, P9D15E, P9DA10E, P9DA15E, P9I10E, P9I10G, P9I15E, P9I5E, P9IA10E, P9IA10G, P9IA15E, P1707G | | |



| | | | |
|--------------------|--|-----------------|----------------------------|
| GEV No. | 375104 | Ref. No. | 1037035900 MA1037035900 |
| description | safety thermostat switch-off temp. 230°C 3-pole 20A probe ø 6mm probe L 167mm capillary pipe 830mm capillary pipe isolated 600mm gland nut M10x1 probe | | |




| | | | |
|--------------------|--|-----------------|-------------------|
| GEV No. | 390168 | Ref. No. | 1878000 733100 |
| description | safety thermostat switch-off temp. 230°C 3-pole 3NC 20A probe ø 6mm probe L 239mm capillary pipe 830mm capillary pipe isolated-gland nut M9x1 probe SS | | |
| For models: | PI707E | | |




| | | | |
|--------------------|---|-----------------|----------------------|
| GEV No. | 375394 | Ref. No. | 2613300 MA2613300 |
| description | safety thermostat switch-off temp. 135°C 3-pole 1CO/2NC 20A probe ø 6mm probe L 73mm capillary pipe 1490mm capillary pipe isolated 1350mm gland nut M9x1 probe SS | | |
| For models: | CS4E, CS4EP, FV4E, FV4E1 | | |

55.32_ series




| | | | |
|--------------------|--|-----------------|-----------|
| GEV No. | 375947 | Ref. No. | CR0585120 |
| description | safety thermostat switch-off temp. 120°C 3-pole 20A probe ø 6mm probe L 94mm capillary pipe 900mm capillary pipe isolated 850mm gland nut starting temperature 111°C probe | | |
| For models: | NB74E, NB78E, NB94E, NB98E | | |




| | | | |
|--------------------|---|-----------------|----------------------|
| GEV No. | 375208 | Ref. No. | 2865100 MA2865100 |
| description | safety thermostat switch-off temp. 139°C 3-pole 2x20/1x0.5A probe ø 6mm probe L 77mm capillary pipe 890mm capillary pipe isolated-gland nut M9x1 probe SS | | |
| For models: | CS102E, CS102EP, CS102G, CS102GP, CS10E, CS10EP, CS10G, CS6E, CS6EP, CS6G, CSM102E, CSM102EP, CSM102G, CSM102GP, CSM10E, CSM10EP, CSM10G, CSM10GP, CSM201E, CSM201EP, CSM201G, CSM201GP, CSM202E, CSM202EP, CSM202G, CSM202GP, CSM6E, CSM6EP, CSM6G, CSM6GP | | |



| | | | |
|--------------------|---|-----------------|----------------------|
| GEV No. | 375199 | Ref. No. | 1878900 MA1878900 |
| description | safety thermostat switch-off temp. 132°C 3-pole 2x20/1x0.5A probe ø 6mm probe L 77mm capillary pipe 890mm capillary pipe isolated-gland nut M10x1 probe SS | | |
| For models: | AR712PA, AR712PP, AR712PS, AR713PA, AR713PP, AR713PS, AR714PA, AR714PP, AR714PS, AR715PA, AR715PP, AR715PS, AR716PA, AR716PP, AR716PS, AR717PA, AR717PP, AR717PS, AR718PA, AR718PP, AR718PS, AR719PA, AR719PP, AR719PS, AR720PA, AR720PP, AR720PS, CP704E, CP92E, CP92E2, CP94E, CP94E2, CP95B2E, CP95B2E2, CP95B4E, CP95B4E2, CPE60, CPE602, CPE60DB, DE92142, DE94242, EAR612PA, EAR612PP, EAR612PS, EAR613PA, EAR613PP, EAR613PS, EAR614PA, EAR614PP, EAR614PS...(Other models you can see in the webshop) | | |



| | | | |
|--------------------|---|-----------------|-----------|
| GEV No. | 375668 | Ref. No. | R65070020 |
| description | safety thermostat switch-off temp. 140°C 3-pole 20A probe ø 6mm probe L 88mm capillary pipe 890mm capillary pipe isolated 800mm gland nut | | |
| For models: | AC, AU04, AU05, AU08, AU10, AU20 | | |



| | | | |
|--------------------|--|-----------------|------------|
| GEV No. | 375209 | Ref. No. | 1037305000 |
| description | safety thermostat switch-off temp. 140°C 3-pole 20A probe ø 6mm probe L 89mm capillary pipe 900mm capillary pipe isolated 900mm gland nut probe SS | | |
| For models: | DLS30, DLS303, DLS30P, DLS30P3, DLS31, DLS313, DLS31P3, MLC50, MLC503, MLC65, MLC653, MLS30, MLS303, MLS30P, MLS30P3, MLS31, MLS313, MLS31P3, MLS35, MLS353, MPLS30P | | |



| | | | |
|--------------------|--|-----------------|----------------------|
| GEV No. | 375189 | Ref. No. | 1982000 MA1982000 |
| description | safety thermostat switch-off temp. 230°C 3-pole 20A probe ø 6mm probe L 89mm capillary pipe 3000mm capillary pipe isolated 2650mm gland nut M9x1 probe SS | | |
| For models: | FR74E, FR74E10, FR74E10L, FR74E10L2, FR74E2, FR77E, FR77E10, FR77E10L, FR77E10L2, FR77E2, FR92E10, FR92E10L, FR92E10L2, FR92E13, FR92E132, FR92E13T, FR92E13T2, FR92E22, FR92E22T, FR94E10, FR94E10L, FR94E10L2, FR94E13, FR94E132, FR94E13T, FR94E13T2, FR94E22, FR94E22T | | |



| | | | |
|--------------------|---|-----------------|------------------------|
| GEV No. | 390159 | Ref. No. | R65070080 R65070081 |
| description | safety thermostat switch-off temp. 150°C 1-pole 20A probe ø 6mm probe L 89mm capillary pipe 900mm capillary pipe isolated 800mm gland nut probe | | |
| For models: | EM010M+SC, EM106H, EM106M, EM106M+SC, EM106P, EM110H, EM110M, EM110M+SC, EM110P, EM210H, EM210M, EM210M+SC, EM210P, GM106H, GM106M, GM106M+SC, GM106P, GM110H, GM110M, GM110M+SC, GM110P, GM210H, GM210M, GM210M+SC, GM210P, GMT06D, GMT20D, ME061D, ME061M, ME061P, ME061T, ME101D, ME101M, ME101P, ME101T, ME102D, ME102M, ME102P, ME102T, ME106M, ME106P, ME106X, ME110M, ME110P, ME110X, ME120M, ME120P, ME120X, ME201D, ME201M...(Other models you can see in the webshop) | | |



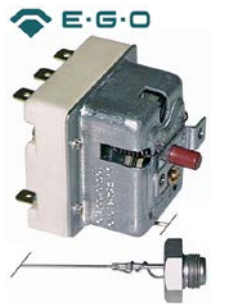
| | | | |
|--------------------|---|-----------------|----------------------------------|
| GEV No. | 375445 | Ref. No. | 097700 CM097701 MACM097701 |
| description | safety thermostat switch-off temp. 230°C 3-pole 2x20/1x0.5A probe ø 4mm probe L 120mm capillary pipe 900mm capillary pipe isolated 700mm gland nut probe | | |
| For models: | EF74E10VG, EF74E12, EF74G15, EF74G8VA, EF74G8VG, F12C4E12, F12C4G15, F74E10, F74E12, F74E6, F74G10, F74G15, F74G6, F76E10, F76G10, F78E12, F78G15, F94E10, F94E12, F94E18, F94E18K, F94E6, F94G10, F94G15, F94G22, F94G22K, F94G6, F96E10, F96G10, F98E12, F98E18, F98E18K, F98G15, F98G22, F98G22K, FQE41R, FQE41RL, FQE61R, FQE61RL, FQG41, FQG61, NF74E10, NF74E15, NF74G10, NF74G15, NF74G15T, NF74G8, NF76E10, NF76G10, NF76G8...(Other models you can see in the webshop) | | |




| | | | |
|--------------------|--|-----------------|----------------------|
| GEV No. | 375358 | Ref. No. | 1871100 MA1871100 |
| description | safety thermostat switch-off temp. 230°C 2-pole 1x20/1x0.5A probe ø 6mm probe L 74mm capillary pipe 880mm capillary pipe isolated-mm gland nut M9x1 probe SS automatic | | |
| For models: | CP9A15GD, FQG40, FQG60, FR74G, FR77G, FR92G13, FR92G22, FR92G22T, FR94G13, FR94G22, FR94G22T, MM10IG, P9110E, P9110G, P9115E, P915G, P91A10E, P91A10G, P1707G | | |




| | | | |
|------------------------|---|-----------------|----------------------|
| GEV No. | 375873 | Ref. No. | 1878600 MA1878600 |
| description | safety thermostat switch-off temp. 236°C 3-pole 20A probe ø 6mm probe L 77mm capillary pipe 1190mm capillary pipe isolated 990mm gland nut starting temperature 218°C probe | | |
| For models: | FQE40, FQE40D, FQE40DSP, FQE41, FQE41L, FQE41L2, FQE60, FQE60D, FQE60DSP, FQE61, FQE61L, FQE61L2, OFQE41, OFQE61, P915E, PI707E | | |
| accessories for | 375873 | | |
| | GEV No. | 550148 | Ref. No. |
| | gland duct ET M12x0.75 IT M9x1 probe ø max. 6.5mm WS 17 silicone | | |



| | | | |
|--------------------|--|-----------------|-----------|
| GEV No. | 375220 | Ref. No. | R65070050 |
| description | safety thermostat switch-off temp. 330°C 3-pole 20A probe ø 11mm probe L 18.5mm capillary pipe 900mm capillary pipe isolated 900mm gland nut probe screw-in probe probe thread M14x1 | | |
| For models: | CVE004H, CVE004M, CVE104H, CVE104M, VE004M, VE004X, VE104M, VE104X | | |



| | | | |
|--------------------|---|-----------------|----------------------|
| GEV No. | 375357 | Ref. No. | 1942900 MA1942900 |
| description | safety thermostat switch-off temp. 325°C 1-pole 0.5A probe ø 3mm probe L 188mm capillary pipe 900mm capillary pipe isolatedmm gland nut probe | | |
| For models: | FTG40B, FTG40BLC, FTG40BR, FTG60B, FTG60BLC, FTG60BR, FTG60BRR, FTG80B, FTG80BLC, FTG80BR | | |



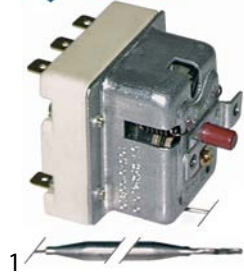
| | | | |
|--------------------|--|-----------------|-----------|
| GEV No. | 375291 | Ref. No. | R65070060 |
| description | safety thermostat switch-off temp. 344°C 1-pole 20A probe ø 6mm probe L 79mm capillary pipe 900mm capillary pipe isolated 900mm gland nut probe | | |
| For models: | FE105M, FE105X, FE110M, FE110X, FE210M, FG105M, FG105X, FG110M, FG110X, FG210M, FG210X, PE040M, PE040X, PE080M, PE080X, PG040M, PG040X, PG080M, PG080X | | |



| | | | |
|--------------------|---|-----------------|----------------------|
| GEV No. | 375206 | Ref. No. | 2864714 MA2864714 |
| description | safety thermostat switch-off temp. 325°C 3-pole 20A probe ø 3.1mm probe L 188mm capillary pipe 900mm capillary pipe isolated 700mm gland nut M10x1 probe SS | | |
| For models: | CON102E, CON102EP, CON102G, CON102GP, CON10E, CON10EP, CON10G, CON10GP, CON201E, CON201EP, CON201G, CON201GP, CON202E, CON202EP, CON202G, CON202GP, CON6E, CON6EP, CON6G, CON6GP, CS102E, CS102EP, CS102G, CS102GP, CS10E, CS10G, CS4E, CS4EP, CS6E, CS6G, CSM102E, CSM102EP, CSM102G, CSM102GP, CSM10E, CSM10EP, CSM10G, CSM10GP, CSM201E, CSM201EP, CSM201G, CSM201GP, CSM202E, CSM202EP, CSM202G, CSM202GP, CSM6E, CSM6EP, CSM6G, CSM6GP...(Other models you can see in the webshop) | | |



| | | | |
|--------------------|--|-----------------|-----------|
| GEV No. | 375455 | Ref. No. | R65070070 |
| description | safety thermostat switch-off temp. 350°C 1-pole 16A probe ø 11mm probe L 16mm capillary pipe 900mm capillary pipe isolated 900mm gland nut probe screw-in probe probe thread M14x1 | | |
| For models: | CVE105H, CVE105M, CVG105H, CVG105M, EC106M, EC110M, EC210M, EM010M+SC, EM106H, EM106M, EM106M+SC, EM106P, EM110H, EM110M, EM110M+SC, EM110P, EM210H, EM210M, EM210M+SC, EM210P, EV006M, EV106H, EV106M, EV106M+SC, EV106P, EV110H, EV110M, EV110M+SC, EV110P, EV210H, EV210M, EV210M+SC, EV210P, GC106M, GC110M, GC210M, GM106H, GM106M, GM106M+SC, GM106P, GM110H, GM110M, GM110M+SC, GM110P, GM210H, GM210M, GM210M+SC, GM210P, GV106H, GV106M...(Other models you can see in the webshop) | | |



| | | | |
|--------------------|---|-----------------|---------|
| GEV No. | 375163 | Ref. No. | 1475513 |
| description | safety thermostat switch-off temp. 350°C 3-pole 0.5A probe ø 6mm probe L 79mm capillary pipe 3000mm capillary pipe isolated 2800mm gland nut probe SS | | |
| For models: | F9V4EC, F9V4ECR, FT74E, FT74ER, FT74ERL, FT77E, FT77EC | | |



| | | | |
|--------------------|--|-----------------|-----------|
| GEV No. | 375684 | Ref. No. | R65070350 |
| description | safety thermostat switch-off temp. 360°C 1-pole 20A probe ø 11mm probe L 16mm capillary pipe 900mm capillary pipe isolated 900mm gland nut probe screw-in probe probe thread M14x1 | | |
| For models: | GMT06D, GMT20D, GVT06D, GVT20D, MACE04M, MACE05M, MACE07M, MACE10M, MACE20M, MACG05M, MACG07M, MACG10M, MACG20M, ME061D, ME061M, ME061P, ME061T, ME101D, ME101M, ME101P, ME101T, ME102D, ME102M, ME102P, ME102T, ME201D, ME201M, ME201P, ME201T, ME202D, ME202M, ME202P, ME202T, MEMT06D, MEMT06P, MEMT10D, MEMT10P, MEMT20D, MEMT20P, MEMT21D, MEMT21P, MEMT40D, MEMT40P, MEVT06D, MEVT06P, MEVT10D, MEVT10P, MEVT20D, MEVT20P, MEVT21D...(Other models you can see in the webshop) | | |



| | | | |
|--------------------|---|-----------------|----------------------|
| GEV No. | 375187 | Ref. No. | 1878500 MA1878500 |
| description | safety thermostat switch-off temp. 360°C 3-pole 3NC 2x20/1x0.5A probe ø 6mm probe L 79mm capillary pipe 890mm capillary pipe isolatedmm gland nut probe SS | | |
| For models: | BF78E, BF98E, BIE40, BIE40B, BIE60, BIE60B, BR707E, BR707EI, BR78EF, BR78EI, BR912EFM, BR912EIM, BR912GFM, BR912GIM, BR94E, BR94EI, BR94G, BR94GI, BR98EF, BR98EFM, BR98EI, BR98EIM, BR98GF, BR98GFM, BR98GI, BR98GIM, BR9M4E, BR9M4EI, BR9M4G, BR9M4GI, BR9M6E, BR9M6EI, BR9M6G, BR9M6GI, BR9S8EF, BR9S8EI, BR9S8GF, BR9S8GI, BR9SB4E, BR9SB4EI, BR9SB4G, BR9SB4GI, C12FEP9G, C7011EFE, C7011EFEQ, C707EFE, C707EFEQ, C7FE12G, C7FE8E, C7FE8EC...(Other models you can see in the webshop) | | |

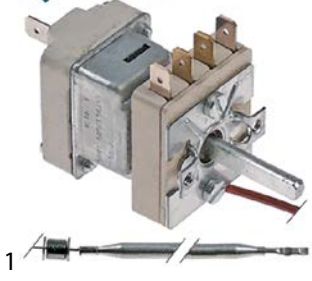
56._ series



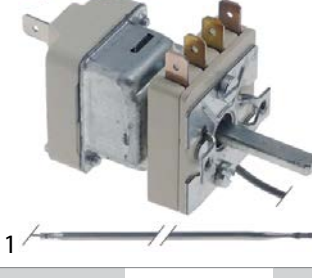
| | | | |
|--------------------|--|-----------------|-----------|
| GEV No. | 390854 | Ref. No. | CR1074320 |
| description | safety thermostat switch-off temp. 245°C 1-pole 1NC 16A probe ø 3.1mm probe L 155mm capillary pipe 1130mm capillary pipe isolatedmm gland nut M9x1 probe | | |

control thermostats with operation switch

55.10/19_ series



| | | | |
|--------------------|--|-----------------|----------------------------|
| GEV No. | 375875 | Ref. No. | 1037317300 MA1037317300 |
| description | thermostat t.max. 180°C temperature range 53-180°C 1-pole 1NO 16A probe ø 6mm probe L 133mm capillary pipe 1170mm capillary pipe isolated 1000mm gland nut shaft ø 6x4.6mm shaft L 23mm rotation 270° outer switch 2NO | | |
| For models: | FQE40, FQE40D, FQE40DSP, FQE41, FQE41L, FQE41L2, FQE60, FQE60D, FQE60DSP, FQE61, FQE61L, FQE61L2, OFQE41, OFQE61 | | |



| | | | |
|--------------------|--|-----------------|-----------|
| GEV No. | 375180 | Ref. No. | CR0589660 |
| description | thermostat t.max. 185°C temperature range 99-185°C 1-pole 1NO 0.5A probe ø 4mm probe L 235mm capillary pipe 870mm capillary pipe isolated 700mm gland nut shaft ø 6x4.6mm shaft L 23mm shaft position rotation 270° outer switch 2NO | | |
| For models: | EF74E10VG, NF74E10, NF74E15, NF76E10, NF78E15, NF94E10, NF94E15, NF94E22, NF94E222, NF96E10, NF98E15, NF98E22, NF98E222 | | |



E·G·O



1

| | | | |
|--------------------|---|-----------------|------------------------|
| GEV No. | 375331 | Ref. No. | CM097800 MACM097800 |
| description | thermostat t.max. 189°C temperature range 62-189°C 1-pole 1NO 0.5A probe ø 4mm probe L 116mm capillary pipe 900mm capillary pipe isolated 700mm gland nut shaft ø 6x4.6mm shaft L 23mm shaft position upper rotation 270° outer switch 2NO | | |
| For models: | EF74E12, F12C4E12, F74E10, F74E12, F74E6, F76E10, F78E12, F94E10, F94E12, F94E18, F94E18K, F94E6, F94G22, F96E10, F98E12, F98E18, F98E18K, F98G22, F9S4E12, F9S4E18, F9S4E18K, F9S4G22, F9S8E12, F9S8E18, F9S8E18K, F9S8G22, FQE41R, FQE41RL, FQE41RL2, FQE61R, FQE61RL, PI76E5, PI96E5, PI98E10, PI98E15, PI98G10, PI98G14, PI98G14A, PI9S8E10 | | |

E·G·O




1

| | | | |
|--------------------|--|-----------------|-----------|
| GEV No. | 375946 | Ref. No. | CR0581280 |
| description | thermostat t.max. 350°C temperature range 100-350°C 1-pole 1NO 16A probe ø 3mm probe L 145mm capillary pipe 900mm capillary pipe isolated 800mm gland nut shaft ø 4.5x6mm shaft L 25mm shaft position upper rotation 275° outer switch 2NC | | |
| For models: | NBR78EF, NBR78EI, NBR912EFM, NBR912EIM, NBR912GFM, NBR912GIM, NBR98EF, NBR98EFM, NBR98EI, NBR98EIM, NBR98GF, NBR98GFM, NBR98GI, NBR98GIM | | |

55.34_ series

E·G·O




1

| | | | |
|--------------------|--|-----------------|-----------------------|
| GEV No. | 375140 | Ref. No. | 21351299 CR0688650 |
| description | thermostat t.max. 650°C temperature range 50°C/50-600°C/70-650°C 3-pole 3NO 16A probe ø 4mm probe L 228mm capillary pipe 1200mm capillary pipe isolated 1200mm gland nut shaft ø 6x4.6mm shaft L 23mm shaft position left rotation 318° outer switch 2NO | | |
| For models: | NV94E, NV98E, NV9FE8E, V9F4E, V9V2E, V9V4E | | |


IMIT / TEMPOMATIC / AR THERMO

control thermostats






1

| | | | |
|--------------------|---|-----------------|--------|
| GEV No. | 390014 | Ref. No. | 120525 |
| description | thermostat t.max. 85°C temperature range 40-78 / 47-85°C 2-pole 2CO 16A probe ø 6.5mm probe L 95mm capillary pipe 1500mm capillary pipe isolated 1450mm gland nut shaft ø 6x4.6mm shaft L 15mm shaft position right rotation 270° | | |



1

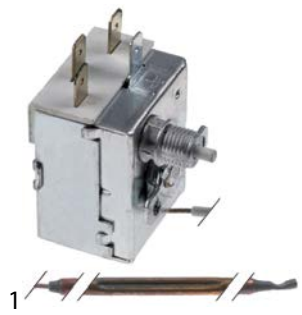
| | | | |
|---|--|-----------------|------------------------|
| GEV No. | 390006 | Ref. No. | 120501 |
| description | thermostat t.max. 86°C temperature range 0-86°C 1-pole 1CO 16A probe ø 6.5mm probe L 95mm capillary pipe 1500mm capillary pipe isolatedmm gland nut shaft ø 6x4.6mm shaft L 19mm rotation 270° | | |
| accessories for | 390006 | | |
|  | GEV No. | 110100 | Ref. No. 450315 |
| | knob thermostat t.max. 90°C 0-90°C ø 42mm shaft ø 6x4.6mm shaft flat -135° black | | |
|  | GEV No. | 110105 | Ref. No. — |
| | rosette knob ø 42mm ø 56mm zero mark | | |



1

| | | | |
|--------------------|--|-----------------|--------|
| GEV No. | 390022 | Ref. No. | 120522 |
| description | thermostat t.max. 90°C temperature range 30-90°C 1-pole 1CO 16A probe ø 9.5mm probe L 50mm capillary pipe 1000mm capillary pipe isolated 1000mm gland nut shaft L 19mm rotation 270° | | |

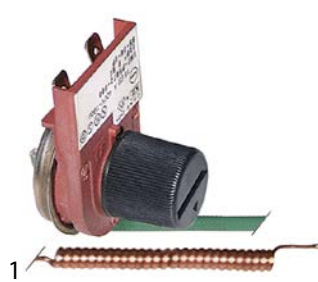
safety thermostats



| | | | |
|--------------------|--|-----------------|--------|
| GEV No. | 390773 | Ref. No. | 120519 |
| description | safety thermostat switch-off temp. 135°C temperature range 95-135°C 1-pole 1CO 16A probe ø 5mm probe L 130mm capillary pipe 1000mm capillary pipe isolated 900mm gland nut probe | | |

RANCO

safety thermostats



| | | | |
|--------------------|--|-----------------|--------|
| GEV No. | 390024 | Ref. No. | 120523 |
| description | safety thermostat t.max. 110°C temperature range°C 1-pole 1NC 16A probe ø 6mm probe L 50mm capillary pipe 1540mm capillary pipe isolated 160mm gland nut shaft ømm shaft Lmm shaft position rotation° probe material copper with coiled probe switch-off temp. 110°C | | |

refrigeration thermostats

RANCO

K22 series



| | | | |
|--------------------|--|-----------------|--|
| GEV No. | 390261 | Ref. No. | 24759.12 995352 FR6639240 FR995352 MA2475912 |
| description | thermostat RANCO type K22L2557 probe ømm probe Lmm capillary pipe 2550mm temperature range -5 up to +13°C | | |
| For models: | AF140MB, AF140MC, AF140MF, AF140MI, AF140MN, AF140MP, AF70MB, AF70MC, AF70MF, AF70MI, AF70MN, AF70MP, EF140DF, EF140DN, EF140DP, EF140MB, EF140MC, EF140MF, EF140MI, EF140MN, EF140MP, EF140DN, EF143DNF, EF143MNI, EF70DF, EF70DN, EF70DP, EF70MB, EF70MC, EF70MF, EF70MI, EF70MN, EF70MP, EF72DNF, EF72MNF, F140DF, F140DI, F140DN, F140DP, F14DFG, F14DNG, F70DF, F70DI, F70DN, F70DP, F7DFG, F7DNG, HF140DPF, IR13C, IR13CC, IR13CV... (Other models you can see in the webshop) | | |

K50 series



| | | | |
|--------------------|---|-----------------|----------------------|
| GEV No. | 390255 | Ref. No. | 2523400 MA2523400 |
| description | thermostat RANCO type K50P1115/012 capillary pipe 2000mm temperature range +1.5 up to +11°C | | |



| | | | |
|--------------------|--|-----------------|----------------------|
| GEV No. | 390292 | Ref. No. | 2523500 MA2523500 |
| description | thermostat RANCO type K50P1118 probe ømm probe Lmm capillary pipe 1250mm temperature range -3 up to +2.5°C | | |




| | | | |
|--------------------|--|-----------------|-----------|
| GEV No. | 390547 | Ref. No. | MA2478500 |
| description | thermostat RANCO type K50H2005 probe ø 10mm probe L 48mm capillary pipe 1500mm temperature range°C | | |

K55 series



| | | | |
|--------------------|---|-----------------|-----------------------|
| GEV No. | 390262 | Ref. No. | 24756.12 MA2475612 |
| description | thermostat RANCO type K55L5085 capillary pipe 2500mm temperature range -0.5 up to +4°C | | |
| For models: | AF140MB, AF140MC, AF140MF, AF140MI, AF140MN, AF140MP, AF70MB, AF70MC, AF70MF, AF70MI, AF70MN, AF70MP, EF140MB, EF140MC, EF140MF, EF140MI, EF140MN, EF140MP, EF143MNI, EF70MB, EF70MC, EF70MF, EF70MI, EF70MN, EF70MP, EF72MNF, SF100MB, SF100MC, SF100MF, SF100MI, SF100MN, SF100MP, SF110MF, SF110MI, SF110MN, SF110MP, SF50MB, SF50MC, SF50MF, SF50MI, SF50MN, SF50MP, SF55MF, SF55MI, SF55MN, SF55MP, SPAR, SPAR15, SPAR16, SPAR18...(Other models you can see in the webshop) | | |




| | | | |
|---|---|-----------------|-----------------------|
|  | | | |
| GEV No. | 390263 | Ref. No. | 24757.12 MA2475712 |
| description | thermostat RANCO type K55L5086 temperature range -10 up to -2°C | | |
| For models: | AF140MB, AF140MC, AF140MF, AF140MI, AF140MN, AF140MP, AF70MB, AF70MC, AF70MF, AF70MI, AF70MN, AF70MP, EF140MB, EF140MC, EF140MF, EF140MI, EF140MN, EF140MP, EF143MNI, EF70MB, EF70MC, EF70MF, EF70MI, EF70MN, EF70MP, EF72MNF, SF100MB, SF100MC, SF100MF, SF100MI, SF100MN, SF100MP, SF110MF, SF110MI, SF110MN, SF110MP, SF50MB, SF50MC, SF50MF, SF50MI, SF50MN, SF50MP, SF55MF, SF55MI, SF55MN, SF55MP, SPAR, SPAR15, SPAR16, SPAR18...(Other models you can see in the webshop) | | |

accessories


probe clips


spring clips

for thermostat


| | | | |
|---|--|-----------------|----------------------|
|  | | | |
| GEV No. | 550419 | Ref. No. | 1567200 MA1567200 |
| description | probe clip for pipe ø 8.5mm for probe ø 6mm Qty 1 pcs | | |
| For models: | FR74E, FR74E2, FR77E, FR77E2, FR92E13, FR92E132, FR92E13T, FR92E13T2, FR92E22, FR92E22T, FR94E13, FR94E132, FR94E13T, FR94E13T2, FR94E22, FR94E22T | | |

for safety thermostat


| | | | |
|---|--|-----------------|----------------------------|
|  | | | |
| GEV No. | 550417 | Ref. No. | 1033515200 MA1033515200 |
| description | probe clip for pipe ø 2x8.5mm for probe ø 6mm for heating elements spacing 15-19mm Qty 1 pcs | | |
| For models: | FQE41, FQE41L, FQE41L2, FQE61, FQE61L, FQE61L2, FR74E10, FR74E10L, FR74E10L2, FR77E10, FR77E10L, FR77E10L2, FR92E10, FR92E10L, FR92E10L2, FR94E10, FR94E10L, FR94E10L2, OFQE41, OFQE61 | | |

| | | | |
|---|--|-----------------|----------------------------|
|  | | | |
| GEV No. | 551080 | Ref. No. | 1033515800 MA1033515800 |
| description | probe clip for pipe ø 8.5mm for probe ø 4mm Qty 1 pcs | | |
| For models: | EF74E10VG, EF74E12, F74E10, F74E6, F76E10, F94E10, F94E18K, F94E6, F96E10, F98E18K, F9S4E18K, F9S8E18K, FQE41R, FQE41RL, FQE41RL2, FQE61R, FQE61RL, NF74E10, NF74E15, NF76E10, NF78E15, NF94E10, NF94E15, NF94E22, NF94E222, NF94E222K, NF94E22K, NF96E10, NF98E15, NF98E22, NF98E222, NF98E222K, NF98E22K | | |


capillary tube clips

| | | | |
|---|--|-----------------|----------------------------|
|  | | | |
| GEV No. | 550970 | Ref. No. | 1033709500 MA1033709500 |
| description | capillary tube clip for pipe ø 8.5mm | | |
| For models: | FQE41, FQE41L, FQE41L2, FQE61, FQE61L, FQE61L2, FR74E10, FR74E10L, FR74E10L2, FR77E10, FR77E10L, FR77E10L2, FR92E10, FR92E10L, FR92E10L2, FR94E10, FR94E10L, FR94E10L2, OFQE41, OFQE61 | | |




gland nut accessories

| | | | |
|---|--|-----------------|----------------------|
|  | | | |
| GEV No. | 100820 | Ref. No. | 1395714 MA1395714 |
| description | gland duct ET M14x1.5 IT M10x0.75 probe ø max. 6.5mm WS 22 | | |
| For models: | FR74G, FR77G, FR92G13, FR94G13 | | |

locking screws




| | | | |
|---|--|-----------------|------------------------|
|  | | | |
| GEV No. | 106605 | Ref. No. | CM012401 MACM012401 |
| description | union screw thread M10x1 probe ø max. 4.5mm | | |
| For models: | EF74E10VG, EF74E12, EF74G15, EF74G8VA, EF74G8VG, F12C4E12, F12C4G15, F74E10, F74E12, F74E6, F74G10, F74G15, F74G6, F76E10, F76G10, F78E12, F78G15, F94E10, F94E12, F94E18, F94E18K, F94E6, F94G10, F94G15, F94G22, F94G22K, F94G6, F96E10, F96G10, F98E12, F98E18, F98E18K, F98G15, F98G22, F98G22K, F9S4E12, F9S4E18, F9S4E18K, F9S4G15, F9S4G22, F9S4G22K, F9S8E12, F9S8E18, F9S8E18K, F9S8G15, F9S8G22, F9S8G22K, FQE41R, FQE41RL, FQE41RL2...(Other models you can see in the webshop) | | |


plunger sockets



| | | | |
|--|--|-----------------|--------|
|  | | | |
| GEV No. | 510935 | Ref. No. | 450515 |
| description | thermowell thread 1/2" L 107mm SS single ø 8mm | | |
| accessories for | 510935 | | |
| | GEV No. | Ref. No. | — |
|  | 361184 | | |
| | GEV No. | Ref. No. | — |
|  | 521122 | | |
| | | | |




electric components

| | | | |
|---|---|-----------------|-------------------|
|  | | | |
| 1 | | | |
| GEV No. | 510987 | Ref. No. | 450519 |
| description | thermowell thread 1/2" L 44mm SS single ø 10mm | | |
| accessories for | 510987 | | |
|  | GEV No. | 361184 | Ref. No. — |
| | nut thread 1/2" H 6mm nickel-plated brass WS 24 Qty 1 pcs | | |
|  | GEV No. | 521122 | Ref. No. — |
| | flat gasket fibre ED ø 31mm ID ø 21.5mm thickness 2mm for thread 1/2" Qty 1 pcs | | |


| | | | |
|---|--|-----------------|---|
| connecting bows | | | |
|  | | | |
| 1 | | | |
| GEV No. | 550060 | Ref. No. | 1037003300 1037033300 1988500 1998500 921200 MA1988500 MA921200 |
| description | connecting bow long for thermostat Qty 1 pcs | | |
| For models: | AR712PA, AR712PP, AR712PS, AR713PA, AR713PP, AR713PS, AR714PA, AR714PP, AR714PS, AR715PA, AR715PP, AR715PS, AR716PA, AR716PP, AR716PS, AR717PA, AR717PP, AR717PS, AR718PA, AR718PP, AR718PS, AR719PA, AR719PP, AR719PS, AR720PA, AR720PP, AR720PS, B9SB2E, B9SB2G, B9SB4E, B9SB4G, B9V2E, B9V2G, B9V4E, B9V4G, BIE40, BIE40B, BIE60, BIE60B, BM74E, BM77E, BME40DM, BME40DMB, BME40M, BME60, BME602, BME60DM, BME60DMB, BME60M, BME80M...(Other models you can see in the webshop) | | |


| | | | |
|---|--|-----------------|--|
| 25.5x25mm | | | |
|  | | | |
| 1 | | | |
| GEV No. | 345278 ¹ | Ref. No. | 2770400 2770500 MA2770400 MA2770500 |
| description | rocker switch mounting measurements 25.5x25mm green 2NO 250V 16A illuminated 0-I connection male faston 6.3mm protection IP40 | | |
| For models: | BR120, BR160, FC5E, FC5G, TAR134C2I, TAR176C2I | | |
| accessories for | 345278 | | |
|  | GEV No. | 301323 | Ref. No. — |
| | protective cover external size 35x35mm H 11mm transparent suitable for rocker switch mounting measurements 25.5x25mm L 35mm W 35mm | | |


¹illuminated

| | | | |
|---|--|-----------------|--------|
| 27.8x25mm | | | |
|  | | | |
| 1 | | | |
| GEV No. | 345843 ¹ | Ref. No. | 130471 |
| description | momentary rocker switch mounting measurements 27.8x25mm green 2CO 24V 16A illuminated outflow connection male faston 6.3mm ambient temperature max. 85°C protection IP40 | | |

¹illuminated


| | | | |
|---|---|-----------------|--------|
|  | | | |
| 1 | | | |
| GEV No. | 345123 | Ref. No. | 130447 |
| description | rocker switch mounting measurements 27.8x25mm black 2CO 250V 16A auto/manual connection male faston 6.3mm ambient temperature max. 85°C protection IP40 | | |

| | | | |
|---|---|-----------------|--------|
|  | | | |
| 1 | | | |
| GEV No. | 510281 | Ref. No. | 160733 |
| description | blank black mounting measurements 27.8x25mm | | |



| | | | |
|---|--|-----------------|----------------------|
| 30x22mm | | | |
|  | | | |
| 1 | | | |
| GEV No. | 347791 | Ref. No. | 4640500 MA4640500 |
| description | rocker switch mounting measurements 30x22mm green 2NO 230V 20A illuminated 0-I connection male faston 6.3mm ambient temperature max. 125/55°C protection IP65 with rubber collar | | |
| For models: | B124E, CRE6220, CRE6230, CRE6320, CRE6330, CSP6220, CSP6230, EF140DF, EF140DN, EF140DP, EF140MB, EF140MC, EF140MF, EF140MI, EF140MN, EF140MP, EF143DNF, EF143MNI, EF70DF, EF70DN, EF70DP, EF70MB, EF70MC, EF70MF, EF70MI, EF70MN, EF70MP, EF72DNF, EF72MNF, F140DF, F140DI, F140DN, F140DP, F14DFG, F14DNG, F70DF, F70DI, F70DN, F70DP, F7DFG, F7DNG, HF140DPF, IR13C, IR13CC, IR13CV, IR13M, IR13MC, IR13MV, IR13V, IR17C...(Other models you can see in the webshop) | | |



switches and momentary switches



rocker/momentary rocker switches



| | | | |
|---|---|-----------------|----------------------------|
| 19x13mm | | | |
|  | | | |
| 1 | | | |
| GEV No. | 345314 | Ref. No. | 1037102500 MA1037102500 |
| description | momentary rocker switch mounting measurements 19x13mm black 1NO 250V 10A 0-I connection male faston 4.8mm ambient temperature max. 85°C protection IP40 | | |







| | | | | | | | |
|---|--|--|----------------------|--------|----------|---|--|
|  | | | | | | | |
| GEV No. | 301003 | Ref. No. | 0109015 211101.99 | | | | |
| description | rocker switch mounting measurements 30x22mm green 2NO 250V 16A illuminated 0-1 connection male faston 6.3mm ambient temperature max. 125/55°C protection IP65 | | | | | | |
| For models: | AF140MB, AF140MC, AF140MF, AF140MI, AF140MN, AF140MP, AF70MB, AF70MC, AF70MF, AF70MI, AF70MN, AF70MP, AFC14, AFC14V, AFC7, AFC7V, AFPC214, AFPC214P, AFPC214V, AFR1143P, AFR14, AFR14V, AFR214P, AFR214PV, AFR7, AFR7P, AFR7PV, AFR7V, AFRC214, AFRC214V, AFRV14, AFRV144A, AFRV14V, AFRV7, AFRV74A, AFRV7V, C9F6E, C9FE6GS, EF140MB, EF140MC, EF140MF, EF140MI, EF140MN, EF140MP, EF143MNI, EF70MB, EF70MC, EF70MF, EF70MI, EF70MN... (Other models you can see in the webshop) | | | | | | |
| accessories for | 301003 | | | | | | |
| |  | <table border="1"> <tr> <td>GEV No.</td> <td>301036</td> <td>Ref. No.</td> <td>—</td> </tr> </table> | GEV No. | 301036 | Ref. No. | — | protective cover internal size 30x22mm for rocker switch mounting measurementsmm |
| GEV No. | 301036 | Ref. No. | — | | | | |

| | | | | | | | |
|---|--|--|-----------------------|--------|----------|---|--|
|  | | | | | | | |
| GEV No. | 345983 | Ref. No. | 40563-00 MA4056300 | | | | |
| description | momentary rocker switch mounting measurements 30x22mm green 2NO 250V 16A illuminated 0-1 connection male faston 6.3mm ambient temperature max. 85°C protection IP65 with cover cap | | | | | | |
| For models: | CRE6220, CRE6230, CRE6320, CRE6330, SBA, SBAC, SVAC, SVAC12, SVAC16, SVAC20, SVCG, SVCG08, SVCG12, SVCG16, SVCG20 | | | | | | |
| accessories for | 345983 | | | | | | |
| |  | <table border="1"> <tr> <td>GEV No.</td> <td>301036</td> <td>Ref. No.</td> <td>—</td> </tr> </table> | GEV No. | 301036 | Ref. No. | — | protective cover internal size 30x22mm for rocker switch mounting measurementsmm |
| GEV No. | 301036 | Ref. No. | — | | | | |

| | | | | | | | |
|---|---|--|-------------------------|--------|----------|---|--|
|  | | | | | | | |
| GEV No. | 301017 | Ref. No. | 211102.99 MA21110299 | | | | |
| description | rocker switch mounting measurements 30x22mm green 2CO 250V 16A illuminated connection male faston 6.3mm ambient temperature max. 125/55°C protection IP40 | | | | | | |
| For models: | AF140MB, AF140MC, AF140MF, AF140MI, AF140MN, AF140MP, AF70MB, AF70MC, AF70MF, AF70MI, AF70MN, AF70MP, SER15, SER15A, SER18, SER18A, SER21 | | | | | | |
| accessories for | 301017 | | | | | | |
| |  | <table border="1"> <tr> <td>GEV No.</td> <td>301036</td> <td>Ref. No.</td> <td>—</td> </tr> </table> | GEV No. | 301036 | Ref. No. | — | protective cover internal size 30x22mm for rocker switch mounting measurementsmm |
| GEV No. | 301036 | Ref. No. | — | | | | |

| | | | | | | | |
|---|---|--|----------------------|--------|----------|---|--|
|  | | | | | | | |
| GEV No. | 345982 | Ref. No. | 4640400 MA4640400 | | | | |
| description | rocker switch mounting measurements 30x22mm green 2CO 250V 16A illuminated connection male faston 6.3mm ambient temperature max. 125/55°C protection IP65 with cover cap | | | | | | |
| For models: | F140DF, F140DI, F140DN, F140DP, F14DFG, F14DNG, F70DF, F70DI, F70DN, F70DP, F7DFG, F7DNG, IR13C, IR13CC, IR13CV, IR13M, IR13MC, IR13MV, IR13V, IR17C, IR17CC, IR17CV, IR17M, IR17MC, IR17MV, IR17V, NF140DF, NF140DFN, NF140DN, NF140DNI, NF140DNN, NF140DP, NF140DPN, NF140DPP, NF143DNF, NF143DNI, NF143DNP, NF14DNG, NF70DF, NF70DI, NF70DN, NF70DP, NF72DNF, NF72DNI, NF72DNN, NF7DFG, NF7DNG, SPAR16, SPAR20, SPRG12...(Other models you can see in the webshop) | | | | | | |
| accessories for | 345982 | | | | | | |
| |  | <table border="1"> <tr> <td>GEV No.</td> <td>301036</td> <td>Ref. No.</td> <td>—</td> </tr> </table> | GEV No. | 301036 | Ref. No. | — | protective cover internal size 30x22mm for rocker switch mounting measurementsmm |
| GEV No. | 301036 | Ref. No. | — | | | | |

| | | | | | | | |
|---|--|--|-----------|--------|----------|---|--|
| blank | | | | | | | |
|  | | | | | | | |
| GEV No. | 347706 | Ref. No. | R65260510 | | | | |
| description | momentary rocker switch mounting measurements 30x22mm black 2CO 250V 16A connection male faston 6.3mm ambient temperature max. 100/55°C protection IP65 with cover cap | | | | | | |
| For models: | EC106M, EC110M, EC210M, EM010M+SC, EM106M, EM106M+SC, EM110M, EM110M+SC, EM210M, EM210M+SC, EV006M, EV106M, EV106M+SC, EV110M, EV110M+SC, EV210M, EV210M+SC, FE105M, FE105X, FE110M, FE110X, FE210M, FG105M, FG105X, FG110M, FG110X, FG210M, FG210X, GC106M, GC110M, GC210M, GM106M, GM106M+SC, GM110M, GM110M+SC, GM210M, GM210M+SC, GV106M, GV106M+SC, GV110M, GV110M+SC, GV210M, GV210M+SC, PE040M, PE040X, PE080M, PE080X, PG040M, PG040X, PG080M... (Other models you can see in the webshop) | | | | | | |
| accessories for | 347706 | | | | | | |
| |  | <table border="1"> <tr> <td>GEV No.</td> <td>301036</td> <td>Ref. No.</td> <td>—</td> </tr> </table> | GEV No. | 301036 | Ref. No. | — | protective cover internal size 30x22mm for rocker switch mounting measurementsmm |
| GEV No. | 301036 | Ref. No. | — | | | | |


| | | | | | | | |
|---|--|--|-----------|--------|----------|---|--|
| labelled | | | | | | | |
|  | | | | | | | |
| GEV No. | 301200 | Ref. No. | R65260050 | | | | |
| description | rocker switch mounting measurements 30x22mm black 2NO 230V 16A 0-1 connection male faston 6.3mm ambient temperature max. 85°C protection IP65 with cover cap | | | | | | |
| For models: | AC, AU04, AU05, AU08, AU10, AU20, EC106M, EC110M, EC210M, EM106M, EM110M, EM210M, EV006M, EV106M, EV110M, EV210M, FE105X, FG105X, FG110X, FG210X, GC106M, GC110M, GC210M, GM106M, GM110M, GM210M, GV106M, GV110M, GV210M, PE040X, PG040X, PG080X | | | | | | |
| accessories for | 301200 | | | | | | |
| |  | <table border="1"> <tr> <td>GEV No.</td> <td>301036</td> <td>Ref. No.</td> <td>—</td> </tr> </table> | GEV No. | 301036 | Ref. No. | — | protective cover internal size 30x22mm for rocker switch mounting measurementsmm |
| GEV No. | 301036 | Ref. No. | — | | | | |



with symbol



1

| | | | |
|---|---|-----------------|-------------------|
| GEV No. | 301228 | Ref. No. | R65260210 |
| description | rocker switch mounting measurements 30x22mm black 2CO 250V 16A I-II connection male faston 6.3mm ambient temperature max. 125/55°C protection IP65 with cover cap | | |
| For models: | FE105X, FG105X, FG110X, FG210X, PE040X, PG040X, PG080X | | |
| accessories for | 301228 | | |
|  | GEV No. | 301036 | Ref. No. — |
| | protective cover internal size 30x22mm for rocker switch mounting measurementsmm | | |

push/momentary push switches

28.5x28.5mm



1

| | | | |
|--------------------|---|-----------------|--------|
| GEV No. | 345846 | Ref. No. | 130459 |
| description | momentary push switch mounting measurements 28.5x28.5mm grey 2CO 250V 16A START connection male faston 6.3mm ambient temperature max. 150°C protection IP40 | | |



1

| | | | |
|--------------------|---|-----------------|--------|
| GEV No. | 345845 | Ref. No. | 130460 |
| description | push switch mounting measurements 28.5x28.5mm green/red 2CO 250V 16A ON-OFF connection male faston 6.3mm ambient temperature max. 150°C protection IP40 | | |

ø16mm



1

| | | | |
|--------------------|---|-----------------|-----------|
| GEV No. | 301172 | Ref. No. | R65260610 |
| description | momentary push switch mounting ø 16mm black 1NO 250V 16A connection male faston 6.3mm protection IP40 ambient temperature max. 150°C | | |
| For models: | MACE04M, MACE05M, MACE07M, MACE10M, MACE20M, MACG05M, MACG07M, MACG10M, MACG20M, ME061M, ME101M, ME102M, ME201M, ME202M, MG061M, MG101M, MG102M, MG201M, MG202M | | |



1

| | | | |
|--------------------|--|-----------------|-----------|
| GEV No. | 346287 ¹ | Ref. No. | R65260480 |
| description | momentary push switch mounting ø 16mm red 1NO 250V 3A illuminated connection male faston 2.8mm ambient temperature max. 125/55°C protection IP65 with cover cap | | |
| For models: | GC106M, GC110M, GC210M, GM106H, GM106M, GM106M+SC, GM106P, GM110H, GM110M, GM110M+SC, GM110P, GM210H, GM210M, GM210M+SC, GM210P, GV106H, GV106M, GV106M+SC, GV106P, GV110H, GV110M, GV110M+SC, GV110P, GV210H, GV210M, GV210M+SC, GV210P | | |

¹illuminated

1

| | | | |
|--------------------|---|-----------------|------------------------|
| GEV No. | 301227 | Ref. No. | R65260120 R65260600 |
| description | push switch mounting ø 16mm black 1NO 250V 16A connection male faston 6.3mm protection IP40 ambient temperature max. 150°C | | |
| For models: | MACE04M, MACE05M, MACE07M, MACE10M, MACE20M, MACG05M, MACG07M, MACG10M, MACG20M, ME061M, ME101M, ME102M, ME201M, ME202M, MEC40M, MG061M, MG101M, MG102M, MG201M, MG202M | | |

ø25mm




1

| | | | |
|--------------------|---|-----------------|-----------|
| GEV No. | 345038 | Ref. No. | CR0410290 |
| description | momentary push switch mounting ø 25mm black 2NO 250V 16A connection male faston 6.3mm ambient temperature max. 85°C protection IP40 | | |
| For models: | CFG70, CFG70M, NBR912EFM, NBR912EIM, NBR912GFM, NBR912GIM, NBR98EF, NBR98EFM, NBR98EI, NBR98EIM, NBR98GF, NBR98GFM, NBR98GI, NBR98GIM | | |



1

| | | | |
|---|---|-----------------|--|
| GEV No. | 345039 | Ref. No. | 1037115000 CR0410310 MACR0410310 |
| description | protective cover round ED ø 33mm external size 23mm internal size 21mm H 12mm clear mounting ø 25mm | | |
| For models: | CFG70, CFG70M, EF140DF, EF140DN, EF140DP, EF143DNF, EF70DF, EF70DN, EF70DP, EF72DNF, F140DF, F140DI, F140DN, F140DP, F14D-FG, F14DNG, F70DF, F70DI, F70DN, F70DP, F7DFG, F7DNG, FB110F, FB110N, FB110P, FB140F, FB140FN, FB140N, FB140NN, FB140P, FB140PF, FB140PN, FB140PP, FB143NI, FB55F, FB55N, FB55P, FB70F, FB70N, FB70P, FB72F, FB72N, FB72NF, FB72P, FR92G22T, FR94G22T, FS140F, FS140FI, FS140FN, FS140I...(Other models you can see in the webshop) | | |
| accessories for | 345039 | | |
|  | GEV No. | 345001 | Ref. No. — |
| | momentary push switch mounting ø 25mm yellow 1NO/indicator light 250V 16A cover connection male faston 6.3mm ambient temperature max. 85°C protection IP65 | | |



microswitches

lever actuated



| | | | |
|--------------------|--|-----------------|--|
| GEV No. | 345254 | Ref. No. | 1037111300 1037304200 MA1037111300 MA1037304200 |
| description | microswitch with lever 250V 16A 1CO connection male faston 6.3mm ambient temperature max. 120°C mounting distance 22mm actuating force: 60g lever length 58mm | | |
| For models: | BR78EF, BR78EI, BR78GF, BR78GI, BR912EFM, BR912EIM, BR912GFM, BR912GIM, BR98EF, BR98EFM, BR98EI, BR98EIM, BR98GF, BR98GFM, BR98GI, BR98GIM, BR9S8EF, BR9S8EI, BR9S8GF, BR9S8GI, DLS30, DLS303, DLS30P, DLS30P3, DLS31, DLS313, DLS31P3, EF140DF, EF140DN, EF140DP, EF140MB, EF140MC, EF140MF, EF140MI, EF140MN, EF140MP, EF143DNF, EF143MNI, EF70DF, EF70DN, EF70DP, EF70MB, EF70MC, EF70MF, EF70MI, EF70MN, EF70MP, EF72DNF, EF72MNF, EF74E10VG...(Other models you can see in the webshop) | | |

pin-plunger actuated



| | | | |
|--------------------|--|-----------------|----------------------------|
| GEV No. | 345326 | Ref. No. | 1037312900 MA1037312900 |
| description | microswitch with plunger 250V 16A 1NO connection male faston 6.3mm ambient temperature max. 85°C mounting distance 22mm type XP52Z11 actuating force: 350g red stroke 15mm | | |
| For models: | FQE40, FQE40D, FQE40DSP, FQE41, FQE41L, FQE41L2, FQE60, FQE60D, FQE60DSP, FQE61, FQE61L, FQE61L2, FR74E10, FR74E10L, FR74E10L2, FR77E10, FR77E10L, FR77E10L2, FR92E10, FR92E10L, FR92E10L2, FR94E10, FR94E10L, FR94E10L2, OFQE41, OFQE61 | | |


M10



| | | | |
|--------------------|---|-----------------|-----------------------------------|
| GEV No. | 345032 | Ref. No. | 1267300 MA1267300 R65260540 |
| description | microswitch with plunger thread M10x1 thread L 12mm 250V 16A 1CO connection male faston 6.3mm stroke 7mm mounting distance 22mm L 28mm ambient temperature max. 125°C type SP9603 actuating force: 180g | | |
| For models: | BR94G, BR94GI, BR9M4G, BR9M4GI, EC106M, EC110M, EC210M, EM010M+SC, EM106H, EM106M, EM106M+SC, EM106P, EM110H, EM110M, EM110M+SC, EM110P, EM210H, EM210M, EM210M+SC, EM210P, EV006M, EV106H, EV106M, EV106M+SC, EV106P, EV110H, EV110M, EV110M+SC, EV110P, EV210H, EV210M, EV210M+SC, EV210P, FC10E, FC10G, FC20E, FC20G, FC5E, FC5G, FC7E, FC7G, FE105M, FE105X, FE110M, FE110X, FE210M, FG105M, FG105X, FG110M, FG110X...(Other models you can see in the webshop) | | |

M12



| | | | |
|------------------------|---|-----------------|-----------|
| GEV No. | 345350 | Ref. No. | R65260530 |
| description | microswitch with plunger mounting distance 22mm thread M12x0.75 thread L 16mm 250V 16A 1CO connection male faston 6.3mm stroke 4mm ambient temperature max. 125°C type EF83161.3 actuating force: 66g | | |
| For models: | CVE004H, CVE004M, CVE104H, CVE104M, CVE105H, CVE105M, CVG105H, CVG105M, VE004M, VE004X, VE104M, VE104X, VE105M, VE105X, VG105M, VG105X | | |
| accessories for | 345350 | | |
| |  | GEV No. | 345351 |
| | | Ref. No. | — |
| | nut thread M12x0.75 H 1.6mm WS 14 chrome-plated brass Qty 1 pcs | | |

position switches

PIZZATO

FD series



| | | | |
|--------------------|--|-----------------|--------|
| GEV No. | 345075 | Ref. No. | 120343 |
| description | position switch cast aluminum 1NO/1NC 400V 3A L 141mm W 40mm H 35mm protection IP67 actuating force: 300g screw connection PG13.5 mounting distance 30x60mm type FD503 | | |

FR series



| | | | |
|--------------------|--|-----------------|----------------------|
| GEV No. | 345144 | Ref. No. | 1871500 MA1871500 |
| description | position switch plastic 1NC/1NO 400V 3A L 92mm W 31mm H 31mm protection IP67 actuating force: 360g screw connection PG13.5 mounting distance 22mm screw | | |
| For models: | BR707E, BR707EI, BR94E, BR94EI, BR94G, BR94GI, BR9M4E, BR9M4EI, BR9M4G, BR9M4GI, BR9M6E, BR9M6EI, BR9M6G, BR9M6GI, BR9SB4E, BR9SB4EI, BR9SB4G, BR9SB4GI, MS10AG, MS10IG, MS70AG, MS70IG, MS70IGS | | |



| | | | |
|--------------------|---|-----------------|----------------------------|
| GEV No. | 345181 | Ref. No. | 1037307700 MA1037307700 |
| description | position switch plastic 1NC/1NO 400V 3A L 92mm W 31mm H 31mm protection IP67 actuating force: 450g screw connection PG13.5 mounting distance 22mm screw | | |
| For models: | MLC50, MLC503, MLC65, MLC653 | | |



system switches (ROLD)



1

| | | | |
|--------------------|---|-----------------|--------|
| GEV No. | 345131 | Ref. No. | 190140 |
| description | element holder mounting measurements 28.5x28.5mm grey single element holder | | |



1

| | | | |
|--------------------|---|-----------------|--------|
| GEV No. | 345130 | Ref. No. | 130449 |
| description | momentary switch unit 1NO 250V 16A connection male faston 6.3mm | | |



1

| | | | |
|--------------------|-------------------------|-----------------|--------|
| GEV No. | 345133 | Ref. No. | 450321 |
| description | push button ø 23mm grey | | |



1

| | | | |
|--------------------|-------------------------------|-----------------|--------|
| GEV No. | 345851 | Ref. No. | 450331 |
| description | push button ø 23mm grey START | | |

cam switches

on/off



1

| | | | |
|--------------------|---|-----------------|----------------------|
| GEV No. | 300021 | Ref. No. | 1230100 MA1230100 |
| description | cam switch 4 operating positions 4NO sequence 0-1-0-1 16A shaft ø 6x4.6mm shaft L 23mm connection screw ceramic | | |
| For models: | B124E, B74E, B78E, B94E, B98E, B9VP2E, B9VP4E, BR94E, BR94EI, BR96E, BR96EI, BR9M4E, BR9M4EI, BR9M4GI, BR9M6E, BR9M6EI, BR9SB4E, BR9SB4EI, BSEI40M, FTE100B, FTE100BR, FTE100C, FTE100CRL, FTE40B, FTE40BR, FTE40C, FTE40D, FTE40DC, FTE60B, FTE60BR, FTE60BRR, FTE60C, FTE60D, FTE60DC, FTE60DCRL, FTE60DR, NB74E, NB78E, NB94E, NB98E, NF94E222K, NF94E22K, NF94G23K, NF98E222K, NF98E22K, NF98G23K, NSP74E, NSP94E, OBSEI40M, OFTE100CRL...(Other models you can see in the webshop) | | |



1

| | | | |
|--------------------|---|-----------------|----------------------|
| GEV No. | 300102 | Ref. No. | 1475900 MA1475900 |
| description | cam switch 4 operating positions 4NO sequence 0-1-0-1 32A shaft ø 6x4.6mm shaft L 23mm connection screw ceramic | | |
| For models: | BR707E, BR707EI, BR94E, BR94EI, BR9M4E, BR9M4EI, FT74E, FT74ER, FT74ERL, FT77E, FT77EC | | |



1

| | | | |
|--------------------|------------------------------|-----------------|--------------------------------|
| GEV No. | 300083 | Ref. No. | 1037307900 1037307900 (NML) |
| description | cam switch ON-OFF | | |
| For models: | MLC50, MLC503, MLC65, MLC653 | | |

4-position



1

| | | | |
|--------------------|---|-----------------|--------------------|
| GEV No. | 300103 | Ref. No. | 501400 MA501400 |
| description | cam switch 4 operating positions 1NO/2CO sequence 0-1-2-3 32A shaft ø 6x4.6mm shaft L 23mm connection screw ceramic | | |
| For models: | C9F4E, C9F6E, C9V2E, C9V4E | | |



1




| | | | |
|--------------------|---|-----------------|----------------------------------|
| GEV No. | 300104 | Ref. No. | 1037100500 790700 MA790700 |
| description | cam switch 4 operating positions 3NO/1CO sequence 0-1-2-3 32A shaft ø 6x4.6mm shaft L 23mm connection screw ceramic | | |
| For models: | CP704E, CP92E, CP94E, CP9SB2E, CP9SB4E, CPE40, CPE402, CPE60, CPE602, FP1E | | |



7-position



1

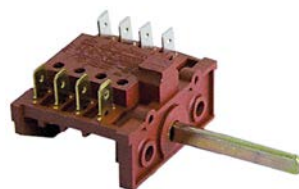
| | | | |
|---|---|-----------------|------------------------------------|
| GEV No. | 300025 | Ref. No. | 1037033100 1616100 MA1616100 |
| description | cam switch 7 operating positions 1NO/2CO sequence 0-1-2-3-4-5-6 16A shaft ø 6x4.6mm shaft L 23mm connection screw 7-position ceramic | | |
| For models: | C7011E, C7011EFE, C7011FEQ, C7011GFE, C704E, C707E, C707EFE, C707EFEQ, C707GFE, C74EC, C78EC, C78EQC, C7FE8E, C7FE8EC, C7FE8EQ, C7FG12G, C7FG8G, C94E, C94EC, C98E, C98EC, C9F4E, C9F6E, C9FE8E, C9FE8EC, C9V2E, C9V4E, CFE60, CFE60P, CFE70, EC74EVG, EC78EVG, EC7FE8E, NC74E2, NC74EC, NC74EQC, NC78E2, NC78EC, NC78EQC, NC7FE8E, NC7FE8E2, NC7FE8EQ, NC94E, NC94E2, NC98E, NC98E2, NC9FE8E, NC9FE8E2, OCPE60, OPCE40...(Other models you can see in the webshop) | | |
| accessories for | 300025 | | |
|  | GEV No. | 112172 | Ref. No. — |
| | knob universal ø 70mm black without adaptor/dial plate | | |
|  | GEV No. | 112213 | Ref. No. — |
| | knob dial plate silver switch 7-position t.max.°C ED ø 63mm ID ø 45.5mm | | |
|  | GEV No. | 112311 | Ref. No. — |
| | knob adapter shaft ø 6x4.6mm L 0mm with spring | | |



1

| | | | |
|--------------------|---|-----------------|----------------------------------|
| GEV No. | 300106 | Ref. No. | 1937800 21131099 MA1937800 |
| description | cam switch 7 operating positions 1NO/2CO sequence 0-1-2-3-4-5-6 32A shaft ø 6x4.6mm shaft L 23mm connection screw 7-position shaft flat upper | | |
| For models: | C74EC, C78EC, C78EQC, C7FE8E, C7FE8EC, C7FE8EQ, C94E, C94EC, C98E, C98EC, C9FE8E, C9FE8EC, NC94E, NC94E2, NC98E, NC98E2, NC9FE8E, NC9FE8E2 | | |

2 operating positions



1

| | | | |
|--------------------|--|-----------------|------------|
| GEV No. | 300085 | Ref. No. | 1037303100 |
| description | cam switch 2 operating positions programme sequence 0-1 shaft ø 6x4.6mm connection male faston 6.3mm 4-pole | | |
| For models: | DLS30, DLS303, DLS30P, DLS30P3, DLS31, DLS313, DLS31P3, MLS30, MLS303, MLS30P, MLS30P3, MLS31, MLS313, MLS31P3, MLS35, MLS353, MPLS30P | | |

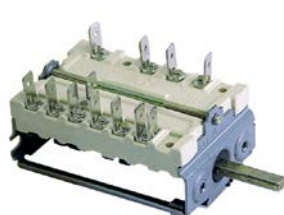
3 operating positions



1

| | | | |
|--------------------|---|-----------------|------------|
| GEV No. | 300086 | Ref. No. | 1037303200 |
| description | cam switch 3 operating positions programme sequence 1-0-2 shaft ø 6x4.6mm connection male faston 10-pole | | |
| For models: | DLS30, DLS303, DLS30P, DLS30P3, DLS31, DLS313, DLS31P3, MLS30, MLS303, MLS30P, MLS30P3, MLS31, MLS313, MLS31P3, MPLS30P | | |

4 operating positions




1

| | | | |
|--------------------|---|-----------------|-----------|
| GEV No. | 300010 | Ref. No. | R65080010 |
| description | cam switch 4 operating positions 2NO/2CO sequence 0-1-2-3 16A shaft ø 6x4.6mm shaft L 23mm connection male faston 6.3mm ceramic | | |
| For models: | EC106M, EC110M, EC210M, FE105M, FE105X, FE110M, FE110X, FE210M, FG105M, FG105X, FG110M, FG110X, FG210M, FG210X, GC106M, GC110M, GC210M, MACE04M, MACE05M, MACE07M, MACE10M, MACE20M, MACG05M, MACG07M, MACG10M, MACG20M, PE040M, PE040X, PE080M, PE080X, PG040M, PG040X, PG080M, PG080X | | |



1

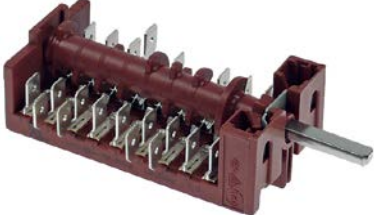
| | | | |
|--------------------|--|-----------------|----------------------|
| GEV No. | 300081 | Ref. No. | 1309000 MA1309000 |
| description | cam switch 4 operating positions 3NO/2CO sequence 0-1-2-3 16A shaft ø 6x4.6mm shaft L 23mm connection screw | | |
| For models: | BF78E, BF98E, C12FEP9G, C7011EFE, C7011EFEQ, C707EFE, C707EFEQ, C7FE12G, C7FE8E, C7FE8EC, C7FE8G, C9F4E, C9F6E, C9FE12G, C9FE6G5, C9FE8E, C9FE8EC, C9FE8G, C9V2E, C9V4E, CFE70, EC74EVG, EC78EVG, EC7FE8E, NC7FE12G36, NC7FE8E, NC7FE8EQ, NC7FE8G24, NC9FE12G44, NC9FE12G52, NC9FE8E, NC9FE8E2, NC9FE8G28, NC9FE8G36, NC9FE8G48, V9F4E, V9FP4E, V9V2E, V9V4E, V9VP2E, V9VP4E | | |



2

| | | | |
|--------------------|---|-----------------|-----------|
| GEV No. | 300239 | Ref. No. | CR0581810 |
| description | operation switch 4 operating positions 4NO sequence 0-1-2-3 16A shaft ø 6x4.6mm shaft L 23mm connection male faston 6.3mm plastic | | |
| For models: | NPC74E, NPC74G, NPC76E, NPC76G, NPC78E, NPC78G, NPC94E, NPC94G, NPC96E, NPC96G, NPC98E, NPC98G, NPD76G5, NPD78G8, NPD96G5, NPD98E10, NPD98E15, NPD98G10, NPD98G15, NPD98G15A, NPI76E5, NPI76G5, NPI78E8, NPI78G8, NPI96E5, NPI96G5, NPI98E10, NPI98E15, NPI98G10, NPI98G14, NPI98G14A | | |


5 operating positions



1

| | | | |
|--------------------|---|-----------------|-----------|
| GEV No. | 347191 | Ref. No. | R65080020 |
| description | cam switch 5 operating positions 9NO sequence 1-0-2-3-4 16A shaft ø 6x4.6mm shaft L 23mm connection male faston 6.3mm plastic | | |
| For models: | CVE004M, CVE104M, CVE105M, CVG105M, EM010M+SC, EM106M, EM106M+SC, EM110M, EM110M+SC, EM210M, EM210M+SC, EV006M, EV106M, EV106M+SC, EV110M, EV110M+SC, EV210M, EV210M+SC, GM106M, GM106M+SC, GM110M, GM110M+SC, GM210M, GM210M+SC, GV106M, GV106M+SC, GV110M, GV110M+SC, GV210M, GV210M+SC, ME061M, ME101M, ME102M, ME106M, ME106X, ME110M, ME110X, ME120M, ME120X, ME201M, ME202M, ME210M, ME210X, ME220M, ME220X, MEC40M, MG061M, MG101M, MG102M, MG106M...(Other models you can see in the webshop) | | |


10 operating positions



1

| | | | |
|--------------------|---|-----------------|----------------------------|
| GEV No. | 345666 | Ref. No. | 1037103800 MA1037103800 |
| description | cam switch 10 operating positions 6NO/1CO sequence 0-1-2-3-4-5-6-7-8-9 8A shaft ø 6x4.6mm shaft L 23mm connection male faston 6.3mm plastic | | |
| For models: | FOE60M, OFOE60M | | |

with potentiometer



1

| | | | |
|--------------------|---|-----------------|-----------|
| GEV No. | 300252 | Ref. No. | CR0737320 |
| description | potentiometer 2 operating positions 2NO sequence 0-1 16A shaft ø 6x4.6mm shaft L 23mm connection coded plug cable length 1420mm 10kOhm 12V with cable and indicator light | | |
| For models: | NI74E, NI78E, NI94E, NI98E, NIW74TE, NIW74TE2, NIW94TE, NIW94TE2 | | |

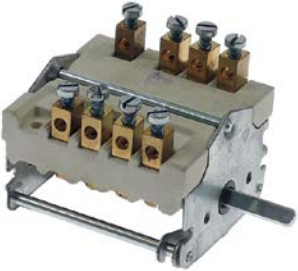
operation switches



1

| | | | |
|------------------------|--|-----------------|---|
| GEV No. | 300080 | Ref. No. | 1037033200 218111 65085010 710300 LAR65085010 MA218111 MA710300 |
| description | cam switch 2 operating positions 4NO 16A sequence 0-1 shaft ø 6x4.6mm shaft L 23mm connection screw operation switch ceramic ambient temperature max. 150°C | | |
| For models: | B9SB2E, B9SB2G, B9SB4E, B9SB4G, B9V2E, B9V2G, B9V4E, B9V4G, BIE40, BIE40B, BIE60, BIE60B, BM74E, BM77E, BME40DM, BME40DMB, BME40M, BME60, BME602, BME60DM, BME60DMB, BME60M, BME80M, BR912GFM, BR912GIM, BR94G, BR94GI, BR96G, BR96GI, BR98GF, BR98GFM, BR98GI, BR98GIM, BR9M4G, BR9M4GI, BR9M6G, BR9M6GI, BR9S8GF, BR9S8GI, BR9SB4G, BR9SB4GI, BRE40, BRE40D, BRE40DB, BRE40DG, BRE40DGB, BRE40G, BSE40M, C7011EFE, C7011EFEQ...(Other models you can see in the webshop) | | |
| accessories for | 300080 | | |
| |  | GEV No. | 551456 |
| | | Ref. No. | — |
| | gasket for switch ED ø 14mm ID ø 2.5mm thickness 3.5mm white | | |



| | | | |
|---|---|-----------------|-----------|
|  | | | |
| 1 | | | |
| GEV No. | 300180 | Ref. No. | CR0686110 |
| description | cam switch 2 operating positions operation switch 32A sequence 0-1 shaft ø 6x4.6mm shaft L 23mm connection screw ceramic | | |
| For models: | NFT74EL, NFT74ELC, NFT74ELCO, NFT74ELO, NFT74ER, NFT74ERC, NFT76EL, NFT76ELC, NFT76EM, NFT76EMC, NFT76ER, NFT78EL, NFT78ELC, NFT78ELCO, NFT78ELO, NFT78EM, NFT78EMC, NFT78ER, NFT78ERC, NFT94EL, NFT94ELC, NFT94ELO, NFT94ER, NFT96EL, NFT96ELC, NFT96EM, NFT96EMC, NFT98EL, NFT98ELC, NFT98ELO, NFT98EM, NFT98EMC, NG912E, NG912E2, NG94E, NG94E2, NG98E, NG98E2 | | |


| | | | |
|---|--|-----------------|---|
|  | | | |
| 1 | | | |
| GEV No. | 300200 | Ref. No. | 1037313200 65260030 LAR65260030 MA1037313200 |
| description | operation switch 2 operating positions 2NO 16A sequence 0-1 shaft ø 6x4.6mm shaft L 23mm connection male faston 6.3mm operation switch ceramic | | |
| For models: | AR712PA, AR712PP, AR712PS, AR713PA, AR713PP, AR713PS, AR714PA, AR714PP, AR714PS, AR715PA, AR715PP, AR715PS, AR716PA, AR716PP, AR716PS, AR717PA, AR717PP, AR717PS, AR718PA, AR718PP, AR718PS, AR719PA, AR719PP, AR719PS, AR720PA, AR720PP, AR720PS, BME40DM, BME40DMB, BME40M, BME60DM, BME60DMB, BME60M, BME80M, BR707E, BR707EI, BR78EF, BR78EI, BR912EFM, BR912EIM, BR912GFM, BR912GIM, BR94E, BR94EI, BR98EF, BR98EFM, BR98EI, BR98EIM, BR98GF, BR98GFM...(Other models you can see in the webshop) | | |

| | | | |
|---|---|-----------------|----------------------------|
|  | | | |
| 1 | | | |
| GEV No. | 300091 | Ref. No. | 1037035700 MA1037035700 |
| description | operation switch EGO 2 operating positions 2NO 16A sequence 0-1 shaft ø 6x4.6mm shaft L 23mm connection screw ceramic | | |
| For models: | FQE4, FQE6, FQE6+6 | | |


rotary switches


BREMAS


A1200 series

| | | | |
|--|---|-----------------|--------|
|  | | | |
| 1 | | | |
| GEV No. | 345019 | Ref. No. | 120712 |
| description | rotary switch sets of contacts 2 2 0-1 type CA0120002 380V 12A shaft ø 5x5mm shaft L 23mm shaft square connection screw | | |


A1600 series

| | | | |
|--|---|-----------------|--------|
|  | | | |
| 1 | | | |
| GEV No. | 345840 | Ref. No. | 120737 |
| description | rotary switch 3 0-1-2 sets of contacts 4 type CS0168308 400V 16A shaft ø 5x5mm shaft L 23mm shaft square connection screw | | |

| | | | |
|--|---|-----------------|--------|
|  | | | |
| 1 | | | |
| GEV No. | 345842 | Ref. No. | 120716 |
| description | rotary switch 5 0-1-2-3-4 sets of contacts 6 type CS0168359 400V 16A shaft ø 5x5mm shaft L 23mm shaft square connection screw | | |


| | | | |
|--|---|-----------------|--------|
|  | | | |
| 1 | | | |
| GEV No. | 345024 | Ref. No. | 120729 |
| description | rotary switch 6 0-1-2-3-4-5 sets of contacts 8 type CS0168339 400V 16A shaft ø 5x5mm shaft L 25mm shaft square connection screw | | |

TECNOMATIC

| | | | |
|--|--|-----------------|----------------------------|
|  | | | |
| 1 | | | |
| GEV No. | 300365 | Ref. No. | 1037308000 MA1037308000 |
| description | rotary switch 4 0-1-2-3 sets of contacts 4 type HD12X274R000 600V 12A shaft ø 5x5mm shaft L 22mm shaft square connection male faston 6.3mm | | |
| For models: | MLC50, MLC503, MLC65, MLC653 | | |



touch sensitive light switches




1

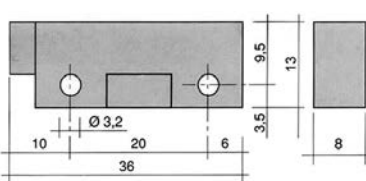
| | | | |
|--------------------|--|-----------------|-----------|
| GEV No. | 346388 | Ref. No. | R65260750 |
| description | touch sensitive light switch 1NOVA for combi-steamer L 47mm W 20mm H 30mm | | |
| For models: | GMT06D, GMT20D, GVT06D, GVT20D, MACE07M, MACE10M, MACE20M, MACG07M, MACG10M, MACG20M, ME061D, ME061M, ME061P, ME061T, ME101D, ME101M, ME101P, ME101T, ME102D, ME102M, ME102P, ME102T, ME201D, ME201M, ME201P, ME201T, ME202D, ME202M, ME202P, ME202T, MEMT06D, MEMT06P, MEMT10D, MEMT10P, MEMT20D, MEMT20P, MEMT21D, MEMT21P, MEMT40D, MEMT40P, MEVT06D, MEVT06P, MEVT10D, MEVT10P, MEVT20D, MEVT20P, MEVT21D, MEVT21P, MEVT40D, MEVT40P...(Other models you can see in the webshop) | | |


magnetic switches

36x13mm




1



| | | | |
|---|--|-----------------|----------------------|
| GEV No. | 345335 | Ref. No. | 5169100 MA5169100 |
| description | magnetic switch L 36mm W 13mm 1NO 250V 0.04A P max. 10W connection cable cable length 960mm | | |
| For models: | CON102E, CON102EP, CON102G, CON102GP, CON10E, CON10EP, CON10G, CON10GP, CON201E, CON201EP, CON201G, CON201GP, CON202E, CON202EP, CON202G, CON202GP, CON6E, CON6EP, CON6G, CON6GP, CSM102E, CSM102EP, CSM102G, CSM102GP, CSM10E, CSM10EP, CSM10G, CSM10GP, CSM201E, CSM201EP, CSM201G, CSM201GP, CSM202E, CSM202EP, CSM202G, CSM202GP, CSM6E, CSM6EP, CSM6G, CSM6GP | | |
| accessories for | 345335 | | |
|  | GEV No. | 519049 | Ref. No. — |
| | magnet ømm L 63mm H 10.7mm W 18.8mm hole distance 52mm M2 hole ø 2mm | | |


37x16mm



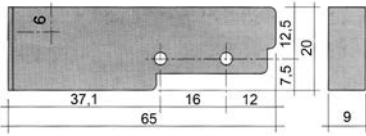
1

| | | | |
|--------------------|---|-----------------|-----------|
| GEV No. | 347790 | Ref. No. | R65265100 |
| description | magnetic switch L 37mm W 16mm 1NO 250V connection cable cable length 1960mm 10W with magnet nominal 0.04A | | |
| For models: | GMT06D, GMT20D, GVT06D, GVT20D, ME061D, ME061M, ME061P, ME061T, ME101D, ME101M, ME101P, ME101T, ME102D, ME102M, ME102P, ME102T, ME106M, ME106P, ME106X, ME110M, ME110P, ME110X, ME120M, ME120P, ME120X, ME201D, ME201M, ME201P, ME201T, ME202D, ME202M, ME202P, ME202T, ME210M, ME210P, ME210X, ME220M, ME220P, ME220X, MEC24H, MEC40M, MEMT06D, MEMT06P, MEMT10D, MEMT10P, MEMT20D, MEMT20P, MEMT21D, MEMT21P, MEMT40D...(Other models you can see in the webshop) | | |

65x20mm




1

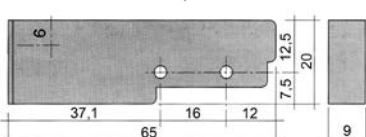



| | | | |
|--------------------|--|-----------------|--------|
| GEV No. | 345122 ¹ | Ref. No. | 120333 |
| description | magnetic switch L 65mm W 20mm 1NO 24V 8A P max. 192W connection male faston 6.3mm cable length 344mm | | |

¹with coded connector




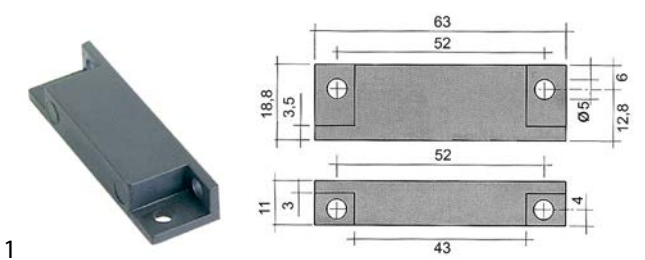
1



| | | | |
|---|--|-----------------|--------------------|
| GEV No. | 345116 | Ref. No. | 120348 BN161801 |
| description | magnetic switch L 65mm W 20mm 1NO 250V 0.4A P max. 100W connection cable cable length 3000mm | | |
| accessories for | 345116 | | |
|  | GEV No. | 345399 | Ref. No. — |
| | magnet ø 3.3mm L 40mm H 8mm W 13mm hole distance 30mm M3 | | |




| miscellaneous | | | |
|---|--|-----------------|-----------|
|  | | | |
| GEV No. | 401961 | Ref. No. | R66110300 |
| description | magnetic switch door contact | | |
| For models: | GMT20D, GVT06D, GVT20D, MACE07M, MACE10M, MACE20M, MACG07M, MACG10M, MACG20M, ME061M, ME061P, ME061T, ME101M, ME101P, ME101T, ME102M, ME102P, ME102T, ME201M, ME201P, ME201T, ME202D, ME202M, ME202P, ME202T, MEMT06D, MEMT06P, MEMT10D, MEMT10P, MEMT20D, MEMT20P, MEMT21D, MEMT21P, MEMT40D, MEMT40P, MEVT06D, MEVT06P, MEVT10D, MEVT10P, MEVT20D, MEVT20P, MEVT21D, MEVT21P, MEVT40D, MEVT40P, MG061M, MG061P, MG061T, MG101M, MG101P...(Other models you can see in the webshop) | | |

| accessories | | | |
|---|--|-----------------|-----------------------------------|
| magnets | | | |
|  | | | |
| GEV No. | 345336 | Ref. No. | 5169200 BN3108890 MA5169200 |
| description | magnet ø 4.8mm L 63mm H 11mm W 18.8mm hole distance 51mm M4 | | |
| For models: | CON102E, CON102EP, CON102G, CON102GP, CON10E, CON10EP, CON10G, CON10GP, CON201E, CON201EP, CON201G, CON201GP, CON202E, CON202EP, CON202G, CON202GP, CON6E, CON6EP, CON6G, CON6GP, CSM102E, CSM102EP, CSM102G, CSM102GP, CSM10E, CSM10EP, CSM10G, CSM10GP, CSM201, CSM201E, CSM201EP, CSM201G, CSM201GP, CSM202, CSM202E, CSM202EP, CSM202G, CSM202GP, CSM6E, CSM6EP, CSM6G, CSM6GP | | |


| 3SB series ø22mm new | | | |
|---|--|-----------------|----------------------|
| rotary switches | | | |
|  | | | |
| GEV No. | 346629 | Ref. No. | 2998200 CR0413380 |
| description | rotary selector mounting measurements ø22mm black momentary sequence 1-0-2 | | |
| For models: | BR78EF, BR78EI, BR78GF, BR78GI, BR912EFM, BR912EIM, BR912GFM, BR912GIM, BR98EF, BR98EFM, BR98EI, BR98EIM, BR98GF, BR98GFM, BR98GI, BR98GIM, BR9S8EF, BR9S8EI, BR9S8GF, BR9S8GI, CP9A15GD, F94E18K, F94G22K, F98E18K, F98G22K, NBR912EFM, NBR912EIM, NBR912GFM, NBR912GIM, NBR98EF, NBR98EFM, NBR98EI, NBR98EIM, NBR98GF, NBR98GFM, NBR98GI, NBR98GIM | | |
| accessories for | 346629 | | |
|  | GEV No. | 346602 | Ref. No. — |
| contact block SIEMENS 3SB3400-0D 2NO max 400V 10A black | | | |
|  | GEV No. | 346603 | Ref. No. — |
| contact block SIEMENS 3SB3400-0E 2NC max 400V 10A black | | | |
|  | GEV No. | 346630 | Ref. No. — |
| contact block SIEMENS 3SB3400-0B 1NO max 400V 10A black | | | |
|  | GEV No. | 346631 | Ref. No. — |
| contact block SIEMENS 3SB3400-0C 1NC max 400V 10A black | | | |
|  | GEV No. | 346632 | Ref. No. — |
| contact block SIEMENS 3SB3400-0D 1NC/1NO max 400V 10A black | | | |

control equipment


SIEMENS

| 3SB series ø22mm old | | | |
|---|--|-----------------|---|
| rotary switches | | | |
|  | | | |
| GEV No. | 345526 | Ref. No. | 2860600 MA2860600 SI0102505 SIR0102505 |
| description | rotary selector mounting measurements ø22mm sequence 0-1 latching black | | |
| For models: | CON102E, CON102EP, CON102G, CON102GP, CON10E, CON10EP, CON10G, CON10GP, CON201E, CON201EP, CON201G, CON201GP, CON202E, CON202EP, CON202G, CON202GP, CON6E, CON6EP, CON6G, CON6GP, CS102E, CS102EP, CS102G, CS102GP, CS10E, CS10EP, CS10G, CS4E, CS4EP, CS6E, CS6EP, CS6G, CSM102E, CSM102EP, CSM102G, CSM102GP, CSM10E, CSM10EP, CSM10G, CSM10GP, CSM201, CSM201E, CSM201EP, CSM201G, CSM201GP, CSM202, CSM202E, CSM202EP, CSM202G, CSM202GP...(Other models you can see in the webshop) | | |

encoders and potentiometers

| | | | |
|--|--|-----------------|-----------|
|  | | | |
| GEV No. | 401338 | Ref. No. | R65301450 |
| description | encoder | | |
| For models: | GMT06D, GMT20D, GVT06D, GVT20D, ME061D, ME061P, ME061T, ME101D, ME101P, ME101T, ME102D, ME102P, ME102T, ME201D, ME201P, ME201T, ME202D, ME202P, ME202T, MEMT06D, MEMT06P, MEMT10D, MEMT10P, MEMT20D, MEMT20P, MEMT21D, MEMT21P, MEMT40D, MEMT40P, MEVT06D, MEVT06P, MEVT10D, MEVT10P, MEVT20D, MEVT20P, MEVT21D, MEVT21P, MEVT40D, MEVT40P, MG061D, MG061P, MG061T, MG101D, MG101P, MG101T, MG102D, MG102P, MG102T, MG201D, MG201P...(Other models you can see in the webshop) | | |



| | | | |
|---|---|-----------------|-----------|
|  | | | |
| 1 | | | |
| GEV No. | 300252 | Ref. No. | CR0737320 |
| description | potentiometer 2 operating positions 2NO sequence 0-1 16A shaft ø 6x4.6mm shaft L 23mm connection coded plug cable length 1420mm 10kOhm 12V with cable and indicator light | | |
| For models: | NI74E, NI78E, NI94E, NI98E, NIW74TE, NIW74TE2, NIW94TE, NIW94TE2 | | |


lamps


indicator lights


indicator lights 2-piece (lens and indicator lamp)

indicator light lenses


ø 6mm (type SQ-20)


| | | | |
|---|--|-----------------|--------|
|  | | | |
| 1 | | | |
| GEV No. | 359806 | Ref. No. | 130707 |
| description | indicator light lens clear Qty 1 pcs ø 6mm | | |

| | | | |
|--|--|-----------------|--------|
|  | | | |
| 1 | | | |
| GEV No. | 359803 | Ref. No. | 130704 |
| description | indicator light lens green Qty 1 pcs ø 6mm | | |


| | | | |
|---|--|-----------------|--------|
|  | | | |
| 1 | | | |
| GEV No. | 359805 | Ref. No. | 130706 |
| description | indicator light lens red Qty 1 pcs ø 6mm | | |


ø12mm (type SDY-3)

| | | | |
|---|--|-----------------|----------------------|
|  | | | |
| 1 | | | |
| GEV No. | 359262 | Ref. No. | 130711 BN6A001438 |
| description | indicator light housings mounting measurements ø12mm green round Qty 1 pcs | | |

| | | | |
|---|--|-----------------|--------|
|  | | | |
| 1 | | | |
| GEV No. | 359261 | Ref. No. | 130710 |
| description | indicator light housings mounting measurements ø12mm red round Qty 1 pcs | | |


indicator lamps for socket type SRZ / SDK / SDY / SFK


| | | | |
|---|---|-----------------|--------|
|  | | | |
| 1 | | | |
| GEV No. | 359129 | Ref. No. | 130170 |
| description | indicator lamp 24V clear connection male faston 6.3mm | | |


| | | | |
|---|--|-----------------|------------|
|  | | | |
| 1 | | | |
| GEV No. | 359132 | Ref. No. | 1037303400 |
| description | indicator lamp green 250V connection male faston 6.3mm protection IP54 ambient temperature max. 85°C | | |
| For models: | DLS30, DLS303, DLS30P, DLS30P3, DLS31, DLS313, DLS31P3, MLC50, MLC503, MLC65, MLC653, MLS30, MLS303, MLS30P, MLS30P3, MLS31, MLS313, MLS31P3, MLS35, MLS353, MPLS30P | | |

indicator lights (complete)


ø 6mm


| | | | |
|---|--|-----------------|----------------------|
|  | | | |
| 1 | | | |
| GEV No. | 359004 | Ref. No. | 2998600 MA2998600 |
| description | indicator light ø 6mm 230V green cable length 400mm temp.-resist. 106°C | | |
| For models: | CON102E, CON102EP, CON102G, CON102GP, CON10E, CON10EP, CON10G, CON10GP, CON201E, CON201EP, CON201G, CON201GP, CON202E, CON202EP, CON202G, CON202GP, CON6E, CON6EP, CON6G, CON6GP | | |


| | | | |
|---|--|-----------------|----------------------|
|  | | | |
| 1 | | | |
| GEV No. | 359005 | Ref. No. | 2998700 MA2998700 |
| description | indicator light ø 6mm 230V yellow cable length 400mm | | |
| For models: | CON102E, CON102EP, CON102G, CON102GP, CON10E, CON10EP, CON10G, CON10GP, CON201E, CON201EP, CON201G, CON201GP, CON202E, CON202EP, CON202G, CON202GP, CON6E, CON6EP, CON6G, CON6GP | | |


| | | | |
|---|---|-----------------|----------------------|
|  | | | |
| 1 | | | |
| GEV No. | 359284 | Ref. No. | 2959600 MA2959600 |
| description | indicator light ø 6mm 24V green cable length 150mm | | |
| For models: | CON201E, CON201EP, CON201G, CON201GP, CON202E, CON202EP, CON202G, CON202GP, CS4E, CS4EP, CSM102E, CSM102EP, CSM102G, CSM102GP, CSM10E, CSM10EP, CSM10G, CSM10GP, CSM201, CSM201E, CSM201EP, CSM201G, CSM201GP, CSM202, CSM202E, CSM202EP, CSM202G, CSM202GP, CSM6E, CSM6EP, CSM6G, CSM6GP | | |





| | | | |
|---|---|-----------------|----------------------|
|  | | | |
| 1 | | | |
| GEV No. | 359285 | Ref. No. | 2959700 MA2959700 |
| description | indicator light ø 6mm 24V yellow cable length 150mm | | |
| For models: | CON201E, CON201EP, CON201G, CON201GP, CON202E, CON202EP, CON202G, CON202GP, CS4E, CS4EP, CSM102E, CSM102EP, CSM102G, CSM102GP, CSM10E, CSM10EP, CSM10G, CSM10GP, CSM201, CSM201E, CSM201EP, CSM201G, CSM201GP, CSM202, CSM202E, CSM202EP, CSM202G, CSM202GP, CSM6E, CSM6EP, CSM6G, CSM6GP | | |


| | | | |
|---|----------------------------------|-----------------|--------|
|  | | | |
| 1 | | | |
| GEV No. | 359031 | Ref. No. | 130157 |
| description | indicator light ø 6mm 230V green | | |

| | | | |
|---|---|-----------------|----------------------------|
| ø10mm | | | |
| with screw socket | | | |
|  | | | |
| 1 | | | |
| GEV No. | 359378 | Ref. No. | 1037300810 MA1037300810 |
| description | indicator light ø 10mm 230V green connection male faston 6.3mm socket screw base | | |
| For models: | B9SB2E, B9SB4E, B9V2E, B9V4E, BIE40, BIE40B, BIE60, BIE60B, BM74E, BM77E, BME40DM, BME40DMB, BME40M, BME60, BME602, BME60DM, BME60DMB, BME60M, BME80M, BRE40, BRE40D, BRE40DB, BRE40DG, BRE40DGB, BRE40G, BSE40M, BSEI40M, CB3, CB5, CD24, CFE60, CFE60P, CFE70, CFGE60, CFGE61, CFGE61D, CFGE61L, CFGE61P, CFVE60, CPE40, CPE402, CPE60, CPE602, CWE42, CWE422, CWE62, CWE622, F9V2E, F9V2E2, F9V2ER...(Other models you can see in the webshop) | | |


| | | | |
|---|--|-----------------|-----------|
|  | | | |
| 1 | | | |
| GEV No. | 359379 | Ref. No. | CR0587500 |
| description | indicator light ø 10mm 230V yellow connection male faston 6.3mm socket screw base | | |
| For models: | EF74E10VG, EF74E12, NB74E, NB78E, NBR78EF, NBR78EI, NBR912EFM, NBR912EIM, NBR912GFM, NBR912GIM, NBR98EF, NBR98EFM, NBR98EI, NBR98EIM, NBR98GF, NBR98GFM, NBR98GI, NBR98GIM, NC74E2, NC74EC, NC74EQC, NC78E2, NC78EC, NC78EQC, NC7FE8E, NC7FE8E2, NC7FE8EQ, NC94E, NC94E2, NC98E, NC98E2, NC9FE8E, NC9FE8E2, NCT78E, NCT7FE8E, NCT98E, NCT98E2, NCT9FE8E, NCT9FE8E2, NF74E10, NF74E15, NF76E10, NF78E15, NF94E10, NF94E15, NF94E22, NF94E222, NF96E10, NF98E15, NF98E22...(Other models you can see in the webshop) | | |


| | | | |
|---|---|-----------------|--|
| with plug-in socket | | | |
|  | | | |
| 1 | | | |
| GEV No. | 359140 | Ref. No. | 1037300900 1037300910 MA1037300910 |
| description | indicator light ø 10mm yellow 230V connection male faston 6.3mm Qty 1 pcs | | |
| For models: | AR712PA, AR712PP, AR712PS, AR713PA, AR713PP, AR713PS, AR714PA, AR714PP, AR714PS, AR715PA, AR715PP, AR715PS, AR716PA, AR716PP, AR716PS, AR717PA, AR717PP, AR717PS, AR718PA, AR718PP, AR718PS, AR719PA, AR719PP, AR719PS, AR720PA, AR720PP, AR720PS, B124E, B74E, B78E, B94E, B98E, B9SB2E, B9SB4E, B9V2E, B9V4E, BF78E, BF98E, BIE40, BIE40B, BIE60, BIE60B, BM74E, BM77E, BME40DM, BME40DMB, BME40M, BME60, BME602, BME60DM...(Other models you can see in the webshop) | | |


| | | | |
|---|---|-----------------|-----------|
| ø12mm | | | |
| with screw socket | | | |
|  | | | |
| 1 | | | |
| GEV No. | 359027 | Ref. No. | R65270230 |
| description | indicator light ø 12mm 250V green connection male faston 6.3mm | | |
| For models: | CVE004M, CVE104M, CVE105M, CVG105M, EC106M, EC110M, EC210M, EM010M+SC, EM106M, EM106M+SC, EM110M, EM110M+SC, EM210M, EM210M+SC, EV006M, EV106M, EV106M+SC, EV110M, EV110M+SC, EV210M, EV210M+SC, FE105M, FE105X, FE110M, FE110X, FE210M, FG105M, FG105X, FG110M, FG110X, FG210M, FG210X, GC106M, GC110M, GC210M, GM106M, GM106M+SC, GM110M, GM110M+SC, GM210M, GM210M+SC, GV106M, GV106M+SC, GV110M, GV110M+SC, GV210M, GV210M+SC, ME106M, ME106X, ME110M...(Other models you can see in the webshop) | | |


| | | | |
|---|---|-----------------|-----------|
|  | | | |
| 1 | | | |
| GEV No. | 359290 | Ref. No. | R65270220 |
| description | indicator light ø 12mm 400V yellow connection male faston 6.3mm | | |
| For models: | AC, AU04, AU05, AU08, AU10, AU20, CVE004M, CVE104M, CVE105M, CVG105M, EC106M, EC110M, EC210M, EM010M+SC, EM106M, EM106M+SC, EM110M, EM110M+SC, EM210M, EM210M+SC, EV006M, EV106M, EV106M+SC, EV110M, EV110M+SC, EV210M, EV210M+SC, FE105M, FE105X, FE110M, FE110X, FE210M, FG105M, FG105X, FG110M, FG110X, FG210M, FG210X, GC106M, GC110M, GC210M, GM106M, GM106M+SC, GM110M, GM110M+SC, GM210M, GM210M+SC, GV106M, GV106M+SC, GV110M...(Other models you can see in the webshop) | | |





| ø13mm | | | |
|---|---|-----------------|--|
| with plug-in socket | | | |
|  | | | |
| 1 | | | |
| GEV No. | 359142 | Ref. No. | 1819800 21016199 MA1819800 MA21016199 |
| description | indicator light ø 13mm green 230V connection male faston 6.3mm temp.-resist. 120°C Qty 1 pcs | | |
| For models: | B9SB2E, B9SB4E, B9V2E, B9V4E, B9VP2E, B9VP4E, BM74E, BM77E, BR707E, BR707EI, C7011E, C7011EFE, C7011EFEQ, C704E, C707E, C707EFE, C707EFEQ, C9F4E, C9F6E, C9V2E, C9V4E, F9V2E, F9V2ER, F9V4E, F9V4EC, F9V4ECR, F9V4ER, F9V4ERL, FC10E, FC10G, FC20E, FC20G, FC5E, FC5G, FC7E, FC7G, FR74E, FR74E10, FR77E, FR77E10, FR92E10, FR92E13, FR92E132, FR92E22, FR94E10, FR94E13, FR94E132, FR94E22, FR9P2E10, FR9P4E10...(Other models you can see in the webshop) | | |


| | | | |
|---|--|-----------------|--|
|  | | | |
| 2 | | | |
| GEV No. | 359143 | Ref. No. | 1819900 21016299 MA1819900 MA21016299 |
| description | indicator light ø 13mm yellow 230V connection male faston 6.3mm temp.-resist. 120°C Qty 1 pcs | | |
| For models: | B9SB2E, B9SB4E, B9V2E, B9V4E, B9VP2E, B9VP4E, BM74E, BM77E, BR707E, BR707EI, C7011EFE, C7011EFEQ, C707EFE, C707EFEQ, C9F4E, C9F6E, C9V2E, C9V4E, CP704E, CP92E, CP94E, CP95B2E, CP95B4E, F9V2E, F9V2ER, F9V4E, F9V4EC, F9V4ECR, F9V4ER, F9V4ERL, FC10E, FC10G, FC20E, FC20G, FC5E, FC5G, FC7E, FC7G, FP1E, FR74E, FR74E10, FR77E, FR77E10, FR92E10, FR92E13, FR92E132, FR92E22, FR94E10, FR94E13, FR94E132...(Other models you can see in the webshop) | | |


| ø16mm | | | |
|---|---|-----------------|-----------|
| with plug-in socket | | | |
|  | | | |
| 1 | | | |
| GEV No. | 359788 | Ref. No. | R65270160 |
| description | indicator light ø 16mm 230V green connection male faston 6.3mm | | |
| For models: | MACE04M, MACE05M, MACE07M, MACE10M, MACE20M, MACG05M, MACG07M, MACG10M, MACG20M, ME061M, ME101M, ME102M, ME201M, ME202M, MG061M, MG101M, MG102M, MG201M, MG202M | | |


| | | | |
|---|---|-----------------|-----------|
|  | | | |
| 1 | | | |
| GEV No. | 359789 | Ref. No. | R65270150 |
| description | indicator light ø 16mm 230V yellow connection male faston 6.3mm | | |
| For models: | MACE04M, MACE05M, MACE07M, MACE10M, MACE20M, MACG05M, MACG07M, MACG10M, MACG20M, ME061M, ME101M, ME102M, ME201M, ME202M, MG061M, MG101M, MG102M, MG201M, MG202M | | |


| 14x11mm | | | |
|---|---|-----------------|----------------------------|
|  | | | |
| 1 | | | |
| GEV No. | 359270 | Ref. No. | 1037036300 MA1037036300 |
| description | indicator light mounting measurements 14x11mm 230V green connection male faston 6.3mm | | |
| For models: | RIE40M, RIEP40M | | |


| 26.5x25.6mm | | | |
|---|---|-----------------|--------|
|  | | | |
| 1 | | | |
| GEV No. | 345853 | Ref. No. | 130168 |
| description | indicator light mounting measurements 27.8x25mm green 230V connection male faston 6.3mm | | |


| | | | |
|---|---|-----------------|--------|
|  | | | |
| 1 | | | |
| GEV No. | 345854 | Ref. No. | 130169 |
| description | indicator light mounting measurements 27.8x25mm green 230V connection male faston 6.3mm | | |

| | | | |
|---|---|-----------------|--------|
|  | | | |
| 1 | | | |
| GEV No. | 345855 | Ref. No. | 130152 |
| description | indicator light mounting measurements 27.8x25mm green 230V connection male faston 6.3mm temp.-resist. 125°C | | |

| | | | |
|---|--|-----------------|--------|
|  | | | |
| 1 | | | |
| GEV No. | 359012 | Ref. No. | 130136 |
| description | indicator light mounting measurements 27.8x25mm yellow 230V connection male faston 6.3mm | | |

| 30x11mm | | | |
|--|---|----------|---------|
|  <p>1</p> | | | |
| GEV No. | 359160 | Ref. No. | 1230300 |
| description | indicator light mounting measurements 30x11mm 230V green connection male faston 6.3mm rectangular temp.-resist. 125°C | | |
| For models: | B9SB2E, B9SB2G, B9SB4E, B9SB4G, B9V2E, B9V2G, B9V4E, B9V4G, F9V2E, F9V2ER, F9V4E, F9V4EC, F9V4ECR, F9V4ER, F9V4ERL, FR92E13, FR92E22, FR92G22, FR94E13, FR94E22, FR94G23, P9D10E, P9D15E, P9DA10E, P9DA15E, P9I10E, P9I10G, P9IA10E, P9IA10G, TP13E, TP17E, TP213E, TP217E, TP21E, TP221E | | |

|  <p>2</p> | | | |
|--|---|----------|--------|
| GEV No. | 359159 | Ref. No. | 912800 |
| description | indicator light mounting measurements 30x11mm 230V yellow connection male faston 6.3mm temp.-resist. 125°C | | |
| For models: | B9SB2E, B9SB2G, B9SB4E, B9SB4G, B9V2E, B9V2G, B9V4E, B9V4G, C9F4E, C9F6E, C9V2E, C9V4E, CB3, CB5, CD24, CP92E, CP94E, F9V2E, F9V2ER, F9V4E, F9V4EC, F9V4ECR, F9V4ER, F9V4ERL, FR92E13, FR92E22, FR92G22, FR94E13, FR94E22, FR94G23, P9D10E, P9D15E, P9DA10E, P9DA15E, P9I10E, P9I10G, P9IA10E, P9IA10G, TP13E, TP17E, TP213E, TP217E, TP21E, TP221E | | |

| 30x22mm | | | |
|--|--|----------|---------|
|  <p>1</p> | | | |
| GEV No. | 359164 | Ref. No. | 1314400 |
| description | indicator light mounting measurements 30x22mm 230V green/white connection male faston 6.3mm temp.-resist. 125°C | | |
| For models: | BR94E, BR94EI, BR94G, BR94GI, BR96E, BR96EI, BR96G, BR96GI, BR9M4E, BR9M4EI, BR9M4G, BR9M4GI, BR9M6E, BR9M6EI, BR9M6G, BR9M6GI, C9F6E, C9F6G6S | | |

screw-on/push-on fit

light bulbs

for ovens


|  <p>1</p> | | | |
|--|---|----------|----------------------|
| GEV No. | 359612 | Ref. No. | 2861900 MA2861900 |
| description | light bulb t.max. 300°C socket E14 25W 230V ø 25mm L 56mm lens L 30mm for oven lamp type Philips | | |
| For models: | CON102E, CON102EP, CON102G, CON102GP, CON201E, CON201EP, CON201G, CON201GP, CON202E, CON202EP, CON202G, CON202GP, CS102E, CS102EP, CS102G, CS102GP, CS10E, CS10EP, CS10G, CS6E, CS6EP, CS6G, CSM102E, CSM102EP, CSM102G, CSM102GP, CSM10E, CSM10EP, CSM10G, CSM10GP, CSM201E, CSM201EP, CSM201G, CSM201GP, CSM202E, CSM202EP, CSM202G, CSM202GP, CSM6E, CSM6EP, CSM6G, CSM6GP | | |

halogen lamp

for socket E14 / E27

|  <p>1</p> | | | |
|---|--|----------|----------------------|
| GEV No. | 359728 | Ref. No. | 4625800 MA4625800 |
| description | halogen lamp socket E14 230V 40W ø 25mm lens L 54mm L 80mm temp.-resist. 300°C Qty 1 | | |
| For models: | F140DF, F140DI, F140DN, F140DP, F143, F70DF, F70DI, F70DN, F70DP, F72, F7DFG, F7DNG, FB110F, FB110N, FB110P, FB140F, FB140FN, FB140N, FB140NN, FB140P, FB140PF, FB140PN, FB140PP, FB143NI, FB55F, FB55N, FB55P, FB70F, FB70N, FB70P, FB72F, FB72N, FB72NF, FB72P, FS140F, FS140FI, FS140FN, FS140I, FS140N, FS140NG, FS140NI, FS140NN, FS140P, FS140PN, FS140PP, FS143F, FS143FI, FS143N, FS143NF, FS143NI...(Other models you can see in the webshop) | | |



for socket G4 / G6.35 / G9

|  <p>1 500°C</p> | | | |
|--|--|----------|-----------|
| GEV No. | 359599 | Ref. No. | R65270020 |
| description | halogen lamp socket G4 12V 20W temp.-resist. 500°C | | |
| For models: | EC106M, EC110M, EC210M, EM010M+SC, EM106H, EM106M, EM106M+SC, EM106P, EM110H, EM110M, EM110M+SC, EM110P, EM210H, EM210M, EM210M+SC, EM210P, EV006M, EV106H, EV106M, EV106M+SC, EV106P, EV110H, EV110M, EV110M+SC, EV110P, EV210H, EV210M, EV210M+SC, EV210P, FE105X, FG105X, FG110X, FG210X, GC106M, GC110M, GC210M, GM106H, GM106M, GM106M+SC, GM106P, GM110H, GM110M, GM110M+SC, GM110P, GM210H, GM210M, GM210M+SC, GM210P, GMT06D, GMT20D...(Other models you can see in the webshop) | | |

oven lamps

universal oven lamps

mounting diameter 35.5mm

|  <p>1</p> | | | |
|---|--|----------|--|
| GEV No. | 359718 | Ref. No. | 1037300100 1037317000 MA1037300100 MA1037317000 |
| description | oven lamp mounting ø 35.5mm 230V 15W socket E14 temp.-resist. 300°C connection male faston 6.3mm hard glas | | |
| For models: | CFE60, CFE60P, CFGE60, CFGE61, CFGE61D, CFGE61L, CFGE61P, CFVE60, FOE60M, OCFE60, OCFGE61, OFOE60M | | |
| spare parts for | 359718 | | |
|  | | | |
| GEV No. | 359701 | Ref. No. | — |
| description | lamp socket socket E14 220-230V mounting ø 35.5mm connection male faston 6.3mm 15W | | |
|  | | | |
| GEV No. | 359740 | Ref. No. | — |
| description | light bulb t.max. 300°C socket E14 15W 230V ø 22mm L 48mm lens L 20mm for oven lamp IMPORT | | |

55x70mm



| | | | |
|--------------------|--|-----------------|-----------|
| GEV No. | 359375 | Ref. No. | R65270510 |
| description | lamp socket complete without lamp socket E14 mounting measurements 55x70mm | | |
| For models: | MACE04M, MACE05M, MACG05M, MVE042P, MVE051P, MVG051P | | |


55x100mm





| | | | |
|--------------------|---|-----------------|----------------------|
| GEV No. | 101372 | Ref. No. | 2862100 MA2862100 |
| description | oven lamp complete L 100mm W 55mm 230V 25W socket E14 rectangular temp.-resist. 300°C connection male faston 6.3mm | | |
| For models: | CON102E, CON102EP, CON102G, CON102GP, CON201E, CON201EP, CON201G, CON201GP, CON202E, CON202EP, CON202G, CON202GP, CS102E, CS102EP, CS102G, CS102GP, CS10E, CS10EP, CS10G, CS6E, CS6EP, CS6G, CSM102E, CSM102EP, CSM102G, CSM102GP, CSM10E, CSM10EP, CSM10G, CSM10GP, CSM201E, CSM201EP, CSM201G, CSM201GP, CSM202E, CSM202EP, CSM202G, CSM202GP, CSM6E, CSM6EP, CSM6G, CSM6GP | | |


spare parts for 101372

| | | | | |
|---|--------------------|--|-----------------|----------------------|
|  | GEV No. | 359612 | Ref. No. | 2861900 MA2861900 |
| | description | light bulb t.max. 300°C socket E14 25W 230V ø 25mm L 56mm lens L 30mm for oven lamp type Philips | | |

| | | | | |
|---|--------------------|--|-----------------|---|
|  | GEV No. | 359698 | Ref. No. | — |
| | description | lamp socket L 100mm W 55mm socket E14 connection male faston 6.3mm | | |

| | | | | |
|---|--------------------|------------------------|-----------------|---|
|  | GEV No. | 359714 | Ref. No. | — |
| | description | gasket for bulb socket | | |

| | | | | |
|---|--------------------|---|-----------------|---|
|  | GEV No. | 359715 | Ref. No. | — |
| | description | lamp glass L 110mm W 65mm thickness 5mm | | |

| | | | | |
|---|--------------------|-----------------------|-----------------|---|
|  | GEV No. | 359716 | Ref. No. | — |
| | description | frame for bulb socket | | |

lamps

light bulbs



| | | | |
|--------------------|---|-----------------|----------------------|
| GEV No. | 359612 | Ref. No. | 2861900 MA2861900 |
| description | light bulb t.max. 300°C socket E14 25W 230V ø 25mm L 56mm lens L 30mm for oven lamp type Philips | | |
| For models: | CON102E, CON102EP, CON102G, CON102GP, CON201E, CON201EP, CON201G, CON201GP, CON202E, CON202EP, CON202G, CON202GP, CS102E, CS102EP, CS102G, CS102GP, CS10E, CS10EP, CS10G, CS6E, CS6EP, CS6G, CSM102E, CSM102EP, CSM102G, CSM102GP, CSM10E, CSM10EP, CSM10G, CSM10GP, CSM201E, CSM201EP, CSM201G, CSM201GP, CSM202E, CSM202EP, CSM202G, CSM202GP, CSM6E, CSM6EP, CSM6G, CSM6GP | | |

halogen lamps

for socket E14 / E27



| | | | |
|--------------------|--|-----------------|----------------------|
| GEV No. | 359728 | Ref. No. | 4625800 MA4625800 |
| description | halogen lamp socket E14 230V 40W ø 25mm lens L 54mm L 80mm temp.-resist. 300°C Qty 1 | | |
| For models: | F140DF, F140DI, F140DN, F140DP, F143, F70DF, F70DI, F70DN, F70DP, F72, F7DFG, F7DNG, FB110F, FB110N, FB110P, FB140F, FB140FN, FB140N, FB140NN, FB140P, FB140PF, FB140PN, FB140PP, FB143NI, FB55F, FB55N, FB55P, FB70F, FB70N, FB70P, FB72F, FB72N, FB72NF, FB72P, FS140F, FS140FI, FS140FN, FS140I, FS140N, FS140NG, FS140NI, FS140NN, FS140P, FS140PN, FS140PP, FS143F, FS143FI, FS143N, FS143NF, FS143NI...(Other models you can see in the webshop) | | |


for socket G4 / G6.35 / G9



| | | | |
|--------------------|--|-----------------|-----------|
| GEV No. | 359599 | Ref. No. | R65270020 |
| description | halogen lamp socket G4 12V 20W temp.-resist. 500°C | | |
| For models: | EC106M, EC110M, EC210M, EM010M+SC, EM106H, EM106M, EM106M+SC, EM106P, EM110H, EM110M, EM110M+SC, EM110P, EM210H, EM210M, EM210M+SC, EM210P, EV006M, EV106H, EV106M, EV106M+SC, EV106P, EV110H, EV110M, EV110M+SC, EV110P, EV210H, EV210M, EV210M+SC, EV210P, FE105X, FG105X, FG110X, FG210X, GC106M, GC110M, GC210M, GM106H, GM106M, GM106M+SC, GM106P, GM110H, GM110M, GM110M+SC, GM110P, GM210H, GM210M, GM210M+SC, GM210P, GMT06D, GMT20D...(Other models you can see in the webshop) | | |




residual heat indicators



1

| | | | |
|--------------------|--|-----------------|----------------------------|
| GEV No. | 359326 | Ref. No. | 1037309400 MA1037309400 |
| description | residual heat indicator 4-fold | | |
| For models: | CFVE60, PCVE40, PCVE40D, PCVE40DB, PCVE60, PCVE60D, PCVE60DB, V74EC, V76EC, V94E, V98E | | |




1

| | | | |
|--------------------|--|-----------------|----------------------------|
| GEV No. | 359327 | Ref. No. | 1037309310 MA1037309310 |
| description | residual heat indicator single | | |
| For models: | PCVE40, PCVE40D, PCVE40DB, PCVE60, PCVE60D, PCVE60DB | | |


timers

programme timers




1

| | | | |
|--------------------|---|-----------------|-----------|
| GEV No. | 403577 | Ref. No. | R65095000 |
| description | gear motor CDC 4901F1 engines 1 chambers 1 operation time 20s 230V 50Hz shaft ø 6x4.6mm shaft L 24mm | | |
| For models: | ME061P, ME061T, ME101P, ME101T, ME102P, ME102T, ME106P, ME110P, ME120P, ME201P, ME201T, ME202P, ME202T, ME210P, ME220P, MEC24H, MEMT06P, MEMT10P, MEMT20P, MEMT21P, MEMT40P, MEVT06P, MEVT10P, MEVT20P, MEVT21P, MEVT40P, MG061P, MG061T, MG101P, MG101T, MG102P, MG102T, MG106P, MG110P, MG120P, MG201P, MG201T, MG202P, MG202T, MG210P, MG220P, MGC24H, MGC40H, MGMT06P, MGMT10P, MGMT20P, MGMT21P, MGMT40P, MGVT06P, MGVT10P...(Other models you can see in the webshop) | | |




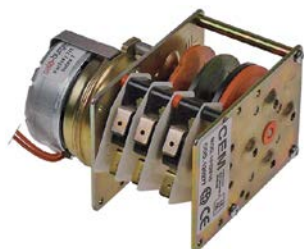
1

| | | | |
|--------------------|--|-----------------|-----------|
| GEV No. | 360752 | Ref. No. | R65090190 |
| description | timer CDC 4902F1 engines 1 chambers 2 operation time 8min 230V shaft ømm shaft Lmm | | |
| For models: | CVE004M, CVE104M, CVE105M, CVG105M, EC106M, EC110M, EC210M, EM010M+SC, EM106M, EM106M+SC, EM110M, EM110M+SC, EM210M, EM210M+SC, EV006M, EV106M, EV106M+SC, EV110M, EV110M+SC, EV210M, EV210M+SC, FE105M, FE105X, FE110M, FE110X, FE210M, FG105M, FG105X, FG110M, FG110X, FG210M, FG210X, GC106M, GC110M, GC210M, GM106M, GM106M+SC, GM110M, GM110M+SC, GM210M, GM210M+SC, GV106M, GV106M+SC, GV110M, GV110M+SC, GV210M, GV210M+SC, MACE04M, MACE05M, MACE07M...(Other models you can see in the webshop) | | |





1

| | | | |
|---|--|-----------------|-------------------|
| GEV No. | 360047 | Ref. No. | 120268 |
| description | timer CDC 4905DV engines 2 chambers 5 operation time 4s / 150s 230V shaft ømm shaft Lmm manif. no. 4905DV / 360047 motor type M48L ATS | | |
| spare parts for | 360047 | | |
|  | GEV No. | 360083 | Ref. No. — |
| | motor CDC pinion ø 4.9mm teeth 10 230V turn direction left motor ø 47mm H 19.3mm motor type M48L ATS for timer | | |





1

| | | | |
|---|--|-----------------|-------------------|
| GEV No. | 360080 | Ref. No. | 120277 |
| description | timer CEM HH3M16 engines 1 chambers 3 operation time 20min 230V manif. no. HH3M16 / 120277 motor type UDS11NE1RH | | |
| spare parts for | 360080 | | |
|  | GEV No. | 360112 | Ref. No. — |
| | motor SAIA pinion ø 4mm teeth 12 230V turn direction right motor ø 48mm motor type UDS11NE1RHZ for timer | | |





1

| | | | |
|---|---|-----------------|-------------------|
| GEV No. | 360043 | Ref. No. | 120262 |
| description | timer CEM HH4M16 engines 1 chambers 4 operation time 120s 230V shaft ømm shaft Lmm manif. no. HH4M16 / 120262 motor type UDS11NE1RH | | |
| spare parts for | 360043 | | |
|  | GEV No. | 360112 | Ref. No. — |
| | motor SAIA pinion ø 4mm teeth 12 230V turn direction right motor ø 48mm motor type UDS11NE1RHZ for timer | | |





1

| | | | |
|---|---|-----------------|-------------------|
| GEV No. | 360044 | Ref. No. | 120263 |
| description | timer CEM HH4M16 engines 1 chambers 4 operation time 150s 230V shaft ømm shaft Lmm manif. no. HH4M16 / 120263 motor type UDS11NE1RH | | |
| spare parts for | 360044 | | |
|  | GEV No. | 360112 | Ref. No. — |
| | motor SAIA pinion ø 4mm teeth 12 230V turn direction right motor ø 48mm motor type UDS11NE1RHZ for timer | | |





1

| | | | |
|---|--|-----------------|----------------------|
| GEV No. | 360332 | Ref. No. | 2971200 MA2971200 |
| description | timer FIBER P25 engines 1 chambers 3 operation time 60s 230V shaft ømm shaft Lmm manif. no. P255J01H191 motor type M51BJ0R6400 | | |
| For models: | CON102E, CON102EP, CON102G, CON102GP, CON10E, CON10EP, CON10G, CON10GP, CON6E, CON6EP, CON6G, CON6GP, CS102E, CS102EP, CS102G, CS102GP | | |
| spare parts for | 360332 | | |
|  | GEV No. | 360673 | Ref. No. — |
| | motor kit pinion ø 6.8mm teeth 15 230V voltage AC 50/60Hz turn direction clockwise motor ø 48mm H 18.5mm motor type UDS-40NE1RNZ165 cable length 150mm with holder | | |




1

| | | | |
|---|--|-----------------|----------------------|
| GEV No. | 350034 | Ref. No. | 5151700 MA5151700 |
| description | timer FIBER P25 engines 1 chambers 1 operation time 60s 24V shaft ømm shaft Lmm manif. no. P255201H191 motor type M51B20R6400 voltage AC | | |
| For models: | CON201E, CON201EP, CON201G, CON201GP, CON202E, CON202EP, CON202G, CON202GP, CSM102E, CSM102EP, CSM102G, CSM102GP, CSM10E, CSM10EP, CSM10G, CSM10GP, CSM201E, CSM201EP, CSM201G, CSM201GP, CSM202E, CSM202EP, CSM202G, CSM202GP, CSM6E, CSM6EP, CSM6G, CSM6GP | | |
| spare parts for | 350034 | | |
|  | GEV No. | 360675 | Ref. No. — |
| | motor kit pinion ø 6.8mm teeth 15 24V voltage AC 50/60Hz turn direction clockwise motor ø 48mm H 18.5mm motor type UDS-40NE1RNZ165 cable length 150mm with holder | | |



1

| | | | |
|---|--|-----------------|----------------------|
| GEV No. | 360331 | Ref. No. | 2971100 MA2971100 |
| description | timer FIBER P25 engines 1 chambers 3 operation time 60min 230V shaft ø 6x4.6mm shaft L 20mm manif. no. P255J03W190 motor type M51BJ0L6400 impulse electric | | |
| For models: | CON102E, CON102EP, CON102G, CON102GP, CON10E, CON10EP, CON10G, CON10GP, CON201E, CON201EP, CON201G, CON201GP, CON202E, CON202EP, CON202G, CON202GP, CON6E, CON6EP, CON6G, CON6GP, CP9A15GD, CS102E, CS102EP, CS102G, CS102GP | | |
| spare parts for | 360331 | | |
|  | GEV No. | 360674 | Ref. No. — |
| | motor kit pinion ø 6.8mm teeth 15 230V voltage AC 50/60Hz turn direction counterclockwise motor ø 48mm H 18.5mm motor type UDS40NE1RNZ165 cable length 150mm with holder | | |






1




| | | | |
|--------------------|--|-----------------|----------------------|
| GEV No. | 350033 | Ref. No. | 5151600 MA5151600 |
| description | timer FIBER P25 engines 1 chambers 3 operation time 60min 24V shaft ø 6x4.6mm shaft L 20mm manuf. no. P255203W190 motor type M51B20L6400 impulse electric | | |
| For models: | CP9A15GD, CSM102E, CSM102EP, CSM102G, CSM102GP, CSM10E, CSM10EP, CSM10G, CSM10GP, CSM201, CSM201E, CSM201EP, CSM201G, CSM201GP, CSM202, CSM202E, CSM202EP, CSM202G, CSM202GP, CSM6E, CSM6EP, CSM6G, CSM6GP | | |


1




| | | | |
|---|--|-----------------|-------------------|
| GEV No. | 360287 | Ref. No. | 121218 |
| description | timer FIBER P25 engines 2 chambers 6 operation time 6s / 3min 230V shaft ømm shaft Lmm manuf. no. P255J06JBG6 motor type M51B-J0R6400 / M51BJ0L6400 | | |
| spare parts for | 360287 | | |
|  | GEV No. | 360673 | Ref. No. — |
| | motor kit pinion ø 6.8mm teeth 15 230V voltage AC 50/60Hz turn direction clockwise motor ø 48mm H 18.5mm motor type UDS-40NE1RNZ165 cable length 150mm with holder | | |
|  | GEV No. | 360674 | Ref. No. — |
| | motor kit pinion ø 6.8mm teeth 15 230V voltage AC 50/60Hz turn direction counterclockwise motor ø 48mm H 18.5mm motor type UDS40NE1RNZ165 cable length 150mm with holder | | |

2




| | | | |
|---|--|-----------------|-------------------|
| GEV No. | 360120 | Ref. No. | 1037303000 |
| description | timer FIBER P25 engines 1 chambers 5 operation time 180s 230V shaft ø 6x4.6mm shaft L 40mm manuf. no. P255J05H542 motor type M51BJ0R6400 for devices with electric dosing pump edition until year of construction 2000 | | |
| For models: | DLS30, DLS303, DLS30P3, DLS31, DLS313, DLS31P3, MLS30, MLS303, MLS30P, MLS30P3, MLS31, MLS313, MLS31P3, MLS35, MLS353, MPLS30P | | |
| spare parts for | 360120 | | |
|  | GEV No. | 360673 | Ref. No. — |
| | motor kit pinion ø 6.8mm teeth 15 230V voltage AC 50/60Hz turn direction clockwise motor ø 48mm H 18.5mm motor type UDS-40NE1RNZ165 cable length 150mm with holder | | |



1




| | | | |
|--------------------|---|-----------------|------------|
| GEV No. | 360398 | Ref. No. | 1037318000 |
| description | timer FIBER P25 engines 2 chambers 7 operation time 12s / 2min 230V shaft ømm shaft Lmm manuf. no. P255J07JGJ7 motor type M51BJ0R6400 / M51BJ0L6400 | | |
| For models: | MLC65, MLC653 | | |



1




| | | | |
|---|--|-----------------|-------------------|
| GEV No. | 360050 | Ref. No. | 120275 |
| description | timer FIBER P25 engines 2 chambers 6 operation time 6s / 3min 230V 50/60Hz shaft ømm shaft Lmm manuf. no. P255J06JB61 motor type M51BJ0R6400 / M51BJ0L6400 | | |
| spare parts for | 360050 | | |
|  | GEV No. | 360673 | Ref. No. — |
| | motor kit pinion ø 6.8mm teeth 15 230V voltage AC 50/60Hz turn direction clockwise motor ø 48mm H 18.5mm motor type UDS-40NE1RNZ165 cable length 150mm with holder | | |
|  | GEV No. | 360674 | Ref. No. — |
| | motor kit pinion ø 6.8mm teeth 15 230V voltage AC 50/60Hz turn direction counterclockwise motor ø 48mm H 18.5mm motor type UDS40NE1RNZ165 cable length 150mm with holder | | |



1




| | | | |
|---|--|-----------------|-------------------|
| GEV No. | 360122 | Ref. No. | 1037307600 |
| description | timer FIBER P25 engines 2 chambers 8 operation time 12s / 2min 230V shaft ømm shaft Lmm manuf. no. P255J08JG75 motor type M51BJ0R6400 / M51BJ0L6400 | | |
| For models: | MLC65, MLC653 | | |
| spare parts for | 360122 | | |
|  | GEV No. | 360673 | Ref. No. — |
| | motor kit pinion ø 6.8mm teeth 15 230V voltage AC 50/60Hz turn direction clockwise motor ø 48mm H 18.5mm motor type UDS-40NE1RNZ165 cable length 150mm with holder | | |
|  | GEV No. | 360674 | Ref. No. — |
| | motor kit pinion ø 6.8mm teeth 15 230V voltage AC 50/60Hz turn direction counterclockwise motor ø 48mm H 18.5mm motor type UDS40NE1RNZ165 cable length 150mm with holder | | |



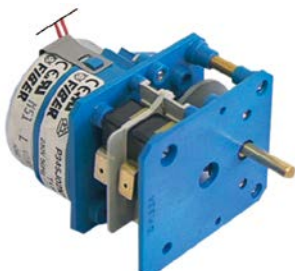
1

| | | | |
|---|--|-----------------|-------------------|
| GEV No. | 360121 | Ref. No. | 1037307500 |
| description | timer FIBER P25 engines 2 chambers 8 operation time 40s / 120s 230V shaft ø6mm shaft Lmm manif. no. P255J08JH76 motor type M51BJ0R6400 / M51BJ0L6400 | | |
| For models: | MLC50, MLC503 | | |
| spare parts for | 360121 | | |
|  | GEV No. | 360673 | Ref. No. — |
| | motor kit pinion ø 6.8mm teeth 15 230V voltage AC 50/60Hz turn direction clockwise motor ø 48mm H 18.5mm motor type UDS-40NE1RNZ165 cable length 150mm with holder | | |
|  | GEV No. | 360674 | Ref. No. — |
| | motor kit pinion ø 6.8mm teeth 15 230V voltage AC 50/60Hz turn direction counterclockwise motor ø 48mm H 18.5mm motor type UDS40NE1RNZ165 cable length 150mm with holder | | |




1


| | | | |
|--------------------|--|-----------------|--------|
| GEV No. | 360041 | Ref. No. | 120290 |
| description | timer FIBER P26 engines 1 chambers 3 operation time 120s 230V shaft ø6mm shaft Lmm manif. no. P265J03H322 motor type M61B40R6400 / M61B40L6400 | | |



1

| | | | |
|---|---|-----------------|-------------------|
| GEV No. | 350038 | Ref. No. | R65090020 |
| description | timer FIBER P34 engines 1 chambers 2 operation time 144min 230V shaft ø 6x4.6mm shaft L 20mm manif. no. P345J02N765 motor type M51BJ0L6400 impulse electric | | |
| For models: | EC106M, EC110M, EC210M, FE105M, FE105X, FE110M, FE110X, FE210M, FG105M, FG105X, FG110M, FG110X, FG210M, FG210X, GC106M, GC110M, GC210M, MACE04M, MACE05M, MACE07M, MACE10M, MACE20M, MACG05M, MACG07M, MACG10M, MACG20M, PE040M, PE040X, PE080M, PE080X, PG040M, PG040X, PG080M, PG080X | | |
| spare parts for | 350038 | | |
|  | GEV No. | 360674 | Ref. No. — |
| | motor kit pinion ø 6.8mm teeth 15 230V voltage AC 50/60Hz turn direction counterclockwise motor ø 48mm H 18.5mm motor type UDS40NE1RNZ165 cable length 150mm with holder | | |

digital timers



1

| | | | |
|--------------------|------------------|-----------------|--------|
| GEV No. | 400946 | Ref. No. | 120254 |
| description | timer electronic | | |

mechanical timers



1

| | | | |
|---|---|-----------------|---------------------------------|
| GEV No. | 350003 | Ref. No. | 2709900 2812300 MA2709900 |
| description | timer M2 with bell 2-pole operation time 120min impulse mechanical 2NO at 250V 16A permanent position no shaft ø 6x4.6mm shaft 6x4.6mm shaft L 23mm mounting distance 28mm connection lateral | | |
| For models: | FC10E, FC10G, FC20E, FC20G, FC5E, FC5G, FC7E, FC7G | | |
| accessories for | 350003 | | |
|  | GEV No. | 110366 | Ref. No. — |
| | knob switch zero mark t.max. °C ø 44mm shaft ø 6x4.6mm shaft flat upper black | | |
|  | GEV No. | 111199 | Ref. No. — |
| | dial plate graduation 120min permanent position no rotation 0-330° ø 60mm timers knob ø 45mm | | |




1

| | | | |
|---|---|-----------------|----------------------------|
| GEV No. | 350049 | Ref. No. | 1037103400 MA1037103400 |
| description | timer M2 with bell 2-pole operation time 30min impulse mechanical 2NO at 250V 16A permanent position yes shaft ø 6x4.6mm shaft 6x4.6mm shaft L 23mm mounting distance 28mm connection lateral | | |
| For models: | SPE60M, SPW60M | | |
| accessories for | 350049 | | |
|  | GEV No. | 110366 | Ref. No. — |
| | knob switch zero mark t.max. °C ø 44mm shaft ø 6x4.6mm shaft flat upper black | | |
|  | GEV No. | 111205 | Ref. No. — |
| | dial plate graduation 30min permanent position yes rotation 30-300° ø 60mm | | |




audible timers


| | | | |
|--|---|-----------------|---------------------------------------|
|  <p>1</p> | | | |
| GEV No. | 350036 | Ref. No. | 1031006400 2600200 MA1031006400 |
| description | audible timer operation time 60min ø 55mm shaft ø 6x4.6mm shaft L 22mm mounting distance 28mm | | |
| For models: | CFE60, CFE60P, CFGE60, CFGE61, CFGE61D, CFGE61L, CFGE61P, CFVE60, FOE60M, FV4E, FV4E1, OCFE60, OCFGE61, OFOE60M | | |


alarm devices


alarm units

| | | | |
|--|--|-----------------|-----------|
|  <p>1</p> | | | |
| GEV No. | 350081 | Ref. No. | R65330020 |
| description | alarm device 9-15VDC H 14.5mm wall-mounted version 75dB protection IPx0 | | |
| For models: | EM106H, EM106P, EM110H, EM110P, EM210H, EM210P, EV106H, EV106P, EV110H, EV110P, EV210H, EV210P, GM106H, GM106P, GM110H, GM110P, GM210H, GM210P, GV106H, GV106P, GV110H, GV110P, GV210H, GV210P | | |


buzzer boards

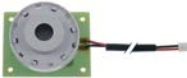
| | | | |
|--|---|-----------------|----------------------|
|  <p>1</p> | | | |
| GEV No. | 350078 | Ref. No. | 2864400 MA2864400 |
| description | buzzer board | | |
| For models: | CON102E, CON102EP, CON102G, CON102GP, CON10E, CON10EP, CON10G, CON10GP, CON6E, CON6EP, CON6G, CON6GP, CP9A15GD, CS102E, CS102EP, CS102G, CS102GP, CS10E, CS10EP, CS10G, CS6E, CS6EP, CS6G | | |


| | | | |
|--|--|-----------------|----------------------|
|  <p>1</p> | | | |
| GEV No. | 350079 | Ref. No. | 5152000 MA5152000 |
| description | buzzer board | | |
| For models: | CON201E, CON201EP, CON201G, CON201GP, CON202E, CON202EP, CON202G, CON202GP, CSM102E, CSM102EP, CSM102G, CSM102GP, CSM10E, CSM10EP, CSM10G, CSM10GP, CSM201E, CSM201EP, CSM201G, CSM201GP, CSM202E, CSM202EP, CSM202G, CSM202GP, CSM6E, CSM6EP, CSM6G, CSM6GP | | |

| | | | |
|---|--|-----------------|-----------|
|  <p>1</p> | | | |
| GEV No. | 400143 | Ref. No. | R65300670 |
| description | buzzer board | | |
| For models: | ME106P, ME110P, ME120P, ME210P, ME220P, MG106P, MG110P, MG120P, MG210P, MG220P, VE106P, VE120P, VE210P, VE220P, VG106P, VG110P, VG120P, VG210P, VG220P | | |

buzzers

| | | | |
|---|--|-----------------|-----------|
|  <p>1</p> | | | |
| GEV No. | 350055 | Ref. No. | R65330040 |
| description | buzzer 12VDC connection cable 200mm PCB buzzer 20dB | | |
| For models: | CVE004H, CVE104H, CVE105H, CVG105H, ME106P, ME110P, ME120P, ME210P, ME220P, MEC24H, MG106P, MG110P, MG120P, MG210P, MG220P, MGC24H, MGC40H, VE106P, VE120P, VE210P, VE220P, VG106P, VG110P, VG120P, VG210P, VG220P | | |

| | | | |
|---|--|-----------------|-----------------------|
|  <p>1</p> | | | |
| GEV No. | 350086 | Ref. No. | R65301440 RA919008 |
| description | buzzer 12VDC connection cable 200mm PCB buzzer 20dB | | |
| For models: | DP018T, DP112T, DPC20T, DPC40T, DX018T, DX110T, DX112T, DXC20T, DXC40T, GMT06D, GMT20D, GVT06D, GVT20D, MDP112T, MDPC20T, MDPC40T, MDX112T, MDXC20T, MDXC40T, ME061D, ME061P, ME061T, ME101D, ME101P, ME101T, ME102D, ME102P, ME102T, ME201D, ME201P, ME201T, ME202D, ME202P, ME202T, MEMT06D, MEMT06P, MEMT10D, MEMT10P, MEMT20D, MEMT20P, MEMT21D, MEMT21P, MEMT40D, MEMT40P, MEVT06D, MEVT06P, MEVT10D, MEVT10P, MEVT20D, MEVT20P...(Other models you can see in the webshop) | | |


| | | | |
|---|--|-----------------|-----------|
|  <p>1</p> | | | |
| GEV No. | 350050 | Ref. No. | R65330010 |
| description | buzzer 230VAC connection male faston 6.3mm screw mounting thread M4 60dB | | |
| For models: | CVE004M, CVE104M, CVE105M, CVG105M, EC106M, EC110M, EC210M, EM010M+SC, EM106M, EM106M+SC, EM110M, EM110M+SC, EM210M, EM210M+SC, EV006M, EV106M, EV106M+SC, EV110M, EV110M+SC, EV210M, EV210M+SC, FE105M, FE105X, FE110M, FE110X, FE210M, FG105M, FG105X, FG110M, FG110X, FG210M, FG210X, GC106M, GC110M, GC210M, GM106M, GM106M+SC, GM110M, GM110M+SC, GM210M, GM210M+SC, GV106M, GV106M+SC, GV110M, GV110M+SC, GV210M, GV210M+SC, MACE04M, MACE05M, MACE07M...(Other models you can see in the webshop) | | |



contactors

GENERAL ELECTRIC (AEG)

power contactors




1

| | | | |
|--------------------|---|-----------------|--------|
| GEV No. | 380248 | Ref. No. | 120429 |
| description | power contactor resistive load 25A 24VAC (AC3/400V) 9A/4kW main contacts 3NO auxiliary contacts 1NO connection screw connection type AEG LS4K 10A type GE CL00A 310 | | |

LOVATO

power contactors




1



| | | | |
|--------------------|--|-----------------|--------|
| GEV No. | 380083 | Ref. No. | 120444 |
| description | power contactor resistive load 25A 230VAC (AC3/400V) 9A/4.2kW main contacts 3NO auxiliary contacts 1NC connection screw connection type BF0901A230 | | |





MOELLER/EATON


power contactors



1

| | | | |
|---|--|-----------------|-------------------|
| GEV No. | 380550 | Ref. No. | R65140550 |
| description | power contactor resistive load 20A 230VAC (AC3/400V) 9A/4kW main contacts 3NO auxiliary contacts 1NC connection screw connection type DILM9 01 | | |
| For models: | GMT06D, GVT06D, MACE04M, MACE05M, MACE07M, MACE10M, MACE20M, MACG07M, MACG10M, MACG20M, MEMT06D, MEMT06P, MEMT10D, MEMT10P, MEVT06D, MEVT06P, MEVT10D, MEVT10P, MGMT06D, MGMT06P, MGMT10D, MGMT10P, MGVT06D, MGVT06P, MGVT10D, MGVT10P, MVE042P, MVE051P | | |
| accessories for | 380550 | | |
|  | GEV No. | 380555 | Ref. No. — |
| | auxiliary contact contacts 2NO/2NC AC15 16A for contactors DILEM connection screw type DILA-XHI22 | | |
|  | GEV No. | 380556 | Ref. No. — |
| | auxiliary contact contacts 4NO AC15 16A for contactors DILM 7-32 connection screw type DILA-XHI40 | | |

| | | | |
|---|---|--------|-------------------|
| accessories for | 380550 | | |
|  | GEV No. | 380557 | Ref. No. — |
| | auxiliary contact contacts 4NC AC15 16A for contactors DILM 7-32 connection screw type DILA-XHI04 | | |
|  | GEV No. | 380558 | Ref. No. — |
| | auxiliary contact contacts 3NO/1NC AC15 16A for contactors DILM 7-32 connection screw type DILA-XHI31 | | |
|  | GEV No. | 380559 | Ref. No. — |
| | auxiliary contact contacts 1NO/3NC AC15 16A for contactors DILM 7-32 connection screw type DILA-XHI13 | | |
|  | GEV No. | 380568 | Ref. No. — |
| | RC circuit suitable for DILM 9-12 rated 110-240V | | |



1

| | | | |
|--------------------|---|-----------------|-----------|
| GEV No. | 381005 | Ref. No. | R65140560 |
| description | power contactor resistive load 35A 230VAC (AC3/400V) 17A/7.5kW main contacts 3NO auxiliary contacts 1NC connection screw connection type DILM 17-01 | | |
| For models: | MACE10M, MACE20M, MEMT10D, MEMT10P, MEVT10D, MEVT10P | | |


overload switches



1

| | | | |
|--------------------|---|-----------------|-----------|
| GEV No. | 381006 | Ref. No. | R65160420 |
| description | overload switch connection screw setting range 1-1.6A type ZB12 | | |
| For models: | MACE10M, MACE20M, MEMT10D, MEVT10D | | |

auxiliary contacts




1

| | | | |
|--------------------|--|-----------------|-----------|
| GEV No. | 380565 | Ref. No. | R65140600 |
| description | auxiliary contact contacts 1NO/1NC AC15 10A for contactors DIL 17-32 connection screw type DILM 32-CHI11-S | | |
| For models: | MEMT10D, MEMT10P, MEVT10D, MEVT10P | | |




SIEMENS

power contactors




1

| | | | |
|--------------------|---|-----------------|-----------|
| GEV No. | 380645 | Ref. No. | R65140240 |
| description | power contactor 230VAC with auxiliary contacts | | |
| For models: | EC110M, EC210M, EM010M+SC, EM110H, EM110M, EM110M+SC, EM110P, EM210H, EM210M, EM210M+SC, EM210P, EV110H, EV110M, EV110M+SC, EV110P, EV210H, EV210M, EV210M+SC, EV210P, FE110M, FE110X, ME110M, ME110P, ME110X, ME120M, ME120P, ME120X, ME210M, ME210P, ME210X, ME220M, ME220P, ME220X, MEC24H, MEC40M, PE080M, PE080X, VE110M, VE110X, VE120M, VE120P, VE120X, VE210M, VE210P, VE210X, VE220M, VE220P, VE220X | | |



1

| | | | |
|--------------------|--|-----------------|------------------------|
| GEV No. | 381387 | Ref. No. | CM187301 MACM187301 |
| description | power contactor resistive load 22A 230VAC (AC3/400V) 4kW main contacts 3NO auxiliary contacts 1NO connection screw connection type 3RT2016-1AP01 | | |




1

| | | | |
|--------------------|--|-----------------|-----------|
| GEV No. | 380652 | Ref. No. | R65140380 |
| description | power contactor resistive load 22A 230VAC (AC3/400V) 9A/4kW main contacts 3NO auxiliary contacts 1NC connection screw connection type 3RT10-16-1AP02 | | |
| For models: | GMT20D, GVT20D, ME061D, ME061M, ME061P, ME061T, ME101D, ME101M, ME101P, ME101T, ME102D, ME102M, ME102P, ME102T, ME201D, ME201M, ME201P, ME201T, ME202D, ME202M, ME202P, ME202T, MEMT20D, MEMT20P, MEMT21D, MEMT21P, MEMT40D, MEMT40P, MEVT20D, MEVT20P, MEVT21D, MEVT21P, MEVT40D, MEVT40P, MG061D, MG061M, MG061P, MG061T, MG101D, MG101M, MG101P, MG101T, MG102D, MG102M, MG102P, MG102T, MG201D, MG201M, MG201P, MG201T...(Other models you can see in the webshop) | | |




1

| | | | |
|--------------------|---|-----------------|--|
| GEV No. | 380389 | Ref. No. | 1037104800 21450299 21453199 CM187300 MACM187300 |
| description | power contactor resistive load 22A 230VAC (AC3/400V) 9A/4kW main contacts 3NO auxiliary contacts 1NO connection screw connection type 3RT10-16-1AP01 | | |
| For models: | AF140MB, AF140MC, AF140MF, AF140MI, AF140MN, AF140MP, AF70MB, AF70MC, AF70MF, AF70MI, AF70MN, AF70MP, BR707E, BR707EI, BR78EF, BR78EI, BR912EFM, BR912EIM, BR94E, BR94EI, BR98EF, BR98EFM, BR98EI, BR98EIM, BR9M4E, BR9M4EI, BR9M6E, BR9M6EI, BR9S8EF, BR9S8EI, BR9SB4E, BR9SB4EI, CON102E, CON102EP, CON102G, CON102GP, CON10E, CON10EP, CON10G, CON10GP, CON6E, CON6EP, CON6G, CON6GP, CP704E, CP92E, CP92E2, CP94E, CP94E2, CP9SB2E... | | |




1

| | | | |
|--------------------|--|-----------------|--|
| GEV No. | 380390 | Ref. No. | 21407999 21452399 21453599 CM187400 CM187401 MACM187400 MACM187401 |
| description | power contactor resistive load 40A 230VAC (AC3/400V) 12A/5.5kW main contacts 3NO auxiliary contacts connection screw connection type 3RT10-24-1AL20 50/60Hz | | |
| For models: | BR78EF, BR78EI, BR912EFM, BR912EIM, BR94E, BR94EI, BR98EF, BR98EFM, BR98EI, BR98EIM, BR9M4E, BR9M4EI, BR9M6E, BR9M6EI, BR9S8EF, BR9S8EI, BR9SB4E, BR9SB4EI, CON102E, CON102EP, CON10E, CON10EP, CON201E, CON201EP, CS10E, CS10EP, F74E12, F78E12, F94E12, F94E18, F94E18K, F98E12, F98E18, F98E18K, F9S4E12, F9S4E18, F9S4E18K, F9S8E12, F9S8E18, F9S8E18K, FC7E, FR92E13, FR92E132, FR92E13T, FR92E13T2, FR92E22, FR92E22T, FR94E13, FR94E132, FR94E13T...(Other models you can see in the webshop) | | |



1


| | | | |
|--------------------|--|-----------------|-----------|
| GEV No. | 380646 | Ref. No. | R65140400 |
| description | power contactor resistive load 40A 230VAC (AC3/400V) 17A/7.5kW main contacts 3NO auxiliary contacts connection screw connection type 3RT10-25-1AL20 | | |
| For models: | ME101D, ME101M, ME101P, ME101T, ME102D, ME102M, ME102P, ME102T, ME201D, ME201M, ME201P, ME201T, ME202D, ME202M, ME202P, ME202T, MEMENT20D, MEMENT20P, MEMENT21D, MEMENT21P, MEMENT40D, MEMENT40P, MEVT20D, MEVT20P, MEVT21D, MEVT21P, MEVT40D, MEVT40P | | |



1


| | | | |
|--------------------|---|-----------------|----------------------------------|
| GEV No. | 380530 | Ref. No. | 187500 CM187500 MACM187500 |
| description | power contactor resistive load 60A 230VAC (AC3/400V) 40A/18.5kW main contacts 3NO connection screw connection type 3RT10-35-1AL20 | | |

auxiliary contacts



1


| | | | |
|--------------------|---|-----------------|-----------|
| GEV No. | 380653 | Ref. No. | R65140420 |
| description | auxiliary contact contacts 1NO/1NC AC15 3A for contactors 3RT101 connection screw connection type 3RH1911-1FA11 | | |
| For models: | ME061D, ME061M, ME061P, ME061T, ME101D, ME101M, ME101P, ME101T | | |



1


| | | | |
|--------------------|---|-----------------|-----------|
| GEV No. | 380647 | Ref. No. | R65140430 |
| description | auxiliary contact contacts 1NO/1NC AC15 3A for contactors 3RT102 3 RT103 connection screw connection type 3RH1921-1EA11 resistive load 10A AC-12 10A | | |
| For models: | ME101D, ME101M, ME101P, ME101T, ME102D, ME102M, ME102P, ME102T, ME201D, ME201M, ME201P, ME201T, ME202D, ME202M, ME202P, ME202T, MEMENT20D, MEMENT20P, MEMENT21D, MEMENT21P, MEMENT40D, MEMENT40P, MEVT20P, MEVT21D, MEVT21P, MEVT40D, MEVT40P | | |

overload switches




1

| | | | |
|--------------------|--|-----------------|-----------|
| GEV No. | 380655 | Ref. No. | R65160150 |
| description | overload switch setting range 0.25-0.4A | | |
| For models: | CVE004H, CVE004M, CVE104H, CVE104M, VE004M, VE004X, VE104M, VE104X | | |




1

| | | | |
|--------------------|--|-----------------|------------------------|
| GEV No. | 380656 | Ref. No. | R65160100 R65160110 |
| description | overload switch setting range 0.63-1A | | |
| For models: | CVE105H, CVE105M, CVG105H, CVG105M, EM110H, EM110P, EM210H, EM210P, EV110H, EV110P, EV210H, EV210P, ME106M, ME106P, ME106X, ME110P, ME110X, ME120P, ME120X, ME210P, ME210X, ME220P, ME220X, MEC24H, MG106M, MG106P, MG106X, VE105M, VE105X, VE106M, VE106P, VE106X, VE110X, VE120P, VE120X, VE210P, VE210X, VE220P, VE220X, VG105M, VG105X, VG106M, VG106P, VG106X | | |



1


| | | | |
|--------------------|--|-----------------|-----------|
| GEV No. | 380659 | Ref. No. | R65160570 |
| description | overload switch setting range 0.7-1A connection screw type 3RU1116-0JB0 (AC3/400V) 0.25kW | | |
| For models: | ME101P, ME101T, ME102P, ME102T, ME201P, ME201T, ME202P, ME202T, MEMENT20P, MEMENT21P, MEMENT40P, MEVT20P, MEVT21P, MEVT40P | | |





1


| | | | |
|--------------------|--|-----------------|-----------|
| GEV No. | 380661 | Ref. No. | R65160620 |
| description | overload switch setting range 1.4-2.0A connection screw type 3RU1116-1BB0 (AC3/400V) 0.75kW | | |
| For models: | ME101D, ME101M, ME101P, ME101T, ME201D, ME201M, ME201P, ME201T, MEMENT21D, MEMENT21P, MEVT21D, MEVT21P, MG101P, MG101T, MG201P, MG201T, MG202P, MG202T, MGMT21P, MGMT40P, MGVT21P, MGVT40P | | |







| | | | |
|---|---|-----------------|-----------|
|  | | | |
| 1 | | | |
| GEV No. | 380657 | Ref. No. | R65160120 |
| description | overload switch setting range 1.8-2.5A | | |
| For models: | EC110M, EC210M, EM010M+SC, EM110H, EM110M, EM110M+SC, EM110P, EM210H, EM210M, EM210M+SC, EM210P, EV110H, EV110M, EV110M+SC, EV110P, EV210H, EV210M, EV210M+SC, EV210P, FE110M, FE110X, FE210M, FG110X, FG210X, GM110H, GM110P, GM210H, GM210P, GV110H, GV110P, GV210H, GV210P, ME110M, ME110P, ME110X, ME120M, ME120P, ME120X, ME210M, ME210P, ME210X, ME220M, ME220P, ME220X, MEC24H, MEC40M, MG110P, MG110X, MG120P, MG120X...(Other models you can see in the webshop) | | |

| | | | |
|---|----------------|--------|-------------------|
| spare parts for 381158 | | | |
|  | GEV No. | 381071 | Ref. No. — |
| overload switch setting range 3.5-5A | | | |

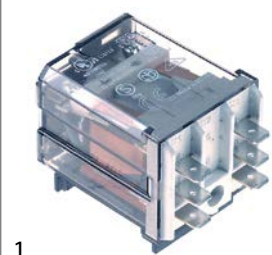
| | | | |
|--|--|-----------------|-----------|
| motor protection circuit breakers | | | |
|  | | | |
| 1 | | | |
| GEV No. | 382000 | Ref. No. | R65160590 |
| description | motor protection circuit breaker type 3RU1116-1EBO setting range 2.8-4A (AC3/400V) 1.5kW | | |
| For models: | GMT20D, GVT20D, MG101D, MG101M, MG101P, MG101T, MG201D, MG201M, MG201P, MG201T, MG202D, MG202M, MG202P, MG202T, MGMT21D, MGMT21P, MGMT40D, MGMT40P, MGVT21D, MGVT21P, MGVT40D, MGVT40P | | |

| | | | |
|---|---|-----------------|------------------------|
| power contactors | | | |
|  | | | |
| 1 | | | |
| GEV No. | 380654 | Ref. No. | R65140150 R65140170 |
| description | power contactor 230V with auxiliary contacts | | |
| For models: | CVE004H, CVE004M, CVE104H, CVE104M, CVE105H, CVE105M, CVG105H, CVG105M, EC106M, EC110M, EC210M, EM010M+SC, EM106H, EM106M, EM106M+SC, EM106P, EM110H, EM110M, EM110M+SC, EM110P, EM210H, EM210M, EM210M+SC, EM210P, EV006M, EV106H, EV106M, EV106M+SC, EV106P, EV110H, EV110M, EV110M+SC, EV110P, EV210H, EV210M, EV210M+SC, EV210P, FE105M, FE105X, FE110M, FE110X, FE210M, FG105M, FG105X, FG110M, FG110X, FG210M, FG210X, GC106M, GC110M...(Other models you can see in the webshop) | | |

| | | | |
|--|--|-----------------|---------------------------|
| miscellaneous | | | |
| kits | | | |
|  | | | |
| 1 | | | |
| GEV No. | 381158 | Ref. No. | R65160130 |
| description | overload switch kit | | |
| For models: | FG110M, FG110X, FG210M, FG210X, GC110M, GC210M, GM110H, GM110M, GM110M+SC, GM110P, GM210H, GM210M, GM210M+SC, GM210P, GV110H, GV110M, GV110M+SC, GV110P, GV210H, GV210M, GV210M+SC, GV210P, MG110M, MG110P, MG110X, MG120M, MG120P, MG120X, MG210M, MG210P, MG210X, MG220M, MG220P, MG220X, MGC20X, MGC24H, MGC40H, PG080M, PG080X, VG110M, VG110P, VG110X, VG120M, VG120P, VG120X, VG210M, VG210P, VG210X, VG220M, VG220P...(Other models you can see in the webshop) | | |
| spare parts for | 381158 | | |
|  | GEV No. | 380652 | Ref. No. R65140380 |
| power contactor resistive load 22A 230VAC (AC3/400V) 9A/4kW main contacts 3NO auxiliary contacts 1NC connection screw connection type 3RT10-16-1AP02 | | | |
|  | GEV No. | 380660 | Ref. No. — |
| base | | | |

| | | | |
|--|---|-----------------|------------|
| relays | | | |
| power relays | | | |
| with DIN rail mounting | | | |
| upper | | | |
|  | | | |
| 1 | | | |
| GEV No. | 380330 | Ref. No. | 1037312400 |
| description | power relays Italiana Relè 230VAC 16A 2CO connection male faston 6.3mm DIN rail manuf. no. A2S-230AC-AD | | |
| For models: | MLC50, MLC503, MLC65, MLC653 | | |

lateral



1

| | | | |
|--------------------|--|-----------------|-----------|
| GEV No. | 380336 | Ref. No. | R65170100 |
| description | power relays FINDER 230VAC 16A 2NO connection male faston 6.3mm DIN rail manuf. no. 62.82.8.230.0308 | | |
| For models: | CVE004H, CVE104H, MVE042P, MVE051P, MVG051P | | |

accessories for 380336

| | | | | |
|--|----------------|---|-----------------|---|
| | GEV No. | 380703 | Ref. No. | — |
| | | adapter for flange mounting suitable for Finder relay 62 series. | | |
| | GEV No. | 380811 | Ref. No. | — |
| | | adapter with bracket mounting suitable for Finder relay 62 series. | | |
| | GEV No. | 380954 | Ref. No. | — |
| | | adapter hole distance 54mm bracket mounting suitable for Finder relay 62 series. L 41mm W 39mm H 49mm | | |
| | GEV No. | 381003 | Ref. No. | — |
| | | adapter for DIN rail mounting suitable for Finder relay 62 series. | | |
| | GEV No. | 381039 | Ref. No. | — |
| | | adapter for DIN rail mounting suitable for Finder relay 62 series. | | |



1

| | | | |
|--------------------|---|-----------------|-------------------------------------|
| GEV No. | 380379 | Ref. No. | 890029 SIRA890029 SIRRA890029 |
| description | power relays SCHRACK 230VAC 25A 2CO connection male faston 6.3mm DIN rail manuf. no. RM809730 | | |

with flange mounting



1

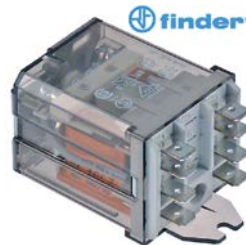
| | | | |
|--------------------|---|-----------------|----------|
| GEV No. | 380310 | Ref. No. | 23685.00 |
| description | power relays FINDER 230VAC 16A 2CO connection male faston 6.3mm screw mounting at 250VA manuf. no. 62.82.8.230.0000+062.10 | | |
| For models: | AF140B, AF140C, AF140F, AF140I, AF140MB, AF140MC, AF140MF, AF140MI, AF140MN, AF140MP, AF140N, AF140P, AF14F, AF14G, AF14N, AF70B, AF70C, AF70F, AF70I, AF70MB, AF70MC, AF70MF, AF70MI, AF70MN, AF70MP, AF70N, AF70P, AF72B, AF72C, AF72F, AF72I, AF72N, AF72P, AF7C, AF7F, AF7G, AFC14, AFC14V, AFC7, AFC7V, AFCP214, AFCP214P, AFCP214V, AFR1143P, AFR14, AFR14V, AFR214P, AFR214PV, AFR7, AFR7P...(Other models you can see in the webshop) | | |



1

| | | | |
|--------------------|---|-----------------|--------|
| GEV No. | 380131 | Ref. No. | 120459 |
| description | power relays Italiana Relè 230VAC 16A 3CO connection male faston 6.3mm screw mounting manuf. no. B2-3-230AC | | |

with bracket mounting



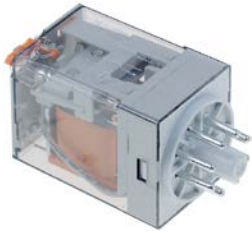
1

| | | | |
|--------------------|---|-----------------|-----------|
| GEV No. | 380139 | Ref. No. | CR0413170 |
| description | power relays FINDER 230VAC 16A 2CO connection F6.3 bracket mounting dimensions 68x38.2x35.8mm manuf. no. 62.82.8.230.0000 | | |
| For models: | FB110F, FB110N, FB110P, FB140F, FB140FN, FB140N, FB140NN, FB140P, FB140PF, FB140PN, FB140PP, FB143NI, FB55F, FB55N, FB55P, FB70F, FB70N, FB70P, FB72F, FB72N, FB72NF, FB72P, SPAR16, SPAR20, SPRG12, SPRG16, SPRG20, SVAR16, SVAR20, SVRG12, SVRG16, SVRG20 | | |



with male contacts

bullet connectors, 8 contacts



1

| | | | |
|--------------------|---|-----------------|----------------------|
| GEV No. | 380951 | Ref. No. | 0683840 CR0683840 |
| description | power relays FINDER 230VAC 10A 2CO connection plug-in connection round 8-pole manuf. no. 60.12.4.101.0040 90.26/ZVE8 250V | | |
| For models: | NPI76E5, NPI76G5, NPI78E8, NPI78G8, NPI96E5, NPI96G5, NPI98E10, NPI98E15, NPI98G10, NPI98G14, NPI98G14A | | |



1

| | | | |
|--------------------|--|-----------------|----------------------|
| GEV No. | 380134 | Ref. No. | 2863600 MA2863600 |
| description | power relays Italiana Relè 230VAC 10A 2CO connection plug-in connection round 8-pole manuf. no. C42-230VAC 90.26/ZVE8 250V | | |
| For models: | CS10E, CS10EP, CS10G, CS6E, CS6EP, CS6G, HF140DPF, NF140DF, NF140DFN, NF140DN, NF140DNI, NF140DNN, NF140DP, NF140DPN, NF140DPP, NF143DNF, NF143DNI, NF143DNP, NF14DNG, NF70DF, NF70DI, NF70DN, NF70DP, NF72DNF, NF72DNI, NF72DNN, NF7DFG, NF7DNG, SPAR16, SPAR20, SPRG12, SPRG16, SPRG20, SVAR16, SVAR20, SVRG12, SVRG16, SVRG20 | | |

| | | | | |
|------------------------|----------------|--|-----------------|----------------------|
| accessories for | 380134 | | | |
| | GEV No. | 380137 | Ref. No. | — |
| | | relay socket 8-pole connection plug-in connection round 8-pole dimensions 65x28x40mm 380V voltage AC 10A Italiana Relè manuf. no. ZVE8 | | |
| | GEV No. | 380638 | Ref. No. | 2609500 MA2609500 |
| | | relay socket 8-pole dimensions 51x41x23mm 250V 10A FINDER manuf. no. 90.26 | | |

female contact 2.0mm



1

| | | | |
|--------------------|--|-----------------|----------------------|
| GEV No. | 380382 | Ref. No. | 2998400 MA2998400 |
| description | power relays 16A 1CO plug-in connection 250V connection 2mm | | |
| For models: | CON102E, CON102EP, CON102G, CON102GP, CON10E, CON10EP, CON10G, CON10GP, CON6E, CON6EP, CON6G, CON6GP | | |

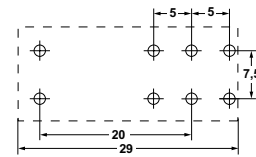
| | | | | |
|------------------------|----------------|--|-----------------|---------|
| accessories for | 380382 | | | |
| | GEV No. | 380341 | Ref. No. | 2998500 |
| | | relay socket 4-pole contacts 12 300V voltage AC 6A Italiana Relè manuf. no. ZMD4 | | |

| | | | | |
|------------------------|----------------|---|-----------------|---|
| accessories for | 380382 | | | |
| | GEV No. | 380378 | Ref. No. | — |
| | | relay socket 2-pole 55/85 dimensions 70.5x30x27mm 250V voltage AC 10A FINDER manuf. no. 94.72 | | |
| | GEV No. | 380384 | Ref. No. | — |
| | | relay socket 2-pole contacts male faston 2.8mm 250V voltage AC 10A W 23mm for | | |
| | GEV No. | 380399 | Ref. No. | — |
| | | relay socket 4-pole dimensions 76.2x27x86.1mm 250V voltage AC 1A FINDER manuf. no. 94.94.3 | | |

plug-in/print relays



1



| | | | | |
|------------------------|--|---|-----------------|----------------------|
| GEV No. | 380333 | Ref. No. | R65170050 | |
| description | print relay 230VAC 2CO at 250V 8A connection pins raster size 5mm FINDER manuf. no. 40.52.8.230.0000 95.65/95.75 | | | |
| For models: | ME061M, ME101M, ME102D, ME102M, ME106M, ME106X, ME110M, ME110X, ME120M, ME120X, ME201M, ME202M, ME210M, ME210X, ME220M, ME220X, MEC40M, MEMT06P, MEMT10P, MEMT20P, MEMT21P, MEMT40P, MG061M, MG101M, MG102M, MG106M, MG106X, MG110M, MG110X, MG120M, MG120X, MG201M, MG202M, MG210M, MG210X, MG220M, MG220X, MGC20X, MGMT06P, MGMT10P, MGMT20P, MGMT21P, MGMT40P, VE106M, VE106X, VE110M, VE110X, VE120M, VE120X, VE210M...(Other models you can see in the webshop) | | | |
| accessories for | 380333 | | | |
| | GEV No. | 380340 | Ref. No. | 5151400 MA5151400 |
| | | relay socket dimensions 62x36x15mm 250V voltage AC 10A Italiana Relè manuf. no. ZMEM/5 | | |
| | GEV No. | 380505 | Ref. No. | — |
| | | relay socket 2CO 40.52 dimensions 81.9x15.5x75mm 250V voltage AC 10A FINDER manuf. no. 95.95.3 | | |
| | GEV No. | 381181 | Ref. No. | — |
| | | relay socket 2-pole 40.51/40.52/40.61 connection screw clamp dimensions 15.8x78.6mm 250V voltage AC 10A FINDER manuf. no. 95.75 | | |




| | | | |
|----------------|--------|-----------------|-----------------------|
| GEV No. | 380331 | Ref. No. | 51513.00 MA5151300 |
|----------------|--------|-----------------|-----------------------|


description print relay 24VAC 1CO at 250V 10A connection pins raster size 5mm

For models: CON201E, CON201EP, CON201G, CON201GP, CON202E, CON202EP, CON202G, CON202GP, CP9A15GD, CSM102E, CSM102EP, CSM102G, CSM102GP, CSM10E, CSM10EP, CSM10G, CSM10GP, CSM201E, CSM201EP, CSM201G, CSM201GP, CSM202E, CSM202EP, CSM202G, CSM202GP, CSM6E, CSM6EP, CSM6G, CSM6GP


| | |
|------------------------|--------|
| accessories for | 380331 |
|------------------------|--------|

| | | | | |
|---|----------------|--------|-----------------|----------------------|
|  | GEV No. | 380340 | Ref. No. | 5151400 MA5151400 |
|---|----------------|--------|-----------------|----------------------|

relay socket dimensions 62x36x15mm 250V voltage AC 10A Italiana Relè manuf. no. ZMEM/5

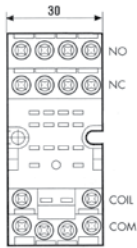
| | | | | |
|---|----------------|--------|-----------------|---|
|  | GEV No. | 380505 | Ref. No. | — |
|---|----------------|--------|-----------------|---|

relay socket 2CO 40.52 dimensions 81.9x15.5x75mm 250V voltage AC 10A FINDER manuf. no. 95.95.3

| | | | | |
|---|----------------|--------|-----------------|---|
|  | GEV No. | 381181 | Ref. No. | — |
|---|----------------|--------|-----------------|---|

relay socket 2-pole 40.51/40.52/40.61 connection screw clamp dimensions 15.8x78.6mm 250V voltage AC 10A FINDER manuf. no. 95.75

relay sockets




| | | | |
|----------------|--------|-----------------|---------|
| GEV No. | 380341 | Ref. No. | 2998500 |
|----------------|--------|-----------------|---------|

description relay socket 4-pole contacts 12 300V voltage AC 6A Italiana Relè manuf. no. ZMD4

For models: CON102E, CON102EP, CON102G, CON102GP, CON10E, CON10EP, CON10G, CON10GP, CON6E, CON6EP, CON6G, CON6GP, CP9A15GD

| | |
|------------------------|--------|
| accessories for | 380341 |
|------------------------|--------|

| | | | | |
|---|----------------|--------|-----------------|---|
|  | GEV No. | 380804 | Ref. No. | — |
|---|----------------|--------|-----------------|---|

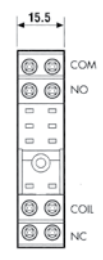
support bracket



| | | | |
|----------------|--------|-----------------|----------------------|
| GEV No. | 380638 | Ref. No. | 2609500 MA2609500 |
|----------------|--------|-----------------|----------------------|

description relay socket 8-pole dimensions 51x41x23mm 250V 10A FINDER manuf. no. 90.26

For models: CS10E, CS10EP, CS10G, CS6E, CS6EP, CS6G, FV4E, FV4E1, HF140DPF, NF140DF, NF140DFN, NF140DN, NF140DNI, NF140DNN, NF140DP, NF140DPN, NF140DPP, NF143DNF, NF143DNI, NF143DNP, NF14DNG, NF70DF, NF70DI, NF70DN, NF70DP, NF72DNF, NF72DNI, NF72DNN, NF7DFG, NF7DNG, NPI76E5, NPI76G5, NPI78E8, NPI78G8, NPI96E5, NPI96G5, NPI98E10, NPI98E15, NPI98G10, NPI98G14, NPI98G14A, SPAR16, SPAR20, SPRG12, SPRG16, SPRG20, SVAR16, SVAR20, SVRG12, SVRG16...(Other models you can see in the webshop)



| | | | |
|----------------|--------|-----------------|----------------------|
| GEV No. | 380340 | Ref. No. | 5151400 MA5151400 |
|----------------|--------|-----------------|----------------------|

description relay socket dimensions 62x36x15mm 250V voltage AC 10A Italiana Relè manuf. no. ZMEM/5

For models: CON201E, CON201EP, CON201G, CON201GP, CON202E, CON202EP, CON202G, CON202GP, CP9A15GD, CSM102E, CSM102EP, CSM102G, CSM102GP, CSM10E, CSM10EP, CSM10G, CSM10GP, CSM201E, CSM201EP, CSM201G, CSM201GP, CSM202E, CSM202EP, CSM202G, CSM202GP, CSM6E, CSM6EP, CSM6G, CSM6GP

level relays

GICAR



| | | | |
|----------------|--------|-----------------|-----------|
| GEV No. | 401224 | Ref. No. | R65120010 |
|----------------|--------|-----------------|-----------|

description level relay 230V connection F6.3 type RL30/3ES/F/G

For models: EM010M+SC, EM106M, EM106M+SC, EM110M, EM110M+SC, EM210M, EM210M+SC, GM106M, GM106M+SC, GM110M, GM110M+SC, GM210M, GM210M+SC, ME061M, ME101M, ME102D, ME102M, ME106M, ME106X, ME110M, ME110X, ME120M, ME120X, ME201M, ME202M, ME210M, ME210X, ME220M, ME220X, MEC40M, MG061M, MG101M, MG102M, MG106M, MG106X, MG110M, MG110X, MG120M, MG120X, MG201M, MG202M, MG210M, MG210X, MG220M, MG220X, MGC20X



time relays

time relays



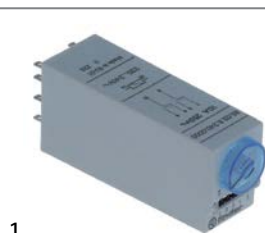
1

| | | | |
|--------------------|--|-----------------|-----------|
| GEV No. | 381421 | Ref. No. | R65090450 |
| description | time relay CROUZET EMAR7 88 829 117 time range 0.1s-20h 240VAC 5A NO connection grip connection | | |
| For models: | CVG105H, CVG105M, MACG05M, MACG07M, MACG10M, MACG20M, ME061M, ME101M, ME102D, ME102M, ME201M, ME202M, MEC40M, MG061M, MG101M, MG102M, MG106M, MG106P, MG106X, MG110M, MG110P, MG110X, MG120M, MG120P, MG120X, MG201M, MG202M, MG210M, MG210P, MG210X, MG220M, MG220P, MG220X, MGC20X, MGC24H, MGC40H, VG105M, VG105X, VG106M, VG106P, VG106X, VG110M, VG110P, VG110X, VG120M, VG120P, VG120X, VG210M, VG210P, VG210X...(Other models you can see in the webshop) | | |



1

| | | | |
|--------------------|--|-----------------|-----------|
| GEV No. | 380489 | Ref. No. | R65090480 |
| description | time relay CROUZET MUR1-88826105 time range 0.1s-100h 24-240VAC/24VDC 8A mounting measurements DIN railmm 1CO connection grip connection | | |
| For models: | EM010M+SC, EM106M, EM106M+SC, EM110M, EM110M+SC, EM210M, EM210M+SC, GM106M, GM106M+SC, GM110M, GM110M+SC, GM210M, GM210M+SC, MVE042P | | |



1

| | | | |
|------------------------|--|-----------------|-------------------|
| GEV No. | 380329 | Ref. No. | R65090460 |
| description | time relay FIBER 85.02.8.240 time range 0.05s - 100h 230-240VAC 10A mounting measurements 20.6x27.7mm 2CO connection 2.0 | | |
| For models: | ME106M, ME106X, ME110M, ME110X, ME120M, ME120X, ME210M, ME210X, ME220M, ME220X, MG106M, MG106X, MG110M, MG110X, MG120M, MG120X, MG210M, MG210X, MG220M, MG220X | | |
| accessories for | 380329 | | |
| | GEV No. | 380378 | Ref. No. — |
| | GEV No. | 380803 | Ref. No. — |

transformers

open transformers

with clamp terminal



1

| | | | |
|--------------------|---|-----------------|--------|
| GEV No. | 400947 | Ref. No. | 120608 |
| description | transformer primary 220/230-240-380/400-415V secondary 12-24V 150VA secondary 4.17A 50/60Hz | | |



1

| | | | |
|--------------------|--|-----------------|----------------------|
| GEV No. | 401152 | Ref. No. | 5153000 MA5153000 |
| description | transformer primary 230/400V secondary 12V 100VA | | |
| For models: | CP9A15GD, CSM102G, CSM102GP, CSM10G, CSM10GP, CSM6E, CSM6EP, CSM6G, CSM6GP | | |




1

| | | | |
|--------------------|--|-----------------|----------------------|
| GEV No. | 401153 | Ref. No. | 5153100 MA5153100 |
| description | transformer primary 230/400V secondary 12V 160VA | | |
| For models: | CON201E, CON201EP, CON201G, CON201GP, CON202E, CON202EP, CON202G, CON202GP, CSM102E, CSM102EP, CSM10E, CSM10EP, CSM201E, CSM201EP, CSM201G, CSM201GP, CSM202E, CSM202EP, CSM202G, CSM202GP | | |



toroidal core transformers




1

| | | | |
|--------------------|--|-----------------|----------------------|
| GEV No. | 401151 | Ref. No. | 5159300 MA5159300 |
| description | transformer primary 230V secondary 12V 20VA | | |
| For models: | CON102E, CON102EP, CON102G, CON102GP, CON10E, CON10EP, CON10G, CON10GP, CON201E, CON201EP, CON201G, CON201GP, CON202E, CON202EP, CON202G, CON202GP, CON6E, CON6EP, CON6G, CON6GP, CP9A15GD, CSM102E, CSM102EP, CSM102G, CSM102GP, CSM10E, CSM10EP, CSM10G, CSM10GP, CSM201E, CSM201EP, CSM201G, CSM201GP, CSM202E, CSM202EP, CSM202G, CSM202GP, CSM6E, CSM6EP, CSM6G, CSM6GP | | |


encapsulated transformers

with screw connection



1


| | | | |
|--------------------|--|-----------------|-----------|
| GEV No. | 402950 | Ref. No. | CR0684780 |
| description | transformer primary 230V secondary 24V 100VA connection screw 50/60Hz type 192 | | |
| For models: | NBR912EFM, NBR912EIM, NBR912GFM, NBR912GIM, NBR98EF, NBR98EFM, NBR98EI, NBR98EIM, NBR98GF, NBR98GFM, NBR98GI, NBR98GIM | | |



1


| | | | |
|--------------------|---|-----------------|-----------|
| GEV No. | 400127 | Ref. No. | R65180430 |
| description | transformer primary 230VAC secondary 12VAC 40VA secondary 3.2A H 63mm L 75mm W 78mm connection 2-wire connection systems 50/60Hz moulded | | |
| For models: | EC110M, EC210M, EM010M+SC, EM110H, EM110M, EM110M+SC, EM110P, EM210H, EM210M, EM210M+SC, EM210P, EV110H, EV110M, EV110M+SC, EV110P, EV210H, EV210M, EV210M+SC, EV210P, FG110X, FG210X, GC110M, GC210M, GM110H, GM110M, GM110M+SC, GM110P, GM210H, GM210M+SC, GM210P, GMT20D, GV110H, GV110M, GV110M+SC, GV110P, GV210H, GV210M+SC, GV210P, GVT20D, ME101D, ME101M, ME101P, ME101T, ME102D, ME102M, ME102P, ME102T, ME110P, ME110X, ME120P...(Other models you can see in the webshop) | | |

PMA




1

| | | | |
|--------------------|---|-----------------|-----------|
| GEV No. | 401340 | Ref. No. | R65180770 |
| description | transformer primary 220/240V secondary 24V 50VA secondary 2.1A connection screw 50/60Hz | | |
| For models: | GMT06D, GMT20D, GVT06D, GVT20D, MACG05M, MACG07M, MACG10M, MACG20M, MG061D, MG061M, MG061P, MG061T, MG101D, MG101M, MG101P, MG101T, MG102D, MG102M, MG102P, MG102T, MG201D, MG201M, MG201P, MG201T, MG202D, MG202M, MG202P, MG202T, MGMT06D, MGMT06P, MGMT10D, MGMT10P, MGMT20D, MGMT20P, MGMT21D, MGMT21P, MGMT40D, MGMT40P, MGVT06D, MGVT06P, MGVT10D, MGVT10P, MGVT20D, MGVT20P, MGVT21D, MGVT21P, MGVT40D, MGVT40P, MVG051P | | |



1


| | | | |
|--------------------|--|-----------------|-----------|
| GEV No. | 400125 | Ref. No. | R65180410 |
| description | transformer primary 220-240V secondary 12V 16VA secondary 12V/0.3A/1AA connection screw 50Hz | | |
| For models: | EM106P, EM110P, EM210P, EV106P, EV110P, EV210P, GM106P, GM110P, GM210P, GV106P, GV110P, GV210P, ME106P, ME110P, ME120P, ME210P, ME220P, MG106P, MG110P, MG120P, MG210P, MG220P, VE106P, VE120P, VE210P, VE220P, VG106P, VG110P, VG120P, VG210P, VG220P | | |



1

| | | | |
|--------------------|---|-----------------|-----------|
| GEV No. | 400126 | Ref. No. | R65180420 |
| description | transformer primary 230VAC secondary 12VAC 20VA secondary 2.1A connection screw 50Hz | | |
| For models: | EC106M, EM106H, EM106M, EM106M+SC, EM106P, EV006M, EV106H, EV106M, EV106M+SC, EV106P, FE105X, FG105X, GC106M, GM106H, GM106M, GM106M+SC, GM106P, GMT06D, GMT20D, GV106H, GV106M, GV106M+SC, GV106P, GVT06D, GVT20D, MACE07M, MACE10M, MACE20M, MACG07M, MACG10M, MACG20M, ME061D, ME061M, ME061P, ME061T, ME101P, ME101T, ME102P, ME102T, ME106P, ME106X, ME201P, ME201T, ME202P, ME202T, MEMENT06D, MEMENT06P, MEMENT10D, MEMENT10P, MEMENT20D...(Other models you can see in the webshop) | | |








| | | | |
|---|---|-----------------|-----------------------|
|  | | | |
| 1 | | | |
| GEV No. | 379054 | Ref. No. | 24706.00 MA2470600 |
| description | transformer primary 230VAC secondary 12VAC 3VA secondary 0.25A H 40mm L 45mm W 50mm connection screw 50/60Hz type 153/M | | |
| For models: | SER15, SER15A, SER18, SER18A, SER21 | | |

electronic controllers

ELIWELL

universal controllers


built-in version

| | | | | |
|---|---|-----------------|----------------------|-----------------------|
|  | | | | |
| 1 | | | | |
| GEV No. | 379563 | Ref. No. | 2959300 MA2959300 | |
| description | electronic controller ELIWELL type ICPlus902 mounting measurements 71x29mm 230V voltage AC NTC/PTC relay outputs 1 relay CO-8A(4) defr. funct. no -55 up to +150°C display 3½ digits Templ1 yes 8A | | | |
| For models: | CON102E, CON102EP, CON102G, CON102GP, CON10E, CON10EP, CON10G, CON10GP, CON201E, CON201EP, CON201G, CON201GP, CON202E, CON202EP, CON202G, CON202GP, CON6E, CON6EP, CON6G, CON6GP, CP9A15GD, CS4E, CS4EP, CSM102E, CSM102EP, CSM102G, CSM102GP, CSM10E, CSM10EP, CSM10G, CSM10GP, CSM201, CSM201E, CSM201EP, CSM201G, CSM201GP, CSM202, CSM202E, CSM202EP, CSM202G, CSM202GP, CSM6E, CSM6EP, CSM6G, CSM6GP | | | |
| accessories for | 379563 | | | |
| | GEV No. | 379053 | Ref. No. | — |
|  | temperature probe PTC 1kOhm cable PVC probe -50 up to +150°C cable -10 up to 100°C probe ø6x30mm cable length 3m without screw connection 2-wire | | | |
| | GEV No. | 379064 | Ref. No. | 23745.00 MA2374500 |
|  | temperature probe PTC 1kOhm cable silicone probe -50 up to +150°C cable -50 up to +180°C probe ø6x40mm cable length 3m without screw connection 2-wire | | | |
| | GEV No. | 379161 | Ref. No. | — |
|  | temperature probe NTC 10kOhm cable thermoplastic probe -40 up to +110°C cable -40 up to +110°C probe ø6x14mm cable length 3m without screw connection 2-wire | | | |
| | GEV No. | 379782 | Ref. No. | — |
|  | temperature probe PTC 1kOhm cable thermoplastic probe -50 up to +150°C cable -40 up to +110°C probe ø6x14mm cable length 3m 2-wire resistor 1kOhm | | | |

EVCO - EVERY CONTROL


refrigeration controllers

built-in version

| | | | |
|--|---|-----------------|----------------------|
|  | | | |
| 1 | | | |
| GEV No. | 379850 | Ref. No. | 1681118 BN1681118 |
| description | electronic controller EVERY CONTROL type EVC20S35N7ALX40 mounting measurements 165x45mm 230V voltage AC NTC relay outputs 4 NO-16A(5) NO-8A(4) CO-8A(4) NO-8A(4) NTC NTC DI DI for fridge front measurementsmm built-in depth 56mm protection IP00 yes yes yes -40 up to +99°C display 4 digits | | |

SHANGFANG


accessories

| | | | |
|--|---|-----------------|-----------------------|
|  | | | |
| 1 | | | |
| GEV No. | 379054 | Ref. No. | 24706.00 MA2470600 |
| description | transformer primary 230VAC secondary 12VAC 3VA secondary 0.25A H 40mm L 45mm W 50mm connection screw 50/60Hz type 153/M | | |
| For models: | SER15, SER15A, SER18, SER18A, SER21 | | |

probes

universal probes

temperature probes

| | | | |
|--|--|-----------------|----------------------------------|
|  | | | |
| 1 | | | |
| GEV No. | 379343 | Ref. No. | 4671600 46716000 MA4671600 |
| description | temperature probe NTC 10kOhm cable silicone probe -40 up to +110°C cable -50 up to +180°C probe ø6x40mm cable length 3m 2-wire | | |
| For models: | FB110F, FB110N, FB110P, FB140F, FB140FN, FB140N, FB140NN, FB140P, FB140PF, FB140PN, FB140PP, FB143NI, FB55F, FB55N, FB55P, FB70F, FB70N, FB70P, FB72F, FB72N, FB72NF, FB72P, FS140F, FS140FI, FS140FN, FS140I, FS140N, FS140NG, FS140NI, FS140NN, FS140P, FS140PN, FS140PP, FS143F, FS143FI, FS143N, FS143NF, FS143NI, FS143NN, FS143NP, FS143P, FS70F, FS70FG, FS70I, FS70N, FS70NG, FS70P, FS72F, FS72FI, FS72IN...(Other models you can see in the webshop) | | |



| | | | |
|--------------------|--|-----------------|-----------|
| | | | |
| GEV No. | 379130 ¹ | Ref. No. | R65325000 |
| description | temperature probe Pt100 cable Vetrotex probe -200 up to +600°C cable -50 up to +350°C probe ø6x100mm cable length 1.4m without screw connection 3-wire resistance at 0°C 100Ohm | | |
| For models: | CVE004H, CVE104H, CVE105H, CVG105H, EM106H, EM106P, EM110H, EM110P, EM210H, EM210P, EV106H, EV106P, EV110H, EV110P, EV210H, EV210P, GM106H, GM106P, GM110H, GM110P, GM210H, GM210P, GMT06D, GMT20D, GV106H, GV106P, GV110H, GV110P, GV210H, GV210P, GVT06D, GVT20D, ME061D, ME061P, ME061T, ME101D, ME101P, ME101T, ME102T, ME106P, ME110P, ME120P, ME201D, ME201P, ME201T, ME202D, ME202P, ME202T, ME210P.. (Other models you can see in the webshop) | | |

¹3-wire

| | | | |
|--------------------|--|-----------------|-----------|
| | | | |
| GEV No. | 379050 ¹ | Ref. No. | R65325010 |
| description | temperature probe Pt100 cable Vetrotex probe -200 up to +600°C cable -50 up to +350°C probe ø6x100mm cable length 2.7m without screw connection 3-wire | | |
| For models: | ME201D, ME202D, ME220P, MEC24H, MEMT21D, MEMT21P, MEMENT40D, MEVT21D, MEVT21P, MEVT40D, MEVT40P, MG201D, MG202D, MG220P, MGC24H, MGC40H, MGMT21D, MGMT21P, MGMT40D, MGMT21D, MGMT21P, MGMT40D, MGMT40P | | |

¹3-wire

| | | | |
|--------------------|---|-----------------|-----------------------|
| | | | |
| GEV No. | 379064 | Ref. No. | 23745.00 MA2374500 |
| description | temperature probe PTC 1kOhm cable silicone probe -50 up to +150°C cable -50 up to +180°C probe ø6x40mm cable length 3m without screw connection 2-wire | | |
| For models: | BR120, BR160, EF140DF, EF140DN, EF140DP, EF143DNF, EF70DF, EF70DN, EF70DP, EF72DNF, F140DF, F140DI, F140DN, F140DP, F14DFG, F14DNG, F70DF, F70DI, F70DN, F70DP, F7DFG, F7DNG, IR13C, IR13CC, IR13CV, IR13M, IR13MC, IR13MV, IR13V, IR17C, IR17CC, IR17CV, IR17M, IR17MC, IR17MV, IR17V, NF140DF, NF140DN, NF140DNI, NF140DNN, NF140DP, NF140DPN, NF140DPP, NF143DNF, NF143DNI, NF143DNP, NF14DNG, NF70DF, NF70DI..(Other models you can see in the webshop) | | |

producer-specific probes

probes

| | | | |
|--------------------|--|-----------------|---------|
| | | | |
| GEV No. | 379387 | Ref. No. | 1957600 |
| description | core temperature probe Pt100 cable PTFE probe -100 up to 450°C cable -40 up to +250°C connection 2-wire thread probe ø4x350mm cable length 0.85m | | |
| For models: | FR92G22T, FR94G22T | | |

| | | | |
|------------------------|--|-----------------|-------------------|
| | | | |
| GEV No. | 379143 | Ref. No. | R65325020 |
| description | temperature probe Pt100 cable Vetrotex probe -200 up to +600°C cable -50 up to +350°C connection 2-wire thread probe ø3-6x90mm cable length 5m | | |
| For models: | ME220P, MG220P, MGC40H, VE220P, VG220P | | |
| spare parts for | 379143 | | |
| | GEV No. | 100909 | Ref. No. — |
| | union screw thread M10x1 for pipe ø 6mm Qty 1 pcs | | |
| | GEV No. | 101286 | Ref. No. — |
| | olive ID ø 6mm Qty 1 pcs | | |

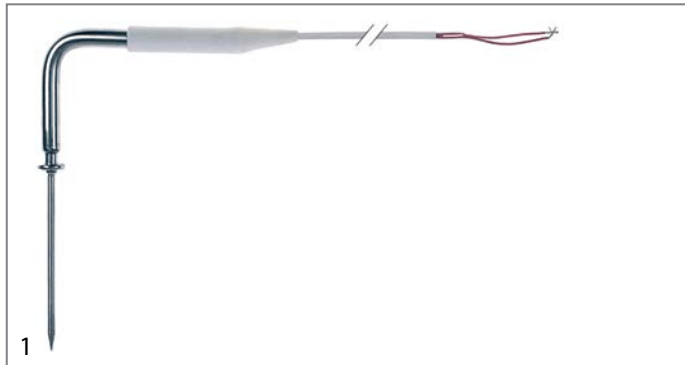
| | | | |
|--------------------|--|-----------------|----------|
| | | | |
| GEV No. | 379711 | Ref. No. | RA932001 |
| description | temperature probe PTC 1kOhm cable silicone probe -50 up to +150°C cable -50 up to +180°C connection coded plug thread probe ø6x40mm cable length 3.5m | | |
| For models: | 10-teglie-GN-MISTI-FR-STD, 10-teglie-GN-MISTI-FR-TOP, 10-teglie-GN-MISTI-IT-STD, 10-teglie-GN-MISTI-IT-TOP, 10-teglie-GN-MISTI-TX-STD, 10-teglie-GN-positivi-FR-STD, 10-teglie-GN-positivi-FR-TOP, 10-teglie-GN-positivi-IT, 10-teglie-GN-positivi-IT-STD, 10-teglie-GN-positivi-IT-TOP, 10-teglie-GN-positivi-TX-STD, 12-teglie-PA-MISTI-FR-STD, 12-teglie-PA-MISTI-FR-TOP, 12-teglie-PA-MISTI-IT-STD, 12-teglie-PA-MISTI-IT-TOP, 12-teglie-PA-positivi-FR-STD, 12-teglie-PA-positivi-FR-TOP, 12-teglie-PA-positivi-IT-STD, 12-teglie-PA-positivi-IT-TOP, 14-teglie-GN-MISTI-FR-dep-STD, 14-teglie-GN-MISTI-FR-dep-TOP, 14-teglie-GN-MISTI-FR-STD, 14-teglie-GN-MISTI-FR-TOP, 14-teglie-GN-MISTI-IT-dep-STD, 14-teglie-GN-MISTI-IT-dep-TOP, 14-teglie-GN-MISTI-IT-STD, 14-teglie-GN-MISTI-IT-TOP, 14-teglie-GN-positivi-FR, 14-teglie-GN-positivi-FR-dep-STD, 14-teglie-GN-positivi-FR-dep-TOP, 14-teglie-GN-positivi-FR-STD, 14-teglie-GN-positivi-FR-TOP, 14-teglie-GN-positivi-IT-dep-STD, 14-teglie-GN-positivi-IT-dep-TOP, 14-teglie-GN-positivi-IT-STD, 14-teglie-GN-positivi-IT-TOP, 14-teglie-GN-positivi-TX-STD, 15-teglie-PA-MISTI-FR-dep, 17-teglie-PA-MISTI-FR-dep-TOP, 17-teglie-PA-MISTI-FR-STD, 17-teglie-PA-MISTI-FR-TOP, 17-teglie-PA-MISTI-IT-dep, 17-teglie-PA-MISTI-IT-dep-TOP, 17-teglie-PA-MISTI-IT-STD, 17-teglie-PA-MISTI-IT-TOP, 17-teglie-PA-positivi-FR-dep-STD, 17-teglie-PA-positivi-FR-dep-TOP..(Other models you can see in the webshop) | | |

| | | | |
|--------------------|---|-----------------|------------------------|
| | | | |
| GEV No. | 379388 | Ref. No. | CM295900 MACM295900 |
| description | temperature probe thermocouple J (Fe-CuNi) cable TP probe -50 up to +750°C cable -40 up to +110°C connection 2-wire thread probe ø4x250mm cable length 0.7m | | |
| For models: | F94E18K, F94G22K, F98E18K, F98G22K, NF94E222K, NF94E22K, NF94G23K, NF98E222K, NF98E22K, NF98G23K | | |

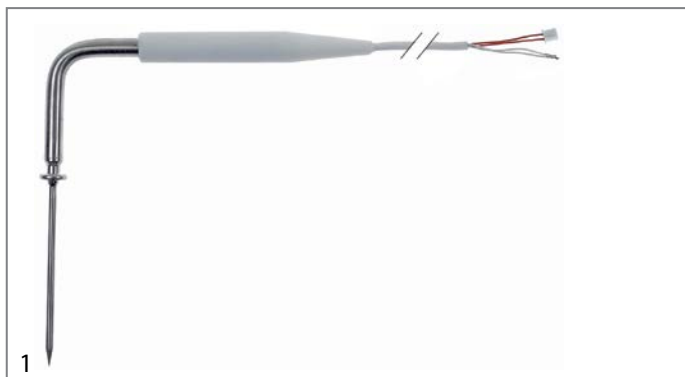
core probes

| | | | |
|--------------------|--|-----------------|-----------|
| | | | |
| GEV No. | 379134 | Ref. No. | R65320900 |
| description | core temperature probe Pt100 cable PTFE probe -40 up to +250°C cable -40 up to +250°C connection plug probe ø4x100mm thread cable length 1m handle ø 15mm handle length 83mm | | |
| For models: | CVE004H, CVE104H, CVE105H, CVG105H, EM010M+SC, EM106H, EM106M+SC, EM106P, EM110H, EM110M+SC, EM110P, EM210H, EM210M+SC, EM210P, EV106H, EV106M+SC, EV106P, EV110H, EV110M+SC, EV110P, EV210H, EV210M+SC, EV210P, GM106H, GM106M+SC, GM106P, GM110H, GM110M+SC, GM110P, GM210H, GM210M+SC, GM210P, GV106H, GV106M+SC, GV106P, GV110H, GV110M+SC, GV110P, GV210H, GV210M+SC, GV210P, ME061M, ME101M, ME102M, ME106P, ME106X, ME110P, ME110X, ME120P, ME120X... (Other models you can see in the webshop) | | |

| | | | |
|--------------------|--|-----------------|------------------------|
| | | | |
| GEV No. | 379132 | Ref. No. | 2912400 LAR65320180 |
| description | core temperature probe Pt100 cable SS corrugated hose probe -40 up to +250°C cable -40 up to +250°C connection 2-wire probe ø4x100mm thread 1/8" cable length 2.5m handle ø 9mm handle length 85mm | | |
| For models: | CS10E, CS10EP, CS10G, CS6E, CS6EP, CS6G | | |



| | | | |
|--------------------|--|-----------------|--|
| GEV No. | 379544 | Ref. No. | RA 930013 SIRA930013 SIRRA930013 |
| description | core temperature probe Pt1000 cable silicone probe -40 up to +120°C cable -50 up to +180°C connection 2-wire probe ø4x100mm thread cable length 3.6m handle ø 16mm handle length 120mm | | |
| For models: | 10-teglie-GN-MISTI-FR-STD, 10-teglie-GN-MISTI-IT-STD, 10-teglie-GN-MISTI-TX-STD, 10-teglie-GN-positivi-FR-STD, 10-teglie-GN-positivi-IT, 10-teglie-GN-positivi-IT-STD, 10-teglie-GN-positivi-TX-STD, 12-teglie-PA-MISTI-FR-STD, 12-teglie-PA-MISTI-IT-STD, 12-teglie-PA-positivi-FR-STD, 12-teglie-PA-positivi-IT-STD, 14-teglie-GN-MISTI-FR-dep-STD, 14-teglie-GN-MISTI-IT-STD, 14-teglie-GN-MISTI-TX-STD, 14-teglie-GN-positivi-FR, 14-teglie-GN-positivi-FR-dep-STD, 14-teglie-GN-positivi-FR-STD, 14-teglie-GN-positivi-IT-dep-STD, 14-teglie-GN-positivi-IT-STD, 14-teglie-GN-positivi-TX-STD, 15-teglie-PA-MISTI-FR-STD, 15-teglie-PA-MISTI-TX-STD, 17-teglie-PA-MISTI-FR-dep, 17-teglie-PA-MISTI-FR-STD, 17-teglie-PA-MISTI-IT-dep, 17-teglie-PA-MISTI-IT-STD, 17-teglie-PA-positivi-FR-dep-STD, 17-teglie-PA-positivi-FR-STD, 17-teglie-PA-positivi-IT-dep-STD, 17-teglie-PA-positivi-IT-STD, 20-teglie-GN-misti-FR-STD, 20-teglie-GN-positivi-FR-STD, 20-teglie-GN-positivi-IT-STD, 21-teglie-PA-MISTI-TX-STD | | |



| | | | |
|--------------------|---|-----------------|--|
| GEV No. | 379757 | Ref. No. | RA 930014 SIRA930014 SIRRA930014 |
| description | core temperature probe Pt1000 cable silicone probe -40 up to +120°C cable -50 up to +180°C connection 2-wire probe ø4x100mm thread cable length 3.6m handle ø 16mm handle length 125mm | | |
| For models: | 10-teglie-GN-MISTI-FR-TOP, 10-teglie-GN-MISTI-IT-TOP, 10-teglie-GN-positivi-FR-TOP, 10-teglie-GN-positivi-IT-TOP, 12-teglie-PA-MISTI-FR-TOP, 12-teglie-PA-MISTI-IT-TOP, 12-teglie-PA-positivi-FR-TOP, 12-teglie-PA-positivi-IT-TOP, 14-teglie-GN-MISTI-FR-dep-TOP, 14-teglie-GN-MISTI-IT-TOP, 14-teglie-GN-MISTI-IT-dep-TOP, 14-teglie-GN-positivi-FR-TOP, 14-teglie-GN-positivi-IT-dep-TOP, 14-teglie-GN-positivi-IT-TOP, 17-teglie-PA-MISTI-FR-dep-TOP, 17-teglie-PA-MISTI-FR-TOP, 17-teglie-PA-MISTI-IT-dep-TOP, 17-teglie-PA-MISTI-IT-TOP, 17-teglie-PA-positivi-FR-dep-TOP, 17-teglie-PA-positivi-FR-TOP, 17-teglie-PA-positivi-IT-dep-TOP, 17-teglie-PA-positivi-IT-TOP, 20-teglie-GN-positivi-FR-TOP, 20-teglie-GN-positivi-IT-TOP | | |

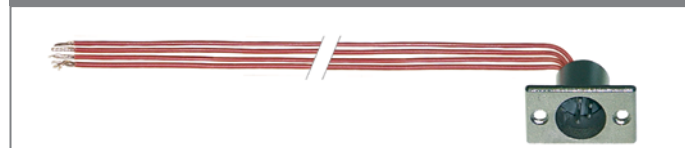
| | | | |
|--------------------|--|-----------------|-----------|
| GEV No. | 379510 | Ref. No. | R65321100 |
| description | core temperature probe thermocouple K (NiCr-Ni) cable PTFE probe -40 up to +250°C cable -40 up to +250°C connection 6-pin connector probe ø3.5x90mm thread cable length 1.1m handle ømm handle length 90mm | | |
| For models: | ME061T, ME101T, ME102T, ME201T, ME202T, MG061T, MG101T, MG102T, MG201T, MG202T | | |

| | | | |
|--------------------|--|-----------------|-----------|
| GEV No. | 379773 ¹ | Ref. No. | R65321120 |
| description | core temperature probe thermocouple K (NiCr-Ni) cable PTFE probe -40 up to +250°C cable -40 up to +250°C connection plug probe ø3.5x90mm thread cable length 1.1m handle ømm handle length 90mm | | |
| For models: | GMT06D, GMT20D, GVT06D, GVT20D, ME061D, ME061P, ME101D, ME101P, ME102D, ME102P, ME201D, ME201P, ME202D, ME202P, MEMT06D, MEMT06P, MEMT10D, MEMT10P, MEMT20D, MEMT20P, MEMT21D, MEMT21P, MEMT40D, MEMT40P, MEVT06D, MEVT06P, MEVT10D, MEVT10P, MEVT20D, MEVT20P, MEVT21D, MEVT21P, MEVT40D, MEVT40P, MG061D, MG061P, MG101D, MG101P, MG102D, MG102P, MG201D, MG201P, MG202D, MG202P, MGMT06D, MGMT06P, MGMT10D, MGMT10P, MGMT20D, MGMT20P...(Other models you can see in the webshop) | | |

¹multipoint probe

accessories

plugs/bushes



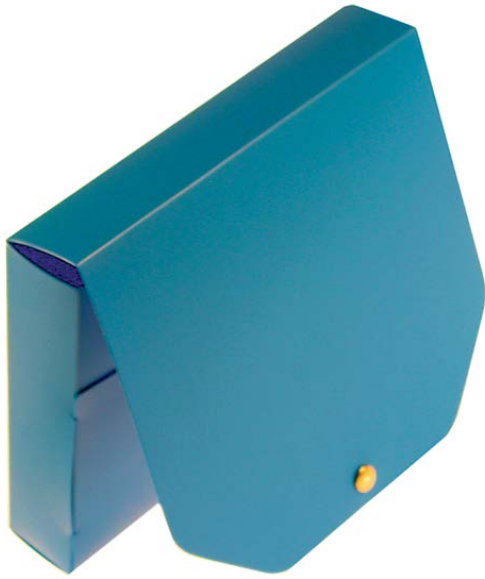
| | | | |
|--------------------|---|-----------------|-----------|
| GEV No. | 378016 | Ref. No. | R65320920 |
| description | female connector 4-pole | | |
| For models: | CVE004H, CVE104H, CVE105H, CVG105H, EM010M+SC, EM106H, EM106M+SC, EM106P, EM110H, EM110M+SC, EM110P, EM210H, EM210M+SC, EM210P, EV106H, EV106M+SC, EV106P, EV110H, EV110M+SC, EV110P, EV210H, EV210M+SC, EV210P, GM106H, GM106M+SC, GM106P, GM110H, GM110M+SC, GM110P, GM210H, GM210M+SC, GM210P, GMT06D, GMT20D, GV106H, GV106M+SC, GV106P, GV110H, GV110M+SC, GV110P, GV210H, GV210M+SC, GV210P, GVT06D, GVT20D, ME061D, ME061M, ME061P, ME101D, ME101M...(Other models you can see in the webshop) | | |



| | | | |
|--------------------|---|-----------------|-----------|
| GEV No. | 378017 | Ref. No. | R65321020 |
| description | lid for plug contact | | |
| For models: | CVE004H, CVE104H, CVE105H, CVG105H, EM010M+SC, EM106H, EM106M+SC, EM106P, EM110H, EM110M+SC, EM110P, EM210H, EM210M+SC, EM210P, EV106H, EV106M+SC, EV106P, EV110H, EV110M+SC, EV110P, EV210H, EV210M+SC, EV210P, GM106H, GM106M+SC, GM106P, GM110H, GM110M+SC, GM110P, GM210H, GM210M+SC, GM210P, GMT06D, GMT20D, GV106H, GV106M+SC, GV106P, GV110H, GV110M+SC, GV110P, GV210H, GV210M+SC, GV210P, GVT06D, GVT20D, ME061D, ME061M, ME061P, ME061T, ME101D...(Other models you can see in the webshop) | | |



miscellaneous



| | | | | |
|--------------------|---|--------------------------------|-----------------|-----------|
| 1 | GEV No. | 379856 | Ref. No. | R86020420 |
| | description | bag for core temperature probe | | |
| For models: | CVE004H, CVE104H, CVE105H, CVG105H, EM010M+SC, EM106H, EM106M+SC, EM106P, EM110H, EM110M+SC, EM110P, EM210H, EM210M+SC, EM210P, EV106H, EV106M+SC, EV106P, EV110H, EV110M+SC, EV110P, EV210H, EV210M+SC, EV210P, GM106H, GM106M+SC, GM106P, GM110H, GM110M+SC, GM110P, GM210H, GM210M+SC, GM210P, GMT06D, GMT20D, GV106H, GV106M+SC, GV106P, GV110H, GV110M+SC, GV110P, GV210H, GV210M+SC, GV210P, GVT06D, GVT20D, ME061D, ME061M, ME101D, ME101M, ME102D...(Other models you can see in the webshop) | | | |

| | | | | |
|--------------------|--------------------------------|------------|-----------------|-----------|
| 1 | GEV No. | 400149 | Ref. No. | R65300580 |
| | description | keypad PCB | | |
| For models: | VE004X, VE104X, VE105X, VG105X | | | |

| | | | | |
|--------------------|---|------------|-----------------|-----------|
| 1 | GEV No. | 401332 | Ref. No. | R65300540 |
| | description | keypad PCB | | |
| For models: | EM010M+SC, EM106M+SC, EM110M+SC, EM210M+SC, EV106M+SC, EV110M+SC, EV210M+SC, GM106M+SC, GM110M+SC, GM210M+SC, GV106M+SC, GV110M+SC, GV210M+SC, ME061M, ME101M, ME102M, ME201M, ME202M, MG061M, MG101M, MG102M, MG201M, MG202M, MGC20X | | | |

| | | | | |
|------------------------|--|--|-----------------|-------------------------------------|
| 1 | GEV No. | 401591 | Ref. No. | R65301410 R65301420 R65301460 |
| | description | keypad PCB combi-steamer ME061T complete | | |
| For models: | ME061T, ME101T, ME102T, ME201T, ME202T, MG061T, MG101T, MG102T, MG201T, MG202T | | | |
| spare parts for | 401591 | | | |
| | GEV No. | 350086 | Ref. No. | R65301440 RA919008 |
| | buzzer 12VDC connection cable 200mm PCB buzzer 20dB | | | |
| | GEV No. | 401338 | Ref. No. | R65301450 |
| | encoder | | | |

| | | | | |
|--------------------|--|---|-----------------|-----------|
| 1 | GEV No. | 400140 | Ref. No. | R65300500 |
| | description | keypad PCB combi-steamer ME106M with keypad | | |
| For models: | ME106M, ME110M, ME120M, ME210M, MG106M, MG110M, MG120M, MG210M, MG220M, VE106M, VE110M, VE120M, VE210M, VE220M, VG106M, VG110M, VG120M, VG210M, VG220M | | | |


electronics


PCBs


| | | | | |
|--------------------|--|---|-----------------|-----------|
| 1 | GEV No. | 403472 | Ref. No. | R65301400 |
| | description | control PCB combi-steamer VE 061/1011 L 410mm W 150mm suitable for LAINOX | | |
| For models: | MEVT06P, MEVT10P, MEVT20P, MEVT21P, MEVT40P, MGVT06P, MGVT10P, MGVT20P, MGVT21P, MGVT40P | | | |


| | | | | |
|--------------------|--|---|-----------------|------------------------|
| 1 | GEV No. | 402427 | Ref. No. | R65301370 R65301390 |
| | description | control PCB L 410mm W 150mm for LAINOX buttons 13 | | |
| For models: | ME061P, ME101P, ME102P, ME201P, ME202P, MEMT06P, MEMT10P, MEMT20P, MEMT21P, MEMT40P, MEVT06P, MEVT10P, MEVT20P, MEVT21P, MEVT40P, MG061P, MG101P, MG102P, MG201P, MG202P, MGMT06P, MGMT10P, MGMT20P, MGMT21P, MGMT40P, MGVT06P, MGVT10P, MGVT20P, MGVT21P, MGVT40P | | | |





| | | | |
|--|------------------------------------|-----------------|-------------------------------------|
|  <p>1</p> | | | |
| GEV No. | 401661 | Ref. No. | R65301800 R65301810 R65301820 |
| description | keypad PCB combi-steamer MVE04 kit | | |
| For models: | MVE042P, MVE051P, MVG051P | | |


| | | | |
|--|--|-----------------|------------------------|
|  <p>1</p> | | | |
| GEV No. | 400687 | Ref. No. | CM295800 MACM295800 |
| description | keypad PCB fryer EFE....K | | |
| For models: | F94E18K, F94G22K, F98E18K, F98G22K, NF94E222K, NF94E22K, NF94G23K, NF98E222K, NF98E22K, NF98G23K | | |

| | | | |
|---|--|-----------------|-----------|
|  <p>1</p> | | | |
| GEV No. | 400142 | Ref. No. | R65300570 |
| description | keypad PCB L 100mm W 95mm buttons 8 | | |
| For models: | ME106X, ME110X, ME120X, ME210X, ME220M, ME220X, MG106X, MG110X, MG120X, MG210X, MG220X, VE106X, VE110X, VE120X, VE210X, VE220X, VG106X, VG110X, VG120X, VG210X, VG220X | | |

| | | | |
|--|--|-----------------|-----------|
|  <p>1</p> | | | |
| GEV No. | 401352 | Ref. No. | R65301330 |
| description | keypad PCB temperature | | |
| For models: | GMT06D, GMT20D, ME061D, ME101D, ME102D, ME201D, MG061D, MG101D, MG102D, MG201D, MG202D | | |

| | | | |
|---|------------------------------------|-----------------|-----------|
|  <p>1</p> | | | |
| GEV No. | 400150 | Ref. No. | R65300830 |
| description | main PCB | | |
| For models: | CVE004H, CVE104H, CVE105H, CVG105H | | |

| | | | |
|---|--------------------------------|-----------------|-----------|
|  <p>1</p> | | | |
| GEV No. | 400148 | Ref. No. | R65300550 |
| description | PCB | | |
| For models: | VE004X, VE104X, VE105X, VG105X | | |

| | | | |
|---|---|-----------------|-----------|
|  <p>1</p> | | | |
| GEV No. | 401333 | Ref. No. | R65300490 |
| description | PCB | | |
| For models: | EM010M+SC, EM106M+SC, EM110M+SC, EM210M+SC, EV106M+SC, EV110M+SC, EV210M+SC, GM106M+SC, GM110M+SC, GM210M+SC, GV106M+SC, GV110M+SC, GV210M+SC, ME061M, ME101M, ME102M, ME201M, ME202M, MG061M, MG101M, MG102M, MG201M, MG202M, MGC20X | | |



1

| | | | |
|--------------------|---|-----------------|-----------|
| GEV No. | 401341 | Ref. No. | R63130020 |
| description | PCB | | |
| For models: | GMT06D, GMT20D, GVT06D, GVT20D, MACG05M, MACG07M, MACG10M, MACG20M, MG061D, MG061M, MG061P, MG061T, MG101D, MG101M, MG101P, MG101T, MG102D, MG102M, MG102P, MG102T, MG201D, MG201M, MG201P, MG201T, MG202D, MG202M, MG202P, MG202T, MGMT06D, MGMT06P, MGMT10D, MGMT10P, MGMT20D, MGMT20P, MGMT21D, MGMT21P, MGMT40D, MGMT40P, MGVT06D, MGVT06P, MGVT10D, MGVT10P, MGVT20D, MGVT20P, MGVT21D, MGVT21P, MGVT40D, MGVT40P, MVG051P | | |



2

| | | | |
|--------------------|--|-----------------|-----------|
| GEV No. | 400141 | Ref. No. | R65300520 |
| description | PCB blast chiller suitable for LAINOX | | |
| For models: | ME106X, ME110X, ME120X, ME210X, ME220X, MG106X, MG110X, MG120X, MG210X, MG220X, VE106X, VE110X, VE120X, VE210X, VE220X, VG106X, VG110X, VG120X, VG210X, VG220X | | |



1

| | | | |
|--------------------|--|-----------------|-----------|
| GEV No. | 402825 | Ref. No. | R65301480 |
| description | PCB combi-steamer GEMT L 130mm W 86mm new edition level control steam generator EVCO | | |
| For models: | GMT06D, GMT20D, ME061D, ME061P, ME101D, ME101P, ME102D, ME102P, ME201D, ME201P, ME202D, ME202P, MEMT06D, MEMT06P, MEMT10D, MEMT10P, MEMT20D, MEMT20P, MEMT21D, MEMT21P, MEMT40D, MEMT40P, MG061D, MG061P, MG101D, MG101P, MG102D, MG102P, MG201D, MG201P, MG202D, MG202P, MGMT06D, MGMT06P, MGMT10D, MGMT10P, MGMT20D, MGMT20P, MGMT21D, MGMT21P, MGMT40D, MGMT40P | | |



1

| | | | |
|--------------------|------------------------------------|-----------------|-----------|
| GEV No. | 400152 | Ref. No. | R65300850 |
| description | PCB core temperature | | |
| For models: | CVE004H, CVE104H, CVE105H, CVG105H | | |



1

| | | | |
|--------------------|-----------|-----------------|-------------------------|
| GEV No. | 401767 | Ref. No. | RA910059 SIRRA910059 |
| description | power PCB | | |



1

| | | | |
|--------------------|-------------------------|-----------------|--|
| GEV No. | 402972 | Ref. No. | O11AD1600001 0509630R BN011AD1600001 CR0509630R |
| description | relay PCB L 69mm W 59mm | | |
| For models: | V94E, V98E | | |

keypads

front foils



1

| | | | |
|--------------------|----------------------------------|-----------------|-----------|
| GEV No. | 401304 | Ref. No. | R67010450 |
| description | front foil | | |
| For models: | CVE004M, CVE104M, VE004M, VE104M | | |



1

| | | | |
|--------------------|--|-----------------|-----------|
| GEV No. | 401308 | Ref. No. | R67010530 |
| description | front foil | | |
| For models: | VE106M, VE110M, VE120M, VE210M, VE220M, VG106M, VG110M, VG120M, VG210M, VG220M | | |

| | | | |
|--------------------|--|-----------------|-----------|
| 1 | | | |
| GEV No. | 401313 | Ref. No. | R67012950 |
| description | front foil | | |
| For models: | ME061M, ME101M, ME102M, ME201M, ME202M, MG061M, MG101M, MG102M, MG201M, MG202M | | |

| | | | |
|--------------------|------------|-----------------|--------|
| 1 | | | |
| GEV No. | 511409 | Ref. No. | 461073 |
| description | front foil | | |

| | | | |
|--------------------|------------|-----------------|--------|
| 1 | | | |
| GEV No. | 511411 | Ref. No. | 461074 |
| description | front foil | | |

| | | | |
|--------------------|------------|-----------------|--------|
| 1 | | | |
| GEV No. | 511412 | Ref. No. | 461101 |
| description | front foil | | |

| | | | |
|--------------------|------------|-----------------|--------|
| 1 | | | |
| GEV No. | 511414 | Ref. No. | 461138 |
| description | front foil | | |

| | | | |
|--------------------|------------|-----------------|--------|
| 1 | | | |
| GEV No. | 511416 | Ref. No. | 461075 |
| description | front foil | | |

| | | | |
|--------------------|---|-----------------|-----------|
| 1 | | | |
| GEV No. | 401305 | Ref. No. | R67010460 |
| description | front foil suitable for LAINOX L 399mm W 74mm | | |
| For models: | VE004X, VE104X | | |

| | | | |
|--------------------|---|-----------------|-----------|
| 1 | | | |
| GEV No. | 401306 | Ref. No. | R67010490 |
| description | front foil suitable for LAINOX L 493mm W 75mm | | |
| For models: | CVE105M, CVG105M, VE105M, VG105M | | |

| | | | |
|--------------------|----------------|-----------------|-----------|
| 1 | | | |
| GEV No. | 401307 | Ref. No. | R67010500 |
| description | keypad foil | | |
| For models: | VE105X, VG105X | | |


| | | | |
|--------------------|--|-----------------|-----------|
| 1 | | | |
| GEV No. | 401309 | Ref. No. | R67010550 |
| description | keypad foil | | |
| For models: | VE106X, VE110X, VE120X, VE210X, VE220X, VG106X, VG110X, VG120X, VG210X, VG220X | | |

| | | | |
|--------------------|--|-----------------|-----------|
| 1 | | | |
| GEV No. | 401311 | Ref. No. | R67010630 |
| description | keypad foil | | |
| For models: | ME106X, ME110X, ME120X, ME210X, ME220X, MG106X, MG110X, MG120X, MG210X, MG220X | | |

| | | | |
|--------------------|--|-----------------|-----------|
| 1 | | | |
| GEV No. | 401312 | Ref. No. | R67012960 |
| description | keypad foil | | |
| For models: | ME061M, ME101M, ME102M, ME201M, ME202M, MG061M, MG101M, MG102M, MG201M, MG202M | | |

| | | | |
|--------------------|------------------------|-----------------|-----------|
| 1 | | | |
| GEV No. | 401324 | Ref. No. | R67010660 |
| description | keypad foil | | |
| For models: | MEC24H, MGC24H, MGC40H | | |

| | | | |
|--------------------|--|-----------------|-----------|
| 1 | | | |
| GEV No. | 401326 | Ref. No. | R67010920 |
| description | keypad foil | | |
| For models: | ME106P, ME110P, ME120P, ME210P, ME220P, MG106P, MG110P, MG120P, MG210P, MG220P | | |

| | | | |
|--------------------|--|-----------------|-----------|
| GEV No. | 401327 | Ref. No. | R67010950 |
| description | keypad foil | | |
| For models: | VE106P, VE120P, VE210P, VE220P, VG106P, VG110P, VG120P, VG210P, VG220P | | |




| | | | |
|--------------------|------------------|-----------------|-----------|
| GEV No. | 401329 | Ref. No. | R67010870 |
| description | keypad foil | | |
| For models: | CVE004H, CVE104H | | |




| | | | |
|--------------------|-------------|-----------------|-----------|
| GEV No. | 401330 | Ref. No. | R67012910 |
| description | keypad foil | | |
| For models: | MG101P | | |



| | | | |
|--------------------|---------------------------|-----------------|-----------|
| GEV No. | 401349 | Ref. No. | R67013461 |
| description | keypad foil | | |
| For models: | MVE042P, MVE051P, MVG051P | | |



| | | | |
|--------------------|------------------------------------|-----------------|------------------------|
| GEV No. | 400688 | Ref. No. | CM247301 MACM247301 |
| description | keypad foil fryer F94/F98 | | |
| For models: | F94E18K, F94G22K, F98E18K, F98G22K | | |



| | | | |
|--------------------|--|-----------------|-----------|
| GEV No. | 504294 | Ref. No. | CR0588380 |
| description | keypad foil suitable for 900 series L 92mm W 54mm buttons 4 | | |
| For models: | NF94E222K, NF94E22K, NF94G23K, NF98E222K, NF98E22K, NF98G23K | | |

solenoid valves



solenoid valves (water)

ELBI

straight




| | | | |
|--------------------|---|-----------------|------------------------|
| GEV No. | 373021 | Ref. No. | R65110040 R65115000 |
| description | solenoid valve double straight 230VAC inlet 3/4" outlet 11.5mm output 1x 4.7l/min DN10 ELBI | | |
| For models: | CVE105H, CVE105M, CVG105H, CVG105M, EM010M+SC, EM106H, EM106M, EM106M+SC, EM106P, EM110H, EM110M, EM110M+SC, EM110P, EM210H, EM210M, EM210M+SC, EM210P, GM106H, GM106M, GM106M+SC, GM106P, GM110H, GM110M, GM110M+SC, GM110P, GM210H, GM210M, GM210M+SC, GM210P, ME106M, ME106P, ME106X, ME110M, ME110P, ME110X, ME120M, ME120P, ME120X, ME210M, ME210P, ME210X, ME220M, ME220P, ME220X, MEC24H, MEC40M, MG106M, MG106P, MG106X, MG110M...(Other models you can see in the webshop) | | |


| | | | |
|--|----------------|---|-------------------|
| spare parts for | 373021 | | |
|  | GEV No. | 370467 | Ref. No. — |
| | | solenoid valve filter suitable for ELBI | |
|  | GEV No. | 371263 | Ref. No. — |
| | | reducer ELBI type EATON (INVENSYS) flow rate 4.7l/min pressure range 0 up to 10bar tolerance ±15/25% grey | |






| | | | |
|--------------------|---|-----------------|-----------|
| GEV No. | 373017 | Ref. No. | R65110010 |
| description | solenoid valve single straight 230VAC inlet 3/4" outlet 11.5mm DN10 ELBI | | |
| For models: | EM010M+SC, EM106M, EM106M+SC, EM110M, EM110M+SC, EM210M, EM210M+SC, EV006M, EV106H, EV106M, EV106M+SC, EV106P, EV110H, EV110M, EV110M+SC, EV110P, EV210H, EV210M, EV210M+SC, EV210P, FE105M, FE105X, FE110M, FE110X, FE210M, FG105M, FG105X, FG110M, FG110X, FG210M, FG210X, GM106M, GM106M+SC, GM110M, GM110M+SC, GM210M, GM210M+SC, GV106H, GV106M, GV106M+SC, GV106P, GV110H, GV110M, GV110M+SC, GV110P, GV210H, GV210M, GV210M+SC, GV210P, ME106M...(Other models you can see in the webshop) | | |


| | | | |
|---|----------------|---|-------------------|
| spare parts for | 373017 | | |
|  | GEV No. | 370467 | Ref. No. — |
| | | solenoid valve filter suitable for ELBI | |





| angled | | | |
|---|---|----------|-------------------------|
|  | | | |
| 1 | | | |
| GEV No. | 370833 | Ref. No. | CR0682320 CR0682320R |
| description | solenoid valve single angled 230VAC inlet 3/4" outlet 11.5mm input 18.5-20l/min DN10 ELBI | | |
| For models: | NBR912EFM, NBR912EIM, NBR912GFM, NBR912GIM, NBR98EF, NBR98EFM, NBR98EI, NBR98EIM, NBR98GF, NBR98GFM, NBR98GI, NBR98GIM, NPD76G5, NPD78G8, NPD96G5, NPD98E10, NPD98E15, NPD98G10, NPD98G15, NPD98G15A, NPI76E5, NPI76G5, NPI78E8, NPI78G8, NPI96E5, NPI96G5, NPI98E10, NPI98E15, NPI98G10, NPI98G14, NPI98G14A | | |

|   | | | |
|---|--|----------|-----------|
| 1 | | | |
| GEV No. | 370360 | Ref. No. | R65115040 |
| description | solenoid valve single straight 230VAC inlet 3/4" outlet 11.5mm output 0.25l/min t.max. 90°C ELBI plastic flow regulating valve outlet white flow regulating valve inlet clear | | |
| For models: | EC110M, EC210M, EV110M, EV110M+SC, EV210M, EV210M+SC, GC110M, GC210M, GV110M, GV110M+SC, GV210M, GV210M+SC, VE106M, VE106P, VE106X, VE110M, VE110X, VE210M, VE210P, VE210X, VG106M, VG106P, VG106X, VG110M, VG110P, VG110X, VG210M, VG210P, VG210X | | |


|  | | | |
|---|---|----------|-----------|
| 1 | | | |
| GEV No. | 370359 | Ref. No. | R65115050 |
| description | solenoid valve double straight 230VAC inlet 3/4" outlet 11.5mm input 5.5l/min t.max. 90°C ELBI plastic flow regulating valve inlet yellow output A 5.5l/min output B 2l/min output A brown output B white | | |
| For models: | CVE004H, CVE004M, CVE104H, CVE104M, VE004M, VE004X, VE104M, VE104X | | |

|  | | | |
|---|--|----------|-----------|
| 1 | | | |
| GEV No. | 370361 | Ref. No. | R65115060 |
| description | solenoid valve double straight 230VAC inlet 3/4" outlet 11.5mm plastic output A 0.25l/min | | |
| For models: | VE120M, VE120P, VE120X, VE220M, VE220P, VE220X, VG120M, VG120P, VG120X, VG220M, VG220P, VG220X | | |

| spare parts and accessories | | | |
|---|---|----------|-----------|
| reducers | | | |
| outlet side | | | |
|  | | | |
| 1 | | | |
| GEV No. | 371060 | Ref. No. | R65110520 |
| description | reducer ELBI flow rate 0.25l/min pressure range 0 up to 10bar tolerance ±15/25% green | | |
| For models: | MGVT10D, MGVT10P | | |


| RPE | | | |
|---|---|----------|-----------|
| JOHN GUEST | | | |
|  | | | |
| 1 | | | |
| GEV No. | 374032 ¹ | Ref. No. | R65110230 |
| description | solenoid valve double straight 230VAC inlet 3/4" outlet 10mm DN10 plastic output A w/t membrane (constantly open) | | |
| For models: | GVT06D, GVT20D, ME061P, ME061T, ME101P, ME101T, ME102P, ME102T, ME201P, ME201T, ME202P, ME202T, MEMT40P, MEVT06D, MEVT06P, MEVT10D, MEVT10P, MEVT20D, MEVT20P, MG061P, MG061T, MG101P, MG101T, MG102P, MG102T, MG201P, MG201T, MG202P, MG202T, MGMT06P, MGMT40P, MGVT06D, MGVT06P, MGVT10D, MGVT10P, MGVT20D, MGVT20P, MGVT40P, MVE042P, MVE051P, MVG051P | | |


¹cylindrical outlet



|  | | | |
|---|--|----------|-----------|
| 1 | | | |
| GEV No. | 370768 ¹ | Ref. No. | R65110200 |
| description | solenoid valve single straight 230VAC inlet 3/4" outlet 10mm input/ min output/ min DN10 t.max. 90°C duty cycle 100% RPE | | |
| For models: | GMT06D, GMT20D, GVT06D, GVT20D, MACE04M, MACE05M, MACE07M, MACE10M, MACE20M, MACG05M, MACG07M, MACG10M, MACG20M, ME061D, ME061M, ME101D, ME101M, ME102D, ME102M, ME201D, ME201M, ME202D, ME202M, MEMT06D, MEMT06P, MEMT10D, MEMT10P, MEMT20D, MEMT20P, MEMT21D, MEMT21P, MEMT40D, MEVT06D, MEVT06P, MEVT10D, MEVT10P, MEVT20D, MEVT20P, MEVT21D, MEVT21P, MEVT40D, MEVT40P, MG061D, MG061M, MG101D, MG101M, MG102D, MG102M, MG201D, MG201M...(Other models you can see in the webshop) | | |


¹cylindrical outlet



| reducers | | | |
|---|---|----------|------------------------|
| outlet side | | | |
|  | | | |
| 1 | | | |
| GEV No. | 371269 | Ref. No. | R65110420 R65110500 |
| description | reducer flow rate 0.07-0.14l/min brown | | |
| For models: | CVE004H, CVE004M, CVE104H, CVE104M, EV106H, EV106P, EV110H, GMT06D, GV106H, GV106P, MACE04M, MACE05M, MACE07M, MACG05M, ME202D, ME202M, ME202P, MEMT06D, MEMT06P, MEMT40D, MEMT40P, MEVT06D, MEVT06P, MEVT40D, MEVT40P, MG202D, MG202M, MG202P, MG202T, MGMT06D, MGMT06P, MGMT40D, MGMT40P, MGVT40D, MGVT40P, MVE042P, MVE051P, MVG051P, VE004M, VE004X, VE104M, VE104X | | |

| solenoid valves with reducers | | | |
|---|--|----------|-----------|
| 2-fold | | | |
|  | | | |
| 1 | | | |
| GEV No. | 374031 | Ref. No. | R65110210 |
| description | solenoid valve double straight 230VAC inlet 3/4" outlet JG 10 input 10-12l/min t.max. 90°C RPE plastic flow regulating valve inlet white + outlet reducer red | | |
| For models: | GMT06D, GMT20D, ME061D, ME061M, ME061P, ME061T, ME101D, ME101M, ME101P, ME101T, ME102D, ME102M, ME102P, ME102T, ME201D, ME201M, ME201P, ME201T, ME202D, ME202M, ME202P, ME202T, MEMT06D, MEMT06P, MEMT10D, MEMT10P, MEMT20D, MEMT20P, MEMT21D, MEMT21P, MEMT40D, MEMT40P, MG061D, MG061M, MG061P, MG061T, MG101D, MG101M, MG101P, MG101T, MG102D, MG102M, MG102P, MG102T, MG201D, MG201M, MG201P, MG201T, MG202D, MG202M...(Other models you can see in the webshop) | | |

|  | | | | |
|---|--|----------|---------------------------------------|---|
| 1 | | | | |
| GEV No. | 374000 | Ref. No. | CR0586050 CR0586050R CR1220370R | |
| description | solenoid valve double straight 230VAC inlet 3/4" outlet 11.5mm input 10-12l/min DN10 t.max. 90°C RPE flow regulating valve inlet white output A 0.32-0.42l/min flow regulating valve outlet A dark green | | | |
| For models: | NPC74E, NPC74G, NPC76E, NPC76G, NPC78E, NPC78G, NPC94E, NPC94G, NPC96E, NPC96G, NPC98E, NPC98G | | | |
| accessories for | 374000 | | | |
|  | GEV No. | 371256 | Ref. No. | — |
| reducer RPE flow rate 10-12l/min pressure range 0.5-10bar white | | | | |

| 3-fold | | | |
|---|---|----------|-----------|
|  | | | |
| 1 | | | |
| GEV No. | 374033 | Ref. No. | R65110240 |
| description | solenoid valve triple straight 230VAC inlet 3/4" outlet 10mm input 10-12l/min t.max. 90°C RPE plastic flow regulating valve inlet white output B w/t membrane (constantly open) | | |
| For models: | ME061T, ME101T, ME102T, ME201T, MEMT40P, MEVT21D, MEVT21P, MEVT40D, MEVT40P, MG102T, MG201T, MG202T, MGMT40P, MGVT21D, MGVT21P, MGVT40D | | |


















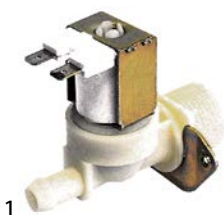


















| TP | | | | |
|---|---|----------|----------------------|---|
|  | | | | |
| 1 | | | | |
| GEV No. | 370017 | Ref. No. | 2709000 MA2709000 | |
| description | solenoid valve single straight 230VAC inlet 3/4" outlet 11.5mm DN10 TP p max 10bar | | | |
| For models: | B124E, CON102E, CON102EP, CON102G, CON102GP, CON10E, CON10EP, CON10G, CON10GP, CON6E, CON6EP, CON6G, CON6GP, CRE6220, CRE6230, CRE6320, CRE6330, CS102E, CS102EP, FC10E, FC10G, FC20E, FC20G, FC5E, FC5G, FC7E, FC7G, SBA, SBAC, SNA12, SNA16, SNA20, SNAC12, SNAC16, SNAC20, SNG08, SNG12, SNG16, SNG20, SVAC, SVAC12, SVAC16, SVAC20, SVCG, SVCG08, SVCG12, SVCG16, SVCG20, SVCG8 | | | |
| spare parts for | 370017 | | | |
|  | GEV No. | 371013 | Ref. No. | — |
| solenoid coil TP 230VAC 50/60Hz | | | | |
| accessories for | 370017 | | | |
|  | GEV No. | 371220 | Ref. No. | — |
| reducer TP flow rate 3l/min red tolerance ±15% | | | | |
|  | GEV No. | 371221 | Ref. No. | — |
| reducer TP flow rate 5.5l/min yellow tolerance ±15% | | | | |
|  | GEV No. | 371222 | Ref. No. | — |
| reducer TP flow rate 6l/min grey tolerance ±15% | | | | |
|  | GEV No. | 371223 | Ref. No. | — |
| reducer TP flow rate 10l/min white tolerance ±15% | | | | |
|  | GEV No. | 371224 | Ref. No. | — |
| reducer TP flow rate 12l/min bronze tolerance ±15% | | | | |
|  | GEV No. | 371225 | Ref. No. | — |
| reducer TP flow rate 16l/min light brown tolerance ±15% | | | | |
|  | GEV No. | 371226 | Ref. No. | — |
| reducer TP flow rate 20l/min red tolerance ±15% | | | | |
|  | GEV No. | 371230 | Ref. No. | — |
| reducer TP flow rate 0.25l/min red tolerance ±25% | | | | |

Table continues overleaf






| accessories for | | 370017 | | |
|--|---------|--------|----------|---|
|  | GEV No. | 371231 | Ref. No. | — |
| reducer TP flow rate 0.35l/min violet tolerance ±25% | | | | |
|  | GEV No. | 371232 | Ref. No. | — |
| reducer TP flow rate 0.5l/min orange tolerance ±25% | | | | |
|  | GEV No. | 371233 | Ref. No. | — |
| reducer TP flow rate 0.8l/min white tolerance ±25% | | | | |
|  | GEV No. | 371234 | Ref. No. | — |
| reducer TP flow rate 1l/min light blue tolerance ±25% | | | | |
|  | GEV No. | 371235 | Ref. No. | — |
| reducer TP flow rate 1.2l/min brown tolerance ±25% | | | | |
|  | GEV No. | 371236 | Ref. No. | — |
| reducer TP flow rate 1.5l/min light brown tolerance ±25% | | | | |
|  | GEV No. | 371237 | Ref. No. | — |
| reducer TP flow rate 2.5l/min yellow tolerance ±25% | | | | |
|  | GEV No. | 371238 | Ref. No. | — |
| reducer TP flow rate 3.4l/min dark green tolerance ±25% | | | | |
|  | GEV No. | 371239 | Ref. No. | — |
| reducer TP flow rate 5l/min black tolerance ±25% | | | | |
|  | GEV No. | 371240 | Ref. No. | — |
| reducer TP flow rate 8l/min blue tolerance ±20% | | | | |

| | | | |
|---|---|-----------------|----------|
|  | | | |
| GEV No. | 370029 | Ref. No. | 2956900 |
| description | solenoid valve single straight 24VAC inlet 3/4" outlet 11.5mm DN10 TP flow regulating valve inlet white | | |
| For models: | CON201E, CON201EP, CON201G, CON201GP, CON202E, CON202EP, CON202G, CON202GP, CS4E, CS4EP, CSM102E, CSM102EP, CSM102G, CSM102GP, CSM10E, CSM10EP, CSM10G, CSM10GP, CSM201E, CSM201EP, CSM201G, CSM201GP, CSM202E, CSM202EP, CSM202G, CSM202GP, CSM6E, CSM6EP, CSM6G, CSM6GP | | |
| spare parts for | | 370029 | |
|  | GEV No. | 371035 | Ref. No. |
| solenoid coil 24VAC | | | |
| accessories for | | 370029 | |
|  | GEV No. | 371220 | Ref. No. |
| reducer TP flow rate 3l/min red tolerance ±15% | | | |
|  | GEV No. | 371221 | Ref. No. |
| reducer TP flow rate 5.5l/min yellow tolerance ±15% | | | |
|  | GEV No. | 371222 | Ref. No. |
| reducer TP flow rate 6l/min grey tolerance ±15% | | | |

| accessories for | | 370029 | | |
|---|---------|--------|----------|---|
|  | GEV No. | 371223 | Ref. No. | — |
| reducer TP flow rate 10l/min white tolerance ±15% | | | | |
|  | GEV No. | 371224 | Ref. No. | — |
| reducer TP flow rate 12l/min bronze tolerance ±15% | | | | |
|  | GEV No. | 371225 | Ref. No. | — |
| reducer TP flow rate 16l/min light brown tolerance ±15% | | | | |
|  | GEV No. | 371226 | Ref. No. | — |
| reducer TP flow rate 20l/min red tolerance ±15% | | | | |
|  | GEV No. | 371230 | Ref. No. | — |
| reducer TP flow rate 0.25l/min red tolerance ±25% | | | | |
|  | GEV No. | 371231 | Ref. No. | — |
| reducer TP flow rate 0.35l/min violet tolerance ±25% | | | | |
|  | GEV No. | 371232 | Ref. No. | — |
| reducer TP flow rate 0.5l/min orange tolerance ±25% | | | | |
|  | GEV No. | 371233 | Ref. No. | — |
| reducer TP flow rate 0.8l/min white tolerance ±25% | | | | |
|  | GEV No. | 371234 | Ref. No. | — |
| reducer TP flow rate 1l/min light blue tolerance ±25% | | | | |
|  | GEV No. | 371235 | Ref. No. | — |
| reducer TP flow rate 1.2l/min brown tolerance ±25% | | | | |
|  | GEV No. | 371236 | Ref. No. | — |
| reducer TP flow rate 1.5l/min light brown tolerance ±25% | | | | |
|  | GEV No. | 371237 | Ref. No. | — |
| reducer TP flow rate 2.5l/min yellow tolerance ±25% | | | | |
|  | GEV No. | 371238 | Ref. No. | — |
| reducer TP flow rate 3.4l/min dark green tolerance ±25% | | | | |
|  | GEV No. | 371239 | Ref. No. | — |
| reducer TP flow rate 5l/min black tolerance ±25% | | | | |
|  | GEV No. | 371240 | Ref. No. | — |
| reducer TP flow rate 8l/min blue tolerance ±20% | | | | |

| | | | |
|---|--|-----------------|----------|
|  | | | |
| 1 | | | |
| GEV No. | 370019 | Ref. No. | 120142 |
| description | solenoid valve double angled 230VAC inlet 3/4" outlet 11.5mm DN10 TP plastic | | |
| spare parts for | 370019 | | |
| | GEV No. | 371013 | Ref. No. |
| |  solenoid coil TP 230VAC 50/60Hz | | |
| accessories for | 370019 | | |
| | GEV No. | 371220 | Ref. No. |
| |  reducer TP flow rate 3l/min red tolerance ±15% | | |
| | GEV No. | 371221 | Ref. No. |
| |  reducer TP flow rate 5.5l/min yellow tolerance ±15% | | |
| | GEV No. | 371222 | Ref. No. |
| |  reducer TP flow rate 6l/min grey tolerance ±15% | | |
| | GEV No. | 371223 | Ref. No. |
| |  reducer TP flow rate 10l/min white tolerance ±15% | | |
| | GEV No. | 371224 | Ref. No. |
| |  reducer TP flow rate 12l/min bronze tolerance ±15% | | |
| | GEV No. | 371225 | Ref. No. |
| |  reducer TP flow rate 16l/min light brown tolerance ±15% | | |
| | GEV No. | 371226 | Ref. No. |
| |  reducer TP flow rate 20l/min red tolerance ±15% | | |
| | GEV No. | 371230 | Ref. No. |
| |  reducer TP flow rate 0.25l/min red tolerance ±25% | | |
| | GEV No. | 371231 | Ref. No. |
| |  reducer TP flow rate 0.35l/min violet tolerance ±25% | | |
| | GEV No. | 371232 | Ref. No. |
| |  reducer TP flow rate 0.5l/min orange tolerance ±25% | | |
| | GEV No. | 371233 | Ref. No. |
| |  reducer TP flow rate 0.8l/min white tolerance ±25% | | |
| | GEV No. | 371234 | Ref. No. |
| |  reducer TP flow rate 1l/min light blue tolerance ±25% | | |
| | GEV No. | 371235 | Ref. No. |
| |  reducer TP flow rate 1.2l/min brown tolerance ±25% | | |
| | GEV No. | 371236 | Ref. No. |
| |  reducer TP flow rate 1.5l/min light brown tolerance ±25% | | |
| | GEV No. | 371237 | Ref. No. |
| |  reducer TP flow rate 2.5l/min yellow tolerance ±25% | | |

| | | | |
|------------------------|---|--------|----------|
| accessories for | 370019 | | |
| | GEV No. | 371238 | Ref. No. |
| |  reducer TP flow rate 3.4l/min dark green tolerance ±25% | | |
| | GEV No. | 371239 | Ref. No. |
| |  reducer TP flow rate 5l/min black tolerance ±25% | | |
| | GEV No. | 371240 | Ref. No. |
| |  reducer TP flow rate 8l/min blue tolerance ±20% | | |


























| | | | |
|--|---|-----------------|----------------------|
|  | | | |
| 1 | | | |
| GEV No. | 370109 | Ref. No. | 5151500 MA5151500 |
| description | solenoid valve double angled 24VAC inlet 3/4" outlet 11.5mm DN10 t.max. 90°C TP plastic flow regulating valve inlet white | | |
| For models: | CSM201E, CSM201EP, CSM201G, CSM201GP, CSM202E, CSM202EP, CSM202G, CSM202GP | | |
| spare parts for | 370109 | | |
| | GEV No. | 371035 | Ref. No. |
| |  solenoid coil 24VAC | | |
| accessories for | 370109 | | |
| | GEV No. | 371220 | Ref. No. |
| |  reducer TP flow rate 3l/min red tolerance ±15% | | |
| | GEV No. | 371221 | Ref. No. |
| |  reducer TP flow rate 5.5l/min yellow tolerance ±15% | | |
| | GEV No. | 371222 | Ref. No. |
| |  reducer TP flow rate 6l/min grey tolerance ±15% | | |
| | GEV No. | 371223 | Ref. No. |
| |  reducer TP flow rate 10l/min white tolerance ±15% | | |
| | GEV No. | 371224 | Ref. No. |
| |  reducer TP flow rate 12l/min bronze tolerance ±15% | | |
| | GEV No. | 371225 | Ref. No. |
| |  reducer TP flow rate 16l/min light brown tolerance ±15% | | |
| | GEV No. | 371226 | Ref. No. |
| |  reducer TP flow rate 20l/min red tolerance ±15% | | |
| | GEV No. | 371230 | Ref. No. |
| |  reducer TP flow rate 0.25l/min red tolerance ±25% | | |
| | GEV No. | 371231 | Ref. No. |
| |  reducer TP flow rate 0.35l/min violet tolerance ±25% | | |
| | GEV No. | 371232 | Ref. No. |
| |  reducer TP flow rate 0.5l/min orange tolerance ±25% | | |









Table continues overleaf




| accessories for | | 370109 | | |
|---|----------|----------|----------|--|
| GEV No. | Ref. No. | Ref. No. | Ref. No. | — |
|  | 371233 | Ref. No. | — | reducer TP flow rate 0.8l/min white tolerance ±25% |
|  | 371234 | Ref. No. | — | reducer TP flow rate 1l/min light blue tolerance ±25% |
|  | 371235 | Ref. No. | — | reducer TP flow rate 1.2l/min brown tolerance ±25% |
|  | 371236 | Ref. No. | — | reducer TP flow rate 1.5l/min light brown tolerance ±25% |
|  | 371237 | Ref. No. | — | reducer TP flow rate 2.5l/min yellow tolerance ±25% |
|  | 371238 | Ref. No. | — | reducer TP flow rate 3.4l/min dark green tolerance ±25% |
|  | 371239 | Ref. No. | — | reducer TP flow rate 5l/min black tolerance ±25% |
|  | 371240 | Ref. No. | — | reducer TP flow rate 8l/min blue tolerance ±20% |



| GEV No. | Ref. No. | Ref. No. | Ref. No. | — |
|---|------------|----------|----------|---|
| 370015 | 1037308800 | | | |
| description solenoid valve single angled 230VAC inlet 3/4" outlet 11.5mm DN10 TP | | | | |
| For models: DLS30, DLS303, DLS30P, DLS30P3, DLS31, DLS313, DLS31P3, MLC50, MLC503, MLC65, MLC653, MLS30, MLS303, MLS30P, MLS30P3, MLS31, MLS313, MLS31P3, MLS35, MLS353, MPLS30P | | | | |
| accessories for | | 370015 | | |
|  | 371220 | Ref. No. | — | reducer TP flow rate 3l/min red tolerance ±15% |
|  | 371221 | Ref. No. | — | reducer TP flow rate 5.5l/min yellow tolerance ±15% |
|  | 371222 | Ref. No. | — | reducer TP flow rate 6l/min grey tolerance ±15% |
|  | 371223 | Ref. No. | — | reducer TP flow rate 10l/min white tolerance ±15% |
|  | 371224 | Ref. No. | — | reducer TP flow rate 12l/min bronze tolerance ±15% |
|  | 371225 | Ref. No. | — | reducer TP flow rate 16l/min light brown tolerance ±15% |
|  | 371226 | Ref. No. | — | reducer TP flow rate 20l/min red tolerance ±15% |

| accessories for | | 370015 | | |
|---|----------|----------|----------|--|
| GEV No. | Ref. No. | Ref. No. | Ref. No. | — |
|  | 371230 | Ref. No. | — | reducer TP flow rate 0.25l/min red tolerance ±25% |
|  | 371231 | Ref. No. | — | reducer TP flow rate 0.35l/min violet tolerance ±25% |
|  | 371232 | Ref. No. | — | reducer TP flow rate 0.5l/min orange tolerance ±25% |
|  | 371233 | Ref. No. | — | reducer TP flow rate 0.8l/min white tolerance ±25% |
|  | 371234 | Ref. No. | — | reducer TP flow rate 1l/min light blue tolerance ±25% |
|  | 371235 | Ref. No. | — | reducer TP flow rate 1.2l/min brown tolerance ±25% |
|  | 371236 | Ref. No. | — | reducer TP flow rate 1.5l/min light brown tolerance ±25% |
|  | 371237 | Ref. No. | — | reducer TP flow rate 2.5l/min yellow tolerance ±25% |
|  | 371238 | Ref. No. | — | reducer TP flow rate 3.4l/min dark green tolerance ±25% |
|  | 371239 | Ref. No. | — | reducer TP flow rate 5l/min black tolerance ±25% |
|  | 371240 | Ref. No. | — | reducer TP flow rate 8l/min blue tolerance ±20% |


solenoid valves with reducers

| | | | |
|---|--|-----------------|--------|
|  <p>Image not available</p> | | | |
| GEV No. | 370011 | Ref. No. | 120144 |
| description | solenoid valve double angled 230VAC inlet 3/4" outlet 11.5mm | | |

spare parts and accessories

reducers

outlet side

| | | | |
|---|--|-----------------|-----------|
|  | | | |
| GEV No. | 691081 | Ref. No. | R65110410 |
| description | reducer flow rate 0.25l/min green tolerance ±25% | | |
| For models: | CVE105H, CVE105M, CVG105H, CVG105M, EV110P, EV210H, EV210P, GV110H, GV110P, GV210H, GV210P, VE105M, VE105X, VG105M, VG105X | | |



various



| | | | |
|--------------------|--|-----------------|-----------|
| GEV No. | 374057 | Ref. No. | R65115120 |
| description | solenoid valve single straight 230VAC inlet 3/4" outlet 11.5mm output 0.12l/min ELBI | | |
| For models: | EC106M, EV006M, EV106M, EV106M+SC, GC106M, GV106M, GV-106M+SC | | |



| | | | |
|--------------------|--|-----------------|-----------|
| GEV No. | 370363 | Ref. No. | R65110260 |
| description | solenoid valve single straight cable length 600mm suitable for LAINOX | | |
| For models: | ME061T, ME101T, ME102T, ME201T, MEMT06P, MEMT10P, MEMT20P, MEMT21P, MEMT40P, MG102T, MG201T, MG202T, MGMT06P, MGMT10P, MGMT20P, MGMT21P, MGMT40P | | |

metal


SIRAI


2-way


L180-B series



| | | | |
|------------------------|--|-----------------|--------|
| GEV No. | 370329 | Ref. No. | 120131 |
| description | solenoid valve 2-ways 24VAC inlet 1/2" outlet 1/2" connection 1/2" L 66mm DN 13.5mm slide-on receptacle compact -10 up to +90°C SIRAI type series L180-B coil type Z610A membranes NBR (water) p max 12bar p min 0.35bar | | |
| spare parts for | 370329 | | |

| | | | | |
|---|--|--------|-----------------|--------|
|  | GEV No. | 371070 | Ref. No. | 630948 |
| | solenoid coil 24VAC 10VA SIRAI coil type Z610A seat ø 10mm | | | |

| | | | | |
|---|--|--------|-----------------|---|
|  | GEV No. | 371171 | Ref. No. | — |
| | membrane series L180-B membrane type NBR (water) | | | |

| | | | | |
|---|--|--------|-----------------|---|
| accessories for | 370329 | | | |
|  | GEV No. | 371091 | Ref. No. | — |
| | power socket plug type DIN 43650B cable lengthmm small | | | |


solenoid valves steam (water)

2-way

L153-D series



| | | | |
|------------------------|--|-----------------|----------|
| GEV No. | 370326 | Ref. No. | 21504199 |
| description | solenoid valve 2-ways 230VAC connection 1" L 105mm DN 22mm slide-on receptacle DIN -10 up to 140°C SIRAI type series L153-D coil type Z914A membranes EPDM (steam/water) p max 8bar p min 0.1bar | | |
| spare parts for | 370326 | | |

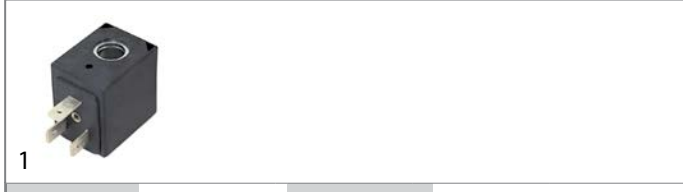
| | | | | |
|---|--|--------|-----------------|---|
|  | GEV No. | 371161 | Ref. No. | — |
| | solenoid coil 230VAC 27VA SIRAI coil type Z923A seat ø 16mm 50Hz | | | |




| | | | |
|--------------------|--|-----------------|--------|
| GEV No. | 370327 | Ref. No. | 120166 |
| description | solenoid valve 2-ways 24VAC connection 1" L 105mm DN 22mm -10 up to 140°C SIRAI coil type Z923A membranes EPDM (steam/water) p max 8bar p min 0.1bar | | |

spare parts and accessories

solenoid coils




| | | | |
|------------------------|--|-----------------|--------|
| GEV No. | 371070 | Ref. No. | 630948 |
| description | solenoid coil 24VAC 10VA SIRAI coil type Z610A seat ø 10mm | | |
| accessories for | 371070 | | |


| | | | | |
|---|--|--------|-----------------|---|
|  | GEV No. | 371091 | Ref. No. | — |
| | power socket plug type DIN 43650B cable lengthmm small | | | |




| | | | |
|--------------------|--|-----------------|--------|
| GEV No. | 371068 | Ref. No. | 630972 |
| description | solenoid coil 24VAC 14VA SIRAI coil type Z534A seat ø 12mm | | |




| | | | |
|---|--|-----------------|--------|
|  | | | |
| 1 | | | |
| GEV No. | 371162 | Ref. No. | 630976 |
| description | solenoid coil 24VAC 27VA SIRAI seat ø 16mm | | |

| membranes | | | |
|---|---|-----------------|--------|
|  | | | |
| 1 | | | |
| GEV No. | 371169 | Ref. No. | 630629 |
| description | membrane connection 1" series L153-D membrane type EPDM | | |

| | | | |
|---|---|-----------------|--------|
|  | | | |
| 1 | | | |
| GEV No. | 371168 | Ref. No. | 630628 |
| description | membrane connection 3/4" series L153-D membrane type EPDM | | |

ball valves electric



| | | | |
|--|--|-----------------|-----------|
|  | | | |
| 1 | | | |
| GEV No. | 403042 | Ref. No. | R65110560 |
| description | ball valve inlet 3/4" IT outlet 3/4" IT 230V L 68mm closed off-current mode of operation electric connection cable 400mm | | |
| For models: | GMT06D, GMT20D, ME061D, ME061P, ME061T, ME101D, ME101M, ME101P, ME101T, ME102D, ME102M, ME102P, ME102T, ME201D, ME201M, ME201P, ME201T, ME202D, ME202M, ME202P, ME202T, MEMENT06D, MEMENT06P, MEMENT10D, MEMENT10P, MEMENT20D, MEMENT20P, MEMENT21D, MEMENT21P, MEMENT40D, MEMENT40P, MG061D, MG061M, MG061P, MG061T, MG101D, MG101M, MG101P, MG101T, MG102D, MG102M, MG102P, MG102T, MG201D, MG201M, MG201P, MG201T, MG202D, MG202M, MG202P...(Other models you can see in the webshop) | | |


pressure switches


for warewashing


ø 58mm with male faston 6.3mm

with connection horizontal


| | | | |
|--|--|-----------------|---------------------------|
|  | | | |
| 1 | | | |
| GEV No. | 541830 | Ref. No. | CR0585951 |
| description | pressure control pressure range 260/230mbar connection 6mm ø 58mm pressure connection ø 6mm | | |
| For models: | NPC74E, NPC74G, NPC76E, NPC76G, NPC78E, NPC78G, NPC94E, NPC94G, NPC96E, NPC96G, NPC98E, NPC98G | | |
| accessories for | 541830 | | |
| | GEV No. | 541831 | Ref. No. CR0731840 |
| |  bracket metal for pressure switch mounting distance 38.5mm | | |


| | | | |
|---|--|-----------------|------------|
|  | | | |
| 1 | | | |
| GEV No. | 541047 | Ref. No. | 1037308700 |
| description | pressure control pressure range 340/200mbar connection 6mm ø 58mm pressure connection horizontal warewashing | | |
| For models: | MLC50, MLC503, MLC65, MLC653 | | |


| | | | |
|--|--|-----------------|------------|
|  | | | |
| 1 | | | |
| GEV No. | 541046 | Ref. No. | 1037302800 |
| description | pressure control pressure range 45/20mbar connection 6mm ø 58mm pressure connection horizontal warewashing | | |
| For models: | DLS30, DLS303, DLS30P, DLS30P3, DLS31, DLS313, DLS31P3, MLS30, MLS303, MLS30P, MLS30P3, MLS31, MLS313, MLS31P3, MLS35, MLS353, MPLS30P | | |

| | | | |
|--|--|-----------------|--------|
|  | | | |
| 1 | | | |
| GEV No. | 541039 | Ref. No. | 130621 |
| description | pressure control pressure range 45/25mbar connection 6mm ø 58mm pressure connection horizontal warewashing | | |




| | | | |
|---|--|-----------------|--------|
|  | | | |
| 1 | | | |
| GEV No. | 541010 | Ref. No. | 130605 |
| description | pressure control pressure range 50/30mbar connection 6mm ø 58mm pressure connection horizontal warewashing | | |


| | | | |
|---|--|-----------------|---------|
|  | | | |
| 1 | | | |
| GEV No. | 541003 | Ref. No. | 1662600 |
| description | pressure control pressure range 55/35mbar connection 6mm ø 58mm pressure connection horizontal warewashing pressure connection ø 6mm | | |

| | | | |
|---|--|-----------------|--------|
|  | | | |
| 1 | | | |
| GEV No. | 541012 | Ref. No. | 130604 |
| description | pressure control pressure range 68/40mbar connection 6mm ø 58mm pressure connection horizontal warewashing pressure connection ø 6mm | | |


miscellaneous


| | | | |
|---|---|-----------------|------------|
|  | | | |
| 1 | | | |
| GEV No. | 541038 | Ref. No. | 1037302900 |
| description | pressure control double | | |
| For models: | DLS30, DLS303, DLS30P, DLS30P3, DLS31, DLS313, DLS31P3, MLS30, MLS303, MLS30P, MLS30P3, MLS31, MLS313, MLS31P3, MPLS30P | | |

accessories


| | | | |
|---|--|-----------------|-----------|
|  | | | |
| 1 | | | |
| GEV No. | 541831 | Ref. No. | CR0731840 |
| description | bracket metal for pressure switch mounting distance 38.5mm | | |
| For models: | NPC94E, NPC94G, NPC98E, NPC98G | | |

for gas equipment


| | | | |
|---|--|-----------------|----------------------|
|  | | | |
| 1 | | | |
| GEV No. | 541051 | Ref. No. | 5151000 MA5151000 |
| description | pressure control ø 45mm pressure range adjustable 10-50mbar pressure connection vertical gas technology connection 1/4" pressure connection ø 1/4"mm | | |
| For models: | CON102G, CON102GP, CON10G, CON10GP, CON201G, CON201GP, CON202G, CON202GP, CON6G, CON6GP, CP9A15GD, CSM102G, CSM102GP, CSM10G, CSM10GP, CSM201G, CSM201GP, CSM202G, CSM202GP, CSM6G, CSM6GP | | |

| | | | |
|---|--|-----------------|-----------|
|  | | | |
| 1 | | | |
| GEV No. | 541073 | Ref. No. | R63070010 |
| description | pressure control ø 45mm pressure range adjustable 5-20mbar pressure connection vertical gas technology connection 1/4" pressure connection ø 1/4"mm | | |
| For models: | CVG105H, CVG105M, GC106M, GC110M, GC210M, GM106H, GM106M, GM106M+SC, GM106P, GM110H, GM110M, GM110M+SC, GM110P, GM210H, GM210M, GM210M+SC, GM210P, GMT06D, GMT20D, GV106H, GV106M, GV106M+SC, GV106P, GV110H, GV110M, GV110M+SC, GV110P, GV210H, GV210M, GV210M+SC, GV210P, GVT06D, GVT20D, MACG05M, MACG07M, MACG10M, MACG20M, MG061D, MG061M, MG061P, MG061T, MG101D, MG101M, MG101P, MG101T, MG102D, MG102M, MG102P, MG102T, MG106M...(Other models you can see in the webshop) | | |


for steam control


| | | | |
|---|---|-----------------|-----------|
|  | | | |
| 1 | | | |
| GEV No. | 541795 | Ref. No. | CR0587800 |
| description | pressure control ø 45mm pressure connection vertical steam control pressure range -1 up to +1bar connection male faston 6.3mm BECK pressure connection 3/8" | | |
| For models: | NPI76E5, NPI76G5, NPI78E8, NPI78G8, NPI96E5, NPI96G5, NPI98E10, NPI98E15, NPI98G10, NPI98G14, NPI98G14A | | |




| | | | |
|---|---|-----------------|-----------|
|  | | | |
| 1 | | | |
| GEV No. | 541074 | Ref. No. | R63070050 |
| description | pressure control ø 45mm triggering pressure 0.5bar reset pressure 0.35bar pressure connection vertical steam control pressure range 0.35/0.51bar connection 1/8" pressure connection 1/8" | | |
| For models: | EV106H, EV106P, EV110H, EV110P, EV210H, EV210P, GV106H, GV106P, GV110H, GV110P, GV210H, GV210P, GVT06D, GVT20D, MEVT06D, MEVT06P, MEVT10D, MEVT10P, MEVT20D, MEVT20P, MEVT21D, MEVT21P, MEVT40D, MEVT40P, MGVT06D, MGVT06P, MGVT10D, MGVT10P, MGVT20D, MGVT20P, MGVT21D, MGVT21P, MGVT40D, MGVT40P, MVE042P, MVE051P, MVG051P, VE106P, VE120P, VE210P, VE220P, VG106P, VG110P, VG120P, VG210P, VG220P | | |


electrodes


| | | | |
|---|--|-----------------|---------|
|  | | | |
| 1 | | | |
| GEV No. | 401154 | Ref. No. | 2911600 |
| description | level electrode 1/4" total length 126mm probe L 100mm insulated probe length 26mm connection male faston 6.3mm stainless steel ø 2.5mm | | |
| For models: | CS6G, CSM6G, CSM6GP | | |


| | | | |
|--|--|-----------------|---------|
|  | | | |
| 1 | | | |
| GEV No. | 401162 | Ref. No. | 2916100 |
| description | level electrode 1/4" total length 129mm probe L 103mm insulated probe length 26mm connection male faston 6.3mm stainless steel ø 2.5mm | | |
| For models: | CS4E, CS4EP, CS6E, CS6EP, CSM6E, CSM6EP | | |


| | | | |
|---|--|-----------------|---------|
|  | | | |
| 1 | | | |
| GEV No. | 401155 | Ref. No. | 2911700 |
| description | level electrode 1/4" total length 133mm probe L 106mm insulated probe length 26mm connection male faston 6.3mm stainless steel ø 2.5mm | | |
| For models: | CS6G, CSM6G, CSM6GP | | |


| | | | |
|---|--|-----------------|---------|
|  | | | |
| 1 | | | |
| GEV No. | 401163 | Ref. No. | 2916200 |
| description | level electrode 1/4" total length 136mm probe L 110mm insulated probe length 27mm connection male faston 6.3mm stainless steel ø 2.5mm | | |
| For models: | CS4E, CS4EP, CS6E, CS6EP, CSM6E, CSM6EP | | |


| | | | |
|--|--|-----------------|---------|
|  | | | |
| 1 | | | |
| GEV No. | 401164 | Ref. No. | 2899600 |
| description | level electrode 1/4" total length 147mm probe L 120mm insulated probe length 26mm connection male faston 6.3mm stainless steel ø 2.5mm | | |
| For models: | CS10E, CS10EP, CSM10E, CSM10EP | | |

| | | | |
|--|--|-----------------|---------|
|  | | | |
| 1 | | | |
| GEV No. | 401157 | Ref. No. | 2908300 |
| description | level electrode 1/4" total length 150mm probe L 122mm insulated probe length 26mm connection male faston 6.3mm stainless steel ø 2.5mm | | |
| For models: | CS102E, CS102EP, CS10G, CSM102E, CSM102EP, CSM10G, CSM10GP, CSM201E, CSM201EP, CSM201G, CSM201GP, CSM202E, CSM202EP | | |

| | | | |
|--|--|-----------------|---------|
|  | | | |
| 1 | | | |
| GEV No. | 401156 | Ref. No. | 2911800 |
| description | level electrode 1/4" total length 150mm probe L 124mm insulated probe length 26mm connection male faston 6.3mm stainless steel ø 2.5mm | | |
| For models: | CS6G, CSM10E, CSM10EP, CSM6E, CSM6EP, CSM6G, CSM6GP | | |

| | | | |
|--|--|-----------------|---------|
|  | | | |
| 1 | | | |
| GEV No. | 401158 | Ref. No. | 2908200 |
| description | level electrode 1/4" total length 162mm probe L 134mm insulated probe length 26mm connection male faston 6.3mm stainless steel ø 2.5mm | | |
| For models: | CS102E, CS102EP, CS10G, CSM102E, CSM102EP, CSM10G, CSM10GP, CSM201E, CSM201EP, CSM201G, CSM201GP, CSM202E, CSM202EP | | |

| | | | |
|--|--|-----------------|---------|
|  | | | |
| 1 | | | |
| GEV No. | 401165 | Ref. No. | 2899800 |
| description | level electrode 1/4" total length 165mm probe L 138mm insulated probe length 26mm connection male faston 6.3mm stainless steel ø 2.5mm | | |
| For models: | CS10E, CS10EP, CSM10E, CSM10EP | | |

| | | | |
|--|--|-----------------|---------|
|  | | | |
| 1 | | | |
| GEV No. | 401160 | Ref. No. | 2908100 |
| description | level electrode 1/4" total length 186mm probe L 158mm insulated probe length 26mm connection male faston 6.3mm stainless steel ø 2.5mm | | |
| For models: | CS102E, CS102EP, CS102G, CS102GP, CS10G, CSM102G, CSM102GP, CSM201E, CSM201EP, CSM201G, CSM201GP, CSM202E, CSM202EP, CSM202G, CSM202GP | | |



compressors

ACC/ZEL

R404a/R507

LBP monophase

Lower evaporation temperature below -20°C



| | | | |
|--------------------|---|-----------------|------------------------|
| GEV No. | 605073 | Ref. No. | 25017199 MA25017199 |
| description | compressor coolant R404a/R507 type MP14FB 220-240V 50Hz LBP fully hermetic 13.9kg 1/2HP cylinder capacity 14cm ³ CSIR H 203.6mm 439W 584W 746W 926W 1124WWWWW test method ASHRAE | | |
| For models: | EF143MNI, EF70MF, EF70MN, EF70MP, EF72MNF, FB140FN, FB140NN, FB140PF, FB140PN, FB140PP, FB143NI, FB55F, FB55N, FB55P, FB70F, FB70N, FB70P, FB72F, FB72N, FB72NF, FB72P, FS140FI, FS140FN, FS140I, FS140NI, FS140NN, FS140PN, FS140PP, FS143FI, FS143NF, FS143NI, FS143NN, FS143NP, FS70F, FS70FG, FS70I, FS70N, FS70NG, FS70P, FS72F, FS72IF, FS72IN, FS72N, FS72NF, FS72NN, FS72P, HF140D-FN, HF140DNN, HF140DPF, HF140DPN...(Other models you can see in the webshop) | | |

CUBIGEL


R404a/R507


LBP monophase


Lower evaporation temperature below -20°C



| | | | |
|--------------------|---|-----------------|----------|
| GEV No. | 605138 | Ref. No. | 25016899 |
| description | compressor coolant R404a/R507 type MP12FB 220-240V 50Hz LBP 12kg 3/8HP cylinder capacity 12cm ³ CSIR H 215mm 381W 510W 657W 819W 999WWWWW test method ASHRAE | | |
| For models: | EF143MNI, EF70MF, EF70MN, EF70MP, EF72MNF, FB140FN, FB140NN, FB140PF, FB140PN, FB140PP, FB143NI, FB55F, FB55N, FB55P, FB70F, FB70N, FB70P, FB72F, FB72N, FB72NF, FB72P, FS140FI, FS140FN, FS140I, FS140NI, FS140NN, FS140PN, FS140PP, FS143FI, FS143NF, FS143NI, FS143NN, FS143NP, FS70F, FS70FG, FS70I, FS70N, FS70NG, FS70P, FS72F, FS72IF, FS72IN, FS72N, FS72NF, FS72NN, FS72P, HF140D-FN, HF140DNN, HF140DPF, HF140DPN...(Other models you can see in the webshop) | | |

| | | | |
|---|--|-----------------|---------|
|  | | | |
| 1 | | | |
| GEV No. | 401159 | Ref. No. | 2987000 |
| description | level electrode 1/4" total length 187mm probe L 160mm insulated probe length 26mm connection male faston 6.3mm stainless steel ø 2.5mm | | |
| For models: | CS102G, CS102GP, CSM102E, CSM102EP, CSM102G, CSM102GP, CSM10G, CSM10GP, CSM201E, CSM201EP, CSM201G, CSM201GP, CSM202G, CSM202GP | | |

| | | | |
|---|--|-----------------|----------------------|
|  | | | |
| 1 | | | |
| GEV No. | 401161 | Ref. No. | 2927500 MA2927500 |
| description | level electrode 1/4" total length 210mm probe L 184mm insulated probe length 26mm connection male faston 6.3mm stainless steel ø 2.5mm | | |
| For models: | CS102G, CS102GP, CSM102G, CSM102GP, CSM201E, CSM201EP, CSM201G, CSM201GP, CSM202G, CSM202GP | | |

| | | | |
|---|---|-----------------|-----------|
|  | | | |
| 1 | | | |
| GEV No. | 400130 | Ref. No. | R65320010 |
| description | level electrode M14x1.25 total length 220mm probe L 194mm insulated probe length 26mm connection male faston 6.3mm ø 2.5mm | | |
| For models: | EM010M+SC, EM106H, EM106M, EM106M+SC, EM106P, EM110H, EM110M, EM110M+SC, EM110P, EM210H, EM210M, EM210M+SC, EM210P, GM106H, GM106M, GM106M+SC, GM106P, GM110H, GM110M, GM110M+SC, GM110P, GM210H, GM210M, GM210M+SC, GM210P, GMT06D, GMT20D, ME061D, ME061P, ME061T, ME101D, ME101M, ME101P, ME101T, ME102D, ME102M, ME102P, ME102T, ME106M, ME106P, ME106X, ME110M, ME110P, ME110X, ME120M, ME120P, ME120X, ME201D, ME201M, ME201P...(Other models you can see in the webshop) | | |



L'UNITE HERMETIQUE / TECUMSEH


R404A
HMBP monophase

High/Medium evaporation temperature above -20/-15 °C



| | | | |
|--------------------|--|-----------------|----------|
| GEV No. | 605027 | Ref. No. | RA070029 |
| description | compressor coolant R404A type CAJ4517Z 220-240V 50Hz HMBP fully hermetic 24kg 1.2HP cylinder capacity 25.95cm ³ CSR H 282mm WW 1588W 1987W 2451W 2971W 3536W 4132W test method EN 12900 4742W | | |



| | | | |
|---|--|-----------------|------------------------|
| GEV No. | 601038 ¹ | Ref. No. | CM250700 MACM250700 |
| description | axial fan L 80mm W 80mm H 38mm 230VAC 50/60Hz 12W bearing ball bearing manuf. no. 8556N metal connection cable 300mm ebm-papst fan wheel ø 75mm temp.-resist. 90°C airflow 50m ³ /h | | |
| For models: | F94E18K, F94G22K, F98E18K, F98G22K, F9S4E18K, F9S4G22K, F9S8E18K, F9S8G22K | | |
| accessories for | 601038 | | |
|  | GEV No. | 691102 | Ref. No. — |
| | guard ø 75mm mounting distance 71mm for axial fan 80mm | | |



¹with ball bearings

fans

axial fans

ebm-papst





| | | | |
|---|--|-----------------|-------------------|
| GEV No. | 601030 ¹ | Ref. No. | R65060050 |
| description | axial fan L 119mm W 119mm H 38mm 230VAC 50Hz 18W bearing ball bearing manuf. no. 4656Z metal connection male faston 2.8mm ebm-papst fan wheel ø 110mm temp.-resist. 75°C | | |
| For models: | EC106M, EC110M, EC210M, EM010M+SC, EM106H, EM106M, EM106M+SC, EM106P, EM110H, EM110M, EM110M+SC, EM110P, EM210H, EM210M, EM210M+SC, EM210P, EV006M, EV106H, EV106M, EV106M+SC, EV106P, EV110H, EV110M, EV110M+SC, EV110P, EV210H, EV210M, EV210M+SC, EV210P, GC106M, GC110M, GC210M, GM106H, GM106M, GM106M+SC, GM106P, GM110H, GM110M, GM110M+SC, GM110P, GM210H, GM210M, GM210M+SC, GM210P, GMT06D, GMT20D, GV106H, GV106M, GV106M+SC, GV106P..(Other models you can see in the webshop) | | |
| accessories for | 601030 | | |
|  | GEV No. | 550898 | Ref. No. — |
| | connecting cable cable length 2000mm connection F 2.8 connection distance 7.9mm for axial flow fan | | |
|  | GEV No. | 692497 | Ref. No. — |
| | guard ø 105mm mounting distance 150mm for axial fan ebm-papst-mm | | |

¹with ball bearings

import



| | | | |
|---|--|-----------------|------------------------|
| GEV No. | 601080 ¹ | Ref. No. | CM303000 MACM303000 |
| description | axial fan L 119mm W 119mm H 38mm 230VAC 50/60Hz 23/20W bearing ball bearing connection male faston 2.8mm metal ADDA fan wheel ø 110mm temp.-resist. 70°C | | |
| For models: | CT78EC, CT7FE8EC, CT98EC, CT9FE8EC, NCT78E, NCT7FE8E, NCT98E, NCT98E2, NCT9FE8E, NCT9FE8E2, NF94G23K, NF98G23K | | |
| accessories for | 601080 | | |
|  | GEV No. | 550898 | Ref. No. — |
| | connecting cable cable length 2000mm connection F 2.8 connection distance 7.9mm for axial flow fan | | |
|  | GEV No. | 692519 | Ref. No. — |
| | guard L 120mm W 120mm plastic | | |

¹with ball bearings

refrigeration fans


refrigeration motors universal

ELCO

N series - multi fit



1

| | | | |
|---|--|-----------------|------------------------------------|
| GEV No. | 601528 | Ref. No. | 12214099 25314099 MA25314099 |
| description | fan motor ELCO 16W 230V 50/60Hz bearing slide bearing L1 48mm L2 64mm L3 91.5mm W 83mm connection cable 500mm 1300/1550rpm 5 mounting options VNT16-25/029 | | |
| For models: | SER15, SER15A, SER18, SER18A, SER21 | | |
| spare parts for | 601528 | | |
|  | GEV No. | 601413 | Ref. No. — |
| | fixing plate suitable for fanwheel ED ø 32mm shaft ø 7 mounting distance 26mm | | |

IMPORT

multi fit fan motors




1

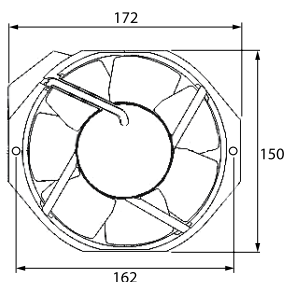
| | | | |
|--------------------|--|-----------------|-----------|
| GEV No. | 601022 | Ref. No. | 253071.99 |
| description | fan motor 10W 230V 50-60Hz L1 44mm L2 54mm L3 85mm W 84mm cable length 500mm 1300rpm YZF10-20-18/26 5 mounting options bearing slide bearing | | |



1

| | | | |
|---|---|-----------------|-------------------|
| GEV No. | 601081 ¹ | Ref. No. | R65060010 |
| description | axial fan L 80mm W 80mm H 38mm 230VAC 50/60Hz 14/13.5W bearing ball bearing connection male faston 2.8mm metal ADDA fan wheel ø 75mm temp.-resist. 70°C | | |
| For models: | CVE105H, CVE105M, CVG105H, CVG105M, ME106M, ME106P, ME106X, ME110M, ME110P, ME110X, ME120M, ME120P, ME120X, ME210M, ME210P, ME210X, ME220M, ME220P, ME220X, MG106M, MG106P, MG106X, MG110M, MG110P, MG110X, MG120M, MG120P, MG120X, MG210M, MG210P, MG210X, MG220M, MG220P, MG220X, MVE042P, MVE051P, MVG051P, VE105M, VE105X, VE106M, VE106P, VE106X, VE110M, VE110X, VE120M, VE120P, VE120X, VE210M, VE210P, VE210X...(Other models you can see in the webshop) | | |
| accessories for | 601081 | | |
|  | GEV No. | 691102 | Ref. No. — |
| | guard ø 75mm mounting distance 71mm for axial fan 80mm | | |

¹with ball bearings




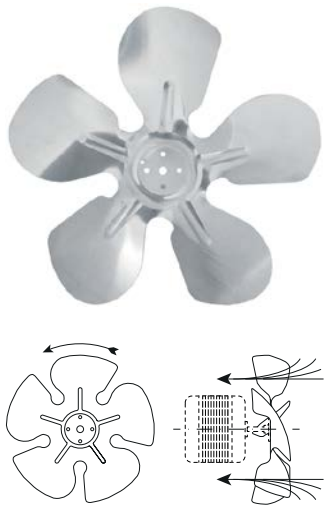
1

| | | | |
|--------------------|---|-----------------|-----------|
| GEV No. | 602151 | Ref. No. | R65060060 |
| description | axial fan L 172mm W 150mm H 51mm 220-240V 50-60Hz manuf. no. AA1752HB-AW connection cable cable length 3000mm ADDA suitable for combi-steamer fan wheel ø 140mm 0.27/0.23A | | |
| For models: | ME101M, ME101P, ME101T, ME201D, ME201M, ME201P, ME201T, ME202D, ME202M, ME202P, ME202T, MEMT40D, MEMT40P, MEVT40D, MEVT40P, MG101M, MG101P, MG101T, MG201D, MG201M, MG201P, MG201T, MG202D, MG202M, MG202P, MG202T, MGMT40D, MG-MT40P, MGVT40D, MGVT40P | | |

| | | | |
|---|--|-----------------|---|
|  | | | |
| 1 | | | |
| GEV No. | 601023 | Ref. No. | 25314399 253154.99 MA25303099 MA25314399 |
| description | fan motor 16W 230V 50-60Hz L1 45mm L2 61mm L3 92mm W 84mm cable length 500mm 1300rpm YZF16-25-18/26 5 mounting options bearing slide bearing | | |
| For models: | AF140B, AF140C, AF140F, AF140I, AF140MB, AF140MC, AF140MF, AF140MI, AF140MN, AF140MP, AF140N, AF140P, AF14F, AF14G, AF14N, AF70B, AF70C, AF70F, AF70I, AF70MB, AF70MC, AF70MF, AF70MI, AF70MN, AF70MP, AF70N, AF70P, AF72B, AF72C, AF72F, AF72I, AF72N, AF72P, AF7C, AF7F, AF7G, EF140DF, EF140DN, EF140DP, EF140MB, EF140MC, EF140MF, EF140MI, EF140MN, EF140MP, EF143MNI, EF70DF, EF70DN, EF70DP, EF70MB...(Other models you can see in the webshop) | | |

| | | | |
|--|--|-----------------|--|
|  | | | |
| 2 | | | |
| GEV No. | 601020 | Ref. No. | 23766.00 253151.99 MA2376600 MA25315199 |
| description | fan motor 5W 230V 50-60Hz L1 44mm L2 48mm L3 79mm W 84mm cable length 500mm 1300rpm YZF5-13-18/26 5 mounting options bearing slide bearing | | |
| For models: | BR120, BR160, SER15, SER15A, SER18, SER18A, SER21 | | |

| | | | |
|--|--|-----------------|------------------------|
| accessories | | | |
| fan wheels | | | |
| aluminium | | | |
|  | | | |
| 1 | | | |
| GEV No. | 601172 | Ref. No. | 25315699 MA25315699 |
| description | fan wheel sucking ø 230mm fan wheel mounting 25.4mm blade angle 34° W 50mm aluminium | | |
| For models: | AF140B, AF140C, AF140F, AF140I, AF140MB, AF140MC, AF140MF, AF140MI, AF140MN, AF140MP, AF140N, AF140P, AF14F, AF14G, AF14N, AF70B, AF70C, AF70F, AF70I, AF70MB, AF70MC, AF70MF, AF70MI, AF70MN, AF70MP, AF70N, AF70P, AF72B, AF72C, AF72F, AF72I, AF72N, AF72P, AF7C, AF7F, AF7G, EF140DF, EF140DN, EF140DP, EF140MB, EF140MC, EF140MF, EF140MI, EF140MN, EF140MP, EF143MNI, EF70DF, EF70DN, EF70DP, EF70MB...(Other models you can see in the webshop) | | |

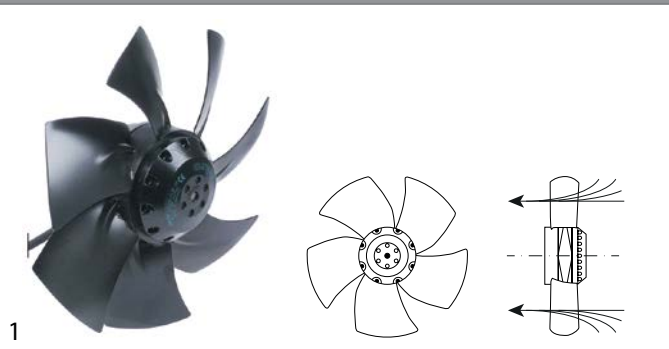
| | | | |
|---|--|-----------------|------------------------|
|  | | | |
| 1 | | | |
| GEV No. | 601387 | Ref. No. | 25315599 MA25315599 |
| description | fan wheel sucking ø 254mm fan wheel mounting 25.4mm blade angle 34° W 50mm aluminium | | |
| For models: | AF140B, AF140C, AF140F, AF140I, AF140MB, AF140MC, AF140MF, AF140MI, AF140MN, AF140MP, AF140N, AF140P, AF14F, AF14G, AF14N, AF70B, AF70C, AF70F, AF70I, AF70MB, AF70MC, AF70MF, AF70MI, AF70MN, AF70MP, AF70N, AF70P, AF72B, AF72C, AF72F, AF72I, AF72N, AF72P, AF7C, AF7F, AF7G, EF140DF, EF140DN, EF140DP, EF140MB, EF140MC, EF140MF, EF140MI, EF140MN, EF140MP, EF143MNI, EF70DF, EF70DN, EF70DP, EF70MB...(Other models you can see in the webshop) | | |



cold air circulating fans (complete)

ebm-papst

A2E series




| | | | |
|----------------|--------|-----------------|----------|
| GEV No. | 601750 | Ref. No. | RA880002 |
|----------------|--------|-----------------|----------|

description
fan A2E250-AL06-09 fan wheel ø 250mm blades 7 230V 50/60Hz 120/160W 2500rpm cable length 200mm ebm-papst sucking suitable capacitor 3µF

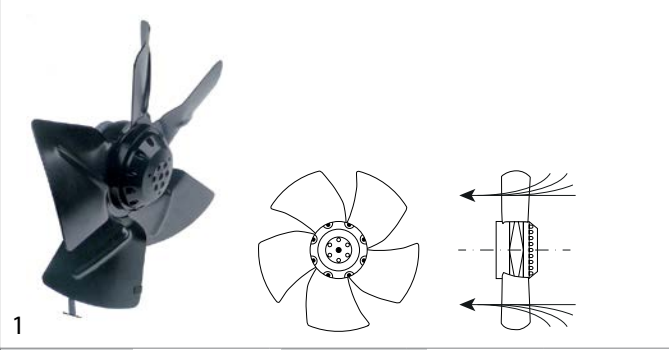
For models:
14-teglie-GN-MISTI-FR-dep-STD, 14-teglie-GN-MISTI-FR-dep-TOP, 14-teglie-GN-MISTI-FR-STD, 14-teglie-GN-MISTI-FR-TOP, 14-teglie-GN-MISTI-IT-dep-STD, 14-teglie-GN-MISTI-IT-dep-TOP, 14-teglie-GN-MISTI-IT-STD, 14-teglie-GN-MISTI-IT-TOP, 14-teglie-GN-MISTI-TX-STD, 14-teglie-GN-positivi-FR, 14-teglie-GN-positivi-FR-dep-STD, 14-teglie-GN-positivi-FR-dep-TOP, 14-teglie-GN-positivi-FR-STD, 14-teglie-GN-positivi-FR-TOP, 14-teglie-GN-positivi-IT-dep-STD, 14-teglie-GN-positivi-IT-dep-TOP, 14-teglie-GN-positivi-IT-STD, 14-teglie-GN-positivi-IT-TOP, 14-teglie-GN-positivi-TX-STD, 15-teglie-PA-MISTI-FR-STD, 17-teglie-PA-MISTI-FR-dep, 17-teglie-PA-MISTI-FR-dep-TOP, 17-teglie-PA-MISTI-FR-STD, 17-teglie-PA-MISTI-FR-TOP, 17-teglie-PA-MISTI-IT-dep, 17-teglie-PA-MISTI-IT-dep-TOP, 17-teglie-PA-MISTI-IT-STD, 17-teglie-PA-MISTI-IT-TOP, 17-teglie-PA-positivi-FR-dep-STD, 17-teglie-PA-positivi-FR-dep-TOP, 17-teglie-PA-positivi-FR-STD, 17-teglie-PA-positivi-FR-TOP, 17-teglie-PA-positivi-IT-dep-STD, 17-teglie-PA-positivi-IT-dep-TOP, 17-teglie-PA-positivi-IT-STD, 17-teglie-PA-positivi-IT-TOP, 20-teglie-GN-misti-FR-STD, 20-teglie-GN-misti-FR-TOP, 20-teglie-GN-misti-IT-STD, 20-teglie-GN-misti-IT-TOP, 20-teglie-GN-positivi-FR-STD, 20-teglie-GN-positivi-FR-TOP, 20-teglie-GN-positivi-IT-STD, 20-teglie-GN-positivi-IT-TOP, 21-teglie-PA-MISTI-TX-STD, 3-teglie-GN-positivi-FR-STD, 3-teglie-GN-positivi-FR-TOP, 3-teglie-GN-positivi-FR-dep-STD, 5-teglie-GN-positivi-FR-STD, 5-teglie-GN-positivi-FR-TOP...(Other models you can see in the webshop)

accessories for 601750

| | | | |
|----------------|--------|-----------------|---|
| GEV No. | 365137 | Ref. No. | — |
|----------------|--------|-----------------|---|

 capacitor capacity 3µF 450V tolerance 5% 50/60Hz ambient temperature max. -25 to +85°C ø 25mm L 56mm M8 plastic connection cable 250mm 416.17.77GF protection

A4E series




| | | | |
|----------------|--------|-----------------|----------|
| GEV No. | 601623 | Ref. No. | RA880046 |
|----------------|--------|-----------------|----------|

description
fan A4E315-AC08-19 fan wheel ø 315mm blades 5 230V 50Hz 95W 1370rpm cable length 450mm ebm-papst sucking suitable capacitor 3µF

For models:
10-teglie-GN-MISTI-FR-STD, 10-teglie-GN-MISTI-FR-TOP, 10-teglie-GN-MISTI-IT-STD, 10-teglie-GN-MISTI-IT-TOP, 10-teglie-GN-MISTI-TX-STD, 10-teglie-GN-positivi-FR-STD, 10-teglie-GN-positivi-FR-TOP, 10-teglie-GN-positivi-IT, 10-teglie-GN-positivi-IT-STD, 10-teglie-GN-positivi-IT-TOP, 10-teglie-GN-positivi-TX-STD, 12-teglie-PA-MISTI-FR-STD, 12-teglie-PA-MISTI-IT-STD, 12-teglie-PA-MISTI-IT-TOP, 12-teglie-PA-positivi-FR-STD, 12-teglie-PA-positivi-FR-TOP, 12-teglie-PA-positivi-IT-STD, 12-teglie-PA-positivi-IT-TOP, 15-teglie-PA-MISTI-TX-STD, 3-teglie-GN-misti-FR-STD, 3-teglie-GN-misti-FR-TOP, 3-teglie-GN-misti-IT-STD, 5-teglie-dep-GN-misti-FR-STD, 5-teglie-dep-GN-misti-IT-STD, 5-teglie-GN-misti-FR-STD, 5-teglie-GN-misti-IT-STD, 5-teglie-GN-misti-IT-TOP, 5-teglie-GN-misti-TX-STD, 5-teglie-PA-misti-FR-STD, 6-teglie-PA-misti-FR-dep, 6-teglie-PA-misti-FR-STD, 6-teglie-PA-misti-FR-TOP, 6-teglie-PA-misti-IT-dep, 6-teglie-PA-misti-IT-STD, 6-teglie-PA-misti-IT-TOP, 6-teglie-PA-misti-TX-STD

accessories for 601623

| | | | |
|----------------|--------|-----------------|---|
| GEV No. | 365137 | Ref. No. | — |
|----------------|--------|-----------------|---|

 capacitor capacity 3µF 450V tolerance 5% 50/60Hz ambient temperature max. -25 to +85°C ø 25mm L 56mm M8 plastic connection cable 250mm 416.17.77GF protection

cross flow fans

ebm-papst



| | | | |
|----------------|--------|-----------------|----------------------|
| GEV No. | 602167 | Ref. No. | 2590900 MA2590900 |
|----------------|--------|-----------------|----------------------|

description
cross flow fan ebm-papst QLK45/1200A39-2513L roller ø 45mm roller length 120mm laminated core thickness 13mm motor position right 230VAC refrigeration bearing rubber connection male faston 6.3mm airflow 80m³/h 0 up to +60°C

For models:
IR13C, IR13CC, IR13CV, IR13M, IR13MC, IR13MV, IR13V, IR17C, IR17CC, IR17CV, IR17M, IR17MC, IR17MV, IR17V, SIPR12, SIPR16, SIPR20, SIVR12, SIVR16, SIVR20, SPAR16, SPAR20, SPRG12, SPRG16, SPRG20, SVAR16, SVAR20, SVRG12, SVRG16, SVRG20, TR13C2P, TR13I4C, TR13I4CC, TR13I4CV, TR13N2C1P, TR13N2C1PC, TR13N2C1PV, TR13N2P, TR13N2PC, TR13N2PV, TR13N4C, TR13N4CC, TR13N4CV, TR17C3P, TR17I6C, TR17I6CC, TR17I6CV, TR17N2C2P, TR17N2C2PC, TR17N2C2PV...(Other models you can see in the webshop)



EMMEVI - FERGAS

with standard coil



1

| | | | |
|--------------------|---|-----------------|----------------------|
| GEV No. | 601718 | Ref. No. | 2522700 MA2522700 |
| description | cross flow fan TG 60/3-420/30 roller ø 60mm roller length 420mm laminated core thickness 30mm motor position right 230V/50Hz 32W universal bearing silicone connection male faston 6.3mm -10 up to +60°C 230V protection F housing aluminium fixing dimensions 40x442.5mm | | |
| For models: | TAR134C2I, TAR176C2I | | |

double fans



1

| | | | |
|--------------------|--|-----------------|--------------------|
| GEV No. | 601455 | Ref. No. | 1215500 1215512 |
| description | cross flow fan roller ø 60mm roller length 2x180mm laminated core thickness 35mm motor position centre 230V/50Hz 30W universal bearing silicone connection F 6.3 airflow 280m³/h -30 up to +100°C total length 470mm | | |
| For models: | TP13E, TP17E, TP213E, TP217E, TP21E, TP221E | | |

COPREL

with standard coil



1

| | | | |
|--------------------|--|-----------------|----------|
| GEV No. | 601025 | Ref. No. | 25320500 |
| description | cross flow fan COPREL TFR(FN) roller ø 60mm roller length 180mm laminated core thickness 15mm motor position right 230V/50Hz 19W refrigeration bearing rubber connection male faston 6.3mm coil type airflow 120m³/h -10 up to +60°C | | |

hot air motors



1

| | | | |
|--------------------|---|-----------------|-----------|
| GEV No. | 550857 | Ref. No. | R58003870 |
| description | counterflange for fan motor ED ø 50mm int. ø 1 25mm int. ø 2 16mm thickness 6mm brass | | |
| For models: | CVE105H, CVE105M, CVG105H, CVG105M, EC106M, EM106H, EM106M, EM106M+SC, EM106P, EV006M, EV106H, EV106M, EV106M+SC, EV106P, FE105M, FE105X, FG105M, FG105X, GC106M, GM106H, GM106M, GM106M+SC, GM106P, GMT06D, GV106H, GV106M, GV106M+SC, GV106P, GVT06D, MACE07M, MACG07M, ME061D, ME061M, ME061P, ME061T, ME106M, ME106P, ME106X, MEMT06D, MEMT06P, MEVT06D, MEVT06P, MG061D, MG061M, MG061P, MG061T, MG106M, MG106P, MG106X, MGMT06D...(Other models you can see in the webshop) | | |




1

| | | | |
|--------------------|---|-----------------|------------------------|
| GEV No. | 601452 | Ref. No. | 25320599 MA25320599 |
| description | cross flow fan TFL 180 roller ø 60mm roller length 180mm laminated core thickness 20mm motor position left 230V/50Hz 19W universal bearing silicone connection male faston 6.3mm airflow 100m³/h -30 up to +100°C 230V 50Hz | | |



1


| | | | |
|--------------------|---|-----------------|-----------|
| GEV No. | 550859 | Ref. No. | R58003850 |
| description | counterflange for fan motor ED ø 60mm int. ø 1 34mm int. ø 2 25mm thickness 6mm brass | | |
| For models: | EC110M, EC210M, EM010M+SC, EM110H, EM110M, EM110M+SC, EM110P, EM210H, EM210M, EM210M+SC, EM210P, EV110H, EV110M, EV110M+SC, EV110P, EV210H, EV210M, EV210M+SC, EV210P, FE110M, FE110X, FE210M, FG110M, FG110X, FG210M, FG210X, GC110M, GC210M, GM110H, GM110M, GM110M+SC, GM110P, GM210H, GM210M, GM210M+SC, GM210P, GMT20D, GV110H, GV110M, GV110M+SC, GV110P, GV210H, GV210M, GV210M+SC, GV210P, GVT20D, MACE10M, MACE20M, MACG10M, MACG20M...(Other models you can see in the webshop) | | |

| | | | |
|---|---|-----------------|---------------------------|
| GEV No. | 500656 | Ref. No. | R65040520 |
| description | fan motor 200-240/415V 3 phase 50/60Hz 0.15/0.55kW 900/1400rpm speeds 2 L1 150mm L2 50mm L3 48mm D1 ø 24mm D2 ø 20mm M12L IT 2.3/1.3-1.2/0.7A at 50Hz 200-240/415V at 60Hz 200-240/480V at 50Hz 900/1400rpm at 60Hz 1100/1700rpm type 3042D4050 | | |
| For models: | ME101P, ME101T, ME201P, ME201T | | |
| spare parts for | 500656 | | |
|  | GEV No. | 511172 | Ref. No. R70020050 |
| shaft sealing ID ø 24mm ED ø 29mm thickness 3mm | | | |


| | | | |
|--------------------|--|-----------------|-----------|
| GEV No. | 500135 | Ref. No. | R65040031 |
| description | fan motor 200-240V 1 phase 50Hz 0.185/0.55kW 900/1400rpm speeds 2 L1 195mm L2 45mm L3 47mm D1 ø 24mm D2 ø 20mm M12L IT 3.6/2A suitable capacitor 16µF-450V/12.5µF-450V at 50Hz 900/1400rpm type 1063D2250 | | |
| For models: | FG110X, FG210X, GM110H, GM110P, GM210H, GM210P, GV110H, GV110P, GV210H, GV210P, MG102P, MG102T, MG110P, MG110X, MG120P, MG120X, MG210P, MG210X, MG220P, MG220X, MGC24H, MGC40H, MGMT10P, MGMT20P, MGMT21P, MGMT10P, MGMT20P, MGMT21P, PG080X, VG110P, VG110X, VG120P, VG120X, VG210P, VG210X, VG220P, VG220X | | |

| | | | |
|--------------------|--|-----------------|-----------|
| GEV No. | 500671 | Ref. No. | R65040071 |
| description | fan motor 200-240V 1 phase 50/60Hz 0.11kW 2760/3320rpm speeds 1 L1 130mm L2 55mm L3 30mm D1 ø 15mm D2 ø 12mm M10L ET at 50Hz 2760rpm at 60Hz 3320rpm | | |
| For models: | CVE105H, CVE105M, CVG105H, CVG105M, VE105M, VE105X, VG105M, VG105X | | |

| | | | |
|--------------------|---|-----------------|-----------|
| GEV No. | 601046 | Ref. No. | R65040061 |
| description | fan motor 220/380V 3 phase 50/60Hz 0.75kW 1350/1650rpm speeds 1 L1 185mm L2 42mm L3 47mm D1 ø 24mm D2 ø 20mm M12L IT 1.9/3.3A Cos(φ) 0.83 at 50Hz 200-240/346-415V at 60Hz 200-277/346-480V at 50Hz 1350rpm at 60Hz 1650rpm type ST80/4 no. 661512 | | |
| For models: | EC110M, EC210M, EM010M+SC, EM110M, EM110M+SC, EM210M, EM210M+SC, EV110M, EV110M+SC, EV210M, EV210M+SC, FE110M, FE210M, ME102D, ME102M, ME110M, ME120M, ME202D, ME202M, ME210M, ME220M, MEC40M, MEMENT10D, MEMENT20D, MEMENT21D, MEMENT40D, MEVT10D, MEVT20D, MEVT21D, MEVT40D, PE080M, VE110M, VE120M, VE210M, VE220M | | |


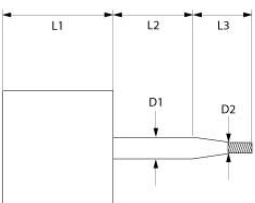
| | | | |
|---|--|-----------------|---------------------------|
| GEV No. | 500134 | Ref. No. | R65040021 |
| description | fan motor 200-240V 1 phase 50/60Hz 0.25HP 1400/1700rpm speeds 1 L1 115mm L2 77mm L3 30mm D1 ø 15mm D2 ø 12mm M10L ET 1A suitable capacitor 5µF/400V at 50Hz 1400rpm at 60Hz 1700rpm type 1060.1950 | | |
| For models: | ME106M, MG106M, VE106M, VG106M | | |
| accessories for | 500134 | | |
|  | GEV No. | 380659 | Ref. No. R65160570 |
| overload switch setting range 0.7-1A connection screw type 3RU1116-0JB0 (AC3/400V) 0.25kW | | | |

| | | | |
|--------------------|---|-----------------|-----------|
| GEV No. | 500662 | Ref. No. | R65041000 |
| description | fan motor 220-240V 1 phase 50/60Hz 0.12kW 2800/3200rpm speeds 1 L1 85mm L2 7mm L3 47mm L4 12mm D1 ø 8/6mm D2 ø 12mm M5R ET 1.6A power input 0.25W suitable capacitor 5µF/400V | | |
| For models: | MACE04M, MACE05M, MACG05M, MVE042P, MVE051P, MVG051P | | |




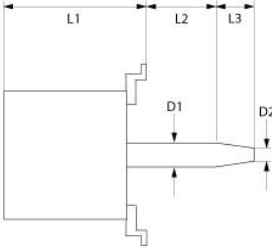
1

| | | | |
|--------------------|--|-----------------|-----------|
| GEV No. | 501587 | Ref. No. | R65040051 |
| description | fan motor 220-240V 1 phase 50/60Hz 0.55kW 1400/1700rpm L1 190mm L2 45mm L3 47mm D1 ø 24mm D2 ø 20mm M12L IT 3.6A type 1063A2250 | | |
| For models: | EM110H, EM110P, EM210H, EM210P, EV110H, EV110P, EV210H, EV210P, ME102P, ME102T, ME110P, ME110X, ME120P, ME120X, ME202P, ME202T, ME210P, ME210X, ME220P, ME220X, MEC24H, MENT10P, MENT20P, MENT21P, MENT40P, MEVT10P, MEVT20P, MEVT21P, MEVT40P, VE110X, VE120P, VE120X, VE210P, VE210X, VE220P, VE220X | | |






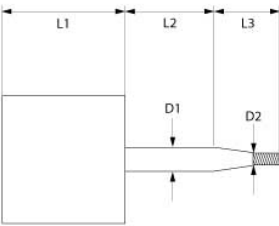
1

| | | | |
|--------------------|---|-----------------|-----------|
| GEV No. | 500133 | Ref. No. | R65040011 |
| description | fan motor 220-240V 1 phase 50Hz 0.1/0.25HP 900/1400rpm speeds 2 L1 123mm L2 77mm L3 30mm D1 ø 15mm D2 ø 12mm M10L ET 1/0.6A suitable capacitor 5µF/450V at 50Hz 900/1400rpm at 60Hz 1100/1700rpm type 1061.1950 | | |
| For models: | ME106P, ME106X, MG106P, MG106X, VE106P, VE106X, VG106P, VG106X | | |






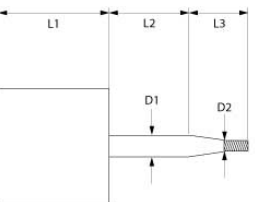
1

| | | | |
|------------------------|--|-----------------|-----------|
| GEV No. | 500136 | Ref. No. | R65040041 |
| description | fan motor 220-240V 1 phase 50/60Hz 0.55kW 1400rpm speeds 1 L1 190mm L2 47mm L3 47mm D1 ø 24mm D2 ø 20mm M12L IT 3.6A suitable capacitor 16µF/450V Cos(φ) 0.9 at 50Hz 1400rpm at 60Hz 1700rpm type 1063/4M | | |
| For models: | FG110M, FG210M, GC110M, GC210M, GM110M, GM110M+SC, GM210M, GM210M+SC, GMT20D, GV110M, GV110M+SC, GV210M, GV210M+SC, GVT20D, MG102D, MG102M, MG110M, MG120M, MG210M, MG220M, MGC20X, MGMT10D, MGMT20D, MGMT21D, MGVT10D, MGVT20D, MGVT21D, PG080M, VG110M, VG120M, VG210M, VG220M | | |
| accessories for | 500136 | | |
| |  | GEV No. | 511172 |
| | | Ref. No. | R70020050 |
| | shaft sealing ID ø 24mm ED ø 29mm thickness 3mm | | |


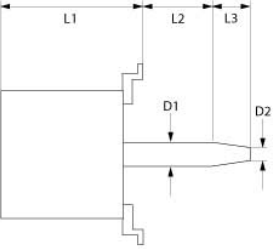
1

| | | | |
|------------------------|--|-----------------|-----------|
| GEV No. | 601043 | Ref. No. | R65040260 |
| description | fan motor 220-240V 1 phase 50Hz 0.37/0.07kW 0.1/0.5HP 1400/2700rpm speeds 2 L1 123mm L2 107mm L3 15mm D1 ø 15mm D2 ø 12mm M10L ET 2/0.7A suitable capacitor 20µF/250V at 50Hz 1400/2700rpm type 1057 | | |
| For models: | FE105M, FE105X, FG105M, FG105X, PE040M, PE040X, PG040M, PG040X | | |
| accessories for | 601043 | | |
| |  | GEV No. | 365019 |
| | | Ref. No. | — |
| | operating capacitor capacity 20µF 400V tolerance 5% 50/60Hz ambient temperature max. -25 to +85°C ø 39.5mm L 70mm M8 plastic connection male faston 6.3mm 16.10.25. protection | | |

1

| | | | |
|--------------------|---|-----------------|-----------|
| GEV No. | 500661 | Ref. No. | R65040431 |
| description | fan motor 220-240V 1 phase 50Hz 0.03/0.2kW 0.05/0.25HP 1400/2700rpm speeds 2 L1 123mm L2 77mm L3 30mm D1 ø 15mm D2 ø 12mm M10L ET 1.6/0.6A suitable capacitor 10µF/450V at 50Hz 1400/2700rpm type 1057D1901 | | |
| For models: | ME061P, ME061T, MENT06P, MEVT06P, MG061P, MGMT06P, MGVT06P | | |

1




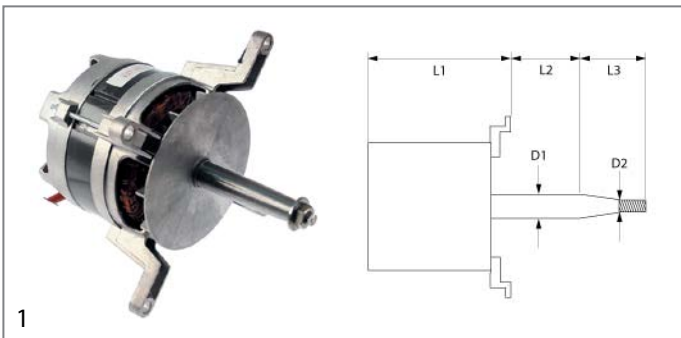
| | | | |
|------------------------|---|-----------------|-----------|
| GEV No. | 500658 | Ref. No. | R65040530 |
| description | fan motor 230/400V 3 phase 50/60Hz 0.55kW 1400/1700rpm speeds 1 L1 145mm L2 47mm L3 47mm D1 ø 24mm D2 ø 20mm M12L IT 2.6-2.3/1.5-1.3A (at 50-60Hz)A Cos(φ) 0.73 at 50Hz 200-240/415V at 60Hz 200-240/480V at 50Hz 1400rpm at 60Hz 1700rpm | | |
| For models: | MACE10M, MACE20M, ME101D, ME101M, ME201D, ME201M | | |
| spare parts for | 500658 | | |
| |  | GEV No. | 511172 |
| | | Ref. No. | R70020050 |
| | shaft sealing ID ø 24mm ED ø 29mm thickness 3mm | | |


Table continues overleaf

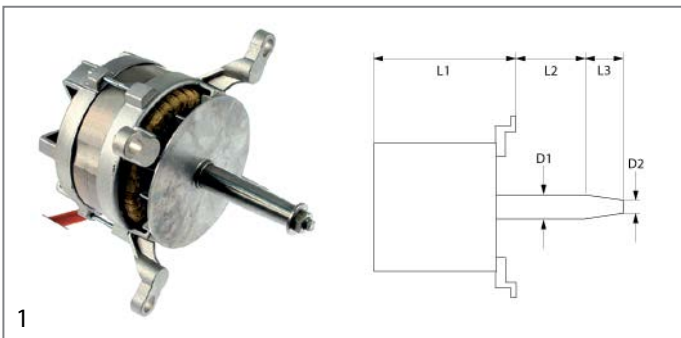


| | | | |
|---|--|--------|---------------------------|
| accessories for 500658 | | | |
|  | GEV No. | 560449 | Ref. No. R58004000 |
| | hexagonal screw thread M12x1.5 L thread L 22mm bore ϕ 6.3mm WS 19 total length 30mm | | |
|  | GEV No. | 601244 | Ref. No. R75400440 |
| | fan wheel D1 ϕ 350mm H1 114mm blades 12 D2 ϕ 19.5mm D3 ϕ 23mm H2 45mm | | |




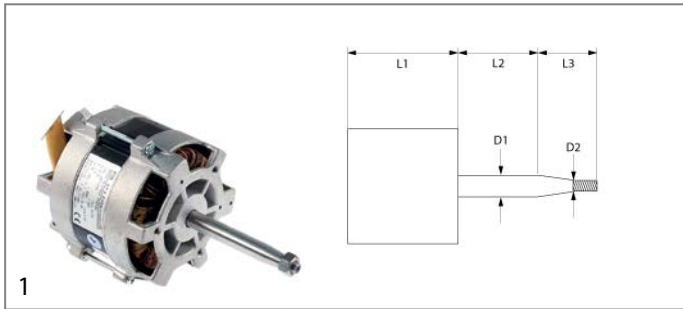
| | | | |
|--------------------|--|-----------------|-----------|
| GEV No. | 500659 | Ref. No. | R65040550 |
| description | fan motor 230V 1 phase 50/60Hz 0.55kW 1400/1700rpm speeds 1 L1 150mm L2 52mm L3 45mm D1 ϕ 24mm D2 ϕ 20mm M12L IT 3A suitable capacitor 20 μ F/450V Cos(f) 0.9 at 50Hz 1400rpm at 60Hz 1700rpm type 3042A2350 | | |
| For models: | GMT20D, GVT20D, MACG10M, MACG20M, MG101D, MG101M, MG201D, MG201M, MG202D, MG202M, MGMT40D, MGVT40D | | |

| | | | |
|--|---|--------|---------------------------|
| spare parts for 500659 | | | |
|  | GEV No. | 511172 | Ref. No. R70020050 |
| | shaft sealing ID ϕ 24mm ED ϕ 29mm thickness 3mm | | |

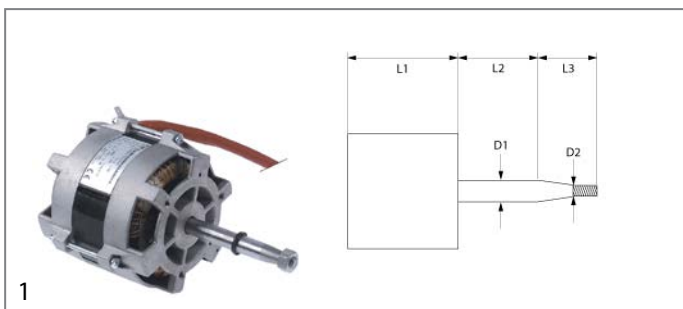


| | | | |
|--------------------|---|-----------------|-----------|
| GEV No. | 500657 | Ref. No. | R65040540 |
| description | fan motor 230V 1 phase 50Hz 0.15/0.55kW 900/1400rpm speeds 2 L1 150mm L2 45mm L3 47mm D1 ϕ 24mm D2 ϕ 20mm M12L IT 1.3/3.0A suitable capacitor 20/10 μ F Cos(f) 0.98 at 50Hz 900/1400rpm at 60Hz 1100/1700rpm 4P/6P type LM/FB 100L no. 472986 | | |
| For models: | MG101P, MG101T, MG201P, MG201T, MG202P, MG202T, MGMT40P, MGVT40P | | |

| | | | |
|---|---|--------|---------------------------|
| spare parts for 500657 | | | |
|  | GEV No. | 511172 | Ref. No. R70020050 |
| | shaft sealing ID ϕ 24mm ED ϕ 29mm thickness 3mm | | |



| | | | |
|--------------------|--|-----------------|-----------|
| GEV No. | 500663 | Ref. No. | R65040421 |
| description | fan motor 230V 1 phase 50Hz 0.18kW 0.25HP 2800rpm speeds 1 L1 123mm L2 77mm L3 30mm D1 ϕ 15mm D2 ϕ 12mm M10L ET 1.6A suitable capacitor 10 μ F/400V Cos(f) 0.95 at 50Hz 2800rpm type 1057C2401 | | |
| For models: | GMT06D, GVT06D, MACE07M, MACG07M, ME061D, ME061M, MEMT06D, MEVT06D, MG061D, MG061M, MGMT06D, MGVT06D | | |



| | | | |
|--------------------|---|-----------------|-----------|
| GEV No. | 500680 | Ref. No. | R65040420 |
| description | fan motor 230V 1 phase 50Hz 0.37kW 2800rpm speeds 1 L1 121mm L2 77mm L3 31mm D1 ϕ 16mm D2 ϕ 11mm 2.5A Cos(f) 0.95 at 50Hz 230V at 50Hz 2800rpm type 1057.2155 | | |
| For models: | EC106M, EM106M, EM106M+SC, EV006M, EV106M, EV106M+SC, GC106M, GM106M, GM106M+SC, GV106M, GV106M+SC | | |

| | | | |
|---|---|--------|---------------------------|
| accessories for 500680 | | | |
|  | GEV No. | 601060 | Ref. No. R75400130 |
| | fan wheel D1 ϕ 180mm H1 60mm blades 16 D2 ϕ 11mm D3 ϕ 16mm H2 30mm | | |



| | | | |
|--------------------|---|-----------------|-----------|
| GEV No. | 601067 | Ref. No. | R75400040 |
| description | fan wheel D1 ϕ 150mm H1 38mm blades 36 D2 ϕ 6mm D3 ϕ 6mm H2 14mm | | |
| For models: | CVE004H, CVE004M, CVE104H, CVE104M, VE004M, VE004X, VE104M, VE104X | | |



1

| | | | |
|--------------------|--|-----------------|-----------|
| GEV No. | 601353 | Ref. No. | R75400510 |
| description | fan wheel D1 ø 150mm H1 50mm blades 36 D2 ø 8mm D3 ø 6/8mm H2 26mm | | |
| For models: | MACE04M, MVE042P | | |



1

| | | | |
|--------------------|--|-----------------|-----------|
| GEV No. | 601068 | Ref. No. | R75400080 |
| description | fan wheel D1 ø 160mm H1 70mm blades 16 D2 ø 12mm D3 ø 16mm H2 29mm | | |
| For models: | CVE105H, CVE105M, CVG105H, CVG105M, VE105M, VE105X, VG105M, VG105X | | |




1

| | | | |
|--------------------|--|-----------------|-----------|
| GEV No. | 601060 | Ref. No. | R75400130 |
| description | fan wheel D1 ø 180mm H1 60mm blades 16 D2 ø 11mm D3 ø 16mm H2 30mm | | |
| For models: | FE105M, FE105X, FG105M, FG105X, PE040M, PE040X, PG040M, PG040X | | |



1

| | | | |
|--------------------|--|-----------------|-----------|
| GEV No. | 601246 | Ref. No. | R75400410 |
| description | fan wheel D1 ø 180mm H1 77mm blades 12 D2 ø 8mm D3 ø 6mm H2 25.5mm | | |
| For models: | MACE05M, MACG05M, MVE051P, MVG051P | | |



1

| | | | |
|--------------------|--|-----------------|-----------|
| GEV No. | 601243 | Ref. No. | R75400400 |
| description | fan wheel D1 ø 220mm H1 78mm blades 12 D2 ø 11mm D3 ø 16mm H2 29mm | | |
| For models: | EC106M, EM106H, EM106M, EM106M+SC, EM106P, EV006M, EV106H, EV106M, EV106M+SC, EV106P, GC106M, GM106H, GM106M, GM106M+SC, GM106P, GMT06D, GV106H, GV106M, GV106M+SC, GV106P, GVT06D, MACE07M, MACG07M, ME061D, ME061M, ME061P, ME061T, MEMT06D, MEMT06P, MEVT06D, MEVT06P, MG061D, MG061M, MG061P, MG061T, MGMT06D, MGMT06P, MGVT06D, MGVT06P | | |



1

| | | | |
|--------------------|--|-----------------|-----------|
| GEV No. | 601064 | Ref. No. | R75400230 |
| description | fan wheel D1 ø 220mm H1 78mm blades 20 D2 ø 11.5mm D3 ø 16.5mm H2 30mm | | |
| For models: | ME106M, ME106P, ME106X, MG106M, MG106P, MG106X, VE106M, VE106P, VE106X, VG106M, VG106P, VG106X | | |




1

| | | | |
|--------------------|---|-----------------|-----------|
| GEV No. | 601065 | Ref. No. | R75400290 |
| description | fan wheel D1 ø 300mm H1 120mm blades 20 D2 ø 19.5mm D3 ø 23mm H2 46mm | | |
| For models: | EC110M, EM010M+SC, EM110H, EM110M, EM110M+SC, EM110P, EV110H, EV110M, EV110M+SC, EV110P, GC110M, GM110H, GM110M, GM110M+SC, GM110P, GV110H, GV110M, GV110M+SC, GV110P, ME110M, ME110P, ME110X, ME120M, ME120P, ME120X, MG110M, MG110P, MG110X, MG120M, MG120P, MG120X, MGC20X, VE110M, VE110X, VE120M, VE120P, VE120X, VG110M, VG110P, VG110X, VG120M, VG120P, VG120X | | |



1

| | | | |
|--------------------|--|-----------------|----------------------|
| GEV No. | 514037 | Ref. No. | 2919900 MA2919900 |
| description | fan wheel D1 ø 330mm H1 110mm blades 12 D2 ø 12mm D3 ø 24mm H2 47mm | | |
| For models: | CON10E, CON10EP, CON10G, CON10GP, CS10E, CS10EP, CS10G, CSM10E, CSM10EP, CSM10G, CSM10GP | | |



1

| | | | |
|--------------------|--|-----------------|----------------------|
| GEV No. | 514038 | Ref. No. | 2939414 MA2939414 |
| description | fan wheel D1 ø 350mm H1 150mm blades 16 D2 ø 12mm D3 ø 23mm H2 48mm | | |
| For models: | CON102E, CON102EP, CON102G, CON102GP, CON201E, CON201EP, CON201G, CON201GP, CS102E, CS102EP, CS102G, CS102GP, CSM102E, CSM102EP, CSM102G, CSM102GP, CSM201E, CSM201EP, CSM201G, CSM201GP | | |



1

| | | | |
|--------------------|--|-----------------|-----------|
| GEV No. | 601244 | Ref. No. | R75400440 |
| description | fan wheel D1 ø 350mm H1 114mm blades 12 D2 ø 19.5mm D3 ø 23mm H2 45mm | | |
| For models: | GMT20D, GVT20D, MACE10M, MACE20M, MACG10M, MACG20M, ME101D, ME101M, ME101P, ME101T, ME102D, ME102M, ME102P, ME102T, ME201D, ME201M, ME201P, ME201T, ME202D, ME202M, ME202P, ME202T, MEMT10D, MEMT10P, MEMT20D, MEMT20P, MEMT21D, MEMT21P, MEMT40D, MEMT40P, MEVT10D, MEVT10P, MEVT20D, MEVT20P, MEVT21D, MEVT21P, MEVT40D, MEVT40P, MG101D, MG101M, MG101P, MG101T, MG102D, MG102M, MG102P, MG102T, MG201D, MG201M, MG201P, MG201T...(Other models you can see in the webshop) | | |




1

| | | | |
|--------------------|--|-----------------|---------|
| GEV No. | 514039 | Ref. No. | 5103414 |
| description | fan wheel D1 ø 350mm H1 190mm blades 16 D2 ø 12mm D3 ø 23.5mm H2 47mm | | |
| For models: | CON202E, CON202EP, CON202G, CON202GP, CSM202E, CSM202EP, CSM202G, CSM202GP | | |




1

| | | | |
|--------------------|--|-----------------|-----------|
| GEV No. | 601066 | Ref. No. | R75400380 |
| description | fan wheel D1 ø 350mm H1 120mm blades 24 D2 ø 19.5mm D3 ø 23.5mm H2 45mm | | |
| For models: | EC210M, EM210H, EM210M, EM210M+SC, EM210P, EV210H, EV210M, EV210M+SC, EV210P, GC210M, GM210H, GM210M, GM210M+SC, GM210P, GV210H, GV210M, GV210M+SC, GV210P, ME210M, ME210P, ME210X, ME220M, ME220P, ME220X, MEC24H, MEC40M, MG210M, MG210P, MG210X, MG220M, MG220P, MG220X, MGC24H, MGC40H, VE210M, VE210P, VE210X, VE220M, VE220P, VE220X, VG210M, VG210P, VG210X, VG220M, VG220P, VG220X | | |




1


| | | | |
|--------------------|---|-----------------|-----------|
| GEV No. | 550855 | Ref. No. | R58005510 |
| description | flange for fan motor ED ø 35mm int. ø 1 22mm int. ø 2 8mm thickness 8mm brass | | |
| For models: | CVE004H, CVE004M, CVE104H, CVE104M, VE004M, VE004X, VE104M, VE104X | | |




1


| | | | |
|--------------------|---|-----------------|-----------|
| GEV No. | 550856 | Ref. No. | R58003860 |
| description | flange for fan motor ED ø 50mm int. ø 1 19.5mm int. ø 2 16mm thickness 3mm brass | | |
| For models: | CVE105H, CVE105M, CVG105H, CVG105M, EC106M, EM106H, EM106M, EM106M+SC, EM106P, EV006M, EV106H, EV106M, EV106M+SC, EV106P, FE105M, FE105X, FG105M, FG105X, GC106M, GM106H, GM106M, GM106M+SC, GM106P, GMT06D, GV106H, GV106M, GV106M+SC, GV106P, GVT06D, MACE07M, MACG07M, ME061D, ME061M, ME061P, ME061T, ME106M, ME106P, ME106X, MEMT06D, MEMT06P, MEVT06D, MEVT06P, MG061D, MG061M, MG061P, MG061T, MG106M, MG106P, MG106X, MGMT06D...(Other models you can see in the webshop) | | |


| | | | |
|---|---|-----------------|-----------|
|  | | | |
| 1 | | | |
| GEV No. | 550858 | Ref. No. | R58003840 |
| description | flange for fan motor ED ø 60mm int. ø 1 28.5mm int. ø 2 25mm thickness 4mm brass | | |
| For models: | EC110M, EC210M, EM010M+SC, EM110H, EM110M, EM110M+SC, EM110P, EM210H, EM210M, EM210M+SC, EM210P, EV110H, EV110M, EV110M+SC, EV110P, EV210H, EV210M, EV210M+SC, EV210P, FE110M, FE110X, FE210M, FG110M, FG110X, FG210M, FG210X, GC110M, GC210M, GM110H, GM110M, GM110M+SC, GM110P, GM210H, GM210M, GM210M+SC, GM210P, GMT20D, GV110H, GV110M, GV110M+SC, GV110P, GV210H, GV210M, GV210M+SC, GV210P, GVT20D, MACE10M, MACE20M, MACG10M, MACG20M...(Other models you can see in the webshop) | | |


| | | | |
|---|--|-----------------|-----------|
|  | | | |
| 1 | | | |
| GEV No. | 550860 | Ref. No. | R58005500 |
| description | flange for gasket ED ø 35mm int. ø 1 22mm int. ø 2 9mm thickness 8mm brass | | |
| For models: | MACE04M, MACE05M, MACG05M, MVE042P, MVE051P, MVG051P | | |


| | | | |
|---|---|-----------------|-----------|
|  | | | |
| 1 | | | |
| GEV No. | 560449 | Ref. No. | R58004000 |
| description | hexagonal screw thread M12x1.5 L thread L 22mm bore ø 6.3mm WS 19 total length 30mm | | |
| For models: | EC110M, EC210M, EM010M+SC, EM110H, EM110M, EM110M+SC, EM110P, EM210H, EM210M, EM210M+SC, EM210P, EV110H, EV110M, EV110M+SC, EV110P, EV210H, EV210M, EV210M+SC, EV210P, FE110M, FE110X, FE210M, FG110M, FG110X, FG210M, FG210X, GC110M, GC210M, GM110H, GM110M, GM110M+SC, GM110P, GM210H, GM210M, GM210M+SC, GM210P, GMT20D, GV110H, GV110M, GV110M+SC, GV110P, GV210H, GV210M, GV210M+SC, GV210P, GVT20D, MACE10M, MACE20M, MACG10M, MACG20M...(Other models you can see in the webshop) | | |

| | | | |
|---|---|-----------------|-----------|
|  | | | |
| 1 | | | |
| GEV No. | 500639 | Ref. No. | R65040101 |
| description | motor kit 220/240V 1 phase 50/60Hz 0.25kW type K48210 | | |
| For models: | CVE004H, CVE004M, CVE104H, CVE104M, VE004M, VE004X, VE104M, VE104X | | |
| spare parts for | 500639 | | |
| |  | GEV No. | 511170 |
| | | Ref. No. | R70020010 |
| | shaft seal ID ø 7mm ED ø 22mm thickness 7mm | | |
| |  | GEV No. | 550855 |
| | | Ref. No. | R58005510 |
| | flange for fan motor ED ø 35mm int. ø 1 22mm int. ø 2 8mm thickness 8mm brass | | |
| |  | GEV No. | 601067 |
| | | Ref. No. | R75400040 |
| | fan wheel D1 ø 150mm H1 38mm blades 36 D2 ø 6mm D3 ø 6mm H2 14mm | | |
| |  | GEV No. | 601856 |
| | | Ref. No. | — |
| | fan motor 230V 1 phase 50Hz 0.075kW 2650rpm speeds 1 L1 85mm L2 30mm L3 23mm L4 12mm D1 ø 8x6mm D2 ø 8mm 0.6A suitable capacitor 5µF/400V | | |

| | | | |
|---|---|-----------------|-----------|
|  | | | |
| 1 | | | |
| GEV No. | 550861 | Ref. No. | R70020020 |
| description | shaft seal for fan motor ID ø 7.5mm ED ø 22mm thickness 7mm | | |
| For models: | MACE04M, MACE05M, MACG05M, MVE042P, MVE051P, MVG051P | | |

| | | | |
|---|---|-----------------|---------------------------|
|  | | | |
| 1 | | | |
| GEV No. | 511171 | Ref. No. | LA70020040 LAR70020040 |
| description | shaft seal ID ø 14.5mm ED ø 20mm thickness 3mm | | |
| For models: | CVE105H, CVE105M, CVG105H, CVG105M, EC106M, EM106H, EM106M, EM106M+SC, EM106P, EV006M, EV106H, EV106M, EV106M+SC, EV106P, FE105M, FE105X, FG105M, FG105X, GC106M, GM106H, GM106M, GM106M+SC, GM106P, GMT06D, GV106H, GV106M, GV106M+SC, GV106P, GVT06D, MACE07M, MACG07M, ME061D, ME061M, ME061P, ME061T, ME106M, ME106P, ME106X, MEMT06D, MEMT06P, MEVT06D, MEVT06P, MG061D, MG061M, MG061P, MG061T, MG106M, MG106P, MG106X, MGMT06D...(Other models you can see in the webshop) | | |

| | | | |
|---|--|-----------------|-----------|
|  | | | |
| 1 | | | |
| GEV No. | 511170 | Ref. No. | R70020010 |
| description | shaft seal ID ø 7mm ED ø 22mm thickness 7mm | | |
| For models: | CVE004H, CVE004M, CVE104H, CVE104M, VE004M, VE004X, VE104M, VE104X | | |

| | | | |
|---|---|-----------------|-----------|
|  | | | |
| 1 | | | |
| GEV No. | 511172 | Ref. No. | R70020050 |
| description | shaft sealing ID ø 24mm ED ø 29mm thickness 3mm | | |
| For models: | EC110M, EC210M, EM010M+SC, EM110H, EM110M, EM110M+SC, EM110P, EM210H, EM210M, EM210M+SC, EM210P, EV110H, EV110M, EV110M+SC, EV110P, EV210H, EV210M, EV210M+SC, EV210P, FE110M, FE110X, FE210M, FG110M, FG110X, FG210M, FG210X, GC110M, GC210M, GM110H, GM110M, GM110M+SC, GM110P, GM210H, GM210M, GM210M+SC, GM210P, GMT20D, GV110H, GV110M, GV110M+SC, GV110P, GV210H, GV210M, GV210M+SC, GV210P, GVT20D, MACE10M, MACE20M, MACG10M, MACG20M...(Other models you can see in the webshop) | | |

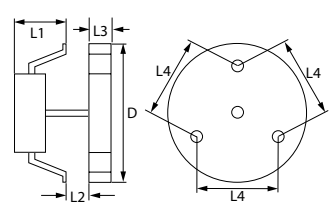


hot air fans

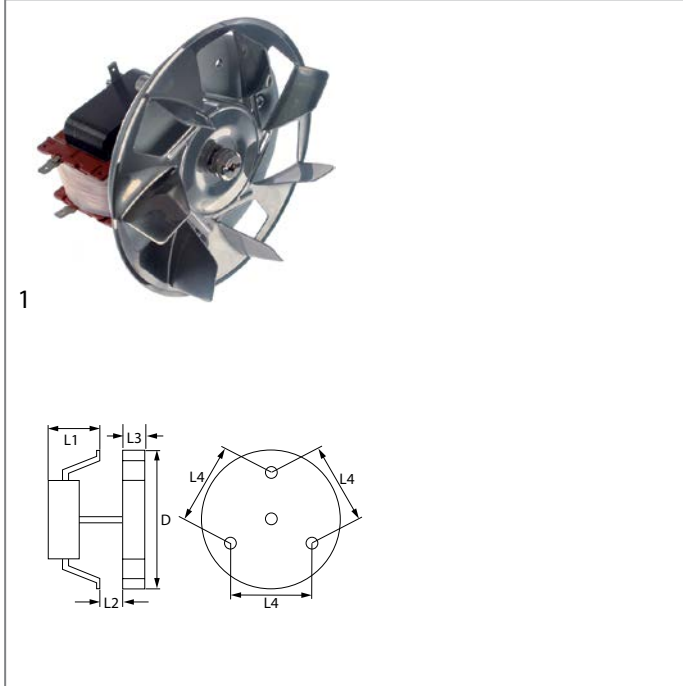
miscellaneous



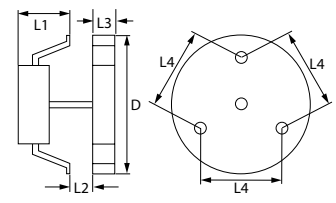
1



| | | | |
|------------------------|---|-----------------|--|
| GEV No. | 601054 | Ref. No. | 1037117200 7800200 MA1037117200 MA7800200 |
| description | hot air fan 220-240V 32W 50/60Hz L1 60mm L2 10mm L3 25mm L4 87mm fan wheel ø 150mm FIME type C20X0E01/46 | | |
| For models: | CFE60, CFE60P, CFGE61, CFGE61D, CFGE61L, CFGE61P, CFVE60, OCFE60, OCFGE61, TP12, TP126, TP126E, TP12E, TP13, TP136, TP136E, TP13E, TP14, TP146, TP146E, TP14E, TP15, TP156, TP156E, TP15E, TP16, TP166, TP166E, TP16E, TP17, TP176, TP176E, TP17E, TP18, TP186, TP186E, TP18E, TP19, TP196, TP196E, TP19E, TP20, TP206, TP206E, TP20E, TP21, TP212, TP2126, TP2126E, TP212E...(Other models you can see in the webshop) | | |
| spare parts for | 601054 | | |
| | GEV No. | 601441 | Ref. No. — |
| | fan wheel ø 150mm W 25mm shaft intake ø 6x5mm stainless steel blades 7 | | |
| accessories for | 601054 | | |
| | GEV No. | 550879 | Ref. No. — |
| | insulation ø 130mm thickness 3mm hole ø 20mm for hot air fan | | |



1



| | | | |
|------------------------|---|-----------------|----------------------|
| GEV No. | 601696 | Ref. No. | 4330800 MA4330800 |
| description | hot air fan 230V 40W 50/60Hz L1 70mm L2 11mm L3 29mm L4 87mm fan wheel ø 155mm with ball bearing | | |
| For models: | AR712PA, AR712PP, AR712PS, AR713PA, AR713PP, AR713PS, AR714PA, AR714PP, AR714PS, AR715PA, AR715PP, AR715PS, AR716PA, AR716PP, AR716PS, AR717PA, AR717PP, AR717PS, AR718PA, AR718PP, AR718PS, AR719PA, AR719PP, AR719PS, AR720PA, AR720PP, AR720PS, EAR612PA, EAR612PP, EAR612PS, EAR613PA, EAR613PP, EAR613PS, EAR614PA, EAR614PP, EAR614PS, EAR615PA, EAR615PP, EAR615PS, EAR616PA, EAR616PP, EAR616PS, EAR617PA, EAR617PP, EAR617PS, EAR618PA, EAR618PP, EAR618PS, EAR619PA, EAR619PP...(Other models you can see in the webshop) | | |
| spare parts for | 601696 | | |
| | GEV No. | 550879 | Ref. No. — |
| | insulation ø 130mm thickness 3mm hole ø 20mm for hot air fan | | |

accessories

fan wheels for hot air fans



1

| | | | |
|--------------------|---|-----------------|----------------------------|
| GEV No. | 601630 | Ref. No. | 1034400200 MA1034400200 |
| description | fan wheel ø 150mm W 25mm shaft intake ø 6x5mm chrome-plated blades 7 | | |
| For models: | CFE60, CFE60P, CFGE61, CFGE61D, CFGE61L, CFGE61P, CFVE60, OCFE60, OCFGE61 | | |



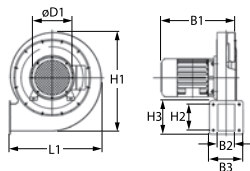
miscellaneous



1

| | | | |
|--------------------|---|-----------------|-----------|
| GEV No. | 551434 | Ref. No. | R58004010 |
| description | plain washer ϕ 30mm thickness 3mm hole ϕ 12.5mm for fan wheel combi-steamer | | |
| For models: | EC110M, EC210M, EM010M+SC, EM110H, EM110M, EM110M+SC, EM110P, EM210H, EM210M, EM210M+SC, EM210P, EV110H, EV110M, EV110M+SC, EV110P, EV210H, EV210M, EV210M+SC, EV210P, FE110M, FE110X, FE210M, FG110M, FG110X, FG210M, FG210X, GC110M, GC210M, GM110H, GM110M, GM110M+SC, GM110P, GM210H, GM210M, GM210M+SC, GM210P, GMT20D, GV110H, GV110M, GV110M+SC, GV110P, GV210H, GV210M, GV210M+SC, GV210P, GVT20D, MACE10M, MACE20M, MACG10M, MACG20M...(Other models you can see in the webshop) | | |

radial fans



1

| | | | |
|------------------------|---|-----------------|----------------------------------|
| GEV No. | 601245 | Ref. No. | R63130010 |
| description | radial fan 24V voltage DC 50Hz 45W H1 170mm L1 170mm D1 ϕ 50mm W1 90mm W2 44mm H2 57mm W3 83mm H3 83mm | | |
| For models: | GMT06D, GMT20D, GVT06D, GVT20D, MACG05M, MACG07M, MACG10M, MACG20M, MG061D, MG061M, MG061P, MG061T, MG101D, MG101M, MG101P, MG101T, MG102D, MG102M, MG102P, MG102T, MG201D, MG201M, MG201P, MG201T, MG202D, MG202M, MG202P, MG202T, MGMT06D, MGMT06P, MGMT10D, MGMT10P, MGMT20D, MGMT20P, MGMT21D, MGMT21P, MGMT40D, MGMT40P, MGVT06D, MGVT06P, MGVT10D, MGVT10P, MGVT20D, MGVT20P, MGVT21D, MGVT21P, MGVT40D, MGVT40P, MVG051P | | |
| accessories for | 601245 | | |
| | | GEV No. | 104309 Ref. No. R63140020 |
| | gasket L 106mm W 100mm H 3mm 4 holes | | |

motors

gear motors

for tilting bratt pans



1

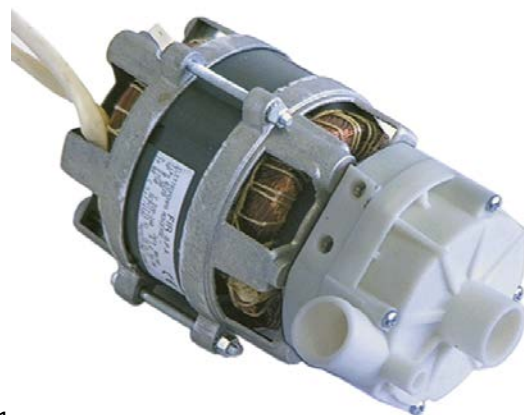
| | | | |
|--------------------|--|-----------------|------------------------|
| GEV No. | 600000 | Ref. No. | CM056300 MACM056300 |
| description | gear motor NERI type M63B4 120W 230V voltage DC 50Hz 1360rpm shaft ϕ 14mm L 308mm W 140mm H 170mm for tilting bratt pan | | |
| For models: | BR78EF, BR78EI, BR78GF, BR78GI, BR912EFM, BR912EIM, BR912GFM, BR912GIM, BR98EF, BR98EFM, BR98EI, BR98EIM, BR98GF, BR98GFM, BR98GI, BR98GIM, BR9S8EF, BR9S8EI, BR9S8GF, BR9S8GI | | |

pumps

wash and rinse pumps

FIR

pumps








1

| | | | |
|------------------------|---|-----------------|-------------------------------|
| GEV No. | 500019 | Ref. No. | 100702 |
| description | pump inlet ϕ 28mm outlet ϕ 26mm type B229.1405 230V 50Hz 1 phase 0.22kW 0.3HP L 200mm rotation direction right capacitor 5 μ F FIR | | |
| spare parts for | 500019 | | |
| | | GEV No. | 365017 Ref. No. — |
| | operating capacitor capacity 5 μ F 450V tolerance 5% 50/60Hz ambient temperature max. -25 to +85°C ϕ 28mm L 54mm M8 plastic connection male faston 6.3mm 16.10.08 protection | | |
| | | GEV No. | 510510 Ref. No. 630125 |
| | pump cover pump type 2212/2228/2229/2211 | | |
| | | GEV No. | 510532 Ref. No. — |
| | impellor ϕ 72mm H 22mm shaft ϕ 11mm shaft length 32mm blades 3 | | |
| | | GEV No. | 510695 Ref. No. 630514 |
| | mechanical shaft seal height counter ring 5.5mm ID ϕ 11mm | | |
| | | GEV No. | 521703 Ref. No. — |
| | pump cover gasket EPDM thickness 2.5mm ID ϕ 75mm Qty 1 pcs | | |





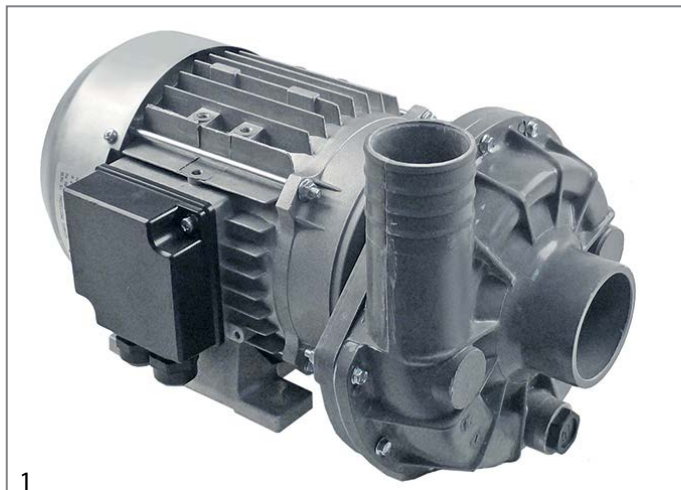
1

| | | | |
|---|---|-----------------|--|
| GEV No. | 500127 | Ref. No. | 100740 |
| description | pump inlet \varnothing 37mm outlet \varnothing 41mm type 4247.1900 230V 50Hz 1 phase 0.44kW 0.6HP L 200mm rotation direction right capacitor 10 μ F FIR | | |
| spare parts for | 500127 | | |
|  | GEV No. | 365015 | Ref. No. 631206 LA65190180 LAR65190180 R65190180 |
| | operating capacitor capacity 10 μ F 400V tolerance 5%Hz ambient temperature max. -25 to +85°C \varnothing 35.5mm L 59mm M8 plastic connection male faston 6.3mm protection | | |
|  | GEV No. | 510608 | Ref. No. 631683 |
| | impellor \varnothing 93mm H 32mm shaft intake \varnothing 9/8mm blades 6 inner height 11mm | | |
|  | GEV No. | 510692 | Ref. No. — |
| | mechanical shaft seal for shaft \varnothing 11mm slide ring ext. \varnothing 24mm slide ring H 13mm counter ring mounting \varnothing 26mm height counter ring 8mm counter ring int. \varnothing 14mm | | |
|  | GEV No. | 521505 | Ref. No. 630129 |
| | pump cover FIR inlet \varnothing 37mm outlet \varnothing 40mm turn direction right \varnothing 160mm ID \varnothing 125mm inner height 25mm | | |
|  | GEV No. | 521702 | Ref. No. 630419 |
| | pump cover gasket thickness 3.5x4.5mm Qty 1 pcs | | |



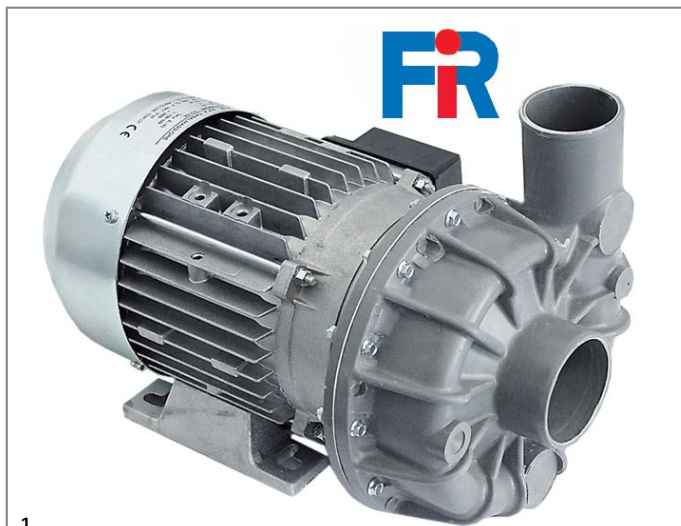
1

| | | | |
|---|---|-----------------|--|
| GEV No. | 500038 | Ref. No. | 1037304600 |
| description | pump inlet \varnothing 45mm outlet \varnothing 40mm type 3911.1425 230V 50Hz 1 phase 0.55kW 0.75HP L 205mm rotation direction right capacitor 10 μ F FIR | | |
| For models: | DLS30, DLS303, DLS30P, DLS30P3, DLS31, DLS313, DLS31P3, MLS30, MLS303, MLS30P, MLS30P3, MLS31, MLS313, MLS31P3, MLS35, MLS353, MPLS30P | | |
| spare parts for | 500038 | | |
|  | GEV No. | 365015 | Ref. No. 631206 LA65190180 LAR65190180 R65190180 |
| | operating capacitor capacity 10 μ F 400V tolerance 5%Hz ambient temperature max. -25 to +85°C \varnothing 35.5mm L 59mm M8 plastic connection male faston 6.3mm protection | | |
|  | GEV No. | 510508 | Ref. No. — |
| | pump cover FIR inlet \varnothing 45mm outlet \varnothing 40mm pump type PU 0.5/3911 turn direction right \varnothing 160mm ID \varnothing 125mm inner height 25mm | | |
|  | GEV No. | 510610 | Ref. No. — |
| | impellor \varnothing 95.5mm H 23mm shaft intake \varnothing 9/8mm rotation direction right seat \varnothing 16mm blades 6 | | |
|  | GEV No. | 510692 | Ref. No. — |
| | mechanical shaft seal for shaft \varnothing 11mm slide ring ext. \varnothing 24mm slide ring H 13mm counter ring mounting \varnothing 26mm height counter ring 8mm counter ring int. \varnothing 14mm | | |
|  | GEV No. | 521702 | Ref. No. 630419 |
| | pump cover gasket thickness 3.5x4.5mm Qty 1 pcs | | |
| accessories for | 500038 | | |
|  | GEV No. | 551286 | Ref. No. — |
| | adapter L 120mm 4-pole for Meiko pump suitable for 500038 plug type dependent on equipment | | |







1

| | | | |
|---|--|-----------------|------------------------|
| GEV No. | 500023 | Ref. No. | 1037307400 |
| description | pump inlet ø 63mm outlet ø 47mm type 1225.2725 230/400V 50Hz 3 phase 1.1kW 1.5HP L 335mm rotation direction right FIR | | |
| For models: | MLC50, MLC503, MLC65, MLC653 | | |
| spare parts for | 500023 | | |
|  | GEV No. | 510602 | Ref. No. — |
| | impellor ø 110mm H 34mm rotation direction right thread M8L shaft ø 28mm seat ø 12.2mm blades 6 | | |
|  | GEV No. | 510693 | Ref. No. 630501 |
| | mechanical shaft seal for shaft ø 12mm slide ring ext. ø 24mm slide ring H 15.5mm slide ring int. ø 11mm counter ring mounting ø 24mm height counter ring 8mm counter ring int. ø 13.5mm | | |
|  | GEV No. | 521513 | Ref. No. — |
| | pump cover FIR inlet ø 63mm outlet ø 47mm turn direction right ID ø 150mm inner high 32mm | | |
|  | GEV No. | 524416 | Ref. No. — |
| | pump cover gasket thickness 4x4mm Qty 1 pcs | | |



1

| | | | |
|---|---|-----------------|------------------------|
| GEV No. | 500111 | Ref. No. | 100663 |
| description | pump inlet ø 63mm outlet ø 53mm type 1241.2500 230/400V 50Hz 3 phase 1.1kW 1.5HP L 330mm rotation direction left FIR | | |
| spare parts for | 500111 | | |
|  | GEV No. | 510531 | Ref. No. 630114 |
| | pump cover FIR inlet ø 63mm outlet ø 53mm auxiliary pressure connection M16x1.5mm supporting pressure open turn direction left ø 185mm ID ø 150mm inner high 37mm | | |
|  | GEV No. | 510612 | Ref. No. 631653 |
| | impellor ø 110mm H 34mm M8R | | |

| | | | |
|---|--|--------|------------------------|
| spare parts for | 500111 | | |
|  | GEV No. | 510693 | Ref. No. 630501 |
| | mechanical shaft seal for shaft ø 12mm slide ring ext. ø 24mm slide ring H 15.5mm slide ring int. ø 11mm counter ring mounting ø 24mm height counter ring 8mm counter ring int. ø 13.5mm | | |
|  | GEV No. | 524416 | Ref. No. — |
| | pump cover gasket thickness 4x4mm Qty 1 pcs | | |



1

| | | | |
|--------------------|---|-----------------|--------|
| GEV No. | 501467 | Ref. No. | 100717 |
| description | pump inlet ø 63mm outlet ø 53mm type 2241.2501 230/400V 50Hz 3 phase 0.89kW 1.5HP L 305mm rotation direction left FIR | | |

LGB



1






| | | | |
|---|---|-----------------|--|
| GEV No. | 500513 | Ref. No. | 100727 |
| description | pump inlet ø 45mm outlet ø 40mm type FM4023SX 230V 50Hz 1 phase 0.75kW 1HP L 300mm rotation direction right capacitor 16µF LGB | | |
| spare parts for | 500513 | | |
|  | GEV No. | 365021 | Ref. No. 631202 LAR65190030 R65190030 |
| | operating capacitor capacity 16µF 425V tolerance 5% 50/60Hz ambient temperature max. -25 to +85°C ø 35mm L 73mm single M8 plastic connection male faston 6.3mm 416.10.99 protection | | |
|  | GEV No. | 510703 | Ref. No. — |
| | mechanical shaft seal for shaft ø 13mm slide ring H 13mm height counter ring 5.5mm ED ø 26mm | | |

Table continues overleaf



| | | | |
|---|--|--------|-----------------|
| spare parts for 500513 | | | |
|  | GEV No. | 521246 | Ref. No. 631674 |
| | impellor ø 103mm H 26mm thread M8L shaft ø 20mm shaft length 7mm seat ø 8.2mm blades 6 | | |
|  | GEV No. | 521542 | Ref. No. — |
| | pump cover LGB inlet ø 45mm outlet ø 40mm auxiliary pressure connection 13mm supporting pressure open ø 150mm ID ø 120mm inner height 25mm | | |
|  | GEV No. | 521714 | Ref. No. 630420 |
| | pump cover gasket thickness 4x4mm Qty 1 pcs | | |

miscellaneous



| | | | |
|----------|---|-----------------|--------|
| 1 | GEV No. 500016 | Ref. No. | 100399 |
| | description pump type AL15 1 phase IBMEI | | |

drain pumps


ASKOLL



| | | | |
|--------------------|--|-----------------|----------------------------|
| 1 | GEV No. 500210 | Ref. No. | 1037304700 MA1037304700 |
| | description drain pump 230V 40W | | |
| For models: | DLS30, DLS303, DLS30P, DLS30P3, DLS31, DLS313, DLS31P3, MLS30, MLS303, MLS30P, MLS30P3, MLS31, MLS313, MLS31P3, MLS35, MLS353, MPLS30P | | |

GRE



| | | | |
|---|--|-----------------|------------|
| 1 | GEV No. 500961 | Ref. No. | 100342 |
| | description drain pump inlet ø 30mm outlet ø 23mm 100W 230V 50Hz GRE | | |
| accessories for | 500961 | | |
|  | GEV No. | 524719 | Ref. No. — |
| | formed hose hose ext. ø 40mm hose int. ø 30mm L 65mm warewashing black Qty 1 | | |

miscellaneous



| | | | |
|--------------------|--|-----------------|-----------|
| 1 | GEV No. 500201 | Ref. No. | R65110300 |
| | description drain pump inlet ø 24mm outlet ø 22mm 230V 100W | | |
| For models: | GMT06D | | |

booster pumps II

accessories



| | | | |
|--------------------|---|-----------------|-------------------------------------|
| 1 | GEV No. 365015 | Ref. No. | 631206 LA65190180 LAR65190180 |
| | description operating capacitor capacity 10µF 400V tolerance 5%Hz ambient temperature max. -25 to +85°C ø 35.5mm L 59mm M8 plastic connection male faston 6.3mm protection | | |
| For models: | EC106M, EM106H, EM106M, EM106M+SC, EM106P, EV006M, EV106H, EV106M, EV106M+SC, EV106P, GC106M, GM106H, GM106M, GM106M+SC, GM106P, GMT06D, GV106H, GV106M, GV106M+SC, GV106P, GVT06D, MACE04M, MACE05M, MACE07M, MACE10M, MACE20M, MACG05M, MACG07M, MACG10M, MACG20M, ME061D, ME061M, ME061P, ME061T, MEMT06D, MEMT06P, MEVT06D, MEVT06P, MG061D, MG061M, MG061P, MG061T, MG101D, MG101M, MG101P, MG101T, MG201D, MG201M, MG201P, MG201T...(Other models you can see in the webshop) | | |



vibration pumps

| | | | |
|------------------------|--|-----------------|-------------------|
| <p>1</p> | | | |
| GEV No. | 500568 | Ref. No. | R65110600 |
| description | vibration pump 230V 32W 50Hz inlet ø 7 outlet ø 1/8" IT CEME type E512/A32 | | |
| For models: | ME061T, ME101T, ME102T, ME201T, MEMT06P, MEMT10P, MEMT20P, MEMT21P, MEMT40P, MG102T, MG201T, MG202T, MGMT06P, MGMT10P, MGMT20P, MGMT21P, MGMT40P | | |
| spare parts for | 500568 | | |
| | GEV No. | 390698 | Ref. No. — |
| | thermal fuse switch-off temp. 110°C suitable for ULKA pump | | |
| | GEV No. | 520153 | Ref. No. — |
| | bracket rubber dimensions 53x34x28mm | | |

accessories

pump cover gaskets

| | | | |
|--------------------|-------------------|-----------------|--------|
| <p>1</p> | | | |
| GEV No. | 510399 | Ref. No. | 630413 |
| description | pump cover gasket | | |

| | | | |
|--------------------|--|-----------------|--------|
| <p>1</p> | | | |
| GEV No. | 510550 | Ref. No. | 630416 |
| description | pump cover gasket pump type 2212/1290/2211/2228/2229/2213 EPDM thickness 2.62mm ID ø 82.22mm Qty 1 pcs | | |

condensators & interference suppression filters


operating capacitors

plastic

| | | | |
|--------------------|---|-----------------|--------------------------------------|
| <p>1</p> | | | |
| GEV No. | 365015 | Ref. No. | 631206 LAR65190180 LAR65190180 |
| description | operating capacitor capacity 10µF 400V tolerance 5%Hz ambient temperature max. -25 to +85°C ø 35.5mm L 59mm M8 plastic connection male faston 6.3mm protection | | |
| For models: | EC106M, EM106H, EM106M, EM106M+SC, EM106P, EV006M, EV106H, EV106M, EV106M+SC, EV106P, GC106M, GM106H, GM106M, GM106M+SC, GM106P, GMT06D, GV106H, GV106M, GV106M+SC, GV106P, GVT06D, MACE04M, MACE05M, MACE07M, MACE10M, MACE20M, MACG05M, MACG07M, MACG10M, MACG20M, ME061D, ME061M, ME061P, ME061T, MEMT06D, MEMT06P, MEVT06D, MEVT06P, MG061D, MG061M, MG061P, MG061T, MG101D, MG101M, MG101P, MG101T, MG201D, MG201M, MG201P, MG201T...(Other models you can see in the webshop) | | |

| | | | |
|-------------------------------------|--|-----------------|-----------|
| <p>1</p> <p>Image not available</p> | | | |
| GEV No. | 365034 | Ref. No. | R65190090 |
| description | operating capacitor capacity 12µF with plastic sheathing | | |
| For models: | GM110H, GM110P, GM210H, GM210P, GV110H, GV110P, GV210H, GV210P, MG102P, MG102T, MG110P, MG110X, MG120P, MG120X, MG210P, MG210X, MG220P, MG220X, MGC24H, MGC40H, MGMT20P, MGVT20P, VG110P, VG110X, VG120P, VG120X, VG210P, VG210X, VG220P, VG220X | | |


| | | | |
|--------------------|--|-----------------|-----------------------|
| <p>1</p> | | | |
| GEV No. | 365021 | Ref. No. | 631202 LAR65190030 |
| description | operating capacitor capacity 16µF 425V tolerance 5% 50/60Hz ambient temperature max. -25 to +85°C ø 35mm L 73mm single M8 plastic connection male faston 6.3mm 416.10.99 protection | | |
| For models: | GC110M, GC210M, GM110H, GM110M, GM110M+SC, GM110P, GM210H, GM210M, GM210M+SC, GM210P, GMT20D, GV110H, GV110M, GV110M+SC, GV110P, GV210H, GV210M, GV210M+SC, GV210P, GVT20D, MG102D, MG102M, MG102P, MG102T, MG110M, MG110P, MG110X, MG120M, MG120P, MG120X, MG210M, MG210P, MG210X, MG220M, MG220P, MG220X, MGC20X, MGC24H, MGC40H, MGMT20D, MGMT20P, MGVT20D, MGVT20P, VG110M, VG110P, VG110X, VG120M, VG120P, VG120X, VG210M...(Other models you can see in the webshop) | | |



1

| | | | |
|--------------------|--|-----------------|-----------|
| GEV No. | 365033 | Ref. No. | R65190080 |
| description | operating capacitor capacity 5µF with plastic sheathing | | |
| For models: | CVE004H, CVE004M, CVE104H, CVE104M, CVE105H, CVE105M, CVG105H, CVG105M, ME106M, ME106P, ME106X, MG106M, MG106P, MG106X, VE004M, VE004X, VE104M, VE104X, VE105M, VE105X, VE106M, VE106P, VE106X, VG105M, VG105X, VG106M, VG106P, VG106X | | |

ferrite rings




1

| | | | |
|--------------------|---|-----------------|-----------|
| GEV No. | 691295 | Ref. No. | R65280450 |
| description | ferrite ring ID ø 17mm ED ø 28mm H 20mm for protection | | |
| For models: | EM106H, EM106P, EM110H, EM110P, EM210H, EM210P, EV106H, EV106P, EV110H, EV110P, EV210H, EV210P, GM106H, GM106P, GM110H, GM110P, GM210H, GM210P, GMT06D, GMT20D, GV106H, GV106P, GV110H, GV110P, GV210H, GV210P, GVT06D, GVT20D, ME061D, ME061P, ME061T, ME101D, ME101P, ME101T, ME102P, ME102T, ME201D, ME201P, ME201T, ME202D, ME202P, ME202T, MEC24H, MEMT06D, MEMT06P, MEMT10D, MEMT10P, MEMT20D, MEMT20P, MEMT21D...(Other models you can see in the webshop) | | |


filters

interference suppression filters




1

| | | | |
|--------------------|--|-----------------|--------|
| GEV No. | 365046 | Ref. No. | 631209 |
| description | interference suppression filter type 10S7E-G1474253105-Q 115/250V 50/60Hz conductor 2 with E connection male faston 6.3mm L 40mm ø 40mm Hmm Wmm M8 plastic Qty 1 pcs | | |



1


| | | | |
|--------------------|--|-----------------|----------------------------|
| GEV No. | 365045 | Ref. No. | 1037116500 MA1037116500 |
| description | interference suppression filter type FC701Y2F 250V 50-60Hz conductor 2 with E connection cable 200mm L 40mm ø 30mm Hmm Wmm plastic Qty 1 pcs | | |
| For models: | CPE60, CPE602, CPE60DB, FQE40, FQE40D, FQE40DSP, FQE41, FQE41L, FQE41L2, FQE60, FQE60D, FQE60DSP, FQE61, FQE61L, FQE61L2, FTVE100, FTVE40, FTVE40D, FTVE60, FTVE60D, OCPE6, OCPE60, OFQE41, OFQE61, PCVE40, PCVE40D, PCVE40DB, PCVE60, PCVE60D, PCVE60DB, SME62M, SME63M, SME70M, TSE60M, V74EC, V76EC, V94E, V98E | | |



1

| | | | |
|--------------------|---|-----------------|-----------------------------------|
| GEV No. | 365044 | Ref. No. | 1984000 MA1984000 R65280200 |
| description | interference suppression filter type FC701Y2F 250V 50-60Hz conductor 2 with E connection cable 200mm L 42mm ø 23mm Hmm Wmm plastic Qty 1 pcs | | |
| For models: | CP704E, CP92E, CP92E2, CP94E, CP94E2, CP95B2E, CP95B2E2, CP95B4E, CP95B4E2, DE92142, DE94242, EC106M, EC110M, EC210M, EM010M+SC, EM106H, EM106M, EM106M+SC, EM106P, EM110H, EM110M, EM110M+SC, EM110P, EM210H, EM210M, EM210M+SC, EM210P, EV006M, EV106H, EV106M, EV106M+SC, EV106P, EV110H, EV110M, EV110M+SC, EV110P, EV210H, EV210M, EV210M+SC, EV210P, FR74E, FR74E10, FR74E10L, FR74E10L2, FR74E2, FR77E, FR77E10, FR77E10L, FR77E10L2, FR77E2...(Other models you can see in the webshop) | | |

RC circuits




1

| | | | |
|--------------------|--|-----------------|-----------|
| GEV No. | 365155 | Ref. No. | R65280130 |
| description | RC circuit 250/630V connection male faston 6.3mm cable length 65mm capacity 47nF 100Ohm | | |
| For models: | EC106M, EC110M, EC210M, EM010M+SC, EM106M, EM106M+SC, EM110M, EM110M+SC, EM210M, EM210M+SC, EV006M, EV106M, EV106M+SC, EV110M, EV110M+SC, EV210M, EV210M+SC, GC106M, GC110M, GC210M, GM106M, GM106M+SC, GM110M, GM110M+SC, GM210M, GM210M+SC, GV106M, GV106M+SC, GV110M, GV110M+SC, GV210M, GV210M+SC, MACE04M, MACE05M, MACE07M, MACE10M, MACE20M, MACG05M, MACG07M, MACG10M, MACG20M, ME061M, ME101M, ME102D, ME102M, ME201M, ME202M, MEC40M, MG061M, MG101M...(Other models you can see in the webshop) | | |

fuses


fine fuses




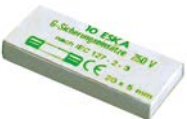
1


| | | | |
|--------------------|---|-----------------|-----------|
| GEV No. | 358532 | Ref. No. | R65200200 |
| description | fine fuse size ø5x20mm 2A fast-acting rated 250V Qty 10 pcs | | |
| For models: | CVE004H, CVE004M, CVE104H, CVE104M, CVE105H, CVE105M, CVG105H, CVG105M, EC106M, EC110M, EC210M, EM010M+SC, EM106H, EM106M, EM106M+SC, EM106P, EM110H, EM110M, EM110M+SC, EM110P, EM210H, EM210M, EM210M+SC, EM210P, EV006M, EV106H, EV106M, EV106M+SC, EV106P, EV110H, EV110M, EV110M+SC, EV110P, EV210H, EV210M, EV210M+SC, EV210P, FE105M, FE105X, FE110M, FE110X, FE210M, FG105M, FG105X, FG110M, FG110X, FG210M, FG210X, GC106M, GC110M...(Other models you can see in the webshop) | | |





| | | | |
|---|---|-----------------|-----------|
|  | | | |
| 1 | | | |
| GEV No. | 358593 | Ref. No. | R65200086 |
| description | fine fuse size ϕ 5x20mm 0.125A slow-acting rated 250V Qty 10 pcs | | |
| For models: | CVE004H, CVE104H, CVE105H, CVG105H, EM010M+SC, EM106H, EM106M+SC, EM106P, EM110M+SC, EM110P, EM210M+SC, EM210P, EV106H, EV106M+SC, EV106P, EV110M+SC, EV110P, EV210M+SC, EV210P, GM106H, GM106M+SC, GM106P, GM110M+SC, GM110P, GM210M+SC, GM210P, GV106H, GV106M+SC, GV106P, GV110M+SC, GV110P, GV210M+SC, GV210P, ME061P, ME061T, ME101P, ME101T, ME102P, ME102T, ME106M, ME106P, ME106X, ME110M, ME110P, ME110X, ME120M, ME120P, ME120X, ME201P, ME201T...(Other models you can see in the webshop) | | |


| | | | |
|---|---|-----------------|-----------|
|  | | | |
| 1 | | | |
| GEV No. | 358592 | Ref. No. | R65200140 |
| description | fine fuse size ϕ 5x20mm 0.1A slow-acting rated 250V Qty 10 pcs | | |
| For models: | GMT20D, MG061M, MG101D, MG101M, MG102D, MG102M, MG201D, MG201M, MGMT20D | | |


| | | | |
|--|---|-----------------|-----------|
|  | | | |
| 1 | | | |
| GEV No. | 358595 | Ref. No. | R65200320 |
| description | fine fuse size ϕ 5x20mm 0.2A slow-acting rated 250V Qty 10 pcs | | |
| For models: | EC106M, EM106H, EM106M, EM106M+SC, EM106P, EM110H, EM110P, EM210H, EM210P, EV006M, EV106H, EV106M, EV106M+SC, EV106P, EV110H, EV110P, EV210H, EV210P, FG105X, GC106M, GM106H, GM106M, GM106M+SC, GM106P, GM110H, GM210H, GV106H, GV106M, GV106M+SC, GV106P, GV110H, GV210H, MACE10M, MACE20M, ME061P, ME061T, ME101D, ME101M, ME102D, ME102M, ME106P, ME106X, ME110P, ME120P, ME201D, ME201M, ME210P, ME220P, MEC24H, MEMT10D...(Other models you can see in the webshop) | | |


| | | | |
|---|---|-----------------|-----------|
|  | | | |
| 1 | | | |
| GEV No. | 358703 | Ref. No. | R65200350 |
| description | fine fuse size ϕ 5x20mm 0.4A slow-acting rated 250V Qty 10 pcs | | |
| For models: | EC110M, EC210M, EM010M+SC, EM110H, EM110M, EM110M+SC, EM110P, EM210H, EM210M, EM210M+SC, EM210P, EV110H, EV110M, EV110M+SC, EV110P, EV210H, EV210M, EV210M+SC, EV210P, FE105X, FG110X, FG210X, GC110M, GC210M, GM110H, GM110M, GM110M+SC, GM110P, GM210H, GM210M, GM210M+SC, GM210P, GV110H, GV110M, GV110M+SC, GV110P, GV210H, GV210M, GV210M+SC, GV210P, ME110P, ME110X, ME120P, ME120X, ME210P, ME210X, ME220P, ME220X, MEC24H, MEC40M...(Other models you can see in the webshop) | | |


| | | | |
|---|---|-----------------|--------|
|  | | | |
| 1 | | | |
| GEV No. | 358033 | Ref. No. | 130259 |
| description | fine fuse size ϕ 10x38mm 1A slow-acting rated 500V type aM Qty 1 pcs | | |

| | | | |
|---|---|-----------------|--------|
|  | | | |
| 1 | | | |
| GEV No. | 358034 | Ref. No. | 130260 |
| description | fine fuse size ϕ 10x38mm 2A slow-acting rated 500V type aM Qty 1 pcs | | |


| | | | |
|---|---|-----------------|--------|
|  | | | |
| 1 | | | |
| GEV No. | 358035 | Ref. No. | 130230 |
| description | fine fuse size ϕ 10x38mm 4A slow-acting rated 500V type aM Qty 1 pcs | | |


| | | | |
|---|--|-----------------|--------|
|  | | | |
| 1 | | | |
| GEV No. | 358196 | Ref. No. | 130246 |
| description | fine fuse size ϕ 10x38mm 12A rated 500V type Gg fast-acting Qty 1 pcs | | |

| | | | |
|---|--|-----------------|--------|
|  | | | |
| 1 | | | |
| GEV No. | 358028 | Ref. No. | 130248 |
| description | fine fuse size ϕ 10x38mm 20A rated 500V type Gg fast-acting Qty 1 pcs | | |


| | | | |
|---|---|-----------------|--------|
|  | | | |
| 1 | | | |
| GEV No. | 358024 | Ref. No. | 130245 |
| description | fine fuse size ϕ 10x38mm 8A rated 500V type gI fast-acting Qty 1 pcs | | |


fine fuse holders


| | | | |
|--|---|-----------------|---|
|  <p>1</p> | | | |
| GEV No. | 358512 | Ref. No. | 208021-99 208021-99 n.m.liefe LA65210020 LAR65210020 |
| description | fuse holder | | |
| For models: | CS102E, CS102EP, CS102G, CS102GP, CVE004H, CVE004M, CVE104H, CVE104M, CVE105H, CVE105M, CVG105H, CVG105M, EC106M, EC110M, EC210M, EM010M+SC, EM106H, EM106M, EM106M+SC, EM106P, EM110H, EM110M, EM110M+SC, EM110P, EM210H, EM210M, EM210M+SC, EM210P, EV006M, EV106H, EV106M, EV106M+SC, EV106P, EV110H, EV110M, EV110M+SC, EV110P, EV210H, EV210M, EV210M+SC, EV210P, FE105M, FE105X, FE110M, FE110X, FE210M, FG105M, FG105X, FG110M, FG110X...(Other models you can see in the webshop) | | |


| | | | |
|--|---|-----------------|--------|
|  <p>2</p> | | | |
| GEV No. | 358075 | Ref. No. | 150710 |
| description | fuse holder for for fuse ø10x38mm suitable fuse ø10x38mm 1-pole 32A rated 690V for DIN rail 35mm cross section 10mm ² suitable for for fuse ø10x38mm | | |

overload switches

| | | | |
|--|--|-----------------|-----------|
|  <p>1</p> | | | |
| GEV No. | 358514 | Ref. No. | R65160300 |
| description | overload switch drop-away current 0.8A | | |
| For models: | EM106H, EM106P, EV106H, EV106P, GM106H, GM106P, GV106H, GV106P, ME061P, ME061T, MEMT06P, MEVT06P, MG061P, MG061T, MGMT06P, MGVT06P | | |

| | | | |
|--|--|-----------------|-----------|
|  <p>1</p> | | | |
| GEV No. | 358515 | Ref. No. | R65160310 |
| description | overload switch drop-away current 2.5A | | |
| For models: | EC106M, EM106H, EM106M, EM106M+SC, EM106P, EV006M, EV106H, EV106M, EV106M+SC, EV106P, GC106M, GM106H, GM106M, GM106M+SC, GM106P, GV106H, GV106M, GV106M+SC, GV106P, MG061T | | |

| | | | |
|--|---|-----------------|-----------|
|  <p>1</p> | | | |
| GEV No. | 358520 | Ref. No. | R65160220 |
| description | overload switch drop-away current 2.5A connection male faston 6.3mm | | |
| For models: | FE105M, FE105X, FG105M, FG105X, PE040M, PE040X, PG040M, PG040X | | |

| | | | |
|--|--|-----------------|-----------|
|  <p>1</p> | | | |
| GEV No. | 358516 | Ref. No. | R65160320 |
| description | overload switch drop-away current 2A | | |
| For models: | GMT06D, GVT06D, MACE07M, MACG07M, ME061D, ME061M, ME061P, ME061T, MEMT06D, MEMT06P, MEVT06D, MEVT06P, MG061D, MG061M, MG061P, MGMT06D, MGMT06P, MGVT06D, MGVT06P | | |

electric accessories


cables


| | | | |
|------------------------------|--|--|--|
| accessories | | | |
| cable glands | | | |
| threaded cable glands | | | |
| screw connections | | | |


| | | | |
|---|--|-----------------|----------------------------|
|  <p>1</p> | | | |
| GEV No. | 550971 | Ref. No. | 1037115100 MA1037115100 |
| description | cable gland thread PG16 cable ø 14mm mounting ø 22.5mm Qty 1 pcs plastic WS 27 | | |
| For models: | AR712PA, AR712PP, AR712PS, AR713PA, AR713PP, AR713PS, AR714PA, AR714PP, AR714PS, AR715PA, AR715PP, AR715PS, AR716PA, AR716PP, AR716PS, AR717PA, AR717PP, AR717PS, AR718PA, AR718PP, AR718PS, AR719PA, AR719PP, AR719PS, AR720PA, AR720PP, AR720PS, B124E, B9SB2E, B9SB4E, B9V2E, B9V4E, BIE40, BIE40B, BIE60, BIE60B, BME40DM, BME40DMB, BME40M, BME60, BME60Z, BME60DM, BME60DMB, BME60M, BME80M, BRE40, BRE40D, BRE40DB, BRE40DG, BRE40DGB...(Other models you can see in the webshop) | | |


| | | | |
|---|--|-----------------|----------------------------|
|  <p>1</p> | | | |
| GEV No. | 550973 | Ref. No. | 1037112400 MA1037112400 |
| description | cable gland thread PG21 cable ø 17mm mounting ø 28mm Qty 1 pcs plastic WS 34 | | |
| For models: | CP92E, CP92E2, CP94E, CP94E2, CP95B2E, CP95B2E2, CP95B4E, CP95B4E2, EC74EVG, EC78EVG, EC7FE8E, EF74E12, F12C4E12, F74E10, F74E6, F76E10, F94E10, F94E6, F96E10, FQE40, FQE40D, FQE40DSP, FQE41, FQE41L, FQE41L2, FQE41R, FQE41RL, FQE41RL2, FQE60, FQE60D, FQE60DSP, FQE61, FQE61L, FQE61L2, FQE61R, FQE61RL, NBR78EF, NBR78EI, NBR912EFM, NBR912EIM, NBR98EF, NBR98EFM, NBR98EI, NBR98EIM, NF74E10, NF76E10, NF94E10, NF96E10, NPC74E, NPC74G...(Other models you can see in the webshop) | | |




| fastening nuts | | | |
|--|--|----------|----------------------------|
|  <p>1</p> | | | |
| GEV No. | 550972 | Ref. No. | 1037115200 MA1037115200 |
| description | nut thread PG16 WS 30 plastic Qty 1 pcs thickness 6mm mounting ømm cable ømm | | |
| For models: | AR712PA, AR712PP, AR712PS, AR713PA, AR713PP, AR713PS, AR714PA, AR714PP, AR714PS, AR715PA, AR715PP, AR715PS, AR716PA, AR716PP, AR716PS, AR717PA, AR717PP, AR717PS, AR718PA, AR718PP, AR718PS, AR719PA, AR719PP, AR719PS, AR720PA, AR720PP, AR720PS, B124E, B9SB2E, B9SB4E, B9V2E, B9V4E, BIE40, BIE40B, BIE60, BIE60B, BME40DM, BME40DMB, BME40M, BME60, BME602, BME60DM, BME60DMB, BME60M, BME80M, BRE40, BRE40D, BRE40DB, BRE40DG, BRE40DGB...(Other models you can see in the webshop) | | |


|  <p>1</p> | | | |
|--|--|----------|----------------------------|
| GEV No. | 550974 | Ref. No. | 1037114500 MA1037114500 |
| description | nut thread PG21 WS 34 plastic Qty 1 pcs thickness 7.5mm mounting ømm cable ømm | | |
| For models: | CP92E, CP92E2, CP94E, CP94E2, CP9SB2E, CP9SB2E2, CP9SB4E, CP9SB4E2, EC74EVG, EC78EVG, EC7FE8E, EF74E12, F12C4E12, F74E10, F74E6, F76E10, F94E10, F94E6, F96E10, FQE40, FQE40D, FQE40DSP, FQE41, FQE41L, FQE41L2, FQE41R, FQE41RL, FQE41RL2, FQE60, FQE60D, FQE60DSP, FQE61, FQE61L, FQE61L2, FQE61R, FQE61RL, NBR78EF, NBR78EI, NBR912EFM, NBR912EIM, NBR98EF, NBR98EFM, NBR98EI, NBR98EIM, NF74E10, NF76E10, NF94E10, NF96E10, NPC74E, NPC74G...(Other models you can see in the webshop) | | |

| ribbon cables | | | |
|--|--|----------|-----------|
| group 1 | | | |
|  <p>1</p> | | | |
| GEV No. | 403107 | Ref. No. | R65301470 |
| description | ribbon cable 16-pole L 85mm plug type 2 row coded | | |
| For models: | ME061P, ME101P, ME102P, ME201P, ME202P, MEMT06P, MEMT10P, MEMT20P, MEMT21P, MGMT40P, MEVT06P, MEVT10P, MEVT20P, MEVT21P, MEVT40P, MG061P, MG101P, MG102P, MG201P, MG202P, MGMT06P, MGMT10P, MGMT20P, MGMT21P, MGMT40P, MGVT06P, MGVT10P, MGVT20P, MGVT21P, MGVT40P | | |

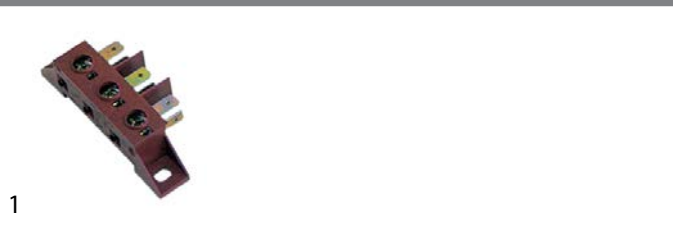
| miscellaneous | | | |
|--|--|----------|-----------|
|  <p>1</p> | | | |
| GEV No. | 401960 | Ref. No. | R66110320 |
| description | kable set | | |
| For models: | GMT20D, GVT20D, MACE07M, MACE10M, MACE20M, MACG07M, MACG10M, MACG20M, ME101D, ME101M, ME101P, ME101T, ME102D, ME102M, ME102P, ME102T, ME201D, ME201M, ME201P, ME201T, ME202D, ME202M, ME202P, ME202T, MEMT10D, MEMT10P, MEMT20D, MEMT20P, MEVT10D, MEVT10P, MEVT20D, MEVT20P, MG101D, MG101M, MG101P, MG101T, MG102D, MG102M, MG102P, MG102T, MG201D, MG201M, MG201P, MG201T, MG202D, MG202M, MG202P, MG202T, MGMT10D, MGMT10P...(Other models you can see in the webshop) | | |

| terminals and connectors | | | |
|--|--|----------|------------|
| not insulated | | | |
| female bullets | | | |
|  <p>1</p> | | | |
| GEV No. | 100023 | Ref. No. | MA20418099 |
| description | female bullet size 2.3mm 0.5-1.5mm ² CuZn t.max. 125°C Qty 20 pcs | | |

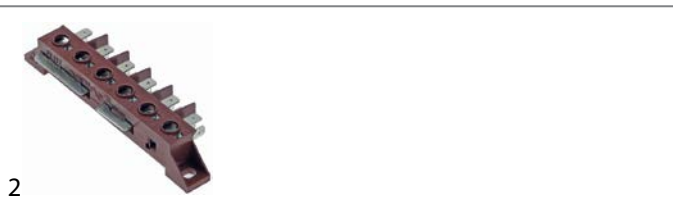
| terminals | | | |
|--|--|----------|----------------------------|
| porcelain clamps | | | |
|  <p>1</p> | | | |
| GEV No. | 550115 | Ref. No. | 1037117600 MA1037117600 |
| description | porcelain terminal block 2-pole 10mm ² max. 30A max 450V L 37mm W 37mm H 23mm mounting distancemm Qty 1 pcs | | |
| For models: | CT78EC, CT7FE8EC, CT98EC, CT9FE8EC, ERA10, ERA12, ERA14, ERA16, ERA18, ERA20, ERA210, ERA212, ERA214, ERA216, ERA218, ERA220, NSP74E, NSP94E, SP74E, SP94E | | |

|  <p>1</p> | | | |
|--|--|----------|--------|
| GEV No. | 550414 | Ref. No. | 112800 |
| description | porcelain terminal block 4-pole 10mm ² hole distance 29mm max. 30A max 450V t.max. 200°C L 60mm W 28mm H 20mm mounting distance 29mm Qty 1 pcs | | |
| For models: | B9SB2E, B9SB4E, B9V2E, B9V4E, BR707E, BR707EI, BR94E, BR94EI, BR96E, BR96EI, BR9M4E, BR9M4EI, BR9M4GI, BR9M6E, BR9M6EI, BR9SB4E, BR9SB4EI, C7011E, C7011EFE, C7011EFEQ, C704E, C707E, C707EFE, C707EFEQ, C9F4E, C9F6E, C9FE6GS, C9V2E, C9V4E, CP92E, CP94E, CP9SB2E, CP9SB4E, F9V2E, F9V2ER, F9V4E, F9V4EC, F9V4ECR, F9V4ER, F9V4ERL, FC10E, FC10G, FC20E, FC20G, FC5E, FC7E, FC7G, FP1E, FR92E13, FR92E22...(Other models you can see in the webshop) | | |

connection terminals with screw/faston connections



| | | | |
|--------------------|---|-----------------|----------------------------|
| GEV No. | 550278 | Ref. No. | 1037117300 MA1037117300 |
| description | power terminal block 3-pole max. 40A max 400V connection $\phi 6\text{mm}^2$ / F6.3 temp.-resist. 150°C cross section 6mm ² | | |
| For models: | AR712PA, AR712PP, AR712PS, AR713PA, AR713PP, AR713PS, AR714PA, AR714PP, AR714PS, AR715PA, AR715PP, AR715PS, AR716PA, AR716PP, AR716PS, AR717PA, AR717PP, AR717PS, AR718PA, AR718PP, AR718PS, AR719PA, AR719PP, AR719PS, AR720PA, AR720PP, AR720PS, B124E, BME40DM, BME40DMB, BME40M, BME60DM, BME60DMB, BME60M, BME80M, BSEI40M, EAR612PA, EAR612PP, EAR612PS, EAR613PA, EAR613PP, EAR613PS, EAR614PA, EAR614PP, EAR614PS, EAR615PA, EAR615PP, EAR615PS, EAR616PA, EAR616PP...(Other models you can see in the webshop) | | |



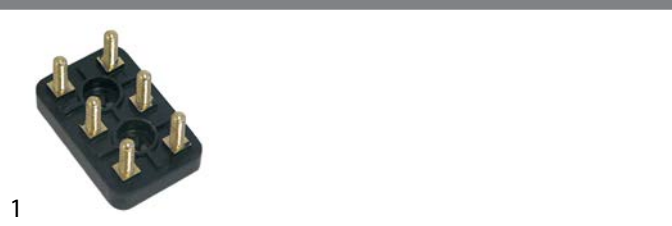
| | | | |
|--------------------|---|-----------------|---------------------------------------|
| GEV No. | 550411 | Ref. No. | 1037104000 1616200 MA1037104000 |
| description | power terminal block 6-pole max. 40A max 450V connection $\phi 6\text{mm}^2$ / F6.3 temp.-resist. 150°C cross section 6mm ² | | |
| For models: | BIE40B, BIE60B, BM74E, BM77E, BME40M, BME60, BME602, BME60M, BME80M, BRE40, BRE40D, BRE40DB, BRE40DG, BRE40DGB, BRE40G, BSE40M, CFE60, CFE60P, CFGE60, CFGE61, CFGE61D, CFGE61L, CFGE61P, CFVE60, CPE60, CPE602, CPE60DB, CRE6220, CRE6230, CRE6320, CRE6330, CSP6220, CSP6230, CWE42, CWE422, CWE62, CWE622, DLS30, DLS303, DLS30P, DLS30P3, DLS31, DLS313, DLS31P3, FQE40, FQE40D, FQE40DSP, FQE41, FQE41L, FQE41L2...(Other models you can see in the webshop) | | |



| | | | |
|--------------------|---|-----------------|-----------|
| GEV No. | 550977 ¹ | Ref. No. | CR0588170 |
| description | power terminal block 6-pole max. 40A max 450V connection $\phi 6\text{mm}^2$ / F6.3 temp.-resist. 150°C cross section 6mm ² with ground lug | | |
| For models: | EC74EVG, EC78EVG, EC7FE8E, EFT74ELVG, EFT74ERVG, EFT78ELVG, EFT78EMVG, EPC74E, NBR78EF, NBR78EI, NC74E2, NC74EC, NC74EQC, NC78E2, NC78EC, NC78EQC, NC7FE8E, NC7FE8E2, NC7FE8EQ, NC94E, NC94E2, NC98E, NC98E2, NC9FE8E, NC9FE8E2, NCT78E, NCT7FE8E, NFT74EL, NFT74ELC, NFT74ELCO, NFT74ELO, NFT74ER, NFT74ERC, NFT76EL, NFT76ELC, NFT76EM, NFT76EMC, NFT76ER, NFT78EL, NFT78ELC, NFT78ELCO, NFT78ELO, NFT78EM, NFT78EMC, NFT78ER, NFT78ERC, NFT94EL, NFT94ELC, NFT94ELO, NFT94ER...(Other models you can see in the webshop) | | |

¹with ground lug

terminal boards



| | | | |
|--------------------|---|-----------------|----------------------|
| GEV No. | 550413 | Ref. No. | 1229800 MA1229800 |
| description | terminal board 3-pole thread M5 L 55mm W 36mm | | |
| For models: | B9SB2E, B9SB2G, B9SB4E, B9SB4G, B9V2E, B9V2G, B9V4E, B9V4G, BR707E, BR707EI, C7011EFE, C7011EFEQ, C707EFE, C707EFEQ, C9F4E, C9F6E, C9FE6GS, C9V2E, C9V4E, CP704E, CP92E, CP94E, CP95B2E, CP95B4E, CPE60, F9V2E, F9V2ER, F9V4E, F9V4EC, F9V4ECR, F9V4ER, F9V4ERL, FC5E, FR74E, FR77E, P9D10E, P9D15E, P9DA10E, P9DA15E, P9DSB10E, P9I10E, P9IA10E, PDASB10E, PI707E, SBA, SBAC, SVAC, SVAC12, SVAC16, SVAC20...(Other models you can see in the webshop) | | |

rail-mounted terminals

rail-mounted terminal blocks




| | | | |
|--------------------|--|-----------------|-----------|
| GEV No. | 550421 ¹ | Ref. No. | R65220090 |
| description | rail-mounted terminal block 5-pole contacts 3P+N+E cross section 1.0-10mm ² | | |
| For models: | CVE004H, CVE004M, CVE104H, CVE104M, CVE105H, CVE105M, CVG105H, CVG105M, EC106M, EM106H, EM106M, EM106M+SC, EM106P, EV006M, EV106H, EV106M, EV106M+SC, EV106P, FE105M, FE105X, FE110M, FE110X, FG110M, FG110X, FG210M, FG210X, MACE04M, MACE05M, MACE07M, MACG05M, ME061D, ME061M, ME061P, ME061T, ME106M, ME106P, ME106X, MEMT06D, MEMT06P, MEVT06D, MEVT06P, MG106M, MG106P, MG106X, MG110M, MG110P, MG110X, MG120M, MG120P, MG120X...(Other models you can see in the webshop) | | |


¹with fused terminal block



| | | | |
|--------------------|--|-----------------|-----------|
| GEV No. | 550420 | Ref. No. | R65220080 |
| description | rail-mounted terminal block 5-pole contacts 3P+N+E cross section 1.5-16mm ² | | |
| For models: | EC110M, EM010M+SC, EM110H, EM110M, EM110M+SC, EM110P, EV110H, EV110M, EV110M+SC, EV110P, FE210M, MACE10M, ME101D, ME101M, ME101P, ME101T, ME110M, ME110P, ME110X, MEMT10D, MEMT10P, MEVT10D, MEVT10P, VE110M, VE110X, VE210P | | |






| | | | |
|---|---|-----------------|-----------|
|  | | | |
| 1 | | | |
| GEV No. | 550422 | Ref. No. | R65220130 |
| description | rail-mounted terminal block 9-pole | | |
| For models: | EC210M, EM210H, EM210M, EM210M+SC, EM210P, EV210H, EV210M, EV210M+SC, EV210P, ME102D, ME102M, ME102P, ME102T, ME120M, ME120P, ME120X, ME201D, ME201M, ME201P, ME201T, ME202D, ME202M, ME202P, ME202T, ME210M, ME210P, ME210X, ME220M, ME220P, ME220X, MEC24H, MEC40M, MEMT20D, MEMT20P, MEMT21D, MEMT21P, MEMT40D, MEMT40P, MEVT20D, MEVT20P, MEVT21D, MEVT21P, MEVT40D, MEVT40P, MG202P, MG202T, MG-MT40P, MGVT40P, VE120M, VE120P...(Other models you can see in the webshop) | | |

| | | | |
|---|---|-----------------|----------------------|
| various | | | |
|  | | | |
| 1 | | | |
| GEV No. | 693955 | Ref. No. | 1878400 MA1878400 |
| description | terminal grounding cable | | |
| For models: | AR712PA, AR712PP, AR712PS, AR713PA, AR713PP, AR713PS, AR-714PA, AR714PP, AR714PS, AR715PA, AR715PP, AR715PS, AR716PA, AR716PP, AR716PS, AR717PA, AR717PP, AR717PS, AR718PA, AR718PP, AR718PS, AR719PA, AR719PP, AR719PS, AR720PA, AR720PP, AR720PS, BIE40B, BIE60B, BME40DM, BME40DMB, BME40M, BME60, BME60Z, BME60DM, BME60DMB, BME60M, BME80M, BRE40, BRE40D, BRE40DB, BRE40DG, BRE40DGB, BRE40G, BSE40M, BSEI40M, CRE6220, CRE6230, CRE6320, CRE6330...(Other models you can see in the webshop) | | |

gas taps

PEL

| | | | |
|---|---|-----------------|---|
| 20S series | | | |
|  | | | |
| 1 | | | |
| GEV No. | 101094 | Ref. No. | 1341700 SIR0100730 |
| description | gas tap PEL type 20S gas inlet M16x1.5 (tube ø 10mm) bypass nozzle ø 0.35mm gas outlet M16x1.5 (tube ø 10/8mm) thermocouple connection M8x1 pilot connection shaft ø 8x6.5mm shaft L 22/15mm shaft flat lower | | |
| For models: | C9F6G, C9F6GS, T9F6GS | | |
| spare parts for | 101094 | | |
|  | GEV No. | 100408 | Ref. No. — |
| | bypass nozzle type PEL20/21 bore ø 0.35mm thread M5x0.5 | | |
|  | GEV No. | 101060 | Ref. No. 24030199 MA24030199 SI0100752 SIR0100752 |
| | magnet unit standard L 39mm D1 ø 15.4mm D2 ø 11mm suitable for PEL20-21/JUNKERS/EGA | | |
|  | GEV No. | 101205 | Ref. No. — |
| | gas tap front part shaft ø 8x6.5mm shaft L 22/15mm shaft flat upper/lower suitable for PEL20 | | |

| | | | |
|---|---|--------|--|
| spare parts for | 101094 | | |
|  | GEV No. | 101230 | Ref. No. 24030299 MA24030299 |
| | thermocouple nut T1: M8x1 T2: M18x1 aluminium | | |
| accessories for | 101094 | | |
|  | GEV No. | 101278 | Ref. No. 867-20 MA86720 |
| | olive for pipe ø 10mm Qty 1 pcs | | |
|  | GEV No. | 101300 | Ref. No. 1326500 MA1326500 |
| | union nut thread M16x1.5 tube ø 10mm | | |
|  | GEV No. | 101450 | Ref. No. — |
| | olive for pipe ø 8mm L 12.7mm Qty 1 pcs ED ø 10mm | | |
|  | GEV No. | 101451 | Ref. No. — |
| | union nut thread M16x1.5 tube ø 8mm | | |
|  | GEV No. | 110081 | Ref. No. — |
| | knob ø 70mm shaft ø 8x6.5mm shaft flat universal | | |
|  | GEV No. | 110083 | Ref. No. — |
| | knob dial plate gas tap without ignition flame silver | | |





| | | | |
|---|---|-----------------|---|
| 21S series | | | |
|  | | | |
| 1 | | | |
| GEV No. | 101095 | Ref. No. | 1700200 1700500 MA1700200 |
| description | gas tap PEL type 21S gas inlet M16x1.5 (tube ø 10mm) bypass nozzle ø 0.35mm gas outlet M16x1.5 (tube ø 10/8mm) thermocouple connection M8x1 pilot connection M10x1 shaft ø 8x6.5mm shaft L 22/15mm shaft flat lower | | |
| For models: | C7011G, C7011GFE, C7011GFG, C704G, C707G, C707GFE, C707GFG, FT74G, FT74GR, FT77G, FT77GRL, GB707G | | |
| spare parts for | 101095 | | |
|  | GEV No. | 100408 | Ref. No. — |
| | bypass nozzle type PEL20/21 bore ø 0.35mm thread M5x0.5 | | |
|  | GEV No. | 101060 | Ref. No. 24030199 MA24030199 SI0100752 SIR0100752 |
| | magnet unit standard L 39mm D1 ø 15.4mm D2 ø 11mm suitable for PEL20-21/JUNKERS/EGA | | |
|  | GEV No. | 101206 | Ref. No. — |
| | gas tap front part shaft ø 8x6.5mm shaft L 22/15mm shaft flat upper/lower suitable for PEL21 | | |
|  | GEV No. | 101230 | Ref. No. 24030299 MA24030299 |
| | thermocouple nut T1: M8x1 T2: M18x1 aluminium | | |
| accessories for | 101095 | | |
|  | GEV No. | 100908 | Ref. No. 0100777 673500 MA673500 R0100777 SIR0100777 |
| | union screw thread M10x1 for pipe ø 4mm Qty 1 pcs | | |

Table continues overleaf




| accessories for | | 101095 | |
|---|---------|--------|-------------------------------|
|  | GEV No. | 100909 | Ref. No. — |
| union screw thread M10x1 for pipe ø 6mm Qty 1 pcs | | | |
|  | GEV No. | 101246 | Ref. No. 673600 MA673600 |
| olive for pipe ø 4mm Qty 1 pcs | | | |
|  | GEV No. | 101278 | Ref. No. 867-20 MA86720 |
| olive for pipe ø 10mm Qty 1 pcs | | | |
|  | GEV No. | 101286 | Ref. No. — |
| olive ID ø 6mm Qty 1 pcs | | | |
|  | GEV No. | 101300 | Ref. No. 1326500 MA1326500 |
| union nut thread M16x1.5 tube ø 10mm | | | |
|  | GEV No. | 101450 | Ref. No. — |
| olive for pipe ø 8mm L 12.7mm Qty 1 pcs ED ø 10mm | | | |
|  | GEV No. | 101451 | Ref. No. — |
| union nut thread M16x1.5 tube ø 8mm | | | |
|  | GEV No. | 110081 | Ref. No. — |
| knob ø 70mm shaft ø 8x6.5mm shaft flat universal | | | |
|  | GEV No. | 112206 | Ref. No. — |
| knob dial plate silver gas tap PEL21/22/23 t.max.°C ED ø 63mm ID ø 45.5mm | | | |














| GEV No. | 101397 | Ref. No. | 1888700 1888800 1888900 1916900 CM226800 MA1888700 |
|---------|--------|----------|---|
|---------|--------|----------|---|

description gas tap PEL type 21S gas inlet M16x1.5 (tube ø 10mm) bypass nozzle ø 0.35mm gas outlet M16x1.5 (tube ø 10/8mm) thermocouple connection M9x1 pilot connection M10x1 shaft ø 8x6.5mm shaft L 22/15mm shaft flat lower

For models: BR78GF, BR78GI, C7011G, C7011GFE, C7011GFG, C704G, C707G, C707GFE, C707GFG, C712G, C74G, C74GS, C78G, C78GS, C79G, C7FE12G, C7FE12GS, C7FE8G, C7FE8GS, C7FG12G, C7FG12GS, C7FG8G, C7FG8GS, C7FG9G, C7FGM12G, C912G, C912GS, C94G, C94GP, C94GS, C98G, C98GP, C98GS, C9F4GS, C9F6GS, C9F8GS, C9FE12G, C9FE12GS, C9FE4GS, C9FE6GS, C9FE8G, C9FE8GS, C9FEP4GS, C9FEP6GS, C9FEP8GS, C9FG12G, C9FG12GS, C9FG16G, C9FG8G, C9FG8GP...(Other models you can see in the webshop)

| spare parts for | | 101397 | |
|--|---------|--------|---|
|  | GEV No. | 100408 | Ref. No. — |
| bypass nozzle type PEL20/21 bore ø 0.35mm thread M5x0.5 | | | |
|  | GEV No. | 101060 | Ref. No. 24030199 MA24030199 SI0100752 SI0100752 |
| magnet unit standard L 39mm D1 ø 15.4mm D2 ø 11mm suitable for PEL20-21/JUNKERS/EGA | | | |
|  | GEV No. | 101206 | Ref. No. — |
| gas tap front part shaft ø 8x6.5mm shaft L 22/15mm shaft flat upper/lower suitable for PEL21 | | | |

| spare parts for | | 101397 | |
|---|---------|--------|------------|
|  | GEV No. | 101231 | Ref. No. — |
| thermocouple nut T1: M9x1 T2: M18x1 | | | |

| accessories for | | 101397 | |
|---|---------|--------|---|
|  | GEV No. | 100908 | Ref. No. 0100777 673500 MA673500 R0100777 SI0100777 |
| union screw thread M10x1 for pipe ø 4mm Qty 1 pcs | | | |
|  | GEV No. | 100909 | Ref. No. — |
| union screw thread M10x1 for pipe ø 6mm Qty 1 pcs | | | |
|  | GEV No. | 101246 | Ref. No. 673600 MA673600 |
| olive for pipe ø 4mm Qty 1 pcs | | | |
|  | GEV No. | 101278 | Ref. No. 867-20 MA86720 |
| olive for pipe ø 10mm Qty 1 pcs | | | |
|  | GEV No. | 101286 | Ref. No. — |
| olive ID ø 6mm Qty 1 pcs | | | |
|  | GEV No. | 101300 | Ref. No. 1326500 MA1326500 |
| union nut thread M16x1.5 tube ø 10mm | | | |
|  | GEV No. | 101450 | Ref. No. — |
| olive for pipe ø 8mm L 12.7mm Qty 1 pcs ED ø 10mm | | | |
|  | GEV No. | 101451 | Ref. No. — |
| union nut thread M16x1.5 tube ø 8mm | | | |
|  | GEV No. | 110081 | Ref. No. — |
| knob ø 70mm shaft ø 8x6.5mm shaft flat universal | | | |
|  | GEV No. | 112206 | Ref. No. — |
| knob dial plate silver gas tap PEL21/22/23 t.max.°C ED ø 63mm ID ø 45.5mm | | | |



| GEV No. | 101693 | Ref. No. | 1031500200 MA1031500200 |
|---------|--------|----------|----------------------------|
|---------|--------|----------|----------------------------|

description gas tap PEL type 21S gas inlet M16x1.5 (tube ø 10mm) bypass nozzle ø 0.7mm gas outlet M16x1.5 (tube ø 10/8mm) thermocouple connection M8x1 pilot connection M10x1 shaft ø 6x4.6mm shaft L 35/28mm shaft flat right

For models: BIG40, BIG60, CFG101, CFG70, CFG70M, CFGE61, CFGE61D, CFGE61L, CFGE61P, OCFG101, OCFG70, OCFG61, OPG41, OPG61, PCG41, PCG41L, PCG61, PCG61L

















| spare parts for | | 101693 | |
|---|---------|--------|---|
|  | GEV No. | 100552 | Ref. No. 0102067 1884200 MA1884200 R0102067 SI0102067 |
| bypass nozzle type PEL20/21 bore ø 0.7mm thread M5x0.5 | | | |
|  | GEV No. | 101060 | Ref. No. 24030199 MA24030199 SI0100752 SI0100752 |
| magnet unit standard L 39mm D1 ø 15.4mm D2 ø 11mm suitable for PEL20-21/JUNKERS/EGA | | | |


Table continues overleaf



| | | | | |
|---|---------|--------|----------|---|
| spare parts for 101693 | | | | |
|  | GEV No. | 101230 | Ref. No. | 24030299 MA24030299 |
| thermocouple nut T1: M8x1 T2: M18x1 aluminium | | | | |
|  | GEV No. | 101877 | Ref. No. | — |
| gas tap front part shaft ø 6x4.6mm type PEL21 | | | | |
| accessories for 101693 | | | | |
|  | GEV No. | 100908 | Ref. No. | 0100777 673500 MA673500 R0100777 SIR0100777 |
| union screw thread M10x1 for pipe ø 4mm Qty 1 pcs | | | | |
|  | GEV No. | 100909 | Ref. No. | — |
| union screw thread M10x1 for pipe ø 6mm Qty 1 pcs | | | | |
|  | GEV No. | 101246 | Ref. No. | 673600 MA673600 |
| olive for pipe ø 4mm Qty 1 pcs | | | | |
|  | GEV No. | 101278 | Ref. No. | 867-20 MA86720 |
| olive for pipe ø 10mm Qty 1 pcs | | | | |
|  | GEV No. | 101286 | Ref. No. | — |
| olive ID ø 6mm Qty 1 pcs | | | | |
|  | GEV No. | 101300 | Ref. No. | 1326500 MA1326500 |
| union nut thread M16x1.5 tube ø 10mm | | | | |
|  | GEV No. | 101450 | Ref. No. | — |
| olive for pipe ø 8mm L 12.7mm Qty 1 pcs ED ø 10mm | | | | |
|  | GEV No. | 101451 | Ref. No. | — |
| union nut thread M16x1.5 tube ø 8mm | | | | |

| | | | | |
|--|--|-----------------|----------------------------|--|
|  <p>1</p> | | | | |
| GEV No. | 101913 | Ref. No. | 1031501300 MA1031501300 | |
| description | gas tap PEL type 21S gas inlet M16x1.5 (tube ø 10mm) bypass nozzle ø 0.9mm gas outlet M16x1.5 (tube ø 10/8mm) thermocouple connection M8x1 pilot connection M10x1 shaft ø 6x4.6mm shaft L 35/28mm shaft flat right | | | |
| For models: | CFG101, CFG70, CFG70M, CFGE61, CFGE61D, CFGE61L, CFGE61P, OCFG101, OCFG70, OCFGE61, OPCG41, OPCG61, OPLG40, OPLG80, PCG41, PCG41L, PCG42, PCG61, PCG61L, PCG82, PLG40, PLG80 | | | |
| spare parts for 101913 | | | | |
|  | GEV No. | 100528 | Ref. No. | 1033720200 1889000 MA1033720200 MA1889000 |
| bypass nozzle type PEL20/21 bore ø 0.9mm thread M5x0.5 | | | | |
|  | GEV No. | 101060 | Ref. No. | 24030199 MA24030199 SIO100752 SIR0100752 |
| magnet unit standard L 39mm D1 ø 15.4mm D2 ø 11mm suitable for PEL20-21/JUNKERS/EGA | | | | |
|  | GEV No. | 101230 | Ref. No. | 24030299 MA24030299 |
| thermocouple nut T1: M8x1 T2: M18x1 aluminium | | | | |

| | | | | |
|---|---------|--------|----------|---|
| spare parts for 101913 | | | | |
|  | GEV No. | 101877 | Ref. No. | — |
| gas tap front part shaft ø 6x4.6mm type PEL21 | | | | |
| accessories for 101913 | | | | |
|  | GEV No. | 100908 | Ref. No. | 0100777 673500 MA673500 R0100777 SIR0100777 |
| union screw thread M10x1 for pipe ø 4mm Qty 1 pcs | | | | |
|  | GEV No. | 100909 | Ref. No. | — |
| union screw thread M10x1 for pipe ø 6mm Qty 1 pcs | | | | |
|  | GEV No. | 101246 | Ref. No. | 673600 MA673600 |
| olive for pipe ø 4mm Qty 1 pcs | | | | |
|  | GEV No. | 101278 | Ref. No. | 867-20 MA86720 |
| olive for pipe ø 10mm Qty 1 pcs | | | | |
|  | GEV No. | 101286 | Ref. No. | — |
| olive ID ø 6mm Qty 1 pcs | | | | |
|  | GEV No. | 101300 | Ref. No. | 1326500 MA1326500 |
| union nut thread M16x1.5 tube ø 10mm | | | | |
|  | GEV No. | 101450 | Ref. No. | — |
| olive for pipe ø 8mm L 12.7mm Qty 1 pcs ED ø 10mm | | | | |
|  | GEV No. | 101451 | Ref. No. | — |
| union nut thread M16x1.5 tube ø 8mm | | | | |
|  | GEV No. | 110078 | Ref. No. | — |
| knob without symbol ø 70mm shaft ø 6x4.6mm shaft flat universal | | | | |
|  | GEV No. | 112206 | Ref. No. | — |
| knob dial plate silver gas tap PEL21/22/23 t.max.°C ED ø 63mm ID ø 45.5mm | | | | |

| | | | | |
|---|--|-----------------|-----------|--|
|  <p>1</p> | | | | |
| GEV No. | 101824 | Ref. No. | CR0580450 | |
| description | gas tap PEL type 21S gas inlet pipe flange ø 21mm bypass nozzle ø 0.9mm gas outlet M16x1.5 (tube ø 10/8mm) thermocouple connection M9x1 pilot connection M10x1 shaft ø 8x6.5mm shaft L 22/15mm shaft flat upper pipe input ø 9mm | | | |
| For models: | NC712G36, NC74G12, NC78G24, NC7FE12G36, NC7FE8G24, NC7FG12G44, NC7FG8G32, NC7FGM12G, NC912G44, NC94G16, NC94G20, NC98G28, NC98G40, NC9FE12G44, NC9FE8G28, NC9FG12G52, NC9FG16G72, NC9FG8G32, NC9FG8G36, NC9FG8G48, NC9FGM12G, NFT74GL, NFT74GR, NFT76GL, NFT76GM, NFT76GR, NFT78GL, NFT78GM, NFT78GR, NFT94GL, NFT94GR, NFT96GL, NFT96GM, NFT96GL, NFT98GM, NFT98GL, NFT98GM, NFT98GR, NS78GS, NS7FG12GS, NS7FG8GS, NT7FG12G, NT9FG12G | | | |



22N/O series





| | | | |
|----------------|--------|-----------------|--------------------------------|
| GEV No. | 101443 | Ref. No. | 1337600 673800 MA1337600 |
|----------------|--------|-----------------|--------------------------------|


description gas tap PEL type 22N/O gas inlet M20x1.5 (tube ø 12mm) bypass nozzle ø 0.35mm gas outlet M20x1.5 (tube ø 12/10mm) thermocouple connection pilot connection M10x1 shaft ø 10x8mm shaft L 25/17mm shaft flat lower


For models: C9F4G, C9F6G, C9F8G, C9SB4GS, C9V2G, C9V4G, C9V6G, C9V8G


spare parts for 101443

| | | | | |
|---|----------------|--------|-----------------|---|
|  | GEV No. | 100259 | Ref. No. | — |
| bypass nozzle type PEL22 bore ø 0.35mm thread M6x0.5 | | | | |


| | | | | |
|---|----------------|--------|-----------------|---|
|  | GEV No. | 101201 | Ref. No. | — |
| gas tap front part shaft ø 10x8mm shaft L 25/17mm shaft flat upper/lower suitable for PEL22 | | | | |


| | | | | |
|---|----------------|--------|-----------------|---|
|  | GEV No. | 101240 | Ref. No. | — |
| gas connection thread M20x1.5 tube ø 12/10mm for PEL gas taps with gasket and screws horizontal | | | | |

| | | | | |
|---|----------------|--------|-----------------|---|
|  | GEV No. | 101460 | Ref. No. | — |
| O-ring ø 12.37mm D1 ø 2.62mm suitable for PEL22 | | | | |

| | | | | |
|---|----------------|--------|-----------------|---|
|  | GEV No. | 101461 | Ref. No. | — |
| screw kit suitable for PEL22 Qty 4 pcs | | | | |

accessories for 101443


| | | | | |
|---|----------------|--------|-----------------|---|
|  | GEV No. | 100908 | Ref. No. | 0100777 673500 MA673500 R0100777 SIR0100777 |
| union screw thread M10x1 for pipe ø 4mm Qty 1 pcs | | | | |


| | | | | |
|---|----------------|--------|-----------------|---|
|  | GEV No. | 100909 | Ref. No. | — |
| union screw thread M10x1 for pipe ø 6mm Qty 1 pcs | | | | |


| | | | | |
|---|----------------|--------|-----------------|--------------------|
|  | GEV No. | 101246 | Ref. No. | 673600 MA673600 |
| olive for pipe ø 4mm Qty 1 pcs | | | | |

| | | | | |
|---|----------------|--------|-----------------|--------------------|
|  | GEV No. | 101248 | Ref. No. | 673300 MA673300 |
| olive for pipe ø 12mm Qty 1 pcs suitable for PEL | | | | |

| | | | | |
|---|----------------|--------|-----------------|--------------------|
|  | GEV No. | 101249 | Ref. No. | 673400 MA673400 |
| olive for pipe ø 10mm Qty 1 pcs | | | | |

| | | | | |
|---|----------------|--------|-----------------|--------------------|
|  | GEV No. | 101250 | Ref. No. | 673200 MA673200 |
| union nut thread M20x1.5 for pipe ø 10mm | | | | |

| | | | | |
|---|----------------|--------|-----------------|--------------------|
|  | GEV No. | 101251 | Ref. No. | 673100 MA673100 |
| union nut thread M20x1.5 for pipe ø 12mm | | | | |

| | | | | |
|---|----------------|--------|-----------------|---|
|  | GEV No. | 101286 | Ref. No. | — |
| olive ID ø 6mm Qty 1 pcs | | | | |

22S/O series





| | | | |
|----------------|--------|-----------------|--|
| GEV No. | 101089 | Ref. No. | 1093600 1093700 1337200 MA1093600 |
|----------------|--------|-----------------|--|


description gas tap PEL type 22S/O gas inlet M20x1.5 (tube ø 12mm) bypass nozzle ø 0.35mm gas outlet M20x1.5 (tube ø 12/10mm) thermocouple connection M8x1 pilot connection M10x1 shaft ø 10x8mm shaft L 25/17mm shaft flat upper


For models: 704S, 706S, C9F4GS, C9F6GS, C9F8GS, C9SB4GS, C9V2GS, C9V4GS, C9V6GS, C9V8GS, CP707G, CP92G, CP94G, F9SB2G, F9SB2GR, F9SB4G, F9SB4GR, F9SB4GRL, F9V2G, F9V2GR, F9V4G, F9V4GR, F9V4GRL, P9D2G, PD707G, T7011GFG, T707G, T707GFG, TPF706S


spare parts for 101089


| | | | | |
|---|----------------|--------|-----------------|---|
|  | GEV No. | 100259 | Ref. No. | — |
| bypass nozzle type PEL22 bore ø 0.35mm thread M6x0.5 | | | | |


| | | | | |
|---|----------------|--------|-----------------|---|
|  | GEV No. | 101058 | Ref. No. | — |
| magnet unit L 39mm D1 ø 15.4mm D2 ø 13.5mm suitable for PEL22/EGA24197 standard | | | | |

| | | | | |
|---|----------------|--------|-----------------|---|
|  | GEV No. | 101201 | Ref. No. | — |
| gas tap front part shaft ø 10x8mm shaft L 25/17mm shaft flat upper/lower suitable for PEL22 | | | | |


| | | | | |
|---|----------------|--------|-----------------|------------------------|
|  | GEV No. | 101230 | Ref. No. | 24030299 MA24030299 |
| thermocouple nut T1: M8x1 T2: M18x1 aluminium | | | | |


| | | | | |
|---|----------------|--------|-----------------|---|
|  | GEV No. | 101240 | Ref. No. | — |
| gas connection thread M20x1.5 tube ø 12/10mm for PEL gas taps with gasket and screws horizontal | | | | |


| | | | | |
|---|----------------|--------|-----------------|---|
|  | GEV No. | 101460 | Ref. No. | — |
| O-ring ø 12.37mm D1 ø 2.62mm suitable for PEL22 | | | | |


| | | | | |
|---|----------------|--------|-----------------|---|
|  | GEV No. | 101461 | Ref. No. | — |
| screw kit suitable for PEL22 Qty 4 pcs | | | | |

accessories for 101089

| | | | | |
|---|----------------|--------|-----------------|---|
|  | GEV No. | 100908 | Ref. No. | 0100777 673500 MA673500 R0100777 SIR0100777 |
| union screw thread M10x1 for pipe ø 4mm Qty 1 pcs | | | | |

| | | | | |
|---|----------------|--------|-----------------|---|
|  | GEV No. | 100909 | Ref. No. | — |
| union screw thread M10x1 for pipe ø 6mm Qty 1 pcs | | | | |

| | | | | |
|---|----------------|--------|-----------------|---|
|  | GEV No. | 101241 | Ref. No. | — |
| olive for pipe ø 4mm Qty 1 pcs | | | | |

| | | | | |
|---|----------------|--------|-----------------|--------------------|
|  | GEV No. | 101246 | Ref. No. | 673600 MA673600 |
| olive for pipe ø 4mm Qty 1 pcs | | | | |









| | | | | |
|---|----------------|--------|-----------------|--------------------|
|  | GEV No. | 101248 | Ref. No. | 673300 MA673300 |
| olive for pipe ø 12mm Qty 1 pcs suitable for PEL | | | | |

Table continues overleaf



| accessories for | | 101089 | | |
|---|---------|--------|----------|--------------------|
|  | GEV No. | 101249 | Ref. No. | 673400 MA673400 |
| olive for pipe ø 10mm Qty 1 pcs | | | | |
|  | GEV No. | 101250 | Ref. No. | 673200 MA673200 |
| union nut thread M20x1.5 for pipe ø 10mm | | | | |
|  | GEV No. | 101251 | Ref. No. | 673100 MA673100 |
| union nut thread M20x1.5 for pipe ø 12mm | | | | |
|  | GEV No. | 101286 | Ref. No. | — |
| olive ID ø 6mm Qty 1 pcs | | | | |
|  | GEV No. | 110080 | Ref. No. | — |
| knob ø 70mm shaft ø 10x8mm shaft flat universal | | | | |
|  | GEV No. | 112206 | Ref. No. | — |
| knob dial plate silver gas tap PEL21/22/23 t.max.°C ED ø 63mm ID ø 45.5mm | | | | |

| | | | | |
|---|--|-----------------|--|---|
|  | | | | |
| 1 | | | | |
| GEV No. | 101086 | Ref. No. | 1888600 1926800 MA1888600 MA1926800 | |
| description | gas tap PEL type 22S/O gas inlet M20x1.5 (tube ø 12mm) bypass nozzle ø 0.35mm gas outlet M20x1.5 (tube ø 12/10mm) thermocouple connection M9x1 pilot connection M10x1 shaft ø 10x8mm shaft L 25/17mm shaft flat lower | | | |
| For models: | C124G, C129G, C12C2G9, C12C9G, C12FG9G, C712G, C74G, C78G, C7FE12G, C7FE8G, C7FG12G, C7FG8G, C7FGM12G, C912G, C912GS, C94G, C94GP, C94GS, C98G, C98GP, C98GS, C9FE12G, C9FE12GS, C9FE8G, C9FE8GS, C9FG12G, C9FG12GS, C9FG16G, C9FG8G, C9FG8GP, C9FG8GS, C9FGM12G, CP704G, CP92G, CP94G, CP9SB2G, CP9SB4G, ET78GVG, ET7FG8G, FB1GS, FP1GS, NG74G, NG78G, NG94G, NG98G, NT78G, NT7FG12G, NT7FG8G, NT98G, NT9FG12G... (Other models you can see in the webshop) | | | |
| spare parts for | | 101086 | | |
|  | GEV No. | 100259 | Ref. No. | — |
| bypass nozzle type PEL22 bore ø 0.35mm thread M6x0.5 | | | | |
|  | GEV No. | 101058 | Ref. No. | — |
| magnet unit L 39mm D1 ø 15.4mm D2 ø 13.5mm suitable for PEL22/ EGA24197 standard | | | | |
|  | GEV No. | 101201 | Ref. No. | — |
| gas tap front part shaft ø 10x8mm shaft L 25/17mm shaft flat upper/lower suitable for PEL22 | | | | |
|  | GEV No. | 101231 | Ref. No. | — |
| thermocouple nut T1: M9x1 T2: M18x1 | | | | |
|  | GEV No. | 101240 | Ref. No. | — |
| gas connection thread M20x1.5 tube ø 12/10mm for PEL gas taps with gasket and screws horizontal | | | | |
|  | GEV No. | 101460 | Ref. No. | — |
| O-ring ø 12.37mm D1 ø 2.62mm suitable for PEL22 | | | | |
|  | GEV No. | 101461 | Ref. No. | — |
| screw kit suitable for PEL22 Qty 4 pcs | | | | |

| accessories for | | 101086 | | |
|---|---------|--------|----------|---|
|  | GEV No. | 100908 | Ref. No. | 0100777 673500 MA673500 R0100777 SIR0100777 |
| union screw thread M10x1 for pipe ø 4mm Qty 1 pcs | | | | |
|  | GEV No. | 100909 | Ref. No. | — |
| union screw thread M10x1 for pipe ø 6mm Qty 1 pcs | | | | |
|  | GEV No. | 101241 | Ref. No. | — |
| gas connection thread M20x1.5 tube ø 12/10mm for PEL gas taps vertical | | | | |
|  | GEV No. | 101246 | Ref. No. | 673600 MA673600 |
| olive for pipe ø 4mm Qty 1 pcs | | | | |
|  | GEV No. | 101248 | Ref. No. | 673300 MA673300 |
| olive for pipe ø 12mm Qty 1 pcs suitable for PEL | | | | |
|  | GEV No. | 101249 | Ref. No. | 673400 MA673400 |
| olive for pipe ø 10mm Qty 1 pcs | | | | |
|  | GEV No. | 101250 | Ref. No. | 673200 MA673200 |
| union nut thread M20x1.5 for pipe ø 10mm | | | | |
|  | GEV No. | 101251 | Ref. No. | 673100 MA673100 |
| union nut thread M20x1.5 for pipe ø 12mm | | | | |
|  | GEV No. | 101286 | Ref. No. | — |
| olive ID ø 6mm Qty 1 pcs | | | | |
|  | GEV No. | 110080 | Ref. No. | — |
| knob ø 70mm shaft ø 10x8mm shaft flat universal | | | | |
|  | GEV No. | 112206 | Ref. No. | — |
| knob dial plate silver gas tap PEL21/22/23 t.max.°C ED ø 63mm ID ø 45.5mm | | | | |

22S/V series




| | | | | |
|--|---|-----------------|--|---|
|  | | | | |
| 1 | | | | |
| GEV No. | 101457 | Ref. No. | 1031027900 932500 MA1031027900 MA932500 | |
| description | gas tap alternatives to JUNKERS type CH110 gas inlet M20x1.5 (tube ø 12mm) bypass nozzle ø 0.35mm gas outlet M20x1.5 (tube ø 12/10mm) thermocouple connection M8x1 pilot connection M10x1 shaft ø 10mm shaft L 25mm shaft flat with pipe outlet | | | |
| For models: | 704S, 706S, TPF706S | | | |
| spare parts for | | 101457 | | |
|  | GEV No. | 100259 | Ref. No. | — |
| bypass nozzle type PEL22 bore ø 0.35mm thread M6x0.5 | | | | |

Table continues overleaf

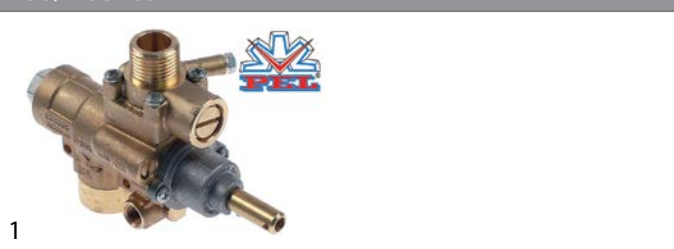
| spare parts for | | 101457 | |
|---|---------|--------|---|
|  | GEV No. | 100908 | Ref. No. |
| | | | 0100777 673500 MA673500 R0100777 SIR0100777 |
| union screw thread M10x1 for pipe ø 4mm Qty 1 pcs | | | |
|  | GEV No. | 101058 | Ref. No. |
| | | | — |
| magnet unit L 39mm D1 ø 15.4mm D2 ø 13.5mm suitable for PEL22/ EGA24197 standard | | | |
|  | GEV No. | 101200 | Ref. No. |
| | | | — |
| gas tap front part shaft ø 10mm shaft L 25mm shaft flat suitable for 22S/O | | | |
|  | GEV No. | 101230 | Ref. No. |
| | | | 24030299 MA24030299 |
| thermocouple nut T1: M8x1 T2: M18x1 aluminium | | | |
|  | GEV No. | 101241 | Ref. No. |
| | | | — |
| gas connection thread M20x1.5 tube ø 12/10mm for PEL gas taps vertical | | | |
|  | GEV No. | 101246 | Ref. No. |
| | | | 673600 MA673600 |
| olive for pipe ø 4mm Qty 1 pcs | | | |
|  | GEV No. | 101460 | Ref. No. |
| | | | — |
| O-ring ø 12.37mm D1 ø 2.62mm suitable for PEL22 | | | |
|  | GEV No. | 101461 | Ref. No. |
| | | | — |
| screw kit suitable for PEL22 Qty 4 pcs | | | |
| accessories for | | 101457 | |
|  | GEV No. | 100945 | Ref. No. |
| | | | — |
| roll pin ø 3.2mm L 10mm | | | |
|  | GEV No. | 101218 | Ref. No. |
| | | | — |
| shaft extension JUNKERS | | | |
|  | GEV No. | 101219 | Ref. No. |
| | | | — |
| shaft extension L 25mm JUNKERS | | | |
|  | GEV No. | 101231 | Ref. No. |
| | | | — |
| thermocouple nut T1: M9x1 T2: M18x1 | | | |
|  | GEV No. | 101248 | Ref. No. |
| | | | 673300 MA673300 |
| olive for pipe ø 12mm Qty 1 pcs suitable for PEL | | | |
|  | GEV No. | 101249 | Ref. No. |
| | | | 673400 MA673400 |
| olive for pipe ø 10mm Qty 1 pcs | | | |
|  | GEV No. | 101250 | Ref. No. |
| | | | 673200 MA673200 |
| union nut thread M20x1.5 for pipe ø 10mm | | | |
|  | GEV No. | 101251 | Ref. No. |
| | | | 673100 MA673100 |
| union nut thread M20x1.5 for pipe ø 12mm | | | |
|  | GEV No. | 101290 | Ref. No. |
| | | | — |
| thermocouple nut T1: M10x1 T2: M18x1 suitable for PEL20/21 | | | |
|  | GEV No. | 110064 | Ref. No. |
| | | | 932600 MA932600 |
| knob | | | |
|  | GEV No. | 110066 | Ref. No. |
| | | | 932700 MA932700 |
| knob screw | | | |

| accessories for | | 101457 | |
|---|---------|--------|----------|
|  | GEV No. | 550396 | Ref. No. |
| | | | — |
| shaft extension L 25mm JUNKERS | | | |

|  Image not available 1 | | | |
|---|---------------------|----------|---|
| GEV No. | 101909 | Ref. No. | 1031503700 |
| description | gas tap type PEL22S | | |
| For models: | BRG40, BRG40G | | |
| spare parts for | | 101909 | |
|  | GEV No. | 100628 | Ref. No. |
| | | | — |
| bypass nozzle type PEL23/24 bore ø 1.05mm thread M8x0.5 | | | |
|  | GEV No. | 100908 | Ref. No. |
| | | | 0100777 673500 MA673500 R0100777 SIR0100777 |
| union screw thread M10x1 for pipe ø 4mm Qty 1 pcs | | | |
|  | GEV No. | 101058 | Ref. No. |
| | | | — |
| magnet unit L 39mm D1 ø 15.4mm D2 ø 13.5mm suitable for PEL22/ EGA24197 standard | | | |
|  | GEV No. | 101200 | Ref. No. |
| | | | — |
| gas tap front part shaft ø 10mm shaft L 25mm shaft flat suitable for 22S/O | | | |
|  | GEV No. | 101230 | Ref. No. |
| | | | 24030299 MA24030299 |
| thermocouple nut T1: M8x1 T2: M18x1 aluminium | | | |
|  | GEV No. | 101241 | Ref. No. |
| | | | — |
| gas connection thread M20x1.5 tube ø 12/10mm for PEL gas taps vertical | | | |
|  | GEV No. | 101246 | Ref. No. |
| | | | 673600 MA673600 |
| olive for pipe ø 4mm Qty 1 pcs | | | |
|  | GEV No. | 101460 | Ref. No. |
| | | | — |
| O-ring ø 12.37mm D1 ø 2.62mm suitable for PEL22 | | | |
|  | GEV No. | 101461 | Ref. No. |
| | | | — |
| screw kit suitable for PEL22 Qty 4 pcs | | | |
| accessories for | | 101909 | |
|  | GEV No. | 101248 | Ref. No. |
| | | | 673300 MA673300 |
| olive for pipe ø 12mm Qty 1 pcs suitable for PEL | | | |
|  | GEV No. | 101249 | Ref. No. |
| | | | 673400 MA673400 |
| olive for pipe ø 10mm Qty 1 pcs | | | |
|  | GEV No. | 101250 | Ref. No. |
| | | | 673200 MA673200 |
| union nut thread M20x1.5 for pipe ø 10mm | | | |
|  | GEV No. | 101251 | Ref. No. |
| | | | 673100 MA673100 |
| union nut thread M20x1.5 for pipe ø 12mm | | | |



23S/V series



| | | | |
|---|--|-----------------|---|
| GEV No. | 101630 | Ref. No. | 745700 MA745700 |
| description | gas tap PEL type 23S/V gas inlet 1/2" IT bypass nozzle ø 0.35mm gas outlet 1/2" MT (tube ø 14mm) thermocouple connection M10x1 pilot connection M10x1 shaft ø 10mm shaft L 25mm shaft flat | | |
| spare parts for | 101630 | | |
|  | GEV No. | 100455 | Ref. No. — |
| | bypass nozzle type PEL23/24 bore ø 0.35mm thread M8x0.5 | | |
|  | GEV No. | 101059 | Ref. No. — |
| | magnet unit T1: M10x1 T2: M22x1 L 46mm ø 18mm suitable for PEL23S M10x1 | | |
|  | GEV No. | 102767 | Ref. No. — |
| | gas tap front part shaft ø 10mm shaft L 26.5mm shaft flat suitable for PEL23S | | |
| accessories for | 101630 | | |
|  | GEV No. | 100908 | Ref. No. 0100777 673500 MA673500 R0100777 SIR0100777 |
| | union screw thread M10x1 for pipe ø 4mm Qty 1 pcs | | |
|  | GEV No. | 100909 | Ref. No. — |
| | union screw thread M10x1 for pipe ø 6mm Qty 1 pcs | | |
|  | GEV No. | 100945 | Ref. No. — |
| | roll pin ø 3.2mm L 10mm | | |
|  | GEV No. | 101218 | Ref. No. — |
| | shaft extension JUNKERS | | |
|  | GEV No. | 101219 | Ref. No. — |
| | shaft extension L 25mm JUNKERS | | |
|  | GEV No. | 101246 | Ref. No. 673600 MA673600 |
| | olive for pipe ø 4mm Qty 1 pcs | | |
|  | GEV No. | 101286 | Ref. No. — |
| | olive ID ø 6mm Qty 1 pcs | | |
|  | GEV No. | 110064 | Ref. No. 932600 MA932600 |
| | knob | | |
|  | GEV No. | 110066 | Ref. No. 932700 MA932700 |
| | knob screw | | |
|  | GEV No. | 550396 | Ref. No. — |
| | shaft extension L 25mm JUNKERS | | |

















| | | | |
|---|--|-----------------|---|
| GEV No. | 101093 | Ref. No. | 1345300 19546-00 MA1345300 MA1954600 |
| description | gas tap PEL type 23S/V gas inlet M28x1.5 (tube ø 20mm) bypass nozzle ø 0.35mm thermocouple connection M10x1 pilot connection M10x1 shaft ø 10x8mm shaft L 25/17mm shaft flat lower | | |
| For models: | MM10DG, MM10DGS, MM15DG, P9D10G, P9D15G, P9DA10G, P9DA15G, P9DASB10G, P9DSB10G, PD98G10, PD98G15, PD98G15A, PD9S8G10, PDASB10G, PI98G10, PI98G14, PI98G14A, T9F4G, T9F6GS, T9S84G, T9V4G, T9V6GS | | |
| spare parts for | 101093 | | |
|  | GEV No. | 100455 | Ref. No. — |
| | bypass nozzle type PEL23/24 bore ø 0.35mm thread M8x0.5 | | |
|  | GEV No. | 101059 | Ref. No. — |
| | magnet unit T1: M10x1 T2: M22x1 L 46mm ø 18mm suitable for PEL23S M10x1 | | |
|  | GEV No. | 101204 | Ref. No. — |
| | gas tap front part shaft ø 10x8mm shaft L 25/17mm shaft flat upper/lower suitable for PEL23S | | |
|  | GEV No. | 101245 | Ref. No. — |
| | gas connection thread M24x1.5 tube ø 12/16mm vertical for PEL gas taps | | |
|  | GEV No. | 101463 | Ref. No. — |
| | screw suitable for PEL23S Qty 4 pcs | | |
|  | GEV No. | 528455 | Ref. No. — |
| | O-ring Viton thickness 2.62mm ID ø 18.72mm Qty 1 pcs | | |
| accessories for | 101093 | | |
|  | GEV No. | 100908 | Ref. No. 0100777 673500 MA673500 R0100777 SIR0100777 |
| | union screw thread M10x1 for pipe ø 4mm Qty 1 pcs | | |
|  | GEV No. | 100909 | Ref. No. — |
| | union screw thread M10x1 for pipe ø 6mm Qty 1 pcs | | |
|  | GEV No. | 101246 | Ref. No. 673600 MA673600 |
| | olive for pipe ø 4mm Qty 1 pcs | | |
|  | GEV No. | 101252 | Ref. No. — |
| | union nut thread M24x1.5 for pipe ø 12mm | | |
|  | GEV No. | 101253 | Ref. No. 1421000 MA1421000 |
| | union nut thread M24x1.5 PEL for pipe ø 16mm | | |
|  | GEV No. | 101254 | Ref. No. 1346900 MA1346900 |
| | union nut thread M28x1.5 tube ø 20mm | | |
|  | GEV No. | 101255 | Ref. No. — |
| | olive for pipe ø 12mm Qty 1 pcs | | |

Table continues overleaf

| accessories for | | 101093 | | |
|---|---------|--------|----------|----------------------|
| | GEV No. | 101256 | Ref. No. | 1127400 MA1127400 |
| olive for pipe ø 16mm Qty 1 pcs | | | | |
| | GEV No. | 101257 | Ref. No. | 1347000 MA1347000 |
| olive for pipe ø 20mm Qty 1 pcs | | | | |
| | GEV No. | 101286 | Ref. No. | — |
| olive ID ø 6mm Qty 1 pcs | | | | |
| | GEV No. | 110080 | Ref. No. | — |
| knob ø 70mm shaft ø 10x8mm shaft flat universal | | | | |
| | GEV No. | 112206 | Ref. No. | — |
| knob dial plate silver gas tap PEL21/22/23 t.max.°C ED ø 63mm ID ø 45.5mm | | | | |

alternatives to JUNKERS

| | | | | |
|---|---|-----------------|--|---|
|  | | | | |
| 1 | | | | |
| GEV No. | 101457 | Ref. No. | 1031027900 932500 MA1031027900 MA932500 | |
| description | gas tap alternatives to JUNKERS type CH110 gas inlet M20x1.5 (tube ø 12mm) bypass nozzle ø 0.35mm gas outlet M20x1.5 (tube ø 12/10mm) thermocouple connection M8x1 pilot connection M10x1 shaft ø 10mm shaft L 25mm shaft flat with pipe outlet | | | |
| For models: | 704S, 706S, TPF706S | | | |
| spare parts for | 101457 | | | |
| | GEV No. | 100259 | Ref. No. | — |
| bypass nozzle type PEL22 bore ø 0.35mm thread M6x0.5 | | | | |
| | GEV No. | 100908 | Ref. No. | 0100777 673500 MA673500 R0100777 SIR0100777 |
| union screw thread M10x1 for pipe ø 4mm Qty 1 pcs | | | | |
| | GEV No. | 101058 | Ref. No. | — |
| magnet unit L 39mm D1 ø 15.4mm D2 ø 13.5mm suitable for PEL22/ EGA24197 standard | | | | |
| | GEV No. | 101200 | Ref. No. | — |
| gas tap front part shaft ø 10mm shaft L 25mm shaft flat suitable for 22S/O | | | | |
| | GEV No. | 101230 | Ref. No. | 24030299 MA24030299 |
| thermocouple nut T1: M8x1 T2: M18x1 aluminium | | | | |
| | GEV No. | 101241 | Ref. No. | — |
| gas connection thread M20x1.5 tube ø 12/10mm for PEL gas taps vertical | | | | |
| | GEV No. | 101246 | Ref. No. | 673600 MA673600 |
| olive for pipe ø 4mm Qty 1 pcs | | | | |
| | GEV No. | 101460 | Ref. No. | — |
| O-ring ø 12.37mm D1 ø 2.62mm suitable for PEL22 | | | | |




| | | | | |
|--|---------|--------|----------|--------------------|
| spare parts for | | 101457 | | |
| | GEV No. | 101461 | Ref. No. | — |
| screw kit suitable for PEL22 Qty 4 pcs | | | | |
| accessories for | | 101457 | | |
| | GEV No. | 100945 | Ref. No. | — |
| roll pin ø 3.2mm L 10mm | | | | |
| | GEV No. | 101218 | Ref. No. | — |
| shaft extension JUNKERS | | | | |
| | GEV No. | 101219 | Ref. No. | — |
| shaft extension L 25mm JUNKERS | | | | |
| | GEV No. | 101231 | Ref. No. | — |
| thermocouple nut T1: M9x1 T2: M18x1 | | | | |
| | GEV No. | 101248 | Ref. No. | 673300 MA673300 |
| olive for pipe ø 12mm Qty 1 pcs suitable for PEL | | | | |
| | GEV No. | 101249 | Ref. No. | 673400 MA673400 |
| olive for pipe ø 10mm Qty 1 pcs | | | | |
| | GEV No. | 101250 | Ref. No. | 673200 MA673200 |
| union nut thread M20x1.5 for pipe ø 10mm | | | | |
| | GEV No. | 101251 | Ref. No. | 673100 MA673100 |
| union nut thread M20x1.5 for pipe ø 12mm | | | | |
| | GEV No. | 101290 | Ref. No. | — |
| thermocouple nut T1: M10x1 T2: M18x1 suitable for PEL20/21 | | | | |
| | GEV No. | 110064 | Ref. No. | 932600 MA932600 |
| knob | | | | |
| | GEV No. | 110066 | Ref. No. | 932700 MA932700 |
| knob screw | | | | |
| | GEV No. | 550396 | Ref. No. | — |
| shaft extension L 25mm JUNKERS | | | | |





| | | | | |
|--|--|-----------------|--------------------|---|
|  | | | | |
| 1 | | | | |
| GEV No. | 101630 | Ref. No. | 745700 MA745700 | |
| description | gas tap PEL type 23S/V gas inlet 1/2" IT bypass nozzle ø 0.35mm gas outlet 1/2" MT (tube ø 14mm) thermocouple connection M10x1 pilot connection M10x1 shaft ø 10mm shaft L 25mm shaft flat | | | |
| spare parts for | 101630 | | | |
| | GEV No. | 100455 | Ref. No. | — |
| bypass nozzle type PEL23/24 bore ø 0.35mm thread M8x0.5 | | | | |
| | GEV No. | 101059 | Ref. No. | — |
| magnet unit T1: M10x1 T2: M22x1 L 46mm ø 18mm suitable for PEL23S M10x1 | | | | |

Table continues overleaf



| | |
|---|--|
| spare parts for 101630 | |
|  | GEV No. 102767 Ref. No. — gas tap front part shaft ø 10mm shaft L 26.5mm shaft flat suitable for PEL23S |
| accessories for 101630 | |
|  | GEV No. 100908 Ref. No. 0100777 673500 MA673500 R0100777 SIR0100777 union screw thread M10x1 for pipe ø 4mm Qty 1 pcs |
|  | GEV No. 100909 Ref. No. — union screw thread M10x1 for pipe ø 6mm Qty 1 pcs |
|  | GEV No. 100945 Ref. No. — roll pin ø 3.2mm L 10mm |
|  | GEV No. 101218 Ref. No. — shaft extension JUNKERS |
|  | GEV No. 101219 Ref. No. — shaft extension L 25mm JUNKERS |
|  | GEV No. 101246 Ref. No. 673600 MA673600 olive for pipe ø 4mm Qty 1 pcs |
|  | GEV No. 101286 Ref. No. — olive ID ø 6mm Qty 1 pcs |
|  | GEV No. 110064 Ref. No. 932600 MA932600 knob |
|  | GEV No. 110066 Ref. No. 932700 MA932700 knob screw |
|  | GEV No. 550396 Ref. No. — shaft extension L 25mm JUNKERS |

| | |
|---|---|
| spare parts for 101909 | |
|  | GEV No. 101200 Ref. No. — gas tap front part shaft ø 10mm shaft L 25mm shaft flat suitable for 22S/O |
|  | GEV No. 101230 Ref. No. 24030299 MA24030299 thermocouple nut T1: M8x1 T2: M18x1 aluminium |
|  | GEV No. 101241 Ref. No. — gas connection thread M20x1.5 tube ø 12/10mm for PEL gas taps vertical |
|  | GEV No. 101246 Ref. No. 673600 MA673600 olive for pipe ø 4mm Qty 1 pcs |
|  | GEV No. 101460 Ref. No. — O-ring ø 12.37mm D1 ø 2.62mm suitable for PEL22 |
|  | GEV No. 101461 Ref. No. — screw kit suitable for PEL22 Qty 4 pcs |
| accessories for 101909 | |
|  | GEV No. 101248 Ref. No. 673300 MA673300 olive for pipe ø 12mm Qty 1 pcs suitable for PEL |
|  | GEV No. 101249 Ref. No. 673400 MA673400 olive for pipe ø 10mm Qty 1 pcs |
|  | GEV No. 101250 Ref. No. 673200 MA673200 union nut thread M20x1.5 for pipe ø 10mm |
|  | GEV No. 101251 Ref. No. 673100 MA673100 union nut thread M20x1.5 for pipe ø 12mm |

| | | | |
|---|---------------------|-----------------|---|
|  Image not available 1 | | | |
| GEV No. | 101909 | Ref. No. | 1031503700 |
| description | gas tap type PEL22S | | |
| For models: | BRG40, BRG40G | | |
| spare parts for 101909 | | | |
|  | GEV No. 100628 | Ref. No. | — |
| bypass nozzle type PEL23/24 bore ø 1.05mm thread M8x0.5 | | | |
|  | GEV No. 100908 | Ref. No. | 0100777 673500 MA673500 R0100777 SIR0100777 |
| union screw thread M10x1 for pipe ø 4mm Qty 1 pcs | | | |
|  | GEV No. 101058 | Ref. No. | — |
| magnet unit L 39mm D1 ø 15.4mm D2 ø 13.5mm suitable for PEL22/ EGA24197 standard | | | |






| | | | |
|---|---|-----------------|--|
| SKG | | | |
|  1 | | | |
| GEV No. | 101154 | Ref. No. | 1031028200 1031028300 MA1031028300 |
| description | gas tap SKG without ignition flame connection | | |
| spare parts for 101154 | | | |
|  | GEV No. 101060 | Ref. No. | 24030199 MA24030199 S10100752 SIR0100752 |
| magnet unit standard L 39mm D1 ø 15.4mm D2 ø 11mm suitable for PEL20-21/JUNKERS/EGA | | | |
| accessories for 101154 | | | |
|  | GEV No. 101060 | Ref. No. | 24030199 MA24030199 S10100752 SIR0100752 |
| magnet unit standard L 39mm D1 ø 15.4mm D2 ø 11mm suitable for PEL20-21/JUNKERS/EGA | | | |
|  | GEV No. 101351 | Ref. No. | — |
| mounting strap for gas tap | | | |

Table continues overleaf

| | | | |
|--|--------|----------|---|
| accessories for | | 101154 | |
| GEV No. | 101376 | Ref. No. | — |
|  <p>gasket ID ø 8mm ED ø 12mm H 3/5mm</p> | | | |

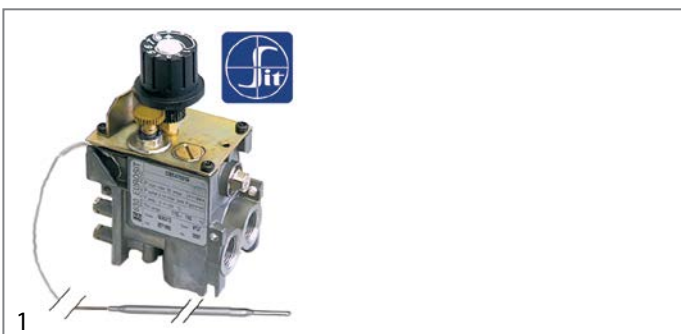
gas thermostats

SIT






630 Eurosit series

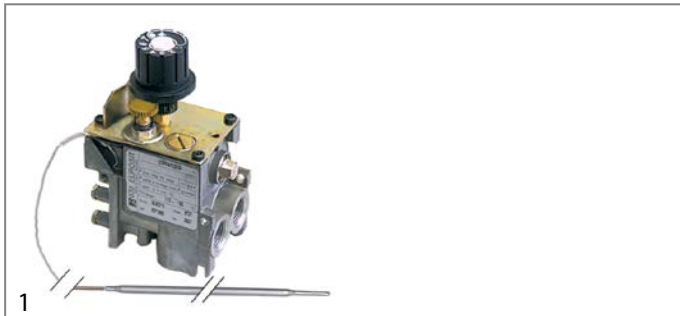


| | | | |
|-------------|--|----------|-----------|
| GEV No. | 107688 | Ref. No. | CR0585671 |
| description | gas thermostat 100-340°C gas inlet 3/8" gas outlet 3/8" thermocouple connection M9x1 pilot connection M10x1 probe ø 4mm probe L 72mm capillary pipe 1050mm | | |

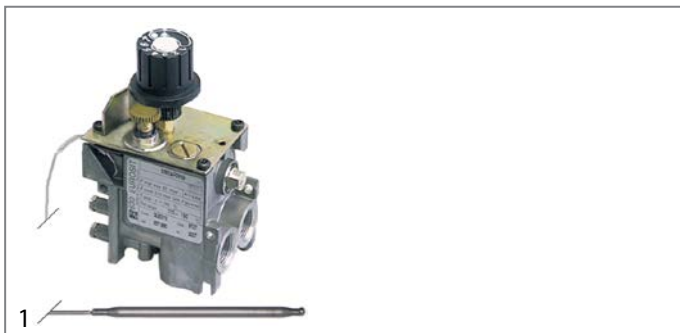


| | | | |
|-------------|--|----------|------------------------|
| GEV No. | 101188 | Ref. No. | CM097000 MACM097000 |
| description | gas thermostat type 630 Eurosit series t.max. 190°C 110-190°C gas inlet 3/8" gas outlet 3/8" thermocouple connection M9x1 pilot connection M10x1 probe ø 4mm probe L 202mm capillary pipe 1050mm SIT | | |
| For models: | F12C4G15, F74G10, F74G15, F74G6, F76G10, F78G15, F94G10, F94G15, F94G6, F96G10, F98G15, F954G15, F958G15, PI76G5, PI96G5 | | |






| | | | | |
|---|---------|--------|----------|---|
| accessories for 101188 | | | | |
|  | GEV No. | 100904 | Ref. No. | 1388000 1394700 MA1394700 |
| locking screw M10x1 for pipe ø 4mm Qty 1 pcs | | | | |
|  | GEV No. | 100905 | Ref. No. | 1394800 MA1394800 |
| locking screw M10x1 for pipe ø 6mm Qty 1 pcs | | | | |
|  | GEV No. | 101273 | Ref. No. | 0100842 417810 MA417810 R0100842 SIR0100842 |
| olive for pipe ø 12mm L 9.5mm brass Qty 1 pcs suitable for universal | | | | |
|  | GEV No. | 101276 | Ref. No. | 459300 MA459300 |
| union screw thread 3/8" tube ø 12mm Qty 1 pcs | | | | |
|  | GEV No. | 101333 | Ref. No. | 1888200 MA1888200 |
| plug thread 3/8" with O-ring | | | | |




| | | | |
|-------------|--|----------|-----------|
| GEV No. | 103076 | Ref. No. | CR0508680 |
| description | gas thermostat type 630 Eurosit series t.max. 190°C 110-190°C gas inlet 3/8" gas outlet 3/8" thermocouple connection M9x1 pilot connection M10x1 probe ø 4mm probe L 202mm capillary pipe 1050mm SIT | | |
| For models: | EF74G15, EF74G8VA, EF74G8VG, FQG41, FQG61, NF74G10, NF74G15, NF74G15T, NF74G8, NF76G10, NF76G8, NF78G15, NF78G15T, NF94G15, NF94G23, NF96G10, NF98G15, NF98G23, OFQG41, OFQG61 | | |

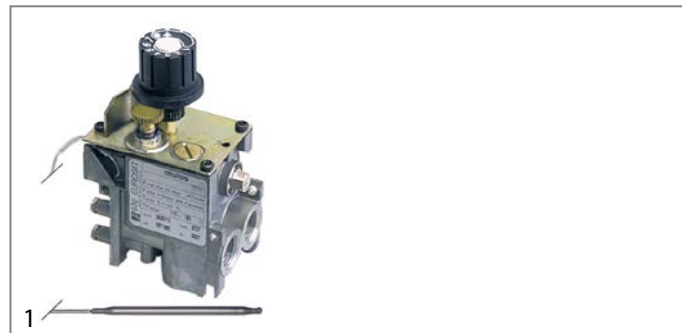


| | | | |
|-------------|--|----------|----------------------------|
| GEV No. | 101409 | Ref. No. | 1031504800 MA1031504800 |
| description | gas thermostat type 630 Eurosit series t.max. 280°C 40-280°C gas inlet 3/8" gas outlet 3/8" thermocouple connection M9x1 pilot connection M10x1 probe ø 4mm probe L 72mm capillary pipe 1050mm SIT | | |

| | | | | |
|---|---------|--------|----------|---|
| spare parts for 101409 | | | | |
|  | GEV No. | 101333 | Ref. No. | 1888200 MA1888200 |
| plug thread 3/8" with O-ring | | | | |
| accessories for 101409 | | | | |
|  | GEV No. | 100904 | Ref. No. | 1388000 1394700 MA1394700 |
| locking screw M10x1 for pipe ø 4mm Qty 1 pcs | | | | |
|  | GEV No. | 100905 | Ref. No. | 1394800 MA1394800 |
| locking screw M10x1 for pipe ø 6mm Qty 1 pcs | | | | |
|  | GEV No. | 101273 | Ref. No. | 0100842 417810 MA417810 R0100842 SIR0100842 |
| olive for pipe ø 12mm L 9.5mm brass Qty 1 pcs suitable for universal | | | | |
|  | GEV No. | 101276 | Ref. No. | 459300 MA459300 |
| union screw thread 3/8" tube ø 12mm Qty 1 pcs | | | | |



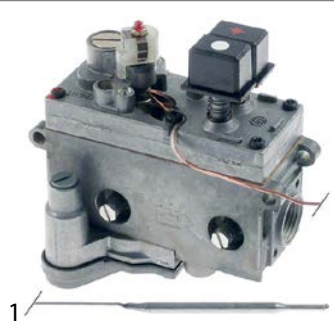
| | | | |
|---|--|-----------------|---|
| GEV No. | 101125 | Ref. No. | 1887600 MA1887600 |
| description | gas thermostat type 630 Eurosit series t.max. 340°C 100-340°C gas inlet 3/8" gas outlet 3/8" thermocouple connection M9x1 pilot connection M10x1 probe ø 4mm probe L 72mm capillary pipe 1050mm SIT | | |
| For models: | BF78G, BF912G, BF912GH, BF98G, BR707G, BR707GI, BR78GF, BR78GI, C12FGP9G, C7FG12G, C7FG8G, C7FGM12G, C9F4E, C9F4GS, C9F6E, C9F6GS, C9F8GS, C9FG12G, C9FG16G, C9FG8G, C9FG8GP, C9FG-M12G, C9FP, C9FP4GS, C9FP6GS, C9FP8GS, FT129GLC, FT129GM, FT12C9GL, FT12C9GM, FT12C9GTLC, FT12C9GTMC, FT12G7L70, FT12G7LC70, FT12G7R70, FT12G7RC70, FT12G7RL70, FT12G7RLC70, FT14G8L90, FT14G8LC90, FT14G8R2L90, FT14G8R2LC90, FT14G8R90, FT14G8RC90, FT6G4L70, FT6G4LC70, FT6G4R70, FT6G4RC70, FT74GL, FT74GLC...(Other models you can see in the webshop) | | |
| accessories for | 101125 | | |
|  | GEV No. | 100825 | Ref. No. — |
| | gas tap spindle shaft ø 8x6.5mm shaft L 22/14mm suitable for EUROSIT | | |
|  | GEV No. | 100904 | Ref. No. 1388000 1394700 MA1394700 |
| | locking screw M10x1 for pipe ø 4mm Qty 1 pcs | | |
|  | GEV No. | 100905 | Ref. No. 1394800 MA1394800 |
| | locking screw M10x1 for pipe ø 6mm Qty 1 pcs | | |
|  | GEV No. | 100949 | Ref. No. — |
| | gasket suitable for 630 Eurosit series | | |
|  | GEV No. | 101273 | Ref. No. 0100842 417810 MA417810 R0100842 SIR0100842 |
| | olive for pipe ø 12mm L 9.5mm brass Qty 1 pcs suitable for universal | | |
|  | GEV No. | 101276 | Ref. No. 459300 MA459300 |
| | union screw thread 3/8" tube ø 12mm Qty 1 pcs | | |
|  | GEV No. | 101333 | Ref. No. 1888200 MA1888200 |
| | plug thread 3/8" with O-ring | | |
|  | GEV No. | 101390 | Ref. No. 1905525 MA1905525 |
| | gas tap spindle shaft ø 6x4.6mm shaft L 32/15mm gas tap with ignition flame suitable for ZANUSSI, MARENO for gas thermostat EUROSIT | | |
|  | GEV No. | 101392 | Ref. No. 1868600 MA1868600 |
| | adapter suitable for 630 Eurosit series | | |
|  | GEV No. | 110357 | Ref. No. — |
| | gas tap spindle shaft ø 8x6.5mm shaft L 36/12mm suitable for 630 Eurosit series | | |
|  | GEV No. | 110358 | Ref. No. — |
| | adapter shaft ø 10x8mm shaft L 29/18mm suitable for 630 Eurosit series | | |



| | | | |
|---|---|-----------------|---|
| GEV No. | 101700 | Ref. No. | CR0585670 |
| description | gas thermostat type 630 Eurosit series t.max. 340°C 100-340°C gas inlet 3/8" gas outlet 3/8" thermocouple connection M9x1 pilot connection M10x1 probe ø 4mm probe L 72mm capillary pipe 1050mm SIT | | |
| For models: | NBR78GF, NBR78GI, NC7FG12G44, NC7FG8G32, NC7FG8G36, NC7FG8G48, NC9FG12G52, NC9FG16G72, NC9FG8G32, NC9FG8G36, NC9FG8G48, NFT74GTLC, NFT74GTLCO, NFT74GTLO, NFT74GTRC, NFT76GLC, NFT76GMC, NFT76GRC, NFT76GTLC, NFT76GTMC, NFT78GTL, NFT78GTLC, NFT78GTLCO, NFT78GTLO, NFT78GTM, NFT78GTMC, NFT78GTR, NFT78GTRC, NFT94GTLC, NFT94GTLO, NFT94GTRC, NFT96GLC, NFT96GMC, NFT98GTL, NFT98GTLC, NFT98GTLO, NFT98GTM, NFT98GTMC, NFT98GTR, NT78G, NT7FG12G, NT7FG8G, NT98G, NT9FG12G, NT9FG8G | | |
| accessories for | 101700 | | |
|  | GEV No. | 100904 | Ref. No. 1388000 1394700 MA1394700 |
| | locking screw M10x1 for pipe ø 4mm Qty 1 pcs | | |
|  | GEV No. | 100905 | Ref. No. 1394800 MA1394800 |
| | locking screw M10x1 for pipe ø 6mm Qty 1 pcs | | |
|  | GEV No. | 101273 | Ref. No. 0100842 417810 MA417810 R0100842 SIR0100842 |
| | olive for pipe ø 12mm L 9.5mm brass Qty 1 pcs suitable for universal | | |
|  | GEV No. | 101276 | Ref. No. 459300 MA459300 |
| | union screw thread 3/8" tube ø 12mm Qty 1 pcs | | |
|  | GEV No. | 101333 | Ref. No. 1888200 MA1888200 |
| | plug thread 3/8" with O-ring | | |



710 Minisit series

















| | | | |
|---|--|-----------------|--|
| GEV No. | 101437 | Ref. No. | 1393300 1451000 1451024 1677300 1677314 MA1393300 |
| description | gas thermostat SIT type MINISIT 710 t.max. 190°C 110-190°C gas inlet 1/2" gas outlet 3/8" thermocouple connection M9x1 pilot connection M10x1 probe ø 6mm probe L 102mm capillary pipe 1050mm probe type type A3 pressure controller yes pressure regulator 3-18mbar gland nut | | |
| For models: | FQG40, FQG60, FR74G, FR77G, FR92G13, FR94G13, MM10IG, P9I10G, P9I5G, P9IA10G, PI707G | | |
| spare parts for | 101437 | | |
| | GEV No. | 101053 | Ref. No. 24021499 MA24021499 |
| magnet unit T1: M9x1 T2: M24x1 L 45mm ø 17mm suitable for Minisit | | | |
| accessories for | 101437 | | |
| | GEV No. | 100809 | Ref. No. 1394000 BN6A011606 MA1394000 |
| O-ring EPDM thickness 2mm ID ø 21mm Qty 1 pcs | | | |
| | GEV No. | 100820 | Ref. No. 1395714 MA1395714 |
| gland duct ET M14x1.5 IT M10x0.75 probe ø max. 6.5mm WS 22 | | | |
| | GEV No. | 100904 | Ref. No. 1388000 1394700 MA1394700 |
| locking screw M10x1 for pipe ø 4mm Qty 1 pcs | | | |
| | GEV No. | 100905 | Ref. No. 1394800 MA1394800 |
| locking screw M10x1 for pipe ø 6mm Qty 1 pcs | | | |
| | GEV No. | 101054 | Ref. No. — |
| magnet unit T1: M10x1 T2: M24x1 L 45mm ø 17mm suitable for Minisit | | | |
| | GEV No. | 101136 | Ref. No. 1393700 24020299 MA1393700 |
| piezoelectric igniter suitable for Minisit with cover cap ømm connection F6.3x0.8 | | | |
| | GEV No. | 101137 | Ref. No. 1393600 MA1393600 |
| cover cap without piezoelectric igniter | | | |
| | GEV No. | 101267 | Ref. No. — |
| reducer IT 3/8" ET 1/2" L 21mm | | | |
| | GEV No. | 101268 | Ref. No. 1393800 MA1393800 |
| gas connection thread 3/8" angled with O-ring MINISIT 710 | | | |
| | GEV No. | 101269 | Ref. No. 1393900 MA1393900 |
| gas connection thread 1/2" angled with O-ring MINISIT 710 | | | |

| | | | |
|--|----------------|--------|---|
| accessories for | 101437 | | |
| | GEV No. | 101270 | Ref. No. — |
| screw connection IT 3/8" ET 3/8" L 28mm | | | |
| | GEV No. | 101272 | Ref. No. — |
| screw connection IT 1/2" ET 3/8" L 57mm | | | |
| | GEV No. | 101273 | Ref. No. 0100842 417810 MA417810 R0100842 SIR0100842 |
| olive for pipe ø 12mm L 9.5mm brass Qty 1 pcs suitable for universal | | | |
| | GEV No. | 101274 | Ref. No. — |
| olive for pipe ø 16mm Qty 1 pcs | | | |
| | GEV No. | 101275 | Ref. No. — |
| union screw thread 1/2" for pipe ø 16mm Qty 1 pcs | | | |
| | GEV No. | 101276 | Ref. No. 459300 MA459300 |
| union screw thread 3/8" tube ø 12mm Qty 1 pcs | | | |
| | GEV No. | 110068 | Ref. No. 1393500 1693500 24020399 MA1393500 |
| knob suitable for Minisit ø 37mm | | | |

| | | | |
|--|----------------|--------|--|
| | GEV No. | 101132 | Ref. No. 1393100 410622 671111 MA1393100 |
| description gas thermostat SIT type MINISIT 710 t.max. 340°C 100-340°C gas inlet 1/2" gas outlet 3/8" thermocouple connection M9x1 pilot connection M10x1 probe ø 5mm probe L 68mm capillary pipe 1050mm probe type type B1 pressure controller no pressure regulator or mbar gland nut ignition gas no | | | |
| For models: C9F4G, C9F4GS, C9F6G, C9F6GS, C9F8G, C9F8GS, T9F4G, T9F6GS | | | |
| spare parts for | 101132 | | |
| | GEV No. | 101053 | Ref. No. 24021499 MA24021499 |
| magnet unit T1: M9x1 T2: M24x1 L 45mm ø 17mm suitable for Minisit | | | |
| | GEV No. | 102102 | Ref. No. 24021699 BN6A011709 MA24021699 |
| probe 100-340°C probe ø 5mm probe L 68mm capillary pipe 1750mm t.max. 340°C oven/grill probe type type B1 suitable for MINISIT 710 | | | |
| accessories for | 101132 | | |
| | GEV No. | 100809 | Ref. No. 1394000 BN6A011606 MA1394000 |
| O-ring EPDM thickness 2mm ID ø 21mm Qty 1 pcs | | | |
| | GEV No. | 100904 | Ref. No. 1388000 1394700 MA1394700 |
| locking screw M10x1 for pipe ø 4mm Qty 1 pcs | | | |

Table continues overleaf



| | |
|---|---|
| accessories for 101132 | |
|  | GEV No. 100905 Ref. No. 1394800 MA1394800 |
| locking screw M10x1 for pipe ø 6mm Qty 1 pcs | |
|  | GEV No. 101054 Ref. No. — |
| magnet unit T1: M10x1 T2: M24x1 L 45mm ø 17mm suitable for Minisit | |
|  | GEV No. 101136 Ref. No. 1393700 24020299 MA1393700 |
| piezoelectric igniter suitable for Minisit with cover cap ømm connection F6.3x0.8 | |
|  | GEV No. 101137 Ref. No. 1393600 MA1393600 |
| cover cap without piezoelectric igniter | |
|  | GEV No. 101267 Ref. No. — |
| reducer IT 3/8" ET 1/2" L 21mm | |
|  | GEV No. 101268 Ref. No. 1393800 MA1393800 |
| gas connection thread 3/8" angled with O-ring MINISIT 710 | |
|  | GEV No. 101269 Ref. No. 1393900 MA1393900 |
| gas connection thread 1/2" angled with O-ring MINISIT 710 | |
|  | GEV No. 101270 Ref. No. — |
| screw connection IT 3/8" ET 3/8" L 28mm | |
|  | GEV No. 101272 Ref. No. — |
| screw connection IT 1/2" ET 3/8" L 57mm | |
|  | GEV No. 101273 Ref. No. 0100842 417810 MA417810 R0100842 SIR0100842 |
| olive for pipe ø 12mm L 9.5mm brass Qty 1 pcs suitable for universal | |
|  | GEV No. 101274 Ref. No. — |
| olive for pipe ø 16mm Qty 1 pcs | |
|  | GEV No. 101275 Ref. No. — |
| union screw thread 1/2" for pipe ø 16mm Qty 1 pcs | |
|  | GEV No. 101276 Ref. No. 459300 MA459300 |
| union screw thread 3/8" tube ø 12mm Qty 1 pcs | |
|  | GEV No. 110068 Ref. No. 1393500 1693500 24020399 MA1393500 |
| knob suitable for Minisit ø 37mm | |


















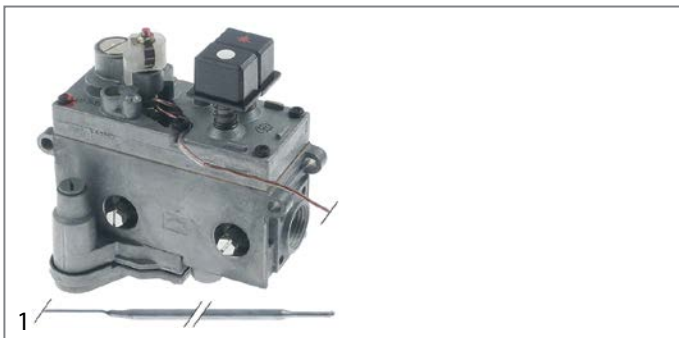



















| | |
|--|--|
|  | |
| GEV No. 101438 | Ref. No. 139300 1393400 1685500 MA1393400 SIR0100855 |
| description | gas thermostat SIT type MINISIT 710 t.max. 340°C 100-340°C gas inlet 1/2" gas outlet 3/8" thermocouple connection M9x1 pilot connection M10x1 probe ø 5mm probe L 68mm capillary pipe 1050mm probe type B1 pressure controller yes pressure regulator 3-18mbar gland nut |
| For models: | BR707G |
| spare parts for 101438 | |
|  | GEV No. 101053 Ref. No. 24021499 MA24021499 |
| magnet unit T1: M9x1 T2: M24x1 L 45mm ø 17mm suitable for Minisit | |
|  | GEV No. 102102 Ref. No. 24021699 BN6A011709 MA24021699 |
| probe 100-340°C probe ø 5mm probe L 68mm capillary pipe 1750mm t.max. 340°C oven/grill probe type type B1 suitable for MINISIT 710 | |
| accessories for 101438 | |
|  | GEV No. 100809 Ref. No. 1394000 BN6A011606 MA1394000 |
| O-ring EPDM thickness 2mm ID ø 21mm Qty 1 pcs | |
|  | GEV No. 100904 Ref. No. 1388000 1394700 MA1394700 |
| locking screw M10x1 for pipe ø 4mm Qty 1 pcs | |
|  | GEV No. 100905 Ref. No. 1394800 MA1394800 |
| locking screw M10x1 for pipe ø 6mm Qty 1 pcs | |
|  | GEV No. 101054 Ref. No. — |
| magnet unit T1: M10x1 T2: M24x1 L 45mm ø 17mm suitable for Minisit | |
|  | GEV No. 101136 Ref. No. 1393700 24020299 MA1393700 |
| piezoelectric igniter suitable for Minisit with cover cap ømm connection F6.3x0.8 | |
|  | GEV No. 101137 Ref. No. 1393600 MA1393600 |
| cover cap without piezoelectric igniter | |
|  | GEV No. 101267 Ref. No. — |
| reducer IT 3/8" ET 1/2" L 21mm | |
|  | GEV No. 101268 Ref. No. 1393800 MA1393800 |
| gas connection thread 3/8" angled with O-ring MINISIT 710 | |
|  | GEV No. 101269 Ref. No. 1393900 MA1393900 |
| gas connection thread 1/2" angled with O-ring MINISIT 710 | |

Table continues overleaf

| accessories for | | 101438 | |
|---|---------|--------|--|
|  | GEV No. | 101270 | Ref. No. — |
| screw connection IT 3/8" ET 3/8" L 28mm | | | |
|  | GEV No. | 101272 | Ref. No. — |
| screw connection IT 1/2" ET 3/8" L 57mm | | | |
|  | GEV No. | 101273 | Ref. No. 0100842 417810 MA417810 R0100842 SIR0100842 |
| olive for pipe 12mm L 9.5mm brass Qty 1 pcs suitable for universal | | | |
|  | GEV No. | 101274 | Ref. No. — |
| olive for pipe 16mm Qty 1 pcs | | | |
|  | GEV No. | 101275 | Ref. No. — |
| union screw thread 1/2" for pipe 16mm Qty 1 pcs | | | |
|  | GEV No. | 101276 | Ref. No. 459300 MA459300 |
| union screw thread 3/8" tube 12mm Qty 1 pcs | | | |
|  | GEV No. | 110068 | Ref. No. 1393500 1693500 24020399 MA1393500 |
| knob suitable for Minisit 37mm | | | |



| | | | |
|--|--|-----------------|---|
| GEV No. | 101088 | Ref. No. | 1031501100 MA1031501100 |
| description | gas thermostat with pressure controller SIT type MINISIT 710 t.max. 100°C 30-100°C gas inlet 1/2" gas outlet 3/8" thermocouple connection M9x1 pilot connection M10x1 probe 5mm probe L 125mm capillary pipe 1050mm probe type type A1 pressure controller yes pressure regulator 3-18mbar gland nut | | |
| For models: | BMG40, BMG60 | | |
| spare parts for | 101088 | | |
|  | GEV No. | 101053 | Ref. No. 24021499 MA24021499 |
| magnet unit T1: M9x1 T2: M24x1 L 45mm 17mm suitable for Minisit | | | |
|  | GEV No. | 102100 | Ref. No. — |
| probe 30-100°C probe 5mm probe L 122mm capillary pipe 1050mm t.max. 100°C bain marie probe type type A1 suitable for MINISIT 710 | | | |
| accessories for | 101088 | | |
|  | GEV No. | 100809 | Ref. No. 1394000 BN6A011606 MA1394000 |
| O-ring EPDM thickness 2mm ID 21mm Qty 1 pcs | | | |
|  | GEV No. | 100820 | Ref. No. 1395714 MA1395714 |
| gland duct ET M14x1.5 IT M10x0.75 probe 6.5mm WS 22 | | | |
|  | GEV No. | 100904 | Ref. No. 1388000 1394700 MA1394700 |
| locking screw M10x1 for pipe 4mm Qty 1 pcs | | | |

| accessories for | | 101088 | |
|---|---------|--------|--|
|  | GEV No. | 100905 | Ref. No. 1394800 MA1394800 |
| locking screw M10x1 for pipe 6mm Qty 1 pcs | | | |
|  | GEV No. | 101054 | Ref. No. — |
| magnet unit T1: M10x1 T2: M24x1 L 45mm 17mm suitable for Minisit | | | |
|  | GEV No. | 101136 | Ref. No. 1393700 24020299 MA1393700 |
| piezoelectric igniter suitable for Minisit with cover cap 6mm connection F6.3x0.8 | | | |
|  | GEV No. | 101137 | Ref. No. 1393600 MA1393600 |
| cover cap without piezoelectric igniter | | | |
|  | GEV No. | 101267 | Ref. No. — |
| reducer IT 3/8" ET 1/2" L 21mm | | | |
|  | GEV No. | 101268 | Ref. No. 1393800 MA1393800 |
| gas connection thread 3/8" angled with O-ring MINISIT 710 | | | |
|  | GEV No. | 101269 | Ref. No. 1393900 MA1393900 |
| gas connection thread 1/2" angled with O-ring MINISIT 710 | | | |
|  | GEV No. | 101270 | Ref. No. — |
| screw connection IT 3/8" ET 3/8" L 28mm | | | |
|  | GEV No. | 101272 | Ref. No. — |
| screw connection IT 1/2" ET 3/8" L 57mm | | | |
|  | GEV No. | 101273 | Ref. No. 0100842 417810 MA417810 R0100842 SIR0100842 |
| olive for pipe 12mm L 9.5mm brass Qty 1 pcs suitable for universal | | | |
|  | GEV No. | 101274 | Ref. No. — |
| olive for pipe 16mm Qty 1 pcs | | | |
|  | GEV No. | 101275 | Ref. No. — |
| union screw thread 1/2" for pipe 16mm Qty 1 pcs | | | |
|  | GEV No. | 101276 | Ref. No. 459300 MA459300 |
| union screw thread 3/8" tube 12mm Qty 1 pcs | | | |
|  | GEV No. | 110680 | Ref. No. — |
| knob graduated Min/Max 82mm shaft 6x4.6mm shaft flat upper black | | | |



| | | | |
|------------------------|---|-----------------|--|
| | | | |
| GEV No. | 101130 | Ref. No. | 1120813 |
| description | gas thermostat without cap, button and angle SIT type MINISIT 710 t.max. 100°C 30-100°C gas inlet 1/2" gas outlet 3/8" thermocouple connection M9x1 pilot connection M10x1 probe ø 5mm probe L 122mm capillary pipe 1050mm probe type type A1 pressure controller no pressure regulator bar gland nut | | |
| spare parts for | 101130 | | |
| | GEV No. | 101053 | Ref. No. 24021499 MA24021499 |
| | magnet unit T1: M9x1 T2: M24x1 L 45mm ø 17mm suitable for Minisit | | |
| | GEV No. | 102100 | Ref. No. — |
| | probe 30-100°C probe ø 5mm probe L 122mm capillary pipe 1050mm t.max. 100°C bain marie probe type type A1 suitable for MINISIT 710 | | |
| accessories for | 101130 | | |
| | GEV No. | 100809 | Ref. No. 1394000 BN6A011606 MA1394000 |
| | O-ring EPDM thickness 2mm ID ø 21mm Qty 1 pcs | | |
| | GEV No. | 100820 | Ref. No. 1395714 MA1395714 |
| | gland duct ET M14x1.5 IT M10x0.75 probe ø max. 6.5mm WS 22 | | |
| | GEV No. | 100904 | Ref. No. 1388000 1394700 MA1394700 |
| | locking screw M10x1 for pipe ø 4mm Qty 1 pcs | | |
| | GEV No. | 100905 | Ref. No. 1394800 MA1394800 |
| | locking screw M10x1 for pipe ø 6mm Qty 1 pcs | | |
| | GEV No. | 101054 | Ref. No. — |
| | magnet unit T1: M10x1 T2: M24x1 L 45mm ø 17mm suitable for Minisit | | |
| | GEV No. | 101136 | Ref. No. 1393700 24020299 MA1393700 |
| | piezoelectric igniter suitable for Minisit with cover cap ømm connection F6.3x0.8 | | |
| | GEV No. | 101137 | Ref. No. 1393600 MA1393600 |
| | cover cap without piezoelectric igniter | | |
| | GEV No. | 101267 | Ref. No. — |
| | reducer IT 3/8" ET 1/2" L 21mm | | |
| | GEV No. | 101268 | Ref. No. 1393800 MA1393800 |
| | gas connection thread 3/8" angled with O-ring MINISIT 710 | | |
| | GEV No. | 101269 | Ref. No. 1393900 MA1393900 |
| | gas connection thread 1/2" angled with O-ring MINISIT 710 | | |
| | GEV No. | 101270 | Ref. No. — |
| | screw connection IT 3/8" ET 3/8" L 28mm | | |
| | GEV No. | 101272 | Ref. No. — |
| | screw connection IT 1/2" ET 3/8" L 57mm | | |

| | | | |
|------------------------|--|--------|---|
| accessories for | 101130 | | |
| | GEV No. | 101273 | Ref. No. 0100842 417810 MA417810 R0100842 SIR0100842 |
| | olive for pipe ø 12mm L 9.5mm brass Qty 1 pcs suitable for universal | | |
| | GEV No. | 101274 | Ref. No. — |
| | olive for pipe ø 16mm Qty 1 pcs | | |
| | GEV No. | 101275 | Ref. No. — |
| | union screw thread 1/2" for pipe ø 16mm Qty 1 pcs | | |
| | GEV No. | 101276 | Ref. No. 459300 MA459300 |
| | union screw thread 3/8" tube ø 12mm Qty 1 pcs | | |
| | GEV No. | 110068 | Ref. No. 1393500 1693500 24020399 MA1393500 |
| | knob suitable for Minisit ø 37mm | | |


| | | | |
|------------------------|--|-----------------|--|
| | | | |
| GEV No. | 101131 | Ref. No. | 1031500300 1743300 1743324 SIR0108030 |
| description | gas thermostat without cap, button and angle SIT type MINISIT 710 t.max. 190°C 50-190°C gas inlet 1/2" gas outlet 3/8" thermocouple connection M9x1 pilot connection M10x1 probe ø 5mm probe L 98mm capillary pipe 1200mm probe type type A2 pressure controller no pressure regulator bar gland nut | | |
| For models: | FR74G, FR77G | | |
| spare parts for | 101131 | | |
| | GEV No. | 101053 | Ref. No. 24021499 MA24021499 |
| | magnet unit T1: M9x1 T2: M24x1 L 45mm ø 17mm suitable for Minisit | | |
| | GEV No. | 102103 | Ref. No. 24021799 BN6A015201 MA24021799 |
| | probe 60-200°C probe ø 5mm probe L 98mm capillary pipe 1050mm t.max. 200°C fryer probe type type A2 suitable for MINISIT 710 | | |
| accessories for | 101131 | | |
| | GEV No. | 100809 | Ref. No. 1394000 BN6A011606 MA1394000 |
| | O-ring EPDM thickness 2mm ID ø 21mm Qty 1 pcs | | |
| | GEV No. | 100820 | Ref. No. 1395714 MA1395714 |
| | gland duct ET M14x1.5 IT M10x0.75 probe ø max. 6.5mm WS 22 | | |
| | GEV No. | 100904 | Ref. No. 1388000 1394700 MA1394700 |
| | locking screw M10x1 for pipe ø 4mm Qty 1 pcs | | |
| | GEV No. | 100905 | Ref. No. 1394800 MA1394800 |
| | locking screw M10x1 for pipe ø 6mm Qty 1 pcs | | |


Table continues overleaf

| accessories for | | 101131 | |
|---|---------|--------|--|
|  | GEV No. | 101054 | Ref. No. — |
| magnet unit T1: M10x1 T2: M24x1 L 45mm ø 17mm suitable for Minisit | | | |
|  | GEV No. | 101136 | Ref. No. 1393700 24020299 MA1393700 |
| piezoelectric igniter suitable for Minisit with cover cap ømm connection F6.3x0.8 | | | |
|  | GEV No. | 101137 | Ref. No. 1393600 MA1393600 |
| cover cap without piezoelectric igniter | | | |
|  | GEV No. | 101267 | Ref. No. — |
| reducer IT 3/8" ET 1/2" L 21mm | | | |
|  | GEV No. | 101268 | Ref. No. 1393800 MA1393800 |
| gas connection thread 3/8" angled with O-ring MINISIT 710 | | | |
|  | GEV No. | 101269 | Ref. No. 1393900 MA1393900 |
| gas connection thread 1/2" angled with O-ring MINISIT 710 | | | |
|  | GEV No. | 101270 | Ref. No. — |
| screw connection IT 3/8" ET 3/8" L 28mm | | | |
|  | GEV No. | 101272 | Ref. No. — |
| screw connection IT 1/2" ET 3/8" L 57mm | | | |
|  | GEV No. | 101273 | Ref. No. 0100842 417810 MA417810 R0100842 SIR0100842 |
| olive for pipe ø 12mm L 9.5mm brass Qty 1 pcs suitable for universal | | | |
|  | GEV No. | 101274 | Ref. No. — |
| olive for pipe ø 16mm Qty 1 pcs | | | |
|  | GEV No. | 101275 | Ref. No. — |
| union screw thread 1/2" for pipe ø 16mm Qty 1 pcs | | | |
|  | GEV No. | 101276 | Ref. No. 459300 MA459300 |
| union screw thread 3/8" tube ø 12mm Qty 1 pcs | | | |
|  | GEV No. | 110068 | Ref. No. 1393500 1693500 24020399 MA1393500 |
| knob suitable for Minisit ø 37mm | | | |

accessories

probes

| | | | |
|--|--------|----------|--------------------------------------|
|  | 1 | | |
| GEV No. | 102102 | Ref. No. | 24021699 BN6A011709 MA24021699 |
| description probe 100-340°C probe ø 5mm probe L 68mm capillary pipe 1750mm t.max. 340°C oven/grill probe type type B1 suitable for MINISIT 710 | | | |
| For models: BR707G, C9F4G, C9F4GS, C9F6G, C9F6GS, C9F8G, C9F8GS, T9F4G, T9F6GS | | | |

| | | | |
|--|--------|----------|--------------------------------------|
|  | 1 | | |
| GEV No. | 102103 | Ref. No. | 24021799 BN6A015201 MA24021799 |
| description probe 60-200°C probe ø 5mm probe L 98mm capillary pipe 1050mm t.max. 200°C fryer probe type type A2 suitable for MINISIT 710 | | | |

PEL

25ST series















| | | | |
|---|---------|----------|--|
|  | 1 | | |
| GEV No. | 101441 | Ref. No. | CM140500 MACM140500 |
| description gas thermostat PEL type 25ST 30-90°C gas inlet M16x1.5 (tube ø 10mm) bypass nozzle ø 0.35mm gas outlet M16x1.5 (tube ø 10/8mm) thermocouple connection M9x1 pilot connection M10x1 capillary pipe 1200mm probe ø 6mm probe L 160mm shaft ø 8x6.5mm shaft L 21/15mm shaft flat upper | | | |
| For models: B74G, B78G, B94G, B98G, NB74G, NB78G, NB94G, NB98G | | | |
| accessories for 101441 | | | |
|  | GEV No. | 100259 | Ref. No. — |
| bypass nozzle type PEL22 bore ø 0.35mm thread M6x0.5 | | | |
|  | GEV No. | 101060 | Ref. No. 24030199 MA24030199 SI0100752 SIR0100752 |
| magnet unit standard L 39mm D1 ø 15.4mm D2 ø 11mm suitable for PEL20-21/JUNKERS/EGA | | | |
|  | GEV No. | 106200 | Ref. No. — |
| nut thread M9x1 suitable for PEL 24/25S | | | |
| accessories for 101441 | | | |
|  | GEV No. | 100908 | Ref. No. 0100777 673500 MA673500 R0100777 SIR0100777 |
| union screw thread M10x1 for pipe ø 4mm Qty 1 pcs | | | |
|  | GEV No. | 100909 | Ref. No. — |
| union screw thread M10x1 for pipe ø 6mm Qty 1 pcs | | | |
|  | GEV No. | 101246 | Ref. No. 673600 MA673600 |
| olive for pipe ø 4mm Qty 1 pcs | | | |
|  | GEV No. | 101278 | Ref. No. 867-20 MA86720 |
| olive for pipe ø 10mm Qty 1 pcs | | | |
|  | GEV No. | 101286 | Ref. No. — |
| olive ID ø 6mm Qty 1 pcs | | | |
|  | GEV No. | 101300 | Ref. No. 1326500 MA1326500 |
| union nut thread M16x1.5 tube ø 10mm | | | |
|  | GEV No. | 101450 | Ref. No. — |
| olive for pipe ø 8mm L 12.7mm Qty 1 pcs ED ø 10mm | | | |




Table continues overleaf









| accessories for | 101441 | | | | |
|---|---|----------|--------|----------|---|
|  | <table border="1"> <tr> <th>GEV No.</th> <th>101451</th> <th>Ref. No.</th> <th>—</th> </tr> </table> <p>union nut thread M16x1.5 tube ø 8mm</p> | GEV No. | 101451 | Ref. No. | — |
| GEV No. | 101451 | Ref. No. | — | | |


| | | | |
|--------------------|---|-----------------|-----------|
| 1 |  | | |
| GEV No. | 107470 | Ref. No. | CR0933740 |
| description | gas thermostat PEL type 25ST 90-250°C gas inlet M16x1.5 (tube ø 10mm) bypass nozzle ø 1mm gas outlet M16x1.5 (tube ø 10/8mm) thermocouple connection M8x1 pilot connection M10x1 capillary pipe 1200mm probe ø 6mm probe L 120mm shaft ø 8x6.5mm shaft L 26/15mm shaft flat upper | | |




| | | | |
|--------------------|--|-----------------|----------------------------|
| 1 |  | | |
| GEV No. | 101906 | Ref. No. | 1031504000 MA1031504000 |
| description | gas thermostat PEL type 25ST up to 250°C gas inlet M16x1.5 (tube ø 10mm) bypass nozzle ø 1mm gas outlet M16x1.5 (tube ø 10/8mm) thermocouple connection M8x1 pilot connection M10x1 capillary pipe 1200mm probe ø 6mm probe L 120mm shaft ø 6x4.6mm shaft L 36/25mm shaft flat lower | | |
| For models: | FTG40B, FTG40BLC, FTG40BR, FTG60B, FTG60BLC, FTG60BR, FTG-60BRR, FTG80B, FTG80BLC, FTG80BR | | |

| spare parts for | 101906 | | | | |
|---|--|----------|---|----------|---|
|  | <table border="1"> <tr> <th>GEV No.</th> <th>100407</th> <th>Ref. No.</th> <th>—</th> </tr> </table> <p>bypass nozzle type PEL22 bore ø 1mm thread M6x0.5</p> | GEV No. | 100407 | Ref. No. | — |
| GEV No. | 100407 | Ref. No. | — | | |
|  | <table border="1"> <tr> <th>GEV No.</th> <th>101060</th> <th>Ref. No.</th> <th>24030199 MA24030199 SI0100752 SIR0100752</th> </tr> </table> <p>magnet unit standard L 39mm D1 ø 15.4mm D2 ø 11mm suitable for PEL20-21/JUNKERS/EGA</p> | GEV No. | 101060 | Ref. No. | 24030199 MA24030199 SI0100752 SIR0100752 |
| GEV No. | 101060 | Ref. No. | 24030199 MA24030199 SI0100752 SIR0100752 | | |
|  | <table border="1"> <tr> <th>GEV No.</th> <th>106199</th> <th>Ref. No.</th> <th>—</th> </tr> </table> <p>nut thread M8x1</p> | GEV No. | 106199 | Ref. No. | — |
| GEV No. | 106199 | Ref. No. | — | | |

| accessories for | 101906 | | | | |
|---|---|----------|---|----------|---|
|  | <table border="1"> <tr> <th>GEV No.</th> <th>100908</th> <th>Ref. No.</th> <th>0100777 673500 MA673500 R0100777 SIR0100777</th> </tr> </table> <p>union screw thread M10x1 for pipe ø 4mm Qty 1 pcs</p> | GEV No. | 100908 | Ref. No. | 0100777 673500 MA673500 R0100777 SIR0100777 |
| GEV No. | 100908 | Ref. No. | 0100777 673500 MA673500 R0100777 SIR0100777 | | |
|  | <table border="1"> <tr> <th>GEV No.</th> <th>100909</th> <th>Ref. No.</th> <th>—</th> </tr> </table> <p>union screw thread M10x1 for pipe ø 6mm Qty 1 pcs</p> | GEV No. | 100909 | Ref. No. | — |
| GEV No. | 100909 | Ref. No. | — | | |
|  | <table border="1"> <tr> <th>GEV No.</th> <th>101246</th> <th>Ref. No.</th> <th>673600 MA673600</th> </tr> </table> <p>olive for pipe ø 4mm Qty 1 pcs</p> | GEV No. | 101246 | Ref. No. | 673600 MA673600 |
| GEV No. | 101246 | Ref. No. | 673600 MA673600 | | |
|  | <table border="1"> <tr> <th>GEV No.</th> <th>101278</th> <th>Ref. No.</th> <th>867-20 MA86720</th> </tr> </table> <p>olive for pipe ø 10mm Qty 1 pcs</p> | GEV No. | 101278 | Ref. No. | 867-20 MA86720 |
| GEV No. | 101278 | Ref. No. | 867-20 MA86720 | | |
|  | <table border="1"> <tr> <th>GEV No.</th> <th>101286</th> <th>Ref. No.</th> <th>—</th> </tr> </table> <p>olive ID ø 6mm Qty 1 pcs</p> | GEV No. | 101286 | Ref. No. | — |
| GEV No. | 101286 | Ref. No. | — | | |
|  | <table border="1"> <tr> <th>GEV No.</th> <th>101300</th> <th>Ref. No.</th> <th>1326500 MA1326500</th> </tr> </table> <p>union nut thread M16x1.5 tube ø 10mm</p> | GEV No. | 101300 | Ref. No. | 1326500 MA1326500 |
| GEV No. | 101300 | Ref. No. | 1326500 MA1326500 | | |
|  | <table border="1"> <tr> <th>GEV No.</th> <th>101450</th> <th>Ref. No.</th> <th>—</th> </tr> </table> <p>olive for pipe ø 8mm L 12.7mm Qty 1 pcs ED ø 10mm</p> | GEV No. | 101450 | Ref. No. | — |
| GEV No. | 101450 | Ref. No. | — | | |



| accessories for | 101906 | | | | |
|---|---|----------|--------|----------|---|
|  | <table border="1"> <tr> <th>GEV No.</th> <th>101451</th> <th>Ref. No.</th> <th>—</th> </tr> </table> <p>union nut thread M16x1.5 tube ø 8mm</p> | GEV No. | 101451 | Ref. No. | — |
| GEV No. | 101451 | Ref. No. | — | | |
|  | <table border="1"> <tr> <th>GEV No.</th> <th>110078</th> <th>Ref. No.</th> <th>—</th> </tr> </table> <p>knob without symbol ø 70mm shaft ø 6x4.6mm shaft flat universal</p> | GEV No. | 110078 | Ref. No. | — |
| GEV No. | 110078 | Ref. No. | — | | |
|  | <table border="1"> <tr> <th>GEV No.</th> <th>110079</th> <th>Ref. No.</th> <th>—</th> </tr> </table> <p>knob dial plate gas thermostat 1-8 silver</p> | GEV No. | 110079 | Ref. No. | — |
| GEV No. | 110079 | Ref. No. | — | | |

| | | | |
|--------------------|--|-----------------|----------------------------|
| 1 |  | | |
| GEV No. | 101907 | Ref. No. | 1031503900 MA1031503900 |
| description | gas thermostat PEL type 25ST up to 280°C gas inlet M16x1.5 (tube ø 10mm) bypass nozzle ø 1mm gas outlet M16x1.5 (tube ø 10/8mm) thermocouple connection M8x1 pilot connection M10x1 capillary pipe 1200mm probe ø 6mm probe L 120mm shaft ø 6x4.6mm shaft L 36/20mm shaft flat lower | | |
| For models: | FTG40B, FTG40BLC, FTG40BR, FTG60B, FTG60BLC, FTG60BR, FTG-60BRR, FTG80B, FTG80BLC, FTG80BR | | |

| spare parts for | 101907 | | | | |
|---|--|----------|---|----------|---|
|  | <table border="1"> <tr> <th>GEV No.</th> <th>100407</th> <th>Ref. No.</th> <th>—</th> </tr> </table> <p>bypass nozzle type PEL22 bore ø 1mm thread M6x0.5</p> | GEV No. | 100407 | Ref. No. | — |
| GEV No. | 100407 | Ref. No. | — | | |
|  | <table border="1"> <tr> <th>GEV No.</th> <th>101060</th> <th>Ref. No.</th> <th>24030199 MA24030199 SI0100752 SIR0100752</th> </tr> </table> <p>magnet unit standard L 39mm D1 ø 15.4mm D2 ø 11mm suitable for PEL20-21/JUNKERS/EGA</p> | GEV No. | 101060 | Ref. No. | 24030199 MA24030199 SI0100752 SIR0100752 |
| GEV No. | 101060 | Ref. No. | 24030199 MA24030199 SI0100752 SIR0100752 | | |
|  | <table border="1"> <tr> <th>GEV No.</th> <th>106199</th> <th>Ref. No.</th> <th>—</th> </tr> </table> <p>nut thread M8x1</p> | GEV No. | 106199 | Ref. No. | — |
| GEV No. | 106199 | Ref. No. | — | | |

| accessories for | 101907 | | | | |
|---|---|----------|---|----------|---|
|  | <table border="1"> <tr> <th>GEV No.</th> <th>100908</th> <th>Ref. No.</th> <th>0100777 673500 MA673500 R0100777 SIR0100777</th> </tr> </table> <p>union screw thread M10x1 for pipe ø 4mm Qty 1 pcs</p> | GEV No. | 100908 | Ref. No. | 0100777 673500 MA673500 R0100777 SIR0100777 |
| GEV No. | 100908 | Ref. No. | 0100777 673500 MA673500 R0100777 SIR0100777 | | |
|  | <table border="1"> <tr> <th>GEV No.</th> <th>100909</th> <th>Ref. No.</th> <th>—</th> </tr> </table> <p>union screw thread M10x1 for pipe ø 6mm Qty 1 pcs</p> | GEV No. | 100909 | Ref. No. | — |
| GEV No. | 100909 | Ref. No. | — | | |
|  | <table border="1"> <tr> <th>GEV No.</th> <th>101246</th> <th>Ref. No.</th> <th>673600 MA673600</th> </tr> </table> <p>olive for pipe ø 4mm Qty 1 pcs</p> | GEV No. | 101246 | Ref. No. | 673600 MA673600 |
| GEV No. | 101246 | Ref. No. | 673600 MA673600 | | |
|  | <table border="1"> <tr> <th>GEV No.</th> <th>101278</th> <th>Ref. No.</th> <th>867-20 MA86720</th> </tr> </table> <p>olive for pipe ø 10mm Qty 1 pcs</p> | GEV No. | 101278 | Ref. No. | 867-20 MA86720 |
| GEV No. | 101278 | Ref. No. | 867-20 MA86720 | | |
|  | <table border="1"> <tr> <th>GEV No.</th> <th>101286</th> <th>Ref. No.</th> <th>—</th> </tr> </table> <p>olive ID ø 6mm Qty 1 pcs</p> | GEV No. | 101286 | Ref. No. | — |
| GEV No. | 101286 | Ref. No. | — | | |
|  | <table border="1"> <tr> <th>GEV No.</th> <th>101300</th> <th>Ref. No.</th> <th>1326500 MA1326500</th> </tr> </table> <p>union nut thread M16x1.5 tube ø 10mm</p> | GEV No. | 101300 | Ref. No. | 1326500 MA1326500 |
| GEV No. | 101300 | Ref. No. | 1326500 MA1326500 | | |
|  | <table border="1"> <tr> <th>GEV No.</th> <th>101450</th> <th>Ref. No.</th> <th>—</th> </tr> </table> <p>olive for pipe ø 8mm L 12.7mm Qty 1 pcs ED ø 10mm</p> | GEV No. | 101450 | Ref. No. | — |
| GEV No. | 101450 | Ref. No. | — | | |
|  | <table border="1"> <tr> <th>GEV No.</th> <th>101451</th> <th>Ref. No.</th> <th>—</th> </tr> </table> <p>union nut thread M16x1.5 tube ø 8mm</p> | GEV No. | 101451 | Ref. No. | — |
| GEV No. | 101451 | Ref. No. | — | | |

Table continues overleaf

| | | | |
|---|---------|--------|------------|
| accessories for 101907 | | | |
|  | GEV No. | 110078 | Ref. No. — |
| knob without symbol ø 70mm shaft ø 6x4.6mm shaft flat universal | | | |
|  | GEV No. | 110079 | Ref. No. — |
| knob dial plate gas thermostat 1-8 silver | | | |









| | | | |
|--------------------|--|-----------------|-----------|
| GEV No. | 107515 | Ref. No. | CR0933730 |
| description | gas thermostat PEL type 25ST up to 280°C gas inlet M16x1.5 (tube ø 10mm) bypass nozzle ø 1mm gas outlet M16x1.5 (tube ø 10/8mm) thermocouple connection M8x1 pilot connection M10x1 capillary pipe 1200mm probe ø 6mm probe L 120mm shaft ø 8x6.5mm shaft L 26/15mm shaft flat upper | | |



SABAF



| | | | |
|--------------------|--|-----------------|--|
| GEV No. | 101173 | Ref. No. | 103150000 1661300 1699400 MA1699400 |
| description | gas thermostat SABAF type SABAF t.max. 300°C gas inlet M13x1 ET (tube ø 8mm) bypass nozzle ø 0.8mm gas outlet 3/8" ET (tube ø 10mm) gas outlet 2 thermocouple connection M8x1 pilot connection capillary pipe 850mm probe ø 4mm probe L 140mm shaft ø 6x4.6mm shaft L 37/15mm shaft flat lower | | |
| For models: | C7011GFG, C707GFE, C707GFG, CFG101, CFG101D, CFG101L, CFG101P, CFG120, CFG70, CFG70D, CFG70L, CFG70M, CFG70P, EC74G-VG, EC78GVG, EC7FG8G, OCFG101, OCFG120, OCFG70, T7011GFG, T707GFG | | |

| | | | |
|---|---------|--------|--|
| spare parts for 101173 | | | |
|  | GEV No. | 101060 | Ref. No. 24030199 MA24030199 SI0100752 SIR0100752 |
| magnet unit standard L 39mm D1 ø 15.4mm D2 ø 11mm suitable for PEL20-21/JUNKERS/EGA | | | |

| | | | |
|---|---------|--------|-------------------------------|
| accessories for 101173 | | | |
|  | GEV No. | 101277 | Ref. No. — |
| olive ID ø 8mm Qty 1 pcs | | | |
|  | GEV No. | 101278 | Ref. No. 867-20 MA86720 |
| olive for pipe ø 10mm Qty 1 pcs | | | |
|  | GEV No. | 101474 | Ref. No. — |
| air mixing tube for pilot burner | | | |
|  | GEV No. | 101476 | Ref. No. 1665300 MA1665300 |
| union nut thread M13x1 for pipe ø 8mm | | | |
|  | GEV No. | 101478 | Ref. No. 1665200 MA1665200 |
| union nut thread 3/8" for pipe ø 10mm | | | |



| | | | |
|---|---------|--------|--|
| accessories for 101173 | | | |
|  | GEV No. | 110361 | Ref. No. 1036702900 1036703300 1841100 MA1036702900 MA1036703300 |
| knob without symbol ø 65mm shaft ø 6x4.6mm shaft flat lower black | | | |
|  | GEV No. | 110603 | Ref. No. 1930400 MA1930400 |
| knob dial plate gas thermostat t.max. 300°C 90-300°C | | | |

gas valves and ignition boxes

gas control valves

HONEYWELL



| | | | |
|---|--|-----------------|------------|
| GEV No. | 106004 | Ref. No. | R63020150 |
| description | gas valve type VK4105C 220-240V 50/60Hz gas inlet flange 32x32mm gas outlet flange 32x32mm thermocouple connection pilot connection pressure range 15-60mbar max 60mbar operator type pressure controller type V5306E 1234 1 suitable for HONEYWELL flange 32x32mm | | |
| For models: | GC106M, GC110M, GC210M, GV106M, GV106M+SC, GV110M, GV-110M+SC, GV210M, GV210M+SC | | |
| accessories for 106004 | | | |
|  | GEV No. | 102845 | Ref. No. — |
| gas connection angled 1/2" flange 32x32mm hole distance 24x24mm Tandem | | | |
|  | GEV No. | 102846 | Ref. No. — |
| gas connection straight 1/2" flange 32x32mm hole distance 24x24mm suitable for Tandem | | | |





| | | | |
|---|---|-----------------|------------|
| GEV No. | 102320 | Ref. No. | R63020160 |
| description | gas valve type VK4105Q 220-240V 50/60Hz gas inlet flange 32x32mm gas outlet flange 32x32mm thermocouple connection pilot connection pressure range 15-60mbar max 60mbar operator type HONEYWELL coil type 220/240V (V4336A 2212 1) flange 32x32mm | | |
| For models: | GM106H, GM106M, GM106M+SC, GM106P, GM110H, GM110M, GM110M+SC, GM110P, GM210H, GM210M, GM210M+SC, GM210P, GV106H, GV106P, GV110H, GV110P, GV210H, GV210P | | |
| accessories for 102320 | | | |
|  | GEV No. | 102845 | Ref. No. — |
| gas connection angled 1/2" flange 32x32mm hole distance 24x24mm Tandem | | | |



Table continues overleaf



| | | | |
|---|---------|--------|------------|
| accessories for | 102320 | | |
|  | GEV No. | 102846 | Ref. No. — |
| gas connection straight 1/2" flange 32x32mm hole distance 24x24mm suitable for Tandem | | | |






| | | | |
|--------------------|---|-----------------|-----------|
| GEV No. | 106012 | Ref. No. | R63020170 |
| description | gas valve type VK4115V 220-240V 50/60Hz gas inlet flange 32x32mm gas outlet flange 32x32mm thermocouple connection pilot connection pressure range 15-60mbar max 60mbar operator type HONEYWELL flange 32x32mm | | |
| For models: | GMT06D, GMT20D, GVT06D, GVT20D, MACG05M, MACG07M, MACG10M, MACG20M, MG061D, MG061M, MG061P, MG061T, MG101D, MG101M, MG101P, MG101T, MG102D, MG102M, MG102P, MG102T, MG201D, MG201M, MG201P, MG201T, MG202D, MG202M, MG202P, MG202T, MGMT06D, MGMT06P, MGMT10D, MGMT10P, MGMT20D, MGMT20P, MGMT21D, MGMT21P, MGMT40D, MGMT40P, MGVT06D, MGVT06P, MGVT10D, MGVT10P, MGVT20D, MGVT20P, MGVT21D, MGVT21P, MGVT40D, MGVT40P, MVG051P | | |

| | | | |
|---|---------|--------|------------|
| accessories for | 106012 | | |
|  | GEV No. | 102845 | Ref. No. — |
| gas connection angled 1/2" flange 32x32mm hole distance 24x24mm Tandem | | | |
|  | GEV No. | 102846 | Ref. No. — |
| gas connection straight 1/2" flange 32x32mm hole distance 24x24mm suitable for Tandem | | | |

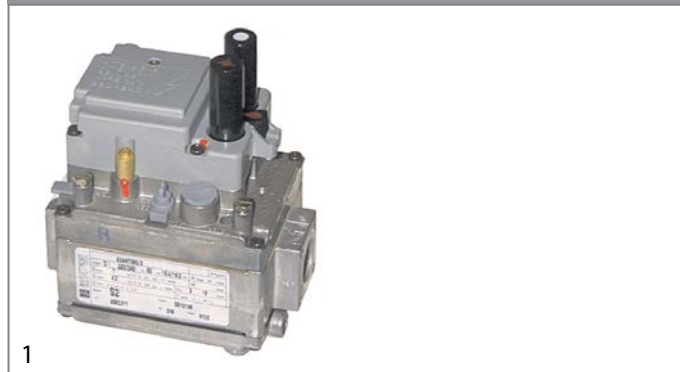


| | | | |
|--------------------|--|-----------------|-----------|
| GEV No. | 101395 | Ref. No. | R63020010 |
| description | gas valve type VR4605P 230V 50Hz gas inlet 1/2" gas outlet 1/2" thermocouple connection pilot connection pressure range 8-50mbar operator type 230V (V404A 1071) pressure controller type 220/240V (V404A 1071 4) HONEYWELL coil type 220/240V (V4336A 2220) flange 45x45mm | | |
| For models: | CVG105H, CVG105M, MG106M, MG106P, MG106X, MG110M, MG110P, MG110X, MG120M, MG120P, MG120X, MG210M, MG210P, MG210X, MG220M, MG220P, MG220X, MGC20X, MGC24H, MGC40H, VG105M, VG105X, VG106M, VG106P, VG106X, VG110M, VG110P, VG110X, VG120M, VG120P, VG120X, VG210M, VG210P, VG210X, VG220M, VG220P, VG220X | | |



| | | | |
|---|---------|--------|------------|
| accessories for | 101395 | | |
|  | GEV No. | 101320 | Ref. No. — |
| cover suitable for gas valves HONEYWELL | | | |
|  | GEV No. | 102845 | Ref. No. — |
| gas connection angled 1/2" flange 32x32mm hole distance 24x24mm Tandem | | | |





| | | | |
|---|---------|--------|------------|
| accessories for | 101395 | | |
|  | GEV No. | 102846 | Ref. No. — |
| gas connection straight 1/2" flange 32x32mm hole distance 24x24mm suitable for Tandem | | | |

SIT
ELETTROSIT



| | | | |
|--------------------|--|-----------------|-----------|
| GEV No. | 101126 | Ref. No. | R63025020 |
| description | gas valve SIT type ELETROSIT 230V gas inlet 1/2" gas outlet 1/2" thermocouple connection M9x1 pilot connection M10x1 bottom equiv. no. 0.810.136 | | |
| For models: | FG105M, FG105X, PG040M, PG040X | | |

| | | | |
|---|---------|--------|--------------------------------------|
| spare parts for | 101126 | | |
|  | GEV No. | 101312 | Ref. No. 1454900 CR0507660 MA1454900 |
| microswitch | | | |
|  | GEV No. | 101352 | Ref. No. — |
| solenoid coil 230V 50Hz suitable for ELETROSIT | | | |

| | | | |
|--|---------|--------|------------------------------------|
| accessories for | 101126 | | |
|  | GEV No. | 100006 | Ref. No. — |
| piezoelectric igniter suitable for ELETROSIT body plastic blowing connection ø2.4mm ø 14mm | | | |
|  | GEV No. | 100904 | Ref. No. 1388000 1394700 MA1394700 |
| locking screw M10x1 for pipe ø 4mm Qty 1 pcs | | | |
|  | GEV No. | 100905 | Ref. No. 1394800 MA1394800 |
| locking screw M10x1 for pipe ø 6mm Qty 1 pcs | | | |
|  | GEV No. | 101301 | Ref. No. — |
| gas connection thread 1/2" straight ELETROSIT screw with O-ring | | | |
|  | GEV No. | 101303 | Ref. No. 1451300 |
| gas connection straight thread 3/4" ELETROSIT | | | |
|  | GEV No. | 101309 | Ref. No. — |
| extension | | | |



| | | | |
|---|---|-----------------|--|
| GEV No. | 101127 | Ref. No. | 1450100 LAR63025030 |
| description | gas valve SIT type ELETTROSIT 230V gas inlet 3/4" gas outlet 3/4" thermocouple connection M9x1 pilot connection M10x1 lateral equiv. no. 0.810.175 | | |
| For models: | BR94G, BR94GI, BR96G, BR96GI, BR9M4G, BR9M4GI, BR9M6G, BR9M6GI, FC10G, FC20G, FC5G, FC7G, FG110M, FG110X, FG210M, FG210X, FR92G22, FR94G23, P9110G, P91A10G, PG080M, PG080X | | |
| spare parts for | 101127 | | |
|  | GEV No. | 101312 | Ref. No. 1454900 CR0507660 MA1454900 |
| | microswitch | | |
|  | GEV No. | 101352 | Ref. No. — |
| | solenoid coil 230V 50Hz suitable for ELETTROSIT | | |
| accessories for | 101127 | | |
|  | GEV No. | 100006 | Ref. No. — |
| | piezoelectric igniter suitable for ELETTROSIT body plastic blowing connection ø2.4mm ø 14mm | | |
|  | GEV No. | 100904 | Ref. No. 1388000 1394700 MA1394700 |
| | locking screw M10x1 for pipe ø 4mm Qty 1 pcs | | |
|  | GEV No. | 100905 | Ref. No. 1394800 MA1394800 |
| | locking screw M10x1 for pipe ø 6mm Qty 1 pcs | | |
|  | GEV No. | 101301 | Ref. No. — |
| | gas connection thread 1/2" straight ELETTROSIT screw with O-ring | | |
|  | GEV No. | 101303 | Ref. No. 1451300 |
| | gas connection straight thread 3/4" ELETTROSIT | | |
|  | GEV No. | 101309 | Ref. No. — |
| | extension | | |

MINISIT











| | | | |
|---|--|-----------------|--|
| GEV No. | 101106 | Ref. No. | 1060500 |
| description | gas valve gas inlet 3/8" gas outlet 3/8" operable temperature range manual thermocouple connection M9x1 pilot connection M10x1 Minisit SIT | | |
| spare parts for | 101106 | | |
|  | GEV No. | 100809 | Ref. No. 1394000 BN6A011606 MA1394000 |
| | O-ring EPDM thickness 2mm ID ø 21mm Qty 1 pcs | | |
|  | GEV No. | 101053 | Ref. No. 24021499 MA24021499 |
| | magnet unit T1: M9x1 T2: M24x1 L 45mm ø 17mm suitable for Minisit | | |
|  | GEV No. | 101054 | Ref. No. — |
| | magnet unit T1: M10x1 T2: M24x1 L 45mm ø 17mm suitable for Minisit | | |
|  | GEV No. | 101136 | Ref. No. 1393700 24020299 MA1393700 |
| | piezoelectric igniter suitable for Minisit with cover cap ømm connection F6.3x0.8 | | |
|  | GEV No. | 101137 | Ref. No. 1393600 MA1393600 |
| | cover cap without piezoelectric igniter | | |
|  | GEV No. | 110068 | Ref. No. 1393500 1693500 24020399 MA1393500 |
| | knob suitable for Minisit ø 37mm | | |
| accessories for | 101106 | | |
|  | GEV No. | 100904 | Ref. No. 1388000 1394700 MA1394700 |
| | locking screw M10x1 for pipe ø 4mm Qty 1 pcs | | |
|  | GEV No. | 100905 | Ref. No. 1394800 MA1394800 |
| | locking screw M10x1 for pipe ø 6mm Qty 1 pcs | | |
|  | GEV No. | 101267 | Ref. No. — |
| | reducer IT 3/8" ET 1/2" L 21mm | | |
|  | GEV No. | 101268 | Ref. No. 1393800 MA1393800 |
| | gas connection thread 3/8" angled with O-ring MINISIT 710 | | |
|  | GEV No. | 101269 | Ref. No. 1393900 MA1393900 |
| | gas connection thread 1/2" angled with O-ring MINISIT 710 | | |
|  | GEV No. | 101270 | Ref. No. — |
| | screw connection IT 3/8" ET 3/8" L 28mm | | |

Table continues overleaf



| | | | | |
|---|---------|--------|----------|---|
| accessories for 101106 | | | | |
|  | GEV No. | 101272 | Ref. No. | — |
| screw connection IT 1/2" ET 3/8" L 57mm | | | | |
|  | GEV No. | 101273 | Ref. No. | 0100842 417810 MA417810 R0100842 SIR0100842 |
| olive for pipe ø 12mm L 9.5mm brass Qty 1 pcs suitable for universal | | | | |
|  | GEV No. | 101274 | Ref. No. | — |
| olive for pipe ø 16mm Qty 1 pcs | | | | |
|  | GEV No. | 101275 | Ref. No. | — |
| union screw thread 1/2" for pipe ø 16mm Qty 1 pcs | | | | |
|  | GEV No. | 101276 | Ref. No. | 459300 MA459300 |
| union screw thread 3/8" tube ø 12mm Qty 1 pcs | | | | |

| | | | | |
|---|---------|--------|----------|----------------------|
| accessories for 101187 | | | | |
|  | GEV No. | 101308 | Ref. No. | — |
| gas connection angled flange 45x45mm hole distance 36x36mm 3/4" ELETTROSIT/V4400/4600/4605 screw with O-ring suitable for SIT/HONEYWELL | | | | |
|  | GEV No. | 102116 | Ref. No. | 1870712 MA1870712 |
| thermopile ROBERTSHAW L 900mm probe ø 9mm probe L 57mm 250-750mV screw connection 7/16" | | | | |

| | | | | |
|---|---|-----------------|--|-----------------------------------|
| NOVASIT | | | | |
|  | | | | |
| 1 | | | | |
| GEV No. | 101187 | Ref. No. | 1870800 826920090 BN826920090 MA1870800 | |
| description | gas valve SIT series Novasit 820 0.17VHz gas inlet 1/2" gas outlet 1/2" thermocouple connection M9x1 pilot connection M10x1 ignition pressurebar pressure range 5-50mbar pressure regulator connection blind equiv. no. 0.820.301 supply Operator millivolt | | | |
| For models: | F94G22, F98G22, F9S4G22, F9S8G22, FR92G22, FR94G22, MM10IG, P9110G, P91A10G | | | |
| spare parts for | 101187 | | | |
|  | GEV No. | 101065 | Ref. No. | — |
| magnet unit with cable L 44mm D1 ø 30mm D2 ø 20mm suitable for NOVASIT | | | | |
| accessories for | 101187 | | | |
|  | GEV No. | 100110 | Ref. No. | 1949700 MA1949700 |
| pilot burner SIT type 190 series 3 flames nozzle 6mm gas connectionmm | | | | |
|  | GEV No. | 101305 | Ref. No. | 2865700 MA2865700 R63080010 |
| gas connection straight 1/2" flange 45x45mm ELETTROSIT/V4400/4600/4605 suitable for SIT/HONEYWELL hole distance 36x36mm | | | | |
|  | GEV No. | 101306 | Ref. No. | 2865800 MA2865800 R63080020 |
| gas connection angled flange 45x45mm hole distance 36x36mm 1/2" ELETTROSIT/V4400/4600/4605 screw with O-ring suitable for SIT/HONEYWELL | | | | |
|  | GEV No. | 101307 | Ref. No. | — |
| gas connection straight flange 45x45mm hole distance 36x36mm 3/4" ELETTROSIT/V4400/4600/4605 screw with O-ring suitable for SIT/HONEYWELL | | | | |
























| | | | | |
|---|--|-----------------|----------------------|-----------------------------------|
|  | | | | |
| 1 | | | | |
| GEV No. | 101162 | Ref. No. | 2863300 MA2863300 | |
| description | gas valve SIT series Novasit 820 230V 50Hz gas inlet 1/2" gas outlet 1/2" thermocouple connection M9x1 pilot connection M10x1 ignition pressure 3-5mbar pressure range 3-30mbar pressure regulator connection blind equiv. no. 0.820.010 | | | |
| For models: | BR912GFM, BR912GIM, BR94G, BR94GI, BR98GF, BR98GFM, BR98GI, BR98GIM, BR9M4G, BR9M4GI, BR9M6G, BR9M6GI, BR9S8GF, BR9S8GI, BR9SB4G, BR9SB4GI, CS10, CS102G, CS102GP, CS6, MS10AG, MS10IG, MS70AG, MS70IG, MS70IGS | | | |
| spare parts for | 101162 | | | |
|  | GEV No. | 101065 | Ref. No. | — |
| magnet unit with cable L 44mm D1 ø 30mm D2 ø 20mm suitable for NOVASIT | | | | |
|  | GEV No. | 101313 | Ref. No. | — |
| solenoid coil 230V 50Hz | | | | |
| accessories for | 101162 | | | |
|  | GEV No. | 100006 | Ref. No. | — |
| piezoelectric igniter suitable for ELETTROSIT body plastic blowing connection ø2.4mm ø 14mm | | | | |
|  | GEV No. | 101305 | Ref. No. | 2865700 MA2865700 R63080010 |
| gas connection straight 1/2" flange 45x45mm ELETTROSIT/V4400/4600/4605 suitable for SIT/HONEYWELL hole distance 36x36mm | | | | |
|  | GEV No. | 101306 | Ref. No. | 2865800 MA2865800 R63080020 |
| gas connection angled flange 45x45mm hole distance 36x36mm 1/2" ELETTROSIT/V4400/4600/4605 screw with O-ring suitable for SIT/HONEYWELL | | | | |
|  | GEV No. | 101307 | Ref. No. | — |
| gas connection straight flange 45x45mm hole distance 36x36mm 3/4" ELETTROSIT/V4400/4600/4605 screw with O-ring suitable for SIT/HONEYWELL | | | | |
|  | GEV No. | 101308 | Ref. No. | — |
| gas connection angled flange 45x45mm hole distance 36x36mm 3/4" ELETTROSIT/V4400/4600/4605 screw with O-ring suitable for SIT/HONEYWELL | | | | |
|  | GEV No. | 101312 | Ref. No. | 1454900 CR0507660 MA1454900 |
| microswitch | | | | |

Table continues overleaf

| | | | | |
|---|---------|--------|----------|----------------------|
| accessories for 101162 | | | | |
|  | GEV No. | 101314 | Ref. No. | — |
| solenoid coil 24V 50Hz | | | | |
|  | GEV No. | 101317 | Ref. No. | 1880600 MA1880600 |
| plug with cable L 1000mm suitable for NOVASIT | | | | |
|  | GEV No. | 101318 | Ref. No. | — |
| cover cap for solenoid coil suitable for NOVASIT | | | | |



| | | | | |
|---|--|--------|-----------------|-----------------------------------|
| 1 | GEV No. | 101908 | Ref. No. | 1871200 MA1871200 |
| description | gas valve SIT series Novasit 820 230V 50Hz gas inlet 1/2" gas outlet 1/2" thermocouple connection M9x1 pilot connection M10x1 ignition pressurebar pressure regulator connection blind equiv. no. 0.820.018 output pilot burner M10x1 input pressure max. 60bar setting range 3-30bar | | | |
| For models: | BR912GFM, BR912GIM, BR98GF, BR98GFM, BR98GI, BR98GIM, F94G22K, F98G22K, F954G22K, F958G22K, FR92G22T, FR94G22T, NBR912GFM, NBR912GIM, NBR98GF, NBR98GFM, NBR98GI, NBR98GIM, NF94G23K, NF98G23K, NPC74G, NPC76G, NPC78G, NPC94G, NPC96G, NPC98G, NPD76G5, NPD78G8, NPD96G5, NPD98G10, NPD98G15, NPD98G15A, NPI76G5, NPI78G8, NPI96G5, NPI98G10, NPI98G14, NPI98G14A | | | |
| spare parts for | 101908 | | | |
|  | GEV No. | 101065 | Ref. No. | — |
| magnet unit with cable L 44mm D1 ø 30mm D2 ø 20mm suitable for NOVASIT | | | | |
|  | GEV No. | 101313 | Ref. No. | — |
| solenoid coil 230V 50Hz | | | | |
| accessories for 101908 | | | | |
|  | GEV No. | 100006 | Ref. No. | — |
| piezoelectric igniter suitable for ELETTROSIT body plastic blowing connection ø2.4mm ø 14mm | | | | |
|  | GEV No. | 101305 | Ref. No. | 2865700 MA2865700 R63080010 |
| gas connection straight 1/2" flange 45x45mm ELETTROSIT/V4400/4600/4605 suitable for SIT/HONEYWELL hole distance 36x36mm | | | | |
|  | GEV No. | 101306 | Ref. No. | 2865800 MA2865800 R63080020 |
| gas connection angled flange 45x45mm hole distance 36x36mm 1/2" ELETTROSIT/V4400/4600/4605 screw with O-ring suitable for SIT/HONEYWELL | | | | |
|  | GEV No. | 101307 | Ref. No. | — |
| gas connection straight flange 45x45mm hole distance 36x36mm 3/4" ELETTROSIT/V4400/4600/4605 screw with O-ring suitable for SIT/HONEYWELL | | | | |
|  | GEV No. | 101308 | Ref. No. | — |
| gas connection angled flange 45x45mm hole distance 36x36mm 3/4" ELETTROSIT/V4400/4600/4605 screw with O-ring suitable for SIT/HONEYWELL | | | | |

| | | | | |
|---|---------|--------|----------|-----------------------------------|
| accessories for 101908 | | | | |
|  | GEV No. | 101312 | Ref. No. | 1454900 CR0507660 MA1454900 |
| microswitch | | | | |
|  | GEV No. | 101314 | Ref. No. | — |
| solenoid coil 24V 50Hz | | | | |
|  | GEV No. | 101317 | Ref. No. | 1880600 MA1880600 |
| plug with cable L 1000mm suitable for NOVASIT | | | | |
|  | GEV No. | 101318 | Ref. No. | — |
| cover cap for solenoid coil suitable for NOVASIT | | | | |

















| | | | | |
|---|--|--------|-----------------|-----------------------------------|
| 1 | GEV No. | 101967 | Ref. No. | 5118500 MA5118500 |
| description | gas valve SIT series Novasit 822 230V 50Hz gas inlet 1/2" gas outlet 1/2" thermocouple connection pilot connection M10x1 ignition pressure 3-5mbar pressure range 3-30mbar pressure regulator connection perforated equiv. no. 0.822.110 | | | |
| For models: | CON102G, CON102GP, CON201G, CON201GP, CON202G, CON202GP, CP9A1 5GD, CSM102G, CSM102GP, CSM201G, CSM201GP, CSM202G, CSM202GP | | | |
| spare parts for | 101967 | | | |
|  | GEV No. | 101313 | Ref. No. | — |
| solenoid coil 230V 50Hz | | | | |
|  | GEV No. | 101542 | Ref. No. | — |
| solenoid coil 50Hz NOVA 822/826/827 suitable for NOVASIT 230V | | | | |
| accessories for 101967 | | | | |
|  | GEV No. | 100904 | Ref. No. | 1388000 1394700 MA1394700 |
| locking screw M10x1 for pipe ø 4mm Qty 1 pcs | | | | |
|  | GEV No. | 100905 | Ref. No. | 1394800 MA1394800 |
| locking screw M10x1 for pipe ø 6mm Qty 1 pcs | | | | |
|  | GEV No. | 101305 | Ref. No. | 2865700 MA2865700 R63080010 |
| gas connection straight 1/2" flange 45x45mm ELETTROSIT/V4400/4600/4605 suitable for SIT/HONEYWELL hole distance 36x36mm | | | | |
|  | GEV No. | 101306 | Ref. No. | 2865800 MA2865800 R63080020 |
| gas connection angled flange 45x45mm hole distance 36x36mm 1/2" ELETTROSIT/V4400/4600/4605 screw with O-ring suitable for SIT/HONEYWELL | | | | |
|  | GEV No. | 101307 | Ref. No. | — |
| gas connection straight flange 45x45mm hole distance 36x36mm 3/4" ELETTROSIT/V4400/4600/4605 screw with O-ring suitable for SIT/HONEYWELL | | | | |


Table continues overleaf





| | | | |
|--|----------------|--------|-------------------|
| accessories for 101967 | | | |
|  | GEV No. | 101308 | Ref. No. — |
| gas connection angled flange 45x45mm hole distance 36x36mm 3/4" ELETROSIT/V4400/4600/4605 screw with O-ring suitable for SIT/HONEYWELL | | | |
|  | GEV No. | 101503 | Ref. No. — |
| O-ring EPDM thickness 2mm ID ø 32mm Qty 1 pcs | | | |
|  | GEV No. | 101924 | Ref. No. — |
| plug with cable L 1090mm suitable for NOVA 822/826/827 | | | |


| | | | |
|---|--|-----------------|-----------------------------------|
| accessories | | | |
|  | 1 | | |
| GEV No. | 101306 | Ref. No. | 2865800 MA2865800 R63080020 |
| description | gas connection angled flange 45x45mm hole distance 36x36mm 1/2" ELETROSIT/V4400/4600/4605 screw with O-ring suitable for SIT/HONEYWELL | | |
| For models: | BR912GFM, BR912GIM, BR94G, BR94GI, BR98GF, BR98GFM, BR98GI, BR98GIM, BR9M4G, BR9M4GI, BR9M6G, BR9M6GI, BR9S8GF, BR9S8GI, BR9SB4G, BR9SB4GI, CON10G, CON10GP, CON201G, CON201GP, CON202G, CON202GP, CON6G, CON6GP, CS10, CS102G, CS102GP, CS6, CSM10G, CSM10GP, CSM201G, CSM201GP, CSM202G, CSM202GP, CSM6G, CSM6GP, CVG105H, CVG105M, MG106M, MG106P, MG106X, MG110M, MG110P, MG110X, MG120M, MG120P, MG120X, MG210M, MG210P, MG210X...(Other models you can see in the webshop) | | |
| spare parts for 101306 | | | |
|  | GEV No. | 517104 | Ref. No. — |
| O-ring EPDM thickness 2.62mm ID ø 31.42mm Qty 1 pcs | | | |

| | | | |
|---|---|-----------------|-----------------------------------|
|  | 1 | | |
| GEV No. | 101305 | Ref. No. | 2865700 MA2865700 R63080010 |
| description | gas connection straight 1/2" flange 45x45mm ELETROSIT/V4400/4600/4605 suitable for SIT/HONEYWELL hole distance 36x36mm | | |
| For models: | BR94G, BR94GI, BR9M4G, BR9M4GI, BR9M6G, BR9M6GI, BR9SB4G, BR9SB4GI, CON10G, CON10GP, CON201G, CON201GP, CON202G, CON202GP, CON6G, CON6GP, CS10, CS102G, CS102GP, CS6, CSM10G, CSM10GP, CSM201G, CSM201GP, CSM202G, CSM202GP, CSM6G, CSM6GP, MG106M, MG106P, MG106X, MG110M, MG110P, MG110X, MG210M, MG210P, MG210X, MS10AG, MS10IG, MS70AG, MS70IG, MS70IGS, VG106M, VG106P, VG106X, VG110M, VG110P, VG110X, VG210M, VG210P...(Other models you can see in the webshop) | | |
| spare parts for 101305 | | | |
|  | GEV No. | 101503 | Ref. No. — |
| O-ring EPDM thickness 2mm ID ø 32mm Qty 1 pcs | | | |

| | | | |
|---|--|-----------------|------------------------------------|
|  | 1 | | |
| GEV No. | 101817 | Ref. No. | CM091301 CM091302 MACM091302 |
| description | knob adapter L 30mm shaft ø 10x8mm shaft L 30/20mm size 10x8mm suitable for MARENO | | |
| For models: | BR912GFM, BR912GIM, BR98GF, BR98GFM, BR98GI, BR98GIM, BR9S8GF, BR9S8GI | | |

| | | | |
|---|--|-----------------|----------------------|
|  | 1 | | |
| GEV No. | 101391 | Ref. No. | 1923500 MA1923500 |
| description | knob adapter shaft ø 6x4.6mm shaft L 31/15mm suitable for NOVA-SIT | | |
| For models: | BR94G, BR94GI, BR9M4G, BR9M4GI, BR9M6G, BR9M6GI, BR9SB4G, BR9SB4GI, MM10IG, MS10AG, MS10IG, MS70AG, MS70IG, MS70IGS, P9110G, P91A10G | | |

| | | | |
|---|--|-----------------|----------------------|
|  | 1 | | |
| GEV No. | 100905 | Ref. No. | 1394800 MA1394800 |
| description | locking screw M10x1 for pipe ø 6mm Qty 1 pcs | | |
| For models: | BR707G, CS10, CS102G, CS102GP, CS6, CSM201E, CSM201EP, CSM201G, CSM201GP, CSM202E, CSM202EP, CSM202G, CSM202GP, FR74G, FR77G | | |

| | | | |
|--|--|-----------------|-----------------------------------|
|  | 1 | | |
| GEV No. | 101312 | Ref. No. | 1454900 CR0507660 MA1454900 |
| description | microswitch | | |
| For models: | BR912GFM, BR912GIM, BR98GF, BR98GFM, BR98GI, BR98GIM, CS10, CS102G, CS102GP, CS6, FR92G22, FR94G23, NBR912GFM, NBR912GIM, NBR98GF, NBR98GFM, NBR98GI, NBR98GIM, NF94G23K, NF98G23K, NPC74G, NPC78G, NPC94G, NPC98G, NPD76G5, NPD78G8, NPD96G5, NPD98G10, NPD98G15, NPD98G15A, NPI76G5, NPI78G8, NPI96G5, NPI98G10, NPI98G14, NPI98G14A | | |



| | | | |
|---|--|-----------------|----------------------|
|  | 1 | | |
| GEV No. | 100110 | Ref. No. | 1949700 MA1949700 |
| description | pilot burner SIT type 190 series 3 flames nozzle ømm gas connecti-onmm | | |
| For models: | MM10IG, P9110G, P91A10G | | |
| accessories for 100110 | | | |
|  | GEV No. | 100202 | Ref. No. — |
| pilot burner nozzle natural gas code 41 Qty 1 pcs nozzle ø 0.41mm | | | |

Table continues overleaf



| accessories for | | 100110 | |
|---|---------|--------|--|
|  | GEV No. | 100203 | Ref. No. — |
| pilot burner nozzle LPG code 25 Qty 1 pcs nozzle ø 0.25mm | | | |
|  | GEV No. | 100701 | Ref. No. 1888300 1949900 MA1888300 MA1949900 |
| ignition electrode connection M4 Qty 1 pcs | | | |
|  | GEV No. | 100906 | Ref. No. 1888400 MA1888400 |
| screw connection thread M10x1 for ignition electrode brass Qty 1 pcs WS 10 | | | |
|  | GEV No. | 100907 | Ref. No. 1891700 24010899 MA1891700 MA24010899 |
| screw connection thread M10x1 Qty 1 pcs type SEF 1 ømm for thermocouple | | | |
|  | GEV No. | 100908 | Ref. No. 0100777 673500 MA673500 R0100777 SIR0100777 |
| union screw thread M10x1 for pipe ø 4mm Qty 1 pcs | | | |
|  | GEV No. | 100909 | Ref. No. — |
| union screw thread M10x1 for pipe ø 6mm Qty 1 pcs | | | |
|  | GEV No. | 101282 | Ref. No. 469000 MA469000 |
| olive for pipe ø 4mm L 7.4mm Qty 1 pcs | | | |
|  | GEV No. | 101287 | Ref. No. — |
| olive for pipe ø 6mm Qty 1 pcs | | | |
|  | GEV No. | 102110 | Ref. No. 1413100 1413200 1682300 1876500 |
| pilot tube copper pipe ø 4mm thickness 1mm L 3000mm | | | |
|  | GEV No. | 102111 | Ref. No. 1690200 |
| pilot tube copper pipe ø 6mm thickness 1mm L 3000mm | | | |
|  | GEV No. | 107650 | Ref. No. 0100802 CR0410100 R0100802 SIR0100802 |
| pilot burner nozzle SIT LPG code 30 Qty 1 pcs | | | |



| | | | |
|--------------------|---|-----------------|----------------------|
| GEV No. | 101317 | Ref. No. | 1880600 MA1880600 |
| description | plug with cable L 1000mm suitable for NOVASIT | | |
| For models: | BR912GFM, BR912GIM, BR94G, BR94GI, BR98GF, BR98GFM, BR98GI, BR98GIM, BR9M4G, BR9M4GI, BR9M6G, BR9M6GI, BR9S8GF, BR9S8GI, BR9S84G, BR9S84GI, CON201G, CON201GI, CON202G, CON202GI, CSM201G, CSM201GI, CSM202G, CSM202GI, F94G22K, F98G22K, F95-4G22K, F958G22K, FR92G22T, FR94G22T, MS10AG, MS10IG, MS70AG, MS70IG, MS70IGS, NBR912GFM, NBR912GIM, NBR98GF, NBR98GFM, NBR98GI, NBR98GIM, NF94G23K, NF98G23K, NPC74G, NPC78G, NPC94G, NPC98G, NPD76G5, NPD78G8, NPD96G5...(Other models you can see in the webshop) | | |

TANDEM



| | | | |
|---|--|-----------------|--|
| GEV No. | 101189 | Ref. No. | 2942600 MA2942600 |
| description | gas valve 230V 50Hz gas inlet 1/2" gas outlet 1/2" pilot connection M10x1 level slow ignition ignition times pressure range 3-50mbar power supply for modulator equiv. no. 0.830.040 suitable for Tandem | | |
| For models: | CON10G, CON10GP, CON6G, CON6GP, CSM10G, CSM10GP, CSM6G, CSM6GP, P198G10, P198G14, P198G14A | | |
| spare parts for | 101189 | | |
|  | GEV No. | 101379 | Ref. No. — |
| solenoid coil 230V 50Hz suitable for Tandem | | | |
| accessories for | 101189 | | |
|  | GEV No. | 100904 | Ref. No. 1388000 1394700 MA1394700 |
| locking screw M10x1 for pipe ø 4mm Qty 1 pcs | | | |
|  | GEV No. | 100905 | Ref. No. 1394800 MA1394800 |
| locking screw M10x1 for pipe ø 6mm Qty 1 pcs | | | |
|  | GEV No. | 101274 | Ref. No. — |
| olive for pipe ø 16mm Qty 1 pcs | | | |
|  | GEV No. | 101275 | Ref. No. — |
| union screw thread 1/2" for pipe ø 16mm Qty 1 pcs | | | |
|  | GEV No. | 101925 | Ref. No. — |
| plug with O-ring thread M10x1 for pilot burner suitable for NOVASIT | | | |
|  | GEV No. | 102845 | Ref. No. — |
| gas connection angled 1/2" flange 32x32mm hole distance 24x24mm Tandem | | | |
|  | GEV No. | 102846 | Ref. No. — |
| gas connection straight 1/2" flange 32x32mm hole distance 24x24mm suitable for Tandem | | | |
|  | GEV No. | 102847 | Ref. No. — |
| O-ring | | | |



ignition boxes

HONEYWELL

Honeywell



| | | | |
|--------------------|---|-----------------|-------------|
| 1 | | | |
| GEV No. | 102367 | Ref. No. | LAR63060120 |
| description | ignition box HONEYWELL type S4565A 2092 1 electrodes 3 waiting times safety time 10s 220-240V 4VA 50/60Hz | | |
| For models: | GMT06D, GMT20D, GVT06D, GVT20D, MACG05M, MACG07M, MACG10M, MACG20M, MG061D, MG061M, MG061P, MG061T, MG101D, MG101M, MG101P, MG101T, MG102D, MG102M, MG102P, MG102T, MG201D, MG201M, MG201P, MG201T, MG202D, MG202M, MG202P, MG202T, MGMT06D, MGMT06P, MGMT10D, MGMT10P, MGMT20D, MGMT20P, MGMT21D, MGMT21P, MGMT40D, MGMT40P, MGVT06D, MGVT06P, MGVT10D, MGVT10P, MGVT20D, MGVT20P, MGVT21D, MGVT21P, MGVT40D, MGVT40P, MVG051P | | |

Honeywell



| | | | |
|--------------------|--|-----------------|-----------|
| 1 | | | |
| GEV No. | 102318 | Ref. No. | R63060100 |
| description | ignition box HONEYWELL type S4565AF 1007V01 electrodes 2 waiting times safety time 10s 220-240V 4VA 50/60Hz | | |
| For models: | GC106M, GC110M, GC210M, GM106H, GM106M, GM106M+SC, GM106P, GM110H, GM110M, GM110M+SC, GM110P, GM210H, GM210M, GM210M+SC, GM210P, GV106H, GV106M, GV106M+SC, GV106P, GV110H, GV110M, GV110M+SC, GV110P, GV210H, GV210M, GV210M+SC, GV210P | | |

SIT



| | | | |
|--------------------|--|-----------------|----------------------|
| 1 | | | |
| GEV No. | 102303 | Ref. No. | 5153200 MA5153200 |
| description | ignition box SIT type 501EFD electrodes 2 waiting time 1.5s safety time 5s 250V 10VA 50-60Hz | | |
| For models: | CON102G, CON102GP, CON10G, CON10GP, CON201G, CON201GP, CON202G, CON202GP, CON6G, CON6GP, CP9A15GD, CSM102G, CSM102GP, CSM10G, CSM10GP, CSM201G, CSM201GP, CSM202G, CSM202GP, CSM6G, CSM6GP | | |

safety valves

SIT

400 series



| | | | | |
|------------------------|--|-----------------|----------------------|---|
| 1 | | | | |
| GEV No. | 101470 | Ref. No. | 1491900 MA1491900 | |
| description | safety valve front fixing M12x1 pressure range 50mbar gas inlet 1/8" IT gas outlet 1/8" - M6x0.75 thermocouple connection M8x1 equiv. no. 0.400.088 suitable for SIT | | | |
| For models: | BR96G, BR96GI, BR9M6G, BR9M6GI, MS10AG, MS10IG | | | |
| spare parts for | 101470 | | | |
| | GEV No. | 101052 | Ref. No. | — |
| | magnet unit L 43.5mm D1 ø 15.3mm D2 ø 10.5mm suitable for SIT M1 | | | |
| accessories for | 101470 | | | |
| | GEV No. | 101299 | Ref. No. | — |
| | nut thread M12x1 | | | |
| | GEV No. | 101499 | Ref. No. | — |
| | protection cap for safety valve thread M12x0.75 ID ø 18mm L 24mm aluminium | | | |

ignition parts

pilot burners

SIT




100 series

















| | | | | |
|------------------------|---|-----------------|------------------------|---------------------------------|
| 1 | | | | |
| GEV No. | 107103 | Ref. No. | 24022099 BN6A013100 | |
| description | pilot burner SIT 1 flame nozzle ø 0.2mm gas connection 6mm | | | |
| spare parts for | 107103 | | | |
| | GEV No. | 100245 | Ref. No. | 1415100 3020054 MA1415100 |
| | pilot burner nozzle LPG code 20 bore ø 0.2mm Qty 1 pcs thread M8x0.75 | | | |
| | GEV No. | 100885 | Ref. No. | 1324900 MA1324900 |
| | air mixing sleeve for pilot burner Qty 1 pcs | | | |
| | GEV No. | 100916 | Ref. No. | — |
| | compression spring for pilot burner Qty 1 pcs | | | |
| | GEV No. | 100917 | Ref. No. | — |
| | gasket for pilot burner Qty 1 pcs aluminium | | | |














Table continues overleaf






| spare parts for | | 107103 | |
|---|--|--------|---|
|  | GEV No. | 100918 | Ref. No. — |
| | screw for pilot burner | | |
|  | GEV No. | 107160 | Ref. No. — |
| | pilot burner cap SIT 1 flame Hmm Lmm Qty 1 pcs | | |
|  | GEV No. | 107166 | Ref. No. — |
| | pilot burner head SIT 1 flame Hmm Lmm Qty 1 pcs | | |
|  | GEV No. | 107701 | Ref. No. — |
| | pilot burner bottom part SIT 100 series nozzle ø 0.2mm | | |
| accessories for | | 107103 | |
|  | GEV No. | 100246 | Ref. No. 1422600 MA1422600 |
| | pilot burner nozzle natural gas bore ø 0.35mm Qty 1 pcs thread M8x0.75 | | |
|  | GEV No. | 100904 | Ref. No. 1388000 1394700 MA1394700 |
| | locking screw M10x1 for pipe ø 4mm Qty 1 pcs | | |
|  | GEV No. | 100905 | Ref. No. 1394800 MA1394800 |
| | locking screw M10x1 for pipe ø 6mm Qty 1 pcs | | |
|  | GEV No. | 102110 | Ref. No. 1413100 1413200 1682300 1876500 |
| | pilot tube copper pipe ø 4mm thickness 1mm L 3000mm | | |
|  | GEV No. | 102111 | Ref. No. 1690200 |
| | pilot tube copper pipe ø 6mm thickness 1mm L 3000mm | | |
|  | GEV No. | 107171 | Ref. No. 1031502100 1842300 MA1031502100 MA1842300 |
| | pilot burner nozzle SIT natural/liquid gas bore ø 0.25mm Qty 1 pcs | | |
|  | GEV No. | 107700 | Ref. No. — |
| | pilot burner bottom part SIT 100 series nozzle ø 0.25mm | | |
|  | GEV No. | 107702 | Ref. No. 1031501800 1314800 MA1314800 |
| | pilot burner bottom part SIT 100 series nozzle ø 0.35mm | | |

|  <p>1</p> | | | |
|--|---|-----------------|--|
| GEV No. | 106902 | Ref. No. | 94400 |
| description | pilot burner SIT type 100 series 2 flames nozzle ø 0.2mm gas connection 6mm | | |
| spare parts for | | 106902 | |
|  | GEV No. | 100245 | Ref. No. 1415100 3020054 MA1415100 |
| | pilot burner nozzle LPG code 20 bore ø 0.2mm Qty 1 pcs thread M8x0.75 | | |
|  | GEV No. | 100842 | Ref. No. — |
| | pilot burner cap 2 flames Qty 1 pcs | | |

| spare parts for | | 106902 | |
|---|--|--------|---|
|  | GEV No. | 100885 | Ref. No. 1324900 MA1324900 |
| | air mixing sleeve for pilot burner Qty 1 pcs | | |
|  | GEV No. | 100916 | Ref. No. — |
| | compression spring for pilot burner Qty 1 pcs | | |
|  | GEV No. | 100917 | Ref. No. — |
| | gasket for pilot burner Qty 1 pcs aluminium | | |
|  | GEV No. | 100918 | Ref. No. — |
| | screw for pilot burner | | |
|  | GEV No. | 107161 | Ref. No. — |
| | pilot burner cap SIT 2 flames Hmm Lmm Qty 1 pcs | | |
|  | GEV No. | 107701 | Ref. No. — |
| | pilot burner bottom part SIT 100 series nozzle ø 0.2mm | | |
| accessories for | | 106902 | |
|  | GEV No. | 100246 | Ref. No. 1422600 MA1422600 |
| | pilot burner nozzle natural gas bore ø 0.35mm Qty 1 pcs thread M8x0.75 | | |
|  | GEV No. | 100904 | Ref. No. 1388000 1394700 MA1394700 |
| | locking screw M10x1 for pipe ø 4mm Qty 1 pcs | | |
|  | GEV No. | 100905 | Ref. No. 1394800 MA1394800 |
| | locking screw M10x1 for pipe ø 6mm Qty 1 pcs | | |
|  | GEV No. | 102110 | Ref. No. 1413100 1413200 1682300 1876500 |
| | pilot tube copper pipe ø 4mm thickness 1mm L 3000mm | | |
|  | GEV No. | 102111 | Ref. No. 1690200 |
| | pilot tube copper pipe ø 6mm thickness 1mm L 3000mm | | |
|  | GEV No. | 107171 | Ref. No. 1031502100 1842300 MA1031502100 MA1842300 |
| | pilot burner nozzle SIT natural/liquid gas bore ø 0.25mm Qty 1 pcs | | |
|  | GEV No. | 107700 | Ref. No. — |
| | pilot burner bottom part SIT 100 series nozzle ø 0.25mm | | |
|  | GEV No. | 107702 | Ref. No. 1031501800 1314800 MA1314800 |
| | pilot burner bottom part SIT 100 series nozzle ø 0.35mm | | |



| | | | |
|--|--|-----------------|--|
|  <p>1</p> | | | |
| GEV No. | 106906 | Ref. No. | 1040511 1314500 431500 6A013200 BN6A013200 LAR63050020 MA1040511 MA431500 |
| description | pilot burner SIT type 100 series 3 flames nozzle ø 0.2mm gas connection 6mm | | |
| For models: | B9SB2G, B9SB4G, B9V2G, B9V4G, F9SB2G, F9SB2GR, F9SB4G, F9SB4GR, F9SB4GRL, F9V2G, F9V2GR, F9V4G, F9V4GR, F9V4GRL, FG105M, FG105X, FG110M, FG110X, FG210M, FG210X, P9110G, P91A10G, PG040M, PG040X, PG080M, PG080X, T7011GFG, T707G, T707GFG, T9F4G, T9F6GS, T9SB4G, T9V4G, T9V6GS | | |
| spare parts for | 106906 | | |
|  | GEV No. | 100245 | Ref. No. 1415100 3020054 MA1415100 |
| | pilot burner nozzle LPG code 20 bore ø 0.2mm Qty 1 pcs thread M8x0.75 | | |
|  | GEV No. | 100855 | Ref. No. — |
| | pilot burner bracket triple | | |
|  | GEV No. | 100885 | Ref. No. 1324900 MA1324900 |
| | air mixing sleeve for pilot burner Qty 1 pcs | | |
|  | GEV No. | 100916 | Ref. No. — |
| | compression spring for pilot burner Qty 1 pcs | | |
|  | GEV No. | 100917 | Ref. No. — |
| | gasket for pilot burner Qty 1 pcs aluminium | | |
|  | GEV No. | 100918 | Ref. No. — |
| | screw for pilot burner | | |
|  | GEV No. | 107162 | Ref. No. — |
| | pilot burner cap SIT 3 flames Hmm Lmm Qty 1 pcs | | |
|  | GEV No. | 107701 | Ref. No. — |
| | pilot burner bottom part SIT 100 series nozzle ø 0.2mm | | |
| accessories for | 106906 | | |
|  | GEV No. | 100245 | Ref. No. 1415100 3020054 MA1415100 |
| | pilot burner nozzle LPG code 20 bore ø 0.2mm Qty 1 pcs thread M8x0.75 | | |
|  | GEV No. | 100246 | Ref. No. 1422600 MA1422600 |
| | pilot burner nozzle natural gas bore ø 0.35mm Qty 1 pcs thread M8x0.75 | | |
|  | GEV No. | 100904 | Ref. No. 1388000 1394700 MA1394700 |
| | locking screw M10x1 for pipe ø 4mm Qty 1 pcs | | |
|  | GEV No. | 100905 | Ref. No. 1394800 MA1394800 |
| | locking screw M10x1 for pipe ø 6mm Qty 1 pcs | | |

| | | | |
|---|--|--------|--|
| accessories for | 106906 | | |
|  | GEV No. | 102110 | Ref. No. 1413100 1413200 1682300 1876500 |
| | pilot tube copper pipe ø 4mm thickness 1mm L 3000mm | | |
|  | GEV No. | 102111 | Ref. No. 1690200 |
| | pilot tube copper pipe ø 6mm thickness 1mm L 3000mm | | |
|  | GEV No. | 107171 | Ref. No. 1031502100 1842300 MA1031502100 MA1842300 |
| | pilot burner nozzle SIT natural/liquid gas bore ø 0.25mm Qty 1 pcs | | |
|  | GEV No. | 107700 | Ref. No. — |
| | pilot burner bottom part SIT 100 series nozzle ø 0.25mm | | |
|  | GEV No. | 107702 | Ref. No. 1031501800 1314800 MA1314800 |
| | pilot burner bottom part SIT 100 series nozzle ø 0.35mm | | |





























| | | | |
|---|--|-----------------|--|
|  <p>1</p> | | | |
| GEV No. | 106907 | Ref. No. | 1315100 CR0588730 |
| description | pilot burner SIT type 100 series 3 flames nozzle ø 0.35mm gas connection 6mm | | |
| For models: | C9F4G, C9F4GS, C9F6G, C9F6GS, C9F8G, C9F8GS, NG74G, NG78G, NG94G, NG98G, P9D10G, P9D15G, P9DA10G, P9DA15G, T9F4G, T9F6GS | | |
| spare parts for | 106907 | | |
|  | GEV No. | 100246 | Ref. No. 1422600 MA1422600 |
| | pilot burner nozzle natural gas bore ø 0.35mm Qty 1 pcs thread M8x0.75 | | |
|  | GEV No. | 100855 | Ref. No. — |
| | pilot burner bracket triple | | |
|  | GEV No. | 100885 | Ref. No. 1324900 MA1324900 |
| | air mixing sleeve for pilot burner Qty 1 pcs | | |
|  | GEV No. | 100916 | Ref. No. — |
| | compression spring for pilot burner Qty 1 pcs | | |
|  | GEV No. | 100917 | Ref. No. — |
| | gasket for pilot burner Qty 1 pcs aluminium | | |
|  | GEV No. | 100918 | Ref. No. — |
| | screw for pilot burner | | |
|  | GEV No. | 107162 | Ref. No. — |
| | pilot burner cap SIT 3 flames Hmm Lmm Qty 1 pcs | | |
|  | GEV No. | 107702 | Ref. No. 1031501800 1314800 MA1314800 |
| | pilot burner bottom part SIT 100 series nozzle ø 0.35mm | | |


Table continues overleaf


| accessories for | | 106907 | |
|--|---------|--------|---|
|  | GEV No. | 100245 | Ref. No. 1415100 3020054 MA1415100 |
| pilot burner nozzle LPG code 20 bore ø 0.2mm Qty 1 pcs thread M8x0.75 | | | |
|  | GEV No. | 100904 | Ref. No. 1388000 1394700 MA1394700 |
| locking screw M10x1 for pipe ø 4mm Qty 1 pcs | | | |
|  | GEV No. | 100905 | Ref. No. 1394800 MA1394800 |
| locking screw M10x1 for pipe ø 6mm Qty 1 pcs | | | |
|  | GEV No. | 102110 | Ref. No. 1413100 1413200 1682300 1876500 |
| pilot tube copper pipe ø 4mm thickness 1mm L 3000mm | | | |
|  | GEV No. | 102111 | Ref. No. 1690200 |
| pilot tube copper pipe ø 6mm thickness 1mm L 3000mm | | | |
|  | GEV No. | 107171 | Ref. No. 1031502100 1842300 MA1031502100 MA1842300 |
| pilot burner nozzle SIT natural/liquid gas bore ø 0.25mm Qty 1 pcs | | | |
|  | GEV No. | 107700 | Ref. No. — |
| pilot burner bottom part SIT 100 series nozzle ø 0.25mm | | | |
|  | GEV No. | 107701 | Ref. No. — |
| pilot burner bottom part SIT 100 series nozzle ø 0.2mm | | | |

| accessories | | | |
|---|---|----------|----------------------|
| pilot burner caps | | | |
|  | | | |
| 1 | | | |
| GEV No. | 100837 | Ref. No. | 1576000 MA1576000 |
| description | pilot burner cap 3 flames H 24mm L 48mm Qty 1 pcs | | |
| For models: | EF74G15, F12C4G15, F74G10, F74G15, F76G10, F78G15, F94G10, F94G15, F94G22, F94G22K, F96G10, F98G15, F98G22, F98G22K, F9S4G15, F9S4G22, F9S4G22K, F9S8G15, F9S8G22, F9S8G22K, FR74G, FR77G, FR92G13, FR92G22, FR92G22T, FR94G13, FR94G22, FR94G22T, NF74G15T, NF78G15T | | |

| pilot burner bottom parts | | | |
|---|--|----------|---|
|  | | | |
| 1 | | | |
| GEV No. | 107702 | Ref. No. | 1031501800 1314800 MA1314800 |
| description | pilot burner bottom part SIT 100 series nozzle ø 0.35mm | | |
| For models: | C7011G, C7011GFE, C7011GFG, C704G, C707G, C707GFE, C707GFG, C9F4G, C9F4GS, C9F6G, C9F6GS, C9F8G, C9F8GS, C9SB4GS, C9V2G, C9V2GS, C9V4G, C9V4GS, C9V6G, C9V6GS, C9V8G, C9V8GS | | |
| spare parts for | 107702 | | |
|  | GEV No. | 100246 | Ref. No. 1422600 MA1422600 |
| pilot burner nozzle natural gas bore ø 0.35mm Qty 1 pcs thread M8x0.75 | | | |
|  | GEV No. | 100916 | Ref. No. — |
| compression spring for pilot burner Qty 1 pcs | | | |
|  | GEV No. | 100917 | Ref. No. — |
| gasket for pilot burner Qty 1 pcs aluminium | | | |
| accessories for 107702 | | | |
|  | GEV No. | 100245 | Ref. No. 1415100 3020054 MA1415100 |
| pilot burner nozzle LPG code 20 bore ø 0.2mm Qty 1 pcs thread M8x0.75 | | | |
|  | GEV No. | 100904 | Ref. No. 1388000 1394700 MA1394700 |
| locking screw M10x1 for pipe ø 4mm Qty 1 pcs | | | |
|  | GEV No. | 100905 | Ref. No. 1394800 MA1394800 |
| locking screw M10x1 for pipe ø 6mm Qty 1 pcs | | | |
|  | GEV No. | 102110 | Ref. No. 1413100 1413200 1682300 1876500 |
| pilot tube copper pipe ø 4mm thickness 1mm L 3000mm | | | |
|  | GEV No. | 102111 | Ref. No. 1690200 |
| pilot tube copper pipe ø 6mm thickness 1mm L 3000mm | | | |
|  | GEV No. | 102742 | Ref. No. — |
| pilot burner nozzle LPG code 25 bore ø 0.25mm Qty 1 pcs | | | |





| | | | |
|---|---|-----------------|----------------------|
|  | | | |
| 1 | | | |
| GEV No. | 100880 | Ref. No. | 1874100 MA1874100 |
| description | pilot burner bottom part SIT 100 series nozzle ϕ 0.4mm | | |
| For models: | EF74G15, F12C4G15, F74G10, F74G15, F76G10, F78G15, F94G10, F94G15, F94G22, F94G22K, F96G10, F98G15, F98G22, F98G22K, F954G15, F954G22, F954G22K, F958G15, F958G22, F958G22K, FR74G, FR77G, FR92G13, FR92G22, FR92G22T, FR94G13, FR94G22, FR94G22T, NF74G15T, NF78G15T | | |


| | | | |
|--|--|-----------------|----------------------|
|  | | | |
| 1 | | | |
| GEV No. | 100246 | Ref. No. | 1422600 MA1422600 |
| description | pilot burner nozzle natural gas bore ϕ 0.35mm Qty 1 pcs thread M8x0.75 | | |
| For models: | B95B2G, B95B4G, B9V2G, B9V4G, C7011G, C7011GFE, C7011GFG, C704G, C707G, C707GFE, C707GFG, C9F4G, C9F4GS, C9F6G, C9F6GS, C9F8G, C9F8GS, C95B4GS, C9V2G, C9V2GS, C9V4G, C9V4GS, C9V6G, C9V6GS, C9V8G, C9V8GS, F95B2G, F95B2GR, F95B4G, F95B4GR, F95B4GRL, F9V2G, F9V2GR, F9V4G, F9V4GR, F9V4GRL, P9D10G, P9D15G, P9DA10G, P9DA15G, P9I10G, P9IA10G, T7011GFG, T707G, T707GFG, T9F4G, T9F6GS, T95B4G, T9V4G, T9V6GS | | |

pilot burner brackets


universal

| | | | |
|---|---|-----------------|------------|
|  | | | |
| 1 | | | |
| GEV No. | 100894 | Ref. No. | 1031502300 |
| description | opposite support for pilot burner suitable for 100 series | | |


| | | | |
|--|---|-----------------|-----------------------------------|
|  | | | |
| 1 | | | |
| GEV No. | 102972 | Ref. No. | 1996200 CR0684580 MA1996200 |
| description | pilot burner nozzle natural gas code 40 bore ϕ 0.4mm Qty 1 pcs | | |
| For models: | EF74G15, F12C4G15, F74G10, F74G15, F76G10, F78G15, F94G10, F94G15, F94G22, F94G22K, F96G10, F98G15, F98G22, F98G22K, F954G15, F954G22, F954G22K, F958G15, F958G22, F958G22K, NF74G15T, NF78G15T, NG74G, NG78G, NG94G, NG98G | | |

| | | | |
|--|--|-----------------|------------|
|  | | | |
| 1 | | | |
| GEV No. | 100893 | Ref. No. | 1031502200 |
| description | pilot burner bracket suitable for 100 series 2-piece | | |


ignition electrodes

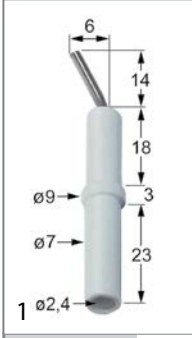
| | | | |
|--|--|-----------------|--|
|  | | | |
| 1 | | | |
| GEV No. | 100706 | Ref. No. | 1031502500 224211 636700 MA224211 MA636700 |
| description | ignition electrode connection M4 Qty 1 pcs | | |
| For models: | 702BMG, 706, 706S, B95B2G, B95B4G, B9V2G, B9V4G, BIG40, BIG60, BMG40, BMG60, BR707G, BR94G, BR94GI, BR96G, BR96GI, BR9M4G, BR9M4GI, BR9M6G, BR9M6GI, BRG40, BRG40G, C7011GFE, C7011GFG, C707GFE, C707GFG, C9F4G, C9F4GS, C9F6G, C9F6GS, C9F8G, C9F8GS, C9F101D, C9F101L, C9F101P, C9F120, C9F70, C9F70D, C9F70L, C9F70M, C9F70P, CP707G, CP92G, CP94G, CS10, CS102G, CS102GP, CS6, EC74GVG...(Other models you can see in the webshop) | | |

producer-specific

| | | | |
|---|--|-----------------|---------------------------------|
|  | | | |
| 1 | | | |
| GEV No. | 100890 | Ref. No. | 1314915 1706100 MA1314915 |
| description | pilot burner bracket suitable for 100 series | | |
| For models: | C7011G, C7011GFE, C7011GFG, C704G, C707G, C707GFE, C707GFG, C9F4G, C9F4GS, C9F6G, C9F6GS, C9F8G, C9F8GS, C95B4GS, C9V2G, C9V2GS, C9V4G, C9V4GS, C9V6G, C9V6GS, C9V8G, C9V8GS | | |


pilot burner nozzles

| | | | |
|---|---|-----------------|---------------------------------|
|  | | | |
| 1 | | | |
| GEV No. | 100245 | Ref. No. | 1415100 3020054 MA1415100 |
| description | pilot burner nozzle LPG code 20 bore ϕ 0.2mm Qty 1 pcs thread M8x0.75 | | |
| For models: | B95B2G, B95B4G, B9V2G, B9V4G, C7011G, C7011GFE, C7011GFG, C704G, C707G, C707GFE, C707GFG, C9F4G, C9F4GS, C9F6G, C9F6GS, C9F8G, C9F8GS, C95B4GS, C9V2G, C9V2GS, C9V4G, C9V4GS, C9V6G, C9V6GS, C9V8G, C9V8GS, EF74G15, F12C4G15, F74G10, F74G15, F76G10, F78G15, F94G10, F94G15, F94G22, F94G22K, F96G10, F98G15, F98G22, F98G22K, F954G15, F954G22, F954G22K, F958G15, F958G22, F958G22K, F95B2G, F95B2GR, F95B4G, F95B4GR...(Other models you can see in the webshop) | | |



| | | | |
|--------------------|---|-----------------|-----------|
| GEV No. | 100707 | Ref. No. | R63050010 |
| description | ignition electrode D1 ø 7mm D2 ø 9mm connection ø2.4mm L1 14mm L2 6mm BL1 18mm BL2 3mm BL3 23mm to clip Qty 1 pcs | | |
| For models: | FG105M, FG105X, FG110M, FG110X, FG210M, FG210X, PG040M, PG040X, PG080M, PG080X | | |

miscellaneous















| | | | |
|--------------------|--|-----------------|----------------------|
| GEV No. | 100885 | Ref. No. | 1324900 MA1324900 |
| description | air mixing sleeve for pilot burner Qty 1 pcs | | |
| For models: | C7011G, C7011GFE, C7011GFG, C704G, C707G, C707GFE, C707GFG, C9F4G, C9F4GS, C9F6G, C9F6GS, C9F8G, C9F8GS, C9SB4GS, C9V2G, C9V2GS, C9V4G, C9V4GS, C9V6G, C9V6GS, C9V8G, C9V8GS | | |

140 - 145 -150 series







| | | | |
|--|--|-----------------|--|
| GEV No. | 106943 ¹ | Ref. No. | 1887700 MA1887700 |
| description | pilot burner SIT type 140 series 1 flame nozzle 0mm gas connectionmm | | |
| For models: | B9SB2G, B9SB4G, B9V2G, B9V4G, B9VP4G, BM74G, BM77G, BR707G, BR707GI, BR94G, BR94GI, BR9M4G, BR9M4GI, BR9M6G, BR9M6GI, BR9SB4G, BR9SB4GI, C124G, C129G, C12C2G9, C12C9G, C12FG9G, C7011G, C7011GFE, C7011GFG, C704G, C707G, C707GFE, C707GFG, C712G, C74G, C78G, C7FE12G, C7FE8G, C7FG12G, C7FG8G, C7FG-M12G, C912G, C912GS, C94G, C94GP, C94GS, C98G, C98GP, C98GS, C9F4E, C9F4GS, C9F6E, C9F6GS, C9F8GS...(Other models you can see in the webshop) | | |
| spare parts for | 106943 | | |
|  | GEV No. | 100907 | Ref. No. |
| | | | 1891700 24010899 MA1891700 MA24010899 |
| | screw connection thread M10x1 Qty 1 pcs type SEF 1 ømm for thermocouple | | |



| | | | |
|---|--|-----------------|--|
| GEV No. | 107114 ¹ | Ref. No. | CM029000 MACM029000 |
| description | pilot burner SIT type 140 series 2 flames nozzle ømm gas connectionmm | | |
| For models: | B74G, B78G, B94G, B98G, BR78GF, BR78GI, BR912GFM, BR912GIM, BR98GF, BR98GFM, BR98GI, BR98GIM, BR9S8GF, BR9S8GI, C7FG9G, EFT74GLVG, EFT74GRVG, EFT78GLVG, EFT78GMVG, ET78GVG, ET-7FG8G, FT129GLC, FT129GM, FT12C9GL, FT12C9GM, FT12C9GTL, FT12C9GTMC, FT74GL, FT74GLC, FT74GR, FT74GRC, FT76GL, FT76GLC, FT76GM, FT76GMC, FT76GR, FT78GL, FT78GLC, FT78GLT, FT78GM, FT78GMC, FT78GMT, FT78GR, FT78GRT, FT94G, FT94GL, FT94GLC, FT-94GR, FT94GRC, FT96GL...(Other models you can see in the webshop) | | |
| spare parts for | 107114 | | |
|  | GEV No. | 100907 | Ref. No. |
| | | | 1891700 24010899 MA1891700 MA24010899 |
| | screw connection thread M10x1 Qty 1 pcs type SEF 1 ømm for thermocouple | | |
| accessories for | 107114 | | |
|  | GEV No. | 100204 | Ref. No. |
| | | | 1888000 MA1888000 |
| | pilot burner nozzle SIT LPG code 14 bore ø 0.18/0.20mm Qty 1 pcs suitable for 140 series | | |
|  | GEV No. | 100205 | Ref. No. |
| | | | 1033722000 BN822140380 MA1033722000 |
| | pilot burner nozzle SIT LPG code 19 bore ø 0.23/0.26mm Qty 1 pcs suitable for SIT 150 series | | |
|  | GEV No. | 100206 | Ref. No. |
| | | | — |
| | pilot burner nozzle SIT natural gas code 36 bore ø 0.60/0.55mm Qty 1 pcs suitable for SIT 150 series | | |
|  | GEV No. | 100207 | Ref. No. |
| | | | 1887800 MA1887800 |
| | pilot burner nozzle SIT natural gas code 27 bore ø 0.40/0.38mm suitable for SIT 140 series | | |
|  | GEV No. | 100216 | Ref. No. |
| | | | — |
| | pilot burner nozzle SIT natural gas code 38 bore ø 0.45mm Qty 1 pcs suitable for SIT 150 series | | |
|  | GEV No. | 100701 | Ref. No. |
| | | | 1888300 1949900 MA1888300 MA1949900 |
| | ignition electrode connection M4 Qty 1 pcs | | |
|  | GEV No. | 100801 | Ref. No. |
| | | | — |
| | gasket for pilot burner Qty 1 pcs | | |
|  | GEV No. | 100897 | Ref. No. |
| | | | 1881000 1888100 MA1888100 |
| | olive for pipe ø 4mm Qty 1 pcs for pilot burner | | |
|  | GEV No. | 100898 | Ref. No. |
| | | | — |
| | olive for pipe ø 6mm Qty 1 pcs for pilot burner | | |
|  | GEV No. | 100906 | Ref. No. |
| | | | 1888400 MA1888400 |
| | screw connection thread M10x1 for ignition electrode brass Qty 1 pcs WS 10 | | |

¹incl. thermocouple fitting
Table continues overleaf










| | | | | |
|---|---------|--------|----------|---|
| accessories for 107114 | | | | |
|  | GEV No. | 100908 | Ref. No. | 0100777 673500 MA673500 R0100777 SIR0100777 |
| union screw thread M10x1 for pipe ø 4mm Qty 1 pcs | | | | |
|  | GEV No. | 100909 | Ref. No. | — |
| union screw thread M10x1 for pipe ø 6mm Qty 1 pcs | | | | |
|  | GEV No. | 102110 | Ref. No. | 1413100 1413200 1682300 1876500 |
| pilot tube copper pipe ø 4mm thickness 1mm L 3000mm | | | | |
|  | GEV No. | 102111 | Ref. No. | 1690200 |
| pilot tube copper pipe ø 6mm thickness 1mm L 3000mm | | | | |








160 series



| | | | |
|--------------------|--|-----------------|------------------------|
| GEV No. | 100109 | Ref. No. | CM040800 MACM040800 |
| description | pilot burner SIT type 160 series 1 flame nozzle ømm gas connecti-onmm | | |
| For models: | BF78G, BF912G, BF912GH, BF98G, C12FGP9G, C7FG12G, C7FG8G, C7FGM12G, C9FG12G, C9FG16G, C9FG8G, C9FG8GP, C9FGM12G, EF74G8VA, EF74G8VG, EPC74G, FQG41, FQG61, NC7FG12G44, NC7FG8G32, NC7FG8G36, NC7FG8G48, NC7FGM12G, NC9FG12G52, NC9FG16G72, NC9FG8G32, NC9FG8G36, NC9FG8G48, NF74G10, NF74G15, NF74G8, NF76G10, NF76G8, NF78G15, NF94G15, NF94G23, NF94G23K, NF96G10, NF98G15, NF98G23, NF98G23K, NPC74G, NPC78G, NPC94G, NPC98G, NPD76G5, NPD78G8, NPD96G5, NPD98G10, NPD98G15...(Other models you can see in the webshop) | | |

| | | | | |
|---|---------|--------|----------|--|
| spare parts for 100109 | | | | |
|  | GEV No. | 100907 | Ref. No. | 1891700 24010899 MA1891700 MA24010899 |
| screw connection thread M10x1 Qty 1 pcs type SEF 1 ømm for thermocouple | | | | |

| | | | | |
|---|---------|--------|----------|--|
| accessories for 100109 | | | | |
|  | GEV No. | 100202 | Ref. No. | — |
| pilot burner nozzle natural gas code 41 Qty 1 pcs nozzle ø 0.41mm | | | | |
|  | GEV No. | 100203 | Ref. No. | — |
| pilot burner nozzle LPG code 25 Qty 1 pcs nozzle ø 0.25mm | | | | |
|  | GEV No. | 100701 | Ref. No. | 1888300 1949900 MA1888300 MA1949900 |
| ignition electrode connection M4 Qty 1 pcs | | | | |
|  | GEV No. | 100801 | Ref. No. | — |
| gasket for pilot burner Qty 1 pcs | | | | |
|  | GEV No. | 100869 | Ref. No. | — |
| pilot burner nozzle natural gas code 51 Qty 1 pcs suitable for 160 series nozzle ø 0.51mm | | | | |
|  | GEV No. | 100906 | Ref. No. | 1888400 MA1888400 |
| screw connection thread M10x1 for ignition electrode brass Qty 1 pcs WS 10 | | | | |

| | | | | |
|---|---------|--------|----------|---|
| accessories for 100109 | | | | |
|  | GEV No. | 100908 | Ref. No. | 0100777 673500 MA673500 R0100777 SIR0100777 |
| union screw thread M10x1 for pipe ø 4mm Qty 1 pcs | | | | |
|  | GEV No. | 100909 | Ref. No. | — |
| union screw thread M10x1 for pipe ø 6mm Qty 1 pcs | | | | |
|  | GEV No. | 101282 | Ref. No. | 469000 MA469000 |
| olive for pipe ø 4mm L 7.4mm Qty 1 pcs | | | | |
|  | GEV No. | 101287 | Ref. No. | — |
| olive for pipe ø 6mm Qty 1 pcs | | | | |
|  | GEV No. | 102110 | Ref. No. | 1413100 1413200 1682300 1876500 |
| pilot tube copper pipe ø 4mm thickness 1mm L 3000mm | | | | |
|  | GEV No. | 102111 | Ref. No. | 1690200 |
| pilot tube copper pipe ø 6mm thickness 1mm L 3000mm | | | | |
|  | GEV No. | 107650 | Ref. No. | 0100802 CR0410100 R0100802 SIR0100802 |
| pilot burner nozzle SIT LPG code 30 Qty 1 pcs | | | | |

190 series















| | | | | |
|---|--|-----------------|----------------------|--|
| GEV No. | 100110 | Ref. No. | 1949700 MA1949700 | |
| description | pilot burner SIT type 190 series 3 flames nozzle ømm gas connecti-onmm | | | |
| For models: | MM10IG, P9110G, P91A10G | | | |
| accessories for 100110 | | | | |
|  | GEV No. | 100202 | Ref. No. | — |
| pilot burner nozzle natural gas code 41 Qty 1 pcs nozzle ø 0.41mm | | | | |
|  | GEV No. | 100203 | Ref. No. | — |
| pilot burner nozzle LPG code 25 Qty 1 pcs nozzle ø 0.25mm | | | | |
|  | GEV No. | 100701 | Ref. No. | 1888300 1949900 MA1888300 MA1949900 |
| ignition electrode connection M4 Qty 1 pcs | | | | |
|  | GEV No. | 100906 | Ref. No. | 1888400 MA1888400 |
| screw connection thread M10x1 for ignition electrode brass Qty 1 pcs WS 10 | | | | |
|  | GEV No. | 100907 | Ref. No. | 1891700 24010899 MA1891700 MA24010899 |
| screw connection thread M10x1 Qty 1 pcs type SEF 1 ømm for thermocouple | | | | |

Table continues overleaf

| accessories for | | 100110 | |
|---|---------|--------|---|
|  | GEV No. | 100908 | Ref. No. |
| | | | 0100777 673500 MA673500 R0100777 SIR0100777 |
| union screw thread M10x1 for pipe ø 4mm Qty 1 pcs | | | |
|  | GEV No. | 100909 | Ref. No. |
| | | | — |
| union screw thread M10x1 for pipe ø 6mm Qty 1 pcs | | | |
|  | GEV No. | 101282 | Ref. No. |
| | | | 469000 MA469000 |
| olive for pipe ø 4mm L 7.4mm Qty 1 pcs | | | |
|  | GEV No. | 101287 | Ref. No. |
| | | | — |
| olive for pipe ø 6mm Qty 1 pcs | | | |
|  | GEV No. | 102110 | Ref. No. |
| | | | 1413100 1413200 1682300 1876500 |
| pilot tube copper pipe ø 4mm thickness 1mm L 3000mm | | | |
|  | GEV No. | 102111 | Ref. No. |
| | | | 1690200 |
| pilot tube copper pipe ø 6mm thickness 1mm L 3000mm | | | |
|  | GEV No. | 107650 | Ref. No. |
| | | | 0100802 CR0410100 R0100802 SIR0100802 |
| pilot burner nozzle SIT LPG code 30 Qty 1 pcs | | | |




JUNKERS

CB 505 series

pilot burners



1

| | | | |
|---|--|-----------------|--|
| GEV No. | 100073 | Ref. No. | 1031027800 411111 509900 578800 MA509900 |
| description | pilot burner JUNKERS type CB505018 3 flames natural gas nozzle no.9 gas connection 6mm with primary air | | |
| For models: | 704, 704S, 706, 706AS, 706S, BIG40, BIG60, BMG40, BMG60, BR707G, BR94G, BR94GI, BR96G, BR96GI, BR9M4G, BR9M4GI, BR9M6G, BR9M6GI, BRG40, BRG40G, CP707G, CP92G, CP94G, CS10, CS102G, CS102GP, CS6, FC10G, FC20G, FCSG, FC7G, FQG40, FQG60, FR15G, FR15G2, FR2G, FR2G15, FR4G, FR4G15, FR74G, FR77G, FR92G22, FR94G23, FT74G, FT74GR, FT77G, FT77GRL, FTG40B, FTG40BLC, FTG-40BR...(Other models you can see in the webshop) | | |
| spare parts for | 100073 | | |
|  | GEV No. | 100231 | Ref. No. |
| | | | — |
| pilot burner nozzle natural gas gas pressure 25mbar code 4 Qty 1 pcs suitable for JUNKERS CB5050_ | | | |
|  | GEV No. | 100703 | Ref. No. |
| | | | 1031025700 638700 |
| ignition electrode D1 ø 9mm connection M4 D2 ø 11mm L1 8mm BL1 13mm BL2 4mm BL3 22mm to clip | | | |
|  | GEV No. | 100907 | Ref. No. |
| | | | 1891700 24010899 MA1891700 MA24010899 |
| screw connection thread M10x1 Qty 1 pcs type SEF 1 ømm for thermocouple | | | |

| spare parts for | | 100073 | |
|--|---------|--------|--------------------|
|  | GEV No. | 101282 | Ref. No. |
| | | | 469000 MA469000 |
| olive for pipe ø 4mm L 7.4mm Qty 1 pcs | | | |
|  | GEV No. | 101283 | Ref. No. |
| | | | 468800 MA468800 |
| union screw thread M10x1 for pipe ø 4mm Qty 1 pcs | | | |
|  | GEV No. | 101292 | Ref. No. |
| | | | 636600 MA636600 |
| union screw for igniter suitable for CB 502/505 Qty 1 pcs | | | |
| accessories for | | 100073 | |
|  | GEV No. | 100217 | Ref. No. |
| | | | — |
| pilot burner nozzle LPG gas pressure 30mbar code 3 Qty 1 pcs suitable for JUNKERS CB5050_ | | | |
|  | GEV No. | 100230 | Ref. No. |
| | | | 932900 MA932900 |
| pilot burner nozzle LPG gas pressure 50mbar code 2 Qty 1 pcs suitable for JUNKERS CB5050_ | | | |
|  | GEV No. | 100232 | Ref. No. |
| | | | — |
| pilot burner nozzle natural gas gas pressure 25mbar code 9 Qty 1 pcs suitable for JUNKERS CB5050_ | | | |
|  | GEV No. | 100233 | Ref. No. |
| | | | — |
| pilot burner nozzle LPG gas pressure 50mbar code 8 Qty 1 pcs suitable for JUNKERS CB5050_ | | | |
|  | GEV No. | 100234 | Ref. No. |
| | | | — |
| pilot burner nozzle natural gas gas pressure 20mbar code 14 Qty 1 pcs suitable for JUNKERS CB5050_ | | | |
|  | GEV No. | 100909 | Ref. No. |
| | | | — |
| union screw thread M10x1 for pipe ø 6mm Qty 1 pcs | | | |
|  | GEV No. | 101288 | Ref. No. |
| | | | — |
| olive for pipe ø 6mm L 6mm aluminium Qty 1 pcs ED ø 8.5mm | | | |

producer-specific pilot burners

MARENO

700 series



1






| | | | |
|---|--------------|-----------------|--------------------|
| GEV No. | 100089 | Ref. No. | 432600 |
| description | pilot burner | | |
| accessories for | 100089 | | |
|  | GEV No. | 100217 | Ref. No. |
| | | | — |
| pilot burner nozzle LPG gas pressure 30mbar code 3 Qty 1 pcs suitable for JUNKERS CB5050_ | | | |
|  | GEV No. | 100230 | Ref. No. |
| | | | 932900 MA932900 |
| pilot burner nozzle LPG gas pressure 50mbar code 2 Qty 1 pcs suitable for JUNKERS CB5050_ | | | |
|  | GEV No. | 100231 | Ref. No. |
| | | | — |
| pilot burner nozzle natural gas gas pressure 25mbar code 4 Qty 1 pcs suitable for JUNKERS CB5050_ | | | |
|  | GEV No. | 100232 | Ref. No. |
| | | | — |
| pilot burner nozzle natural gas gas pressure 25mbar code 9 Qty 1 pcs suitable for JUNKERS CB5050_ | | | |




Table continues overleaf




| | |
|---|---|
| accessories for 100089 | |
|  | GEV No. 100233 Ref. No. — pilot burner nozzle LPG gas pressure 50mbar code 8 Qty 1 pcs suitable for JUNKERS CB5050_ |
|  | GEV No. 100234 Ref. No. — pilot burner nozzle natural gas gas pressure 20mbar code 14 Qty 1 pcs suitable for JUNKERS CB5050_ |
|  | GEV No. 100909 Ref. No. — union screw thread M10x1 for pipe ø 6mm Qty 1 pcs |
|  | GEV No. 101282 Ref. No. 469000 MA469000 olive for pipe ø 4mm L 7.4mm Qty 1 pcs |
|  | GEV No. 101283 Ref. No. 468800 MA468800 union screw thread M10x1 for pipe ø 4mm Qty 1 pcs |
|  | GEV No. 101288 Ref. No. — olive for pipe ø 6mm L 6mm aluminium Qty 1 pcs ED ø 8.5mm |

Snack 600 / Protagonista 70 / Easy series

| | |
|---|--|
|  | |
| GEV No. 100082 | Ref. No. N/A |
| description pilot burner | |
| accessories for 100082 | |
|  | GEV No. 100202 Ref. No. — pilot burner nozzle natural gas code 41 Qty 1 pcs nozzle ø 0.41mm |
|  | GEV No. 100203 Ref. No. — pilot burner nozzle LPG code 25 Qty 1 pcs nozzle ø 0.25mm |
|  | GEV No. 100834 Ref. No. — pilot burner cap |
|  | GEV No. 100908 Ref. No. 0100777 673500 MA673500 R0100777 SIR0100777 union screw thread M10x1 for pipe ø 4mm Qty 1 pcs |
|  | GEV No. 100909 Ref. No. — union screw thread M10x1 for pipe ø 6mm Qty 1 pcs |
|  | GEV No. 101282 Ref. No. 469000 MA469000 olive for pipe ø 4mm L 7.4mm Qty 1 pcs |
|  | GEV No. 101287 Ref. No. — olive for pipe ø 6mm Qty 1 pcs |
|  | GEV No. 101860 Ref. No. — nut thread M10x1 H 4mm WS 14 chrome-plated brass Qty 1 pcs |
|  | GEV No. 107650 Ref. No. 0100802 CR0410100 R0100802 SIR0100802 pilot burner nozzle SIT LPG code 30 Qty 1 pcs |


| | |
|---|---|
|  | |
| GEV No. 102979 | Ref. No. 1032501300 MA1032501300 |
| description pilot burner suitable for MARENO | |
| For models: C74GS, C78GS, C79G, C7FE12GS, C7FE8GS, C7FG12GS, C7FG8GS, C7FG9G, CFG101, CFG70, CFG70M, CFGE61, CFGE61D, CFGE61L, CFGE61P, EC74GVG, EC78GVG, EC7FG8G, OCFG101, OCFG70, OCFG61, OPCG41, OPCG61, PCG41, PCG41L, PCG61, PCG61L | |
| accessories for 102979 | |
|  | GEV No. 101860 Ref. No. — nut thread M10x1 H 4mm WS 14 chrome-plated brass Qty 1 pcs |
|  | GEV No. 102980 Ref. No. 1033717300 1033717300R MA1033717300 pilot burner mushroom cap with mounting thread |

NP70 / NP90 series

| | |
|--|---------------------------|
|  | |
| GEV No. 103074 | Ref. No. CR0586451 |
| description venturi for burner cap ø 102mm with pilot burner suitable for 900 series | |
| For models: NC912G44, NC94G16, NC94G20, NC98G28, NC98G40, NC9FE12G44, NC9FE8G28, NC9FG12G52, NC9FG16G72, NC9FG8G32, NC9FG8G36, NC9FG8G48, NC9FGM12G, NT9FG12G | |

| | |
|--|---|
|  | |
| GEV No. 107422 | Ref. No. CR0586441 |
| description venturi for burner cap ø 64mm with pilot burner suitable for 900 series | |
| For models: NC712G36, NC74G12, NC78G24, NC7FE12G36, NC7FE8G24, NC7FG12G44, NC7FG8G32, NC7FGM12G, NC912G44, NC94G16, NC94G20, NC98G28, NC98G40, NC9FE12G44, NC9FE8G28, NC9FG12G52, NC9FG16G72, NC9FG8G32, NC9FG8G36, NC9FG8G48, NC9FGM12G, NS78GS, NS7FG12GS, NT7FG12G, NT9FG12G | |
| accessories for 107422 | |
|  | GEV No. 103071 Ref. No. CR0580010 burner cap ø 64mm H 26mm suitable for 900 series |
|  | GEV No. 103072 Ref. No. CR0580030 burner head for burner cap ø 64mm H 37mm suitable for 900 series |
|  | GEV No. 103075 Ref. No. CR0581700 nozzle holder ø 34mm H 150mm suitable for 900 series |

Table continues overleaf

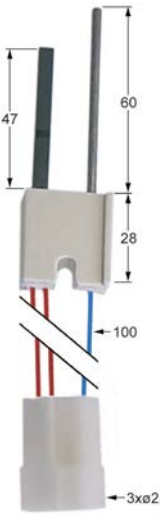
| | | | | | |
|---|--|----------|--|----------|--|
| accessories for 107422 | | | | | |
|  | <table border="1"> <tr> <td>GEV No.</td> <td>103083</td> <td>Ref. No.</td> <td>8204760 R8204760 S18204760 SIR8204760</td> </tr> </table> | GEV No. | 103083 | Ref. No. | 8204760 R8204760 S18204760 SIR8204760 |
| GEV No. | 103083 | Ref. No. | 8204760 R8204760 S18204760 SIR8204760 | | |
| gasket L 77mm W 69mm thickness 2mm graphite for Venturi suitable for 900 series | | | | | |

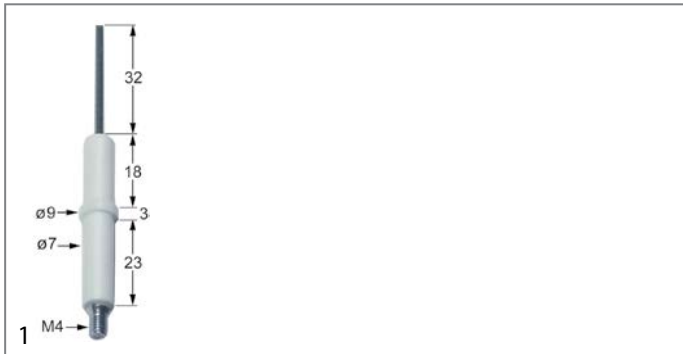
accessories universal


covers

| | | | |
|---|--|-----------------|------------------------|
|  | | | |
| 1 | | | |
| GEV No. | 107883 | Ref. No. | CM060801 MACM060801 |
| description | cover for pilot burner for gas range suitable for LAINOX | | |
| For models: | C124G, C129G, C12C2G9, C12C9G, C12FG9G, C712G, C74G, C78G, C7FE12G, C7FE8G, C7FG12G, C7FG8G, C7FGM12G, C912G, C912GS, C94G, C94GP, C94GS, C98G, C98GP, C98GS, C9FE12G, C9FE12GS, C9FE8G, C9FE8GS, C9FG12G, C9FG12GS, C9FG16G, C9FG8G, C9FG8GP, C9FG8GS, C9FGM12G | | |

electrodes

| | | | |
|---|--|-----------------|-----------|
|  | | | |
| 1 | | | |
| GEV No. | 100730 | Ref. No. | R63050040 |
| description | glow plug cable length 100mm connection ø2.4mm L1 47mm L2 60mm | | |
| For models: | CVG105H, CVG105M, MG106M, MG106P, MG106X, MG110M, MG110X, MG120M, MG120P, MG120X, MG210M, MG210P, MG210X, MG220M, MG220P, MG220X, MGC20X, MGC24H, MGC40H, VG105M, VG105X, VG106M, VG106P, VG106X, VG110M, VG110P, VG110X, VG120M, VG120P, VG120X, VG210M, VG210P, VG210X, VG220M, VG220P, VG220X | | |



| | | | |
|---|---|-----------------|--|
| GEV No. | 100701 | Ref. No. | 1888300 1949900 MA1888300 MA1949900 |
| description | ignition electrode connection M4 Qty 1 pcs | | |
| For models: | B74G, B78G, B94G, B98G, B9SB2G, B9SB4G, B9V2G, B9V4G, B9VP4G, BF78G, BF912G, BF912GH, BF98G, BM74G, BM77G, BR707G, BR707GI, BR78GF, BR78GI, BR912GFM, BR912GIM, BR94G, BR94GI, BR98GF, BR98GFM, BR98GI, BR98GIM, BR9M4G, BR9M4GI, BR9M6G, BR9M6GI, BR9S8GF, BR9S8GI, BR9SB4G, BR9SB4GI, C124G, C129G, C12C2G9, C12C9G, C12FG9G, C12FGP9G, C7011G, C7011GFE, C7011GFG, C704G, C707G, C707GFE, C707GFG, C712G, C74G...(Other models you can see in the webshop) | | |
| accessories for | 100701 | | |
|  | GEV No. | 100906 | Ref. No. 1888400 MA1888400 |
| | screw connection thread M10x1 for ignition electrode brass Qty 1 pcs WS 10 | | |



| | | | |
|--------------------|--|-----------------|--|
| GEV No. | 100706 | Ref. No. | 1031502500 224211 636700 MA224211 MA636700 |
| description | ignition electrode connection M4 Qty 1 pcs | | |
| For models: | 702BMG, 706, 706S, B9SB2G, B9SB4G, B9V2G, B9V4G, BIG40, BIG60, BMG40, BMG60, BR707G, BR94G, BR94GI, BR96G, BR96GI, BR9M4G, BR9M4GI, BR9M6G, BR9M6GI, BRG40, BRG40G, C7011GFE, C7011GFG, C707GFE, C707GFG, C9F4G, C9F4GS, C9F6G, C9F6GS, C9F8G, C9F8GS, CFG101, CFG101D, CFG101L, CFG101P, CFG120, CFG70, CFG70D, CFG70L, CFG70M, CFG70P, CP707G, CP92G, CP94G, CS10, CS102G, CS102GP, CS6, EC74GVG...(Other models you can see in the webshop) | | |



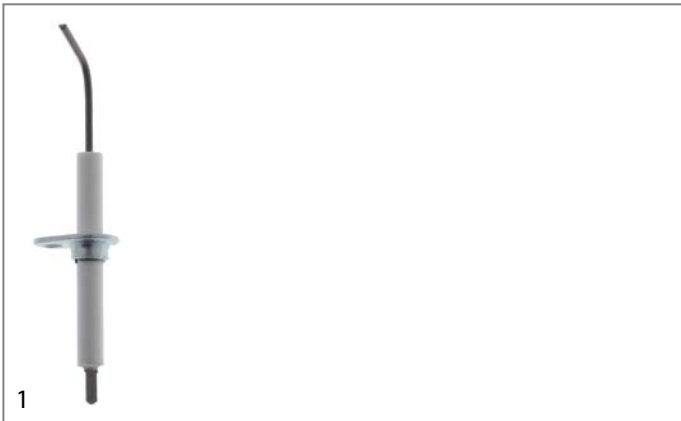
| | | | |
|--------------------|---|-----------------|-----------|
| GEV No. | 102314 | Ref. No. | CR0687080 |
| description | ignition electrode D1 ø 7mm D2 ø 9mm connection M4 L1 2mm BL1 28mm BL2 3mm BL3 23mm to clip | | |
| For models: | NC712G36, NC74G12, NC78G24, NC7FE12G36, NC7FE8G24, NC7FG12G44, NC7FG8G32, NC7FGM12G, NC912G44, NC94G16, NC94G20, NC98G28, NC98G40, NC9FE12G44, NC9FE8G28, NC9FG12G52, NC9FG16G72, NC9FG8G32, NC9FG8G36, NC9FG8G48, NC9FGM12G, NS78GS, NS7FG12GS, NT7FG12G, NT9FG12G | | |

| | | | |
|--------------------|---|-----------------|-----------|
| GEV No. | 100707 | Ref. No. | R63050010 |
| description | ignition electrode D1 ø 7mm D2 ø 9mm connection ø2.4mm L1 14mm L2 6mm BL1 18mm BL2 3mm BL3 23mm to clip Qty 1 pcs | | |
| For models: | FG105M, FG105X, FG110M, FG110X, FG210M, FG210X, PG040M, PG040X, PG080M, PG080X | | |

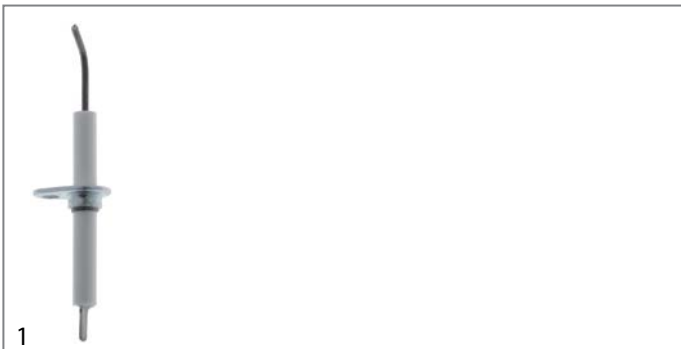
| | | | |
|--------------------|--|-----------------|----------------------|
| GEV No. | 100703 | Ref. No. | 1031025700 638700 |
| description | ignition electrode D1 ø 9mm connection M4 D2 ø 11mm L1 8mm BL1 13mm BL2 4mm BL3 22mm to clip | | |

| | | | |
|--------------------|---|-----------------|------------------------|
| GEV No. | 104687 | Ref. No. | R63050080 R63050090 |
| description | ignition electrode flange length 17mm flange width 24mm D1 ø 9.5mm D2 ø 9.5mm L1 49mm BL1 64mm BL2 52mm connection male faston 2.8mm fixing dimensions 4.5mm flange | | |
| For models: | MG102M, MG102P, MG102T, MG201M, MG201P | | |

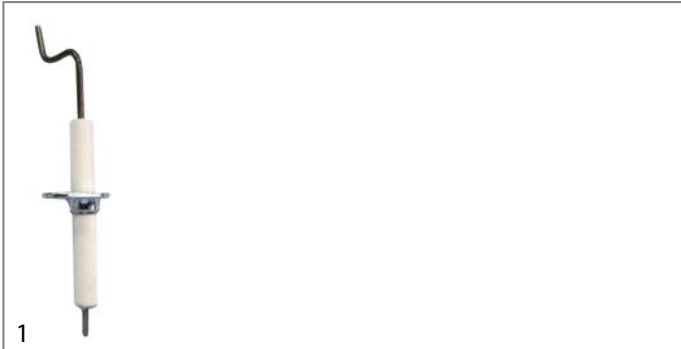
| | | | |
|--------------------|--|-----------------|-----------|
| GEV No. | 104695 | Ref. No. | R63050310 |
| description | ignition electrode flange length 23mm flange width 15mm D1 ø 7mm D2 ø 7mm L1 13mm L2 19mm L3 13mm BL1 31mm BL2 24mm connection M4 fixing dimensions 4x5mm flange | | |
| For models: | GC106M, GM106H, GM106M, GM106M+SC, GM106P, GV106H, GV106M, GV106M+SC, GV106P | | |



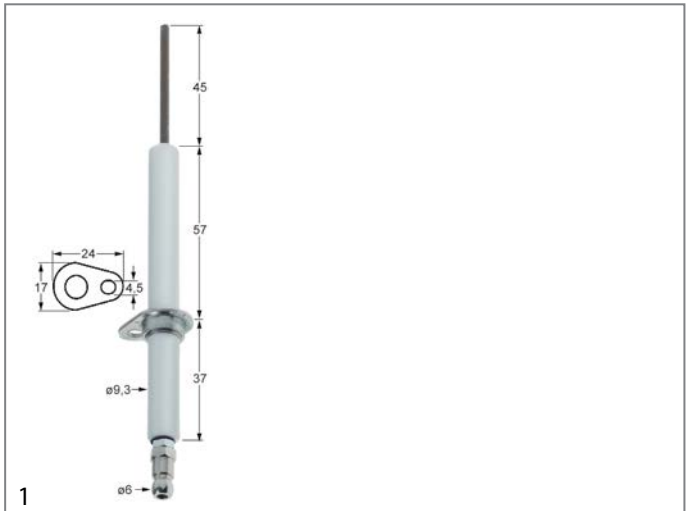
| | | | |
|--------------------|--|-----------------|-----------|
| GEV No. | 104686 | Ref. No. | R63050340 |
| description | ignition electrode flange length 23mm flange width 15mm D1 ø 7mm D2 ø 7mm L1 20mm L2 15mm BL1 22mm BL2 4mm BL3 28mm connection male faston 2.8mm | | |
| For models: | GC110M, GC210M, GM110H, GM110M, GM110M+SC, GM110P, GM210H, GM210M, GM210M+SC, GM210P, GV110H, GV110M, GV110M+SC, GV110P, GV210H, GV210M, GV210M+SC, GV210P | | |



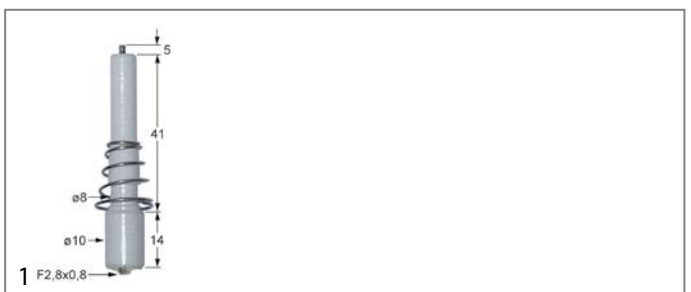
| | | | |
|--------------------|--|-----------------|-----------|
| GEV No. | 104685 | Ref. No. | R63050300 |
| description | ignition electrode flange length 23mm flange width 15mm D1 ø 7mm L1 15mm L2 12mm BL1 22mm BL2 31mm connection male faston 2.8mm fixing dimensions ø4mm with flange | | |
| For models: | GC106M, GM106H, GM106M, GM106M+SC, GM106P, GV106H, GV106M, GV106M+SC, GV106P | | |



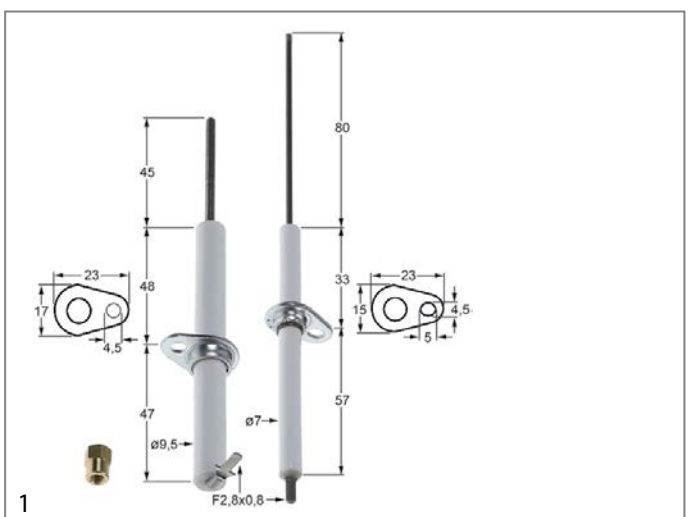
| | | | |
|--------------------|--|-----------------|-----------|
| GEV No. | 104451 | Ref. No. | R63050350 |
| description | ignition electrode flange length 23mm flange width 15mm D1 ø 7mm L1 25mm L2 14mm L4 15mm BL1 22mm BL2 34mm | | |
| For models: | GC110M, GC210M, GM110H, GM110M, GM110M+SC, GM110P, GM210H, GM210M, GM210M+SC, GM210P, GV110H, GV110M, GV110M+SC, GV110P, GV210H, GV210M, GV210M+SC, GV210P | | |



| | | | |
|--------------------|---|-----------------|-------------|
| GEV No. | 106756 | Ref. No. | LAR63050130 |
| description | ignition electrode flange length 24mm flange width 17mm D1 ø 9.3mm L1 45mm BL1 57mm BL2 37mm connection ø6 fixing dimensions ø4.5mm A1/B13/C2 | | |



| | | | |
|--------------------|---|-----------------|----------------------------|
| GEV No. | 100729 | Ref. No. | 1031025600 MA1031025600 |
| description | ignition electrode L1 5mm D1 ø 8mm D2 ø 10mm BL1 41mm BL2 14mm connection F 2.8x0.8mm to clip with spring | | |



| | | | |
|--------------------|---|-----------------|-----------|
| GEV No. | 106525 | Ref. No. | R63050070 |
| description | ignition electrode set Qty 2 flange length 23mm flange width 15/17mm D1 ø 7/9.5mm L1 80/45mm BL1 33/48mm BL2 57/47mm connection F2.8x0.8 fixing dimensions ø4.5mm | | |
| For models: | MACG05M, MACG07M, MG061D, MG061M, MG061P, MG061T, MG101M, MG101P, MG101T, MG201T, MVG051P | | |



| | | | |
|--------------------|--|-----------------|-----------|
| GEV No. | 106647 | Ref. No. | R63050100 |
| description | ignition electrode set flange length 24mm flange width 17mm D1 ø 9.5mm L1 45mm BL1 48mm BL2 48mm connection male faston 2.8mm with screw connection 1x ignition 1x flame monitoring | | |
| For models: | GMT06D, GMT20D, GVT06D, GVT20D, MACG10M, MACG20M, MG101D, MG101M, MG101P, MG102D, MG102M, MG102P, MG102T, MG201D, MG201M, MG201P, MG201T, MG202D, MG202M, MG202P, MG202T, MGMT06D, MGMT06P, MGMT10D, MGMT10P, MGMT20D, MGMT20P, MGMT21D, MGMT21P, MGMT40D, MGMT40P, MGVT06D, MGVT06P, MGVT10D, MGVT10P, MGVT20D, MGVT20P, MGVT21D, MGVT21P, MGVT40D, MGVT40P | | |

| | | | |
|--------------------|--|-----------------|----------------------|
| GEV No. | 100906 | Ref. No. | 1888400 MA1888400 |
| description | screw connection thread M10x1 for ignition electrode brass Qty 1 pcs WS 10 | | |
| For models: | B74G, B78G, B94G, B98G, B9SB2G, B9SB4G, B9V2G, B9V4G, B9VP4G, BF78G, BF912G, BF912GH, BF98G, BM74G, BM77G, BR707G, BR707GI, BR78GF, BR78GI, BR912GFM, BR912GIM, BR94G, BR94GI, BR98GF, BR98GFM, BR98GI, BR98GIM, BR9M4G, BR9M4GI, BR9M6G, BR9M6GI, BR9S8GF, BR9S8GI, BR9SB4G, BR9SB4GI, C124G, C129G, C12C2G9, C12C9G, C12FG9G, C12FGP9G, C7011G, C7011GF, C7011GFG, C704G, C707G, C707GFE, C707GFG, C712G, C74G...(Other models you can see in the webshop) | | |

ignition cables

terminals and connectors

| | | | |
|--------------------|--|-----------------|------------|
| GEV No. | 100023 | Ref. No. | MA20418099 |
| description | female bullet size 2.3mm 0.5-1.5mm ² CuZn t.max. 125°C Qty 20 pcs | | |

pre-assembled cables

| | | | |
|--------------------|---|-----------------|---------------------|
| GEV No. | 100026 | Ref. No. | 548300 BN2532997 |
| description | ignition cable cable length 1000mm connection ø4mm / F6.3mm | | |

| | | | |
|--------------------|---|-----------------|---------|
| GEV No. | 102157 | Ref. No. | 1152900 |
| description | ignition cable cable length 1200mm connection F2.8mm / lug M4 | | |
| For models: | P9D10G, P9D15G, P9DA10G, P9DA15G, P9I10G, P9IA10G | | |


| | | | |
|--------------------|---|-----------------|-----------|
| GEV No. | 100179 | Ref. No. | R66600400 |
| description | ignition cable cable length 1200mm connection F2.8mm / ø2.4mm | | |
| For models: | FG105M, FG105X, PG040M, PG040X | | |

| | | | |
|--------------------|--|-----------------|---------------------------------|
| GEV No. | 100195 | Ref. No. | 1950312 1950324 MA1950324 |
| description | ignition cable cable length 1200mm connection ø2.4mm / lug M4 | | |
| For models: | BF78G, BF912G, BF912GH, BF98G, C124G, C129G, C12C2G9, C12C9G, C12FG9G, C7011G, C7011GFE, C7011GFG, C704G, C707G, C707GFE, C707GFG, C712G, C74G, C78G, C7FE12G, C7FE8G, C7FG12G, C7FG8G, C7FG9G, C7FGM12G, C912G, C912GS, C94G, C94GP, C94GS, C98G, C98GP, C98GS, C9F4GS, C9F6GS, C9F8GS, C9FE12G, C9FE12GS, C9FE4GS, C9FE6GS, C9FE8G, C9FE8GS, C9FEP4GS, C9FEP6GS, C9FEP8GS, C9FG12G, C9FG12GS, C9FG16G, C9FG8G, C9FG8GP.. (Other models you can see in the webshop) | | |


| | | | |
|--------------------|---|-----------------|-----------|
| GEV No. | 102163 | Ref. No. | R66600410 |
| description | ignition cable cable length 1500mm connection F2.8mm / ø2.4mm | | |
| For models: | FG110M, FG110X, FG210M, FG210X, PG080M, PG080X | | |

| | | | |
|--------------------|--|-----------------|-----------|
| GEV No. | 102189 | Ref. No. | CR0508710 |
| description | ignition cable cable length 300mm connection ø2.4mm / lug M4 | | |
| For models: | FQG41, FQG61, OFQG41, OFQG61 | | |


| | | | |
|--------------------|---|-----------------|-----------|
| GEV No. | 107851 | Ref. No. | R66110370 |
| description | ignition cable cable length 300mm set 2-piece | | |
| For models: | MACG05M, MACG07M, MACG10M, MACG20M, MG061D, MG061M, MG061P, MG061T, MG101D, MG101M, MG101P, MG101T, MG201D, MG201M, MG201P, MG201T, MVG051P | | |




| | | | |
|--------------------|--|-----------------|----------------------------|
| GEV No. | 100196 | Ref. No. | 1047024200 MA1047024200 |
| description | ignition cable cable length 400mm connection F2.8mm / ø2.4mm | | |




| | | | |
|--------------------|--|-----------------|----------------------------|
| GEV No. | 100036 | Ref. No. | 1047102900 MA1047102900 |
| description | ignition cable cable length 500mm connection F2.8mm / F2.8mm | | |




| | | | |
|--------------------|--|-----------------|---|
| GEV No. | 100197 | Ref. No. | 1047024300 BN8220191 MA1047024300 |
| description | ignition cable cable length 600mm connection F2.8mm / ø2.4mm | | |




| | | | |
|--------------------|--|-----------------|--|
| GEV No. | 100186 | Ref. No. | 1047024400 1936300 MA1047024400 MA1936300 |
| description | ignition cable cable length 600mm connection ø2.4mm / lug M4 | | |
| For models: | B74G, B78G, B94G, B98G, B9SB2G, B9SB4G, B9V2G, B9V4G, BIG40, BIG60, BM74G, BM77G, BMG40, BMG60, BR707G, BR707GI, BR912G-FM, BR912GIM, BR98GF, BR98GFM, BR98GI, BR98GIM, BRG40, BRG40G, CP704G, EF74G15, EF74G8VA, EF74G8VG, EFT74GLVG, EFT74GRVG, EFT78GLVG, EFT78GMVG, EPC74G, F12C4G15, F74G10, F74G15, F74G6, F76G10, F78G15, F94G10, F94G15, F94G22, F94G22K, F94G6, F96G10, F98G15, F98G22, F98G22K, F954G15, F954G22...(Other models you can see in the webshop) | | |




| | | | |
|--------------------|---|-----------------|--|
| GEV No. | 100199 | Ref. No. | 1088300 1088600 1088900 1152700 1152800 MA1152800 |
| description | ignition cable cable length 600mm connection ø4mm / F2.8mm | | |
| For models: | B9SB2G, B9V2G, BR94G, BR94GI, BR96G, BR96GI, BR9M4G, BR9M4GI, BR9M6G, BR9M6GI, CP92G, CP94G, F9SB2G, F9SB2GR, F9SB4G, F9SB-4GR, F9SB4GRL, F9V2G, F9V2GR, F9V4G, F9V4GR, F9V4GRL, FR74G, FR77G, FR92G22, FR94G23, FT74G, FT74GR, FT77G, FT77GRL, GB707G, P9D2G, T7011GFG, T707G, T707GFG | | |




| | | | |
|--------------------|--|-----------------|--|
| GEV No. | 100025 | Ref. No. | 1394600 671300 671400 671500 672400 MA1394600 |
| description | ignition cable cable length 600mm connection ø4mm / F6.3mm | | |
| For models: | FR92G13, FR94G13 | | |



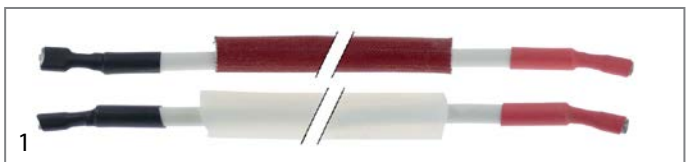
| | | | |
|--------------------|--|-----------------|------------|
| GEV No. | 100037 | Ref. No. | 1047103000 |
| description | ignition cable cable length 900mm connection F2.8mm / F2.8mm | | |



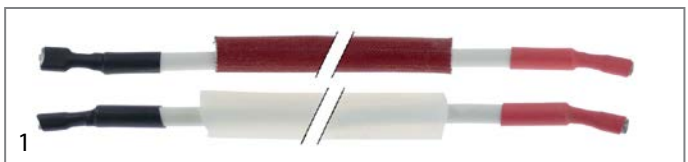
| | | | |
|--------------------|---|-----------------|---|
| GEV No. | 100019 | Ref. No. | 1047024600 1936400 1950300 BN4185326050610 CR0688770 MA1936400 |
| description | ignition cable cable length 900mm connection ø2.4mm / ø4mm | | |
| For models: | B9SB2G, B9SB4G, B9V2G, B9V4G, B9VP4G, BF78G, BF912G, BF912GH, BF98G, BR78GF, BR78GI, BR912GFM, BR912GIM, BR98GF, BR98GFM, BR98GI, BR98GIM, BR9S8GF, BR9S8GI, C12FGP9G, C7FG12G, C7FG8G, C9F4E, C9F4GS, C9F6E, C9F6GS, C9F8GS, C9FE4GS, C9FE6GS, C9FE8GS, C9FG12G, C9FG16G, C9FG8G, C9FG8GP, C9FGM12G, C9FP, C9FP4GS, C9FP6GS, C9FP8GS, C9V2GS, C9V4GS, C9V6GS, C9V8GS, CP92G, CP94G, CP9SB2G, CP9SB4G, ET78GVG, ET7FG8G, FT129GLC...(Other models you can see in the webshop) | | |



| | | | |
|--------------------|--|-----------------|------------------------------------|
| GEV No. | 102155 | Ref. No. | 1152600 SI9303074 SIR9303074 |
| description | ignition cable cable length 900mm connection ø4mm / F2.8mm | | |
| For models: | B9SB4G, B9V4G, C9F4G, C9F4GS, C9F6G, C9F6GS, C9F8G, C9F8GS, T9F4G, T9F6GS, T9SB4G, T9V4G, T9V6GS | | |



| | | | |
|--------------------|--|-----------------|-----------|
| GEV No. | 107853 | Ref. No. | R66605900 |
| description | ignition cable for combi-steamer set 2-piece L 800mm | | |
| For models: | GC106M, GC110M, GC210M, GM106H, GM106M, GM106M+SC, GM106P, GM110H, GM110M, GM110M+SC, GM110P, GM210H, GM210M, GM210M+SC, GM210P, GV106H, GV106M, GV106M+SC, GV106P, GV110H, GV110M, GV110M+SC, GV110P, GV210H, GV210M, GV210M+SC, GV210P | | |




| | | | |
|--------------------|------------------------------------|-----------------|-----------|
| GEV No. | 107855 | Ref. No. | R66110380 |
| description | ignition cable set 2-piece L 700mm | | |
| For models: | MG102M, MG102P, MG102T | | |




piezoelectric igniters

mounting diameter 18mm






1


| | | | |
|--------------------|--|-----------------|--|
| GEV No. | 100003 | Ref. No. | 1936100 986000 MA1936100 MA986000 |
| description | piezoelectric igniter body metal blowing mounting ø 18mm connection F2.8x0.8 | | |
| For models: | 702BMG, 706, 706S, B74G, B78G, B94G, B98G, B9SB2G, B9SB4G, B9V2G, B9V4G, B9VP4G, BF78G, BF912G, BF912GH, BF98G, BIG40, BIG60, BM74G, BM77G, BMG40, BMG60, BR707G, BR707GI, BR78GF, BR78GI, BR912GFM, BR912GIM, BR98GF, BR98GFM, BR98GI, BR98GIM, BR9S8GF, BR9S8GI, BRG40, BRG40G, C124G, C129G, C12C2G9, C12C9G, C12FG9G, C12FGP9G, C7011G, C7011GF, C7011GFG, C704G, C707G, C707GFE, C707GFG, C712G...(Other models you can see in the webshop) | | |




1

| | | | |
|---|--|-----------------|--|
| GEV No. | 100009 | Ref. No. | 1906100 BN6A041105 MA1906100 |
| description | piezoelectric igniter body plastic blowing mounting ø 18mm connection ø2.4mm front measurements 26mm M18x1.5 | | |
| accessories for | 100009 | | |
|  | GEV No. | 101339 | Ref. No. — |
| | cover cap for piezoelectric igniter | | |
|  | GEV No. | 106869 | Ref. No. CM136000 MACM136000 |
| | cover cap for piezoelectric igniter ID ø 22mm ED ø 35mm H 25mm | | |
|  | GEV No. | 107931 | Ref. No. — |
| | cover cap for piezoelectric igniter ID ø 21mm ED ø 36mm | | |


mounting diameter 22mm



1

| | | | |
|---|---|-----------------|----------------------------|
| GEV No. | 100013 | Ref. No. | 1031500600 |
| description | piezoelectric igniter body plastic blowing mounting ø 22mm connection ø2.4mm cable lengthmm | | |
| accessories for | 100013 | | |
|  | GEV No. | 100023 | Ref. No. MA20418099 |
| | female bullet size 2.3mm 0.5-1.5mm ² CuZn t.max. 125°C Qty 20 pcs | | |


miscellaneous




1

| | | | |
|--------------------|---|-----------------|--------|
| GEV No. | nla ¹ | Ref. No. | 224311 |
| description | piezoelectric igniter body metal connection F6.3x0.8 2 hole fixing ø 22mm | | |
| For models: | 702BMG, 706, 706S, TPF706, TPF706S | | |

¹no longer available




1

| | | | |
|--|---|-----------------|----------------------------------|
| GEV No. | nla ¹ | Ref. No. | 1393700 24020299 MA1393700 |
| description | piezoelectric igniter suitable for Minisit with cover cap ømm connection F6.3x0.8 | | |
| For models: | FR92G13, FR94G13 | | |
| spare parts for | 101136 | | |
|  | GEV No. | 100001 | Ref. No. — |
| | piezoelectric igniter suitable for Minisit connection F6.3x0.8 ømm | | |


¹no longer available

accessories



1


| | | | |
|--------------------|--|-----------------|------------------------|
| GEV No. | 106869 | Ref. No. | CM136000 MACM136000 |
| description | cover cap for piezoelectric igniter ID ø 22mm ED ø 35mm H 25mm | | |
| For models: | EPC74G, F12C4G15, NB74G, NB78G, NB94G, NB98G, NBR78GF, NBR78GI, NC712G36, NC74G12, NC78G24, NC7FE12G36, NC7FE8G24, NC7FG12G44, NC7FG8G32, NC7FG8G36, NC7FG8G48, NC7FGM12G, NC912G44, NC94G16, NC94G20, NC98G28, NC98G40, NC9FE12G44, NC9FE8G28, NC9FG12G52, NC9FG16G72, NC9FG8G32, NC9FG8G36, NC9FG8G48, NC9FGM12G, NF74G10, NF74G15, NF74G15T, NF74G8, NF76G10, NF76G8, NF78G15, NF78G15T, NF94G15, NF94G23, NF96G10, NF98G15, NF98G23, NFT74GL, NFT74GR, NFT74GTLC, NFT74GTLCO, NFT74GTLO, NFT74GTRC...(Other models you can see in the webshop) | | |




1


| | | | |
|--------------------|--|-----------------|------------------------|
| GEV No. | 106868 | Ref. No. | CM136100 MACM136100 |
| description | disc for piezoelectric igniter ID ø 18mm ED ø 32mm H 4mm | | |
| For models: | NB74G, NB78G, NBR78GF, NBR78GI, NF74G15T, NF78G15T, NF96G10, NG74G, NG78G, NG94G, NG98G, NGL74G, NGL78G, PC12C9G | | |

ignition units

| | | | |
|---|--|-----------------|--|
|  | | | |
| 1 | | | |
| GEV No. | 102485 | Ref. No. | 1450300 2971400 BN6A050100 MA2971400 R65180290 |
| description | ignition unit outputs 2 220-240VAC 0.6VA 50-60Hz | | |
| For models: | BR912GFM, BR912GIM, BR94G, BR94GI, BR98GF, BR98GFM, BR98GI, BR98GIM, BR9M4G, BR9M4GI, BR9M6G, BR9M6GI, BR9S5B4G, BR9S5B4GI, CS10, CS102G, CS102GP, CS6, FC10G, FC20G, FC5G, FC7G, FG105M, FG105X, FG110M, FG110X, FG210M, FG210X, FR92G22, FR94G23, MS10AG, MS10IG, MS70AG, MS70IG, MS70IGS, NBR912GFM, NBR912GIM, NBR98GF, NBR98GFM, NBR98GI, NBR98GIM, NF94G23K, NF98G23K, NPC74G, NPC76G, NPC78G, NPC94G, NPC96G, NPC98G, NPD76G5...(Other models you can see in the webshop) | | |

| | | | |
|---|--|-----------------|----------------------------|
|  | | | |
| 1 | | | |
| GEV No. | 102388 | Ref. No. | 1037301400 MA1037301400 |
| description | ignition unit outputs 4 230VAC dimensions 111x23x34mm mounting distance 100mm inlet F6.3x0.8 outlet F2.8x0.8 type WAC-T4 0.6VA 50/60Hz | | |

ignition switches

| | | | |
|---|---|-----------------|-----------|
|  | | | |
| 1 | | | |
| GEV No. | 345038 | Ref. No. | CR0410290 |
| description | momentary push switch mounting ø 25mm black 2NO 250V 16A connection male faston 6.3mm ambient temperature max. 85°C protection IP40 | | |
| For models: | CFG70, CFG70M, NBR912EFM, NBR912EIM, NBR912GFM, NBR912GIM, NBR98EF, NBR98EFM, NBR98EI, NBR98EIM, NBR98GF, NBR98GFM, NBR98GI, NBR98GIM | | |

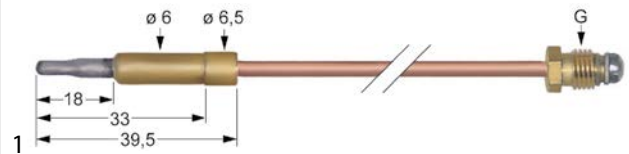
thermocouples

plug-in thermocouples

plug-in thermocouples standard

with barrel socket ø6mm

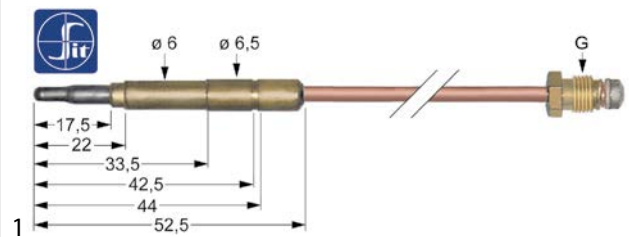
type Junkers with aluminised tip



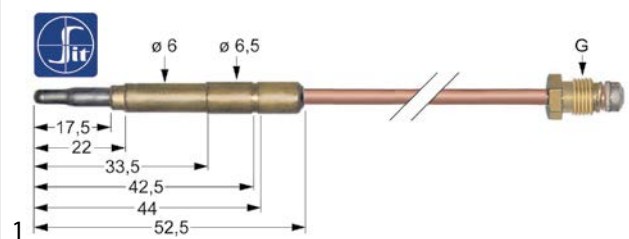
| | | | |
|--------------------|---|-----------------|--------|
| GEV No. | 102225 | Ref. No. | 933300 |
| description | thermocouple M10x1 L 320mm plug connection ø6.0mm | | |

with barrel socket ø6(6.5)mm

thermocouples SIT

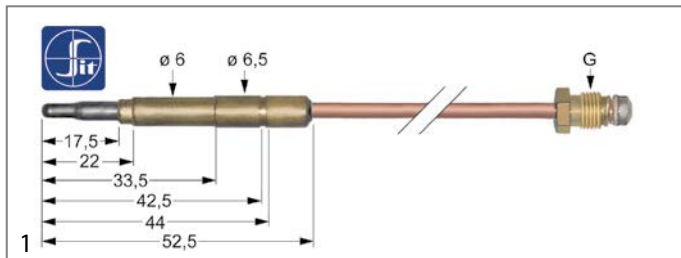


| | | | |
|--------------------|--|-----------------|--------------------|
| GEV No. | 107618 | Ref. No. | 641600 MA641600 |
| description | thermocouple SIT M10x1 L 750mm plug connection ø6.0(6.5)mm | | |



| | | | |
|--------------------|---|-----------------|--|
| GEV No. | 107601 | Ref. No. | 1033027500 1033027800 1206400 MA1033027800 MA1206400 |
| description | thermocouple SIT M8x1 L 600mm plug connection ø6.0(6.5)mm | | |

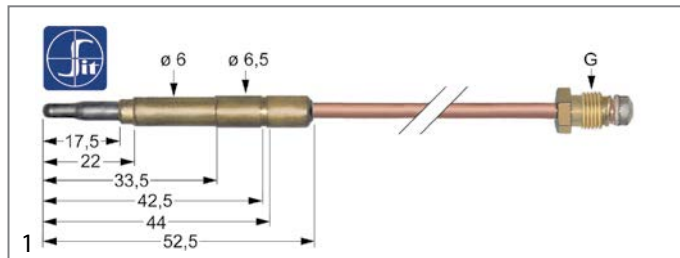
For models: BIG40, BIG60, BRG40, BRG40G, CFG101, CFG101D, CFG101L, CFG101P, CFG120, CFG70, CFG70D, CFG70L, CFG70M, CFG70P, CFGE61, CFGE61D, CFGE61L, CFGE61P, FTG40B, FTG40BLC, FTG40BR, FTG60B, FTG60BLC, FTG60BR, FTG60BRR, FTG80B, FTG80BLC, FTG80BR, OCFG101, OCFG120, OCFG70, OCFG61, OPCG41, OPCG61, PCG41, PCG41D, PCG41L, PCG41P, PCG61, PCG61D, PCG61L, PCG61P, PCGD41, PCGD41D, PCGD41L, PCGD41P, PCGD61, PCGD61D, PCGD61L, PCGD61P



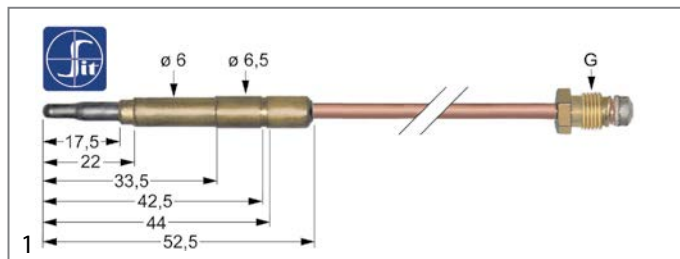
| | | | |
|--------------------|--|-----------------|----------------------|
| GEV No. | 107602 | Ref. No. | 1206500 MA1206500 |
| description | thermocouple SIT M8x1 L 850mm plug connection $\phi 6.0(6.5)$ mm | | |
| For models: | BR96G, BR96GI, BR9M6G, BR9M6GI, GB707G | | |

accessories for 107602

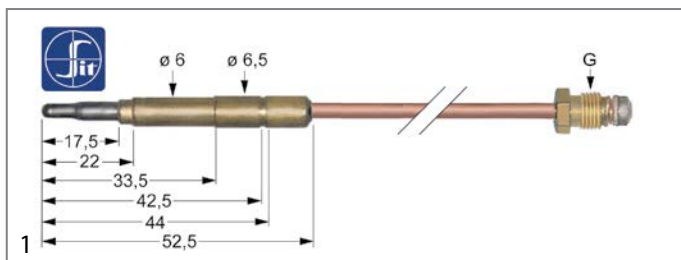
| | | | | |
|--|---|--------|-----------------|---|
| | GEV No. | 100920 | Ref. No. | — |
| | thermocouple fitting thread M8x1 / M9x1 Qty 1 pcs | | | |
| | GEV No. | 100922 | Ref. No. | — |
| | thermocouple fitting thread M10x1 / ASA 11/32 Qty 1 pcs | | | |



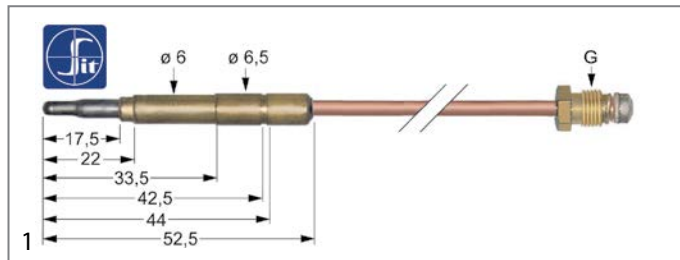
| | | | |
|--------------------|--|-----------------|----------------------------|
| GEV No. | 107606 | Ref. No. | 1031500400 MA1031500400 |
| description | thermocouple SIT M9x1 L 320mm plug connection $\phi 6.0(6.5)$ mm | | |
| For models: | FQG40, FQG60 | | |



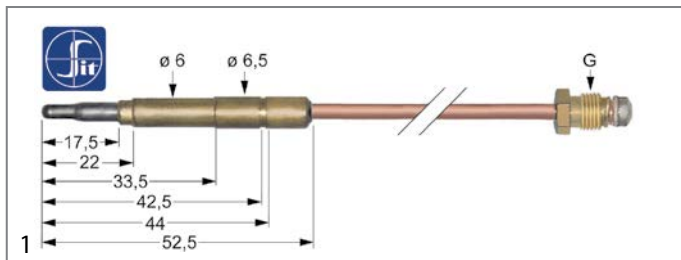
| | | | |
|--------------------|--|-----------------|--|
| GEV No. | 107608 | Ref. No. | 1031504300 641900 6A011912 BN6A011912 MA1031504300 MA641900 |
| description | thermocouple SIT M9x1 L 500mm plug connection $\phi 6.0(6.5)$ mm | | |
| For models: | C124G, C129G, C12C2G9, C12C9G, C12FG9G, EFT74GLVG, EFT74GR-VG, EFT78GLVG, EFT78GMVG, FT74G, FT74GR, FT77G, FT77GRL | | |



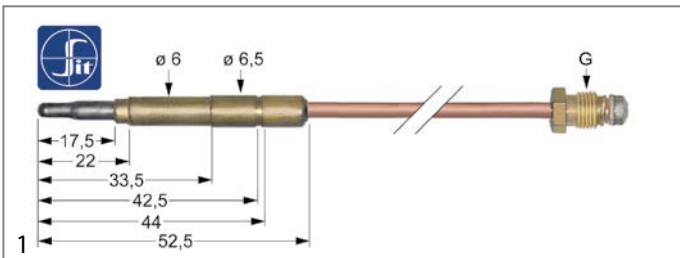
| | | | |
|--------------------|---|-----------------|--------------------|
| GEV No. | 107613 | Ref. No. | 263800 MA263800 |
| description | thermocouple SIT M9x1 L 1200mm plug connection $\phi 6.0(6.5)$ mm | | |
| For models: | 704, 704S, 706, 706AS, 706S, B9SB2G, B9SB4G, B9V2G, B9V4G, B9VP4G, C7FG9G, CS10, CS6, MM10DG, MM10DGS, MM15DG, NC7FG12G44, NC7FG8G32, NC7FG8G36, NC7FG8G48, NC9FG12G52, NC9FG16G72, NC9FG8G32, NC9FG8G36, NC9FG8G48, NT7FG12G, NT7FG8G, NT9FG12G, NT9FG8G, P9D10G, P9D15G, P9DA10G, P9DA15G, P9DASB10G, P9DSB10G, PDASB10G, TPF706, TPF706S | | |



| | | | |
|--------------------|---|-----------------|--|
| GEV No. | 107609 | Ref. No. | 1031501500 1033027600 90520 MA1031501500 MA1033027600 MA90520 |
| description | thermocouple SIT M9x1 L 600mm plug connection $\phi 6.0(6.5)$ mm | | |
| For models: | B9SB2G, B9V2G, BMG40, BMG60, BR707G, C9F4G, C9F4GS, C9F6G, C9F6GS, C9F8G, C9F8GS, CP92G, CP94G, F9SB2G, F9SB2GR, F9SB4G, F9SB4GR, F9SB4GRL, F9V2G, F9V2GR, F9V4G, F9V4GR, F9V4GRL, FR15G, FR15G2, FR2G, FR2G15, FR4G, FR4G15, P9D2G, PD707G, T7011GFG, T707G, T707GFG, T9F4G, T9F6GS, T9SB4G, T9V4G, T9V6GS | | |



| | | | |
|--------------------|---|-----------------|---|
| GEV No. | 107614 | Ref. No. | 2639-00 R63040030 SI0100818 SIR0100818 |
| description | thermocouple SIT M9x1 L 1500mm plug connection $\phi 6.0(6.5)$ mm | | |
| For models: | CS102G, CS102GP, FG110M, FG110X, FG210M, FG210X, PG080M, PG080X | | |

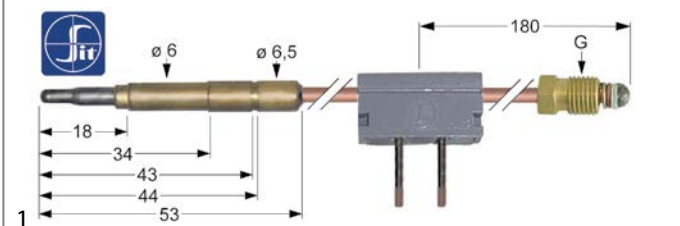


| | | | |
|----------------|--------|-----------------|---|
| GEV No. | 107611 | Ref. No. | 1031501600 1916000 2716500 CM029100 MA1031501600 MA1916000 MA2716500 MACM029100 R63040020 |
|----------------|--------|-----------------|---|

description thermocouple SIT M9x1 L 850mm plug connection $\varnothing 6.0(6.5)$ mm

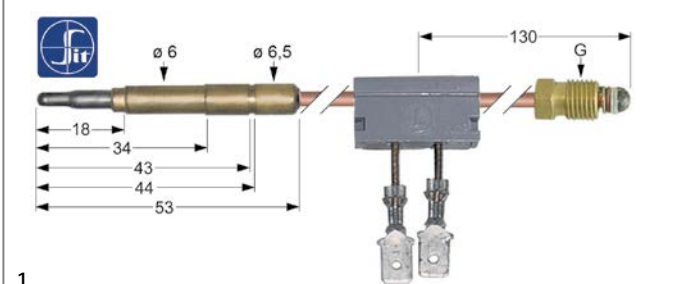
For models: B74G, B78G, B94G, B98G, B9SB2G, B9SB4G, B9V2G, B9V4G, BF78G, BF912G, BF912GH, BF98G, BM74G, BM77G, BMG40, BMG60, BR707G, BR707GI, BR78GF, BR78GI, BR94G, BR94GI, BR9M4G, BR9M4GI, BR9M6G, BR9M6GI, C12FGP9G, C7011G, C7011GFE, C7011GFG, C704G, C707G, C707GFE, C707GFG, C712G, C74G, C74GS, C78G, C78GS, C79G, C7FE12G, C7FE12GS, C7FE8G, C7FE8GS, C7FG12G, C7FG12GS, C7FG8G, C7FG8GS, C7FG9G, C7FGM12G...(Other models you can see in the webshop)

plug-in thermocouples with interruption



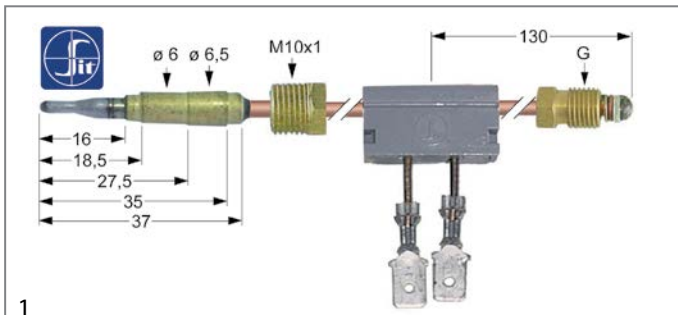
| | | | |
|----------------|--------|-----------------|-----------|
| GEV No. | 107864 | Ref. No. | MA1955400 |
|----------------|--------|-----------------|-----------|

description thermocouple SIT with interrupter M9x1 L 600mm plug connection $\varnothing 6.0(6.5)$ mm soldering connection

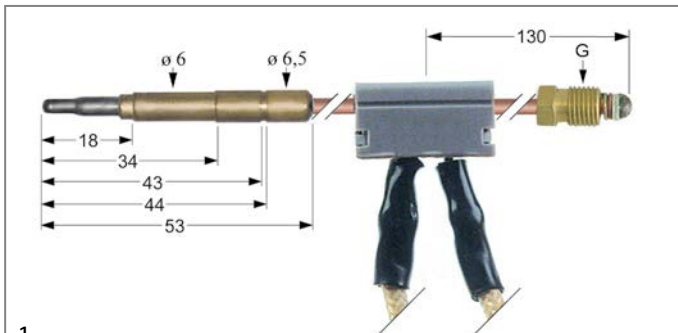


| | | | |
|----------------|--------|-----------------|------------------------------|
| GEV No. | 107177 | Ref. No. | 41826920050 BN41826920050 |
|----------------|--------|-----------------|------------------------------|

description thermocouple SIT with interrupter M9x1 L 600mm plug connection $\varnothing 6.0$ mm F 6.3mm



| | | | |
|--------------------|--|-----------------|----------------------|
| GEV No. | 102238 | Ref. No. | 1949800 MA1949800 |
| description | thermocouple with interrupter M9x1 L 600mm M10x1 F 6.3mm | | |
| For models: | MM10IG, P9I10G, P9IA10G | | |



| | | | |
|----------------|--------|-----------------|---|
| GEV No. | 102247 | Ref. No. | 1950100 1955500 838323 CR0508700 MA1950100 MA1955500 MA838323 |
|----------------|--------|-----------------|---|

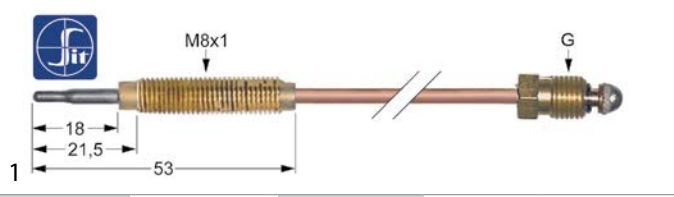
description thermocouple with interrupter M9x1 L 600mm plug connection $\varnothing 6.0$ mm cable 700mm

For models: BR912GFM, BR912GIM, BR94G, BR94GI, BR98GF, BR98GFM, BR98GI, BR98GIM, BR9M4G, BR9M4GI, BR9M6G, BR9M6GI, BR9SB4G, BR9SB4GI, EF74G15, EF74G8VA, EF74G8VG, F12C4G15, F74G10, F74G15, F74G6, F76G10, F78G15, F94G10, F94G15, F94G22, F94G22K, F94G6, F96G10, F98G15, F98G22, F98G22K, F954G15, F954G22, F954G22K, F958G15, F958G22, F958G22K, FQG41, FQG61, FR74G, FR77G, FR92G13, FR92G22, FR92G22T, FR94G13, FR94G22, FR94G22T, FR94G23, FT129GLC...(Other models you can see in the webshop)

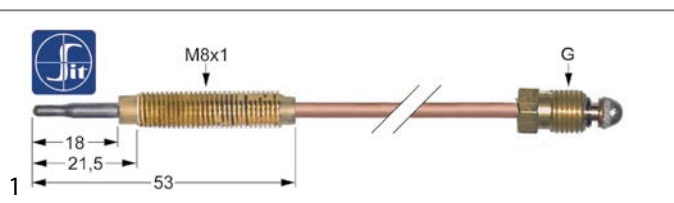


threaded thermocouples
threaded thermocouples standard
with socket with thread M8x1

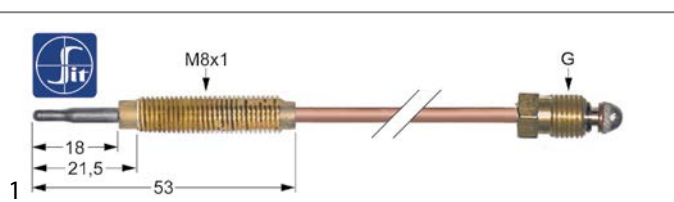
SIT



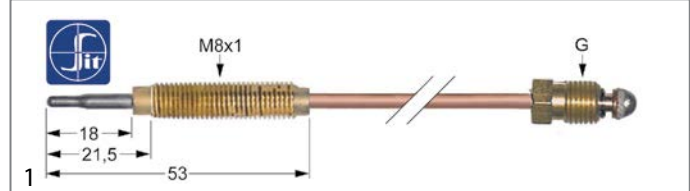
| | | | |
|--|---|-----------------|---|
| GEV No. | 107633 | Ref. No. | 1665000 MA1665000 |
| description | thermocouple SIT M8x1 L 1200mm M8x1 | | |
| For models: | C7011GFG, C707GFE, C707GFG, CFG101, CFG101D, CFG101L, CFG101P, CFG120, CFG70, CFG70D, CFG70L, CFG70M, CFG70P, EC74G-VG, EC78GVG, EC7FG8G, OCFG101, OCFG120, OCFG70, T7011GFG, T707GFG | | |
| accessories for | 107633 | | |
| | GEV No. | 102067 | Ref. No. 6A012300 939300 BN6A012300 MA939300 |
| nut thread M8x1 H 3mm brass Qty 1 pcs type SEF 1 | | | |



| | | | |
|--------------------|---|-----------------|--------------------|
| GEV No. | 107627 | Ref. No. | 641500 MA641500 |
| description | thermocouple SIT M8x1 L 220mm M8x1 | | |
| For models: | 702BMG, 706, 706S, C9F6G, C9F6GS, T9F6GS, TPF706, TPF706S | | |

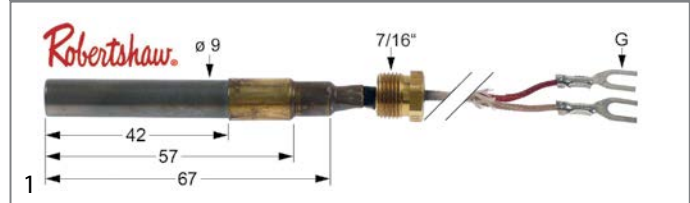


| | | | |
|--|--|-----------------|---|
| GEV No. | 107628 | Ref. No. | 1033027100 641400 MA1033027100 MA641400 |
| description | thermocouple SIT M8x1 L 320mm M8x1 | | |
| For models: | 704S, 706S, C7011G, C7011GFE, C7011GFG, C704G, C707G, C707GFE, C707GFG, C9F4GS, C9F6GS, C9F8GS, C9S84GS, C9V2GS, C9V4GS, C9V6GS, C9V8GS, TPF706S | | |
| accessories for | 107628 | | |
| | GEV No. | 102067 | Ref. No. 6A012300 939300 BN6A012300 MA939300 |
| nut thread M8x1 H 3mm brass Qty 1 pcs type SEF 1 | | | |



| | | | |
|--|--|-----------------|---|
| GEV No. | 107630 | Ref. No. | 641300 MA1033027200 MA641300 |
| description | thermocouple SIT M8x1 L 600mm M8x1 | | |
| For models: | 704S, 706S, C7011G, C7011GFE, C7011GFG, C704G, C707G, C707GFE, C707GFG, C9F4GS, C9F6GS, C9F8GS, C9S84GS, C9V2GS, C9V4GS, C9V6GS, C9V8GS, TPF706S | | |
| accessories for | 107630 | | |
| | GEV No. | 102067 | Ref. No. 6A012300 939300 BN6A012300 MA939300 |
| nut thread M8x1 H 3mm brass Qty 1 pcs type SEF 1 | | | |

thermopiles



| | | | |
|--------------------|---|-----------------|----------------------|
| GEV No. | 102116 | Ref. No. | 1870712 MA1870712 |
| description | thermopile ROBERTSHAW L 900mm probe ø 9mm probe L 57mm 250-750mV screw connection 7/16" | | |
| For models: | F94G22, F98G22, F9S4G22, F9S8G22, FR92G22, FR94G22, MM10IG, P9110G, P91A10G | | |

extensions



| | | | |
|--------------------|--|-----------------|--------|
| GEV No. | 102011 | Ref. No. | 933400 |
| description | thermocouple extension thread M10x1 L 400mm | | |
| For models: | C9F4G, C9F4GS, C9F6G, C9F6GS, C9F8G, C9F8GS, CS10, CS102G, CS102GP, CS6, P9110G, P91A10G, T9F4G, T9F6GS, T9S84G, T9V4G, T9V6GS | | |

accessories


nuts




| | | | |
|--------------------|---|-----------------|--|
| GEV No. | 102067 | Ref. No. | 6A012300 939300 BN6A012300 MA939300 |
| description | nut thread M8x1 H 3mm brass Qty 1 pcs type SEF 1 | | |
| For models: | 702BMG, 704S, 706, 706S, C7011G, C7011GFE, C7011GFG, C704G, C707G, C707GFE, C707GFG, C9F4GS, C9F6G, C9F6GS, C9F8GS, C9S84GS, C9V2GS, C9V4GS, C9V6GS, C9V8GS, CFG101, CFG101D, CFG101L, CFG101P, CFG120, CFG70, CFG70D, CFG70L, CFG70M, CFG70P, EC74G-VG, EC78GVG, EC7FG8G, OCFG101, OCFG120, OCFG70, T7011GFG, T707GFG, T9F6GS, TPF706, TPF706S | | |




screws

| | | | |
|---|--|-----------------|---------|
|  | | | |
| 1 | | | |
| GEV No. | 101262 | Ref. No. | 1162800 |
| description | thermocouple fitting thread M10x1 Qty 1 pcs | | |
| For models: | C9F4G, C9F4GS, C9F6G, C9F6GS, C9F8G, C9F8GS, MM10DG, MM10D-GS, MM15DG, P9D10G, P9D15G, P9DA10G, P9DA15G, P9DASB10G, P9DSB10G, PDASB10G, T9F4G, T9F6GS, T9SB4G, T9V4G, T9V6GS | | |

| | | | |
|---|---|-----------------|----------------------|
|  | | | |
| 1 | | | |
| GEV No. | 101260 | Ref. No. | 1359100 MA1359100 |
| description | thermocouple fitting thread M8x1 Qty 1 pcs | | |
| For models: | BR96G, BR96GI, BR9M6G, BR9M6GI, C7FG9G, CP707G, CP92G, CP94G, F9SB2G, F9SB2GR, F9SB4G, F9SB4GR, F9SB4GRL, F9V2G, F9V2GR, F9V4G, F9V4GR, F9V4GRL, FT74G, FT74GR, FT77G, FT77GRL, FTG40B, FTG60B, FTG60BLC, FTG60BR, FTG80B, FTG80BR, GB707G, OPLG40, OPLG80, P9D2G, PCG42, PCG82, PD707G, PLG40, PLG80, T7011GFG, T707G, T707GFG | | |

interrupters


| | | | |
|---|--|-----------------|---|
|  | | | |
| 1 | | | |
| GEV No. | 101265 | Ref. No. | 1031500500 1533400 MA1533400 R63040210 |
| description | interrupter thread M9x1 | | |
| For models: | FG105M, FG105X, FG110M, FG110X, FG210M, FG210X, FQG40, FQG60, PG040M, PG040X, PG080M, PG080X | | |





gas burners

hob burners


universal hob burners

GEV

| | | | |
|---|--|-----------------|-----|
|  | | | |
| 1 | | | |
| GEV No. | 106379 | Ref. No. | N/A |
| description | air mixing tube for burner cap ø 80mm L 23mm D1 ø 20mm D2 ø 15.6mm D3 ø 14mm | | |

| | | | |
|---|--------------------|-----------------|--|
|  | | | |
| 1 | | | |
| GEV No. | 103068 | Ref. No. | 1032000800 MA1032000800 |
| description | burner cap ø 100mm | | |
| accessories for | 103068 | | |
|  | GEV No. | 103067 | Ref. No. |
| | | | 1032009600 MA1032009600 SIR0100247 |
| burner ring for burner cap ø 100mm | | | |
|  | GEV No. | 104102 | Ref. No. |
| | | | 1032009400 MA1032009400 |
| burner head for burner cap ø 100mm ext. ø 130 | | | |
|  | GEV No. | 104103 | Ref. No. |
| | | | 1032009200 MA1032009200 |
| burner holder suitable for burner ø100mm with nozzle holder | | | |

| | | | |
|---|-------------------|-----------------|--|
|  | | | |
| 1 | | | |
| GEV No. | 103066 | Ref. No. | 1032000700 MA1032000700 SIR0100250 |
| description | burner cap ø 80mm | | |
| accessories for | 103066 | | |
|  | GEV No. | 103065 | Ref. No. |
| | | | 1032009500 MA1032009500 |
| burner ring for burner cap ø 80mm | | | |
|  | GEV No. | 104100 | Ref. No. |
| | | | 1032009300 MA1032009300 |
| burner head for burner cap ø 80mm | | | |
|  | GEV No. | 104101 | Ref. No. |
| | | | 1032009100 MA1032009100 SIR0100260 |
| burner holder for burner cap ø 80mm with nozzle holder with mixing sleeve | | | |

| | | | |
|--|---|-----------------|----------------------------|
|  | | | |
| 1 | | | |
| GEV No. | 104102 | Ref. No. | 1032009400 MA1032009400 |
| description | burner head for burner cap ø 100mm ext. ø 130 | | |













| | | | |
|---|-----------------------------------|-----------------|--|
|  | | | |
| 1 | | | |
| GEV No. | 104100 | Ref. No. | 1032009300 MA1032009300 |
| description | burner head for burner cap ø 80mm | | |
| accessories for | 104100 | | |
|  | GEV No. | 103065 | Ref. No. |
| | | | 1032009500 MA1032009500 |
| burner ring for burner cap ø 80mm | | | |
|  | GEV No. | 103066 | Ref. No. |
| | | | 1032000700 MA1032000700 SIR0100250 |
| burner cap ø 80mm | | | |





Table continues overleaf







| | | | |
|---|----------------|--------|--|
| accessories for | 104100 | | |
|  | GEV No. | 104103 | Ref. No. 1032009200 MA1032009200 |
| burner holder suitable for burner ø100mm with nozzle holder | | | |

| | | | |
|--|----------------|--------|--|
|  | GEV No. | 104101 | Ref. No. 1032009100 MA1032009100 SIR0100260 |
| description burner holder for burner cap ø 80mm with nozzle holder with mixing sleeve | | | |
| accessories for | 104101 | | |
|  | GEV No. | 103065 | Ref. No. 1032009500 MA1032009500 |
| burner ring for burner cap ø 80mm | | | |
|  | GEV No. | 103066 | Ref. No. 1032000700 MA1032000700 SIR0100250 |
| burner cap ø 80mm | | | |
|  | GEV No. | 104100 | Ref. No. 1032009300 MA1032009300 |
| burner head for burner cap ø 80mm | | | |

| | | | |
|---|----------------|--------|--|
|  | GEV No. | 104103 | Ref. No. 1032009200 MA1032009200 |
| description burner holder suitable for burner ø100mm with nozzle holder | | | |
| accessories for | 104103 | | |
|  | GEV No. | 103067 | Ref. No. 1032009600 MA1032009600 SIR0100247 |
| burner ring for burner cap ø 100mm | | | |
|  | GEV No. | 103068 | Ref. No. 1032000800 MA1032000800 |
| burner cap ø 100mm | | | |
|  | GEV No. | 104102 | Ref. No. 1032009400 MA1032009400 |
| burner head for burner cap ø 100mm ext. ø 130 | | | |


| | | | |
|---|----------------|--------|--|
|  | GEV No. | 103067 | Ref. No. 1032009600 MA1032009600 SIR0100247 |
| description burner ring for burner cap ø 100mm | | | |
| accessories for | 103067 | | |
|  | GEV No. | 103068 | Ref. No. 1032000800 MA1032000800 |
| burner cap ø 100mm | | | |
|  | GEV No. | 104102 | Ref. No. 1032009400 MA1032009400 |
| burner head for burner cap ø 100mm ext. ø 130 | | | |
|  | GEV No. | 104103 | Ref. No. 1032009200 MA1032009200 |
| burner holder suitable for burner ø100mm with nozzle holder | | | |





| | | | |
|---|----------------|--------|--|
|  | GEV No. | 103065 | Ref. No. 1032009500 MA1032009500 |
| description burner ring for burner cap ø 80mm | | | |
| accessories for | 103065 | | |
|  | GEV No. | 103066 | Ref. No. 1032000700 MA1032000700 SIR0100250 |
| burner cap ø 80mm | | | |
|  | GEV No. | 104100 | Ref. No. 1032009300 MA1032009300 |
| burner head for burner cap ø 80mm | | | |
|  | GEV No. | 104101 | Ref. No. 1032009100 MA1032009100 SIR0100260 |
| burner holder for burner cap ø 80mm with nozzle holder with mixing sleeve | | | |

producer-specific hob burners

MARENO

600 (1) series

| | | | |
|---|----------------|--------|---------------------|
|  | GEV No. | 106379 | Ref. No. N/A |
| description air mixing tube for burner cap ø 80mm L 23mm D1 ø 20mm D2 ø 15.6mm D3 ø 14mm | | | |

| | | | |
|--|----------------|--------|--|
|  | GEV No. | 103068 | Ref. No. 1032000800 MA1032000800 |
| description burner cap ø 100mm | | | |
| accessories for | 103068 | | |
|  | GEV No. | 103067 | Ref. No. 1032009600 MA1032009600 SIR0100247 |
| burner ring for burner cap ø 100mm | | | |
|  | GEV No. | 104102 | Ref. No. 1032009400 MA1032009400 |
| burner head for burner cap ø 100mm ext. ø 130 | | | |
|  | GEV No. | 104103 | Ref. No. 1032009200 MA1032009200 |
| burner holder suitable for burner ø100mm with nozzle holder | | | |









| | | | |
|---|----------------|--------|--|
|  | GEV No. | 103066 | Ref. No. 1032000700 MA1032000700 SIR0100250 |
| description burner cap ø 80mm | | | |
| accessories for | 103066 | | |
|  | GEV No. | 103065 | Ref. No. 1032009500 MA1032009500 |
| burner ring for burner cap ø 80mm | | | |





Table continues overleaf





| | | | | |
|---|---|--------|-----------------|--|
| accessories for | 103066 | | | |
|  | GEV No. | 104100 | Ref. No. | 1032009300 MA1032009300 |
| | burner head for burner cap ø 80mm | | | |
|  | GEV No. | 104101 | Ref. No. | 1032009100 MA1032009100 SIR0100260 |
| | burner holder for burner cap ø 80mm with nozzle holder with mixing sleeve | | | |





| | | | | |
|---|---|-----------------|----------------------------|--|
|  | 1 | | | |
| GEV No. | 104102 | Ref. No. | 1032009400 MA1032009400 | |
| description | burner head for burner cap ø 100mm ext. ø 130 | | | |

| | | | | |
|---|---|-----------------|----------------------------|--|
|  | 1 | | | |
| GEV No. | 104100 | Ref. No. | 1032009300 MA1032009300 | |
| description | burner head for burner cap ø 80mm | | | |
| accessories for | 104100 | | | |
|  | GEV No. | 103065 | Ref. No. | 1032009500 MA1032009500 |
| | burner ring for burner cap ø 80mm | | | |
|  | GEV No. | 103066 | Ref. No. | 1032000700 MA1032000700 SIR0100250 |
| | burner cap ø 80mm | | | |
|  | GEV No. | 104103 | Ref. No. | 1032009200 MA1032009200 |
| | burner holder suitable for burner ø100mm with nozzle holder | | | |

| | | | | |
|---|---|-----------------|--|--|
|  | 1 | | | |
| GEV No. | 104101 | Ref. No. | 1032009100 MA1032009100 SIR0100260 | |
| description | burner holder for burner cap ø 80mm with nozzle holder with mixing sleeve | | | |
| accessories for | 104101 | | | |
|  | GEV No. | 103065 | Ref. No. | 1032009500 MA1032009500 |
| | burner ring for burner cap ø 80mm | | | |
|  | GEV No. | 103066 | Ref. No. | 1032000700 MA1032000700 SIR0100250 |
| | burner cap ø 80mm | | | |
|  | GEV No. | 104100 | Ref. No. | 1032009300 MA1032009300 |
| | burner head for burner cap ø 80mm | | | |


| | | | | |
|---|---|-----------------|----------------------------|--|
|  | 1 | | | |
| GEV No. | 104103 | Ref. No. | 1032009200 MA1032009200 | |
| description | burner holder suitable for burner ø100mm with nozzle holder | | | |
| accessories for | 104103 | | | |
|  | GEV No. | 103067 | Ref. No. | 1032009600 MA1032009600 SIR0100247 |
| | burner ring for burner cap ø 100mm | | | |
|  | GEV No. | 103068 | Ref. No. | 1032000800 MA1032000800 |
| | burner cap ø 100mm | | | |
|  | GEV No. | 104102 | Ref. No. | 1032009400 MA1032009400 |
| | burner head for burner cap ø 100mm ext. ø 130 | | | |

| | | | | |
|---|---|-----------------|--|----------------------------|
|  | 1 | | | |
| GEV No. | 103067 | Ref. No. | 1032009600 MA1032009600 SIR0100247 | |
| description | burner ring for burner cap ø 100mm | | | |
| accessories for | 103067 | | | |
|  | GEV No. | 103068 | Ref. No. | 1032000800 MA1032000800 |
| | burner cap ø 100mm | | | |
|  | GEV No. | 104102 | Ref. No. | 1032009400 MA1032009400 |
| | burner head for burner cap ø 100mm ext. ø 130 | | | |
|  | GEV No. | 104103 | Ref. No. | 1032009200 MA1032009200 |
| | burner holder suitable for burner ø100mm with nozzle holder | | | |

| | | | | |
|---|---|-----------------|----------------------------|--|
|  | 1 | | | |
| GEV No. | 103065 | Ref. No. | 1032009500 MA1032009500 | |
| description | burner ring for burner cap ø 80mm | | | |
| accessories for | 103065 | | | |
|  | GEV No. | 103066 | Ref. No. | 1032000700 MA1032000700 SIR0100250 |
| | burner cap ø 80mm | | | |
|  | GEV No. | 104100 | Ref. No. | 1032009300 MA1032009300 |
| | burner head for burner cap ø 80mm | | | |
|  | GEV No. | 104101 | Ref. No. | 1032009100 MA1032009100 SIR0100260 |
| | burner holder for burner cap ø 80mm with nozzle holder with mixing sleeve | | | |



| 600 (2) series | | | | |
|---|---|-----------------|--|--|
|  | | | | |
| 1 | | | | |
| GEV No. | 107203 | Ref. No. | 0937560 1032501400 1032501413 1032501422 CM264200 CR0937560 MA1032501422 | |
| description | burner cap ø 85mm 3.5kW | | | |
| For models: | C74GS, C78GS, C7FE12GS, C7FE8GS, C7FG12GS, C7FG8GS, CFG101, CFG70, CFG70M, CFGE61, CFGE61D, CFGE61L, CFGE61P, EC74GVG, EC78GVG, EC7FG8G, OCFG101, OCFG70, OCFGE61, OPG41, OPG61, PCG41, PCG41L, PCG61, PCG61L | | | |
| accessories for | 107203 | | | |
|  | | | | |
| GEV No. | 103140 | Ref. No. | 1032101400 1032101422 CR0795730 MA1032101400 | |
| burner head seat ø 75mm for burner cap ø 85mm 3.5kW | | | | |

| | | | | |
|---|-------------------------|-----------------|------------|--|
|  | | | | |
| 1 | | | | |
| GEV No. | 103144 | Ref. No. | 1032501600 | |
| description | burner cap ø 95mm 5.5kW | | | |

| | | | | |
|---|---|-----------------|--|--|
|  | | | | |
| 1 | | | | |
| GEV No. | 103145 | Ref. No. | 1032501500 1032501522 MA1032501522 | |
| description | burner cap ø 95mm 7kW with central hole | | | |
| accessories for | 103145 | | | |
|  | | | | |
| GEV No. | 103147 | Ref. No. | 1032101300 MA1032101300 | |
| burner lower part for burner cap ø 95mm 5.5/7kW | | | | |
|  | | | | |
| GEV No. | 103149 | Ref. No. | 1036607900 MA1036607900 | |
| gasket L 55mm W 62mm for burner 5.5/7kW | | | | |
|  | | | | |
| GEV No. | 105230 | Ref. No. | 1033717200 MA1033717200 | |
| nozzle holder | | | | |
|  | | | | |
| GEV No. | 107143 | Ref. No. | CM297300 MACM297300 | |
| burner head for burner cap ø 95mm 5.5kW | | | | |






| | | | | |
|--|--|-----------------|--------------------------------------|--|
|  | | | | |
| 1 | | | | |
| GEV No. | 105259 | Ref. No. | 1032501613 CM264300 MACM264300 | |
| description | burner cap ø 95mm with central hole | | | |
| For models: | CFG101, CFG70, CFGE61D, CFGE61L, CFGE61P, PCG41, PCG41L, PCG61, PCG61L | | | |
| accessories for | 105259 | | | |
|  | | | | |
| GEV No. | 103141 | Ref. No. | 1032101500 | |
| burner head ø 95mm suitable for burner 5.5kW | | | | |
|  | | | | |
| GEV No. | 103147 | Ref. No. | 1032101300 MA1032101300 | |
| burner lower part for burner cap ø 95mm 5.5/7kW | | | | |
|  | | | | |
| GEV No. | 103149 | Ref. No. | 1036607900 MA1036607900 | |
| gasket L 55mm W 62mm for burner 5.5/7kW | | | | |
|  | | | | |
| GEV No. | 105230 | Ref. No. | 1033717200 MA1033717200 | |
| nozzle holder | | | | |
|  | | | | |
| GEV No. | 105262 | Ref. No. | CM264100 MACM264100 | |
| burner head for burner cap ø 95mm 5.5kW | | | | |

| | | | | |
|---|---|-----------------|------------------------|--|
|  | | | | |
| 1 | | | | |
| GEV No. | 107143 | Ref. No. | CM297300 MACM297300 | |
| description | burner head for burner cap ø 95mm 5.5kW | | | |
| For models: | C79G, C7FG9G, EC74GVG, EC78GVG, EC7FG8G, OPG41, OPG61, PCG41, PCG41L, PCG61, PCG61L | | | |

| | | | | |
|--|---|-----------------|--|--|
|  | | | | |
| 1 | | | | |
| GEV No. | 103142 | Ref. No. | 1032101600 MA1032101600 | |
| description | burner head for burner cap ø 95mm 5.5kW with central hole | | | |
| accessories for | 103142 | | | |
|  | | | | |
| GEV No. | 103145 | Ref. No. | 1032501500 1032501522 MA1032501522 | |
| burner cap ø 95mm 7kW with central hole | | | | |
|  | | | | |
| GEV No. | 103147 | Ref. No. | 1032101300 MA1032101300 | |
| burner lower part for burner cap ø 95mm 5.5/7kW | | | | |
|  | | | | |
| GEV No. | 103149 | Ref. No. | 1036607900 MA1036607900 | |
| gasket L 55mm W 62mm for burner 5.5/7kW | | | | |
|  | | | | |
| GEV No. | 105230 | Ref. No. | 1033717200 MA1033717200 | |
| nozzle holder | | | | |

| | | | |
|---|---|-----------------|--|
|  | | | |
| 1 | | | |
| GEV No. | 103141 | Ref. No. | 1032101500 CM297300+CR0937570 MA1032101500 MACM297300+CR0937570 |
| description | burner head ø 95mm suitable for burner 5.5kW | | |
| For models: | CFG101, CFG70, CFGE61, CFGE61D, CFGE61L, CFGE61P, OCFG101, OCFG70, OCFG61, OPG41, OPG61, PCG41, PCG41L, PCG61, PCG61L | | |
| accessories for | 103141 | | |
|  | GEV No. | 103147 | Ref. No. 1032101300 MA1032101300 |
| burner lower part for burner cap ø 95mm 5.5/7kW | | | |
|  | GEV No. | 103149 | Ref. No. 1036607900 MA1036607900 |
| gasket L 55mm W 62mm for burner 5.5/7kW | | | |
|  | GEV No. | 105230 | Ref. No. 1033717200 MA1033717200 |
| nozzle holder | | | |
|  | GEV No. | 105259 | Ref. No. 1032501613 CM264300 MACM264300 |
| burner cap ø 95mm with central hole | | | |

| | | | |
|---|--|-----------------|--|
|  | | | |
| 1 | | | |
| GEV No. | 103140 | Ref. No. | 1032101400 1032101422 CR0795730 MA1032101400 |
| description | burner head seat ø 75mm for burner cap ø 85mm 3.5kW | | |
| For models: | CFG101, CFG70, CFGE61, CFGE61D, CFGE61L, CFGE61P, EC74GVG, EC78GVG, EC7FG8G, OCFG101, OCFG70, OCFG61, OPG41, OPG61, PCG41, PCG41L, PCG61, PCG61L | | |
| accessories for | 103140 | | |
|  | GEV No. | 103146 | Ref. No. 1032101200 MA1032101200 |
| burner lower part for burner cap ø 85mm 3.5kW | | | |
|  | GEV No. | 103148 | Ref. No. 1036607800 MA1036607800 |
| gasket L 47mm W 53mm suitable for burner 3.5kW | | | |
|  | GEV No. | 105230 | Ref. No. 1033717200 MA1033717200 |
| nozzle holder | | | |
|  | GEV No. | 107203 | Ref. No. 0937560 1032501400 1032501413 1032501422 CM264200 CR0937560 MA1032501422 |
| burner cap ø 85mm 3.5kW | | | |

| | | | |
|--|--|-----------------|--|
|  | | | |
| 1 | | | |
| GEV No. | 103146 | Ref. No. | 1032101200 MA1032101200 |
| description | burner lower part for burner cap ø 85mm 3.5kW | | |
| For models: | C74GS, C78GS, C7FE12GS, C7FE8GS, C7FG12GS, C7FG8GS, CFG101, CFG70, CFG70M, CFGE61, CFGE61D, CFGE61L, CFGE61P, EC74GVG, EC78GVG, EC7FG8G, OCFG101, OCFG70, OCFG61, OPG41, OPG61, PCG41, PCG41L, PCG61, PCG61L | | |
| accessories for | 103146 | | |
|  | GEV No. | 103140 | Ref. No. 1032101400 1032101422 CR0795730 MA1032101400 |
| burner head seat ø 75mm for burner cap ø 85mm 3.5kW | | | |
|  | GEV No. | 103148 | Ref. No. 1036607800 MA1036607800 |
| gasket L 47mm W 53mm suitable for burner 3.5kW | | | |
|  | GEV No. | 105230 | Ref. No. 1033717200 MA1033717200 |
| nozzle holder | | | |
|  | GEV No. | 107203 | Ref. No. 0937560 1032501400 1032501413 1032501422 CM264200 CR0937560 MA1032501422 |
| burner cap ø 85mm 3.5kW | | | |

| | | | |
|--|--|-----------------|--|
|  | | | |
| 1 | | | |
| GEV No. | 103147 | Ref. No. | 1032101300 MA1032101300 |
| description | burner lower part for burner cap ø 95mm 5.5/7kW | | |
| For models: | C74GS, C78GS, C79G, C7FE12GS, C7FE8GS, C7FG12GS, C7FG8GS, C7FG9G, CFG101, CFG70, CFG70M, CFGE61, CFGE61D, CFGE61L, CFGE61P, EC74GVG, EC78GVG, EC7FG8G, OCFG101, OCFG70, OCFG61, OPG41, OPG61, PCG41, PCG41L, PCG61, PCG61L | | |
| accessories for | 103147 | | |
|  | GEV No. | 103141 | Ref. No. 1032101500 |
| burner head ø 95mm suitable for burner 5.5kW | | | |
|  | GEV No. | 103147 | Ref. No. 1032101300 MA1032101300 |
| burner lower part for burner cap ø 95mm 5.5/7kW | | | |
|  | GEV No. | 103149 | Ref. No. 1036607900 MA1036607900 |
| gasket L 55mm W 62mm for burner 5.5/7kW | | | |
|  | GEV No. | 105230 | Ref. No. 1033717200 MA1033717200 |
| nozzle holder | | | |
|  | GEV No. | 105259 | Ref. No. 1032501613 CM264300 MACM264300 |
| burner cap ø 95mm with central hole | | | |



| | | | |
|---|---|-----------------|--|
|  | | | |
| GEV No. | 103148 | Ref. No. | 1036607800 MA1036607800 |
| description | gasket L 47mm W 53mm suitable for burner 3.5kW | | |
| For models: | C74GS, C78GS, C7FE12GS, C7FE8GS, C7FG12GS, C7FG8GS, CFG101, CFG70, CFG70M, CFGE61, CFGE61D, CFGE61L, CFGE61P, EC74GVG, EC78GVG, EC7FG8G, OCFG101, OCFG70, OCFGE61, OPCG41, OPCG61, PCG41, PCG41L, PCG61, PCG61L | | |
| accessories for | 103148 | | |
|  | GEV No. | 103140 | Ref. No. 1032101400 1032101422 CR0795730 MA1032101400 |
| burner head seat ø 75mm for burner cap ø 85mm 3.5kW | | | |
|  | GEV No. | 103146 | Ref. No. 1032101200 MA1032101200 |
| burner lower part for burner cap ø 85mm 3.5kW | | | |
|  | GEV No. | 105230 | Ref. No. 1033717200 MA1033717200 |
| nozzle holder | | | |
|  | GEV No. | 107203 | Ref. No. 0937560 1032501400 1032501413 1032501422 CM264200 CR0937560 MA1032501422 |
| burner cap ø 85mm 3.5kW | | | |

| | | | |
|---|---|-----------------|--|
|  | | | |
| GEV No. | 103149 | Ref. No. | 1036607900 MA1036607900 |
| description | gasket L 55mm W 62mm for burner 5.5/7kW | | |
| For models: | C74GS, C78GS, C79G, C7FE12GS, C7FE8GS, C7FG12GS, C7FG8GS, C7FG9G, CFG101, CFG70, CFG70M, CFGE61, CFGE61D, CFGE61L, CFGE61P, EC74GVG, EC78GVG, EC7FG8G, OCFG101, OCFG70, OCFGE61, OPCG41, OPCG61, PCG41, PCG41L, PCG61, PCG61L | | |
| accessories for | 103149 | | |
|  | GEV No. | 103141 | Ref. No. 1032101500 |
| burner head ø 95mm suitable for burner 5.5kW | | | |
|  | GEV No. | 103145 | Ref. No. 1032501500 1032501522 MA1032501522 |
| burner cap ø 95mm 7kW with central hole | | | |
|  | GEV No. | 103147 | Ref. No. 1032101300 MA1032101300 |
| burner lower part for burner cap ø 95mm 5.5/7kW | | | |
|  | GEV No. | 105230 | Ref. No. 1033717200 MA1033717200 |
| nozzle holder | | | |
|  | GEV No. | 105259 | Ref. No. 1032501613 CM264300 MACM264300 |
| burner cap ø 95mm with central hole | | | |
|  | GEV No. | 107143 | Ref. No. CM297300 MACM297300 |
| burner head for burner cap ø 95mm 5.5kW | | | |

| | | | |
|---|--|-----------------|---|
|  | | | |
| GEV No. | 105230 | Ref. No. | 1033717200 MA1033717200 |
| description | nozzle holder | | |
| For models: | C74GS, C78GS, C79G, C7FE12GS, C7FE8GS, C7FG12GS, C7FG8GS, C7FG9G, CFG70, CFG70M, CFGE61, CFGE61D, CFGE61L, CFGE61P, EC74GVG, EC78GVG, EC7FG8G, OCFGE61, OPCG41, OPCG61, PCG41, PCG41L, PCG61, PCG61L | | |
| accessories for | 105230 | | |
|  | GEV No. | 103140 | Ref. No. 1032101400 1032101422 CR0795730 MA1032101400 |
| burner head seat ø 75mm for burner cap ø 85mm 3.5kW | | | |
|  | GEV No. | 103141 | Ref. No. 1032101500 |
| burner head ø 95mm suitable for burner 5.5kW | | | |
|  | GEV No. | 103146 | Ref. No. 1032101200 MA1032101200 |
| burner lower part for burner cap ø 85mm 3.5kW | | | |
|  | GEV No. | 103147 | Ref. No. 1032101300 MA1032101300 |
| burner lower part for burner cap ø 95mm 5.5/7kW | | | |
|  | GEV No. | 107143 | Ref. No. CM297300 MACM297300 |
| burner head for burner cap ø 95mm 5.5kW | | | |

700, 900, 1000 (1) series


















| | | | |
|---|--|-----------------|---|
|  | | | |
| GEV No. | 105051 | Ref. No. | 1314700 MA1314700 |
| description | air mixing sleeve L 45mm ED ø 45mm ID ø 42mm aluminium | | |
| For models: | C124G, C129G, C12C2G9, C12C9G, C12FG9G, C7011G, C7011GFE, C7011GF, C704G, C707G, C707GFE, C707GF, C712G, C74G, C78G, C7FE12G, C7FE8G, C7FG12G, C7FG8G, C7FGM12G, C912G, C912GS, C94G, C94GP, C94GS, C98G, C98GP, C98GS, C9F4G, C9F4GS, C9F6G, C9F6GS, C9F8G, C9F8GS, C9FE12G, C9FE12GS, C9FE4GS, C9FE6GS, C9FE8G, C9FE8GS, C9FEP4GS, C9FEP6GS, C9FEP8GS, C9FG12G, C9FG12GS, C9FG16G, C9FG8G, C9FG8GP, C9FG8GS, C9FGM12G... (Other models you can see in the webshop) | | |
| accessories for | 105051 | | |
|  | GEV No. | 103150 | Ref. No. 1315812 1892500 MA1892500 |
| burner lower part for burner cap ø 110/120mm | | | |
|  | GEV No. | 104030 | Ref. No. 1315412 1315422 MA1315422 |
| burner head for burner cap ø 80mm | | | |
|  | GEV No. | 104031 | Ref. No. 1315512 1315522 MA1315522 |
| burner head for burner cap ø 110mm | | | |
|  | GEV No. | 104032 | Ref. No. 1315912 1315922 MA1315922 |
| burner head for burner cap ø 120mm | | | |
|  | GEV No. | 104033 | Ref. No. 1315200 |
| burner lower part for burner cap ø 80mm 1. generation | | | |

Table continues overleaf

| accessories for | | 105051 | |
|---|---------|--------|---|
|  | GEV No. | 104034 | Ref. No. 1315300 1315312 MA1315300 |
| burner lower part for burner cap ø 110mm | | | |
|  | GEV No. | 105052 | Ref. No. 1306400 1306600 1306615 MA1306615 |
| nozzle holder ID ø 10mm nozzle mounting M10x1 | | | |
|  | GEV No. | 105265 | Ref. No. CM006001 MACM006001 |
| burner head for burner cap ø 80mm | | | |
|  | GEV No. | 105266 | Ref. No. CM042900 MACM042900 |
| burner lower part for burner cap ø 80mm | | | |
|  | GEV No. | 105269 | Ref. No. CM005901 MACM005901 |
| burner head ø 158mm for burner cap ø 110mm | | | |
|  | GEV No. | 105272 | Ref. No. CM043000 MACM043000 |
| burner lower part for burner cap ø 110mm | | | |
|  | GEV No. | 105274 | Ref. No. CM006502 MACM006502 |
| burner head for burner cap ø 120mm | | | |
|  | GEV No. | 105275 | Ref. No. CM043100 MACM043100 |
| burner lower part for burner cap ø 120mm | | | |

| | | | |
|---|---------|----------|--|
|  | | | |
| 1 | | | |
| GEV No. | 103021 | Ref. No. | 1315700 1315712 MA1315712 |
| description burner cap ø 110mm | | | |
| For models: C7011G, C7011GFE, C7011GFG, C704G, C707G, C707GFE, C707GFG, C9F4G, C9F4GS, C9F6G, C9F6GS, C9F8G, C9F8GS, C9FE4GS, C9FE6GS, C9FE8GS, C9FEP4GS, C9FEP6GS, C9FEP8GS, C9FP4GS, C9FP6GS, C9FP8GS, C9SB4GS, C9V2G, C9V2GS, C9V4G, C9V4GS, C9V6G, C9V6GS, C9V8G, C9V8GS, C9VP2GS, C9VP4GS, C9VP6GS, C9VP8GS, FB1GS, FB2GS, FB3GS, T7011GFG, T9F6GS, T9V6GS | | | |
| accessories for | | 103021 | |
|  | GEV No. | 103150 | Ref. No. 1315812 1892500 MA1892500 |
| burner lower part for burner cap ø 110/120mm | | | |
|  | GEV No. | 103151 | Ref. No. 1893300 MA1893300 |
| reducer suitable for burner head ø 110mm | | | |
|  | GEV No. | 104031 | Ref. No. 1315512 1315522 MA1315522 |
| burner head for burner cap ø 110mm | | | |
|  | GEV No. | 104034 | Ref. No. 1315300 1315312 MA1315300 |
| burner lower part for burner cap ø 110mm | | | |
|  | GEV No. | 105051 | Ref. No. 1314700 MA1314700 |
| air mixing sleeve L 45mm ED ø 45mm ID ø 42mm aluminium | | | |

| accessories for | | 103021 | |
|---|---------|--------|---|
|  | GEV No. | 105052 | Ref. No. 1306400 1306600 1306615 MA1306615 |
| nozzle holder ID ø 10mm nozzle mounting M10x1 | | | |

| | | | |
|---|---------|----------|---|
|  | | | |
| 1 | | | |
| GEV No. | 103022 | Ref. No. | 1316000 1316012 MA1316012 |
| description burner cap ø 120mm with central hole | | | |
| For models: C7011G, C7011GFE, C7011GFG, C704G, C707G, C707GFE, C707GFG, C9F4G, C9F4GS, C9F6G, C9F6GS, C9F8G, C9F8GS, C9FE4GS, C9FE6GS, C9FE8GS, C9FEP4GS, C9FEP6GS, C9FEP8GS, C9FP4GS, C9FP6GS, C9FP8GS, C9SB4GS, C9V2G, C9V2GS, C9V4G, C9V4GS, C9V6G, C9V6GS, C9V8G, C9V8GS, C9VP2GS, C9VP4GS, C9VP6GS, C9VP8GS, CFG120, OCFG120, PCG42, PCG82, T7011GFG, T9F6GS, T9V6GS | | | |
| accessories for | | 103022 | |
|  | GEV No. | 103150 | Ref. No. 1315812 1892500 MA1892500 |
| burner lower part for burner cap ø 110/120mm | | | |
|  | GEV No. | 104032 | Ref. No. 1315912 1315922 MA1315922 |
| burner head for burner cap ø 120mm | | | |
|  | GEV No. | 104035 | Ref. No. 1315800 MA1315800 |
| burner lower part for burner cap ø 120mm | | | |
|  | GEV No. | 105051 | Ref. No. 1314700 MA1314700 |
| air mixing sleeve L 45mm ED ø 45mm ID ø 42mm aluminium | | | |
|  | GEV No. | 105052 | Ref. No. 1306400 1306600 1306615 MA1306615 |
| nozzle holder ID ø 10mm nozzle mounting M10x1 | | | |






| | | | |
|--|---------|----------|--|
|  | | | |
| 1 | | | |
| GEV No. | 103020 | Ref. No. | 1315600 1315612 MA1315612 |
| description burner cap ø 80mm | | | |
| For models: C7011G, C7011GFE, C7011GFG, C704G, C707G, C707GFE, C707GFG, C9F4G, C9F4GS, C9F6G, C9F6GS, C9F8G, C9F8GS, C9FE4GS, C9FE6GS, C9FE8GS, C9FEP4GS, C9FEP6GS, C9FEP8GS, C9FP4GS, C9FP6GS, C9FP8GS, C9SB4GS, C9V2G, C9V2GS, C9V4G, C9V4GS, C9V6G, C9V6GS, C9V8G, C9V8GS, C9VP2GS, C9VP4GS, C9VP6GS, C9VP8GS, CFG120, FB1GS, FB2GS, FB3GS, OCFG120, PCG42, PCG82, T7011GFG, T9F6GS, T9V6GS | | | |
| accessories for | | 103020 | |
|  | GEV No. | 104030 | Ref. No. 1315412 1315422 MA1315422 |
| burner head for burner cap ø 80mm | | | |
|  | GEV No. | 104033 | Ref. No. 1315200 |
| burner lower part for burner cap ø 80mm 1. generation | | | |

Table continues overleaf











| | | | | |
|---|----------------|--------|-----------------|--|
| accessories for 103020 | | | | |
|  | GEV No. | 105051 | Ref. No. | 1314700 MA1314700 |
| air mixing sleeve L 45mm ED ø 45mm ID ø 42mm aluminium | | | | |
|  | GEV No. | 105052 | Ref. No. | 1306400 1306600 1306615 MA1306615 |
| nozzle holder ID ø 10mm nozzle mounting M10x1 | | | | |



| | | | | |
|---|---|-----------------|---------------------------------|--|
|  | | | | |
| 1 | | | | |
| GEV No. | 104031 | Ref. No. | 1315512 1315522 MA1315522 | |
| description | burner head for burner cap ø 110mm | | | |
| For models: | C7011G, C7011GFE, C7011GFG, C704G, C707G, C707GFE, C707GFG, C9F4G, C9F4GS, C9F6G, C9F6GS, C9F8G, C9F8GS, C9FE4GS, C9FE6GS, C9FE8GS, C9FEP4GS, C9FEP6GS, C9FEP8GS, C9FP4GS, C9FP6GS, C9FP8GS, C9SB4GS, C9V2G, C9V2GS, C9V4G, C9V4GS, C9V6G, C9V6GS, C9V8G, C9V8GS, C9VP2GS, C9VP4GS, C9VP6GS, C9VP8GS, FB1GS, FB2GS, FB3GS, T7011GFG, T9F6GS, T9V6GS | | | |
| accessories for 104031 | | | | |
|  | GEV No. | 103021 | Ref. No. | 1315700 1315712 MA1315712 |
| burner cap ø 110mm | | | | |
|  | GEV No. | 103150 | Ref. No. | 1315812 1892500 MA1892500 |
| burner lower part for burner cap ø 110/120mm | | | | |
|  | GEV No. | 103151 | Ref. No. | 1893300 MA1893300 |
| reducer suitable for burner head ø 110mm | | | | |
|  | GEV No. | 104034 | Ref. No. | 1315300 1315312 MA1315300 |
| burner lower part for burner cap ø 110mm | | | | |
|  | GEV No. | 105051 | Ref. No. | 1314700 MA1314700 |
| air mixing sleeve L 45mm ED ø 45mm ID ø 42mm aluminium | | | | |
|  | GEV No. | 105052 | Ref. No. | 1306400 1306600 1306615 MA1306615 |
| nozzle holder ID ø 10mm nozzle mounting M10x1 | | | | |




| | | | | |
|--|---|-----------------|---------------------------------|--|
|  | | | | |
| 1 | | | | |
| GEV No. | 104032 | Ref. No. | 1315912 1315922 MA1315922 | |
| description | burner head for burner cap ø 120mm | | | |
| For models: | C7011G, C7011GFE, C7011GFG, C704G, C707G, C707GFE, C707GFG, C9F4G, C9F4GS, C9F6G, C9F6GS, C9F8G, C9F8GS, C9FE4GS, C9FE6GS, C9FE8GS, C9FEP4GS, C9FEP6GS, C9FEP8GS, C9FP4GS, C9FP6GS, C9FP8GS, C9SB4GS, C9V2G, C9V2GS, C9V4G, C9V4GS, C9V6G, C9V6GS, C9V8G, C9V8GS, C9VP2GS, C9VP4GS, C9VP6GS, C9VP8GS, CFG120, OCFG120, PCG42, PCG82, T7011GFG, T9F6GS, T9V6GS | | | |
| accessories for 104032 | | | | |
|  | GEV No. | 103022 | Ref. No. | 1316000 1316012 MA1316012 |
| burner cap ø 120mm with central hole | | | | |
|  | GEV No. | 103150 | Ref. No. | 1315812 1892500 MA1892500 |
| burner lower part for burner cap ø 110/120mm | | | | |
|  | GEV No. | 105051 | Ref. No. | 1314700 MA1314700 |
| air mixing sleeve L 45mm ED ø 45mm ID ø 42mm aluminium | | | | |
|  | GEV No. | 105052 | Ref. No. | 1306400 1306600 1306615 MA1306615 |
| nozzle holder ID ø 10mm nozzle mounting M10x1 | | | | |


| | | | | |
|--|--|-----------------|---------------------------------|--|
|  | | | | |
| 1 | | | | |
| GEV No. | 104030 | Ref. No. | 1315412 1315422 MA1315422 | |
| description | burner head for burner cap ø 80mm | | | |
| For models: | C7011G, C7011GFE, C7011GFG, C704G, C707G, C707GFE, C707GFG, C9F4G, C9F4GS, C9F6G, C9F6GS, C9F8G, C9F8GS, C9FE4GS, C9FE6GS, C9FE8GS, C9FEP4GS, C9FEP6GS, C9FEP8GS, C9FP4GS, C9FP6GS, C9FP8GS, C9SB4GS, C9V2G, C9V2GS, C9V4G, C9V4GS, C9V6G, C9V6GS, C9V8G, C9V8GS, C9VP2GS, C9VP4GS, C9VP6GS, C9VP8GS, CFG120, FB1GS, FB2GS, FB3GS, OCFG120, PCG42, PCG82, T7011GFG, T9F6GS, T9V6GS | | | |
| accessories for 104030 | | | | |
|  | GEV No. | 103020 | Ref. No. | 1315600 1315612 MA1315612 |
| burner cap ø 80mm | | | | |
|  | GEV No. | 104033 | Ref. No. | 1315200 |
| burner lower part for burner cap ø 80mm 1. generation | | | | |
|  | GEV No. | 105051 | Ref. No. | 1314700 MA1314700 |
| air mixing sleeve L 45mm ED ø 45mm ID ø 42mm aluminium | | | | |
|  | GEV No. | 105052 | Ref. No. | 1306400 1306600 1306615 MA1306615 |
| nozzle holder ID ø 10mm nozzle mounting M10x1 | | | | |




| | | | |
|---|--|-----------------|--|
|  | | | |
| GEV No. | 103150 | Ref. No. | 1315812 1892500 MA1892500 |
| description | burner lower part for burner cap ø 110/120mm | | |
| For models: | C7011G, C7011GFE, C7011GFG, C704G, C707G, C707GFE, C707GFG, C9F4GS, C9F6GS, C9F8GS, C9FE4GS, C9FE6GS, C9FE8GS, C9FEP4GS, C9FEP6GS, C9FEP8GS, C9FP4GS, C9FP6GS, C9FP8GS, C9V2GS, C9V4GS, C9V6GS, C9V8GS, C9VP2GS, C9VP4GS, C9VP6GS, C9VP8GS, CFG120, FB1GS, FB2GS, FB3GS, OCFG120, PCG42, PCG82, T7011GFG, T9F6GS, T9V6GS | | |
| accessories for | 103150 | | |
|  | GEV No. | 103021 | Ref. No. |
| | | | 1315700 1315712 MA1315712 |
| burner cap ø 110mm | | | |
|  | GEV No. | 103022 | Ref. No. |
| | | | 1316000 1316012 MA1316012 |
| burner cap ø 120mm with central hole | | | |
|  | GEV No. | 103151 | Ref. No. |
| | | | 1893300 MA1893300 |
| reducer suitable for burner head ø110mm | | | |
|  | GEV No. | 104031 | Ref. No. |
| | | | 1315512 1315522 MA1315522 |
| burner head for burner cap ø 110mm | | | |
|  | GEV No. | 104032 | Ref. No. |
| | | | 1315912 1315922 MA1315922 |
| burner head for burner cap ø 120mm | | | |
|  | GEV No. | 105051 | Ref. No. |
| | | | 1314700 MA1314700 |
| air mixing sleeve L 45mm ED ø 45mm ID ø 42mm aluminium | | | |
|  | GEV No. | 105052 | Ref. No. |
| | | | 1306400 1306600 1306615 MA1306615 |
| nozzle holder ID ø 10mm nozzle mounting M10x1 | | | |

| | | | |
|---|--|-----------------|---------------------------------|
|  | | | |
| GEV No. | 104034 | Ref. No. | 1315300 1315312 MA1315300 |
| description | burner lower part for burner cap ø 110mm | | |
| For models: | C7011G, C7011GFE, C7011GFG, C704G, C707G, C707GFE, C707GFG, C9F4G, C9F4GS, C9F6G, C9F6GS, C9F8G, C9F8GS, C9SB4GS, C9V2G, C9V2GS, C9V4G, C9V4GS, C9V6G, C9V6GS, C9V8G, C9V8GS | | |
| accessories for | 104034 | | |
|  | GEV No. | 103021 | Ref. No. |
| | | | 1315700 1315712 MA1315712 |
| burner cap ø 110mm | | | |

| | | | |
|---|----------------|--------|--|
| accessories for | 104034 | | |
|  | GEV No. | 104031 | Ref. No. |
| | | | 1315512 1315522 MA1315522 |
| burner head for burner cap ø 110mm | | | |
|  | GEV No. | 105051 | Ref. No. |
| | | | 1314700 MA1314700 |
| air mixing sleeve L 45mm ED ø 45mm ID ø 42mm aluminium | | | |
|  | GEV No. | 105052 | Ref. No. |
| | | | 1306400 1306600 1306615 MA1306615 |
| nozzle holder ID ø 10mm nozzle mounting M10x1 | | | |

| | | | |
|--|--|-----------------|----------------------|
|  | | | |
| GEV No. | 104035 | Ref. No. | 1315800 MA1315800 |
| description | burner lower part for burner cap ø 120mm | | |
| For models: | C9F4G, C9F4GS, C9F6G, C9F6GS, C9F8G, C9F8GS, C9SB4GS, C9V2G, C9V2GS, C9V4G, C9V4GS, C9V6G, C9V6GS, C9V8G, C9V8GS | | |

| | | | |
|---|--|-----------------|---------|
|  | | | |
| GEV No. | 104033 | Ref. No. | 1315200 |
| description | burner lower part for burner cap ø 80mm 1. generation | | |
| For models: | C7011G, C7011GFE, C7011GFG, C704G, C707G, C707GFE, C707GFG, C9F4G, C9F4GS, C9F6G, C9F6GS, C9F8G, C9F8GS, C9SB4GS, C9V2G, C9V2GS, C9V4G, C9V4GS, C9V6G, C9V6GS, C9V8G, C9V8GS | | |











| | | | |
|---|---|-----------------|--|
|  | | | |
| GEV No. | 105052 | Ref. No. | 1306400 1306600 1306615 MA1306615 |
| description | nozzle holder ID ø 10mm nozzle mounting M10x1 | | |
| For models: | B9SB2G, B9SB4G, B9V2G, B9V4G, C7011G, C7011GFE, C7011GFG, C704G, C707G, C707GFE, C707GFG, C9F4E, C9F4G, C9F4GS, C9F6E, C9F6G, C9F6GS, C9F8G, C9F8GS, C9FP, C9FP4GS, C9FP6GS, C9FP8GS, C9SB4GS, C9V2G, C9V2GS, C9V4G, C9V4GS, C9V6G, C9V6GS, C9V8G, C9V8GS, CFG101, CFG101D, CFG101L, CFG101P, CFG120, CFG70, CFG70D, CFG70L, CFG70M, CFG70P, EC74GVG, EC78GVG, EC7FG8G, FB1GS, FB2GS, FB3GS, FP1GS, FT74G...(Other models you can see in the webshop) | | |
| accessories for | 105052 | | |
|  | GEV No. | 100469 | Ref. No. |
| | | | 521611 MA521611 |
| gas injector thread M10x1 WS 12 bore ø 1.15mm | | | |
|  | GEV No. | 100478 | Ref. No. |
| | | | 522811 MA522811 |
| gas injector thread M10x1 WS 12 bore ø 1.75mm | | | |

Table continues overleaf



| | | | | |
|---|---------|--------|----------|---------------------------------|
| accessories for 105052 | | | | |
|  | GEV No. | 103150 | Ref. No. | 1315812 1892500 MA1892500 |
| burner lower part for burner cap ø 110/120mm | | | | |
|  | GEV No. | 104030 | Ref. No. | 1315412 1315422 MA1315422 |
| burner head for burner cap ø 80mm | | | | |
|  | GEV No. | 104031 | Ref. No. | 1315512 1315522 MA1315522 |
| burner head for burner cap ø 110mm | | | | |
|  | GEV No. | 104032 | Ref. No. | 1315912 1315922 MA1315922 |
| burner head for burner cap ø 120mm | | | | |
|  | GEV No. | 104033 | Ref. No. | 1315200 |
| burner lower part for burner cap ø 80mm 1. generation | | | | |
|  | GEV No. | 104034 | Ref. No. | 1315300 1315312 MA1315300 |
| burner lower part for burner cap ø 110mm | | | | |
|  | GEV No. | 105051 | Ref. No. | 1314700 MA1314700 |
| air mixing sleeve L 45mm ED ø 45mm ID ø 42mm aluminium | | | | |

| | | | | |
|--|---------|--------|----------|--|
|  | | | | |
| 1 | GEV No. | 103151 | Ref. No. | 1893300 MA1893300 |
| description reducer suitable for burner head ø110mm | | | | |
| For models: C7011G, C7011GFE, C7011GFG, C704G, C707G, C707GFE, C707GFG, C9F4GS, C9F6GS, C9F8GS, C9FE4GS, C9FE6GS, C9FE8GS, C9FEP4GS, C9FEP6GS, C9FEP8GS, C9FP4GS, C9FP6GS, C9FP8GS, C9V2GS, C9V4GS, C9V6GS, C9V8GS, C9VP2GS, C9VP4GS, C9VP6GS, C9VP8GS, FB1GS, FB2GS, FB3GS, T7011GFG, T9F6GS, T9V6GS | | | | |
| accessories for 103151 | | | | |
|  | GEV No. | 103021 | Ref. No. | 1315700 1315712 MA1315712 |
| burner cap ø 110mm | | | | |
|  | GEV No. | 103150 | Ref. No. | 1315812 1892500 MA1892500 |
| burner lower part for burner cap ø 110/120mm | | | | |
|  | GEV No. | 104031 | Ref. No. | 1315512 1315522 MA1315522 |
| burner head for burner cap ø 110mm | | | | |
|  | GEV No. | 105051 | Ref. No. | 1314700 MA1314700 |
| air mixing sleeve L 45mm ED ø 45mm ID ø 42mm aluminium | | | | |
|  | GEV No. | 105052 | Ref. No. | 1306400 1306600 1306615 MA1306615 |
| nozzle holder ID ø 10mm nozzle mounting M10x1 | | | | |

| | | | | |
|--|---------|--------|----------|-------------------------------------|
| solid tops | | | | |
|  | | | | |
| 1 | GEV No. | 105042 | Ref. No. | 1315000 1316400 MA1316400 |
| description burner cap ø 175mm with central hole | | | | |
| For models: NT78G, NT7FG12G, NT7FG8G, NT98G, NT9FG12G, NT9FG8G, T129G, T7011GFG, T707G, T707GFG, T78G, T7FG12G, T7FG8G, T98G, T9F4G, T9F6GS, T9FE4G, T9FG12G, T9FG8G, T9FP4G, T9SB4G, T9V4G, T9V6GS, T9VP4G | | | | |
| accessories for 105042 | | | | |
|  | GEV No. | 105041 | Ref. No. | 1316300 MA1316300 |
| burner head ø 175mm for solid top suitable for 1000, BS series | | | | |
|  | GEV No. | 105484 | Ref. No. | CM0005004 CM005004 MACM005004 |
| burner head ø 175mm for solid top suitable for Protagonista series | | | | |

| | | | | |
|---|---------|--------|----------|---------------------------------|
|  | | | | |
| 1 | GEV No. | 105041 | Ref. No. | 1316300 MA1316300 |
| description burner head ø 175mm for solid top suitable for 1000, BS series | | | | |
| For models: T7011GFG, T707G, T707GFG, T9F4G, T9F6GS, T9FE4G, T9FP4G, T9SB4G, T9V4G, T9V6GS, T9VP4G | | | | |
| accessories for 105041 | | | | |
|  | GEV No. | 105042 | Ref. No. | 1315000 1316400 MA1316400 |
| burner cap ø 175mm with central hole | | | | |

| | | | | |
|--|---------|--------|----------|-------------------------------------|
|  | | | | |
| 1 | GEV No. | 105484 | Ref. No. | CM0005004 CM005004 MACM005004 |
| description burner head ø 175mm for solid top suitable for Protagonista series | | | | |
| For models: NT98G, NT9FG12G, NT9FG8G, T129G, T78G, T7FG12G, T7FG8G, T98G, T9FG12G, T9FG8G | | | | |
| accessories for 105484 | | | | |
|  | GEV No. | 105042 | Ref. No. | 1315000 1316400 MA1316400 |
| burner cap ø 175mm with central hole | | | | |



700, 900, 1000 (2) series



| | | | |
|--------------------|--|-----------------|----------------------------|
| GEV No. | 105336 | Ref. No. | 1044229212 MA1044229212 |
| description | air mixing sleeve | | |
| For models: | C74GS, C78GS, C79G, C7FE12GS, C7FE8GS, C7FG12GS, C7FG8GS, C7FG9G, CFG101, CFG70, CFG70M, CFGE61, CFGE61D, CFGE61L, CFGE61P, OCFG101, OCFG70, OCFGE61, OPCG41, OPCG61, PCG41, PCG41L, PCG61, PCG61L | | |

accessories for 105336

| | | | | |
|---|----------------|--------|-----------------|---|
| | GEV No. | 103140 | Ref. No. | 1032101400 1032101422 CR0795730 MA1032101400 |
| burner head seat ø 75mm for burner cap ø 85mm 3.5kW | | | | |
| | GEV No. | 103141 | Ref. No. | 1032101500 |
| burner head ø 95mm suitable for burner 5.5kW | | | | |
| | GEV No. | 103146 | Ref. No. | 1032101200 MA1032101200 |
| burner lower part for burner cap ø 85mm 3.5kW | | | | |
| | GEV No. | 103147 | Ref. No. | 1032101300 MA1032101300 |
| burner lower part for burner cap ø 95mm 5.5/7kW | | | | |
| | GEV No. | 105262 | Ref. No. | CM264100 MACM264100 |
| burner head for burner cap ø 95mm 5.5kW | | | | |
| | GEV No. | 107143 | Ref. No. | CM297300 MACM297300 |
| burner head for burner cap ø 95mm 5.5kW | | | | |



| | | | |
|----------------|--------|-----------------|--|
| GEV No. | 107203 | Ref. No. | 0937560 1032501400 1032501413 1032501422 CM264200 CR0937560 MA1032501422 |
|----------------|--------|-----------------|--|

| | | | |
|--------------------|---|--|--|
| description | burner cap ø 85mm 3.5kW | | |
| For models: | C74GS, C78GS, C7FE12GS, C7FE8GS, C7FG12GS, C7FG8GS, CFG101, CFG70, CFG70M, CFGE61, CFGE61D, CFGE61L, CFGE61P, EC74GVG, EC78GVG, EC7FG8G, OCFG101, OCFG70, OCFGE61, OPCG41, OPCG61, PCG41, PCG41L, PCG61, PCG61L | | |

accessories for 107203

| | | | | |
|---|----------------|--------|-----------------|---|
| | GEV No. | 103140 | Ref. No. | 1032101400 1032101422 CR0795730 MA1032101400 |
| burner head seat ø 75mm for burner cap ø 85mm 3.5kW | | | | |



| | | | |
|--------------------|---|-----------------|---|
| GEV No. | 107169 | Ref. No. | 1032501622 CR0937570 MA1032501622 |
| description | burner cap ø 95mm 5.5kW with central hole | | |
| For models: | C74GS, C78GS, C79G, C7FE12GS, C7FE8GS, C7FG12GS, C7FG8GS, C7FG9G, CFG101, CFG70, CFG70M, CFGE61, CFGE61D, CFGE61L, CFGE61P, EC74GVG, EC78GVG, EC7FG8G, OCFG101, OCFG70, OCFGE61, OPCG41, OPCG61, PCG41, PCG41L, PCG61, PCG61L | | |



| | | | |
|--------------------|--|-----------------|--------------------------------------|
| GEV No. | 105259 | Ref. No. | 1032501613 CM264300 MACM264300 |
| description | burner cap ø 95mm with central hole | | |
| For models: | CFG101, CFG70, CFGE61D, CFGE61L, CFGE61P, PCG41, PCG41L, PCG61, PCG61L | | |

accessories for 105259

| | | | | |
|---|----------------|--------|-----------------|----------------------------|
| | GEV No. | 103141 | Ref. No. | 1032101500 |
| burner head ø 95mm suitable for burner 5.5kW | | | | |
| | GEV No. | 103147 | Ref. No. | 1032101300 MA1032101300 |
| burner lower part for burner cap ø 95mm 5.5/7kW | | | | |
| | GEV No. | 103149 | Ref. No. | 1036607900 MA1036607900 |
| gasket L 55mm W 62mm for burner 5.5/7kW | | | | |
| | GEV No. | 105230 | Ref. No. | 1033717200 MA1033717200 |
| nozzle holder | | | | |
| | GEV No. | 105262 | Ref. No. | CM264100 MACM264100 |
| burner head for burner cap ø 95mm 5.5kW | | | | |



| | | | |
|--------------------|--|-----------------|------------------------|
| GEV No. | 105249 | Ref. No. | CM264000 MACM264000 |
| description | burner head for burner cap ø 85mm 3.5kW | | |
| For models: | C74GS, C78GS, C7FE12GS, C7FE8GS, C7FG12GS, C7FG8GS | | |



| | | | |
|--|--|-----------------|--|
|  <p>1</p> | | | |
| GEV No. | 105262 | Ref. No. | CM264100 MACM264100 |
| description | burner head for burner cap ø 95mm 5.5kW | | |
| For models: | C74GS, C78GS, C7FE12GS, C7FE8GS, C7FG12GS, C7FG8GS | | |
| accessories for | 105262 | | |
|  | GEV No. | 103147 | Ref. No. 1032101300 MA1032101300 |
| burner lower part for burner cap ø 95mm 5.5/7kW | | | |
|  | GEV No. | 103149 | Ref. No. 1036607900 MA1036607900 |
| gasket L 55mm W 62mm for burner 5.5/7kW | | | |
|  | GEV No. | 105230 | Ref. No. 1033717200 MA1033717200 |
| nozzle holder | | | |
|  | GEV No. | 105259 | Ref. No. 1032501613 CM264300 MACM264300 |
| burner cap ø 95mm with central hole | | | |
|  | GEV No. | 105336 | Ref. No. 1044229212 MA1044229212 |
| air mixing sleeve | | | |

| | | | |
|---|---|-----------------|--|
|  <p>1</p> | | | |
| GEV No. | 103146 | Ref. No. | 1032101200 MA1032101200 |
| description | burner lower part for burner cap ø 85mm 3.5kW | | |
| For models: | C74GS, C78GS, C7FE12GS, C7FE8GS, C7FG12GS, C7FG8GS, CFG101, CFG70, CFG70M, CFGE61, CFGE61D, CFGE61L, CFGE61P, EC74GVG, EC78GVG, EC7FG8G, OCFG101, OCFG70, OCFGE61, OPCG41, OPCG61, PCG41, PCG41L, PCG61, PCG61L | | |
| accessories for | 103146 | | |
|  | GEV No. | 103140 | Ref. No. 1032101400 1032101422 CR0795730 MA1032101400 |
| burner head seat ø 75mm for burner cap ø 85mm 3.5kW | | | |
|  | GEV No. | 103148 | Ref. No. 1036607800 MA1036607800 |
| gasket L 47mm W 53mm suitable for burner 3.5kW | | | |
|  | GEV No. | 105230 | Ref. No. 1033717200 MA1033717200 |
| nozzle holder | | | |
|  | GEV No. | 107203 | Ref. No. 0937560 1032501400 1032501413 1032501422 CM264200 CR0937560 MA1032501422 |
| burner cap ø 85mm 3.5kW | | | |

| | | | |
|---|---|-----------------|--|
|  <p>1</p> | | | |
| GEV No. | 103147 | Ref. No. | 1032101300 MA1032101300 |
| description | burner lower part for burner cap ø 95mm 5.5/7kW | | |
| For models: | C74GS, C78GS, C79G, C7FE12GS, C7FE8GS, C7FG12GS, C7FG8GS, C7FG9G, CFG101, CFG70, CFG70M, CFGE61, CFGE61D, CFGE61L, CFGE61P, EC74GVG, EC78GVG, EC7FG8G, OCFG101, OCFG70, OCFGE61, OPCG41, OPCG61, PCG41, PCG41L, PCG61, PCG61L | | |
| accessories for | 103147 | | |
|  | GEV No. | 103141 | Ref. No. 1032101500 |
| burner head ø 95mm suitable for burner 5.5kW | | | |
|  | GEV No. | 103147 | Ref. No. 1032101300 MA1032101300 |
| burner lower part for burner cap ø 95mm 5.5/7kW | | | |
|  | GEV No. | 103149 | Ref. No. 1036607900 MA1036607900 |
| gasket L 55mm W 62mm for burner 5.5/7kW | | | |
|  | GEV No. | 105230 | Ref. No. 1033717200 MA1033717200 |
| nozzle holder | | | |
|  | GEV No. | 105259 | Ref. No. 1032501613 CM264300 MACM264300 |
| burner cap ø 95mm with central hole | | | |

| | | | |
|---|--|-----------------|----------------------|
|  <p>1</p> | | | |
| GEV No. | 104127 | Ref. No. | 1315212 MA1315212 |
| description | burner lower part ø 80mm without bores for pilot burner type 2. generation | | |
| For models: | C7011G, C7011GFE, C7011GFG, C704G, C707G, C707GFE, C707GFG, C9F4GS, C9F6GS, C9F8GS, C9FE4GS, C9FE6GS, C9FE8GS, C9FEP4GS, C9FEP6GS, C9FEP8GS, C9FP4GS, C9FP6GS, C9FP8GS, C9V2GS, C9V4GS, C9V6GS, C9V8GS, C9VP2GS, C9VP4GS, C9VP6GS, C9VP8GS, CFG120, FB1GS, FB2GS, FB3GS, OCFG120, PCG42, PCG82, T7011GFG, T9F6GS, T9V6GS | | |









| | | | |
|--|---|-----------------|---|
|  <p>1</p> | | | |
| GEV No. | 103148 | Ref. No. | 1036607800 MA1036607800 |
| description | gasket L 47mm W 53mm suitable for burner 3.5kW | | |
| For models: | C74GS, C78GS, C7FE12GS, C7FE8GS, C7FG12GS, C7FG8GS, CFG101, CFG70, CFG70M, CFGE61, CFGE61D, CFGE61L, CFGE61P, EC74GVG, EC78GVG, EC7FG8G, OCFG101, OCFG70, OCFGE61, OPCG41, OPCG61, PCG41, PCG41L, PCG61, PCG61L | | |
| accessories for | 103148 | | |
|  | GEV No. | 103140 | Ref. No. 1032101400 1032101422 CR0795730 MA1032101400 |
| burner head seat ø 75mm for burner cap ø 85mm 3.5kW | | | |

Table continues overleaf

| | | | | |
|---|---------|--------|----------|--|
| accessories for 103148 | | | | |
|  | GEV No. | 103146 | Ref. No. | 1032101200 MA1032101200 |
| burner lower part for burner cap ø 85mm 3.5kW | | | | |
|  | GEV No. | 105230 | Ref. No. | 1033717200 MA1033717200 |
| nozzle holder | | | | |
|  | GEV No. | 107203 | Ref. No. | 0937560 1032501400 1032501413 1032501422 CM264200 CR0937560 MA1032501422 |
| burner cap ø 85mm 3.5kW | | | | |

| | | | | |
|---|---|-----------------|----------------------------|--|
|  | | | | |
| GEV No. | 103149 | Ref. No. | 1036607900 MA1036607900 | |
| description | gasket L 55mm W 62mm for burner 5.5/7kW | | | |
| For models: | C74GS, C78GS, C79G, C7FE12GS, C7FE8GS, C7FG12GS, C7FG8GS, C7FG9G, CFG101, CFG70, CFG70M, CFGE61, CFGE61D, CFGE61L, CFGE61P, EC74GVG, EC78GVG, EC7FG8G, OCFG101, OCFG70, OCFG61, OPCG41, OPG61, PCG41, PCG41L, PCG61, PCG61L | | | |
| accessories for 103149 | | | | |
|  | GEV No. | 103141 | Ref. No. | 1032101500 |
| burner head ø 95mm suitable for burner 5.5kW | | | | |
|  | GEV No. | 103145 | Ref. No. | 1032501500 1032501522 MA1032501522 |
| burner cap ø 95mm 7kW with central hole | | | | |
|  | GEV No. | 103147 | Ref. No. | 1032101300 MA1032101300 |
| burner lower part for burner cap ø 95mm 5.5/7kW | | | | |
|  | GEV No. | 105230 | Ref. No. | 1033717200 MA1033717200 |
| nozzle holder | | | | |
|  | GEV No. | 105259 | Ref. No. | 1032501613 CM264300 MACM264300 |
| burner cap ø 95mm with central hole | | | | |
|  | GEV No. | 107143 | Ref. No. | CM297300 MACM297300 |
| burner head for burner cap ø 95mm 5.5kW | | | | |

| | | | | |
|---|--|-----------------|----------------------------|---|
|  | | | | |
| GEV No. | 105230 | Ref. No. | 1033717200 MA1033717200 | |
| description | nozzle holder | | | |
| For models: | C74GS, C78GS, C79G, C7FE12GS, C7FE8GS, C7FG12GS, C7FG8GS, C7FG9G, CFG70, CFG70M, CFGE61, CFGE61D, CFGE61L, CFGE61P, EC74GVG, EC78GVG, EC7FG8G, OCFG61, OPCG41, OPG61, PCG41, PCG41L, PCG61, PCG61L | | | |
| accessories for 105230 | | | | |
|  | GEV No. | 103140 | Ref. No. | 1032101400 1032101422 CR0795730 MA1032101400 |
| burner head seat ø 75mm for burner cap ø 85mm 3.5kW | | | | |
|  | GEV No. | 103141 | Ref. No. | 1032101500 |
| burner head ø 95mm suitable for burner 5.5kW | | | | |

| | | | | |
|---|---------|--------|----------|----------------------------|
| accessories for 105230 | | | | |
|  | GEV No. | 103146 | Ref. No. | 1032101200 MA1032101200 |
| burner lower part for burner cap ø 85mm 3.5kW | | | | |
|  | GEV No. | 103147 | Ref. No. | 1032101300 MA1032101300 |
| burner lower part for burner cap ø 95mm 5.5/7kW | | | | |
|  | GEV No. | 107143 | Ref. No. | CM297300 MACM297300 |
| burner head for burner cap ø 95mm 5.5kW | | | | |

700, 900, 1000 (3) series















| | | | | |
|---|--|-----------------|----------------------|--|
|  | | | | |
| GEV No. | 105051 | Ref. No. | 1314700 MA1314700 | |
| description | air mixing sleeve L 45mm ED ø 45mm ID ø 42mm aluminium | | | |
| For models: | C124G, C129G, C12C2G9, C12C9G, C12FG9G, C7011G, C7011GFE, C7011GFG, C704G, C707G, C707GFE, C707GFG, C712G, C74G, C78G, C7FE12G, C7FE8G, C7FG12G, C7FG8G, C7FGM12G, C912G, C912GS, C94G, C94GP, C94GS, C98G, C98GP, C98GS, C9F4G, C9F4GS, C9F6G, C9F6GS, C9F8G, C9F8GS, C9FE12G, C9FE12GS, C9FE4GS, C9FE6GS, C9FE8G, C9FE8GS, C9FEP4GS, C9FEP6GS, C9FEP8GS, C9FG12G, C9FG12GS, C9FG16G, C9FG8G, C9FG8GP, C9FG8GS, C9FGM12G... (Other models you can see in the webshop) | | | |
| accessories for 105051 | | | | |
|  | GEV No. | 103150 | Ref. No. | 1315812 1892500 MA1892500 |
| burner lower part for burner cap ø 110/120mm | | | | |
|  | GEV No. | 104030 | Ref. No. | 1315412 1315422 MA1315422 |
| burner head for burner cap ø 80mm | | | | |
|  | GEV No. | 104031 | Ref. No. | 1315512 1315522 MA1315522 |
| burner head for burner cap ø 110mm | | | | |
|  | GEV No. | 104032 | Ref. No. | 1315912 1315922 MA1315922 |
| burner head for burner cap ø 120mm | | | | |
|  | GEV No. | 104033 | Ref. No. | 1315200 |
| burner lower part for burner cap ø 80mm 1. generation | | | | |
|  | GEV No. | 104034 | Ref. No. | 1315300 1315312 MA1315300 |
| burner lower part for burner cap ø 110mm | | | | |
|  | GEV No. | 105052 | Ref. No. | 1306400 1306600 1306615 MA1306615 |
| nozzle holder ID ø 10mm nozzle mounting M10x1 | | | | |
|  | GEV No. | 105265 | Ref. No. | CM006001 MACM006001 |
| burner head for burner cap ø 80mm | | | | |
|  | GEV No. | 105266 | Ref. No. | CM042900 MACM042900 |
| burner lower part for burner cap ø 80mm | | | | |
|  | GEV No. | 105269 | Ref. No. | CM005901 MACM005901 |
| burner head ø 158mm for burner cap ø 110mm | | | | |


Table continues overleaf








| | | | | |
|---|---------|--------|----------|------------------------|
| accessories for 105051 | | | | |
|  | GEV No. | 105272 | Ref. No. | CM043000 MACM043000 |
| burner lower part for burner cap ø 110mm | | | | |
|  | GEV No. | 105274 | Ref. No. | CM006502 MACM006502 |
| burner head for burner cap ø 120mm | | | | |
|  | GEV No. | 105275 | Ref. No. | CM043100 MACM043100 |
| burner lower part for burner cap ø 120mm | | | | |

| | | | | |
|---|---------|----------|------------------------|------------------------|
|  | | | | |
| 1 | | | | |
| GEV No. | 105268 | Ref. No. | CM027100 MACM027100 | |
| description burner cap ø 110mm | | | | |
| For models: C124G, C129G, C12FG9G, C712G, C74G, C78G, C7FE12G, C7FE8G, C7FG12G, C7FG8G, C7FGM12G, C912G, C912GS, C94G, C94GP, C94GS, C98G, C98GP, C98GS, C9FE12G, C9FE12GS, C9FE8G, C9FE8GS, C9FG12G, C9FG12GS, C9FG16G, C9FG8G, C9FG8GP, C9FG8GS, C9FGM12G | | | | |
| accessories for 105268 | | | | |
|  | GEV No. | 105051 | Ref. No. | 1314700 MA1314700 |
| air mixing sleeve L 45mm ED ø 45mm ID ø 42mm aluminium | | | | |
|  | GEV No. | 105267 | Ref. No. | 1781800 MA1781800 |
| nozzle holder nozzle M10x1 M14x1 screw pipe fitting M16x1.5 tube ø 10mm | | | | |
|  | GEV No. | 105269 | Ref. No. | CM005901 MACM005901 |
| burner head ø 158mm for burner cap ø 110mm | | | | |
|  | GEV No. | 105272 | Ref. No. | CM043000 MACM043000 |
| burner lower part for burner cap ø 110mm | | | | |

| | | | | |
|--|---------|----------|------------------------|------------------------|
|  | | | | |
| 1 | | | | |
| GEV No. | 105273 | Ref. No. | CM027200 MACM027200 | |
| description burner cap ø 120mm with central hole | | | | |
| For models: C124G, C129G, C12C2G9, C12C9G, C12FG9G, C712G, C74G, C78G, C7FE12G, C7FE8G, C7FG12G, C7FG8G, C7FGM12G, C912G, C912GS, C94G, C94GP, C94GS, C98G, C98GP, C98GS, C9FE12G, C9FE12GS, C9FE8G, C9FE8GS, C9FG12G, C9FG12GS, C9FG16G, C9FG8G, C9FG8GP, C9FG8GS, C9FGM12G | | | | |
| accessories for 105273 | | | | |
|  | GEV No. | 105051 | Ref. No. | 1314700 MA1314700 |
| air mixing sleeve L 45mm ED ø 45mm ID ø 42mm aluminium | | | | |
|  | GEV No. | 105267 | Ref. No. | 1781800 MA1781800 |
| nozzle holder nozzle M10x1 M14x1 screw pipe fitting M16x1.5 tube ø 10mm | | | | |
|  | GEV No. | 105274 | Ref. No. | CM006502 MACM006502 |
| burner head for burner cap ø 120mm | | | | |

| | | | | |
|---|---------|--------|----------|------------------------|
| accessories for 105273 | | | | |
|  | GEV No. | 105275 | Ref. No. | CM043100 MACM043100 |
| burner lower part for burner cap ø 120mm | | | | |

| | | | | |
|--|---------|----------|------------------------|------------------------|
|  | | | | |
| 1 | | | | |
| GEV No. | 105263 | Ref. No. | CM027600 MACM027600 | |
| description burner cap ø 80mm | | | | |
| For models: C712G, C74G, C78G, C7FE12G, C7FE8G, C7FG12G, C7FG8G, C7FGM12G, C912G, C912GS, C94G, C94GP, C94GS, C98G, C98GP, C98GS, C9FE12G, C9FE12GS, C9FE8G, C9FE8GS, C9FG12G, C9FG12GS, C9FG16G, C9FG8G, C9FG8GP, C9FG8GS, C9FGM12G | | | | |
| accessories for 105263 | | | | |
|  | GEV No. | 105051 | Ref. No. | 1314700 MA1314700 |
| air mixing sleeve L 45mm ED ø 45mm ID ø 42mm aluminium | | | | |
|  | GEV No. | 105265 | Ref. No. | CM006001 MACM006001 |
| burner head for burner cap ø 80mm | | | | |
|  | GEV No. | 105266 | Ref. No. | CM042900 MACM042900 |
| burner lower part for burner cap ø 80mm | | | | |
|  | GEV No. | 105267 | Ref. No. | 1781800 MA1781800 |
| nozzle holder nozzle M10x1 M14x1 screw pipe fitting M16x1.5 tube ø 10mm | | | | |

| | | | | |
|--|---------|----------|------------------------|------------------------|
|  | | | | |
| 1 | | | | |
| GEV No. | 105274 | Ref. No. | CM006502 MACM006502 | |
| description burner head for burner cap ø 120mm | | | | |
| For models: C124G, C129G, C12C2G9, C12C9G, C12FG9G, C712G, C74G, C78G, C7FE12G, C7FE8G, C7FG12G, C7FG8G, C7FGM12G, C912G, C912GS, C94G, C94GP, C94GS, C98G, C98GP, C98GS, C9FE12G, C9FE12GS, C9FE8G, C9FE8GS, C9FG12G, C9FG12GS, C9FG16G, C9FG8G, C9FG8GP, C9FG8GS, C9FGM12G | | | | |
| accessories for 105274 | | | | |
|  | GEV No. | 105051 | Ref. No. | 1314700 MA1314700 |
| air mixing sleeve L 45mm ED ø 45mm ID ø 42mm aluminium | | | | |
|  | GEV No. | 105267 | Ref. No. | 1781800 MA1781800 |
| nozzle holder nozzle M10x1 M14x1 screw pipe fitting M16x1.5 tube ø 10mm | | | | |
|  | GEV No. | 105273 | Ref. No. | CM027200 MACM027200 |
| burner cap ø 120mm with central hole | | | | |
|  | GEV No. | 105275 | Ref. No. | CM043100 MACM043100 |
| burner lower part for burner cap ø 120mm | | | | |



1

| | | | |
|---|---|-----------------|--|
| GEV No. | 105265 | Ref. No. | CM006001 MACM006001 |
| description | burner head for burner cap ø 80mm | | |
| For models: | C712G, C74G, C78G, C7FE12G, C7FE8G, C7FG12G, C7FG8G, C7FG-M12G, C912G, C912GS, C94G, C94GP, C94GS, C98G, C98GP, C98GS, C9FE12G, C9FE12GS, C9FE8G, C9FE8GS, C9FG12G, C9FG12GS, C9FG16G, C9FG8G, C9FG8GP, C9FG8GS, C9FGM12G | | |
| accessories for | 105265 | | |
|  | GEV No. | 105051 | Ref. No. 1314700 MA1314700 |
| air mixing sleeve L 45mm ED ø 45mm ID ø 42mm aluminium | | | |
|  | GEV No. | 105263 | Ref. No. CM027600 MACM027600 |
| burner cap ø 80mm | | | |
|  | GEV No. | 105266 | Ref. No. CM042900 MACM042900 |
| burner lower part for burner cap ø 80mm | | | |
|  | GEV No. | 105267 | Ref. No. 1781800 MA1781800 |
| nozzle holder nozzle M10x1 M14x1 screw pipe fitting M16x1.5 tube ø 10mm | | | |



1

| | | | |
|---|---|-----------------|--|
| GEV No. | 105269 | Ref. No. | CM005901 MACM005901 |
| description | burner head ø 158mm for burner cap ø 110mm | | |
| For models: | C124G, C129G, C12FG9G, C712G, C74G, C78G, C7FE12G, C7FE8G, C7FG12G, C7FG8G, C7FGM12G, C912G, C912GS, C94G, C94GP, C94GS, C98G, C98GP, C98GS, C9FE12G, C9FE12GS, C9FE8G, C9FE8GS, C9FG12G, C9FG12GS, C9FG16G, C9FG8G, C9FG8GP, C9FG8GS, C9FGM12G | | |
| accessories for | 105269 | | |
|  | GEV No. | 105051 | Ref. No. 1314700 MA1314700 |
| air mixing sleeve L 45mm ED ø 45mm ID ø 42mm aluminium | | | |
|  | GEV No. | 105267 | Ref. No. 1781800 MA1781800 |
| nozzle holder nozzle M10x1 M14x1 screw pipe fitting M16x1.5 tube ø 10mm | | | |
|  | GEV No. | 105268 | Ref. No. CM027100 MACM027100 |
| burner cap ø 110mm | | | |
|  | GEV No. | 105272 | Ref. No. CM043000 MACM043000 |
| burner lower part for burner cap ø 110mm | | | |



1

| | | | |
|---|---|-----------------|--|
| GEV No. | 105272 | Ref. No. | CM043000 MACM043000 |
| description | burner lower part for burner cap ø 110mm | | |
| For models: | C124G, C129G, C12FG9G, C712G, C74G, C78G, C7FE12G, C7FE8G, C7FG12G, C7FG8G, C7FGM12G, C912G, C912GS, C94G, C94GP, C94GS, C98G, C98GP, C98GS, C9FE12G, C9FE12GS, C9FE8G, C9FE8GS, C9FG12G, C9FG12GS, C9FG16G, C9FG8G, C9FG8GP, C9FG8GS, C9FGM12G | | |
| accessories for | 105272 | | |
|  | GEV No. | 105051 | Ref. No. 1314700 MA1314700 |
| air mixing sleeve L 45mm ED ø 45mm ID ø 42mm aluminium | | | |
|  | GEV No. | 105267 | Ref. No. 1781800 MA1781800 |
| nozzle holder nozzle M10x1 M14x1 screw pipe fitting M16x1.5 tube ø 10mm | | | |
|  | GEV No. | 105268 | Ref. No. CM027100 MACM027100 |
| burner cap ø 110mm | | | |
|  | GEV No. | 105269 | Ref. No. CM005901 MACM005901 |
| burner head ø 158mm for burner cap ø 110mm | | | |











1

| | | | |
|---|--|-----------------|--|
| GEV No. | 105275 | Ref. No. | CM043100 MACM043100 |
| description | burner lower part for burner cap ø 120mm | | |
| For models: | C124G, C129G, C12C2G9, C12C9G, C12FG9G, C712G, C74G, C78G, C7FE12G, C7FE8G, C7FG12G, C7FG8G, C7FGM12G, C912G, C912GS, C94G, C94GP, C94GS, C98G, C98GP, C98GS, C9FE12G, C9FE12GS, C9FE8G, C9FE8GS, C9FG12G, C9FG12GS, C9FG16G, C9FG8G, C9FG8GP, C9FG8GS, C9FGM12G | | |
| accessories for | 105275 | | |
|  | GEV No. | 105051 | Ref. No. 1314700 MA1314700 |
| air mixing sleeve L 45mm ED ø 45mm ID ø 42mm aluminium | | | |
|  | GEV No. | 105267 | Ref. No. 1781800 MA1781800 |
| nozzle holder nozzle M10x1 M14x1 screw pipe fitting M16x1.5 tube ø 10mm | | | |
|  | GEV No. | 105273 | Ref. No. CM027200 MACM027200 |
| burner cap ø 120mm with central hole | | | |
|  | GEV No. | 105274 | Ref. No. CM006502 MACM006502 |
| burner head for burner cap ø 120mm | | | |





| | | | |
|--|---|-----------------|--|
|  <p>1</p> | | | |
| GEV No. | 105266 | Ref. No. | CM042900 MACM042900 |
| description | burner lower part for burner cap ø 80mm | | |
| For models: | C712G, C74G, C78G, C7FE12G, C7FE8G, C7FG12G, C7FG8G, C7FG-M12G, C912G, C912GS, C94G, C94GP, C94GS, C98G, C98GP, C98GS, C9FE12G, C9FE12GS, C9FE8G, C9FE8GS, C9FG12G, C9FG12GS, C9FG16G, C9FG8G, C9FG8GP, C9FG8GS, C9FGM12G | | |
| accessories for | 105266 | | |
|  | GEV No. | 105051 | Ref. No. 1314700 MA1314700 |
| air mixing sleeve L 45mm ED ø 45mm ID ø 42mm aluminium | | | |
|  | GEV No. | 105263 | Ref. No. CM027600 MACM027600 |
| burner cap ø 80mm | | | |
|  | GEV No. | 105265 | Ref. No. CM006001 MACM006001 |
| burner head for burner cap ø 80mm | | | |
|  | GEV No. | 105267 | Ref. No. 1781800 MA1781800 |
| nozzle holder nozzle M10x1 M14x1 screw pipe fitting M16x1.5 tube ø 10mm | | | |

| | | | |
|---|---|-----------------|--|
|  <p>1</p> | | | |
| GEV No. | 105267 | Ref. No. | 1781800 MA1781800 |
| description | nozzle holder nozzle M10x1 M14x1 screw pipe fitting M16x1.5 tube ø 10mm | | |
| For models: | C124G, C129G, C12C2G9, C12C9G, C12FG9G, C7011G, C7011GFE, C7011GFG, C704G, C707G, C707GFE, C707GFG, C712G, C74G, C78G, C7FE12G, C7FE8G, C7FG12G, C7FG8G, C7FGM12G, C912G, C912GS, C94G, C94GP, C94GS, C98G, C98GP, C98GS, C9F4GS, C9F6GS, C9F8GS, C9FE12G, C9FE12GS, C9FE4GS, C9FE6GS, C9FE8G, C9FE8GS, C9FEP4GS, C9FEP6GS, C9FEP8GS, C9FG12G, C9FG12GS, C9FG16G, C9FG8G, C9FG8GP, C9FG8GS, C9FGM12G, C9FP4GS, C9FP6GS, C9FP8GS...(Other models you can see in the webshop) | | |
| accessories for | 105267 | | |
|  | GEV No. | 105051 | Ref. No. 1314700 MA1314700 |
| air mixing sleeve L 45mm ED ø 45mm ID ø 42mm aluminium | | | |
|  | GEV No. | 105265 | Ref. No. CM006001 MACM006001 |
| burner head for burner cap ø 80mm | | | |
|  | GEV No. | 105266 | Ref. No. CM042900 MACM042900 |
| burner lower part for burner cap ø 80mm | | | |
|  | GEV No. | 105269 | Ref. No. CM005901 MACM005901 |
| burner head ø 158mm for burner cap ø 110mm | | | |
|  | GEV No. | 105272 | Ref. No. CM043000 MACM043000 |
| burner lower part for burner cap ø 110mm | | | |
|  | GEV No. | 105274 | Ref. No. CM006502 MACM006502 |
| burner head for burner cap ø 120mm | | | |
|  | GEV No. | 105275 | Ref. No. CM043100 MACM043100 |
| burner lower part for burner cap ø 120mm | | | |

| | | | |
|---|---|-----------------|---------------------------------|
| stockpot stoves/boiling pan | | | |
|  <p>1</p> | | | |
| GEV No. | 105276 | Ref. No. | 1104400 1205900 MA1205900 |
| description | burner cap ø 225mm with central hole | | |
| For models: | FB1GS, FP1GS, MM10IG, P9D5G, P9I10G, P9I5G, P9IA10G, PD707G, PI707G | | |

| | | | |
|---|---|-----------------|----------------------|
|  <p>1</p> | | | |
| GEV No. | 105277 | Ref. No. | 1104300 MA1104300 |
| description | burner head for burner cap ø 225mm for stockpot stoves | | |
| For models: | FB1GS, FP1GS, MM10IG, P9D5G, P9I10G, P9I5G, P9IA10G, PD707G, PI707G | | |

| | | | |
|--|---|-----------------|---------------------------------|
|  <p>1</p> | | | |
| GEV No. | 105278 | Ref. No. | 1104600 1104612 MA1104612 |
| description | gasket for burner head | | |
| For models: | FB1GS, FP1GS, MM10IG, P9D5G, P9I10G, P9I5G, P9IA10G, PD707G, PI707G | | |

| | | | |
|---|---|-----------------|------------------------|
| pan supports | | | |
|  <p>1</p> | | | |
| GEV No. | 210019 | Ref. No. | CM018402 MACM018402 |
| description | pan support W 290mm L 345mm gas range suitable for 700 series | | |
| For models: | C712G, C74G, C78G, C7FE12G, C7FE8G, C7FG12G, C7FG8G, C7FG-M12G, C912G, C912GS, C94G, C94GP, C94GS, C98G, C98GP, C98GS, C9FE12G, C9FE12GS, C9FE8G, C9FE8GS, C9FG12G, C9FG12GS, C9FG16G, C9FG8G, C9FG8GP, C9FG8GS, C9FGM12G | | |



1

| | | | |
|--------------------|--|-----------------|--|
| GEV No. | 210151 | Ref. No. | 1032101100 1032101101 MA1032101100 MA1032101101 |
| description | pan support W 295mm L 545mm gas range | | |
| For models: | CFGE61, CFGE61D, CFGE61L, CFGE61P, OCFGE61, OPG41, OPG61, PCG41, PCG41L, PCG61, PCG61L | | |



1

| | | | |
|--------------------|---|-----------------|--|
| GEV No. | 210150 | Ref. No. | 1032101000 1032101001 MA1032101000 MA1032101001 |
| description | pan support W 340mm L 545mm | | |
| For models: | CFG101, CFG70, CFG70M, EC74GVG, EC78GVG, EC7FG8G, OCFG101, OCFG70, OPG41, OPG61, PCG41, PCG41L, PCG61, PCG61L | | |




1

| | | | |
|--------------------|--|-----------------|------------------------|
| GEV No. | 210000 | Ref. No. | CM018501 MACM018501 |
| description | pan support W 345mm L 345mm gas range suitable for 900 series suitable for MARENO | | |
| For models: | C124G, C129G, C12C2G9, C12C9G, C12FG9G, C712G, C74G, C78G, C7FE12G, C7FE8G, C7FG12G, C7FG8G, C7FGM12G, C912G, C912GS, C94G, C94GP, C94GS, C98G, C98GP, C98GS, C9FE12G, C9FE12GS, C9FE8G, C9FE8GS, C9FG12G, C9FG12GS, C9FG16G, C9FG8G, C9FG8GP, C9FG8GS, C9FGM12G | | |



1


| | | | |
|--------------------|--|-----------------|----------------------|
| GEV No. | 210103 | Ref. No. | 1316622 MA1316622 |
| description | pan support W 350mm L 400mm mounting pos. rear for 900 | | |
| For models: | C9F4GS, C9F6GS, C9F8GS, C9FE4GS, C9FE6GS, C9FE8GS, C9FEP4GS, C9FEP6GS, C9FEP8GS, C9FP4GS, C9FP6GS, C9FP8GS, C9V2GS, C9V4GS, C9V6GS, C9V8GS, C9VP2GS, C9VP4GS, C9VP6GS, C9VP8GS, PCG42, PCG82, T9F6GS, T9V6GS | | |



1

| | | | |
|--------------------|---|-----------------|----------------------------------|
| GEV No. | 210104 | Ref. No. | 13165-00 1316522 MA1316522 |
| description | pan support W 400mm L 430mm for 900 | | |
| For models: | C9F4GS, C9F6GS, C9F8GS, C9FE4GS, C9FE6GS, C9FE8GS, C9FEP4GS, C9FEP6GS, C9FEP8GS, C9FP4GS, C9FP6GS, C9FP8GS, C9SB4GS, C9V2GS, C9V4GS, C9V6GS, C9V8GS, C9VP2GS, C9VP4GS, C9VP6GS, C9VP8GS, CFG120, FB1GS, FB2GS, FB3GS, OCFG120, T9F6GS, T9V6GS | | |

reducers for pan supports



1

| | | | |
|--------------------|---|-----------------|------------------|
| GEV No. | 210001 | Ref. No. | 86400 MA86400 |
| description | reducer for pan support L 265mm W 265mm SS suitable for universal | | |
| For models: | 704S, 706S, C7011G, C7011GFE, C7011GFG, C704G, C707G, C707G-FE, C707GFG, C9F4GS, C9F6GS, C9F8GS, C9FEP4GS, C9FEP6GS, C9FEP8GS, C9FP4GS, C9FP6GS, C9FP8GS, C9SB4GS, C9V2GS, C9V4GS, C9V6GS, C9V8GS, C9VP4GS, C9VP6GS, C9VP8GS, TPF706S | | |

solid tops




1

| | | | |
|--------------------|--|-----------------|---|
| GEV No. | 104755 | Ref. No. | 13162-00 CM052300 MA1316200 MACM052300 |
| description | cast plate round ø 300mm suitable for MARENO T9FP-4G | | |
| For models: | ET78GVG, ET7FG8G, NT78G, NT7FG12G, NT7FG8G, NT98G, NT-9FG12G, NT9FG8G, T129G, T78G, T7FG12G, T7FG8G, T98G, T9F4G, T9F6GS, T9FE4G, T9FG12G, T9FG8G, T9FP4G, T9SB4G, T9V4G, T9V6GS, T9VP4G | | |




accessories

reducers for pan supports


| | | | |
|---|--|-----------------|------------------|
|  | | | |
| 1 | | | |
| GEV No. | 210001 | Ref. No. | 86400 MA86400 |
| description | reducer for pan support L 265mm W 265mm SS suitable for universal | | |
| For models: | 704S, 706S, C7011G, C7011GFE, C7011GFG, C704G, C707G, C707GFE, C707GFG, C9F4GS, C9F6GS, C9F8GS, C9FEP4GS, C9FEP6GS, C9FEP8GS, C9FP4GS, C9FP6GS, C9FP8GS, C9SB4GS, C9V2GS, C9V4GS, C9V6GS, C9V8GS, C9VP4GS, C9VP6GS, C9VP8GS, TPF706S | | |


pan supports

| | | | |
|---|--|-----------------|------------------------|
|  | | | |
| 1 | | | |
| GEV No. | 210019 | Ref. No. | CM018402 MACM018402 |
| description | pan support W 290mm L 345mm gas range suitable for 700 series | | |
| For models: | C712G, C74G, C78G, C7FE12G, C7FE8G, C7FG12G, C7FG8G, C7FGM12G, C912G, C912GS, C94G, C94GP, C94GS, C98G, C98GP, C98GS, C9FE12G, C9FE12GS, C9FE8G, C9FE8GS, C9FG12G, C9FG12GS, C9FG16G, C9FG8G, C9FG8GP, C9FG8GS, C9FGM12G | | |

| | | | |
|---|--|-----------------|--|
|  | | | |
| 1 | | | |
| GEV No. | 210151 | Ref. No. | 1032101100 1032101101 MA1032101100 MA1032101101 |
| description | pan support W 295mm L 545mm gas range | | |
| For models: | CFGE61, CFGE61D, CFGE61L, CFGE61P, OCFGE61, OPCG41, OPCG61, PCG41, PCG41L, PCG61, PCG61L | | |


| | | | |
|---|---|-----------------|--|
|  | | | |
| 1 | | | |
| GEV No. | 210150 | Ref. No. | 1032101000 1032101001 MA1032101000 MA1032101001 |
| description | pan support W 340mm L 545mm | | |
| For models: | CFG101, CFG70, CFG70M, EC74GVG, EC78GVG, EC7FG8G, OCFG101, OCFG70, OPCG41, OPCG61, PCG41, PCG41L, PCG61, PCG61L | | |


| | | | |
|--|--|-----------------|------------------------|
|  | | | |
| 1 | | | |
| GEV No. | 210000 | Ref. No. | CM018501 MACM018501 |
| description | pan support W 345mm L 345mm gas range suitable for 900 series suitable for MARENO | | |
| For models: | C124G, C129G, C12C2G9, C12C9G, C12FG9G, C712G, C74G, C78G, C7FE12G, C7FE8G, C7FG12G, C7FG8G, C7FGM12G, C912G, C912GS, C94G, C94GP, C94GS, C98G, C98GP, C98GS, C9FE12G, C9FE12GS, C9FE8G, C9FE8GS, C9FG12G, C9FG12GS, C9FG16G, C9FG8G, C9FG8GP, C9FG8GS, C9FGM12G | | |


| | | | |
|--|--|-----------------|----------------------|
|  | | | |
| 1 | | | |
| GEV No. | 210103 | Ref. No. | 1316622 MA1316622 |
| description | pan support W 350mm L 400mm mounting pos. rear for 900 | | |
| For models: | C9F4GS, C9F6GS, C9F8GS, C9FE4GS, C9FE6GS, C9FE8GS, C9FEP4GS, C9FEP6GS, C9FEP8GS, C9FP4GS, C9FP6GS, C9FP8GS, C9V2GS, C9V4GS, C9V6GS, C9V8GS, C9VP2GS, C9VP4GS, C9VP6GS, C9VP8GS, PCG42, PCG82, T9F6GS, T9V6GS | | |

| | | | |
|--|---|-----------------|----------------------------------|
|  | | | |
| 1 | | | |
| GEV No. | 210104 | Ref. No. | 13165-00 1316522 MA1316522 |
| description | pan support W 400mm L 430mm for 900 | | |
| For models: | C9F4GS, C9F6GS, C9F8GS, C9FE4GS, C9FE6GS, C9FE8GS, C9FEP4GS, C9FEP6GS, C9FEP8GS, C9FP4GS, C9FP6GS, C9FP8GS, C9SB4GS, C9V2GS, C9V4GS, C9V6GS, C9V8GS, C9VP2GS, C9VP4GS, C9VP6GS, C9VP8GS, CFG120, FB1GS, FB2GS, FB3GS, OCFG120, T9F6GS, T9V6GS | | |

air mixers

| | | | |
|---|--|-----------------|-----------|
|  | | | |
| 1 | | | |
| GEV No. | 106804 | Ref. No. | CR0508690 |
| description | air mixer | | |
| For models: | FQG41, FQG61, NF74G8, NF76G8, OFQG41, OFQG61 | | |


| | | | |
|---|--|-----------------|-----------|
|  | | | |
| 1 | | | |
| GEV No. | 106805 | Ref. No. | CR0508400 |
| description | air mixer | | |
| For models: | EF74G8VA, EF74G8VG, FQG41, FQG61, NF74G8, NF76G8, OFQG41, OFQG61 | | |


| | | | |
|---|---|-----------------|------------------------|
|  | | | |
| 1 | | | |
| GEV No. | 106066 | Ref. No. | CM136600 MACM136600 |
| description | air mixing tube dimensions 18x42mm ED ø 24mm | | |
| For models: | EFT74GLVG, EFT74GRVG, EFT78GLVG, EFT78GMVG, FT12C9GL, FT12C9GM, FT12C9GTLG, FT12C9GTMC, FT74GL, FT74GLC, FT74GR, FT74GRC, FT76GL, FT76GLC, FT76GM, FT76GMC, FT76GR, FT78GL, FT78GLC, FT78GLT, FT78GM, FT78GMC, FT78GMT, FT78GR, FT78GRT, FT94G, FT94GL, FT94GLC, FT94GR, FT94GRC, FT96GL, FT96GLC, FT96GM, FT96GMC, FT96GR, FT98GL, FT98GLC, FT98GLT, FT98GM, FT98GMC, FT98GMT, FT98GR, FT98GRT | | |


bar burners


bar burners

| | | | |
|---|---|-----------------|-----------|
|  | | | |
| 1 | | | |
| GEV No. | 108098 | Ref. No. | R63016520 |
| description | bar burner 1-row L 440mm ø 50mm flange width 57mm flange length 57mm MG110, VG110 | | |
| For models: | GC110M, GM110H, GM110M, GM110M+SC, GM110P, GV110H, GV110M, GV110M+SC, GV110P | | |


| | | | |
|---|---|-----------------|-----------|
|  | | | |
| 1 | | | |
| GEV No. | 105831 | Ref. No. | R63016050 |
| description | bar burner 2 row L 425mm Wmm ø 40mm Hmm flange width 43mm flange length 43mm combi-steamer MG106, VG106 | | |
| For models: | MG106M, MG106P, MG106X, VG106M, VG106P, VG106X | | |


| | | | |
|---|---|-----------------|---|
|  | | | |
| 1 | | | |
| GEV No. | 104156 | Ref. No. | 1031501400 1828100 1828112 MA1828112 |
| description | bar burner 2 row L 445mm W 200mm ømm H 50mm chargrill stainless steel | | |
| For models: | GB704G, GB707G, GB92G, GB94G, OPLG40, OPLG80, PLG40, PLG80 | | |

| | | | |
|--|---|-----------------|----------------------------|
|  | | | |
| 1 | | | |
| GEV No. | 105260 | Ref. No. | 1031504600 MA1031504600 |
| description | bar burner 2 row L 450mm W 300mm ømm H 50mm 8.5kW griddle | | |


| | | | |
|--|--|-----------------|-----------|
|  | | | |
| 1 | | | |
| GEV No. | 105827 | Ref. No. | R63016060 |
| description | bar burner 2 row L 485mm W 160mm ø 40mm H 90mm combi-steamer MG106 | | |
| For models: | MG106M, MG106P, MG106X | | |

| | | | |
|--|---|-----------------|------------------------|
|  | | | |
| 1 | | | |
| GEV No. | 105490 | Ref. No. | CM081302 MACM081302 |
| description | bar burner 2 row L 485mm W 190mm ømm H 55mm griddle | | |
| For models: | FT12C9GL, FT12C9GM, FT12C9GTLG, FT12C9GTMC, FT74GL, FT74GLC, FT74GR, FT74GRC, FT76GL, FT76GLC, FT76GM, FT76GMC, FT76GR, FT78GL, FT78GLC, FT78GLT, FT78GM, FT78GMC, FT78GMT, FT78GR, FT78GRT, FT94G, FT94GL, FT94GLC, FT94GR, FT94GRC, FT96GL, FT96GLC, FT96GM, FT96GMC, FT96GR, FT98GL, FT98GLC, FT98GLT, FT98GM, FT98GMC, FT98GMT, FT98GR, FT98GRT | | |


| | | | |
|--|---|-----------------|------------------------|
|  | | | |
| 1 | | | |
| GEV No. | 105494 | Ref. No. | CM203100 MACM203100 |
| description | bar burner 2 row L 525mm W 200mm ømm H 65mm chargrill | | |
| For models: | GL12C4G, GL12C9G, GL74G, GL78G, NGL74G, NGL78G | | |

| | | | |
|--|---|-----------------|-----------|
|  | | | |
| 1 | | | |
| GEV No. | 105845 | Ref. No. | R63015280 |
| description | bar burner 2 row L 550mm W 165mm ø 50mm H 85mm combi-steamer MG21 | | |
| For models: | FG110M, FG110X, PG080M, PG080X | | |



| | | | |
|---|--|-----------------|-----------|
|  | | | |
| GEV No. | 105834 | Ref. No. | R63016090 |
| description | bar burner 2 row L 575mm W 240mm ø 50mm H 110mm combi-steamer MG210, VG210 | | |
| For models: | MG210M, MG210P, MG210X, VG210M, VG210P, VG210X | | |


| | | | |
|---|---|-----------------|------------------------|
|  | | | |
| GEV No. | 105491 | Ref. No. | CM033503 MACM033503 |
| description | bar burner 2 row L 665mm W 190mm ømm H 55mm griddle chrome-plated | | |
| For models: | FT74GL, FT74GLC, FT74GR, FT74GRC, FT76GL, FT76GLC, FT76GM, FT76GMC, FT76GR, FT78GL, FT78GLC, FT78GLT, FT78GM, FT78GMC, FT78GMT, FT78GR, FT78GRT, FT94G, FT94GL, FT94GLC, FT94GR, FT94GRC, FT96GL, FT96GLC, FT96GM, FT96GMC, FT96GR, FT98GL, FT98GLC, FT98GLT, FT98GM, FT98GMC, FT98GMT, FT98GR, FT98GRT | | |


| | | | |
|--|---|-----------------|------------------------|
|  | | | |
| GEV No. | 105495 | Ref. No. | CM201900 MACM201900 |
| description | bar burner 2 row L 695mm W 200mm ømm H 65mm chargrill stainless steel | | |
| For models: | GL94G, GL98G | | |


| | | | |
|---|---|-----------------|------------------------|
|  | | | |
| GEV No. | 105492 | Ref. No. | CM081402 MACM081402 |
| description | bar burner 3 row L 484mm W 340mm ømm H 55mm griddle | | |
| For models: | FT74GL, FT74GLC, FT74GR, FT74GRC, FT76GL, FT76GLC, FT76GM, FT76GMC, FT76GR, FT78GL, FT78GLC, FT78GLT, FT78GM, FT78GMC, FT78GMT, FT78GR, FT78GRT, FT94G, FT94GL, FT94GLC, FT94GR, FT94GRC, FT96GL, FT96GLC, FT96GM, FT96GMC, FT96GR, FT98GL, FT98GLC, FT98GLT, FT98GM, FT98GMC, FT98GMT, FT98GR, FT98GRT | | |


| | | | |
|--|--|-----------------|------------------------|
|  | | | |
| GEV No. | 105493 | Ref. No. | CM079801 MACM079801 |
| description | bar burner 3 row L 650mm W 340mm ømm H 55mm griddle | | |
| For models: | FT129GLC, FT129GM, FT74GL, FT74GLC, FT74GR, FT74GRC, FT76GL, FT76GLC, FT76GM, FT76GMC, FT76GR, FT78GL, FT78GLC, FT78GLT, FT78GM, FT78GMC, FT78GMT, FT78GR, FT78GRT, FT94G, FT94GL, FT94GLC, FT94GR, FT94GRC, FT96GL, FT96GLC, FT96GM, FT96GMC, FT96GR, FT98GL, FT98GLC, FT98GLT, FT98GM, FT98GMC, FT98GMT, FT98GR, FT98GRT, PM129G | | |


| | | | |
|--|---|-----------------|------------------------------------|
|  | | | |
| GEV No. | 105519 | Ref. No. | CM069900 CM069901 MACM069901 |
| description | bar burner 6 row L 350mm W 618mm ømm H 60mm tilting bratt pan | | |
| For models: | BR78GF, BR78GI | | |


| | | | |
|---|--|-----------------|--|
|  | | | |
| GEV No. | 105520 | Ref. No. | CM070003 CM070003R MACM070003 MACM070003R |
| description | bar burner 6 row L 520mm W 620mm ømm H 60mm tilting bratt pan | | |
| For models: | BR78EF, BR78EI, BR912EFM, BR912EIM, BR912GFM, BR912GIM, BR98EF, BR98EFM, BR98EI, BR98EIM, BR98GF, BR98GFM, BR98GI, BR98GIM, BR9S8EF, BR9S8EI, BR9S8GF, BR9S8GI | | |


| | | | |
|--|--|-----------------|------------------------------------|
|  | | | |
| GEV No. | 105521 | Ref. No. | CM070100 CM070103 MACM070103 |
| description | bar burner 8 row L 520mm W 1010mm ømm H 60mm tilting bratt pan | | |
| For models: | BR912GFM, BR912GIM, BR98GF, BR98GFM, BR98GI, BR98GIM, BR9S8GF, BR9S8GI | | |


| | | | |
|--|---|-----------------|----------------------|
|  | | | |
| GEV No. | 105486 | Ref. No. | 1664300 MA1664300 |
| description | bar burner angled L 440mm W 200mm ømm Hmm oven | | |
| For models: | C7011GFG, C707GFE, C707GFG, CFG101, CFG101D, CFG101L, CFG101P, CFG120, CFG70, CFG70D, CFG70L, CFG70M, CFG70P, EC74G-VG, EC78GVG, EC7FG8G, OCFG101, OCFG120, OCFG70, T7011GFG, T707GFG | | |


| | | | |
|---|--|-----------------|---------|
|  | | | |
| GEV No. | 105513 | Ref. No. | 1845614 |
| description | bar burner angled L 505mm W 145mm ømm Hmm bain marie | | |
| For models: | BM74G, BM77G | | |


| | | | |
|---|--|-----------------|---------------------------------|
|  | | | |
| GEV No. | 105487 | Ref. No. | 1305012 1305024 MA1305024 |
| description | bar burner angled L 610mm W 380mm ømm Hmm oven | | |
| For models: | C9F4E, C9F4G, C9F4GS, C9F6E, C9F6G, C9F6GS, C9F8G, C9F8GS, C9FP, C9FP4GS, C9FP6GS, C9FP8GS, T9F4G, T9F6G, T9F6GS, T9FP, T9FP4G | | |


| | | | |
|--|--------------------------------|-----------------|-----------|
|  Image not available | | | |
| GEV No. | 105828 | Ref. No. | R63016080 |
| description | bar burner combi-steamer MG110 | | |
| For models: | MG110M, MG110P, MG110X | | |


| | | | |
|--|--|-----------------|-----------|
|  Image not available | | | |
| GEV No. | 105829 | Ref. No. | R63016100 |
| description | bar burner combi-steamer MG120/210 | | |
| For models: | MG120M, MG120P, MG120X, MG210M, MG210P, MG210X, MGC20X, MGC24H | | |


| | | | |
|--|--------------------------------|-----------------|-----------|
|  Image not available | | | |
| GEV No. | 105830 | Ref. No. | R63016130 |
| description | bar burner combi-steamer MG220 | | |
| For models: | MG220M, MG220P, MG220X, MGC40H | | |


| | | | |
|--|--------------------------------|-----------------|-----------|
|  Image not available | | | |
| GEV No. | 105846 | Ref. No. | R63015270 |
| description | bar burner combi-steamer PG04 | | |
| For models: | FG105M, FG105X, PG040M, PG040X | | |

| | | | |
|---|--|-----------------|-----------|
|  Image not available | | | |
| GEV No. | 105832 | Ref. No. | R63016070 |
| description | bar burner convection oven MG110, VG190 | | |
| For models: | MG110M, MG110P, MG110X, VG110M, VG110P, VG110X | | |


| | | | |
|---|--|-----------------|-----------|
|  Image not available | | | |
| GEV No. | 105833 | Ref. No. | R63016110 |
| description | bar burner convection oven MG120, VG120 | | |
| For models: | MG120M, MG120P, MG120X, MGC20X, VG120M, VG120P, VG120X | | |


| | | | |
|---|--|-----------------|-----------|
|  Image not available | | | |
| GEV No. | 105835 | Ref. No. | R63016120 |
| description | bar burner convection oven MG220, VG220 | | |
| For models: | MG220M, MG220P, MG220X, MGC24H, MGC40H, VG220M, VG220P, VG220X | | |


| | | | |
|---|---------------------------------|-----------------|-----------|
|  Image not available | | | |
| GEV No. | 105847 | Ref. No. | R63015260 |
| description | bar burner convection oven PG12 | | |
| For models: | FG210M, FG210X | | |


| | | | |
|---|--|-----------------|------------------------|
|  | | | |
| GEV No. | 105515 | Ref. No. | CM140600 MACM140600 |
| description | bar burner ø 40mm Wmm Hmm L 250mm flange ø 61mm bain marie | | |
| For models: | B74G, B78G, B94G, B98G, NB74G, NB78G, NB94G, NB98G | | |




| | | | |
|---|---|-----------------|----------------------|
|  | | | |
| 1 | | | |
| GEV No. | 104154 | Ref. No. | 1685400 MA1685400 |
| description | bar burner ø 40mm Wmm Hmm L 345mm 3.5kW griddle | | |
| For models: | BR707G, BR707GI, FT12G7L70, FT12G7LC70, FT12G7R70, FT-12G7RC70, FT12G7RL70, FT12G7RLC70, FT6G4L70, FT6G4LC70, FT6G4R70, FT6G4RC70 | | |


| | | | |
|--|--|-----------------|----------------------|
|  | | | |
| 1 | | | |
| GEV No. | 104243 | Ref. No. | 1833100 MA1833100 |
| description | bar burner ø 50mm Wmm Hmm L 260mm flange width 52mm flange ø 75mm with bolt M5x12 pasta cooker | | |
| For models: | CP704G | | |


| | | | |
|---|---|-----------------|----------------------------|
|  | | | |
| 1 | | | |
| GEV No. | 104240 | Ref. No. | 1031501000 MA1031501000 |
| description | bar burner ø 40mm Wmm Hmm L 400mm flange ø 61mm 1-row chargrill with bolt M5x12 | | |
| For models: | BIG40, BIG60, FTG40B, FTG40BLC, FTG40BR, FTG60B, FTG60BLC, FTG60BR, FTG60BRR, FTG80B, FTG80BLC, FTG80BR | | |

| | | | |
|--|---|-----------------|------------------------|
|  | | | |
| 1 | | | |
| GEV No. | 105498 | Ref. No. | CM088200 MACM088200 |
| description | bar burner ø 50mm Wmm Hmm L 308mm flange width 71mm flange ø 75mm pasta cooker | | |
| For models: | EPC74G, NPC74G, NPC78G, NPD76G5, NPD78G8, NPD96G5, NPI76G5, NPI78G8, NPI96G5, PC12C4G, PC74G, PC76G, PC78G, PC94G, PC96G, PC98G, PC9S4G, PC9S6G, PC9S8G, PD76G5, PD96G5, PI76G5, PI96G5 | | |


| | | | |
|--|--|-----------------|----------------------|
|  | | | |
| 1 | | | |
| GEV No. | 104153 | Ref. No. | 1475100 MA1475100 |
| description | bar burner ø 40mm Wmm Hmm L 480mm with retainer for nozzle rod tilting bratt pan | | |
| For models: | BR94G, BR94GI, BR96G, BR96GI, BR9M4G, BR9M4GI, BR9M6G, BR9M-6GI, BR9SB4G, BR9SB4GI, FT14G8L90, FT14G8LC90, FT14G8R2L90, FT14G8R2LC90, FT14G8R90, FT14G8RC90, FT7G4L90, FT7G4LC90, FT7G4R90, FT7G4RC90, MS10AG, MS10IG, MS70AG, MS70IG, MS70IGS | | |


| | | | |
|---|--|-----------------|---------------------------------|
|  | | | |
| 1 | | | |
| GEV No. | 104244 | Ref. No. | 2708500 2708514 MA2708514 |
| description | bar burner ø 50mm Wmm Hmm L 410mm flange width 52mm flange ø 75mm kettle | | |
| For models: | CP92G, CP94G, CP9SB2G, CP9SB4G, FC10G, FC20G, FC5G, FC7G, MM10DG, MM10DGS, MM10IG, MM15DG, P9D10G, P9D15G, P9D2G, P9DA10G, P9DA15G, P9DASB10G, P9DSB10G, P9I10G, P9IA10G, PDASB10G | | |

| | | | |
|---|--|-----------------|------------------------|
|  | | | |
| 1 | | | |
| GEV No. | 105516 | Ref. No. | CM140700 MACM140700 |
| description | bar burner ø 40mm Wmm Hmm L 600mm flange ø 61mm bain marie | | |
| For models: | B74G, B78G, B94G, B98G, NB74G, NB78G, NB94G, NB98G | | |


| | | | |
|--|---|-----------------|----------------------|
|  | | | |
| 1 | | | |
| GEV No. | 105730 | Ref. No. | 2862914 MA2862914 |
| description | bar burner ø 50mm Wmm Hmm L 460mm flange width 52mm flange ø 75mm with bolt M5x12 combi-steamer for convection oven with 10 grids 1/1 | | |
| For models: | CON6G, CON6GP, CSM6G, CSM6GP | | |





| | | | |
|---|--|-----------------|------------------------|
|  | | | |
| 1 | | | |
| GEV No. | 105523 | Ref. No. | CM088100 MACM088100 |
| description | bar burner ø 50mm Wmm Hmm L 475mm flange ø 75mm | | |
| For models: | NPC76G, NPC94G, NPC96G, NPC98G, NPD98G10, NPD98G15, NPD-98G15A, NPI98G10, NPI98G14, NPI98G14A, PC12C9G, PC74G, PC76G, PC78G, PC94G, PC96G, PC98G, PC9S4G, PC9S6G, PC9S8G, PD98G10, PD98G15, PD98G15A, PD9S8G10, PI98G10, PI98G14, PI98G14A | | |


| | | | |
|---|--|-----------------|------------------------|
|  | | | |
| 1 | | | |
| GEV No. | 105488 | Ref. No. | CM021402 MACM021402 |
| description | bar burner ø 50mm Wmm Hmm L 590mm flange width 71mm flange ø 75mm 8.5kW oven | | |
| For models: | BF78G, BF912G, BF912GH, BF98G, C7FG12G, C7FG8G, C7FGM12G, C9FG12G, C9FG16G, C9FG8G, C9FG8GP, C9FGM12G, NC7FGM12G, T7FG12G, T7FG8G, T9FG12G, T9FG8G | | |

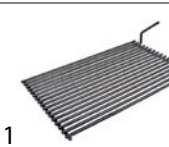
| | | | |
|---|---|-----------------|----------------------|
|  | | | |
| 1 | | | |
| GEV No. | 105735 | Ref. No. | 5163800 MA5163800 |
| description | bar burner ø 50mm Wmm Hmm L 480mm flange width 52mm flange ø 75mm with bolt M5x12 combi-steamer for boiler 10 grids 1/1 | | |
| For models: | CSM10G, CSM10GP | | |

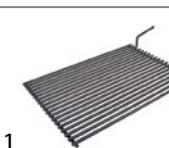
| | | | |
|---|--|-----------------|----------------------------|
|  | | | |
| 1 | | | |
| GEV No. | 104150 | Ref. No. | 1031002300 MA1031002300 |
| description | bar burner ømm W 28mm H 42mm L 340mm flange width 40mm flange length 54mm with bolt M5x25 4.65kW tilting bratt pan | | |
| For models: | BMG40, BMG60, BRG40, BRG40G | | |

| | | | |
|--|--|-----------------|----------------------|
|  | | | |
| 1 | | | |
| GEV No. | 105734 | Ref. No. | 2862614 MA2862614 |
| description | bar burner ø 50mm Wmm Hmm L 480mm flange width 52mm flange ø 75mm with bolt M5x12 combi-steamer for boiler 6 grids 1/1 | | |
| For models: | CP9A15GD, CSM6G, CSM6GP | | |


| | | | |
|--|--|-----------------|--|
|  | | | |
| 1 | | | |
| GEV No. | 105255 | Ref. No. | 1031504500 MA1031504500 SIR0109046 |
| description | bar burner ømm W 41mm H 34mm L 490mm flange width 70mm 5.5kW griddle | | |
| For models: | EFT74GLVG, EFT74GRVG, EFT78GLVG, EFT78GMVG | | |


| | | | |
|---|--|-----------------|-----------|
|  | | | |
| 1 | | | |
| GEV No. | 103077 | Ref. No. | CR0684490 |
| description | bar burner ø 50mm Wmm Hmm L 490mm flange width 52mm flange length 75mm fryer | | |
| For models: | NF74G10, NF74G15, NF76G10, NF78G15, NF94G15, NF96G10, NF98G15 | | |


| | | | |
|---|--|-----------------|----------------------------|
|  | | | |
| 1 | | | |
| GEV No. | 210257 | Ref. No. | 1041301200 MA1041301200 |
| description | chargrill grid L 500mm W 330mm | | |
| For models: | GB704G, GB707G, GB92G, GB94G, OPLG40, OPLG80, PLG40, PLG80 | | |

| | | | |
|---|--|-----------------|----------------------------|
|  | | | |
| 1 | | | |
| GEV No. | 210258 | Ref. No. | 1041301900 MA1041301900 |
| description | chargrill grid L 500mm W 370mm | | |
| For models: | GB704G, GB707G, GB92G, GB94G, GL12C4G, GL12C9G, GL74G, GL78G, NGL74G, NGL78G, OPLG40, OPLG80, PLG40, PLG80 | | |





| | | | |
|--|--|-----------------|----------------------|
|  <p>1</p> | | | |
| GEV No. | 211029 | Ref. No. | 1829522 MA1829522 |
| description | lava rock grid L 464mm W 310mm | | |
| For models: | GB704G, GB707G, GB92G, GB94G, OPLG40, OPLG80, PLG40, PLG80 | | |

| | | | |
|--|--|-----------------|------------------------|
|  <p>1</p> | | | |
| GEV No. | 211030 | Ref. No. | CM207900 MACM207900 |
| description | lava rock grid L 465mm W 325mm | | |
| For models: | GL12C4G, GL12C9G, GL74G, GL78G, NGL74G, NGL78G | | |


| | | | |
|--|--|-----------------|------------------------|
|  <p>1</p> | | | |
| GEV No. | 211031 | Ref. No. | CM209400 MACM209400 |
| description | lava rock grid L 630mm W 325mm stainless steel | | |
| For models: | GL94G, GL98G | | |


chargrill grids


| | | | |
|--|--|-----------------|----------------------------|
|  <p>1</p> | | | |
| GEV No. | 210257 | Ref. No. | 1041301200 MA1041301200 |
| description | chargrill grid L 500mm W 330mm | | |
| For models: | GB704G, GB707G, GB92G, GB94G, OPLG40, OPLG80, PLG40, PLG80 | | |

| | | | |
|--|--|-----------------|----------------------------|
|  <p>1</p> | | | |
| GEV No. | 210258 | Ref. No. | 1041301900 MA1041301900 |
| description | chargrill grid L 500mm W 370mm | | |
| For models: | GB704G, GB707G, GB92G, GB94G, GL12C4G, GL12C9G, GL74G, GL78G, NGL74G, NGL78G, OPLG40, OPLG80, PLG40, PLG80 | | |

lava rock grids


| | | | |
|---|--|-----------------|----------------------|
|  <p>1</p> | | | |
| GEV No. | 211029 | Ref. No. | 1829522 MA1829522 |
| description | lava rock grid L 464mm W 310mm | | |
| For models: | GB704G, GB707G, GB92G, GB94G, OPLG40, OPLG80, PLG40, PLG80 | | |

| | | | |
|---|--|-----------------|------------------------|
|  <p>1</p> | | | |
| GEV No. | 211030 | Ref. No. | CM207900 MACM207900 |
| description | lava rock grid L 465mm W 325mm | | |
| For models: | GL12C4G, GL12C9G, GL74G, GL78G, NGL74G, NGL78G | | |

| | | | |
|---|--|-----------------|------------------------|
|  <p>1</p> | | | |
| GEV No. | 211031 | Ref. No. | CM209400 MACM209400 |
| description | lava rock grid L 630mm W 325mm stainless steel | | |
| For models: | GL94G, GL98G | | |

tube burners


| | | | |
|---|---|-----------------|----------------------|
|  <p>1</p> | | | |
| GEV No. | 105517 | Ref. No. | 1450000 MA1450000 |
| description | tubular burner L 295mm W 59mm H 55mm for fryer oval | | |
| For models: | FR74G, FR77G, FR92G13, FR92G22, FR92G22T, FR94G13, FR94G22, FR94G22T, FR94G23 | | |

| | | | |
|---|---|-----------------|------------------------|
|  <p>1</p> | | | |
| GEV No. | 105518 | Ref. No. | CM011401 MACM011401 |
| description | tubular burner L 310mm W 49mm H 73mm for fryer oval | | |
| For models: | EF74G15, F12C4G15, F74G10, F74G15, F74G6, F76G10, F78G15, F94G10, F94G15, F94G22, F94G22K, F94G6, F96G10, F98G15, F98G22, F98G22K, F954G15, F954G22, F954G22K, F958G15, F958G22, F958G22K, NF74G15T, NF78G15T | | |



1


| | | | |
|--------------------|---|-----------------|--|
| GEV No. | 104241 | Ref. No. | 1032001200 1032001212 MA1032001212 |
| description | tubular burner ø 67mm L 165mm H 44mm mounting pos. left round for fryer | | |
| For models: | FQG40, FQG60 | | |



1

| | | | |
|--------------------|--|-----------------|------------|
| GEV No. | 104242 | Ref. No. | 1032001300 |
| description | tubular burner ø 67mm L 165mm H 44mm mounting pos. right round for fryer | | |
| For models: | FQG40, FQG60 | | |

solid top burners



1


| | | | |
|--------------------|--|-----------------|------------------------|
| GEV No. | 105485 | Ref. No. | CM002900 MACM002900 |
| description | solid top burner ø 65mm H 102mm L 284mm | | |
| For models: | ET78G8G, ET7FG8G, NS78GS, NS7FG8GS, NT78G, NT7FG12G, NT7FG8G, S78GD, S78GS, S7FG8GD, S7FG8GS, T78G, T7FG12G, T7FG8G, T98G, T9FG12G, T9FG8G | | |

forced air burners



1

| | | | |
|--------------------|--|-----------------|-----------|
| GEV No. | 104309 | Ref. No. | R63140020 |
| description | gasket L 106mm W 100mm H 3mm 4 holes | | |
| For models: | GMT20D, GVT20D, MACG10M, MACG20M, MG101D, MG101M, MG101P, MG101T, MG102D, MG102M, MG102P, MG102T, MG201D, MG201M, MG201P, MG201T, MG202D, MG202M, MG202P, MG202T, MGMT10D, MGMT10P, MGMT20D, MGMT20P, MGMT21D, MGMT21P, MGMT40D, MGMT40P, MGVT10D, MGVT10P, MGVT20D, MGVT20P, MGVT21D, MGVT21P, MGVT40D, MGVT40P | | |



1

| | | | |
|--------------------|--------------------------------------|-----------------|-----------|
| GEV No. | 104314 | Ref. No. | R63140060 |
| description | gasket L 108mm W 103mm H 3mm 6 holes | | |
| For models: | GMT20D, GVT20D, MACG10M, MACG20M | | |



1

| | | | |
|--------------------|--|-----------------|-------------------------------------|
| GEV No. | 108149 | Ref. No. | R63120020 R63120030 R63120040 |
| description | venturi for combi-steamer LAINOX | | |
| For models: | GMT06D, GMT20D, GVT06D, GVT20D, MACG05M, MACG07M, MACG20M, MG061D, MG061M, MG061P, MG061T, MG102D, MG102M, MG102P, MG102T, MG201D, MG201M, MG201P, MG201T, MG202D, MG202M, MG202P, MG202T, MGMT06D, MGMT06P, MGMT20D, MGMT20P, MGMT21D, MGMT21P, MGMT40D, MGMT40P, MGVT06D, MGVT06P, MGVT20D, MGVT20P, MGVT21D, MGVT21P, MGVT40D, MGVT40P, MVG051P | | |

accessories


gaskets



1

| | | | |
|--------------------|---|-----------------|-----------|
| GEV No. | 510254 | Ref. No. | R63140000 |
| description | gasket L 77mm W 70mm H 3mm hole ø 7mm hole distance 55x60mm graphite for gas burner | | |
| For models: | GMT06D, GVT06D, MACG05M, MACG07M, MG061D, MG061M, MG061P, MG061T, MGMT06D, MGMT06P, MGVT06D, MGVT06P, MVG051P | | |

nozzle holders



1







| | | | |
|---|--|-----------------|---|
| GEV No. | 105230 | Ref. No. | 1033717200 MA1033717200 |
| description | nozzle holder | | |
| For models: | C74GS, C78GS, C79G, C7FE12GS, C7FE8GS, C7FG12GS, C7FG8GS, C7FG9G, CFG70, CFG70M, CFGE61, CFGE61D, CFGE61L, CFGE61P, EC74G8G, EC78G8G, EC7FG8G, OCFGE61, OPCG41, OPCG61, PCG41, PCG41L, PCG61, PCG61L | | |
| accessories for | 105230 | | |
|  | GEV No. | 103140 | Ref. No. |
| | | | 1032101400 1032101422 CRO795730 MA1032101400 |
| | burner head seat ø 75mm for burner cap ø 85mm 3.5kW | | |









Table continues overleaf



| | | | | |
|---|---------|--------|----------|----------------------------|
| accessories for 105230 | | | | |
|  | GEV No. | 103141 | Ref. No. | 1032101500 |
| burner head ø 95mm suitable for burner 5.5kW | | | | |
|  | GEV No. | 103146 | Ref. No. | 1032101200 MA1032101200 |
| burner lower part for burner cap ø 85mm 3.5kW | | | | |
|  | GEV No. | 103147 | Ref. No. | 1032101300 MA1032101300 |
| burner lower part for burner cap ø 95mm 5.5/7kW | | | | |
|  | GEV No. | 107143 | Ref. No. | CM297300 MACM297300 |
| burner head for burner cap ø 95mm 5.5kW | | | | |

| | | | | |
|---|---|----------|--|---------------------------------|
|  | | | | |
| 1 | | | | |
| GEV No. | 105052 | Ref. No. | 1306400 1306600 1306615 MA1306615 | |
| description | nozzle holder ID ø 10mm nozzle mounting M10x1 | | | |
| For models: | B9SB2G, B9SB4G, B9V2G, B9V4G, C7011G, C7011GFE, C7011GFG, C704G, C707G, C707GFE, C707GFG, C9F4E, C9F4G, C9F4GS, C9F6E, C9F6G, C9F6GS, C9F8G, C9F8GS, C9FP, C9FP4GS, C9FP6GS, C9FP8GS, C9SB4GS, C9V2G, C9V2GS, C9V4G, C9V4GS, C9V6G, C9V6GS, C9V8G, C9V8GS, CFG101, CFG101D, CFG101L, CFG101P, CFG120, CFG70, CFG70D, CFG70L, CFG70M, CFG70P, EC74GVG, EC78GVG, EC7FG8G, FB1GS, FB2GS, FB3GS, FP1GS, FT74G...(Other models you can see in the webshop) | | | |
| accessories for 105052 | | | | |
|  | GEV No. | 100469 | Ref. No. | 521611 MA521611 |
| gas injector thread M10x1 WS 12 bore ø 1.15mm | | | | |
|  | GEV No. | 100478 | Ref. No. | 522811 MA522811 |
| gas injector thread M10x1 WS 12 bore ø 1.75mm | | | | |
|  | GEV No. | 103150 | Ref. No. | 1315812 1892500 MA1892500 |
| burner lower part for burner cap ø 110/120mm | | | | |
|  | GEV No. | 104030 | Ref. No. | 1315412 1315422 MA1315422 |
| burner head for burner cap ø 80mm | | | | |
|  | GEV No. | 104031 | Ref. No. | 1315512 1315522 MA1315522 |
| burner head for burner cap ø 110mm | | | | |
|  | GEV No. | 104032 | Ref. No. | 1315912 1315922 MA1315922 |
| burner head for burner cap ø 120mm | | | | |
|  | GEV No. | 104033 | Ref. No. | 1315200 |
| burner lower part for burner cap ø 80mm 1. generation | | | | |
|  | GEV No. | 104034 | Ref. No. | 1315300 1315312 MA1315300 |
| burner lower part for burner cap ø 110mm | | | | |


| | | | | |
|---|---------|--------|----------|----------------------|
| accessories for 105052 | | | | |
|  | GEV No. | 105051 | Ref. No. | 1314700 MA1314700 |
| air mixing sleeve L 45mm ED ø 45mm ID ø 42mm aluminium | | | | |

| | | | | |
|---|---|----------|----------------------|------------------------|
|  | | | | |
| 1 | | | | |
| GEV No. | 105267 | Ref. No. | 1781800 MA1781800 | |
| description | nozzle holder nozzle M10x1 M14x1 screw pipe fitting M16x1.5 tube ø 10mm | | | |
| For models: | C124G, C129G, C12C2G9, C12C9G, C12FG9G, C7011G, C7011GFE, C7011GFG, C704G, C707G, C707GFE, C707GFG, C712G, C74G, C78G, C7FE12G, C7FE8G, C7FG12G, C7FG8G, C7FGM12G, C912G, C912GS, C94G, C94GP, C94GS, C98G, C98GP, C98GS, C9F4GS, C9F6GS, C9F8GS, C9FE12G, C9FE12GS, C9FE4GS, C9FE6GS, C9FE8G, C9FE8GS, C9FEP4GS, C9FEP6GS, C9FEP8GS, C9FG12G, C9FG12GS, C9FG16G, C9FG8G, C9FG8GP, C9FG8GS, C9FGM12G, C9FP4GS, C9FP6GS, C9FP8GS...(Other models you can see in the webshop) | | | |
| accessories for 105267 | | | | |
|  | GEV No. | 105051 | Ref. No. | 1314700 MA1314700 |
| air mixing sleeve L 45mm ED ø 45mm ID ø 42mm aluminium | | | | |
|  | GEV No. | 105265 | Ref. No. | CM006001 MACM006001 |
| burner head for burner cap ø 80mm | | | | |
|  | GEV No. | 105266 | Ref. No. | CM042900 MACM042900 |
| burner lower part for burner cap ø 80mm | | | | |
|  | GEV No. | 105269 | Ref. No. | CM005901 MACM005901 |
| burner head ø 158mm for burner cap ø 110mm | | | | |
|  | GEV No. | 105272 | Ref. No. | CM043000 MACM043000 |
| burner lower part for burner cap ø 110mm | | | | |
|  | GEV No. | 105274 | Ref. No. | CM006502 MACM006502 |
| burner head for burner cap ø 120mm | | | | |
|  | GEV No. | 105275 | Ref. No. | CM043100 MACM043100 |
| burner lower part for burner cap ø 120mm | | | | |


| | | | | |
|--|---|----------|-----------|--|
|  | | | | |
| 1 | | | | |
| GEV No. | 106599 | Ref. No. | CR0508630 | |
| description | nozzle holder nozzle M10x1 M14x1 screw pipe fitting M16x1.5 tube ø 10mm | | | |
| For models: | EF74G8VA, EF74G8VG, FQG41, FQG61, NF74G10, NF74G15, NF74G8, NF76G10, NF76G8, NF78G15, NF94G15, NF94G23, NF94G23K, NF96G10, NF98G15, NF98G23, NF98G23K, NPD76G5, NPD78G8, NPD96G5, NPI76G5, NPI78G8, NPI96G5, OFQG41, OFQG61 | | | |




| | | | |
|---|--|-----------------|------------------------|
|  | | | |
| 1 | | | |
| GEV No. | 106600 | Ref. No. | CM021700 MACM021700 |
| description | nozzle holder nozzle M10x1 M14x1 screw pipe fitting M16x1.5 tube ø 10mm | | |
| For models: | B74G, B78G, B94G, B98G, BF78G, BF912G, BF912GH, BF98G, BMG40, BMG60, BR78GF, BR78GI, BRG40, BRG40G, C12FGP9G, C7FG12G, C7FG8G, C7FG9G, C7FGM12G, C9FG12G, C9FG16G, C9FG8G, C9FG8GP, C9FGM12G, EPC74G, F74G6, F94G6, FQG40, FQG60, FT-129GLC, FT129GM, FT12C9GL, FT12C9GM, FT12C9GTL, FT12C9GTM, FT74GL, FT74GLC, FT74GR, FT74GRC, FT76GL, FT76GLC, FT76GM, FT76GMC, FT76GR, FT78GL, FT78GLC, FT78GLT, FT78GM, FT78GMC, FT78GMT...(Other models you can see in the webshop) | | |

| | | | |
|---|---|-----------------|----------------------------|
|  | | | |
| 1 | | | |
| GEV No. | 106601 | Ref. No. | 1031504900 MA1031504900 |
| description | nozzle holder nozzle M10x1 M14x1 screw pipe fitting M16x1.5 tube ø 10mm | | |
| For models: | EFT74GLVG, EFT74GRVG, EFT78GLVG, EFT78GMVG | | |

miscellaneous

| | | | |
|---|--|-----------------|----------------------|
|  | | | |
| 1 | | | |
| GEV No. | 107689 | Ref. No. | 1207400 MA1207400 |
| description | flame spreader | | |
| For models: | FB1GS, FP1GS, MM10IG, NT98G, NT9FG12G, NT9FG8G, P910G, P915G, P91A10G, PD707G, PI707G, T129G, T7011GFG, T707G, T707GFG, T78G, T7FG12G, T7FG8G, T98G, T9F4G, T9F6GS, T9FE4G, T9FG12G, T9FG8G, T9FP4G, T9SB4G, T9V4G, T9V6GS, T9VP4G | | |


| | | | |
|---|---|-----------------|----------------------|
|  | | | |
| 1 | | | |
| GEV No. | 109078 | Ref. No. | 1033600 MA1033600 |
| description | level glass for burner | | |
| For models: | B9SB2G, B9SB4G, B9V2G, B9V4G, B9VP4G, BRG40, BRG40G, CP704G, CP92G, CP94G, CP9SB2G, CP9SB4G, EF74G8VA, EF74G8VG, ET78GVG, ET7FG8G, FC10G, FC20G, FC5G, FC7G, FQG41, FQG61, FT12G7L70, FT12G7LC70, FT12G7R70, FT12G7RC70, FT12G7RL70, FT12G7RLC70, FT14G8L90, FT14G8LC90, FT14G8R2L90, FT14G8R2LC90, FT14G8R90, FT14G8RC90, FT6G4L70, FT6G4LC70, FT6G4R70, FT6G4RC70, FT7G4L90, FT7G4LC90, FT7G4R90, FT7G4RC90, NF74G10, NF74G15, NF74G8, NF76G10, NF76G8, NF78G15, NF94G15, NF94G23...(Other models you can see in the webshop) | | |


| | | | | |
|--|---|-----------------|----------------------|--|
|  | | | | |
| 1 | | | | |
| GEV No. | 103151 | Ref. No. | 1893300 MA1893300 | |
| description | reducer suitable for burner head ø110mm | | | |
| For models: | C7011G, C7011GFE, C7011GFG, C704G, C707G, C707GFE, C707GFG, C9F4GS, C9F6GS, C9F8GS, C9FE4GS, C9FE6GS, C9FE8GS, C9FEP4GS, C9FEP6GS, C9FEP8GS, C9FP4GS, C9FP6GS, C9FP8GS, C9V2GS, C9V4GS, C9V6GS, C9V8GS, C9VP2GS, C9VP4GS, C9VP6GS, C9VP8GS, FB1GS, FB2GS, FB3GS, T7011GFG, T9F6GS, T9V6GS | | | |
| accessories for | 103151 | | | |
|  | GEV No. | 103021 | Ref. No. | 1315700 1315712 MA1315712 |
| burner cap ø 110mm | | | | |
|  | GEV No. | 103150 | Ref. No. | 1315812 1892500 MA1892500 |
| burner lower part for burner cap ø 110/120mm | | | | |
|  | GEV No. | 104031 | Ref. No. | 1315512 1315522 MA1315522 |
| burner head for burner cap ø 110mm | | | | |
|  | GEV No. | 105051 | Ref. No. | 1314700 MA1314700 |
| air mixing sleeve L 45mm ED ø 45mm ID ø 42mm aluminium | | | | |
|  | GEV No. | 105052 | Ref. No. | 1306400 1306600 1306615 MA1306615 |
| nozzle holder ID ø 10mm nozzle mounting M10x1 | | | | |

gas nozzles


main nozzles


gas nozzles M6x0.75


| | | | |
|---|--|-----------------|----------------------------|
|  | | | |
| 1 | | | |
| GEV No. | 106591 | Ref. No. | 1033718900 MA1033718900 |
| description | gas injector thread M6x0.75 WS 7 bore ø 1.15mm | | |
| For models: | C74GS, C78GS, C7FE12GS, C7FE8GS, C7FG12GS, C7FG8GS, C7FG9G, CFG101, CFG70, CFG70M, CFGE61, CFGE61D, CFGE61L, CFGE61P, EC74GVG, EC78GVG, EC7FG8G, OCFG101, OCFG70, OCFG61, OPCG41, OPCG61, PCG41, PCG41L, PCG61, PCG61L | | |


| | | | |
|---|--|-----------------|----------------------------|
|  | | | |
| 1 | | | |
| GEV No. | 106483 | Ref. No. | 1033718300 MA1033718300 |
| description | gas injector thread M6x0.75 WS 7 bore ø 1.35mm | | |
| For models: | C74GS, C78GS, C7FE12GS, C7FE8GS, C7FG12GS, C7FG8GS, CFG101, CFG70, CFG70M, CFGE61, CFGE61D, CFGE61L, CFGE61P, EC74GVG, EC78GVG, EC7FG8G, OCFG101, OCFG70, OCFG61, OPCG41, OPCG61, PCG41, PCG41L, PCG61, PCG61L | | |





| | | | |
|---|--|-----------------|----------------------------|
|  | | | |
| 1 | | | |
| GEV No. | 106590 | Ref. No. | 1033718500 MA1033718500 |
| description | gas injector thread M6x0.75 WS 7 bore ø 0.8mm | | |
| For models: | C74GS, C78GS, C7FE12GS, C7FE8GS, C7FG12GS, C7FG8GS, CFG101, CFG70, CFG70M, CFGE61, CFGE61D, CFGE61L, CFGE61P, EC74GVG, EC78GVG, EC7FG8G, OCFG101, OCFG70, OCFG61, OPG41, OPG61, PCG41, PCG41L, PCG61, PCG61L | | |


| | | | |
|--|--|-----------------|----------------------------|
|  | | | |
| 1 | | | |
| GEV No. | 106589 | Ref. No. | 1033719000 MA1033719000 |
| description | gas injector thread M6x0.75 WS 7 bore ø 1.9mm | | |
| For models: | C74GS, C78GS, C79G, C7FE12GS, C7FE8GS, C7FG12GS, C7FG8GS, C7FG9G, CFG101, CFG70, CFG70M, CFGE61, CFGE61D, CFGE61L, CFGE61P, EC74GVG, EC78GVG, EC7FG8G, OCFG101, OCFG70, OCFG61, OPG41, OPG61, PCG41, PCG41L, PCG61, PCG61L | | |


| | | | |
|---|--|-----------------|----------------------------|
|  | | | |
| 1 | | | |
| GEV No. | 106588 | Ref. No. | 1033718600 MA1033718600 |
| description | gas injector thread M6x0.75 WS 7 bore ø 0.9mm | | |
| For models: | C74GS, C78GS, C79G, C7FE12GS, C7FE8GS, C7FG12GS, C7FG8GS, C7FG9G, CFG101, CFG70, CFG70M, CFGE61, CFGE61D, CFGE61L, CFGE61P, EC74GVG, EC78GVG, EC7FG8G, OCFG101, OCFG70, OCFG61, OPG41, OPG61, PCG41, PCG41L, PCG61, PCG61L | | |


| | | | |
|--|--|-----------------|-----------|
| gas nozzles M10x1 | | | |
|  | | | |
| 1 | | | |
| GEV No. | 106595 | Ref. No. | CR0508730 |
| description | gas injector thread M10x1 bore ø 0.83mm L 30mm WS 12 | | |
| For models: | EF74G8VA, EF74G8VG, FQG41, FQG61, NF74G8, NF76G8, OFQG41, OFQG61 | | |

| | | | |
|--|--|-----------------|----------------------------|
|  | | | |
| 1 | | | |
| GEV No. | 106592 | Ref. No. | 1033719100 MA1033719100 |
| description | gas injector thread M6x0.75 WS 7 bore ø 1mm | | |
| For models: | C74GS, C78GS, C7FE12GS, C7FE8GS, C7FG12GS, C7FG8GS, C7FG9G, CFG101, CFG70, CFG70M, CFGE61, CFGE61D, CFGE61L, CFGE61P, EC74GVG, EC78GVG, EC7FG8G, OCFG101, OCFG70, OCFG61, OPG41, OPG61, PCG41, PCG41L, PCG61, PCG61L | | |


| | | | |
|--|---|-----------------|----------------------|
|  | | | |
| 1 | | | |
| GEV No. | 100150 | Ref. No. | 1491100 MA1491100 |
| description | gas injector thread M10x1 bore ø 0.95mm L 30mm WS 12 | | |
| For models: | BR94G, BR94GI, BR96G, BR96GI, BR9M4G, BR9M4GI, BR9M6G, BR9M6GI, EF74G8VA, EF74G8VG, FQG41, FQG61, FT14G8L90, FT14G8LC90, FT14G8R2L90, FT14G8R2LC90, FT14G8R90, FT14G8RC90, FT7G4L90, FT7G4LC90, FT7G4R90, FT7G4RC90, NF74G8, NF76G8, OFQG41, OFQG61 | | |

| | | | |
|---|--|-----------------|----------------------------|
|  | | | |
| 1 | | | |
| GEV No. | 106593 | Ref. No. | 1033718400 MA1033718400 |
| description | gas injector thread M6x0.75 WS 7 bore ø 1.5mm | | |
| For models: | C74GS, C78GS, C79G, C7FE12GS, C7FE8GS, C7FG12GS, C7FG8GS, C7FG9G, CFG101, CFG70, CFG70M, CFGE61, CFGE61D, CFGE61L, CFGE61P, EC74GVG, EC78GVG, EC7FG8G, OCFG101, OCFG70, OCFG61, OPG41, OPG61, PCG41, PCG41L, PCG61, PCG61L | | |


| | | | |
|--|---|-----------------|----------------------|
|  | | | |
| 1 | | | |
| GEV No. | 100670 | Ref. No. | 1695400 MA1695400 |
| description | gas injector thread M10x1 bore ø 0.9mm L 30mm WS 12 | | |
| For models: | BIG40, BIG60, BR707G, BR707GI, BR94G, BR94GI, BR9M4G, BR9M4GI, BR9M6G, BR9M6GI, BR9SB4G, BR9SB4GI, EF74G8VA, EF74G8VG, FQG41, FQG61, FT12G7L70, FT12G7LC70, FT12G7R70, FT12G7RC70, FT12G7RL70, FT12G7RLC70, FT6G4L70, FT6G4LC70, FT6G4R70, FT6G4RC70, FT74G, FT74GR, FT77G, FT77GRL, FTG40B, FTG40BLC, FTG40BR, FTG60B, FTG60BLC, FTG60BR, FTG60BRR, FTG80B, FTG80BLC, FTG80BR, MS10AG, MS10IG, MS70AG, MS70IG, MS70IGS, NF74G8, NF76G8, OFQG41, OFQG61 | | |

| | | | |
|---|--|-----------------|----------------------------|
|  | | | |
| 1 | | | |
| GEV No. | 106594 | Ref. No. | 1033718700 MA1033718700 |
| description | gas injector thread M6x0.75 WS 7 bore ø 1.75mm | | |
| For models: | C74GS, C78GS, C79G, C7FE12GS, C7FE8GS, C7FG12GS, C7FG8GS, C7FG9G, CFG101, CFG70, CFG70M, CFGE61, CFGE61D, CFGE61L, CFGE61P, EC74GVG, EC78GVG, EC7FG8G, OCFG101, OCFG70, OCFG61, OPG41, OPG61, PCG41, PCG41L, PCG61, PCG61L | | |

| | | | |
|--|--|-----------------|----------------------|
|  | | | |
| 1 | | | |
| GEV No. | 100671 | Ref. No. | 1513000 MA1513000 |
| description | gas injector thread M10x1 bore ø 1.25mm L 30mm WS 12 | | |
| For models: | B74G, B78G, B94G, B98G, BF78G, BF912G, BF912GH, BF98G, C7FG12G, C7FG8G, C9FG12G, C9FG16G, C9FG8G, C9FG8GP, C9FGM12G, CP704G, CP92G, CP94G, CS10, CS6, CSM10G, CSM10GP, CSM6G, CSM6GP, FQG40, FQG60, FT12C9GL, FT12C9GM, FT12C9GTLC, FT12C9GTMC, FT74GL, FT74GLC, FT74GR, FT74GRC, FT76GL, FT76GLC, FT76GM, FT76GMC, FT76GR, FT78GL, FT78GLC, FT78GLT, FT78GM, FT78GMC, FT78GMT, FT78GR, FT78GRT, FT94G, FT94GL, FT94GLC... (Other models you can see in the webshop) | | |




| | | | |
|--------------------|---|-----------------|----------------------|
| GEV No. | 101974 | Ref. No. | 2715400 MA2715400 |
| description | gas injector thread M10x1 bore ø 1.35mm L 30mm WS 12 | | |
| For models: | BMG40, BMG60, CP92G, CP94G, CP95B2G, CP95B4G, EF74G8VA, EF74G8VG, FQG40, FQG41, FQG60, FQG61, FT12G7L70, FT12G7LC70, FT12G7R70, FT12G7RC70, FT12G7RL70, FT12G7RLC70, FT6G4L70, FT6G4LC70, FT6G4R70, FT6G4RC70, FT74GL, FT74GLC, FT74GR, FT74GRC, FT76GL, FT76GLC, FT76GM, FT76GMC, FT76GR, FT78GL, FT78GLC, FT78GLT, FT78GM, FT78GMC, FT78GMT, FT78GR, FT78GRT, FT94G, FT94GL, FT94GLC, FT94GR, FT94GRC, FT96GL, FT96GLC, FT96GM, FT96GMC, FT96GR, FT98GL...(Other models you can see in the webshop) | | |




| | | | |
|--------------------|---|-----------------|----------------------|
| GEV No. | 100816 | Ref. No. | 2715300 MA2715300 |
| description | gas injector thread M10x1 bore ø 1.5mm WS 12 | | |
| For models: | B74G, B78G, B94G, B98G, BIG40, BIG60, BMG40, BMG60, ET78GVG, ET78G8G, FC10G, FC5G, FQG41, FQG61, FT12G7L70, FT12G7LC70, FT12G7R70, FT12G7RC70, FT12G7RL70, FT12G7RLC70, FT6G4L70, FT6G4LC70, FT6G4R70, FT6G4RC70, FT74G, FT74GL, FT74GLC, FT74GR, FT74GRC, FT76GL, FT76GLC, FT76GM, FT76GMC, FT76GR, FT77G, FT77GRL, FT78GL, FT78GLC, FT78GLT, FT78GM, FT78GMC, FT78GMT, FT94GL, FT94GLC, FT94GR, FT94GRC, FT96GL, FT96GLC, FT96GM, FT96GMC...(Other models you can see in the webshop) | | |




| | | | |
|--------------------|---|-----------------|----------------------|
| GEV No. | 100156 | Ref. No. | 1421700 MA1421700 |
| description | gas injector thread M10x1 bore ø 1.3mm L 30mm WS 12 | | |
| For models: | B74G, B78G, B94G, B98G, C7FG9G, CS10, CS6, ET78GVG, ET78G8G, FT74GL, FT74GLC, FT74GR, FT74GRC, FT76GL, FT76GLC, FT76GM, FT76GMC, FT76GR, FT78GL, FT78GLC, FT78GLT, FT78GM, FT78GMC, FT78GMT, FT94GL, FT94GLC, FT94GR, FT94GRC, FT96GL, FT96GLC, FT96GM, FT96GMC, FT96GR, FT98GL, FT98GLC, FT98GLT, FT98GM, FT98GMC, FT98GMT, FT98GR, FT98GRT, GL12C4G, GL12C9G, GL74G, GL78G, GL94G, GL98G, MM10DG, MM10DG5, MM10IG...(Other models you can see in the webshop) | | |




| | | | |
|--------------------|--|-----------------|----------------------|
| GEV No. | 100151 | Ref. No. | 1631300 MA1631300 |
| description | gas injector thread M10x1 bore ø 1.65mm L 30mm WS 12 | | |
| For models: | BR78GF, BR78GI, FT129GLC, FT129GM, FT74GL, FT74GLC, FT74GR, FT74GRC, FT76GL, FT76GLC, FT76GM, FT76GMC, FT76GR, FT78GL, FT78GLC, FT78GLT, FT78GM, FT78GMC, FT78GMT, FT94GL, FT94GLC, FT94GR, FT94GRC, FT96GL, FT96GLC, FT96GM, FT96GMC, FT96GR, FT98GL, FT98GLC, FT98GLT, FT98GM, FT98GMC, FT98GMT, FT98GR, FT98GRT, NBR78GF, NBR78GI, NF94G23, NF98G23, NPC74G, NPC76G, NPC78G, NPC94G, NPC96G, NPC98G, PC12C9G, PC74G, PC76G, PC78G...(Other models you can see in the webshop) | | |




| | | | |
|--------------------|---|-----------------|----------------------|
| GEV No. | 100155 | Ref. No. | 2902500 MA2902500 |
| description | gas injector thread M10x1 bore ø 1.45mm L 30mm WS 12 | | |
| For models: | BF78G, BF912G, BF912GH, BF98G, BMG40, BMG60, C7FG12G, C7FG8G, C7FG9G, C9FG12G, C9FG16G, C9FG8G, C9FG8GP, C9FGM12G, CON10G, CON10GP, CS10, CS6, CSM10G, CSM10GP, EF74G8VA, EF74G8VG, EPC74G, FQG41, FQG61, FT129GLC, FT129GM, FT14G8L90, FT14G8LC90, FT14G8R2L90, FT14G8R2LC90, FT14G8R90, FT14G8RC90, FT74GL, FT74GLC, FT74GR, FT74GRC, FT76GL, FT76GLC, FT76GM, FT76GMC, FT76GR, FT78GL, FT78GLC, FT78GLT, FT78GM, FT78GMC, FT78GMT, FT7G4L90, FT7G4LC90...(Other models you can see in the webshop) | | |



| | | | |
|--------------------|--|-----------------|----------------------|
| GEV No. | 100153 | Ref. No. | 1631200 MA1631200 |
| description | gas injector thread M10x1 bore ø 1.6mm L 30mm WS 12 | | |
| For models: | BF78G, BF912G, BF912GH, BF98G, BMG40, BMG60, BRG40, BRG40G, C7FG12G, C7FG8G, C7FGM12G, C9FG12G, C9FG16G, C9FG8G, C9FG8GP, C9FGM12G, CS10, CS6, EF74G8VA, EF74G8VG, FQG41, FQG61, FT14G8L90, FT14G8LC90, FT14G8R2L90, FT14G8R2LC90, FT14G8R90, FT14G8RC90, FT7G4L90, FT7G4LC90, FT7G4R90, FT7G4RC90, NC7FGM12G, NF74G10, NF74G8, NF76G10, NF76G8, NF94G23K, NF96G10, NF98G23K, NPD76G5, NPD96G5, NPI76G5, NPI96G5, OFQG41, OFQG61, PC12C4G, PC74G, PC76G, PC78G...(Other models you can see in the webshop) | | |





| | | | |
|--------------------|--|-----------------|----------------------|
| GEV No. | 100675 | Ref. No. | 1630700 MA1630700 |
| description | gas injector thread M10x1 bore ø 1.4mm L 30mm WS 12 | | |
| For models: | BF78G, BF912G, BF912GH, BF98G, BIG40, BIG60, BR707G, BR707GI, C7FG12G, C7FG8G, C7FGM12G, C9FG12G, C9FG16G, C9FG8G, C9FG8GP, C9FGM12G, CON6G, CON6GP, CP92G, CP94G, CS10, CS6, CSM10G, CSM10GP, CSM6G, CSM6GP, ET78GVG, ET78G8G, PC12C4G, PC74G, PC76G, PC78G, PC94G, PC96G, PC98G, PC954G, PC956G, PC958G, PD76G5, PD96G5, PD98G10, PD98G15, PD98G15A, PD958G10, PI76G5, PI96G5, PI98G10, PI98G14, PI98G14A, T7FG12G...(Other models you can see in the webshop) | | |





| | | | |
|--------------------|--|-----------------|--------------------|
| GEV No. | 106403 | Ref. No. | 707200 MA707200 |
| description | gas injector thread M10x1 bore ø 1.9mm L 30mm WS 12 | | |
| For models: | B74G, B78G, B94G, B98G, BR78GF, BR78GI, CON202G, CON202GP, CP704G, CP707G, CSM202G, CSM202GP, FT12C9GL, FT12C9GM, FT12C9GTLC, FT12C9GTMC, FT74GL, FT74GLC, FT74GR, FT74GRC, FT76GL, FT76GLC, FT76GM, FT76GMC, FT76GR, FT78GL, FT78GLC, FT78GLT, FT78GM, FT78GMC, FT78GMT, FT78GR, FT78GRT, FT94G, FT94GL, FT94GLC, FT94GR, FT94GRC, FT96GL, FT96GLC, FT96GM, FT96GMC, FT96GR, FT98GL, FT98GLC, FT98GLT, FT98GM, FT98GMC, FT98GMT, FT98GR...(Other models you can see in the webshop) | | |




| | | | |
|---|--|-----------------|--------------------|
|  | | | |
| 1 | | | |
| GEV No. | 106401 | Ref. No. | 795800 MA795800 |
| description | gas injector thread M10x1 bore ø 2.2mm L 30mm WS 12 | | |
| For models: | BMG40, BMG60, CS10, CS6, CSM10G, CSM10GP, FT74GL, FT74GLC, FT74GR, FT74GRC, FT76GL, FT76GLC, FT76GM, FT76GMC, FT76GR, FT78GL, FT78GLC, FT78GLT, FT78GM, FT78GMC, FT78GMT, FT78GR, FT78GRT, FT94G, FT94GL, FT94GLC, FT94GR, FT94GRC, FT96GL, FT96GLC, FT96GM, FT96GMC, FT96GR, FT98GL, FT98GLC, FT98GLT, FT98GM, FT98GMC, FT98GMT, FT98GR, FT98GRT, GL12C4G, GL12C9G, GL74G, GL78G, MM10DG, MM10DGS, MM10IG, MM15DG, NF74G15... (Other models you can see in the webshop) | | |

| | | | |
|---|---|-----------------|----------|
|  | | | |
| 2 | | | |
| GEV No. | 100157 | Ref. No. | MA795900 |
| description | gas injector thread M10x1 bore ø 2.4mm L 30mm WS 12 | | |

| | | | |
|---|--|-----------------|----------------------|
|  | | | |
| 1 | | | |
| GEV No. | 106408 | Ref. No. | 1695300 MA1695300 |
| description | gas injector thread M10x1 bore ø 3mm L 30mm WS 12 | | |
| For models: | BR707G, BR78GF, BR78GI, CP92G, CP94G, FT74G, FT74GR, FT77G, FT77GRL, NBR78GF, NBR78GI, P9D2G, PD98G10, PD98G15, PD98G15A, PD9S8G10 | | |

| | | | |
|---|--|-----------------|--------|
|  | | | |
| 1 | | | |
| GEV No. | 100464 | Ref. No. | 520811 |
| description | gas injector thread M10x1 WS 12 bore ø 0.75mm | | |
| For models: | B9SB2G, B9SB4G, B9V2G, B9V4G, BM74G, BM77G, BMG40, BMG60, FQG40, FQG60 | | |


| | | | |
|---|---|-----------------|--------------------|
|  | | | |
| 1 | | | |
| GEV No. | 100444 | Ref. No. | 520911 MA520911 |
| description | gas injector thread M10x1 WS 12 bore ø 0.8mm | | |
| For models: | 702BMG, 706, 706S, BMG40, BMG60, C7011G, C7011GFE, C7011GFG, C704G, C707G, C707GFE, C707GFG, C712G, C74G, C78G, C7FE12G, C7FE8G, C7FG12G, C7FG8G, C7FGM12G, C912G, C912GS, C94G, C94GP, C94GS, C98G, C98GP, C98GS, C9F4G, C9F4GS, C9F6G, C9F6GS, C9F8G, C9F8GS, C9FE12G, C9FE12GS, C9FE4GS, C9FE6GS, C9FE8G, C9FE8GS, C9FEP4GS, C9FEP6GS, C9FEP8GS, C9FG12G, C9FG12GS, C9FG16G, C9FG8G, C9FG8GP, C9FG8GS, C9FGM12G... (Other models you can see in the webshop) | | |

| | | | |
|--|---|-----------------|--------------------|
|  | | | |
| 1 | | | |
| GEV No. | 100466 | Ref. No. | 521211 MA521211 |
| description | gas injector thread M10x1 WS 12 bore ø 0.95mm | | |
| For models: | 704S, 706S, BMG40, BMG60, C7011G, C7011GFE, C7011GFG, C704G, C707G, C707GFE, C707GFG, C712G, C74G, C78G, C7FE12G, C7FE8G, C7FG12G, C7FG8G, C7FGM12G, C912G, C912GS, C94G, C94GP, C94GS, C98G, C98GP, C98GS, C9F4G, C9F4GS, C9F6G, C9F6GS, C9F8G, C9F8GS, C9FE12G, C9FE12GS, C9FE4GS, C9FE6GS, C9FE8G, C9FE8GS, C9FEP4GS, C9FEP6GS, C9FEP8GS, C9FG12G, C9FG12GS, C9FG16G, C9FG8G, C9FG8GP, C9FG8GS, C9FGM12G, C9FP4GS... (Other models you can see in the webshop) | | |

| | | | |
|--|--|-----------------|--------------------|
|  | | | |
| 1 | | | |
| GEV No. | 100442 | Ref. No. | 521411 MA521411 |
| description | gas injector thread M10x1 WS 12 bore ø 1.05mm | | |
| For models: | 704, 704S, 706, 706AS, 706S, BRG40, BRG40G, C7011G, C7011GFE, C7011GFG, C704G, C707G, C707GFE, C707GFG, C9F4G, C9F4GS, C9F6G, C9F6GS, C9F8G, C9F8GS, C9SB4GS, C9V2G, C9V2GS, C9V4G, C9V4GS, C9V6G, C9V6GS, C9V8G, C9V8GS, F74G6, F94G6, FR74G, FR77G, FR92G13, FR92G22, FR92G22T, FR94G13, FR94G22, FR94G22T, FR94G23, NC712G36, NC74G12, NC78G24, NC7FE12G36, NC7FE8G24, NC7FG12G44, NC7FG8G32, NC7FGM12G, NC912G44, NC94G16... (Other models you can see in the webshop) | | |


| | | | |
|--|--|-----------------|--------------------|
|  | | | |
| 1 | | | |
| GEV No. | 100469 | Ref. No. | 521611 MA521611 |
| description | gas injector thread M10x1 WS 12 bore ø 1.15mm | | |
| For models: | B9SB2G, B9SB4G, B9V2G, B9V4G, B9VP4G, C7011G, C7011GFE, C7011GFG, C704G, C707G, C707GFE, C707GFG, C9F4E, C9F4G, C9F4GS, C9F6E, C9F6G, C9F6GS, C9F8G, C9F8GS, C9FP, C9FP4GS, C9FP6GS, C9FP8GS, C9SB4GS, C9V2G, C9V2GS, C9V4G, C9V4GS, C9V6G, C9V6GS, C9V8G, C9V8GS, CFG101, CFG101D, CFG101L, CFG101P, CFG120, CFG70, CFG70D, CFG70L, CFG70M, CFG70P, EC74GVG, EC78GVG, EC7FG8G, EFT74GLVG, EFT74GRVG, EFT78GLVG, EFT78GM-VG... (Other models you can see in the webshop) | | |

| | | | |
|--|---|-----------------|--------------------|
|  | | | |
| 1 | | | |
| GEV No. | 100468 | Ref. No. | 521511 MA521511 |
| description | gas injector thread M10x1 WS 12 bore ø 1.1mm | | |
| For models: | C124G, C129G, C12FG9G, C7011G, C7011GFE, C7011GFG, C704G, C707G, C707GFE, C707GFG, C712G, C74G, C78G, C7FE12G, C7FE8G, C7FG12G, C7FG8G, C7FGM12G, C912G, C912GS, C94G, C94GP, C94GS, C98G, C98GP, C98GS, C9F4GS, C9F6GS, C9F8GS, C9FE12G, C9FE12GS, C9FE4GS, C9FE6GS, C9FE8G, C9FE8GS, C9FEP4GS, C9FEP6GS, C9FEP8GS, C9FG12G, C9FG12GS, C9FG16G, C9FG8G, C9FG8GP, C9FG8GS, C9FGM12G, C9FP4GS, C9FP6GS, C9FP8GS, C9V2GS, C9V4GS... (Other models you can see in the webshop) | | |




1

| | | | |
|--------------------|--|-----------------|--------------------|
| GEV No. | 106754 | Ref. No. | 521811 MA521811 |
| description | gas injector thread M10x1 WS 12 bore ø 1.25mm | | |
| For models: | C124G, C129G, C12C2G9, C12C9G, C12FG9G, C712G, C74G, C78G, C7FE12G, C7FE8G, C7FG12G, C7FG8G, C7FGM12G, C912G, C912GS, C94G, C94GP, C94GS, C98G, C98GP, C98GS, C9FE12G, C9FE12GS, C9FE8G, C9FE8GS, C9FG12G, C9FG12GS, C9FG16G, C9FG8G, C9FG8GP, C9FG8GS, C9FGM12G | | |




1

| | | | |
|--------------------|---|-----------------|--------------------|
| GEV No. | 102721 | Ref. No. | 521911 MA521911 |
| description | gas injector thread M10x1 WS 12 bore ø 1.3mm | | |
| For models: | B9SB2G, B9SB4G, B9V2G, B9V4G, B9VP4G, BM74G, BM77G, C7011G, C7011GFE, C7011GFG, C704G, C707G, C707GFE, C707GFG, C712G, C74G, C78G, C7FE12G, C7FE8G, C7FG12G, C7FG8G, C7FGM12G, C912G, C912GS, C94G, C94GP, C94GS, C98G, C98GP, C98GS, C9F4E, C9F4G, C9F4GS, C9F6E, C9F6G, C9F6GS, C9F8G, C9F8GS, C9FE12G, C9FE12GS, C9FE4GS, C9FE6GS, C9FE8G, C9FE8GS, C9FEP4GS, C9FEP6GS, C9FEP8GS, C9FG12G, C9FG12GS, C9FG16G...(Other models you can see in the webshop) | | |



1

| | | | |
|--------------------|---|-----------------|---|
| GEV No. | 100472 | Ref. No. | 0100931 522111 MA522111 R0100931 SIR0100931 |
| description | gas injector thread M10x1 WS 12 bore ø 1.4mm | | |
| For models: | 702BMG, 706, 706S, B9SB2G, B9SB4G, B9V2G, B9V4G, BM74G, BM77G, C7011G, C7011GFE, C7011GFG, C704G, C707G, C707GFE, C707GFG, C712G, C74G, C78G, C7FE12G, C7FE8G, C7FG12G, C7FG8G, C7FGM12G, C912G, C912GS, C94G, C94GP, C94GS, C98G, C98GP, C98GS, C9F4GS, C9F6G, C9F6GS, C9F8GS, C9FE12G, C9FE12GS, C9FE4GS, C9FE6GS, C9FE8G, C9FE8GS, C9FEP4GS, C9FEP6GS, C9FEP8GS, C9FG12G, C9FG12GS, C9FG16G, C9FG8G, C9FG8GP...(Other models you can see in the webshop) | | |



1

| | | | |
|--------------------|--|-----------------|--------------------|
| GEV No. | 100478 | Ref. No. | 522811 MA522811 |
| description | gas injector thread M10x1 WS 12 bore ø 1.75mm | | |
| For models: | C7011G, C7011GFE, C7011GFG, C704G, C707G, C707GFE, C707GFG, C9F4GS, C9F6GS, C9F8GS, C9FE4GS, C9FE6GS, C9FE8GS, C9FEP4GS, C9FEP6GS, C9FEP8GS, C9FP4GS, C9FP6GS, C9FP8GS, C9V2GS, C9V4GS, C9V6GS, C9V8GS, C9VP2GS, C9VP4GS, C9VP6GS, C9VP8GS, CFG101, CFG101D, CFG101L, CFG101P, CFG120, CFG70, CFG70D, CFG70L, CFG70M, CFG70P, EC74GVG, EC78GVG, EC7FG8G, F12C4G15, F74G10, F74G15, F76G10, F78G15, F94G10, F94G15, F94G22, F94G22K, F96G10...(Other models you can see in the webshop) | | |



1

| | | | |
|--------------------|--|-----------------|---------------------|
| GEV No. | 100482 | Ref. No. | 523211 CR0586770 |
| description | gas injector thread M10x1 WS 12 bore ø 1.95mm | | |
| For models: | BR912GFM, BR912GIM, BR98GF, BR98GFM, BR98GI, BR98GIM, BR9S8GF, BR9S8GI, C7011G, C7011GFE, C7011GFG, C704G, C707G, C707GFE, C707GFG, C9F4G, C9F4GS, C9F6G, C9F6GS, C9F8G, C9F8GS, C9FE4GS, C9FE6GS, C9FE8GS, C9FEP4GS, C9FEP6GS, C9FEP8GS, C9FP4GS, C9FP6GS, C9FP8GS, C9SB4GS, C9V2G, C9V2GS, C9V4G, C9V4GS, C9V6G, C9V6GS, C9V8G, C9V8GS, C9VP2GS, C9VP4GS, C9VP6GS, C9VP8GS, CFG101, CFG101D, CFG101L, CFG101P, CFG120, CFG70, CFG70D...(Other models you can see in the webshop) | | |




1

| | | | |
|--------------------|--|-----------------|--------------------|
| GEV No. | 100484 | Ref. No. | 523411 MA523411 |
| description | gas injector thread M10x1 WS 12 bore ø 2.05mm | | |
| For models: | F12C4G15, F74G15, F74G6, F78G15, F94G15, F94G6, F98G15, F9S4G15, F9S8G15, GB704G, GB707G, GB92G, GB94G, NF74G15T, NF78G15T, NG74G, NG78G, OPLG40, OPLG80, PLG40, PLG80 | | |



1


| | | | |
|--------------------|--|-----------------|--------------------|
| GEV No. | 100486 | Ref. No. | 523811 MA523811 |
| description | gas injector thread M10x1 WS 12 bore ø 2.25mm | | |
| For models: | B9SB2G, B9SB4G, B9V2G, B9V4G, B9VP4G, C7011G, C7011GFE, C7011GFG, C704G, C707G, C707GFE, C707GFG, C9F4E, C9F4GS, C9F6E, C9F6GS, C9F8GS, C9FE4GS, C9FE6GS, C9FE8GS, C9FEP4GS, C9FEP6GS, C9FEP8GS, C9FP, C9FP4GS, C9FP6GS, C9FP8GS, C9V2GS, C9V4GS, C9V6GS, C9V8GS, C9VP2GS, C9VP4GS, C9VP6GS, C9VP8GS, CFG120, FB1GS, FP1GS, GB707G, NBR912GFM, NBR912GIM, NBR98GF, NBR98GFM, NBR98GI, NBR98GIM, OCFG120, PCG42, PCG82, T7011GFG, T9F4G...(Other models you can see in the webshop) | | |





1

| | | | |
|--------------------|---|-----------------|--------------------|
| GEV No. | 100485 | Ref. No. | 523711 MA523711 |
| description | gas injector thread M10x1 WS 12 bore ø 2.2mm | | |
| For models: | BR912GFM, BR912GIM, BR98GF, BR98GFM, BR98GI, BR98GIM, BR9S8GF, BR9S8GI, GB704G, GB707G, GB92G, GB94G, NFT74GL, NFT74GR, NFT76GL, NFT76GM, NFT76GR, NFT78GL, NFT78GM, NFT78GR, NFT94GL, NFT94GR, NFT96GL, NFT96GM, NFT98GL, NFT98GM, NFT98GR, NG74G, NG78G, OPLG40, OPLG80, PLG40, PLG80, T7011GFG, T707G, T707GFG | | |



| | | | |
|---|---|-----------------|--------------------|
|  | | | |
| 1 | | | |
| GEV No. | 100487 | Ref. No. | 524111 MA524111 |
| description | gas injector thread M10x1 WS 12 bore ø 2.4mm | | |
| For models: | C124G, C129G, C12FG9G, C712G, C74G, C78G, C7FE12G, C7FE8G, C7FG12G, C7FG8G, C7FGM12G, C912G, C912GS, C94G, C94GP, C94GS, C98G, C98GP, C98GS, C9FE12G, C9FE12GS, C9FE8G, C9FE8GS, C9FG12G, C9FG12GS, C9FG16G, C9FG8G, C9FG8GP, C9FG8GS, C9FGM12G, MM10IG, NC712G36, NC74G12, NC78G24, NC7FE12G36, NC7FE8G24, NC7FG12G44, NC7FG8G32, NC7FGM12G, NC912G44, NC94G16, NC94G20, NC98G28, NC98G40, NC9FE12G44, NC9FE8G28, NC9FG12G52, NC9FG16G72, NC9FG8G32, NC9FG8G36...(Other models you can see in the webshop) | | |

| | | | |
|---|--|-----------------|--------|
|  | | | |
| 1 | | | |
| GEV No. | 100491 | Ref. No. | 525211 |
| description | gas injector thread M10x1 WS 12 bore ø 3mm | | |
| For models: | C7011G, C7011GFE, C7011GFG, C704G, C707G, C707GFE, C707GFG, C9F4G, C9F4GS, C9F6G, C9F6GS, C9F8G, C9F8GS, C9SB4GS, C9V2G, C9V2GS, C9V4G, C9V4GS, C9V6G, C9V6GS, C9V8G, C9V8GS, PD707G, PI707G, T9F4G, T9F6GS, T9SB4G, T9V4G, T9V6GS | | |

| | | | |
|--|--|-----------------|----------------------|
|  | | | |
| 1 | | | |
| GEV No. | 103234 | Ref. No. | 1630800 MA1630800 |
| description | nozzle thread M10x1 WS 12 bore ø 1.5mm | | |
| For models: | BR707G, BR707GI, BR94G, BR94GI, BR9M4G, BR9M4GI, BR9M6G, BR9M6GI, BR9SB4G, BR9SB4GI, C12FGP9G, EPC74G, FC20G, MS10AG, MS10IG, MS70AG, MS70IG, MS70IGS, NC7FGM12G, NF94G23, NF98G23, NPC74G, NPC78G, NPD98G10, NPD98G15, NPD98G15A, NPI98G10, NPI98G14, NPI98G14A, PD98G10, PD98G15, PD98G15A, PD9S8G10, T12FGP9G | | |

pilot burner nozzles


pilot burner nozzles JUNKERS


CB 5050_ series


| | | | |
|---|---|-----------------|--------------------|
|  | | | |
| 1 | | | |
| GEV No. | 100230 | Ref. No. | 932900 MA932900 |
| description | pilot burner nozzle LPG gas pressure 50mbar code 2 Qty 1 pcs suitable for JUNKERS CB5050_ | | |
| For models: | 704, 704S, 706, 706AS, 706S, BIG40, BIG60, BMG40, BMG60, BR707G, BR94G, BR94GI, BR96G, BR96GI, BR9M4G, BR9M4GI, BR9M6G, BR9M6GI, BRG40, BRG40G, CP92G, CP92G, CP94G, CS10, CS102G, CS102GP, CS6, FQG40, FQG60, FR15G, FR15G2, FR2G, FR2G15, FR4G, FR4G15, FR74G, FR77G, FR92G22, FR94G23, FT74G, FT74GR, FT77G, FT77GRL, FTG40B, FTG40BLC, FTG40BR, FTG60B, FTG60BLC, FTG60BR, FTG60BRR...(Other models you can see in the webshop) | | |


pilot burner nozzles SIT

100 series

| | | | |
|--|---|-----------------|---------------------------------|
|  | | | |
| 1 | | | |
| GEV No. | 100245 | Ref. No. | 1415100 3020054 MA1415100 |
| description | pilot burner nozzle LPG code 20 bore ø 0.2mm Qty 1 pcs thread M8x0.75 | | |
| For models: | B9SB2G, B9SB4G, B9V2G, B9V4G, C7011G, C7011GFE, C7011GFG, C704G, C707G, C707GFE, C707GFG, C9F4G, C9F4GS, C9F6G, C9F6GS, C9F8G, C9F8GS, C9SB4GS, C9V2G, C9V2GS, C9V4G, C9V4GS, C9V6G, C9V6GS, C9V8G, C9V8GS, EF74G15, F12C4G15, F74G10, F74G15, F76G10, F78G15, F94G10, F94G15, F94G22, F94G22K, F96G10, F98G15, F98G22, F98G22K, F9S4G15, F9S4G22, F9S4G22K, F9S8G15, F9S8G22, F9S8G22K, F9SB2G, F9SB2GR, F9SB4G, F9SB4GR...(Other models you can see in the webshop) | | |

| | | | |
|--|--|-----------------|----------------------|
|  | | | |
| 1 | | | |
| GEV No. | 100246 | Ref. No. | 1422600 MA1422600 |
| description | pilot burner nozzle natural gas bore ø 0.35mm Qty 1 pcs thread M8x0.75 | | |
| For models: | B9SB2G, B9SB4G, B9V2G, B9V4G, C7011G, C7011GFE, C7011GFG, C704G, C707G, C707GFE, C707GFG, C9F4G, C9F4GS, C9F6G, C9F6GS, C9F8G, C9F8GS, C9SB4GS, C9V2G, C9V2GS, C9V4G, C9V4GS, C9V6G, C9V6GS, C9V8G, C9V8GS, F9SB2G, F9SB2GR, F9SB4G, F9SB4GR, F9SB4GRL, F9V2G, F9V2GR, F9V4G, F9V4GR, F9V4GRL, P9D10G, P9D15G, P9DA10G, P9DA15G, P9I10G, P9IA10G, T7011GFG, T707G, T707GFG, T9F4G, T9F6GS, T9SB4G, T9V4G, T9V6GS | | |

| | | | |
|--|---|-----------------|-----------------------------------|
|  | | | |
| 1 | | | |
| GEV No. | 102972 | Ref. No. | 1996200 CR0684580 MA1996200 |
| description | pilot burner nozzle natural gas code 40 bore ø 0.4mm Qty 1 pcs | | |
| For models: | EF74G15, F12C4G15, F74G10, F74G15, F76G10, F78G15, F94G10, F94G15, F94G22, F94G22K, F96G10, F98G15, F98G22, F98G22K, F9S4G15, F9S4G22, F9S4G22K, F9S8G15, F9S8G22, F9S8G22K, NF74G15T, NF78G15T, NG74G, NG78G, NG94G, NG98G | | |

| | | | |
|--|---|-----------------|--|
|  | | | |
| 1 | | | |
| GEV No. | 107171 | Ref. No. | 1031502100 1842300 MA1031502100 MA1842300 |
| description | pilot burner nozzle SIT natural/liquid gas bore ø 0.25mm Qty 1 pcs | | |
| For models: | EF74G15, F12C4G15, F74G10, F74G15, F76G10, F78G15, F94G10, F94G15, F94G22, F94G22K, F96G10, F98G15, F98G22, F98G22K, F9S4G15, F9S4G22, F9S4G22K, F9S8G15, F9S8G22, F9S8G22K, FR74G, FR77G, FR92G13, FR92G22, FR92G22T, FR94G13, FR94G22, FR94G22T, NF74G15T, NF78G15T, NG74G, NG78G, NG94G, NG98G | | |

**140/150 series**

| | | | |
|--------------------|---|-----------------|----------------------|
| GEV No. | 100204 | Ref. No. | 1888000 MA1888000 |
| description | pilot burner nozzle SIT LPG code 14 bore \varnothing 0.18/0.20mm Qty 1 pcs suitable for 140 series | | |
| For models: | B9SB2G, B9SB4G, B9V2G, B9V4G, B9VP4G, BM74G, BM77G, BR707G, BR707GI, BR78GF, BR78GI, BR912GFM, BR912GIM, BR94G, BR94GI, BR98GF, BR98GFM, BR98GI, BR98GIM, BR9M4G, BR9M4GI, BR9M6G, BR9M6GI, BR9S8GF, BR9S8GI, BR9S8GI, BR9S8GI, BR9S8GI, C124G, C129G, C12C2G9, C12C9G, C12FG9G, C7011G, C7011GFE, C7011GFG, C704G, C707G, C707GFE, C707GFG, C712G, C74G, C78G, C7FE12G, C7FE8G, C7FG12G, C7FG8G, C7FG9G, C7FGM12G, C912G, C912GS...(Other models you can see in the webshop) | | |



| | | | |
|--------------------|--|-----------------|---|
| GEV No. | 100205 | Ref. No. | 1033722000 BN822140380 MA1033722000 |
| description | pilot burner nozzle SIT LPG code 19 bore \varnothing 0.23/0.26mm Qty 1 pcs suitable for SIT 150 series | | |
| For models: | EFT74GLVG, EFT74GRVG, EFT78GLVG, EFT78GMVG | | |



| | | | |
|--------------------|---|-----------------|----------------------|
| GEV No. | 100207 | Ref. No. | 1887800 MA1887800 |
| description | pilot burner nozzle SIT natural gas code 27 bore \varnothing 0.40/0.38mm suitable for SIT 140 series | | |
| For models: | B74G, B78G, B94G, B98G, B9SB2G, B9SB4G, B9V2G, B9V4G, B9VP4G, BM74G, BM77G, BR707G, BR707GI, BR78GF, BR78GI, BR912GFM, BR912GIM, BR94G, BR94GI, BR98GF, BR98GFM, BR98GI, BR98GIM, BR9M4G, BR9M4GI, BR9M6G, BR9M6GI, BR9S8GF, BR9S8GI, BR9S8GI, BR9S8GI, C124G, C129G, C12C2G9, C12C9G, C12FG9G, C7011G, C7011GFE, C7011GFG, C704G, C707G, C707GFE, C707GFG, C712G, C74G, C78G, C7FE12G, C7FE8G, C7FG12G, C7FG8G...(Other models you can see in the webshop) | | |



| | | | |
|--------------------|--|-----------------|----------------------|
| GEV No. | 103288 | Ref. No. | 1887900 MA1887900 |
| description | pilot burner nozzle SIT natural gas code 50 bore \varnothing 0.50mm suitable for 140 series | | |
| For models: | B74G, B78G, B94G, B98G, C124G, C129G, C12C2G9, C12C9G, C12FG9G, C7011G, C7011GFE, C7011GFG, C704G, C707G, C707GFE, C707GFG, C712G, C74G, C78G, C7FE12G, C7FE8G, C7FG12G, C7FG8G, C7FGM12G, C912G, C912GS, C94G, C94GP, C94GS, C98G, C98GP, C98GS, C9F4E, C9F4GS, C9F6E, C9F6GS, C9F8GS, C9FE12G, C9FE12GS, C9FE4GS, C9FE6GS, C9FE8G, C9FE8GS, C9FG12G, C9FG12GS, C9FG16G, C9FG8G, C9FG8GP, C9FG8GS, C9FGM12G...(Other models you can see in the webshop) | | |

160 series

| | | | |
|--------------------|--|-----------------|----------------------------|
| GEV No. | 107649 | Ref. No. | 1033719600 MA1033719600 |
| description | pilot burner nozzle SIT LPG code 20 Qty 1 pcs | | |
| For models: | BF78G, BF912G, BF912GH, BF98G, C74GS, C78GS, C79G, C7FE12GS, C7FE8GS, C7FG12G, C7FG12GS, C7FG8G, C7FG8GS, C7FG9G, C7FGM12G, C9FG12G, C9FG16G, C9FG8G, C9FG8GP, C9FGM12G, CFG101, CFG70, CFG70M, CFGE61, CFGE61D, CFGE61L, CFGE61P, EC74GVG, EC78GVG, EC7FG8G, EF74G8VA, EF74G8VG, FQG41, FQG61, FT12C9GL, FT12C9GM, FT12C9GTLC, FT12C9GTMC, FT74GL, FT74GR, FT76GL, FT76GLC, FT76GM, FT76GMC, FT78GL, FT78GLC, FT78GLT, FT78GM, FT78GMC, FT78GMT...(Other models you can see in the webshop) | | |




| | | | |
|--------------------|--|-----------------|----------------------|
| GEV No. | 107172 | Ref. No. | 1874700 MA1874700 |
| description | pilot burner nozzle SIT LPG code 25 Qty 1 pcs | | |
| For models: | BF78G, BF912G, BF912GH, BF98G, C12FGP9G, C7FG12G, C7FG8G, C7FG9G, C7FGM12G, C9FG12G, C9FG16G, C9FG8G, C9FG8GP, C9FGM12G, EF74G8VA, EF74G8VG, EPC74G, FQG41, FQG61, MM10IG, NC7FG12G44, NC7FG8G32, NC7FG8G36, NC7FG8G48, NC7FGM12G, NC9FG12G52, NC9FG16G72, NC9FG8G32, NC9FG8G36, NC9FG8G48, NF74G10, NF74G15, NF74G8, NF76G10, NF76G8, NF78G15, NF94G15, NF94G23, NF94G23K, NF96G10, NF98G15, NF98G23, NF98G23K, NPC74G, NPC78G, NPC94G, NPC98G, NPD76G5, NPD78G8, NPD96G5...(Other models you can see in the webshop) | | |



| | | | |
|--------------------|--|-----------------|--|
| GEV No. | 107650 | Ref. No. | 0100802 CR0410100 R0100802 SIR0100802 |
| description | pilot burner nozzle SIT LPG code 30 Qty 1 pcs | | |
| For models: | C12FGP9G, EF74G8VA, EF74G8VG, EPC74G, NC712G36, NC74G12, NC78G24, NC7FE12G36, NC7FE8G24, NC7FG12G44, NC7FG8G32, NC7FGM12G, NC912G44, NC94G16, NC94G20, NC98G28, NC98G40, NC9FE12G44, NC9FE8G28, NC9FG12G52, NC9FG16G72, NC9FG8G32, NC9FG8G36, NC9FG8G48, NC9FGM12G, NF74G10, NF74G15, NF74G8, NF76G10, NF76G8, NF78G15, NF94G15, NF94G23, NF94G23K, NF96G10, NF98G15, NF98G23, NPC74G, NPC78G, NPC94G, NPC98G, NPD98G10, NPD98G15, NPD98G15A, NPI98G10, NPI98G14, NPI98G14A, NS78GS, NS7FG12GS...(Other models you can see in the webshop) | | |





| | | | |
|---|--|-----------------|----------------------------|
|  | | | |
| 1 | | | |
| GEV No. | 107174 | Ref. No. | 1033719700 MA1033719700 |
| description | pilot burner nozzle SIT natural gas code 41 Qty 1 pcs | | |
| For models: | BF78G, BF912G, BF912GH, BF98G, C12FGP9G, C74GS, C78GS, C79G, C7FE12GS, C7FE8GS, C7FG12G, C7FG12GS, C7FG8G, C7FG8GS, C7FG9G, C7FGM12G, C9FG12G, C9FG16G, C9FG8G, C9FG8GP, C9FGM12G, C9FG101, C9FG70, C9FG70M, C9FE61, C9FE61D, C9FE61L, C9FE61P, EC74GVG, EC78GVG, EC7FG8G, EF74G8VA, EF74G8VG, EPC74G, FQG41, FQG61, NC7FG12G44, NC7FG8G32, NC7FG8G36, NC7FG8G48, NC7FGM12G, NC9FG12G52, NC9FG16G72, NC9FG8G32, NC9FG8G36, NC9FG8G48, NF74G10, NF74G15, NF74G8, NF76G10... (Other models you can see in the webshop) | | |


| | | | |
|---|---|-----------------|----------------------|
|  | | | |
| 1 | | | |
| GEV No. | 107175 | Ref. No. | 1874400 MA1874400 |
| description | pilot burner nozzle SIT natural gas code 51 Qty 1 pcs suitable for 160 series | | |
| For models: | MM10IG, P9I10G, P9IA10G | | |


bypass nozzles


bypass nozzles PEL20/21


| | | | |
|---|---|-----------------|----------------------------|
|  | | | |
| 1 | | | |
| GEV No. | 100550 | Ref. No. | 1033720000 MA1033720000 |
| description | bypass nozzle type PEL20/21 bore ø 0.55mm thread M5x0.5 | | |
| For models: | C7011G, C7011GFE, C7011GFG, C704G, C707G, C707GFE, C707GFG, C712G, C74G, C74GS, C78G, C78GS, C79G, C7FE12G, C7FE12GS, C7FE8G, C7FE8GS, C7FG12G, C7FG12GS, C7FG8G, C7FG8GS, C7FG9G, C7FGM12G, C912G, C912GS, C94G, C94GP, C94GS, C98G, C98GP, C98GS, C9F4GS, C9F6GS, C9F8GS, C9FE12G, C9FE12GS, C9FE4GS, C9FE6GS, C9FE8G, C9FE8GS, C9FEP4GS, C9FEP6GS, C9FEP8GS, C9FG12G, C9FG12GS, C9FG16G, C9FG8G, C9FG8GP, C9FG8GS, C9FGM12G... (Other models you can see in the webshop) | | |

| | | | |
|---|---|-----------------|-----------|
|  | | | |
| 1 | | | |
| GEV No. | 100548 | Ref. No. | CR0586840 |
| description | bypass nozzle type PEL20/21 bore ø 0.65mm thread M5x0.5 | | |
| For models: | NC712G36, NC74G12, NC78G24, NC7FE12G36, NC7FE8G24, NC7FG12G44, NC7FG8G32, NC7FGM12G, NC912G44, NC94G16, NC94G20, NC98G28, NC98G40, NC9FE12G44, NC9FE8G28, NC9FG12G52, NC9FG16G72, NC9FG8G32, NC9FG8G36, NC9FG8G48, NC9FGM12G, NS78GS, NS7FG12GS, NT7FG12G, NT9FG12G | | |

| | | | |
|--|---|-----------------|---|
|  | | | |
| 1 | | | |
| GEV No. | 100552 | Ref. No. | 0102067 1884200 MA1884200 R0102067 SIR0102067 |
| description | bypass nozzle type PEL20/21 bore ø 0.7mm thread M5x0.5 | | |
| For models: | C7011G, C7011GFE, C7011GFG, C704G, C707G, C707GFE, C707GFG, C712G, C74G, C74GS, C78G, C78GS, C7FE12G, C7FE12GS, C7FE8G, C7FE8GS, C7FG12G, C7FG12GS, C7FG8G, C7FG8GS, C7FGM12G, C912G, C912GS, C94G, C94GP, C94GS, C98G, C98GP, C98GS, C9F4GS, C9F6GS, C9F8GS, C9FE12G, C9FE12GS, C9FE4GS, C9FE6GS, C9FE8G, C9FE8GS, C9FEP4GS, C9FEP6GS, C9FEP8GS, C9FG12G, C9FG12GS, C9FG16G, C9FG8G, C9FG8GP, C9FG8GS, C9FGM12G, C9FP4GS, C9FP6GS... (Other models you can see in the webshop) | | |


| | | | |
|--|---|-----------------|--|
|  | | | |
| 1 | | | |
| GEV No. | 100528 | Ref. No. | 1033720200 1889000 MA1033720200 MA1889000 |
| description | bypass nozzle type PEL20/21 bore ø 0.9mm thread M5x0.5 | | |
| For models: | C7011G, C7011GFE, C7011GFG, C704G, C707G, C707GFE, C707GFG, C712G, C74G, C74GS, C78G, C78GS, C79G, C7FE12G, C7FE12GS, C7FE8G, C7FE8GS, C7FG12G, C7FG12GS, C7FG8G, C7FG8GS, C7FG9G, C7FGM12G, C912G, C912GS, C94G, C94GP, C94GS, C98G, C98GP, C98GS, C9F4GS, C9F6GS, C9F8GS, C9FE12G, C9FE12GS, C9FE4GS, C9FE6GS, C9FE8G, C9FE8GS, C9FEP4GS, C9FEP6GS, C9FEP8GS, C9FG12G, C9FG12GS, C9FG16G, C9FG8G, C9FG8GP, C9FG8GS, C9FGM12G... (Other models you can see in the webshop) | | |

| | | | |
|--|---|-----------------|----------------------|
|  | | | |
| 1 | | | |
| GEV No. | 100534 | Ref. No. | 1883400 MA1883400 |
| description | bypass nozzle type PEL20/21 bore ø 1.4mm thread M5x0.5 | | |
| For models: | FT74GL, FT74GLC, FT74GR, FT74GRC, FT76GL, FT76GLC, FT76GM, FT76GMC, FT76GR, FT78GL, FT78GLC, FT78GLT, FT78GM, FT78GMC, FT78GMT, FT78GR, FT78GRT, FT94G, FT94GL, FT94GLC, FT94GR, FT94GRC, FT96GL, FT96GLC, FT96GM, FT96GMC, FT96GR, FT98GL, FT98GLC, FT98GLT, FT98GM, FT98GMC, FT98GMT, FT98GR, FT98GRT, GB704G, GB707G, GB92G, GB94G, NS78GS, NS7FG8GS, OPLG40, OPLG80, PLG40, PLG80, S78GD, S78GS, S7FG8GD, S7FG8GS | | |


| | | | |
|--|---|-----------------|----------------------|
|  | | | |
| 1 | | | |
| GEV No. | 100529 | Ref. No. | 1889100 MA1889100 |
| description | bypass nozzle type PEL20/21 bore ø 1mm thread M5x0.5 | | |
| For models: | BIG40, BIG60, C7011G, C7011GFE, C7011GFG, C704G, C707G, C707GFE, C707GFG, C712G, C74G, C74GS, C78G, C7FE12G, C7FE8G, C7FG12G, C7FG8G, C7FGM12G, C912G, C912GS, C94G, C94GP, C94GS, C98G, C98GP, C98GS, C9F4GS, C9F6GS, C9F8GS, C9FE12G, C9FE12GS, C9FE4GS, C9FE6GS, C9FE8G, C9FE8GS, C9FEP4GS, C9FEP6GS, C9FEP8GS, C9FG12G, C9FG12GS, C9FG16G, C9FG8G, C9FG8GP, C9FG8GS, C9FGM12G, C9FP4GS, C9FP6GS, C9FP8GS, C9V2GS, C9V4GS, C9V6GS... (Other models you can see in the webshop) | | |


1 gas components




| | | | |
|---|---|-----------------|-----------|
|  | | | |
| GEV No. | 106871 | Ref. No. | CR0586570 |
| description | bypass nozzle type PEL20/21 bore ø 2.2mm thread M5x0.5 | | |
| For models: | NFT74GL, NFT74GR, NFT76GL, NFT76GM, NFT76GR, NFT78GL, NFT78GM, NFT78GR, NFT94GL, NFT94GR, NFT96GL, NFT96GM, NFT98GL, NFT98GM, NFT98GR | | |


bypass nozzles PEL22

| | | | |
|---|---|-----------------|----------------------------|
|  | | | |
| GEV No. | 100429 | Ref. No. | 1033720600 MA1033720600 |
| description | bypass nozzle type PEL22 bore ø 0.7mm thread M6x0.5 | | |
| For models: | BRG40, BRG40G | | |


| | | | |
|---|--|-----------------|----------------------|
|  | | | |
| GEV No. | 100435 | Ref. No. | 1884100 MA1884100 |
| description | bypass nozzle type PEL22 bore ø 1.05mm thread M6x0.5 | | |
| For models: | B74G, B78G, B94G, B98G, BRG40, BRG40G, C124G, C129G, C12FG9G, CP704G, CP92G, CP94G, CP95B2G, CP95B4G, ET78GVG, ET7FG8G, FB1GS, FP1GS, NB74G, NB78G, NB94G, NB98G, NG74G, NG78G, NG94G, NG98G, NT78G, NT7FG12G, NT7FG8G, PC12C4G, PC12C9G, PC74G, PC76G, PC78G, PC94G, PC96G, PC98G, PC9S4G, PC9S6G, PC9S8G, PD76G5, PD96G5, T129G, T7011GFG, T707G, T707GFG, T78G, T7FG12G, T7FG8G, T98G...(Other models you can see in the webshop) | | |


bypass nozzles PEL23/24

| | | | |
|---|--|-----------------|----------------------|
|  | | | |
| GEV No. | 103235 | Ref. No. | 1954900 MA1954900 |
| description | bypass nozzle type PEL23/24 bore ø 1.4mm thread M8x0.5 | | |
| For models: | MM10DG, MM10DGS, MM15DG, P9D10G, P9D15G, P9DA10G, P9DA15G, P9DASB10G, P9DSB10G, PD98G10, PD98G15, PD98G15A, PD9S8G10, PDASB10G, PI98G10, PI98G14, PI98G14A | | |

| | | | |
|---|---|-----------------|----------------------|
|  | | | |
| GEV No. | 100265 | Ref. No. | 1883800 MA1883800 |
| description | bypass nozzle type PEL23/24 bore ø 1.8mm thread M8x0.5 | | |
| For models: | CP704G, CP92G, CP94G, ET78GVG, ET7FG8G, FP1GS, NG74G, NG78G, NG94G, NG98G, NT78G, NT7FG12G, NT7FG8G, NT98G, NT9FG12G, NT9FG8G, P9D5G, PC12C4G, PC12C9G, PC74G, PC76G, PC78G, PC94G, PC96G, PC98G, PC9S4G, PC9S6G, PC9S8G, PD707G, PD76G5, PD96G5, T129G, T7011GFG, T707G, T707GFG, T78G, T7FG12G, T7FG8G, T98G, T9F4G, T9F6G5, T9FE4G, T9FG12G, T9FG8G, T9FP4G, T9SB4G, T9V4G, T9V6G5, T9VP4G | | |

bypass nozzles SABAF



| | | | |
|--|---|-----------------|----------------------|
|  | | | |
| GEV No. | 106586 | Ref. No. | 1885000 MA1885000 |
| description | bypass nozzle bore ø 0.5mm thread M4x0.5 SABAF | | |
| For models: | C7011GFG, C707GFG, CFG101, CFG101D, CFG101L, CFG101P, CFG120, CFG70, CFG70D, CFG70L, CFG70M, CFG70P, EC74GVG, EC78GVG, EC7FG8G, OCFG101, OCFG120, OCFG70, T7011GFG, T707GFG | | |

| | | | |
|--|---|-----------------|----------------------|
|  | | | |
| GEV No. | 106587 | Ref. No. | 1885600 MA1885600 |
| description | bypass nozzle bore ø 0.8mm thread M4x0.5 SABAF | | |
| For models: | C7011GFG, C707GFG, CFG101, CFG101D, CFG101L, CFG101P, CFG120, CFG70, CFG70D, CFG70L, CFG70M, CFG70P, EC74GVG, EC78GVG, EC7FG8G, OCFG101, OCFG120, OCFG70, T7011GFG, T707GFG | | |

auxiliary gas parts

screw connections

olives

| | | | |
|---|--|-----------------|--------------------|
|  | | | |
| GEV No. | 101249 | Ref. No. | 673400 MA673400 |
| description | olive for pipe ø 10mm Qty 1 pcs | | |
| For models: | 704S, 706S, BM74G, BM77G, BRG40, BRG40G, C124G, C129G, C12C2G9, C12C9G, C12FG9G, C7011G, C7011GFE, C7011GFG, C704G, C707G, C707GFE, C707GFG, C712G, C74G, C78G, C7FE12G, C7FE8G, C7FG12G, C7FG8G, C7FGM12G, C912G, C912GS, C94G, C94GP, C94GS, C98G, C98GP, C98GS, C9F4G, C9F4GS, C9F6G, C9F6GS, C9F8G, C9F8GS, C9FE12G, C9FE12GS, C9FE8G, C9FE8GS, C9FG12G, C9FG12GS, C9FG16G, C9FG8G, C9FG8GP, C9FG8GS...(Other models you can see in the webshop) | | |
| accessories for | 101249 | | |
|  | GEV No. | 101250 | Ref. No. |
| | | | 673200 MA673200 |
| | union nut thread M20x1.5 for pipe ø 10mm | | |









| | | | |
|---|---|-----------------|-------------------|
|  | | | |
| GEV No. | 101278 | Ref. No. | 867-20 MA86720 |
| description | olive for pipe ø 10mm Qty 1 pcs | | |
| For models: | 704S, 706S, B74G, B78G, B94G, B98G, B9SB2G, B9SB4G, B9V2G, B9V4G, BF78G, BF912G, BF912GH, BF98G, BIG40, BIG60, BMG40, BMG60, BR707G, BR707GI, BR78GF, BR78GI, BRG40, BRG40G, C124G, C129G, C12C2G9, C12C9G, C12FG9G, C12FGP9G, C7011G, C7011GFE, C7011GFG, C704G, C707G, C707GFE, C707GFG, C712G, C74G, C74GS, C78G, C78GS, C79G, C7FE12G, C7FE12GS, C7FE8G, C7FE8GS, C7FG12G, C7FG12GS, C7FG8G...(Other models you can see in the webshop) | | |
| accessories for | 101278 | | |
|  | GEV No. | 100943 | Ref. No. |
| | | | — |
| | union nut thread M17x1 tube ø 10mm | | |



Table continues overleaf






| | | | | |
|---|----------------|--------|-----------------|----------------------|
| accessories for 101278 | | | | |
|  | GEV No. | 101300 | Ref. No. | 1326500 MA1326500 |
| union nut thread M16x1.5 tube ø 10mm | | | | |
|  | GEV No. | 101478 | Ref. No. | 1665200 MA1665200 |
| union nut thread 3/8" for pipe ø 10mm | | | | |



| | | | | |
|---|----------------|-----------------|---|--------------------|
|  | | | | |
| GEV No. | 101273 | Ref. No. | 0100842 417810 MA417810 R0100842 SIR0100842 | |
| description olive for pipe ø 12mm L 9.5mm brass Qty 1 pcs suitable for universal | | | | |
| For models: 704, 704S, 706, 706AS, 706S, B9SB2G, B9SB4G, B9V2G, B9V4G, B9VP4G, BF78G, BF912G, BF912GH, BF98G, BM74G, BM77G, BR707G, BR707GI, BR78GF, BR78GI, BRG40, BRG40G, C12FGP9G, C7FG12G, C7FG8G, C7FGM12G, C9F4G, C9F4GS, C9F6G, C9F6GS, C9F8G, C9F8GS, C9FG12G, C9FG16G, C9FG8G, C9FG8GP, C9FGM12G, C9FP4GS, C9FP6GS, C9FP8GS, C9SB4GS, C9V2G, C9V2GS, C9V4G, C9V4GS, C9V6G, C9V6GS, C9V8G, C9V8GS, CP92G...(Other models you can see in the webshop) | | | | |
| accessories for 101273 | | | | |
|  | GEV No. | 100944 | Ref. No. | — |
| union nut thread M18x1.5 for pipe ø 12mm | | | | |
|  | GEV No. | 101276 | Ref. No. | 459300 MA459300 |
| union screw thread 3/8" tube ø 12mm Qty 1 pcs | | | | |

| | | | | |
|---|--------|-----------------|--------------------|--|
|  | | | | |
| GEV No. | 106598 | Ref. No. | 866200 MA866200 | |
| description olive for pipe ø 18mm Qty 1 pcs ED ø 21mm | | | | |
| For models: B9SB2E, B9SB2G, B9SB4E, B9SB4G, B9V2E, B9V2G, B9V4E, B9V4G, B9VP2E, B9VP4E, B9VP4G, BF78G, BF912G, BF912GH, BF98G, BM74E, BM74G, BM77E, BM77G, BME40DM, BME40DMB, BME40M, BME60, BME60D, BME60DM, BME60DMB, BME60M, BME80M, BMG40, BMG60, BV712, BV74, BV76, BV78, BV912, BV94, BV96, BV98, C12FGP9G, C7FG12G, C7FG8G, C7FGM12G, C9FG12G, C9FG16G, C9FG8G, C9FG8GP, C9FGM12G, CPE40, CPE402, CPE60...(Other models you can see in the webshop) | | | | |




| | | | | |
|---|----------------|-----------------|--------------------|--------------------|
|  | | | | |
| GEV No. | 101248 | Ref. No. | 673300 MA673300 | |
| description olive for pipe ø 12mm Qty 1 pcs suitable for PEL | | | | |
| For models: 704S, 706S, C124G, C129G, C12C2G9, C12C9G, C12FG9G, C712G, C74G, C78G, C7FE12G, C7FE8G, C7FG12G, C7FG8G, C7FGM12G, C912G, C912GS, C94G, C94GP, C94GS, C98G, C98GP, C98GS, C9F4G, C9F4GS, C9F6G, C9F6GS, C9F8G, C9F8GS, C9FE12G, C9FE12GS, C9FE8G, C9FE8GS, C9FG12G, C9FG12GS, C9FG16G, C9FG8G, C9FG8GP, C9FG8GS, C9FGM12G, C9SB4GS, C9V2G, C9V2GS, C9V4G, C9V4GS, C9V6G, C9V6GS, C9V8G, C9V8GS, CP704G...(Other models you can see in the webshop) | | | | |
| accessories for 101248 | | | | |
|  | GEV No. | 101251 | Ref. No. | 673100 MA673100 |
| union nut thread M20x1.5 for pipe ø 12mm | | | | |



| | | | | |
|---|----------------|-----------------|----------------------|----------------------|
|  | | | | |
| GEV No. | 101256 | Ref. No. | 1127400 MA1127400 | |
| description olive for pipe ø 16mm Qty 1 pcs | | | | |
| For models: BR707G, BR912GFM, BR912GIM, BR94G, BR94GI, BR98GF, BR98GFM, BR98GI, BR98GIM, BR9M4G, BR9M4GI, BR9M6G, BR9M6GI, BR9S8GF, BR9S8GI, BR9SB4G, BR9SB4GI, C9FEP4GS, C9FEP6GS, C9FEP8GS, C9FP4GS, C9FP6GS, C9FP8GS, C9VP4GS, C9VP6GS, C9VP8GS, CON10G, CON10GP, CON201G, CON201GP, CON202G, CON202GP, CON6G, CON6GP, CP707G, CP92E, CP92G, CP94E, CP94G, CS10, CS102G, CS102GP, CS6, CSM10G, CSM10GP, CSM201G, CSM201GP, CSM202G, CSM202GP, CSM6G...(Other models you can see in the webshop) | | | | |
| accessories for 101256 | | | | |
|  | GEV No. | 101253 | Ref. No. | 1421000 MA1421000 |
| union nut thread M24x1.5 PEL for pipe ø 16mm | | | | |


| | | | | |
|---|--------|-----------------|--------------------|--|
|  | | | | |
| GEV No. | 106598 | Ref. No. | 866200 MA866200 | |
| description olive for pipe ø 18mm Qty 1 pcs ED ø 21mm | | | | |
| For models: B9SB2E, B9SB2G, B9SB4E, B9SB4G, B9V2E, B9V2G, B9V4E, B9V4G, B9VP2E, B9VP4E, B9VP4G, BF78G, BF912G, BF912GH, BF98G, BM74E, BM74G, BM77E, BM77G, BME40DM, BME40DMB, BME40M, BME60, BME60D, BME60DM, BME60DMB, BME60M, BME80M, BMG40, BMG60, BV712, BV74, BV76, BV78, BV912, BV94, BV96, BV98, C12FGP9G, C7FG12G, C7FG8G, C7FGM12G, C9FG12G, C9FG16G, C9FG8G, C9FG8GP, C9FGM12G, CPE40, CPE402, CPE60...(Other models you can see in the webshop) | | | | |

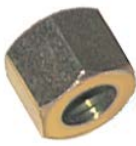
| | | | | |
|---|----------------|-----------------|----------------------|----------------------|
|  | | | | |
| GEV No. | 101257 | Ref. No. | 1347000 MA1347000 | |
| description olive for pipe ø 20mm Qty 1 pcs | | | | |
| For models: MM10DG, MM10DGS, MM15DG, P9D10G, P9D15G, P9DA10G, P9DA15G, P9DASB10G, P9DSB10G, PD98G10, PD98G15, PD98G15A, PD9S8G10, PDASB10G, PI98G10, PI98G14, PI98G14A, T9F4G, T9F6GS, T9SB4G, T9V4G, T9V6GS | | | | |
| accessories for 101257 | | | | |
|  | GEV No. | 101254 | Ref. No. | 1346900 MA1346900 |
| union nut thread M28x1.5 tube ø 20mm | | | | |





| | | | |
|---|--|-----------------|--|
|  | | | |
| 1 | | | |
| GEV No. | 101282 | Ref. No. | 469000 MA469000 |
| description | olive for pipe ø 4mm L 7.4mm Qty 1 pcs | | |
| For models: | 704S, 706S, BIG40, BIG60, BMG40, BMG60, BRG40, BRG40G, CP707G, CP92G, CP94G, FQG40, FQG60, FT74G, FT74GR, FT77G, FT77GRL, FTG40B, FTG40BLC, FTG40BR, FTG60B, FTG60BLC, FTG60BR, FTG-60BRR, FTG80B, FTG80BLC, FTG80BR, GB707G, P9D2G, PD707G, PI707G, TPF706S | | |
| accessories for | 101282 | | |
|  | GEV No. | 100908 | Ref. No. 0100777 673500 MA673500 R0100777 SIR0100777 |
| union screw thread M10x1 for pipe ø 4mm Qty 1 pcs | | | |
|  | GEV No. | 101283 | Ref. No. 468800 MA468800 |
| union screw thread M10x1 for pipe ø 4mm Qty 1 pcs | | | |



| | | | |
|---|---|-----------------|--|
|  | | | |
| 1 | | | |
| GEV No. | 101246 | Ref. No. | 673600 MA673600 |
| description | olive for pipe ø 4mm Qty 1 pcs | | |
| For models: | 704S, 706S, B74G, B78G, B94G, B98G, B9SB2G, B9SB4G, B9V2G, B9V4G, BF78G, BF912G, BF912GH, BF98G, BIG40, BIG60, BR78GF, BR78GI, BR912GFM, BR912GIM, BR94G, BR94GI, BR98GF, BR98GFM, BR98GI, BR98GIM, BR9M4G, BR9M4GI, BR9M6G, BR9M6GI, BR9S8GF, BR9S8GI, BR9SB4G, BR9SB4GI, BRG40, BRG40G, C124G, C129G, C12C2G9, C12C9G, C12FG9G, C12FGP9G, C7011G, C7011GFE, C7011GFG, C704G, C707G, C707GFE, C707GFG, C712G...(Other models you can see in the webshop) | | |
| accessories for | 101246 | | |
|  | GEV No. | 100908 | Ref. No. 0100777 673500 MA673500 R0100777 SIR0100777 |
| union screw thread M10x1 for pipe ø 4mm Qty 1 pcs | | | |


| | | | |
|---|---|-----------------|---------------------------------|
|  | | | |
| 1 | | | |
| GEV No. | 100897 | Ref. No. | 1881000 1888100 MA1888100 |
| description | olive for pipe ø 4mm Qty 1 pcs for pilot burner | | |
| For models: | B9SB2G, B9SB4G, B9V2G, B9V4G, B9VP4G, BM74G, BM77G, BR707G, BR707GI, BR78GF, BR78GI, BR94G, BR94GI, BR9M4G, BR9M4GI, BR9M6G, BR9M6GI, BR9SB4G, BR9SB4GI, C124G, C129G, C12C2G9, C12C9G, C12FG9G, C7011G, C7011GFE, C7011GFG, C704G, C707G, C707GFE, C707GFG, C712G, C74G, C74GS, C78G, C78GS, C79G, C7FE12G, C7FE12GS, C7FE8G, C7FE8GS, C7FG12G, C7FG12GS, C7FG8G, C7FG8GS, C7FG9G, C7FGM12G, C912G, C912GS, C94G...(Other models you can see in the webshop) | | |

| | | | |
|---|---|-----------------|----------------------|
| union nuts | | | |
|  | | | |
| 1 | | | |
| GEV No. | 101478 | Ref. No. | 1665200 MA1665200 |
| description | union nut thread 3/8" for pipe ø 10mm | | |
| For models: | C7011GFG, C707GFG, CFG101, CFG101D, CFG101L, CFG101P, CFG120, CFG70, CFG70D, CFG70L, CFG70P, EC74GVG, EC78GVG, EC7FG8G, OCFG101, OCFG120, OCFG70, T7011GFG, T707GFG | | |


| | | | |
|---|---|-----------------|----------------------|
|  | | | |
| 1 | | | |
| GEV No. | 101476 | Ref. No. | 1665300 MA1665300 |
| description | union nut thread M13x1 for pipe ø 8mm | | |
| For models: | C7011GFG, C707GFG, CFG101, CFG101D, CFG101L, CFG101P, CFG120, CFG70, CFG70M, EC74GVG, EC78GVG, EC7FG8G, OCFG101, OCFG120, OCFG70, T7011GFG, T707GFG | | |


| | | | |
|--|--|-----------------|------------------|
|  | | | |
| 1 | | | |
| GEV No. | 520223 | Ref. No. | 86643 MA86643 |
| description | union nut thread M16x1 WS 19 L 15mm for pipe ø 10mm | | |
| For models: | 704S, 706S, B9SB2G, B9SB4G, B9V2G, B9V4G, BR707G, BR707GI, C7011GFG, C707GFG, C9F4G, C9F4GS, C9F6G, C9F6GS, C9F8G, C9F8GS, C9FP4GS, C9FP6GS, C9FP8GS, C9SB4GS, C9V2G, C9V2GS, C9V4G, C9V4GS, C9V6G, C9V6GS, C9V8G, C9V8GS, CFG101, CFG101D, CFG101L, CFG101P, CFG120, CFG70, CFG70D, CFG70L, CFG70M, CFG70P, EC74GVG, EC78GVG, EC7FG8G, EF74G15, F12C4G15, F74G10, F74G15, F74G6, F76G10, F78G15, F94G10, F94G15...(Other models you can see in the webshop) | | |

| | | | |
|---|--|-----------------|--------------------------------------|
|  | | | |
| 1 | | | |
| GEV No. | 101300 | Ref. No. | 1326500 MA1326500 |
| description | union nut thread M16x1.5 tube ø 10mm | | |
| For models: | B74G, B78G, B94G, B98G, BF78G, BF912G, BF912GH, BF98G, BIG40, BIG60, BMG40, BMG60, BR78GF, BR78GI, BRG40, BRG40G, C124G, C129G, C12C2G9, C12C9G, C12FG9G, C12FGP9G, C7011G, C7011GFE, C7011GFG, C704G, C707G, C707GFE, C707GFG, C712G, C74G, C74GS, C78G, C78GS, C79G, C7FE12G, C7FE12GS, C7FE8G, C7FE8GS, C7FG12G, C7FG12GS, C7FG8G, C7FG8GS, C7FG9G, C7FGM12G, C912G, C912GS, C94G, C94GP, C94GS...(Other models you can see in the webshop) | | |
| accessories for | 101300 | | |
|  | GEV No. | 101278 | Ref. No. 867-20 MA86720 |
| olive for pipe ø 10mm Qty 1 pcs | | | |





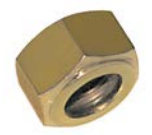
1

| | | | |
|---|---|-----------------|------------------------------------|
| GEV No. | 101250 | Ref. No. | 673200 MA673200 |
| description | union nut thread M20x1.5 for pipe ø 10mm | | |
| For models: | 704S, 706S, BRG40, BRG40G, C124G, C129G, C12C2G9, C12C9G, C12FG9G, C712G, C74G, C78G, C7FE12G, C7FE8G, C7FG12G, C7FG8G, C7FGM12G, C912G, C912GS, C94G, C94GP, C94GS, C98G, C98GP, C98GS, C9F4G, C9F4GS, C9F6G, C9F6GS, C9F8G, C9F8GS, C9FE12G, C9FE12GS, C9FE8G, C9FE8GS, C9FG12G, C9FG12GS, C9FG16G, C9FG8G, C9FG8GP, C9FG8GS, C9FGM12G, C9SB4GS, C9V2G, C9V2GS, C9V4G, C9V4GS, C9V6G, C9V6GS, C9V8G...(Other models you can see in the webshop) | | |
| accessories for | 101250 | | |
|  | GEV No. | 101249 | Ref. No. 673400 MA673400 |
| olive for pipe ø 10mm Qty 1 pcs | | | |




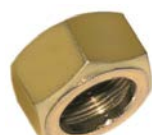
1

| | | | |
|---|---|-----------------|------------------------------------|
| GEV No. | 101251 | Ref. No. | 673100 MA673100 |
| description | union nut thread M20x1.5 for pipe ø 12mm | | |
| For models: | 704S, 706S, BRG40, BRG40G, C124G, C129G, C12C2G9, C12C9G, C12FG9G, C712G, C74G, C78G, C7FE12G, C7FE8G, C7FG12G, C7FG8G, C7FGM12G, C912G, C912GS, C94G, C94GP, C94GS, C98G, C98GP, C98GS, C9F4G, C9F4GS, C9F6G, C9F6GS, C9F8G, C9F8GS, C9FE12G, C9FE12GS, C9FE8G, C9FE8GS, C9FG12G, C9FG12GS, C9FG16G, C9FG8G, C9FG8GP, C9FG8GS, C9FGM12G, C9SB4GS, C9V2G, C9V2GS, C9V4G, C9V4GS, C9V6G, C9V6GS, C9V8G...(Other models you can see in the webshop) | | |
| accessories for | 101251 | | |
|  | GEV No. | 101248 | Ref. No. 673300 MA673300 |
| olive for pipe ø 12mm Qty 1 pcs suitable for PEL | | | |




1


| | | | |
|---|--|-----------------|--------------------------------------|
| GEV No. | 101253 | Ref. No. | 1421000 MA1421000 |
| description | union nut thread M24x1.5 PEL for pipe ø 16mm | | |
| For models: | BR912GFM, BR912GIM, BR94G, BR94GI, BR98GF, BR98GFM, BR98GI, BR98GIM, BR9M4G, BR9M4GI, BR9M6G, BR9M6GI, BR9S8GF, BR9S8GI, BR9SB4G, BR9SB4GI, C9FEP4GS, C9FEP6GS, C9FEP8GS, C9FP4GS, C9FP6GS, C9FP8GS, C9VP4GS, C9VP6GS, C9VP8GS, CON10G, CON10GP, CON201G, CON201GP, CON202G, CON202GP, CON6G, CON6GP, CP707G, CP92E, CP92G, CP94E, CP94G, CS10, CS102G, CS102GP, CS6, CSM10G, CSM10GP, CSM201G, CSM201GP, CSM202G, CSM202GP, CSM6G, CSM6GP...(Other models you can see in the webshop) | | |
| accessories for | 101253 | | |
|  | GEV No. | 101256 | Ref. No. 1127400 MA1127400 |
| olive for pipe ø 16mm Qty 1 pcs | | | |



1


| | | | |
|---|--|-----------------|--------------------------------------|
| GEV No. | 101254 | Ref. No. | 1346900 MA1346900 |
| description | union nut thread M28x1.5 tube ø 20mm | | |
| For models: | MM10DG, MM10DGS, MM15DG, P9D10G, P9D15G, P9DA10G, P9DA15G, P9DASB10G, P9DSB10G, PD98G10, PD98G15, PD98G15A, PD9S8G10, PDASB10G, PI98G10, PI98G14, PI98G14A, T9F4G, T9F6GS, T9SB4G, T9V4G, T9V6GS | | |
| accessories for | 101254 | | |
|  | GEV No. | 101257 | Ref. No. 1347000 MA1347000 |
| olive for pipe ø 20mm Qty 1 pcs | | | |

union screws




1

| | | | |
|--------------------|--|-----------------|---------------------------------|
| GEV No. | 100904 | Ref. No. | 1388000 1394700 MA1394700 |
| description | locking screw M10x1 for pipe ø 4mm Qty 1 pcs | | |
| For models: | B9SB2G, B9SB4G, B9V2G, B9V4G, B9VP4G, BF78G, BF912G, BF912GH, BF98G, BM74G, BM77G, BMG40, BMG60, BR707G, BR707GI, BR78GF, BR78GI, C12FGP9G, C7FG12G, C7FG8G, C7FGM12G, C9F4G, C9F4GS, C9F6G, C9F6GS, C9F8G, C9F8GS, C9FG12G, C9FG16G, C9FG8G, C9FG8GP, C9FGM12G, C9FP4GS, C9FP6GS, C9FP8GS, EF74G15, EF74G8VA, EF74G8VG, F12C4G15, F74G10, F74G15, F74G6, F76G10, F78G15, F94G10, F94G15, F94G22, F94G22K, F94G6, F96G10...(Other models you can see in the webshop) | | |




1

| | | | |
|--------------------|--|-----------------|----------------------|
| GEV No. | 100905 | Ref. No. | 1394800 MA1394800 |
| description | locking screw M10x1 for pipe ø 6mm Qty 1 pcs | | |
| For models: | BR707G, CS10, CS102G, CS102GP, CS6, CSM201E, CSM201EP, CSM201G, CSM201GP, CSM202E, CSM202EP, CSM202G, CSM202GP, FR74G, FR77G | | |




| | | | |
|--------------------|---|-----------------|----------------------|
| GEV No. | 100906 | Ref. No. | 1888400 MA1888400 |
| description | screw connection thread M10x1 for ignition electrode brass Qty 1 pcs WS 10 | | |
| For models: | B74G, B78G, B94G, B98G, B9SB2G, B9SB4G, B9V2G, B9V4G, B9VP4G, BF78G, BF912G, BF912GH, BF98G, BM74G, BM77G, BR707G, BR707GI, BR78GF, BR78GI, BR912GFM, BR912GIM, BR94G, BR94GI, BR98GF, BR98GFM, BR98GI, BR98GIM, BR9M4G, BR9M4GI, BR9M6G, BR9M6GI, BR9S8GF, BR9S8GI, BR9S84G, BR9S84GI, C124G, C129G, C12C2G9, C12C9G, C12FG9G, C12FGP9G, C7011G, C7011GFE, C7011GFG, C704G, C707G, C707GFE, C707GFG, C712G, C74G...(Other models you can see in the webshop) | | |








| | | | |
|--------------------|--|-----------------|--|
| GEV No. | 100907 | Ref. No. | 1891700 24010899 MA1891700 MA24010899 |
| description | screw connection thread M10x1 Qty 1 pcs type SEF 1 ømm for thermocouple | | |
| For models: | B9SB2G, B9SB4G, B9V2G, B9V4G, B9VP4G, BF78G, BF912G, BF912GH, BF98G, BIG40, BIG60, BM74G, BM77G, BR707G, BR707GI, BR912GFM, BR912GIM, BR94G, BR94GI, BR96G, BR96GI, BR98GF, BR98GFM, BR98GI, BR98GIM, BR9M4G, BR9M4GI, BR9M6G, BR9M6GI, BR9S84G, BR9S84GI, C124G, C129G, C12C2G9, C12C9G, C12FG9G, C12FGP9G, C7011G, C7011GFE, C7011GFG, C704G, C707G, C707GFE, C707GFG, C712G, C74G, C78G, C7FE12G, C7FE8G, C7FG12G...(Other models you can see in the webshop) | | |




| | | | |
|--------------------|--|-----------------|--------------------|
| GEV No. | 106597 | Ref. No. | 866000 MA866000 |
| description | union screw thread 3/4" for pipe ø 18mm L 20mm Qty 1 pcs WS 27 | | |
| For models: | B9SB2E, B9SB2G, B9SB4E, B9SB4G, B9V2E, B9V2G, B9V4E, B9V4G, B9VP2E, B9VP4E, B9VP4G, BF78G, BF912G, BF912GH, BF98G, BM74E, BM74G, BM77E, BM77G, BME40DM, BME40DMB, BME40M, BME60DM, BME60DMB, BME60M, BME80M, BV712, BV74, BV76, BV78, BV912, BV94, BV96, BV98, C12FGP9G, C7FG12G, C7FG8G, C7FGM12G, C9FG12G, C9FG16G, C9FG8G, C9FG8GP, C9FGM12G, CPE60, CPE602, CPE60DB, EF74E10VG, EF74G8VA, EF74G8VG, F74E10...(Other models you can see in the webshop) | | |





| | | | | |
|---|---|-----------------|---|---------------------------------|
| GEV No. | 100908 | Ref. No. | 0100777 673500 MA673500 R0100777 SIRO100777 | |
| description | union screw thread M10x1 for pipe ø 4mm Qty 1 pcs | | | |
| For models: | 704S, 706S, B74G, B78G, B94G, B98G, B9SB2G, B9SB4G, B9V2G, B9V4G, B9VP4G, BF78G, BF912G, BF912GH, BF98G, BIG40, BIG60, BM74G, BM77G, BR707G, BR707GI, BR912GFM, BR912GIM, BR94G, BR94GI, BR98GF, BR98GFM, BR98GI, BR98GIM, BR9M4G, BR9M4GI, BR9M6G, BR9M6GI, BR9S8GF, BR9S8GI, BR9S84G, BR9S84GI, BRG40, BRG40G, C124G, C129G, C12C2G9, C12C9G, C12FG9G, C12FGP9G, C7011G, C7011GFE, C7011GFG, C704G, C707G...(Other models you can see in the webshop) | | | |
| accessories for | 100908 | | | |
|  | GEV No. | 100897 | Ref. No. | 1881000 1888100 MA1888100 |
| | olive for pipe ø 4mm Qty 1 pcs for pilot burner | | | |
|  | GEV No. | 101246 | Ref. No. | 673600 MA673600 |
| | olive for pipe ø 4mm Qty 1 pcs | | | |
|  | GEV No. | 101280 | Ref. No. | — |
| | olive for pipe ø 4mm Qty 1 pcs | | | |
|  | GEV No. | 101282 | Ref. No. | 469000 MA469000 |
| | olive for pipe ø 4mm L 7.4mm Qty 1 pcs | | | |



| | | | | |
|---|---|-----------------|--------------------|--------------------|
| GEV No. | 101283 | Ref. No. | 468800 MA468800 | |
| description | union screw thread M10x1 for pipe ø 4mm Qty 1 pcs | | | |
| For models: | 704S, 706S, BIG40, BIG60, BMG40, BMG60, BRG40, BRG40G, CP707G, CP92G, CP94G, FQG40, FQG60, FT74G, FT74GR, FT77G, FT77GRL, FTG40B, FTG40BLC, FTG40BR, FTG60B, FTG60BLC, FTG60BR, FTG60BRR, FTG80B, FTG80BLC, FTG80BR, GB707G, P9D2G, PD707G, PI707G, TPF706S | | | |
| accessories for | 101283 | | | |
|  | GEV No. | 101282 | Ref. No. | 469000 MA469000 |
| | olive for pipe ø 4mm L 7.4mm Qty 1 pcs | | | |



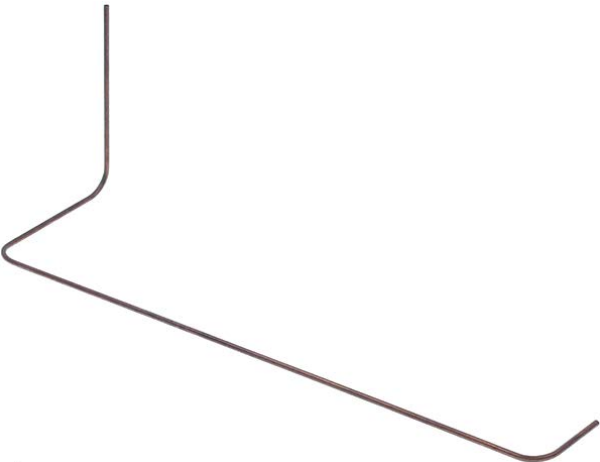
| | | | |
|--|--|-----------------|--------------------|
|  <p>1</p> | | | |
| GEV No. | 103237 | Ref. No. | 459500 MA459500 |
| description | union screw thread M14x1.5 for pipe ø 10mm Qty 1 pcs | | |
| For models: | BMG40, BMG60, FQG40, FQG60, FT129GLC, FT129GM, FT14G8L90, FT14G8LC90, FT14G8R2L90, FT14G8R2LC90, FT14G8R90, FT14G8RC90, FT74GL, FT74GLC, FT74GR, FT74GRC, FT76GL, FT76GLC, FT76GM, FT76GMC, FT76GR, FT78GL, FT78GLC, FT78GLT, FT78GM, FT78GMC, FT78GMT, FT7G4L90, FT7G4LC90, FT7G4R90, FT7G4RC90, FT94GL, FT94GLC, FT94GR, FT94GRC, FT96GL, FT96GLC, FT96GM, FT96GMC, FT96GR, FT98GL, FT98GLC, FT98GLT, FT98GM, FT98GMC, FT98GMT, FT98GR, FT98GRT, NC712G36, NC74G12...(Other models you can see in the webshop) | | |

| | | | |
|---|---|-----------------|---------|
|  <p>1</p> | | | |
| GEV No. | 102111 | Ref. No. | 1690200 |
| description | pilot tube copper pipe ø 6mm thickness 1mm L 3000mm | | |
| For models: | BR707G | | |


gas lines


pilot tubes

producer-specific




| | | | |
|---|--|-----------------|-----------|
|  <p>1</p> | | | |
| GEV No. | 107884 | Ref. No. | CR0730240 |
| description | pilot tube tube ø 4mm L 430mm W 115mm H 140mm copper | | |
| For models: | NC712G36, NC74G12, NC78G24, NC7FE12G36, NC7FE8G24, NC7FG12G44, NC7FG8G32, NC7FGM12G, NS78GS, NS7FG12GS, NT7FG12G | | |

pressure switches

| | | | |
|--|--|-----------------|----------------------|
|  <p>1</p> | | | |
| GEV No. | 541051 | Ref. No. | 5151000 MA5151000 |
| description | pressure control ø 45mm pressure range adjustable 10-50mbar pressure connection vertical gas technology connection 1/4" pressure connection ø 1/4"mm | | |
| For models: | CON102G, CON102GP, CON10G, CON10GP, CON201G, CON201GP, CON202G, CON202GP, CON6G, CON6GP, CP9A15GD, CSM102G, CSM102GP, CSM10G, CSM10GP, CSM201G, CSM201GP, CSM202G, CSM202GP, CSM6G, CSM6GP | | |

| | | | |
|---|--|-----------------|-----------|
|  <p>1</p> | | | |
| GEV No. | 541073 | Ref. No. | R63070010 |
| description | pressure control ø 45mm pressure range adjustable 5-20mbar pressure connection vertical gas technology connection 1/4" pressure connection ø 1/4"mm | | |
| For models: | CVG105H, CVG105M, GC106M, GC110M, GC210M, GM106H, GM106M, GM106M+SC, GM106P, GM110H, GM110M, GM110M+SC, GM110P, GM210H, GM210M, GM210M+SC, GM210P, GMT06D, GMT20D, GV106H, GV106M, GV106M+SC, GV106P, GV110H, GV110M, GV110M+SC, GV110P, GV210H, GV210M, GV210M+SC, GV210P, GVT06D, GVT20D, MACG05M, MACG07M, MACG10M, MACG20M, MG061D, MG061M, MG061P, MG061T, MG101D, MG101M, MG101P, MG101T, MG102D, MG102M, MG102P, MG102T, MG106M...(Other models you can see in the webshop) | | |

universal

| | | | |
|--|--|-----------------|--|
|  <p>1</p> | | | |
| GEV No. | 102110 | Ref. No. | 1413100 1413200 1682300 1876500 |
| description | pilot tube copper pipe ø 4mm thickness 1mm L 3000mm | | |
| For models: | MM10IG, P9D10G, P9D15G, P9DA10G, P9DA15G, P9I10G, P9I5G, P9IA10G, PD707G | | |
| accessories for | 102110 | | |
|  | GEV No. | 100908 | Ref. No. 0100777 673500 MA673500 R0100777 SIR0100777 |
| union screw thread M10x1 for pipe ø 4mm Qty 1 pcs | | | |
|  | GEV No. | 101246 | Ref. No. 673600 MA673600 |
| olive for pipe ø 4mm Qty 1 pcs | | | |

equipment-specific units

for vegetable slicers

miscellaneous

| | | | |
|---|--|-----------------|----------------------|
|  <p>1</p> | | | |
| GEV No. | 110703 | Ref. No. | 1829200 MA1829200 |
| description | cylindrical handle thread M10 ø 28mm L 87mm | | |
| For models: | CRE6220, CRE6230, CRE6320, CRE6330, GB704G, GB707G, GB92G, GB94G, GL12C4G, GL12C9G, GL74G, GL78G, GL94G, GL98G, NGL74G, NGL78G, OPLG40, OPLG80, PLG40, PLG80, SME62M, SME63M, SME70M, SPE60M, SPW60M, TSE60M | | |

for cheese graters

miscellaneous



1

| | | | |
|--------------------|--|-----------------|----------------------|
| GEV No. | 110703 | Ref. No. | 1829200 MA1829200 |
| description | cylindrical handle thread M10 ø 28mm L 87mm | | |
| For models: | CRE6220, CRE6230, CRE6320, CRE6330, GB704G, GB707G, GB92G, GB94G, GL12C4G, GL12C9G, GL74G, GL78G, GL94G, GL98G, NGL74G, NGL78G, OPLG40, OPLG80, PLG40, PLG80, SME62M, SME63M, SME70M, SPE60M, SPW60M, TSE60M | | |

for dough mixers

spindles

for mixer bowls



1

| | | | |
|--------------------|---|-----------------|------------------------|
| GEV No. | 696629 | Ref. No. | CM219100 MACM219100 |
| description | spindle ø 19mm L 410mm | | |
| For models: | BR78EF, BR78EI, BR78G, BR78GF, BR78GI, BR912EFM, BR912EIM, BR912GFM, BR912GIM, BR98EF, BR98EFM, BR98EI, BR98EIM, BR98GF, BR98GFM, BR98GI, BR98GIM, BR958EF, BR958EI, BR958GF, BR958GI | | |

for refrigerated counters

filters



1

| | | | |
|--------------------|--|-----------------|--|
| GEV No. | 694068 | Ref. No. | 1817200 1817201R 1817300 MA1817200 MA1817201R MA1817300 |
| description | container filter type series 700/900 | | |
| For models: | CP704E, CP704G, CP707G, CP92E, CP92E2, CP92G, CP94E, CP94E2, CP94G, CP95B2E, CP95B2E2, CP95B2G, CP95B4E, CP95B4E2, CP95B4G, DE92142, DE94242, EPC74E, EPC74G, FQE6, FQE6+6, NPC76E, NPC76G, NPC96E, NPC96G, PC12C4E, PC12C4G, PC12C9E, PC12C9G, PC74E, PC74G, PC76E, PC76G, PC78E, PC78G, PC94E, PC94G, PC96E, PC96G, PC98E, PC98G, PC954E, PC954G, PC956E, PC956G, PC958E, PC958G, SPAR16, SPAR20, SPRG12...(Other models you can see in the webshop) | | |

for display coolers

doors



1

| | | | |
|--------------------|-------------------------------------|-----------------|----------------------|
| GEV No. | 697877 | Ref. No. | 4121900 MA4121900 |
| description | door L 643mm W 237mm H 6mm | | |
| For models: | SER15, SER15A, SER18, SER18A, SER21 | | |

for ice-cube maker

hoses

formed hoses

straight

silicone hoses



1

| | | | |
|--------------------|---|-----------------|--------------|
| GEV No. | 530063 | Ref. No. | MA1036100700 |
| description | silicone hose ID ø 18mm ED ø 25mm L 1m t.max. 200°C transparent | | |

for espresso machines

brewing units

filter holder gaskets

O-rings



1

| | | | |
|--------------------|--|-----------------|---|
| GEV No. | 510409 | Ref. No. | 1036504200 LA70045010 LAR70045010 |
| description | O-ring EPDM thickness 5.34mm ID ø 56.52mm Qty 1 pcs | | |
| For models: | DLS30, DLS303, DLS30P, DLS30P3, DLS31, DLS313, DLS31P3, ME101M, ME101P, ME101T, ME102D, ME102M, ME102P, ME102T, ME201D, ME201M, ME201P, ME201T, ME202D, ME202M, ME202P, ME202T, MEMT06D, MEMT06P, MEMT10D, MEMT10P, MEMT20D, MEMT20P, MEMT21D, MEMT21P, MEMT40D, MEMT40P, MLC50, MLC503, MLC65, MLC653, MLS30, MLS303, MLS30P, MLS30P3, MLS31, MLS313, MLS31P3, MLS35, MLS353, MPLS30P | | |

steam/water taps

steam/water pipes

accessories

gaskets

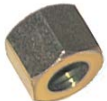


1

| | | | |
|--------------------|--|-----------------|--------|
| GEV No. | 510893 | Ref. No. | 200810 |
| description | O-ring EPDM thickness 2.62mm ID ø 9.92mm Qty 1 pcs | | |

pipes


union nuts



1

| | | | |
|--------------------|---|-----------------|----------------------|
| GEV No. | 101478 | Ref. No. | 1665200 MA1665200 |
| description | union nut thread 3/8" for pipe ø 10mm | | |
| For models: | C7011GFG, C707GFG, CFG101, CFG101D, CFG101L, CFG101P, CFG120, CFG70, CFG70D, CFG70L, CFG70P, EC74GVG, EC78GVG, EC7FG8G, OCFG101, OCFG120, OCFG70, T7011GFG, T707GFG | | |

for coffee grinders



1

| | | | |
|--------------------|---|-----------------|--------|
| GEV No. | 345019 | Ref. No. | 120712 |
| description | rotary switch sets of contacts 2 2 0-1 type CA0120002 380V 12A shaft ø 5x5mm shaft L 23mm shaft square connection screw | | |

for pyroceram ranges

ceramic hobs

ceramic hobs (complete)



1

| | | | |
|--------------------|--|-----------------|--|
| GEV No. | 692140 | Ref. No. | 1041711623 1041711623R MA1041711623R |
| description | ceramic hob L 600mm W 400mm H 40mm | | |
| For models: | PCVE40, PCVE40D, PCVE40DB, PCVE60, PCVE60D, PCVE60DB | | |

ceramic glass plates



1

| | | | |
|--------------------|--|-----------------|--|
| GEV No. | 693117 | Ref. No. | 1041711723 1041711723R MA1041711723R |
| description | ceramic plate with frame L 510mm W 548mm | | |
| For models: | CFVE60, PCVE40, PCVE40D, PCVE40DB, PCVE60, PCVE60D, PCVE60DB | | |

for deep fryers

lids



1

| | | | |
|--------------------|-------------------------------|-----------------|------------------------------|
| GEV No. | 691353 | Ref. No. | 1041306013R MA1041306013R |
| description | lid L 440mm W 245mm for fryer | | |

filters



1

| | | | |
|--------------------|--|-----------------|--|
| GEV No. | 694068 | Ref. No. | 1817200 1817201R 1817300 MA1817200 MA1817201R MA1817300 |
| description | container filter type series 700/900 | | |
| For models: | CP704E, CP704G, CP707G, CP92E, CP92E2, CP92G, CP94E, CP94E2, CP94G, CP95B2E, CP95B2E2, CP95B2G, CP95B4E, CP95B4E2, CP95B4G, DE92142, DE94242, EPC74E, EPC74G, FQE6, FQE6+6, NPC76E, NPC76G, NPC96E, NPC96G, PC12C4E, PC12C4G, PC12C9E, PC12C9G, PC74E, PC74G, PC76E, PC76G, PC78E, PC78G, PC94E, PC94G, PC96E, PC96G, PC98E, PC98G, PC954E, PC954G, PC956E, PC956G, PC958E, PC958G, SPAR16, SPAR20, SPRG12...(Other models you can see in the webshop) | | |

for griddles

housing and bezels



1

| | | | |
|--------------------|---|-----------------|----------------------------|
| GEV No. | 691349 | Ref. No. | 1044314900 MA1044314900 |
| description | spraying protection L 520mm W 390mm H 75mm | | |
| For models: | BIE40B, BIE60B, FTE100B, FTE100BR, FTE100C, FTE100CRL, FTE40B, FTE40BR, FTE40C, FTE40D, FTE40DC, FTE60B, FTE60BR, FTE60BRR, FTE60C, FTE60D, FTE60DC, FTE60DCRL, FTE60DR, FTG40B, FTG60B, FTG60BLC, FTG60BR, FTG80B, FTG80BR, FTVE100, FTVE40, FTVE40D, FTVE60, FTVE60D, OFTE100CRL, OFTE40B, OFTE40BR, OFTE40C, OFTE60B, OFTE60BR, OFTE60BRR, OFTE60C | | |



1

| | | | |
|--------------------|---|-----------------|----------------------------|
| GEV No. | 691350 | Ref. No. | 1044315000 MA1044315000 |
| description | spraying protection L 520mm W 590mm H 75mm | | |
| For models: | BIE40B, BIE60B, FTE100B, FTE100BR, FTE100C, FTE100CRL, FTE40B, FTE40BR, FTE40C, FTE40D, FTE40DC, FTE60B, FTE60BR, FTE60BRR, FTE60C, FTE60D, FTE60DC, FTE60DCRL, FTE60DR, FTG40B, FTG60B, FTG60BLC, FTG60BR, FTG80B, FTG80BR, FTVE100, FTVE40, FTVE40D, FTVE60, FTVE60D, OFTE100CRL, OFTE40B, OFTE40BR, OFTE40C, OFTE60B, OFTE60BR, OFTE60BRR, OFTE60C | | |



1

| | | | |
|--------------------|--|-----------------|----------------------------|
| GEV No. | 691351 | Ref. No. | 1044320700 MA1044320700 |
| description | spraying protection L 520mm W 790mm H 75mm | | |
| For models: | FTG40B, FTG60B, FTG60BLC, FTG60BR, FTG80B, FTG80BR | | |



drain stoppers



| | | | |
|--------------------|--|-----------------|------------------------|
| GEV No. | 691331 | Ref. No. | 97313000 MA97313000 |
| description | outflow plug for grease drain flange 30x70mm H 100mm | | |
| For models: | BIE40B, BIE60B, EFT74ELVG, EFT74ERVG, EFT74GLVG, EFT74GRVG, EFT78ELVG, EFT78EMVG, EFT78GLVG, EFT78GMVG, FT74GL, FT74GLC, FT74GR, FT74GRC, FT76GL, FT76GLC, FT76GM, FT76GMC, FT76GR, FT78GL, FT78GLC, FT78GLT, FT78GM, FT78GMC, FT78GMT, FT78GR, FT78GRT, FT94G, FT94GL, FT94GLC, FT94GR, FT94GRC, FT96GL, FT96GLC, FT96GM, FT96GMC, FT96GR, FT98GL, FT98GLC, FT98GLT, FT98GM, FT98GMC, FT98GMT, FT98GR, FT98GRT, FTE100B, FTE100BR, FTE100C, FTE100CRL, FTE40B...(Other models you can see in the webshop) | | |



| | | | |
|--------------------|---|-----------------|----------------------------|
| GEV No. | 691330 | Ref. No. | 1033705600 MA1033705600 |
| description | outflow plug for grease drain ϕ 32mm L 50mm ID ϕ 17.8mm ED ϕ 25.5mm | | |
| For models: | BIE40B, BIE60B, FTE100B, FTE100BR, FTE100C, FTE100CRL, FTE40B, FTE40BR, FTE40C, FTE40D, FTE40DC, FTE60B, FTE60BR, FTE60BRR, FTE60C, FTE60D, FTE60DC, FTE60DCRL, FTE60DR, FTG40B, FTG40BLC, FTG40BR, FTG60B, FTG60BLC, FTG60BR, FTG60BRR, FTG80B, FTG80BLC, FTG80BR, OFTE100CRL, OFTE40B, OFTE40BR, OFTE40C, OFTE60B, OFTE60BR, OFTE60BRR, OFTE60C | | |

for convection ovens/combi-steamers

drain units

drip rails



| | | | |
|--------------------|--------------------------------------|-----------------|-----------|
| GEV No. | 691961 | Ref. No. | R69180000 |
| description | drain unit L 90mm edition since 2009 | | |
| For models: | GMT20D, GVT06D, GVT20D | | |



| | | | |
|--------------------|--|-----------------|-----------|
| GEV No. | 694606 | Ref. No. | R11200520 |
| description | drip rail L 90mm edition from 2000 until 2009 | | |
| For models: | ME061M, ME061P, ME061T, ME101M, ME101P, ME101T, ME102M, ME102P, ME102T, MG061M, MG061P, MG061T, MG101M, MG101P, MG101T, MG102M, MG102P, MG102T | | |



| | | | |
|--------------------|--|-----------------|-----------|
| GEV No. | 699451 | Ref. No. | R70080010 |
| description | bush for steam generator ID ϕ 60mm ED ϕ 76mm L 70mm ceramic suitable for combi-steamer | | |
| For models: | GMT20D, MG101D, MG101M, MG101P, MG101T, MG102D, MG102M, MG102P, MG102T, MG201D, MG201M, MG201P, MG201T, MG202D, MG202M, MG202P, MG202T, MGMT10D, MGMT10P, MGMT20D, MGMT20P, MGMT21D, MGMT21P, MGMT40D, MGMT40P | | |

injection nozzles




| | | | |
|--------------------|--|-----------------|------------------------|
| GEV No. | 691278 | Ref. No. | R58006130 R58006140 |
| description | injection nozzle bore ϕ 1mm for combi-steamer | | |
| For models: | GMT06D, GMT20D, GVT06D, GVT20D, ME061P, ME061T, ME101D, ME101M, ME101P, ME101T, ME102D, ME102M, ME102P, ME102T, ME201D, ME201M, ME201P, ME201T, ME202D, ME202M, ME202P, ME202T, MEMT06D, MEMT06P, MEMT10D, MEMT10P, MEMT20D, MEMT20P, MEMT21D, MEMT21P, MEMT40D, MEMT40P, MEVT06D, MEVT06P, MEVT10D, MEVT10P, MEVT20D, MEVT20P, MEVT21D, MEVT21P, MEVT40D, MEVT40P, MG061D, MG061M, MG061P, MG061T, MG101D, MG101M, MG101P, MG101T...(Other models you can see in the webshop) | | |




| | | | |
|--------------------|--|-----------------|-----------|
| GEV No. | 692326 | Ref. No. | R58006080 |
| description | injection nozzle bore ϕ 2mm L 33mm WS 14 brass for combi-steamer T1: M10x1 T2: M10x1 | | |
| For models: | EM210H, EM210M, EM210M+SC, EM210P, EV210H, EV210M, EV210M+SC, EV210P, GM210H, GM210M, GM210M+SC, GM210P, GV210H, GV210M, GV210M+SC, GV210P, ME120M, ME120P, ME120X, ME210M, ME210P, ME210X, ME220M, ME220P, ME220X, MEC24H, MEC40M, MG120M, MG120P, MG120X, MG210M, MG210P, MG210X, MG220M, MG220P, MG220X, MGC20X, MGC24H, MGC40H, VE120M, VE120P, VE120X, VE210M, VE210P, VE210X, VE220M, VE220P, VE220X, VG120M, VG120P...(Other models you can see in the webshop) | | |

injection pipes




1

| | | | |
|--------------------|---|-----------------|-----------|
| GEV No. | 696767 | Ref. No. | R10206480 |
| description | extension U-shape for injection pipe ED ø 8/12mm ID ø 6/8mm | | |
| For models: | EC110M, EC210M, EM010M+SC, EM110H, EM110M, EM110M+SC, EM110P, EM210H, EM210M, EM210M+SC, EM210P, EV110H, EV110M, EV110M+SC, EV110P, EV210H, EV210M, EV210M+SC, EV210P, GC110M, GC210M, GM110H, GM110M, GM110M+SC, GM110P, GM210H, GM210M, GM210M+SC, GM210P, GV110H, GV110M, GV110M+SC, GV110P, GV210H, GV210M, GV210M+SC, GV210P, MEC24H, MEC40M, MGC20X, MGC24H, MGC40H, VE110M, VE110X, VE120M, VE120P, VE120X, VE210M, VE210P, VE210X...(Other models you can see in the webshop) | | |




1

| | | | |
|--------------------|--|-----------------|-----------|
| GEV No. | 692819 | Ref. No. | R11201980 |
| description | injection pipe for combi-steamer ED ø 8mm ID ø 5.5mm L 170mm W 115mm | | |
| For models: | GVT20D, MGVT10D, MGVT10P, MGVT20D, MGVT20P, MGVT40D, MGVT40P | | |




1

| | | | |
|--------------------|---|-----------------|-----------|
| GEV No. | 692821 | Ref. No. | R18200540 |
| description | injection pipe for combi-steamer H 75mm ED ø 8mm ID ø 6mm L 105mm | | |
| For models: | MACE04M, MACE05M, MACG05M, MVE042P, MVE051P, MVG051P | | |




1

| | | | |
|--------------------|--|-----------------|-----------|
| GEV No. | 692832 | Ref. No. | R11201990 |
| description | injection pipe for combi-steamer U-shape ED ø 8mm ID ø 6mm | | |
| For models: | GMT20D, MACG10M, MACG20M, MG101M, MG101P, MG101T, MG102D, MG102M, MG102P, MG102T, MGMT20D, MGMT20P | | |



1


| | | | |
|--------------------|---|-----------------|-----------|
| GEV No. | 694318 | Ref. No. | R10206540 |
| description | injection pipe L1 66mm L2 49mm tube ø 8mm mounting distance 36mm | | |
| For models: | EC106M, EC110M, EC210M, EM010M+SC, EM106H, EM106M, EM106M+SC, EM106P, EM110H, EM110M, EM110M+SC, EM110P, EM210H, EM210M, EM210M+SC, EM210P, EV006M, EV106H, EV106M, EV106M+SC, EV106P, EV110H, EV110M, EV110M+SC, EV110P, EV210H, EV210M, EV210M+SC, EV210P, GC106M, GC110M, GC210M, GM106H, GM106M, GM106M+SC, GM106P, GM110H, GM110M, GM110M+SC, GM110P, GM210H, GM210M, GM210M+SC, GM210P, GV106H, GV106M, GV106M+SC, GV106P, GV110H, GV110M...(Other models you can see in the webshop) | | |



1


| | | | |
|--------------------|--|-----------------|-----------|
| GEV No. | 692820 | Ref. No. | R11200650 |
| description | injection pipe with holder for combi-steamer ED ø 8mm ID ø 6mm L 150mm H 75mm | | |
| For models: | GMT06D, GVT06D, MACE07M, MACG07M, ME061D, ME061M, ME061P, ME061T, MEMENT06D, MEMENT06P, MEVTO6D, MEVTO6P, MG061D, MG061M, MG061P, MG061T, MGMT06D, MGMT06P, MGVT06D, MGVT06P | | |

filters



1


| | | | |
|--------------------|---------------------|-----------------|-----------|
| GEV No. | 691269 | Ref. No. | R18200260 |
| description | drain filter ø 43mm | | |
| For models: | MACE04M, MVE042P | | |

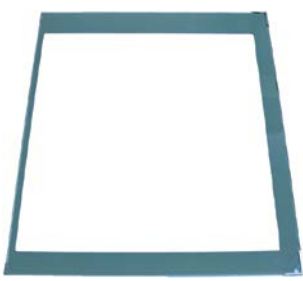



1


| | | | |
|--------------------|---|-----------------|------------------------|
| GEV No. | 691270 | Ref. No. | R02200280 R10201700 |
| description | drain filter ø 76mm | | |
| For models: | EC106M, EC110M, EC210M, EM010M+SC, EM106H, EM106M, EM106M+SC, EM106P, EM110H, EM110M, EM110M+SC, EM110P, EM210H, EM210M, EM210M+SC, EM210P, EV006M, EV106H, EV106M, EV106M+SC, EV106P, EV110H, EV110M, EV110M+SC, EV110P, EV210H, EV210M, EV210M+SC, EV210P, FE105M, FE105X, FE110M, FE110X, FG105M, FG105X, FG110M, FG110X, GC106M, GC110M, GC210M, GM106H, GM106M, GM106M+SC, GM106P, GM110H, GM110M, GM110M+SC, GM110P, GM210H, GM210M...(Other models you can see in the webshop) | | |



| | | | |
|---|--|-----------------|------------------------|
|  | | | |
| 1 | | | |
| GEV No. | 691271 | Ref. No. | R10201710 R10201720 |
| description | drain filter ø 87mm | | |
| For models: | GMT06D, GMT20D, GVT06D, MACE10M, MACE20M, MACG10M, MACG20M, ME102D, ME102M, ME102P, ME102T, ME120M, ME120P, ME120X, ME201D, ME201M, ME201P, ME201T, ME202D, ME202M, ME202P, ME202T, ME220M, ME220P, ME220X, MEC24H, MEC40M, MEMT06D, MEMT06P, MEMT10D, MEMT10P, MEMT20D, MEMT20P, MEMT21D, MEMT21P, MEMT40D, MEMT40P, MEVT06D, MEVT06P, MEVT10D, MEVT10P, MEVT20D, MEVT20P, MEVT21D, MEVT21P, MEVT40D, MEVT40P, MG120M, MG120P, MG120X...(Other models you can see in the webshop) | | |


| | | | |
|---|--|-----------------|-----------|
| <p>glass panels</p>  | | | |
| 1 | | | |
| GEV No. | 696396 | Ref. No. | R11100140 |
| description | glass panel L 860mm W 730mm thickness 6mm mounting pos. inner for combi-steamer | | |
| For models: | GMT20D, GVT20D, ME101D, ME101M, ME101P, ME101T, ME102D, ME102M, ME102P, ME102T, MEMT20D, MEMT20P, MEVT20D, MEVT20P, MG101D, MG101M, MG101P, MG101T, MG102D, MG102M, MG102P, MG102T, MGMT20D, MGMT20P, MGV20D, MGV20P | | |

| | | | |
|---|--|-----------------|-----------|
| <p>cleaning system</p> <p>nozzles</p>  | | | |
| 1 | | | |
| GEV No. | 550864 | Ref. No. | R62210042 |
| description | nozzle flow rate 0.56l/min for combi-steamer | | |
| For models: | ME061T, ME101T, ME102T, ME201T, MEMT06P, MEMT10P, MEMT20P, MEMT21P, MEMT40P, MG102T, MG201T, MG202T, MGMT06P, MGMT10P, MGMT20P, MGMT21P, MGMT40P | | |

| | | | |
|---|--|-----------------|-----------|
|  | | | |
| 1 | | | |
| GEV No. | 550865 | Ref. No. | R62210032 |
| description | nozzle flow rate 1.3l/min for combi-steamer | | |
| For models: | ME061T, ME101T, ME102T, ME201T, MEMT06P, MEMT10P, MEMT20P, MEMT21P, MEMT40P, MG102T, MG201T, MG202T, MGMT06P, MGMT10P, MGMT20P, MGMT21P, MGMT40P | | |

| | | | |
|---|--|-----------------|-----------|
| <p>coupling bushings</p>  | | | |
| 1 | | | |
| GEV No. | 550863 | Ref. No. | R58004980 |
| description | bush for wash arm | | |
| For models: | ME061T, ME101T, ME102T, ME201T, MEMT06P, MEMT10P, MEMT20P, MEMT21P, MEMT40P, MG102T, MG201T, MG202T, MGMT06P, MGMT10P, MGMT20P, MGMT21P, MGMT40P | | |

| | | | |
|--|--|-----------------|-----------|
| <p>pipes</p>  | | | |
| 1 | | | |
| GEV No. | 520970 | Ref. No. | R62180022 |
| description | drain pipe flexible L 135mm ID ø 18mm ED ø 27.5mm connection 3/4" ET - 3/4" IT SS for combi-steamer | | |
| For models: | GMT06D, ME201D, ME201M, ME201P, ME201T, MEMT21D, MEMT21P, MG061D, MG061M, MG061P, MG061T, MG101D, MG101M, MG101P, MG101T, MG120M, MG120P, MG120X, MG201D, MG201M, MG201P, MG201T, MG202D, MG202M, MG202P, MG202T, MGC20X, MGMT06D, MGMT06P, MGMT10D, MGMT10P, MGMT21D, MGMT21P, MGMT40D, MGMT40P | | |

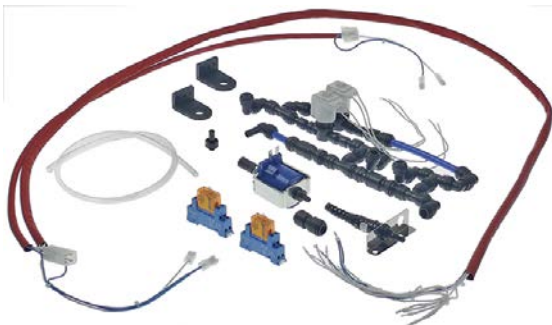
| | | | |
|--|--|-----------------|-----------|
| <p>hoses</p>  | | | |
| 1 | | | |
| GEV No. | 520534 | Ref. No. | R70060040 |
| description | hose ID ø 50mm ED ø 58mm L 50mm silicone Qty 1 for combi-steamer thickness 4mm | | |
| For models: | FE105M, FE105X, FE110M, FE110X, FG105M, FG105X, FG110M, FG110X, GMT20D, ME061P, ME061T, ME101M, ME101P, ME101T, ME102M, ME102P, ME102T, ME106M, ME106P, ME106X, ME110M, ME110P, ME110X, ME120M, ME120P, ME120X, ME201D, ME201M, ME201P, ME201T, ME202D, ME202M, ME202P, ME202T, ME210M, ME210P, ME210X, ME220M, ME220P, ME220X, MEC24H, MEC40M, MEMT21D, MEMT21P, MEMT40D, MEMT40P, MEVT21D, MEVT21P, MEVT40D, MEVT40P...(Other models you can see in the webshop) | | |



1

| | | | |
|--------------------|--|-----------------|-----------|
| GEV No. | 530901 | Ref. No. | R70060050 |
| description | hose ID ø 54mm ED ø 60mm L 50mm for combi-steamer | | |
| For models: | FE210M, FG210M, FG210X, ME102P, ME102T, ME202D, ME202M, ME202P, ME202T, MEMT40D, MEMT40P, MEVT40D, MEVT40P, MG102P, MG102T, MG202D, MG202M, MG202P, MG202T, MGMT40D, MGMT40P, MGVT40D, MGVT40P | | |

service kits



1

| | | | |
|--------------------|--|-----------------|-----------|
| GEV No. | 512503 | Ref. No. | R62300028 |
| description | backflow preventer kit | | |
| For models: | ME061T, ME101T, ME102T, ME201T, MEMT06P, MEMT10P, MEMT20P, MG102T, MG201T, MGMT06P, MGMT10P, MGMT20P | | |



1

| | | | |
|--------------------|--|-----------------|-----------|
| GEV No. | 699468 | Ref. No. | R58003100 |
| description | mounting set for air baffle 4-piece | | |
| For models: | GMT06D, GMT20D, GVT06D, GVT20D, ME061D, ME061M, ME061P, ME061T, ME101D, ME101M, ME101P, ME101T, ME102D, ME102M, ME102P, ME106M, ME106P, ME106X, ME110M, ME110P, ME110X, ME120M, ME120P, ME120X, ME201D, ME201M, ME201P, ME201T, ME202D, ME202M, ME202P, ME202T, ME210M, ME210P, ME210X, ME220M, ME220P, ME220X, MEC24H, MEC40M, MEMT06D, MEMT06P, MEMT10D, MEMT10P, MEMT20D, MEMT20P, MEMT21D, MEMT21P, MEMT40D, MEMT40P...(Other models you can see in the webshop) | | |

doors



1

| | | | |
|--------------------|--|-----------------|-----------|
| GEV No. | 692325 | Ref. No. | R71010010 |
| description | glass panel W 514mm H 314mm thickness 4mm for hot air oven Qty 1 pcs | | |
| For models: | FE105M, FE105X, FG105M, FG105X, PE040M, PE040X, PG040M, PG040X | | |



1


| | | | |
|--------------------|--------------------|-----------------|-----------|
| GEV No. | 691298 | Ref. No. | R18100000 |
| description | oven door complete | | |
| For models: | MACE04M, MVE042P | | |



1


| | | | |
|--------------------|--|-----------------|-----------|
| GEV No. | 692836 | Ref. No. | R11401360 |
| description | protective plate lower for glass plate combi-steamer H 8mm W 8mm | | |
| For models: | GMT06D, GMT20D, GVT06D, GVT20D, ME061D, ME061M, ME061P, ME061T, ME101D, ME101M, ME101P, ME101T, ME102D, ME102M, ME102P, ME102T, MEMT06D, MEMT06P, MEMT10D, MEMT10P, MEMT20D, MEMT20P, MEVT06D, MEVT06P, MEVT10D, MEVT10P, MEVT20D, MEVT20P, MG061D, MG061M, MG061P, MG061T, MG101D, MG101M, MG101P, MG101T, MG102D, MG102M, MG102P, MG102T, MGMT06D, MGMT06P, MGMT10D, MGMT10P, MGMT20D, MGMT20P, MGVT06D, MGVT06P, MGVT10D, MGVT10P...(Other models you can see in the webshop) | | |




| | | | |
|--|--|-----------------|-----------|
|  <p>1</p> | | | |
| GEV No. | 692837 | Ref. No. | R11401340 |
| description | protective plate upper for glass plate combi-steamer H 8mm W 8mm | | |
| For models: | GMT06D, GMT20D, GVT06D, GVT20D, MACE07M, MACE10M, MACE20M, MACG07M, MACG10M, MACG20M, ME061D, ME061M, ME061P, ME061T, ME101D, ME101M, ME101P, ME101T, ME102D, ME102M, ME102P, ME102T, MEMT06D, MEMT06P, MEMT10D, MEMT10P, MEMT20D, MEMT20P, MEVT06D, MEVT06P, MEVT10D, MEVT10P, MEVT20D, MEVT20P, MG061D, MG061M, MG061P, MG061T, MG101D, MG101M, MG101P, MG101T, MG102D, MG102M, MG102P, MG102T, MGMT06D, MGMT06P, MGMT10D, MGMT10P...(Other models you can see in the webshop) | | |


door mechanics

holders




| | | | |
|--|--|-----------------|-----------|
|  <p>1</p> | | | |
| GEV No. | 691272 | Ref. No. | R18203910 |
| description | bracket for glass plate mounting pos. lower | | |
| For models: | MACE07M, MACE10M, MACE20M, MACG07M, MACG10M, MACG20M | | |

| | | | |
|---|--|-----------------|-----------|
|  <p>1</p> | | | |
| GEV No. | 691273 | Ref. No. | R18203920 |
| description | bracket for glass plate mounting pos. upper | | |
| For models: | MACE07M, MACE10M, MACE20M, MACG07M, MACG10M, MACG20M | | |


accessories

| | | | |
|--|--|-----------------|-----------|
|  <p>1</p> | | | |
| GEV No. | 692834 | Ref. No. | R10207680 |
| description | fixing plate for door W 30mm L 50mm | | |
| For models: | ME120M, ME120P, ME120X, ME201D, ME201M, ME201P, ME201T, ME202D, ME202M, ME202P, ME202T, ME220M, ME220P, ME220X, MEC24H, MEC40M, MEMT21D, MEMT21P, MEMT40D, MEMT40P, MEVT21D, MEVT21P, MEVT40D, MEVT40P, MG120M, MG120P, MG120X, MG201D, MG201M, MG201P, MG201T, MG202D, MG202M, MG202P, MG202T, MG220M, MG220P, MG220X, MGC20X, MGC24H, MGC40H, MGMT21D, MGMT21P, MGMT40D, MGMT40P, MGVT21D, MGVT21P, MGVT40D, MGVT40P, VE120M...(Other models you can see in the webshop) | | |


vibration pumps

| | | | | |
|---|--|-----------------|-----------------|---|
|  <p>1</p> | | | | |
| GEV No. | 500568 | Ref. No. | R65110600 | |
| description | vibration pump 230V 32W 50Hz inlet ø 7 outlet ø 1/8" IT CEME type E512/A32 | | | |
| For models: | ME061T, ME101T, ME102T, ME201T, MEMT06P, MEMT10P, MEMT20P, MEMT21P, MEMT40P, MG102T, MG201T, MG202T, MGMT06P, MGMT10P, MGMT20P, MGMT21P, MGMT40P | | | |
| spare parts for | 500568 | | | |
| | GEV No. | 390698 | Ref. No. | — |
| |  thermal fuse switch-off temp. 110°C suitable for ULKA pump | | | |
| | GEV No. | 520153 | Ref. No. | — |
| |  bracket rubber dimensions 53x34x28mm | | | |


heat exchangers

| | | | |
|--|--|-----------------|-----------|
|  <p>1</p> | | | |
| GEV No. | 520509 | Ref. No. | R58004170 |
| description | reducing washer gas burner brass ID ø 3mm ED ø 16mm thickness 2.2mm code 3 | | |
| For models: | MACG05M, MVG051P | | |


miscellaneous


| | | | |
|---|--|-----------------|-----------|
|  <p>1</p> | | | |
| GEV No. | 696428 | Ref. No. | R11201970 |
| description | extension U-shape for injection pipe D1 ø 8mm D2 ø 10mm L 212mm WS 12 stainless steel | | |
| For models: | MACE10M, MACE20M, ME101D, ME101M, ME101P, ME101T, ME102D, ME102M, ME102P, ME201D, ME201M, ME201P, ME201T, ME202D, ME202M, ME202P, ME202T, MEMT10D, MEMT10P, MEMT20D, MEMT20P, MEMT21D, MEMT21P, MEMT40D, MEMT40P, MEVT10D, MEVT10P, MEVT20D, MEVT20P, MEVT21D, MEVT21P, MEVT40D, MEVT40P, MG101D, MG201D, MG201M, MG201P, MG201T, MG202D, MG202M, MG202P, MG202T, MGMT10D, MGMT10P, MGMT21D, MGMT21P, MGMT40D, MGMT40P, MGVT21D, MGVT21P | | |


| | | | |
|---|--|-----------------|-----------|
|  | | | |
| 1 | | | |
| GEV No. | 696394 | Ref. No. | R10206470 |
| description | extension U-shape for injection pipe D1 ø 8mm D2 ø 12mm L 113mm W 72mm | | |
| For models: | EC106M, EM106H, EM106M, EM106M+SC, EM106P, EV006M, EV106H, EV106M, EV106M+SC, EV106P, GC106M, GM106H, GM106M, GM106M+SC, GM106P, GV106H, GV106M, GV106M+SC, GV106P, VE106M, VE106P, VE106X, VG106M, VG106P, VG106X | | |

| | | | |
|---|--|-----------------|-----------|
|  | | | |
| 1 | | | |
| GEV No. | 691290 | Ref. No. | R10100140 |
| description | extractor stubs complete | | |
| For models: | ME061P, ME061T, ME101P, ME101T, ME106M, ME106P, ME106X, ME110M, ME110P, ME110X, ME120M, ME120P, ME120X, ME210M, ME210P, ME210X, ME220M, ME220P, ME220X, MEC24H, MEMT06P, MEMT10P, MEVT06P, MEVT10P, MG061P, MG061T, MG101P, MG101T, MG106M, MG106P, MG106X, MG110M, MG110P, MG110X, MG120M, MG120P, MG120X, MG210M, MG210P, MG210X, MG220M, MG220P, MG220X, MGC24H, MGC40H, MGMT06P, MGMT10P, MGVT06P, MGVT10P, VE106M...(Other models you can see in the webshop) | | |

| | | | |
|---|---|-----------------|-----------|
|  | | | |
| 1 | | | |
| GEV No. | 691282 | Ref. No. | R58005350 |
| description | gasket for door handle D1 ø 30mm D2 ø 18mm mounting pos. upper H 1.4mm | | |
| For models: | CVE004H, CVE004M, CVE104H, CVE104M, CVE105H, CVE105M, CVG105H, CVG105M, EC106M, EC110M, EC210M, EM010M+SC, EM106H, EM106M, EM106M+SC, EM106P, EM110H, EM110M, EM110M+SC, EM110P, EM210H, EM210M, EM210M+SC, EM210P, EV006M, EV106H, EV106M, EV106M+SC, EV106P, EV110H, EV110M, EV110M+SC, EV110P, EV210H, EV210M, EV210M+SC, EV210P, FE105M, FE105X, FE110M, FE110X, FE210M, FG105M, FG105X, FG110M, FG110X, FG210M, FG210X, GC106M, GC110M...(Other models you can see in the webshop) | | |


| | | | |
|--|--|-----------------|-----------|
|  | | | |
| 1 | | | |
| GEV No. | 691291 | Ref. No. | R70060020 |
| description | gasket for extractor stubs D1 ø 30mm D2 ø 35mm W 9mm | | |
| For models: | ME061P, ME061T, ME101P, ME101T, ME106M, ME106P, ME106X, ME110M, ME110P, ME110X, ME120M, ME120P, ME120X, ME210M, ME210P, ME210X, ME220M, ME220P, ME220X, MEC24H, MEMT06P, MEMT10P, MEVT06P, MEVT10P, MG061P, MG061T, MG101P, MG101T, MG106M, MG106P, MG106X, MG110M, MG110P, MG110X, MG120M, MG120P, MG120X, MG210M, MG210P, MG210X, MG220M, MG220P, MG220X, MGC24H, MGC40H, MGMT06P, MGMT10P, MGVT06P, MGVT10P, VE106M...(Other models you can see in the webshop) | | |


| | | | |
|---|---|-----------------|-----------|
|  | | | |
| 1 | | | |
| GEV No. | 690099 | Ref. No. | R58002150 |
| description | hinge pin mounting pos. upper for door | | |
| For models: | EC106M, EC110M, EC210M, EM010M+SC, EM106H, EM106M, EM106M+SC, EM106P, EM110H, EM110M, EM110M+SC, EM110P, EM210H, EM210M, EM210M+SC, EM210P, EV006M, EV106H, EV106M, EV106M+SC, EV106P, EV110H, EV110M, EV110M+SC, EV110P, EV210H, EV210M, EV210M+SC, EV210P, GC106M, GC110M, GC210M, GM106H, GM106M, GM106M+SC, GM106P, GM110H, GM110M, GM110M+SC, GM110P, GM210H, GM210M, GM210M+SC, GM210P, GMT06D, GMT20D, GV106H, GV106M, GV106M+SC, GV106P...(Other models you can see in the webshop) | | |


| | | | |
|--|--|-----------------|-----------|
|  | | | |
| 1 | | | |
| GEV No. | 506229 | Ref. No. | R11200380 |
| description | injection pipe for combi-steamer L 205mm ø 10mm | | |
| For models: | GMT06D, GMT20D, GVT06D, GVT20D, MACE07M, MACE10M, MACE20M, MACG07M, MACG10M, MACG20M, ME061D, ME061M, ME061P, ME061T, ME101D, ME101M, ME101P, ME101T, ME102D, ME102M, ME102P, ME201D, ME201M, ME201P, ME201T, ME202D, ME202M, ME202P, ME202T, MEMT06D, MEMT06P, MEMT10D, MEMT10P, MEMT20D, MEMT20P, MEMT21D, MEMT21P, MEMT40D, MEMT40P, MEVT06D, MEVT06P, MEVT10D, MEVT10P, MEVT20D, MEVT20P, MEVT21D, MEVT21P, MEVT40D, MEVT40P, MG061D...(Other models you can see in the webshop) | | |


| | | | |
|---|---|-----------------|-----------|
|  | | | |
| 1 | | | |
| GEV No. | 691289 | Ref. No. | R58004830 |
| description | nut thread M18x1 H 5mm WS 22 brass Qty 1 pcs for door handle | | |
| For models: | CVE004H, CVE004M, CVE104H, CVE104M, CVE105H, CVE105M, CVG105H, CVG105M, EC106M, EC110M, EC210M, EM010M+SC, EM106H, EM106M, EM106M+SC, EM106P, EM110H, EM110M, EM110M+SC, EM110P, EM210H, EM210M, EM210M+SC, EM210P, EV006M, EV106H, EV106M, EV106M+SC, EV106P, EV110H, EV110M, EV110M+SC, EV110P, EV210H, EV210M, EV210M+SC, EV210P, FE105M, FE105X, FE110M, FE110X, FE210M, FG105M, FG105X, FG110M, FG110X, FG210M, FG210X, GC106M, GC110M...(Other models you can see in the webshop) | | |




| | | | |
|---|---|-----------------|-----------|
|  | | | |
| 1 | | | |
| GEV No. | 691296 | Ref. No. | R61400052 |
| description | plain washer ID ø 10.5mm ED ø 21mm thickness 2mm SS Qty 1 pcs for fan wheel | | |
| For models: | CVE105H, CVE105M, CVG105H, CVG105M, EC106M, EM106H, EM106M, EM106M+SC, EM106P, EV006M, EV106H, EV106M, EV106M+SC, EV106P, FE105M, FE105X, FG105M, FG105X, GC106M, GM106H, GM106M, GM106M+SC, GM106P, GMT06D, GV106H, GV106M, GV106M+SC, GV106P, GVT06D, MACE07M, MACG07M, ME061D, ME061M, ME061P, ME061T, ME106M, ME106P, ME106X, MEMT06D, MEMT06P, MEVT06D, MEVT06P, MG061D, MG061M, MG061P, MG061T, MG106M, MG106P, MG106X, MGMT06D...(Other models you can see in the webshop) | | |


| | | | |
|---|--|-----------------|-----------|
|  | | | |
| 1 | | | |
| GEV No. | 691292 | Ref. No. | R10401710 |
| description | plain washer ID ø 12mm ED ø 17.5mm thickness 1mm SS Qty 1 pcs | | |
| For models: | GMT06D, GMT20D, GVT06D, GVT20D, MACE07M, MACE10M, MACE20M, MACG07M, MACG10M, MACG20M, ME061D, ME061M, ME061P, ME061T, ME101D, ME101M, ME101P, ME101T, ME102D, ME102M, ME102P, ME102T, ME106M, ME106P, ME106X, ME110M, ME110P, ME110X, ME210M, ME210P, ME210X, MEMT06D, MEMT06P, MEMT10D, MEMT10P, MEMT20D, MEMT20P, MEVT06D, MEVT06P, MEVT10D, MEVT10P, MEVT20D, MEVT20P, MG061D, MG061M, MG061P, MG061T, MG101D, MG101M, MG101P...(Other models you can see in the webshop) | | |


| | | | |
|---|--|-----------------|-----------|
|  | | | |
| 1 | | | |
| GEV No. | 691283 | Ref. No. | R58003240 |
| description | pressure bolt for door handle D1 ø 8mm D2 ø 11mm L 73mm thread M6 bolt 16mm bolt ø 5mm | | |
| For models: | CVE105H, CVE105M, CVG105H, CVG105M, FE105M, FE105X, FE110M, FE110X, FE210M, FG105M, FG105X, FG110M, FG110X, FG210M, FG210X, MACE04M, MACE05M, MACE07M, MACE10M, MACE20M, MACG05M, MACG07M, MACG10M, MACG20M, ME106M, ME106P, ME106X, ME110M, ME110P, ME110X, ME210M, ME210P, ME210X, MG106M, MG106P, MG106X, MG110M, MG110P, MG110X, MG210M, MG210P, MG210X, MVE042P, MVE051P, MVG051P, PE040M, PE040X, PE080M, PE080X, PG040M...(Other models you can see in the webshop) | | |

| | | | |
|---|--|-----------------|-----------|
|  | | | |
| 1 | | | |
| GEV No. | 691297 | Ref. No. | R62030118 |
| description | reducer thread 1/4 / 1/8 | | |
| For models: | GVT06D, GVT20D, MEVT06D, MEVT06P, MEVT10D, MEVT10P, MEVT20D, MEVT20P, MEVT21D, MEVT21P, MEVT40D, MEVT40P, MGVT06D, MGVT06P, MGVT10D, MGVT10P, MGVT20D, MGVT20P, MGVT21D, MGVT21P, MGVT40D, MVE042P, MVE051P, MVG051P | | |

| | | | |
|---|--|-----------------|-----------|
|  | | | |
| 1 | | | |
| GEV No. | 694319 | Ref. No. | R58003390 |
| description | screw connection for pressure switch L 50mm WS 30 brass thread 1/4" | | |
| For models: | CVE004H, CVE004M, CVE104H, CVE104M, CVE105H, CVE105M, CVG105H, CVG105M, EV106H, EV106P, EV110H, EV110P, EV210H, EV210P, GV106H, GV106P, GV110H, GV110P, GV210H, GV210P, MG202D, MG202M, MG202P, MGMT40D, MGMT40P, MGVT40D, MGVT40P, VE004M, VE004X, VE104M, VE104X, VE105M, VE105X, VE106P, VE120P, VE210P, VE220P, VG105M, VG105X, VG106P, VG110P, VG120P, VG210P, VG220P | | |

| | | | |
|---|---|-----------------|-----------|
|  | | | |
| 1 | | | |
| GEV No. | 691280 | Ref. No. | R58005340 |
| description | sealing disc for door handle mounting pos. lower ED ø 25mm ID ø 5.5mm H 5mm | | |
| For models: | CVE004H, CVE004M, CVE104H, CVE104M, CVE105H, CVE105M, CVG105H, CVG105M, EC106M, EC110M, EC210M, EM010M+SC, EM106H, EM106M, EM106M+SC, EM106P, EM110H, EM110M, EM110M+SC, EM110P, EM210H, EM210M, EM210M+SC, EM210P, EV006M, EV106H, EV106M, EV106M+SC, EV106P, EV110H, EV110M, EV110M+SC, EV110P, EV210H, EV210M, EV210M+SC, EV210P, FE105M, FE105X, FE110M, FE110X, FE210M, FG105M, FG105X, FG110M, FG110X, FG210M, FG210X, GC106M, GC110M...(Other models you can see in the webshop) | | |

| | | | |
|---|--|-----------------|-----------|
|  | | | |
| 1 | | | |
| GEV No. | 691281 | Ref. No. | R58004270 |
| description | spacer piece for door handle L 34mm ID ø 6mm ED ø 8mm | | |
| For models: | CVE004H, CVE004M, CVE104H, CVE104M, CVE105H, CVE105M, CVG105H, CVG105M, FE105M, FE105X, FE110M, FE110X, FE210M, FG105M, FG105X, FG110M, FG110X, FG210M, FG210X, MACE04M, MACE05M, MACE07M, MACE10M, MACE20M, MACG05M, MACG07M, MACG10M, MACG20M, ME106M, ME106P, ME106X, ME110M, ME110P, ME110X, ME210M, ME210P, ME210X, MG106M, MG106P, MG106X, MG110M, MG110P, MG110X, MG210M, MG210P, MG210X, MVE042P, MVE051P, MVG051P, PE040M...(Other models you can see in the webshop) | | |

| | | | |
|---|--|-----------------|-----------|
|  | | | |
| 1 | | | |
| GEV No. | 692300 | Ref. No. | R70050100 |
| description | stopper with screw connection for glass plate D1 ø 15mm L 8mm thread M4 | | |
| For models: | GMT06D, GMT20D, GVT06D, GVT20D, MACE07M, MACE10M, MACE20M, MACG07M, MACG10M, MACG20M, ME061D, ME061M, ME061P, ME061T, ME101D, ME101M, ME101P, ME101T, ME102D, ME102M, ME102P, ME102T, ME201D, ME201M, ME201P, ME201T, ME202D, ME202M, ME202P, ME202T, MEMT06D, MEMT06P, MEMT10D, MEMT10P, MEMT20D, MEMT20P, MEMT21D, MEMT21P, MEMT40D, MEMT40P, MEVT06D, MEVT06P, MEVT10D, MEVT10P, MEVT20D, MEVT20P, MEVT21D, MEVT21P, MEVT40D, MEVT40P...(Other models you can see in the webshop) | | |

for tilting bratt pans

spare parts and accessories



1

| | | | |
|--------------------|---|-----------------|--------------------|
| GEV No. | 514223 | Ref. No. | 291110 MA291110 |
| description | bearing screw kettle type series 700/900 tilting bratt pan | | |
| For models: | BR707E, BR707EI, BR707G, BR707GI, BR94E, BR94EI, BR94G, BR94GI, BR96E, BR96EI, BR96G, BR96GI, BR9M4E, BR9M4EI, BR9M4G, BR9M4GI, BR9M6E, BR9M6EI, BR9M6G, BR9M6GI, BR9SB4E, BR9SB4EI, BR9SB4G, BR9SB4GI, P9D10E, P9D10G, P9D15E, P9D15G, P9D5G, P9DA10E, P9DA10G, P9DA15E, P9DA15G, P9DSB10E, P9DSB10G, P9I10E, P9I10G, P9I15E, P9I5G, P9IA10E, P9IA10G, P9IA15E, PD707G, PDASB10E, PDASB10G, PI707E, PI707G | | |



1

| | | | |
|--------------------|---|-----------------|--------------------|
| GEV No. | 514225 | Ref. No. | 290900 MA290900 |
| description | bush ID ø 18mm ext. ø 37 | | |
| For models: | BR707E, BR707EI, BR707G, BR707GI, BR94E, BR94EI, BR94G, BR94GI, BR96E, BR96EI, BR96G, BR96GI, BR9M4E, BR9M4EI, BR9M4G, BR9M4GI, BR9M6E, BR9M6EI, BR9M6G, BR9M6GI, BR9SB4E, BR9SB4EI, BR9SB4G, BR9SB4GI, P9D10E, P9D10G, P9D15E, P9D15G, P9D5G, P9DA10E, P9DA10G, P9DA15E, P9DA15G, P9DSB10E, P9DSB10G, P9I10E, P9I10G, P9I15E, P9I5G, P9IA10E, P9IA10G, P9IA15E, PD707G, PDASB10E, PDASB10G, PI707E, PI707G | | |



1

| | | | |
|--------------------|---|-----------------|------------------------|
| GEV No. | 514232 | Ref. No. | CM051403 MACM051403 |
| description | bush left tilting bratt pan type series 700 kettle series 900 | | |
| For models: | BR78EF, BR78EI, BR78G, BR78GF, BR78GI, BR912EFM, BR912EIM, BR912GFM, BR912GIM, BR98EF, BR98EFM, BR98EI, BR98EIM, BR98GF, BR98GFM, BR98GI, BR98GIM, BR9S8EF, BR9S8EI, BR9S8GF, BR9S8GI, NPD76G5, NPD96G5, NPI76E5, NPI76G5, NPI96E5, NPI96G5, PD76G5, PD96G5, PD98E10, PD98E15, PD98G10, PD98G15, PD98G15A, PD9S8E10, PD9S8G10, PI76E5, PI76G5, PI96E5, PI96G5, PI98E10, PI98E15, PI98G10, PI98G14, PI98G14A, PI9S8E10 | | |



1

| | | | |
|--------------------|--|-----------------|--|
| GEV No. | 514229 | Ref. No. | 192100 CM051301 CM192101 MACM192101 |
| description | bush right tilting bratt pan type series 700 kettle series 900 | | |
| For models: | BR78EF, BR78EI, BR78G, BR78GF, BR78GI, BR912EFM, BR912EIM, BR912GFM, BR912GIM, BR98EF, BR98EFM, BR98EI, BR98EIM, BR98GF, BR98GFM, BR98GI, BR98GIM, BR9S8EF, BR9S8EI, BR9S8GF, BR9S8GI, NPD76G5, NPD78G8, NPD96G5, NPI76E5, NPI76G5, NPI78E8, NPI78G8, NPI96E5, NPI96G5, PD76G5, PD96G5, PD98E10, PD98E15, PD98G10, PD98G15, PD98G15A, PD9S8E10, PD9S8G10, PI76E5, PI76G5, PI96E5, PI96G5, PI98E10, PI98E15, PI98G10, PI98G14, PI98G14A, PI9S8E10 | | |



1


| | | | |
|--------------------|--|-----------------|------------------------|
| GEV No. | 514227 | Ref. No. | CM051604 MACM051604 |
| description | hinge bolt kettle type series 700/900 tilting bratt pan | | |
| For models: | BR78EF, BR78EI, BR78G, BR78GF, BR78GI, BR912EFM, BR912EIM, BR912GFM, BR912GIM, BR98EF, BR98EFM, BR98EI, BR98EIM, BR98GF, BR98GFM, BR98GI, BR98GIM, BR9S8EF, BR9S8EI, BR9S8GF, BR9S8GI, NPD76G5, NPD78G8, NPD96G5, NPI76E5, NPI76G5, NPI78E8, NPI78G8, NPI96E5, NPI96G5, PD76G5, PD98E10, PD98E15, PD98G10, PD98G15, PD98G15A, PD9S8E10, PD9S8G10, PI76E5, PI76G5, PI98E10, PI98E15, PI98G10, PI98G14, PI98G14A, PI9S8E10 | | |





1


| | | | |
|--------------------|---|-----------------|------------------------|
| GEV No. | 692579 | Ref. No. | CM219200 MACM219200 |
| description | spacer bush thickness 1mm ID ø 16mm H 18mm ext. ø 18 | | |
| For models: | BR78EF, BR78EI, BR78G, BR78GF, BR78GI, BR912EFM, BR912EIM, BR912GFM, BR912GIM, BR98EF, BR98EFM, BR98EI, BR98EIM, BR98GF, BR98GFM, BR98GI, BR98GIM, BR9S8EF, BR9S8EI, BR9S8GF, BR9S8GI | | |





| spindles | | | |
|--|---|-----------------|----------------------|
|  <p>1</p> | | | |
| GEV No. | 514023 | Ref. No. | 1685800 MA1685800 |
| description | spindle nut thread M20x2.5 left-hand thread W 39mm bolt ø 20mm D 40mm H 40mm | | |
| For models: | BR707E, BR707EI, BR707G, BR707GI, BR94E, BR94EI, BR94G, BR94GI, BR96E, BR96EI, BR9M4E, BR9M4EI, BR9M4G, BR9M4GI, BR9M6E, BR9M6EI, BR9M6G, BR9M6GI, BR9S84E, BR9S84EI, BR9S84G, BR9S84GI | | |

| | | | |
|--|---|-----------------|----------------------|
|  <p>1</p> | | | |
| GEV No. | 514024 | Ref. No. | 1688000 MA1688000 |
| description | spindle nut thread M20x2.5 right-hand thread W 39mm bolt ø 20mm D 40mm H 40mm | | |
| For models: | BR707E, BR707EI, BR707G, BR707GI, BR94E, BR94EI, BR94G, BR94GI, BR96E, BR96EI, BR9M4E, BR9M4EI, BR9M4G, BR9M4GI, BR9M6E, BR9M6EI, BR9M6G, BR9M6GI, BR9S84E, BR9S84EI, BR9S84G, BR9S84GI | | |

| | | | |
|---|--|-----------------|------------------------|
|  <p>1</p> | | | |
| GEV No. | 514237 | Ref. No. | CM184300 MACM184300 |
| description | thread block thread TR20x4 right-hand thread W 39mm bolt ø 20mm D 40mm H 40mm | | |
| For models: | BR78EF, BR78EI, BR78GF, BR78GI, BR912EFM, BR912EIM, BR912GFM, BR912GIM, BR98EF, BR98EFM, BR98EI, BR98EIM, BR98GF, BR98GFM, BR98GI, BR98GIM, BR9S8EF, BR9S8EI, BR9S8GF, BR9S8GI, NBR78EF, NBR78EI, NBR78GF, NBR78GI, NBR912EFM, NBR912EIM, NBR912GFM, NBR912GIM, NBR98EF, NBR98EFM, NBR98EI, NBR98EIM, NBR98GF, NBR98GFM, NBR98GI, NBR98GIM, XCABR7E, XCABR7G | | |




| | | | |
|--|--|-----------------|------------------------------------|
|  <p>1</p> | | | |
| GEV No. | 692503 | Ref. No. | 19622-00 1962200R MA1962200R |
| description | threaded rod L 49.5mm complete | | |
| For models: | BR94E, BR94EI, BR94G, BR94GI, BR9M4E, BR9M4EI, BR9M4G, BR9M4GI, BR9M6E, BR9M6EI, BR9M6G, BR9M6GI, BR9S84E, BR9S84EI, BR9S84G, BR9S84GI | | |


| | | | |
|--|--|-----------------|------------------------------------|
|  <p>1</p> | | | |
| GEV No. | 514239 | Ref. No. | CM199200 CM199201 MACM199201 |
| description | threaded rod thread TR20x4 total length 915mm tilting bratt pan | | |
| For models: | BR78EF, BR78EI, BR78GF, BR78GI, BR912EFM, BR912EIM, BR912GFM, BR912GIM, BR98EF, BR98EFM, BR98EI, BR98EIM, BR98GF, BR98GFM, BR98GI, BR98GIM, BR9S8EF, BR9S8EI, BR9S8GF, BR9S8GI | | |

| | | | |
|---|--|-----------------|--|
|  <p>1</p> | | | |
| GEV No. | 514238 | Ref. No. | CM199100 CM199101 MACM199100 MACM199101 |
| description | threaded rod total length 740mm tilting bratt pan | | |
| For models: | BR78EF, BR78EI, BR78GF, BR78GI, BR912EFM, BR912EIM, BR912GFM, BR912GIM, BR98EF, BR98EFM, BR98EI, BR98EIM, BR98GF, BR98GFM, BR98GI, BR98GIM, BR9S8EF, BR9S8EI, BR9S8GF, BR9S8GI | | |

| miscellaneous | | | |
|---|---|-----------------|------------------------|
|  <p>1</p> | | | |
| GEV No. | 514190 | Ref. No. | CM219000 MACM219000 |
| description | pipe L 622mm ø 40mm for tilting bratt pan chrome-plated | | |
| For models: | BR78EF, BR78EI, BR78G, BR78GF, BR78GI, BR912EFM, BR912EIM, BR912GFM, BR912GIM, BR98EF, BR98EFM, BR98EI, BR98EIM, BR98GF, BR98GFM, BR98GI, BR98GIM, BR9S8EF, BR9S8EI, BR9S8GF, BR9S8GI | | |


| | | | |
|--|--|-----------------|----------------------------|
|  <p>1</p> | | | |
| GEV No. | 691352 | Ref. No. | 1041724100 MA1041724100 |
| description | stockpot L 650mm W 350mm H 95mm | | |
| For models: | BRE40, BRE40D, BRE40DB, BRE40DG, BRE40DGB, BRE40G, BRG40, BRG40G, OBRE40 | | |

| | | | | |
|---|---|-----------------|---------------------------------|----------------------|
|  <p>1</p> | | | | |
| GEV No. | 514235 | Ref. No. | 1687600 1687632 MA1687632 | |
| description | tilting mechanism complete | | | |
| For models: | BR707E, BR707EI, BR707G, BR707GI | | | |
| spare parts for | 514235 | | | |
|  | GEV No. | 514023 | Ref. No. | 1685800 MA1685800 |
| | spindle nut thread M20x2.5 left-hand thread W 39mm bolt ø 20mm D 40mm H 40mm | | | |
|  | GEV No. | 514024 | Ref. No. | 1688000 MA1688000 |
| | spindle nut thread M20x2.5 right-hand thread W 39mm bolt ø 20mm D 40mm H 40mm | | | |

| | | | |
|--|--|-----------------|----------------------|
|  | | | |
| GEV No. | 514236 | Ref. No. | 1478432 MA1478432 |
| description | tilting mechanism complete | | |
| For models: | BR94E, BR94EI, BR94G, BR94GI, BR9M4E, BR9M4EI, BR9M4G, BR9M4GI, BR9M6E, BR9M6EI, BR9M6G, BR9M6GI, BR9SB4E, BR9SB4EI, BR9SB4G, BR9SB4GI | | |


for boiling pans

spare parts and accessories

| | | | |
|--|---|-----------------|--------------------|
|  | | | |
| GEV No. | 514223 | Ref. No. | 291110 MA291110 |
| description | bearing screw kettle type series 700/900 tilting bratt pan | | |
| For models: | BR707E, BR707EI, BR707G, BR707GI, BR94E, BR94EI, BR94G, BR94GI, BR96E, BR96EI, BR96G, BR96GI, BR9M4E, BR9M4EI, BR9M4G, BR9M4GI, BR9M6E, BR9M6EI, BR9M6G, BR9M6GI, BR9SB4E, BR9SB4EI, BR9SB4G, BR9SB4GI, P9D10E, P9D10G, P9D15E, P9D15G, P9D5G, P9DA10E, P9DA10G, P9DA15E, P9DA15G, P9DSB10E, P9DSB10G, P9I10E, P9I10G, P9I15E, P9I5G, P9IA10E, P9IA10G, P9IA15E, PD707G, PDASB10E, PDASB10G, PI707E, PI707G | | |

| | | | |
|---|---|-----------------|--------------------|
|  | | | |
| GEV No. | 514225 | Ref. No. | 290900 MA290900 |
| description | bush ID ø 18mm ext. ø 37 | | |
| For models: | BR707E, BR707EI, BR707G, BR707GI, BR94E, BR94EI, BR94G, BR94GI, BR96E, BR96EI, BR96G, BR96GI, BR9M4E, BR9M4EI, BR9M4G, BR9M4GI, BR9M6E, BR9M6EI, BR9M6G, BR9M6GI, BR9SB4E, BR9SB4EI, BR9SB4G, BR9SB4GI, P9D10E, P9D10G, P9D15E, P9D15G, P9D5G, P9DA10E, P9DA10G, P9DA15E, P9DA15G, P9DSB10E, P9DSB10G, P9I10E, P9I10G, P9I15E, P9I5G, P9IA10E, P9IA10G, P9IA15E, PD707G, PDASB10E, PDASB10G, PI707E, PI707G | | |

| | | | |
|--|---|-----------------|------------------------|
|  | | | |
| GEV No. | 514232 | Ref. No. | CM051403 MACM051403 |
| description | bush left tilting bratt pan type series 700 kettle series 900 | | |
| For models: | BR78EF, BR78EI, BR78G, BR78GF, BR78GI, BR912EFM, BR912EIM, BR912GFM, BR912GIM, BR98EF, BR98EFM, BR98EI, BR98EIM, BR98GF, BR98GFM, BR98GI, BR98GIM, BR9S8EF, BR9S8EI, BR9S8GF, BR9S8GI, NPD76G5, NPD96G5, NPI76E5, NPI76G5, NPI96E5, NPI96G5, PD76G5, PD96G5, PD98E10, PD98E15, PD98G10, PD98G15, PD98G15A, PD9S8E10, PD9S8G10, PI76E5, PI76G5, PI96E5, PI96G5, PI98E10, PI98E15, PI98G10, PI98G14, PI98G14A, PI9S8E10 | | |

| | | | |
|--|--|-----------------|--|
|  | | | |
| GEV No. | 514229 | Ref. No. | 192100 CM051301 CM192101 MACM192101 |
| description | bush right tilting bratt pan type series 700 kettle series 900 | | |
| For models: | BR78EF, BR78EI, BR78G, BR78GF, BR78GI, BR912EFM, BR912EIM, BR912GFM, BR912GIM, BR98EF, BR98EFM, BR98EI, BR98EIM, BR98GF, BR98GFM, BR98GI, BR98GIM, BR9S8EF, BR9S8EI, BR9S8GF, BR9S8GI, NPD76G5, NPD78G8, NPD96G5, NPI76E5, NPI76G5, NPI78E8, NPI78G8, NPI96E5, NPI96G5, PD76G5, PD96G5, PD98E10, PD98E15, PD98G10, PD98G15, PD98G15A, PD9S8E10, PD9S8G10, PI76E5, PI76G5, PI96E5, PI96G5, PI98E10, PI98E15, PI98G10, PI98G14, PI98G14A, PI9S8E10 | | |

| | | | |
|---|--|-----------------|------------------------|
|  | | | |
| GEV No. | 514227 | Ref. No. | CM051604 MACM051604 |
| description | hinge bolt kettle type series 700/900 tilting bratt pan | | |
| For models: | BR78EF, BR78EI, BR78G, BR78GF, BR78GI, BR912EFM, BR912EIM, BR912GFM, BR912GIM, BR98EF, BR98EFM, BR98EI, BR98EIM, BR98GF, BR98GFM, BR98GI, BR98GIM, BR9S8EF, BR9S8EI, BR9S8GF, BR9S8GI, NPD76G5, NPD78G8, NPD96G5, NPI76E5, NPI76G5, NPI78E8, NPI78G8, NPI96E5, NPI96G5, PD76G5, PD98E10, PD98E15, PD98G10, PD98G15, PD98G15A, PD9S8E10, PD9S8G10, PI76E5, PI76G5, PI98E10, PI98E15, PI98G10, PI98G14, PI98G14A, PI9S8E10 | | |



for sliding doors

door guides



1

| | | | |
|--------------------|--|-----------------|-----------------------|
| GEV No. | 690705 | Ref. No. | 119390.0 MA1193900 |
| description | guide bar | | |
| For models: | IR13C, IR13CC, IR13CV, IR13M, IR13MC, IR13MV, IR13V, IR17C, IR17CC, IR17CV, IR17M, IR17MC, IR17MV, IR17V, TR13C2P, TR13I4C, TR13I4CC, TR13I4CV, TR13N2C1P, TR13N2C1PC, TR13N2C1PV, TR13N2P, TR13N2PC, TR13N2PV, TR13N4C, TR13N4CC, TR13N4CV, TR17C3P, TR17I6C, TR17I6CC, TR17I6CV, TR17N2C2P, TR17N2C2PC, TR17N2C2PV, TR17N2P, TR17N3P, TR17N3PC, TR17N3PV, TR17N4C1P, TR17N4C1PC, TR17N4C1PV, TR17N6C, TR17N6CC, TR17N6CV, TR21N2C3P, TR21N2C3PC, TR21N2C3PV, TR21N2P, TR21N4C2P, TR21N4C2PC... (Other models you can see in the webshop) | | |



1

| | | | |
|--------------------|--|-----------------|----------|
| GEV No. | 690706 | Ref. No. | 25351.00 |
| description | guide bar left | | |
| For models: | IR13C, IR13CC, IR13CV, IR13M, IR13MC, IR13MV, IR13V, IR17C, IR17CC, IR17CV, IR17M, IR17MC, IR17MV, IR17V, TR13C2P, TR13I4C, TR13I4CC, TR13I4CV, TR13N2C1P, TR13N2C1PC, TR13N2C1PV, TR13N2P, TR13N2PC, TR13N2PV, TR13N4C, TR13N4CC, TR13N4CV, TR17C3P, TR17I6C, TR17I6CC, TR17I6CV, TR17N2C2P, TR17N2C2PC, TR17N2C2PV, TR17N2P, TR17N3P, TR17N3PC, TR17N3PV, TR17N4C1P, TR17N4C1PC, TR17N4C1PV, TR17N6C, TR17N6CC, TR17N6CV, TR21N2C3P, TR21N2C3PC, TR21N2C3PV, TR21N2P, TR21N4C2P, TR21N4C2PC... (Other models you can see in the webshop) | | |

for dishwashers

drain and intake components

MARENO

drain /intake bodies



1

| | | | |
|--------------------|--|-----------------|------------|
| GEV No. | 511916 | Ref. No. | 1036600400 |
| description | intake body | | |
| For models: | DLS30, DLS303, DLS30P, DLS30P3, DLS31, DLS313, DLS31P3, MLS30, MLS303, MLS30P, MLS30P3, MLS31, MLS313, MLS31P3, MLS35, MLS353, MPLS30P | | |




1

| | | | |
|--------------------|------------------------------|-----------------|------------|
| GEV No. | 506224 | Ref. No. | 1032100700 |
| description | nut thread 1 1/2" plastic | | |
| For models: | MLC50, MLC503, MLC65, MLC653 | | |

filters



1

| | | | |
|--|--|-----------------|------------|
| GEV No. | 511917 | Ref. No. | 1036601300 |
| description | intake filter | | |
| For models: | DLS30, DLS303, DLS30P, DLS30P3, DLS31, DLS313, DLS31P3, MLS30, MLS303, MLS30P, MLS30P3, MLS31, MLS313, MLS31P3, MLS35, MLS353, MPLS30P | | |
| spare parts for | 511917 | | |
|  GEV No. | 511916 | Ref. No. | 1036600400 |
| description | intake body | | |

overflow pipes



1

| | | | |
|--------------------|--|-----------------|------------|
| GEV No. | 532062 | Ref. No. | 1036502300 |
| description | O-ring EPDM thickness 2.62mm ID ø 29.82mm Qty 10 pcs | | |
| For models: | DLS30, DLS303, DLS30P, DLS30P3, DLS31, DLS313, DLS31P3, MLC50, MLC503, MLC65, MLC653, MLS30, MLS303, MLS30P, MLS30P3, MLS31, MLS313, MLS31P3, MLS35, MLS353, MPLS30P | | |



1

| | | | |
|--------------------|---|-----------------|------------------------|
| GEV No. | 514221 | Ref. No. | CM142100 MACM142100 |
| description | overflow pipe ø 20mm L 150mm | | |
| For models: | B124E, B74E, B74G, B78E, B78G, B94E, B94G, B98E, B98G, NB74E, NB74G, NB78E, NB78G, NB94E, NB94G, NB98E, NB98G | | |



1

| | | | |
|--------------------|--|-----------------|------------|
| GEV No. | 519454 | Ref. No. | 1036600700 |
| description | overflow pipe \varnothing 31mm L 238mm ID \varnothing 27mm ED \varnothing 31mm thickness 3mm | | |
| For models: | DLS30, DLS303, DLS30P, DLS30P3, DLS31, DLS313, DLS31P3, MLS30, MLS303, MLS30P, MLS30P3, MLS31, MLS313, MLS31P3, MLS35, MLS353, MPLS30P | | |

containers

accessories



1

| | | | |
|--------------------|--|-----------------|--------|
| GEV No. | 510654 | Ref. No. | 200454 |
| description | gasket H 6mm D1 \varnothing 82mm D2 \varnothing 68mm | | |

boilers

boilers for dishwashers



1

| | | | |
|--------------------|---|-----------------|--------|
| GEV No. | 511000 | Ref. No. | 330307 |
| description | boiler \varnothing 160mm L 500mm capacity 10l flange 3 hole flange inlet \varnothing 12 | | |

softener cartridges

softening columns



1

| | | | |
|--------------------|---------------------------------|-----------------|--------|
| GEV No. | 530000 | Ref. No. | 640209 |
| description | softener 4-fold L 380mm W 180mm | | |

housing and bezels

fastening angles



1

| | | | |
|--------------------|-----------------------------------|-----------------|--------|
| GEV No. | 510937 | Ref. No. | 330725 |
| description | mounting angle for solenoid valve | | |

hood mechanics for dishwashers

bolts



1

| | | | |
|--------------------|---------------------|-----------------|--------|
| GEV No. | 510988 | Ref. No. | 340493 |
| description | bolt for hood joint | | |

bushes



1

| | | | |
|--------------------|---------------------|-----------------|--------|
| GEV No. | 510867 | Ref. No. | 190632 |
| description | bush hood mechanics | | |



1

| | | | |
|--------------------|---------------------------------------|-----------------|--------|
| GEV No. | 510848 | Ref. No. | 290821 |
| description | spacer bush for switch hood mechanics | | |

springs



1

| | | | |
|--------------------|---|-----------------|---------------|
| GEV No. | 511968 | Ref. No. | 10.337.114.00 |
| description | spring for hood mechanics L 383mm wire gauge \varnothing 5.5mm \varnothing 43mm | | |
| For models: | MLC50, MLC503, MLC65, MLC653 | | |



| guide bars | | | |
|--------------------|---|-----------------|--------|
| 1 | | | |
| GEV No. | 511005 | Ref. No. | 180604 |
| description | guide bar L 575mm hood mechanics C33, C34, LC380, LC400 | | |

| | | | |
|--------------------|--|-----------------|--------|
| 1 | | | |
| GEV No. | 510948 | Ref. No. | 180624 |
| description | guide bar L 575mm hood mechanics C95, C155, C165, C166 | | |

| | | | |
|--------------------|--|-----------------|--------|
| 1 | | | |
| GEV No. | 510827 | Ref. No. | 180606 |
| description | guide bar mounting pos. left hood mechanics for door | | |

| | | | |
|--------------------|---|-----------------|--------|
| 1 | | | |
| GEV No. | 510826 | Ref. No. | 180605 |
| description | guide bar mounting pos. right hood mechanics for door | | |

| hood handle supports | | | |
|----------------------|-----------------------|-----------------|--------|
| 1 | | | |
| GEV No. | 510350 | Ref. No. | 190608 |
| description | guide for hood handle | | |

| | | | |
|--------------------|------------------------------|-----------------|--------|
| 1 | | | |
| GEV No. | 510856 | Ref. No. | 190110 |
| description | handle holder hood mechanics | | |

| | | | |
|--------------------|------------------------------|-----------------|--------|
| 1 | | | |
| GEV No. | 510868 | Ref. No. | 191013 |
| description | handle holder hood mechanics | | |

| | | | |
|--------------------|------------------------------|-----------------|--------|
| 1 | | | |
| GEV No. | 510869 | Ref. No. | 191014 |
| description | handle holder hood mechanics | | |

| miscellaneous | | | |
|--------------------|---------------------------------------|-----------------|--------|
| 1 | | | |
| GEV No. | 510864 | Ref. No. | 190607 |
| description | bush for spring holder hood mechanics | | |

| | | | |
|--------------------|------------------------|-----------------|--------|
| 1 | | | |
| GEV No. | 510810 | Ref. No. | 320627 |
| description | fixing plate for guide | | |

| | | | |
|--------------------|---------------------------------------|-----------------|--------|
| 1 | | | |
| GEV No. | 510889 | Ref. No. | 200497 |
| description | gasket for door guides hood mechanics | | |




| | | | |
|--------------------|--|-----------------|--------|
| 1 | | | |
| GEV No. | 510882 | Ref. No. | 200451 |
| description | gasket for opposite support L 100mm hood mechanics rubber H 3mm black W 30mm | | |



| | | | |
|--------------------|---------------------------------|-----------------|--------|
| 1 | | | |
| GEV No. | 511397 | Ref. No. | 330917 |
| description | opposite support hood mechanics | | |






| | | | |
|--------------------|--|-----------------|--------|
| 1 | | | |
| GEV No. | 511393 | Ref. No. | 190149 |
| description | strengthening for handle holder hood mechanics | | |


| air traps | | | | |
|------------------------|---|-----------------|-----------------|--------|
| 1 | | | | |
| GEV No. | 510347 | Ref. No. | 161303 | |
| description | air trap | | | |
| spare parts for | 510347 | | | |
| | | | | |
| | GEV No. | 510877 | Ref. No. | 200415 |
| | description flat gasket rubber ED ø 18mm ID ø 10mm thickness 3mm Qty 1 pcs | | | |

Table continues overleaf

| | | | | |
|---|---|--------|----------|--------|
| spare parts for | 510347 | | | |
|  | GEV No. | 560197 | Ref. No. | 260407 |
| | nut thread M10 H 8mm WS 17 SS DIN/ISO DIN 934 / ISO 4032/8673 Qty 1 pcs | | | |
| accessories for | 510347 | | | |
|  | GEV No. | 510877 | Ref. No. | 200415 |
| | flat gasket rubber ED ø 18mm ID ø 10mm thickness 3mm Qty 1 pcs | | | |
|  | GEV No. | 560197 | Ref. No. | 260407 |
| | nut thread M10 H 8mm WS 17 SS DIN/ISO DIN 934 / ISO 4032/8673 Qty 1 pcs | | | |


| | | | | |
|---|--|-----------------|----------|--------|
|  | 1 | | | |
| GEV No. | 511199 | Ref. No. | 161308 | |
| description | air trap | | | |
| accessories for | 511199 | | | |
|  | GEV No. | 511283 | Ref. No. | 200927 |
| | flat gasket rubber ED ø 30mm ID ø 20mm thickness 2mm Qty 1 pcs | | | |
|  | GEV No. | 511284 | Ref. No. | 270121 |
| | nut | | | |
|  | GEV No. | 511286 | Ref. No. | 450143 |
| | hose clamp ø 38mm wire gauge ø 3.2mm Qty 1 pcs | | | |
|  | GEV No. | 511289 | Ref. No. | 161312 |
| | hose ED ø 9.5mm ID ø 5mm L 420mm equiv. no. 161312 | | | |


| | | | | |
|---|---|-----------------|----------|--------|
|  | 1 | | | |
| GEV No. | 510342 | Ref. No. | 161301 | |
| description | air trap ø 49mm H 155mm | | | |
| spare parts for | 510342 | | | |
|  | GEV No. | 510877 | Ref. No. | 200415 |
| | flat gasket rubber ED ø 18mm ID ø 10mm thickness 3mm Qty 1 pcs | | | |
|  | GEV No. | 560197 | Ref. No. | 260407 |
| | nut thread M10 H 8mm WS 17 SS DIN/ISO DIN 934 / ISO 4032/8673 Qty 1 pcs | | | |
| accessories for | 510342 | | | |
|  | GEV No. | 510877 | Ref. No. | 200415 |
| | flat gasket rubber ED ø 18mm ID ø 10mm thickness 3mm Qty 1 pcs | | | |
|  | GEV No. | 560197 | Ref. No. | 260407 |
| | nut thread M10 H 8mm WS 17 SS DIN/ISO DIN 934 / ISO 4032/8673 Qty 1 pcs | | | |


| | | | |
|---|--|-----------------|------------|
|  | 1 | | |
| GEV No. | 511454 | Ref. No. | 1036600900 |
| description | air trap W 45mm H 95mm | | |
| For models: | DLS30, DLS303, DLS30P, DLS30P3, DLS31, DLS313, DLS31P3, MLC50, MLC503, MLC65, MLC653, MLS30, MLS303, MLS30P, MLS30P3, MLS31, MLS313, MLS31P3, MLS35, MLS353, MPLS30P | | |

air trap accessories


| | | | |
|--|----------------------|-----------------|--------|
|  | 1 | | |
| GEV No. | 510486 | Ref. No. | 161306 |
| description | air ducting ø 1/2"mm | | |

| | | | |
|---|------------------|-----------------|--------|
|  | 1 | | |
| GEV No. | 510354 | Ref. No. | 160727 |
| description | end cap ø 1/2"mm | | |

| | | | |
|---|--|-----------------|--------|
|  | 1 | | |
| GEV No. | 510877 | Ref. No. | 200415 |
| description | flat gasket rubber ED ø 18mm ID ø 10mm thickness 3mm Qty 1 pcs | | |


| | | | |
|---|--|-----------------|--------|
|  | 1 | | |
| GEV No. | 511283 | Ref. No. | 200927 |
| description | flat gasket rubber ED ø 30mm ID ø 20mm thickness 2mm Qty 1 pcs | | |

| | | | |
|--|--|-----------------|--------|
|  | 1 | | |
| GEV No. | 511289 | Ref. No. | 161312 |
| description | hose ED ø 9.5mm ID ø 5mm L 420mm equiv. no. 161312 | | |

1

| | | | |
|--------------------|--|-----------------|--------|
| GEV No. | 511286 | Ref. No. | 450143 |
| description | hose clamp ø 38mm wire gauge ø 3.2mm Qty 1 pcs | | |



1

| | | | |
|--------------------|--------|-----------------|--------|
| GEV No. | 511284 | Ref. No. | 270121 |
| description | nut | | |

pipes



1

| | | | |
|--------------------|-----------------------|-----------------|--------|
| GEV No. | 510808 | Ref. No. | 160115 |
| description | pipe L 1000mm ø 9.5mm | | |

backflow preventers


backflow preventers



1

| | | | |
|--------------------|--------------------|-----------------|--------|
| GEV No. | 510993 | Ref. No. | 620243 |
| description | backflow preventer | | |


non-return valves



1

| | | | |
|--------------------|--|-----------------|-----------|
| GEV No. | 520886 | Ref. No. | R65110640 |
| description | non-return valve plastic total length 67mm | | |
| For models: | ME061T, ME101T, ME102T, ME201T, MEMT06P, MEMT10P, MEMT20P, MEMT21P, MEMT40P, MG102T, MG201T, MG202T, MGMT06P, MGMT10P, MGMT20P, MGMT21P, MGMT40P | | |

accessories



1

| | | | |
|--------------------|----------------------------|-----------------|--------|
| GEV No. | 511277 | Ref. No. | 190330 |
| description | T-piece thread 1/2" ø 18mm | | |

miscellaneous




1

| | | | |
|------------------------|---|-----------------|--------|
| GEV No. | 510349 | Ref. No. | 160755 |
| description | plug D1 ø 87mm mounting ø 72mm ID ø 60mm | | |
| accessories for | 510349 | | |
| | GEV No. | Ref. No. | |
| | 510947 | 200489 | |
| description | flat gasket rubber ED ø 85mm ID ø 73mm thickness 2mm Qty 1 pcs equiv. no. 200489 suitable for COMENDA | | |

door mechanics


linkage



1

| | | | |
|--------------------|------------------|-----------------|--------|
| GEV No. | 511154 | Ref. No. | 330231 |
| description | door pin tie bar | | |


threaded shafts



1

| | | | |
|--------------------|-----------------------------|-----------------|--------|
| GEV No. | 511156 | Ref. No. | 342010 |
| description | threaded part threaded part | | |

sliding plates




1

| | | | |
|--------------------|---------------------------|-----------------|--------|
| GEV No. | 510492 | Ref. No. | 160905 |
| description | sliding plate for tie bar | | |

hinges


| | | | |
|---|-------------------------------------|-----------------|--------|
|  | | | |
| 1 | | | |
| GEV No. | 511368 | Ref. No. | 441107 |
| description | door hinge hinge mounting pos. left | | |

| | | | |
|---|--------------------------------------|-----------------|--------|
|  | | | |
| 1 | | | |
| GEV No. | 511367 | Ref. No. | 441108 |
| description | door hinge hinge mounting pos. right | | |

hinge pins


| | | | |
|---|---------------------|-----------------|--------|
|  | | | |
| 1 | | | |
| GEV No. | 511369 | Ref. No. | 341921 |
| description | hinge pin hinge pin | | |

door bumpers



| | | | |
|---|----------------------|-----------------|--------|
|  | | | |
| 1 | | | |
| GEV No. | 510957 | Ref. No. | 190619 |
| description | door bumper end stop | | |


locks

| | | | |
|---|-----------------------------------|-----------------|-----------|
|  | | | |
| 1 | | | |
| GEV No. | 510628 | Ref. No. | 103650180 |
| description | catch hook plastic for door latch | | |


| | | | |
|---|---------------------------|-----------------|--------|
|  | | | |
| 1 | | | |
| GEV No. | 510008 | Ref. No. | 180506 |
| description | door catch for dishwasher | | |




| | | | |
|---|--|-----------------|----------------------------|
| 1 | | | |
| GEV No. | 510627 | Ref. No. | 1036501710 |
| description | housing plastic for door latch | | |
| For models: | DLS30, DLS303, DLS30P, DLS30P3, DLS31, DLS313, DLS31P3, MLS30, MLS303, MLS30P, MLS30P3, MLS31, MLS313, MLS31P3, MLS35, MLS353, MPLS30P | | |
| accessories for | 510627 | | |
|  | GEV No. | 510628 | Ref. No. 103650180 |
|  | GEV No. | 510629 | Ref. No. 1033706100 |

| | | | |
|--------------------|--|-----------------|------------|
| 1 |  | | |
| GEV No. | 510629 | Ref. No. | 1033706100 |
| description | spring for door latch | | |
| For models: | DLS30, DLS303, DLS30P, DLS30P3, DLS31, DLS313, DLS31P3, MLS30, MLS303, MLS30P, MLS30P3, MLS31, MLS313, MLS31P3, MLS35, MLS353, MPLS30P | | |


miscellaneous


| | | | |
|--|---|-----------------|--------|
|  | | | |
| 1 | | | |
| GEV No. | 510938 | Ref. No. | 331764 |
| description | fixing plate for door seal fixing plate | | |


screw connections

| | | | |
|--|----------------------------|-----------------|--------|
|  | | | |
| 1 | | | |
| GEV No. | 510809 | Ref. No. | 160709 |
| description | screw connection thread 1" | | |


washing and rinsing systems




| | | | |
|---|-------------------|-----------------|--------|
|  | | | |
| 1 | | | |
| GEV No. | 511240 | Ref. No. | 191076 |
| description | bush for wash arm | | |


| | | | |
|---|--------|-----------------|--------|
|  | | | |
| 1 | | | |
| GEV No. | 510946 | Ref. No. | 200434 |
| description | gasket | | |

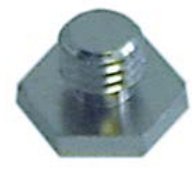
| | | | |
|---|-----------------------------|-----------------|--------|
|  | | | |
| 1 | | | |
| GEV No. | 510956 | Ref. No. | 200435 |
| description | gasket for wash pipe ø 40mm | | |


| | | | |
|--|---|-----------------|------------|
|  | | | |
| 1 | | | |
| GEV No. | 510238 | Ref. No. | 1033706200 |
| description | knurled nut ø 27mm H 13.4mm wash arm support | | |
| For models: | DLS30, DLS303, DLS30P, DLS30P3, DLS31, DLS313, DLS31P3, MLC50, MLC503, MLS30, MLS303, MLS30P, MLS30P3, MLS31, MLS313, MLS31P3, MLS35, MLS353, MPLS30P | | |


| | | | |
|---|--|-----------------|--------|
|  | | | |
| 1 | | | |
| GEV No. | 510374 | Ref. No. | 270118 |
| description | nut thread M15x1.25 H 6.5mm WS 27 SS Qty 1 pcs | | |


| | | | | |
|---|--|-----------------|-----------------|--------|
|  | | | | |
| 1 | | | | |
| GEV No. | 510481 | Ref. No. | 190315 | |
| description | rinse arm support | | | |
| accessories for | 510481 | | | |
|  | GEV No. | 511180 | Ref. No. | 200457 |
| | flat gasket rubber ED ø 24mm ID ø 16mm thickness 3mm Qty 1 pcs | | | |
|  | GEV No. | 511182 | Ref. No. | — |
| | nut thread 3/8" H 8mm brass WS 24 Qty 1 pcs | | | |

| | | | |
|--|---|-----------------|--------|
|  | | | |
| 1 | | | |
| GEV No. | 511255 | Ref. No. | 280529 |
| description | rinse arm support mounting pos. upper H 31mm thread 3/8" L 51mm WS 26 hose ø 12mm | | |

| | | | |
|--|--|-----------------|--------|
|  | | | |
| 1 | | | |
| GEV No. | 511185 | Ref. No. | 261005 |
| description | screw for wash arm support mounting pos. upper | | |

| | | | |
|--|--|-----------------|------------|
|  | | | |
| 1 | | | |
| GEV No. | 519469 | Ref. No. | 1036600500 |
| description | screw connection for wash arm support mounting pos. lower | | |
| For models: | DLS30, DLS303, DLS30P, DLS30P3, DLS31, DLS313, DLS31P3, MLS30, MLS303, MLS30P, MLS30P3, MLS31, MLS313, MLS31P3, MLS35, MLS353, MPLS30P | | |

| | | | |
|--|---|-----------------|--------|
|  | | | |
| 1 | | | |
| GEV No. | 510338 | Ref. No. | 170701 |
| description | union nut dosing pump thread 1/2" ø 32mm H 15mm for dosing pump | | |

| | | | |
|--|-------------------------------------|-----------------|--------|
|  | | | |
| 1 | | | |
| GEV No. | 510485 | Ref. No. | 180123 |
| description | union nut for rinse arm thread 5/8" | | |

washing and rinsing systems (sorted by producer)

MARENO

wash arms

rotary


complete




| | | | |
|----------------|--------|-----------------|--------|
| GEV No. | 510271 | Ref. No. | 420511 |
|----------------|--------|-----------------|--------|

description wash arm L 510mm mounting pos. upper/lower nozzles 16 mounting ø 20/57mm


spare parts for 510271

| | | | | |
|--|----------------|--------|-----------------|--------|
|  | GEV No. | 510300 | Ref. No. | 160719 |
|--|----------------|--------|-----------------|--------|

end cap for wash arm

| | | | | |
|---|----------------|--------|-----------------|--------|
|  | GEV No. | 510302 | Ref. No. | 200824 |
|---|----------------|--------|-----------------|--------|


O-ring EPDM ID ø 12.42mm thickness 1.78mm Qty 1 pcs

| | | | | |
|---|----------------|--------|-----------------|--------|
|  | GEV No. | 510305 | Ref. No. | 180213 |
|---|----------------|--------|-----------------|--------|


opposite support for wash jet

| | | | | |
|---|----------------|--------|-----------------|--------|
|  | GEV No. | 510346 | Ref. No. | 280409 |
|---|----------------|--------|-----------------|--------|


knurled nut thread M17x1 ø 35mm H 6mm SS

| | | | | |
|---|----------------|--------|-----------------|---|
|  | GEV No. | 510352 | Ref. No. | — |
|---|----------------|--------|-----------------|---|

nozzle mounting pos. right type C34

| | | | | |
|---|----------------|--------|-----------------|---|
|  | GEV No. | 510353 | Ref. No. | — |
|---|----------------|--------|-----------------|---|

nozzle mounting pos. left type C34

| | | | | |
|---|----------------|--------|-----------------|---|
|  | GEV No. | 510865 | Ref. No. | — |
|---|----------------|--------|-----------------|---|

bush for wash arm

rinse arms

rotary

complete




1


| | | | |
|----------------|--------|-----------------|--------|
| GEV No. | 510266 | Ref. No. | 430316 |
|----------------|--------|-----------------|--------|

description rinse arm L 490mm mounting pos. upper/lower nozzles 6 mounting ø 12mm


spare parts for 510266

| | | | | |
|---|----------------|--------|-----------------|--------|
|  | GEV No. | 510307 | Ref. No. | 261009 |
|---|----------------|--------|-----------------|--------|


Thumb screw thread M6 H 3mm thread L 8mm ø 28mm SS

| | | | | |
|--|----------------|--------|-----------------|--------|
|  | GEV No. | 510369 | Ref. No. | 380314 |
|--|----------------|--------|-----------------|--------|

nozzle for rinse arm

| | | | | |
|---|----------------|--------|-----------------|--------|
|  | GEV No. | 510813 | Ref. No. | 190641 |
|---|----------------|--------|-----------------|--------|

bush for rinse arm

| | | | | |
|---|----------------|--------|-----------------|--------|
|  | GEV No. | 511242 | Ref. No. | 450218 |
|---|----------------|--------|-----------------|--------|

connector holder L 30mm H 16mm W 22mm

| | | | | |
|---|----------------|--------|-----------------|--------|
|  | GEV No. | 530293 | Ref. No. | 200809 |
|---|----------------|--------|-----------------|--------|

O-ring EPDM thickness 1.78mm ID ø 8.73mm Qty 1 pcs







1

| | | | |
|----------------|--------|-----------------|--------|
| GEV No. | 510283 | Ref. No. | 430319 |
|----------------|--------|-----------------|--------|

description rinse arm L 540mm mounting pos. upper nozzles 6 mounting ø 16mm



1

| | | | |
|---|---|-----------------|------------------------|
| GEV No. | 511250 | Ref. No. | 430323 |
| description | rinse arm L 595mm mounting pos. upper/lower nozzles 6 mounting ø 16mm | | |
| spare parts for | 511250 | | |
|  | GEV No. | 510230 | Ref. No. — |
| | connector holder L 31mm W 25mm H 16mm | | |
|  | GEV No. | 510307 | Ref. No. 261009 |
| | Thumb screw thread M6 H 3mm thread L 8mm ø 28mm SS | | |
|  | GEV No. | 511245 | Ref. No. 190642 |
| | bushing | | |
|  | GEV No. | 511246 | Ref. No. 380333 |
| | nozzle for rinse arm | | |
|  | GEV No. | 530293 | Ref. No. 200809 |
| | O-ring EPDM thickness 1.78mm ID ø 8.73mm Qty 1 pcs | | |

for toasters

pliers

pliers



1

| | | | |
|--------------------|--|-----------------|-------------------------------|
| GEV No. | 690010 | Ref. No. | 10.310.098-00 MA1031009800 |
| description | plier for toaster H 180mm total length 100mm | | |
| For models: | TSE60M | | |

knobs

producer-specific knobs

MARENO



1

| | | | |
|--------------------|--------|-----------------|---------|
| GEV No. | 110021 | Ref. No. | 1621500 |
| description | knob | | |



1

| | | | |
|--------------------|---------------------------------------|-----------------|---------|
| GEV No. | 110022 | Ref. No. | 1621700 |
| description | knob | | |
| For models: | BR707E, FT74E, FT74ER, FT77E, FT77ERL | | |



1

| | | | |
|--------------------|--|-----------------|------------|
| GEV No. | 110424 | Ref. No. | 1036703014 |
| description | knob | | |
| For models: | CWE42, CWE422, CWE62, CWE622, OCWE42, OCWE422, OCWE62, OCWE622 | | |















1















| | | | |
|--------------------|--|-----------------|----------|
| GEV No. | 110438 | Ref. No. | 18414-13 |
| description | knob | | |
| For models: | C7011EFE, C7011EFEQ, C707EFE, C707EFEQ | | |

















1

| | | | |
|--------------------|--------------|-----------------|--|
| GEV No. | 110412 | Ref. No. | 1036700900+1218500 1036701113+1218500 MA1036700900+MA1218500 |
| description | knob 30-90°C | | |

| | | | |
|---|---|-----------------|---|
|  | | | |
| 1 | | | |
| GEV No. | 110364 | Ref. No. | 1623600 1840900 1841700 862800 MA1840900 |
| description | knob without symbol ø 65mm shaft ø 10x8mm shaft flat upper black | | |
| For models: | 704S, 706S, CP704G, CP707G, FB1GS, FP1GS, PD707G, T7011GFG, T707G, T707GFG, TPF706S | | |
| accessories for | 110364 | | |
|  | GEV No. | 110601 | Ref. No. 1039110800 1039111800 1842000 862300 MA1842000 MA862300 |
| knob dial plate gas tap with ignition flame t.max.°C°C | | | |
|  | GEV No. | 110606 | Ref. No. 1039107300 MA1039107300 |
| knob dial plate switch 7-position t.max.°C°C | | | |
|  | GEV No. | 110607 | Ref. No. 1986600 MA1986600 |
| knob dial plate energy regulator Min/Max t.max.°C°C | | | |
|  | GEV No. | 110608 | Ref. No. 1039115600 MA1039115600 |
| knob dial plate energy regulator 1-12 t.max.°C°C | | | |
|  | GEV No. | 110609 | Ref. No. 1039115700 MA1039115700 |
| knob dial plate energy regulator 2-circuit t.max.°C°C | | | |
|  | GEV No. | 110610 | Ref. No. 1218500 MA1218500 |
| knob dial plate thermostat t.max. 90°C 30-90°C | | | |
|  | GEV No. | 110612 | Ref. No. 1840600 MA1840600 |
| knob dial plate thermostat t.max. 180°C 100-180°C | | | |
|  | GEV No. | 110614 | Ref. No. 1840400 MA1840400 |
| knob dial plate thermostat t.max. 300°C 50-300°C | | | |
|  | GEV No. | 110616 | Ref. No. 1840513 MA1840513 |
| knob dial plate oven BH/TH/BH+TH t.max.°C°C | | | |
|  | GEV No. | 110948 | Ref. No. 1039121600 MA1039121600 |
| knob dial plate gas thermostat 1-7 t.max.°C°C | | | |
|  | GEV No. | 111531 | Ref. No. 862500 MA862500 |
| knob dial plate thermostat t.max. 90°C 30-90°C | | | |

| | | | |
|---|---|-----------------|---|
|  | | | |
| 1 | | | |
| GEV No. | 110361 | Ref. No. | 1036702900 1036703300 1841100 MA1036702900 MA1036703300 |
| description | knob without symbol ø 65mm shaft ø 6x4.6mm shaft flat lower black | | |
| For models: | BIG40, BIG60, BRG40, BRG40G, C7011GFG, C707GFE, C707GFG, CFG101, CFG70, CFG70M, FTG40B, FTG40BLC, FTG40BR, FTG60B, FTG60BLC, FTG60BR, FTG60BRR, FTG80B, FTG80BLC, FTG80BR, OCFG101, OCFG70, OPLG40, OPLG80, PLG40, PLG80, T7011GFG, T707GFG | | |
| accessories for | 110361 | | |
|  | GEV No. | 110437 | Ref. No. 1804800 MA1804800 |
| knob dial plate gas thermostat t.max. 325°C 145-325°C | | | |
|  | GEV No. | 110601 | Ref. No. 1039110800 1039111800 1842000 862300 MA1842000 MA862300 |
| knob dial plate gas tap with ignition flame t.max.°C°C | | | |
|  | GEV No. | 110603 | Ref. No. 1930400 MA1930400 |
| knob dial plate energy regulator Min/Max t.max.°C°C | | | |
|  | GEV No. | 110606 | Ref. No. 1039107300 MA1039107300 |
| knob dial plate gas thermostat t.max. 300°C 90-300°C | | | |
|  | GEV No. | 110607 | Ref. No. 1986600 MA1986600 |
| knob dial plate switch 7-position t.max.°C°C | | | |
|  | GEV No. | 110608 | Ref. No. 1039115600 MA1039115600 |
| knob dial plate energy regulator 1-12 t.max.°C°C | | | |
|  | GEV No. | 110609 | Ref. No. 1039115700 MA1039115700 |
| knob dial plate energy regulator 2-circuit t.max.°C°C | | | |
|  | GEV No. | 110610 | Ref. No. 1218500 MA1218500 |
| knob dial plate thermostat t.max. 90°C 30-90°C | | | |
|  | GEV No. | 110612 | Ref. No. 1840600 MA1840600 |
| knob dial plate thermostat t.max. 180°C 100-180°C | | | |
|  | GEV No. | 110614 | Ref. No. 1840400 MA1840400 |
| knob dial plate thermostat t.max. 300°C 50-300°C | | | |
|  | GEV No. | 110616 | Ref. No. 1840513 MA1840513 |
| knob dial plate oven BH/TH/BH+TH t.max.°C°C | | | |
|  | GEV No. | 110948 | Ref. No. 1039121600 MA1039121600 |
| knob dial plate gas thermostat 1-7 t.max.°C°C | | | |
|  | GEV No. | 111531 | Ref. No. 862500 MA862500 |
| knob dial plate thermostat t.max. 90°C 30-90°C | | | |



| | | | | |
|---|---|-----------------|--|--|
|  | | | | |
| 1 | | | | |
| GEV No. | 110362 | Ref. No. | 1036700900 1036701314 1036706400 1036708100 CM188200 MA1036700900 MACM188200 | |
| description | knob without symbol ø 65mm shaft ø 6x4.6mm shaft flat right black | | | |
| For models: | BIE40, BIE40B, BIE60, BIE60B, BME40DM, BME40DMB, BME40M, BME60DM, BME60DMB, BME60M, BME80M, BRE40, BRE40D, BRE40DB, BRE40DG, BRE40DGB, BRE40G, BSEI40M, CFE60, CFE60P, CFE70, CFG101, CFG120, CFG70, CFG70M, CFGE61, CFGE61D, CFGE61L, CFGE61P, CFVE60, CRE6220, CRE6230, CRE6320, CRE6330, FQE41, FQE41L, FQE41L2, FQE61, FQE61L, FQE61L2, FTE100B, FTE100BR, FTE100C, FTE100CRL, FTE40B, FTE40BR, FTE40C, FTE40D, FTE40DC, FTE60B...(Other models you can see in the webshop) | | | |
| accessories for | 110362 | | | |
|  | GEV No. | 110437 | Ref. No. | 1804800 MA1804800 |
| | knob dial plate gas thermostat t.max. 325°C 145-325°C | | | |
|  | GEV No. | 110601 | Ref. No. | 1039110800 1039111800 1842000 862300 MA1842000 MA862300 |
| | knob dial plate gas tap with ignition flame t.max.°C°C | | | |
|  | GEV No. | 110603 | Ref. No. | 1930400 MA1930400 |
| | knob dial plate gas thermostat t.max. 300°C 90-300°C | | | |
|  | GEV No. | 110606 | Ref. No. | 1039107300 MA1039107300 |
| | knob dial plate switch 7-position t.max.°C°C | | | |
|  | GEV No. | 110607 | Ref. No. | 1986600 MA1986600 |
| | knob dial plate energy regulator Min/Max t.max.°C°C | | | |
|  | GEV No. | 110608 | Ref. No. | 1039115600 MA1039115600 |
| | knob dial plate energy regulator 1-12 t.max.°C°C | | | |
|  | GEV No. | 110609 | Ref. No. | 1039115700 MA1039115700 |
| | knob dial plate energy regulator 2-circuit t.max.°C°C | | | |
|  | GEV No. | 110610 | Ref. No. | 1218500 MA1218500 |
| | knob dial plate thermostat t.max. 90°C 30-90°C | | | |
|  | GEV No. | 110612 | Ref. No. | 1840600 MA1840600 |
| | knob dial plate thermostat t.max. 180°C 100-180°C | | | |
|  | GEV No. | 110614 | Ref. No. | 1840400 MA1840400 |
| | knob dial plate thermostat t.max. 300°C 50-300°C | | | |
|  | GEV No. | 110616 | Ref. No. | 1840513 MA1840513 |
| | knob dial plate oven BH/TH/BH+TH t.max.°C°C | | | |
|  | GEV No. | 110948 | Ref. No. | 1039121600 MA1039121600 |
| | knob dial plate gas thermostat 1-7 t.max.°C°C | | | |
|  | GEV No. | 111531 | Ref. No. | 862500 MA862500 |
| | knob dial plate thermostat t.max. 90°C 30-90°C | | | |














| | | | | |
|---|---|-----------------|---|--|
|  | | | | |
| 1 | | | | |
| GEV No. | 110360 | Ref. No. | 1036708200 1229100 1622100 1623100 1804000 1840700 1841300 1841600 1930300 862900 862914 863200 MA1840700 MA862900 | |
| description | knob without symbol ø 65mm shaft ø 6x4.6mm shaft flat upper black | | | |
| For models: | BM74E, BM77E, BR707E, BR707EI, BR707G, BR707GI, C7011E, C7011EFE, C7011EFEQ, C704E, C707E, C707EFE, C707EFEQ, CP704E, CPE60, CPE60DB, CWE42, CWE422, CWE62, CWE622, FP1E, FQE40, FQE40D, FQE40DSP, FQE41, FQE41L, FQE41L2, FQE41R, FQE41RL, FQE41RL2, FQE60, FQE60D, FQE60DSP, FQE61, FQE61L, FQE61L2, FQE61R, FQE61RL, FR74E, FR74E10, FR74E10L, FR74E10L2, FR74E2, FR77E, FR77E10, FR77E10L, FR77E10L2, FR77E2, FR92E13, FR92E132...(Other models you can see in the webshop) | | | |
| accessories for | 110360 | | | |
|  | GEV No. | 110437 | Ref. No. | 1804800 MA1804800 |
| | knob dial plate gas thermostat t.max. 325°C 145-325°C | | | |
|  | GEV No. | 110601 | Ref. No. | 1039110800 1039111800 1842000 862300 MA1842000 MA862300 |
| | knob dial plate gas tap with ignition flame t.max.°C°C | | | |
|  | GEV No. | 110603 | Ref. No. | 1930400 MA1930400 |
| | knob dial plate gas thermostat t.max. 300°C 90-300°C | | | |
|  | GEV No. | 110606 | Ref. No. | 1039107300 MA1039107300 |
| | knob dial plate switch 7-position t.max.°C°C | | | |
|  | GEV No. | 110607 | Ref. No. | 1986600 MA1986600 |
| | knob dial plate energy regulator Min/Max t.max.°C°C | | | |
|  | GEV No. | 110608 | Ref. No. | 1039115600 MA1039115600 |
| | knob dial plate energy regulator 1-12 t.max.°C°C | | | |
|  | GEV No. | 110609 | Ref. No. | 1039115700 MA1039115700 |
| | knob dial plate energy regulator 2-circuit t.max.°C°C | | | |
|  | GEV No. | 110610 | Ref. No. | 1218500 MA1218500 |
| | knob dial plate thermostat t.max. 90°C 30-90°C | | | |
|  | GEV No. | 110612 | Ref. No. | 1840600 MA1840600 |
| | knob dial plate thermostat t.max. 180°C 100-180°C | | | |
|  | GEV No. | 110614 | Ref. No. | 1840400 MA1840400 |
| | knob dial plate thermostat t.max. 300°C 50-300°C | | | |

Table continues overleaf

| | | | | |
|---|----------------|--------|-----------------|----------------------|
| accessories for 110360 | | | | |
|  | GEV No. | 110616 | Ref. No. | 1840513 MA1840513 |
| knob dial plate oven BH/TH/BH+TH t.max. °C°C | | | | |
|  | GEV No. | 111531 | Ref. No. | 862500 MA862500 |
| knob dial plate thermostat t.max. 90°C 30-90°C | | | | |





| | | | |
|----------------|--------|-----------------|---|
| GEV No. | 110363 | Ref. No. | 1623300 1840800 1841000 MA1840800 MA1841000 |
|----------------|--------|-----------------|---|

description knob without symbol ø 65mm shaft ø 8x7mm shaft flat upper black


For models: C7011G, C7011GFE, C7011GFG, C704G, C707G, C707GFE, C707GFG, FB1GS, FB2GS, FB3GS, FT74G, FT74GR, FT77G, FT77GRL, GB704G, GB707G, T7011GFG

accessories for 110363

| | | | | |
|---|----------------|--------|-----------------|----------------------|
|  | GEV No. | 110437 | Ref. No. | 1804800 MA1804800 |
| knob dial plate gas thermostat t.max. 325°C 145-325°C | | | | |

| | | | | |
|---|----------------|--------|-----------------|--|
|  | GEV No. | 110601 | Ref. No. | 1039110800 1039111800 1842000 862300 MA1842000 MA862300 |
| knob dial plate gas tap with ignition flame t.max. °C°C | | | | |


description knob dial plate gas tap with ignition flame t.max. °C°C

| | | | | |
|---|----------------|--------|-----------------|----------------------|
|  | GEV No. | 110603 | Ref. No. | 1930400 MA1930400 |
| knob dial plate gas thermostat t.max. 300°C 90-300°C | | | | |


description knob dial plate gas thermostat t.max. 300°C 90-300°C

| | | | | |
|---|----------------|--------|-----------------|----------------------------|
|  | GEV No. | 110606 | Ref. No. | 1039107300 MA1039107300 |
| knob dial plate switch 7-position t.max. °C°C | | | | |


description knob dial plate switch 7-position t.max. °C°C

| | | | | |
|---|----------------|--------|-----------------|----------------------|
|  | GEV No. | 110607 | Ref. No. | 1986600 MA1986600 |
| knob dial plate energy regulator Min/Max t.max. °C°C | | | | |


description knob dial plate energy regulator Min/Max t.max. °C°C

| | | | | |
|---|----------------|--------|-----------------|----------------------------|
|  | GEV No. | 110608 | Ref. No. | 1039115600 MA1039115600 |
| knob dial plate energy regulator 1-12 t.max. °C°C | | | | |

description knob dial plate energy regulator 1-12 t.max. °C°C

| | | | | |
|---|----------------|--------|-----------------|----------------------------|
|  | GEV No. | 110609 | Ref. No. | 1039115700 MA1039115700 |
| knob dial plate energy regulator 2-circuit t.max. °C°C | | | | |

description knob dial plate energy regulator 2-circuit t.max. °C°C

| | | | | |
|---|----------------|--------|-----------------|----------------------|
|  | GEV No. | 110610 | Ref. No. | 1218500 MA1218500 |
| knob dial plate thermostat t.max. 90°C 30-90°C | | | | |

description knob dial plate thermostat t.max. 90°C 30-90°C

| | | | | |
|---|----------------|--------|-----------------|----------------------|
|  | GEV No. | 110612 | Ref. No. | 1840600 MA1840600 |
| knob dial plate thermostat t.max. 180°C 100-180°C | | | | |


description knob dial plate thermostat t.max. 180°C 100-180°C

| | | | | |
|---|----------------|--------|-----------------|----------------------|
|  | GEV No. | 110614 | Ref. No. | 1840400 MA1840400 |
| knob dial plate thermostat t.max. 300°C 50-300°C | | | | |


description knob dial plate thermostat t.max. 300°C 50-300°C

| | | | | |
|---|----------------|--------|-----------------|----------------------|
|  | GEV No. | 110616 | Ref. No. | 1840513 MA1840513 |
| knob dial plate oven BH/TH/BH+TH t.max. °C°C | | | | |


description knob dial plate oven BH/TH/BH+TH t.max. °C°C

| | | | | |
|---|----------------|--------|-----------------|----------------------------|
|  | GEV No. | 110948 | Ref. No. | 1039121600 MA1039121600 |
| knob dial plate gas thermostat 1-7 t.max. °C°C | | | | |

description knob dial plate gas thermostat 1-7 t.max. °C°C

| | | | | |
|---|----------------|--------|-----------------|----------------------------|
|  | GEV No. | 110948 | Ref. No. | 1039121600 MA1039121600 |
| knob dial plate gas thermostat 1-7 t.max. °C°C | | | | |

description knob dial plate gas thermostat 1-7 t.max. °C°C

| | | | | |
|---|----------------|--------|-----------------|--------------------|
| accessories for 110363 | | | | |
|  | GEV No. | 111531 | Ref. No. | 862500 MA862500 |
| knob dial plate thermostat t.max. 90°C 30-90°C | | | | |



| | | | |
|----------------|--------|-----------------|----------------------------|
| GEV No. | 110608 | Ref. No. | 1039115600 MA1039115600 |
|----------------|--------|-----------------|----------------------------|

description knob dial plate energy regulator 1-12 t.max. °C°C

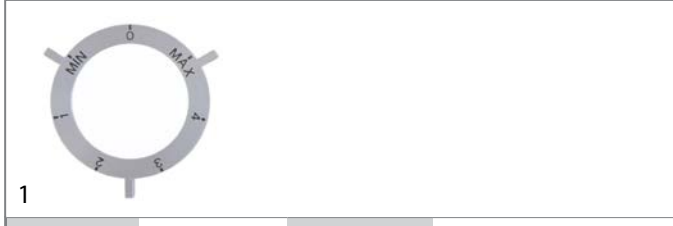
For models: CFVE60, FTVE100, FTVE40, FTVE40D, FTVE60, FTVE60D, PCVE40, PCVE40D, PCVE40DB, PCVE60, PCVE60D, PCVE60DB



| | | | |
|----------------|--------|-----------------|----------------------------|
| GEV No. | 110609 | Ref. No. | 1039115700 MA1039115700 |
|----------------|--------|-----------------|----------------------------|

description knob dial plate energy regulator 2-circuit t.max. °C°C

For models: CFVE60, PCVE40, PCVE40D, PCVE40DB, PCVE60, PCVE60D, PCVE60DB



| | | | |
|----------------|--------|-----------------|----------------------|
| GEV No. | 110607 | Ref. No. | 1986600 MA1986600 |
|----------------|--------|-----------------|----------------------|

description knob dial plate energy regulator Min/Max t.max. °C°C

For models: CP704E, CPE60, CPE602, CPE60DB, OCPE6, OCPE60





| | | | |
|----------------|--------|-----------------|--|
| GEV No. | 110601 | Ref. No. | 1039110800 1039111800 1842000 862300 MA1842000 MA862300 |
|----------------|--------|-----------------|--|


description knob dial plate gas tap with ignition flame t.max. °C°C

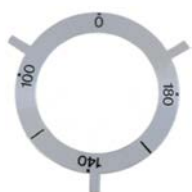
For models: BIG40, BIG60, BRG40, BRG40G, C7011G, C7011GFE, C7011GFG, C704G, C707G, C707GFE, C707GFG, CFG101, CFG120, CFG70, CFG70M, CFGE61, CFGE61D, CFGE61L, CFGE61P, CP704G, FP1GS, GB704G, GB707G, OCFG101, OCFG120, OCFG70, OCFG61, OPG41, OPG61, OPLG40, OPLG80, PCG41, PCG41L, PCG42, PCG61, PCG61L, PCG82, PD707G, PLG40, PLG80, T7011GFG, T707G, T707GFG





| | | | |
|---|---|-----------------|----------------------------|
|  | | | |
| 1 | | | |
| GEV No. | 110948 | Ref. No. | 1039121600 MA1039121600 |
| description | knob dial plate gas thermostat 1-7 t.max.°C°C | | |
| For models: | FTG40B, FTG40BLC, FTG40BR, FTG60B, FTG60BLC, FTG60BR, FTG60BRR, FTG80B, FTG80BLC, FTG80BR | | |


| | | | |
|--|--|-----------------|----------------------------|
|  | | | |
| 1 | | | |
| GEV No. | 110606 | Ref. No. | 1039107300 MA1039107300 |
| description | knob dial plate switch 7-position t.max.°C°C | | |
| For models: | C7011E, C7011EFE, C7011EFEQ, C704E, C707E, C707EFE, C707EFEQ, CFE60, CFE60P, CFE70, OCFE60, OPCE40, OPCE60, PCE40, PCE40D, PCE40DB, PCE60, PCE60D, PCE60DB | | |


| | | | |
|---|---|-----------------|----------------------|
|  | | | |
| 1 | | | |
| GEV No. | 112482 | Ref. No. | 1840200 MA1840200 |
| description | knob dial plate gas thermostat t.max. 300°C 140-300°C | | |
| For models: | C7011GFG, C707GFG, CFG101, CFG120, CFG70, CFG70M, OCFG101, OCFG120, OCFG70, T7011GFG, T707GFG | | |


| | | | |
|--|--|-----------------|----------------------|
|  | | | |
| 1 | | | |
| GEV No. | 110612 | Ref. No. | 1840600 MA1840600 |
| description | knob dial plate thermostat t.max. 180°C 100-180°C | | |
| For models: | FR74E, FR74E10, FR74E10L, FR74E10L2, FR74E2, FR77E, FR77E10, FR77E10L, FR77E10L2, FR77E2, PI707E | | |

| | | | |
|--|---|-----------------|----------------------|
|  | | | |
| 1 | | | |
| GEV No. | 110603 | Ref. No. | 1930400 MA1930400 |
| description | knob dial plate gas thermostat t.max. 300°C 90-300°C | | |
| For models: | FT12G7L70, FT12G7LC70, FT12G7R70, FT12G7RC70, FT12G7RL70, FT12G7RLC70, FT6G4L70, FT6G4LC70, FT6G4R70, FT6G4RC70 | | |

| | | | |
|---|--|-----------------|----------------------|
|  | | | |
| 1 | | | |
| GEV No. | 110614 | Ref. No. | 1840400 MA1840400 |
| description | knob dial plate thermostat t.max. 300°C 50-300°C | | |
| For models: | BIE40B, BIE60B, BR707E, BRE40, BRE40D, BRE40DB, BRE40DG, BRE40DGB, BRE40G, C7011E, C7011EFE, C7011EFEQ, C707E, C707EFE, C707EFEQ, CFE70, CWE42, CWE422, CWE62, CWE622, FT74E, FT74E2, FT74ER, FT74ER2, FT77E, FT77E2, FT77EC, FT77EC2, FT77ECRL, FT77ECRL2, FT77ERL, FT77ERL2, FTE100B, FTE100BR, FTE100C, FTE100CRL, FTE40B, FTE40BR, FTE40C, FTE40D, FTE40DC, FTE60B, FTE60BR, FTE60BRR, FTE60C, FTE60D, FTE60DC, FTE60DCRL, FTE60DR, OBRE40...(Other models you can see in the webshop) | | |

| | | | |
|---|---|-----------------|----------------------|
|  | | | |
| 1 | | | |
| GEV No. | 110437 | Ref. No. | 1804800 MA1804800 |
| description | knob dial plate gas thermostat t.max. 325°C 145-325°C | | |
| For models: | BR707G, BR707GI | | |

| | | | |
|--|--|-----------------|----------------------------|
|  | | | |
| 1 | | | |
| GEV No. | 110615 | Ref. No. | 1039107500 MA1039107500 |
| description | knob dial plate thermostat t.max. 300°C 50-300°C | | |

| | | | |
|---|---|-----------------|----------------------|
|  | | | |
| 1 | | | |
| GEV No. | 110616 | Ref. No. | 1840513 MA1840513 |
| description | knob dial plate oven BH/TH/BH+TH t.max.°C°C | | |
| For models: | C7011EFE, C7011EFEQ, C707EFE, C707EFEQ, CFE70 | | |



1

| | | | |
|--------------------|---|-----------------|----------------------|
| GEV No. | 110610 | Ref. No. | 1218500 MA1218500 |
| description | knob dial plate thermostat t.max. 90°C 30-90°C | | |
| For models: | BM74E, BM77E, BME40DM, BME40DMB, BME40M, BME60DM, BME60DMB, BME60M, BME80M, BSEI40M, CRE6220, CRE6230, CRE6320, CRE6330, OBSEI40M, TP, TP2, TPA | | |



1

| | | | |
|--------------------|--|-----------------|--------------------|
| GEV No. | 111531 | Ref. No. | 862500 MA862500 |
| description | knob dial plate thermostat t.max. 90°C 30-90°C | | |



1

| | | | |
|--------------------|---|-----------------|---------|
| GEV No. | 110007 | Ref. No. | 1322400 |
| description | knob | | |
| For models: | C9F4G, C9F4GS, C9F6G, C9F6GS, C9F8G, C9F8GS, C9SB4GS, C9V2G, C9V2GS, C9V4G, C9V4GS, C9V6G, C9V6GS, C9V8G, C9V8GS, CP92G, CP94G, CP9SB2G, CP9SB4G, F9SB2G, F9SB2GR, F9SB4G, F9SB4GR, F9SB4GRL, F9V2G, F9V2GR, F9V4G, F9V4GR, F9V4GRL, P9D10G, P9D15G, P9D2G, P9D5G, P9DA10G, P9DA15G, P9DSB10G, PDASB10G, T9F4G, T9F6GS, T9FE4G, T9FP4G, T9SB4G, T9V4G, T9V6GS, T9VP4G | | |



1

| | | | |
|--------------------|---|-----------------|---------|
| GEV No. | 110008 | Ref. No. | 1323800 |
| description | knob | | |
| For models: | B9VP2E, B9VP4E, BR94E, BR94EI, BR96E, BR96EI, BR9M4E, BR9M4EI, BR9M4GI, BR9M6E, BR9M6EI, BR9SB4E, BR9SB4EI, TP13E, TP17E, TP213E, TP217E, TP21E, TP221E | | |



1

| | | | |
|--------------------|--|-----------------|---------|
| GEV No. | 110010 | Ref. No. | 1322600 |
| description | knob | | |
| For models: | BR94G, BR94GI, BR96G, BR96GI, BR9M4G, BR9M4GI, BR9M6G, BR9M6GI | | |



1

| | | | |
|--------------------|---|-----------------|---------|
| GEV No. | 110012 | Ref. No. | 1323100 |
| description | knob | | |
| For models: | B9SB2E, B9SB2G, B9SB4E, B9SB4G, B9V2E, B9V2G, B9V4E, B9V4G, B9VP2E, B9VP4E, TP13E, TP17E, TP213E, TP217E, TP21E, TP221E | | |



1

| | | | |
|--------------------|---|-----------------|---------|
| GEV No. | 110014 | Ref. No. | 2712100 |
| description | knob | | |
| For models: | FC10E, FC10G, FC20E, FC20G, FC5E, FC5G, FC7E, FC7G, V9F4E, V9FP4E, V9V2E, V9V4E, V9VP2E, V9VP4E | | |



1

| | | | |
|--------------------|--|-----------------|---------|
| GEV No. | 110009 | Ref. No. | 1322800 |
| description | knob ø 72mm | | |
| For models: | C9F4E, C9F6E, C9V2E, C9V4E, CP92E, CP94E, CP9SB2E, CP9SB4E | | |









1


| | | | |
|------------------------|--|-----------------|--|
| GEV No. | 110388 | Ref. No. | 1022200 1022400 1322200 MA1322200 |
| description | knob without symbol ø 72mm shaft ø 10x8mm shaft flat universal MARENO | | |
| For models: | CP92G, CP94G, MM10DG, MM10DGS, MM15DG, P9D10G, P9D15G, P9DA10G, P9DA15G, P9DASB10G, P9DSB10G, T9F4G, T9F6GS, T9FE4G, T9SB4G, T9V4G, T9V6GS | | |
| accessories for | 110388 | | |


| | | | | |
|--|----------------|--------|-----------------|---------------------------------|
| | GEV No. | 110620 | Ref. No. | 1322300 1893500 MA1322300 |
| | GEV No. | 110997 | Ref. No. | 1323500 MA1323513 |






| | | | |
|---|--|-----------------|--|
|  | | | |
| 1 | | | |
| GEV No. | 110386 | Ref. No. | 1323000 1323400 1323600 1508100 1875000 1875200 1889700 1923200 1966700 MA1508100 |
| description | knob without symbol ø 72mm shaft ø 6x4.6mm shaft flat universal MARENO | | |
| For models: | B9SB2E, B9SB4E, B9V2E, B9V4E, BR94E, BR94EI, BR94G, BR94GI, BR96E, BR96EI, BR9M4E, BR9M4EI, BR9M4G, BR9M4GI, BR9M6E, BR9M6EI, BR9M6G, BR9M6GI, BR9SB4E, BR9SB4EI, BR9SB4G, BR9SB4GI, C9F4E, C9F4GS, C9F6E, C9F6GS, C9F8GS, C9FE6GS, C9FP, C9FP4GS, C9FP6GS, C9FP8GS, C9V2E, C9V4E, CB3, CB5, CD24, CP92E, CP92EI, CP94E, CP94E2, CP9SB2E, CP9SB2E2, CP9SB4E, CP9SB4E2, F9V2E, F9V2E2, F9V2ER, F9V2ER2, F9V4E...(Other models you can see in the webshop) | | |
| accessories for | 110386 | | |
|  | GEV No. | 110624 | Ref. No. 1323700 MA1323700 |
| | knob dial plate ON-OFF t.max.°C°C | | |
|  | GEV No. | 110629 | Ref. No. 1322900 MA1322900 |
| | knob dial plate gas thermostat t.max. 180°C 100-180°C | | |
|  | GEV No. | 110631 | Ref. No. 1323300 MA1323300 |
| | knob dial plate thermostat t.max. 300°C 50-300°C | | |
|  | GEV No. | 110635 | Ref. No. 1322500 MA1322500 |
| | knob dial plate gas thermostat t.max. 300°C 50-300°C | | |
|  | GEV No. | 112621 | Ref. No. — |
| | knob time 120min t.max.°C°C ø 48mm shaft ø 6x4.6mm shaft flat upper black | | |

| | | | |
|---|--|-----------------|----------------------|
|  | | | |
| 1 | | | |
| GEV No. | 110387 | Ref. No. | 1893400 MA1893400 |
| description | knob without symbol ø 72mm shaft ø 8x6.5mm shaft flat universal MARENO | | |
| For models: | C9F4GS, C9F6GS, C9F8GS, C9FE4GS, C9FE6GS, C9FE8GS, C9V2GS, C9V4GS, C9V6GS, C9V8GS, MM10IG, P9I10G, P9IA10G, T9F6GS, T9V6GS | | |


| | | | |
|--|--|-----------------|---------------------------------|
|  | | | |
| 1 | | | |
| GEV No. | 110620 | Ref. No. | 1322300 1893500 MA1322300 |
| description | knob dial plate gas tap with ignition flame t.max.°C°C | | |
| For models: | C9F4GS, C9F6GS, C9F8GS, C9FE4GS, C9FE6GS, C9FE8GS, C9FEP4GS, C9FEP6GS, C9FEP8GS, C9FP4GS, C9FP6GS, C9FP8GS, C9V2GS, C9V4GS, C9V6GS, C9V8GS, C9VP2GS, C9VP4GS, C9VP6GS, C9VP8GS, CP92G, CP94G, GB92G, GB94G, MM10DG, MM10DGS, MM15DG, P9D10G, P9D15G, P9DA10G, P9DA15G, P9DASB10G, P9DSB10G, T9F4G, T9F6GS, T9FE4G, T9SB4G, T9V4G, T9V6GS | | |


| | | | |
|--|--|-----------------|----------------------|
|  | | | |
| 1 | | | |
| GEV No. | 110621 | Ref. No. | 1875100 MA1875100 |
| description | knob dial plate gas tap without low flame t.max.°C°C | | |
| For models: | BR94G, BR94GI, BR9M4G, BR9M4GI, BR9M6G, BR9M6GI, BR9SB4G, BR9SB4GI, MM10IG, MS10AG, MS10IG, MS70AG, MS70IG, MS70IGS, P9I10G, P9IA10G | | |

| | | | |
|--|--|-----------------|--|
|  | | | |
| 1 | | | |
| GEV No. | 110629 | Ref. No. | 1322900 MA1322900 |
| description | knob dial plate gas thermostat t.max. 180°C 100-180°C | | |
| accessories for | 110629 | | |
|  | GEV No. | 110386 | Ref. No. 1323000 1323400 1323600 1508100 1875000 1875200 1889700 1923200 1966700 MA1508100 |
| | knob without symbol ø 72mm shaft ø 6x4.6mm shaft flat universal MARENO | | |





1

| | | | |
|---|--|-----------------|---|
| GEV No. | 110635 | Ref. No. | 1322500 MA1322500 |
| description | knob dial plate gas thermostat t.max. 300°C 50-300°C | | |
| accessories for | 110635 | | |
|  | GEV No. | 110386 | Ref. No. 1323000 1323400 1323600 1508100 1875000 1875200 1889700 1923200 1966700 MA1508100 |
| knob without symbol ø 72mm shaft ø 6x4.6mm shaft flat universal MARENO | | | |




1

| | | | |
|---|-----------------------------------|-----------------|---|
| GEV No. | 110624 | Ref. No. | 1323700 MA1323700 |
| description | knob dial plate ON-OFF t.max.°C°C | | |
| accessories for | 110624 | | |
|  | GEV No. | 110386 | Ref. No. 1323000 1323400 1323600 1508100 1875000 1875200 1889700 1923200 1966700 MA1508100 |
| knob without symbol ø 72mm shaft ø 6x4.6mm shaft flat universal MARENO | | | |




1

| | | | |
|--------------------|---|-----------------|----------------------|
| GEV No. | 110622 | Ref. No. | 1923300 MA1923300 |
| description | knob dial plate gas thermostat t.max. 300°C 90-300°C | | |
| For models: | FT14G8L90, FT14G8LC90, FT14G8R2L90, FT14G8R2LC90, FT14G8R90, FT14G8RC90, FT7G4L90, FT7G4LC90, FT7G4R90, FT7G4RC90 | | |




1

| | | | |
|--------------------|---|-----------------|----------------------|
| GEV No. | 110997 | Ref. No. | 1323500 MA1323513 |
| description | knob dial plate oven BH/TH/BH+TH t.max.°C°C | | |




1

| | | | |
|--------------------|---|-----------------|----------------------|
| GEV No. | 110623 | Ref. No. | 1889800 MA1889800 |
| description | knob dial plate gas thermostat t.max. 330°C 120-330°C | | |
| For models: | C9F4GS, C9F6GS, C9F8GS, C9FP4GS, C9FP6GS, C9FP8GS, T9F4G, T9F6G, T9FP4G | | |




1

| | | | |
|--------------------|---|-----------------|----------------------|
| GEV No. | 110627 | Ref. No. | 1966800 MA1966800 |
| description | knob dial plate switch 7-position Min/Max t.max.°C°C | | |
| For models: | CP92E, CP92E2, CP94E, CP94E2, P9D10E, P9D15E, P9DA10E, P9DA15E, P9DSB10E, V9F4E, V9V2E, V9V4E | | |




1

| | | | |
|--------------------|--|-----------------|----------------------|
| GEV No. | 110632 | Ref. No. | 1875300 MA1875300 |
| description | knob dial plate graduated t.max.°C°C rotation 270° | | |
| For models: | MM10IG, P9I10G, P9IA10G | | |



1


| | | | |
|--------------------|---|-----------------|----------------------|
| GEV No. | 110630 | Ref. No. | 1953900 MA1953900 |
| description | knob dial plate thermostat t.max. 190°C 100-190°C | | |
| For models: | FR92G22, FR94G22, P9I10E, P9I15E, P9IA10E | | |

1

| | | | |
|------------------------|--|-----------------|--|
| GEV No. | 110631 | Ref. No. | 1323300 MA1323300 |
| description | knob dial plate thermostat t.max. 300°C 50-300°C | | |
| For models: | BR94G, BR94GI, BR9M4G, BR9M4GI, BR9M6G, BR9M6GI, BR9SB4G, BR9SB4GI, MS10AG, MS10IG, MS70AG, MS70IG, MS70IGS, V9F4E, V9V2E, V9V4E | | |
| accessories for | 110631 | | |
| | | | 1323000 1323400 1323600 1508100 1875000 1875200 1889700 1923200 1966700 MA1508100 |
| | GEV No. | 110386 | Ref. No. |
| | | | 1323000 1323400 1323600 1508100 1875000 1875200 1889700 1923200 1966700 MA1508100 |

knob without symbol ø 72mm shaft ø 6x4.6mm shaft flat universal MARENO



1

| | | | |
|------------------------|---|-----------------|--|
| GEV No. | 110628 | Ref. No. | 1323200 MA1323200 |
| description | knob dial plate thermostat t.max. 90°C 30-90°C | | |
| For models: | B9SB2E, B9SB4E, B9V2E, B9V4E, CB3, CB5, CD24, P9D10E, P9D15E, P9DA10E, P9DA15E, P9I10E, P9IA10E | | |
| accessories for | 110628 | | |
| | | | 1323000 1323400 1323600 1508100 1875000 1875200 1889700 1923200 1966700 MA1508100 |
| | GEV No. | 110386 | Ref. No. |
| | | | 1323000 1323400 1323600 1508100 1875000 1875200 1889700 1923200 1966700 MA1508100 |

knob without symbol ø 72mm shaft ø 6x4.6mm shaft flat universal MARENO




1

| | | | |
|--------------------|---|-----------------|-----------|
| GEV No. | 112519 | Ref. No. | CR0502150 |
| description | knob universal ø 67mm shaft ø 6x4.6mm shaft flat horizontal | | |
| For models: | CFG101, CFG120, CFG70, CPE60, CPE602, CPE60DB, CWE42, CWE422, CWE62, CWE622, FQE41, FQE41L, FQE41L2, FQE61, FQE61L, FQE61L2, FTG40B, FTG40BLC, FTG40BR, FTG60B, FTG60BLC, FTG60BR, FTG60BRR, FTG80B, FTG80BLC, FTG80BR, OCFG101, OCFG120, OCFG70, OCPE6, OCPE60, OCWE42, OCWE422, OCWE62, OCWE622, OFQE41, OFQE61, OPLG40, OPLG80, PLG40, PLG80 | | |




1

| | | | |
|--------------------|---|-----------------|-----------|
| GEV No. | 112518 | Ref. No. | CR0502140 |
| description | knob universal ø 67mm shaft ø 6x4.6mm shaft flat vertical | | |
| For models: | BIE40B, BIE60B, BRE40, BRE40D, BRE40DB, BRE40DG, BRE40DGB, BRE40G, BSEI40M, CFE60, CFE60P, CFG101, CFG120, CFG70, CFGE61, CFGE61D, CFGE61L, CFGE61P, FTE100B, FTE100BR, FTE100C, FTE100CRL, FTE40B, FTE40BR, FTE40C, FTE40D, FTE40DC, FTE60B, FTE60BR, FTE60BRR, FTE60C, FTE60D, FTE60DC, FTE60DCRL, FTE60DR, OBSEI40M, OCFE60, OCFG101, OCFG120, OCFG70, OCFG61, OFTE100CRL, OFTE40B, OFTE40BR, OFTE40C, OFTE60B, OFTE60BR, OFTE60BRR, OFTE60C, OPCE40...(Other models you can see in the webshop) | | |




1

| | | | |
|--------------------|---|-----------------|----------------------------|
| GEV No. | 110608 | Ref. No. | 1039115600 MA1039115600 |
| description | knob dial plate energy regulator 1-12 t.max.°C | | |
| For models: | CFVE60, FTVE100, FTVE40, FTVE40D, FTVE60, FTVE60D, PCVE40, PCVE40D, PCVE40DB, PCVE60, PCVE60D, PCVE60DB | | |




1


| | | | |
|--------------------|--|-----------------|----------------------------|
| GEV No. | 110609 | Ref. No. | 1039115700 MA1039115700 |
| description | knob dial plate energy regulator 2-circuit t.max.°C | | |
| For models: | CFVE60, PCVE40, PCVE40D, PCVE40DB, PCVE60, PCVE60D, PCVE60DB | | |





1


| | | | |
|--------------------|---|-----------------|----------------------|
| GEV No. | 110607 | Ref. No. | 1986600 MA1986600 |
| description | knob dial plate energy regulator Min/Max t.max.°C | | |
| For models: | CP704E, CPE60, CPE602, CPE60DB, OCPE6, OCPE60 | | |


| | | | |
|---|--|-----------------|--|
|  | | | |
| 1 | | | |
| GEV No. | 110601 | Ref. No. | 1039110800 1039111800 1842000 862300 MA1842000 MA862300 |
| description | knob dial plate gas tap with ignition flame t.max.°C°C | | |
| For models: | BIG40, BIG60, BRG40, BRG40G, C7011G, C7011GFE, C7011GFG, C704G, C707G, C707GFE, C707GFG, CFG101, CFG120, CFG70, CFG70M, CFGE61, CFGE61D, CFGE61L, CFGE61P, CP704G, FP1GS, GB704G, GB707G, OCFG101, OCFG120, OCFG70, OCFG61, OPG41, OPG61, OPLG40, OPLG80, PCG41, PCG41L, PCG42, PCG61, PCG61L, PCG82, PD707G, PLG40, PLG80, T7011GFG, T707G, T707GFG | | |

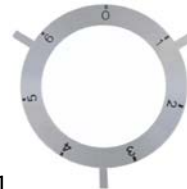
| | | | |
|---|---|-----------------|----------------------------|
|  | | | |
| 1 | | | |
| GEV No. | 110948 | Ref. No. | 1039121600 MA1039121600 |
| description | knob dial plate gas thermostat 1-7 t.max.°C°C | | |
| For models: | FTG40B, FTG40BLC, FTG40BR, FTG60B, FTG60BLC, FTG60BR, FTG60BRR, FTG80B, FTG80BLC, FTG80BR | | |

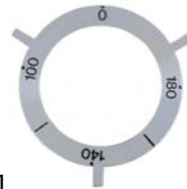
| | | | |
|---|---|-----------------|----------------------|
|  | | | |
| 1 | | | |
| GEV No. | 112482 | Ref. No. | 1840200 MA1840200 |
| description | knob dial plate gas thermostat t.max. 300°C 140-300°C | | |
| For models: | C7011GFG, C707GFG, CFG101, CFG120, CFG70, CFG70M, OCFG101, OCFG120, OCFG70, T7011GFG, T707GFG | | |

| | | | |
|---|---|-----------------|----------------------|
|  | | | |
| 1 | | | |
| GEV No. | 110603 | Ref. No. | 1930400 MA1930400 |
| description | knob dial plate gas thermostat t.max. 300°C 90-300°C | | |
| For models: | FT12G7L70, FT12G7LC70, FT12G7R70, FT12G7RC70, FT12G7RL70, FT12G7RLC70, FT6G4L70, FT6G4LC70, FT6G4R70, FT6G4RC70 | | |


| | | | |
|--|---|-----------------|----------------------|
|  | | | |
| 1 | | | |
| GEV No. | 110437 | Ref. No. | 1804800 MA1804800 |
| description | knob dial plate gas thermostat t.max. 325°C 145-325°C | | |
| For models: | BR707G, BR707GI | | |


| | | | |
|--|---|-----------------|----------------------|
|  | | | |
| 1 | | | |
| GEV No. | 110616 | Ref. No. | 1840513 MA1840513 |
| description | knob dial plate oven BH/TH/BH+TH t.max.°C°C | | |
| For models: | C7011EFE, C7011EFEQ, C707EFE, C707EFEQ, CFE70 | | |


| | | | |
|---|--|-----------------|----------------------------|
|  | | | |
| 1 | | | |
| GEV No. | 110606 | Ref. No. | 1039107300 MA1039107300 |
| description | knob dial plate switch 7-position t.max.°C°C | | |
| For models: | C7011E, C7011EFE, C7011EFEQ, C704E, C707E, C707EFE, C707EFEQ, CFE60, CFE60P, CFE70, OCFE60, OPCE40, OPCE60, PCE40, PCE40D, PCE40DB, PCE60, PCE60D, PCE60DB | | |


| | | | |
|--|--|-----------------|----------------------|
|  | | | |
| 1 | | | |
| GEV No. | 110612 | Ref. No. | 1840600 MA1840600 |
| description | knob dial plate thermostat t.max. 180°C 100-180°C | | |
| For models: | FR74E, FR74E10, FR74E10L, FR74E10L2, FR74E2, FR77E, FR77E10, FR77E10L, FR77E10L2, FR77E2, PI707E | | |





| | | | |
|---|--|-----------------|----------------------|
|  | | | |
| 1 | | | |
| GEV No. | 110614 | Ref. No. | 1840400 MA1840400 |
| description | knob dial plate thermostat t.max. 300°C 50-300°C | | |
| For models: | BIE40B, BIE60B, BR707E, BRE40, BRE40D, BRE40DB, BRE40DG, BRE40DGB, BRE40G, C7011E, C7011EFE, C7011EFEQ, C707E, C707EFE, C707EFEQ, CFE70, CWE42, CWE422, CWE62, CWE622, FT74E, FT74E2, FT74ER, FT74ER2, FT77E, FT77E2, FT77EC, FT77EC2, FT77ECRL, FT77ECRL2, FT77ERL, FT77ERL2, FTE100B, FTE100BR, FTE100C, FTE100CRL, FTE40B, FTE40BR, FTE40C, FTE40D, FTE40DC, FTE60B, FTE60BR, FTE60BRR, FTE60C, FTE60D, FTE60DC, FTE60DCRL, FTE60DR, OBRE40...(Other models you can see in the webshop) | | |

| | | | |
|---|--|-----------------|----------------------------|
|  | | | |
| 2 | | | |
| GEV No. | 110615 | Ref. No. | 1039107500 MA1039107500 |
| description | knob dial plate thermostat t.max. 300°C 50-300°C | | |


| | | | |
|--|---|-----------------|----------------------|
|  | | | |
| 1 | | | |
| GEV No. | 110610 | Ref. No. | 1218500 MA1218500 |
| description | knob dial plate thermostat t.max. 90°C 30-90°C | | |
| For models: | BM74E, BM77E, BME40DM, BME40DMB, BME40M, BME60DM, BME60DMB, BME60M, BME80M, BSEI40M, CRE6220, CRE6230, CRE6320, CRE6330, OBSEI40M, TP, TP2, TPA | | |


| | | | |
|---|--|-----------------|--------------------|
|  | | | |
| 1 | | | |
| GEV No. | 111531 | Ref. No. | 862500 MA862500 |
| description | knob dial plate thermostat t.max. 90°C 30-90°C | | |

| | | | |
|--|---|-----------------|------------------------|
|  | | | |
| 1 | | | |
| GEV No. | 110995 | Ref. No. | CM062500 MACM062500 |
| description | knob energy regulator 1-6 t.max.°C°C ø 67mm shaft ø 6x4.6mm shaft flat upper black | | |
| For models: | I74E, I78E, I94E, I98E, IW74E, IW94E, PC12C4E, PC12C9E, PC74E, PC76E, PC78E, PC94E, PC96E, PC98E, PC9S4E, PC9S6E, PC9S8E, PD98E10, PD98E15, PD9S8E10, SPAC12, SPAC16, SPAC20, SPCG08, SPCG12, SPCG16, SPCG20, SPCG8, V74EC, V76EC, V94E, V98E | | |

| | | | |
|--|---|-----------------|------------------------|
|  | | | |
| 1 | | | |
| GEV No. | 110993 | Ref. No. | CM061600 MACM061600 |
| description | knob gas tap with ignition flame t.max.°C°C ø 67mm shaft ø 10x8mm shaft flat upper black | | |
| For models: | C124G, C129G, C12C2G9, C12C9G, C12FG9G, C712G, C74G, C78G, C7FE12G, C7FE8G, C7FG12G, C7FG8G, C7FGM12G, C912G, C912GS, C94G, C94GP, C94GS, C98G, C98GP, C98GS, C9FE12G, C9FE12GS, C9FE8G, C9FE8GS, C9FG12G, C9FG12GS, C9FG16G, C9FG8G, C9FG8GP, C9FG8GS, C9FGM12G, PC12C4G, PC12C9G, PC74G, PC76G, PC78G, PC94G, PC96G, PC98G, PC9S4G, PC9S6G, PC9S8G, PD76G5, PD96G5, PD98G10, PD98G15, PD98G15A, PD9S8G10, PI98G10...(Other models you can see in the webshop) | | |

| | | | |
|--|--|-----------------|------------------------|
|  | | | |
| 1 | | | |
| GEV No. | 110894 | Ref. No. | CM061700 MACM061700 |
| description | knob gas tap with ignition flame t.max.°C°C ø 67mm shaft ø 8x6.5mm shaft flat upper black | | |
| For models: | C712G, C74G, C74GS, C78G, C78GS, C79G, C7FE12G, C7FE12GS, C7FE8G, C7FE8GS, C7FG12G, C7FG12GS, C7FG8G, C7FG8GS, C7FG9G, C7FGM12G, C912G, C912GS, C94G, C94GP, C94GS, C98G, C98GP, C98GS, C9FE12G, C9FE12GS, C9FE8G, C9FE8GS, C9FG12G, C9FG12GS, C9FG16G, C9FG8G, C9FG8GP, C9FG8GS, C9FGM12G, FT12C9GL, FT12C9GM, FT12C9GTL, FT12C9GTMC, FT74GL, FT74GLC, FT74GR, FT74GRC, FT76GL, FT76GLC, FT76GM, FT76GMC, FT76GR, FT78GL, FT78GLC...(Other models you can see in the webshop) | | |

| | | | |
|--|---|-----------------|------------------------|
|  | | | |
| 1 | | | |
| GEV No. | 110440 | Ref. No. | CM061501 MACM061501 |
| description | knob gas tap without ignition flame t.max.°C°C ø 67mm shaft ø 10x8mm shaft flat upper black | | |
| For models: | BR912GFM, BR912GIM, BR98GF, BR98GFM, BR98GI, BR98GIM | | |



| | | | |
|--------------------|--|-----------------|------------------------|
| GEV No. | 110460 | Ref. No. | CM062401 MACM062401 |
| description | knob gas thermostat t.max. 300°C 90-300°C ø 67mm shaft ø 10x8mm shaft flat upper black | | |
| For models: | BR78EF, BR78EI, BR78GF, BR78GI, BR912EFM, BR912EIM, BR98EF, BR98EFM, BR98EI, BR98EIM, BR9S8EF, BR9S8EI, FT129GLC, FT129GM, FT12C9GL, FT12C9GM, FT12C9GTLC, FT12C9GTMC, FT74EL, FT74ER, FT74GL, FT74GLC, FT74GR, FT74GRC, FT76EL, FT76ELC, FT76EM, FT76EMC, FT76GL, FT76GLC, FT76GM, FT76GMC, FT76GR, FT78EL, FT78ELC, FT78EM, FT78EMC, FT78GL, FT78GLC, FT78GLT, FT78GM, FT78GMC, FT78GMT, FT78GR, FT78GRT, FT94EL, FT94ELC, FT94ER, FT94G, FT94GL...(Other models you can see in the webshop) | | |




| | | | |
|--------------------|--|-----------------|------------------------|
| GEV No. | 110415 | Ref. No. | CM062301 MACM062301 |
| description | knob thermostat t.max. 190°C ø 67mm shaft ø 10x8mm shaft flat upper black temperature range 100-190°C | | |
| For models: | F12C4G15, F74G10, F74G15, F74G6, F76G10, F78G15, F94G10, F94G15, F94G6, F96G10, F98G15, F9S4G15, F9S8G15, P176G5, P196G5 | | |



| | | | |
|--------------------|--|-----------------|------------------------|
| GEV No. | 110999 | Ref. No. | CM059700 MACM059700 |
| description | knob oven BH/TH/BH+TH t.max.°C°C ø 67mm shaft ø 6x4.6mm shaft flat upper black | | |
| For models: | BF78E, BF98E, C12FEP9G, C7FE12G, C7FE8E, C7FE8EC, C7FE8G, C9FE12G, C9FE8E, C9FE8EC, C9FE8G | | |




| | | | |
|--------------------|---|-----------------|------------------------|
| GEV No. | 110998 | Ref. No. | CM059800 MACM059800 |
| description | knob thermostat t.max. 300°C ø 67mm shaft ø 6x4.6mm shaft flat upper black temperature range 50-300°C rotation 270° | | |
| For models: | BF78E, BF98E, BR78EF, BR78EI, BR912EFM, BR912EIM, BR912GFM, BR912GIM, BR98EF, BR98EFM, BR98EI, BR98EIM, BR98GF, BR98GFM, BR98GI, BR98GIM, BR9S8EF, BR9S8EI, BR9S8GF, BR9S8GI, C12FEP9G, C7FE12G, C7FE8E, C7FE8EC, C7FE8G, C9FE12G, C9FE8E, C9FE8EC, C9FE8G, FT129ELC, FT129EM, FT12C9EL, FT12C9ELC, FT12C9EM, FT12C9EMC, FT74EL, FT74ELC, FT74ER, FT76EL, FT76ELC, FT76EM, FT76EMC, FT78EL, FT78ELC, FT78EM, FT78EMC, FT94EL, FT94ELC, FT94ER, FT96EL...(Other models you can see in the webshop) | | |




| | | | |
|--------------------|--|-----------------|------------------------|
| GEV No. | 111503 | Ref. No. | CM140000 MACM140000 |
| description | knob switch 0-1-0-1 t.max.°C°C ø 67mm shaft ø 6x4.6mm shaft flat upper black | | |
| For models: | B124E, B74E, B78E, B94E, B98E, SP74E, SP94E | | |



| | | | |
|--------------------|---|-----------------|------------------------|
| GEV No. | 110996 | Ref. No. | CM058001 MACM058001 |
| description | knob thermostat t.max. 330°C ø 67mm shaft ø 10x8mm shaft flat upper black temperature range 100-330°C | | |
| For models: | BF78G, BF912G, BF912GH, BF98G, BR78GF, BR78GI, C12FGP9G, C7FG12G, C7FG8G, C7FGM12G, C9FG12G, C9FG16G, C9FG8G, C9FG8GP, C9FGM12G, T12FGP9G, T7FG12G, T7FG8G, T9FG12G, T9FG8G | | |



| | | | |
|--------------------|--|-----------------|------------------------|
| GEV No. | 110994 | Ref. No. | CM062100 MACM062100 |
| description | knob switch 7-position t.max.°C°C ø 67mm shaft ø 6x4.6mm shaft flat upper black | | |
| For models: | C74EC, C78EC, C78EQC, C7FE8E, C7FE8EC, C7FE8EQ, C7FG12G, C7FG8G, C94E, C94EC, C98E, C98EC, C9FE8E, C9FE8EC | | |




| | | | |
|--------------------|--|-----------------|------------------------|
| GEV No. | 110410 | Ref. No. | CM062200 MACM062200 |
| description | knob thermostat t.max. 60°C ø 67mm shaft ø 6x4.6mm shaft flat upper black temperature range 60-190°C rotation 270° | | |
| For models: | F12C4E12, F74E10, F74E6, F76E10, F94E10, F94E6, F94G22, F96E10, F98G22, F9S4G22, F9S8G22, P176E5, P196E5, P198E10, P198E15, P198G10, P198G14, P198G14A, P19S8E10 | | |




| | | | |
|---|---|-----------------|------------------------|
|  | | | |
| 1 | | | |
| GEV No. | 111504 | Ref. No. | CM140100 MACM140100 |
| description | knob thermostat t.max. 90°C 30-90°C ø 66mm shaft ø 4x6.4mm shaft flat upper | | |
| For models: | B124E, B74E, B78E, B94E, B98E, SNA12, SNA16, SNA20, SNAC12, SNAC16, SNAC20, SNG08, SNG12, SNG16, SNG20, SP74E, SP94E, SPAC12, SPAC16, SPAC20, SPCG08, SPCG12, SPCG16, SPCG20, SPCG8, SVAC16, SVAC20, SVCG08, SVCG12, SVCG16, SVCG20, SVCG8, TP126E, TP12E, TP136E, TP13E, TP146E, TP14E, TP156E, TP15E, TP166E, TP16E, TP176E, TP17E, TP186E, TP18E, TP196E, TP19E, TP206E, TP20E...(Other models you can see in the webshop) | | |


| | | | |
|--|---|-----------------|----------------------------|
|  | | | |
| 1 | | | |
| GEV No. | 110463 | Ref. No. | 1036700700 MA1036700700 |
| description | knob switch zero mark ø 50mm shaft ø 6x4.6mm shaft flat lower green | | |
| For models: | CPE40, CPE402, CPE60, CPE602, CPE60DB, CWE42, CWE422, CWE62, CWE622, FQE41, FQE41L, FQE41L2, FQE41R, FQE41RL, FQE41RL2, FQE61, FQE61L, FQE61L2, FQE61R, FQE61RL, OCPE60, OCWE42, OCWE422, OCWE62, OCWE622 | | |

| | | | |
|---|---|-----------------|------------------------|
|  | | | |
| 1 | | | |
| GEV No. | 514061 | Ref. No. | CM143100 MACM143100 |
| description | knob water cold t.max.°C ø 67mm shaft ø 10x8mm shaft flat variable | | |
| For models: | BR78EF, BR78E, BR78GF, BR78GI, BR912EFM, BR912EIM, BR912GFM, BR912GIM, BR98EF, BR98EFM, BR98EI, BR98EIM, BR98GF, BR98GFM, BR98GI, BR98GIM, BR9S8EF, BR9S8EI, BR9S8GF, BR9S8GI, PC12C4E, PC12C4G, PC12C9E, PC12C9G, PC74E, PC74G, PC76E, PC76G, PC78E, PC78G, PC94E, PC94G, PC96E, PC96G, PC98E, PC98G, PC9S4E, PC9S4G, PC9S6E, PC9S6G, PC9S8E, PC9S8G, PD96G5, PD98E10, PD98E15, PD98G10, PD98G15, PD98G15A, PD9S8E10, PD9S8G10...(Other models you can see in the webshop) | | |

| | | | |
|--|---|-----------------|----------------------------|
|  | | | |
| 1 | | | |
| GEV No. | 110408 | Ref. No. | 1036702200 MA1036702200 |
| description | knob switch zero mark ø 50mm shaft ø 6x4.6mm shaft flat right black | | |
| For models: | BIE40, BIE40B, BIE60, BIE60B, BME40DM, BME40DMB, BME40M, BME60, BME602, BME60DM, BME60DMB, BME60M, BME80M, BRE40, BRE40D, BRE40DB, BRE40DG, BRE40DGB, BRE40G, BSE40M, BSEI40M, CFE60, CFE60P, CFE70, CFG101, CFG70, CFGE60, CFGE61, CFGE61D, CFGE61L, CFGE61P, CFVE60, CPE40, CPE402, CPE60, CPE602, CRE6220, CRE6230, CRE6320, CRE6330, CWE42, CWE62, FQE60M, FQE40, FQE40D, FQE40DSP, FQE41, FQE41L, FQE41L2, FQE60...(Other models you can see in the webshop) | | |

| | | | |
|---|--|-----------------|------------------------|
|  | | | |
| 1 | | | |
| GEV No. | 514245 | Ref. No. | CM143200 MACM143200 |
| description | knob water hot t.max.°C ø 67mm shaft ø 10x8mm shaft flat variable | | |
| For models: | PD96G5, PD98E10, PD98E15, PD98G10, PD98G15, PD98G15A, PD9S8E10, PD9S8G10, PI96E5, PI96G5, PI98E10, PI98E15, PI98G10, PI98G14, PI98G14A, PI9S8E10 | | |


| | | | |
|--|--|-----------------|----------------------------|
|  | | | |
| 1 | | | |
| GEV No. | 110405 | Ref. No. | 1036700500 MA1036700500 |
| description | knob switch zero mark ø 50mm shaft ø 6x4.6mm shaft flat right green | | |
| For models: | BIE40, BIE40B, BIE60, BIE60B, BME40DM, BME40DMB, BME40M, BME60, BME602, BME60DM, BME60DMB, BME60M, BME80M, BRE40, BRE40D, BRE40DB, BRE40DG, BRE40DGB, BRE40G, BSE40M, BSEI40M, CFE60, CFE60P, CFE70, CFG101, CFG70, CFGE60, CFGE61, CFGE61D, CFGE61L, CFGE61P, CFVE60, CRE6220, CRE6230, CRE6320, CRE6330, FQE40, FQE40D, FQE40DSP, FQE41, FQE41L, FQE41L2, FQE60, FQE60D, FQE60DSP, FQE61, FQE61L, FQE61L2, FTE100B, FTE100BR...(Other models you can see in the webshop) | | |

| | | | |
|---|---|-----------------|----------------------------|
|  | | | |
| 1 | | | |
| GEV No. | 110450 | Ref. No. | 1036702300 MA1036702300 |
| description | knob switch zero mark ø 50mm shaft ø 6x4.6mm shaft flat lower black | | |
| For models: | BIG40, BIG60, BRG40, BRG40G, CFG101, CFG70, CFGE61, CFGE61D, CFGE61L, CFGE61P, FTG40B, FTG40BLC, FTG40BR, FTG60B, FTG60BLC, FTG60BR, FTG60BRR, FTG80B, FTG80BLC, FTG80BR, OCFG101, OCFG70, OCFG61, OPG41, OPG61, OPLG40, OPLG80, PCG41, PCG41L, PCG42, PCG61, PCG61L, PCG82, PLG40, PLG80 | | |





1

| | | | |
|--------------------|---|-----------------|--|
| GEV No. | 111500 | Ref. No. | 1036702600 2795000 MA1036702600 MA2795000 |
| description | knob switch zero mark ø 50mm shaft ø 6x4.6mm shaft flat upper black | | |
| For models: | CPE60, CPE602, CPE60DB, CS102E, CS102EP, CS102G, CS102GP, CS10E, CS10EP, CS10G, CS6E, CS6EP, CS6G, CWE42, CWE422, CWE62, CWE622, FQE41R, FQE41RL, FQE41RL2, FQE61R, FQE61RL, FV4E, FV4E1, OCPE60, OCWE42, OCWE422, OCWE62, OCWE622, SBA, SBAC, SPE60M, SVAC12, SVAC16, SVAC20, SVCG08, SVCG12, SVCG16, SVCG20, TSE60M | | |




1

| | | | | |
|---|---------------------|-----------------|--------------------|--------------------|
| GEV No. | 110064 | Ref. No. | 932600 MA932600 | |
| description | knob | | | |
| For models: | 704S, 706S, TPF706S | | | |
| accessories for | 110064 | | | |
|  | GEV No. | 110066 | Ref. No. | 932700 MA932700 |
| | knob screw | | | |




1

| | | | |
|--------------------|--|-----------------|------------|
| GEV No. | 110416 | Ref. No. | 1036706500 |
| description | knob | | |
| For models: | CFVE60, PCVE40, PCVE40D, PCVE40DB, PCVE60, PCVE60D, PCVE60DB | | |




1

| | | | |
|--------------------|---|-----------------|------------|
| GEV No. | 110417 | Ref. No. | 1036704700 |
| description | knob | | |
| For models: | FTE100B, FTE100BR, FTE100CRL, FTE40B, FTE40C, FTE60B, FTE60BR, FTE60C | | |




1

| | | | |
|--------------------|--------------|-----------------|------------|
| GEV No. | 110418 | Ref. No. | 1036703000 |
| description | knob | | |
| For models: | CWE42, CWE62 | | |




1

| | | | |
|--------------------|------------------------------|-----------------|------------|
| GEV No. | 110419 | Ref. No. | 1036703100 |
| description | knob | | |
| For models: | CPE40, CPE402, CPE60, CPE602 | | |




1

| | | | |
|--------------------|---|-----------------|------------|
| GEV No. | 110420 | Ref. No. | 1036708400 |
| description | knob | | |
| For models: | CFG101, CFG70, CFGE61, CFGE61D, CFGE61L, CFGE61P, OCFG101, OCFG70, OCFG61, OPCG41, OPCG61, PCG41, PCG41L, PCG42, PCG61, PCG61L, PCG82 | | |



1


| | | | |
|--------------------|--|-----------------|----------------------------|
| GEV No. | 110425 | Ref. No. | 1036701300 MA1036701300 |
| description | knob | | |
| For models: | BIE40, BIE60, BRE40, BRE40G, FTE100B, FTE100BR, FTE100CRL, FTE40B, FTE40C, FTE60B, FTE60BR, FTE60C | | |



1


| | | | |
|--------------------|--------|-----------------|----------|
| GEV No. | 110433 | Ref. No. | 18186-00 |
| description | knob | | |




Image not available


1

| | | | |
|--------------------|---|-----------------|----------|
| GEV No. | 110436 | Ref. No. | 18412-00 |
| description | knob | | |
| For models: | C7011E, C7011EFE, C704E, C707E, C707EFE | | |


Image not available

1

| | | | |
|--------------------|---|-----------------|----------------------------|
| GEV No. | 110411 | Ref. No. | 1036704600 MA1036704600 |
| description | knob ø 70mm black gas thermostat shaft ø 8x6.5mm shaft flat upper | | |
| For models: | FTG40B, FTG60B, FTG60BLC, FTG60BR, FTG80B, FTG80BR | | |


Image not available


2

| | | | |
|--------------------|---|-----------------|----------|
| GEV No. | 110441 | Ref. No. | 19305-00 |
| description | knob | | |
| For models: | FT12G7L70, FT12G7LC70, FT12G7R70, FT12G7RC70, FT12G7RL70, FT14G8L90, FT14G8LC90, FT14G8R2L90, FT14G8R90, FT14G8RC90, FT6G4L70, FT6G4LC70, FT6G4R70, FT6G4RC70, FT7G4L90, FT7G4LC90, FT7G4R90, FT7G4RC90 | | |




1

| | | | |
|--------------------|--|-----------------|----------------------------|
| GEV No. | 111501 | Ref. No. | 1036700400 MA1036700400 |
| description | knob switch zero mark ø 40mm green shaft special | | |
| For models: | BMG40, BMG60, FQG40, FQG60 | | |


Image not available

1

| | | | |
|--------------------|---|-----------------|----------|
| GEV No. | 110459 | Ref. No. | 27115-00 |
| description | knob | | |
| For models: | FC10E, FC10G, FC20E, FC20G, FC7E, FC7G, P9D10E, P9D15E, P9DA10E, P9DA15E, P9DSB10E, P9I10E, P9IA10E, PDASB10E | | |




1

| | | | |
|--------------------|--|-----------------|----------------------------|
| GEV No. | 110407 | Ref. No. | 1036702400 MA1036702400 |
| description | knob switch zero mark ø 40mm shaft ø 14mm shaft flat special green | | |
| For models: | BMG40, BMG60, FQG40, FQG60 | | |


Image not available


1

| | | | |
|--------------------|--|-----------------|----------------------------|
| GEV No. | 110414 | Ref. No. | 1036701200 MA1036701200 |
| description | knob 7-position | | |
| For models: | CFE60, CFE60P, CFE70, OCFE60, OPCE40, OPCE60, PCE100, PCE40, PCE40D, PCE40DB, PCE40M, PCE60, PCE60D, PCE60DB | | |




1

| | | | |
|--------------------|--|-----------------|--------|
| GEV No. | 110093 | Ref. No. | 450323 |
| description | knob switch zero mark t.max.°C ø 42mm shaft ø 5x5mm shaft flat black | | |




1

| | | | |
|--------------------|--|-----------------|----------------------------|
| GEV No. | 110895 | Ref. No. | 1031019000 MA1031019000 |
| description | knob graduated ø 50mm shaft ø 6x4.6mm shaft flat upper black | | |
| For models: | RIE40M, RIEP40M | | |




1

| | | | |
|--------------------|---|-----------------|----------------------------|
| GEV No. | 110896 | Ref. No. | 1031019800 MA1031019800 |
| description | knob thermostat t.max. 180°C ø 45mm shaft ø 6x4.6mm shaft flat right black temperature range 90-180°C rotation 270° | | |
| For models: | FQE4, FQE6, FQE6+6 | | |




1

| | | | |
|--------------------|---|-----------------|----------------------------|
| GEV No. | 110422 | Ref. No. | 1031019900 MA1031019900 |
| description | knob thermostat t.max. 300°C ø 45mm shaft ø 6x4.6mm shaft flat right black temperature range 50-300°C rotation 270° | | |
| For models: | CFE60, CFE60P, CFGE60, CFGE61, CFGE61D, CFGE61L, CFGE61P, CFVE60, OCFE60, OCFGE61 | | |





1

| | | | |
|--------------------|---|-----------------|----------------------------|
| GEV No. | 110421 | Ref. No. | 1031020000 MA1031020000 |
| description | knob time 60min ø 45mm shaft ø 6x4.6mm shaft flat right black | | |
| For models: | CFE60, CFE60P, CFGE60, CFGE61, CFGE61D, CFGE61L, CFGE61P, CFVE60, OCFE60, OCFGE61 | | |



1

| | | | |
|---|--|-----------------|-------------------|
| GEV No. | 112810 | Ref. No. | CR0581710 |
| description | knob zero mark t.max.°C ø 82.5mm shaft ø 6x4.6mm | | |
| For models: | NB74E, NB78E, NB94E, NB98E, NBR78EF, NBR78EI, NBR912EFM, NBR912EIM, NBR912GFM, NBR912GIM, NBR98EF, NBR98EFM, NBR98EI, NBR98EIM, NBR98GF, NBR98GFM, NBR98GI, NBR98GIM, NC74E2, NC74EC, NC74EQC, NC78E2, NC78EC, NC78EQC, NC7FE12G36, NC7FE8E, NC7FE8EQ, NC7FE8G24, NC94E, NC94E2, NC98E, NC98E2, NC9FE12G44, NC9FE12G52, NC9FE8E, NC9FE8E2, NC9FE8G28, NC9FE8G36, NC9FE8G48, NCT78E, NCT7FE8E, NCT98E, NCT98E2, NCT9FE8E, NCT9FE8E2, NF74E10, NF74E15, NF76E10, NF78E15...(Other models you can see in the webshop) | | |
| accessories for | 112810 | | |
|  | GEV No. | 550132 | Ref. No. — |
| knob spring ø 6x4.6mm Qty 10 pcs | | | |




1

| | | | |
|--------------------|--|-----------------|-----------|
| GEV No. | 111810 | Ref. No. | CR0580660 |
| description | knob zero mark t.max.°C ø 82.5mm shaft ø 8x6.5mm shaft flat upper chrome | | |
| For models: | NB74G, NB78G, NB94G, NB98G, NC712G36, NC74G12, NC78G24, NC7FE12G36, NC7FE8G24, NC7FG12G44, NC7FG8G32, NC7FGM12G, NC912G44, NC94G16, NC94G20, NC98G28, NC98G40, NC9FE12G44, NC9FE8G28, NC9FG12G52, NC9FG16G72, NC9FG8G32, NC9FG8G36, NC9FG8G48, NC9FGM12G, NFT74GL, NFT74GR, NFT76GL, NFT76GM, NFT76GR, NFT78GL, NFT78GM, NFT78GR, NFT94GL, NFT94GR, NFT96GL, NFT96GM, NFT98GL, NFT98GM, NFT98GR, NGL74G, NGL78G, NS78GS, NS7FG12GS, NT7FG12G, NT9FG12G | | |

steam/water taps

steam/water taps




1


| | | | |
|--------------------|--|-----------------|---------|
| GEV No. | 111370 | Ref. No. | 1693600 |
| description | knob zero mark ø 31mm shaft ø 8x5.5mm shaft flat right black | | |

accessories


fascias



1

| | | | |
|--|---|-----------------|-------------------|
| GEV No. | 111811 | Ref. No. | CR0580460 |
| description | bezel ø 72.5mm | | |
| For models: | NB74E, NB74G, NB78E, NB78G, NB94E, NB94G, NB98E, NB98G, NBR78EF, NBR78EI, NBR78GF, NBR78GI, NBR912EFM, NBR912EIM, NBR912GFM, NBR912GIM, NBR98EF, NBR98EFM, NBR98EI, NBR98EIM, NBR98GF, NBR98GFM, NBR98GI, NBR98GIM, NC712G36, NC74E2, NC74EC, NC74EQC, NC74G12, NC78E2, NC78EC, NC78EQC, NC78G24, NC7FE12G36, NC7FE8E, NC7FE8E2, NC7FE8EQ, NC7FE8G24, NC7FG12G44, NC7FG8G32, NC7FG8G36, NC7FG8G48, NC7FGM12G, NC912G44, NC94E, NC94E2, NC94G16, NC94G20, NC98E, NC98E2... (Other models you can see in the webshop) | | |
| accessories for | 111811 | | |
|  | GEV No. | 560056 | Ref. No. — |
| clamping washer nominal-ø 4mm ED ø 10mm spring steel | | | |


knob screws



1

| | | | |
|--------------------|---------------------|-----------------|--------------------|
| GEV No. | 110066 | Ref. No. | 932700 MA932700 |
| description | knob screw | | |
| For models: | 704S, 706S, TPF706S | | |

rosettes



1

| | | | |
|--------------------|---------------------------|-----------------|--------|
| GEV No. | 110310 | Ref. No. | 191040 |
| description | rosette knob up to ø 45mm | | |



handles and hand wheels

hand wheels

hand wheels



1


| | | | |
|---|--|-----------------|---------------------------------|
| GEV No. | 514026 | Ref. No. | 1685600 1685691 MA1685691 |
| description | hand wheel \varnothing 160mm D1 \varnothing 40mm bore \varnothing 16mm thread M8 hole distance 9mm groove widthmm L1 22mm L2 50mm handle length 75mm with folding handle | | |
| For models: | BR707E, BR707EI, BR707G, BR707GI | | |
| accessories for | 514026 | | |
|  | GEV No. | Ref. No. | — |
| | grub screw thread M8 L 10mm WS 4 Qty 1 pcs | | |



1

| | | | |
|---|---|-----------------|---------------------------------|
| GEV No. | 690086 | Ref. No. | 1475200 1475291 MA1475291 |
| description | hand wheel \varnothing 200mm D1 \varnothing 48mm bore \varnothing 20mm thread M8 hole distance 9mm groove widthmm L1 30mm L2 60mm handle length 82mm with folding handle | | |
| For models: | BR78EF, BR78EI, BR78GF, BR78GI, BR912EFM, BR912EIM, BR912GFM, BR912GIM, BR94E, BR94EI, BR94G, BR94GI, BR96E, BR96EI, BR96G, BR96GI, BR98EF, BR98EFM, BR98EI, BR98EIM, BR98GF, BR98GFM, BR98GI, BR98GIM, BR9M4E, BR9M4EI, BR9M4G, BR9M4GI, BR9M6E, BR9M6EI, BR9M6G, BR9M6GI, BR9S8EF, BR9S8EI, BR9S8GF, BR9S8GI, BR9SB4E, BR9SB4EI, BR9SB4G, BR9SB4GI, NBR78EF, NBR78EI, NBR78GF, NBR78GI, NBR912EFM, NBR912EIM, NBR912GFM, NBR912GIM, NBR98EF, NBR98EFM...(Other models you can see in the webshop) | | |
| spare parts for | 690086 | | |
|  | GEV No. | Ref. No. | — |
| | folding handle \varnothing 26mm total length 85mm seat \varnothing 20mm shaft \varnothing mm thread M6 with pin L 85mm | | |
| accessories for | 690086 | | |
|  | GEV No. | Ref. No. | 15131099 |
| | grub screw thread M8 L 16mm DIN 914/ISO 4027 intake internal hexagon WS 4 Qty 1 pcs | | |

spare parts and accessories



1

| | | | |
|--------------------|--|-----------------|------------------------|
| GEV No. | 514241 | Ref. No. | CM184800 MACM184800 |
| description | spindle for hand wheel | | |
| For models: | BR78EF, BR78EI, BR78GF, BR78GI, BR912EFM, BR912EIM, BR912GFM, BR912GIM, BR98EF, BR98EFM, BR98EI, BR98EIM, BR98GF, BR98GFM, BR98GI, BR98GIM, BR9S8EF, BR9S8EI, BR9S8GF, BR9S8GI | | |

cylindrical handles

fixed



1

| | | | |
|--------------------|--|-----------------|----------------------|
| GEV No. | 110703 | Ref. No. | 1829200 MA1829200 |
| description | cylindrical handle thread M10 \varnothing 28mm L 87mm | | |
| For models: | CRE6220, CRE6230, CRE6320, CRE6330, GB704G, GB707G, GB92G, GB94G, GL12C4G, GL12C9G, GL74G, GL78G, GL94G, GL98G, NGL74G, NGL78G, OPLG40, OPLG80, PLG40, PLG80, SME62M, SME63M, SME70M, SPE60M, SPW60M, TSE60M | | |


cone handles



1

| | | | |
|--------------------|---|-----------------|--------------------|
| GEV No. | 514033 | Ref. No. | 498500 MA498500 |
| description | cone handle plastic black | | |
| For models: | B9SB2E, B9SB2G, B9SB4E, B9SB4G, B9V2E, B9V2G, B9V4E, B9V4G, B9VP2E, B9VP4E, B9VP4G, CS10, CS6, F9V2E, F9V2ER, F9V4E, F9V4EC, F9V4ECR, F9V4ER, F9V4ERL, FC10E, FC20E, FC5E, FC7E, FT74E, FT74ER, FT74G, FT74GR, FT77E, FT77ERL, FT77G, FT77GRL, GB707G, T9F4G, T9F6GS, T9SB4G, T9V4G, T9V6GS | | |

star handles



1

| | | | |
|--------------------|--|-----------------|------------------------|
| GEV No. | 514051 | Ref. No. | 32000599 MA32000599 |
| description | star handle shaft 7x7mm \varnothing 60mm L 23mm black thermoplastic | | |
| For models: | CP704E, CP704G, CP92E, CP92E2, CP92G, CP94E, CP94E2, CP94G, CP9SB2E, CP9SB2E2, CP9SB2G, CP9SB4E, CP9SB4E2, CP9SB4G | | |

handle bars

handle bars



| | | | |
|--------------------|--|-----------------|-----------------------|
| 1 | | | |
| GEV No. | 690715 | Ref. No. | 46191.00 MA4619100 |
| description | handle rod | | |
| For models: | EF140DF, EF140DN, EF140DP, EF140MB, EF140MC, EF140MF, EF140MI, EF140MN, EF140MP, EF70DF, EF70DN, EF70DP, EF70MB, EF70MC, EF70MI, EF70MN, EF70MP, HF140D, HF140DF, HF140DN, HF140DP, HF143DNI, HF70DF, HF70DN, HF70DP, NF140D, NF140DF, NF140DN, NF140DP, NF143DNF, NF143DNI, NF143DNP, NF14DNG, NF70DF, NF70DI, NF70DN, NF70DP, NF72DF, NF72DNI, NF72DN, NF72DNF, NF72DNN, NF72DP, NF7DFG, NF7DNG, SF100DF, SF100DN, SF100DP, SF100MB, SF100MC...(Other models you can see in the webshop) | | |

consoles



| | | | |
|--------------------|---|-----------------|----------------------|
| 1 | | | |
| GEV No. | 690716 | Ref. No. | 4621300 MA4621300 |
| description | console | | |
| For models: | EF140DF, EF140DN, EF140DP, EF140MB, EF140MC, EF140MF, EF140MI, EF140MN, EF140MP, EF143DNF, EF143MNI, EF70DF, EF70DN, EF70DP, EF70MB, EF70MC, EF70MF, EF70MI, EF70MN, EF70MP, EF72DNF, EF72MNF, F140DF, F140DI, F140DN, F140DP, F143, F14DFG, F14DNG, F70DF, F70DI, F70DN, F70DP, F72, F7DFG, F7DNG, HF140D, HF140DF, HF140DN, HF140DP, HF143DNI, HF70DF, HF70DN, HF70DP, NF140D, NF140DF, NF140DFN, NF140DN, NF140DNI, NF140DNN...(Other models you can see in the webshop) | | |



| | | | |
|--------------------|---|-----------------|----------------------|
| 1 | | | |
| GEV No. | 693135 | Ref. No. | 1300213 MA1300213 |
| description | console for handle rod H 60mm Qty 1 pcs | | |
| For models: | C9F4E, C9F6E, C9V2E, C9V4E, FR92E10, FR92E10L, FR92E10L2, FR92E13, FR92E132, FR92E13T, FR92E13T2, FR92E22, FR92E22T, FR92G13, FR92G22, FR92G22T, FR94E10, FR94E10L, FR94E10L2, FR94E13, FR94E132, FR94E13T, FR94E13T2, FR94E22, FR94E22T, FR94G13, FR94G22, FR94G22T, FR9P2E10, FR9P4E10, V9F4E, V9FP4E, V9V2E, V9V4E, V9VP2E, V9VP4E | | |

bracket handles



| | | | |
|--------------------|--|-----------------|-------------------------|
| 1 | | | |
| GEV No. | 696630 | Ref. No. | CR0580340 CR0580340R |
| description | handle L 305mm H 40mm mounting distance 270mm chrome | | |
| For models: | NBV712, NBV712P, NBV72, NBV74, NBV76, NBV78, NBV78P, NC7FE12G36, NC7FE8E, NC7FE8EQ, NC7FE8G24, NC7FG12G44, NC7FG8G32, NC7FG8G36, NC7FG8G48, NC9FE12G44, NC9FE12G52, NC9FE8E, NC9FE8E2, NC9FE8G28, NC9FE8G36, NC9FE8G48, NC9FG12G52, NC9FG16G72, NC9FG8G32, NC9FG8G36, NC9FG8G48, NG74E, NG74E2, NG74G, NG78E, NG78E2, NG78G, NG912E, NG912E2, NG94E, NG94E2, NG94G, NG98E, NG98E2, NG98G, NT7FG12G, NT7FG8G, NT9FG12G, NT9FG8G, NXBVAE, NXBVC4, NXBVC6, NXBVP4, NXBVP6...(Other models you can see in the webshop) | | |



| | | | |
|--------------------|--|-----------------|------------------------|
| 1 | | | |
| GEV No. | 691327 | Ref. No. | CM073100 MACM073100 |
| description | pull handle L 119mm H 37mm mounting distance 105mm handle M6 | | |
| For models: | EF74E10VG, EF74E12, EF74G15, EF74G8VA, EF74G8VG, F12C4E12, F12C4G15, F74E10, F74E12, F74E6, F74G10, F74G15, F74G6, F76E10, F76G10, F78E12, F78G15, F94E10, F94E12, F94E18, F94E18K, F94E6, F94G10, F94G15, F94G22, F94G22K, F94G6, F96E10, F96G10, F98E12, F98E18, F98E18K, F98G15, F98G22, F98G22K, F954E12, F954E18, F954E18K, F954G15, F954G22, F954G22K, F958E12, F958E18, F958E18K, F958G15, F958G22, F958G22K, FQE4, FQE41, FQE41L...(Other models you can see in the webshop) | | |




| | | | |
|--------------------|--|-----------------|----------------------------|
| 1 | | | |
| GEV No. | 691328 | Ref. No. | 1031110900 MA1031110900 |
| description | pull handle L 248mm H 56mm mounting distance 235mm handle M6 | | |
| For models: | CFG120, OCFG120 | | |



| | | | |
|--------------------|---|-----------------|----------------------------|
| 1 | | | |
| GEV No. | 691336 | Ref. No. | 1031111000 MA1031111000 |
| description | pull handle L 544mm H 55mm mounting distance 530mm handle M6 | | |
| For models: | CFE60, CFE60P, CFE70, CFG101, CFG120, CFG70, CFGE60, CFGE61, CFGE61D, CFGE61L, CFGE61P, CFVE60, OCFE60, OCFG101, OCFG120, OCFG70, OCFGE61 | | |



| | | | |
|---|---|-----------------|----------------------|
|  | | | |
| 1 | | | |
| GEV No. | 697878 | Ref. No. | 4124500 MA4124500 |
| description | pull handle L 72mm H 28mm ø 8mm W 64mm | | |
| For models: | SER15, SER15A, SER18, SER18A, SER21, SER21A, SKTE15, SKTE18, SKTE21 | | |

| | | | |
|--|---|-----------------|----------------------------|
|  | | | |
| 1 | | | |
| GEV No. | 514011 | Ref. No. | 1031400100 MA1031400100 |
| description | lever right equiv. no. 1031400100 | | |
| For models: | EF74E10VG, EF74G8VA, EF74G8VG, FQE41, FQE41L, FQE41L2, FQE61, FQE61L, FQE61L2, FQG40, FQG41, FQG60, FQG61, OFQE41, OFQE61, OFQG41, OFQG61 | | |

levers

without handle

| | | | |
|---|---|-----------------|----------------------------|
|  | | | |
| 1 | | | |
| GEV No. | 514007 | Ref. No. | 1044109600 MA1044109600 |
| description | lever | | |
| For models: | BM74E, BM74G, BM77E, BM77G, BME40DM, BME40DMB, BME40M, BME60, BME602, BME60DM, BME60DMB, BME60M, BME80M, BMG40, BMG60, FQE41, FQE41L, FQE41L2, FQE61, FQE61L, FQE61L2 | | |

lever handles

| | | | |
|---|---|-----------------|--|
|  | | | |
| 1 | | | |
| GEV No. | 514015 | Ref. No. | 1036702000 1851700 MA1036702000 MA1851700 |
| description | lever handle plastic black | | |
| For models: | BM74E, BM74G, BM77E, BM77G, BME40DM, BME40DMB, BME40M, BME60, BME602, BME60DM, BME60DMB, BME60M, BME80M, BMG40, BMG60, CPE40, CPE402, CPE60, CPE602, CPE60DB, CRE6220, CRE6230, CRE6320, CRE6330, EF74E10VG, EF74G8VA, EF74G8VG, FQE40, FQE40D, FQE40DSP, FQE41, FQE41L, FQE41L2, FQE41R, FQE41RL, FQE41RL2, FQE60, FQE60D, FQE60DSP, FQE61, FQE61L, FQE61L2, FQE61R, FQE61RL, FQG40, FQG41, FQG60, FQG61, OCPE6, OCPE60... (Other models you can see in the webshop) | | |

| | | | |
|--|--|-----------------|----------------------|
|  | | | |
| 1 | | | |
| GEV No. | 514032 | Ref. No. | 1041622 MA1041622 |
| description | lever | | |
| For models: | B9SB2E, B9SB2G, B9SB4E, B9SB4G, B9V2E, B9V2G, B9V4E, B9V4G, B9VP2E, B9VP4E, B9VP4G | | |

| | | | |
|--|---|-----------------|----------------------------|
|  | | | |
| 1 | | | |
| GEV No. | 514008 | Ref. No. | 1036700000 MA1036700000 |
| description | lever handle plastic green | | |
| For models: | BME40M, BME60, BME602, BME60M, BME80M, BMG40, BMG60, CPE40, CPE402, CPE60, CPE602, CPE60DB, CRE6220, CRE6230, CRE6320, CRE6330, FQE40, FQE40D, FQE40DSP, FQE41, FQE41L, FQE41L2, FQE41R, FQE41RL, FQE41RL2, FQE60, FQE60D, FQE60DSP, FQE61, FQE61L, FQE61L2, FQE61R, FQE61RL, FQG40, FQG60, OCPE6, OCPE60, OFQE41, OFQE61, PL40, PL60 | | |

| | | | |
|---|--|-----------------|----------------------------|
|  | | | |
| 1 | | | |
| GEV No. | 514013 | Ref. No. | 1031400400 MA1031400400 |
| description | lever equiv. no. 1031400400 | | |
| For models: | CPE40, CPE402, CPE60, CPE602, CPE60DB, OCPE6, OCPE60 | | |

accessories

miscellaneous



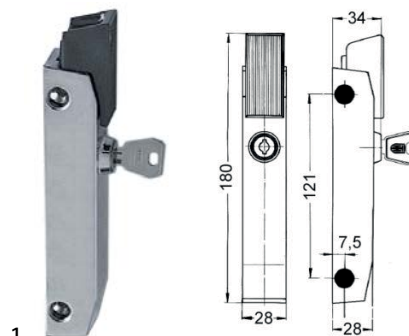
| | | | |
|--------------------|---|-----------------|-----------------------|
| 1 | | | |
| GEV No. | 690717 | Ref. No. | 46214.00 MA4621400 |
| description | spacer for door handle | | |
| For models: | EF140DF, EF140DN, EF140DP, EF140MB, EF140MC, EF140MF, EF140MI, EF140MN, EF140MP, EF143DNF, EF143MNI, EF70DF, EF70DN, EF70DP, EF70MB, EF70MC, EF70MF, EF70MI, EF70MN, EF70MP, EF72DNF, EF72MNF, F140DF, F140DI, F140DN, F140DP, F143, F14DFG, F14DNG, F70DF, F70DI, F70DN, F70DP, F72, F7DFG, F7DNG, HF140D, HF140DF, HF140DN, HF140DP, HF143DNI, HF70DF, HF70DN, HF70DP, NF140D, NF140DF, NF140DFN, NF140DN, NF140DNI, NF140DNN...(Other models you can see in the webshop) | | |

edgemount latches

push button latches

RAHRBACH

6186 PRESTO series



| | | | |
|---|--|-----------------|--------------------|
| 1 | | | |
| GEV No. | 690023 | Ref. No. | 720300 MA720300 |
| description | push button latch L 180mm mounting distance 121mm lockable refrigeration units 6186 H 34mm W 28mm type PRESTO | | |
| For models: | SPAR, SPAR15, SPAR16, SPAR18, SPAR20, SPRG, SPRG12, SPRG16, SPRG20, SVAR, SVAR15, SVAR16, SVAR18, SVAR20, SVRG, SVRG12, SVRG15, SVRG16, SVRG18, SVRG20 | | |
| spare parts for | 690023 | | |
|  | GEV No. | 700046 | Ref. No. — |
| | handle H 26.5mm L 55mm W 23.5mm plastic with spring spring length 14mm mounting thread M4 spring thickness 0.5mm | | |
| accessories for | 690023 | | |
|  | GEV No. | 690108 | Ref. No. — |
| | base plate H 5mm L 47.5mm W 21mm for swinging strike hole distance 31mm type PRESTO no. 6186 | | |
|  | GEV No. | 690109 | Ref. No. — |
| | base plate H 1mm L 47.5mm W 21mm plastic hole distance 31mm type PRESTO no. 6186 | | |
|  | GEV No. | 700050 | Ref. No. — |
| | door catch H 5mm L 47mm W 21mm hole distance 31mm with spigot refrigeration units type PRESTO no. 6186 | | |
|  | GEV No. | 700051 | Ref. No. — |
| | door catch H 5mm L 48mm W 21mm adjustable hole distance 31mm with spigot type PRESTO no. 6186 | | |

locks

locking devices

producer-specific

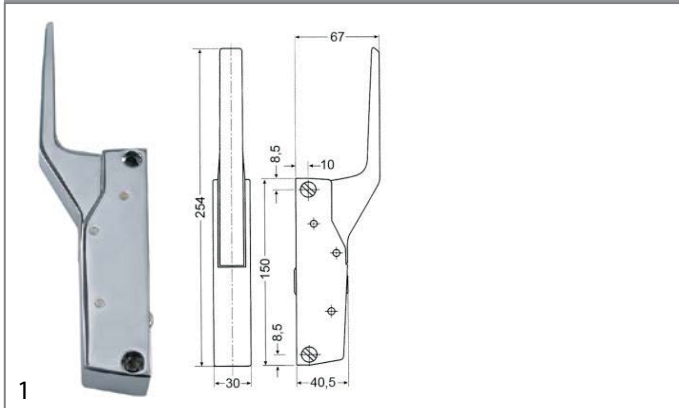
MARENO





| | | | |
|---|--|-----------------|------------------------------------|
| 1 | | | |
| GEV No. | 690462 | Ref. No. | 23153.00 BN1483003 MA2315300 |
| description | key cylinder ø 23mm thread M19x1 mounting measurements 16.5x19mm hub 38-45mm shaft ø 11mm thread L 12mm | | |
| For models: | AF140B, AF140C, AF140F, AF140I, AF140MB, AF140MC, AF140MF, AF140MI, AF140MN, AF140MP, AF140N, AF140P, AF70B, AF70C, AF70F, AF70I, AF70MB, AF70MC, AF70MF, AF70MI, AF70MN, AF70MP, AF70N, AF70P, AFR1143P, AFR1143PE, EF140DF, EF140DN, EF140DP, EF140MB, EF140MC, EF140MF, EF140MI, EF140MN, EF140MP, EF143DNF, EF143MNI, EF70DF, EF70DN, EF70DP, EF70MB, EF70MC, EF70MF, EF70MI, EF70MN, EF70MP, EF72DNF, EF72MNF, F140DF, F140DI...(Other models you can see in the webshop) | | |
| spare parts for | 690462 | | |
|  | GEV No. | 691589 | Ref. No. — |
| | spare keys for key cylinder 690462 key number 9233 | | |

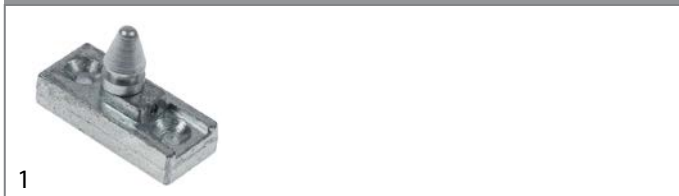
handle latches

CAFF/FERMOD





| | | | |
|---|--|-----------------|--------------------------------------|
| GEV No. | 700060 | Ref. No. | 2872000 MA2872000 |
| description | handle latch L 150mm mounting distance 133mm non lockable heated units G 791 | | |
| For models: | CON102E, CON102EP, CON102G, CON102GP, CON10E, CON10EP, CON10G, CON10GP, CON6E, CON6EP, CON6G, CON6GP, CS102E, CS102EP, CS102G, CS102GP, CSM102E, CSM102EP, CSM102G, CSM102GP, CSM10E, CSM10EP, CSM10G, CSM10GP, CSM6E, CSM6EP, CSM6G, CSM6GP | | |
| accessories for | 700060 | | |
|  | GEV No. | 700061 | Ref. No. 5129900 MA5129900 |
| | door catch L 58mm W 20mm H 35mm mounting distance 42mm chrome-plated brass for headed units | | |
|  | GEV No. | 700062 | Ref. No. — |
| | handle protection heated units | | |

door catches




| | | | |
|--------------------|--|-----------------|------------------------|
| GEV No. | 694577 | Ref. No. | 32051099 MA32051099 |
| description | door catch H 10mm L 48mm W 21mm mounting distance 31mm thread M5 with spigot | | |
| For models: | SPAR, SPAR15, SPAR16, SPAR18, SPAR20, SPRG, SPRG12, SPRG16, SPRG20, SVAR, SVAR15, SVAR16, SVAR18, SVAR20, SVRG, SVRG12, SVRG15, SVRG16, SVRG18, SVRG20 | | |

| | | | | |
|---|---|--|-----------------|----------------------|
|  | GEV No. | 700061 | Ref. No. | 5129900 MA5129900 |
| | description | door catch L 58mm W 20mm H 35mm mounting distance 42mm chrome-plated brass for headed units | | |
| | For models: | CON102E, CON102EP, CON102G, CON102GP, CON10E, CON10EP, CON10G, CON10GP, CON6E, CON6EP, CON6G, CON6GP, CSM102E, CSM102EP, CSM102G, CSM102GP, CSM10E, CSM10EP, CSM10G, CSM10GP, CSM6E, CSM6EP, CSM6G, CSM6GP | | |
| | accessories for | 700061 | | |
|  | GEV No. | 690414 | Ref. No. | — |
| | handle latch L 150mm mounting distance 133mm non lockable refrigeration units G 791 | | | |


snap locks

universal

| | | | | |
|--|--------------------|--|-----------------|--------------------------------------|
|  | GEV No. | 690596 | Ref. No. | 2844800 LA69050010 LAR69050010 |
| | description | snap lock L 60mm W 15mm H 36mm mounting distance 48/28mm spring thickness 1.5mm complete with door catch zamak | | |
| | For models: | CS4E, CS4EP, FC10E, FC20GP, FC5E, FC7E | | |


producer-specific


MARENO

| | | | | |
|--|--------------------|----------------------|-----------------|---------------------------|
|  | GEV No. | 694586 | Ref. No. | SIRRZ960029 SIRZ960029 |
| | description | snap lock repair set | | |


espagnolette locks


universal

| | | | | |
|--|--------------------|------------------------------------|-----------------|----------------------|
|  | GEV No. | 690041 | Ref. No. | 5145100 MA5145100 |
| | description | cam L 148mm mounting distance 32mm | | |
| | For models: | CSM201, CSM202 | | |



| | | | |
|---|---|-----------------|----------------------|
|  | | | |
| 1 | | | |
| GEV No. | 690040 | Ref. No. | 5156000 MA5156000 |
| description | door catch with roller H 42mm L 40mm W 40mm zinc die cast mounting distance 26mm type 0751 series | | |
| For models: | CSM201, CSM202 | | |



producer-specific
MARENO

| | | | |
|---|------------------------------------|-----------------|----------------------|
|  | | | |
| 1 | | | |
| GEV No. | 690041 | Ref. No. | 5145100 MA5145100 |
| description | cam L 148mm mounting distance 32mm | | |
| For models: | CSM201, CSM202 | | |

| | | | |
|---|---|-----------------|----------------------|
|  | | | |
| 1 | | | |
| GEV No. | 690040 | Ref. No. | 5156000 MA5156000 |
| description | door catch with roller H 42mm L 40mm W 40mm zinc die cast mounting distance 26mm type 0751 series | | |
| For models: | CSM201, CSM202 | | |

| | | | |
|---|---------------------------|-----------------|----------------------|
|  | | | |
| 1 | | | |
| GEV No. | nla | Ref. No. | 5156100 MA5156100 |
| description | door handle black plastic | | |
| For models: | CSM201, CSM202 | | |

| | | | | |
|---|--|-----------------|----------------------|----------------------|
|  | | | | |
| 1 | | | | |
| GEV No. | 690042 | Ref. No. | 5154800 MA5154800 | |
| description | latch gear opening to the right shaft intake ø 8x8mm L 170mm W 40mm H 40mm | | | |
| For models: | CSM201, CSM202 | | | |
| accessories for | 690042 | | | |
|  | GEV No. | 690040 | Ref. No. | 5156000 MA5156000 |
| door catch with roller H 42mm L 40mm W 40mm zinc die cast mounting distance 26mm type 0751 series | | | | |

| | | | | |
|---|----------------|--------|-----------------|----------------------|
| accessories for | 690042 | | | |
|  | GEV No. | 690041 | Ref. No. | 5145100 MA5145100 |
| cam L 148mm mounting distance 32mm | | | | |
|  | GEV No. | 691050 | Ref. No. | — |
| bar ø 10mm for door latch L 113.5mm | | | | |

miscellaneous

| | | | |
|--|--|-----------------|-----------|
|  | | | |
| 1 | | | |
| GEV No. | 691286 | Ref. No. | R58001780 |
| description | catch for glass plate | | |
| For models: | GMT06D, GMT20D, GVT06D, GVT20D, MACE07M, MACE10M, MACE20M, MACG07M, MACG10M, MACG20M, ME061D, ME061M, ME061P, ME061T, ME101D, ME101M, ME101P, ME101T, ME102D, ME102M, ME102P, ME102T, ME201D, ME201M, ME201P, ME201T, ME202D, ME202M, ME202P, ME202T, MEMT06D, MEMT06P, MEMT10D, MEMT10P, MEMT20D, MEMT20P, MEMT21D, MEMT21P, MEMT40D, MEMT40P, MEVT06D, MEVT06P, MEVT10D, MEVT10P, MEVT20D, MEVT20P, MEVT21D, MEVT21P, MEVT40D, MEVT40P...(Other models you can see in the webshop) | | |



hinges

spring assisted hinges

universal

CAFF/FERMOD

group 2

| | | | |
|--------------------|--|-----------------|----------------------|
| GEV No. | 690494 | Ref. No. | 4837000 MA4837000 |
| description | spring assisted hinge series 175 mounting pos. left/right torx L 75mm W 25.6mm H 100mm A 4mm B 11mm mounting measurements 22x22mm intake torx refrigeration units mounting distance 25mm | | |
| For models: | FB110F, FB110N, FB110P, FB140F, FB140FN, FB140N, FB140NN, FB140P, FB140PF, FB140PN, FB140PP, FB143NI, FB55F, FB55N, FB55P, FB70F, FB70N, FB70P, FB72F, FB72N, FB72NF, FB72P, FS140F, FS140FN, FS140NI, FS140N, FS140NG, FS140NI, FS140NN, FS140P, FS140PN, FS140PP, FS143F, FS143FI, FS143N, FS143NF, FS143NI, FS143NN, FS143NP, FS143P, FS70F, FS70FG, FS70I, FS70N, FS70NG, FS70P, FS72F, FS72IF, FS72IN...(Other models you can see in the webshop) | | |

INTERKLIMAT

hinges

| | | | |
|--------------------|---|-----------------|--|
| GEV No. | 690714 | Ref. No. | 1412050 2476700 BN1412050 MA2476700 |
| description | spring assisted hinge series 28XC mounting pos. left/right L 75mm W 25mm H 103mm A 8mm B 11mm intake 7.5x7.5 refrigeration units mounting distance 25mm | | |
| For models: | AF140B, AF140C, AF140F, AF140I, AF140MB, AF140MC, AF140MF, AF140MI, AF140MN, AF140MP, AF140N, AF140P, AF70B, AF70C, AF70F, AF70I, AF70MB, AF70MC, AF70MF, AF70MI, AF70MN, AF70MP, AF70N, AF70P, EF140DF, EF140DN, EF140DP, EF140MB, EF140MC, EF140MF, EF140MI, EF140MN, EF140MP, EF143DNF, EF143MNI, EF70DF, EF70DN, EF70DP, EF70MB, EF70MC, EF70MF, EF70MI, EF70MN, EF70MP, EF72DNF, EF72MNF, F140DF, F140DI, F140DN, F140DP...(Other models you can see in the webshop) | | |

accessories

| | | | |
|--------------------|--|-----------------|----------------------|
| GEV No. | 690747 | Ref. No. | 4621214 MA4621214 |
| description | bush for hinge ID ø 7.5mm L 25.5mm W 25.5mm white mounting measurements 22x22mm H 4.5mm | | |
| For models: | EF140DF, EF140DN, EF140DP, EF140MB, EF140MC, EF140MF, EF140MI, EF140MN, EF140MP, EF143DNF, EF143MNI, EF70DF, EF70DN, EF70DP, EF70MB, EF70MC, EF70MF, EF70MI, EF70MN, EF70MP, EF72DNF, EF72MNF, F140DF, F140DI, F140DN, F140DP, F143, F70DF, F70DI, F70DN, F70DP, F72, F7DFG, F7DNG, FB110F, FB110N, FB110P, FB140F, FB140FN, FB140N, FB140NN, FB140P, FB140PF, FB140PN, FB140PP, FB143NI, FB55F, FB55N, FB55P, FB70F...(Other models you can see in the webshop) | | |

1 mechanical components, equipment accessories

producer-specific

ELECTROLUX/ZANUSSI



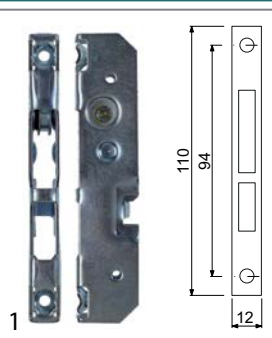
| | | | |
|--------------------|--|-----------------|----------------------|
| GEV No. | 690747 | Ref. No. | 4621214 MA4621214 |
| description | bush for hinge ID ϕ 7.5mm L 25.5mm W 25.5mm white mounting measurements 22x22mm H 4.5mm | | |
| For models: | EF140DF, EF140DN, EF140DP, EF140MB, EF140MC, EF140MF, EF140MI, EF140MN, EF140MP, EF143DNF, EF143MNI, EF70DF, EF70DN, EF70DP, EF70MB, EF70MC, EF70MF, EF70MI, EF70MN, EF70MP, EF72DNF, EF72MNF, F140DF, F140DI, F140DN, F140DP, F143, F70DF, F70DI, F70DN, F70DP, F72, F7DFG, F7DNG, FB110F, FB110N, FB110P, FB140F, FB140FN, FB140N, FB140NN, FB140P, FB140PF, FB140PN, FB140PP, FB143NI, FB55F, FB55N, FB55P, FB70F...(Other models you can see in the webshop) | | |

SAGI

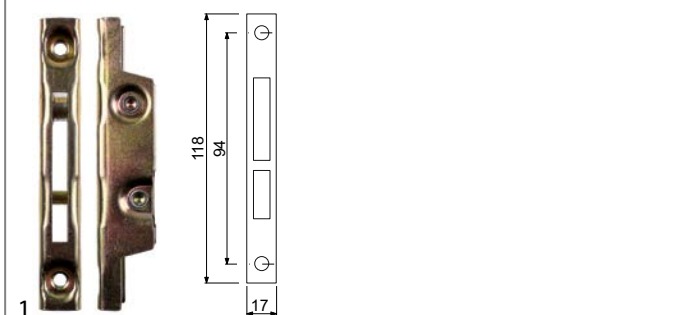


| | | | |
|--------------------|--|-----------------|----------------------|
| GEV No. | 690747 | Ref. No. | 4621214 MA4621214 |
| description | bush for hinge ID ϕ 7.5mm L 25.5mm W 25.5mm white mounting measurements 22x22mm H 4.5mm | | |
| For models: | EF140DF, EF140DN, EF140DP, EF140MB, EF140MC, EF140MF, EF140MI, EF140MN, EF140MP, EF143DNF, EF143MNI, EF70DF, EF70DN, EF70DP, EF70MB, EF70MC, EF70MF, EF70MI, EF70MN, EF70MP, EF72DNF, EF72MNF, F140DF, F140DI, F140DN, F140DP, F143, F70DF, F70DI, F70DN, F70DP, F72, F7DFG, F7DNG, FB110F, FB110N, FB110P, FB140F, FB140FN, FB140N, FB140NN, FB140P, FB140PF, FB140PN, FB140PP, FB143NI, FB55F, FB55N, FB55P, FB70F...(Other models you can see in the webshop) | | |

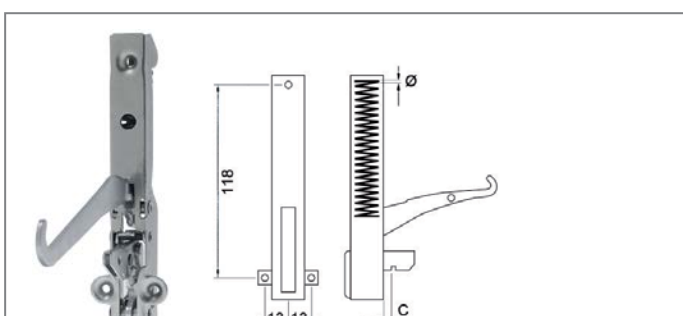
oven hinges



| | | | |
|--------------------|--|-----------------|--|
| GEV No. | 700003 | Ref. No. | 1031106000 1034400800 MA1031106000 MA1034400800 |
| description | opposite support L 110mm W 12mm mounting distance 94mm | | |
| For models: | CFE60, CFE60P, CFGE60, CFGE61, CFGE61D, CFGE61L, CFGE61P, CFVE60, FOE60M, OCFE60, OCFGE61, OFOE60M | | |



| | | | |
|--------------------|--|-----------------|----------------------|
| GEV No. | 700001 | Ref. No. | 1304500 MA1304500 |
| description | opposite support L 118mm W 17mm mounting distance 94mm | | |
| For models: | BF78E, BF78G, BF912G, BF912GH, BF98E, BF98G, C12FEP9G, C12FGP9G, C7011EFE, C7011EFEQ, C7011GFE, C7011GFG, C707EFE, C707EFEQ, C707GFE, C707GFG, C7FE12G, C7FE8E, C7FE8EC, C7FE8G, C7FG12G, C7FG8G, C7FGM12G, C9F4E, C9F4GS, C9F6E, C9F6GS, C9F8GS, C9FE12G, C9FE6GS, C9FE8E, C9FE8EC, C9FE8G, C9FG12G, C9FG16G, C9FG8G, C9FG8GP, C9FGM12G, C9FP4GS, C9FP6GS, C9FP8GS, C9V2E, C9V4E, CFE70, CFG101, CFG101D, CFG101L, CFG101P, CFG120, CFG70...(Other models you can see in the webshop) | | |



| | | | |
|------------------------|--|-----------------|--|
| GEV No. | 690030 | Ref. No. | 1034400400 CR1075440 MA1034400400 |
| description | oven hinge mounting distance 118mm lug mounting 13mm lever length 117mm groove distance 10mm spring thickness 3.5mm mounting ear position left/right spring length 60mm L 155mm W 21mm | | |
| For models: | CFE60, CFE60P, CFGE61, CFGE61D, CFGE61L, CFGE61P, CFVE60, OCFE60, OCFGE61 | | |
| accessories for | 690030 | | |
| GEV No. | 700003 | Ref. No. | 1031106000 1034400800 MA1031106000 MA1034400800 |
| description | opposite support L 110mm W 12mm mounting distance 94mm | | |

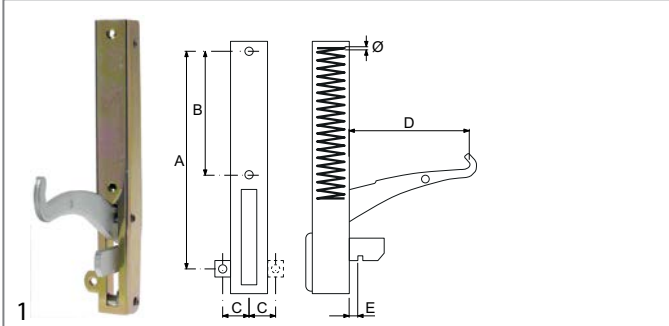



| | | | |
|--|---|-----------------|---|
| GEV No. | 700013 | Ref. No. | 1031102000 MA1031102000 |
| description | oven hinge mounting distance 118mm lug mounting 13mm lever length 119mm groove distance 13mm spring thickness 3.5mm mounting ear position left spring length 60mm L 154mm | | |
| For models: | CFE60, CFE60P, CFGE60, CFGE61, CFGE61D, CFGE61L, CFGE61P, CFVE60 | | |
| accessories for | 700013 | | |
| | GEV No. | 700003 | Ref. No. 1031106000 1034400800 MA1031106000 MA1034400800 |
| opposite support L 110mm W 12mm mounting distance 94mm | | | |

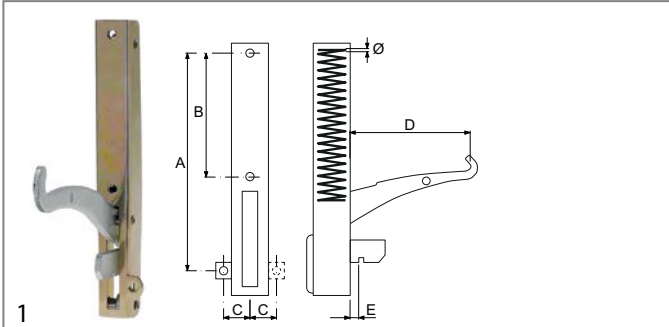
| | | | |
|--|---|-----------------|---|
| GEV No. | 700015 | Ref. No. | 1031105800 MA1031105800 |
| description | oven hinge mounting distance 118mm mounting distance 2mm lug mounting 13mm lever length 116mm groove distance 11mm spring thickness 3.5mm mounting ear position right spring length 61mm L 153mm W 20mm | | |
| For models: | FOE60M, OFOE60M | | |
| accessories for | 700015 | | |
| | GEV No. | 700003 | Ref. No. 1031106000 1034400800 MA1031106000 MA1034400800 |
| opposite support L 110mm W 12mm mounting distance 94mm | | | |


| | | | |
|--|--|-----------------|---|
| GEV No. | 700016 | Ref. No. | 1031105900 MA1031105900 |
| description | oven hinge mounting distance 118mm mounting distance 2mm lug mounting 13mm lever length 116mm groove distance 11mm spring thickness 3.5mm mounting ear position left spring length 61mm L 153mm W 20mm | | |
| For models: | FOE60M, OFOE60M | | |
| accessories for | 700016 | | |
| | GEV No. | 700003 | Ref. No. 1031106000 1034400800 MA1031106000 MA1034400800 |
| opposite support L 110mm W 12mm mounting distance 94mm | | | |

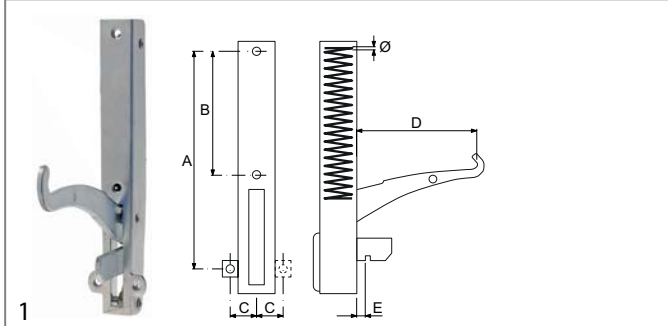
| | | | |
|--|--|-----------------|---|
| GEV No. | 700014 | Ref. No. | 1031105500 MA1031105500 |
| description | oven hinge mounting distance 118mm mounting distance 2mm lug mounting 13mm lever length 119mm groove distance 13mm spring thickness 3.5mm mounting ear position right spring length 60mm L 154mm | | |
| For models: | CFE60, CFE60P, CFGE60, CFGE61, CFGE61D, CFGE61L, CFGE61P, CFVE60 | | |
| accessories for | 700014 | | |
| | GEV No. | 700003 | Ref. No. 1031106000 1034400800 MA1031106000 MA1034400800 |
| opposite support L 110mm W 12mm mounting distance 94mm | | | |




| | | | |
|---|--|-----------------|--------------------------------------|
| GEV No. | 700005 | Ref. No. | 1304700 MA1304700 |
| description | oven hinge mounting distance 173mm mounting distance 2 105mm lug mounting 14mm lever length 118mm groove distance 7mm spring thickness 3.5mm mounting ear position left spring length 112mm W 25mm | | |
| For models: | BF78G, BF912G, BF912GH, BF98G, C7011EFE, C7011EFEQ, C7011GFE, C7011GFG, C707EFE, C707EFEQ, C707GFE, C707GFG, C7FG12G, C7FG8G, C9F4E, C9F4GS, C9F6E, C9F6GS, C9F8GS, C9FE6GS, C9FG12G, C9FG16G, C9FG8G, C9FG8GP, C9FGM12G, C9FP4GS, C9FP6GS, C9FP8GS, C9V2E, C9V4E, CFE70, CFG101, CFG101D, CFG101L, CFG101P, CFG120, CFG70, CFG70D, CFG70L, CFG70M, CFG70P, EC74EVG, EC74GVG, EC78EVG, EC78GVG, EC7FE8E, EC7FG8G, OCFG101, OCFG120, OCFG70...(Other models you can see in the webshop) | | |
| accessories for | 700005 | | |
|  | GEV No. | 700001 | Ref. No. 1304500 MA1304500 |
| | opposite support L 118mm W 17mm mounting distance 94mm | | |



| | | | |
|---|--|-----------------|--------------------------------------|
| GEV No. | 700004 | Ref. No. | 1304600 MA1304600 |
| description | oven hinge mounting distance 173mm mounting distance 2 105mm lug mounting 14mm lever length 119mm groove distance 7mm spring thickness 3.5mm mounting ear position right spring length 112mm L 206mm W 25mm | | |
| For models: | BF78G, BF912G, BF912GH, BF98G, C7011EFE, C7011EFEQ, C7011GFE, C7011GFG, C707EFE, C707EFEQ, C707GFE, C707GFG, C7FG12G, C7FG8G, C9F4E, C9F4GS, C9F6E, C9F6GS, C9F8GS, C9FE6GS, C9FG12G, C9FG16G, C9FG8G, C9FG8GP, C9FGM12G, C9FP4GS, C9FP6GS, C9FP8GS, C9V2E, C9V4E, CFE70, CFG101, CFG101D, CFG101L, CFG101P, CFG120, CFG70, CFG70D, CFG70L, CFG70M, CFG70P, EC74EVG, EC74GVG, EC78EVG, EC78GVG, EC7FE8E, EC7FG8G, OCFG101, OCFG120, OCFG70...(Other models you can see in the webshop) | | |
| accessories for | 700004 | | |
|  | GEV No. | 700001 | Ref. No. 1304500 MA1304500 |
| | opposite support L 118mm W 17mm mounting distance 94mm | | |




| | | | |
|---|--|-----------------|--------------------------------------|
| GEV No. | 700164 | Ref. No. | CM041300 MACM041300 |
| description | oven hinge mounting distance 173mm mounting distance 2mm lug mounting 14mm lever length 118mm groove distance 7mm spring thickness 3.5mm mounting ear position left/right spring length 113mm L 207mm | | |
| For models: | BF78E, BF78G, BF912G, BF912GH, BF98E, BF98G, C12FEP9G, C12FGP9G, C7FE12G, C7FE8E, C7FE8EC, C7FE8G, C7FG12G, C7FG8G, C9FE12G, C9FE8E, C9FE8EC, C9FE8G, C9FG12G, C9FG16G, C9FG8G, C9FG8GP, C9FGM12G, NC7FE12G36, NC7FE8E, NC7FE8EQ, NC7FE8G24, NC7FG12G44, NC7FG8G32, NC7FG8G36, NC7FG8G48, NC9FE12G44, NC9FE12G52, NC9FE8E, NC9FE8E2, NC9FE8G28, NC9FE8G36, NC9FE8G48, NC9FG12G52, NC9FG16G72, NC9FG8G32, NC9FG8G36, NC9FG8G48, NT7FG12G, NT7FG8G, NT9FG12G, NT9FG8G, T12FGP9G, T7FG12G, T7FG8G...(Other models you can see in the webshop) | | |
| accessories for | 700164 | | |
|  | GEV No. | 700001 | Ref. No. 1304500 MA1304500 |
| | opposite support L 118mm W 17mm mounting distance 94mm | | |


door bearing





| | | | |
|--------------------|---|-----------------|----------------------------------|
| GEV No. | 690758 | Ref. No. | 46375.14 4637524 MA4637524 |
| description | bolt | | |
| For models: | EF140DF, EF140DN, EF140DP, EF140MB, EF140MC, EF140MF, EF140MI, EF140MN, EF140MP, EF70DF, EF70DN, EF70DP, EF70MB, EF70MC, EF70MF, EF70MI, EF70MN, EF70MP, F140DF, F140DI, F140DN, F140DP, F143, F70DF, F70DI, F70DN, F70DP, F7DFG, F7DNG, FB110F, FB110N, FB110P, FB140F, FB140FN, FB140N, FB140NN, FB140P, FB140PF, FB140PN, FB140PP, FB143NI, FB55F, FB55N, FB55P, FB70F, FB70N, FB70P, FS140F, FS140FI, FS140FN...(Other models you can see in the webshop) | | |





| | | | |
|--------------------|--|-----------------|----------------------|
| GEV No. | 514029 | Ref. No. | 1488800 MA1488800 |
| description | bolt for pivot bearing | | |
| For models: | BR707E, BR707EI, BR707G, BR707GI, BR78EF, BR78EI, BR78GF, BR78GI, BR912EFM, BR912EIM, BR912GFM, BR912GIM, BR94E, BR94EI, BR94G, BR94GI, BR96E, BR96EI, BR96G, BR96GI, BR98EF, BR98EFM, BR98EI, BR98EIM, BR98GF, BR98GFM, BR98GI, BR98GIM, BR9M4E, BR9M4EI, BR9M4G, BR9M4GI, BR9M6E, BR9M6EI, BR9M6G, BR9M6GI, BR9S8EF, BR9S8EI, BR9S8GF, BR9S8GI, BR9S84E, BR9S84EI, BR9S84G, BR9S84GI | | |


| | | | |
|---|--|-----------------|---|
|  | | | |
| 1 | | | |
| GEV No. | 690708 | Ref. No. | 25163.00 25165.00 25944.00 MA2594400 |
| description | bush mounting pos. upper/lower for door hinge | | |
| For models: | AA710PA, AA710PS, AP708PA, AP708PS, AP709PA, AP709PS, BC2704, BC3704, BC4704, BCB704, BCP704, BPB704, BPB708, BRP704, BTR704, EAA710PA, EAA710PS, EAP608PA, EAP608PS, EAP609PA, EAP609PS, EAP708PA, EAP708PS, EAP709PA, EAP709PS, EPA607AA, EPA608PS, EPA609PS, EPP607AA, EPP607SC, EPP608PS, EPP609PS, IR13C, IR13CC, IR13CV, IR13M, IR13MC, IR13MV, IR13V, IR17C, IR17CC, IR17CV, IR17M, IR17MC, IR17MV, IR17V, PA607AA, PA608PS, PA609PS, PP607AA... (Other models you can see in the webshop) | | |


| | | | |
|---|--|-----------------|-----------|
|  | | | |
| 1 | | | |
| GEV No. | 691288 | Ref. No. | R58002520 |
| description | door bolt | | |
| For models: | GMT06D, GMT20D, GVT06D, GVT20D, MACE07M, MACE10M, MACE20M, MACG07M, MACG10M, MACG20M, ME061D, ME101D, ME102D, MEMT06D, MEMT06P, MEMT10D, MEMT10P, MEMT20D, MEMT20P, MEVT06D, MEVT06P, MEVT10D, MEVT10P, MEVT20D, MEVT20P, MG061D, MG101D, MG102D, MGMT06D, MGMT06P, MGMT10D, MGMT10P, MGMT20D, MGMT20P, MGVT06D, MGVT06P, MGVT10D, MGVT10P, MGVT20D, MGVT20P | | |


| | | | |
|---|--|-----------------|-----------|
|  | | | |
| 1 | | | |
| GEV No. | 692831 | Ref. No. | R58002670 |
| description | door bolt mounting pos. bottom left thread M12 bolt 15mm bolt ø 10mm | | |
| For models: | GMT20D, GVT06D, GVT20D | | |

| | | | |
|---|--|-----------------|-----------------------|
|  | | | |
| 1 | | | |
| GEV No. | 692439 | Ref. No. | 46222.40 MA4622240 |
| description | door hinge bolt ø 7mm flange length 24mm flange width 49mm | | |
| For models: | FB143NI, FB72F, FB72N, FB72NF, FB72P, FS143F, FS143FI, FS143N, FS143NF, FS143NI, FS143NN, FS143NP, FS143P, FS72F, FS72IF, FS72IN, FS72N, FS72NF, FS72NN, FS72P | | |

| | | | |
|--|--|-----------------|----------------------|
|  | | | |
| 1 | | | |
| GEV No. | 701437 | Ref. No. | 1412262 BN1412262 |
| description | door hinge L 45mm W 35mm mounting pos. upper bolt 14.5mm bolt ø 6mm refrigerator | | |

| | | | |
|---|--|-----------------|-----------|
|  | | | |
| 1 | | | |
| GEV No. | 690098 | Ref. No. | R10201330 |
| description | door hinge mounting pos. lower with holder | | |
| For models: | ME120M, ME120P, ME120X, ME220M, ME220P, ME220X, MEC24H, MEC40M, MG120M, MG120P, MG120X, MG220M, MG220P, MG220X, MGC20X, MGC24H, MGC40H, VE120M, VE120P, VE120X, VE220M, VE220P, VE220X, VG120M, VG120P, VG120X, VG220M, VG220P, VG220X | | |


| | | | |
|--|--|-----------------|-----------|
|  | | | |
| 1 | | | |
| GEV No. | 690097 | Ref. No. | R10201290 |
| description | door hinge mounting pos. upper | | |
| For models: | ME106M, ME106P, ME106X, ME110M, ME110P, ME110X, ME120M, ME120P, ME120X, ME210M, ME210P, ME210X, MG106M, MG106P, MG106X, MG110M, MG110P, MG110X, MG120M, MG120P, MG120X, MG210M, MG210P, MG210X, MGC20X, VE106M, VE106P, VE106X, VE110M, VE110X, VE120M, VE120P, VE120X, VE210M, VE210P, VE210X, VG106M, VG106P, VG106X, VG110M, VG110P, VG110X, VG120M, VG120P, VG120X, VG210M, VG210P, VG210X | | |

| | | | |
|--|--|-----------------|-----------|
|  | | | |
| 1 | | | |
| GEV No. | 691287 | Ref. No. | R18404500 |
| description | hinge | | |
| For models: | MACE07M, MACE10M, MACE20M, MACG07M, MACG10M, MACG20M | | |




1

| | | | |
|--------------------|--|-----------------|-----------|
| GEV No. | 691284 | Ref. No. | R58001760 |
| description | hinge for glass plate | | |
| For models: | GMT06D, GMT20D, GVT06D, GVT20D, MACE07M, MACE10M, MACE20M, MACG07M, MACG10M, MACG20M, ME061D, ME061M, ME061P, ME061T, ME101D, ME101M, ME101P, ME101T, ME102D, ME102M, ME102P, ME102T, ME201D, ME201M, ME201P, ME201T, ME202D, ME202M, ME202P, ME202T, MEMT06D, MEMT06P, MEMT10D, MEMT10P, MEMT20D, MEMT20P, MEMT21D, MEMT21P, MEMT40D, MEMT40P, MEVT06D, MEVT06P, MEVT10D, MEVT10P, MEVT20D, MEVT20P, MEVT21D, MEVT21P, MEVT40D, MEVT40P...(Other models you can see in the webshop) | | |




1

| | | | |
|--------------------|---|-----------------|--|
| GEV No. | 699245 | Ref. No. | 32213056 RA051004 RRA051004 SIRRA051004 |
| description | hinge L 58.5mm W 35mm H 109mm mounting pos. lower bolt 94mm bolt ø 8mm with accessories | | |




1

| | | | |
|--------------------|--|-----------------|-----------|
| GEV No. | 691277 | Ref. No. | R18201270 |
| description | hinge mounting pos. bottom left | | |
| For models: | MACE04M, MACE05M, MACG05M, MVE042P, MVE051P, MVG051P | | |




1

| | | | |
|--------------------|---|-----------------|----------------------|
| GEV No. | 514224 | Ref. No. | 1489000 MA1489000 |
| description | hinge bearing mounting ø 18mm without bolt tilting bratt pan | | |
| For models: | BR707E, BR707EI, BR707G, BR707GI, BR94E, BR94EI, BR94G, BR94GI, BR96E, BR96EI, BR96G, BR96GI, BR9M4E, BR9M4EI, BR9M4G, BR9M4GI, BR9M6E, BR9M6EI, BR9M6G, BR9M6GI, BR9SB4E, BR9SB4EI, BR9SB4G, BR9SB4GI, P9D10E, P9D10G, P9D15E, P9D15G, P9D5G, P9DA10E, P9DA10G, P9DA15E, P9DA15G, P9DSB10E, P9DSB10G, P9I10E, P9I10G, P9I15E, P9I5G, P9IA10E, P9IA10G, P9IA15E, PD707G, PDASB10E, PDASB10G, PI707E, PI707G | | |




1

| | | | |
|--------------------|---|-----------------|----------------------------|
| GEV No. | 691347 | Ref. No. | 1044230423 MA1044230423 |
| description | hinge bearing mounting pos. bottom right without bolt | | |
| For models: | CFG120, OCFG120 | | |




1

| | | | |
|--------------------|---|-----------------|-----------------------|
| GEV No. | 690759 | Ref. No. | 46222.24 MA4622224 |
| description | hinge bearing mounting pos. centre with bolt | | |
| For models: | EF143DNF, EF143MNI, EF72DNF, EF72MNF, F143, F72, HF143DNI, NF143DNF, NF143DNI, NF143DNP, NF72DF, NF72DIN, NF72DN, NF72DNF, NF72DNI, NF72DNN, NF72DP | | |



1


| | | | |
|--------------------|--|-----------------|------------------------|
| GEV No. | 514230 | Ref. No. | CM051903 MACM051903 |
| description | hinge bearing mounting pos. left series 900 without bolt tilting bratt pan kettle type series 700 | | |
| For models: | BR78EF, BR78EI, BR78G, BR78GF, BR78GI, BR912EFM, BR912EIM, BR912GFM, BR912GIM, BR98EF, BR98EFM, BR98EI, BR98EIM, BR98GF, BR98GFM, BR98GI, BR98GIM, BR9S8EF, BR9S8EI, BR9S8GF, BR9S8GI, NPD76G5, NPD78G8, NPD96G5, NPI76E5, NPI76G5, NPI78E8, NPI78G8, NPI96E5, NPI96G5, PD76G5, PD96G5, PD98E10, PD98E15, PD98G10, PD98G15, PD98G15A, PD9S8E10, PD9S8G10, PI76E5, PI76G5, PI96E5, PI96G5, PI98E10, PI98E15, PI98G10, PI98G14, PI98G14A, PI9S8E10 | | |





1


| | | | |
|--------------------|--|-----------------|------------------------|
| GEV No. | 690587 | Ref. No. | R11200550 R11200551 |
| description | hinge bearing mounting pos. lower with bolt | | |
| For models: | ME061M, ME061P, ME061T, ME101M, ME101P, ME101T, ME102M, ME102P, ME102T, MG061M, MG061P, MG061T, MG101M, MG101P, MG101T, MG102M, MG102P, MG102T | | |




| | | | |
|---|--|-----------------|-----------|
|  | | | |
| GEV No. | 690096 | Ref. No. | R10201190 |
| description | hinge bearing mounting pos. lower without bolt | | |
| For models: | ME106M, ME106P, ME106X, ME110M, ME110P, ME110X, ME210M, ME210P, ME210X, MG106M, MG106P, MG106X, MG110M, MG110P, MG110X, MG210M, MG210P, MG210X, VE106M, VE106P, VE106X, VE110M, VE110X, VE210M, VE210P, VE210X, VG106M, VG106P, VG106X, VG110M, VG110P, VG110X, VG210M, VG210P, VG210X | | |



| | | | |
|---|--|-----------------|------------------------------------|
|  | | | |
| GEV No. | 514228 | Ref. No. | CM192400 CM192401 MACM192401 |
| description | hinge bearing mounting pos. right series 900 without bolt tilting bratt pan kettle type series 700 | | |
| For models: | BR78EF, BR78EI, BR78G, BR78GF, BR78GI, BR912EFM, BR912EIM, BR912GFM, BR912GIM, BR98EF, BR98EFM, BR98EI, BR98EIM, BR98GF, BR98GFM, BR98GI, BR98GIM, BR9S8EF, BR9S8EI, BR9S8GF, BR9S8GI, NPD76G5, NPD78G8, NPD96G5, NPI76E5, NPI76G5, NPI78E8, NPI78G8, NPI96E5, NPI96G5, PD76G5, PD96G5, PD98E10, PD98E15, PD98G10, PD98G15, PD98G15A, PD9S8E10, PD9S8G10, PI76E5, PI76G5, PI96E5, PI96G5, PI98E10, PI98E15, PI98G10, PI98G14, PI98G14A, PI9S8E10 | | |


| | | | |
|---|---|-----------------|---|
|  | | | |
| GEV No. | 690712 | Ref. No. | 25158.00 25159.00 25160.12 MA2516012 |
| description | hinge bearing mounting pos. right/left without bolt | | |
| For models: | IR13C, IR13CC, IR13CV, IR13M, IR13MC, IR13MV, IR13V, IR17C, IR17CC, IR17CV, IR17M, IR17MC, IR17MV, IR17V, TR13C2P, TR13I4C, TR13I4CC, TR13I4CV, TR13N2C1P, TR13N2C1PC, TR13N2C1PV, TR13N2P, TR13N2PC, TR13N2PV, TR13N4C, TR13N4CC, TR13N4CV, TR17C3P, TR17I6C, TR17I6CC, TR17I6CV, TR17N2C2P, TR17N2C2PC, TR17N2C2PV, TR17N2P, TR17N3P, TR17N3PC, TR17N3PV, TR17N4C1P, TR17N4C1PC, TR17N4C1PV, TR17N6C, TR17N6CC, TR17N6CV, TR21N2C3P, TR21N2C3PC, TR21N2C3PV, TR21N2P, TR21N4C2P, TR21N4C2PC...(Other models you can see in the webshop) | | |


| | | | |
|---|--|-----------------|-----------|
|  | | | |
| GEV No. | 691276 | Ref. No. | R18201260 |
| description | hinge bearing mounting pos. upper left | | |
| For models: | MACE04M, MACE05M, MACG05M, MVE042P, MVE051P, MVG051P | | |

| | | | |
|--|--|-----------------|-----------|
|  | | | |
| GEV No. | 690586 | Ref. No. | R11200560 |
| description | hinge bearing mounting pos. upper left without bolt | | |
| For models: | GMT06D, GMT20D, GVT06D, GVT20D, MACE07M, MACE10M, MACE20M, MACG07M, MACG10M, MACG20M, ME061D, ME061M, ME061P, ME061T, ME101D, ME101M, ME101P, ME101T, ME102D, ME102M, ME102P, ME102T, ME201D, ME201M, ME201P, ME201T, ME202D, ME202M, ME202P, ME202T, MEMT06D, MEMT06P, MEMT10D, MEMT10P, MEMT20D, MEMT20P, MEMT21D, MEMT21P, MEMT40D, MEMT40P, MEVT06D, MEVT06P, MEVT10D, MEVT10P, MEVT20D, MEVT20P, MEVT21D, MEVT21P, MEVT40D, MEVT40P...(Other models you can see in the webshop) | | |


| | | | |
|--|--|-----------------|----------------------------|
|  | | | |
| GEV No. | 691346 | Ref. No. | 1044237100 MA1044237100 |
| description | hinge bearing mounting pos. upper right without bolt | | |
| For models: | CFG120, OCFG120 | | |

| | | | |
|---|--|-----------------|----------------------|
|  | | | |
| GEV No. | 514028 | Ref. No. | 1488600 MA1488600 |
| description | hinge bearing without bolt | | |
| For models: | BR707E, BR707EI, BR707G, BR707GI, BR94E, BR94EI, BR94G, BR94GI, BR96E, BR96EI, BR96G, BR96GI, BR9M4E, BR9M4EI, BR9M4G, BR9M4GI, BR9M6E, BR9M6EI, BR9M6G, BR9M6GI, BR9SB4E, BR9SB4EI, BR9SB4G, BR9SB4GI | | |
| accessories for | 514028 | | |
| |  | GEV No. | 514029 |
| | | Ref. No. | 1488800 MA1488800 |
| | bolt for pivot bearing | | |

| | | | |
|--|--|-----------------|-----------|
|  | | | |
| GEV No. | 514524 | Ref. No. | R11207240 |
| description | hinge bearing without bolt for combi-steamer mounting pos. bottom left | | |
| For models: | GMT20D, GVT06D, GVT20D | | |

| | | | |
|---|--|-----------------|-----------|
| 1  | | | |
| GEV No. | 691285 | Ref. No. | R58001770 |
| description | hinge bolt | | |
| For models: | GMT06D, GMT20D, GVT06D, GVT20D, MACE07M, MACE10M, MACE20M, MACG07M, MACG10M, MACG20M, ME061D, ME061M, ME061P, ME061T, ME101D, ME101M, ME101P, ME101T, ME102D, ME102M, ME102P, ME102T, ME201D, ME201M, ME201P, ME201T, ME202D, ME202M, ME202P, ME202T, MEMT06D, MEMT06P, MEMT10D, MEMT10P, MEMT20D, MEMT20P, MEMT21D, MEMT21P, MEMT40D, MEMT40P, MEVT06D, MEVT06P, MEVT10D, MEVT10P, MEVT20D, MEVT20P, MEVT21D, MEVT21P, MEVT40D, MEVT40P...(Other models you can see in the webshop) | | |


| | | | |
|---|---|-----------------|-----------|
| 1  | | | |
| GEV No. | 690099 | Ref. No. | R58002150 |
| description | hinge pin mounting pos. upper for door | | |
| For models: | EC106M, EC110M, EC210M, EM010M+SC, EM106H, EM106M, EM106M+SC, EM106P, EM110H, EM110M, EM110M+SC, EM110P, EM210H, EM210M, EM210M+SC, EM210P, EV006M, EV106H, EV106M, EV106M+SC, EV106P, EV110H, EV110M, EV110M+SC, EV110P, EV210H, EV210M, EV210M+SC, EV210P, GC106M, GC110M, GC210M, GM106H, GM106M, GM106M+SC, GM106P, GM110H, GM110M, GM110M+SC, GM110P, GM210H, GM210M, GM210M+SC, GM210P, GMT06D, GMT20D, GV106H, GV106M, GV106M+SC, GV106P...(Other models you can see in the webshop) | | |

| | | | |
|--|---|-----------------|-----------|
| 1  | | | |
| GEV No. | 692657 | Ref. No. | BN1412270 |
| description | mounting bracket L 45mm W 40mm mounting distance 22mm | | |


accessories

miscellaneous

| | | | |
|---|--|-----------------|-----------|
| 1  | | | |
| GEV No. | 690595 | Ref. No. | R58002550 |
| description | bush for door hinge | | |
| For models: | ME120M, ME120P, ME120X, ME201D, ME201M, ME201P, ME201T, ME202D, ME202M, ME202P, ME202T, ME220M, ME220P, ME220X, MEC24H, MEC40M, MEMT21D, MEMT21P, MEMT40D, MEMT40P, MEVT21D, MEVT21P, MEVT40D, MEVT40P, MG120M, MG120P, MG120X, MG201D, MG201M, MG201P, MG201T, MG202D, MG202M, MG202P, MG202T, MG220M, MG220P, MG220X, MGC20X, MGC24H, MGC40H, MGMT21D, MGMT21P, MGMT40D, MGMT40P, MGVT21D, MGVT21P, MGVT40D, MGVT40P, VE120M...(Other models you can see in the webshop) | | |


| | | | |
|---|---|-----------------|------------------------|
| 1  | | | |
| GEV No. | 694495 | Ref. No. | CM219300 MACM219300 |
| description | distance washer for lid hinge for tilting bratt pan ID ø 18.2mm ED ø 20mm L 20mm stainless steel | | |
| For models: | BR78EF, BR78EI, BR78G, BR78GF, BR78GI, BR912EFM, BR912EIM, BR912GFM, BR912GIM, BR98EF, BR98EFM, BR98EI, BR98EIM, BR98GF, BR98GFM, BR98GI, BR98GIM, BR98SEF, BR98SEI, BR98SGF, BR98SGI | | |


| | | | |
|--|---|-----------------|------------------------|
| 1  | | | |
| GEV No. | 514231 | Ref. No. | CM051503 MACM051503 |
| description | hinge pin tilting bratt pan kettle type series 700/900 | | |
| For models: | BR78EF, BR78EI, BR78G, BR78GF, BR78GI, BR912EFM, BR912EIM, BR912GFM, BR912GIM, BR98EF, BR98EFM, BR98EI, BR98EIM, BR98GF, BR98GFM, BR98GI, BR98GIM, BR98SEF, BR98SEI, BR98SGF, BR98SGI, NPD76G5, NPD78G8, NPD96G5, NPI76E5, NPI76G5, NPI78E8, NPI78G8, NPI96E5, NPI96G5, PD76G5, PD96G5, PD98E10, PD98E15, PD98G10, PD98G15, PD98G15A, PD98E10, PD98G10, PI76E5, PI76G5, PI96E5, PI96G5, PI98E10, PI98E15, PI98G10, PI98G14, PI98G14A, PI98E10 | | |


| | | | |
|--|--|-----------------|-----------|
| 1  | | | |
| GEV No. | 690592 | Ref. No. | R58002540 |
| description | pin for hinge | | |
| For models: | ME120M, ME120P, ME120X, ME201D, ME201M, ME201P, ME201T, ME202D, ME202M, ME202P, ME202T, ME220M, ME220P, ME220X, MEC24H, MEC40M, MEMT21D, MEMT21P, MEMT40D, MEMT40P, MEVT21D, MEVT21P, MEVT40D, MEVT40P, MG120M, MG120P, MG120X, MG201D, MG201M, MG201P, MG201T, MG202D, MG202M, MG202P, MG202T, MG220M, MG220P, MG220X, MGC20X, MGC24H, MGC40H, MGMT21D, MGMT21P, MGMT40D, MGMT40P, MGVT21D, MGVT21P, MGVT40D, MGVT40P, VE120M...(Other models you can see in the webshop) | | |

| | | | |
|--|--|-----------------|-----------|
| 1  | | | |
| GEV No. | 690593 | Ref. No. | R58002570 |
| description | plain washer ID ø 15mm ED ø 30mm thickness 3mm Qty 1 pcs for door hinge | | |
| For models: | ME120M, ME120P, ME120X, ME201D, ME201M, ME201P, ME201T, ME202D, ME202M, ME202P, ME202T, ME220M, ME220P, ME220X, MEC24H, MEC40M, MEMT21D, MEMT21P, MEMT40D, MEMT40P, MEVT21D, MEVT21P, MEVT40D, MEVT40P, MG120M, MG120P, MG120X, MG201D, MG201M, MG201P, MG201T, MG202D, MG202M, MG202P, MG202T, MG220M, MG220P, MG220X, MGC20X, MGC24H, MGC40H, MGMT21D, MGMT21P, MGMT40D, MGMT40P, MGVT21D, MGVT21P, MGVT40D, MGVT40P, VE120M...(Other models you can see in the webshop) | | |



| | | | |
|---|--|-----------------|-----------|
|  | | | |
| 1 | | | |
| GEV No. | 690594 | Ref. No. | R58002560 |
| description | pressure screw for door hinge | | |
| For models: | ME120M, ME120P, ME120X, ME201D, ME201M, ME201P, ME201T, ME202D, ME202M, ME202P, ME202T, ME220M, ME220P, ME220X, MEC24H, MEC40M, MEMT21D, MEMT21P, MEMT40D, MEMT40P, MEVT21D, MEVT21P, MEVT40D, MEVT40P, MG120M, MG120P, MG120X, MG201D, MG201M, MG201P, MG201T, MG202D, MG202M, MG202P, MG202T, MG220M, MG220P, MG220X, MGC20X, MGC24H, MGC40H, MGMT21D, MGMT21P, MGMT40D, MGMT40P, MGVT21D, MGVT21P, MGVT40D, MGVT40P, VE120M...(Other models you can see in the webshop) | | |

| | | | |
|---|--|-----------------|------------------------|
|  | | | |
| 1 | | | |
| GEV No. | 694496 | Ref. No. | CM052201 MACM052201 |
| description | screw for spring compressor for tilting bratt pan ED ø 8mm L 20mm thread M6 | | |
| For models: | BR78EF, BR78EI, BR78G, BR78GF, BR78GI, BR912EFM, BR912EIM, BR912GFM, BR912GIM, BR98EF, BR98EFM, BR98EI, BR98EIM, BR98GF, BR98GFM, BR98GI, BR98GIM, BR9S8EF, BR9S8EI, BR9S8GF, BR9S8GI, NPD76G5, NPD78G8, NPD96G5, NPI76E5, NPI76G5, NPI78E8, NPI78G8, NPI96E5, NPI96G5, PD76G5, PD98E10, PD98E15, PD98G10, PD98G15, PD9S8E10, PD9S8G10, PI76E5, PI76G5, PI98E10, PI98E15, PI98G10, PI98G14, PI9S8E10 | | |

| | | | |
|---|---|-----------------|------------------------|
|  | | | |
| 1 | | | |
| GEV No. | 694494 | Ref. No. | CM051804 MACM051804 |
| description | spacer for lid hinge for tilting bratt pan ID ø 7mm | | |
| For models: | BR78EF, BR78EI, BR78G, BR78GF, BR78GI, BR912EFM, BR912EIM, BR912GFM, BR912GIM, BR98EF, BR98EFM, BR98EI, BR98EIM, BR98GF, BR98GFM, BR98GI, BR98GIM, BR9S8EF, BR9S8EI, BR9S8GF, BR9S8GI | | |

pullouts


drawer slides

producer-specific


| | | | |
|---|--|-----------------|--|
|  | | | |
| 1 | | | |
| GEV No. | 691339 | Ref. No. | 1031006100 MA1031006100 |
| description | drawer slide L 525mm pull-out lengthmm W 57mm H 15mm mounting pos. right | | |
| For models: | CS40, CS60, EN124, EN12C4, EN72, EN74, EN76, EN78, EN92, EN94, EN96, EN98, M100, M120, M140, M160, M180, M40, M60, M80, NEN72, NEN74, NEN74C, NEN76, NEN76C, NEN78, NEN78C, NEN92, NEN94, NEN94C, NEN96, NEN96C, NEN98, NEN98C, NXBVC4, NXBVC6, NXKPA, NXPZM, OPL40, P40D, P40S, P60D, P60S, PL40, PL6, PL60, PL704C, PL707C, XR | | |
| accessories for | 691339 | | |
| | GEV No. | 692500 | Ref. No. 1031006200 MA1031006200 |
| |  drawer slide L 525mm W 57mm H 15mm mounting pos. left | | |


rollers

rollers

| | | | |
|--|--|-----------------|----------------------|
|  | | | |
| 1 | | | |
| GEV No. | 690709 | Ref. No. | 1194001 MA1194001 |
| description | roller rollerø 28mm B1 6mm overall width 13mm A 28mm B 6mm C 10mm D 6mm E 13mm plastic | | |
| For models: | AC705PA, AC705PS, AC709PA, AC709PS, AC714PA, AC714PS, AC716PA, AC716PS, AC717PA, AC717PS, AC718PA, AC718PS, AC719PA, AC719PS, AC720PA, AC720PS, AC721PA, AC721PS, AP-708PA, AP708PS, AP709PA, AP709PS, AP710BPS, AP710PA, AP710PS, AP711BPS, AP711PA, AP711PS, AP712BPS, AP712PA, AP712PP, AP712PS, AP713BPS, AP713PA, AP713PP, AP713PS, AP714BPS, AP-714PA, AP714PP, AP714PS, AP715BPS, AP715PA, AP715PP, AP715PS, AP716BPS, AP716PA, AP716PP, AP716PS, AP717BPS, AP717PA...(Other models you can see in the webshop) | | |

accessories

| | | | |
|---|---|-----------------|--------|
|  | | | |
| 1 | | | |
| GEV No. | 560133 | Ref. No. | 260404 |
| description | hexagonal nut thread M6 H 5mm WS 10 SS DIN/ISO DIN 934 / ISO 4032/8673 Qty 20 pcs | | |

| | | | |
|---|--|-----------------|-----------------------|
|  | | | |
| 1 | | | |
| GEV No. | 690703 | Ref. No. | 11870.00 MA1187000 |
| description | rubber pad | | |
| For models: | BR120, BR160, IR13C, IR13CC, IR13CV, IR13M, IR13MC, IR13MV, IR13V, IR17C, IR17CC, IR17CV, IR17M, IR17MC, IR17MV, IR17V, TP13, TP13E, TP17, TP17E, TP21, TP21E, TPC17, TPC21, TR13C2P, TR13I4C, TR13I4CC, TR13I4CV, TR13N2C1P, TR13N2C1PC, TR13N2C1PV, TR13N2P, TR13N2PC, TR13N2PV, TR13N4C, TR13N4CC, TR13N4CV, TR17C3P, TR17I6C, TR17I6CC, TR17I6CV, TR17N2C2P, TR17N2C2PC, TR17N2C2PV, TR17N2P, TR17N3P, TR17N3PC, TR17N3PV, TR17N4C1P, TR17N4C1PC...(Other models you can see in the webshop) | | |

fittings for catering equipment

outlet taps

producer-specific

MARENO



1

| | | | |
|--------------------|---|-----------------|----------------------|
| GEV No. | 514325 | Ref. No. | 1950700 MA1950700 |
| description | ball valve connection 1" IT - 1" IT DN25 total length 83mm with lever handle | | |
| For models: | EF74E12, EF74G15, F12C4E12, F12C4G15, F74E10, F74E12, F74G15, F76E10, F78E12, F78G15, F94E10, F94E12, F94E18, F94E18K, F94G15, F94G22, F94G22K, F96E10, F98E12, F98E18, F98E18K, F98G15, F98G22, F98G22K, F9S4E12, F9S4E18, F9S4E18K, F9S4G15, F9S4G22, F9S4G22K, F9S8E12, F9S8E18, F9S8E18K, F9S8G15, F9S8G22, F9S8G22K, FR74E, FR74E2, FR74G, FR77E, FR77E2, FR77G, FR92E13, FR92E132, FR92E22, FR92G13, FR92G22, FR92G22T, FR94E13, FR94E132...(Other models you can see in the webshop) | | |



1

| | | | |
|--------------------|--|-----------------|----------------------|
| GEV No. | 540658 | Ref. No. | 1450500 MA1450500 |
| description | ball valve connection 3/4" IT - 3/4" IT DN20 total length 69mm | | |
| For models: | CP704E, CP704G, CP92E, CP92E2, CP92G, CP94E, CP94E2, CP94G, CP95B2E, CP95B2E2, CP95B2G, CP95B4E, CP95B4E2, CP95B4G, CPE40, CPE402, CPE60, CPE602, CPE60DB, F74E10, F74E6, F76E10, F94E10, F94E6, F96E10, FR74E, FR74E10, FR74E10L, FR74E10L2, FR74G, FR77E, FR77E10, FR77E10L, FR77E10L2, FR77G, FR92E10, FR92E10L, FR92E10L2, FR92E13, FR92E22, FR92G22, FR94E10, FR94E10L, FR94E10L2, FR94E13, FR94E22, FR94G23, FR9P2E10, FR9P4E10, NF74E10...(Other models you can see in the webshop) | | |



1

| | | | |
|--------------------|--|-----------------|----------------------|
| GEV No. | 514099 | Ref. No. | 1515900 MA1515900 |
| description | centring piece L 20mm for extension thread ID ø 10mm D1 ø 18mm D2 ø 20mm | | |
| For models: | CP92E, CP92E2, CP92G, CP94E, CP94E2, CP94G, CP95B2E, CP95B2E2, CP95B2G, CP95B4E, CP95B4E2, CP95B4G, EPC74E, EPC74G, NPC74E, NPC74G, NPC76E, NPC76G, NPC78E, NPC78G, NPC94E, NPC94G, NPC98E, NPC98G, PC12C4E, PC12C4G, PC12C9E, PC12C9G, PC74E, PC74G, PC76E, PC76G, PC78E, PC78G, PC94E, PC94G, PC96E, PC96G, PC98E, PC98G, PC9S4E, PC9S4G, PC9S6E, PC9S6G, PC9S8E, PC9S8G | | |



1

| | | | |
|--------------------|---|-----------------|--------------------|
| GEV No. | 514033 | Ref. No. | 498500 MA498500 |
| description | cone handle plastic black | | |
| For models: | B9SB2E, B9SB2G, B9SB4E, B9SB4G, B9V2E, B9V2G, B9V4E, B9V4G, B9VP2E, B9VP4E, B9VP4G, CS10, CS6, F9V2E, F9V2ER, F9V4E, F9V4EC, F9V4ECR, F9V4ER, F9V4ERL, FC10E, FC20E, FC5E, FC7E, FT74E, FT74ER, FT74G, FT74GR, FT77E, FT77ERL, FT77G, FT77GRL, GB707G, T9F4G, T9F6GS, T9SB4G, T9V4G, T9V6GS | | |



1

| | | | |
|--------------------|--|-----------------|----------------------|
| GEV No. | 514006 | Ref. No. | 1033061900 866100 |
| description | drain pipe L 200mm thread ø 22mm | | |
| For models: | B9SB2E, B9SB2G, B9SB4E, B9SB4G, B9V2E, B9V2G, B9V4E, B9V4G | | |



1

| | | | |
|--------------------|--|-----------------|----------------------|
| GEV No. | 514219 | Ref. No. | 1577500 MA1577500 |
| description | drain pipe thread 1" ET connection 1" total length 230mm shaft intake ø 24mm | | |
| For models: | FR74E, FR74E2, FR74G, FR77E, FR77E2, FR77G, FR92E13, FR92E132, FR92E13T, FR92E13T2, FR92E22, FR92E22T, FR92G13, FR92G22, FR92G22T, FR94E13, FR94E132, FR94E13T, FR94E13T2, FR94E22, FR94E22T, FR94G13, FR94G22, FR94G22T | | |



1


| | | | |
|--------------------|--|-----------------|------------------------|
| GEV No. | 514220 | Ref. No. | CM012000 MACM012000 |
| description | drain pipe thread 1/2" ET | | |
| For models: | EF74E12, EF74G15, F12C4E12, F12C4G15, F74E10, F74E12, F74G15, F76E10, F78E12, F78G15, F94E10, F94E12, F94E18, F94E18K, F94G15, F94G22, F94G22K, F96E10, F98E12, F98E18, F98E18K, F98G15, F98G22, F98G22K, F9S4E12, F9S4E18, F9S4E18K, F9S4G15, F9S4G22, F9S4G22K, F9S8E12, F9S8E18, F9S8E18K, F9S8G15, F9S8G22, F9S8G22K | | |





1


| | | | |
|--------------------|--------------------------------|-----------------|----------------------------|
| GEV No. | 691356 | Ref. No. | 1033720900 MA1033720900 |
| description | extension for lever outlet tap | | |



| | | | |
|---|---|-----------------|----------------------------|
|  | | | |
| 1 | | | |
| GEV No. | 514007 | Ref. No. | 1044109600 MA1044109600 |
| description | lever | | |
| For models: | BM74E, BM74G, BM77E, BM77G, BME40DM, BME40DMB, BME40M, BME60, BME602, BME60DM, BME60DMB, BME60M, BME80M, BMG40, BMG60, FQE41, FQE41L, FQE41L2, FQE61, FQE61L, FQE61L2 | | |









| | | | |
|---|--|-----------------|----------------------|
|  | | | |
| 1 | | | |
| GEV No. | 514032 | Ref. No. | 1041622 MA1041622 |
| description | lever | | |
| For models: | B9SB2E, B9SB2G, B9SB4E, B9SB4G, B9V2E, B9V2G, B9V4E, B9V4G, B9VP2E, B9VP4E, B9VP4G | | |

| | | | |
|---|------------------------------------|-----------------|----------------------------|
|  | | | |
| 1 | | | |
| GEV No. | 691333 | Ref. No. | 1044235200 MA1044235200 |
| description | lever for outlet tap left thread | | |
| For models: | CRE6220, CRE6230, CRE6320, CRE6330 | | |

| | | | |
|---|-----------------------------------|-----------------|----------------------------|
|  | | | |
| 1 | | | |
| GEV No. | 691334 | Ref. No. | 1044235100 MA1044235100 |
| description | lever for outlet tap right thread | | |

| | | | |
|---|---|-----------------|--|
|  | | | |
| 1 | | | |
| GEV No. | 514015 | Ref. No. | 1036702000 1851700 MA1036702000 MA1851700 |
| description | lever handle plastic black | | |
| For models: | BM74E, BM74G, BM77E, BM77G, BME40DM, BME40DMB, BME40M, BME60, BME602, BME60DM, BME60DMB, BME60M, BME80M, BMG40, BMG60, CPE40, CPE402, CPE60, CPE602, CPE60DB, CRE6220, CRE6230, CRE6320, CRE6330, EF74E10VG, EF74G8VA, EF74G8VG, FQE40, FQE40D, FQE40DSP, FQE41, FQE41L, FQE41L2, FQE41R, FQE41RL, FQE41RL2, FQE60, FQE60D, FQE60DSP, FQE61, FQE61L, FQE61L2, FQE61R, FQE61RL, FQG40, FQG41, FQG60, FQG61, OCPE6, OCPE60... (Other models you can see in the webshop) | | |

| | | | |
|---|--|-----------------|--------------------|
|  | | | |
| 1 | | | |
| GEV No. | 106598 | Ref. No. | 866200 MA866200 |
| description | olive for pipe ø 18mm Qty 1 pcs ED ø 21mm | | |
| For models: | B9SB2E, B9SB2G, B9SB4E, B9SB4G, B9V2E, B9V2G, B9V4E, B9V4G, B9VP2E, B9VP4E, B9VP4G, BF78G, BF912G, BF912GH, BF98G, BM74E, BM74G, BM77E, BM77G, BME40DM, BME40DMB, BME40M, BME60, BME602, BME60DM, BME60DMB, BME60M, BME80M, BMG40, BMG60, BV712, BV74, BV76, BV78, BV912, BV94, BV96, BV98, C12FGP9G, C7FG12G, C7FG8G, C7FGM12G, C9FG12G, C9FG16G, C9FG8G, C9FG8GP, C9FGM12G, CPE40, CPE402, CPE60...(Other models you can see in the webshop) | | |

| | | | |
|---|--|-----------------|---|
|  | | | |
| 1 | | | |
| GEV No. | 540776 | Ref. No. | BN41826900950 |
| description | outlet tap L 83mm without handle thread 3/4" IT shaft L 9mm shaft ø 10x7.3mm handle M6 | | |
| spare parts for | 540776 | | |
|  | GEV No. | 532453 | Ref. No. — |
| | O-ring EPDM thickness 2.62mm ID ø 21.89mm Qty 1 pcs | | |
| accessories for | 540776 | | |
|  | GEV No. | 110734 | Ref. No. — |
| | lever for outlet tap | | |
|  | GEV No. | 514006 | Ref. No. 1033061900 866100 |
| | drain pipe L 200mm thread ø 22mm | | |
|  | GEV No. | 514217 | Ref. No. — |
| | handle for outlet tap | | |
|  | GEV No. | 540651 | Ref. No. 0109013 1033300300 MA1033300300 R0109013 SIR0109013 |
| | drain pipe total length 210mm shaft ø 22mm | | |
|  | GEV No. | 540734 | Ref. No. — |
| | drain pipe thread | | |
|  | GEV No. | 693082 | Ref. No. — |
| | lever handle thread | | |



| | | | |
|--------------------|--|-----------------|----------------------------|
| GEV No. | 514005 | Ref. No. | 1031024110 MA1031024110 |
| description | outlet tap without handle thread 3/4" IT shaft L 12mm | | |
| For models: | BME40DM, BME40DMB, BME40M, BME60, BME602, BME60DM, BME60DMB, BME60M, BME80M, BMG40, BMG60, CRE6220, CRE6230, CRE6320, CRE6330, EF74E10VG, EF74G8VA, EF74G8VG, FQE40, FQE40D, FQE40DSP, FQE41, FQE41L, FQE41L2, FQE41R, FQE41RL, FQE41RL2, FQE60, FQE60D, FQE60DSP, FQE61, FQE61L, FQE61L2, FQE61R, FQE61RL, FQG40, FQG41, FQG60, FQG61, OFQE41, OFQE61, OFQG41, OFQG61 | | |

accessories for 514005

| | | | | |
|--|----------------|--------|-----------------|--------------------|
| | GEV No. | 106597 | Ref. No. | 866000 MA866000 |
| union screw thread 3/4" for pipe ø 18mm L 20mm Qty 1 pcs WS 27 | | | | |

| | | | | |
|---|----------------|--------|-----------------|--------------------|
| | GEV No. | 106598 | Ref. No. | 866200 MA866200 |
| olive for pipe ø 18mm Qty 1 pcs ED ø 21mm | | | | |

| | | | | |
|-----------------------------------|----------------|--------|-----------------|----------------------------|
| | GEV No. | 514011 | Ref. No. | 1031400100 MA1031400100 |
| lever right equiv. no. 1031400100 | | | | |

| | | | | |
|----------------------------|----------------|--------|-----------------|--|
| | GEV No. | 514015 | Ref. No. | 1036702000 1851700 MA1036702000 MA1851700 |
| lever handle plastic black | | | | |

| | | | | |
|--|----------------|--------|-----------------|---|
| | GEV No. | 540651 | Ref. No. | 0109013 1033300300 MA1033300300 R0109013 SIR0109013 |
| drain pipe total length 210mm shaft ø 22mm | | | | |

| | | | | |
|-----------------------------------|----------------|--------|-----------------|----------------------------|
| | GEV No. | 691334 | Ref. No. | 1044235100 MA1044235100 |
| lever for outlet tap right thread | | | | |

| | | | | |
|--------------------------------|----------------|--------|-----------------|----------------------------|
| | GEV No. | 691356 | Ref. No. | 1033720900 MA1033720900 |
| extension for lever outlet tap | | | | |

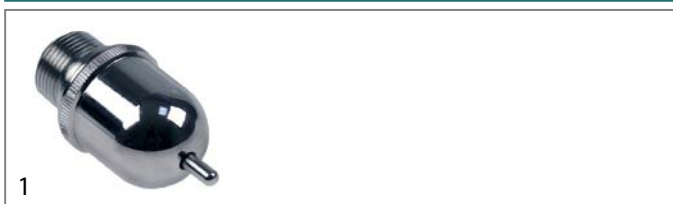


| | | | |
|--------------------|--|-----------------|------------------------|
| GEV No. | 514051 | Ref. No. | 32000599 MA32000599 |
| description | star handle shaft 7x7mm ø 60mm L 23mm black thermoplastic | | |
| For models: | CP704E, CP704G, CP92E, CP92E2, CP92G, CP94E, CP94E2, CP94G, CP95B2E, CP95B2E2, CP95B2G, CP95B4E, CP95B4E2, CP95B4G | | |



| | | | |
|--------------------|--|-----------------|--------------------|
| GEV No. | 106597 | Ref. No. | 866000 MA866000 |
| description | union screw thread 3/4" for pipe ø 18mm L 20mm Qty 1 pcs WS 27 | | |
| For models: | B9SB2E, B9SB2G, B9SB4E, B9SB4G, B9V2E, B9V2G, B9V4E, B9V4G, B9VP2E, B9VP4E, B9VP4G, BF78G, BF912G, BF912GH, BF98G, BM74E, BM74G, BM77E, BM77G, BME40DM, BME40DMB, BME40M, BME60DM, BME60DMB, BME60M, BME80M, BV712, BV74, BV76, BV78, BV912, BV94, BV96, BV98, C12FGP9G, C7FG12G, C7FG8G, C7FGM12G, C9FG12G, C9FG16G, C9FG8G, C9FG8GP, C9FGM12G, CPE60, CPE602, CPE60DB, EF74E10VG, EF74G8VA, EF74G8VG, F74E10...(Other models you can see in the webshop) | | |

aerators and air bleeders



| | | | |
|--------------------|--|-----------------|------------------------|
| GEV No. | 540827 | Ref. No. | 14206399 BN6A021600 |
| description | aerator and air bleeder thread 3/4" ET chrome-plated L 45mm ø 36mm | | |
| For models: | PV, PVA | | |



| | | | |
|--------------------|---|-----------------|----------------------|
| GEV No. | 540825 | Ref. No. | 0587810 CR0587810 |
| description | aerator and air bleeder thread 3/8" ET WS 24 chrome-plated L 37mm | | |
| For models: | NPD76G5, NPD78G8, NPD96G5, NPD98E10, NPD98E15, NPD98G10, NPD98G15, NPD98G15A, NPI76E5, NPI76G5, NPI78E8, NPI78G8, NPI96E5, NPI96G5, NPI98E10, NPI98E15, NPI98G10, NPI98G14, NPI98G14A | | |

lid hinges

miscellaneous

spare parts



| | | | |
|--------------------|---|-----------------|------------------------|
| GEV No. | 691659 | Ref. No. | CM192301 MACM192301 |
| description | extension for lid hinge ø 18mm L 209mm since 2003 | | |
| For models: | BR78EF, BR78EI, BR78G, BR78GF, BR78GI, BR912EFM, BR912EIM, BR912GFM, BR912GIM, BR98EF, BR98EFM, BR98EI, BR98EIM, BR98GF, BR98GFM, BR98GI, BR98GIM, BR98SEF, BR98SEI, BR98SGF, BR98SGI | | |




| | | | |
|---|---|-----------------|------------------------|
|  | | | |
| 1 | | | |
| GEV No. | 691660 | Ref. No. | CM051702 MACM051702 |
| description | pipe for lid hinge ø 40mm L 420mm | | |
| For models: | BR78EF, BR78EI, BR78G, BR78GF, BR78GI, BR912EFM, BR912EIM, BR912GFM, BR912GIM, BR98EF, BR98EFM, BR98EI, BR98EIM, BR98GF, BR98GFM, BR98GI, BR98GIM, BR9S8EF, BR9S8EI, BR9S8GF, BR9S8GI | | |

drain taps

stainless steel

gaskets

| | | | |
|---|---|-----------------|--------|
|  | | | |
| 1 | | | |
| GEV No. | 510974 | Ref. No. | 200852 |
| description | O-ring EPDM thickness 2.62mm ID ø 58.42mm Qty 1 pcs | | |

brass


drain taps

| | | | | |
|---|--|-----------------|-----------------|-----------|
|  | | | | |
| 1 | | | | |
| GEV No. | 540132 | Ref. No. | 1677200 | |
| description | drain tap 1 1/2" IT conical seal kettle A 90mm B 137mm B1 70mm chrome-plated brass | | | |
| For models: | P9D2G, PD707G, PI707E, PI707G | | | |
| spare parts for | 540132 | | | |
|  | GEV No. | 540213 | Ref. No. | — |
| | handle ID ø 5mm L 117mm | | | |
|  | GEV No. | 540461 | Ref. No. | — |
| | shim for drain tap | | | |
|  | GEV No. | 540464 | Ref. No. | — |
| | nut for drain tap thread 1 1/2" | | | |
| accessories for | 540132 | | | |
|  | GEV No. | 510404 | Ref. No. | CR0682770 |
| | flat gasket fibre ED ø 44mm ID ø 34mm thickness 2mm Qty 1 pcs | | | |


| | | | | |
|--|---|-----------------|----------------------|---|
|  | | | | |
| 1 | | | | |
| GEV No. | 540131 | Ref. No. | 1677800 MA1677800 | |
| description | drain tap 1 1/4" IT chrome-plated brass | | | |
| For models: | P9D10E, P9D10G, P9D15E, P9D15G, P9D5G, P9DA10E, P9DA10G, P9DA15E, P9DA15G, P9DSB10E, P9DSB10G, P9I10E, P9I10G, P9I15E, P9I5G, P9IA10E, P9IA10G, P9IA15E, PD707G, PD76G5, PD96G5, PDASB10E, PDASB10G, PI707E, PI707G, PI76E5, PI76G5, PI96E5, PI96G5 | | | |
| spare parts for | 540131 | | | |
|  | GEV No. | 540213 | Ref. No. | — |
| | handle ID ø 5mm L 117mm | | | |
|  | GEV No. | 540461 | Ref. No. | — |
| | shim for drain tap | | | |
|  | GEV No. | 540464 | Ref. No. | — |
| | nut for drain tap thread 1 1/2" | | | |

| | | | | |
|---|---|-----------------|--|---|
|  | | | | |
| 1 | | | | |
| GEV No. | 540275 | Ref. No. | 679400 BN6A021000 CM128900 MACM128900 | |
| description | drain tap 2" IT with union nut A 90mm B 151mm B1 80mm chrome-plated brass | | | |
| For models: | NPD98E10, NPD98E15, NPD98G10, NPD98G15, NPD98G15A, NPI98E10, NPI98E15, NPI98G10, NPI98G14, NPI98G14A, P9D10E, P9D10G, P9D15E, P9D15G, P9DA10E, P9DA10G, P9DA15E, P9DA15G, P9I10E, P9I10G, P9IA10E, P9IA10G, PD98E10, PD98E15, PD98G10, PD98G15, PD98G15A, PD9S8E10, PD9S8G10, PI98E10, PI98E15, PI98G10, PI98G14, PI98G14A, PI9S8E10, PV, PVA | | | |
| spare parts for | 540275 | | | |
|  | GEV No. | 540214 | Ref. No. | — |
| | handle ID ø 6mm L 145mm | | | |
| accessories for | 540275 | | | |
|  | GEV No. | 529484 | Ref. No. | — |
| | flat gasket fibre ED ø 58mm ID ø 50mm thickness 2mm Qty 1 pcs | | | |
|  | GEV No. | 542448 | Ref. No. | — |
| | gasket silicone 60x49x2 for drain tap 2" | | | |


accessories



| | | | |
|--------------------|--|-----------------|----------------------|
| GEV No. | 540119 | Ref. No. | 1420925 MA1420925 |
| description | O-ring EPDM thickness 2.5mm ID ø 59mm Qty 1 pcs | | |
| For models: | NPD98E10, NPD98E15, NPD98G10, NPD98G15, NPD98G15A, NPI98E10, NPI98E15, NPI98G10, NPI98G14, NPI98G14A, P9D10E, P9D10G, P9D15E, P9D15G, P9D5G, P9DA10E, P9DA10G, P9DA15E, P9DA15G, P9DSB10E, P9DSB10G, P9I10E, P9I10G, P9I15E, P9I5G, P9IA10E, P9IA10G, P9IA15E, PD98E10, PD98E15, PD98G10, PD98G15, PD98G15A, PD98E10, PD98G10, PD98G15, PD98G15A, PD9S8E10, PD9S8G10, PDASB10E, PDASB10G, PI98E10, PI98E15, PI98G10, PI98G14, PI98G14A, PI9S8E10 | | |




| | | | |
|--------------------|--|-----------------|------------------------|
| GEV No. | 505517 | Ref. No. | 77121600 MA77121600 |
| description | O-ring EPDM thickness 5.34mm ID ø 53.34mm Qty 1 pcs | | |
| For models: | PD98E10, PD98E15, PD98G10, PD98G15, PD98G15A, PD9S8E10, PD9S8G10, PI98E10, PI98E15, PI98G10, PI98G14, PI98G14A, PI9S8E10 | | |



| | | | |
|--------------------|--|-----------------|------------------------|
| GEV No. | 699248 | Ref. No. | 77121900 MA77121900 |
| description | O-ring set silicone 2" for drain tap Qty 3 pcs | | |
| For models: | NPD98E10, NPD98E15, NPD98G10, NPD98G15, NPD98G15A, NPI98E10, NPI98E15, NPI98G10, NPI98G14, NPI98G14A, PD98E10, PD98E15, PD98G10, PD98G15, PD9S8E10, PD9S8G10, PI98E10, PI98E15, PI98G10, PI98G14, PI9S8E10 | | |

safety fittings

accessories



| | | | |
|--------------------|--|-----------------|------------------------|
| GEV No. | 540836 | Ref. No. | 14206599 BN6A021700 |
| description | funnel thread 1/2" with shut-off valve | | |


safety valves



| | | | | |
|------------------------|---|-----------------|--|--|
| GEV No. | 540721 | Ref. No. | 14206200 14206299 BN6A021510 MA14206299 | |
| description | safety valve triggering pressure 0.5bar M88 thread 1 1/4" | | | |
| For models: | PV, PVA | | | |
| accessories for | 540721 | | | |
| | GEV No. | 541501 | Ref. No. | — |
| | | | | reducer for safety fitting IT 1 1/4" ET 3/4" |

filters

device filters




| | | | |
|--------------------|---|-----------------|--|
| GEV No. | 692816 | Ref. No. | 140408 935320 BN140408 FR935320 |
| description | filter L 290mm W 290mm H 5mm for fridge | | |

equipment feet and end caps

equipment feet



with fixing plate




| | | | |
|--------------------|--|-----------------|--|
| GEV No. | 700724 | Ref. No. | 49621 6086100 6086113 MA6086113 |
| description | equipment foot tube ø 58mm plate size 70x70mm hole distance 56x56mm H 130-210mm SS size 2 1/4" Qty 1 pcs | | |
| For models: | AA710PA, AA710PS, AC705PA, AC705PS, AC709PA, AC709PS, AC714PA, AC714PS, AC716PA, AC716PS, AC717PA, AC717PS, AC718PA, AC718PS, AC719PA, AC719PS, AC720PA, AC720PS, AC721PA, AC721PS, AFR1143P, AFR1143PE, AP708PA, AP708PS, AP709PA, AP709PS, AP710BPS, AP710PA, AP710PS, AP711BPS, AP711PA, AP711PS, AP712BPS, AP712PA, AP712PP, AP712PS, AP713BPS, AP713PA, AP713PP, AP713PS, AP714BPS, AP714PA, AP714PP, AP714PS, AP715BPS, AP715PA, AP715PP, AP715PS, AP716BPS, AP716PA...(Other models you can see in the webshop) | | |



screw-in feet

| | | | |
|---|--|-----------------|--------|
|  | | | |
| 1 | | | |
| GEV No. | 510939 | Ref. No. | 440201 |
| description | equipment foot thread M10 thread L 40mm H 14mm ø 60mm | | |
| accessories for | 510939 | | |
|  | | | |
| GEV No. | 524547 | Ref. No. | — |
| description | plug pipe type 40x40 thickness 1.5mm thread M10 plastic Qty 1 pcs for equipment foot | | |

| | | | |
|---|---|-----------------|--------|
|  | | | |
| 1 | | | |
| GEV No. | 510904 | Ref. No. | 210203 |
| description | equipment foot thread M10 thread L 40mm ø 60mm H 30mm Qty 1 pcs | | |


bolting feet

| | | | |
|--|--|-----------------|--|
|  | | | |
| 1 | | | |
| GEV No. | 514009 | Ref. No. | 1036021600 1036021613 MA1036021613 |
| description | equipment foot L 50mm W 29mm H 25mm bore ø 10mm mounting distance 40mm Qty 1 pcs | | |
| For models: | BIE40, BIE40B, BIE60, BIE60B, BIG40, BIG60, BME40DM, BME40DMB, BME40M, BME60, BME60, BME602, BME60DM, BME60DMB, BME60M, BME80M, BMG40, BMG60, BRE40, BRE40D, BRE40DB, BRE40DG, BRE40DGB, BRE40G, BRG40, BRG40G, BSE40M, BSEI40M, CPE60, CPE602, CPE60DB, CRE6220, CRE6230, CRE6320, CRE6330, CSP6220, CSP6230, CWE42, CWE422, CWE62, CWE622, FQE40, FQE40D, FQE40DSP, FQE41, FQE41L, FQE41L2, FQE60, FQE60D, FQE60DSP, FQE61...(Other models you can see in the webshop) | | |

equipment feet with stem

| | | | |
|---|--|-----------------|----------------------------|
|  | | | |
| 1 | | | |
| GEV No. | 514010 | Ref. No. | 1036016200 MA1036016200 |
| description | equipment foot ø 20mm H 4mm mounting ø 10mm overall height 12mm rubber Qty 1 pcs | | |
| For models: | BIE40, BIE60, BIG40, BIG60, BME40M, BME60, BME602, BME60M, BME80M, BMG40, BMG60, BRE40, BRE40G, BRG40, BRG40G, BSE40M, CPE60, CSP6220, CSP6230, CWE42, CWE62, FQE41, FQE41L, FQE41L2, FQE61, FQE61L, FQE61L2, FQG40, FQG60, FTE100B, FTE100BR, FTE100CRL, FTE40B, FTE40C, FTE60B, FTE60BR, FTE60C, FTG40B, FTG60B, FTG60BLC, FTG60BR, FTG80B, FTG80BR, FTVE100, FTVE40, FTVE60, LA60, PCE40, PCE60, PCVE40...(Other models you can see in the webshop) | | |

miscellaneous

| | | | |
|---|----------------------------|-----------------|--------|
|  | | | |
| 1 | | | |
| GEV No. | 511153 | Ref. No. | 160509 |
| description | bracket for equipment foot | | |

DERBY RUOTE

with bolt hole


chrome-plated steel

| | | | |
|--|---|-----------------|----------|
|  | | | |
| 1 | | | |
| GEV No. | 700201 ¹ | Ref. No. | 30700699 |
| description | swivel castor with swivel brake ø 100mm bolt hole bolt hole ø 12mm housing chrome-plated sheet steel capacity 80kg bearing ball bearing wheel body polypropylene tread TPE tyres H 132mm wheel width 30mm Qty 1 pcs | | |
| For models: | CB3, CB5, CD24 | | |

¹with swivel brake

spare parts and accessories

miscellaneous


| | | | |
|---|--|-----------------|------------------------|
|  | | | |
| 1 | | | |
| GEV No. | 560193 | Ref. No. | 15812699 MA15812699 |
| description | tooth lock washer ID ø 10.4mm ED ø 18mm zinc-coated steel DIN/ISO DIN 6798A Qty 1 pcs for thread M10 | | |
| For models: | CPE60, CPE602, CPE60DB, OCPE6, OCPE60 | | |

TENTE

with fixing plate

stainless steel


| | | | |
|--|--|-----------------|-----------|
|  | | | |
| 1 | | | |
| GEV No. | 701624 | Ref. No. | R69090100 |
| description | swivel castor with swivel brake ø 125mm plate fixing housing stainless steel plate size 105x85mm hole distance 78x60mm capacity 200kg bearing slide bearing wheel body polyamide tread polyurethane H 155mm wheel width 32mm | | |
| For models: | ME201D, ME201M, ME201P, ME201T, ME202D, ME202M, ME202T, MEMT21D, MEMT21P, MEMT40D, MEMT40P, MEVT21D, MEVT21P, MEVT40D, MEVT40P, MG201D, MG201M, MG201P, MG201T, MG202D, MG202M, MG202P, MG202T, MGMT21D, MGMT21P, MGMT40D, MGMT40P, MGVT21D, MGVT21P, MGVT40D, MGVT40P | | |

| | | | |
|---|--|-----------------|-----------|
|  | | | |
| 1 | | | |
| GEV No. | 701622 | Ref. No. | R69090090 |
| description | swivel castor without brake ø 125mm plate fixing housing stainless steel plate size 105x85mm hole distance 78x60mm capacity 200kg bearing slide bearing wheel body polyamide tread polyurethane H 155mm wheel width 32mm | | |
| For models: | ME201D, ME201M, ME201P, ME201T, ME202D, ME202M, ME202P, ME202T, MEMT21D, MEMT21P, MEMT40D, MEMT40P, MEVT21D, MEVT21P, MEVT40D, MEVT40P, MG201D, MG201M, MG201P, MG201T, MG202D, MG202M, MG202P, MG202T, MGMT21D, MGMT21P, MGMT40D, MGMT40P, MGVT21D, MGVT21P, MGVT40D, MGVT40P | | |


baskets


fryer baskets

MARENO


| | | | |
|--|---|-----------------|----------------------------|
|  | | | |
| 1 | | | |
| GEV No. | 970335 | Ref. No. | 1031108700 MA1031108700 |
| description | fryer basket L1 230mm W1 200mm H1 115mm chrome-plated steel | | |
| For models: | FQE6, FQE6+6 | | |

| | | | |
|---|--|-----------------|---------------------------------|
|  | | | |
| 1 | | | |
| GEV No. | 970170 | Ref. No. | 1464712 9323400 MA1464712 |
| description | fryer basket L1 250mm W1 256mm H1 150mm L2 540mm H2 160mm H3 270mm chrome-plated steel | | |
| For models: | FR74E, FR74E2, FR74G, FR77E, FR77E2, FR77G, FR92E13, FR92E132, FR92E13T, FR92E13T2, FR92E22, FR92E22T, FR92G13, FR94E13, FR94E132, FR94E13T, FR94E13T2, FR94E22, FR94E22T, FR94G13 | | |


| | | | |
|--|---|-----------------|----------------------------|
|  | | | |
| 1 | | | |
| GEV No. | 970334 | Ref. No. | 1031108200 MA1031108200 |
| description | fryer basket L1 260mm W1 135mm H1 100mm chrome-plated steel | | |
| For models: | FQE4 | | |


| | | | |
|--|--|-----------------|----------------------------|
|  | | | |
| 1 | | | |
| GEV No. | 970156 | Ref. No. | 1031004810 MA1031004810 |
| description | fryer basket L1 280mm W1 200mm H1 105mm chrome-plated steel | | |
| For models: | FQE40, FQE40D, FQE40DSP, FQE60, FQE60D, FQE60DSP, FQG40, FQG60, FR74E10, FR77E10, FR92E10, FR94E10, FR9P2E10, FR9P4E10 | | |


| | | | |
|---|--|-----------------|------------------------|
|  | | | |
| 1 | | | |
| GEV No. | 970353 | Ref. No. | CM030400 MACM030400 |
| description | fryer basket L1 290mm W1 255mm H1 120mm chrome-plated steel | | |
| For models: | EF74E12, EF74G15, F12C4E12, F12C4G15, F74E10, F74E12, F74G15, F76E10, F78E12, F78G15, F94E10, F94E12, F94E18, F94E18K, F94G15, F96E10, F98E12, F98E18, F98E18K, F98G15, F9S4E12, F9S4E18, F9S4E18K, F9S4G15, F9S8E12, F9S8E18, F9S8E18K, F9S8G15, NF74G15T, NF78G15T | | |

| | | | |
|--|---|-----------------|--|
|  | | | |
| 1 | | | |
| GEV No. | 970198 | Ref. No. | 1031110200 1031110222 MA1031110222 |
| description | fryer basket L1 300mm W1 175mm H1 110mm chrome-plated steel | | |
| For models: | EF74E10VG, F74E10, F76E10, F94E10, F96E10, FQE41, FQE41L, FQE41L2, FQE41R, FQE41RL, FQE41RL2, FQE61, FQE61L, FQE61L2, FQE61R, FQE61RL, FR74E10, FR74E10L, FR74E10L2, FR77E10, FR77E10L, FR77E10L2, FR92E10, FR92E10L, FR92E10L2, FR94E10, FR94E10L, FR94E10L2, NF74E10, NF76E10, NF94E10, NF96E10, OFQE41, OFQE61 | | |




| | | | |
|---|--|-----------------|-----------|
|  | | | |
| 1 | | | |
| GEV No. | 970613 | Ref. No. | CR0508550 |
| description | fryer basket L1 350mm W1 200mm H1 110mm L2 560mm H2 180mm H3 210mm | | |
| For models: | EF74G8VA, EF74G8VG, FQG41, FQG61, NF74G8, NF76G8, OFQG41, OFQG61 | | |

| | | | |
|---|--|-----------------|------------------------|
|  | | | |
| 1 | | | |
| GEV No. | 970352 | Ref. No. | CM030200 MACM030200 |
| description | fryer basket L1 360mm W1 160mm H1 120mm chrome-plated steel | | |
| For models: | F74E10, F74E12, F76E10, F78E12, F94E10, F94E12, F94E18, F94E18K, F94G22, F94G22K, F96E10, F98E12, F98E18, F98E18K, F98G22, F98G22K, F954E12, F954E18, F954E18K, F954G22, F954G22K, F958E12, F958E18, F958E18K, F958G22, F958G22K | | |

| | | | |
|---|---|-----------------|---------------------------------|
|  | | | |
| 1 | | | |
| GEV No. | 970171 | Ref. No. | 1464600 9323300 MA1464600 |
| description | fryer basket L1 360mm W1 160mm H1 150mm L2 650mm H2 160mm H3 270mm chrome-plated steel | | |
| For models: | FR92E13, FR92E132, FR92E13T, FR92E13T2, FR92E22, FR92E22T, FR92G22, FR94E13, FR94E132, FR94E13T, FR94E13T2, FR94E22, FR94E22T, FR94G22, FR94G23 | | |

| | | | |
|--|--|-----------------|-----------------------------------|
|  | | | |
| 1 | | | |
| GEV No. | 970351 | Ref. No. | 9733900 CM070300 MACM070300 |
| description | pasta basket L1 240mm W1 280mm H1 180mm H3 375mm stainless steel | | |

| | | | |
|--|---|-----------------|----------------------------|
|  | | | |
| 1 | | | |
| GEV No. | 970196 | Ref. No. | 1031100000 MA1031100000 |
| description | pasta basket L1 280mm W1 100mm H1 115mm L2 490mm H3 207mm stainless steel | | |
| For models: | CPE40, CPE402, CPE60, CPE602, CPE60DB, OCPE6, OCPE60 | | |

| | | | |
|--|--|-----------------|------------------------------------|
|  | | | |
| 1 | | | |
| GEV No. | 970347 | Ref. No. | 97337000 MA069502 MA97337000 |
| description | pasta basket L1 280mm W1 160mm H1 180mm H3 345mm stainless steel | | |

pasta baskets

MARENO

| | | | |
|---|--|-----------------|-----------------------------------|
|  | | | |
| 1 | | | |
| GEV No. | 970566 | Ref. No. | 9330100 CM182900 MACM182900 |
| description | pasta basket L1 160mm W1 96mm H1 180mm stainless steel | | |

| | | | |
|--|--|-----------------|-----------------------------------|
|  | | | |
| 1 | | | |
| GEV No. | 970348 | Ref. No. | 9733800 CM070800 MACM070800 |
| description | pasta basket L1 280mm W1 310mm H1 180mm H3 380mm stainless steel | | |

crumb screens



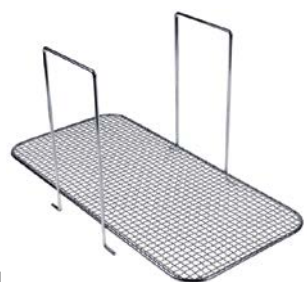
| | | | |
|--------------------|---|-----------------|------------------------|
| 1 | | | |
| GEV No. | 970764 | Ref. No. | CM030600 MACM030600 |
| description | crumb screen L 334mm W 272mm H 5.5mm for fryer | | |
| For models: | EF74E12, EF74G15, F12C4E12, F12C4G15, F74E10, F74E12, F74G15, F76E10, F78E12, F78G15, F94E10, F94E12, F94E18, F94E18K, F94G15, F96E10, F98E12, F98E18, F98E18K, F98G15, F9S4E12, F9S4E18, F9S4E18K, F9S4G15, F9S8E12, F9S8E18, F9S8E18K, F9S8G15, NF-74G15T, NF78G15T | | |



| | | | |
|--------------------|---|-----------------|-----------|
| 1 | | | |
| GEV No. | 970614 | Ref. No. | CR0508560 |
| description | crumb screen L 400mm W 220mm suitable for fryer | | |
| For models: | EF74G8VA, EF74G8VG, FQG41, FQG61, NF74E15, NF74G10, NF74G15, NF74G8, NF76G10, NF76G8, NF78E15, NF78G15, NF94E15, NF94G15, NF96G10, NF98E15, NF98G15, OFQG41, OFQG61 | | |



| | | | |
|--------------------|--|-----------------|-----------|
| 1 | | | |
| GEV No. | 970832 | Ref. No. | CR1073750 |
| description | crumb screen L 375mm W 195mm H 145mm chrome-plated steel | | |



| | | | |
|--------------------|--|-----------------|--|
| 1 | | | |
| GEV No. | 970615 | Ref. No. | 1031112600 1041718424 MA1031112600 |
| description | crumb screen L 388mm W 186mm suitable for fryer | | |
| For models: | FQE41, FQE41L, FQE41L2, FQE61, FQE61L, FQE61L2, FR74E10, FR74E10L, FR74E10L2, FR77E10, FR77E10L, FR77E10L2, FR92E10, FR92E10L, FR92E10L2, FR94E10, FR94E10L, FR94E10L2, OFQE41, OFQE61 | | |

shelves and shelf rails

chargrill grids



| | | | |
|--------------------|--|-----------------|----------------------------|
| 1 | | | |
| GEV No. | 210152 | Ref. No. | 1032100000 MA1032100000 |
| description | chargrill grid L 480mm W 100mm suitable for chargrill | | |
| For models: | CWE42, CWE422, CWE62, CWE622, OCWE42, OCWE422, OCWE62, OCWE622 | | |

grates





universal





without upstand

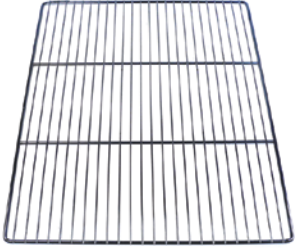





| | | | |
|------------------------|--|-----------------|--|
| 1 | | | |
| GEV No. | 970125 | Ref. No. | 2522400 9019000 FR6351760 FR990028 MA2522400 |
| description | grate W 325mm D 530mm GN 1/1 plastic-coated steel crossing wires 1 white suitable for refrigerator | | |
| For models: | IR13C, IR17C, TR13N2C1P, TR13N2P, TR13N4C, TR17N2C2P, TR17N3P, TR17N4C1P, TR17N6C, TR21N2C3P, TR21N4C2P, TR21N4P | | |
| accessories for | 970125 | | |
| | GEV No. | 690330 | Ref. No. — |
| | rack L 1000mm W 22mm H 4mm aperture 3x8mm hole distance 12.5mm stainless steel | | |
| | GEV No. | 694700 | Ref. No. — |
| | shelf support L 31/28mm W 22mm H 18mm SS Qty 12 pcs | | |
| | GEV No. | 694701 | Ref. No. — |
| | shelf support L 31/28mm W 22mm H 17mm SS with hook Qty 12 pcs | | |




| | | | |
|---|--|-----------------|---------------------------------|
|  | | | |
| GEV No. | 970133 | Ref. No. | 4624600 4657100 MA4657100 |
| description | grate W 530mm D 600mm plastic-coated steel wire gauge frame 9mm lengthwise wires gauge 5mm crossing wires 2 white suitable for refrigerator | | |
| For models: | EF140MF, EF140MN, EF140MP, EF70MF, EF70MN, EF70MP, FB110F, FB110N, FB110P, FB140F, FB140FN, FB140N, FB140NN, FB140P, FB140PF, FB140PN, FB140PP, FB55F, FB55N, FB55P, FB70F, FB70N, FB70P, FS140F, FS140FI, FS140FN, FS140I, FS140N, FS140NG, FS140NI, FS140NN, FS140P, FS140PN, FS140PP, FS70F, FS70FG, FS70I, FS70N, FS70NG, FS70P, HF140D, HF140DF, HF140DN, HF140DP, HF70DF, HF70DN, HF70DP, NF140D, NF140DF, NF140DN...(Other models you can see in the webshop) | | |
| accessories for | 970133 | | |
| | GEV No. | 690330 | Ref. No. — |
|  | rack L 1000mm W 22mm H 4mm aperture 3x8mm hole distance 12.5mm stainless steel | | |
|  | GEV No. | 694700 | Ref. No. — |
| shelf support L 31/28mm W 22mm H 18mm SS Qty 12 pcs | | | |
|  | GEV No. | 694701 | Ref. No. — |
| shelf support L 31/28mm W 22mm H 17mm SS with hook Qty 12 pcs | | | |

| | | | |
|--|---|-----------------|----------------------|
|  | | | |
| GEV No. | 970527 | Ref. No. | 2306800 MA2306800 |
| description | grate W 530mm D 650mm GN 2/1 chrome-plated steel with hinge camp crossing wires 2 suitable for refrigerator | | |
| For models: | AF140B, AF140C, AF140F, AF140I, AF140MB, AF140MC, AF140MF, AF140MI, AF140MN, AF140MP, AF140N, AF140P, AF70B, AF70C, AF70F, AF70I, AF70MB, AF70MC, AF70MF, AF70MI, AF70MN, AF70MP, AF70N, AF70P, AFR1143P, AFR1143PE, BF78G, BF912G, BF912GH, BF98G, C7FG12G, C7FG8G, C9F4GS, C9F6E, C9F6GS, C9F8GS, C9FE6GS, C9FG12G, C9FG16G, C9FG8G, C9FG8GP, C9FGM12G, EF140DF, EF140DN, EF140DP, EF140MB, EF140MC, EF140MF, EF140MI, EF140MN... (Other models you can see in the webshop) | | |
| accessories for | 970527 | | |
| | GEV No. | 690330 | Ref. No. — |
|  | rack L 1000mm W 22mm H 4mm aperture 3x8mm hole distance 12.5mm stainless steel | | |
|  | GEV No. | 694700 | Ref. No. — |
| shelf support L 31/28mm W 22mm H 18mm SS Qty 12 pcs | | | |
|  | GEV No. | 694701 | Ref. No. — |
| shelf support L 31/28mm W 22mm H 17mm SS with hook Qty 12 pcs | | | |

| | | | |
|---|--|-----------------|----------------------|
|  | | | |
| GEV No. | 970121 | Ref. No. | 4657000 MA4657000 |
| description | grate W 650mm D 530mm GN 2/1 chrome-plated steel crossing wires 2 | | |
| For models: | EF140MF, EF140MN, EF140MP, EF143MNI, EF70MF, EF70MN, EF70MP, EF72MNF, FB110F, FB110N, FB110P, FB140F, FB140FN, FB140N, FB140NN, FB140P, FB140PF, FB140PN, FB140PP, FB143NI, FB55F, FB55N, FB55P, FB70F, FB70N, FB70P, FB72F, FB72N, FB72NF, FB72P, FS140F, FS140FI, FS140FN, FS140I, FS140N, FS140NG, FS140NI, FS140NN, FS140P, FS140PN, FS140PP, FS143F, FS143FI, FS143N, FS143NF, FS143NI, FS143NN, FS143NP, FS143P, FS70F...(Other models you can see in the webshop) | | |
| accessories for | 970121 | | |
| | GEV No. | 690330 | Ref. No. — |
|  | rack L 1000mm W 22mm H 4mm aperture 3x8mm hole distance 12.5mm stainless steel | | |
|  | GEV No. | 694700 | Ref. No. — |
| shelf support L 31/28mm W 22mm H 18mm SS Qty 12 pcs | | | |
|  | GEV No. | 694701 | Ref. No. — |
| shelf support L 31/28mm W 22mm H 17mm SS with hook Qty 12 pcs | | | |

| | | | |
|--|---|-----------------|-----------------------|
| <h2>shelf rails and supports</h2> | | | |
| <h3>producer-specific</h3> | | | |
|  | | | |
| GEV No. | 690737 | Ref. No. | 46249.12 MA4624912 |
| description | guide U-shape L 500mm W 14mm mounting pos. left/right inner height 20mm | | |
| For models: | F140DF, F140DI, F140DN, F140DP, F143, F70DF, F70DI, F70DN, F70DP, F72, F7DFG, F7DNG | | |

| | | | |
|---|--|-----------------|-----------------------|
|  | | | |
| GEV No. | 690736 | Ref. No. | 46248.00 MA4624800 |
| description | shelf support L 38mm W 20mm H 25mm | | |
| For models: | EF140DF, EF140DN, EF140DP, EF140MB, EF140MC, EF140MF, EF140MI, EF140MN, EF140MP, EF143MNI, EF70DF, EF70DN, EF70DP, EF70MB, EF70MC, EF70MF, EF70MI, EF70MN, EF70MP, EF72MNF, HF140D, HF140DF, HF140DN, HF140DP, HF143DNI, HF70DF, HF70DN, HF70DP, NF140D, NF140DF, NF140DN, NF140DP, NF143DNF, NF143DNI, NF143DNP, NF14DNG, NF70DF, NF70DI, NF70DN, NF70DP, NF72DF, NF72DIN, NF72DN, NF72DNF, NF72DNI, NF72DNN, NF72DP, NF7DFG, NF7DNG, SF100DF...(Other models you can see in the webshop) | | |

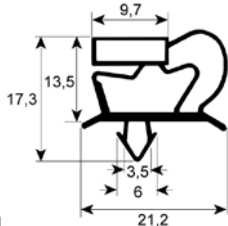
gaskets

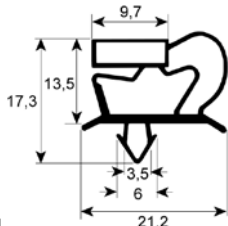
refrigeration gaskets

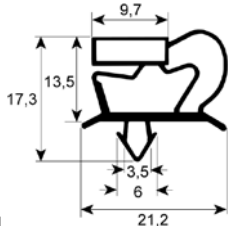
plug-in gaskets

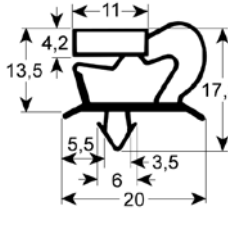
profile 9048

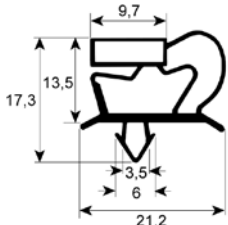
We offer custom-made gaskets for this profile

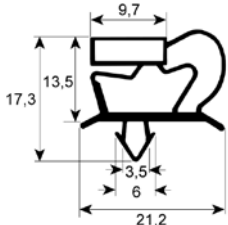
| | | | |
|--|---|-----------------|------------------------------|
|  | | | |
| GEV No. | 901172 | Ref. No. | 14414300254 BN14414300254 |
| description | refrigeration gasket profile 9048 W 383mm L 254mm plug size | | |

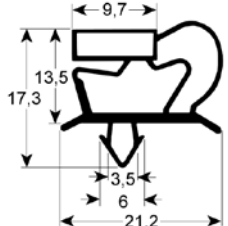
| | | | |
|---|---|-----------------|--|
|  | | | |
| GEV No. | 901173 | Ref. No. | 14414300569 926058 BN14414300569 FR926058 |
| description | refrigeration gasket profile 9048 W 569mm L 254mm plug size | | |

| | | | |
|---|---|-----------------|---------------------------|
|  | | | |
| GEV No. | 901230 | Ref. No. | SIRA190067 SIRRA190067 |
| description | refrigeration gasket profile 9048 W 390mm L 685mm plug size for blast chiller | | |

| | | | |
|--|---|-----------------|---------------|
|  | | | |
| GEV No. | 902212 | Ref. No. | BN14415396616 |
| description | refrigeration gasket profile 9048 W 396mm L 628mm plug size | | |

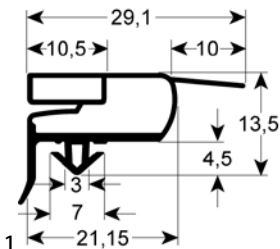
| | | | |
|--|--|-----------------|----------------------------------|
|  | | | |
| GEV No. | 901228 | Ref. No. | N/A SIRA190071 SIRRA190071 |
| description | refrigeration gasket profile 9048 W 685mm L 1105mm plug size for blast chiller | | |

| | | | |
|---|---|-----------------|--------------------|
|  | | | |
| GEV No. | 901229 | Ref. No. | N/A SIRRA190070 |
| description | refrigeration gasket profile 9048 W 690mm L 825mm plug size | | |

| | | | |
|--|--|-----------------|-----|
|  | | | |
| GEV No. | 902258 | Ref. No. | N/A |
| description | refrigeration gasket profile 9048 Wmm L 2500mm | | |

profile 9773

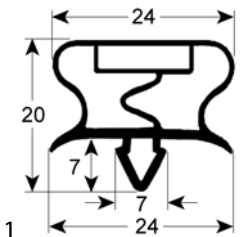
We offer custom-made gaskets for this profile



| | | | |
|--------------------|---|-----------------|--------------------|
| GEV No. | 901231 | Ref. No. | LAR70043000 N/A |
| description | refrigeration gasket profile 9773 W 385mm L 660mm external size W1 372mm L1 647mm plug size suitable for HIBER/LAINOX for blast chiller | | |

profile 9195

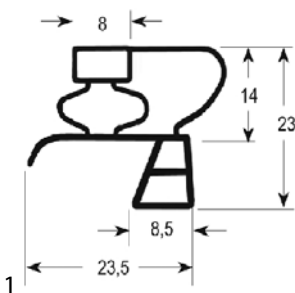
We offer custom-made gaskets for this profile



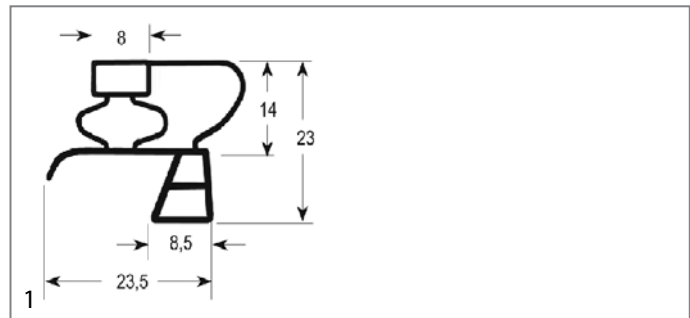
| | | | |
|--------------------|---|-----------------|-----------|
| GEV No. | 902435 | Ref. No. | FR4501492 |
| description | refrigeration gasket profile 9195 W 400mm L 690mm | | |

profile 9783

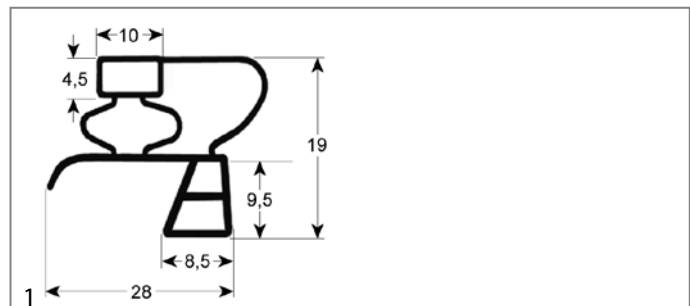
We offer custom-made gaskets for this profile



| | | | |
|--------------------|---|-----------------|-----------------------|
| GEV No. | 900024 | Ref. No. | 25006.00 MA2500600 |
| description | refrigeration gasket profile 9783 W 190mm L 357mm plug size drawer refrigeration size 1/3 | | |



| | | | |
|--------------------|--|-----------------|---|
| GEV No. | 900025 | Ref. No. | 23007.12 25007.00 25007.12 MA2500712 |
| description | refrigeration gasket profile 9783 W 260mm L 355mm plug size drawer refrigeration size 1/2 | | |
| For models: | IR13C, IR13CC, IR13CV, IR13M, IR13MC, IR13MV, IR13V, IR17C, IR17CC, IR17CV, IR17M, IR17MC, IR17MV, IR17V, TR13C2P, TR13I4C, TR13I4CC, TR13I4CV, TR13N2C1P, TR13N2C1PC, TR13N2C1PV, TR13N2P, TR13N2PC, TR13N2PV, TR13N4C, TR13N4CC, TR13N4CV, TR17C3P, TR17I6C, TR17I6CC, TR17I6CV, TR17N2C2P, TR17N2C2PC, TR17N2C2PV, TR17N2P, TR17N3P, TR17N3PC, TR17N3PV, TR17N4C1P, TR17N4C1PC, TR17N4C1PV, TR17N6C, TR17N6CC, TR17N6CV, TR21N2C3P, TR21N-2C3PC, TR21N2C3PV, TR21N2P, TR21N4C2P, TR21N4C2PC...(Other models you can see in the webshop) | | |



| | | | |
|--------------------|--|-----------------|-----------------------------------|
| GEV No. | 900026 | Ref. No. | 25009.00 25009.12 MA2500912 |
| description | refrigeration gasket profile 9783 W 355mm L 585mm plug size drawer refrigeration size 1/1 | | |
| For models: | IR13C, IR13CC, IR13CV, IR13M, IR13MC, IR13MV, IR13V, IR17C, IR17CC, IR17CV, IR17M, IR17MC, IR17MV, IR17V, TR13C2P, TR13I4C, TR13I4CC, TR13I4CV, TR13N2C1P, TR13N2C1PC, TR13N2C1PV, TR13N2P, TR13N2PC, TR13N2PV, TR13N4C, TR13N4CC, TR13N4CV, TR17C3P, TR17I6C, TR17I6CC, TR17I6CV, TR17N2C2P, TR17N2C2PC, TR17N2C2PV, TR17N2P, TR17N3P, TR17N3PC, TR17N3PV, TR17N4C1P, TR17N4C1PC, TR17N4C1PV, TR17N6C, TR17N6CC, TR17N6CV, TR21N2C3P, TR21N-2C3PC, TR21N2C3PV, TR21N2P, TR21N4C2P, TR21N4C2PC...(Other models you can see in the webshop) | | |

| | | | |
|--------------------|--|-----------------|-----------------------------------|
| GEV No. | 900084 | Ref. No. | 23045.00 23045.14 MA2304514 |
| description | refrigeration gasket profile 9783 W 625mm L 720mm plug size 1/2 door refrigeration | | |
| For models: | AFC14, AFC14V, AFC7, AFC7V, AFPC214, AFPC214P, AFPC214V, AFR1143P, AFR1143PE, AFR14, AFR14V, AFR214P, AFR214PV, AFR7, AFR7P, AFR7PV, AFR7V, AFRC214, AFRC214V, AFRV14, AFRV144A, AFRV14V, AFRV7, AFRV74A, AFRV7V, EF143DNF, EF143MNI, EF72DNF, EF72MNF, F143, F72, FB143NI, FB72F, FB72N, FB72NF, FB72P, FS143F, FS143FI, FS143N, FS143NF, FS143NI, FS143NN, FS143NP, FS143P, FS72F, FS72IF, FS72IN, FS72N, FS72NF, FS72NN...(Other models you can see in the webshop) | | |

| | | | |
|--------------------|---|-----------------|---|
| GEV No. | 900049 | Ref. No. | 2304400 2304414 2304414 unverpackt MA2304414 |
| description | refrigeration gasket profile 9783 W 635mm L 1530mm plug size door refrigeration | | |
| For models: | AF70B, AF70C, AF70F, AF70I, AF70MB, AF70MC, AF70MF, AF70MI, AF70MN, AF70MP, AF70N, AF70P, AFR1143P, AFR1143PE, EF140DF, EF140DN, EF140DP, EF140MB, EF140MC, EF140MF, EF140MI, EF140MN, EF140MP, EF143DNF, EF143MNI, EF70DF, EF70DN, EF70DP, EF70MB, EF70MC, EF70MF, EF70MI, EF70MN, EF70MP, EF72DNF, EF72MNF, F140DF, F140DI, F140DN, F140DP, F143, F14DFG, F14DNG, F70DF, F70DI, F70DN, F70DP, F72, F7DFG, F7DNG...(Other models you can see in the webshop) | | |

| | | | |
|--------------------|--|-----------------|-----|
| GEV No. | 902306 | Ref. No. | N/A |
| description | refrigeration gasket profile 9783 Wmm L 2500mm | | |

screw-in gaskets

profile 9031

We offer custom-made gaskets for this profile

| | | | |
|--------------------|---|-----------------|--------|
| GEV No. | 900010 | Ref. No. | 336500 |
| description | refrigeration gasket profile 9031 W 195mm L 385mm external size drawer refrigeration size 1/3 | | |

| | | | |
|--------------------|---|-----------------|--------|
| GEV No. | 900010 | Ref. No. | 336500 |
| description | refrigeration gasket profile 9031 W 195mm L 385mm external size drawer refrigeration size 1/3 | | |

| | | | |
|--------------------|---|-----------------|--------|
| GEV No. | 900209 | Ref. No. | 336400 |
| description | refrigeration gasket profile 9031 W 458mm L 605mm external size | | |

| | | | |
|--------------------|---|-----------------|--------|
| GEV No. | 900209 | Ref. No. | 336400 |
| description | refrigeration gasket profile 9031 W 458mm L 605mm external size | | |

profile 9140

We offer custom-made gaskets for this profile

| | | | |
|--------------------|--|-----------------|-----|
| GEV No. | 902264 | Ref. No. | N/A |
| description | refrigeration gasket profile 9140 Wmm L 2500mm | | |

| | | | |
|--------------------|--|-----------------|-----|
| GEV No. | 902264 | Ref. No. | N/A |
| description | refrigeration gasket profile 9140 Wmm L 2500mm | | |

profile 9106

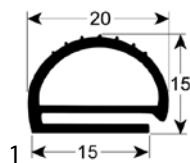
We offer custom-made gaskets for this profile

| | | | |
|--------------------|--|-----------------|-----|
| GEV No. | 902262 | Ref. No. | N/A |
| description | refrigeration gasket profile 9106 Wmm L 2500mm | | |

| | | | |
|--------------------|--|-----------------|-----|
| GEV No. | 902262 | Ref. No. | N/A |
| description | refrigeration gasket profile 9106 Wmm L 2500mm | | |



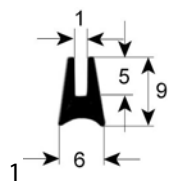
profile 9164



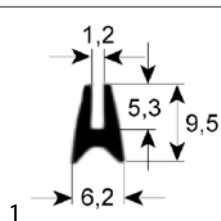
| | | | |
|--------------------|--|-----------------|--------------------|
| GEV No. | 901607 | Ref. No. | 143510 MA143510 |
| description | refrigeration gasket profile 9164 W 462mm L 612mm external size Qty 1 | | |
| For models: | SPAR, SPAR15, SPAR16, SPAR18, SPAR20, SPRG, SPRG12, SPRG16, SPRG20, SVAR, SVAR15, SVAR16, SVAR18, SVAR20, SVRG, SVRG12, SVRG15, SVRG16, SVRG18, SVRG20 | | |

gaskets for heated units

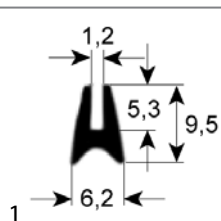
window seals



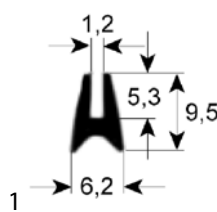
| | | | |
|--------------------|---|-----------------|-----------|
| GEV No. | 900787 | Ref. No. | R70044650 |
| description | window gasket profile 1515 L 2200mm suitable for LAINOX | | |
| For models: | MACE07M, MACG07M | | |



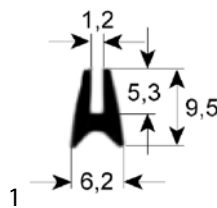
| | | | |
|--------------------|--|-----------------|-----------|
| GEV No. | 900129 | Ref. No. | R70040840 |
| description | window gasket profile 1530 L 1015mm Qty 1 | | |
| For models: | ME110M, ME110P, ME110X, ME210M, ME210P, ME210X, MG110M, MG110P, MG110X, MG210M, MG210P, MG210X, VE110M, VE110P, VE110X, VG110M, VG110P, VG110X, VG210M, VG210P, VG210X | | |



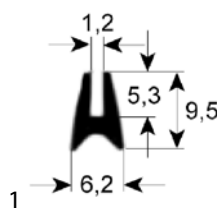
| | | | |
|--------------------|--|-----------------|-----------|
| GEV No. | 900501 | Ref. No. | R70044260 |
| description | window gasket profile 1530 L 1200mm Qty 1 | | |
| For models: | MACE10M, MACE20M, MACG10M, MACG20M, ME101D, ME101M, ME101P, ME101T, ME102M, ME102P, ME102T, MG101D, MG101M, MG101P, MG101T, MG102M, MG102P, MG102T | | |



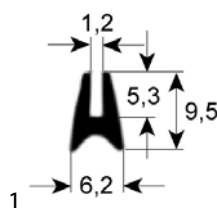
| | | | |
|--------------------|--|-----------------|-----------|
| GEV No. | 900130 | Ref. No. | R70040850 |
| description | window gasket profile 1530 L 1750mm Qty 1 | | |
| For models: | ME120M, ME120P, ME120X, ME220M, ME220P, ME220X, MEC40M, MG120M, MG120P, MG120X, MG220M, MG220P, MG220X, MGC20X, MGC40H, VE120M, VE120P, VE120X, VE220M, VE220P, VE220X, VG120M, VG120P, VG120X, VG220M, VG220P, VG220X | | |



| | | | |
|--------------------|--|-----------------|-----------|
| GEV No. | 900503 | Ref. No. | R70044280 |
| description | window gasket profile 1530 L 1800mm Qty 1 | | |
| For models: | ME201D, ME201M, ME201P, ME201T, MG201D, MG201M, MG201P, MG201T | | |



| | | | |
|--------------------|--|-----------------|-----------|
| GEV No. | 900504 | Ref. No. | R70044290 |
| description | window gasket profile 1530 L 1950mm Qty 1 | | |
| For models: | ME202D, ME202M, ME202P, ME202T, MEMT21D, MEMT21P, MEMT40D, MEMT40P, MEVT21D, MEVT21P, MEVT40D, MEVT40P, MG202D, MG202M, MG202P, MG202T, MGMT21D, MGMT21P, MGMT40D, MGMT40P, MGVT21D, MGVT21P, MGVT40D, MGVT40P | | |



| | | | |
|--------------------|--|-----------------|-----------|
| GEV No. | 900483 | Ref. No. | R70044150 |
| description | window gasket profile 1530 L 2400mm Qty 1 | | |
| For models: | GMT20D, GVT20D, MACE10M, MACE20M, MACG10M, MACG20M, ME061D, ME061M, ME061P, ME061T, ME101D, ME101M, ME101P, ME101T, ME102D, ME102M, ME102P, ME102T, MEMT20D, MEMT20P, MEVT20D, MEVT20P, MG061D, MG061M, MG061P, MG061T, MG101D, MG101M, MG101P, MG101T, MG102D, MG102M, MG102P, MG102T, MGMT20D, MGMT20P, MGVT20D, MGVT20P | | |

| | | | |
|--------------------|--|-----------------|-----------|
| GEV No. | 900484 | Ref. No. | R70044160 |
| description | window gasket profile 1530 L 3720mm Qty 1 | | |
| For models: | ME201D, ME201M, ME201P, ME201T, ME202D, ME202M, ME202P, ME202T, MEMT40D, MEMT40P, MEVT40D, MEVT40P, MG201D, MG201M, MG201P, MG201T, MG202D, MG202M, MG202P, MG202T, MGMT40D, MGMT40P, MGVT40D, MGVT40P | | |

| | | | |
|--------------------|--|-----------------|-----------|
| GEV No. | 900637 | Ref. No. | R70040640 |
| description | window gasket profile 1530 Qty supplied by meter | | |
| For models: | FE110M, FE110X, FE210M, FG110M, FG110X, FG210M, FG210X, MEMT10D, MEMT10P, MEVT10D, MEVT10P, MGMT10D, MGMT10P, MGVT10D, MGVT10P, PE080M, PE080X, PG080M, PG080X | | |

| | | | |
|--------------------|--|-----------------|-----------|
| GEV No. | 900117 | Ref. No. | R70040810 |
| description | window gasket profile 1530 L 505mm Qty 1 | | |
| For models: | CVE004H, CVE004M, CVE104H, CVE104M, VE004M, VE004X, VE104M, VE104X | | |

| | | | |
|--------------------|--|-----------------|-----------|
| GEV No. | 900120 | Ref. No. | R70040050 |
| description | window gasket profile 1620 L 1175mm Qty 1 | | |
| For models: | CVE004H, CVE004M, CVE104H, CVE104M, VE004M, VE004X, VE104M, VE104X | | |

| | | | |
|--------------------|--|-----------------|-----------|
| GEV No. | 900118 | Ref. No. | R70040820 |
| description | window gasket profile 1530 L 595mm Qty 1 | | |
| For models: | CVE105H, CVE105M, CVG105H, CVG105M, VE105M, VE105X, VG105M, VG105X | | |

| | | | |
|--------------------|--|-----------------|-----------|
| GEV No. | 900119 | Ref. No. | R70040010 |
| description | window gasket profile 1620 L 1500mm Qty 1 | | |
| For models: | CVE105H, CVE105M, CVG105H, CVG105M, VE105M, VE105X, VG105M, VG105X | | |

| | | | |
|--------------------|--|-----------------|-----------|
| GEV No. | 900128 | Ref. No. | R70040830 |
| description | window gasket profile 1530 L 750mm Qty 1 | | |
| For models: | ME106M, ME106P, ME106X, MG106M, MG106P, MG106X, VE106M, VE106P, VE106X, VG106M, VG106P, VG106X | | |

| | | | |
|--------------------|--|-----------------|-----------|
| GEV No. | 900121 | Ref. No. | R70040080 |
| description | window gasket profile 1620 L 1690mm Qty 1 | | |
| For models: | ME106M, ME106P, ME106X, MG106M, MG106P, MG106X, VE106M, VE106P, VE106X, VG106M, VG106P, VG106X | | |

| | | | |
|--------------------|---|-----------------|-----------|
| GEV No. | 900500 | Ref. No. | R70044250 |
| description | window gasket profile 1530 L 900mm Qty 1 | | |
| For models: | MACE07M, MACG07M, ME061D, ME061M, ME061P, ME061T, MG061D, MG061M, MG061P, MG061T, MVE042P, MVE051P, MVG051P | | |

| | | | |
|--------------------|---|-----------------|-----------|
| GEV No. | 900122 | Ref. No. | R70040200 |
| description | window gasket profile 1620 L 2125mm Qty 1 | | |
| For models: | ME110M, ME110P, ME110X, ME120M, ME120P, ME120X, ME210M, ME210P, ME210X, ME220M, ME220P, ME220X, MEC24H, MEC40M, MG110M, MG110P, MG110X, MG120M, MG120P, MG120X, MG210M, MG210P, MG210X, MG220M, MG220P, MG220X, MGC20X, MGC24H, MGC40H, VE110M, VE110X, VE120M, VE120P, VE120X, VE210M, VE210P, VE210X, VE220M, VE220P, VE220X, VG110M, VG110P, VG110X, VG120M, VG120P, VG120X, VG210M, VG210P, VG210X, VG220M, VG220P, VG220X... (Other models you can see in the webshop) | | |

| | | | |
|--------------------|---|-----------------|----------------------|
| GEV No. | 900437 | Ref. No. | 2838000 MA2838000 |
| description | window gasket profile 1640 L 10000mm Qty 1 | | |
| For models: | CSM201, CSM202, SER15, SER15A, SER18, SER18A, SER21 | | |

| | | | |
|--------------------|--|-----------------|---------|
| GEV No. | 900436 | Ref. No. | 2891700 |
| description | window gasket profile 1640 L 2170mm Qty 1 | | |
| For models: | CON102E, CON102EP, CON102G, CON102GP, CON10E, CON10EP, CON10G, CON10GP, CS102E, CS102EP, CS102G, CS102GP, CSM102E, CSM102EP, CSM102G, CSM102GP, CSM10E, CSM10EP, CSM10G, CSM10GP | | |

| | | | |
|--------------------|--|-----------------|---------|
| GEV No. | 900435 | Ref. No. | 2885800 |
| description | window gasket profile 1640 L 2350mm Qty 1 | | |
| For models: | CON6E, CON6EP, CON6G, CON6GP, CSM6E, CSM6EP, CSM6G, CSM6GP | | |

| | | | |
|--------------------|--|-----------------|-----|
| GEV No. | 900539 | Ref. No. | N/A |
| description | window gasket profile 1640 Qty supplied by meter | | |

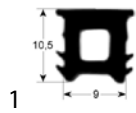
| | | | |
|--------------------|--|-----------------|-------------|
| GEV No. | 902460 | Ref. No. | LAR70042680 |
| description | window gasket profile 1887 L 3200mm Qty 1 suitable for LAINOX | | |
| For models: | EC210M, EM210H, EM210M, EM210M+SC, EM210P, EV210H, EV210M, EV210M+SC, EV210P, GC210M, GM210H, GM210M, GM210M+SC, GM210P, GV210H, GV210M, GV210M+SC, GV210P | | |

| | | | |
|--------------------|---|-----------------|------------------------|
| GEV No. | 902459 | Ref. No. | R70042770 R70042780 |
| description | window gasket profile 1887/1515 L 2200mm suitable for LAINOX set 2-piece | | |
| For models: | EC110M, EC210M, EM010M+SC, EM110H, EM110M, EM110M+SC, EM110P, EM210H, EM210M, EM210M+SC, EM210P, EV110H, EV110M, EV110M+SC, EV110P, EV210H, EV210M, EV210M+SC, EV210P, GC110M, GC210M, GM110H, GM110M, GM110M+SC, GM110P, GM210H, GM210M, GM210M+SC, GM210P, GV110H, GV110M, GV110M+SC, GV110P, GV210H, GV210M, GV210M+SC, GV210P | | |

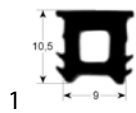
door seals

| | | | |
|--------------------|--|-----------------|-----------|
| GEV No. | 902461 | Ref. No. | R70042860 |
| description | door seal profile 2010 L 1900mm Qty 1 suitable for LAINOX | | |
| For models: | EC106M, EM106H, EM106M, EM106M+SC, EM106P, EV006M, EV106H, EV106M, EV106M+SC, EV106P, GC106M, GM106H, GM106M, GM106M+SC, GM106P, GV106H, GV106M, GV106M+SC, GV106P | | |

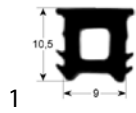
| | | | |
|--------------------|--|-----------------|-----------|
| GEV No. | 901147 | Ref. No. | R70042880 |
| description | door seal profile 2010 L 3000mm Qty 1 | | |
| For models: | EC210M, EM210H, EM210M, EM210M+SC, EM210P, EV210H, EV210M, EV210M+SC, EV210P, GC210M, GM210H, GM210M, GM210M+SC, GM210P, GV210H, GV210M, GV210M+SC, GV210P | | |



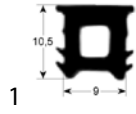
| | | | |
|--------------------|--|-----------------|------------------------|
| GEV No. | 900142 | Ref. No. | R70043280 R70043290 |
| description | door seal profile 2010 Qty supplied by meter | | |
| For models: | MEC24H, MGC20X, MGC24H | | |



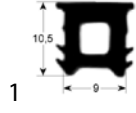
| | | | |
|--------------------|--|-----------------|-----------|
| GEV No. | 900131 | Ref. No. | R70040980 |
| description | door seal profile 2010 W 520mm L 610mm external size Qty 1 | | |
| For models: | ME106M, ME106P, ME106X, MG106M, MG106P, MG106X, VE106M, VE106P, VE106X, VG106M, VG106P, VG106X | | |



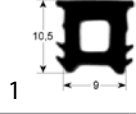
| | | | |
|--------------------|--|-----------------|-----------|
| GEV No. | 900132 | Ref. No. | R70040990 |
| description | door seal profile 2010 W 625mm L 750mm external size Qty 1 | | |
| For models: | ME110M, ME110P, ME110X, MG110M, MG110P, MG110X, VE110M, VE110P, VE110X, VG110M, VG110P, VG110X | | |



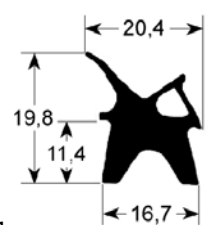
| | | | |
|--------------------|--|-----------------|-----------|
| GEV No. | 900134 | Ref. No. | R70041010 |
| description | door seal profile 2010 W 680mm L 1425mm external size Qty 1 | | |
| For models: | ME120M, ME120P, ME120X, MG120M, MG120P, MG120X, VE120M, VE120P, VE120X, VG120M, VG120P, VG120X | | |



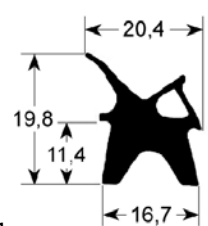
| | | | |
|--------------------|--|-----------------|-----------|
| GEV No. | 900135 | Ref. No. | R70041020 |
| description | door seal profile 2010 W 700mm L 1410mm external size Qty 1 | | |
| For models: | ME220M, ME220P, ME220X, MG220M, MG220P, MG220X, VE220M, VE220P, VE220X, VG220M, VG220P, VG220X | | |



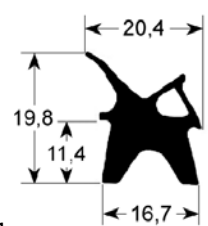
| | | | |
|--------------------|--|-----------------|-----------|
| GEV No. | 900133 | Ref. No. | R70041000 |
| description | door seal profile 2010 W 740mm L 765mm external size Qty 1 | | |
| For models: | ME210M, ME210P, ME210X, MG210M, MG210P, MG210X, VE210M, VE210P, VE210X, VG210M, VG210P, VG210X | | |



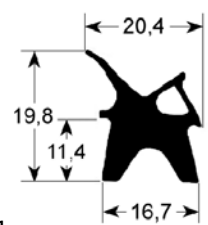
| | | | |
|--------------------|--|-----------------|-----------|
| GEV No. | 900115 | Ref. No. | R70041990 |
| description | door seal profile 2410 W 320mm L 420mm external size Qty 1 | | |
| For models: | CVE004H, CVE004M, CVE104H, CVE104M, VE004M, VE004X, VE104M, VE104X | | |



| | | | |
|--------------------|--|-----------------|-----------|
| GEV No. | 900116 | Ref. No. | R70042000 |
| description | door seal profile 2410 W 380mm L 608mm external size Qty 1 | | |
| For models: | CVE105H, CVE105M, CVG105H, CVG105M, VE105M, VE105X, VG105M, VG105X | | |



| | | | |
|--------------------|--|-----------------|-----------|
| GEV No. | 900157 | Ref. No. | R70041540 |
| description | door seal profile 2410 W 380mm L 632mm external size Qty 1 | | |
| For models: | FE105M, FE105X, FG105M, FG105X, PE040M, PE040X, PG040M, PG040X | | |



| | | | |
|--------------------|--|-----------------|-----------|
| GEV No. | 900817 | Ref. No. | R70042560 |
| description | door seal profile 2410 W 465mm L 495mm external size Qty 1 | | |
| For models: | EC106M, EM106H, EM106M, EM106M+SC, EM106P, EV006M, EV106H, EV106M, EV106M+SC, EV106P, GC106M, GM106H, GM106M, GM106M+SC, GM106P, GV106H, GV106M, GV106M+SC, GV106P | | |



| | | | |
|--------------------|---|-----------------|-----------|
| GEV No. | 900818 | Ref. No. | R70042570 |
| description | door seal profile 2410 W 465mm L 765mm external size Qty 1 | | |
| For models: | EC110M, EM010M+SC, EM110H, EM110M, EM110M+SC, EM110P, EV110H, EV110M, EV110M+SC, EV110P, GC110M, GM110H, GM110M, GM110M+SC, GM110P, GV110H, GV110M, GV110M+SC, GV110P | | |

| | | | |
|--------------------|--|-----------------|-----------|
| GEV No. | 900486 | Ref. No. | R70041550 |
| description | door seal profile 2410 W 666mm L 701mm external size Qty 1 | | |
| For models: | FE110M, FE110X, FG110M, FG110X, PE080M, PE080X, PG080M, PG080X | | |

| | | | |
|--------------------|--|-----------------|-----------|
| GEV No. | 900123 | Ref. No. | R70042010 |
| description | door seal profile 2410 W 500mm L 627mm external size Qty 1 | | |
| For models: | ME106M, ME106P, ME106X, MG106M, MG106P, MG106X, VE106M, VE106P, VE106X, VG106M, VG106P, VG106X | | |

| | | | |
|--------------------|--|-----------------|-----------|
| GEV No. | 900762 | Ref. No. | R70041350 |
| description | door seal profile 2410 W 701mm L 705mm external size Qty 1 | | |
| For models: | FE210M, FG210M, FG210X | | |

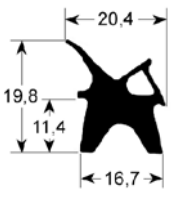
| | | | |
|--------------------|--|-----------------|-----------|
| GEV No. | 900124 | Ref. No. | R70042020 |
| description | door seal profile 2410 W 627mm L 738mm external size Qty 1 | | |
| For models: | ME110M, ME110P, ME110X, MG110M, MG110P, MG110X, VE110M, VE110X, VG110M, VG110P, VG110X | | |

| | | | |
|--------------------|---|-----------------|-----------|
| GEV No. | 900568 | Ref. No. | R70042150 |
| description | door seal profile 2410 W 710mm L 1310mm external size Qty 1 | | |
| For models: | MGC20X | | |

| | | | |
|--------------------|--|-----------------|-------------|
| GEV No. | 900820 | Ref. No. | LAR70042580 |
| description | door seal profile 2410 W 645mm L 765mm external size Qty 1 | | |
| For models: | EC210M, EM210H, EM210M, EM210M+SC, EM210P, EV210H, EV210M, EV210M+SC, EV210P, GC210M, GM210H, GM210M, GM210M+SC, GM210P, GV210H, GV210M, GV210M+SC, GV210P | | |

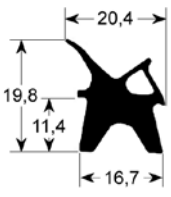
| | | | |
|--------------------|--|-----------------|-----------|
| GEV No. | 900126 | Ref. No. | R70042040 |
| description | door seal profile 2410 W 710mm L 1430mm external size Qty 1 | | |
| For models: | ME120M, ME120P, ME120X, MG120M, MG120P, MG120X, VE120M, VE120P, VE120X, VG120M, VG120P, VG120X | | |

| | | | |
|--------------------|---|-----------------|-----------|
| GEV No. | 900813 | Ref. No. | R70042160 |
| description | door seal profile 2410 W 735mm L 1310mm external size Qty 1 | | |
| For models: | MEC40M, MGC40H | | |



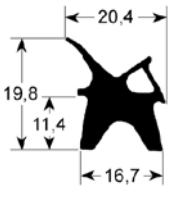
1

| | | | |
|--------------------|--|-----------------|-----------|
| GEV No. | 900127 | Ref. No. | R70042050 |
| description | door seal profile 2410 W 735mm L 1430mm external size Qty 1 | | |
| For models: | ME220M, ME220P, ME220X, MG220M, MG220P, MG220X, VE220M, VE220P, VE220X, VG220M, VG220P, VG220X | | |



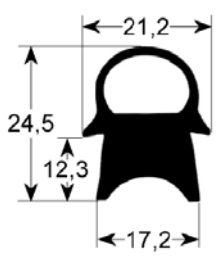
1

| | | | |
|--------------------|--|-----------------|-----------|
| GEV No. | 900815 | Ref. No. | R70041940 |
| description | door seal profile 2410 W 735mm L 830mm external size Qty 1 | | |
| For models: | MEC24H, MGC24H | | |



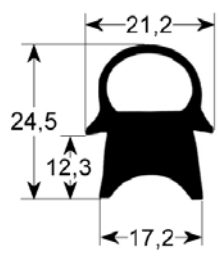
1

| | | | |
|--------------------|--|-----------------|-----------|
| GEV No. | 900125 | Ref. No. | R70042030 |
| description | door seal profile 2410 W 738mm L 777mm external size Qty 1 | | |
| For models: | ME210M, ME210P, ME210X, MG210M, MG210P, MG210X, VE210M, VE210P, VE210X, VG210M, VG210P, VG210X | | |



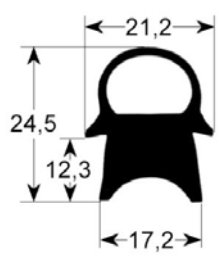
1

| | | | |
|--------------------|--|-----------------|----------------------|
| GEV No. | 900768 | Ref. No. | 2784500 MA2784500 |
| description | door seal profile 2440 W 340mm L 405mm external size Qty 1 | | |



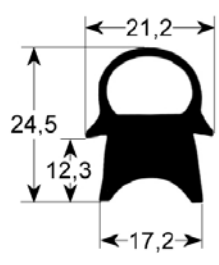
1

| | | | |
|--------------------|--|-----------------|----------------------|
| GEV No. | 900722 | Ref. No. | 2725600 MA2725600 |
| description | door seal profile 2440 W 415mm L 580mm external size Qty 1 | | |
| For models: | FC10G, FC5E, FC5G, FC7G | | |



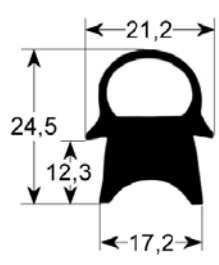
1

| | | | |
|--------------------|--|-----------------|----------------------|
| GEV No. | 900106 | Ref. No. | 2885900 MA2885900 |
| description | door seal profile 2440 W 490mm L 645mm external size Qty 1 | | |
| For models: | CON6G, CON6GP, CSM6E, CSM6EP, CSM6G, CSM6GP | | |



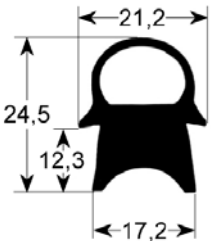
1

| | | | |
|--------------------|--|-----------------|----------------------|
| GEV No. | 900724 | Ref. No. | 2725700 MA2725700 |
| description | door seal profile 2440 W 530mm L 580mm external size Qty 1 | | |
| For models: | FC7E, FC7G | | |



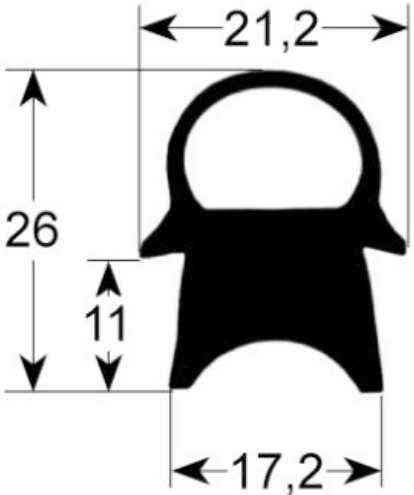
1

| | | | |
|--------------------|--|-----------------|----------------------|
| GEV No. | 900107 | Ref. No. | 2891900 MA2891900 |
| description | door seal profile 2440 W 645mm L 740mm external size Qty 1 | | |
| For models: | CON102E, CON102EP, CON102G, CON102GP, CON10E, CON10EP, CON10G, CON10GP, CS102E, CS102EP, CS102G, CS102GP, CSM102E, CSM102EP, CSM102G, CSM102GP, CSM10E, CSM10EP, CSM10G, CSM10GP | | |



1

| | | | |
|--------------------|---|-----------------|----------------------|
| GEV No. | 900108 | Ref. No. | 5113500 MA5113500 |
| description | door seal profile 2440 W 720mm L 1460mm external size Qty 1 | | |
| For models: | CSM201, CSM202 | | |




1

| | | | |
|--------------------|--|-----------------|--------------------|
| GEV No. | 900769 | Ref. No. | 2842100 2842114 |
| description | door seal profile 2441 W 340mm L 405mm external size Qty 1 | | |
| For models: | CS4E, CS4EP | | |



1

| | | | |
|--------------------|--|-----------------|-----------|
| GEV No. | 901573 | Ref. No. | R70044270 |
| description | door seal profile 2770/2771 H 1550mm W 470mm outer plug size Qty 1 | | |
| For models: | GMT20D, GVT20D, ME102D, MEMENT20D, MEMENT20P, MEMENT21D, MEMENT21P, MEVT20D, MEVT20P, MEVT21D, MEVT21P, MG102D, MGMT20D, MGMT20P, MGMT21D, MGMT21P, MGVT20D, MGVT20P, MGVT21D, MGVT21P | | |



1

| | | | |
|--------------------|--|-----------------|-----------|
| GEV No. | 900493 | Ref. No. | R70044130 |
| description | door seal profile 2770/2771 H 1550mm W 680mm outer plug size Qty 1 | | |
| For models: | ME201D, ME201M, ME201P, ME201T, MG201D, MG201M, MG201P, MG201T | | |



1

| | | | |
|--------------------|--|-----------------|-----------|
| GEV No. | 900494 | Ref. No. | R70044140 |
| description | door seal profile 2770/2771 H 1550mm W 700mm outer plug size Qty 1 | | |
| For models: | ME202D, ME202M, ME202P, ME202T, MEMENT40D, MEMENT40P, MEVT40D, MEVT40P, MG202D, MG202M, MG202P, MG202T, MGMT40D, MGMT40P, MGVT40D, MGVT40P | | |



1

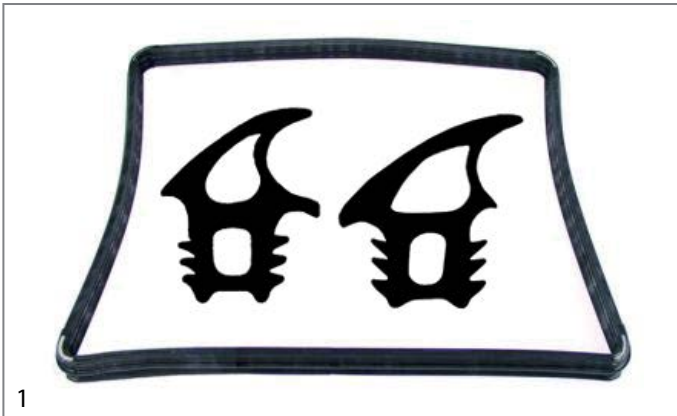
| | | | |
|--------------------|---|-----------------|-----------|
| GEV No. | 900488 | Ref. No. | R70044330 |
| description | door seal profile 2770/2771 H 380mm W 420mm outer plug size Qty 1 | | |
| For models: | MACE04M, MVE042P | | |



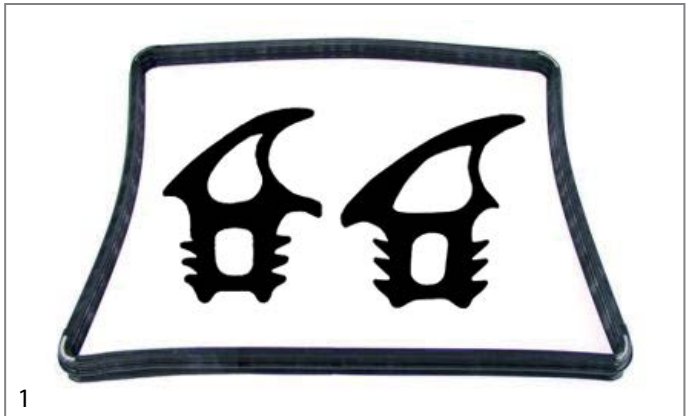
| | | | |
|--------------------|---|-----------------|-----------|
| GEV No. | 900489 | Ref. No. | R70044340 |
| description | door seal profile 2770/2771 H 440mm W 600mm outer plug size Qty 1 | | |
| For models: | MACE05M, MACG05M, MVE051P, MVG051P | | |



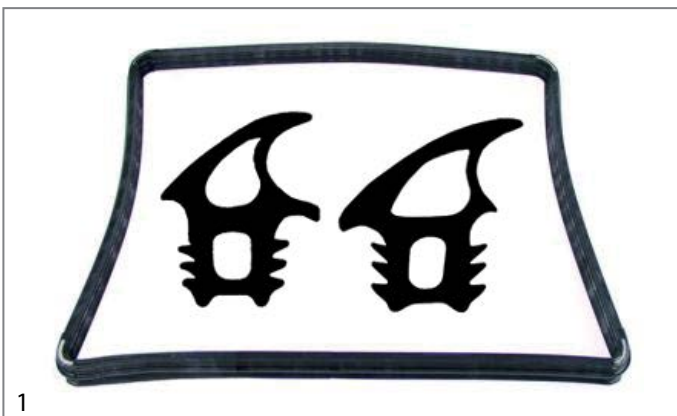
| | | | |
|--------------------|---|-----------------|-----------|
| GEV No. | 900788 | Ref. No. | R70044230 |
| description | door seal profile 2770/2771 H 580mm W 680mm outer plug size Qty 1 | | |
| For models: | MACE07M, MACG07M | | |



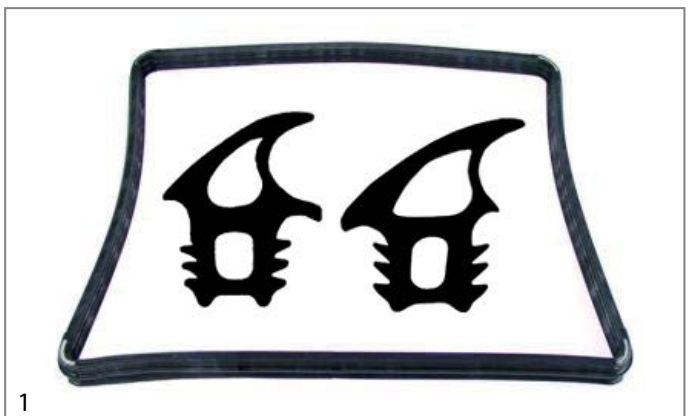
| | | | |
|--------------------|---|-----------------|-----------|
| GEV No. | 901679 | Ref. No. | R70044210 |
| description | door seal profile 2770/2771 H 520mm W 470mm outer plug size suitable for LAINOX | | |
| For models: | GMT06D, GVT06D, MEMT06D, MEMT06P, MEVT06D, MEVT06P, MG-MT06D, MGMT06P, MGVT06D, MGVT06P | | |



| | | | |
|--------------------|---|-----------------|-----------|
| GEV No. | 901276 | Ref. No. | R70044220 |
| description | door seal profile 2770/2771 H 800mm W 470mm outer plug size Qty 1 suitable for LAINOX | | |
| For models: | MEMT10D, MEMT10P, MEVT10D, MEVT10P, MGMT10D, MGMT10P, MGVT10D, MGVT10P | | |



| | | | |
|--------------------|---|-----------------|-----------|
| GEV No. | 900490 | Ref. No. | R70044100 |
| description | door seal profile 2770/2771 H 520mm W 620mm outer plug size Qty 1 | | |
| For models: | ME061D, ME061M, ME061P, ME061T, MG061D, MG061M, MG061P, MG061T | | |



| | | | |
|--------------------|--|-----------------|-----------|
| GEV No. | 900491 | Ref. No. | R70044110 |
| description | door seal profile 2770/2771 H 800mm W 680mm outer plug size Qty 1 | | |
| For models: | MACE10M, MACG10M, ME101D, ME101M, ME101P, ME101T, MG101D, MG101M, MG101P, MG101T | | |



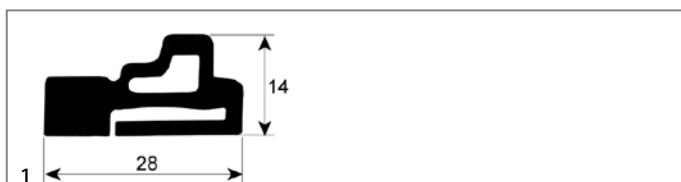
1

| | | | |
|--------------------|---|-----------------|-----------|
| GEV No. | 900492 | Ref. No. | R70044120 |
| description | door seal profile 2770/2771 H 800mm W 700mm outer plug size Qty 1 | | |
| For models: | GMT20D, GVT20D, ME102D, ME102M, ME102P, MEMT20D, MEMT20P, MEVT20D, MEVT20P, MG102D, MG102M, MG102P, MG102T, MG-MT20D, MGMT20P, MGVT20D, MGVT20P | | |



1

| | | | |
|--------------------|---|-----------------|-----------|
| GEV No. | 901603 | Ref. No. | R70044240 |
| description | door seal profile 2770/2771 H 800mm W 760mm outer plug size Qty 1 | | |
| For models: | MACE20M, MACG20M | | |



1

| | | | |
|--------------------|--|-----------------|-----------|
| GEV No. | 900745 | Ref. No. | R70044300 |
| description | door seal profile 2954 L 700mm | | |
| For models: | ME201D, ME201M, ME201P, ME201T, ME202D, ME202M, ME202P, ME202T, MEMT40D, MEMT40P, MEVT40D, MEVT40P, MG201D, MG201M, MG201P, MG201T, MG202D, MG202M, MG202P, MG202T, MGMT40D, MGMT40P, MGVT40D, MGVT40P | | |

door seals with fixing hook



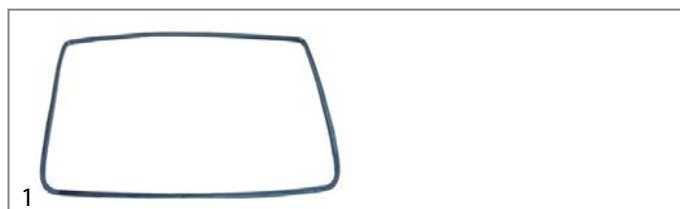
1

| | | | |
|--------------------|-----------------------------------|-----------------|-----------|
| GEV No. | 901917 | Ref. No. | CR0931990 |
| description | door seal L 570mm W 295mm 4-sided | | |



1

| | | | |
|--------------------|---|-----------------|----------------------------|
| GEV No. | 900405 | Ref. No. | 1036101400 MA1036101400 |
| description | oven gasket L 430mm W 260mm external size | | |
| For models: | FOE60M, OFOE60M | | |



1

| | | | |
|--------------------|---|-----------------|----------------------------|
| GEV No. | 900404 | Ref. No. | 1036608000 MA1036608000 |
| description | oven gasket L 450mm W 330mm external size | | |
| For models: | CFE60, CFE60P, CFGE61, CFGE61D, CFGE61L, CFGE61P, CFVE60, OCFE60, OCFGE61 | | |

door seals with tension springs




1

| | | | |
|--------------------|--|-----------------|--|
| GEV No. | 900959 | Ref. No. | 17319099 17319099R MA17319099 MA17319099R |
| description | oven gasket profile 2960 L 2000mm | | |
| For models: | BF912G, BF912GH, C7FGM12G, C9FGM12G, NC7FGM12G | | |




1

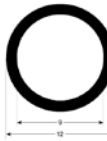
| | | | |
|--------------------|--|-----------------|---------|
| GEV No. | 900105 | Ref. No. | 1336200 |
| description | oven gasket profile 2960 L 310mm Qty 1 mounting pos. lateral | | |
| For models: | C9F4E, C9F4GS, C9F6E, C9F6GS, C9F8GS, C9FE6GS, C9FP4GS, C9FP6GS, C9FP8GS, C9V2E, C9V4E, T9F4G, T9F6GS, T9FP4G, V9F4E, V9FP4E, V9V2E, V9V4E, V9VP2E, V9VP4E | | |



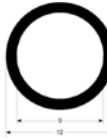
| | | | |
|--------------------|---|-----------------|---------|
| GEV No. | 900103 | Ref. No. | 1336100 |
| description | oven gasket profile 2960 L 575mm Qty 1 mounting pos. lower | | |
| For models: | C7011EFE, C7011EFEQ, C7011GFE, C7011GFG, C707EFE, C707EFEQ, C707GFE, C707GFG, C9F4E, C9F4GS, C9F6E, C9F6GS, C9F8GS, C9FE6GS, C9FP4GS, C9FP6GS, C9FP8GS, C9V2E, C9V4E, CFE70, CFG101, CFG120, CFG70, CFG70M, EC74EVG, EC74GVG, EC78EVG, EC78GVG, EC7FE8E, EC7FG8G, OCFG101, OCFG120, OCFG70, T7011GFG, T707GFG, T9F4G, T9F6GS, T9FP4G, V9F4E, V9FP4E, V9V2E, V9V4E, V9VP2E, V9VP4E | | |




| | | | |
|--------------------|---|-----------------|---------|
| GEV No. | 900102 | Ref. No. | 1706300 |
| description | oven gasket profile 2960 L 650mm Qty 1 mounting pos. upper | | |
| For models: | C7011EFE, C7011EFEQ, C7011GFE, C7011GFG, C707EFE, C707EFEQ, C707GFE, C707GFG, CFE70, CFG101, CFG120, CFG70, EC74EVG, EC74GVG, EC78EVG, EC78GVG, EC7FE8E, EC7FG8G, OCFG101, OCFG120, OCFG70, T7011GFG, T707GFG | | |




| | | | |
|--------------------|--|-----------------|------------------------|
| GEV No. | 900249 | Ref. No. | 1662814R MA1662814R |
| description | oven gasket profile 2965 L 305mm Qty 1 mounting pos. lateral | | |




| | | | |
|--------------------|--|-----------------|---------|
| GEV No. | 900258 | Ref. No. | 1662800 |
| description | oven gasket profile 2965 Qty supplied by meter | | |




| | | | |
|--------------------|---|-----------------|-----|
| GEV No. | 570001 | Ref. No. | N/A |
| description | silicone hose ID \varnothing 6.5mm ED \varnothing 7.9mm thickness 0.7mm Qty supplied by meter | | |




| | | | |
|--------------------|--|-----------------|----------------------|
| GEV No. | 514004 | Ref. No. | 1336000 MA1336000 |
| description | spring L 325mm for gasket mounting pos. lateral | | |
| For models: | BF912G, BF912GH, C7FGM12G, C9F4E, C9F4GS, C9F6E, C9F6GS, C9F8GS, C9FE6GS, C9FGM12G, C9FP4GS, C9FP6GS, C9FP8GS, C9V2E, C9V4E, NC7FGM12G, T9F4G, T9F6GS, T9FP4G, V9F4E, V9FP4E, V9V2E, V9V4E, V9VP2E, V9VP4E | | |



| | | | |
|--------------------|---|-----------------|----------------------|
| GEV No. | 514003 | Ref. No. | 1662614 MA1662614 |
| description | spring L 370mm for gasket mounting pos. lateral | | |
| For models: | C7011EFE, C7011EFEQ, C7011GFE, C7011GFG, C707EFE, C707EFEQ, C707GFE, C707GFG, CFE70, CFG101, CFG120, CFG70, CFG70M, EC74EVG, EC74GVG, EC78EVG, EC78GVG, EC7FE8E, EC7FG8G, OCFG101, OCFG120, OCFG70, T7011GFG, T707GFG | | |

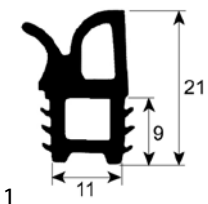


| | | | |
|--------------------|---|-----------------|----------------------|
| GEV No. | 514002 | Ref. No. | 1335900 MA1335900 |
| description | spring L 595mm for gasket mounting pos. upper | | |
| For models: | C7011EFE, C7011EFEQ, C7011GFE, C7011GFG, C707EFE, C707EFEQ, C707GFE, C707GFG, C9F4E, C9F4GS, C9F6E, C9F6GS, C9F8GS, C9FE6GS, C9FP4GS, C9FP6GS, C9FP8GS, C9V2E, C9V4E, CFE70, CFG101, CFG120, CFG70, EC74EVG, EC74GVG, EC78EVG, EC78GVG, EC7FE8E, EC7FG8G, OCFG101, OCFG120, OCFG70, T7011GFG, T707GFG, T9F4G, T9F6GS, T9FP4G, V9F4E, V9FP4E, V9V2E, V9V4E, V9VP2E, V9VP4E | | |



| | | | |
|--------------------|---|-----------------|----------------------|
| GEV No. | 514001 | Ref. No. | 1706200 MA1706200 |
| description | spring L 655mm for gasket mounting pos. upper | | |
| For models: | C7011EFE, C7011EFEQ, C7011GFE, C7011GFG, C707EFE, C707EFEQ, C707GFE, C707GFG, CFE70, CFG101, CFG120, CFG70, EC74EVG, EC74GVG, EC78EVG, EC78GVG, EC7FE8E, EC7FG8G, OCFG101, OCFG120, OCFG70, T7011GFG, T707GFG, T9F4G, T9F6GS, T9FP4G, V9F4E, V9FP4E, V9V2E, V9V4E, V9VP2E, V9VP4E | | |

gaskets for tray rack trolleys



| | | | |
|--------------------|--|-----------------|-----------|
| GEV No. | 900776 | Ref. No. | R70041150 |
| description | tray rack trolley gasket profile 4050 L 1020mm Qty 1 | | |
| For models: | MEC24H, MEC40M, MGC20X, MGC24H, MGC40H | | |



O-rings

EPDM

| | | | |
|--------------------|---|-----------------|--------|
| GEV No. | 510302 | Ref. No. | 200824 |
| description | O-ring EPDM ID ø 12.42mm thickness 1.78mm Qty 1 pcs | | |

| | | | |
|--------------------|--|-----------------|--------|
| GEV No. | 510303 | Ref. No. | 200818 |
| description | O-ring EPDM thickness 1.78mm ID ø 6.75mm Qty 1 pcs | | |

| | | | |
|--------------------|--|-----------------|--------|
| GEV No. | 530293 | Ref. No. | 200809 |
| description | O-ring EPDM thickness 1.78mm ID ø 8.73mm Qty 1 pcs | | |

| | | | |
|--------------------|---|-----------------|--------|
| GEV No. | 511191 | Ref. No. | 200813 |
| description | O-ring EPDM thickness 2.21mm ID ø 16.36mm Qty 1 pcs | | |

| | | | |
|--------------------|---|-----------------|----------------------|
| GEV No. | 540119 | Ref. No. | 1420925 MA1420925 |
| description | O-ring EPDM thickness 2.5mm ID ø 59mm Qty 1 pcs | | |
| For models: | NPD98E10, NPD98E15, NPD98G10, NPD98G15, NPD98G15A, NPI98E10, NPI98E15, NPI98G10, NPI98G14, NPI98G14A, P9D10E, P9D10G, P9D15E, P9D15G, P9D5G, P9DA10E, P9DA10G, P9DA15E, P9DA15G, P9DSB10E, P9DSB10G, P9I10E, P9I10G, P9I15E, P9I5G, P9IA10E, P9IA10G, P9IA15E, PD98E10, PD98E15, PD98G10, PD98G15, PD98G15A, PD9S8E10, PD9S8G10, PDASB10E, PDASB10G, PI98E10, PI98E15, PI98G10, PI98G14, PI98G14A, PI9S8E10 | | |

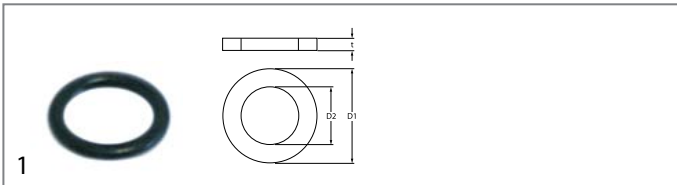
| | | | |
|--------------------|--|-----------------|--------|
| GEV No. | 528333 | Ref. No. | 200806 |
| description | O-ring EPDM thickness 2.62mm ID ø 13.1mm Qty 1 pcs | | |

| | | | |
|--------------------|--|-----------------|------------|
| GEV No. | 532062 | Ref. No. | 1036502300 |
| description | O-ring EPDM thickness 2.62mm ID ø 29.82mm Qty 10 pcs | | |
| For models: | DLS30, DLS303, DLS30P, DLS30P3, DLS31, DLS313, DLS31P3, MLC50, MLC503, MLC65, MLC653, MLS30, MLS303, MLS30P, MLS30P3, MLS31, MLS313, MLS31P3, MLS35, MLS353, MPLS30P | | |

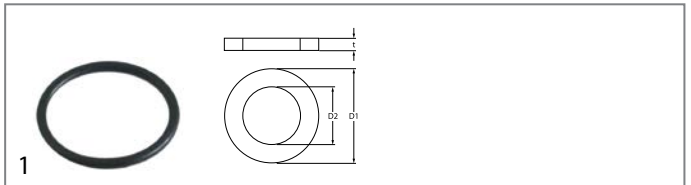
| | | | |
|--------------------|---|-----------------|--------|
| GEV No. | 510974 | Ref. No. | 200852 |
| description | O-ring EPDM thickness 2.62mm ID ø 58.42mm Qty 1 pcs | | |

| | | | |
|--------------------|--|-----------------|--------|
| GEV No. | 528583 | Ref. No. | 200845 |
| description | O-ring EPDM thickness 2.62mm ID ø 9.13mm Qty 1 pcs | | |

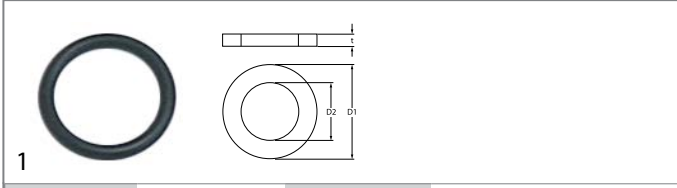
| | | | |
|--------------------|--|-----------------|----------------------|
| GEV No. | 528487 | Ref. No. | 2867700 MA2867700 |
| description | O-ring EPDM thickness 2.62mm ID ø 9.19mm Qty 1 pcs | | |
| For models: | CON10G, CON10GP, CON201G, CON201GP, CON202G, CON202GP, CON6G, CON6GP, CS4E, CS4EP, CSM10G, CSM10GP, CSM201E, CSM201EP, CSM201G, CSM201GP, CSM202G, CSM202GP, CSM6G, CSM6GP, NBR912EFM, NBR912EIM, NBR912GFM, NBR912GIM, NBR98EF, NBR98EFM, NBR98EI, NBR98EIM, NBR98GF, NBR98GFM, NBR98GI, NBR98GIM, NPC74E, NPC74G, NPC76E, NPC76G, NPC78E, NPC78G, NPC94E, NPC94G, NPC96E, NPC96G, NPC98E, NPC98G, NPD76G5, NPD78G8, NPD96G5, NPD98E10, NPD98E15, NPD98G10... (Other models you can see in the webshop) | | |



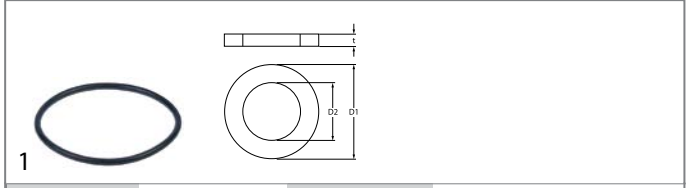
GEV No. 510893 **Ref. No.** 200810
description O-ring EPDM thickness 2.62mm ID ø 9.92mm Qty 1 pcs



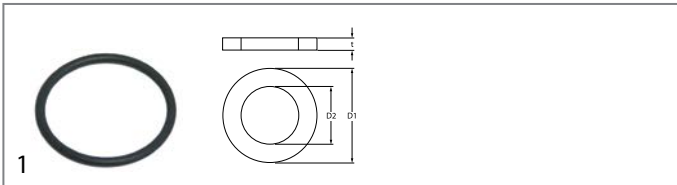
GEV No. 506015 **Ref. No.** 200822
description O-ring EPDM thickness 3.53mm ID ø 39.69mm Qty 1 pcs



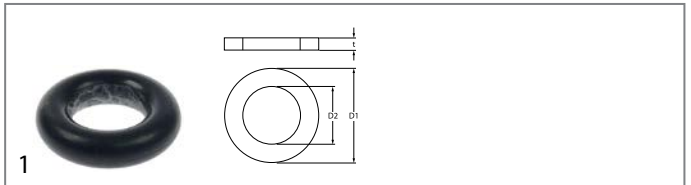
GEV No. 510901 **Ref. No.** 200843
description O-ring EPDM thickness 2mm ID ø 13mm Qty 1 pcs



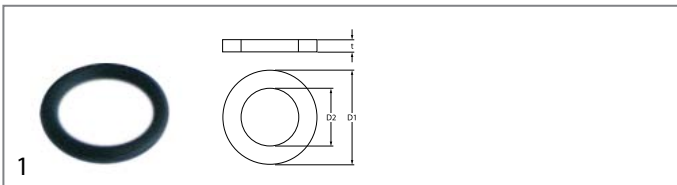
GEV No. 510811 **Ref. No.** 200816
description O-ring EPDM thickness 3mm ID ø 59.2mm Qty 1 pcs



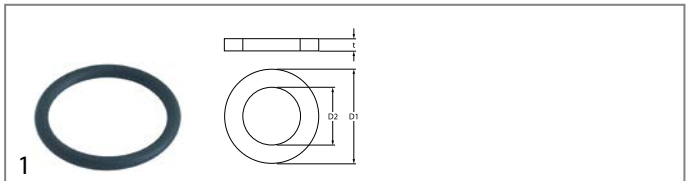
GEV No. 100809 **Ref. No.** 1394000
 BN6A011606
 MA1394000
description O-ring EPDM thickness 2mm ID ø 21mm Qty 1 pcs
For models: BMG40, BMG60, BR707G, FQG40, FQG60, FR74G, FR77G, MM10IG, P9110G, P915G, P91A10G, PI707G



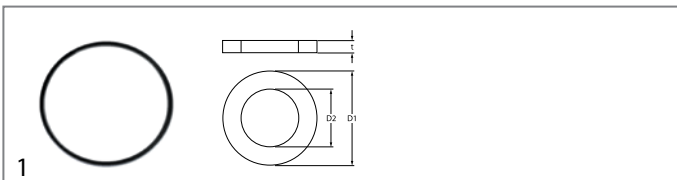
GEV No. 510955 **Ref. No.** 200854
description O-ring EPDM thickness 3mm ID ø 6mm Qty 1 pcs



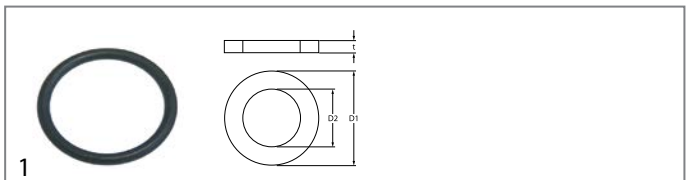
GEV No. 510902 **Ref. No.** 200844
description O-ring EPDM thickness 2mm ID ø 9.5mm Qty 1 pcs



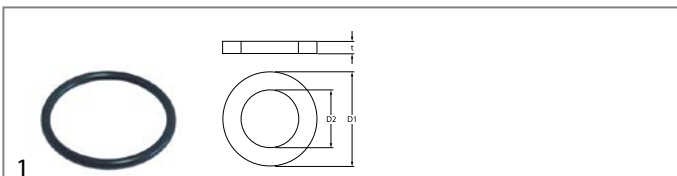
GEV No. 505092 **Ref. No.** 2604100
 BN0119472130
 MA2604100
description O-ring EPDM thickness 5.34mm ID ø 43.82mm Qty 1 pcs
For models: CS102E, CS102EP, CS10E, CS10EP, CS6E, CS6EP, FV4E, FV4E1, P915E, PI707E, PI76E5, PI96E5, PI98E10, PI98E15, PI9S8E10



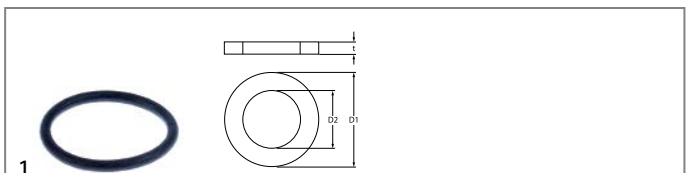
GEV No. 510896 **Ref. No.** 200828
description O-ring EPDM thickness 3.53mm ID ø 183.75mm Qty 1 pcs



GEV No. 510408 **Ref. No.** 200820
 BN0118462630
description O-ring EPDM thickness 5.34mm ID ø 47mm Qty 1 pcs





GEV No. 510895 **Ref. No.** 200814
description O-ring EPDM thickness 3.53mm ID ø 34.52mm Qty 1 pcs

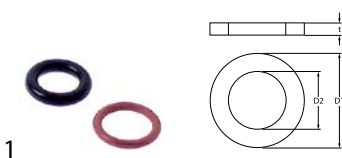


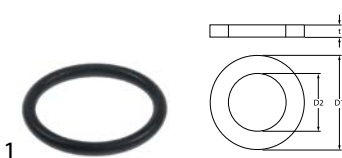
GEV No. 505517 **Ref. No.** 77121600
 MA77121600
description O-ring EPDM thickness 5.34mm ID ø 53.34mm Qty 1 pcs
For models: PD98E10, PD98E15, PD98G10, PD98G15, PD98G15A, PD9S8E10, PD9S8G10, PI98E10, PI98E15, PI98G10, PI98G14, PI98G14A, PI9S8E10




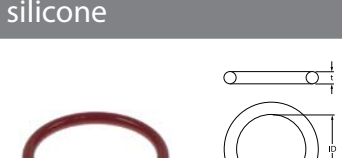
| | | | |
|---|--|-----------------|---|
|  | | | |
| GEV No. | 510409 | Ref. No. | 1036504200 LA70045010 LAR70045010 |
| description | O-ring EPDM thickness 5.34mm ID ø 56.52mm Qty 1 pcs | | |
| For models: | DLS30, DLS303, DLS30P, DLS30P3, DLS31, DLS313, DLS31P3, ME101M, ME101P, ME101T, ME102D, ME102M, ME102P, ME102T, ME201D, ME201M, ME201P, ME201T, ME202D, ME202M, ME202P, ME202T, MEMENT06D, MEMENT06P, MEMENT10D, MEMENT10P, MEMENT20D, MEMENT20P, MEMENT21D, MEMENT21P, MEMENT40D, MEMENT40P, MLC50, MLC503, MLC65, MLC653, MLS30, MLS303, MLS30P, MLS30P3, MLS31, MLS313, MLS31P3, MLS35, MLS353, MPLS30P | | |

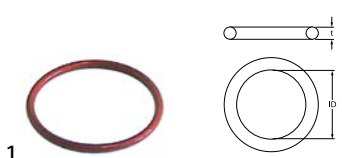
| | | | |
|---|---|-----------------|--------|
|  | | | |
| GEV No. | 510447 | Ref. No. | 200829 |
| description | O-ring EPDM thickness 5.34mm ID ø 81.92mm Qty 1 pcs | | |


| | | | |
|--|--|-----------------|-----------|
|  | | | |
| GEV No. | 532492 | Ref. No. | R70010050 |
| description | O-ring set EPDM thickness 1.78/2.62mm ID ø 9.25/7.59mm Qty 2 pcs | | |
| For models: | ME061T, ME101T, ME102T, ME201T, MEMENT06P, MEMENT10P, MEMENT20P, MEMENT21P, MEMENT40P, MG102T, MG201T, MG202T, MGMT06P, MGMT10P, MGMT20P, MGMT21P, MGMT40P | | |

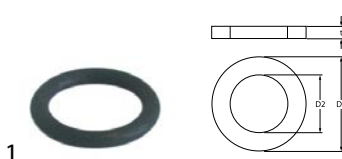
| | | | |
|---|---|-----------------|--|
|  | | | |
| GEV No. | 501478 | Ref. No. | 77121700 77122000 MA77121700 MA77122000 |
| description | O-ring set EPDM thickness 5.34mm ID ø 44.45mm Qty 3 pcs | | |
| For models: | PD76G5, PD96G5, PI76E5, PI76G5, PI96E5, PI96G5, PV, PVA | | |

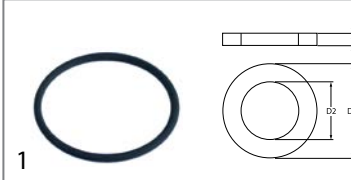
| | | | |
|---|--|-----------------|--------|
|  | | | |
| GEV No. | 510551 | Ref. No. | 630441 |
| description | pump cover gasket ID ø 158.3mm pump type 1214/1293/1225/2243/1226/1204/3473/1241 thickness 3.53mm EPDM Qty 1 pcs | | |

| | | | |
|--|--|-----------------|---|
| silicone | | | |
|  | | | |
| GEV No. | 514017 | Ref. No. | 0105246 1036500200 1814400 MA1814400 R0105246 SIR0105246 |
| description | O-ring silicone thickness 3.53mm ID ø 32.93mm Qty 1 pcs | | |
| For models: | CP704E, CP92E, CP92E2, CP94E, CP94E2, CP95B2E, CP95B2E2, CP95B4E, CP95B4E2, CPE40, CPE402, CPE60, CPE602, CPE60DB, DE92142, DE94242, EPC74E, OCPE6, OCPE60, PC12C4E, PC12C9E, PC74E, PC76E, PC78E, PC94E, PC96E, PC98E, PC954E, PC956E, PC958E | | |

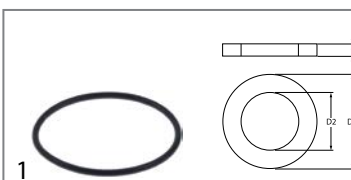
| | | | |
|--|--|-----------------|------------------------------------|
|  | | | |
| GEV No. | 514021 | Ref. No. | 1036500300 1814700 MA1814700 |
| description | O-ring silicone thickness 3.53mm ID ø 49.21mm Qty 1 pcs | | |
| For models: | CP704E, CP92E, CP92E2, CP94E, CP94E2, CP95B2E, CP95B2E2, CP95B4E, CP95B4E2, CPE40, CPE402, CPE60, CPE602, CPE60DB, EPC74E, OCPE6, OCPE60, PC12C4E, PC12C9E, PC74E, PC76E, PC78E, PC94E, PC96E, PC98E, PC954E, PC956E, PC958E | | |

| | | | |
|--|--|-----------------|------------------------|
| Viton | | | |
|  | | | |
| GEV No. | 528687 | Ref. No. | CM097900 MACM097900 |
| description | O-ring Viton thickness 1.78mm ID ø 3.69mm Qty 1 pcs | | |
| For models: | EF74E10VG, EF74E12, EF74G15, EF74G8VA, EF74G8VG, F12C4E12, F12C4G15, F74E10, F74E12, F74E6, F74G10, F74G15, F74G6, F76E10, F76G10, F78E12, F78G15, F94E10, F94E12, F94E18, F94E18K, F94E6, F94G10, F94G15, F94G22, F94G22K, F94G6, F96E10, F96G10, F98E12, F98E18, F98E18K, F98G15, F98G22, F98G22K, F9S4E12, F9S4E18, F9S4E18K, F9S4G15, F9S4G22, F9S4G22K, F9S8E12, F9S8E18, F9S8E18K, F9S8G15, F9S8G22, F9S8G22K, FQE41R, FQE41RL, FQE41RL2...(Other models you can see in the webshop) | | |

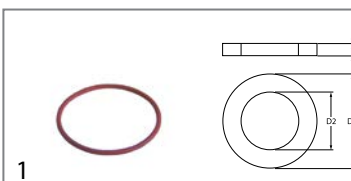
| | | | |
|--|---|-----------------|------------------------|
|  | | | |
| GEV No. | 514222 | Ref. No. | CM142000 MACM142000 |
| description | O-ring Viton thickness 3.53mm ID ø 20.22mm Qty 1 pcs | | |
| For models: | B124E, B74E, B74G, B78E, B78G, B94E, B94G, B98E, B98G, NB74E, NB74G, NB78E, NB78G, NB94E, NB94G, NB98E, NB98G | | |



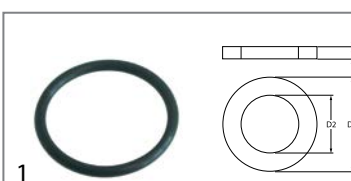
| | | | |
|--------------------|--|-----------------|------------------------|
| GEV No. | 550496 | Ref. No. | CM099200 MACM099200 |
| description | O-ring Viton thickness 3.53mm ID ø 50.39mm Qty 1 pcs | | |
| For models: | EF74E10VG, EF74E12, F12C4E12, F74E10, F74E12, F74E6, F76E10, F78E12, F94E10, F94E12, F94E18, F94E18K, F94E6, F96E10, F98E12, F98E18, F98E18K, F9S4E12, F9S4E18, F9S4E18K, F9S8E12, F9S8E18, F9S8E18K, FQE41R, FQE41RL, FQE41RL2, FQE61R, FQE61RL, NF74E10, NF74E15, NF76E10, NF78E15, NF94E10, NF94E15, NF94E22, NF94E222, NF94E222K, NF94E22K, NF96E10, NF98E15, NF98E22, NF98E222, NF98E222K, NF98E22K, NPC74E, NPC76E, NPC78E, NPC94E, NPC96E, NPC98E | | |



| | | | |
|--------------------|--|-----------------|-----------|
| GEV No. | 532681 | Ref. No. | CR0582140 |
| description | O-ring Viton thickness 3.53mm ID ø 66.27mm Qty 1 pcs | | |
| For models: | NF74E15, NF78E15, NF94E15, NF98E15, NPC74E, NPC76E, NPC78E, NPC94E, NPC98E | | |



| | | | |
|--------------------|--|-----------------|----------------------|
| GEV No. | 521116 | Ref. No. | 1422200 MA1422200 |
| description | O-ring Viton thickness 3.53mm ID ø 78.97mm Qty 1 pcs | | |
| For models: | P9D10E, P9D15E, P9DA10E, P9DA15E, P9I10E, P9I15E, P9IA10E, P9IA15E | | |




| | | | |
|--------------------|---|-----------------|------------------------|
| GEV No. | 521146 | Ref. No. | CM046200 MACM046200 |
| description | O-ring Viton thickness 5.34mm ID ø 56.52mm Qty 1 pcs | | |
| For models: | NPI76E5, NPI78E8, NPI96E5, NPI98E10, NPI98E15, PI76E5, PI96E5, PI98E10, PI98E15, PI9S8E10 | | |

sealing washers


fibre gaskets




| | | | |
|--------------------|--|-----------------|------------------------|
| GEV No. | 504209 | Ref. No. | 14072299 MA14072299 |
| description | flat gasket FIBER ED ø 18.5mm ID ø 11mm thickness 2mm Qty 1 pcs | | |
| For models: | BR78EF, BR78EI, BR78GF, BR78GI, BR912EFM, BR912EIM, BR912GFM, BR912GIM, BR98EF, BR98EFM, BR98EI, BR98EIM, BR98GF, BR98GFM, BR98GI, BR98GIM, BR9S8EF, BR9S8EI, BR9S8GF, BR9S8GI, CP92G, CP94G, NBR78EF, NBR78EI, NBR78GF, NBR78GI, NBR912EFM, NBR912EIM, NBR912GFM, NBR912GIM, NBR98EF, NBR98EFM, NBR98EI, NBR98EIM, NBR98GF, NBR98GFM, NBR98GI, NBR98GIM, P9D10E, P9D10G, P9D15E, P9D15G, P9D5G, P9DA10E, P9DA10G, P9DA15E, P9DA15G, P9DSB10E, P9DSB10G, P9I10E... (Other models you can see in the webshop) | | |




| | | | |
|--------------------|---|-----------------|-----------|
| GEV No. | 518393 | Ref. No. | R70030050 |
| description | flat gasket FIBER ED ø 24mm ID ø 17mm thickness 2mm Qty 1 pcs | | |
| For models: | MG120M, MG120P, MG120X, MGC20X | | |



| | | | |
|--------------------|---|-----------------|--------|
| GEV No. | 510996 | Ref. No. | 460502 |
| description | flat gasket FIBER ED ø 31mm ID ø 21.5mm thickness 2mm for thread 1/2" Qty 1 pcs | | |




| | | | |
|--------------------|---|-----------------|-----------|
| GEV No. | 510404 | Ref. No. | CR0682770 |
| description | flat gasket fibre ED ø 44mm ID ø 34mm thickness 2mm Qty 1 pcs | | |
| For models: | NPI76E5, NPI76G5, NPI78E8, NPI78G8, NPI96E5, NPI96G5, NPI98E10, NPI98E15, NPI98G10, NPI98G14, NPI98G14A | | |




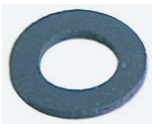
| | | | |
|--------------------|--|-----------------|--------|
| GEV No. | 510355 | Ref. No. | 460501 |
| description | gasket fibre ED ø 24mm ID ø 17mm thickness 2mm Qty 1 pcs | | |




rubber gaskets


| | | | |
|---|--|-----------------|--------|
|  | | | |
| 1 | | | |
| GEV No. | 510877 | Ref. No. | 200415 |
| description | flat gasket rubber ED ø 18mm ID ø 10mm thickness 3mm Qty 1 pcs | | |


| | | | |
|---|---|-----------------|--------|
|  | | | |
| 1 | | | |
| GEV No. | 510989 | Ref. No. | 160811 |
| description | flat gasket rubber ED ø 18mm ID ø 8.5mm thickness 1mm Qty 1 pcs | | |


| | | | |
|---|--|-----------------|--------|
|  | | | |
| 1 | | | |
| GEV No. | 510886 | Ref. No. | 200467 |
| description | flat gasket rubber ED ø 21mm ID ø 11.5mm thickness 2mm Qty 1 pcs | | |


| | | | |
|--|---|-----------------|--------|
|  | | | |
| 1 | | | |
| GEV No. | 520054 ¹ | Ref. No. | 200416 |
| description | flat gasket rubber ED ø 23.5mm ID ø 14mm thickness 2.3mm Qty 10 pcs | | |


¹Qty 10 pieces


| | | | |
|---|--|-----------------|--------|
|  | | | |
| 1 | | | |
| GEV No. | 511180 | Ref. No. | 200457 |
| description | flat gasket rubber ED ø 24mm ID ø 16mm thickness 3mm Qty 1 pcs | | |


| | | | |
|---|--|-----------------|--------|
|  | | | |
| 1 | | | |
| GEV No. | 511283 | Ref. No. | 200927 |
| description | flat gasket rubber ED ø 30mm ID ø 20mm thickness 2mm Qty 1 pcs | | |

| | | | |
|---|--|-----------------|--------|
|  | | | |
| 1 | | | |
| GEV No. | 510876 | Ref. No. | 200412 |
| description | flat gasket rubber ED ø 45mm ID ø 33mm thickness 3mm Qty 1 pcs | | |


| | | | |
|---|--|-----------------|--------|
|  | | | |
| 1 | | | |
| GEV No. | 516254 | Ref. No. | 200410 |
| description | flat gasket rubber ED ø 66mm ID ø 46mm thickness 2.1mm Qty 1 pcs | | |


| | | | |
|---|---|-----------------|--------|
|  | | | |
| 1 | | | |
| GEV No. | 510947 | Ref. No. | 200489 |
| description | flat gasket rubber ED ø 85mm ID ø 73mm thickness 2mm Qty 1 pcs equiv. no. 200489 suitable for COMENDA | | |

| | | | |
|---|--|-----------------|--------|
|  | | | |
| 1 | | | |
| GEV No. | 510832 | Ref. No. | 200906 |
| description | flat gasket rubber ED ø 92mm ID ø 66mm thickness 2mm Qty 1 pcs equiv. no. 200906/33456 | | |


| | | | |
|--|---|-----------------|--------|
|  | | | |
| 1 | | | |
| GEV No. | 511158 | Ref. No. | 200482 |
| description | gasket rubber ED ø 50mm ID ø 35mm thickness 4mm Qty 1 pcs | | |

plastic gaskets


| | | | |
|---|---|-----------------|--------|
|  | | | |
| 1 | | | |
| GEV No. | 510838 | Ref. No. | 160803 |
| description | gasket plastic ED ø 10.5mm ID ø 5mm thickness 3mm Qty 1 pcs | | |

| | | | |
|---|---|-----------------|--------|
|  | | | |
| 1 | | | |
| GEV No. | 510840 | Ref. No. | 160805 |
| description | gasket plastic ED ø 16mm ID ø 8.5mm thickness 4mm Qty 1 pcs | | |


PTFE gaskets


| | | | |
|---|--|-----------------|------------------------------------|
|  | | | |
| 1 | | | |
| GEV No. | 514016 | Ref. No. | 1036500400 1814500 MA1814500 |
| description | flat gasket PTFE ED ø 45mm ID ø 40mm thickness 4mm Qty 1 pcs equiv. no. 1036500400/1814500 suitable for MARENO | | |
| For models: | CP704E, CP92E, CP92E2, CP94E, CP94E2, CP95B2E, CP95B2E2, CP95B4E, CP95B4E2, CPE40, CPE402, CPE60, CPE602, CPE60DB, DE92142, DE94242, EPC74E, OCP6E, OCP6E0, PC12C4E, PC12C9E, PC74E, PC76E, PC78E, PC94E, PC96E, PC98E, PC9S4E, PC9S6E, PC9S8E | | |


silicone gaskets


| | | | |
|---|--|-----------------|----------------------|
|  | | | |
| 1 | | | |
| GEV No. | 691332 | Ref. No. | 2993700 MA2993700 |
| description | flat gasket silicone ED ø 13.8mm ID ø 6mm thickness 1.5mm Qty 1 pcs | | |
| For models: | B124E, B74E, B78E, B94E, B98E, B9SB2E, B9SB4E, B9V2E, B9V4E, B9VP2E, B9VP4E, BF78E, BF98E, BIE40, BIE40B, BIE60, BIE60B, BM74E, BM77E, BME40DM, BME40DMB, BME40M, BME60, BME602, BME60DM, BME60DMB, BME60M, BME80M, BR707E, BR707EI, BR78EF, BR78EI, BR912EFM, BR912EIM, BR912GFM, BR912GIM, BR94E, BR94EI, BR94G, BR94GI, BR98EF, BR98EFM, BR98EI, BR98EIM, BR98GF, BR98GFM, BR98GI, BR98GIM, BR9M4E, BR9M4EI...(Other models you can see in the webshop) | | |

foam rubber gaskets


| | | | |
|---|--|-----------------|----------------------------|
|  | | | |
| 1 | | | |
| GEV No. | 691329 | Ref. No. | 1036607700 MA1036607700 |
| description | foam rubber gasket W 10mm thickness 5mm self-adhesive Qty supplied by meter | | |
| For models: | FQE41, FQE41L, FQE41L2, FQE61, FQE61L, FQE61L2, FR74E10, FR74E10L, FR74E10L2, FR77E10, FR77E10L, FR77E10L2, OFQE41, OFQE61 | | |

| | | | |
|---|---|-----------------|--------|
|  | | | |
| 1 | | | |
| GEV No. | 511391 | Ref. No. | 200402 |
| description | foam rubber gasket W 24mm thickness 4mm self-adhesive Qty 1m suitable for COMENDA | | |


| | | | |
|---|---|-----------------|--------|
|  | | | |
| 1 | | | |
| GEV No. | 510881 | Ref. No. | 200433 |
| description | foam rubber gasket W 6mm thickness 2.5mm self-adhesive Qty 1m | | |


| | | | |
|--|--|-----------------|--------|
|  | | | |
| 1 | | | |
| GEV No. | 510880 | Ref. No. | 200432 |
| description | foam rubber gasket W 8mm thickness 4mm self-adhesive Qty supplied by meter | | |

shaft gaskets

| | | | |
|--|---|-----------------|----------------------|
|  | | | |
| 1 | | | |
| Image not available | | | |
| GEV No. | 514191 | Ref. No. | 4609200 MA4609200 |
| description | V-ring ID ø 14mm ED ø 20mm thickness 6mm | | |
| For models: | AF140B, AF140C, AF140F, AF140I, AF140MB, AF140MC, AF140MF, AF140MI, AF140MN, AF140MP, AF140N, AF140P, AF14F, AF14G, AF14N, AF70B, AF70C, AF70F, AF70I, AF70MB, AF70MC, AF70MF, AF70MI, AF70MN, AF70MP, AF70N, AF70P, EF140DF, EF140DN, EF140DP, EF140MB, EF140MC, EF140MF, EF140MI, EF140MN, EF140MP, EF143MNI, EF70DF, EF70DN, EF70DP, EF70MB, EF70MC, EF70MF, EF70MI, EF70MN, EF70MP, EF72MNF, F140DF, F140DI, F140DN...(Other models you can see in the webshop) | | |


shaft gaskets

| | | | |
|---|---|-----------------|---------------------------|
|  | | | |
| 1 | | | |
| GEV No. | 511171 | Ref. No. | LA70020040 LAR70020040 |
| description | shaft seal ID ø 14.5mm ED ø 20mm thickness 3mm | | |
| For models: | CVE105H, CVE105M, CVG105H, CVG105M, EC106M, EM106H, EM106M, EM106M+SC, EM106P, EV006M, EV106H, EV106M, EV106M+SC, EV106P, FE105M, FE105X, FG105M, FG105X, GC106M, GM106H, GM106M, GM106M+SC, GM106P, GMT06D, GV106H, GV106M, GV106M+SC, GV106P, GVT06D, MACE07M, MACG07M, ME061D, ME061M, ME061P, ME061T, ME106M, ME106P, ME106X, MEMT06D, MEMT06P, MEVT06D, MEVT06P, MG061D, MG061M, MG061P, MG061T, MG106M, MG106P, MG106X, MGMT06D...(Other models you can see in the webshop) | | |

| | | | |
|---|--|-----------------|-----------|
|  | | | |
| 1 | | | |
| GEV No. | 511170 | Ref. No. | R70020010 |
| description | shaft seal ID ø 7mm ED ø 22mm thickness 7mm | | |
| For models: | CVE004H, CVE004M, CVE104H, CVE104M, VE004M, VE004X, VE104M, VE104X | | |



| | | | |
|---|---|-----------------|-----------|
|  | | | |
| GEV No. | 511172 | Ref. No. | R70020050 |
| description | shaft sealing ID ø 24mm ED ø 29mm thickness 3mm | | |
| For models: | EC110M, EC210M, EM010M+SC, EM110H, EM110M, EM110M+SC, EM110P, EM210H, EM210M, EM210M+SC, EM210P, EV110H, EV110M, EV110M+SC, EV110P, EV210H, EV210M, EV210M+SC, EV210P, FE110M, FE110X, FE210M, FG110M, FG110X, FG210M, FG210X, GC110M, GC210M, GM110H, GM110M, GM110M+SC, GM110P, GM210H, GM210M, GM210M+SC, GM210P, GMT20D, GV110H, GV110M, GV110M+SC, GV110P, GV210H, GV210M, GV210M+SC, GV210P, GVT20D, MACE10M, MACE20M, MACG10M, MACG20M...(Other models you can see in the webshop) | | |


| | | | |
|--|--|-----------------|-----------|
|  | | | |
| GEV No. | 699246 | Ref. No. | R70045110 |
| description | service kit gasket for combi-steamer | | |
| For models: | ME201T, MEMT21P, MEMT40P, MG201T, MG202T, MGMT21P, MGMT40P | | |

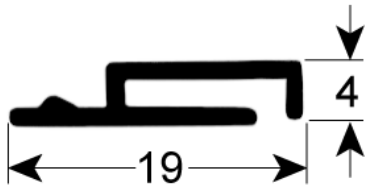
special gaskets

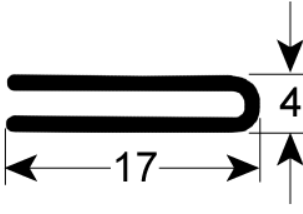
for combi-steamers


| | | | |
|---|---|-----------------|-----------|
|  | | | |
| GEV No. | 699384 | Ref. No. | R63140050 |
| description | gasket suitable for LAINOX ED ø 84mm ID ø 50mm fibre thickness 2mm hole distance 50mm hole ø 6mm | | |
| For models: | GMT06D, GMT20D, GVT06D, GVT20D, MACG05M, MACG07M, MACG10M, MACG20M, MG061D, MG061M, MG061P, MG061T, MG101D, MG101M, MG101P, MG101T, MG102D, MG102M, MG102P, MG102T, MG201D, MG201M, MG201P, MG201T, MG202D, MG202M, MG202P, MG202T, MGMT06D, MGMT06P, MGMT10D, MGMT10P, MGMT20D, MGMT20P, MGMT21D, MGMT21P, MGMT40D, MGMT40P, MGVT06D, MGVT06P, MGVT10D, MGVT10P, MGVT20D, MGVT20P, MGVT21D, MGVT21P, MGVT40D, MGVT40P, MVG051P | | |

| | | | |
|---|---|-----------------|-----------|
|  | | | |
| GEV No. | 694955 | Ref. No. | R63140010 |
| description | gasket suitable for LAINOX L 80mm W 65mm combi-steamer ID ø 51mm graphite thickness 3mm hole distance 45x60mm | | |
| For models: | GMT06D, GVT06D, MACG05M, MACG07M, MG061D, MG061M, MG061P, MG061T, MGMT06D, MGMT06P, MGVT06D, MGVT06P, MVG051P | | |

| | | | |
|---|--|-----------------|-----------|
|  | | | |
| GEV No. | 699385 | Ref. No. | R70045100 |
| description | gasket set suitable for LAINOX for cleaning system | | |
| For models: | ME102T, MEMT10P, MEMT20P, MG102T, MGMT10P, MGMT20P | | |

| | | | |
|--|--|-----------------|--------|
| <p>door seals for dishwashers</p>  | | | |
| GEV No. | 511311 | Ref. No. | 200923 |
| description | door seal L 1000mm dishwasher suitable for COMENDA equiv. no. 200923 | | |

| | | | |
|---|---|-----------------|--------|
|  | | | |
| GEV No. | 511390 | Ref. No. | 200215 |
| description | door seal L 930mm dishwasher suitable for COMENDA equiv. no. 200215 | | |

| | | | |
|--|---|-----------------|--------|
|  | | | |
| GEV No. | 511391 | Ref. No. | 200402 |
| description | foam rubber gasket W 24mm thickness 4mm self-adhesive Qty 1m suitable for COMENDA | | |

| | | | |
|--|---|-----------------|--------|
|  | | | |
| GEV No. | 510881 | Ref. No. | 200433 |
| description | foam rubber gasket W 6mm thickness 2.5mm self-adhesive Qty 1m | | |


| | | | |
|--|--|-----------------|--------|
|  | | | |
| GEV No. | 510880 | Ref. No. | 200432 |
| description | foam rubber gasket W 8mm thickness 4mm self-adhesive Qty supplied by meter | | |

miscellaneous




1

| | | | |
|--------------------|--|-----------------|--------|
| GEV No. | 510882 | Ref. No. | 200451 |
| description | gasket for opposite support L 100mm hood mechanics rubber H 3mm black W 30mm | | |



1


| | | | |
|--------------------|---|-----------------|--------|
| GEV No. | 511370 | Ref. No. | 160837 |
| description | gasket L 34mm W 14mm for door guides ID ø 7mm thickness 3mm | | |



1

| | | | |
|--------------------|---|-----------------|--------|
| GEV No. | 510847 | Ref. No. | 440405 |
| description | gasket polishing agent dosing ID ø 22mm ED ø 32mm external height 5mm | | |

thermostat gaskets



1

| | | | |
|--------------------|--|-----------------|--------|
| GEV No. | 512154 | Ref. No. | 200494 |
| description | gasket for thermostat ID ø 20mm equiv. no. 200494/H200494 hole distance 41mm suitable for COMENDA, HOONVED | | |

miscellaneous




1

| | | | |
|--------------------|----------------------------------|-----------------|-----------|
| GEV No. | 550862 | Ref. No. | R70045090 |
| description | gasket set for wash arm | | |
| For models: | ME061T, ME101T, MEMT06P, MGMT06P | | |

evaporators

for fridges

producer-specific



1

| | | | |
|--------------------|--|-----------------|----------------------|
| GEV No. | 750272 | Ref. No. | 2474763 MA2474763 |
| description | evaporator | | |
| For models: | EF143MNI, EF70MF, EF70MN, EF70MP, EF72MNF, FB140FN, FB140NN, FB140PF, FB140PN, FB140PP, FB143NI, FB55F, FB55N, FB55P, FB70F, FB70N, FB70P, FB72F, FB72N, FB72NF, FB72P, FS140FI, FS140FN, FS140I, FS140NI, FS140NN, FS140PN, FS140PP, FS143FI, FS143NF, FS143NI, FS143NN, FS143NP, FS70F, FS70FG, FS70I, FS70N, FS70NG, FS70P, FS72F, FS72FI, FS72IN, FS72N, FS72NF, FS72NN, FS72P, HF140DFN, HF140DNN, HF140DPF, HF140DPN...(Other models you can see in the webshop) | | |

transmission technology and ball bearings

ball bearings

thrust ball bearings




1

| | | | |
|--------------------|--|-----------------|--------------------|
| GEV No. | 523537 | Ref. No. | 288700 MA288700 |
| description | thrust ball bearing shaft ø 20mm ED ø 35mm W 10mm type 51104 DIN 711 | | |
| For models: | BR78EF, BR78EI, BR78GF, BR78GI, BR912EFM, BR912EIM, BR912GFM, BR912GIM, BR94E, BR94EI, BR94G, BR94GI, BR98EF, BR98EFM, BR98EI, BR98EIM, BR98GF, BR98GFM, BR98GI, BR98GIM, BR9M4E, BR9M4EI, BR9M4G, BR9M4GI, BR9M6E, BR9M6EI, BR9M6G, BR9M6GI, BR9S8EF, BR9S8EI, BR9S8GF, BR9S8GI, BR9SB4E, BR9SB4EI, BR9SB4G, BR9SB4GI | | |

springs


torsion springs




1


| | | | |
|--------------------|--|-----------------|--------------------|
| GEV No. | 514234 | Ref. No. | 810210 MA810210 |
| description | torsion spring ø 32.3mm L2 188mm wire gauge ø 5.7mm L1 15mm tilting bratt pan series 900 | | |
| For models: | BR78EF, BR78EI, BR78G, BR78GF, BR78GI, BR912EFM, BR912EIM, BR912GFM, BR912GIM, BR98EF, BR98EFM, BR98EI, BR98EIM, BR98GF, BR98GFM, BR98GI, BR98GIM, BR9S8EF, BR9S8EI, BR9S8GF, BR9S8GI, CP9A15GD, NPD78G8, NPI78E8, NPI78G8 | | |



| | | | |
|---|--|-----------------|--------------------|
|  | | | |
| GEV No. | 514226 | Ref. No. | 139732 MA139732 |
| description | torsion spring ø 32.3mm L2 192mm wire gauge ø 5.9mm L1 14mm kettle type series 700 series 900 | | |
| For models: | BR707E, BR707EI, BR707G, BR707GI, BR78EF, BR78EI, BR78G, BR78GF, BR78GI, BR912EFM, BR912EIM, BR912GFM, BR912GIM, BR94E, BR94EI, BR94G, BR94GI, BR96E, BR96EI, BR96G, BR96GI, BR98EF, BR98EFM, BR98EI, BR98EIM, BR98GF, BR98GFM, BR98GI, BR98GIM, BR9M4E, BR9M4EI, BR9M4G, BR9M4GI, BR9M6E, BR9M6EI, BR9M6G, BR9M6GI, BR9S8EF, BR9S8EI, BR9S8GF, BR9S8GI, BR9SB4E, BR9SB4EI, BR9SB4G, BR9SB4GI, CP9A15GD, NPD76G5, NPD96G5, NPI76E5, NPI76G5... (Other models you can see in the webshop) | | |

| | | | |
|---|---|-----------------|-----------|
|  | | | |
| GEV No. | 690095 | Ref. No. | R61620012 |
| description | torsion spring ø 6mm L2 15mm wire gauge ø 0.9mm L1 2x6mm L3 15mm Qty 1 pcs for closing hub | | |
| For models: | CVE004H, CVE004M, CVE104H, CVE104M, CVE105H, CVE105M, CVG105H, CVG105M, EC106M, EC110M, EC210M, EM010M+SC, EM106H, EM106M, EM106M+SC, EM106P, EM110H, EM110M, EM110M+SC, EM110P, EM210H, EM210M, EM210M+SC, EM210P, EV006M, EV106H, EV106M, EV106M+SC, EV106P, EV110H, EV110M, EV110M+SC, EV110P, EV210H, EV210M, EV210M+SC, EV210P, FE105M, FE105X, FE110M, FE110X, FE210M, FG105M, FG105X, FG110M, FG110X, FG210M, FG210X, GC106M, GC110M...(Other models you can see in the webshop) | | |


compression springs

| | | | |
|---|---|-----------------|-----------|
|  | | | |
| GEV No. | 690091 | Ref. No. | R61620041 |
| description | compression spring ø 12mm L 49mm wire gauge ø 1mm | | |
| For models: | CVE004H, CVE004M, CVE104H, CVE104M, CVE105H, CVE105M, CVG105H, CVG105M, EC106M, EC110M, EC210M, EM010M+SC, EM106H, EM106M, EM106M+SC, EM106P, EM110H, EM110M, EM110M+SC, EM110P, EM210H, EM210M, EM210M+SC, EM210P, EV006M, EV106H, EV106M, EV106M+SC, EV106P, EV110H, EV110M, EV110M+SC, EV110P, EV210H, EV210M, EV210M+SC, EV210P, FE105M, FE105X, FE110M, FE110X, FE210M, FG105M, FG105X, FG110M, FG110X, FG210M, FG210X, GC106M, GC110M...(Other models you can see in the webshop) | | |


miscellaneous

| | | | |
|---|--|-----------------|-----------|
|  | | | |
| GEV No. | 697932 | Ref. No. | R10205120 |
| description | spring for controllers/switches shaft diameter 6x4.6mm ømm L 40mm W 23mm H 7mm wire gauge ø 1mm | | |
| For models: | CVE004H, CVE104H, CVE105H, CVG105H, EM106H, EM106P, EM110H, EM110P, EM210H, EM210P, EV106H, EV106P, EV110H, EV110P, EV210H, EV210P, GM106H, GM106P, GM110H, GM110P, GM210H, GM210P, GV106H, GV106P, GV110H, GV110P, GV210H, GV210P, ME106P, ME110P, ME120P, ME210P, ME220P, MEC24H, MG106P, MG110P, MG120P, MG210P, MG220P, MGC24H, MGC40H, VE106P, VE120P, VE210P, VE220P, VG106P, VG110P, VG120P, VG210P, VG220P | | |

tension springs

| | | | |
|--|-------------------------|-----------------|--------|
|  | | | |
| GEV No. | 510926 | Ref. No. | 391312 |
| description | tension spring for hood | | |


| | | | |
|--|--|-----------------|-----------|
|  | | | |
| GEV No. | 517406 | Ref. No. | CR0589520 |
| description | tension spring ø 29mm total length 230mm wire gauge ø 4mm for tilting bratt pan | | |
| For models: | NBR78EF, NBR78EI, NBR78GF, NBR78GI, NBR912EFM, NBR912EIM, NBR912GFM, NBR912GIM, NBR98EF, NBR98EFM, NBR98EI, NBR98EIM, NBR98GF, NBR98GFM, NBR98GI, NBR98GIM, XCABR7E, XCABR7G | | |

| | | | |
|--|--|-----------------|--------|
|  | | | |
| GEV No. | 510928 | Ref. No. | 391316 |
| description | tension spring ø 37mm total length 910mm wire gauge ø 5.3mm for hood C85/140-G75 | | |

kitchen accessories


gastronorm

bridges

| | | | |
|---|--|-----------------|-----------|
|  | | | |
| GEV No. | 691337 | Ref. No. | CR0506490 |
| description | bridge for Gastronorm container L1 525mm L2 505mm SS W 72mm H 15mm Qty 1 pcs | | |

hose reels and spray guns

spray guns

| | | | |
|--|--|-----------------|-----------|
|  | | | |
| GEV No. | 548455 | Ref. No. | R62200133 |
| description | spray gun for appliances 3/8" IT | | |
| For models: | ME061P, ME061T, ME101P, ME101T, ME102P, ME201P, ME201T, ME202P, ME202T, MG061P, MG061T, MG101P, MG101T, MG102P, MG102T, MG201P, MG201T, MG202P, MG202T | | |







hose reels

appliance hose reels





1


| | | | |
|---|--|-----------------|-------------------|
| GEV No. | 542099 | Ref. No. | R62200131 |
| description | hose reel complete with spray gun hose length 1.6m connection John Guest 10mm hose ø 6x12mm | | |
| For models: | ME061P, ME061T, ME101P, ME101T, ME102P, ME201P, ME201T, ME202P, ME202T, MG061P, MG061T, MG101P, MG101T, MG102P, MG102T, MG201P, MG201T, MG202P, MG202T | | |
| accessories for | 542099 | | |
|  | GEV No. | 542098 | Ref. No. — |
| | spray gun for appliances 3/8" IT L 130mm type LAINOX | | |


| | | | |
|---|--------------------------------|--------|------------------------|
| spare parts for | 361002 | | |
|  | GEV No. | 510870 | Ref. No. 191018 |
| | filter support for dosing pump | | |
|  | GEV No. | 510894 | Ref. No. 381105 |
| | press ring for membrane | | |
|  | GEV No. | 510916 | Ref. No. 330543 |
| | filter for dosing pump | | |


spare parts

| | | | |
|---|------------------------|-----------------|--------|
|  | | | |
| 1 | | | |
| GEV No. | 510916 | Ref. No. | 330543 |
| description | filter for dosing pump | | |

| | | | |
|---|--------------------------------|-----------------|--------|
|  | | | |
| 1 | | | |
| GEV No. | 510870 | Ref. No. | 191018 |
| description | filter support for dosing pump | | |

| | | | |
|---|---|-----------------|--------|
|  | | | |
| 1 | | | |
| GEV No. | 510847 | Ref. No. | 440405 |
| description | gasket polishing agent dosing ID ø 22mm ED ø 32mm external height 5mm | | |

| | | | |
|---|---|-----------------|--------|
|  | | | |
| 1 | | | |
| GEV No. | 510297 | Ref. No. | 630614 |
| description | membrane for dosing pump ED ø 83mm thickness 1mm dosing pump equiv. no. 630614 suitable for COMENDA | | |

| | | | |
|---|---|-----------------|--------|
|  | | | |
| 1 | | | |
| GEV No. | 510338 | Ref. No. | 170701 |
| description | union nut dosing pump thread 1/2" ø 32mm H 15mm for dosing pump | | |

dosing pumps

membrane dosing pumps

self-priming

various



1

| | | | |
|---|---|-----------------|------------------------|
| GEV No. | 361002 | Ref. No. | 620120 |
| description | dosing pump rinse aid inlet 6x8mm outlet 4x6mm pressure connection ø 4x6mm suction connection ø 6x8mm | | |
| spare parts for | 361002 | | |
|  | GEV No. | 510297 | Ref. No. 630614 |
| | membrane for dosing pump ED ø 83mm thickness 1mm dosing pump equiv. no. 630614 suitable for COMENDA | | |
|  | GEV No. | 510298 | Ref. No. — |
| | lip valve dosing pump suitable for DB2/DS5 | | |
|  | GEV No. | 510299 | Ref. No. 180306 |
| | hose connector for dosing pump | | |
|  | GEV No. | 510328 | Ref. No. 340483 |
| | plunger rinse aid dosing pump | | |
|  | GEV No. | 510338 | Ref. No. 170701 |
| | union nut dosing pump thread 1/2" ø 32mm H 15mm for dosing pump | | |
|  | GEV No. | 510847 | Ref. No. 440405 |
| | gasket polishing agent dosing ID ø 22mm ED ø 32mm external height 5mm | | |



self-priming with supporting pressure

HOONVED



| | | | |
|--------------------|--|-----------------|--------|
| GEV No. | 361383 | Ref. No. | 200444 |
| description | lip valve rinse aid pressure connection 8mm suction connection 8mm auxiliary pressure connectionmm | | |

accessories

container filters with non-return valve



| | | | |
|--------------------|--|-----------------|-----------|
| GEV No. | 361058 | Ref. No. | R65110650 |
| description | container filter with non-return valve SS hose ø 4x6mm ø 20mm L 56mm | | |
| For models: | ME061T, ME101T, ME102T, ME201T, MEMT06P, MEMT10P, MEMT20P, MEMT21P, MENT40P, MG102T, MG201T, MG202T, MGMT06P, MGMT10P, MGMT20P, MGMT21P, MGMT40P | | |

intake lances

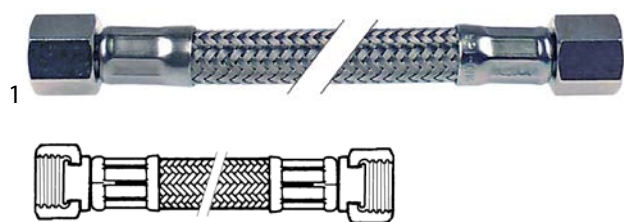


| | | | |
|--------------------|---|-----------------|--------|
| GEV No. | 361118 | Ref. No. | 180719 |
| description | intake lance with filter L 415mm ø 17mm tube ø 10mm hose ø 4x6mm cable lengthmm PVC | | |

hoses

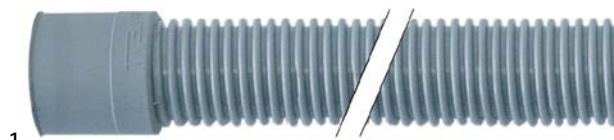
stainless steel flexi hoses

universal hoses



| | | | |
|--------------------|---|-----------------|--------|
| GEV No. | 520627 | Ref. No. | 200715 |
| description | flex hose SS braid straight-straight DN12 connections 3/4" L 2000mm approval DVGW operating p. 10bar test pressure 32bar burst p. 95bar | | |

drain hoses



| | | | |
|--------------------|--|-----------------|--------|
| GEV No. | 530587 | Ref. No. | 200721 |
| description | drain hose DN28 L 2000mm straight ø inside 32mm straight ext. ø 40mm outer hose ø 35mm | | |

industrial hoses

Niplaflex hoses



| | | | |
|--------------------|---|-----------------|--------|
| GEV No. | 530561 | Ref. No. | 200122 |
| description | pressure hose ID ø 10mm ED ø 17mm L 5m thickness 3.5mm operating p. 10bar burst p. 30bar t.max. 110°C | | |

PE hoses




| | | | |
|--------------------|---|-----------------|------------------------|
| GEV No. | 520973 | Ref. No. | R70070040 R70070050 |
| description | hose John Guest thickness 1.5mm LLDPE blue ID ø 7mm ED ø 10mm | | |


For models: GMT06D, GMT20D, GVT06D, ME061P, ME061T, ME101D, ME101M, ME101P, ME101T, ME102D, ME102M, ME102P, ME102T, ME201D, ME201M, ME201P, ME201T, ME202D, ME202M, ME202P, ME202T, MEMT06P, MEMT10D, MEMT10P, MEMT20D, MEMT20P, MEMT21D, MEMT21P, MENT40D, MENT40P, MEVT06P, MEVT10D, MEVT10P, MEVT21D, MEVT21P, MEVT40D, MEVT40P, MG061D, MG061M, MG061P, MG061T, MG101D, MG101M, MG101P, MG101T, MG102D, MG102M, MG102P, MG102T, MG201D...(Other models you can see in the webshop)


| | | | | |
|------------------------|---|--------|-----------------|-----------|
| accessories for | 520973 | | | |
| | GEV No. | 440564 | Ref. No. | — |
| | push-in fitting John Guest straight thread 1/4" BSP pipe connection ø10mm | | | |
| | GEV No. | 440565 | Ref. No. | — |
| | push-in fitting John Guest straight thread 3/8" BSP pipe connection ø10mm | | | |
| | GEV No. | 440608 | Ref. No. | — |
| | push-in fitting John Guest straight thread 1/2" BSP stub ø 10mm | | | |
| | GEV No. | 440639 | Ref. No. | — |
| | push-in fitting John Guest angled thread 1/4" BSP pipe connection ø10mm | | | |
| | GEV No. | 520359 | Ref. No. | R62090528 |
| | push-in fitting John Guest angled pipe connection ø10mm grommet ø 10mm | | | |
| | GEV No. | 520363 | Ref. No. | R62090468 |
| | push-in fitting John Guest T-piece pipe connection ø10mm - ø10mm | | | |

Table continues overleaf





| | | | |
|---|---|--------|---------------------------|
| accessories for | 520973 | | |
|  | GEV No. | 520494 | Ref. No. R62090478 |
| | push-in fitting John Guest angled pipe connection ø10mm - ø10mm | | |


| pressure control hoses | | | |
|---|---|-----------------|--------|
|  | | | |
| GEV No. | 530560 | Ref. No. | 160121 |
| description | pressure control hose ID ø 5mm ED ø 9mm L 5m operating p. 30bar burst p. 90bar temp.-resist. 60°C | | |


| PVC hoses | | | |
|---|--|-----------------|--------|
| PVC hoses without fabric | | | |
|  | | | |
| GEV No. | 520026 | Ref. No. | 160105 |
| description | PVC hose ID ø 4mm ED ø 6mm L 10m thickness 1mm t.max. 60°C transparent | | |

| | | | |
|---|--|--------|---------------------------|
| accessories for | 520026 | | |
|  | GEV No. | 361058 | Ref. No. R65110650 |
| | container filter with non-return valve SS hose ø 4x6mm L 56mm | | |
|  | GEV No. | 361066 | Ref. No. — |
| | container filter straight SS hose ø 4x6mm L 37mm non return valve ball valve | | |
|  | GEV No. | 361106 | Ref. No. — |
| | container filter with weight and non-return valve SS hose ø 4x6mm L 21mm L 51mm non return valve lip valve | | |
|  | GEV No. | 361141 | Ref. No. — |
| | container filter with weight ceramic hose ø 4mm | | |
|  | GEV No. | 361230 | Ref. No. — |
| | container filter with weight stainless steel hose ø 4x6mm | | |
|  | GEV No. | 361462 | Ref. No. — |
| | container filter with weight SS hose ø 4x6mm | | |
|  | GEV No. | 361728 | Ref. No. — |
| | container filter with 4m 4x6 hose SS hose ø 4x6mm hose length 4000mm | | |

| | | | |
|--|--|-----------------|-----------|
|  | | | |
| GEV No. | 520278 | Ref. No. | R70070100 |
| description | PVC hose ID ø 6mm ED ø 8mm L 2m thickness 1mm t.max. 60°C transparent | | |
| For models: | ME061T, ME101T, ME102T, ME201T, MEMT06P, MEMT10P, MEMT20P, MEMT21P, MEMT40P, MG102T, MG201T, MG202T, MGMT06P, MGMT10P, MGMT20P, MGMT21P, MGMT40P | | |

| silicone hoses | | | |
|--|--|-----------------|-----------|
| without fabric | | | |
|  | | | |
| GEV No. | 530899 | Ref. No. | R70060080 |
| description | silicone hose ID ø 13mm ED ø 18mm L 0.08m thickness 2.5mm red for combi-steamer | | |
| For models: | EM010M+SC, EM106H, EM106M, EM106M+SC, EM106P, EM110H, EM110M, EM110M+SC, EM110P, EM210H, EM210M, EM210M+SC, EM210P, EV006M, EV106H, EV106M, EV106M+SC, EV106P, EV110H, EV110M, EV110M+SC, EV110P, EV210H, EV210M, EV210M+SC, EV210P, GM106H, GM106M, GM106M+SC, GM106P, GM110H, GM110M, GM110M+SC, GM110P, GM210H, GM210M, GM210M+SC, GM210P, GMT06D, GMT20D, GV106H, GV106M, GV106M+SC, GV106P, GV110H, GV110M, GV110M+SC, GV110P, GV210H, GV210M...(Other models you can see in the webshop) | | |


| | | | |
|--|---|-----------------|------------------------|
|  | | | |
| GEV No. | 530884 | Ref. No. | R70060060 R70060070 |
| description | silicone hose ID ø 15mm ED ø 19mm L 0.08m thickness 3mm red for combi-steamer | | |
| For models: | CVE004H, CVE004M, CVE104H, CVE104M, CVE105H, CVE105M, CVG105H, CVG105M, EM010M+SC, EM106H, EM106M, EM106M+SC, EM106P, EM110H, EM110M, EM110M+SC, EM110P, EM210H, EM210M, EM210M+SC, EM210P, GM106H, GM106M, GM106M+SC, GM106P, GM110H, GM110M, GM110M+SC, GM110P, GM210H, GM210M, GM210M+SC, GM210P, ME106M, ME106P, ME106X, ME110M, ME110P, ME110X, ME120M, ME120P, ME120X, ME210M, ME210P, ME210X, ME220M, ME220P, ME220X, MEC24H, MEC40M...(Other models you can see in the webshop) | | |

| | | | |
|--|---|-----------------|--------------|
|  | | | |
| GEV No. | 530063 | Ref. No. | MA1036100700 |
| description | silicone hose ID ø 18mm ED ø 25mm L 1m t.max. 200°C transparent | | |



formed hoses

straight



1

| | | | |
|--------------------|---|-----------------|--------|
| GEV No. | 511362 | Ref. No. | 200758 |
| description | formed hose dishwasher straight equiv. no. 200758 | | |



1

| | | | |
|--------------------|--|-----------------|-----------|
| GEV No. | 520534 | Ref. No. | R70060040 |
| description | hose ID ø 50mm ED ø 58mm L 50mm silicone Qty 1 for combi-steamer thickness 4mm | | |
| For models: | FE105M, FE105X, FE110M, FE110X, FG105M, FG105X, FG110M, FG110X, GMT20D, ME061P, ME061T, ME101M, ME101P, ME101T, ME102M, ME102P, ME102T, ME106M, ME106P, ME106X, ME110M, ME110P, ME110X, ME120M, ME120P, ME120X, ME201D, ME201M, ME201P, ME201T, ME202D, ME202M, ME202P, ME202T, ME210M, ME210P, ME210X, ME220M, ME220P, ME220X, MEC24H, MEC40M, MEMENT21D, MEMENT21P, MEMENT40D, MEMENT40P, MEVT21D, MEVT21P, MEVT40D, MEVT40P...(Other models you can see in the webshop) | | |



1

| | | | |
|--------------------|--|-----------------|-----------|
| GEV No. | 530901 | Ref. No. | R70060050 |
| description | hose ID ø 54mm ED ø 60mm L 50mm for combi-steamer | | |
| For models: | FE210M, FG210M, FG210X, ME102P, ME102T, ME202D, ME202M, ME202P, ME202T, MEMENT40D, MEMENT40P, MEVT40D, MEVT40P, MG102P, MG102T, MG202D, MG202M, MG202P, MG202T, MGMT40D, MGMT40P, MGVT40D, MGVT40P | | |



1


| | | | |
|--------------------|--|-----------------|-----------|
| GEV No. | 694499 | Ref. No. | R70070060 |
| description | hose ID ø 7mm L 2000mm LLDPE for beverage technology ED ø 10mm John Guest | | |
| For models: | GVT20D, MACE07M, MACE10M, MACE20M, MACG07M, MACG10M, MACG20M, ME061D, MEMENT06D, MEVT06D, MEVT20D, MEVT20P, MGVT20D, MGVT20P | | |

form L



1

| | | | |
|--------------------|---|-----------------|--------|
| GEV No. | 530577 | Ref. No. | 200750 |
| description | formed hose L 350mm warewashing L-shape equiv. no. 200750 ID ø 60mm | | |



1

| | | | |
|--------------------|---|-----------------|--------|
| GEV No. | 530579 | Ref. No. | 200724 |
| description | formed hose warewashing L-shape equiv. no. 200724 | | |



1

| | | | |
|--------------------|---|-----------------|--------|
| GEV No. | 530544 | Ref. No. | 200769 |
| description | formed hose warewashing L-shape equiv. no. 200769 | | |



1

| | | | |
|--------------------|---|-----------------|--------|
| GEV No. | 511348 | Ref. No. | 200781 |
| description | formed hose warewashing L-shape equiv. no. 200781 | | |



with branch



| | | | | |
|---|--------------------|--|-----------------|-----------------------|
| 1 | GEV No. | 524930 | Ref. No. | 1036506200 2703130 |
| | description | formed hose ext. ø 62/55 D1 ø 43mm D2 ø 49mm L 170mm warewashing black | | |
| | For models: | MLC50, MLC503, MLC65, MLC653 | | |



| | | | | |
|---|--------------------|--|-----------------|--------|
| 2 | GEV No. | 511208 | Ref. No. | 200768 |
| | description | formed hose warewashing equiv. no. 200768 with piggyback | | |

form S



| | | | | |
|---|--------------------|-------------|-----------------|--------|
| 1 | GEV No. | 511226 | Ref. No. | 200755 |
| | description | formed hose | | |



| | | | | |
|---|--------------------|---|-----------------|--------|
| 1 | GEV No. | 511342 | Ref. No. | 200719 |
| | description | formed hose S-shape warewashing equiv. no. 200719 | | |

for dishwashers

miscellaneous



| | | | | |
|---|--------------------|--|-----------------|----------------------|
| 1 | GEV No. | 510806 | Ref. No. | 1036602000 160108 |
| | description | extraction hose ED ø 8mm ID ø 5mm Qty supplied by meter | | |
| | For models: | DLS30, DLS303, DLS30P, DLS30P3, DLS31, DLS313, DLS31P3, MLC50, MLC503, MLC65, MLC653, MLS30, MLS303, MLS30P, MLS30P3, MLS31, MLS313, MLS31P3, MLS35, MLS353, MPLS30P | | |



| | | | | |
|---|--------------------|---|-----------------|--------|
| 1 | GEV No. | 530590 | Ref. No. | 200117 |
| | description | hose ED ø 15mm ID ø 8mm equiv. no. 200117 Qty supplied by meter | | |



| | | | | |
|---|--------------------|-----------------------------------|-----------------|--------|
| 1 | GEV No. | 530589 | Ref. No. | 200113 |
| | description | hose ED ø 22mm ID ø 12mm L 1000mm | | |



| | | | | |
|---|--------------------|--|-----------------|--------|
| 1 | GEV No. | 511289 | Ref. No. | 161312 |
| | description | hose ED ø 9.5mm ID ø 5mm L 420mm equiv. no. 161312 | | |

fittings, hose and pipe connectors

hose connectors

without screw connection



| | | | | |
|---|--------------------|----------------------------------|-----------------|--------|
| 1 | GEV No. | 510843 | Ref. No. | 180408 |
| | description | T-piece plastic hose ø 10-6-10mm | | |



fittings

angle pieces



| | | | |
|--------------------|--|-----------------|--------|
| GEV No. | 510464 | Ref. No. | 280118 |
| description | angle piece thread 1/4" IT - 3/8" IT brass | | |



| | | | |
|--------------------|--|-----------------|-----------|
| GEV No. | 520339 | Ref. No. | R62090518 |
| description | hose connector thread 1/4" straight grommet ø 10mm grommet length 20mm WS 20 total length 37mm thread L 11mm plastic | | |
| For models: | ME061T, ME101T, ME102T, ME201T, MEMT06P, MEMT10P, MEMT20P, MEMT21P, MEMENT40P, MG102T, MG201T, MG202T, MGMT06P, MGMT10P, MGMT20P, MGMT21P, MGMT40P | | |

hose connectors

plastic



| | | | |
|--------------------|--|-----------------|-----------|
| GEV No. | 362010 | Ref. No. | R62090492 |
| description | hose connector plastic straight thread 1/4" hose ø 8mm Qty 1 pcs | | |
| For models: | ME061T, ME101T, ME102T, ME201T, MEMT06P, MEMT10P, MEMT20P, MEMT21P, MEMENT40P, MG102T, MG201T, MG202T, MGMT06P, MGMT10P, MGMT20P, MGMT21P, MGMT40P | | |



| | | | |
|--------------------|--|-----------------|-----------|
| GEV No. | 520360 | Ref. No. | R62090508 |
| description | hose connector thread 1/4" with coupling straight plastic | | |
| For models: | GVT06D, GVT20D, ME061T, ME101T, ME102T, ME201T, MEMT06P, MEMT10P, MEMT20P, MEMT21P, MEMENT40P, MEVT06D, MEVT06P, MEVT10D, MEVT10P, MEVT20D, MEVT20P, MEVT21D, MEVT21P, MEVT40D, MEVT40P, MG102T, MG201T, MG202T, MGMT06P, MGMT10P, MGMT20P, MGMT21P, MGMT40P, MGMT06D, MGMT06P, MGMT10D, MGMT10P, MGMT20D, MGMT20P, MGMT21D, MGMT21P, MGMT40D, MVE042P, MVE051P, MVG051P | | |



| | | | |
|--------------------|--|-----------------|-----------|
| GEV No. | 362011 | Ref. No. | R62090538 |
| description | hose connector plastic straight thread 1/4" hose ø 8x6mm Qty 1 pcs | | |
| For models: | ME061T, ME101T, ME102T, ME201T, MEMT06P, MEMT10P, MEMT20P, MEMT21P, MEMENT40P, MG102T, MG201T, MG202T, MGMT06P, MGMT10P, MGMT20P, MGMT21P, MGMT40P | | |



| | | | |
|--------------------|-------------------------------------|-----------------|--------|
| GEV No. | 510954 | Ref. No. | 190309 |
| description | hose connector thread 3/8" straight | | |


brass



| | | | |
|--------------------|---|-----------------|--------|
| GEV No. | 511280 | Ref. No. | 290410 |
| description | hose connector brass straight thread 1/2" hose ø 14mm Qty 1 pcs | | |



| | | | |
|--------------------|--|-----------------|--------|
| GEV No. | 510933 | Ref. No. | 180411 |
| description | T-piece connection 1/4" plastic hose ø 11-4-11mm | | |

| | | | | |
|---|---|--------|-----------------|---|
| accessories for | 510933 | | | |
|  | GEV No. | 511563 | Ref. No. | — |
| | union nut thread 1/4" connection 1/4" plastic H 17.5mm for by-pass hose ø 4mm | | | |

producer-specific



| | | | |
|--------------------|--|-----------------|-----------|
| GEV No. | 440027 | Ref. No. | R62090482 |
| description | connecting piece for hose ID 6mm WS 15 total length 79mm plastic John Guest | | |
| For models: | ME061T, ME101T, ME102T, ME201T, MEMT06P, MEMT10P, MEMT20P, MEMT21P, MEMENT40P, MG102T, MG201T, MG202T, MGMT06P, MGMT10P, MGMT20P, MGMT21P, MGMT40P | | |




| | | | |
|--------------------|----------------------------|-----------------|--------|
| GEV No. | 511277 | Ref. No. | 190330 |
| description | T-piece thread 1/2" ø 18mm | | |




push-in fittings

JOHN GUEST



| | | | |
|---|--|-----------------|-------------------|
| GEV No. | 440019 | Ref. No. | R62090548 |
| description | push-in fitting John Guest straight pipe connection ø6mm grommet ø 10mm | | |
| For models: | ME061T, ME101T, ME102T, ME201T, MEMT06P, MEMT10P, MEMT20P, MEMT21P, MEMT40P, MG102T, MG201T, MG202T, MGMT06P, MGMT10P, MGMT20P, MGMT21P, MGMT40P, MGMT40P, MGMT40P | | |
| accessories for | 440019 | | |
|  | GEV No. | 520971 | Ref. No. — |
| hose thickness 1mm LLDPE blue ID ø 4mm ED ø 6mm operating pressure at 20°C 16bar | | | |



| | | | |
|---|---|-----------------|--|
| GEV No. | 520359 | Ref. No. | R62090528 |
| description | push-in fitting John Guest angled pipe connection ø10mm grommet ø 10mm | | |
| For models: | ME061T, ME101T, ME102T, ME201T, MEMT06P, MEMT10P, MEMT20P, MEMT21P, MEMT40P, MG102T, MG201T, MG202T, MGMT06P, MGMT10P, MGMT20P, MGMT21P, MGMT40P, MGMT40P | | |
| accessories for | 520359 | | |
|  | GEV No. | 520973 | Ref. No. R70070040 R70070050 |
| hose John Guest thickness 1.5mm LLDPE blue ID ø 7mm ED ø 10mm | | | |




| | | | |
|--------------------|---|-----------------|-----------|
| GEV No. | 520493 | Ref. No. | R62090618 |
| description | hose connector John Guest straight pipe connection ø8mm - ø10mm L 41mm PM201008E NSF, SK | | |
| For models: | ME061T, ME101T, ME102T, MEMT06P, MEMT10P, MEMT20P, MEMT21P, MG102T, MG202D, MG202M, MG202P, MG202T, MGMT06P, MGMT10P, MGMT20P, MGMT21P, MGMT40D, MGMT40P, MGMT40P | | |




| | | | |
|--------------------|---|-----------------|-----------|
| GEV No. | 520492 | Ref. No. | R62090458 |
| description | push-in fitting John Guest straight pipe connection ø10mm - ø10mm | | |
| For models: | GMT06D, GMT20D, GVT06D, GVT20D, MACE04M, MACE05M, MACG05M, ME061D, ME061T, ME101D, ME101M, ME101P, ME101T, ME102D, ME102M, ME102P, ME102T, ME201D, ME201M, ME201P, ME201T, ME202D, ME202M, MEMT06D, MEMT06P, MEMT10D, MEMT10P, MEMT20D, MEMT20P, MEMT21D, MEMT21P, MEMT40D, MEMT40P, MEVT06D, MEVT06P, MEVT10D, MEVT10P, MEVT20D, MEVT20P, MEVT21D, MEVT21P, MEVT40D, MEVT40P, MG061D, MG061M, MG101D, MG101M, MG101P, MG101T, MG102D...(Other models you can see in the webshop) | | |




| | | | |
|---|--|-----------------|--|
| GEV No. | 520494 | Ref. No. | R62090478 |
| description | push-in fitting John Guest angled pipe connection ø10mm - ø10mm | | |
| For models: | GMT20D, GVT06D, GVT20D, MACE04M, MACE05M, MACE07M, MACE10M, MACE20M, MACG05M, MACG07M, MACG10M, MACG20M, ME061D, ME061P, ME061T, ME101D, ME101M, ME101P, ME101T, ME102D, ME102M, ME102P, ME102T, ME201D, ME201M, ME201P, ME201T, ME202D, ME202M, ME202P, ME202T, MEMT06D, MEMT06P, MEMT10D, MEMT10P, MEMT20D, MEMT20P, MEMT21D, MEMT21P, MEMT40D, MEMT40P, MEVT06D, MEVT06P, MEVT10D, MEVT10P, MEVT20D, MEVT20P, MEVT21D, MEVT21P, MEVT40D...(Other models you can see in the webshop) | | |
| accessories for | 520494 | | |
|  | GEV No. | 520973 | Ref. No. R70070040 R70070050 |
| hose John Guest thickness 1.5mm LLDPE blue ID ø 7mm ED ø 10mm | | | |



| | | | |
|---|---|-----------------|--|
| GEV No. | 520363 | Ref. No. | R62090468 |
| description | push-in fitting John Guest T-piece pipe connection ø10mm - ø10mm | | |
| For models: | ME061P, ME061T, ME101M, ME101P, ME101T, ME102M, ME102P, ME102T, ME201D, ME201M, ME201P, ME201T, ME202D, ME202M, ME202P, ME202T, MEMT06P, MEMT10P, MEMT20P, MEMT21D, MEMT21P, MEMT40D, MEMT40P, MEVT21D, MEVT21P, MEVT40D, MEVT40P, MG061M, MG061P, MG061T, MG101M, MG101P, MG101T, MG102M, MG102P, MG102T, MG201D, MG201M, MG201P, MG201T, MG202D, MG202M, MG202P, MG202T, MGMT06P, MGMT10P, MGMT20P, MGMT21D, MGMT21P, MGMT40D...(Other models you can see in the webshop) | | |
| accessories for | 520363 | | |
|  | GEV No. | 520973 | Ref. No. R70070040 R70070050 |
| hose John Guest thickness 1.5mm LLDPE blue ID ø 7mm ED ø 10mm | | | |



| | | | |
|---|--|-----------------|-------------------|
| GEV No. | 520495 | Ref. No. | R62090608 |
| description | push-in fitting John Guest straight thread 1/8" BSP stub ø 8mm | | |
| For models: | ME061T, ME101T, ME102T, ME201T, MEMT06P, MEMT10P, MEMT20P, MEMT21P, MEMT40P, MG102T, MG201T, MG202D, MG202M, MG202P, MG202T, MGMT06P, MGMT10P, MGMT20P, MGMT21P, MGMT40D, MGMT40P, MGMT40P | | |
| accessories for | 520495 | | |
|  | GEV No. | 520971 | Ref. No. — |
| hose thickness 1mm LLDPE blue ID ø 4mm ED ø 6mm operating pressure at 20°C 16bar | | | |



valves and tank inlets

ball valves

universal

ball valves with butterfly handle



1

| | | | |
|--------------------|--|-----------------|----------------------|
| GEV No. | 540658 | Ref. No. | 1450500 MA1450500 |
| description | ball valve connection 3/4" IT - 3/4" IT DN20 total length 69mm | | |
| For models: | CP704E, CP704G, CP92E, CP92E2, CP92G, CP94E, CP94E2, CP94G, CP95B2E, CP95B2E2, CP95B2G, CP95B4E, CP95B4E2, CP95B4G, CPE40, CPE402, CPE60, CPE602, CPE60DB, F74E10, F74E6, F76E10, F94E10, F94E6, F96E10, FR74E, FR74E10, FR74E10L, FR74E10L2, FR74G, FR77E, FR77E10, FR77E10L, FR77E10L2, FR77G, FR92E10, FR92E10L, FR92E10L2, FR92E13, FR92E22, FR92G22, FR94E10, FR94E10L, FR94E10L2, FR94E13, FR94E22, FR94G23, FR9P2E10, FR9P4E10, NF74E10...(Other models you can see in the webshop) | | |

ball valves with lever handle



1


| | | | |
|--------------------|---|-----------------|----------------------|
| GEV No. | 514325 | Ref. No. | 1950700 MA1950700 |
| description | ball valve connection 1" IT - 1" IT DN25 total length 83mm with lever handle | | |
| For models: | EF74E12, EF74G15, F12C4E12, F12C4G15, F74E10, F74E12, F74G15, F76E10, F78E12, F78G15, F94E10, F94E12, F94E18, F94E18K, F94G15, F94G22, F94G22K, F96E10, F98E12, F98E18, F98E18K, F98G15, F98G22, F98G22K, F9S4E12, F9S4E18, F9S4E18K, F9S4G15, F9S4G22, F9S4G22K, F9S8E12, F9S8E18, F9S8E18K, F9S8G15, F9S8G22, F9S8G22K, FR74E, FR74E2, FR74G, FR77E, FR77E2, FR77G, FR92E13, FR92E132, FR92E22, FR92G13, FR92G22, FR92G22T, FR94E13, FR94E132...(Other models you can see in the webshop) | | |

producer-specific

MARENO






1

| | | | |
|---|--|-----------------|---|
| GEV No. | 514400 | Ref. No. | 1031400300 1031400313 MA1031400313 |
| description | ball valve connection 1/2" IT - 1/2" IT total length 47mm handle length 68mm | | |
| For models: | CPE60, CPE602, CPE60DB, OCPE6, OCPE60 | | |
| accessories for | 514400 | | |
|  | GEV No. | 514098 | Ref. No. CM149100 CM149101 MACM149100 MACM149101 |
| extension for lever L 220mm | | | |




1

| | | | |
|---|--|-----------------|---|
| GEV No. | 514097 | Ref. No. | CR0412260 |
| description | ball valve inlet 1" IT outlet 1" IT L 84mm H 82mm | | |
| For models: | PC12C4E, PC12C4G, PC12C9E, PC12C9G, PC74E, PC74G, PC76E, PC76G, PC78E, PC78G, PC94E, PC94G, PC96E, PC96G, PC98E, PC98G | | |
| accessories for | 514097 | | |
|  | GEV No. | 514059 | Ref. No. CM155200 MACM155200 |
| lever | | | |
|  | GEV No. | 514098 | Ref. No. CM149100 CM149101 MACM149100 MACM149101 |
| extension for lever L 220mm | | | |
|  | GEV No. | 514099 | Ref. No. 1515900 MA1515900 |
| centring piece L 20mm for extension thread ID ø 10mm D1 ø 18mm D2 ø 20mm | | | |



1

| | | | |
|---|--|-----------------|---|
| GEV No. | 540698 | Ref. No. | 1031401900 MA1031401900 |
| description | ball valve inlet 1/2" IT outlet 1/2" ET L 59mm without handle shaft ø 10x7mm | | |
| For models: | FQE6, FQE6+6 | | |
| accessories for | 540698 | | |
|  | GEV No. | 514059 | Ref. No. CM155200 MACM155200 |
| lever | | | |
|  | GEV No. | 514098 | Ref. No. CM149100 CM149101 MACM149100 MACM149101 |
| extension for lever L 220mm | | | |
|  | GEV No. | 514099 | Ref. No. 1515900 MA1515900 |
| centring piece L 20mm for extension thread ID ø 10mm D1 ø 18mm D2 ø 20mm | | | |




1


| | | | |
|--------------------|--|-----------------|--|
| GEV No. | 514098 | Ref. No. | CM149100 CM149101 MACM149100 MACM149101 |
| description | extension for lever L 220mm | | |
| For models: | PC74E, PC74G, PC76E, PC76G, PC78E, PC78G, PC94E, PC94G, PC96E, PC96G, PC98E, PC98G, PC9S4E, PC9S4G, PC9S6E, PC9S6G, PC9S8E, PC9S8G | | |

| | | | |
|---|---|-----------------|----------------------|
|  | | | |
| 1 | | | |
| GEV No. | 514492 | Ref. No. | 2863500 MA2863500 |
| description | handle for drain tap shaft diameter 6x6mm L 70mm H 37mm | | |
| For models: | BR94E, BR94EI, BR94G, BR94GI, BR9M4E, BR9M4EI, BR9M4G, BR9M4GI, BR9M6E, BR9M6EI, BR9M6G, BR9M6GI, BR9SB4E, BR9SB4EI, BR9SB4G, BR9SB4GI, CP9A15GD, CSM102E, CSM102EP, CSM102G, CSM102GP, CSM10E, CSM10EP, CSM10G, CSM10GP, CSM201E, CSM201EP, CSM201G, CSM201GP, CSM202E, CSM202EP, CSM202G, CSM202GP, CSM6E, CSM6EP, CSM6G, CSM6GP, NPC94E, NPC94G, NPC96E, NPC96G, NPC98E, NPC98G, PC74E, PC74G, PC76E, PC76G, PC78E, PC78G, PC94E...(Other models you can see in the webshop) | | |

ball valves electric




| | | | |
|---|---|-----------------|-----------|
|  | | | |
| 1 | | | |
| GEV No. | 403026 ¹ | Ref. No. | R65110540 |
| description | ball valve inlet 1/2" IT outlet 1/2" IT 230V L 90mm 50/60Hz off-current open mode of operation electric W 60mm H 100mm connection cable 450mm IT 1/2" | | |
| For models: | EM010M+SC, EM106H, EM106M, EM106M+SC, EM106P, EM110H, EM110M, EM110M+SC, EM110P, EM210H, EM210M, EM210M+SC, EM210P, GM106H, GM106M, GM106M+SC, GM106P, GM110H, GM110M, GM110M+SC, GM110P, GM210H, GM210M, GM210M+SC, GM210P, ME106M, ME106P, ME106X, ME110M, ME110P, ME110X, ME120M, ME120P, ME120X, ME210M, ME210P, ME210X, ME220M, ME220P, ME220X, MEC24H, MEC40M, MG106M, MG106P, MG106X, MG110M, MG110P, MG110X, MG120M, MG120P...(Other models you can see in the webshop) | | |

¹off-current open

| | | | |
|---|--|-----------------|-----------|
|  | | | |
| 1 | | | |
| GEV No. | 403042 | Ref. No. | R65110560 |
| description | ball valve inlet 3/4" IT outlet 3/4" IT 230V L 68mm closed off-current mode of operation electric connection cable 400mm | | |
| For models: | GMT06D, GMT20D, ME061D, ME061P, ME061T, ME101D, ME101M, ME101P, ME101T, ME102D, ME102M, ME102P, ME102T, ME201D, ME201M, ME201P, ME201T, ME202D, ME202M, ME202P, ME202T, MEMT06D, MEMT06P, MEMT10D, MEMT10P, MEMT20D, MEMT20P, MEMT21D, MEMT21P, MEMT40D, MEMT40P, MG061D, MG061M, MG061P, MG061T, MG101D, MG101M, MG101P, MG101T, MG102D, MG102M, MG102P, MG102T, MG201D, MG201M, MG201P, MG201T, MG202D, MG202M, MG202P...(Other models you can see in the webshop) | | |

shut-off valves

universal

| | | | | |
|--|--|-----------------|--------------------------------|--------------------|
|  | | | | |
| 1 | | | | |
| GEV No. | 514052 | Ref. No. | 1475300 700700 MA1475300 | |
| description | shut-off valve connection 1/2" 1/2" straight total length 123mm mounting pos. | | | |
| For models: | BR94E, BR94EI, BR94G, BR94GI, BR96G, BR96GI, BR9M4E, BR9M4EI, BR9M4G, BR9M4GI, BR9M6E, BR9M6EI, BR9M6G, BR9M6GI, BR9SB4E, BR9SB4EI, BR9SB4G, BR9SB4GI, CP92E, CP92E2, CP92G, CP94E, CP94E2, CP94G, CP95B2E, CP95B2E2, CP95B2G, CP95B4E, CP95B4E2, CP95B4G, P9D2G | | | |
| spare parts for | 514052 | | | |
|  | GEV No. | 514244 | Ref. No. | 955600 MA955600 |
| | tap head without handle T1: 26x19G engagement length H1 38mm shaft length H3 52mm shaft ø 6/12mm rosette thread G2 32x19G | | | |
| accessories for | 514052 | | | |
|  | GEV No. | 693081 | Ref. No. | 832400 MA832400 |
| | cross handle ø 80mm H 40mm shaft diameter 9x9mm marking blue chrome-plated brass suitable for MONOLITH | | | |

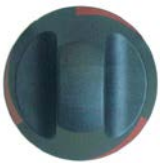
producer-specific


MARENO




| | | | |
|---|---|-----------------|--------------------|
|  | | | |
| 1 | | | |
| GEV No. | 693081 | Ref. No. | 832400 MA832400 |
| description | cross handle ø 80mm H 40mm shaft diameter 9x9mm marking blue chrome-plated brass suitable for MONOLITH | | |
| For models: | B9SB2E, B9SB2G, B9SB4E, B9SB4G, B9V2E, B9V2G, B9V4E, B9V4G, BR94E, BR94EI, BR94G, BR94GI, BR96G, BR96GI, BR9M4E, BR9M4EI, BR9M4G, BR9M4GI, BR9M6E, BR9M6EI, BR9M6G, BR9M6GI, BR9SB4E, BR9SB4EI, BR9SB4G, BR9SB4GI, CP92E, CP92E2, CP92G, CP94E, CP94E2, CP94G, CP95B2E, CP95B2E2, CP95B2G, CP95B4E, CP95B4E2, CP95B4G, P9D10E, P9D10G, P9D15E, P9D15G, P9D2G, P9D5G, P9DA10E, P9DA10G, P9DA15E, P9DA15G, P9DSB10E, P9DSB10G...(Other models you can see in the webshop) | | |



| | | | |
|---|---|-----------------|------------------------|
|  | | | |
| 1 | | | |
| GEV No. | 514061 | Ref. No. | CM143100 MACM143100 |
| description | knob water cold t.max.°C ø 67mm shaft ø 10x8mm shaft flat variable | | |
| For models: | BR78EF, BR78EI, BR78GF, BR78GI, BR912EFM, BR912EIM, BR912GFM, BR912GIM, BR98EF, BR98EFM, BR98EI, BR98EIM, BR98GF, BR98GFM, BR98GI, BR98GIM, BR9S8EF, BR9S8EI, BR9S8GF, BR9S8GI, PC12C4E, PC12C4G, PC12C9E, PC12C9G, PC74E, PC74G, PC76E, PC76G, PC78E, PC78G, PC94E, PC94G, PC96E, PC96G, PC98E, PC98G, PC9S4E, PC9S4G, PC9S6E, PC9S6G, PC9S8E, PC9S8G, PD96G5, PD98E10, PD98E15, PD98G10, PD98G15, PD98G15A, PD9S8E10, PD9S8G10... (Other models you can see in the webshop) | | |




| | | | |
|---|--|-----------------|------------------------|
|  | | | |
| 2 | | | |
| GEV No. | 514245 | Ref. No. | CM143200 MACM143200 |
| description | knob water hot t.max.°C ø 67mm shaft ø 10x8mm shaft flat variable | | |
| For models: | PD96G5, PD98E10, PD98E15, PD98G10, PD98G15, PD98G15A, PD9S8E10, PD9S8G10, PI96E5, PI96G5, PI98E10, PI98E15, PI98G10, PI98G14, PI98G14A, PI9S8E10 | | |



| | | | |
|---|----------------|-----------------|--------------------|
|  | | | |
| 1 | | | |
| GEV No. | 514055 | Ref. No. | 700714 MA700714 |
| description | shut-off valve | | |
| For models: | CP704E, CP704G | | |


| | | | |
|--|--|-----------------|--------------------------------|
|  | | | |
| 1 | | | |
| GEV No. | 514052 | Ref. No. | 1475300 700700 MA1475300 |
| description | shut-off valve connection 1/2" 1/2" straight total length 123mm mounting pos. | | |
| For models: | BR94E, BR94EI, BR94G, BR94GI, BR96G, BR96GI, BR9M4E, BR9M4EI, BR9M4G, BR9M4GI, BR9M6E, BR9M6EI, BR9M6G, BR9M6GI, BR9SB4E, BR9SB4EI, BR9SB4G, BR9SB4GI, CP92E, CP92E2, CP92G, CP94E, CP94E2, CP94G, CP9SB2E, CP9SB2E2, CP9SB2G, CP9SB4E, CP9SB4E2, CP9SB4G, P9D2G | | |
| spare parts for | 514052 | | |
| |  | GEV No. | 514244 |
| | | Ref. No. | 955600 MA955600 |
| | tap head without handle T1: 26x19G engagement length H1 38mm shaft length H3 52mm shaft ø 6/12mm rosette thread G2 32x19G | | |
| accessories for | 514052 | | |
| |  | GEV No. | 693081 |
| | | Ref. No. | 832400 MA832400 |
| | cross handle ø 80mm H 40mm shaft diameter 9x9mm marking blue chrome-plated brass suitable for MONOLITH | | |


| | | | |
|---|--|-----------------|------------------------|
|  | | | |
| 1 | | | |
| GEV No. | 540930 | Ref. No. | CM127800 MACM127800 |
| description | shut-off valve connection 1/2" 1/2" total length 48mm mounting pos. left shaft ø 8x10mm shaft L 61mm marking S rosette thread G2 27x19G | | |
| For models: | BR78EF, BR78EI, BR78GF, BR78GI, BR912EFM, BR912EIM, BR912GFM, BR912GIM, BR98EF, BR98EFM, BR98EI, BR98EIM, BR98GF, BR98GFM, BR98GI, BR98GIM, BR9S8EF, BR9S8EI, BR9S8GF, BR9S8GI, DE92142, DE94242, PC12C4E, PC12C4G, PC12C9E, PC12C9G, PC74E, PC74G, PC76E, PC76G, PC78E, PC78G, PC94E, PC94G, PC96E, PC96G, PC98E, PC98G, PC9S4E, PC9S4G, PC9S6E, PC9S6G, PC9S8E, PC9S8G, PD96G5, PD98E10, PD98E15, PD98G10, PD98G15, PD98G15A...(Other models you can see in the webshop) | | |
| spare parts for | 540930 | | |
| |  | GEV No. | 111642 |
| | | Ref. No. | — |
| | knob water cold ø 70mm shaft ø 10x8mm shaft flat upper black H 39mm | | |
| |  | GEV No. | 111678 |
| | | Ref. No. | — |
| | knob water hot ø 70mm shaft ø 10x8mm shaft flat upper black/red H 29mm | | |
| |  | GEV No. | 514061 |
| | | Ref. No. | CM143100 MACM143100 |
| | knob water cold t.max.°C ø 67mm shaft ø 10x8mm shaft flat variable | | |

Table continues overleaf

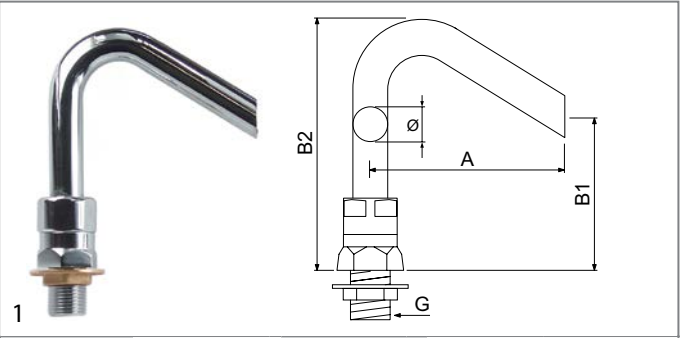
| | | | | |
|---|--|--------|----------|------------------------|
| spare parts for 540930 | | | | |
|  | GEV No. | 514083 | Ref. No. | — |
| | rosette connection 27x19G chrome-plated total lengthmm mounting pos. | | | |
|  | GEV No. | 514084 | Ref. No. | — |
| | nut thread 27x19G WS 34 | | | |
|  | GEV No. | 514245 | Ref. No. | CM143200 MACM143200 |
| | knob water hot t.max.°C ø 67mm shaft ø 10x8mm shaft flat variable | | | |





| | | | | |
|---|--|----------|--------------------|--------------------|
|  | | | | |
| 1 | | | | |
| GEV No. | 514244 | Ref. No. | 955600 MA955600 | |
| description | tap head without handle T1: 26x19G engagement length H1 38mm shaft length H3 52mm shaft ø 6/12mm rosette thread G2 32x19G | | | |
| For models: | B9SB4E, B9V4E, P9D10E, P9D10G, P9D15E, P9D15G, P9D5G, P9DA10E, P9DA10G, P9DA15E, P9DA15G, P9DSB10E, P9DSB10G, P9I10E, P9I10G, P9I15E, P9I5G, P9IA10E, P9IA10G, P9IA15E, PDASB10E, PDASB10G | | | |
| accessories for | 514244 | | | |
|  | GEV No. | 693081 | Ref. No. | 832400 MA832400 |
| | cross handle ø 80mm H 40mm shaft diameter 9x9mm marking blue chrome-plated brass suitable for MONOLITH | | | |




| | | | | |
|---|--|----------|--------------------|--|
| accessories | | | | |
|  | | | | |
| 1 | | | | |
| GEV No. | 514247 | Ref. No. | 675100 MA675100 | |
| description | marking cap for handle blue | | | |
| For models: | B9SB2E, B9SB2G, B9SB4E, B9SB4G, B9V2E, B9V2G, B9V4E, B9V4G, BR94E, BR94EI, BR94G, BR94GI, BR96G, BR96GI, BR9M4E, BR9M4EI, BR9M4G, BR9M4GI, BR9M6E, BR9M6EI, BR9M6G, BR9M6GI, BR9SB4E, BR9SB4EI, BR9SB4G, BR9SB4GI, CP92E, CP92E2, CP92G, CP94E, CP94E2, CP94G, CP9SB2E, CP9SB2E2, CP9SB2G, CP9SB4E, CP9SB4E2, CP9SB4G, P9D10E, P9D10G, P9D15E, P9D15G, P9D2G, P9D5G, P9DA10E, P9DA10G, P9DA15E, P9DA15G, P9DSB10E, P9DSB10G... (Other models you can see in the webshop) | | | |

| | | | | |
|---|---|----------|--------------------|--|
|  | | | | |
| 1 | | | | |
| GEV No. | 514246 | Ref. No. | 677700 MA677700 | |
| description | marking cap for handle red | | | |
| For models: | P9D10E, P9D10G, P9D15E, P9D15G, P9D5G, P9DA10E, P9DA10G, P9DA15E, P9DA15G, P9DSB10E, P9DSB10G, P9I10E, P9I10G, P9I15E, P9I5G, P9IA10E, P9IA10G, P9IA15E, PDASB10E, PDASB10G | | | |

inlet taps



| | | | | |
|---|--|----------|--------------------|---|
| GEV No. | 540950 | Ref. No. | 450000 MA450000 | |
| description | inlet spout connection 1/2" ET tube ø 18mm projection 105mm overall height 130mm spout height 70mm rotation 90° | | | |
| For models: | CP92E, CP92E2, CP92G, CP94E, CP94E2, CP94G, CP9SB2E, CP9SB2E2, CP9SB2G, CP9SB4E, CP9SB4E2, CP9SB4G, P9D10E, P9D10G, P9D15E, P9D15G, P9D2G, P9D5G, P9DA10E, P9DA10G, P9DA15E, P9DA15G, P9DSB10E, P9DSB10G, P9I10E, P9I10G, P9I15E, P9I5G, P9IA10E, P9IA10G, P9IA15E, PC12C4E, PC12C4G, PC12C9E, PC12C9G, PC74E, PC74G, PC76E, PC76G, PC78E, PC78G, PC94E, PC94G, PC96E, PC96G, PC98E, PC98G, PC9S4E, PC9S4G, PC9S6E...(Other models you can see in the webshop) | | | |
| spare parts for | 540950 | | | |
|  | GEV No. | 511470 | Ref. No. | — |
| | nut thread 1/2" ø 40mm H 8mm WS 25 brass Qty 1 pcs | | | |
|  | GEV No. | 512071 | Ref. No. | — |
| | O-ring EPDM thickness 2.62mm ID ø 22.22mm Qty 1 pcs | | | |
| accessories for | 540950 | | | |
|  | GEV No. | 511474 | Ref. No. | — |
| | flat washer for thread 1/2" | | | |
|  | GEV No. | 511477 | Ref. No. | — |
| | flat gasket rubber ED ø 42mm ID ø 21mm thickness 2mm Qty 1 pcs | | | |

| | | | | |
|--|--|----------|------------|----------------------|
|  | | | | |
| 1 | | | | |
| GEV No. | 514401 | Ref. No. | 1031112300 | |
| description | inlet spout connection M16x1.5 tube ø 10mm projection 48mm overall height 35mm spout height 15mm rotation° | | | |
| For models: | CPE60, CPE602, CPE60DB, OCPE6, OCPE60 | | | |
| accessories for | 514401 | | | |
|  | GEV No. | 101278 | Ref. No. | 867-20 MA86720 |
| | olive for pipe ø 10mm Qty 1 pcs | | | |
|  | GEV No. | 101300 | Ref. No. | 1326500 MA1326500 |
| | union nut thread M16x1.5 tube ø 10mm | | | |



drain systems and wash basins

drain fittings

universal



1

| | | | |
|------------------------|---|-----------------|----------------------------|
| GEV No. | 515042 | Ref. No. | 1031402200 MA1031402200 |
| description | drain fitting size 1½" usable heightmm overall height 32mm ED ø 69mm chrome-plated brass | | |
| For models: | LA60, OLA60 | | |
| accessories for | 515042 | | |
| | GEV No. | 515051 | Ref. No. — |
| | standpipe size 1½" usable height 170mm overall height 185mm ED ø 40mm SS | | |
| | GEV No. | 515052 | Ref. No. — |
| | standpipe size 1½" usable height 220mm overall height 235mm ED ø 40mm SS | | |
| | GEV No. | 515053 | Ref. No. — |
| | standpipe size 1½" usable height 260mm overall height 275mm ED ø 40mm SS | | |
| | GEV No. | 515054 | Ref. No. — |
| | standpipe size 1½" usable height 310mm overall height 325mm ED ø 40mm SS | | |
| | GEV No. | 515062 | Ref. No. — |
| | standpipe size 1½" usable height 190mm overall height 200mm ED ø 46mm chrome-plated brass with filter | | |
| | GEV No. | 515063 | Ref. No. — |
| | standpipe size 1½" usable height 230mm overall height 240mm ED ø 46mm chrome-plated brass with filter | | |
| | GEV No. | 515064 | Ref. No. — |
| | standpipe size 1½" usable height 280mm overall height 290mm ED ø 46mm chrome-plated brass with filter | | |

standpipes

¾"



1

| | | | |
|--------------------|--|-----------------|----------------------|
| GEV No. | 515118 | Ref. No. | 4330200 MA4330200 |
| description | standpipe size ¾" usable height 38mm overall height 64mm ED ø 20mm chrome-plated brass with O-ring | | |
| For models: | SNA12, SNA16, SNA20, SNAC12, SNAC16, SNAC20, SNG08, SNG12, SNG16, SNG20, SVAC16, SVAC20, SVCG08, SVCG12, SVCG16, SVCG20, SVCG8 | | |

1¼"



1

| | | | |
|------------------------|---|-----------------|----------------------------|
| GEV No. | 515042 | Ref. No. | 1031402200 MA1031402200 |
| description | drain fitting size 1¼" usable heightmm overall height 32mm ED ø 69mm chrome-plated brass | | |
| For models: | LA60, OLA60 | | |
| accessories for | 515042 | | |
| | GEV No. | 515051 | Ref. No. — |
| | standpipe size 1¼" usable height 170mm overall height 185mm ED ø 40mm SS | | |
| | GEV No. | 515052 | Ref. No. — |
| | standpipe size 1¼" usable height 220mm overall height 235mm ED ø 40mm SS | | |
| | GEV No. | 515053 | Ref. No. — |
| | standpipe size 1¼" usable height 260mm overall height 275mm ED ø 40mm SS | | |
| | GEV No. | 515054 | Ref. No. — |
| | standpipe size 1¼" usable height 310mm overall height 325mm ED ø 40mm SS | | |
| | GEV No. | 515062 | Ref. No. — |
| | standpipe size 1¼" usable height 190mm overall height 200mm ED ø 46mm chrome-plated brass with filter | | |
| | GEV No. | 515063 | Ref. No. — |
| | standpipe size 1¼" usable height 230mm overall height 240mm ED ø 46mm chrome-plated brass with filter | | |
| | GEV No. | 515064 | Ref. No. — |
| | standpipe size 1¼" usable height 280mm overall height 290mm ED ø 46mm chrome-plated brass with filter | | |

1½"








1






| | | | |
|------------------------|---|-----------------|----------------------------|
| GEV No. | 515042 | Ref. No. | 1031402200 MA1031402200 |
| description | drain fitting size 1½" usable heightmm overall height 32mm ED ø 69mm chrome-plated brass | | |
| For models: | LA60, OLA60 | | |
| accessories for | 515042 | | |
| | GEV No. | 515051 | Ref. No. — |
| | standpipe size 1½" usable height 170mm overall height 185mm ED ø 40mm SS | | |
| | GEV No. | 515052 | Ref. No. — |
| | standpipe size 1½" usable height 220mm overall height 235mm ED ø 40mm SS | | |
| | GEV No. | 515053 | Ref. No. — |
| | standpipe size 1½" usable height 260mm overall height 275mm ED ø 40mm SS | | |
| | GEV No. | 515054 | Ref. No. — |
| | standpipe size 1½" usable height 310mm overall height 325mm ED ø 40mm SS | | |
| | GEV No. | 515062 | Ref. No. — |
| | standpipe size 1½" usable height 190mm overall height 200mm ED ø 46mm chrome-plated brass with filter | | |




Table continues overleaf











| | | | | |
|---|---|--------|----------|---|
| accessories for | 515042 | | | |
|  | GEV No. | 515063 | Ref. No. | — |
| | standpipe size 1½" usable height 230mm overall height 240mm ED ø 46mm chrome-plated brass with filter | | | |
|  | GEV No. | 515064 | Ref. No. | — |
| | standpipe size 1½" usable height 280mm overall height 290mm ED ø 46mm chrome-plated brass with filter | | | |

| | | | | |
|--|---|-----------------|----------------------------|---|
|  <p>1</p> | | | | |
| GEV No. | 515042 | Ref. No. | 1031402200 MA1031402200 | |
| description | drain fitting size 1½" usable height 32mm overall height 32mm ED ø 69mm chrome-plated brass | | | |
| For models: | LA60, OLA60 | | | |
| accessories for | 515042 | | | |
|  | GEV No. | 515051 | Ref. No. | — |
| | standpipe size 1½" usable height 170mm overall height 185mm ED ø 40mm SS | | | |
|  | GEV No. | 515052 | Ref. No. | — |
| | standpipe size 1½" usable height 220mm overall height 235mm ED ø 40mm SS | | | |
|  | GEV No. | 515053 | Ref. No. | — |
| | standpipe size 1½" usable height 260mm overall height 275mm ED ø 40mm SS | | | |
|  | GEV No. | 515054 | Ref. No. | — |
| | standpipe size 1½" usable height 310mm overall height 325mm ED ø 40mm SS | | | |
|  | GEV No. | 515062 | Ref. No. | — |
| | standpipe size 1½" usable height 190mm overall height 200mm ED ø 46mm chrome-plated brass with filter | | | |
|  | GEV No. | 515063 | Ref. No. | — |
| | standpipe size 1½" usable height 230mm overall height 240mm ED ø 46mm chrome-plated brass with filter | | | |
|  | GEV No. | 515064 | Ref. No. | — |
| | standpipe size 1½" usable height 280mm overall height 290mm ED ø 46mm chrome-plated brass with filter | | | |

| | | | | |
|--|---|-----------------|----------------------------|---|
|  <p>1</p> | | | | |
| GEV No. | 515042 | Ref. No. | 1031402200 MA1031402200 | |
| description | drain fitting size 1½" usable height 32mm overall height 32mm ED ø 69mm chrome-plated brass | | | |
| For models: | LA60, OLA60 | | | |
| accessories for | 515042 | | | |
|  | GEV No. | 515051 | Ref. No. | — |
| | standpipe size 1½" usable height 170mm overall height 185mm ED ø 40mm SS | | | |
|  | GEV No. | 515052 | Ref. No. | — |
| | standpipe size 1½" usable height 220mm overall height 235mm ED ø 40mm SS | | | |
|  | GEV No. | 515053 | Ref. No. | — |
| | standpipe size 1½" usable height 260mm overall height 275mm ED ø 40mm SS | | | |
|  | GEV No. | 515054 | Ref. No. | — |
| | standpipe size 1½" usable height 310mm overall height 325mm ED ø 40mm SS | | | |

| | | | | |
|---|---|--------|----------|---|
| accessories for | 515042 | | | |
|  | GEV No. | 515062 | Ref. No. | — |
| | standpipe size 1½" usable height 190mm overall height 200mm ED ø 46mm chrome-plated brass with filter | | | |
|  | GEV No. | 515063 | Ref. No. | — |
| | standpipe size 1½" usable height 230mm overall height 240mm ED ø 46mm chrome-plated brass with filter | | | |
|  | GEV No. | 515064 | Ref. No. | — |
| | standpipe size 1½" usable height 280mm overall height 290mm ED ø 46mm chrome-plated brass with filter | | | |

| | | | | |
|--|---|-----------------|----------------------------|---|
|  <p>1</p> | | | | |
| GEV No. | 515042 | Ref. No. | 1031402200 MA1031402200 | |
| description | drain fitting size 1½" usable height 32mm overall height 32mm ED ø 69mm chrome-plated brass | | | |
| For models: | LA60, OLA60 | | | |
| accessories for | 515042 | | | |
|  | GEV No. | 515051 | Ref. No. | — |
| | standpipe size 1½" usable height 170mm overall height 185mm ED ø 40mm SS | | | |
|  | GEV No. | 515052 | Ref. No. | — |
| | standpipe size 1½" usable height 220mm overall height 235mm ED ø 40mm SS | | | |
|  | GEV No. | 515053 | Ref. No. | — |
| | standpipe size 1½" usable height 260mm overall height 275mm ED ø 40mm SS | | | |
|  | GEV No. | 515054 | Ref. No. | — |
| | standpipe size 1½" usable height 310mm overall height 325mm ED ø 40mm SS | | | |
|  | GEV No. | 515062 | Ref. No. | — |
| | standpipe size 1½" usable height 190mm overall height 200mm ED ø 46mm chrome-plated brass with filter | | | |
|  | GEV No. | 515063 | Ref. No. | — |
| | standpipe size 1½" usable height 230mm overall height 240mm ED ø 46mm chrome-plated brass with filter | | | |
|  | GEV No. | 515064 | Ref. No. | — |
| | standpipe size 1½" usable height 280mm overall height 290mm ED ø 46mm chrome-plated brass with filter | | | |










| | | | | |
|--|---|-----------------|----------------------------|---|
| producer-specific | | | | |
| MARENO | | | | |
|  <p>1</p> | | | | |
| GEV No. | 515042 | Ref. No. | 1031402200 MA1031402200 | |
| description | drain fitting size 1½" usable height 32mm overall height 32mm ED ø 69mm chrome-plated brass | | | |
| For models: | LA60, OLA60 | | | |
| accessories for | 515042 | | | |
|  | GEV No. | 515051 | Ref. No. | — |
| | standpipe size 1½" usable height 170mm overall height 185mm ED ø 40mm SS | | | |
|  | GEV No. | 515052 | Ref. No. | — |
| | standpipe size 1½" usable height 220mm overall height 235mm ED ø 40mm SS | | | |

Table continues overleaf



| accessories for | | 515042 | |
|---|---|--------|------------|
|  | GEV No. | 515053 | Ref. No. — |
| | standpipe size 1½" usable height 260mm overall height 275mm ED ø 40mm SS | | |
|  | GEV No. | 515054 | Ref. No. — |
| | standpipe size 1½" usable height 310mm overall height 325mm ED ø 40mm SS | | |
|  | GEV No. | 515062 | Ref. No. — |
| | standpipe size 1½" usable height 190mm overall height 200mm ED ø 46mm chrome-plated brass with filter | | |
|  | GEV No. | 515063 | Ref. No. — |
| | standpipe size 1½" usable height 230mm overall height 240mm ED ø 46mm chrome-plated brass with filter | | |
|  | GEV No. | 515064 | Ref. No. — |
| | standpipe size 1½" usable height 280mm overall height 290mm ED ø 46mm chrome-plated brass with filter | | |

| | | | |
|---|--|----------|----------------------------|
|  | 1 | | |
| GEV No. | 515086 | Ref. No. | 1031402300 MA1031402300 |
| description | standpipe usable height 135mm overall height 150mm size 1½" SS ED ø 40mm | | |
| For models: | LA60, OLA60 | | |

U-bends

| | | | |
|---|---|----------|----------------------------|
|  | 1 | | |
| GEV No. | 515122 | Ref. No. | 1031402400 MA1031402400 |
| description | drain connection thread 1½" hose ø 50mm | | |
| For models: | LA60, OLA60 | | |

beverage technology


valves

non-return valves

| | | | |
|---|--|----------|-----------|
|  | 1 | | |
| GEV No. | 440026 | Ref. No. | R62300018 |
| description | non-return valve kit John Guest pipe connection ø10x10mm operating pressure at 20°C 10bar opening pressure 0.02bar POM | | |
| For models: | ME061T, ME101T, ME102T, ME201T, MG102T, MG201T, MG202T | | |

water cycle components

supply filters


| | | | |
|--|--|----------|--------|
|  | 1 | | |
| GEV No. | 510836 | Ref. No. | 620209 |
| description | supply filter thread 3/4" ET - 3/4" IT total length 76mm plastic | | |

ancillary products


clamps

hose clamps


DIN 3017 - W2


| | | | |
|--|--|----------|--------|
|  | 1 | | |
| GEV No. | 520111 | Ref. No. | 450102 |
| description | hose clamp ø 10-16mm width 9mm Qty 10 pcs DIN 3017 | | |


| | | | |
|--|---|----------|---------------------|
|  | 1 | | |
| GEV No. | 520112 | Ref. No. | 450103 R61630011 |
| description | hose clamp ø 12-20mm width 9mm Qty 10 pcs DIN 3017 | | |
| For models: | CVE004H, CVE004M, CVE104H, CVE104M, CVE105H, CVE105M, CVG105H, CVG105M, EC106M, EC110M, EC210M, EM010M+SC, EM106H, EM106M, EM106M+SC, EM106P, EM110H, EM110M, EM110M+SC, EM110P, EM210H, EM210M, EM210M+SC, EM210P, EV006M, EV106H, EV106M, EV106M+SC, EV106P, EV110H, EV110M, EV110M+SC, EV110P, EV210H, EV210M, EV210M+SC, EV210P, GC106M, GC110M, GC210M, GM106H, GM106M, GM106M+SC, GM106P, GM110H, GM110M, GM110M+SC, GM110P, GM210H, GM210M...(Other models you can see in the webshop) | | |

| | | | |
|--|--|----------|--------|
|  | 1 | | |
| GEV No. | 520113 | Ref. No. | 450104 |
| description | hose clamp ø 16-27mm width 9mm Qty 10 pcs DIN 3017 | | |



| | | | |
|---|--|-----------------|--------|
|  | | | |
| 1 | | | |
| GEV No. | 520115 | Ref. No. | 450105 |
| description | hose clamp ø 25-40mm width 9mm Qty 10 pcs DIN 3017 | | |


| | | | |
|---|---|-----------------|--------|
|  | | | |
| 1 | | | |
| GEV No. | 520116 | Ref. No. | 450107 |
| description | hose clamp ø 32-50mm width 9mm Qty 5 pcs DIN 3017 | | |


| | | | |
|---|---|-----------------|--------|
|  | | | |
| 1 | | | |
| GEV No. | 520119 | Ref. No. | 450119 |
| description | hose clamp ø 60-80mm width 9mm Qty 5 pcs DIN 3017 | | |

| | | | |
|--|---|-----------------|--------|
|  | | | |
| 1 | | | |
| GEV No. | 520117 | Ref. No. | 450135 |
| description | hose clamp stainless steel ø 40-60mm width 9mm Qty 5 pcs DIN 3017 | | |

double wire clamps

| | | | |
|---|--|-----------------|--------|
|  | | | |
| 1 | | | |
| GEV No. | 511286 | Ref. No. | 450143 |
| description | hose clamp ø 38mm wire gauge ø 3.2mm Qty 1 pcs | | |


| | | | |
|---|---|-----------------|--------|
|  | | | |
| 1 | | | |
| GEV No. | 510959 | Ref. No. | 450115 |
| description | hose clamp ø 8mm wire gauge ø 1mm Qty 1 pcs | | |


| | | | |
|--|---|-----------------|--------|
|  | | | |
| 1 | | | |
| GEV No. | 511147 | Ref. No. | 450125 |
| description | wire clamp ø 12-14mm wire gauge ø 1.5mm zinc-coated steel Qty 1 pcs | | |

tools

cleaning tools

scrapers

| | | | |
|--|-------------------------------------|-----------------|----------------------|
|  | | | |
| 1 | | | |
| GEV No. | 705008 | Ref. No. | 2510513 BN2510513 |
| description | scraper for griddle | | |
| spare parts for | 705008 | | |
| | GEV No. | 705021 | Ref. No. |
| | | | — |
| | spare blades for scraper Qty 10 pcs | | |

| | | | |
|---|---|-----------------|--|
|  | | | |
| 1 | | | |
| GEV No. | 705009 | Ref. No. | 1030000600 2510513 (old version) BN2510513 (old version) MA1030000600 |
| description | scraper for griddle W 80mm | | |
| For models: | BIE40, BIE40B, BIE60, BIE60B, BIG40, BIG60, EFT74ELVG, EFT74ERVG, EFT74GLVG, EFT74GRVG, EFT78ELVG, EFT78EMVG, EFT78GLVG, EFT78GMVG, F9V2E, F9V2E2, F9V2ER, F9V2ER2, F9V4E, F9V4E2, F9V4EC, F9V4EC2, F9V4ECRL, F9V4ECRL2, F9V4ER, F9V4ER2, F9V4ERL, F9V4ERL2, FT129ELC, FT129EM, FT129GLC, FT129GM, FT12C9EL, FT12C9ELC, FT12C9EM, FT12C9EMC, FT12C9GL, FT12C9GM, FT12C9GTL, FT12C9GTMC, FT12G7L70, FT12G7LC70, FT12G7R70, FT12G7RC70, FT12G7RL70, FT12G7RLC70, FT14G8L90, FT14G8LC90, FT14G8R2L90, FT14G8R2LC90...(Other models you can see in the webshop) | | |




measuring equipment

thermometers

built-in thermometers

| | | | |
|---|---|-----------------|-----------------------|
|  | | | |
| GEV No. | 541080 | Ref. No. | 24831.00 MA2483100 |
| description | thermometer mounting measurements 58x25.5mm -40 up to +40°C capillary pipe 2500mm probe ø 6mm probe L 30mm | | |
| For models: | EF140MB, EF140MC, EF140MF, EF140MI, EF140MN, EF140MP, EF143MNI, EF70MB, EF70MC, EF70MF, EF70MI, EF70MN, EF70MP, EF72MNF, SF100MB, SF100MC, SF100MF, SF100MI, SF100MN, SF100MP, SF110MF, SF110MI, SF110MN, SF110MP, SF50MB, SF50MC, SF50MF, SF50MI, SF50MN, SF50MP, SF55MF, SF55MI, SF55MN, SF55MP | | |

| | | | |
|--|--|-----------------|---|
|  | | | |
| GEV No. | 541077 | Ref. No. | 65340050 LA65340050 LAR65340050 MA65340050 |
| description | thermometer mounting ø 52mm t.max. 350°C +50 up to +350°C probe ø 6mm probe L 30mm capillary pipe 1000mm built-in depth 28mm | | |
| For models: | EC106M, EC110M, EC210M, EM010M+SC, EM106M, EM106M+SC, EM110M, EM110M+SC, EM210M, EM210M+SC, EV006M, EV106M, EV106M+SC, EV110M, EV110M+SC, EV210M, EV210M+SC, FE105M, FE105X, FE110M, FE110X, FE210M, FG105M, FG105X, FG110M, FG110X, FG210M, FG210X, GC106M, GC110M, GC210M, GM106M, GM106M+SC, GM110M, GM110M+SC, GM210M, GM210M+SC, GV106M, GV106M+SC, GV110M, GV110M+SC, GV210M, GV210M+SC, MEC40M, MGC20X, PE040M, PE040X, PE080M, PE080X, PG040M... (Other models you can see in the webshop) | | |

| | | | |
|--|--|-----------------|--------|
|  | | | |
| GEV No. | 541065 | Ref. No. | 450905 |
| description | thermometer mounting ø 52mm t.max. 120°C 0 up to +120°C probe ø 6.5mm probe L 28mm capillary pipe 1500mm | | |


| | | | |
|---|--|-----------------|-----------------------|
|  | | | |
| GEV No. | 541148 | Ref. No. | 24826.00 MA2482600 |
| description | thermometer mounting ø 52mm t.max. 40°C -40 up to +40°C probe ø 6mm probe L 44mm capillary pipe 1400mm | | |
| For models: | AF140MB, AF140MC, AF140MF, AF140MI, AF140MN, AF140MP, AF70MB, AF70MC, AF70MF, AF70MI, AF70MN, AF70MP, SPAR, SPAR15, SPAR16, SPAR18, SPAR20, SPRG, SPRG12, SPRG16, SPRG20, SVAR, SVAR15, SVAR16, SVAR18, SVAR20, SVRG, SVRG12, SVRG15, SVRG16, SVRG18, SVRG20 | | |

| | | | |
|---|--|-----------------|---------------------|
|  | | | |
| GEV No. | 541582 | Ref. No. | 2715000 27727000 |
| description | thermometer mounting ø 52mm t.max. 350°C +50 up to +350°C probe ø 6mm probe L 17mm capillary pipe 1700mm | | |

fastening material

screws

flat-headed bolts

| | | | |
|---|---|-----------------|------------------------|
|  | | | |
| GEV No. | 560021 | Ref. No. | 15534899 MA15534899 |
| description | flat-headed bolt thread M3 thread L 10mm SS DIN 7985/ISO 7045 Qty 20 pcs head ø 6mm head thickness 2mm Phillips | | |
| For models: | SER15, SER15A, SER18, SER18A, SER21 | | |



1

| | | | |
|--------------------|---|-----------------|--------|
| GEV No. | 511004 | Ref. No. | 260226 |
| description | flat-headed bolt thread M4 thread L 12mm SS DIN 84/ISO 1207 Qty 1 pcs intake slotted L 14.5mm | | |

raised countersunk head screws



1

| | | | |
|--------------------|--|-----------------|-----------|
| GEV No. | 560541 | Ref. No. | R61040272 |
| description | raised countersunk head screw thread M6 thread L 13mm SS DIN 966/ISO 7047 Qty 1 pcs intake slotted head ø 11mm head thickness 5mm | | |
| For models: | ME201D, ME201M, ME201P, ME201T, ME202D, ME202M, ME202P, ME202T, MEC24H, MEC40M, MEMT21D, MEMT21P, MEMT40D, MEMT40P, MEVT21D, MEVT21P, MEVT40D, MEVT40P, MG201D, MG201M, MG201P, MG201T, MG202D, MG202M, MG202P, MG202T, MGC20X, MGC24H, MGC40H, MGMT21D, MGMT21P, MGMT40D, MGMT40P, MGVT21D, MGVT21P, MGVT40D, MGVT40P | | |

hexagonal screws



1

| | | | |
|--------------------|--|-----------------|--------|
| GEV No. | 560087 | Ref. No. | 260104 |
| description | hexagonal screw thread M6 thread L 16mm SS WS 10 Qty 20 pcs DIN 933 / ISO 4017 | | |



1

| | | | |
|--------------------|---|-----------------|--------|
| GEV No. | 510990 | Ref. No. | 260113 |
| description | hexagonal screw thread M8 thread L 20mm SS WS 13 Qty 1 pcs DIN 933 / ISO 4017 | | |



1

| | | | |
|--------------------|---|-----------------|-----------|
| GEV No. | 560594 | Ref. No. | R61020562 |
| description | hexagonal screw thread M6 thread L 20mm WS 10 total length 59mm | | |
| For models: | EC110M, EC210M, EM010M+SC, EM110H, EM110M, EM110M+SC, EM110P, EM210H, EM210M, EM210M+SC, EM210P, EV110H, EV110M, EV110M+SC, EV110P, EV210H, EV210M, EV210M+SC, EV210P, FE110M, FE110X, FE210M, FG110M, FG110X, FG210M, FG210X, GC110M, GC210M, GM110H, GM110M, GM110M+SC, GM110P, GM210H, GM210M, GM210M+SC, GM210P, GMT20D, GV110H, GV110M, GV110M+SC, GV110P, GV210H, GV210M, GV210M+SC, GV210P, GVT20D, MACE10M, MACE20M, MACG10M, MACG20M...(Other models you can see in the webshop) | | |

cylinder head bolts

DIN 912/ISO 4762



1

| | | | |
|--------------------|--|-----------------|-----------|
| GEV No. | 520455 | Ref. No. | R61030601 |
| description | screw thread M8 thread L 20mm WS 6 SS Qty 1 pcs DIN 912/ISO 4762 | | |
| For models: | ME201D, ME201M, ME201P, ME201T, ME202D, ME202M, ME202P, ME202T, MEMT21D, MEMT21P, MEMT40D, MEMT40P, MEVT21D, MEVT21P, MEVT40D, MEVT40P, MG201D, MG201M, MG201P, MG201T, MG202D, MG202M, MG202P, MG202T, MGMT21D, MGMT21P, MGMT40D, MGMT40P, MGVT21D, MGVT21P, MGVT40D, MGVT40P | | |

miscellaneous



1

| | | | |
|--------------------|--|-----------------|--------|
| GEV No. | 510953 | Ref. No. | 260213 |
| description | cylinder head bolt thread M5 thread L 25mm SS Qty 1 pcs intake slotted | | |

side bolts



1

| | | | |
|--------------------|--|-----------------|--------|
| GEV No. | 560052 | Ref. No. | 260223 |
| description | side bolts thread M5 L 10mm SS Qty 20 pcs intake slotted head ø 12.5mm | | |

grub screws


DIN 913/ISO 4026





1


| | | | |
|--------------------|--|-----------------|-----------|
| GEV No. | 560024 | Ref. No. | R61090052 |
| description | grub screw thread M6 L 16mm SS DIN 913/ISO 4026 intake internal hexagon WS 3 Qty 20 pcs | | |
| For models: | ME120M, ME120P, ME120X, ME201D, ME201M, ME201P, ME201T, ME202D, ME202M, ME202P, ME202T, ME220M, ME220P, ME220X, MEC24H, MEC40M, MEMT21D, MEMT21P, MEMT40D, MEMT40P, MEVT21D, MEVT21P, MEVT40D, MEVT40P, MG120M, MG120P, MG120X, MG201D, MG201M, MG201P, MG201T, MG202D, MG202M, MG202P, MG202T, MG220M, MG220P, MG220X, MGC20X, MGC24H, MGC40H, MGMT21D, MGMT21P, MGMT40D, MGMT40P, MGVT21D, MGVT21P, MGVT40D, MGVT40P, VE120M...(Other models you can see in the webshop) | | |





| DIN 914/ISO 4027 | | | |
|--|--|-----------------|------------------------|
|  <p>1</p> | | | |
| GEV No. | 504230 | Ref. No. | 15119299 MA15119299 |
| description | grub screw thread M5 L 8mm A2-A2L DIN 914/ISO 4027 WS 2.5 Qty 1 pcs | | |
| For models: | EF74E10VG, EF74E12, EPC74E, EPC74G, F74E10, F74E12, F74E6, F76E10, F78E12, F94E10, F94E12, F94E18, F94E18K, F94E6, F96E10, F98E12, F98E18, F98E18K, F9S4E18K, F9S8E18K, FQE41R, FQE41RL, FQE41RL2, FQE61R, FQE61RL, NF74E10, NF74E15, NF76E10, NF78E15, NF94E10, NF94E15, NF94E22, NF94E222, NF94E222K, NF94E22K, NF96E10, NF98E15, NF98E22, NF98E222, NF98E222K, NF98E22K, NPC74E, NPC74G, NPC76E, NPC76G, NPC78E, NPC78G, NPC94E, NPC96E, NPC98E...(Other models you can see in the webshop) | | |


| | | | |
|--|--|-----------------|----------|
|  <p>1</p> | | | |
| GEV No. | 560175 | Ref. No. | 15131099 |
| description | grub screw thread M8 L 16mm DIN 914/ISO 4027 intake internal hexagon WS 4 Qty 1 pcs | | |
| For models: | BR707E, BR707G, BR94E, BR94EI, BR94G, BR94GI, BR96E, BR96EI, BR96G, BR96GI, BR9M4E, BR9M4EI, BR9M6E, BR9M6EI | | |


| DIN 916/ISO 4029 | | | |
|---|--|-----------------|--------|
|  <p>1</p> | | | |
| GEV No. | 510906 | Ref. No. | 250206 |
| description | grub screw thread M6 L 8mm stainless steel DIN 914/ISO 4027 WS 3 Qty 1 pcs | | |

| threaded rods | | | |
|--|-------------------------------------|-----------------|--|
| miscellaneous | | | |
|  <p>1</p> | | | |
| GEV No. | 514019 | Ref. No. | 1033202200 1033709000 MA1033202200 |
| description | threaded rod thread M8 L 45mm brass | | |
| For models: | CPE60 | | |

| knurled screws | | | |
|--|--|-----------------|--------|
|  <p>1</p> | | | |
| GEV No. | 510307 | Ref. No. | 261009 |
| description | Thumb screw thread M6 H 3mm thread L 8mm ø 28mm SS | | |


| miscellaneous | | | |
|--|--|-----------------|-----------|
|  <p>1</p> | | | |
| GEV No. | 690594 | Ref. No. | R58002560 |
| description | pressure screw for door hinge | | |
| For models: | ME120M, ME120P, ME120X, ME201D, ME201M, ME201P, ME201T, ME202D, ME202M, ME202P, ME202T, ME220M, ME220P, ME220X, MEC24H, MEC40M, MEMT21D, MEMT21P, MEMT40D, MEMT40P, MEVT21D, MEVT21P, MEVT40D, MEVT40P, MG120M, MG120P, MG120X, MG201D, MG201M, MG201P, MG201T, MG202D, MG202M, MG202P, MG202T, MG220M, MG220P, MG220X, MGC20X, MGC24H, MGC40H, MGMT21D, MGMT21P, MGMT40D, MGMT40P, MGVT21D, MGVT21P, MGVT40D, MGVT40P, VE120M...(Other models you can see in the webshop) | | |

| | | | |
|---|--------|-----------------|--------|
|  <p>1</p> | | | |
| GEV No. | 511006 | Ref. No. | 260228 |
| description | screw | | |

| | | | |
|--|---|-----------------|-----------|
|  <p>1</p> | | | |
| GEV No. | 694991 | Ref. No. | R58006400 |
| description | screw thread M6 L 16mm for air baffle combi-steamer | | |
| For models: | CVE004H, CVE004M, CVE104H, CVE104M, CVE105H, CVE105M, CVG105H, CVG105M, EC106M, EC110M, EC210M, EM010M+SC, EM106H, EM106M, EM106M+SC, EM106P, EM110H, EM110M, EM110M+SC, EM110P, EM210H, EM210M, EM210M+SC, EM210P, EV006M, EV106H, EV106M, EV106M+SC, EV106P, EV110H, EV110M, EV110M+SC, EV110P, EV210H, EV210M, EV210M+SC, EV210P, GC106M, GC110M, GC210M, GM106H, GM106M, GM106M+SC, GM106P, GM110H, GM110M, GM110M+SC, GM110P, GM210H, GM210M...(Other models you can see in the webshop) | | |

nuts


long nuts



1

| | | | |
|--------------------|--|-----------------|----------------------|
| GEV No. | 540438 | Ref. No. | 1868700 MA1868700 |
| description | long nut thread M10 L 25mm WS 13 brass Qty 1 pcs | | |
| For models: | CP704E, CP92E, CP92E2, CP94E, CP94E2, CP9SB2E, CP9SB2E2, CP9SB4E, CP9SB4E2, CPE40, CPE402, CPE60, CPE602, CPE60DB, DE92142, DE94242, EPC74E, OCP6, OCP60, PC12C4E, PC12C9E, PC74E, PC76E, PC78E, PC94E, PC96E, PC98E, PC9S4E, PC9S6E, PC9S8E | | |

knurled nuts



1

| | | | |
|--------------------|--|-----------------|--------|
| GEV No. | 510346 | Ref. No. | 280409 |
| description | knurled nut thread M17x1 ø 35mm H 6mm SS | | |


hexagonal nuts

DIN 934 / ISO 4032/8673




1

| | | | |
|--------------------|---|-----------------|--------|
| GEV No. | 560133 | Ref. No. | 260404 |
| description | hexagonal nut thread M6 H 5mm WS 10 SS DIN/ISO DIN 934 / ISO 4032/8673 Qty 20 pcs | | |



1


| | | | |
|--------------------|---|-----------------|--------|
| GEV No. | 560197 | Ref. No. | 260407 |
| description | nut thread M10 H 8mm WS 17 SS DIN/ISO DIN 934 / ISO 4032/8673 Qty 1 pcs | | |



1

| | | | |
|--------------------|--|-----------------|--------|
| GEV No. | 506166 | Ref. No. | 260408 |
| description | nut thread M12 H 10mm WS 19 SS DIN/ISO DIN 934 / ISO 4032/8673 Qty 1 pcs | | |


ISO 4033 / UNI5587



1


| | | | |
|--------------------|---|-----------------|-----------|
| GEV No. | 550866 | Ref. No. | R58004020 |
| description | nut thread M10x1.5 H 10mm SS WS 17 Qty 1 pcs DIN/ISO DIN 934 / ISO 4032/8673 left-hand thread | | |
| For models: | CVE105H, CVE105M, CVG105H, CVG105M, EC106M, EM106H, EM106M, EM106M+SC, EM106P, EV006M, EV106H, EV106M, EV106M+SC, EV106P, FE105M, FE105X, FG105M, FG105X, GC106M, GM106H, GM106M, GM106M+SC, GM106P, GMT06D, GV106H, GV106M, GV106M+SC, GV106P, GVT06D, MACE07M, MACG07M, ME061D, ME061M, ME061P, ME061T, ME106M, ME106P, ME106X, MEMT06D, MEMT06P, MEVT06D, MEVT06P, MG061D, MG061M, MG061P, MG061T, MG106M, MG106P, MG106X, MGMT06D...(Other models you can see in the webshop) | | |

DIN 985



1

| | | | |
|--------------------|--|-----------------|------------------------|
| GEV No. | 560227 | Ref. No. | 15774399 MA15774399 |
| description | hexagonal nut thread M3 H 4mm SS WS 5.5 Qty 1 pcs self-locking | | |
| For models: | SER15, SER15A, SER18, SER18A, SER21 | | |



1

| | | | |
|--------------------|---|-----------------|--------|
| GEV No. | 560140 | Ref. No. | 260402 |
| description | hexagonal nut thread M4 H 4.8mm SS WS 7 Qty 20 pcs DIN/ISO DIN 985 self-locking | | |


hexagonal nuts metric (without norm)




1


| | | | |
|--------------------|---|-----------------|----------------------------|
| GEV No. | 540436 | Ref. No. | 1033514900 MA1033514900 |
| description | hexagonal nut thread M10x1.25 H 4mm WS 13 brass Qty 1 pcs | | |
| For models: | C74GS, C78GS, C79G, C7FE12GS, C7FE8GS, C7FG12GS, C7FG8GS, C7FG9G, CFGE61, CFGE61D, CFGE61L, CFGE61P, CP704E, CP92E, CP92E2, CP94E, CP94E2, CP9SB2E, CP9SB2E2, CP9SB4E, CP9SB4E2, CPE40, CPE402, CPE60, CPE602, CPE60DB, DE92142, DE94242, EC74GVG, EC78GVG, EC7FG8G, EPC74E, OCFGE61, OCP6, OCP60, OCP60G, OCP61, PC12C4E, PC12C9E, PC74E, PC76E, PC78E, PC94E, PC96E, PC98E, PC9S4E, PC9S6E, PC9S8E, PCG41, PCG41L...(Other models you can see in the webshop) | | |




| | | | |
|--|--|-----------------|-----------|
|  <p>1</p> | | | |
| GEV No. | 550681 | Ref. No. | R58004050 |
| description | nut thread M12x1.25 H 5mm WS 17 brass Qty 1 pcs | | |
| For models: | EC106M, EC110M, EC210M, EM010M+SC, EM106H, EM106M, EM106M+SC, EM106P, EM110H, EM110M, EM110M+SC, EM110P, EM210H, EM210M, EM210M+SC, EM210P, EV006M, EV106H, EV106M, EV106M+SC, EV106P, EV110H, EV110M, EV110M+SC, EV110P, EV210H, EV210M, EV210M+SC, EV210P, GC106M, GC110M, GC210M, GM106H, GM106M, GM106M+SC, GM106P, GM110H, GM110M, GM110M+SC, GM110P, GM210H, GM210M, GM210M+SC, GM210P, GMT06D, GMT20D, GV106H, GV106M, GV106M+SC, GV106P..(Other models you can see in the webshop) | | |

| | | | |
|--|---|-----------------|----------------------------|
|  <p>2</p> | | | |
| GEV No. | 102382 | Ref. No. | 1033700200 MA1033700200 |
| description | nut thread M14x1 H 3.5mm WS 18 brass Qty 1 pcs | | |
| For models: | BF78G, BF912G, BF912GH, BF98G, C12FGP9G, C7FG12G, C7FG8G, C7FG9G, C7FGM12G, C9FG12G, C9FG16G, C9FG8G, C9FG8GP, C9FG-M12G, EF74G15, EF74G8VA, EF74G8VG, EFT74GLVG, EFT74GRVG, EFT-78GLVG, EFT78GMVG, EPC74G, ET78GVG, ET7FG8G, F74G6, F94G6, FQG41, FQG61, FT129GLC, FT129GM, GL12C4G, GL12C9G, NB74G, NB78G, NB94G, NB98G, NBR78GF, NBR78GI, NBR912GFM, NBR-912GIM, NBR98GF, NBR98GFM, NBR98GI, NBR98GIM, NC7FG12G44, NC7FG8G32, NC7FG8G36, NC7FG8G48, NC7FGM12G, NC9FG12G52... (Other models you can see in the webshop) | | |


| | | | |
|--|---|-----------------|----------------------|
|  <p>1</p> | | | |
| GEV No. | 521133 | Ref. No. | 1325313 MA1325313 |
| description | nut thread M14x1.5 H 6mm WS 19 zinc-coated steel Qty 1 pcs | | |
| For models: | B9SB2G, B9SB4G, B9V2G, B9V4G, B9VP4G, BM74G, BM77G, C124G, C129G, C12C2G9, C12C9G, C12FG9G, C7011G, C7011GFE, C7011GFG, C704G, C707G, C707GFE, C707GFG, C712G, C74G, C78G, C7FE12G, C7FE8G, C7FG12G, C7FG8G, C7FGM12G, C912G, C912GS, C94G, C94GP, C94GS, C98G, C98GP, C98GS, C9F4E, C9F4GS, C9F6E, C9F6GS, C9F8GS, C9FE12G, C9FE12GS, C9FE4GS, C9FE6GS, C9FE8G, C9FE8GS, C9FEP4GS, C9FEP6GS, C9FEP8GS, C9FG12G...(Other models you can see in the webshop) | | |


| | | | |
|--|--|-----------------|--------|
|  <p>1</p> | | | |
| GEV No. | 510374 | Ref. No. | 270118 |
| description | nut thread M15x1.25 H 6.5mm WS 27 SS Qty 1 pcs | | |


| | | | |
|--|---|-----------------|-----------|
|  <p>1</p> | | | |
| GEV No. | 691289 | Ref. No. | R58004830 |
| description | nut thread M18x1 H 5mm WS 22 brass Qty 1 pcs for door handle | | |
| For models: | CVE004H, CVE004M, CVE104H, CVE104M, CVE105H, CVE105M, CVG105H, CVG105M, EC106M, EC110M, EC210M, EM010M+SC, EM106H, EM106M, EM106M+SC, EM106P, EM110H, EM110M, EM110M+SC, EM110P, EM210H, EM210M, EM210M+SC, EM210P, EV006M, EV106H, EV106M, EV106M+SC, EV106P, EV110H, EV110M, EV110M+SC, EV110P, EV210H, EV210M, EV210M+SC, EV210P, FE105M, FE105X, FE110M, FE110X, FE210M, FG105M, FG105X, FG110M, FG110X, FG210M, FG210X, GC106M, GC110M...(Other models you can see in the webshop) | | |

| | | | |
|--|--|-----------------|--|
|  <p>1</p> | | | |
| GEV No. | 102067 | Ref. No. | 6A012300 939300 BN6A012300 MA939300 |
| description | nut thread M8x1 H 3mm brass Qty 1 pcs type SEF 1 | | |
| For models: | 702BMG, 704S, 706, 706S, C7011G, C7011GFE, C7011GFG, C704G, C707G, C707GFE, C707GFG, C9F4GS, C9F6G, C9F6GS, C9F8GS, C9SB-4GS, C9V2GS, C9V4GS, C9V6GS, C9V8GS, CFG101, CFG101D, CFG101L, CFG101P, CFG120, CFG70, CFG70D, CFG70L, CFG70M, CFG70P, EC74G-VG, EC78GVG, EC7FG8G, OCFG101, OCFG120, OCFG70, T7011GFG, T707GFG, T9F6GS, TPF706, TPF706S | | |

hexagonal nuts inch thread

| | | | |
|--|--|-----------------|--------|
|  <p>1</p> | | | |
| GEV No. | 510331 | Ref. No. | 270101 |
| description | nut thread 1/2" H 7mm SS WS 30 Qty 1 pcs | | |

| | | | |
|--|---|-----------------|--------------------------------------|
|  <p>1</p> | | | |
| GEV No. | 514022 | Ref. No. | 1032300100 14044599 MA14044599 |
| description | nut thread 1 1/2" H 12mm SS WS 59 Qty 1 pcs | | |
| For models: | CP704E, CP92E, CP92E2, CP94E, CP94E2, CP9SB2E, CP9SB2E2, CP9S-B4E, CP9SB4E2, CPE40, CPE402, CPE60, CPE602, CPE60DB, DE92142, DE94242, EPC74E, OCPPE6, OCPPE60, PC12C4E, PC12C9E, PC74E, PC76E, PC78E, PC94E, PC96E, PC98E, PC9S4E, PC9S6E, PC9S8E | | |

| | | | |
|--|--|-----------------|--------|
|  <p>1</p> | | | |
| GEV No. | 511309 | Ref. No. | 270104 |
| description | nut thread 1 1/2" ø 66mm H 9mm WS 51 brass Qty 1 pcs | | |

washers

spring washers



| | | | |
|--------------------|--|-----------------|-----------|
| GEV No. | 697933 | Ref. No. | R61420021 |
| description | spring washer ID ø 13mm ED ø 24mm Qty 1 pcs | | |
| For models: | ME120M, ME120P, ME120X, ME201D, ME201M, ME201P, ME201T, ME202D, ME202M, ME202P, ME202T, ME220M, ME220P, ME220X, MEC24H, MEC40M, MEMT21D, MEMT21P, MEMENT40D, MEMENT40P, MEVT21D, MEVT21P, MEVT40D, MEVT40P, MG120M, MG120P, MG120X, MG201D, MG201M, MG201P, MG201T, MG202D, MG202M, MG202P, MG202T, MG220M, MG220P, MG220X, MGC20X, MGC24H, MGC40H, MGMT21D, MGMT21P, MGMT40D, MGMT40P, MGVT21D, MGVT21P, MGVT40D, MGVT40P, VE120M...(Other models you can see in the webshop) | | |



| | | | |
|--------------------|--|-----------------|-----------|
| GEV No. | 696397 | Ref. No. | R61620091 |
| description | spring washer ID ø 6.3mm ED ø 14mm Qty 1 pcs | | |
| For models: | ME120M, ME120P, ME120X, ME201D, ME201M, ME201P, ME201T, ME202D, ME202M, ME202P, ME202T, ME220M, ME220P, ME220X, MEC24H, MEC40M, MEMT21D, MEMT21P, MEMENT40D, MEMENT40P, MEVT21D, MEVT21P, MEVT40D, MEVT40P, MG120M, MG120P, MG120X, MG201D, MG201M, MG201P, MG201T, MG202D, MG202M, MG202P, MG202T, MG220M, MG220P, MG220X, MGC20X, MGC24H, MGC40H, MGMT21D, MGMT21P, MGMT40D, MGMT40P, MGVT21D, MGVT21P, MGVT40D, MGVT40P, VE120M...(Other models you can see in the webshop) | | |

washers

DIN 125A



| | | | |
|--------------------|---|-----------------|------------------------|
| GEV No. | 540437 | Ref. No. | 15800699 MA15800699 |
| description | plain washer ED ø 20mm for thread M10 | | |
| For models: | 90HTGA2H2, 90HTGA2H5, 90HTGA4H2, 90HTGA4H5, 90HTGABR, 90HTSC2C, 90HTSC2F, 90HTSC4C, 90HTSC4F, CPE60, CPE602, CPE60DB, OCPE6, OCPE60 | | |



| | | | |
|--------------------|---|-----------------|------------------------|
| GEV No. | 560112 | Ref. No. | 15830499 MA15830499 |
| description | plain washer ID ø 5.3mm ED ø 10mm thickness 1mm SS Qty 20 pcs DIN 125A for thread M5 | | |
| For models: | BR707E, BR707EI, BR707G, BR707GI, BR94E, BR94EI, BR94G, BR94GI, BR96E, BR96EI, BR96G, BR96GI, BR9M4E, BR9M4EI, BR9M4G, BR9M4GI, BR9M6E, BR9M6EI, BR9M6G, BR9M6GI, BR9SB4E, BR9SB4EI, BR9SB4G, BR9SB4GI, EPC74E, EPC74G, PC12C4E, PC12C4G, PC12C9E, PC12C9G, PC74E, PC74G, PC76E, PC76G, PC78E, PC78G, PC94E, PC94G, PC96E, PC96G, PC98E, PC98G, PD707G, PI707E, PI707G, SER15, SER15A, SER18, SER18A, SER21 | | |

miscellaneous



| | | | |
|--------------------|---------------------------------------|-----------------|--------|
| GEV No. | 511254 | Ref. No. | 260537 |
| description | disc ø 13mm D1 ø 20mm thickness 0.8mm | | |



| | | | |
|--------------------|---|-----------------|-----------|
| GEV No. | 691296 | Ref. No. | R61400052 |
| description | plain washer ID ø 10.5mm ED ø 21mm thickness 2mm SS Qty 1 pcs for fan wheel | | |
| For models: | CVE105H, CVE105M, CVG105H, CVG105M, EC106M, EM106H, EM106M, EM106M+SC, EM106P, EV006M, EV106H, EV106M, EV106M+SC, EV106P, FE105M, FE105X, FG105M, FG105X, GC106M, GM106H, GM106M, GM106M+SC, GM106P, GMT06D, GV106H, GV106M, GV106M+SC, GV106P, GVT06D, MACE07M, MACG07M, ME061D, ME061M, ME061P, ME061T, ME106M, ME106P, ME106X, MEMENT06D, MEMENT06P, MEVT06D, MEVT06P, MG061D, MG061M, MG061P, MG061T, MG106M, MG106P, MG106X, MGMT06D...(Other models you can see in the webshop) | | |



| | | | |
|--------------------|--|-----------------|-----------|
| GEV No. | 691292 | Ref. No. | R10401710 |
| description | plain washer ID ø 12mm ED ø 17.5mm thickness 1mm SS Qty 1 pcs | | |
| For models: | GMT06D, GMT20D, GVT06D, GVT20D, MACE07M, MACE10M, MACE20M, MACG07M, MACG10M, MACG20M, ME061D, ME061M, ME061P, ME061T, ME101D, ME101M, ME101P, ME101T, ME102D, ME102M, ME102P, ME102T, ME106M, ME106P, ME106X, ME110M, ME110P, ME110X, ME210M, ME210P, ME210X, MEMENT06D, MEMENT06P, MEMENT10D, MEMENT10P, MEMENT20D, MEMENT20P, MEVT06D, MEVT06P, MEVT10D, MEVT10P, MEVT20D, MEVT20P, MG061D, MG061M, MG061P, MG061T, MG101D, MG101M, MG101P...(Other models you can see in the webshop) | | |



| | | | |
|--------------------|--|-----------------|-----------|
| GEV No. | 690593 | Ref. No. | R58002570 |
| description | plain washer ID ø 15mm ED ø 30mm thickness 3mm Qty 1 pcs for door hinge | | |
| For models: | ME120M, ME120P, ME120X, ME201D, ME201M, ME201P, ME201T, ME202D, ME202M, ME202P, ME202T, ME220M, ME220P, ME220X, MEC24H, MEC40M, MEMT21D, MEMT21P, MEMENT40D, MEMENT40P, MEVT21D, MEVT21P, MEVT40D, MEVT40P, MG120M, MG120P, MG120X, MG201D, MG201M, MG201P, MG201T, MG202D, MG202M, MG202P, MG202T, MG220M, MG220P, MG220X, MGC20X, MGC24H, MGC40H, MGMT21D, MGMT21P, MGMT40D, MGMT40P, MGVT21D, MGVT21P, MGVT40D, MGVT40P, VE120M...(Other models you can see in the webshop) | | |



| | | | |
|---|---|-----------------|-----------|
|  | | | |
| 1 | | | |
| GEV No. | 551434 | Ref. No. | R58004010 |
| description | plain washer ø 30mm thickness 3mm hole ø 12.5mm for fan wheel combi-steamer | | |
| For models: | EC110M, EC210M, EM010M+SC, EM110H, EM110M, EM110M+SC, EM110P, EM210H, EM210M, EM210M+SC, EM210P, EV110H, EV110M, EV110M+SC, EV110P, EV210H, EV210M, EV210M+SC, EV210P, FE110M, FE110X, FE210M, FG110M, FG110X, FG210M, FG210X, GC110M, GC210M, GM110H, GM110M, GM110M+SC, GM110P, GM210H, GM210M, GM210M+SC, GM210P, GMT20D, GV110H, GV110M, GV110M+SC, GV110P, GV210H, GV210M, GV210M+SC, GV210P, GVT20D, MACE10M, MACE20M, MACG10M, MACG20M...(Other models you can see in the webshop) | | |

tooth lock washers


| | | | |
|---|--|-----------------|------------------------|
| DIN 6798A | | | |
|  | | | |
| 1 | | | |
| GEV No. | 560193 | Ref. No. | 15812699 MA15812699 |
| description | tooth lock washer ID ø 10.4mm ED ø 18mm zinc-coated steel DIN/ISO DIN 6798A Qty 1 pcs for thread M10 | | |
| For models: | CPE60, CPE602, CPE60DB, OCPE6, OCPE60 | | |

fasteners

clamps

hose clamps

DIN 3017 - W2

| | | | |
|---|--|-----------------|--------|
|  | | | |
| 1 | | | |
| GEV No. | 520111 | Ref. No. | 450102 |
| description | hose clamp ø 10-16mm width 9mm Qty 10 pcs DIN 3017 | | |

| | | | |
|---|---|-----------------|---------------------|
|  | | | |
| 1 | | | |
| GEV No. | 520112 | Ref. No. | 450103 R61630011 |
| description | hose clamp ø 12-20mm width 9mm Qty 10 pcs DIN 3017 | | |
| For models: | CVE004H, CVE004M, CVE104H, CVE104M, CVE105H, CVE105M, CVG105H, CVG105M, EC106M, EC110M, EC210M, EM010M+SC, EM106H, EM106M, EM106M+SC, EM106P, EM110H, EM110M, EM110M+SC, EM110P, EM210H, EM210M, EM210M+SC, EM210P, EV006M, EV106H, EV106M, EV106M+SC, EV106P, EV110H, EV110M, EV110M+SC, EV110P, EV210H, EV210M, EV210M+SC, EV210P, GC106M, GC110M, GC210M, GM106H, GM106M, GM106M+SC, GM106P, GM110H, GM110M, GM110M+SC, GM110P, GM210H, GM210M...(Other models you can see in the webshop) | | |

| | | | |
|--|--|-----------------|--------|
|  | | | |
| 1 | | | |
| GEV No. | 520113 | Ref. No. | 450104 |
| description | hose clamp ø 16-27mm width 9mm Qty 10 pcs DIN 3017 | | |

| | | | |
|--|--|-----------------|--------|
|  | | | |
| 1 | | | |
| GEV No. | 520115 | Ref. No. | 450105 |
| description | hose clamp ø 25-40mm width 9mm Qty 10 pcs DIN 3017 | | |


| | | | |
|--|---|-----------------|--------|
|  | | | |
| 1 | | | |
| GEV No. | 520116 | Ref. No. | 450107 |
| description | hose clamp ø 32-50mm width 9mm Qty 5 pcs DIN 3017 | | |

| | | | |
|---|---|-----------------|--------|
|  | | | |
| 1 | | | |
| GEV No. | 520119 | Ref. No. | 450119 |
| description | hose clamp ø 60-80mm width 9mm Qty 5 pcs DIN 3017 | | |

| | | | |
|--|---|-----------------|--------|
|  | | | |
| 1 | | | |
| GEV No. | 520117 | Ref. No. | 450135 |
| description | hose clamp stainless steel ø 40-60mm width 9mm Qty 5 pcs DIN 3017 | | |


double wire clamps

| | | | |
|--|--|-----------------|--------|
|  | | | |
| 1 | | | |
| GEV No. | 511286 | Ref. No. | 450143 |
| description | hose clamp ø 38mm wire gauge ø 3.2mm Qty 1 pcs | | |

| | | | |
|---|---|-----------------|--------|
|  | | | |
| 1 | | | |
| GEV No. | 510959 | Ref. No. | 450115 |
| description | hose clamp ø 8mm wire gauge ø 1mm Qty 1 pcs | | |


| | | | |
|---|---|-----------------|--------|
|  | | | |
| 1 | | | |
| GEV No. | 511147 | Ref. No. | 450125 |
| description | wire clamp ø 12-14mm wire gauge ø 1.5mm zinc-coated steel Qty 1 pcs | | |

miscellaneous


| | | | |
|---|---|-----------------|--------|
|  | | | |
| 1 | | | |
| GEV No. | 510923 | Ref. No. | 440817 |
| description | clamping ring for shaft ø 10mm ID ø 9.4mm H 6mm | | |

retaining rings

DIN 471

| | | | |
|---|--|-----------------|------------------------------------|
|  | | | |
| 1 | | | |
| GEV No. | 514030 | Ref. No. | 15901700 15901799 MA15901799 |
| description | retaining ring shaft ø 20mm thickness 1.3mm steel DIN 471 | | |
| For models: | BR707E, BR707EI, BR707G, BR707GI, BR78EF, BR78EI, BR78GF, BR78GI, BR912EFM, BR912EIM, BR912GFM, BR912GIM, BR94E, BR94EI, BR94G, BR94GI, BR96E, BR96EI, BR96G, BR96GI, BR98EF, BR98EFM, BR98EI, BR98EIM, BR98GF, BR98GFM, BR98GI, BR98GIM, BR9M4E, BR9M4EI, BR9M4G, BR9M4GI, BR9M6E, BR9M6EI, BR9M6G, BR9M6GI, BR9S8EF, BR9S8EI, BR9S8GF, BR9S8GI, BR9SB4E, BR9SB4EI, BR9SB4G, BR9SB4GI | | |

DIN 472

| | | | |
|---|--|-----------------|--------|
|  | | | |
| 1 | | | |
| GEV No. | 511248 | Ref. No. | 440816 |
| description | retaining ring bore ø 48mm thickness 1.9mm stainless steel DIN 472 | | |

roll pins

| | | | |
|--|--|-----------------|----------------------|
|  | | | |
| 1 | | | |
| GEV No. | 692210 | Ref. No. | 1891900 MA1891900 |
| description | roll pin ø 3.5mm L 8mm steel burnished | | |
| For models: | BR78EF, BR78EI, BR78G, BR78GF, BR78GI, BR912EFM, BR912EIM, BR912GFM, BR912GIM, BR98EF, BR98EFM, BR98EI, BR98EIM, BR98GF, BR98GFM, BR98GI, BR98GIM, BR9S8EF, BR9S8EI, BR9S8GF, BR9S8GI, C12C2G9, C12C9G | | |


| | | | |
|--|--|-----------------|------------------------|
|  | | | |
| 1 | | | |
| GEV No. | 516092 | Ref. No. | 15935599 MA15935599 |
| description | roll pin ø 3mm L 30mm | | |
| For models: | CP704E, CP704G, CP92E, CP92E2, CP92G, CP94E, CP94E2, CP94G, CP95B2E, CP95B2E2, CP95B2G, CP95B4E, CP95B4E2, CP95B4G | | |

consumables

lubricants

oils


for boiling pans

| | | | |
|---|--|-----------------|------------------------------------|
|  | | | |
| 1 | | | |
| GEV No. | 890005 | Ref. No. | 18176999 (20L) MA18176999 (20L) |
| description | oil Qty 1 pcs for kettle content 8.5kg 10l | | |




fuses

fine fuses




1

| | | | |
|--------------------|---|-----------------|-----------|
| GEV No. | 358532 | Ref. No. | R65200200 |
| description | fine fuse size ϕ 5x20mm 2A fast-acting rated 250V Qty 10 pcs | | |
| For models: | CVE004H, CVE004M, CVE104H, CVE104M, CVE105H, CVE105M, CVG105H, CVG105M, EC106M, EC110M, EC210M, EM010M+SC, EM106H, EM106M, EM106M+SC, EM106P, EM110H, EM110M, EM110M+SC, EM110P, EM210H, EM210M, EM210M+SC, EM210P, EV006M, EV106H, EV106M, EV106M+SC, EV106P, EV110H, EV110M, EV110M+SC, EV110P, EV210H, EV210M, EV210M+SC, EV210P, FE105M, FE105X, FE110M, FE110X, FE210M, FG105M, FG105X, FG110M, FG110X, FG210M, FG210X, GC106M, GC110M...(Other models you can see in the webshop) | | |




1

| | | | |
|--------------------|---|-----------------|-----------|
| GEV No. | 358593 | Ref. No. | R65200086 |
| description | fine fuse size ϕ 5x20mm 0.125A slow-acting rated 250V Qty 10 pcs | | |
| For models: | CVE004H, CVE104H, CVE105H, CVG105H, EM010M+SC, EM106H, EM106M+SC, EM106P, EM110M+SC, EM110P, EM210M+SC, EM210P, EV106H, EV106M+SC, EV106P, EV110M+SC, EV110P, EV210M+SC, EV210P, GM106H, GM106M+SC, GM106P, GM110M+SC, GM110P, GM210M+SC, GM210P, GV106H, GV106M+SC, GV106P, GV110M+SC, GV110P, GV210M+SC, GV210P, ME061P, ME061T, ME101P, ME101T, ME102P, ME102T, ME106M, ME106P, ME106X, ME110M, ME110P, ME110X, ME120M, ME120P, ME120X, ME201P, ME201T...(Other models you can see in the webshop) | | |




1

| | | | |
|--------------------|---|-----------------|-----------|
| GEV No. | 358592 | Ref. No. | R65200140 |
| description | fine fuse size ϕ 5x20mm 0.1A slow-acting rated 250V Qty 10 pcs | | |
| For models: | GMT20D, MG061M, MG101D, MG101M, MG102D, MG102M, MG201D, MG201M, MGMT20D | | |



1


| | | | |
|--------------------|---|-----------------|-----------|
| GEV No. | 358595 | Ref. No. | R65200320 |
| description | fine fuse size ϕ 5x20mm 0.2A slow-acting rated 250V Qty 10 pcs | | |
| For models: | EC106M, EM106H, EM106M, EM106M+SC, EM106P, EM110H, EM110P, EM210H, EM210P, EV006M, EV106H, EV106M, EV106M+SC, EV106P, EV110H, EV110P, EV210H, EV210P, FG105X, GC106M, GM106H, GM106M, GM106M+SC, GM106P, GM110H, GM210H, GV106H, GV106M, GV106M+SC, GV106P, GV110H, GV210H, MACE10M, MACE20M, ME061P, ME061T, ME101D, ME101M, ME102D, ME102M, ME106P, ME106X, ME110P, ME120P, ME201D, ME201M, ME210P, ME220P, MEC24H, MEMT10D...(Other models you can see in the webshop) | | |



1


| | | | |
|--------------------|---|-----------------|-----------|
| GEV No. | 358703 | Ref. No. | R65200350 |
| description | fine fuse size ϕ 5x20mm 0.4A slow-acting rated 250V Qty 10 pcs | | |
| For models: | EC110M, EC210M, EM010M+SC, EM110H, EM110M, EM110M+SC, EM110P, EM210H, EM210M, EM210M+SC, EM210P, EV110H, EV110M, EV110M+SC, EV110P, EV210H, EV210M, EV210M+SC, EV210P, FE105X, FG110X, FG210X, GC110M, GC210M, GM110H, GM110M, GM110M+SC, GM110P, GM210H, GM210M, GM210M+SC, GM210P, GV110H, GV110M, GV110M+SC, GV110P, GV210H, GV210M, GV210M+SC, GV210P, ME110P, ME110X, ME120P, ME120X, ME210P, ME210X, ME220P, ME220X, MEC24H, MEC40M...(Other models you can see in the webshop) | | |

ϕ 10x38mm 500V




1

| | | | |
|--------------------|--|-----------------|--------|
| GEV No. | 358196 | Ref. No. | 130246 |
| description | fine fuse size ϕ 10x38mm 12A rated 500V type Gg fast-acting Qty 1 pcs | | |




1

| | | | |
|--------------------|--|-----------------|--------|
| GEV No. | 358028 | Ref. No. | 130248 |
| description | fine fuse size ϕ 10x38mm 20A rated 500V type Gg fast-acting Qty 1 pcs | | |




1

| | | | |
|--------------------|---|-----------------|--------|
| GEV No. | 358024 | Ref. No. | 130245 |
| description | fine fuse size ϕ 10x38mm 8A rated 500V type gI fast-acting Qty 1 pcs | | |




1


| | | | |
|--------------------|---|-----------------|--------|
| GEV No. | 358033 | Ref. No. | 130259 |
| description | fine fuse size ϕ 10x38mm 1A slow-acting rated 500V type aM Qty 1 pcs | | |



1

| | | | |
|--------------------|---|-----------------|--------|
| GEV No. | 358034 | Ref. No. | 130260 |
| description | fine fuse size ϕ 10x38mm 2A slow-acting rated 500V type aM Qty 1 pcs | | |

| | | | |
|---|---|-----------------|--------|
|  | | | |
| 1 | | | |
| GEV No. | 358035 | Ref. No. | 130230 |
| description | fine fuse size ø10x38mm 4A slow-acting rated 500V type aM Qty 1 pcs | | |

| fine fuse holders | | | |
|---|---|-----------------|---|
|  | | | |
| 1 | | | |
| GEV No. | 358512 | Ref. No. | 208021-99 208021-99 n.m.liefe LA65210020 LAR65210020 |
| description | fuse holder | | |
| For models: | CS102E, CS102EP, CS102G, CS102GP, CVE004H, CVE004M, CVE104H, CVE104M, CVE105H, CVE105M, CVG105H, CVG105M, EC106M, EC110M, EC210M, EM010M+SC, EM106H, EM106M, EM106M+SC, EM106P, EM110H, EM110M, EM110M+SC, EM110P, EM210H, EM210M, EM210M+SC, EM210P, EV006M, EV106H, EV106M, EV106M+SC, EV106P, EV110H, EV110M, EV110M+SC, EV110P, EV210H, EV210M, EV210M+SC, EV210P, FE105M, FE105X, FE110M, FE110X, FE210M, FG105M, FG105X, FG110M, FG110X...(Other models you can see in the webshop) | | |

| | | | |
|---|----------|--------------------------------------|----------|
| A | | | |
| alarm devices | 65 | electronic controllers | 75 |
| appliance hose reels | 282 | energy regulators | 31 |
| audible timers | 65 | espagnolette locks | 239 |
| axial fans | 93 | evaporators | 280 |
| B | | F | |
| ball valves | 289 | fans | 93 |
| ball valves electric | 89, 290 | fasteners | 303 |
| bar burners | 176 | fastening material | 297 |
| beverage technology | 295 | female bullets | 113 |
| bi-metal thermostats | 32, 32 | ferrite rings | 110 |
| booster pumps II | 108 | filters | 110 |
| C | | fine fuses | 305 |
| cable glands | 112 | fittings | 287 |
| cables | 112 | flat-headed bolts | 297 |
| cam switches | 50 | foam rubber gaskets | 278 |
| capillary tube clips | 45 | foil heating elements | 26 |
| castors and bumper angles | 255 | forced air burners | 182 |
| ceramic heaters | 19 | formed hoses | 285 |
| clamps | 295, 303 | fuses | 110, 305 |
| cleaning tools | 296 | G | |
| cold air circulating fans (complete) | 96 | gas burners | 158 |
| compressors | 92 | gas control valves | 132 |
| condensators & interference suppression filters | 109 | gas lines | 197 |
| consumables | 304 | gas nozzles | 184 |
| contactors | 66 | gas taps | 115 |
| container filters | 283 | gas thermostats | 124 |
| control equipment | 55 | gaskets for heated units | 263 |
| control thermostats | 32, 43 | gaskets for tray rack trolleys | 272 |
| cross flow fans | 96 | gastronorm | 281 |
| cylinder head bolts | 298 | grates | 258 |
| D | | grub screws | 298 |
| digital timers | 64 | H | |
| door catches | 239 | halogen lamp | 59 |
| door seals | 265 | handle latches | 239 |
| door seals for dishwashers | 279 | heating cables | 18 |
| door seals with fixing hook | 271 | heating cartridges | 18 |
| door seals with tension springs | 271 | heating elements | 3 |
| dosing pumps | 282 | heating elements for bain maries | 4 |
| double wire clamps | 296, 303 | heating elements for charrills | 17 |
| drain fittings | 293 | heating elements for chip scuttles | 5 |
| drain hoses | 283 | heating elements for convection | 22 |
| drain pumps | 108 | heating elements for defrosting | 12 |
| drain systems and wash basins | 293 | heating elements for fryers | 5 |
| E | | heating elements for frying pans | 5 |
| edgemount latches | 238 | heating elements for griddles | 11 |
| electric accessories | 112 | heating elements for heated cabinets | 18 |
| electrodes | 91 | heating elements for heating bridges | 18 |
| | | heating elements for ovens | 3 |
| | | heating elements for pasta cookers | 14 |
| | | heating elements for pizza ovens | 16 |

| | | | |
|---|----------|----------------------------------|---------|
| heating elements for refrigeration | 12 | oven hinges | 242 |
| heating elements for salamanders/toasters | 17 | oven lamps | 59 |
| heating elements for tilting bratt pan | 13 | | |
| hexagonal nuts | 300 | P | |
| hexagonal screws | 298 | PE hoses | 283 |
| hob burners | 158 | piezoelectric igniters | 153 |
| hose clamps | 295, 303 | pilot burners | 139 |
| hose connectors | 286, 287 | plug-in gaskets | 260 |
| hose reels | 282 | plunger sockets | 45 |
| hoses | 283 | position switches | 49 |
| hot air fans | 104 | pressure control hoses | 284 |
| hot air motors | 97 | pressure switches | 89, 197 |
| hot plates | 29 | probe clips | 45 |
| | | probes | 75 |
| I | | programme timers | 61 |
| ignition boxes | 139 | pumps | 105 |
| ignition cables | 151 | push button latches | 238 |
| ignition switches | 154 | push/momentary push switches | 48 |
| ignition units | 154 | push-in fittings | 288 |
| immersion heating elements | 19 | PVC hoses | 284 |
| indicator lights | 56 | | |
| indicator lights (complete) | 56 | R | |
| industrial hoses | 283 | radial fans | 105 |
| inlet spouts | 292 | radiation heaters | 24 |
| inlet taps | 292 | raised countersunk head screws | 298 |
| intake lances | 283 | refrigeration fans | 94 |
| | | refrigeration gaskets | 260 |
| K | | refrigeration motors universal | 94 |
| knurled nuts | 300 | refrigeration thermostats | 44 |
| knurled screws | 299 | relays | 69 |
| | | residual heat indicators | 61 |
| L | | retaining rings | 304 |
| lamps | 56 | ribbon cables | 113 |
| light bulbs | 59 | rocker/momentary rocker switches | 46 |
| long nuts | 300 | roll pins | 304 |
| lubricants | 304 | rotary switches | 53 |
| | | | |
| M | | S | |
| magnetic switches | 54 | safety thermostats | 38, 44 |
| measuring equipment | 297 | safety valves | 139 |
| mechanical timers | 64 | screw-in gaskets | 262 |
| microswitches | 49 | screws | 297 |
| motors | 105 | sealing washers | 276 |
| | | shaft gaskets | 278 |
| N | | shelves and shelf rails | 258 |
| Niplaflex hoses | 283 | shut-off valves | 290 |
| non-return valves | 295 | side bolts | 298 |
| nuts | 300 | silicone hoses | 284 |
| | | snap locks | 239 |
| O | | solenoid valves | 82 |
| oils | 304 | solid top burners | 182 |
| operating capacitors | 109 | spray guns | 281 |
| O-rings | 273 | spring assisted hinges | 241 |

| | |
|---------------------------------|----------|
| spring clips | 45 |
| spring washers | 302 |
| stainless steel flexi hoses | 283 |
| standpipes | 293 |
| supply filters | 295, 295 |
| supply hoses | 283 |
| switches and momentary switches | 46 |
| system switches (ROLD) | 50 |

T

| | |
|--------------------------------|-----|
| temperature probes | 75 |
| terminals | 113 |
| terminals and connectors | 113 |
| thermocouples | 154 |
| thermostat gaskets | 280 |
| thermostats | 32 |
| threaded cable glands | 112 |
| threaded rods | 299 |
| time relays | 73 |
| timers | 61 |
| tools | 296 |
| tooth lock washers | 303 |
| touch sensitive light switches | 54 |
| transformers | 73 |
| tube burners | 181 |

U

| | |
|------------------|-----|
| U-bends | 295 |
| universal hoses | 283 |
| universal probes | 75 |

V

| | |
|------------------------|-----|
| valves | 295 |
| valves and tank inlets | 289 |
| vibration pumps | 109 |

W

| | |
|------------------------|-----|
| wash and rinse pumps | 105 |
| washers | 302 |
| water cycle components | 295 |
| window seals | 263 |