



GAS COMPONENTS



ELECTRIC COMPONENTS



WATER TECHNOLOGY



MECHANICAL COMPONENTS



TOOLS

Spare parts suitable for

MARELS

Find the complete and up-to-date range of products in our GEV Webshop



Manufacturer catalogue

The most important spare parts and accessories arranged clearly for every manufacturer

- ✓ Complete product range and all appliance data always up to date in the GEV Webshop
- ✓ Alphabetical Index at the end of the catalogue

GEV Webshop

www.gev-online.co.uk

www.gev-online.com



- 🔍 Add to Favourites
- 🔍 Sign In with email address and usual password
- 🔍 Easy-order – place several items in your basket at the same time
- 🔍 Quick Item search – no login needed



heating elements

heating elements for fryers

2 hole fixing



GEV No.	419031	Ref. No.	965.009.00
description	heating element 3400/3700W 230/240V heating circuits 1 L 405mm W 44mm H 228mm L1 25mm L2 380mm H1 192mm H2 36mm thread M14x1.5 mounting distance 36mm tube ø 8.5mm 2 hole fixing connection M5 immersion heater windings 4 fryer		

immersion heating elements

3 hole flange ø38.5mm

connection angled



GEV No.	420212	Ref. No.	465.008.14	
description	heating element 2000W 230V mounting ø 38.5mm heating circuits 1 L 330mm W 33mm H 16mm hole distance 57mm hole ø 10mm tube ø 6mm connection male faston 6.3mm immersion heater 3 hole flange			
accessories for	420212			
	GEV No.	532577	Ref. No.	—
	O-ring EPDM thickness 5.34mm ID ø 40.65mm Qty 1 pcs			



GEV No.	419033	Ref. No.	465.009.00	
description	heating element 4500W 230V mounting ø 38.5mm heating circuits 3 L 295mm W 28mm H 35mm L1 30mm L2 265mm H2 30mm hole distance 58mm hole ø 10mm tube ø 6.3mm connection male faston 6.3mm immersion heater 3 hole flange			
spare parts for	419033			
	GEV No.	521120	Ref. No.	—
	O-ring EPDM thickness 5.34mm ID ø 37.47mm Qty 1 pcs			

3 hole flange ø47.5mm



GEV No.	419032	Ref. No.	465.010.13	
description	heating element 4500W 230V mounting ø 47.5mm heating circuits 3 L 285mm W 32mm H 40mm number of thermostat sleeves 1 thermostat sleeves ø 7.5mm length thermostat sleeves 233mm thermostat sleeve eccentric, clinging tube ø 6.3mm hole distance 63mm hole ø 8mm connection length 25mm connection M4 3 hole flange immersion heater			
accessories for	419032			
	GEV No.	510408	Ref. No.	—
	O-ring EPDM thickness 5.34mm ID ø 47mm Qty 1 pcs			

heating elements for convection



GEV No.	418020	Ref. No.	999.22.042
description	heating element 7800W 230V heating circuits 3 ID ø 264mm ED ø 277mm L 315mm H 100mm L1 35mm W1 101mm H1 29mm H2 67mm flange length 142mm flange width 23mm hole distance 63mm connection M4 connection length 75mm tube ø 6.3mm convection heating element mounting thread M4 rectangular flange		

thermostats

control and safety thermostats

EGO

control thermostats

55.10/19_ series





GEV No.	375948	Ref. No.	461.016.00 461.016.01
description	thermostat t.max. 90°C temperature range 30-90°C 1-pole 1CO 16A probe ø 6mm probe L 102mm capillary pipe 1000mm capillary pipe isolated 960mm gland nut shaft Lmm shaft position rotation 180°		

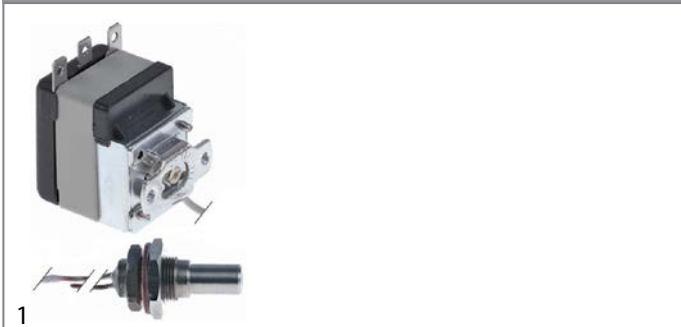

CAEM

control thermostats





GEV No.	390672	Ref. No.	46101500
description	thermostat t.max. 53°C temperature range fixed 53°C 1-pole 1CO 16A probe ø 9.5mm probe L 30mm capillary pipe 600mm capillary pipe isolated 540mm gland nut shaft Lmm screw-in probe probe thread M14x1		
spare parts for	390672		
	GEV No.	510417	Ref. No. —
	flat gasket fibre ED ø 20mm ID ø 14mm thickness 2mm Qty 1 pcs		
	GEV No.	550261	Ref. No. —
	nut thread M14x1 H 4mm WS 19 SS Qty 1 pcs		

switches and momentary switches

rotary switches

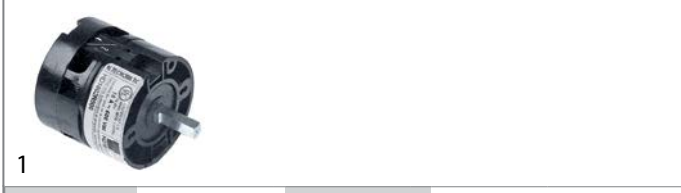
TECNOMATIC



GEV No.	300331	Ref. No.	461.030.00
description	rotary switch 2 0-1 sets of contacts 2 type HD1602R000 600V 16A shaft ø 4x6mm shaft L 17mm shaft 6x6 connection screw ED ø 43mm L 39mm		
accessories for	300331		
	GEV No.	111012	Ref. No. —
	knob switch zero mark t.max.°C°C ø 34/60mm shaft ø 5x5mm shaft flat black H 22mm L 50mm		

miscellaneous

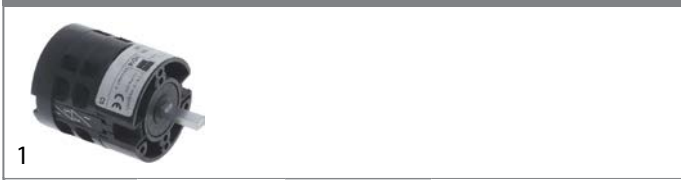

GEV No.	300329	Ref. No.	461.045.00
description	rotary switch sets of contacts 4 3 1-0-2 momentary type HD16 600V 16A shaft square connection screw ambient temperature max. 75°C		

pressure switches

for warewashing

ø 58mm with male faston 6.3mm

with connection horizontal



GEV No.	542137	Ref. No.	462.012.00
description	pressure control pressure range 100/65mbar connection male faston 6.3mm ø 58mm pressure connection horizontal warewashing pressure connection ø 6mm		





GEV No.	541133	Ref. No.	462.003.00
description	pressure control pressure range 60/25mbar connection male faston 6.3mm ø 58mm pressure connection horizontal warewashing pressure connection ø 6mm		

pumps

wash and rinse pumps

LGB



GEV No.	500583	Ref. No.	46408200 46408300
description	pump inlet ø 28mm outlet ø 26mm type ZF130SX 230V 50Hz 1 phase 0.2kW 0.27HP L 195mm rotation direction right capacitor 6.3µF LGB		
spare parts for	500583		
	GEV No.	509004	Ref. No. 46410600
	impeller ø 71mm H 16mm M7L rotation direction right shaft ø 13mm shaft length 13mm blades 8		
	GEV No.	510703	Ref. No. —
	mechanical shaft seal for shaft ø 13mm slide ring H 13mm height counter ring 5.5mm ED ø 26mm		







1

GEV No.	500553	Ref. No.	464.013.00
description	pump inlet ø 45mm outlet ø 38mm type ZF290SX 230V 50Hz 1 phase 0.65kW 0.88HP L 200mm rotation direction right capacitor 12.5µF auxiliary pressure connection 13mm supporting pressure open LGB		
spare parts for	500553		
	GEV No.	365014	Ref. No. —
	operating capacitor capacity 12.5µF 450V tolerance 5%Hz ambient temperature max. -25 to +85°C ø 35mm L 70mm M8 plastic connection male faston 6.3mm 45S.C3DS.12.5 protection		
	GEV No.	510702	Ref. No. —
	mechanical shaft seal height counter ring 5.5mm ID ø 12mm		
	GEV No.	521106	Ref. No. 464.021.00
	impellor ø 97mm H 24mm rotation direction right thread M8L seat ø 8.2mm blades 5		
	GEV No.	521542	Ref. No. —
	pump cover LGB inlet ø 45mm outlet ø 40mm auxiliary pressure connection 13mm supporting pressure open ø 150mm ID ø 120mm inner high 25mm		
	GEV No.	521714	Ref. No. —
	pump cover gasket thickness 4x4mm Qty 1 pcs		



1

GEV No.	500512	Ref. No.	464.015.00
description	pump inlet ø 45mm outlet ø 40mm type ZF340VSX 230V 50Hz 1 phase 0.75kW 1HP L 245mm rotation direction right capacitor 16µF LGB		
spare parts for	500512		
	GEV No.	365021	Ref. No. —
	operating capacitor capacity 16µF 425V tolerance 5% 50/60Hz ambient temperature max. -25 to +85°C ø 35mm L 73mm single M8 plastic connection male faston 6.3mm 416.10.99 protection		
	GEV No.	510702	Ref. No. —
	mechanical shaft seal height counter ring 5.5mm ID ø 12mm		
	GEV No.	521246	Ref. No. 464.022.00 464.031.00
	impellor ø 103mm H 26mm thread M8L shaft ø 20mm shaft length 7mm seat ø 8.2mm blades 6		
	GEV No.	521542	Ref. No. —
	pump cover LGB inlet ø 45mm outlet ø 40mm auxiliary pressure connection 13mm supporting pressure open ø 150mm ID ø 120mm inner high 25mm		
	GEV No.	521714	Ref. No. —
	pump cover gasket thickness 4x4mm Qty 1 pcs		

equipment-specific units

for pasta cookers



1

GEV No.	697881	Ref. No.	611.266.00
description	drain filter for pasta cooker ø 40mm stainless steel		

for dishwashers

hood mechanics for dishwashers

bolts

			
1			
GEV No.	510793	Ref. No.	441.079.00
description	screw bolt ED ø 10mm L 33mm thread M6		

springs

 <p>Image not available</p>			
1			
GEV No.	519403	Ref. No.	260.014.00
description	spring hood mechanics L 475mm ø 20mm		

linkage

			
1			
GEV No.	510708	Ref. No.	412.130.00
description	linkage L 270mm for dishwasher hood mechanics		

			
1			
GEV No.	510689	Ref. No.	412.078.00
description	linkage L 530mm for dishwasher hood mechanics		

friction rings

			
1			
GEV No.	510796	Ref. No.	451.024.00
description	slide ring for dishwasher ED ø 19mm ID ø 12mm thickness 1.5mm		

rollers

			
1			
GEV No.	510795	Ref. No.	451.079.00
description	roller ø 36mm H 19mm for hood mechanics plastic grey hole ø 10mm		

air traps

			
1			
GEV No.	510111	Ref. No.	451.036.00
description	air trap ø 34mm H 130mm hose ø 6mm plastic		
spare parts for	510111		
	GEV No.	504618	Ref. No. —
	O-ring EPDM thickness 2.62mm ID ø 15.54mm Qty 1 pcs		
	GEV No.	510075	Ref. No. —
	flat gasket rubber ED ø 22mm ID ø 13mm thickness 1.5mm Qty 1 pcs		
	GEV No.	510106	Ref. No. —
	hose connector for air trap		

			
1			
GEV No.	510653	Ref. No.	451.036.00
description	air trap ø 34mm H 95mm hose ø 6mm plastic		

door mechanics

 <p>Image not available</p>			
1			
GEV No.	519404	Ref. No.	260.018.00
description	spring L 255mm ø 19mm		





			
GEV No.	519394	Ref. No.	260.017.00
description	tension spring ø 19mm L1 230mm		

			
GEV No.	519400	Ref. No.	260.012.00
description	tension spring ø 19mm L1 300mm		

linkage			
			
GEV No.	518591	Ref. No.	412.094.00
description	tie bar L 215mm ø 5mm		

sliding plates			
			
GEV No.	518590	Ref. No.	451.091.00
description	sliding plate		

hinges			
 Image not available			
GEV No.	519401	Ref. No.	412.038.00
description	hinge mounting pos. left		

screw connections			
			
GEV No.	511919	Ref. No.	451.022.01
description	quick-fit retaining nut		

washing and rinsing systems			
			
GEV No.	524654	Ref. No.	441.041.00
description	rinse arm shaft mounting pos. upper ø 16mm H 61mm thread M12x1		

			
GEV No.	510794	Ref. No.	441.040.00
description	rinse jet H 11.6mm thread M6 WS 8		

			
GEV No.	510796	Ref. No.	451.024.00
description	slide ring for dishwasher ED ø 19mm ID ø 12mm thickness 1.5mm		

			
GEV No.	524653	Ref. No.	411.049.00
description	throttle disc ED ø 90mm ID ø 16mm		

			
GEV No.	510797	Ref. No.	412.173.00
description	wash pipe suitable for MARELS, MODULAR		

hinges			
door bearing			
 Image not available			
GEV No.	519402	Ref. No.	451.099.00
description	bush for door hinge		

miscellaneous



1

GEV No.	519395	Ref. No.	412.037.00
description	door hinge mounting pos. right		

rubber gaskets



1

GEV No.	510876	Ref. No.	N/A
description	flat gasket rubber ED ø 45mm ID ø 33mm thickness 3mm Qty 1 pcs		

gaskets

O-rings

EPDM



1

GEV No.	510769	Ref. No.	0835.25303.1
description	O-ring EPDM thickness 2.62mm ID ø 25.07mm Qty 1 pcs		

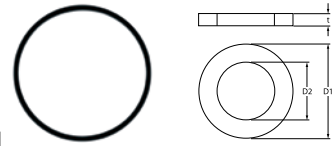

1

GEV No.	510009	Ref. No.	0835.35101.1
description	O-ring EPDM thickness 3.53mm ID ø 101.2mm Qty 1 pcs		

sealing washers

fibre gaskets



1

GEV No.	529349	Ref. No.	45300100
description	flat gasket FIBER ED ø 22mm ID ø 16.5mm thickness 2mm for thread 3/8" Qty 1 pcs		



1

GEV No.	510730	Ref. No.	0840.25122.0
description	flat gasket fibre ED ø 25mm ID ø 12mm thickness 2mm Qty 1 pcs		

springs

roller springs



1

GEV No.	511552	Ref. No.	N/A
description	roller spring complete incl. holder W 40mm ID ømm lug length 70mm		

tension springs



1

GEV No.	519394	Ref. No.	260.017.00
description	tension spring ø 19mm L1 230mm		



1

GEV No.	519400	Ref. No.	260.012.00
description	tension spring ø 19mm L1 300mm		

fittings, hose and pipe connectors

hose connectors

producer-specific



1

GEV No.	691661	Ref. No.	412032015 451098000
description	angle piece thread M12x1 for hose ID 12mm		



fastening material

nuts

hexagonal nuts

hexagonal nuts metric (without norm)



1

GEV No.	510792	Ref. No.	441.045.00
description	hexagonal nut thread M12x1 H 4mm WS 17 stainless steel Qty 1 pcs		

hexagonal nuts inch thread



1

GEV No.	506024	Ref. No.	44102000
description	nut thread 3/8" H 6mm SS WS 22 Qty 1 pcs		

C

control thermostats 3

F

fastening material 9

H

heating elements 3

heating elements for convection 3

heating elements for fryers 3

hexagonal nuts 9

hose connectors 8

I

immersion heating elements 3

N

nuts 9

O

O-rings 8

P

pressure switches 4

pumps 4

R

rotary switches 4

S

sealing washers 8

switches and momentary switches 4

T

thermostats 3

W

wash and rinse pumps 4