



GAS COMPONENTS



ELECTRIC COMPONENTS



WATER TECHNOLOGY



MECHANICAL COMPONENTS



TOOLS

Spare parts suitable for

MAGISTER

Find the complete and up-to-date range of products in our GEV Webshop



Manufacturer catalogue

The most important spare parts and accessories arranged clearly for every manufacturer

- ✓ Complete product range and all appliance data always up to date in the GEV Webshop
- ✓ Alphabetical Index at the end of the catalogue

GEV Webshop

www.gev-online.co.uk

www.gev-online.com







- 🔍 Add to Favourites
- 🔍 Sign In with email address and usual password
- 🔍 Easy-order – place several items in your basket at the same time
- 🔍 Quick Item search – no login needed





heating elements



heating elements for coffee machine

 <p>1</p>			
GEV No.	417237	Ref. No.	180050
description	heating element 1600W 230V heating circuits 1 mounting \varnothing 43mm hole distance 72mm L 178mm W 19mm H 40mm windings 2 hole \varnothing 9mm thermostat sleeves \varnothing 5mm length thermostat sleeves 142mm number of thermostat sleeves 1 thermostat sleeve eccentric, non clinging tube \varnothing 8mm connection M3 immersion heater 2 hole flange		
accessories for	417237		
	GEV No.	Ref. No.	190007
	flat gasket PTFE D1 \varnothing 61.5mm D2 \varnothing 46mm thickness 1.6mm for heating element Qty 1 pcs		

 <p>1</p>			
GEV No.	417238	Ref. No.	180052
description	heating element 2700W 230V heating circuits 3 mounting \varnothing 42mm hole distance 72mm L 210mm W 33mm H 32mm windings 3 hole \varnothing 9mm thermostat sleeves \varnothing 5mm length thermostat sleeves 143mm number of thermostat sleeves 1 thermostat sleeve eccentric, non clinging tube \varnothing 8mm connection M3 immersion heater 2 hole flange		
accessories for	417238		
	GEV No.	Ref. No.	190007
	flat gasket PTFE D1 \varnothing 61.5mm D2 \varnothing 46mm thickness 1.6mm for heating element Qty 1 pcs		

 <p>1</p>			
GEV No.	420363	Ref. No.	180138
description	heating element 3000W 230V heating circuits 3 mounting \varnothing 42mm L 205mm W 33mm H 32mm hole distance 72mm hole \varnothing 9mm tube \varnothing 8mm connection M3 immersion heater 2 hole flange number of thermostat sleeves 1 thermostat sleeves \varnothing 5mm length thermostat sleeves 130mm thermostat sleeve eccentric, clinging		

 <p>1</p>			
GEV No.	417239	Ref. No.	180053
description	heating element 4500W 230V heating circuits 3 mounting \varnothing 42mm hole distance 72mm L 368mm W 34mm H 31mm windings 3 hole \varnothing 9mm thermostat sleeves \varnothing 5mm length thermostat sleeves 142mm number of thermostat sleeves 1 thermostat sleeve eccentric, non clinging tube \varnothing 8mm connection M3 immersion heater 2 hole flange		
accessories for	417239		
	GEV No.	Ref. No.	190007
	flat gasket PTFE D1 \varnothing 61.5mm D2 \varnothing 46mm thickness 1.6mm for heating element Qty 1 pcs		

 <p>1</p>			
GEV No.	417240	Ref. No.	180054
description	heating element 5400W 230V heating circuits 3 mounting \varnothing 42mm hole distance 72mm L 580mm W 33mm H 31mm windings 3 hole \varnothing 9mm thermostat sleeves \varnothing 5mm length thermostat sleeves 142mm number of thermostat sleeves 1 thermostat sleeve eccentric, non clinging tube \varnothing 8mm connection M3 immersion heater 2 hole flange		
accessories for	417240		
	GEV No.	Ref. No.	190007
	flat gasket PTFE D1 \varnothing 61.5mm D2 \varnothing 46mm thickness 1.6mm for heating element Qty 1 pcs		

accessories

sealing washers

PTFE gaskets

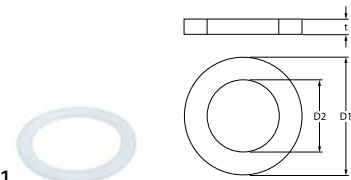
 <p>1</p>			
GEV No.	528540	Ref. No.	190007
description	flat gasket PTFE D1 \varnothing 61.5mm D2 \varnothing 46mm thickness 1.6mm for heating element Qty 1 pcs		

thermostats

bi-metal thermostats

safety bi-metal thermostats

 <p>1</p>			
GEV No.	390370	Ref. No.	180158
description	bi-metal safety thermostat hole distance mm switch-off temp. 145°C 1NC 1-pole 16A connection F6.3 M4		





control and safety thermostats

RANCO

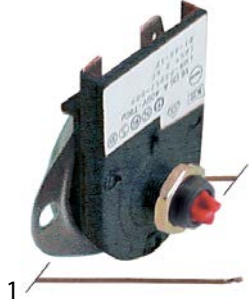
safety thermostats



GEV No.	390305	Ref. No.	180039
description	safety thermostat t.max. 165°C temperature range°C 1-pole 1NC 25A probe ø 2mm probe Lmm capillary pipe 490mm capillary pipe isolatedmm gland nut shaft ømm shaft Lmm shaft position rotation° probe material copper with capillary probe screw connection M10x0.75 switch-off temp. 165°C		
accessories for	390305		
	GEV No.	390313	Ref. No. —
	screw connection		
	GEV No.	390317	Ref. No. —
	double nipple		
	GEV No.	390373	Ref. No. —
	union screw thread M10x1 L 20mm ID ø 2.7mm WS 12 thread L 15mm		



GEV No.	346110	Ref. No.	180034
description	rocker switch mounting measurements 30x22mm red 2NO 250V 16A illuminated coffee connection male faston 6.3mm ambient temperature max. 125/55°C protection IP40		



GEV No.	346111	Ref. No.	180033
description	rocker switch mounting measurements 30x22mm red 2NO 250V 16A illuminated cup warmer connection male faston 6.3mm ambient temperature max. 125/55°C protection IP40		



GEV No.	347114	Ref. No.	180032
description	rocker switch mounting measurements 30x22mm red 2NO 250V 16A illuminated heating connection male faston 6.3mm ambient temperature max. 100/55°C protection IP40		
accessories for	347114		
	GEV No.	301036	Ref. No. —
	protective cover internal size 30x22mm for rocker switch mounting measurementsmm		



GEV No.	346109	Ref. No.	180031
description	rocker switch mounting measurements 30x22mm red 2NO 250V 16A illuminated water connection male faston 6.3mm ambient temperature max. 125/55°C protection IP40		

switches and momentary switches

rocker/momentary rocker switches

30x22mm



GEV No.	346474	Ref. No.	180035
description	dummy element external size 30x22mm suitable for rocker switch		



GEV No.	347202	Ref. No.	180034
description	rocker switch mounting measurements 30x22mm orange 2NO 250V 16A illuminated cup connection male faston 6.3mm ambient temperature max. 100/55°C protection IP40		



GEV No.	346108	Ref. No.	180030
description	rocker switch mounting measurements 30x22mm orange 2NO 250V 16A illuminated ignition connection male faston 6.3mm ambient temperature max. 125/55°C protection IP40		

microswitches

roller-lever actuated

microswitches



GEV No.	345250	Ref. No.	180128
description	microswitch with handle with a switch 250V 16A 1CO connection male faston 6.3mm L 27mm L1 36mm ambient temperature max. 125°C mounting distance 22mm type RL6-1-FGE-P12-5-L actuating force: 90g		





pin-plunger actuated			
M10			
			
1			
GEV No.	347216	Ref. No.	180171
description	microswitch with plunger thread M10x0.75 thread L 14mm 250V 10A 1CO connection male faston 6.3mm stroke 7.5mm mounting distance 22mm L 28mm ambient temperature max. 125°C type NR6K5 actuating force: 260g		

lamps

indicator lights

indicator lights (complete)			
ø12mm			
with screw socket			
			
1			
GEV No.	359464	Ref. No.	180067
description	indicator light housings mounting measurements ø12mm green		

			
1			
GEV No.	359465	Ref. No.	180069
description	indicator light housings mounting measurements ø12mm yellow		

			
1			
GEV No.	359467	Ref. No.	180066
description	indicator lamp 240V green cable length 290mm ø 8mm		

			
1			
GEV No.	359466	Ref. No.	180068
description	indicator lamp 240V orange cable length 290mm ø 8mm		

contactors

LOVATO

power contactors

			
1			
GEV No.	380713	Ref. No.	180024
description	power contactor resistive load 20A 230VAC (AC3/400V) 9A/4kW main contacts 4NO connection male faston type 11BGF09T4A230		

relays

power relays

with bracket mounting

			
1			
GEV No.	380185	Ref. No.	180026
description	power relays Italiana Relè 230VAC 30A 1NO connection F6.3 bracket mounting dimensions 36.5x32.2x51.8mm manuf. no. A10-230AC-FA		

level relays

GICAR

			
1			
GEV No.	402103	Ref. No.	180028
description	level controller 230/240V voltage AC 50/60Hz connection F6.3 type NRL30/1E-2C/F		



1	GEV No.	528636	Ref. No.	180159
description level controller 230V voltage AC 50/60Hz 16/5A connection F6.3 type RL30 MICRO ST				

electronics

PCBs



1	GEV No.	528981	Ref. No.	900151
description display L 80mm W 29mm type KAPPA XP				

central units



1	GEV No.	528638	Ref. No.	180090 180239
description central unit 3 groups 230V 50/60Hz type 3d5 3GRCT XLC (SC) voltage AC				



1	GEV No.	528639	Ref. No.	180218
description central unit F2006 230V 50/60Hz type 4d5 Maestro Clock 4GRCTZNL-D voltage AC				

dosing electronics

GICAR



1	GEV No.	528635	Ref. No.	180087
description control box 230V voltage AC 50/60Hz 5/5/10A type RL30 MICRO Z				



1	GEV No.	528637	Ref. No.	180168
description dosing electronics 230V voltage AC 50/60Hz 5/5/10A type RL30 MICRO Z „DOUBLE 5L“				

keypads

keypad units



1	GEV No.	527817	Ref. No.	900233
description control panel suitable for F2006 2-group				





1	GEV No.	527818	Ref. No.	900234
description control panel suitable for F2006 2-group				



1	GEV No.	528799	Ref. No.	900149
description keypad unit 1 group ES STILO, KAPPA XP buttons 6 L 118mm W 29mm				



			
1			
GEV No.	528785	Ref. No.	900150
description	keypad unit buttons 3 L 61mm W 29mm F2006, XP		

			
1			
GEV No.	528725	Ref. No.	180095
description	keypad unit coffee machine F2006/Kappa/Leva/Stilo buttons 6 L 88mm W 60mm		

			
1			
GEV No.	528764	Ref. No.	180170
description	keypad unit coffee machine MS/ES/40/45 buttons 3 L 88mm W 37mm		

pressure switches

for coffee machines

ø 38mm

			
1			
GEV No.	541155	Ref. No.	180161
description	pressure control ø 38mm pressure range 1-2.5bar pressure connection vertical 16A 250V coffee machine parts connection 1/8" pressure connection 1/8"		

electrodes

			
1			
GEV No.	528989	Ref. No.	900159
description	level electrode 1/4" total length 76mm probe L 62mm insulated probe length 26mm angled connection screw clamp stainless steel ø 2.5mm PTFE		

			
1			
GEV No.	528990	Ref. No.	900078
description	level electrode 3/8" total length 120mm probe L 102mm insulated probe length 26mm angled stainless steel ø 2mm		

flow meters and flow sensors

flow meters



<p>GICAR</p> 			
1			
GEV No.	542378	Ref. No.	180040
description	flow meter thread 1/4" stainless steel with LED approval NSF		

pumps

booster pumps II

pump motors

clip connection

			
1			
GEV No.	500080	Ref. No.	180020
description	pump motor capacitor 10µF ULKA type 128P 180W 230V 50Hz connection clip L 155mm W 130mm H 160mm at 50Hz 1400rpm		
accessories for	500080		
	GEV No.	365014	Ref. No.
			—
	 <p>operating capacitor capacity 12.5µF 450V tolerance 5%Hz ambient temperature max. -25 to +85°C ø 35mm L 70mm M8 plastic connection male faston 6.3mm 45S.C3DS.12.5 protection</p>		



pump heads

PROCON



1	GEV No.	501559	Ref. No.	210002
description pump head PROCON L 97mm 200l/h connection 3/8" NPT clip connection shaft ø 5x11mm				



1	GEV No.	400229	Ref. No.	180096
description ribbon cable 16-pole L 800mm plug type FC-16P raster size 2.54mm				

equipment-specific units

for espresso machines

filter holders

filter holders standard

filter holders (complete)



1	GEV No.	528994	Ref. No.	189075 210030
description filter holder with outlet, 2-fold with filter ID ø 62mm outlet distance 44mm				

filter holder without spout



1	GEV No.	525977	Ref. No.	N/A
description filter holder suitable for CREM-EXPOBAR/WEGA/GRIMAC/SANRAMO without outlet mounting ø 83mm outlet 3/8" ID ø 61.5mm wedge height 10mm wedge position horizontal number of wedges 2 lever inclined				

filters

for 1 cup



1	GEV No.	528995	Ref. No.	210036 210058
description coffee filter ø 70mm mounting ø 60mm H 16mm cups 1				

fuses

fine fuses



1	GEV No.	358676	Ref. No.	180101
description fine fuse size ø5x20mm 3.15A fast-acting rated 250V Qty 10 pcs				



1	GEV No.	358607	Ref. No.	180155
description fine fuse size ø5x20mm 6.3A slow-acting rated 250V Qty 10 pcs				

electric accessories

cables

ribbon cables

group 1



1	GEV No.	400706	Ref. No.	180097
description ribbon cable 16-pole L 1100mm plug type FC-16P raster size 2.54mm				



1	GEV No.	400707	Ref. No.	180098
description ribbon cable 16-pole L 1400mm plug type FC-16P raster size 2.54mm				



1	GEV No.	400228	Ref. No.	180173
description ribbon cable 16-pole L 600mm plug type FC-16P raster size 2.54mm				

			
1			
GEV No.	526069	Ref. No.	210026
description	coffee filter ø 70mm mounting ø 60mm H 20.5mm cups 1 amount of coffee 7g perforation ø 0.4mm		

for 2 cups			
			
1			
GEV No.	529700	Ref. No.	210027
description	coffee filter ø 70mm mounting ø 60mm H 22mm cups 2 amount of coffee 14g		

brewing units			
shower screens			
flat			
			
1			
GEV No.	528996	Ref. No.	210057
description	shower screen ø 34mm hole ø 6.2mm flat		

with upstand and central hole			
			
1			
GEV No.	528997	Ref. No.	210025
description	shower screen ø 57mm H 4mm hole ø 5.3mm		

filter holder gaskets			
flat			
with external notch			
			
1			
GEV No.	528034	Ref. No.	190003
description	filter holder gasket D1 ø 73.5mm D2 ø 57.5mm H 8mm with outside notch Qty 1 pcs		

standard			
			
1			
GEV No.	528610	Ref. No.	190003
description	filter holder gasket D1 ø 73.5mm D2 ø 57.5mm H 8.1mm with outside notch		

shim gaskets			
			
1			
GEV No.	528599	Ref. No.	190019
description	shim gasket D1 ø 72mm D2 ø 58mm thickness 0.4mm paper Qty 1 pcs		

brewing units with solenoid valve			
components			
			
1			
GEV No.	528993	Ref. No.	900091
description	infusor 1/8" L 48mm suitable for MAGISTER WS 32		

components			
screw connections			
			
1			
GEV No.	560369	Ref. No.	171002
description	grub screw thread M12x1.75 L 14.2mm stainless steel DIN 914 intake internal hexagon WS 6 Qty 1 pcs		

water dispersions

water dispersions

group 2



1

GEV No.	529535	Ref. No.	100002
----------------	--------	-----------------	--------

description	water distributor ø 21mm hole ø 5.5mm grooves 8
--------------------	---

group 3



1

GEV No.	528998	Ref. No.	100001
----------------	--------	-----------------	--------

description	water distributor ø 55.5 / 58mm H 8mm 1 holes hole ø 16mm brass
--------------------	---



1

GEV No.	528999	Ref. No.	100058
----------------	--------	-----------------	--------

description	water distributor ø 55mm H 11.5mm 4 holes hole ø 1.5mm mounting ø 5.6mm brass
--------------------	---

accessories for	528999
------------------------	--------



GEV No.	528632	Ref. No.	190026
----------------	--------	-----------------	--------

description	O-ring EPDM thickness 3.53mm ID ø 44.04mm Qty 1 pcs
--------------------	---



GEV No.	528996	Ref. No.	210057
----------------	--------	-----------------	--------

description	shower screen ø 34mm hole ø 6.2mm flat
--------------------	--

safety valves

safety valves

3/8"



1

GEV No.	531313	Ref. No.	900080
----------------	--------	-----------------	--------

Ref. No.	900162
-----------------	--------

description	safety valve connection 3/8" triggering pressure 1.5bar
--------------------	---

expansion valves



1

GEV No.	531314	Ref. No.	900081
----------------	--------	-----------------	--------

description	valve T1: 3/8" BL 28mm total length 38mm
--------------------	--

with hose connection



1

GEV No.	528992	Ref. No.	900027
----------------	--------	-----------------	--------

description	expansion valve T1: 3/8" ET hose ø 7mm L 47mm
--------------------	---

drain pans

drain pans



1

GEV No.	528982	Ref. No.	900057
----------------	--------	-----------------	--------

description	drain pan 1 group L 90mm W 90mm H 40mm hole ø 18mm connection 3/4" hose length 120/300mm suitable for 60
--------------------	--



1

GEV No.	528983	Ref. No.	900058
----------------	--------	-----------------	--------

description	drain pan 2 groups L 90mm W 90mm H 40mm hole ø 18mm connection 3/4" hose length 120/300mm suitable for 70/100
--------------------	---



1

GEV No.	528984	Ref. No.	900059
----------------	--------	-----------------	--------

description	drain pan 3 groups L 90mm W 90mm H 40mm hole ø 18mm connection 3/4" hose length 120/300mm suitable for 100
--------------------	--

boilers

pipes





1

GEV No.	528988	Ref. No.	900036
----------------	--------	-----------------	--------

description	aspiration tube boiler tube ø 8x1 mm pipe length 110mm PE connection ø 10/14mm copper fitting
--------------------	---



heat exchangers			
injector tubes			
			
1			
GEV No.	528986	Ref. No.	900035
description	injector pipe boiler tube ø 6x1mm pipe length 130mm PE connection ø 8/14mm copper fitting		

			
1			
GEV No.	528987	Ref. No.	900152
description	injector pipe boiler tube ø 6x1mm pipe length 180mm PE connection ø 8/14mm copper fitting		

steam/water taps			
steam/water taps			
steam taps			
bushes			
			
1			
GEV No.	529536	Ref. No.	100050
description	bush D1 ø 12mm D2 ø 9mm ID ø 7mm H 5mm brass level glass		

			
1			
GEV No.	528618	Ref. No.	100115
description	stop D1 ø 12mm D2 ø 9.7mm ID ø 7mm H 3mm brass steam tap		

steam taps (complete)																																											
																																											
1																																											
GEV No.	528612	Ref. No.	900116																																								
description	steam tap complete																																										
spare parts for	528612																																										
<table border="1"> <tr> <td style="text-align: center;">  </td> <td>GEV No.</td> <td>528344</td> <td>Ref. No.</td> <td>190006</td> </tr> <tr> <td></td> <td colspan="4">O-ring silicone thickness 2.62mm ID ø 12.37mm Qty 1 pcs</td> </tr> <tr> <td style="text-align: center;">  </td> <td>GEV No.</td> <td>528615</td> <td>Ref. No.</td> <td>160007</td> </tr> <tr> <td></td> <td colspan="4">compression spring ø 10.7mm L 34.5mm wire gauge ø 1.5mm steam tap</td> </tr> <tr> <td style="text-align: center;">  </td> <td>GEV No.</td> <td>528616</td> <td>Ref. No.</td> <td>100114</td> </tr> <tr> <td></td> <td colspan="4">washer ID ø 7.4mm ED ø 10.9mm thickness 0.5mm stainless steel steam tap</td> </tr> <tr> <td style="text-align: center;">  </td> <td>GEV No.</td> <td>528617</td> <td>Ref. No.</td> <td>190023</td> </tr> <tr> <td></td> <td colspan="4">flat gasket PTFE ED ø 11.3mm ID ø 7.6mm thickness 1.1mm steam tap Qty 1 pcs</td> </tr> </table>					GEV No.	528344	Ref. No.	190006		O-ring silicone thickness 2.62mm ID ø 12.37mm Qty 1 pcs					GEV No.	528615	Ref. No.	160007		compression spring ø 10.7mm L 34.5mm wire gauge ø 1.5mm steam tap					GEV No.	528616	Ref. No.	100114		washer ID ø 7.4mm ED ø 10.9mm thickness 0.5mm stainless steel steam tap					GEV No.	528617	Ref. No.	190023		flat gasket PTFE ED ø 11.3mm ID ø 7.6mm thickness 1.1mm steam tap Qty 1 pcs			
	GEV No.	528344	Ref. No.	190006																																							
	O-ring silicone thickness 2.62mm ID ø 12.37mm Qty 1 pcs																																										
	GEV No.	528615	Ref. No.	160007																																							
	compression spring ø 10.7mm L 34.5mm wire gauge ø 1.5mm steam tap																																										
	GEV No.	528616	Ref. No.	100114																																							
	washer ID ø 7.4mm ED ø 10.9mm thickness 0.5mm stainless steel steam tap																																										
	GEV No.	528617	Ref. No.	190023																																							
	flat gasket PTFE ED ø 11.3mm ID ø 7.6mm thickness 1.1mm steam tap Qty 1 pcs																																										

spare parts for	528612																																																				
<table border="1"> <tr> <td style="text-align: center;">  </td> <td>GEV No.</td> <td>528618</td> <td>Ref. No.</td> <td>100115</td> </tr> <tr> <td></td> <td colspan="4">stop D1 ø 12mm D2 ø 9.7mm ID ø 7mm H 3mm brass steam tap</td> </tr> <tr> <td style="text-align: center;">  </td> <td>GEV No.</td> <td>528619</td> <td>Ref. No.</td> <td>190020</td> </tr> <tr> <td></td> <td colspan="4">gasket rubber ED ø 13.5mm ID ø 4mm thickness 4mm steam/water tap Qty 1 pcs</td> </tr> <tr> <td style="text-align: center;">  </td> <td>GEV No.</td> <td>528620</td> <td>Ref. No.</td> <td>140042</td> </tr> <tr> <td></td> <td colspan="4">spacer steam tap stainless steel L 15.1mm W 10mm thickness 2mm</td> </tr> <tr> <td style="text-align: center;">  </td> <td>GEV No.</td> <td>528621</td> <td>Ref. No.</td> <td>171100</td> </tr> <tr> <td></td> <td colspan="4">ball ø 9.55mm steam tap SS</td> </tr> <tr> <td style="text-align: center;">  </td> <td>GEV No.</td> <td>529724</td> <td>Ref. No.</td> <td>171101</td> </tr> <tr> <td></td> <td colspan="4">retaining ring E D1 ø 4mm D2 ø 9mm SS DIN 6799 thickness 0.7mm for shaft ø 4-5mm</td> </tr> </table>					GEV No.	528618	Ref. No.	100115		stop D1 ø 12mm D2 ø 9.7mm ID ø 7mm H 3mm brass steam tap					GEV No.	528619	Ref. No.	190020		gasket rubber ED ø 13.5mm ID ø 4mm thickness 4mm steam/water tap Qty 1 pcs					GEV No.	528620	Ref. No.	140042		spacer steam tap stainless steel L 15.1mm W 10mm thickness 2mm					GEV No.	528621	Ref. No.	171100		ball ø 9.55mm steam tap SS					GEV No.	529724	Ref. No.	171101		retaining ring E D1 ø 4mm D2 ø 9mm SS DIN 6799 thickness 0.7mm for shaft ø 4-5mm			
	GEV No.	528618	Ref. No.	100115																																																	
	stop D1 ø 12mm D2 ø 9.7mm ID ø 7mm H 3mm brass steam tap																																																				
	GEV No.	528619	Ref. No.	190020																																																	
	gasket rubber ED ø 13.5mm ID ø 4mm thickness 4mm steam/water tap Qty 1 pcs																																																				
	GEV No.	528620	Ref. No.	140042																																																	
	spacer steam tap stainless steel L 15.1mm W 10mm thickness 2mm																																																				
	GEV No.	528621	Ref. No.	171100																																																	
	ball ø 9.55mm steam tap SS																																																				
	GEV No.	529724	Ref. No.	171101																																																	
	retaining ring E D1 ø 4mm D2 ø 9mm SS DIN 6799 thickness 0.7mm for shaft ø 4-5mm																																																				
accessories for	528612																																																				
<table border="1"> <tr> <td style="text-align: center;">  </td> <td>GEV No.</td> <td>111259</td> <td>Ref. No.</td> <td>030136</td> </tr> <tr> <td></td> <td colspan="4">knob ø 50mm black/grey</td> </tr> <tr> <td style="text-align: center;">  </td> <td>GEV No.</td> <td>111260</td> <td>Ref. No.</td> <td>030020</td> </tr> <tr> <td></td> <td colspan="4">knob steam ø 50mm black</td> </tr> </table>					GEV No.	111259	Ref. No.	030136		knob ø 50mm black/grey					GEV No.	111260	Ref. No.	030020		knob steam ø 50mm black																																	
	GEV No.	111259	Ref. No.	030136																																																	
	knob ø 50mm black/grey																																																				
	GEV No.	111260	Ref. No.	030020																																																	
	knob steam ø 50mm black																																																				

knobs			
			
1			
GEV No.	111259	Ref. No.	030136
description	knob ø 50mm black/grey		

			
1			
GEV No.	111260	Ref. No.	030020
description	knob steam ø 50mm black		

components			
gaskets			
			
1			
GEV No.	528617	Ref. No.	190023
description	flat gasket PTFE ED ø 11.3mm ID ø 7.6mm thickness 1.1mm steam tap Qty 1 pcs		



1			
GEV No.	528619	Ref. No.	190020
description	gasket rubber ED ø 13.5mm ID ø 4mm thickness 4mm steam/water tap Qty 1 pcs		

springs



1			
GEV No.	528615	Ref. No.	160007
description	compression spring ø 10.7mm L 34.5mm wire gauge ø 1.5mm steam tap		



1			
GEV No.	528622	Ref. No.	160003
description	spring ø 15.3mm L 25mm wire gauge ø 1.25mm for water filling		

miscellaneous



1			
GEV No.	528621	Ref. No.	171100
description	ball ø 9.55mm steam tap SS		



1			
GEV No.	528620	Ref. No.	140042
description	spacer steam tap stainless steel L 15.1mm W 10mm thickness 2mm		

water taps

knobs



1			
GEV No.	528627	Ref. No.	100020
description	push button ø 20mm chrome-plated brass thread M6		

steam/water pipes



steam pipes



1			
GEV No.	531073	Ref. No.	900186
description	steam pipe stainless steel		





1			
GEV No.	528624	Ref. No.	900014
description	steam pipe thread M10x1 H 150mm L 135mm ø 14.5mm ball head tube ø 10mm chrome-plated brass 60/60 series		

accessories for	528624		
	GEV No.	528623	Ref. No.
			160005
description	compression spring ø 12.1mm L 11.5mm wire gauge ø 1.5mm steam pipe coffee machine		
	GEV No.	528625	Ref. No.
			210071
description	tube handle L 35mm rubber ID ø 8mm		



1			
GEV No.	528626	Ref. No.	900001
description	steam pipe thread M10x1 H 150mm L 140mm ø 12mm ball head tube ø 10mm chrome-plated brass 100 series		

accessories for	528626		
	GEV No.	528231	Ref. No.
			—
description	O-ring Viton thickness 2.62mm ID ø 12.37mm Qty 1 pcs		
	GEV No.	528623	Ref. No.
			160005
description	compression spring ø 12.1mm L 11.5mm wire gauge ø 1.5mm steam pipe coffee machine		
	GEV No.	528625	Ref. No.
			210071
description	tube handle L 35mm rubber ID ø 8mm		

water pipes



1			
GEV No.	528633	Ref. No.	900003
description	water pipe thread 3/8" ø 23.5mm L 58mm ball head WS 22 water hot		

accessories

springs







1			
GEV No.	528623	Ref. No.	160005
description	compression spring ø 12.1mm L 11.5mm wire gauge ø 1.5mm steam pipe coffee machine		

tube handles







1			
GEV No.	528625	Ref. No.	210071
description	tube handle L 35mm rubber ID ø 8mm		





intake valves			
intake valves			
			
1			
GEV No.	528611	Ref. No.	900005
description	intake valve water complete		
spare parts for	528611		
	GEV No.	528619	Ref. No. 190020
	gasket rubber ED ø 13.5mm ID ø 4mm thickness 4mm steam/water tap Qty 1 pcs		
	GEV No.	528622	Ref. No. 160003
	spring ø 15.3mm L 25mm wire gauge ø 1.25mm for water filling		
	GEV No.	528627	Ref. No. 100020
	push button ø 20mm chrome-plated brass thread M6		
	GEV No.	528698	Ref. No. 150004
	flat gasket copper ED ø 24mm ID ø 20mm thickness 1mm		

level glasses			
level glasses			
gaskets			
			
1			
GEV No.	529537	Ref. No.	190025
description	flat gasket PTFE ED ø 24mm ID ø 20.4mm thickness 1mm Qty 1 pcs		

balls			
			
1			
GEV No.	528630	Ref. No.	030100
description	ball ø 6.6mm plastic water level glass		

level glass pipes			
			
1			
GEV No.	528629	Ref. No.	210001
description	water level tube ø 12mm H 140mm ID ø 9mm		
accessories for	528629		
	GEV No.	528344	Ref. No. 190006
	O-ring silicone thickness 2.62mm ID ø 12.37mm Qty 1 pcs		
	GEV No.	528628	Ref. No. 100026
	washer ID ø 13.3mm ED ø 17mm thickness 0.5mm brass Qty 1 pcs water level glass		
	GEV No.	528630	Ref. No. 030100
	ball ø 6.6mm plastic water level glass		

non-return valves			
complete			
			
1			
GEV No.	529993	Ref. No.	900079
description	non-return valve inlet 3/8" outlet 3/8" L 40mm		

			
1			
GEV No.	528991	Ref. No.	900079
description	non-return valve inlet 3/8" outlet 3/8" L 40mm suitable for MAGISTER		

for coffee grinders			
grinding burrs			
grinding burrs straight			
standard			
			
1			
GEV No.	527227	Ref. No.	PRCOPMACM12
description	grinding burrs pair turn direction right D1 ø 63mm ID ø 38mm H 9.5mm tooth spacing 3mm hole ø 5.5mm bore ø 8.5mm mounting ø 48 straight suitable for FIORENZATO		

knobs			
steam/water taps			
			
1			
GEV No.	111259	Ref. No.	030136
description	knob ø 50mm black/grey		

			
1			
GEV No.	111260	Ref. No.	030020
description	knob steam ø 50mm black		

gaskets

O-rings

EPDM

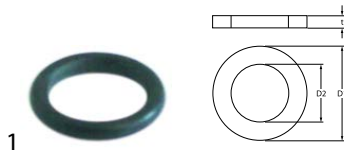

GEV No. 528110 **Ref. No.** 190010

description O-ring EPDM thickness 2.62mm ID \varnothing 12.37mm Qty 1 pcs

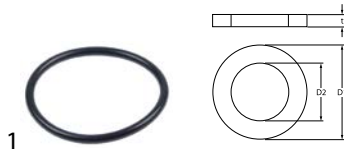

GEV No. 528632 **Ref. No.** 190026

description O-ring EPDM thickness 3.53mm ID \varnothing 44.04mm Qty 1 pcs

silicone

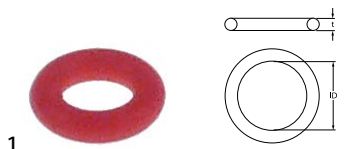

GEV No. 526403 **Ref. No.** 190013

description O-ring silicone thickness 1.78mm ID \varnothing 3.69mm Qty 1 pcs



GEV No. 528344 **Ref. No.** 190006

description O-ring silicone thickness 2.62mm ID \varnothing 12.37mm Qty 1 pcs

Viton

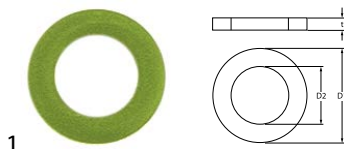

GEV No. 101526 **Ref. No.** 190013

description O-ring Viton thickness 1.78mm ID \varnothing 4.48mm Qty 1 pcs

sealing washers

rubber gaskets



GEV No. 528619 **Ref. No.** 190020

description gasket rubber ED \varnothing 13.5mm ID \varnothing 4mm thickness 4mm steam/water tap Qty 1 pcs

copper gaskets

DIN-7603-A



GEV No. 528698 **Ref. No.** 150004

description flat gasket copper ED \varnothing 24mm ID \varnothing 20mm thickness 1mm

PTFE gaskets



GEV No. 528617 **Ref. No.** 190023

description flat gasket PTFE ED \varnothing 11.3mm ID \varnothing 7.6mm thickness 1.1mm steam tap Qty 1 pcs



GEV No. 528634 **Ref. No.** 190011

description flat gasket PTFE ED \varnothing 20.5mm ID \varnothing 17.5mm thickness 1.5mm Qty 1 pcs



GEV No. 529537 **Ref. No.** 190025

description flat gasket PTFE ED \varnothing 24mm ID \varnothing 20.4mm thickness 1mm Qty 1 pcs



springs

compression springs

			
1			
GEV No.	528623	Ref. No.	160005
description	compression spring ø 12.1mm L 11.5mm wire gauge ø 1.5mm steam pipe coffee machine		

coffee accessories

milk foamers

			
1			
GEV No.	802043	Ref. No.	900262 VENMONTMAN
description	milk foamer connection 3/8" stainless steel		

manometers

			
1			
GEV No.	528843	Ref. No.	210022
description	manometer MAGISTER ø 60mm pressure range 0-3 / 0-15bar connection on the backside thread 1/8"		

			
1			
GEV No.	528980	Ref. No.	210089
description	manometer MAGISTER ø 60mm pressure range 0-3 / 0-15bar connection on the backside thread 1/8" suitable for F2006 with hole for lampe		

			
1			
GEV No.	528675	Ref. No.	210090
description	manometer ø 51.5mm pressure range 0-16bar MAGISTER thread 1/4" marking 9 pump connection on the backside		

			
1			
GEV No.	528714	Ref. No.	210021
description	manometer ø 51.5mm pressure range 0-3bar MAGISTER thread 1/4" marking 1.8 steam connection on the backside		

fittings, hose and pipe connectors

hose connectors

			
1			
GEV No.	528985 ¹	Ref. No.	900076
description	hose connector plastic angled thread 3/4" hose ø 13mm Qty 1 pcs		
	¹ incl. flat rubber gasket		

fastening material

screws

countersunk screws

			
1			
GEV No.	560383	Ref. No.	170501
description	countersunk screw thread M5 L 16mm SS DIN 965/ISO 7046 Qty 1 pcs head ø 9mm oval head		

			
1			
GEV No.	560370	Ref. No.	170413
description	countersunk screw thread M5 L 16mm stainless steel DIN 965/ISO 7046 Qty 1 pcs intake Phillips head ø 9mm		

flat-headed bolts

			
1			
GEV No.	560371	Ref. No.	170400
description	flat-headed bolt thread M4 thread L 12mm SS DIN 7985/ISO 7045 Qty 1 pcs intake Phillips head ø 8mm head thickness 3mm		

grub screws

DIN 914/ISO 4027



1

GEV No.	560369	Ref. No.	171002
description	grub screw thread M12x1.75 L 14.2mm stainless steel DIN 914 intake internal hexagon WS 6 Qty 1 pcs		



1

GEV No.	697410	Ref. No.	171003
description	grub screw thread M5 L 6mm stainless steel DIN 914/ISO 4027 WS 2.5 with spike Qty 1 pcs		

washers

washers

miscellaneous



1

GEV No.	528628	Ref. No.	100026
description	washer ID \varnothing 13.3mm ED \varnothing 17mm thickness 0.5mm brass Qty 1 pcs water level glass		



1

GEV No.	528616	Ref. No.	100114
description	washer ID \varnothing 7.4mm ED \varnothing 10.9mm thickness 0.5mm stainless steel steam tap		

fasteners

retaining rings

DIN 6799



1

GEV No.	529724	Ref. No.	171101
description	retaining ring E D1 \varnothing 4mm D2 \varnothing 9mm SS DIN 6799 thickness 0.7mm for shaft \varnothing 4-5mm		

consumables

fuses

fine fuses



1

GEV No.	358676	Ref. No.	180101
description	fine fuse size \varnothing 5x20mm 3.15A fast-acting rated 250V Qty 10 pcs		

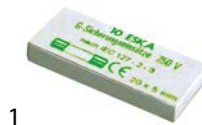

1

GEV No.	358607	Ref. No.	180155
description	fine fuse size \varnothing 5x20mm 6.3A slow-acting rated 250V Qty 10 pcs		

B

bi-metal thermostats	3
booster pumps II	7

C

cables	8
consumables	16
contactors	5
countersunk screws	15

E

electric accessories	8
electrodes	7

F

fasteners	16
fastening material	15
fine fuses	16
flat-headed bolts	15
flow meters	7
fuses	8, 16

G

grub screws	16
-------------	----

H

heating elements	3
heating elements for coffee machine	3
hose connectors	15

I

indicator lights	5
indicator lights (complete)	5

L

lamps	5
-------	---

M

microswitches	4
milk foamers	15

O

O-rings	14
---------	----

P

pressure switches	7
pumps	7

R

relays	5
retaining rings	16
ribbon cables	8

rocker/momentary rocker switches	4
----------------------------------	---

S

safety bi-metal thermostats	3
screws	15
sealing washers	14
switches and momentary switches	4

T

thermostats	3
-------------	---

W

washers	16
---------	----