



GAS COMPONENTS



ELECTRIC COMPONENTS



WATER TECHNOLOGY



MECHANICAL COMPONENTS



TOOLS

Spare parts suitable for

MAFIROL

Find the complete and up-to-date range of products in our GEV Webshop



Manufacturer catalogue

The most important spare parts and accessories arranged clearly for every manufacturer

- ✓ Complete product range and all appliance data always up to date in the GEV Webshop
- ✓ Alphabetical Index at the end of the catalogue

GEV Webshop

www.gev-online.co.uk

www.gev-online.com



- 🔍 Add to Favourites
- 🔍 Sign In with email address and usual password
- 🔍 Easy-order – place several items in your basket at the same time
- 🔍 Quick Item search – no login needed



heating elements

heating elements for refrigeration

heating elements for condensate evaporation



1

GEV No.	418732	Ref. No.	877107800
description	heating element 650W 230V L 280mm W 95mm H 87mm L1 65mm L2 215mm cable length 1500mm connection distance 86mm tube ø 8.5mm heating circuits 1 immersion heater		
For models:	927100100, 927102100, 927200200, 927300200, 927300300		



1

GEV No.	418733	Ref. No.	877107900
description	heating element 750W 230V L 430mm W 95mm H 98mm L1 85mm L2 345mm cable length 1500mm connection cable connection distance 86mm tube ø 8.5mm heating circuits 1 immersion heater		
For models:	927100200, 927100300, 927100400, 927102200, 927102300, 927102400, 927200300		

condensing trays heated







1

GEV No.	750005	Ref. No.	222312100
description	condensing tray heated L 240mm W 240mm H 250mm		
For models:	927100100, 927102100		
spare parts for	750005		
	GEV No.	Ref. No.	877107800
	heating element 650W 230V L 280mm W 95mm H 87mm L1 65mm L2 215mm cable length 1500mm connection distance 86mm tube ø 8.5mm heating circuits 1 immersion heater		



1

GEV No.	750003	Ref. No.	226303600
description	condensing tray heated L 240mm W 240mm H 75mm 230V 650W connect with power contactor		
For models:	927200200, 927300200, 927300300		
spare parts for	750003		
	GEV No.	Ref. No.	—
	float switch 250V 1A 1NO or 1NC thread M16x1.5 ø 17.4mm L 100.5mm mounting ø 28mm cable cable length 1500mm temp.-resist. -20 up to +90°C		
	GEV No.	Ref. No.	877107800
	heating element 650W 230V L 280mm W 95mm H 87mm L1 65mm L2 215mm cable length 1500mm connection distance 86mm tube ø 8.5mm heating circuits 1 immersion heater		
accessories for	750003		
	GEV No.	Ref. No.	880302100
	power relays Italiana Relè 230VAC 30A 1NO connection F6.3 bracket mounting dimensions 36.5x32.2x51.8mm manuf. no. A10-230AC-FA		



1





GEV No.	750007	Ref. No.	224011500
description	condensing tray heated L 300mm W 155mm H 105mm 230V 300W without level electrode		



1

GEV No.	750006	Ref. No.	222312200
description	condensing tray heated L 380mm W 240mm H 250mm		
For models:	927100200, 927100300, 927100400, 927102200, 927102300, 927102400		





			
1			
GEV No.	750004	Ref. No.	227206000
description	condensing tray heated L 380mm W 240mm H 75mm 230V 750W with float switch		
For models:	927200300		
spare parts for	750004		
	GEV No.	348139	Ref. No. —
	float switch 250V 1A 1NO or 1NC thread M16x1.5 ø 17.4mm L 100.5mm mounting ø 28mm cable length 1500mm temp.-resist. -20 up to +90°C		
	GEV No.	418733	Ref. No. 877107900
	heating element 750W 230V L 430mm W 95mm H 98mm L1 85mm L2 345mm cable length 1500mm connection cable connection distance 86mm tube ø 8.5mm heating circuits 1 immersion heater		
accessories for	750004		
	GEV No.	380185	Ref. No. 880302100
	power relays Italiana Relè 230VAC 30A 1NO connection F6.3 bracket mounting dimensions 36.5x32.2x51.8mm manuf. no. A1O-230AC-FA		

heating cables

drain heating cables

			
1			
GEV No.	418735	Ref. No.	224820200
description	drain heating cable 37W 230V L 1980mm L1 (unheated) 190mm L2 (heated) 1790mm silicone 25W/m connection cable		
For models:	925701300, 925702300		

			
1			
GEV No.	418734	Ref. No.	224820100
description	drain heating cable 37W 230V ø 6mm L 1670mm L1 (unheated) 130mm L2 (heated) 1650mm cable length 110mm silicone 25W/m connection cable		
For models:	925701200, 925702200		

			
1			
GEV No.	418736	Ref. No.	224820300
description	drain heating cable 50W 230V ø 6mm L 2120mm L1 (unheated) 130mm L2 (heated) 2010mm cable length 110mm silicone 25W/m connection cable		
For models:	925701400, 925702400		

			
1			
GEV No.	418737	Ref. No.	224820400
description	drain heating cable 62W 230V ø 6mm L 2680mm L1 (unheated) 130mm L2 (heated) 2550mm silicone 25W/m connection cable		
For models:	925701500, 925702500		

accessories



hexagonal nuts

			
1			
GEV No.	560132	Ref. No.	886003500
description	hexagonal nut thread M5 H 4mm WS 8 SS DIN/ISO DIN 934 / ISO 4032/8673 Qty 20 pcs		
For models:	925600100, 925600200, 925600300, 925601200, 925601300, 925601400, 925603300, 925603400, 925603500, 925701100, 925701200, 925701300, 925701400, 925701500, 925701600, 925702100, 925702200, 925702300, 925702400, 925702500, 925702600, 926002000, 926002500, 926002600, 926003000, 926003100		

switches and momentary switches

rocker/momentary rocker switches

30x22mm

			
1			
GEV No.	301003	Ref. No.	877124300
description	rocker switch mounting measurements 30x22mm green 2NO 250V 16A illuminated 0-I connection male faston 6.3mm ambient temperature max. 125/55°C protection IP65		
For models:	927100100, 927100200, 927100300, 927100400, 927102100, 927102200, 927102300, 927102400, 927200300, 927300100, 927300200, 927300300		
accessories for	301003		
	GEV No.	301036	Ref. No. —
	protective cover internal size 30x22mm for rocker switch mounting measurementsmm		

			
1			
GEV No.	347019	Ref. No.	877124200
description	rocker switch mounting measurements 30x22mm orange 2NO 250V 16A illuminated lamp connection male faston 6.3mm ambient temperature max. 100/55°C protection IP40		
For models:	925701100, 925701200, 925701300, 925701400, 925701500, 925701600, 925702100, 925702200, 925702300, 925702400, 925702500, 925702600, 927100100, 927100200, 927100300, 927100400, 927102100, 927102200, 927102300, 927102400, 927200300		



float switches

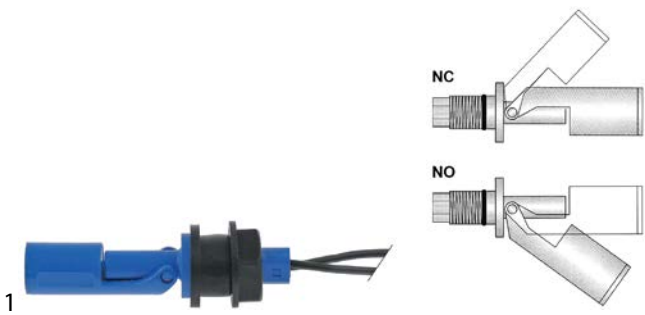

GEV No.	347020	Ref. No.	877121600
description	float switch thread M16x2 1NO or 1NC ø 16mm L 88.5mm mounting ø 16mm 250V 1A cable cable length 800mm		
For models:	927200200, 927200300, 927300200, 927300300		

lamps

fluorescent lamps

fluorescent lamps

G13



GEV No.	357008	Ref. No.	877016000
description	fluorescent lamp socket G13 L 1198mm 36W 230V Qty 1 pcs		
For models:	927100200, 927100400, 927102200, 927102400		



GEV No.	359386	Ref. No.	877010700
description	fluorescent lamp socket G13 L 1198mm 36W 230V Qty 1 pcs		
For models:	925600300, 925601300, 925603300, 925701300, 925701600, 925702300, 925702600, 927100100, 927100200, 927100300, 927100400, 927102100, 927102200, 927102300, 927102400		



GEV No.	359390	Ref. No.	877016600
description	fluorescent lamp socket G13 L 1500mm 58W 230V Qty 1 pcs		
For models:	925601400, 925603400, 925701400, 925702400		



GEV No.	359383	Ref. No.	877010200
description	fluorescent lamp socket G13 L 438mm 15W 230V Qty 1 pcs light colour 640		
For models:	927200100		







GEV No.	359371	Ref. No.	877010400
description	fluorescent lamp socket G13 L 590mm 18W 230V Qty 1 pcs		
For models:	925600100, 925701100, 925702100, 927200200		



GEV No.	359372	Ref. No.	877010500
description	fluorescent lamp socket G13 L 895mm 30W 230V Qty 1 pcs		
For models:	927200300		



GEV No.	357007	Ref. No.	877016300	
description	fluorescent lamp socket G13 L 895mm 30W ø 27mm 230V Qty 1 pcs			
For models:	927100100, 927100300, 927102100, 927102300			
accessories for	357007			
	GEV No.	380464	Ref. No.	877003100
	starter 4-65W			
	GEV No.	401505	Ref. No.	877000500
	electrical ballast 36W 230V Qty 1 pcs			
	GEV No.	402065	Ref. No.	877000400
	electrical ballast 30W 230V for fluorescent lamps Qty 1 pcs			



GEV No.	359738	Ref. No.	877016700
description	fluorescent lamp socket G13 L 970mm 23W 230V Qty 1 pcs		
For models:	925600200, 925601200, 925603500, 925701200, 925701500, 925702200, 925702500		

accessories

starter



GEV No.	380464	Ref. No.	877003100
description	starter 4-65W		
For models:	925600100, 925600200, 925600300, 925601200, 925601300, 925601400, 925603300, 925603400, 925603500, 925701100, 925701200, 925701300, 925701400, 925701500, 925701600, 925702100, 925702200, 925702300, 925702400, 925702500, 925702600, 927100100, 927100200, 927100300, 927100400, 927102100, 927102200, 927102300, 927102400		

ballasts





GEV No.	402063	Ref. No.	877000100
description	electrical ballast 15W 230V for fluorescent lamps Qty 1 pcs		
For models:	927200100		



			
1			
GEV No.	401504	Ref. No.	877000200
description	electrical ballast 18W 230V Qty 1 pcs		
For models:	925600100, 925701100, 925702100, 927200200		

			
1			
GEV No.	402064	Ref. No.	877000300
description	electrical ballast 25W 230V Qty 1 pcs		
For models:	925600200, 925601200, 925603500, 925701200, 925701500, 925702200, 925702500		

			
1			
GEV No.	402065	Ref. No.	877000400
description	electrical ballast 30W 230V for fluorescent lamps Qty 1 pcs		
For models:	927100100, 927100300, 927102100, 927102300, 927200300		

			
1			
GEV No.	401505	Ref. No.	877000500
description	electrical ballast 36W 230V Qty 1 pcs		
For models:	925600300, 925601300, 925603300, 925701300, 925701600, 925702300, 925702600, 927100200, 927100400, 927102200, 927102400		

			
1			
GEV No.	402066	Ref. No.	877000800
description	electrical ballast 58W 230V for fluorescent lamps Qty 1 pcs		
For models:	925601400, 925603400, 925701400, 925702400		

covers

			
1			
GEV No.	551020	Ref. No.	877030500
description	protection cap for fluorescent lamps ø 30mm		
For models:	927100100, 927100200, 927100300, 927100400, 927102100, 927102200, 927102300, 927102400		

protective tube

			
1			
GEV No.	550614	Ref. No.	127113400
description	protection pipe for fluorescent lamps L 1195mm ømm		
For models:	927100100, 927100200, 927100300, 927100400, 927102100, 927102200, 927102300, 927102400		

			
1			
GEV No.	550613	Ref. No.	870736300
description	protection pipe for fluorescent lamps ø 28.7mm L 1180mm Qty 1 pcs		
For models:	927100200, 927100400, 927102200, 927102400		

			
1			
GEV No.	550612	Ref. No.	870736100
description	protection pipe for fluorescent lamps ø 28.7mm L 875mm Qty 1 pcs		
For models:	927100100, 927100300, 927102100, 927102300		

contactors

MOELLER/EATON

power contactors

			
1			
GEV No.	380172	Ref. No.	877121000
description	power contactor resistive load 20A 230VAC (AC3/400V) 9A/4kW main contacts 3NO auxiliary contacts 1NC connection screw connection type DILEM 01		
For models:	927100100, 927100200, 927100300, 927100400, 927102100, 927102200, 927102300, 927102400, 927200300, 927300100, 927300200, 927300300		



relays

power relays

with bracket mounting



1

GEV No.	380185	Ref. No.	880302100
description	power relays Italiana Relè 230VAC 30A 1NO connection F6.3 bracket mounting dimensions 36.5x32.2x51.8mm manuf. no. A10-230AC-FA		
For models:	927200300		

level relays

miscellaneous



1

GEV No.	402067	Ref. No.	877121500
description	level relay 230V voltage AC type RNP20-023		
For models:	927100100, 927100200, 927100300, 927100400, 927102100, 927102200, 927102300, 927102400, 927200100, 927300100		

electronic controllers



DIXELL













refrigeration controllers

built-in version



1

GEV No.	378000	Ref. No.	880313100 8803173+8803195
description	electronic controller DIXELL XR20CX-5N0C1 mounting measurements 71x29mm 230V voltage AC NTC/PTC relay outputs 1 NO-20A(8) NTC/PTC NTC/PTC/DI protection IP54 -50 up to +150°C display 3½ digits		
accessories for	378000		
	GEV No.	378194	Ref. No. —
	temperature probe NTC 10kOhm cable PVC probe -20 up to +80°C cable -10 up to 100°C probe ø7x24.5mm cable length 1.5m without screw connection 2-wire		
	GEV No.	378551	Ref. No. —
	adapter for reducer mounting measurements 71x29mm		

accessories for	378000		
	GEV No.	379052	Ref. No. —
	temperature probe PTC 1kOhm cable silicone probe -50 up to +150°C cable -50 up to +180°C probe ø6x40mm cable length 1.5m without screw connection 2-wire		
	GEV No.	379053	Ref. No. —
	temperature probe PTC 1kOhm cable PVC probe -50 up to +150°C cable -10 up to 100°C probe ø6x30mm cable length 3m without screw connection 2-wire		
	GEV No.	379057	Ref. No. —
	temperature probe NTC 10kOhm cable PVC probe -20 up to +80°C cable -10 up to 100°C probe ø6x25mm cable length 3m 2-wire		
	GEV No.	379064	Ref. No. —
	temperature probe PTC 1kOhm cable silicone probe -50 up to +150°C cable -50 up to +180°C probe ø6x40mm cable length 3m without screw connection 2-wire		
	GEV No.	379142	Ref. No. —
	temperature probe PTC 1kOhm cable PVC probe -50 up to +150°C cable -10 up to 100°C probe ø6x30mm cable length 1.5m without screw connection 2-wire		
	GEV No.	379160	Ref. No. —
	temperature probe NTC 10kOhm cable thermoplastic probe -40 up to +110°C cable -40 up to +110°C probe ø6x14mm cable length 1.5m without screw connection 2-wire		
	GEV No.	379161	Ref. No. —
	temperature probe NTC 10kOhm cable thermoplastic probe -40 up to +110°C cable -40 up to +110°C probe ø6x14mm cable length 3m without screw connection 2-wire		
	GEV No.	379343	Ref. No. —
	temperature probe NTC 10kOhm cable silicone probe -40 up to +110°C cable -50 up to +180°C probe ø6x40mm cable length 3m 2-wire		
	GEV No.	379458	Ref. No. —
	temperature probe NTC 10kOhm cable silicone probe -40 up to +110°C cable -50 up to +180°C probe ø6x40mm cable length 1.5m without screw connection 2-wire		
	GEV No.	379781	Ref. No. —
	temperature probe PTC 1kOhm cable thermoplastic probe -50 up to +150°C cable -40 up to +110°C probe ø6x14mm cable length 1.5m without screw connection 2-wire		
	GEV No.	379782	Ref. No. —
	temperature probe PTC 1kOhm cable thermoplastic probe -50 up to +150°C cable -40 up to +110°C probe ø6x14mm cable length 3m 2-wire resistor 1kOhm		
	GEV No.	402818	Ref. No. —
	programming key 4K for electronic controller DIXELL		
	GEV No.	699260	Ref. No. —
	connection cable L 2m connection coded plug		

→ electric components



built-in version 2-piece



1

GEV No.	402068	Ref. No.	880312100
description	power PCB DIXELL XM470K-500C1 mounting measurements 132x152mm built-in depth 40mm 230V voltage AC NTC relay outputs 4 NO-8A(3) NO-20A(8) NO-8A(3) NO-16A(3) NO-8A(3) NTC NTC NTC -40 up to +110°C display		
For models:	927300200, 927300300		
accessories for	402068		
	GEV No.	378278	Ref. No. —
	keypad unit DIXELL T640 mounting measurements 150x30mm built-in depth 23mmV voltage relay outputs°C display 3½ digits		



1

GEV No.	605069	Ref. No.	880218400
description	compressor coolant R404a/R507 type ML80TG 220-240V 50Hz HMBP fully hermetic 11.2kg 3/8HP cylinder capacity 7.6cm ³ CSIR H 175.5mmW 386W 487W 603W 734W 880W 1041W test method ASHRAE ambient temperature max. 43°C		
For models:	925601400, 925603400, 925701100, 925702100		



1

GEV No.	605028	Ref. No.	880216900
description	compressor coolant R404a/R507 type ML90TB 220-240V 50Hz HMBP fully hermetic 11.6kg 3/8HP cylinder capacity 8.85cm ³ CSIR H 175.5mmW 323W 418W 532W 666W 819W 990W 1181W 1391W test method ASHRAE ambient temperature max. 43°C		
For models:	925603500, 925701200, 925701300, 925702200, 925702300		

compressors

ACC/ZEL

R404a/R507

HMBP monophase

High/Medium evaporation temperature above -20/-15 °C



1

GEV No.	605068	Ref. No.	880218000
description	compressor coolant R404a/R507 type ML45TB 220-240V 50Hz HMBP fully hermetic 10kg 1/5HP cylinder capacity 4.5cm ³ CSIR H 175.5mmW 192W 246W 309W 382W 465W 557W 659W 771W test method ASHRAE		
For models:	925600100		





1

GEV No.	605071	Ref. No.	880217400
description	compressor coolant R404a/R507 type MS26TB 230V 50Hz HMBP fully hermetic 23kg cylinder capacity 25.9cm ³ CSR 1295W 1687W 2132W 2631W 3184W 3791W test method ASHRAE		
For models:	927100200, 927100400, 927102200, 927102400, 927200300		



1

GEV No.	605072	Ref. No.	880216500
description	compressor coolant R404a/R507 type MX18TBa 220-240V 50Hz HMBP fully hermetic 17.2kg 7/8HP cylinder capacity 18.4cm ³ CSR H 213mmW 640W 839W 1076W 1350W 1663W 2013W 2400W 2826W test method ASHRAE ambient temperature max. 43°C		
For models:	925701600, 925702600, 927100300, 927102300, 927200100, 927300200, 927300300		
spare parts for	605072		
	GEV No.	365006	Ref. No. —
	operating capacitor capacity 16µF 400V tolerance 5% 50/60Hz ambient temperature max. -25 to +85°C ø 35mm L 121mm M8 aluminium connection cable 300mm MKP protection IP65		
	GEV No.	365128	Ref. No. —
	operating capacitor capacity 16µF 450V tolerance 5% 50-60Hz ambient temperature max. -25 to +85°C ø 40mm L 100mm M8 aluminium connection male faston 6.3mm 16.26.16 protection		



1

GEV No.	605093	Ref. No.	8802172
description	compressor coolant R404a/R507 type MX21TB 220-240V 50Hz HMBP 17.5kg 1HP cylinder capacity 20.73cm ³ CSR H 221mmW 733W 813W 892W 970W 1046W 1121W 1195W 1268W test method ASHRAE ambient temperature max. 43°C		

CUBIGEL

R404a/R507

HMBP monophase

High/Medium evaporation temperature above -20/-15 °C



1

GEV No.	605013	Ref. No.	880216700
description	compressor coolant R404a/R507 type ML60TB 220-240V 50Hz HMBP fully hermetic 10.1kg 1/4HP power input 647W cylinder capacity 5.68cm ³ CSIR H 175.5mmW 244W 319W 407W 511W 628W 760W 906W 1067W test method ASHRAE		
For models:	925600200, 925600300, 925601200, 925601300, 925603300		



1

GEV No.	605029	Ref. No.	880217000
description	compressor coolant R404a/R507 type MP12RB 220-240V 50Hz HMBP fully hermetic 13.5kg 1/2HP cylinder capacity 12cm ³ CSR H 203.6mmW 561W 734W 933W 1157W 1407W 1681W 1982WW test method ASHRAE ambient temperature max. 43°C		
For models:	925701400, 925702400		



1			
GEV No.	605067	Ref. No.	880217100
description	compressor coolant R404a/R507 type MPT14RA 220-240V 50Hz HMBP fully hermetic 13.5kg 1/2HP cylinder capacity 14.32cm ³ CSR H 210mmWWW 665W 720W 775W 829W 882W 934W test method ASHRAE		
For models:	925701500, 925702500, 927300100		

EMBRACO / ASPERA

R404a/R507
HMBP monophase

High/Medium evaporation temperature above -20/-15 °C



1			
GEV No.	605149	Ref. No.	8802189
description	compressor coolant R404a/R507 type NEK6144GK 220-240V 50Hz HMBP fully hermetic 10kg 1/6HP cylinder capacity 4.51cm ³ CSIR H 190mmW 271W 326W 395W 480W 580W 694W 825W test method ASHRAE46		



1			
GEV No.	605132	Ref. No.	8802195
description	compressor coolant R404a/R507 type NT6222GK 200-240V 50Hz HMBP fully hermetic 17kg 1HP cylinder capacity 17.39cm ³ CSR H 252mmW 810W 1032W 1040W 1174W 1307W 1583W 2247W test method ASHRAE		
accessories for	605132		

	GEV No.	365142	Ref. No.	—
	operating capacitor capacity 15µF 450V with metal case tolerance 5% 50/60Hz ø 40mm L 110mm M8x1.25			
	GEV No.	365153	Ref. No.	—
	starting capacitor 52µF 330V 50/60Hz duty cycle 3s 41280A133 2252347 ø 36mm L 83mm M8 plastic connection cable 350mm			
	GEV No.	390981	Ref. No.	—
	klixon suitable for NT6222GK			

L'UNITE HERMETIQUE / TECUMSEH

R404A
HMBP monophase

High/Medium evaporation temperature above -20/-15 °C



1			
GEV No.	605027	Ref. No.	880217400
description	compressor coolant R404A type CAJ4517Z 220-240V 50Hz HMBP fully hermetic 24kg 1.2HP cylinder capacity 25.95cm ³ CSR H 282mmWW 1588W 1987W 2451W 2971W 3536W 4132W test method EN 12900 4742W		



1

GEV No.	605070	Ref. No.	880224900
description	compressor coolant R404A type CAJ9513Z 220-240V 50Hz HMBP fully hermetic 23kg 1.1HP cylinder capacity 24.2cm ³ CSR H 282mmW 930W 1269W 1654W 2086W 2568W 3096W 3671W test method EN 12900 4278W		

SECOP DANFOSS
R404a/R507
HMBP monophase

High/Medium evaporation temperature above -20/-15 °C



1

GEV No.	605146	Ref. No.	8802143
description	compressor coolant R404a/R507 type SC15MLX 220-240V 50Hz HMBP fully hermetic 14kg 3/4HP cylinder capacity 15.28cm ³ CSIR H 219mmW 758W 951W 1183W 1458W 1780W 2155WW test method ASHRAE		
spare parts for	605146		
	GEV No.	381548	Ref. No.
			—
			start relay DANFOSS

evaporation and condensing trays

condensing trays heated

producer-specific







1

GEV No.	750005	Ref. No.	222312100
description	condensing tray heated L 240mm W 240mm H 250mm		
For models:	927100100, 927102100		
spare parts for	750005		
	GEV No.	418732	Ref. No.
			877107800
			heating element 650W 230V L 280mm W 95mm H 87mm L1 65mm L2 215mm cable length 1500mm connection distance 86mm tube ø 8.5mm heating circuits 1 immersion heater



1

GEV No.	750003	Ref. No.	226303600
description	condensing tray heated L 240mm W 240mm H 75mm 230V 650W connect with power contactor		
For models:	927200200, 927300200, 927300300		
spare parts for	750003		
	GEV No.	348139	Ref. No.
			—
			float switch 250V 1A 1NO or 1NC thread M16x1.5 ø 17.4mm L 100.5mm mounting ø 28mm cable cable length 1500mm temp.-resist. -20 up to +90°C
	GEV No.	418732	Ref. No.
			877107800
			heating element 650W 230V L 280mm W 95mm H 87mm L1 65mm L2 215mm cable length 1500mm connection distance 86mm tube ø 8.5mm heating circuits 1 immersion heater
accessories for	750003		
	GEV No.	380185	Ref. No.
			880302100
			power relays Italiana Relè 230VAC 30A 1NO connection F6.3 bracket mounting dimensions 36.5x32.2x51.8mm manuf. no. A10-230AC-FA





1

GEV No.	750006	Ref. No.	222312200
description	condensing tray heated L 380mm W 240mm H 250mm		
For models:	927100200, 927100300, 927100400, 927102200, 927102300, 927102400		



1

GEV No.	750004	Ref. No.	227206000
description	condensing tray heated L 380mm W 240mm H 75mm 230V 750W with float switch		
For models:	927200300		
spare parts for	750004		
	GEV No.	Ref. No.	—
	348139		
	float switch 250V 1A 1NO or 1NC thread M16x1.5 ø 17.4mm L 100.5mm mounting ø 28mm cable length 1500mm temp.-resist. -20 up to +90°C		
	GEV No.	Ref. No.	877107900
	418733		
	heating element 750W 230V L 430mm W 95mm H 98mm L1 85mm L2 345mm cable length 1500mm connection cable connection distance 86mm tube ø 8.5mm heating circuits 1 immersion heater		
accessories for	750004		
	GEV No.	Ref. No.	880302100
	380185		
	power relays Italiana Relè 230VAC 30A 1NO connection F6.3 bracket mounting dimensions 36.5x32.2x51.8mm manuf. no. A10-230AC-FA		

universal



1

GEV No.	750007	Ref. No.	224011500
description	condensing tray heated L 300mm W 155mm H 105mm 230V 300W without level electrode		

fans

axial fans

ebm-papst



1

GEV No.	601482 ¹	Ref. No.	880102000
description	axial fan L 119mm W 119mm H 38mm 230VAC 50/60Hz 13W bearing slide bearing manuf. no. 4580ZW connection cable 310mm ebm-papst temp.-resist. 65°C		
For models:	925701100, 925701200, 925701300, 925701400, 925701500, 925701600, 925702100, 925702200, 925702300, 925702400, 925702500, 925702600, 927300100, 927300200, 927300300		

¹with ball bearings



1

GEV No.	601089 ¹	Ref. No.	880101400
description	axial fan L 119mm W 119mm H 38mm 230VAC 50/60Hz 19W bearing slide bearing manuf. no. 4650N metal connection male faston 2.8mm ebm-papst fan wheel ø 110mm temp.-resist. 55°C		
For models:	927100100, 927100300, 927102100, 927102300, 927200300		
accessories for	601089		
	GEV No.	Ref. No.	—
	550898		
	connecting cable cable length 2000mm connection F 2.8 connection distance 7.9mm for axial flow fan		
	GEV No.	Ref. No.	—
	691104		
	guard ø 115mm mounting distance 105mm for axial fan 119mm		

¹with slide bearings



1

GEV No.	601481 ¹	Ref. No.	880103500
description	axial fan L 127mm W 127mm H 38mm 230VAC 50/60Hz 18W bearing slide bearing manuf. no. 5950W metal connection male faston 2.8mm ebm-papst fan wheel ø 120mm temp.-resist. 75°C		
For models:	927100200, 927100400, 927102200, 927102400		

¹with slide bearings



1

GEV No.	601038 ¹	Ref. No.	880100800 880101300
description	axial fan L 80mm W 80mm H 38mm 230VAC 50/60Hz 12W bearing ball bearing manuf. no. 8556N metal connection cable 300mm ebm-papst fan wheel ø 75mm temp.-resist. 90°C airflow 50m ³ /h		
For models:	925600100, 925600200, 925600300, 925601200, 925601300, 925601400, 925603300, 925603400, 925603500		
accessories for	601038		
	GEV No.	691102	Ref. No. —
	guard ø 75mm mounting distance 71mm for axial fan 80mm		

¹with ball bearings

refrigeration fans

refrigeration motors universal

ELCO

N series - multi fit



1

GEV No.	601427	Ref. No.	880100300
description	fan motor ELCO 10W 230V 50/60Hz bearing slide bearing L1 49mm L2 59mm L3 86.5mm W 83mm connection cable 500mm 1300/1550rpm 5 mounting options VNT10-20/028		
For models:	925600100, 925600200, 925600300, 925601200, 925601300, 925601400, 925603300, 925603400, 925603500, 925701100, 925701200, 925701300, 925701400, 925701500, 925701600, 925702100, 925702200, 925702300, 925702400, 925702500, 925702600, 927100100, 927100200, 927100300, 927100400, 927102100, 927102200, 927102300, 927102400, 927200300, 927300100, 927300200, 927300300		
spare parts for	601427		
	GEV No.	560140	Ref. No. —
	hexagonal nut thread M4 H 4.8mm SS WS 7 Qty 20 pcs DIN/ISO DIN 985 self-locking		
	GEV No.	560332	Ref. No. —
	plain washer ID ø 4.3mm ED ø 9mm thickness 0.8mm SS Qty 1 pcs		
	GEV No.	560340	Ref. No. —
	hexagonal nut thread M4 H 3.2mm WS 7 SS DIN/ISO DIN 934 / ISO 4032/8673 Qty 1 pcs		

electronic components

miscellaneous



1

GEV No.	403602	Ref. No.	8803200
description	delayer starting relay suitable for MAFIROL L 70mm W 54mm H 54mm 230V input current 20A 50Hz		

equipment-specific units

for refrigerated counters

spare parts and accessories



1

GEV No.	691499	Ref. No.	876032300 879008600
description	bush eccentric for glass plate		
For models:	925600100, 925600200, 925600300, 925701100, 925701200, 925701300, 925701400, 925701500, 925701600, 925702100, 925702200, 925702300, 925702400, 925702500, 925702600		



1

GEV No.	691498	Ref. No.	870730700
description	bush for glass plate \varnothing 7.5mm		
For models:	925600100, 925600200, 925600300, 925601200, 925601300, 925601400, 925603300, 925603400, 925603500, 925701100, 925701200, 925701300, 925701400, 925701500, 925701600, 925702100, 925702200, 925702300, 925702400, 925702500, 925702600, 926002000, 926002500, 926002600, 926003000, 926003100, 926006900, 926007000, 926007500, 926007600, 926008100, 926008200		



1

GEV No.	691497	Ref. No.	879002300 890004800
description	fastening angle for glass plate		
For models:	925600100, 925600200, 925600300, 925601200, 925601300, 925601400, 925603300, 925603400, 925603500, 925701100, 925701200, 925701300, 925701400, 925701500, 925701600, 925702100, 925702200, 925702300, 925702400, 925702500, 925702600		



1

GEV No.	691493	Ref. No.	879002200 890004700
description	suction cup for glass plate		
For models:	925600100, 925600200, 925600300, 925601200, 925601300, 925601400, 925603300, 925603400, 925603500, 925701100, 925701200, 925701300, 925701400, 925701500, 925701600, 925702100, 925702200, 925702300, 925702400, 925702500, 925702600		

for display coolers

housing and bezels

miscellaneous



1

GEV No.	692309	Ref. No.	222357700
description	curtain for display refrigerator W 590mm		
For models:	927200100		

glass panels

glass panels

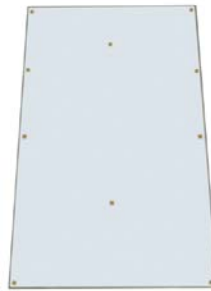

1

GEV No.	691501	Ref. No.	875036200
description	glass panel L 1419mm W 602mm thickness 6mm		
For models:	925600300		



1

GEV No.	691500	Ref. No.	875036000
description	glass panel L 959mm W 602mm thickness 6mm		
For models:	925600100		



1

GEV No.	691502	Ref. No.	875059400
description	glass panel mounting pos. lateral		
For models:	925600100, 925600200, 925600300		



doors



1			
GEV No.	691480	Ref. No.	8754405 875440500
description	door W 545mm H 335mm with gasket		
For models:	925600100, 925600200, 925600300, 925601200, 925601300, 925601400, 925603300, 925603400, 925603500, 925701100, 925701200, 925701300, 925701400, 925701500, 925701600, 925702100, 925702200, 925702300, 925702400, 925702500, 925702600		

hinges

accessories

shafts



1			
GEV No.	693137	Ref. No.	886079700
description	hinge pin ø 6mm L 18mm		

bearings



1			
GEV No.	693136	Ref. No.	870290600
description	hinge camp		

gaskets

refrigeration gaskets

plug-in gaskets

profile 9153

We offer custom-made gaskets for this profile

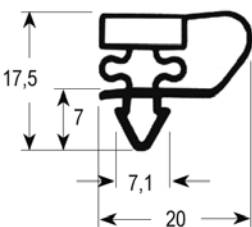

1			
GEV No.	900940	Ref. No.	879007200
description	refrigeration gasket profile 9153 W 345mm L 473mm plug size		

refrigeration cycle components

filter driers

miscellaneous



1			
GEV No.	750254	Ref. No.	880409800
description	dryer size 20g ø 19mm L 138mm connection 2,5/6,2mm		
For models:	925600100, 925600200, 925600300, 925601200, 925601300, 925601400, 925603300, 925603400, 925603500, 925701100, 925701200, 925701300, 925701400, 925702100, 925702200, 925702300, 925702400		



1			
GEV No.	750255	Ref. No.	8804099 880410000
description	dryer size 40g ø 24mm L 170mm connection 6,6/6,6mm		
For models:	925701500, 925701600, 925702500, 925702600, 927100100, 927100200, 927100300, 927100400, 927102100, 927102200, 927102300, 927102400		

fastening material

screws

sheet metal screws



1			
GEV No.	560104	Ref. No.	886015000
description	sheet metal screws ø 3.9mm L 19mm SS Qty 20 pcs DIN 7981/ISO 7049 head ø 7.5mm oval head		
For models:	926002500, 926002600, 926003000, 926003100, 926006900, 926007000, 926007500, 926007600, 926008100, 926008200		

side bolts



1

GEV No.	560052	Ref. No.	886012700
description	side bolts thread M5 L 10mm SS Qty 20 pcs intake slotted head ø 12.5mm		
For models:	925701100, 925701200, 925701300, 925701400, 925701500, 925701600, 925702100, 925702200, 925702300, 925702400, 925702500, 925702600		



1

GEV No.	560053	Ref. No.	886012800
description	side bolts thread M5 L 16mm SS Qty 20 pcs intake slotted head ø 12.5mm		
For models:	925600100, 925600200, 925600300, 925701100, 925701200, 925701300, 925701400, 925701500, 925701600, 925702100, 925702200, 925702300, 925702400, 925702500, 925702600, 926002000, 926002500, 926002600, 926003000, 926003100, 926006900, 926007000, 926007500, 926007600, 926008100, 926008200, 927100100, 927100200, 927100300, 927100400, 927102100, 927102200, 927102300, 927102400		



1

GEV No.	560345	Ref. No.	886012400
description	side bolts thread M5 L 22mm SS Qty 1 pcs head ø 12mm		
For models:	925600100, 925600200, 925600300, 925601200, 925601300, 925601400, 925603300, 925603400, 925603500		

nuts

hexagonal nuts

DIN 934 / ISO 4032/8673



1

GEV No.	560132	Ref. No.	886003500
description	hexagonal nut thread M5 H 4mm WS 8 SS DIN/ISO DIN 934 / ISO 4032/8673 Qty 20 pcs		
For models:	925600100, 925600200, 925600300, 925601200, 925601300, 925601400, 925603300, 925603400, 925603500, 925701100, 925701200, 925701300, 925701400, 925701500, 925701600, 925702100, 925702200, 925702300, 925702400, 925702500, 925702600, 926002000, 926002500, 926002600, 926003000, 926003100		

consumables

containers

canister



1

GEV No.	890246	Ref. No.	876900100 879013900
description	canister 5l L 180mm W 180mm H 200mm		
For models:	925600100, 925600200, 925600300, 925601200, 925601300, 925601400, 925603300, 925603400, 925603500, 925701100, 925701200, 925701300, 925701400, 925701500, 925701600, 925702100, 925702200, 925702300, 925702400, 925702500, 925702600		

A			
axial fans	12		
B			
ballasts	5		
C			
canister	16		
compressors	8		
condensing trays heated	11		
consumables	16		
contactors	6		
containers	16		
E			
electronic controllers	7		
F			
fans	12		
fastening material	15		
filter driers	15		
float switches	5		
fluorescent lamps	5, 5		
H			
heating cables	4		
heating elements	3		
heating elements for condensate evaporation	3		
heating elements for refrigeration	3		
hexagonal nuts	16		
L			
lamps	5		
N			
nuts	16		
P			
plug-in gaskets	15		
R			
refrigeration cycle components	15		
refrigeration fans	13		
refrigeration gaskets	15		
refrigeration motors universal	13		
relays	7		
rocker/momentary rocker switches	4		
S			
screws	15		
sheet metal screws	15		
side bolts	16		
		starter	5
		switches and momentary switches	4