



**GAS COMPONENTS**



**ELECTRIC COMPONENTS**



**WATER TECHNOLOGY**



**MECHANICAL COMPONENTS**



**TOOLS**

Spare parts suitable for

**MACAP**

Find the complete and up-to-date range of products in our GEV Webshop



# Manufacturer catalogue

The most important spare parts and accessories arranged clearly for every manufacturer

- ✓ Complete product range and all appliance data always up to date in the GEV Webshop
- ✓ Alphabetical Index at the end of the catalogue

## GEV Webshop

[www.gev-online.co.uk](http://www.gev-online.co.uk)

[www.gev-online.com](http://www.gev-online.com)



- 🔍 Add to Favourites
- 🔍 Sign In with email address and usual password
- 🔍 Easy-order – place several items in your basket at the same time
- 🔍 Quick Item search – no login needed



## switches and momentary switches

### rocker/momentary rocker switches

30x22mm

labelled



1

<b>GEV No.</b>	300125	<b>Ref. No.</b>	C00061001
<b>description</b>	rocker switch mounting measurements 30x22mm green 2NO 230V 16A 0-I connection male faston 6.3mm ambient temperature max. 125/55°C protection IP65 with cover cap		
<b>accessories for</b>	300125		
	<b>GEV No.</b>	301036	<b>Ref. No.</b>
			—
	protective cover internal size 30x22mm for rocker switch mounting measurementsmm		



1

<b>GEV No.</b>	345648	<b>Ref. No.</b>	C00061021
<b>description</b>	rocker switch mounting measurements 30x22mm white 2NO 250V 16A illuminated 0-I connection male faston 6.3mm ambient temperature max. 100/55°C protection IP65 with cover cap		
<b>accessories for</b>	345648		
	<b>GEV No.</b>	301036	<b>Ref. No.</b>
			—
	protective cover internal size 30x22mm for rocker switch mounting measurementsmm		

### push/momentary push switches

ø12mm



1

<b>GEV No.</b>	527725	<b>Ref. No.</b>	C0006M103
<b>description</b>	push button mounting ø 12mm red 1NO connection cable 300mm ambient temperature max. 85°C protection IP40		

### microswitches

#### pin-plunger actuated



1

<b>GEV No.</b>	527736	<b>Ref. No.</b>	C00061019
<b>description</b>	microswitch 250V 16A 1CO connection male faston 4.8mm ambient temperature max. 125°C mounting distance 22mm with plunger blue/black		

### miscellaneous



1

<b>GEV No.</b>	527714	<b>Ref. No.</b>	C0006M104+C0002M135+C0007M171B
<b>description</b>	switch L 60mm W 50mm chrome-plated buttons 1		
<b>spare parts for</b>	527714		
	<b>GEV No.</b>	403513	<b>Ref. No.</b>
			C0006M104
	encoder shaft L 15mm for coffee grinder cable length 400mm shaft 6x4.6mm		

## encoders and potentiometers



1



<b>GEV No.</b>	403513	<b>Ref. No.</b>	C0006M104
<b>description</b>	encoder shaft L 15mm for coffee grinder cable length 400mm shaft 6x4.6mm		

## timers

### mechanical timers



1

<b>GEV No.</b>	350020	<b>Ref. No.</b>	C00061004
<b>description</b>	timer M2 2-pole operation time 4min 2NO at 250V 16A permanent position no shaft ø 6x4.6mm shaft 6x4.6mm shaft L 23mm mounting distance 28mm connection lateral		
<b>accessories for</b>	350020		
	<b>GEV No.</b>	110366	<b>Ref. No.</b>
			—
	knob switch zero mark t.max.°C ø 44mm shaft ø 6x4.6mm shaft flat upper black		
	<b>GEV No.</b>	110370	<b>Ref. No.</b>
			—
	dial plate graduation 4min permanent position no rotation 30-330° ø 60mm timers knob ø 45mm		



## contactors

### LOVATO

#### power contactors



1

<b>GEV No.</b>	380705	<b>Ref. No.</b>	C00061002
<b>description</b>	power contactor resistive load 20A 230VAC (AC3/400V) 9A/4kW main contacts 3NO auxiliary contacts 1NO connection screw connection type 11BG0910A230		
<b>accessories for</b>	380705		
	<b>GEV No.</b>	380057	<b>Ref. No.</b> —
	auxiliary contact contacts 1NO/1NC AC1 10A for contactors BG series connection screw type BGX1011		

## electronics

### PCBs



1

<b>GEV No.</b>	527713	<b>Ref. No.</b>	C0006M105
<b>description</b>	display PCB for dosing pump		



1

<b>GEV No.</b>	527724	<b>Ref. No.</b>	C0006M101
<b>description</b>	PCB L 75mm W 48mm suitable for for dosing pump		

## pumps

### booster pumps II

#### accessories



1

<b>GEV No.</b>	365015	<b>Ref. No.</b>	C00061107
<b>description</b>	operating capacitor capacity 10µF 400V tolerance 5%Hz ambient temperature max. -25 to +85°C ø 35.5mm L 59mm M8 plastic connection male faston 6.3mm protection		



1

<b>GEV No.</b>	365012	<b>Ref. No.</b>	C00061126
<b>description</b>	operating capacitor capacity 6.3µF 450V tolerance 5% 50Hz ambient temperature max. -25 to +85°C ø 30mm L 61mm M8 plastic connection male faston 6.3mm protection		

## condensators & interference suppression filters

### operating capacitors

#### plastic



1

<b>GEV No.</b>	365015	<b>Ref. No.</b>	C00061107
<b>description</b>	operating capacitor capacity 10µF 400V tolerance 5%Hz ambient temperature max. -25 to +85°C ø 35.5mm L 59mm M8 plastic connection male faston 6.3mm protection		



1

<b>GEV No.</b>	365014	<b>Ref. No.</b>	C00061111
<b>description</b>	operating capacitor capacity 12.5µF 450V tolerance 5%Hz ambient temperature max. -25 to +85°C ø 35mm L 70mm M8 plastic connection male faston 6.3mm 45S.C3DS.12.5 protection		



			
1			
<b>GEV No.</b>	365021	<b>Ref. No.</b>	C00061108
<b>description</b>	operating capacitor capacity 16µF 425V tolerance 5% 50/60Hz ambient temperature max. -25 to +85°C ø 35mm L 73mm single M8 plastic connection male faston 6.3mm 416.10.99 protection		

			
1			
<b>GEV No.</b>	365019	<b>Ref. No.</b>	C00061128
<b>description</b>	operating capacitor capacity 20µF 400V tolerance 5% 50/60Hz ambient temperature max. -25 to +85°C ø 39.5mm L 70mm M8 plastic connection male faston 6.3mm 16.10.25. protection		

			
1			
<b>GEV No.</b>	365012	<b>Ref. No.</b>	C00061126
<b>description</b>	operating capacitor capacity 6.3µF 450V tolerance 5% 50Hz ambient temperature max. -25 to +85°C ø 30mm L 61mm M8 plastic connection male faston 6.3mm protection		

### electromechanical circuit breakers

			
1			
<b>GEV No.</b>	527807	<b>Ref. No.</b>	C00061130
<b>description</b>	electromechanical circuit breaker 320/480VAC 50/60Hz		

### equipment-specific units

#### for bar blender

##### blenders

##### jar components

##### gaskets

			
1			
<b>GEV No.</b>	651007	<b>Ref. No.</b>	C0007F323
<b>description</b>	gasket ED ø 75mm ID ø 55mm thickness 3mm Qty 1 pcs		

##### holders

			
1			
<b>GEV No.</b>	696744	<b>Ref. No.</b>	C0007F321
<b>description</b>	bracket for jar ø 87mm ID ø 74mm		

##### blades

##### blades with adaptor (complete)

			
1			
<b>GEV No.</b>	696742	<b>Ref. No.</b>	C0007F305
<b>description</b>	slicing unit ø 52mm P100/P102/P103/P105		

##### mixers

##### mixer discs

			
1			
<b>GEV No.</b>	696747	<b>Ref. No.</b>	C0007F216
<b>description</b>	mixer disc ø 26mm H 28.5mm M6		

			
1			
<b>GEV No.</b>	696746	<b>Ref. No.</b>	C0004F213
<b>description</b>	mixer disc ø 26mm ID ø 6.2mm 7		



## miscellaneous



1

<b>GEV No.</b>	698278	<b>Ref. No.</b>	C0007F215A
<b>description</b>	housing for motor L 150mm W 105mm H 60mm plastic F4/F6		

## for citrus juicers

## spillage trays



1

<b>GEV No.</b>	696743	<b>Ref. No.</b>	C0007S820
<b>description</b>	drip tray for citrus juicers ø 79.5mm plastic		



1

<b>GEV No.</b>	650268	<b>Ref. No.</b>	C0007S810
<b>description</b>	tray ø 145mm H 78mm		

## housings



1

<b>GEV No.</b>	650269	<b>Ref. No.</b>	C0007S807
<b>description</b>	protective cover ø 205mm H 52mm		

## juicer insert



1

<b>GEV No.</b>	650244	<b>Ref. No.</b>	C0007S822
<b>description</b>	juicer insert for citrus juicers MACAP		



1

<b>GEV No.</b>	650267	<b>Ref. No.</b>	C0004S803
<b>description</b>	juicer insert for citrus juicers ø 110mm H 48mm		



1

<b>GEV No.</b>	650266	<b>Ref. No.</b>	C0004S817
<b>description</b>	juicer insert ø 91mm H 64mm mounting pos. upper		

## for coffee grinders

## grinding burrs

## grinding burrs straight

## standard



1

<b>GEV No.</b>	527701	<b>Ref. No.</b>	C0004M135
<b>description</b>	grinding burrs pair turn direction right D1 ø 58mm ID ø 34mm H 8.5mm tooth spacing 3mm hole ø 4.5mm bore ø 7.5mm mounting ø 47		



1

<b>GEV No.</b>	527700	<b>Ref. No.</b>	C0004M122
<b>description</b>	grinding burrs pair turn direction right D1 ø 64.5mm ID ø 38mm H 8.5mm tooth spacing 3mm hole ø 5mm bore ø 8.5mm mounting ø 48		



1

<b>GEV No.</b>	527703	<b>Ref. No.</b>	C0004M122A
<b>description</b>	grinding burrs pair turn direction right D1 ø 64.5mm ID ø 38mm H 8.5mm tooth spacing 3mm hole ø 5mm bore ø 8.5mm mounting ø 50		



1

<b>GEV No.</b>	527704	<b>Ref. No.</b>	C0004M121
<b>description</b>	grinding burrs pair turn direction right D1 ø 74mm ID ø 42.5mm H 9.2mm tooth spacing 3.5mm hole ø 5.5mm bore ø 8.5mm mounting ø 57		



1

<b>GEV No.</b>	527699	<b>Ref. No.</b>	C0004M121A
<b>description</b>	grinding burrs pair turn direction right D1 ø 74mm ID ø 42.5mm H 9.2mm tooth spacing 3.5mm hole ø 5mm bore ø 8.5mm mounting ø 59		

grinding burrs conical



1

<b>GEV No.</b>	527705	<b>Ref. No.</b>	C0004M122B
<b>description</b>	grinding burrs pair turn direction right D1 ø 63mm D2 ø 40mm H 23.5mm shaft ø 13mm		

grinding burrs holders



1

<b>GEV No.</b>	527681	<b>Ref. No.</b>	2M109 C0002M109
<b>description</b>	grinding burr holder D1 ø 57.5mm H 41mm		



1

<b>GEV No.</b>	527694	<b>Ref. No.</b>	C0002M108
<b>description</b>	grinding burr holder D1 ø 58mm		



1

<b>GEV No.</b>	527679	<b>Ref. No.</b>	C0002M118
<b>description</b>	grinding burr holder D1 ø 63mm H 40mm		



1

<b>GEV No.</b>	527695	<b>Ref. No.</b>	C0002M104
<b>description</b>	grinding burr holder D1 ø 64.5mm		



1

<b>GEV No.</b>	527697	<b>Ref. No.</b>	C0002M1041
<b>description</b>	grinding burr holder D1 ø 64.5mm		



1

<b>GEV No.</b>	527678	<b>Ref. No.</b>	C0002M101 C0002M133
<b>description</b>	grinding burr holder D1 ø 64mm H 41mm		



1

<b>GEV No.</b>	527693	<b>Ref. No.</b>	C0002M113
<b>description</b>	grinding burr holder D1 ø 65mm		

			
1			
<b>GEV No.</b>	527677	<b>Ref. No.</b>	C0002M110 C0002M134
<b>description</b>	grinding burr holder D1 ø 73mm H 41mm		

			
1			
<b>GEV No.</b>	527696	<b>Ref. No.</b>	C0002M111
<b>description</b>	grinding burr holder D1 ø 74mm		

			
1			
<b>GEV No.</b>	527698	<b>Ref. No.</b>	C0002M111A
<b>description</b>	grinding burr holder D1 ø 74mm		

## spillage trays

			
1			
<b>GEV No.</b>	527673	<b>Ref. No.</b>	C0007M7041
<b>description</b>	drain tray L 140mm W 135mm		

			
1			
<b>GEV No.</b>	527676	<b>Ref. No.</b>	C00071800 C0007M1031
<b>description</b>	drain tray L 160mm W 170mm		

			
1			
<b>GEV No.</b>	527674	<b>Ref. No.</b>	C0007M115
<b>description</b>	drain tray ø 138mm		

			
1			
<b>GEV No.</b>	527675	<b>Ref. No.</b>	C0007M103
<b>description</b>	drain tray ø 180mm		

## miscellaneous

			
1			
<b>GEV No.</b>	527730	<b>Ref. No.</b>	C0007M141
<b>description</b>	grid for motor		

## dosing containers

## dosing container lids

			
1			
<b>GEV No.</b>	527672	<b>Ref. No.</b>	C0007M105
<b>description</b>	lid for dosing container ø 122.5mm		

## springs

## group 1

			
1			
<b>GEV No.</b>	527718	<b>Ref. No.</b>	C0008M108
<b>description</b>	compression spring ø 10mm wire gauge ø 1mm L1 50mm		

			
1			
<b>GEV No.</b>	527717	<b>Ref. No.</b>	C0008M107
<b>description</b>	compression spring ø 5.5mm wire gauge ø 0.5mm L1 25mm		

			
1			
<b>GEV No.</b>	527719	<b>Ref. No.</b>	C0008M110
<b>description</b>	compression spring ø 5mm L 23mm wire gauge ø 0.5mm		

			
1			
<b>GEV No.</b>	527715	<b>Ref. No.</b>	C0008M102
<b>description</b>	torsion spring ø 21mm wire gauge ø 1.5mm		





glass cylinders



1

<b>GEV No.</b>	527668	<b>Ref. No.</b>	C0007M1062
<b>description</b>	cylinder for automatic grinder ø 123mm H 113mm polycarbonate		

<b>GEV No.</b>	527668	<b>Ref. No.</b>	C0007M1062
<b>description</b>	cylinder for automatic grinder ø 123mm H 113mm polycarbonate		



1

<b>GEV No.</b>	527669	<b>Ref. No.</b>	C0007M1591
<b>description</b>	cylinder for automatic grinder ø 123mm H 90mm polycarbonate		

<b>GEV No.</b>	527669	<b>Ref. No.</b>	C0007M1591
<b>description</b>	cylinder for automatic grinder ø 123mm H 90mm polycarbonate		



1

<b>GEV No.</b>	527667	<b>Ref. No.</b>	C0007M159
<b>description</b>	cylinder ø 123mm H 90mm polycarbonate		

<b>GEV No.</b>	527667	<b>Ref. No.</b>	C0007M159
<b>description</b>	cylinder ø 123mm H 90mm polycarbonate		



1

<b>GEV No.</b>	527670	<b>Ref. No.</b>	C0007M106
<b>description</b>	cylinder ø 124mm H 113mm polycarbonate		

<b>GEV No.</b>	527670	<b>Ref. No.</b>	C0007M106
<b>description</b>	cylinder ø 124mm H 113mm polycarbonate		

levers

bolts



1

<b>GEV No.</b>	527731	<b>Ref. No.</b>	C0004M111
<b>description</b>	bolt for dosing pump D1 ø 2mm L 17mm		

<b>GEV No.</b>	527731	<b>Ref. No.</b>	C0004M111
<b>description</b>	bolt for dosing pump D1 ø 2mm L 17mm		



1

<b>GEV No.</b>	527732	<b>Ref. No.</b>	C0001M138
<b>description</b>	bolt for dosing pump D1 ø 6mm L 6mm		

<b>GEV No.</b>	527732	<b>Ref. No.</b>	C0001M138
<b>description</b>	bolt for dosing pump D1 ø 6mm L 6mm		



1

<b>GEV No.</b>	527733	<b>Ref. No.</b>	C0004M112
<b>description</b>	bolt for dosing pump L 24mm		

<b>GEV No.</b>	527733	<b>Ref. No.</b>	C0004M112
<b>description</b>	bolt for dosing pump L 24mm		

levers



1

<b>GEV No.</b>	527680	<b>Ref. No.</b>	C0002M103
<b>description</b>	lever dosing pump		

<b>GEV No.</b>	527680	<b>Ref. No.</b>	C0002M103
<b>description</b>	lever dosing pump		

coffee presses

components

bolts



1

<b>GEV No.</b>	527721	<b>Ref. No.</b>	C0004M127
<b>description</b>	bolt D1 ø 8mm D2 ø 12mm L 137mm T1: M8 T2: M8 stainless steel		

<b>GEV No.</b>	527721	<b>Ref. No.</b>	C0004M127
<b>description</b>	bolt D1 ø 8mm D2 ø 12mm L 137mm T1: M8 T2: M8 stainless steel		

springs



1

<b>GEV No.</b>	527716	<b>Ref. No.</b>	C0008M111
<b>description</b>	compression spring ø 10.5mm L 66mm wire gauge ø 1mm		

<b>GEV No.</b>	527716	<b>Ref. No.</b>	C0008M111
<b>description</b>	compression spring ø 10.5mm L 66mm wire gauge ø 1mm		

holders



1

<b>GEV No.</b>	527688	<b>Ref. No.</b>	C0007M1071
<b>description</b>	bracket for coffee press H 19mm L 75mm plastic		

<b>GEV No.</b>	527688	<b>Ref. No.</b>	C0007M1071
<b>description</b>	bracket for coffee press H 19mm L 75mm plastic		



1

<b>GEV No.</b>	527687	<b>Ref. No.</b>	C0007M134
<b>description</b>	bracket for coffee press H 65mm plastic		

<b>GEV No.</b>	527687	<b>Ref. No.</b>	C0007M134
<b>description</b>	bracket for coffee press H 65mm plastic		

pressers





1

<b>GEV No.</b>	527692	<b>Ref. No.</b>	C0007M135A
<b>description</b>	coffee press ø 51.5mm H 18mm		

<b>GEV No.</b>	527692	<b>Ref. No.</b>	C0007M135A
<b>description</b>	coffee press ø 51.5mm H 18mm		

			
1			
<b>GEV No.</b>	527689	<b>Ref. No.</b>	C0007M102B
<b>description</b>	coffee press ø 52mm H 25mm		

			
1			
<b>GEV No.</b>	527691	<b>Ref. No.</b>	C0007M135
<b>description</b>	coffee press ø 57mm H 18mm		

			
1			
<b>GEV No.</b>	527690	<b>Ref. No.</b>	C0007M102A
<b>description</b>	coffee press ø 57mm H 25mm		

automatic grinding

automatic grinding

			
1			
<b>GEV No.</b>	527709	<b>Ref. No.</b>	C0007M139B
<b>description</b>	housing complete		

			
1			
<b>GEV No.</b>	527710	<b>Ref. No.</b>	C0007M139A
<b>description</b>	housing complete		

sector plates

			
1			
<b>GEV No.</b>	527711	<b>Ref. No.</b>	C0004M108
<b>description</b>	sector plates		

miscellaneous

			
1			
<b>GEV No.</b>	527684	<b>Ref. No.</b>	C0007M138
<b>description</b>	lid plastic		

			
1			
<b>GEV No.</b>	527723	<b>Ref. No.</b>	C0007M110
<b>description</b>	protector plastic		

			
1			
<b>GEV No.</b>	527734	<b>Ref. No.</b>	C0004M110
<b>description</b>	ring		

ratches

ratches

			
1			
<b>GEV No.</b>	527726	<b>Ref. No.</b>	C0002M106
<b>description</b>	ratchet ø 26mm int. ø 18mm CE 423 005 J customized		

stars

central

			
1			
<b>GEV No.</b>	527707	<b>Ref. No.</b>	C0002M1241
<b>description</b>	star mounting pos. centre ø 108mm H 48mm		

upper



1

<b>GEV No.</b>	527708	<b>Ref. No.</b>	C0002M124
<b>description</b>	star mounting pos. upper ø 108mm hole ø 19mm H 16mm		

bottom



1

<b>GEV No.</b>	527706	<b>Ref. No.</b>	C0002M1242
<b>description</b>	star mounting pos. lower ø 108mm		

accessories



1

<b>GEV No.</b>	527729	<b>Ref. No.</b>	C0007M123
<b>description</b>	knob plastic		



1

<b>GEV No.</b>	527735	<b>Ref. No.</b>	C0004M120
<b>description</b>	washer ø 35mm		

adjustment mechanism

lockable adjustment



1

<b>GEV No.</b>	527722	<b>Ref. No.</b>	C0002M102
<b>description</b>	push button shaft ø 7mm		

springs



1

<b>GEV No.</b>	527720	<b>Ref. No.</b>	C0008M109
<b>description</b>	compression spring		

gearboxes



1

<b>GEV No.</b>	527712	<b>Ref. No.</b>	C0004M140
<b>description</b>	gearbox motor shaft ø 11mm flange ø 79mm drive shaft ø 13mm fixing dimensions 51mm		

coffee beans containers

container lids



1

<b>GEV No.</b>	357013	<b>Ref. No.</b>	C0007M156
<b>description</b>	lid for coffee beans container ø 164mm		



1

<b>GEV No.</b>	527671	<b>Ref. No.</b>	C0007M114
<b>description</b>	lid for coffee beans container ø 229mm		

coffee beans containers



1

<b>GEV No.</b>	527666	<b>Ref. No.</b>	C0007M161
<b>description</b>	coffee beans container ø 163mm H 150mm seat ø 59mm		



1

<b>GEV No.</b>	527665	<b>Ref. No.</b>	C0007M157
<b>description</b>	coffee beans container ø 164mm H 194mm seat ø 58.5mm		



1

<b>GEV No.</b>	527664	<b>Ref. No.</b>	C0007M113
<b>description</b>	coffee beans container ø 230mm H 265mm seat ø 67mm		

## support for filter holder



1

<b>GEV No.</b>	527685	<b>Ref. No.</b>	C0004M109 C000M109
<b>description</b>	filter holder support L 106mm W 85mm H 5mm		



1

<b>GEV No.</b>	527682	<b>Ref. No.</b>	C0001M710
<b>description</b>	filter holder support L 146mm W 65mm H 21mm		



1

<b>GEV No.</b>	527683	<b>Ref. No.</b>	C0001M114
<b>description</b>	filter holder support L 146mm W 65mm H 21mm		



1

<b>GEV No.</b>	696745	<b>Ref. No.</b>	C2040131
<b>description</b>	filter holder support L 85mm ø 10mm		



1

<b>GEV No.</b>	527727	<b>Ref. No.</b>	C0004M109A
<b>description</b>	nut thread M5 H 5mm SS WS 8 Qty 1 pcs		

## counters

## counters



1

<b>GEV No.</b>	527686	<b>Ref. No.</b>	C0009M102
<b>description</b>	counter for dosing unit		

## equipment feet and end caps

## equipment feet with stem



1

<b>GEV No.</b>	527728	<b>Ref. No.</b>	C00071614
<b>description</b>	foot ø 14mm H 9mm mounting ø 12mm overall height 20mm Qty 1 pcs rubber bore ø 3mm		

## gaskets

## sealing washers

## silicone gaskets



1

<b>GEV No.</b>	651007	<b>Ref. No.</b>	C0007F323
<b>description</b>	gasket ED ø 75mm ID ø 55mm thickness 3mm Qty 1 pcs		



## springs

### torsion springs

			
1			
<b>GEV No.</b>	527715	<b>Ref. No.</b>	C0008M102
<b>description</b>	torsion spring ø 21mm wire gauge ø 1.5mm		

### compression springs

			
1			
<b>GEV No.</b>	527720	<b>Ref. No.</b>	C0008M109
<b>description</b>	compression spring		

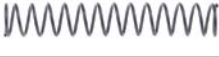
			
1			
<b>GEV No.</b>	527716	<b>Ref. No.</b>	C0008M111
<b>description</b>	compression spring ø 10.5mm L 66mm wire gauge ø 1mm		

			
1			
<b>GEV No.</b>	527718	<b>Ref. No.</b>	C0008M108
<b>description</b>	compression spring ø 10mm wire gauge ø 1mm L1 50mm		

			
1			
<b>GEV No.</b>	527717	<b>Ref. No.</b>	C0008M107
<b>description</b>	compression spring ø 5.5mm wire gauge ø 0.5mm L1 25mm		

			
1			
<b>GEV No.</b>	527719	<b>Ref. No.</b>	C0008M110
<b>description</b>	compression spring ø 5mm L 23mm wire gauge ø 0.5mm		

			
1			
<b>GEV No.</b>	696748	<b>Ref. No.</b>	C0008CPS056
<b>description</b>	spring ø 19mm L 43mm wire gauge ø 2mm windings 10 steel		

## fastening material

### nuts

#### hexagonal nuts

DIN 6923 / ISO 4161

			
1			
<b>GEV No.</b>	527727	<b>Ref. No.</b>	C0004M109A
<b>description</b>	nut thread M5 H 5mm SS WS 8 Qty 1 pcs		





**B**

booster pumps II 4

**C**

condensators & interference suppression filters 4

contactors 4

**F**

fastening material 13

**H**

hexagonal nuts 13

**M**

mechanical timers 3

microswitches 3

**N**

nuts 13

**O**

operating capacitors 4

**P**

pumps 4

push/momentary push switches 3

**R**

rocker/momentary rocker switches 3

**S**

sealing washers 12

switches and momentary switches 3

**T**

timers 3