



GAS COMPONENTS



ELECTRIC COMPONENTS



WATER TECHNOLOGY



MECHANICAL COMPONENTS



TOOLS

Spare parts suitable for

LUXIA

Find the complete and up-to-date range of products in our GEV Webshop



Manufacturer catalogue

The most important spare parts and accessories arranged clearly for every manufacturer

- ✓ Complete product range and all appliance data always up to date in the GEV Webshop
- ✓ Alphabetical Index at the end of the catalogue

GEV Webshop

www.gev-online.co.uk

www.gev-online.com



- 🔍 Add to Favourites
- 🔍 Sign In with email address and usual password
- 🔍 Easy-order – place several items in your basket at the same time
- 🔍 Quick Item search – no login needed



heating elements

immersion heating elements

3 hole flange ø47.5mm

GEV No.	418793	Ref. No.	L2123 L2134
description	heating element 4300W 230/400V mounting ø 47.5mm heating circuits 3 L 270mm W 30mm H 32mm number of thermostat sleeves 1 thermostat sleeves ø 7mm length thermostat sleeves 230mm thermostat sleeve eccentric, non clinging tube ø 8mm connection M4		
For models:	K1000QBS, K660, OCEANO60, POLY1000, T50		

GEV No.	418794	Ref. No.	L2135
description	heating element 6000W 230/400V mounting ø 47.5mm heating circuits 3 L 380mm W 33mm H 32mm number of thermostat sleeves 1 thermostat sleeves ø 7mm length thermostat sleeves 240mm thermostat sleeve eccentric, non clinging tube ø 8.5mm connection M4		
For models:	K1300, POLY1500		

GEV No.	415028	Ref. No.	L7415
description	heating element 9000W 230/400V mounting ø 47.5mm heating circuits 3 L 440mm W 33mm H 32mm number of thermostat sleeves 1 thermostat sleeves ø 7mm length thermostat sleeves 235mm thermostat sleeve upper tube ø 8.5mm hole distance 63mm hole ø 10mm connection M4 3 hole flange immersion heater		
For models:	POLY2000		
spare parts for	415028		
	GEV No.	510408	Ref. No. L5107
	O-ring EPDM thickness 5.34mm ID ø 47mm Qty 1 pcs		
accessories for	415028		
	GEV No.	510408	Ref. No. L5107
	O-ring EPDM thickness 5.34mm ID ø 47mm Qty 1 pcs		
	GEV No.	510562	Ref. No. —
	O-ring silicone thickness 5.34mm ID ø 47mm Qty 1 pcs		
	GEV No.	521103	Ref. No. —
	nut thread M4 H 3mm WS 7 brass Qty 20 pcs		
	GEV No.	521104	Ref. No. —
	washer ID ø 4.3mm ED ø 8mm thickness 0.5mm brass Qty 20 pcs for thread M4		

accessories for	415028		
	GEV No.	560111	Ref. No. —
	plain washer ID ø 4.3mm ED ø 9mm thickness 0.8mm SS Qty 20 pcs DIN 125A for thread M4		
	GEV No.	560131	Ref. No. —
	hexagonal nut thread M4 H 3.2mm WS 7 SS DIN/ISO DIN 934 / ISO 4032/8673 Qty 20 pcs		

GEV No.	418709	Ref. No.	L2120 L2122 L2128
description	heating element 2400W 230V mounting ø 47.5mm heating circuits 1 L 190mm W 32mm H 40mm number of thermostat sleeves 1 thermostat sleeves ø 7mm length thermostat sleeves 170mm thermostat sleeve eccentric, non clinging tube ø 6.5mm hole distance 72mm hole ø 8x10mm connection M4 3 hole flange immersion heater		
For models:	K10QT, K11QS, K12QS, K400QS, K502QBS, OCEANO35, OCEANO40, OCEANO50, T40, T45		
spare parts for	418709		
	GEV No.	510408	Ref. No. L5107
	O-ring EPDM thickness 5.34mm ID ø 47mm Qty 1 pcs		
accessories for	418709		
	GEV No.	510562	Ref. No. —
	O-ring silicone thickness 5.34mm ID ø 47mm Qty 1 pcs		

GEV No.	416378	Ref. No.	L7212
description	heating element 1000W 230V heating circuits 1 L 152mm W 35mm H 25mm H1 5mm H2 20mm thread M10x1 mounting distance 26mm tube ø 6.5mm		
For models:	OCEANO35, OCEANO40, OCEANO50, OCEANO60		
accessories for	416378		
	GEV No.	510416	Ref. No. —
	flat gasket fibre ED ø 19mm ID ø 10.5mm thickness 1.5mm for thread M10 Qty 1 pcs		
	GEV No.	510893	Ref. No. —
	O-ring EPDM thickness 2.62mm ID ø 9.92mm Qty 1 pcs		
	GEV No.	520231	Ref. No. —
	nut thread M10x1 H 6mm WS 14 zinc-coated steel Qty 1 pcs		
	GEV No.	521129	Ref. No. —
	nut thread M10 H 6mm SS WS 17 Qty 1 pcs DIN/ISO DIN 439		



			
GEV No.	416379	Ref. No.	2127 L2127
description	heating element 2000W 230V L 265mm W 37mm H 40mm thread M10x1 mounting distance 30mm tube ø 6.5mm connection M4		
For models:	K1000QBS, K10QT, K11QS, K12QS, K1300, K400QS, K502QBS, K660, POLY1000, POLY1500, POLY2000		

foil heating elements

			
GEV No.	416372	Ref. No.	L7011
description	foil heating element L 220mm W 110mm 450W 230V t.max.°C with thermostat 140°C silicone cable length 1000mm thickness 1mm		
For models:	T40, T45, T50		

accessories

sealing washers

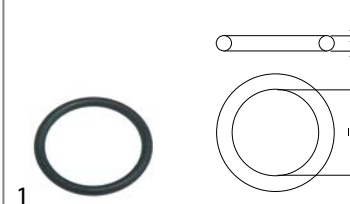

O-rings

			
GEV No.	510408	Ref. No.	L5107
description	O-ring EPDM thickness 5.34mm ID ø 47mm Qty 1 pcs		
For models:	K1000QBS, K10QT, K11QS, K12QS, K1300, K400QS, K502QBS, K660, OCEANO35, OCEANO40, OCEANO50, OCEANO60, POLY1000, POLY1500, POLY2000, T40, T45, T50		

thermostats

bi-metal thermostats

safety bi-metal thermostats

			
GEV No.	390233	Ref. No.	L2062 L7292
description	bi-metal safety thermostat hole distance 24mm switch-off temp. 110°C 1NC 1-pole 16A connection F6.3 2 hole fixing without holder		
For models:	K660, OCEANO35, OCEANO40, OCEANO50, OCEANO60, POLY1500, POLY2000		
accessories for	390233		
	GEV No.	504736	Ref. No. —
bracket for contact thermostat			
	GEV No.	550388	Ref. No. —
bracket for contact thermostat mounting distance 24.5mm mounting ø 3.8			

bi-metal thermostats

			
GEV No.	390301	Ref. No.	L2061 L2083
description	bi-metal thermostat hole distance 23.8mm switch-off temp. 60°C 1NC 1-pole 16A connection F6.3 2 hole fixing		
For models:	K10QT, K12QS, OCEANO35, OCEANO40, OCEANO50, OCEANO60		

control and safety thermostats

IMIT / TEMPOMATIC / ARTHERMO

control thermostats

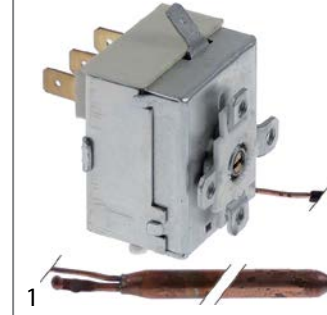
			
GEV No.	376053	Ref. No.	L2060
description	thermostat t.max. 87°C temperature range 0-87°C 1-pole 1CO 16A probe ø 6.5mm probe L 97mm capillary pipe 1500mm capillary pipe isolated 1400mm gland nut shaft ømm shaft Lmm shaft position		
For models:	K1000QBS, K10QT, K11QS, K12QS, K1300, K400QS, K502QBS, K660, OCEANO35, OCEANO40, OCEANO50, OCEANO60, POLY1000, POLY1500, POLY2000, T40, T45, T50		

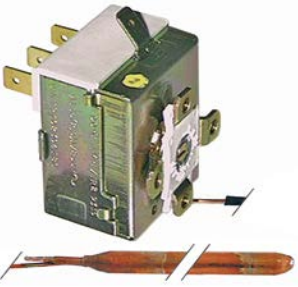
1

GEV No.	390460	Ref. No.	2060
description	thermostat t.max. 90°C temperature range 30-90°C 1-pole 1CO 16A probe ø 6.5mm probe L 95mm capillary pipe 2000mm capillary pipe isolated 1950mm gland nut shaft ømm shaft Lmm shaft position rotation 270° probe material copper		

28.5x28.5mm





1

GEV No.	345565	Ref. No.	L7440
description	push switch mounting measurements 28.5x28.5mm green 2NO 250V 16A connection male faston 6.3mm ambient temperature max. 150°C protection IP40		
For models:	POLY1500		

refrigeration thermostats

RANCO

K61 series

1

GEV No.	390289	Ref. No.	FA1073 L4750 M06711020
description	thermostat RANCO type K61L1502 probe ømm probe Lmm capillary pipe 2150mm		

28.5x52.6mm



1

GEV No.	346076	Ref. No.	L7210
description	switch combination mounting measurements 28.5x52.6mm black/grey 2NO/1NO 250V 16A ON-OFF, timer connection male faston 6.3mm ambient temperature max. 85°C protection IP40		
For models:	OCEANO35, OCEANO40, OCEANO50, OCEANO60, POLY1000, POLY1500		

switches and momentary switches

push/momentary push switches

19x13mm



1

GEV No.	301105	Ref. No.	L7066
description	momentary push switch mounting measurements 19.3x12.9mm black 1NO 250V 16A connection male faston 6.3mm ambient temperature max. 150 85°C protection IP40		
For models:	POLY2000, T40, T45, T50		

28.5x77.5mm



1

GEV No.	346551	Ref. No.	L2037
description	switch combination latching/momentary/latching mounting measurements 28.5x77.5mm green/grey/black 2NO/1NO/2NO 250V 16A time/main switch connection male faston 6.3mm ambient temperature max. 85°C protection IP40		
For models:	K1300		



1

GEV No.	301106	Ref. No.	L7065
description	push switch mounting measurements 19x13mm black 2NO 230V 16A connection male faston 6.3mm ambient temperature max. 150 85°C protection IP40		
For models:	POLY2000, T40, T45, T50		



1

GEV No.	346996	Ref. No.	L2034
description	switch combination momentary mounting measurements 28.5x77.5mm blue/grey/black 2NO/1NO/1NO 250V 16A with indicator main switch/time/rinsing connection male faston 6.3mm ambient temperature max. 55/120°C protection IP40		
For models:	K1000QBS, K10QT, K11QS, K12QS, K400QS, K502QBS, K660		



microswitches

lever actuated



1

GEV No.	345742	Ref. No.	L7071
description	microswitch with lever 250V 16A 1CO connection male faston 6.3mm L 55mm ambient temperature max. 120°C mounting distance 22mm actuating force: 75g lever length 46mm		
For models:	T40, T45, T50		

pin-plunger actuated

miscellaneous



1

GEV No.	346997	Ref. No.	2131 L2131
description	microswitch 250V 6A 1NO connection male faston 6.3mm ambient temperature max. 125°C		
For models:	K1000QBS, K10QT, K11QS, K12QS, K400QS, K502QBS, OCEANO35, OCEANO40, OCEANO50, OCEANO60		

position switches

BREMAS



1

GEV No.	346080	Ref. No.	L2109
description	position switch with plunger 1NO/1NC		
For models:	K1300		

system switches (ROLD)



1

GEV No.	346617	Ref. No.	L7392
description	indicator light lens size 11x15.8mm green		
For models:	POLY1000		

rotary switches

LOVATO



1

GEV No.	346555	Ref. No.	L2028
description	rotary switch 3 1-2-3 sets of contacts 3 type GN128940U 690V 12A shaft ø 6x6mm shaft L 23.5mm shaft square connection screw		
For models:	K1300, POLY1500, POLY2000		

miscellaneous



1

GEV No.	347689	Ref. No.	L2030 L7070
description	rotary switch sets of contacts 2 2 0-1 type CS20-00063 690V 25A shaft ø 5x5mm shaft L 22mm shaft square connection male faston 6.3mm		

magnetic switches

36x13mm



1

GEV No.	345795	Ref. No.	L7363
description	magnetic switch L 36mm W 13mm 1NO 250V 0.04A connection male faston 6.3mm 10W		
For models:	POLY1000, POLY1500, POLY2000		

lamps

indicator lights

indicator lights 2-piece (lens and indicator lamp)

indicator lamps for socket type SA / SC / SD / SF / SR



1

GEV No.	359982	Ref. No.	L7063
description	indicator lamp 230V clear connection male faston 6.3mm Qty 1 pcs		
For models:	T40, T45, T50		



			
1			
GEV No.	359983	Ref. No.	L7064
description	indicator lamp 230V green connection male faston 6.3mm Qty 1 pcs		
For models:	T40, T45, T50		

indicator lights (complete)
 ø10mm
 with plug-in socket

			
1			
GEV No.	359139	Ref. No.	L2041
description	indicator light ø 10mm green 230V connection male faston 6.3mm Qty 1 pcs		
For models:	K1000QBS, K10QT, K11QS, K12QS, K1300, K400QS, K502QBS, K660		

			
1			
GEV No.	359138	Ref. No.	L2040
description	indicator light ø 10mm red 230V connection male faston 6.3mm Qty 1 pcs		
For models:	K1000QBS, K10QT, K11QS, K12QS, K1300, K400QS, K502QBS, K660		

19x13mm

			
1			
GEV No.	359201	Ref. No.	L7393
description	indicator light mounting measurements 19x13mm 230V green connection male faston 6.3mm temp.-resist. 150°C		
For models:	POLY2000		

			
1			
GEV No.	359200	Ref. No.	L7397
description	indicator light mounting measurements 19x13mm 230V red connection male faston 6.3mm		
For models:	POLY2000		



28.5x52.6mm



			
1			
GEV No.	359111	Ref. No.	L7211
description	indicator light mounting measurements 28.5x52.6mm 230V green/red		
For models:	OCEANO35, OCEANO40, OCEANO50, OCEANO60, POLY1000, POLY1500		

timers

programme timers

			
1			
GEV No.	360400	Ref. No.	L2010
description	timer BIGATTI engines 1 chambers 2 operation time 120s 230V shaft ø 6x4.6mm shaft L 20mm manif. no. D94 / LU003 motor type 82394544		

			
1			
GEV No.	360411	Ref. No.	L2014
description	timer CDC 11803 engines 1 chambers 3 operation time 120s 230V shaft ømm shaft Lmm motor type M48R ATS		
For models:	K1000QBS, K10QT, K11QS, K12QS, K400QS, K502QBS, K660, OCEANO35, OCEANO40, OCEANO50, OCEANO60, POLY1000, T40, T45, T50		
spare parts for	360411		
	GEV No.	360118	Ref. No. —
	motor CDC pinion ø 4.9mm teeth 10 230V voltage AC 50/60Hz turn direction right motor ø 47mm H 19.3mm motor type M48R ATS for timer cable length 260mm 1.9/2.5W		

			
1			
GEV No.	360524	Ref. No.	4695 L4695 M06712020
description	timer CDC 11904 engines 1 chambers 4 operation time 12min 230V shaft ømm shaft Lmm manif. no. 11904F1 / BDR000.0000 motor type M48R ATS		
spare parts for	360524		
	GEV No.	360118	Ref. No. —
	motor CDC pinion ø 4.9mm teeth 10 230V voltage AC 50/60Hz turn direction right motor ø 47mm H 19.3mm motor type M48R ATS for timer cable length 260mm 1.9/2.5W		

1

GEV No.	360154	Ref. No.	N23248
description	timer FIBER P20 engines 1 chambers 4 operation time 15min 230V shaft ømm shaft Lmm manuf. no. P205J04J714 motor type M51B-J0R6400		
spare parts for	360154		
	GEV No.	360673	Ref. No. —
	motor kit pinion ø 6.8mm teeth 15 230V voltage AC 50/60Hz turn direction clockwise motor ø 48mm H 18.5mm motor type UDS-40NE1RNZ165 cable length 150mm with holder		

contactors

LOVATO

power contactors





1

GEV No.	380705	Ref. No.	L2113
description	power contactor resistive load 20A 230VAC (AC3/400V) 9A/4kW main contacts 3NO auxiliary contacts 1NO connection screw connection type 11BG0910A230		
For models:	K1000QBS, K1300, K660, OCEANO60, POLY1000, POLY1500, POLY2000, T50		
accessories for	380705		
	GEV No.	380057	Ref. No. —
	auxiliary contact contacts 1NO/1NC AC1 10A for contactors BG series connection screw type BGX1011		



1

GEV No.	380855	Ref. No.	L2111
description	power contactor resistive load 25A 230VAC (AC3/400V) 4.2kW main contacts 3NO auxiliary contacts 1NO		
For models:	K1300, POLY1500, POLY2000		
accessories for	380855		
	GEV No.	380055	Ref. No. —
	RC circuit voltage AC/DC suitable for BF09-32 rated 240V		
	GEV No.	380118	Ref. No. —
	auxiliary contact contacts 1NO/1NC AC1 10A for contactors BF series connection screw type G480/11		

overload switches



1

GEV No.	380670	Ref. No.	L2081
description	overload switch setting range 3-5A for contactors BG (BG06-BG12) series connection screw		
For models:	K1300		

relays

power relays

with bracket mounting



1

GEV No.	380054	Ref. No.	L2082 L7391
description	power relays 230VAC 16A 2CO connection male faston 6.3mm bracket mounting		
For models:	K1300, POLY1000, POLY1500, POLY2000		

solenoïd valves

solenoïd valves (water)

RPE

















solenoïd valves with reducers





single



1

GEV No.	370440	Ref. No.	N10368
description	solenoïd valve 1-fold, without membrane (constantly open) angled inlet 3/4" outlet 11.5mm input 10-12l/min RPE plastic flow regulating valve inlet white		

TP			
			
1			
GEV No.	370021	Ref. No.	L2020
description	solenoid valve double straight 230VAC inlet 3/4" outlet 11.5mm DN10 TP flow regulating valve inlet white		
For models:	K1000QBS, K100QT, K11QS, K12QS, K400QS, K502QBS		
spare parts for	370021		
		GEV No.	371013 Ref. No. —
	solenoid coil TP 230VAC 50/60Hz		
accessories for	370021		
		GEV No.	371220 Ref. No. —
	reducer TP flow rate 3l/min red tolerance ±15%		
		GEV No.	371221 Ref. No. —
	reducer TP flow rate 5.5l/min yellow tolerance ±15%		
		GEV No.	371222 Ref. No. —
	reducer TP flow rate 6l/min grey tolerance ±15%		
		GEV No.	371223 Ref. No. —
	reducer TP flow rate 10l/min white tolerance ±15%		
		GEV No.	371224 Ref. No. —
	reducer TP flow rate 12l/min bronze tolerance ±15%		
		GEV No.	371225 Ref. No. —
	reducer TP flow rate 16l/min light brown tolerance ±15%		
		GEV No.	371226 Ref. No. —
	reducer TP flow rate 20l/min red tolerance ±15%		
		GEV No.	371230 Ref. No. —
	reducer TP flow rate 0.25l/min red tolerance ±25%		
		GEV No.	371231 Ref. No. —
	reducer TP flow rate 0.35l/min violet tolerance ±25%		
		GEV No.	371232 Ref. No. —
	reducer TP flow rate 0.5l/min orange tolerance ±25%		
		GEV No.	371233 Ref. No. —
	reducer TP flow rate 0.8l/min white tolerance ±25%		
		GEV No.	371234 Ref. No. —
	reducer TP flow rate 1l/min light blue tolerance ±25%		
		GEV No.	371235 Ref. No. —
	reducer TP flow rate 1.2l/min brown tolerance ±25%		
		GEV No.	371236 Ref. No. —
	reducer TP flow rate 1.5l/min light brown tolerance ±25%		

accessories for 370021			
		GEV No.	371237 Ref. No. —
	reducer TP flow rate 2.5l/min yellow tolerance ±25%		
		GEV No.	371238 Ref. No. —
	reducer TP flow rate 3.4l/min dark green tolerance ±25%		
		GEV No.	371239 Ref. No. —
	reducer TP flow rate 5l/min black tolerance ±25%		
		GEV No.	371240 Ref. No. —
	reducer TP flow rate 8l/min blue tolerance ±20%		

TP			
			
1			
GEV No.	370017	Ref. No.	L2021
description	solenoid valve single straight 230VAC inlet 3/4" outlet 11.5mm DN10 TP p max 10bar		
For models:	K1300, K660, OCEANO35, OCEANO40, OCEANO50, OCEANO60, POLY1000, POLY1500, POLY2000, T40, T45, T50		
spare parts for	370017		
		GEV No.	371013 Ref. No. —
	solenoid coil TP 230VAC 50/60Hz		
accessories for	370017		
		GEV No.	371220 Ref. No. —
	reducer TP flow rate 3l/min red tolerance ±15%		
		GEV No.	371221 Ref. No. —
	reducer TP flow rate 5.5l/min yellow tolerance ±15%		
		GEV No.	371222 Ref. No. —
	reducer TP flow rate 6l/min grey tolerance ±15%		
		GEV No.	371223 Ref. No. —
	reducer TP flow rate 10l/min white tolerance ±15%		
		GEV No.	371224 Ref. No. —
	reducer TP flow rate 12l/min bronze tolerance ±15%		
		GEV No.	371225 Ref. No. —
	reducer TP flow rate 16l/min light brown tolerance ±15%		
		GEV No.	371226 Ref. No. —
	reducer TP flow rate 20l/min red tolerance ±15%		
		GEV No.	371230 Ref. No. —
	reducer TP flow rate 0.25l/min red tolerance ±25%		
		GEV No.	371231 Ref. No. —
	reducer TP flow rate 0.35l/min violet tolerance ±25%		
		GEV No.	371232 Ref. No. —
	reducer TP flow rate 0.5l/min orange tolerance ±25%		

Table continues overleaf



accessories for		370017	
	GEV No.	371233	Ref. No. —
reducer TP flow rate 0.8l/min white tolerance ±25%			
	GEV No.	371234	Ref. No. —
reducer TP flow rate 1l/min light blue tolerance ±25%			
	GEV No.	371235	Ref. No. —
reducer TP flow rate 1.2l/min brown tolerance ±25%			
	GEV No.	371236	Ref. No. —
reducer TP flow rate 1.5l/min light brown tolerance ±25%			
	GEV No.	371237	Ref. No. —
reducer TP flow rate 2.5l/min yellow tolerance ±25%			
	GEV No.	371238	Ref. No. —
reducer TP flow rate 3.4l/min dark green tolerance ±25%			
	GEV No.	371239	Ref. No. —
reducer TP flow rate 5l/min black tolerance ±25%			
	GEV No.	371240	Ref. No. —
reducer TP flow rate 8l/min blue tolerance ±20%			

solenoid valves with reducers

	1		
GEV No.	370427	Ref. No.	L4690
description	solenoid valve single angled 230VAC inlet 3/4" outlet 11.5mm input/min output 1.2l/min DN10 t.max. 90°C TP plastic flow regulating valve outlet dark brown		

pressure switches
for warewashing

ø 58mm with male faston 6.3mm
with connection horizontal

	1		
GEV No.	541539	Ref. No.	L7375 L7433
description	pressure control pressure range 160/50mbar connection male faston 6.3mm ø 58mm pressure connection horizontal warewashing pressure connection ø 5mm		
For models:	POLY1000, POLY1500, POLY2000		

	1		
GEV No.	541010	Ref. No.	2091 L2091 L7106
description	pressure control pressure range 50/30mbar connection 6mm ø 58mm pressure connection horizontal warewashing		
For models:	K10QT, K11QS, K12QS, K660, T40, T45		

	1		
GEV No.	541141	Ref. No.	L7109
description	pressure control pressure range 75/35mbar connection 6mm ø 58mm pressure connection horizontal warewashing pressure connection ø 6mm		
For models:	OCEANO50, OCEANO60, T50		

	1		
GEV No.	541311	Ref. No.	L2092
description	pressure control pressure range 76/38mbar connection 6mm ø 58mm pressure connection horizontal warewashing pressure connection ø 6mm		
For models:	K1000QBS, K1300, K400QS, K502QBS		

	1		
GEV No.	541577	Ref. No.	L7249
description	pressure control pressure range 83/33mbar connection 6mm ø 58mm pressure connection horizontal pressure connection ø 6mm		
For models:	OCEANO35, OCEANO40		



pumps





wash and rinse pumps

ALBA (C&A)

pumps





1

GEV No.	500296	Ref. No.	L1301
description	pump inlet ø 28mm outlet ø 28mm type C903 230V 50Hz 1 phase 0.11kW 0.15HP L 200mm rotation direction left capacitor 6.3µF auxiliary pressure connection 13mm supporting pressure closed ALBA PUMPS (C&A)		
For models:	K10QT		
spare parts for	500296		
	GEV No.	365012	Ref. No. —
	operating capacitor capacity 6.3µF 450V tolerance 5% 50Hz ambient temperature max. -25 to +85°C ø 30mm L 61mm M8 plastic connection male faston 6.3mm protection		
	GEV No.	510692	Ref. No. —
	mechanical shaft seal for shaft ø 11mm slide ring ext. ø 24mm slide ring H 13mm counter ring mounting ø 26mm height counter ring 8mm counter ring int. ø 14mm		
	GEV No.	521226	Ref. No. —
	impellor ø 72mm H 19mm thread M7R shaft ø 11mm shaft length 29mm blades 3		
	GEV No.	521521	Ref. No. —
	pump cover ALBA PUMPS (C&A) inlet ø 28mm outlet ø 28mm auxiliary pressure connection 13mm supporting pressure closed turn direction left ø 93mm ID ø 76mm inner height 31mm		
	GEV No.	532490	Ref. No. —
	O-ring EPDM thickness 2.62mm ID ø 72.69mm Qty 1 pcs		



1





GEV No.	499191	Ref. No.	L7180 L7181 L7450 L7483
description	pump inlet ø 28mm outlet ø 28mm type CL.1301 230V 50Hz 1 phase 0.11kW 0.15HP L 190mm rotation direction left capacitor 6.3µF ALBA PUMPS (C&A)		
For models:	OCEANO35, OCEANO40		
spare parts for	499191		
	GEV No.	365012	Ref. No. —
	operating capacitor capacity 6.3µF 450V tolerance 5% 50Hz ambient temperature max. -25 to +85°C ø 30mm L 61mm M8 plastic connection male faston 6.3mm protection		
	GEV No.	510692	Ref. No. —
	mechanical shaft seal for shaft ø 11mm slide ring ext. ø 24mm slide ring H 13mm counter ring mounting ø 26mm height counter ring 8mm counter ring int. ø 14mm		
	GEV No.	521226	Ref. No. —
	impellor ø 72mm H 19mm thread M7R shaft ø 11mm shaft length 29mm blades 3		
	GEV No.	521521	Ref. No. —
	pump cover ALBA PUMPS (C&A) inlet ø 28mm outlet ø 28mm auxiliary pressure connection 13mm supporting pressure closed turn direction left ø 93mm ID ø 76mm inner height 31mm		
	GEV No.	532490	Ref. No. —
	O-ring EPDM thickness 2.62mm ID ø 72.69mm Qty 1 pcs		







1			
GEV No.	500945	Ref. No.	L1321
description	pump inlet \varnothing 45mm outlet \varnothing 40mm 230V 1 phase 0.3kW 0.4HP L 175mm rotation direction right capacitor 10 μ F ALBA PUMPS (C&A)		
For models:	K12QS		
spare parts for	500945		
	GEV No.	365015	Ref. No. —
	operating capacitor capacity 10 μ F 400V tolerance 5%Hz ambient temperature max. -25 to +85°C \varnothing 35.5mm L 59mm M8 plastic connection male faston 6.3mm protection		
	GEV No.	509018	Ref. No. —
	O-ring EPDM thickness 3.53mm ID \varnothing 107.5mm Qty 1 pcs		
	GEV No.	509028	Ref. No. —
	impellor \varnothing 87mm H 21mm rotation direction right thread M7L shaft \varnothing 12mm		
	GEV No.	510693	Ref. No. —
	mechanical shaft seal for shaft \varnothing 12mm slide ring ext. \varnothing 24mm slide ring H 15.5mm slide ring int. \varnothing 11mm counter ring mounting \varnothing 24mm height counter ring 8mm counter ring int. \varnothing 13.5mm		
	GEV No.	521528	Ref. No. —
	pump cover ALBA PUMPS (C&A) inlet \varnothing 45mm outlet \varnothing 40mm turn direction right \varnothing 129mm ID \varnothing 105mm inner height 19mm		







1			
GEV No.	500085	Ref. No.	L1304 L1305
description	pump inlet \varnothing 45mm outlet \varnothing 40mm type C1001 230V 50Hz 1 phase 0.55kW 0.75HP L 200mm rotation direction right capacitor 16 μ F ALBA PUMPS (C&A)		
For models:	K502QBS		
spare parts for	500085		
	GEV No.	365014	Ref. No. —
	operating capacitor capacity 12.5 μ F 450V tolerance 5%Hz ambient temperature max. -25 to +85°C \varnothing 35mm L 70mm M8 plastic connection male faston 6.3mm 45S.C3DS.12.5 protection		

spare parts for	500085		
	GEV No.	509021	Ref. No. —
	impellor \varnothing 102mm H 32mm shaft intake \varnothing 9/8mm rotation direction right		
	GEV No.	510693	Ref. No. —
	mechanical shaft seal for shaft \varnothing 12mm slide ring ext. \varnothing 24mm slide ring H 15.5mm slide ring int. \varnothing 11mm counter ring mounting \varnothing 24mm height counter ring 8mm counter ring int. \varnothing 13.5mm		
	GEV No.	521531	Ref. No. —
	pump cover ALBA PUMPS (C&A) inlet \varnothing 45mm outlet \varnothing 40mm turn direction right \varnothing 153mm ID \varnothing 127mm inner height 24mm		
	GEV No.	521709	Ref. No. —
	O-ring EPDM thickness 3mm ID \varnothing 126mm Qty 1 pcs		



1			
GEV No.	500482	Ref. No.	L7072
description	pump inlet \varnothing 45mm outlet \varnothing 40mm type C7675 230V 50Hz 1 phase 0.29kW 0.4HP L 210mm rotation direction right capacitor 10 μ F ALBA PUMPS (C&A)		
For models:	T40, T45		
spare parts for	500482		
	GEV No.	365015	Ref. No. —
	operating capacitor capacity 10 μ F 400V tolerance 5%Hz ambient temperature max. -25 to +85°C \varnothing 35.5mm L 59mm M8 plastic connection male faston 6.3mm protection		
	GEV No.	509018	Ref. No. —
	O-ring EPDM thickness 3.53mm ID \varnothing 107.5mm Qty 1 pcs		
	GEV No.	509028	Ref. No. —
	impellor \varnothing 87mm H 21mm rotation direction right thread M7L shaft \varnothing 12mm		
	GEV No.	510693	Ref. No. —
	mechanical shaft seal for shaft \varnothing 12mm slide ring ext. \varnothing 24mm slide ring H 15.5mm slide ring int. \varnothing 11mm counter ring mounting \varnothing 24mm height counter ring 8mm counter ring int. \varnothing 13.5mm		



GEV No.	501429	Ref. No.	L7362
description	pump inlet ø 63mm outlet ø 48mm type C.POLY2000 230/400V 50Hz 3 phase 0.9kW 1.2HP L 300mm rotation direction right ALBA PUMPS (C&A)		
For models:	POLY2000		
spare parts for	501429		
	GEV No.	510551	Ref. No. —
	pump cover gasket ID ø 158.3mm pump type 1214/1293/1225/2243/1226/1204/3473/1241 thickness 3.53mm EPDM Qty 1 pcs		
	GEV No.	510620	Ref. No. —
	impellor ø 109mm H 27mm rotation direction right thread M8L blades 6		
	GEV No.	510693	Ref. No. —
	mechanical shaft seal for shaft ø 12mm slide ring ext. ø 24mm slide ring H 15.5mm slide ring int. ø 11mm counter ring mounting ø 24mm height counter ring 8mm counter ring int. ø 13.5mm		
	GEV No.	521236	Ref. No. —
	impellor ø 105mm H 32mm M8R		





FIR pumps



GEV No.	500457	Ref. No.	L7383
description	pump inlet ø 28mm outlet ø 26mm type 2213.1417 230V 50Hz 1 phase 0.15kW 0.2HP L 198mm rotation direction left capacitor 6.3µF FIR		
For models:	OCEANO50, OCEANO60		
spare parts for	500457		
	GEV No.	365012	Ref. No. —
	operating capacitor capacity 6.3µF 450V tolerance 5% 50Hz ambient temperature max. -25 to +85°C ø 30mm L 61mm M8 plastic connection male faston 6.3mm protection		
	GEV No.	510384	Ref. No. —
	pump cover inlet ø 28mm outlet ø 26mm ø 100mm ID ø 76mm		
	GEV No.	510695	Ref. No. —
	mechanical shaft seal height counter ring 5.5mm ID ø 11mm		
	GEV No.	521703	Ref. No. —
	pump cover gasket EPDM thickness 2.5mm ID ø 75mm Qty 1 pcs		





LGB



GEV No.	500946	Ref. No.	L1303 L7501
description	pump inlet ø 45mm outlet ø 40mm type ZF150SX 230V 50Hz 1 phase 0.36kW 0.5HP L 180mm rotation direction right capacitor 10µF LGB		
For models:	K11QS, K400QS		
spare parts for	500946		
	GEV No.	365015	Ref. No. —
	operating capacitor capacity 10µF 400V tolerance 5%Hz ambient temperature max. -25 to +85°C ø 35.5mm L 59mm M8 plastic connection male faston 6.3mm protection		
	GEV No.	510703	Ref. No. —
	mechanical shaft seal for shaft ø 13mm slide ring H 13mm height counter ring 5.5mm ED ø 26mm		
	GEV No.	521140	Ref. No. —
	pump cover LGB inlet ø 45mm outlet ø 40mm auxiliary pressure connection 12mm pump type ZF150SX		
	GEV No.	521701	Ref. No. —
	pump cover gasket		



GEV No.	500943	Ref. No.	L7455
description	pump inlet ø 62mm outlet ø 50mm type ZF522VSX 230V 50Hz 1 phase 0.7kW 0.95HP L 250mm rotation direction right capacitor 16µF LGB		
spare parts for	500943		
	GEV No.	365021	Ref. No. —
	operating capacitor capacity 16µF 425V tolerance 5% 50/60Hz ambient temperature max. -25 to +85°C ø 35mm L 73mm single M8 plastic connection male faston 6.3mm 416.10.99 protection		

spare parts for	500943		
	GEV No.	510551	Ref. No. —
	pump cover gasket ID ø 158.3mm pump type 1214/1293/1225/2243/1226/1204/3473/1241 thickness 3.53mm EPDM Qty 1 pcs		
	GEV No.	510694	Ref. No. —
	mechanical shaft seal for shaft ø 13mm height counter ring 8mm ID ø 11.5mm H 16mm mounting ø 24/26mm int. ø 1 14mm		
	GEV No.	521239	Ref. No. —
	impeller ø 110mm H 26mm rotation direction right thread M8L shaft ø 19.5mm shaft length 17mm seat ø 8.2mm blades 6		
	GEV No.	521536	Ref. No. —
	pump cover ALBA / LGB inlet ø 62mm outlet ø 50mm auxiliary pressure connection 12mm supporting pressure closed turn direction right ø 180mm ID ø 150mm inner height 38mm		

condensators & interference suppression filters

filters

RC circuits

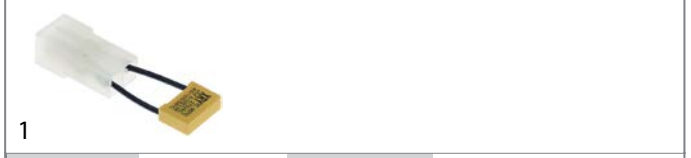

GEV No.	365211	Ref. No.	NC23457
description	interference suppression filter type XRY RC MKPX2 275V connection plug		

equipment-specific units for ice-cube maker

ice chutes

slide grates

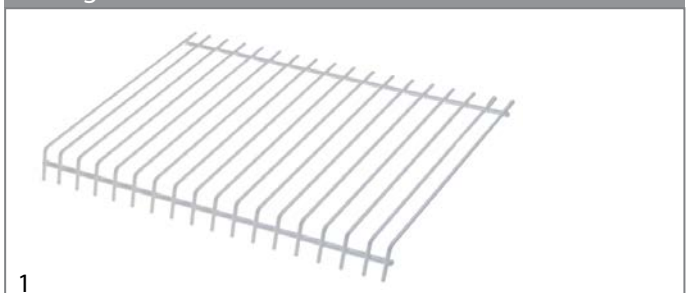

GEV No.	694281	Ref. No.	ND12001
description	slide grate for ice-cube maker L 325mm W 210mm		



curtains

with holder



1

GEV No.	695506	Ref. No.	NC22034
description	curtain for ice maker W 328mm H 150mm with holder shaft length 325mm shaft ø 7.5mm		



1

GEV No.	696594	Ref. No.	NC22106
description	curtain for ice-cube maker W 273mm H 160mm shaft length 280mm shaft ø 7.6mm holder length 316mm		

without holder



1

GEV No.	695116	Ref. No.	NC10533
description	curtain for ice-cube maker W 320mm H 80mm shaft length 325mm shaft ø 7.5mm		

for coffee grinders



1

GEV No.	345742	Ref. No.	L7071
description	microswitch with lever 250V 16A 1CO connection male faston 6.3mm L 55mm ambient temperature max. 120°C mounting distance 22mm actuating force: 75g lever length 46mm		
For models:	T40, T45, T50		

for dishwashers

drain and intake components

LUXIA

drain /intake bodies



1

GEV No.	507478	Ref. No.	L3042
description	drain fitting thread 1" ED ø 50mm ID ø 25/21mm hose ø 26mm		
For models:	K10QT, K11QS, K12QS, OCEANO50, OCEANO60		

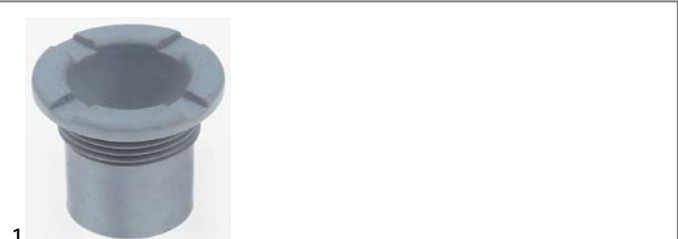

1

GEV No.	507481	Ref. No.	L3043
description	drain fitting thread 1¼" ED ø 55mm ID ø 34/30mm hose ø 37mm		
For models:	K1000QBS, K1300, K400QS, K502QBS, K660, POLY1000, POLY1500, POLY2000		

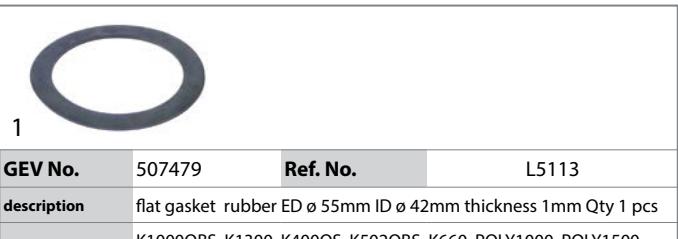

1

GEV No.	507479	Ref. No.	L5113
description	flat gasket rubber ED ø 55mm ID ø 42mm thickness 1mm Qty 1 pcs		
For models:	K1000QBS, K1300, K400QS, K502QBS, K660, POLY1000, POLY1500, POLY2000		



1



GEV No.	519559	Ref. No.	L7006
description	intake/drain body ED ø 110mm ID ø 85mm outlet ø 45 outlet 2 ø 26		
For models:	T40, T45		
accessories for	519559		

	GEV No.	512402	Ref. No.	L7099
	description	gasket rubber ED ø 105mm ID ø 85mm thickness 3mm Qty 1 pcs		

	GEV No.	519558	Ref. No.	L7007
	description	locknut ED ø 105mm H 19mm ID ø 76mm		



1

GEV No.	519558	Ref. No.	L7007
description	locknut ED ø 105mm H 19mm ID ø 76mm		
For models:	T40, T45, T50		
accessories for	519558		
	GEV No.	512402	Ref. No. L7099
	gasket rubber ED ø 105mm ID ø 85mm thickness 3mm Qty 1 pcs		
	GEV No.	519559	Ref. No. L7006
	intake/drain body ED ø 110mm ID ø 85mm outlet ø 45 outlet 2 ø 26		



1

GEV No.	507477	Ref. No.	L3311
description	nut thread 1" ø 50mm H 7.5mm WS 36 brass Qty 1 pcs		
For models:	K10QT, K11QS, K12QS		



1

GEV No.	507480	Ref. No.	L3314
description	nut thread 1¼" ø 58mm H 8mm WS 44 brass Qty 1 pcs		
For models:	K1000QBS, K1300, K400QS, K502QBS, K660, POLY1000, POLY1500, POLY2000		

filters



1

GEV No.	507363	Ref. No.	3011 L3011
description	round filters ø 110mm H 65mm suction		
For models:	K10QT, K11QS, K12QS, K400QS, K502QBS		



1

GEV No.	507364	Ref. No.	L3016
description	round filters ø 140mm H 130mm suction		
For models:	K1300		



1

GEV No.	507365	Ref. No.	L3012
description	round filters ø 143mm H 80mm suction		
For models:	K1000QBS, K660		



1

GEV No.	507366	Ref. No.	L3030
description	screw connection for filter		
For models:	K1000QBS, K10QT, K11QS, K12QS, K1300, K400QS, K502QBS, K660		

overflow pipes



1

GEV No.	507484	Ref. No.	L3053 L3054
description	overflow pipe L 131mm ø 35mm		
For models:	K1000QBS, K400QS, K502QBS, K660		



1

GEV No.	507437	Ref. No.	L7980
description	overflow pipe L 180mm ø 35mm plastic		



 <p>1</p>			
GEV No.	507483	Ref. No.	L7105 L7299
description	overflow pipe L 230mm ø 25mm stainless steel		
For models:	T40, T45		



 <p>1</p>			
GEV No.	507429	Ref. No.	L3055
description	overflow pipe L 250mm ø 35mm		
For models:	K1300		

 <p>1</p>			
GEV No.	507482	Ref. No.	L3050
description	overflow pipe L 90mm ø 26mm plastic		
For models:	K10QT, K11QS, K12QS		

air traps

air traps

 <p>1</p>			
GEV No.	511447	Ref. No.	L3072
description	air trap with gasket L 84mm W 34mm H 50mm thread 3/4" hose ø 6mm		
For models:	K1000QBS, K10QT, K11QS, K12QS, K1300, K400QS, K502QBS, K660		

 <p>1</p>			
GEV No.	507489	Ref. No.	L7114
description	air trap without gasket L 84mm W 34mm H 50mm thread 3/4" hose ø 6mm		
For models:	OCEANO35, OCEANO40, OCEANO50, OCEANO60, POLY1000, POLY1500, POLY2000, T40, T45, T50		
accessories for	507489		
	GEV No.	502036	Ref. No. —
	GEV No.	510154	Ref. No. L7045 L7100
	flat gasket rubber ED ø 33mm ID ø 26mm thickness 2mm Qty 1 pcs		

door mechanics

locks

 <p>1</p>			
GEV No.	507011	Ref. No.	L3110
description	door catch complete door locking catch		
For models:	K1000QBS, K10QT, K11QS, K12QS, K400QS, K502QBS, OCEANO35, OCEANO40, OCEANO50, OCEANO60		

washing and rinsing systems

 <p>1</p>			
GEV No.	507435	Ref. No.	L3360 L7083
description	bush for wash arm ø 16mm		
For models:	K1000QBS, K10QT, K11QS, K12QS, K1300, K400QS, K502QBS, K660, OCEANO35, OCEANO40, OCEANO50, OCEANO60, POLY1000, POLY1500, POLY2000, T40, T45, T50		

 <p>1</p>			
GEV No.	507427	Ref. No.	L3361
description	bush for wash arm ø 25mm		
For models:	K1300		

 <p>1</p>			
GEV No.	507434	Ref. No.	L3382
description	knurled nut thread M17x1 ø 30mm H 5mm SS		
For models:	K1300		

washing and rinsing systems (sorted by producer)

LUXIA



1			
GEV No.	507431	Ref. No.	L5041
description	wash arm L 215mm nozzles 6 number B		
For models:	K1000QBS, K1300, K660		



1			
GEV No.	507430	Ref. No.	L5040
description	wash arm L 215mm nozzles 7 number A		
For models:	K1000QBS, K1300, K660		



1			
GEV No.	507426	Ref. No.	L3378 L5032
description	wash arm boss		
For models:	K1300		



1			
GEV No.	507472	Ref. No.	L5109
description	rinse arm L 155mm nozzles 2 type B		
For models:	K10QT, K11QS, OCEANO35		
spare parts for	507472		
	GEV No.	507474	Ref. No. L5030
	wash arm boss ø 12mm L 80mm W 78mm H 54mm		



1			
GEV No.	507470	Ref. No.	L5051
description	wash arm L 140mm nozzles 4 ø 25mm type A		
For models:	K10QT, K11QS		



1			
GEV No.	507469	Ref. No.	L5052
description	wash arm L 140mm nozzles 5 ø 25mm type B		
For models:	K10QT, K11QS		



1			
GEV No.	507474	Ref. No.	L5030
description	wash arm boss ø 12mm L 80mm W 78mm H 54mm		
For models:	K1000QBS, K10QT, K11QS, K12QS, K400QS, K502QBS, K660		





1			
GEV No.	507473	Ref. No.	L5112
description	rinse arm L 325mm nozzles 5 mounting ø 12mm mounting pos. upper		
For models:	K10QT, OCEANO35, OCEANO40		





1			
GEV No.	507472	Ref. No.	L5109
description	rinse arm L 155mm nozzles 2 type B		
For models:	K10QT, K11QS, OCEANO35		
spare parts for	507472		
	GEV No.	507474	Ref. No. L5030
	wash arm boss ø 12mm L 80mm W 78mm H 54mm		





			
1			
GEV No.	503166	Ref. No.	L7112
description	wash arm mounting pos. lower L 480mm nozzles 6		
For models:	T50		

miscellaneous			
			
1			
GEV No.	507432	Ref. No.	L2161
description	end cap for rinse arm ø 10mm		

			
1			
GEV No.	507433	Ref. No.	L2160
description	end cap for wash arm ø 15.5mm		

			
1			
GEV No.	502051	Ref. No.	3325 L3325 L3325+2xL3410 L3325+L3410
description	rinse jet		

			
1			
GEV No.	503167	Ref. No.	L7417
description	wash arm mounting pos. upper L 20mm nozzles 3 ø 12mm		

			
1			
GEV No.	502050	Ref. No.	L3321
description	wash jet		

			
1			
GEV No.	507475	Ref. No.	L3319 L3319+L3410
description	wash jet complete		

			
1			
GEV No.	507428	Ref. No.	L3366
description	wash arm support mounting pos. upper/lower		
For models:	K1300, K660, POLY1000, POLY1500, POLY2000		

rinse arm shafts			
			
1			
GEV No.	507441	Ref. No.	L3356
description	rinse arm shaft		

knobs

producer-specific knobs

LUXIA			
			
1			
GEV No.	112287	Ref. No.	L3001
description	knob switch zero mark ø 43mm shaft ø 5x5mm black		
For models:	K1300, POLY1500, POLY2000		

			
1			
GEV No.	112286	Ref. No.	L3002
description	knob switch zero mark ø 43mm shaft ø 6x4.6mm shaft flat upper black		
For models:	K1000QBS, K10QT, K11QS, K12QS, K1300, K400QS, K502QBS, K660, T40, T45, T50		

			
1			
GEV No.	110431	Ref. No.	L3000
description	knob set switch zero mark ø 43mm shaft ø 6x4.6/5x5mm 2-piece		

baskets

warewashing baskets

steel wire baskets round

mix baskets



GEV No.	970520	Ref. No.	L3503
description	mix basket ED ø 455mm H 160mm seat ø 390mm		

plastic baskets round



GEV No.	970826	Ref. No.	L3502
description	mix basket ED ø 410mm H 190mm		

plastic baskets square

mix baskets



GEV No.	971058	Ref. No.	L3510 L7185
description	mix basket L 350mm W 350mm H 150mm		
For models:	K10QT, K11QS, OCEANO35		

gaskets

O-rings

EPDM



GEV No.	504561	Ref. No.	L7104
description	O-ring EPDM thickness 2.62mm ID ø 29.82mm Qty 1 pcs		
For models:	OCEANO35, OCEANO40, OCEANO50, OCEANO60, POLY1000, POLY1500, POLY2000, T40, T45, T50		

GEV No.	510408	Ref. No.	L5107
description	O-ring EPDM thickness 5.34mm ID ø 47mm Qty 1 pcs		
For models:	K1000QBS, K10QT, K11QS, K12QS, K1300, K400QS, K502QBS, K660, OCEANO35, OCEANO40, OCEANO50, OCEANO60, POLY1000, POLY1500, POLY2000, T40, T45, T50		

sealing washers

rubber gaskets



GEV No.	510154	Ref. No.	L7045 L7100
description	flat gasket rubber ED ø 33mm ID ø 26mm thickness 2mm Qty 1 pcs		
For models:	OCEANO35, OCEANO40, OCEANO50, OCEANO60, POLY1000, POLY1500, POLY2000, T40, T45, T50		



GEV No.	507479	Ref. No.	L5113
description	flat gasket rubber ED ø 55mm ID ø 42mm thickness 1mm Qty 1 pcs		
For models:	K1000QBS, K1300, K400QS, K502QBS, K660, POLY1000, POLY1500, POLY2000		



GEV No.	512402	Ref. No.	L7099
description	gasket rubber ED ø 105mm ID ø 85mm thickness 3mm Qty 1 pcs		
For models:	T40, T45, T50		
accessories for	512402		



GEV No.	519558	Ref. No.	L7007
description	locknut ED ø 105mm H 19mm ID ø 76mm		



GEV No.	519559	Ref. No.	L7006
description	intake/drain body ED ø 110mm ID ø 85mm outlet ø 45 outlet 2 ø 26		



GEV No.	507476	Ref. No.	L5111
description	gasket rubber ED ø 50mm ID ø 34mm thickness 2mm Qty 1 pcs		
For models:	K10QT, K11QS, K12QS, OCEANO35, OCEANO40, OCEANO50, OCEANO60		



refrigeration cycle components

valves

Schrader valves

valve bodies



1

GEV No.	750097	Ref. No.	N14007
description	valve body for Schrader valve thread 1/4" SAE connection 6mm soldering connection		

dosing pumps

peristaltic dosing pumps





GERMAC

built-in version

with frequency control



1

GEV No.	361620	Ref. No.	L1308 L7002 L7215
description	dosing pump GERMAC frequency control 2.5l/h 230VAC detergent hose ø 4x6mm hose thermoplastic type G252 dimensions 62x70x93mm		
For models:	K1300, OCEANO35, OCEANO40, OCEANO50, OCEANO60, POLY1000, POLY1500, POLY2000		
spare parts for	361620		
	GEV No.	361263	Ref. No. —
	roller assembly GERMAC suitable for G80/82/150/152/200/202/250/252/600		
	GEV No.	361554	Ref. No. —
	pump hose GERMAC detergent hose type thermoplastic hose ø 5x8mm for model G200/G250/G252		
	GEV No.	361556	Ref. No. —
	control PCB type G82/G152/G202/G252 GERMAC		
accessories for	361620		
	GEV No.	520090	Ref. No. —
	PVC hose ID ø 4mm ED ø 6mm L 2m thickness 1mm t.max. 60°C transparent		
	GEV No.	520091	Ref. No. —
	nylon hose ID ø 4mm ED ø 6mm L 2m thickness 1mm operating p. 10bar burst p. 50bar t.max. 100°C transparent		



membrane dosing pumps

self-priming

various



1

GEV No.	361015	Ref. No.	L1504 L7012 L7013 L7219 L7374
description	dosing pump membrane dosing pump rinse aid inlet 6x8mm outlet 4x6mm pressure connection ø 4x6mm suction connection ø 6x8mm		
For models:	K1000QBS, K10QT, K11QS, K12QS, K1300, K400QS, K502QBS, K660, OCEANO35, OCEANO40, OCEANO50, OCEANO60, POLY1000, POLY1500, POLY2000, T40, T45, T50		
spare parts for	361015		
	GEV No.	361132	Ref. No. —
	membrane dosing pump		
	GEV No.	510298	Ref. No. —
	lip valve dosing pump suitable for DB2/DS5		

hoses

supply hoses

stainless steel flexi hoses

universal hoses

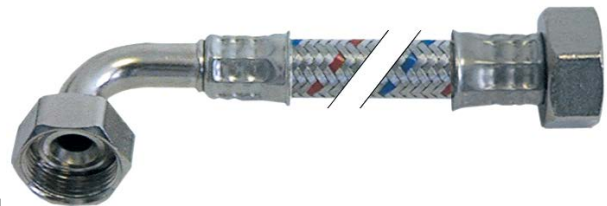

1



GEV No.	520008	Ref. No.	L3008
description	flex hose SS braid straight-curved DN12 connection 1: 3/4" connection 2: 3/4" L 1500mm approval DVGW operating p. 10bar test pressure 32bar burst p. 95bar		
For models:	K1300, POLY2000		
accessories for	520008		
	GEV No.	520054	Ref. No. —
	flat gasket rubber ED ø 23.5mm ID ø 14mm thickness 2.3mm Qty 10 pcs		

drain hoses



1

GEV No.	530570	Ref. No.	L3006
description	drain hose DN21 L 2000mm A int. ø 21mm A ext. ø 25mm B int. ø 20/29mm B ext. ø 27/35mm outer hose ø 25mm		
For models:	K1000QBS, K1300, K400QS, K502QBS, K660, OCEANO50, OCEANO60, POLY1000, POLY1500, POLY2000		

fittings, hose and pipe connectors

hose connectors

without screw connection



1

GEV No.	518347	Ref. No.	L3092
description	T-piece plastic hose ø 10-10-10mm 3-way		
For models:	K1000QBS, K10QT, K11QS, K12QS, K400QS, K502QBS, OCEANO35, OCEANO40		

ancillary products

clamps

hose clamps

DIN 3017 - W2



1

GEV No.	520112	Ref. No.	L3390
description	hose clamp ø 12-20mm width 9mm Qty 10 pcs DIN 3017		
For models:	K1000QBS, K10QT, K11QS, K12QS, K1300, K400QS, K502QBS, K660, POLY1000, POLY1500, POLY2000, T40, T45, T50		

measuring equipment

thermometers

built-in thermometers



1

GEV No.	541568	Ref. No.	L7062
description	thermometer mounting measurements 62x11mm 0 up to +120°C capillary pipe 1500mm probe ø 6mm probe L 32mm		
For models:	POLY2000, T40, T50		

fastening material

nuts

knurled nuts



1

GEV No.	507434	Ref. No.	L3382
description	knurled nut thread M17x1 ø 30mm H 5mm SS		
For models:	K1300		

hexagonal nuts

hexagonal nuts inch thread



1

GEV No.	507477	Ref. No.	L3311
description	nut thread 1" ø 50mm H 7.5mm WS 36 brass Qty 1 pcs		
For models:	K10QT, K11QS, K12QS		



1

GEV No.	507480	Ref. No.	L3314
description	nut thread 1¼" ø 58mm H 8mm WS 44 brass Qty 1 pcs		
For models:	K1000QBS, K1300, K400QS, K502QBS, K660, POLY1000, POLY1500, POLY2000		



fasteners

clamps

hose clamps

DIN 3017 - W2



1

GEV No.	520112	Ref. No.	L3390
description	hose clamp ø 12-20mm width 9mm Qty 10 pcs DIN 3017		
For models:	K1000QBS, K10QT, K11QS, K12QS, K1300, K400QS, K502QBS, K660, POLY1000, POLY1500, POLY2000, T40, T45, T50		

B		
bi-metal thermostats	4, 4	
C		
clamps	22, 23	
condensators & interference suppression filters	14	
contactors	8	
control thermostats	4	
D		
dosing pumps	21	
drain hoses	22	
F		
fasteners	23	
fastening material	22	
filters	14	
foil heating elements	4	
H		
heating elements	3	
hexagonal nuts	22	
hose clamps	22, 23	
hose connectors	22	
hoses	21	
I		
immersion heating elements	3	
indicator lights	6	
indicator lights (complete)	7	
K		
knurled nuts	22	
L		
lamps	6	
M		
magnetic switches	6	
measuring equipment	22	
microswitches	6	
N		
nuts	22	
O		
O-rings	20	
P		
position switches	6	
pressure switches	10	
programme timers	7	
pumps		11
push/momentary push switches		5
R		
refrigeration cycle components		21
refrigeration thermostats		5
relays		8
rotary switches		6
S		
safety bi-metal thermostats		4
Schrader valves		21
sealing washers		20
solenoid valves		8
stainless steel flexi hoses		21
supply hoses		21
switches and momentary switches		5
system switches (ROLD)		6
T		
thermostats		4
timers		7
U		
universal hoses		21
W		
wash and rinse pumps		11