



GAS COMPONENTS



ELECTRIC COMPONENTS



WATER TECHNOLOGY



MECHANICAL COMPONENTS



TOOLS

Spare parts suitable for

LA-SPAZIALE

Find the complete and up-to-date range of products in our GEV Webshop



Manufacturer catalogue

The most important spare parts and accessories arranged clearly for every manufacturer

- ✓ Complete product range and all appliance data always up to date in the GEV Webshop
- ✓ Alphabetical Index at the end of the catalogue

GEV Webshop

www.gev-online.co.uk

www.gev-online.com





- 🔍 Add to Favourites
- 🔍 Sign In with email address and usual password
- 🔍 Easy-order – place several items in your basket at the same time
- 🔍 Quick Item search – no login needed







heating elements

heating elements for coffee machine

			
1			
GEV No.	417390	Ref. No.	806
description	heating element 1250W 220V heating circuits 1 L 135mm W 50mm H 22mm L1 24mm L2 36mm L3 75mm mounting distance 42mm thread 1/4" connection male faston 6.3mm connection length 22mm tube ø 8.3mm 2 hole fixing immersion heater		

			
1			
GEV No.	417391	Ref. No.	7201
description	heating element 1250W 230V heating circuits 1 flange ø 50mm L 160mm W 22mm H 54mm tube ø 8.3mm connection male faston 6.3mm immersion heater		

			
1			
GEV No.	417393	Ref. No.	7478
description	heating element 1250W 230V heating circuits 1 ø 65mm H 200mm W1 48mm H1 135mm H2 65mm mounting distance 32mm thread 3/8" copper windings 5 tube ø 8.5mm immersion heater 2 hole fixing connection male faston 6.3mm		

			
1			
GEV No.	417038	Ref. No.	N/A
description	heating element 2700W 230V heating circuits 1 ø 110mm H 200mm W1 48mm H1 158mm H2 42mm mounting distance 40mm thread 3/8" copper windings 4 tube ø 8mm immersion heater 2 hole fixing connection M6		
accessories for	417038		
	GEV No.	361183	Ref. No. —
	nut thread 3/8" H 6mm nickel-plated brass WS 20 Qty 1 pcs		
	GEV No.	521137	Ref. No. —
	flat gasket fibre ED ø 20mm ID ø 18mm thickness 1.5mm for thread 3/8" Qty 1 pcs		

			
1			
GEV No.	417394	Ref. No.	425
description	heating element 2700W 230V heating circuits 1 ø 112mm H 205mm W1 44mm H1 160mm H2 45mm mounting distance 30mm thread 3/8" copper windings 4 tube ø 8.5mm immersion heater connection male faston 6.3mm		

			
1			
GEV No.	417387	Ref. No.	5504
description	heating element 2800W 230V heating circuits 3 mounting ø 50mm hole distance 63mm L 345mm W 35mm H 75mm L1 40mm L2 50mm L3 255mm H1 35mm H2 40mm tube ø 8.3mm connection male faston 6.3mm immersion heater 3 hole flange		

			
1			
GEV No.	417389	Ref. No.	426
description	heating element 3500W 230V heating circuits 1 ø 115mm H 205mm W1 50mm H1 160mm H2 45mm mounting distance 32mm thread 3/8" copper windings 4 tube ø 8.5mm immersion heater 2 hole fixing connection male faston 6.3mm		

			
1			
GEV No.	417388	Ref. No.	1724
description	heating element 3500W 230V heating circuits 3 mounting ø 50mm hole distance 63mm L 350mm W 35mm H 70mm L1 40mm L2 60mm L3 250mm H1 35mm H2 35mm hole ø 8mm tube ø 8.3mm connection male faston 6.3mm immersion heater 3 hole flange		

			
1			
GEV No.	417386	Ref. No.	5505
description	heating element 3800W 230V heating circuits 3 mounting ø 50mm hole distance 63mm L 550mm W 35mm H 70mm L1 45mm L2 55mm L3 450mm H1 35mm H2 35mm hole ø 8mm tube ø 8.3mm connection male faston 6.3mm immersion heater 3 hole flange		



			
GEV No.	417147	Ref. No.	5505
description	heating element 3800W 230V heating circuits 3 mounting \varnothing 51mm hole distance 63mm L 550mm W 38mm H 65mm hole \varnothing 10mm thermostat sleeves \varnothing 7mm length thermostat sleeves 245mm number of thermostat sleeves 1 thermostat sleeve not clinging tube \varnothing 8mm connection M6 immersion heater 3 hole flange		

			
GEV No.	417392	Ref. No.	7356
description	heating element 800W 230V heating circuits 1 flange \varnothing 50mm L 160mm W 22mm H 54mm tube \varnothing 8.3mm connection male faston 6.3mm immersion heater		

heating elements for contact grills

			
GEV No.	416145	Ref. No.	2987
description	heating element 1000W 230V L 177mm W 180mm H 18mm W1 46mm W2 88mm tube \varnothing 6.3mm windings 3 connection M4 dry heating element		

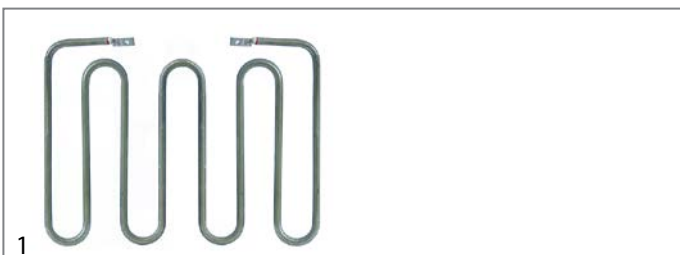
			
GEV No.	416146	Ref. No.	5684
description	heating element 1200W 230V L 180mm W 228mm H 20mm W1 55mm W2 118mm connection length 23mm tube \varnothing 6.3mm windings 4 connection M4 dry heating element		

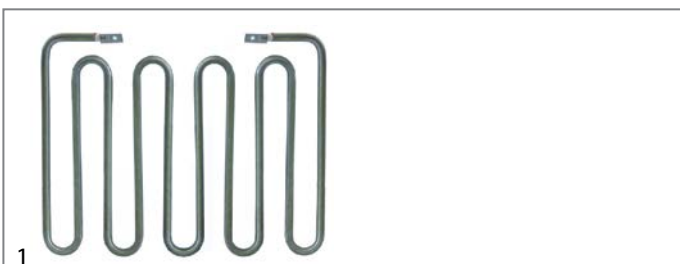
			
GEV No.	416147	Ref. No.	5697
description	heating element 1500W 230V L 180mm W 175mm H 15mm W1 52mm W2 71mm connection length 22mm tube \varnothing 6.3mm windings 5 connection M4 dry heating element		

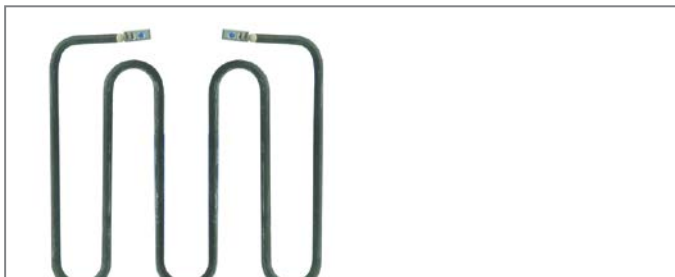
			
GEV No.	416148	Ref. No.	2986
description	heating element 800W 230V heating circuits 1 L 175mm W 180mm H 20mm W1 46mm W2 118mm connection length 23mm tube \varnothing 6.3mm windings 3 connection M4 dry heating element		

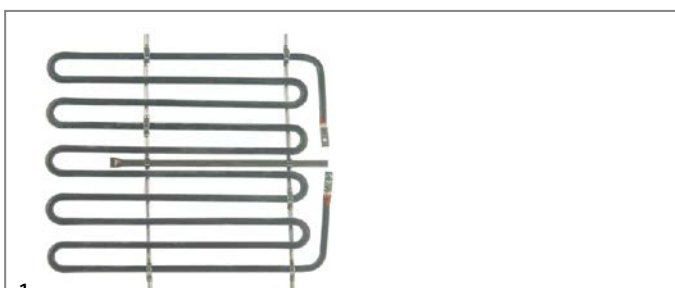
			
GEV No.	416173	Ref. No.	6521
description	heating element 850W 230V heating circuits 1 L 254mm W 202mm H 25mm W1 68mm W2 66mm connection length 23mm tube \varnothing 6.3mm windings 5 connection M4 number of thermostat sleeves 1 thermostat sleeves \varnothing 5mm length thermostat sleeves 195mm bridge length 240mm dry heating element		

accessories

washers

			
GEV No.	560113	Ref. No.	1746 624
description	plain washer ID \varnothing 6.4mm ED \varnothing 12mm thickness 1.6mm SS Qty 20 pcs DIN 125A for thread M6		

sealing washers

graphite gaskets

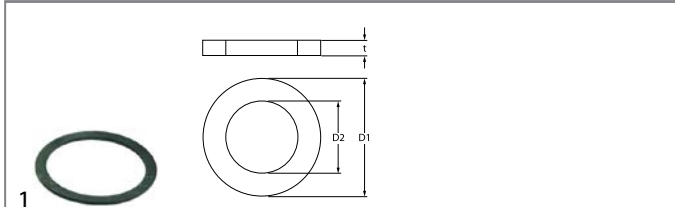
			
GEV No.	528016	Ref. No.	N/A
description	flat gasket graphite ED \varnothing 62mm ID \varnothing 50mm thickness 2mm Qty 1 pcs		



PTFE gaskets

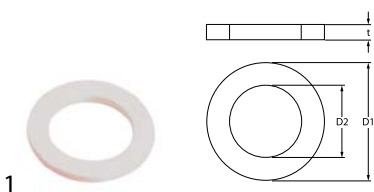

GEV No.	528885	Ref. No.	424
description	flat gasket PTFE ED ø 26mm ID ø 17mm thickness 2mm Qty 1 pcs suitable for SPAZIALE		

O-rings

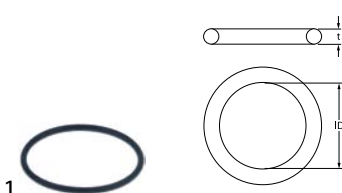

GEV No.	510243	Ref. No.	02418
description	O-ring Viton thickness 3.53mm ID ø 55.56mm Qty 1 pcs		

flange gaskets



GEV No.	528024	Ref. No.	N/A
description	gasket for heating element		



GEV No.	528015	Ref. No.	N/A
description	gasket ID ø 55mm fibre thickness 2mm hole ø 8mm hole distance 62mm suitable for SPAZIALE for heating element coffee machine parts		

thermostats

bi-metal thermostats

safety bi-metal thermostats



GEV No.	390590	Ref. No.	3343
description	bi-metal safety thermostat hole distance 24mm switch-off temp.°C 1NC 1-poleAV connection plug 2 hole fixing		



GEV No.	390709	Ref. No.	6687
description	bi-metal safety thermostat switch-off temp. 180°C 1NC 1-pole 16A connection F6.3 screw mounting thread M4		

control and safety thermostats

EGO

safety thermostats

55.32_ series



GEV No.	390324	Ref. No.	1477
description	safety thermostat switch-off temp. 169°C 3-pole 3NC 20A probe ø 4mm probe L 128mm capillary pipe 890mm capillary pipe isolated 210/210mm gland nut probe SS		

IMIT / TEMPOMATIC / ARTHERMO

control thermostats





GEV No.	390707	Ref. No.	11168 809
description	thermostat t.max. 130°C temperature range°C 1-pole NC 16A probe ø 7mm probe L 90mm capillary pipe 150mm capillary pipe isolatedmm gland nut M14x1 shaft ø 6x4.6mm shaft L 23mm rotation 270°		

switches and momentary switches

rocker/momentary rocker switches

30x11mm



GEV No.	301010	Ref. No.	805	
description	rocker switch mounting measurements 30x11mm red 1NO/indicator light 250V 16A 0-I connection male faston 6.3mm ambient temperature max. 85/125°C protection IP40			
accessories for	301010			
	GEV No.	301035	Ref. No.	—
	protective cover mounting measurements 30x11mm			



30x22mm



1

GEV No.	301001	Ref. No.	804
description	rocker switch mounting measurements 30x22mm red 2NO 250V 16A illuminated 0-I connection male faston 6.3mm ambient temperature max. 125/55°C protection IP65		

accessories for 301001



GEV No.	301036	Ref. No.	—
description	protective cover internal size 30x22mm for rocker switch mounting measurementsmm		

push/momentary push switches

20.6x16.4mm



1

GEV No.	347320	Ref. No.	4953
description	momentary push switch mounting measurements 20.6x16.4mm black 1NO 250V 12A connection male faston 6.3mm ambient temperature max. 85°C protection IP40		

28.5x28.5mm



1

GEV No.	345142	Ref. No.	2942
description	push switch mounting measurements 28.5x28.5mm red/green 2NO 250V 16A cup connection male faston 6.3mm ambient temperature max. 150°C protection IP40 with indicator		



1

GEV No.	347319	Ref. No.	2942
description	push switch mounting measurements 28.5x28.5mm green/red 2NO 250V 16A cup connection male faston 6.3mm ambient temperature max. 150°C protection IP40 with indicator		

spare parts for 347319



GEV No.	345604	Ref. No.	—
description	element holder single mounting measurements 28.5x28.5mm black for push buttons 23x23mm		



GEV No.	345720	Ref. No.	—
description	switch 2NO 250V 16A connection male faston 6.3mm		



GEV No.	346251	Ref. No.	—
description	rotary disc orange/green disc ø 20.6mm		

miscellaneous



1

GEV No.	347321	Ref. No.	5825
description	switch black 1NO 20V 1A momentary connection coded plug ambient temperature max. 85°C		

microswitches

pin-plunger actuated

M10



1

GEV No.	347216	Ref. No.	607
description	microswitch with plunger thread M10x0.75 thread L 14mm 250V 10A 1CO connection male faston 6.3mm stroke 7.5mm mounting distance 22mm L 28mm ambient temperature max. 125°C type NR6K5 actuating force: 260g		



1

GEV No.	345032	Ref. No.	607
description	microswitch with plunger thread M10x1 thread L 12mm 250V 16A 1CO connection male faston 6.3mm stroke 7mm mounting distance 22mm L 28mm ambient temperature max. 125°C type SP9603 actuating force: 180g		

system switches (ROLD)



1

GEV No.	347192	Ref. No.	6619
description	switch 2NO 250V 16A connection male faston 6.3mm		

accessories for 347192



GEV No.	347183	Ref. No.	—
description	push button mounting ø 14.3mm chrome-plated		



float switches

			
1			
GEV No.	347337	Ref. No.	1322
description	float switch thread 1/8" 1NC ø 28mm L 100mm mounting ø 1/8"mm 230V 0.5A plug-in connection cable length 300mm		

rotary switches

GIOVENZANA

rotary switches

			
1			
GEV No.	347323	Ref. No.	503
description	rotary switch 2 0-1 sets of contacts 2 type PO20 690V 20A shaft ø 5x5mm shaft L 28mm shaft square connection screw		

			
1			
GEV No.	347326	Ref. No.	2496
description	rotary switch 2 0-1 sets of contacts 2 type PO20 690V 32A shaft ø 5x5mm shaft L 28mm shaft square connection screw 2 operating positions		

			
1			
GEV No.	347324	Ref. No.	2620
description	rotary switch 2 0-1 sets of contacts 4 type PO20 690V 20A shaft ø 5x5mm shaft L 28mm shaft square connection screw		

			
1			
GEV No.	347325	Ref. No.	5694
description	rotary switch 3 0-1-2 sets of contacts 6 type PO20 690V 20A shaft ø 5x5mm shaft L 23mm shaft square connection screw		

accessories

			
1			
GEV No.	111344	Ref. No.	2421
description	knob zero mark ø 40mm shaftmm shaft diameter 5x5mm		

VM

			
1			
GEV No.	347322	Ref. No.	504
description	rotary switch 0-1 36A shaft L 24mm connection screw 2 operating positions 4-pole CODE P501531 shaft 5x5mm		

accessories

levers

			
1			
GEV No.	111342	Ref. No.	1611 4968 6049
description	lever for rotary switch ON-OFF L 80mm W 32mm aperture 5x5mm black		

magnetic switches

23x14mm

			
1			
GEV No.	347339	Ref. No.	7635
description	magnetic switch L 23mm W 14mm NO connection male faston 2.8mm cable length 250mm		

ø 9mm

			
1			
GEV No.	346107	Ref. No.	2727
description	magnetic switch NO connection male faston 6.3mm cable length 140mm L 31.5mm mounting ø 9mm		



lamps

indicator lights

indicator lights 2-piece (lens and indicator lamp)

indicator light lenses

ø10mm (type SRZ-3)



1

GEV No.	359123	Ref. No.	1113
description	indicator light housings mounting measurements ø10mm green round Qty 1 pcs		
accessories for	359123		
	GEV No.	Ref. No.	—
	359132		
description	indicator lamp green 250V connection male faston 6.3mm protection IP54 ambient temperature max. 85°C		

indicator lamps for socket type SRZ / SDK / SDY / SFK



1

GEV No.	359130	Ref. No.	1112 6593
description	indicator lamp 230V clear connection male faston 6.3mm ø 8mm		



1

GEV No.	359573	Ref. No.	1112 6593
description	indicator lamp 230V connection plug-in connection ø 8mm		

indicator lights (complete)

30x11mm



1

GEV No.	359158	Ref. No.	1096
description	indicator light mounting measurements 30x11mm 230V red connection male faston 6.3mm temp.-resist. 125°C		

relays

level relays

GIEMME



1

GEV No.	402535	Ref. No.	5236
description	level controller 230V 50/60Hz type RL0 2 RELE+LIV/F		



1

GEV No.	402532	Ref. No.	1964
description	level controller 230V type MAGNETIC+AUTOL.		



1

GEV No.	401945	Ref. No.	N/A
description	level relay 230V voltage AC 5A connection male faston 6.3mm type RL1E/2C/F		

probes

producer-specific probes

probes





1

GEV No.	379482	Ref. No.	2817
description	temperature probe NTC 200kOhm cable PTFE probe -40 up to +125°C cable -40 up to +250°C connection coded plug thread probe ø4x30mm cable length 0.14m		



			
1			
GEV No.	402551	Ref. No.	5060
description	temperature probe NTC cable PTFE probe -40 up to +125°C cable -40 up to +250°C connection male faston 2.8mm thread 3/8" probe ø5x10mm cable length 0.1m		

			
1			
GEV No.	379481	Ref. No.	1486 7540
description	temperature probe NTC cable PVC probe -40 up to +110°C cable -10 up to 100°C connection male faston 2.8mm thread probe ø4x30mm cable length 0.15m		

			
1			
GEV No.	379490	Ref. No.	6226
description	temperature probe PTC cable silicone probe -50 up to +150°C cable -50 up to +180°C connection 2-wire thread probe ø6x40mm cable length 1.2m		

Hall sensors

			
1			
GEV No.	402550	Ref. No.	3418
description	Hall sensor L 16mm W 16mm H 10mm for flow meter		

electronics

PCBs

			
1			
GEV No.	402513	Ref. No.	6683
description	display L 150mm W 98mm		

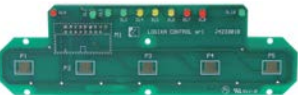
			
1			
GEV No.	402522	Ref. No.	7390
description	keypad PCB L 154mm W 49mm buttons 5		

			
1			
GEV No.	402520	Ref. No.	1485
description	keypad PCB L 31mm W 27mm buttons 1		

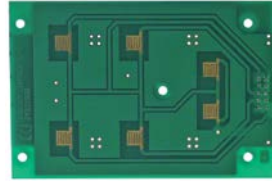
			
1			
GEV No.	402521	Ref. No.	6001
description	keypad PCB L 94mm W 64mm buttons 6		

			
1			
GEV No.	402508	Ref. No.	1561
description	PCB L 100mm W 60mm with button supply 240VAC		

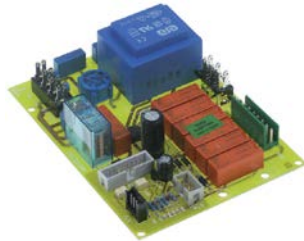
			
1			
GEV No.	402506	Ref. No.	6682
description	PCB L 135mm W 100mm supply 230VAC		

			
1			
GEV No.	402498	Ref. No.	7389
description	PCB L 140mm W 80mm supply 230VAC		



1

GEV No.	402499	Ref. No.	7522
description	PCB L 140mm W 80mm supply 230VAC		



1

GEV No.	402536	Ref. No.	6263
description	PCB L 178mm W 100mm doser supply 230VAC		



1

GEV No.	402493	Ref. No.	1584 1585
description	PCB L 200mm W 100mm for display PCB supply 230VAC		



1

GEV No.	402505	Ref. No.	4850
description	PCB L 200mm W 100mm supply 230VAC		



1

GEV No.	402510	Ref. No.	2948
description	PCB L 80mm W 55mm supply 24VAC		



1

GEV No.	402511	Ref. No.	5067
description	PCB L 80mm W 55mm supply 24VAC		

central units



1

GEV No.	402538	Ref. No.	6381
description	central unit 24V 5A		



1

GEV No.	402512	Ref. No.	4951
description	central unit with display		

dosing electronics

GICAR

group 5



1

GEV No.	403207	Ref. No.	N/A
description	dosing electronics 230V voltage AC 50/60Hz 10A type DOS 30/2GR+LIV		



GIEMME



1			
GEV No.	402533	Ref. No.	2473
description	dosing electronics 230V 50/60Hz 8A type RL0 2GR+RL/F		



1			
GEV No.	402534	Ref. No.	3200
description	dosing electronics 230V 50/60Hz 5-10A type RL2 4GR+RL+THE/F-C		

keypads

front foils



1			
GEV No.	402529	Ref. No.	1518
description	keypad foil coffee machine Super 3000 L 193mm W 60mm buttons 5		



1			
GEV No.	400499	Ref. No.	1521
description	keypad foil L 110mm W 38mm buttons 5		



1			
GEV No.	400500	Ref. No.	2475
description	keypad foil L 110mm W 38mm buttons 5		



1			
GEV No.	402531	Ref. No.	4643
description	keypad foil L 110mm W 38mm buttons 5		



1			
GEV No.	402530	Ref. No.	1519
description	keypad foil L 193mm W 59mm buttons 1		

membrane keypads



1			
GEV No.	403677	Ref. No.	08500
description	membrane keypad for espresso machine S5/S5 COMPACT buttons 5 L 75mm W 32mm		



1			
GEV No.	402523	Ref. No.	5805
description	membrane keypad L 108mm W 48mm		



1			
GEV No.	402524	Ref. No.	6308
description	membrane keypad L 135mm W 100mm		

keypad units



1			
GEV No.	402514	Ref. No.	1605
description	keypad unit buttons 1 lighting red L 70mm W 48mm		



1			
GEV No.	402516	Ref. No.	1598
description	keypad unit buttons 5 L 118mm W 43mm		



1			
GEV No.	402518	Ref. No.	2474
description	keypad unit buttons 5 L 118mm W 43mm		



solenoid valves

solenoid valves (water)

TP

solenoid valves with reducers



1

GEV No.	370427	Ref. No.	3345
description	solenoid valve single angled 230VAC inlet 3/4" outlet 11.5mm input/ min output 1.2l/min DN10 t.max. 90°C TP plastic flow regulating valve outlet dark brown		

metal

ASCO

spare parts and accessories

O-rings



1

GEV No.	371095	Ref. No.	625
description	O-ring Viton thickness 1.78mm ID ø 6.07mm Qty 1 pcs		

LUCIFER

3-way

131F series



1





GEV No.	370053	Ref. No.	628	
description	solenoid valve 3-ways 230VAC DN 2.5mm slide-on receptacle DIN -10 up to 140°C type series 131F coil type DZ06S6 membranes FKM (water/steam) p max 10bar flange 32x32mm			
spare parts for	370053			
	GEV No.	370061	Ref. No.	626
	solenoid valve body LUCIFER-PARKER 3-ways outer cone			
	GEV No.	371031	Ref. No.	—
	solenoid coil LUCIFER-PARKER 230VAC 9VA coil type DZ06S6 seat ø 15mm			
accessories for	370053			
	GEV No.	371090	Ref. No.	—
	power socket plug type DIN 43650A screw			
	GEV No.	371095	Ref. No.	625
	O-ring Viton thickness 1.78mm ID ø 6.07mm Qty 1 pcs			

Table continues overleaf



1

GEV No.	402519	Ref. No.	4848
description	keypad unit buttons 5 L 118mm W 43mm		

accessories



1

GEV No.	402527	Ref. No.	7396
description	buttons strip buttons 5 L 154mm W 31mm		



1

GEV No.	402528	Ref. No.	7397
description	buttons strip buttons 5 L 154mm W 31mm		



1

GEV No.	402526	Ref. No.	7395
description	buttons strip buttons 5 L 156mm W 31mm		



1

GEV No.	402525	Ref. No.	5498
description	buttons strip buttons 5 L 88mm W 64mm		



1

GEV No.	347334	Ref. No.	6297
description	push button external size 28x40mm black		



accessories for 370053			
	GEV No.	371100	Ref. No. —
	O-ring silicone thickness 1.78mm ID ø 6.07mm Qty 1 pcs		

spare parts and accessories

valve bodies

	1		
GEV No.	370061	Ref. No.	626
description	solenoid valve body LUCIFER-PARKER 3-ways outer cone		

ODE

solenoid valves steam (water)

21A series

	1		
GEV No.	370582	Ref. No.	4843
description	solenoid valve brass 2-ways 24VAC inlet 1/4" outlet 1/4" connection 1/4" L 40mm DN 5.5mm -10 up to 140°C ODE coil type BDA membranes FKM (water/steam) p max 3bar 50/60Hz		

31A1 series

	1		
GEV No.	370583	Ref. No.	1379
description	solenoid valve brass 3-ways 24VAC DN 1.5mm -10 up to 140°C ODE type series 31A1 coil type BDA membranes ruby p max 15bar p min 0bar flange 32x32mm 24V voltage AC		



PARKER

2-way

7121 series

	1		
GEV No.	370584	Ref. No.	907
description	solenoid valve SS 230VAC inlet 1/8" outlet 1/8" connection 1/8" DN 1.5mm coil type BDA p max 15bar 50Hz inlet 1/8"mm		

E-146 series

	1		
GEV No.	370067	Ref. No.	6478
description	solenoid valve 2-ways 230VAC connection 1/4" L 40mm DN 3mm slide-on receptacle DIN -20° up to 130°C PARKER type series VE-146 coil type ZB09 membranes FKM (water) p max 7bar		
spare parts for	370067		
	GEV No.	371029	Ref. No. —
	solenoid coil PARKER 230VAC 9VA coil type ZB09 seat ø 14mm H 33mm W 34mm D 43mm		
accessories for	370067		
	GEV No.	371090	Ref. No. —
	power socket plug type DIN 43650A screw		

Solenoid valve - accessories

	1		
GEV No.	371095	Ref. No.	625
description	O-ring Viton thickness 1.78mm ID ø 6.07mm Qty 1 pcs		

electrodes

	1		
GEV No.	402554	Ref. No.	6357
description	level electrode 1/4" total length 105mm probe L 87mm insulated probe length 74mm connection curved ø 3mm		

	1		
GEV No.	402555	Ref. No.	7852
description	level electrode 1/4" total length 130mm probe L 110mm insulated probe length 105mm connection curved ø 3mm		

	1		
GEV No.	400020	Ref. No.	911
description	level electrode 1/4" total length 150mm probe L 124mm insulated probe length 26mm connection male faston 6.3mm stainless steel ø 2.5mm		



			
1			
GEV No.	402553	Ref. No.	911
description	level electrode 1/4" total length 155mm probe L 136mm insulated probe length 124mm connection curved \varnothing 3mm		

			
1			
GEV No.	402556	Ref. No.	6368
description	level electrode total length 303mm connection curved SS \varnothing 3mm		

flow meters and flow sensors

flow meters



miscellaneous

			
1			
GEV No.	402542	Ref. No.	2498
description	flow meter thread 1/4" SS		

			
1			
GEV No.	402550	Ref. No.	3418
description	Hall sensor L 16mm W 16mm H 10mm for flow meter		

pumps

pumps for ice machines

			
1			
GEV No.	500161	Ref. No.	2980
description	pump REBO type NR40 55W 230V 50Hz outlet \varnothing 17mm L 110mm rotation direction left for ice-cube maker		
spare parts for	500161		
	GEV No.	500970	Ref. No. —
	pump motor 55W 230V 50Hz REBO L 205mm type outlet \varnothing 17mm suitable for for ice maker		

fuses

fine fuses

			
1			
GEV No.	358605	Ref. No.	6249
description	fine fuse size \varnothing 5x20mm 3.15A slow-acting rated 250V Qty 10 pcs		

equipment-specific units

for bar blender

blenders

jar components

blades

blades with adaptor (complete)

			
1			
GEV No.	696742	Ref. No.	C0007F305
description	slicing unit \varnothing 52mm P100/P102/P103/P105		



for ice-cube maker

drain systems

overflow pipes

			
1			
GEV No.	695083	Ref. No.	6120
description	overflow pipe ID ø 22mm D1 ø 27mm D2 ø 19mm L 144mm		

for espresso machines

fascias

			
1			
GEV No.	692672	Ref. No.	01591
description	side panel L 180mm H 67mm D 30 mounting pos. left Super 3000		

			
1			
GEV No.	692673	Ref. No.	01592
description	side panel L 180mm H 67mm D 30 mounting pos. right Super 3000		



filter holders



filter holders standard

filter holder without spout

			
1			
GEV No.	525986	Ref. No.	N/A
description	filter holder suitable for SPAZIALE without outlet mounting ø 76mm outlet 3/8" ID ø 56mm wedge high 12mm wedge position horizontal number of wedges 2 lever straight		

filter holders short

			
1			
GEV No.	525165	Ref. No.	2891
description	filter holder mounting ø 76mm outlet 3/8" ID ø 56mm handle M12x1.25 wedge high 12mm wedge position horizontal number of wedges 2 lever straight chrome-plated brass		
accessories for	525165		
	GEV No.	525127	Ref. No.
			4962
			
	handle ø 25mm thread M12x1.25 thread L 12mm L 122mm black thermoplastic		

			
1			
GEV No.	529060	Ref. No.	N/A
description	filter holder mounting ø 76mm outlet 3/8" ID ø 56mm handle M12x1.75 wedge high 12mm wedge position horizontal number of wedges 2 lever straight chrome-plated brass		
accessories for	529060		
	GEV No.	529045	Ref. No.
			—
			
	handle ø 35mm thread M12x1.75 thread L 15mm L 125mm black		

handles

with external thread

			
1			
GEV No.	525127	Ref. No.	4962
description	handle ø 25mm thread M12x1.25 thread L 12mm L 122mm black thermoplastic		

sleeves

			
1			
GEV No.	525139	Ref. No.	4961 9924
description	sleeve ø 36mm L 38mm black		

filters

for 1 cup

			
1			
GEV No.	525156	Ref. No.	1945
description	coffee filter ø 65mm mounting ø 55mm H 23.3mm cups 1 amount of coffee 6g		

			
1			
GEV No.	529029	Ref. No.	646
description	coffee filter ø 65mm mounting ø 55mm H 25mm cups 1 amount of coffee 7g		

for 2 cups



1			
GEV No.	525155	Ref. No.	1943
description	coffee filter ø 65mm mounting ø 55mm H 25.7mm cups 2 amount of coffee 12g		



1			
GEV No.	529030	Ref. No.	645
description	coffee filter ø 65mm mounting ø 55mm H 27.5mm cups 2 amount of coffee 14g		

blind filters



1			
GEV No.	529064	Ref. No.	647
description	blind filter ø 65mm mounting ø 55mm H 25mm		

filter holder springs



1			
GEV No.	529065	Ref. No.	649 7051
description	filter holder spring L 70mm W 60mm wire gauge ø 1.1mm for espresso filter holder		

brewing units

shower screens

2-piece



1			
GEV No.	529090	Ref. No.	2908+2909
description	shower screen ø 51.6/49.1mm H 3.6/2.3mm hole ø 5.5mm 2-piece		

filter holder gaskets

flat

standard



1			
GEV No.	528086	Ref. No.	1939
description	filter holder gasket D1 ø 64.5mm D2 ø 52.5mm H 6.3mm Qty 1 pcs		



1			
GEV No.	528041	Ref. No.	1968
description	filter holder gasket D1 ø 64.5mm D2 ø 52.5mm H 6.65mm		

brewing units manual

components

levers

accessories



1			
GEV No.	525151	Ref. No.	618
description	bolt with ball ø 6mm L 12mm		

magnets



1			
GEV No.	525122	Ref. No.	614
description	magnet thread M5 for solenoid valve H 23mm ED ø 49mm ID ø 15mm		



components

nozzles

without thread

			
1			
GEV No.	525121	Ref. No.	276
description	nozzle bore \varnothing 0.57mm \varnothing 5mm D1 \varnothing 6.5mm L 10mm		

			
1			
GEV No.	528888	Ref. No.	276
description	nozzle bore \varnothing 0.65mm \varnothing 5mm D1 \varnothing 6.5mm L 10mm		

gaskets

			
1			
GEV No.	529190	Ref. No.	1631
description	O-ring Viton thickness 2.62mm ID \varnothing 31.42mm Qty 1 pcs		

safety valves

safety valves

1/2"			
			
1			
GEV No.	525125	Ref. No.	1932
description	safety valve connection 1/2" triggering pressure 1.7bar approval CE 0036 sealed		

3/8"

			
1			
GEV No.	529312	Ref. No.	381
description	safety valve connection 3/8" triggering pressure 1.8bar		

expansion valves

with hose connection

			
1			
GEV No.	525123	Ref. No.	288
description	expansion valve T1: 1/4" ET hose \varnothing 6.5mm total length 78mm		

			
1			
GEV No.	525124	Ref. No.	1626
description	expansion valve T1: 1/4" ET hose \varnothing 9mm total length 78mm		

compression springs

			
1			
GEV No.	525118	Ref. No.	292
description	compression spring \varnothing 14.3mm L 30.5mm wire gauge \varnothing 2mm		

drain pans

			
1			
GEV No.	525157	Ref. No.	1590
description	drain pan L 100mm W 72mm H 75mm hose \varnothing 10/16mm hose length 20/25mm		

aerators and air bleeders

			
1			
GEV No.	527981	Ref. No.	508
description	aerator and air bleeder connection 1/4"		

steam/water taps

steam/water taps

steam/water taps

			
1			
GEV No.	525126	Ref. No.	217
description	steam/water tap inlet 1/4" outlet 3/8" shaft 5x7 shaft L 6mm brass		



1			
GEV No.	529610	Ref. No.	216
description	steam/water tap inlet 3/8" outlet 3/8" shaft 5x7 shaft L 6mm brass		

steam taps

miscellaneous



1			
GEV No.	525154	Ref. No.	233
description	disc ø 8mm thickness 1mm		

steam/water pipes

steam pipes



1			
GEV No.	529613	Ref. No.	1838
description	steam pipe mounting pos. left		



1			
GEV No.	525133	Ref. No.	7546
description	steam pipe mounting pos. left thread 3/8" H 160mm tube ø 8mm chrome-plated brass		



1			
GEV No.	525132	Ref. No.	4832
description	steam pipe mounting pos. left thread 3/8" H 180mm tube ø 8mm chrome-plated brass		



1			
GEV No.	525116	Ref. No.	1838
description	steam pipe mounting pos. left thread 3/8" H 210mm tube ø 8mm chrome-plated brass		



1			
GEV No.	525131	Ref. No.	4831
description	steam pipe mounting pos. right thread 3/8" H 180mm tube ø 8mm chrome-plated brass		



1			
GEV No.	525117	Ref. No.	1839
description	steam pipe mounting pos. right thread 3/8" H 210mm tube ø 8mm chrome-plated brass		



1			
GEV No.	529612	Ref. No.	1839
description	steam pipe mounting pos. right thread 3/8" H 210mm tube ø 8mm chrome-plated brass		



1			
GEV No.	525159	Ref. No.	7832
description	steam pipe thread 3/8" H 160mm tube ø 10mm SS		





1			
GEV No.	525158	Ref. No.	6591
description	steam pipe thread 3/8" H 170mm tube ø 10mm SS		





1			
GEV No.	525130	Ref. No.	4473
description	steam pipe thread 3/8" H 180mm tube ø 10mm SS		





			
1			
GEV No.	525129	Ref. No.	825
description	steam pipe thread 3/8" H 210mm tube ø 8mm chrome-plated brass		

water pipes			
			
1			
GEV No.	525128	Ref. No.	2686
description	water pipe thread 3/8" ø 25mm L 87mm tube ø 12mm WS 20 chrome-plated brass		

accessories			
bushes			
			
1			
GEV No.	529705	Ref. No.	7579
description	bush D1 ø 8.3mm D2 ø 12mm H 6mm brass ID ø 7mm		

gaskets			
			
1			
GEV No.	528402	Ref. No.	807
description	O-ring Viton thickness 2.62mm ID ø 10.78mm Qty 1 pcs		

springs			
			
1			
GEV No.	525162	Ref. No.	5327
description	compression spring ø 11.5mm L 19mm wire gauge ø 1.7mm stainless steel		

			
1			
GEV No.	529704	Ref. No.	7568
description	compression spring ø 11.8mm L 16mm wire gauge ø 1.6mm steel		

miscellaneous			
			
1			
GEV No.	528898	Ref. No.	523
description	plain washer ID ø 11.2mm ED ø 14.8mm thickness 1mm SS		

union nuts			
			
1			
GEV No.	528899	Ref. No.	524
description	union nut thread 3/8" L 22mm hole ø 12mm brass		

fine filters			
			
1			
GEV No.	525161	Ref. No.	2284
description	fine filter flat fabric ø 8mm H 1.5mm		

			
1			
GEV No.	528889	Ref. No.	275
description	fine filter flat with rim ø 7mm		

intake valves			
accessories			
levers			
			
1			
GEV No.	111343	Ref. No.	1837
description	lever thread M8 ø 18/22mm plastic		

level glasses

level glasses

gaskets



1

GEV No.	529427	Ref. No.	266
description	gasket D1 ø 13mm D2 ø 17.5mm ID ø 11mm H 9mm rubber water level glass suitable for PAVONI		



1

GEV No.	525164	Ref. No.	265
description	gasket D1 ø 14mm D2 ø 17mm ID ø 10.78mm H 9mm silicone		



1

GEV No.	525163	Ref. No.	266
description	gasket D1 ø 14mm D2 ø 17mm ID ø 10.8mm H 9mm Viton		

level glass pipes



1

GEV No.	529404	Ref. No.	267 268
description	water level tube ø 11mm H 150mm ID ø 8mm		



1

GEV No.	529405	Ref. No.	267 268
description	water level tube ø 11mm H 150mm ID ø 8mm		

non-return valves

gaskets



1

GEV No.	528425	Ref. No.	290
description	gasket D1 ø 14.9mm D2 ø 6mm total length 8.9mm L1 4mm L2 4.9mm		

compression springs



1

GEV No.	525119	Ref. No.	279
description	compression spring ø 8mm L 28mm wire gauge ø 0.4mm		

pistons



1

GEV No.	528886	Ref. No.	280
description	valve triangular ø 12mm L 22mm		

for coffee grinders

grinding burrs

grinding burrs conical



1

GEV No.	527705	Ref. No.	8785 C0004M122B
description	grinding burrs pair turn direction right D1 ø 63mm D2 ø 40mm H 23.5mm shaft ø 13mm		

knobs

steam/water taps

steam/water taps



1

GEV No.	525134	Ref. No.	249
description	turning handle ø 33mm shaft ø 6.5x8mm black		



1			
GEV No.	525136	Ref. No.	1558
description	turning handle ø 46mm shaft ø 6.5x8mm black		

1			
GEV No.	525137	Ref. No.	4963
description	turning handle ø 47mm shaft ø 6.5x8mm black		

1			
GEV No.	525135	Ref. No.	6037
description	turning handle steam ø 52mm black		

knob dial plates

1			
GEV No.	525141	Ref. No.	6039
description	clamping ring for handle ø 22.4mm L 11mm black		

1			
GEV No.	525140	Ref. No.	5124
description	ring for tap ø 38mm L 13mm black		

1			
GEV No.	525138	Ref. No.	4959
description	sleeve ø 53mm L 25mm black		

1			
GEV No.	525144	Ref. No.	3063
description	symbol level ø 40mm L 16.5mm		

1			
GEV No.	525115	Ref. No.	244
description	symbol steam ø 19mm		

1			
GEV No.	525142	Ref. No.	3061
description	symbol steam ø 40mm L 16.5mm black/gold		

1			
GEV No.	525145	Ref. No.	4960
description	symbol steam ø 47mm L 26.5mm black/gold		

1			
GEV No.	525143	Ref. No.	3062
description	symbol water ø 40mm L 16.5mm		

handles and hand wheels

cylindrical handles

fixed

1			
GEV No.	525160	Ref. No.	4916
description	cylindrical handle thread M6 bore ø conical 12mm ø 18mm L 40mm thermoplastic		

levers

with handle

1			
GEV No.	111343	Ref. No.	1837
description	lever thread M8 ø 18/22mm plastic		

lever handles

1			
GEV No.	525160	Ref. No.	4916
description	cylindrical handle thread M6 bore ø conical 12mm ø 18mm L 40mm thermoplastic		

gaskets

O-rings

EPDM

1

GEV No.	529545	Ref. No.	5328
description	O-ring EPDM thickness 1.78mm ID ø 10.82mm Qty 1 pcs		

1

GEV No.	528485	Ref. No.	586
description	O-ring EPDM thickness 1.78mm ID ø 6.07mm Qty 1 pcs		

1

GEV No.	529412	Ref. No.	1472
description	O-ring EPDM thickness 2.62mm ID ø 10.78mm Qty 1 pcs		

1

GEV No.	525608	Ref. No.	7580
description	O-ring EPDM thickness 2.7mm ID ø 12.1mm		

1

GEV No.	361080	Ref. No.	08289
description	O-ring EPDM thickness 2mm ID ø 16mm Qty 1 pcs		

1

GEV No.	361085	Ref. No.	281
description	O-ring EPDM thickness 2mm ID ø 8mm Qty 1 pcs		

silicone

1

GEV No.	528222	Ref. No.	1470
description	O-ring silicone thickness 2.62mm ID ø 10.78mm Qty 1 pcs		

Viton

1

GEV No.	528833	Ref. No.	1470
description	O-ring Viton thickness 1.78mm ID ø 11.11mm Qty 1 pcs		

1

GEV No.	528687	Ref. No.	219
description	O-ring Viton thickness 1.78mm ID ø 3.69mm Qty 1 pcs		

1

GEV No.	371095	Ref. No.	625
description	O-ring Viton thickness 1.78mm ID ø 6.07mm Qty 1 pcs		

1

GEV No.	528282	Ref. No.	281
description	O-ring Viton thickness 1.78mm ID ø 7.66mm Qty 1 pcs		

1

GEV No.	528246	Ref. No.	1469
description	O-ring Viton thickness 1.78mm ID ø 8.73mm Qty 1 pcs		



1		
	GEV No. 528402	Ref. No. 807
description O-ring Viton thickness 2.62mm ID ø 10.78mm Qty 1 pcs		

1		
	GEV No. 525147	Ref. No. 4553
description O-ring Viton thickness 3.53mm ID ø 142.5mm Qty 1 pcs		

1		
	GEV No. 528291	Ref. No. 1472
description O-ring Viton thickness 2.62mm ID ø 11.91mm Qty 1 pcs		

1		
	GEV No. 510243	Ref. No. 02418
description O-ring Viton thickness 3.53mm ID ø 55.56mm Qty 1 pcs		

1		
	GEV No. 528647	Ref. No. 1468
description O-ring Viton thickness 2.62mm ID ø 15.08mm Qty 1 pcs		

miscellaneous		
1		
	GEV No. 525608	Ref. No. 7580
description O-ring EPDM thickness 2.7mm ID ø 12.1mm		

1		
	GEV No. 528293	Ref. No. 1471
description O-ring Viton thickness 2.62mm ID ø 15.88mm Qty 1 pcs		

sealing washers

fibre gaskets		
1		
	GEV No. 525149	Ref. No. 899
description flat gasket fibre ED ø 93mm ID ø 81mm thickness 2mm for boiler Qty 1 pcs		

1		
	GEV No. 532560	Ref. No. 225
description O-ring Viton thickness 2.62mm ID ø 20.63mm Qty 1 pcs		

graphite gaskets

1		
	GEV No. 528016	Ref. No. N/A
description flat gasket graphite ED ø 62mm ID ø 50mm thickness 2mm Qty 1 pcs		

1		
	GEV No. 529190	Ref. No. 1631
description O-ring Viton thickness 2.62mm ID ø 31.42mm Qty 1 pcs		

PTFE gaskets

1		
	GEV No. 528885	Ref. No. 424
description flat gasket PTFE ED ø 26mm ID ø 17mm thickness 2mm Qty 1 pcs suitable for SPAZIALE		

1		
	GEV No. 525146	Ref. No. 7418
description O-ring Viton thickness 2.62mm ID ø 42.52mm Qty 1 pcs		

			
1			
GEV No.	528683	Ref. No.	225
description	flat gasket PTFE ED ø 26mm ID ø 21mm thickness 2mm Qty 1 pcs suitable for GAGGIA, SPAZIALE		

			
1			
GEV No.	528131	Ref. No.	405
description	flat gasket PTFE ED ø 52mm ID ø 40mm thickness 2mm Qty 1 pcs		

			
1			
GEV No.	528149	Ref. No.	405
description	flat gasket PTFE ED ø 85mm ID ø 72mm thickness 2mm Qty 1 pcs suitable for SPAZIALE		

Viton gaskets

			
1			
GEV No.	528686	Ref. No.	00221
description	gasket Viton ED ø 15mm ID ø 6mm thickness 3.5mm Qty 1 pcs		

special gaskets

group gaskets

			
Image not available			
1			
GEV No.	528147	Ref. No.	N/A
description	group gasket		

			
1			
GEV No.	525148	Ref. No.	485
description	gasket ED ø 34mm ID ø 18mm H 6.3mm		

springs

compression springs

			
1			
GEV No.	525162	Ref. No.	5327
description	compression spring ø 11.5mm L 19mm wire gauge ø 1.7mm stainless steel		

			
1			
GEV No.	529704	Ref. No.	7568
description	compression spring ø 11.8mm L 16mm wire gauge ø 1.6mm steel		

			
1			
GEV No.	525118	Ref. No.	292
description	compression spring ø 14.3mm L 30.5mm wire gauge ø 2mm		

			
1			
GEV No.	525120	Ref. No.	223
description	compression spring ø 14.4mm L 26mm wire gauge ø 1.8mm		

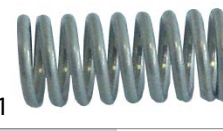
			
1			
GEV No.	528684	Ref. No.	223
description	compression spring ø 14.5mm L 33mm wire gauge ø 2.1mm		

			
1			
GEV No.	528475	Ref. No.	292
description	compression spring ø 14.7mm L 33mm wire gauge ø 2mm		



			
1			
GEV No.	528257	Ref. No.	522
description	compression spring ø 15mm L 17mm wire gauge ø 1.8mm		

			
1			
GEV No.	528894	Ref. No.	1624
description	compression spring ø 21.7mm L 40mm wire gauge ø 1.3mm		

			
1			
GEV No.	528887	Ref. No.	1625
description	compression spring ø 6.5mm L 13mm wire gauge ø 0.9mm		

			
1			
GEV No.	525119	Ref. No.	279
description	compression spring ø 8mm L 28mm wire gauge ø 0.4mm		

			
1			
GEV No.	528392	Ref. No.	279
description	compression spring ø 8mm L 29mm wire gauge ø 0.5mm		

manometers

			
1			
GEV No.	541735	Ref. No.	1481
description	manometer double scale ø 58mm pressure range 0-2.5 / 0-15bar connection on the backside thread 1/8"		

			
1			
GEV No.	541737	Ref. No.	5044
description	manometer double scale ø 58mm pressure range 0-2.5 / 0-15bar connection on the backside thread 1/8"		

			
1			
GEV No.	541233	Ref. No.	N/A
description	manometer double scale ø 60mm pressure range 0-2.5 / 0-15bar connection on the backside thread 1/8"		

			
1			
GEV No.	541287	Ref. No.	N/A
description	manometer double scale ø 60mm pressure range 0-2.5 / 0-15bar connection on the backside thread 1/8"		

			
1			
GEV No.	541410	Ref. No.	N/A
description	manometer double scale ø 60mm pressure range 0-2.5 / 0-15bar connection on the backside thread 1/8"		

			
1			
GEV No.	541222	Ref. No.	N/A
description	manometer double scale ø 60mm pressure range 0-2.5 / 0-16bar connection on the backside thread 1/8"		

			
1			
GEV No.	541226	Ref. No.	N/A
description	manometer double scale ø 60mm pressure range 0-2.5 / 0-16bar connection on the backside thread 1/8"		

			
1			
GEV No.	541227	Ref. No.	N/A
description	manometer double scale ø 60mm pressure range 0-2.5 / 0-16bar connection on the backside thread 1/8"		



1

GEV No.	541224	Ref. No.	N/A
description	manometer double scale ø 63mm pressure range 0-2.5 / 0-15bar connection on the backside thread 1/8"		



1

GEV No.	541740	Ref. No.	6738
description	manometer ø 42mm pressure range 0-16bar thread 1/8" connection on the backside		



1

GEV No.	541739	Ref. No.	6237
description	manometer ø 42mm pressure range 0-2.5bar thread 1/8" connection on the backside		



1

GEV No.	541741	Ref. No.	6737
description	manometer ø 43mm pressure range 0-2.5bar thread 1/8" connection on the backside		



1

GEV No.	541738	Ref. No.	2047
description	manometer ø 58mm pressure range 0-2.5bar connection on the backside marking 1.35-2.5 thread 1/4"		

fastening material

screws

hexagonal screws



1

GEV No.	560274	Ref. No.	643
description	hexagonal screw thread M5 thread L 25mm SS WS 8 without pole Qty 20 pcs DIN 933 / ISO 4017		

cylinder head bolts

DIN 912/ISO 4762



1

GEV No.	560025	Ref. No.	669
description	cylinder head bolt thread M4 thread L 10mm WS 3 SS Qty 20 pcs DIN 912/ISO 4762		

nuts

wing nuts



1

GEV No.	560147	Ref. No.	4939
description	wing nuts thread M6 SS DIN/ISO DIN 315 Qty 20 pcs		

hexagonal nuts

hexagonal nuts inch thread



1

GEV No.	503045	Ref. No.	07063
description	nut thread 1/4" H 4.5mm brass WS 17 Qty 1 pcs		

washers

washers

DIN 125A





1

GEV No.	560113	Ref. No.	1746 624
description	plain washer ID ø 6.4mm ED ø 12mm thickness 1.6mm SS Qty 20 pcs DIN 125A for thread M6		



miscellaneous			
			
1			
GEV No.	528898	Ref. No.	523
description	plain washer ID ø 11.2mm ED ø 14.8mm thickness 1mm SS		

			
1			
GEV No.	560413	Ref. No.	241
description	plain washer ID ø 17mm ED ø 25mm thickness 0.8mm SS		



			
1			
GEV No.	560412	Ref. No.	1131
description	plain washer ID ø 5mm ED ø 8mm thickness 1mm brass		

fasteners

retaining rings

DIN 472

			
1			
GEV No.	525153	Ref. No.	487
description	retaining ring bore ø 32mm thickness 1.1mm DIN 472		

DIN 6799			
 			
1			
GEV No.	518557	Ref. No.	634
description	retaining ring E D1 ø 5mm D2 ø 11mm SS DIN 6799 thickness 0.7mm		

consumables

fuses

fine fuses

			
1			
GEV No.	358605	Ref. No.	6249
description	fine fuse size ø5x20mm 3.15A slow-acting rated 250V Qty 10 pcs		

B			
bi-metal thermostats	5	retaining rings	27
C		rocker/momentary rocker switches	5
consumables	27	rotary switches	7
control thermostats	5	S	
cylinder head bolts	26	safety bi-metal thermostats	5
E		safety thermostats	5
electrodes	13	screws	26
F		sealing washers	23
fasteners	27	solenoid valves	12
fastening material	26	switches and momentary switches	5
fine fuses	27	system switches (ROLD)	6
float switches	7	T	
flow meters	14	thermostats	5
fuses	14, 27	W	
H		washers	26
Hall sensors	9	wing nuts	26
heating elements	3		
heating elements for coffee machine	3		
heating elements for contact grills	4		
hexagonal nuts	26		
hexagonal screws	26		
I			
indicator lights	8		
indicator lights (complete)	8		
L			
lamps	8		
M			
magnetic switches	7		
microswitches	6		
N			
nuts	26		
O			
O-rings	22		
P			
probes	8		
pumps	14		
pumps for ice machines	14		
push/momentary push switches	6		
R			
relays	8		